

Report of the Energy Survey of India Committee



सत्यमेव जयते

**Government of India,
New Delhi, India
1965**

Energy Survey of India

Report of the Energy Survey of India Committee



**Government of India,
New Delhi, India
1965**



PC. 119
8000

Price:

Printed by the General Manager,
Government of India Press,
New Delhi. 1965

CONTENTS

		Paragraph Beginning	Page
FOREWORD			
PREFACE			
ABBREVIATIONS AND EQUIVALENTS			1
CHAPTER 1 Terms of Reference			3
CHAPTER 2 The Energy Problems of India	1		5
CHAPTER 3 Recent Trends of Energy Consumption	23		9
CHAPTER 4 Estimates of Future Demands	42		19
CHAPTER 5 Forecasts Based on Sectoral Projections, Transport	55		23
CHAPTER 6 Forecasts Based on Sectoral Projections, Industry	80		35
CHAPTER 7 Energy Use in Agriculture	137		57
CHAPTER 8 The Domestic Sector	144		61
CHAPTER 9 Final Estimates of Demands	194		75
CHAPTER 10 The Regional Distribution of Demands	213		85
CHAPTER 11 Problems of Coal Supplies	220		95
CHAPTER 12 Problems of Oil Supplies	267		113
CHAPTER 13 Problems of Electricity Supplies	292		121
CHAPTER 14 Capital Investment in Energy	420		147
CHAPTER 15 The Pricing of Energy	442		155
CHAPTER 16 Summary and Conclusions	476		161
ANNEX 1 Statistical Note on Domestic Consumption			167
ANNEX 2 An Examination of the Development of General Facilities by Regions, By A.E. Bush			173
ANNEX 3 India's Hydro-Electric Resources			185
ANNEX 4 Basic Energy Statistics in Original Units			215
ANNEX 5 Basic Energy Statistics in Coal Replacement Units			321
ANNEX 6 Basic Energy Statistics in Kilocalories			389

FOREWORD

This report represents the results of the first official Energy Survey of India. It has been apparent for some time that an adequate supply of energy would be a key factor and play an important role in the national development of the country. Any shortage of energy will hold up the national planned economic growth. During the year 1962 and later, the matter became one of increasing concern to the Government of India. At the same time, the requirements of the development of national power resources had come to form an increasingly large part of India's requests for foreign aid. In consultation with Mr. Tyler Wood of the United States AID Mission, Mr. C.S. Krishnamurthy, then of the Indian Embassy in Washington, and on the advice of Mr. Walker Cisler of the Detroit Edison Company, Detroit, U.S.A., whose interest in these problems is well-known, it was agreed that a survey of the energy resources of India and her prospective needs would be of great advantage. It was considered that the purpose of the survey would be to take a long term view of the probable demands and to suggest how best the resources could be developed sufficiently in advance so as to eliminate any shortfalls and to help planned development.

2. Accordingly, the Government of India appointed a Committee to undertake the Energy Survey of India. With the help of Mr. Tyler Wood and Mr. Walker Cisler, the assistance of a group of foreign experts was secured, who like Mr. Cisler himself had been concerned in making a similar study for the Organisation for Economic Cooperation and Development of the energy problems of Europe under the Chairmanship of Professor Austin Robinson of the University of Cambridge, England. Mr. Cisler and Mr. Desrousseaux, who had been members of the (European) Energy Advisory Commission, and Mr. Laading, who has been Secretary of the (European) Energy Advisory Commission, were also associated with the Study, besides Mr. L. de Heem of Belgium, who has had vast experience of similar work in the field of electricity. Professor Austin Robinson has had to pay repeated visits to India and organise studies and discussions and on him has fallen the main burden of writing the report. To these foreign experts, we are deeply indebted for the time and trouble that they have devoted to the questions connected with India's energy studies, and the wide experience that they have brought to bear on the problems involved. We are grateful to the United States Agency for International Development and the United Kingdom Colombo Plan, which helped in making available their services as well as for rendering all possible assistance and help during various stages of the study.

Associated with the foreign experts have been a group of Indian specialists covering all aspects both

of the problems of Indian development and of energy supplies and collectively equipped to take a wide and an authoritative view of the energy problems of India, both in the public and the private sectors. To them equally our thanks are due for the time and trouble that they have devoted to the study of these important and difficult problems.

3. The work of the Energy Survey Committee inevitably involved a vast amount of technical and statistical preparation. Fortunately, for this, we were able to rely on a team of enthusiastic and devoted workers under the leadership of Mr. Bush and Mr. Tauber of The Detroit Edison Company, whose services Mr. Walker Cisler and the United States Agency for International Development had very kindly made available to us. They devoted more than a year of continuous work to the preparatory studies, which underlie the report and without their help throughout, the report could not possibly have been completed. They were assisted by a staff of Indian specialists, who have done an admirable job of work in setting in order the statistics of energy production and consumption in India.

4. This being the first study of its kind undertaken in India, and in the absence of further studies and researches, which would have entailed much more time than was available to us and as such not practicable, some assumptions have had to be made in some cases. Such assumptions have, however, been reasonable in the circumstances and have, in the absence of detailed statistics, helped to establish orders of magnitude. We trust that such studies and researches will be taken up and the available statistics improved upon and brought up to date in the years to come. I am happy to note that the Planning Commission have accepted the responsibility for ensuring that such researches and studies are carried out. Prof. M. S. Thacker, Member, Planning Commission, who has already been associated with these studies and the preparation of this report, has kindly agreed to supervise this work in the Planning Commission.

5. The Committee has received very valuable cooperation in the collection of data and statistics from various agencies and is grateful for such assistance to the Planning Commission, the Central Statistical Office, various Ministries of the Govt. of India and their attached offices dealing with the different energy resources: in particular the Central Water and Power Commission; the Coal Board; the Coal Commissioner's office; the Central Fuel Research Institute; the Atomic Energy Commission; the Steel Plants; the Oil and Natural Gas Commission; the Oil Companies; the Indian Institute of Petroleum; the Railway Board; the National Minerals Development Corporation; the National Council of Applied Economic

Research; the State Governments and Electricity Boards; Corporate Institutions and other industrial establishments. We are also grateful to the World Bank Mission for all their help.

6. I am of the view that this study has made a very valuable contribution to the planning of energy development in India. For the first time we have been enabled to see the problems of energy as a whole and the full implications - to take only two of the development examples - of steel, with the consequential growth of surplus by-product coals for the most economical generation of electricity, or those of the

probably impending shortages of firewood on the provision of new forms of domestic energy. I trust that the report will not only be useful to the Government of India, but also to all those concerned with the problems of speeding up India's economic development.

Panjim, Goa
Dated: 30th June 1964

M. R. Sachdev
CHAIRMAN
ENERGY SURVEY COMMITTEE

PREFACE

This report had been completed in draft before the sad death of Shri M.R. Sachdev. The foreword had been written by him in his own words and admirably states the problems that the Energy Survey of India Committee was appointed to examine and solve. Though he did not live to see the final completion of the report and its signature, we think that his foreword should remain as he wrote it. To the work of this Committee he devoted much time, energy and patience. We hope that the report may in some respects represent a memorial to his devotion to these among many aspects of the problems of Indian development, and to his wisdom and far-sightedness in solving them.

M. S. Thacker
Chairman

Walker Cisler
Joint Chairman

Austin Robinson
Joint Chairman

ABBREVIATIONS AND EQUIVALENTS

ABBREVIATIONS

AID	- Agency for International Development (USA)
BFG	- Blast Furnace gas
CFRI	- Central Fuel Research Institute (India)
CWPC	- Central Water & Power Commission (India)
DVC	- Damodar Valley Corporation (India)
EHV	- Extra high voltage (above 220,000 volts)
HSDO	- High speed diesel oil
hydel	- Hydro-electric
IIP	- Indian Institute of Petroleum (India)
IISCO	- Indian Iron & Steel Co. (India)
LDO	- Light diesel oil
LPG	- Liquid petroleum gas
mtCR	- Million tonnes of coal replacement
N	- Nitrogen
NCAER	- National Council of Applied Economic Research (India)
NH ₃	- Ammonia
NMDC	- National Minerals Development Corporation (India)
OECD	- Organisation for Economic Cooperation & Development (W. Europe)
OEEC	- Organisation for European Economic Cooperation (W. Europe)
ONGC	- Oil & Natural Gas Commission (India)
para	- Paragraph
P ₂ O ₅	- Phosphorous pentoxide
TISCO	- Tata Iron & Steel Company (India)
UCPTE	- Union pour la coordination de la production et du Transport de l'Electricite (W. Europe)

EQUIVALENTS

1 lakh	= 10 ⁵
1 crore	= 10 ⁷
M or m	= million = 10 ⁶
b	= billion = 10 ⁹
t	= tonne (metric) = 1000 kg = 0.984 long tonne = 2205 pounds
mt	= million tonnes
kg	= kilogram = 2.205 pounds
km	= kilometre = 1000 metres = 0.621 mile
km ²	= square kilometre = 100 hectares = 0.386 square mile
hectare	= 0.01 km ² = 2.471 acres
m ³	= cubic metre = 35.31 cubic feet
MW	= megawatt = 1000 kW (kilowatts)
GW	= gigawatt = 10 ⁶ kW
kWh	= kilowatthour = 860 kcals = 0.746 Horse Power Hour
GWh	= gigawatthour = 10 ⁶ kWh
TWh	= terawatthour = 10 ⁹ kWh
kcal	= kilocalorie = 3.968 British Thermal Units (Btu)
1 kcal/kg	= 1.8 Btu/lb.
Rs	= rupees = \$0.21 US (approximately)
np	= naya paisa = 0.01 Rupee = 2.1 mills US (approximately)

CHAPTER 1

Terms of Reference

The Energy Survey of India Committee was appointed by the Government of India by Memorandum of January 3, 1963 of the Ministry of Irrigation and Power with Terms of Reference, which, with subsequent amendments, are as follows:

“The Energy Study would cover present and prospective demands and supplies of energy, both total and in respect of all constituents of energy on a national, regional and sectoral basis. It would be expected to provide the Government of India basic material for development planning in the field of energy up to 1981. In making this study, the Committee will give consideration, among other things, to use of energy in rural areas.”

“The Committee will also study development of power resources - hydro-electric, thermal (including coal, lignite, oil and gas) and atomic energy, and make recommendations as to phasing in which these should be brought into use progressively. The Committee will also study the question of fuel for thermal power stations, availability of fuel, best location and sizes of plants. The fuels to be considered would be coal, oil, gas and atomic energy.”

The following were appointed to be Members of the Committee:

Shri M. R. Sachdev (then Secretary, Ministry of Irrigation and Power, subsequently Lt.-Governor of Goa). (Chairman)

Mr. Walker Cisler (President, Detroit Edison Company, U.S.A.) (Joint Chairman)

Professor Austin Robinson (Professor of Economics, Cambridge University, U.K.) (Joint Chairman)

Mr. Louis de Heem (Directeur General du Centre d'Etude de l'Energie Nucleaire, Brussels, Belgium).

Mr. Jacques Desrousseaux (Directeur General des Etudes Economiques aux Charbonnages de France, Paris, France).

Shri K. R. Damle (Secretary, Ministry of Mines & Fuel).

Shri K. P. S. Nair (Member, Central Water and Power Commission, Power Wing).

Shri P. R. Nayak (then Managing Director, Indian Refineries Ltd., subsequently Chairman, Oil and Natural Gas Commission).

Shri A. B. Guha (Coal Mining Adviser to Ministry of Mines and Fuels).

Shri S. S. Kumar (Director General, Directorate of Technical Development).

Shri S. Bose (Chief Engineer, Damodar Valley Corporation).

Shri M. N. Chakravarti (Project Administrator, Tarapur Atomic Power Plant, Department of Atomic Energy).

Shri B. S. Nag (Adviser to Planning Commission on Irrigation and Power).

Shri P. S. Lokanathan (Director-General, National Council of Applied Economic Research).

Dr. V. K. R. V. Rao (then Director, Institute of Economic Growth, subsequently Member of the Planning Commission).

Dr. M. S. Randhawa (Adviser on Resources and Scientific Research to the Planning Commission).

Shri Pitambar Pant (Chief of the Perspective Planning Division of the Planning Commission).

Shri V. Nanjappa was subsequently appointed to the Committee when he succeeded Shri M. R. Sachdev as Secretary of the Ministry of Irrigation and Power.

Shri C. S. Krishnamoorthi (Joint Secretary, Department of Economic Affairs, Ministry of Finance) was also appointed at a late stage in the work of the Committee.

The following were appointed to advise the Committee:

Professor M. S. Thacker (Member of the Planning Commission).

Shri C. M. Trivedi (then Member of the Planning Commission).

Dr. H. J. Bhabha (Secretary and Chairman, Atomic Energy Commission).

A Working Group was appointed to conduct on behalf of the Committee a study of the energy resources of India and of the prospective demands for energy under the general direction of Mr. A. E. Bush and Mr. H. Tauber, Consultants to United States Agency for International Development.

Professor Austin Robinson, Joint Chairman and Member of the Energy Survey Committee, worked for considerable periods as a member of the Working Group and was principally responsible for drafting the report.

The following staff was responsible for the statistical and technical studies embodied in this report:

Full Time on Staff of Energy Survey

Shri A.R.N. Rao - Central Water & Power Commission

Shri S.D. Kushare - Central Water & Power Commission

Shri M.K. Sambamurthy - Central Water & Power Commission.

Shri J.S. Advani - Central Water & Power Commission

Shri I.H. Khan - Central Water & Power Commission

Shri T. Ramachandran - Planning Commission

Dr. K.P. Bhatnagar - Oil & Natural Gas Commission.

Part Time on Staff of Energy Survey

Shri J. Padmanabha Iyer - National Minerals Development Corporation

Shri M. Kurien - Indian Institute of Petroleum
Shri S. Majumdar - Central Fuel Research Institute
Dr. J. S. Ahluwalia - Indian Institute of Petroleum

Others have assisted the Working Group as consultants for shorter periods: Mr. K. F. Laading of the Organisation for Economic Co-operation and Development in Paris; Mr. P. Chantler of the United Kingdom Ministry of Power; Mr. J. W. Kushing, Electricity Consultant, Lansing, Michigan, U.S.A.; Mr. J. H. McCarthy, Electricity Consultant, Detroit, Michigan, U.S.A.; Professor L. Chawner of the University of Washington, Seattle, U.S.A.

The Committee has held three groups of meetings: the first during January 1963; the second during July 1963; the third during December 1963. It entrusted to the Working Group the task of preparing a draft report which formed the basis of the final report now presented.

At its meetings in December 1963, the Committee authorised the submission of the present report, as amended under the supervision of Shri Sachdev, Professor Thacker, Shri Trivedi and Professor Robinson, to the Government of India. The amended report was further considered at meetings held in June and December 1964 and has been further amended in the light of them. The final report was discussed, approved and signed by the members July 26-27, 1965.

CHAPTER 2

The Energy Problems of India

1. The appointment of the Energy Survey Committee reflects the need for more thorough and more searching examination of some of the problems that have arisen during the past few years in the field of energy and the need to remove, if possible, some of the obstacles to development that have arisen from shortages of energy. Any survey must begin, therefore, by emphasizing the nature of some of these problems.

2. The sub-continent in which the peoples of India are seeking to build a modern economy is, by the standards of Europe or North America, not exceptionally rich in natural sources of energy. In the past, India has depended principally on the traditional non-commercial fuels - firewood and cow-dung in particular. In the last half century the commercial fuels - coal, lignite, oil and hydro-electricity have all been developed. Currently the first steps are being taken in proving and developing nuclear fuels and introducing nuclear energy.

3. The first coal resources to be exploited were the mines of Bihar and West Bengal, which in the past have provided four-fifths of the nation's coal production and the whole of the coking coal. These mines, though close to the new industries that have been rapidly growing up in the neighbourhood of Calcutta, are some 1450 kilometres from Bombay, over 1500 kilometres from Madras and nearly 1000 kilometres from Delhi. New coal resources nearer to some of these areas of consumption have been discovered, and are in several cases now in process of development in Central India and Andhra Pradesh. But even these are by European standards at considerable distances from the more remote industrial areas. The supplies of non-coking coal are fully adequate to India's potential needs for many years ahead. More serious problems are presented by the limited resources of the coking coals and their concentration in Bihar and West Bengal. While there is a clear need to conserve coking coals, the supply is likely to be adequate for a generation ahead. These questions are considered in more detail in Chapter 11.

4. Indian coal resources are, however, deficient in quality. The coals, and particularly the coking coals, have a very high ash content and the ash is so intimately interspersed into the coal that even by washing the ash content cannot be reduced to the levels customary in Europe or North America. Thus, added to the costs and difficulties created by distance itself are further costs and difficulties imposed

by the necessity to carry and dispose of large volumes of waste material inseparable from the coal. These matters of low grade coal and washery by-products present very special problems and will be examined in detail at a later stage in this report.

5. At present the output and consumption of coal in India as a whole is equivalent to about 0.13 tonnes per head per year. This may be contrasted with coal production per head of about 2.1 tonnes in the United States (where oil is the principal fuel), 3.7 tonnes in the United Kingdom, 1.1 tonnes in West Germany and 1.1 tonnes in France. More nearly comparable countries include Japan (0.6 tonnes per head) and Spain (0.5 tonnes per head). In part the low output of coal per head in India has reflected the low degree of industrialisation of the economy rather than lack of resources.

6. The limits of India's oil resources are not yet fully known. The existing indigenous supplies come almost wholly from Assam. The reserves of the parts of that field that were first exploited are approaching exhaustion and new discoveries will be needed merely to maintain existing supplies. New discoveries in Gujarat and Rajasthan hold out hopes of supplies substantially nearer to the centres of consumption in Western India. The potential resources of oil are discussed in Chapter 12. While it is immensely to be hoped that new discoveries will be made as the result of the intensive search that is now proceeding, these will need to be on a scale wholly different from any that have been made hitherto if India is to be enabled to develop, without risk of interruption through balance of payments difficulties, an oil-based technology such as is prevalent in most of the advanced countries today.

7. The difficulties of the concentration of coal and oil predominantly in the north-east are to a significant extent mitigated by the location of the nation's hydel resources. The Southern, Western and Northern regions, which are remote from coal supplies, contain between them five-sixths of the nation's present hydel production and a very large part of the longer-term hydel potential. This can do much to make a balanced development of the country more possible. It remains true, however, that there will be an economic advantage if energy-intensive industries can predominantly be located in the areas of coking-coal and other coal supplies in the north-east and if non-energy-intensive industries find their predominant location in the areas served by hydel. Hydel is being rapidly developed;

but the development needs massive construction and considerable volumes of capital. Thus, even with a maximum of effort, the contribution of hydro-electricity to the total energy needs of the country is not likely to represent more than about one-twentieth of the total energy supplies even by 1980. The hydel resources of India are discussed in Chapter 13.

8. In the special circumstances of India, with great distances between centres of consumption and the coal fields, and thus high delivered costs of coal, there are more than normally favourable conditions for the competition of nuclear energy. These are, in some degree at least, offset by the scarcity of capital in India and the need to economise scarce capital and foreign exchange resources. A close examination is made in Chapter 13 of the extent to which it may be

reasonable to hope that, in suitably chosen locations nuclear energy will be economically competitive in the present and within the next fifteen or twenty years. If the construction and operating costs of nuclear energy can in practice be at the levels that we have set out in Chapter 13, nuclear energy is likely to have an increasingly important part to play. But while its contribution to the problems of the next century may be great, its contribution to the problems of the next twenty years however represents a small fraction of India's total energy requirements.

9. Table 1 shows the distribution in different parts of India and different states of the population of industrial development, of commercial energy consumption and of commercial energy production.

TABLE 1
DISTRIBUTION BY STATES AND REGIONS OF POPULATION
INDUSTRY, ENERGY CONSUMPTION AND PRODUCTION

REGIONS	Popul- ation 1961	Factories covered by Survey of Industry 1960		Consumption 1960/1 Commercial Energy Electricity		Production 1960/1 Coal Hydel Oil		
		Em-ploy- ment %	Value Added %	%	%	%	%	%
EASTERN								
Bihar	10.8	5.7	7.1	12.6	10.6	48.3	1.0	—
Orissa	4.0	0.9	1.0	2.6	4.4	1.6	6.2	—
West Bengal	8.0	22.9	22.3	16.6	16.7	30.5	2.1	—
Total	22.5	29.5	30.4	32.0	33.7	80.4	10.1	—
NORTHERN								
Punjab	4.6	2.4	1.9	6.4(a)	6.8 (a)	—	12.4	—
Rajasthan	4.6	1.5	1.0	2.6	1.4	0.1	—	—
Delhi	0.6	1.4	1.6	(a)	(a)	—	—	—
Jammu & Kashmir	0.8	0.3	0.1	0.2	0.3	—	0.6	—
Himachal Pradesh	0.3	0.1	0.1	(a)	(a)	—	—	—
Total	11.0	5.8	4.7	9.2	8.5	0.1	13.0	—
CENTRAL								
Madhya Pradesh	7.4	3.0	2.4	6.7	3.6	12.1	0.3	—
Uttar Pradesh	16.8	8.0	6.4	6.4	6.7	—	5.7	—
Total	24.2	11.0	8.8	15.2	10.5	12.1	6.0	—
WESTERN								
Maharashtra	9.0	21.6	27.7	16.2	17.1	1.5	17.6	—
Gujarat	4.7	9.7	10.1	6.6	6.4	—	—	—
Total	13.7	31.3	37.8	23.0	23.5	1.5	17.6	—
SOUTHERN								
Madras	7.8	7.1	7.1	6.6	10.5	—	23.0	—
Kerala	3.8	4.6	2.4	2.4	2.9	—	7.5	—
Mysore	5.5	3.8	3.0	3.6	5.9	—	12.9	—
Andhra Pradesh	8.2	4.9	2.7	5.4	4.3	4.6	9.6	—
Total	25.3	20.3	15.2	18.0	23.6	4.6	53.0	—
ASSAM	3.3	2.4	3.0	2.5	0.3	1.3	0.3	100.0
TOTAL ALL INDIA	100.0	100.0	100.0	100.0	100.0	100.0	100.0	100.0

(a) included in figures for Punjab.

10. This table shows clearly the extent to which Indian indigenous energy supplies have in the past been physically concentrated in the North East of India. But Bihar, Orissa, West Bengal and Assam contained in 1960/1 only 26% of the population of India and produced only 33% of the total output of the factories covered by the Survey of Industries (1). They took about 35% of the energy consumed in India and about 34% of the electricity. In the Southern and Western Regions, as we have here defined them, there live, however, 39% of the population of India, producing 53% of the factory output, and absorbing in 1960/1 about 41% of all energy and 47% of all electricity. It is the problem of creating a modern energy-based economy in these regions, at a considerable distance from indigenous supplies of coal and oil, though well endowed with hydel, that need careful consideration.

11. Many of the most urgent problems of energy supply in India are presented by the needs to expand both generation and distribution of electricity to meet rapidly increasing demands. Some of the problems have arisen from the rapidity of growth and the difficulties of estimating and keeping up with demand. Some of the problems are concerned with the best choice of generating plant as between thermal, hydro-electric, or nuclear. Some are concerned with the present inadequacy of facilities for transporting energy - in the form of coal by rail or electricity by transmission line. Some are concerned with the present inadequacy of local and inter-regional inter-connections. Some again are concerned with integrating regional electricity development into a general development of electricity supply throughout the country and with securing optimum use of plant large enough in size to secure reasonable economy. Finally, a specially urgent problem arises from the need to integrate electricity development into a general energy policy and to use, for low-cost electricity generation, the low grade and by-product coals that are likely to be without sufficient alternative markets. All these problems will be analysed in Chapter 13.

12. Even with rapid development of electricity, however, India will for some time ahead use more of her energy in the natural forms of coal and oil and much less after transformation into electricity or gas than is now normal in an advanced industrial country. In Europe about 40% of all energy is now transformed into electricity or gas before use. In India the proportion, even by 1975/6 is likely to be less than a quarter of commercial energy and only about 15% of all energy.

13. Until very recently India has depended almost wholly on traditional, non-commercial, sources for the

major part of the energy consumed. Apart from large dependence on the bullock cart for much of the transport, on the plough-bullock in agriculture and often also on bullocks to work the wells, the population of India has used from time beyond memory firewood, waste products and cow-dung as the main sources of domestic fuel. Even today, over 60% of the total energy of the country, other than that provided by animals, is derived from these three traditional non-commercial sources. Firewood alone provides almost 40 per cent of the energy used in the country. Rather more energy is consumed in the form of cow-dung than in that of electricity.

14. These non-commercial forms of energy present a number of special problems of their own. There has till lately been very insufficient evidence even about the orders of magnitude of the consumption of firewood and cow-dung. Both present serious problems. The cow-dung, though it provides a cost-free and thus attractive fuel, should be used as fertiliser rather than fuel. The 100 million tonnes of timber burnt as firewood may well exceed the total annual growth of suitable timber and be made possible only by the progressive denudation of Indian forests.

15. These non-commercial fuels have, of course, been consumed not only for domestic purposes proper, but also by a great deal of small scale industry, including much brick-making, sugar manufacture, village and small-town processing industries and the like.

16. One of the future trends most difficult to judge is that of the continued availability of these non-commercial fuels. If, as seems likely, there will need to be a large scale substitution of commercial forms of energy for these non-commercial forms during the next ten or twenty years, it is important that provision should begin to be made for it in the immediate future.

17. The purpose of an Energy Survey is to foresee, so far as is possible, the trends of future demand for energy in all its various forms; to estimate the possibly available supplies and the need to develop them to certain levels by certain dates; to bring to the surface and thus help to secure the removal of obstacles to development; to see the energy policies which can best contribute to securing adequate supplies of low-cost energy. While energy obtained at low cost can do much to improve the efficiency of an economy, the cost of energy is a very small part of total costs outside of a few metallurgical and chemical energy-intensive industries. Adequacy of supplies is in most cases far more important than artificial cheapness of supplies. These problems of energy pricing will be considered fully in a later chapter.

18. In order to see the scale on which energy supplies must be developed, this report will begin with a study of the trends of recent years and then proceed to estimates of future demands. Since, as has been stressed, the areas and the distances in-

1) The Survey of Industries covers fully all factories employing 50 or more workers with the aid of power, or 100 or more workers without power, It covers by sample all factories employing 10 or more workers with power, or 20 or more without power.

volved are immense, an attempt will necessarily be made to see the probable energy demands in different parts of India. The report will then study the energy resources of India and the problems involved in achieving sufficient expansion to meet these demands. It will then attempt to see what should be the essentials of an energy policy for India.

19. Already the energy supplies of India make heavy claims on the foreign exchange resources of India and on the available foreign aid, both for capital and current purposes. If the Indian economy is to become, as it must, increasingly dependent on growing horse-power per head in industry and agriculture, it is important to see the possible repercussions on the balance of payments, and the necessary implications of that, in turn, on the types of energy that India is likely to be in a position to purchase.

20. The development of energy supplies also makes very heavy claims on the capital resources of a country. In the similar energy survey made in Europe, it was found that the capital developments of the energy sector absorbed about 12% of all the gross capital investment of the countries concerned. We have, therefore, to study the similar problems in the case of India. Our estimates are set out in Chapter 14.

21. But an internally consistent energy policy needs to go far beyond a consideration of possible demands and supplies. It is important that the users

of energy shall have the right incentives to demand those types of energy that the Indian economy can best provide and to restrain their demands for those types that are more costly to supply. It is important that users shall have incentives not to use energy wastefully; on the other hand it is equally important that there shall be incentives to use additional horse-power to increase productivity wherever it is economic to do so. Equally it is important that the energy supplying industries shall charge relative prices for different types of energy that will encourage the fullest use of all types - the use of low grade coals and washery by-products for example - so that each type of energy is fully used where its contribution to the economy can be greatest. A satisfactory and internally consistent energy policy requires a satisfactorily working system of relative prices for energy and a system of relative taxes which supports and does not frustrate the general energy policy.

22. These are the big issues that we shall be discussing in this report. The need for it does not arise from any special defects of Indian policies; few countries, certainly none of the countries of Europe, can claim to be following wholly rational energy policies. But India, because of rapid growth, of rapid industrialisation and increase of horse-power per head, and of immense distances, has greater need than most to see that energy policies are the most rational that can be found.

CHAPTER 3

Recent Trends of Energy Consumption

23. Any forecast of energy demands in India must start from a firmly established knowledge of the levels and trends of energy consumption in the recent past. While the government departments and administrative bodies concerned have collected for their own working purposes a minimum body of statistics, these were not, when the work of the Energy Survey started, on a sufficiently comprehensive and comparable basis to make possible the more detailed analysis of the uses of energy which was a necessary preliminary. Much of the work of the staff of the Survey has necessarily been devoted to the re-organisation and amplification of the statistical evidence. In this work, invaluable aid has been received from the office of the Coal Controller in Calcutta, from the head offices of the Oil Companies working in India, as well as from all Government Departments concerned.

24. We emphasise this because it is a necessary precondition of any continuing study of the energy problems of India that the statistical material that we have collected and organised for purposes of the present report and print in detail in the Annexes shall be maintained in the future, so that the Government of India can at intervals review the trends and if necessary revise its policies. We suggest that the responsibility for the regular collection and organisation of the necessary statistics be given to the division of the Planning Commission which has recently been established to handle the problems of Energy. But an adequate supply of statistical material must depend ultimately on the collection of the basic data. We hope that the Survey of Industries will again collect the relevant information regarding the use of energy.

25. The detailed statistical evidence, that we have organised goes back to 1953/4. Beyond that year, the records of the Coal Controller, on which we have depended heavily for our estimates of the use of coal, no longer survive in the complete detail that has been necessary for our purposes. While the broad trends can be measured over longer periods, we would hesitate to depend on the figures of earlier years to measure either total consumption after allowing for stock changes, or the exact distribution of the total of coal consumed between different users.

26. The energy supplies of any country must derive ultimately from a few basic sources of "primary" energy. They may, as has already been said, be transformed before consumption into "secondary" forms, such as electricity or gas, but these depend in turn on the primary sources from which they are transformed. In most countries of the world the chief sources of primary energy have until recently been three: coal, oil and water-power converted into electricity. In the past few years nuclear energy has been added to these three sources. In most countries there are other "minor" sources of energy: peat, wind-power, timber burned as fuel, charcoal and the like; in most countries, however, these are small and the major primary sources of commercial energy account for almost the whole supply. In India the situation is very different in that these "minor" sources of "non-commercial" energy are in fact the major source of energy, in the sense that they provide, as has been said above, more than half of all energy.

27. Regarding the sources of commercial energy, reasonably reliable data have now been organised. Regarding the sources of non-commercial energy the estimates are much less certain. They derive principally from a sample survey, covering this among other issues, that has been conducted by the National Council of Applied Economic Research. A stratified sample of nine thousand rural family units, spread over all of India, has provided a basis for estimating rural consumption of non-commercial energy. An earlier survey of domestic energy consumption in the bigger towns of India makes it possible to fill out the results of the rural survey to cover the whole country. The rural survey has included the consumption of small-scale rural industries.

28. For the year 1960/1, Table 2 shows the sources both of commercial and non-commercial energy. In this Table, the various sources are measured in the original natural units in which energy of that kind is usually bought and sold. For all energy, the annual consumptions are carried back to 1953/4. For the non-commercial sources, the available statistics relate in part to 1958/9 and in part to 1962/3; the series as a whole is estimated on the basis of these data and of population growth (see Annex 1).

TABLE 2
ENERGY CONSUMPTION IN INDIA
IN TERMS OF PRIMARY SOURCES MEASURED
IN ORIGINAL UNITS¹

Year	Commercial Fuels			Non-commercial Fuels ⁴		
	Coal million tonnes	Oil ² million tonnes	Hydro ³ Power Generated TWh	Dung million tonnes	Firewood million tonnes	Vegetable Waste million tonnes
1953/4	34.1	3.5	2.9	46.4	86.3	26.4
1954/5	34.2	3.9	3.2	47.6	87.5	27.0
1955/6	35.1	4.4	3.7	48.0	88.0	27.7
1956/7	37.1	4.8	4.3	50.1	90.1	28.4
1957/8	41.6	5.2	5.1	51.4	91.4	29.1
1958/9	43.6	5.5	5.6	52.7	92.7	29.9
1959/60	43.9	6.1	7.0	53.3	96.3	30.2
1960/1	49.9	6.7	7.8	54.0	100.0	30.7
1961/2	54.4	7.5	9.0	54.5	100.8	30.9
1962/3	59.6	8.5	11.0	54.9	101.6	31.1

1 Total internal consumption excluding international ocean going vessels (bunkers) and taking account of the balance of foreign trade and stock changes in primary and secondary forms of energy.

2 Includes refinery losses and consumption but excludes non-energy products.

3 Gives the net electricity generated.

4 The estimates for the consumption of non-commercial fuels have been made by methods described in Chapter 8. They are necessarily much less firm estimates than those for the commercial fuels.

29. For the purposes of measuring the growth in the consumption of energy and to envisage the problems of substituting one form of energy for another it is valuable to reduce all these estimates of primary energy to some common unit. There are various ways in which this may be done. In most of the similar energy studies that have been made in Europe and elsewhere the volumes of energy derived from each primary source have been expressed either in kilocalories or in tonnes of coal equivalent by a process of measuring the kilocalorie content of each fuel and, where the coal equivalent method has been used, by measuring also the average heat value of a tonne of locally available coal.

30. That method has very obvious scientific advantages and for the technical purposes for which some data are valuable we have included in Annex 6 to this report, estimates of the sources and uses of energy over the period 1953/4 to 1960/1 in kilocalories.

31. For the particular problems of India that method has, however, certain disadvantages and limitations. Different types of energy are normally used, particularly in the circumstances of India, with

very widely differing thermal efficiencies. Measurement in terms of kilocalories will greatly exaggerate the effective part played by, say, cow-dung and greatly undervalue the effective part played by, say, oil in the Indian energy economy. What is even more important, the major practical problems of the Indian energy economy are the substitution of newer forms of energy, such as oil or electricity, for the older forms such as cow-dung or firewood. It is convenient and helpful to clear thinking if 10 million tonnes of cow-dung, as measured in terms of coal, are capable of being replaced by 10 million tonnes of oil, when measured in the same units. We have therefore used throughout this study units of coal replacement; each type or source of energy has been measured in terms of the coal that it replaces, when both the original source and the coal are used in appliances or equipment, and with the thermal efficiencies that are likely to be used in practice. The replacement ratios¹ that have been used and the reasons for their adoption are set out in more detail in Annex 5.

(1) The "replacement ratios" express the amount of coal needed to substitute for oil products, dung, firewood and waste products in their final

use, taking account of the efficiencies involved in typical cases of substitution. The factors for coke and gas are however purely technical conversion factors, permitting the expression of the final consumption of these fuels in terms of the primary input of coal actually needed. The replacement factor used for final electricity consumption permits its expression in terms of the amount of coal that would have been needed if no hydel or oil generation were available. The assumptions made have been set out in Annex 5: Indian Energy Statistics in Coal Replacement. The actual replacement ratios employed have been as follows:

10^9 kWh electricity (1 TWh) 1953/4 to 1960/1	= 1.0 million tonnes coal replacement
1965/6 to 1980/1	= 0.7 " " "
1 million tonnes oil products	= 6.5 " " "
1 million tonnes soft coke	= 1.5 " " "
1 million tonnes hard coke	= 1.13 " " "
1000 m. m ³ manu- factured gas	= 0.83 " " "
1000 m. m ³ blast furnace gas	= 0.18 " " "
1 million tonnes dry dung	= 0.4 " " "
1 million tonnes firewood or waste	= 0.95 " " "

32. Table 3 shows the total consumption of energy in India, expressed in terms of the primary sources and measured in terms of coal replacement. It will be seen from this Table and from Table 4 that, as has been pointed out earlier, the non-commercial sources still provide more than half of the energy available to India. Of the commercial sources coal provides a little over a half. Oil, when measured

at the replacement ratios that we have used, provides about two-fifths of the effective commercial energy used in the country; measurement in terms of kilocalories tends to under-rate the important part that oil plays in meeting India's needs for energy. Hydel, though its share has increased very appreciably in recent years, still provides only about 7% of commercial energy and about 3% of total energy.

TABLE 3
ENERGY CONSUMPTION IN INDIA
IN TERMS OF PRIMARY SOURCES MEASURED
IN MILLION TONNES OF COAL REPLACEMENT¹

Year	Commercial Fuels				Non-commercial Fuels ⁴			Total Non- Commer- cial	Grand Total
	Coal	Oil ²	Hydro ³ Power	Total Commer- cial	Dung	Fire- wood	Vege- table Waste		
1953/4	34.1	22.0	2.5	58.6	18.6	82.2	25.1	125.9	184.5
1954/5	34.2	23.4	2.8	60.4	19.1	83.3	25.6	128.0	188.4
1955/6	35.1	25.7	3.3	64.1	19.8	84.4	26.3	130.3	194.4
1956/7	37.1	28.0	3.8	68.9	20.1	85.6	27.0	132.7	201.6
1957/8	41.8	30.3	4.5	76.4	20.8	86.9	27.7	135.2	211.6
1958/9	43.6	32.5	5.2	81.3	21.1	88.3	28.4	137.8	219.1
1959/60	43.9	35.7	6.2	85.8	21.3	91.7	28.7	141.7	227.5
1960/1	49.9	39.1	6.8	95.8	21.6	95.3	29.2	146.1	241.9
1961/2	54.4	44.1	8.6	107.1	21.8	96.0	29.4	147.2	254.3
1962/3	59.8	51.0	10.4	121.0	22.0	96.8	29.6	148.3	269.3

1 Total internal consumption excluding international ocean going vessels (bunkers) and taking account of the balance of foreign trade and stock changes in primary and secondary forms of energy. For further definitions, see the Introductory Notes to Annexes 4 and 5.

2 Coal replacement for oil is obtained by multiplying actual tonnes of:

- LDO consumption in power generation by 3
- Fuel oil consumption in power generation by 2 and
- Total internal final consumption excluding oil refineries' consumption by 6.5

3 Hydro power coal replacement is obtained by deducting transmission and distribution losses at 12% from hydro generation to arrive at units sold and taking 1 million tonnes coal replacement per TWh (10^9 kWh) sold.

4 The estimates for the consumption of non-commercial fuels have been made by methods described in Chapter 8. They are necessarily much less firm estimates than those for the commercial fuels.

TABLE 4
CONTRIBUTION OF THE VARIOUS FORMS OF PRIMARY
ENERGY TO THE TOTAL CONSUMPTION OF PRIMARY
ENERGY IN INDIA
(Percentages)

Year	Coal	Oil	Hydro Power	Non-commercial Forms	Grand Total
1953/4	18.5	11.9	1.4	68.2	100.0
1954/5	18.2	12.4	1.5	67.9	100.0
1955/6	18.1	13.2	1.7	67.0	100.0
1956/7	18.4	13.9	1.9	65.8	100.0
1957/8	19.7	14.3	2.1	63.9	100.0
1958/9	19.9	14.8	2.4	62.9	100.0
1959/60	19.3	15.7	2.7	62.3	100.0
1960/1	20.6	16.2	2.8	60.4	100.0
1961/2	21.4	17.4	3.4	57.8	100.0
1962/3	22.2	18.9	3.9	55.0	100.0

33. In Table 5 we show the total consumption of energy in the natural units after such transformation into secondary forms as has taken place. We

have continued to treat oil products as a group, though transformation does, of course, occur in the process of refining the crude oil into petroleum products.

TABLE 5
FINAL CONSUMPTION IN INDIA
OF VARIOUS FORMS OF PRIMARY AND SECONDARY ENERGY
(Original Units⁽¹⁾)

Year	Coking coal million tonnes.	Non-coking coal million tonnes	Metal-lurgical coke million tonnes	Non-metal-lurgical coke million tonnes	Liquid fuels million tonnes	Manufactured gas 10 ⁹ cubic metres (2)	Electricity TWh	Non-commercial fuels (3) million tonnes
1953/4	7.9	15.8	1.5	1.4	3.4	1.6	6.0	159.1
1954/5	7.4	15.6	1.5	1.6	3.8	1.7	9.7	162.1
1955/6	7.0	16.0	1.8	1.7	4.3	1.7	10.0	165.3
1956/7	7.8	16.9	1.7	1.9	4.7	1.7	12.0	168.6
1957/8	8.2	20.3	1.7	1.9	5.0	1.8	13.6	171.9
1958/9	7.1	21.6	2.4	2.1	5.3	2.1	15.5	175.3
1959/60	5.2	22.0	2.9	2.0	5.8	2.9	17.8	179.6
1960/1	4.2	26.0	3.3	1.8	6.4	4.4	20.2	184.7
1961/2	3.9	27.6	4.9	1.9	6.7	5.2	23.2	186.2
1962/3	4.7	30.2	5.6	2.1	7.6	6.3	26.3	187.6

(1) Total internal final consumption including consumption by the energy sector and losses but excluding consumption for transformation, i.e. the final coal consumption does not include the coal consumed in industrial auto-producers: power and gas plants; the coke equivalent of the blast furnace gas produced has been deducted from the coke figures to arrive at final coke consumption in steel plants; the final gas consumption includes the consumption and losses in blast furnaces and under firing of coke ovens. See also Introductory Note to Annex 4 as well as Tables Nos. 4-24-33 of that Annex and in particular the item "Total Internal Final Consumption"

(2) Coke oven gas at 4500 kcal/m³ and blast furnace gas at 950 kcal/m³ are expressed in terms of gas works gas at 4200 kcal/m³.

(3) Dung, firewood and vegetable waste.

34. In Table 6 the same data are presented in the comparable form of tonnes of coal replacement. It can be seen from this Table and from Table 7, which analyses the same data in percentage form, that in

India only about 20% of all commercial energy was up-graded before consumption in 1960/1, and less than 8% of total energy.

TABLE 6
FINAL CONSUMPTION IN INDIA (1)
OF THE VARIOUS FORMS OF PRIMARY AND SECONDARY ENERGY
(Million tonnes of coal replacement)

Year	Coking coal	Non-coking coal	Metal-lurgical coke	Non-Metal-lurgical coke	Liquid fuels	Manufactured gas	Electricity	Total Commercial sources	Non-Commercial fuels	Grand Total
1953/4	7.9	15.6	1.7	2.2	22.0	1.3	7.6	58.3	125.9	184.2
1954/5	7.4	15.6	1.8	2.4	23.4	1.3	8.4	60.3	128.0	188.3
1955/6	7.0	16.0	2.0	2.5	25.7	1.3	9.4	63.9	130.3	194.2
1956/7	7.8	16.9	1.9	2.9	28.0	1.2	10.2	68.9	132.7	201.6
1957/8	8.2	20.3	1.9	2.8	30.3	1.4	11.8	76.7	135.2	211.9
1958/9	7.1	21.6	2.7	3.1	32.5	1.6	13.2	81.8	137.8	219.6
1959/60	5.2	22.0	3.3	3.0	35.7	2.2	15.4	86.8	141.7	228.5
1960/1	4.2	26.0	3.9	2.8	39.1	3.5	16.9	96.4	146.1	242.5
1961/2	3.9	27.6	5.5	2.8	43.4	4.2	19.7	107.1	147.2	254.3
1962/3	4.7	30.2	6.3	3.2	49.7	4.7	22.2	121.0	148.3	269.3

(1) Total internal final consumption including consumption by the energy sector and losses but excluding consumption for transformation, i.e. the final coal consumption does not include the coal consumed in industrial auto producer's power and gas plants; the coke equivalent of the blast-furnace gas produced has been deducted from the coke figures to arrive at final coke consumption in steel plants; the final gas consumption includes the consumption and losses in blast furnaces and under firing of coke ovens. See Introductory Notes to Annexes 4 and 5.

TABLE 7
CONTRIBUTION OF THE VARIOUS FORMS OF PRIMARY AND SECONDARY ENERGY TO THE TOTAL CONSUMPTION OF ENERGY IN INDIA
(percentages)

Year	Coking Coal	Non-coking coal	Metal-lurgical Coke	Non-metal-lurgical Coke	Liquid Fuels	Manufactured Gas	Electricity	Non-commercial fuels	Total
1953/4	4.3	8.5	0.9	1.2	12.0	0.7	4.1	68.3	100.0
1954/5	3.9	8.3	1.0	1.3	12.4	0.7	4.5	67.9	100.0
1955/6	3.6	8.2	1.0	1.3	13.2	0.7	4.8	67.2	100.0
1956/7	3.9	8.4	0.9	1.4	13.9	0.6	5.0	65.9	100.0
1957/8	3.8	9.5	0.9	1.3	14.2	0.7	5.6	64.0	100.0
1958/9	3.2	9.9	1.2	1.4	14.8	0.7	6.0	62.8	100.0
1959/60	2.3	9.6	1.4	1.3	15.6	1.0	6.7	62.1	100.0
1960/1	1.7	10.7	1.6	1.2	16.1	1.4	7.0	60.3	100.0
1961/2	1.5	10.9	2.2	1.1	17.1	1.7	7.7	57.2	100.0
1962/3	1.7	11.2	2.4	1.2	18.5	1.8	8.2	55.0	100.0

35. Table 8 shows the rates of growth in recent years of consumption of energy in the various forms of coal, coke and gas, of petroleum products and of electricity. It will be seen that, over the years 1953/4 to 1962/3 final consumption in all forms increased by 107%, an average of 8.4% per year consumption of coal and coke as such (excluding, that is, coal used for generation of electricity) increased by 71%, an average of 6.1% per year. Consumption of oil products

as such increased 126%, an average of about 9½% per year. Consumption of electricity increased by 192%, an average of about 12.6% per year. In interpreting these figures, it is important to remember that at different times there have been scarcities or restrictions on demand for different types of energy and that the growths may indicate in some cases the increases of available supplies rather than the increases of demand proper.

TABLE 8
RATES OF INCREASE OF FINAL CONSUMPTION OF
COMMERCIAL ENERGY
1953/4 to 1962/3
(1953/4 = 100)

	Consumption of coal, coke as such. (1)	Consumption of Petroleum Products as such. (2)	Consumption of Electricity	Total Final Consumption
1953/4	100	100	100	100
1954/5	99	106	110	103
1955/6	100	117	124	110
1956/7	107	127	134	118
1957/8	120	138	155	132
1958/9	126	148	174	140
1959/60	124	162	202	149
1960/1	141	178	222	165
1961/2	153	198	260	184
1962/3	171	226	292	207
Average Rate of growth 1953/4 to 1962/3	6.1%	9.5%	12.6%	8.4%

- (1) Total internal final consumption, including consumption by the energy sector, but excluding consumption for electricity generation; consumption of gas is included in these figures.
(2) Excluding consumption for electricity generation.

36. In the case of India, where imports create special problems, it is important also to know what proportion of all energy requires to be imported. In Table 9 we show, again in terms of coal replacement, the indigenous production, net imports, bunkers and stock changes for the commercial fuels for each year from 1953/4 to 1962/3. It will be seen that in 1962/3 about 37% of the consumption of commercial energy and about 17% of all energy was provided by import. During the years since 1953/4 these proportions have risen despite the considerable increase of indigenous coal production; in 1953/4 the proportion of commercial energy provided by import was about 34% and of total energy probably about 11%.

37. The commercial energy of India principally serves the growing needs of the modern economy. In

1962/3 about 17.5% of the whole went to domestic consumption; this proportion has been almost constant during the past nine years. Of the remaining 82.5%, 30% went to transport, 43.5% to industry and 3% to agriculture; the greater part of the remainder represented the use of energy by the coal-mining industry itself. Table 10 shows the trends in the consumption of commercial energy by different sectors.

38. The total consumption of commercial energy increased during the period 1953/4 to 1962/3 by about 8.5% compound per annum. Domestic consumption, as may be seen from Table 11, increased at about the same rate. The increases were most rapid among the sectors here identified, in iron and steel, as might be expected and, somewhat more surprisingly, in agriculture. The consumption in transport

(principally road transport) has grown more slowly, partly no doubt as a consequence of deliberate restraint over this form of expenditure. The growth of consumption in industries other than iron and steel has been about 8.8% compound per annum. In all industry, including both the iron and steel industry and all other industry, the average growth has been a little over 10% per annum.

39. If the experience of the past is to be used as a basis for estimating future demand it is useful to examine in some detail the relation of the growth of energy over these years to the growths of national income and of industrial production. During the years 1953/4 to 1962/3, energy consumption, national income, and industrial production increased as shown in Table 12.

40. While there are inevitable uncertainties regarding the growth of the consumption of non-commercial energy and the estimates of the latter have assumptions about the growth of domestic consump-

tion, it would seem that the increase of consumption of total energy was slightly greater than the increase of national income: Our estimates suggest a 46% increase of energy consumption between 1953/4 and 1962/3 associated with a 33% increase of national income. For the last five years 1957/8 to 1962/3 an increase of energy consumption of 27% has been associated with a 22% increase of national income.

41. The consumption of commercial energy in the modern economy outside the Domestic sector increased during the period 1953/4 to 1962/3 by 109%; industrial production increased by about 85%. Again the increase of energy consumption in the sector concerned was greater than the increase of production. Over the period 1953/4 to 1962/3 a 7% average growth of industrial production was associated with a 8½% average growth of energy consumption in these sectors. Over the last five years, a 60% increase of energy consumption in the sector was associated with a 45% increase of industrial production.

TABLE 9

ENERGY CONSUMPTION IN INDIA
EXPRESSED IN TERMS OF INDIGENOUS PRIMARY SOURCES AND IMPORTS
(million tonnes of coal replacement)

Year	Indigenous Production				Total	Net Imports	Stock Changes	Bunkers	Total Consump-	Net Imports as % of Total Consumption
	Coal	Oil Products from Indigenous Crude	Hydro-power	Non-Commercial Energy						
1953/4	36.7	1.3	2.2	125.9	166.1	20.0	+0.2	-2.1	184.2	10.8
1954/5	37.6	2.0	2.7	128.0	170.3	22.7	-2.7	-2.0	186.3	12.1
1955/6	38.9	2.3	3.3	130.3	174.8	24.8	-3.4	-2.1	194.2	12.8
1956/7	40.8	2.7	3.8	132.7	180.0	26.8	-2.3	-2.7	201.6	13.2
1957/8	44.8	3.0	4.5	135.2	187.3	29.8	-2.0	-3.0	211.9	14.0
1958/9	46.9	3.1	5.2	137.8	193.0	32.1	-2.6	-2.9	219.6	14.6
1959/60	48.4	3.1	6.2	141.7	199.4	35.8	-4.1	-2.6	228.5	15.7
1960/1	55.5	3.1	6.8	146.1	211.5	38.7	-4.7	-3.0	242.5	16.0
1961/2	56.0	4.0	8.8	147.0	215.6	43.0	-0.2	-3.0	255.4	16.8
1962/3	64.9	7.7	10.4	148.2	231.3	45.4	-2.9	-3.2	270.6	16.8

- put to stocks
+ taken from stocks

Note: 1) Production figures are inclusive of Bunkers.
2) coal replacement of oil is obtained by multiplying total internal final consumption excluding oil refineries' consumption by 6.5, LDO consumption in power generation (transformation) by 3 and fuel oil consumption in transformation by 2.

3) Hydro power coal replacement is obtained by deducting transmission and transformation losses at 12% from hydro generation and taking 1 million tonnes coal replacement per TWh (109 kWh) sold
4) Indigenous production of non-commercial energy is measured in terms of actual consumption of such energy and not in terms of the potentially available supply.
5) For further definitions, see Introductory Notes to Annexes 4 and 5.

TABLE 10

TRENDS OF CONSUMPTION OF COMMERCIAL ENERGY BY SECTORS⁽¹⁾

(Million tonnes of coal replacement)

	1953/4	1954/5	1955/6	1956/7	1957/8	1958/9	1959/60	1960/1	1961/2
Transport	20.3	20.3	21.8	24.2	26.3	27.3	28.8	31.0	33.5
Industry: Iron & Steel ⁽²⁾	3.9	3.9	4.0	4.0	4.3	5.6	6.5	8.5	12.2
Other	18.1	19.0	19.3	20.4	24.4	26.1	26.2	28.0	32.2
Agriculture	1.7	1.8	2.1	2.3	2.8	3.0	3.0	3.1	3.2
Domestic	10.6	11.5	12.5	13.7	14.3	15.0	16.6	17.2	19.1
Commercial, Government and other	1.4	1.5	1.7	1.7	1.7	2.0	2.3	2.4	2.0
Collieries & Refineries	2.3	2.3	2.5	2.6	2.9	2.8	3.4	4.2	4.9
	58.3	60.3	63.9	68.9	76.7	81.8	86.8	96.4	107.1

1) Total internal final consumption; see also footnotes to Table 5 and introductory notes to Annexes 4 and 5.

(2) Except in 1960/1 and later years, excluding oil products which are not separately available for Iron and Steel Industry and which are included under "other Industry".

TABLE 11

PER CENTAGE INCREASES IN CONSUMPTION OF COMMERCIAL ENERGY
IN DIFFERENT SECTORS.

	1953/4	1954/5	1955/6	1956/7	1957/8	1958/9	1959/60	1960/1	1961/2	1962/3	Average annual growth in % from 1953/4 to 1962/3
Transport	100	100	107	118	130	134	142	153	185	177	6.5
Industry: Iron & Steel	100	100	103	103	110	143	167	233	313	356	15.4
Other	100	105	107	113	135	144	145	162	178	214	8.8
Agriculture	100	106	124	135	165	178	178	182	188	208	6.3
Domestic ^(a)	100	109	118	129	135	141	157	162	180	199	7.8
Commercial, Government and other	100	107	121	121	121	143	164	171	143	164	5.6
Collieries & Refineries	100	100	109	113	126	122	148	183	213	239	19.2
TOTAL	100	104	110	118	132	140	149	165	184	208	8.5

(a) Commercial energy only

TABLE 12
ENERGY CONSUMPTION IN RELATION TO
NATIONAL INCOME AND INDUSTRIAL PRODUCTION
(1953/4 = 100)

	1953/4	1954/5	1955/6	1956/7	1957/8	1958/9	1959/60	1960/1	1961/2	1962/3
Net National Output (at factor cost) at prices of 1948/9	100	102	104	110	109	116	118	127	130	133
Industrial Production	100	106	115	124	128	134	146	161	173	185
Consumption of Commercial Energy outside Domestic Sector	100	102	108	116	131	140	147	166	184	209
Consumption of Total Energy	100	102	105	109	115	119	124	132	138	146

CHAPTER 4

Estimates of Future Demand

I GENERAL PROBLEMS OF FORECASTING

42. In the last Chapter we set out some of the general macro-economic relations between the consumption of total energy and of commercial energy, on the one hand, and national income and industrial production, on the other hand. In attempting forecasts of energy demands in India these general relations can be used as a check on other methods of forecasting.

43. If forecasts are to be of practical use in Indian conditions they must be attempted not only in aggregate terms and for all India, but also in terms of the probable scales of demand in different regions of India and for different types of energy - coal, oil and electricity in particular - in each region. Such estimates may be made by either of two methods: by building up a series of individual estimates for each region and type of energy separately and then aggregating them; or alternatively by estimating the aggregate trends of the Indian economy as a whole and in various sectors and seeing how the demands in each sector are likely to be distributed between the regions of India. Since the limits on possible industrial development are set by general and all-India considerations of the availability of capital, foreign exchange and other resources and by the over-all trends of the whole economy, more accurate forecasts are likely to be made by starting with the aggregate trends of the Indian economy as a whole, and in its various sectors, and by breaking down these estimated aggregates into regional estimates. It is easier to estimate with reasonable accuracy the total demand for steel or cement or textiles in India as a whole than to estimate what volume of each of these any particular state will be able to produce for an uncertain market. Thus our estimates of energy demand have started from estimated levels of activity and production in India as a whole.

44. The methods that we have used have been two-fold. We have estimated, as a broad check on our results, the probable aggregate of energy likely to be required if the Indian economy grows at certain rates. We have estimated sector by sector the probable growth of production of activity and the appropriate energy consumption in each, and have totalled these estimates. Next, we have attempted to estimate the consumption of different types of energy within the total. Finally, we have attempted to estimate the probable levels of demand for different types of energy in different regions.

45. In making our forecasts we have set the furthest horizon as far ahead as 1980/1, but have attempted to estimate for the last year of each plan

period up to that date. We are well aware that the uncertainties multiply with the distance of time ahead. On the other hand, the planning and creation of the supply of energy takes an exceptionally long time. Hydro-electricity projects take eight to ten years from first conception to final completion. A deep coal mine may equally take eight to ten years to plan, sink shafts and develop fully. Thus it is important to be looking ahead in the preliminary stages of energy planning some fifteen or more years if the scale and strategy of necessary development is to be got right.

II FORECASTS BASED ON MACRO-ECONOMIC RELATIONS

46. We begin, therefore, by establishing, on the basis of past experience the orders of magnitude of the possible aggregate demands for energy in all forms. The past growths of 8½% per annum in consumption of commercial energy and of about 4.3% in consumption of total energy have been related, as has been shown, to growths of 7% in industrial production and 3.2% in net national income.

47. We have taken, as a basis for our forecasting, alternative possible rates of future growth of the Indian economy. The rates of assumed national income growth that we have taken are 5%, 6% and 7%. Much of the thinking and calculation regarding the future pattern of development of the Indian economy has been based on the assumption of 7% growth. We have made very considerable use of the patterns of growth assumed in that work, but have adjusted them also to 5% and 6% growth rates.

48. What we shall continue to call the 7% growth rate for the Indian national income is fundamentally based on the study entitled *Notes on Perspective of Development: 1960/1 to 1975/6** as revised April 1964. The growth path of national income assumed in that study is not consistently one of 7%. It assumes for the economy as a whole a growth of 4.9% from 1960/1 to 1965/6 - falling below the 7% growth path as a result of the abnormal difficulties of these years. From 1965/6 to 1975/6 it assumes for the economy as a whole a growth of slightly over 7%, so that by 1975/6 an average growth since 1960/1 of 6.6% is achieved and the economy is supposedly geared to further growth at a rate of 7% per year. We have assumed that rate of further growth to 1980/1, which implies an average growth rate of 6.8% over the whole twenty years.

49. For the two cases that we shall call 6% and 5% national income growth we have assumed

*Issued by the Perspective Planning Division,
Planning Commission, New Delhi.

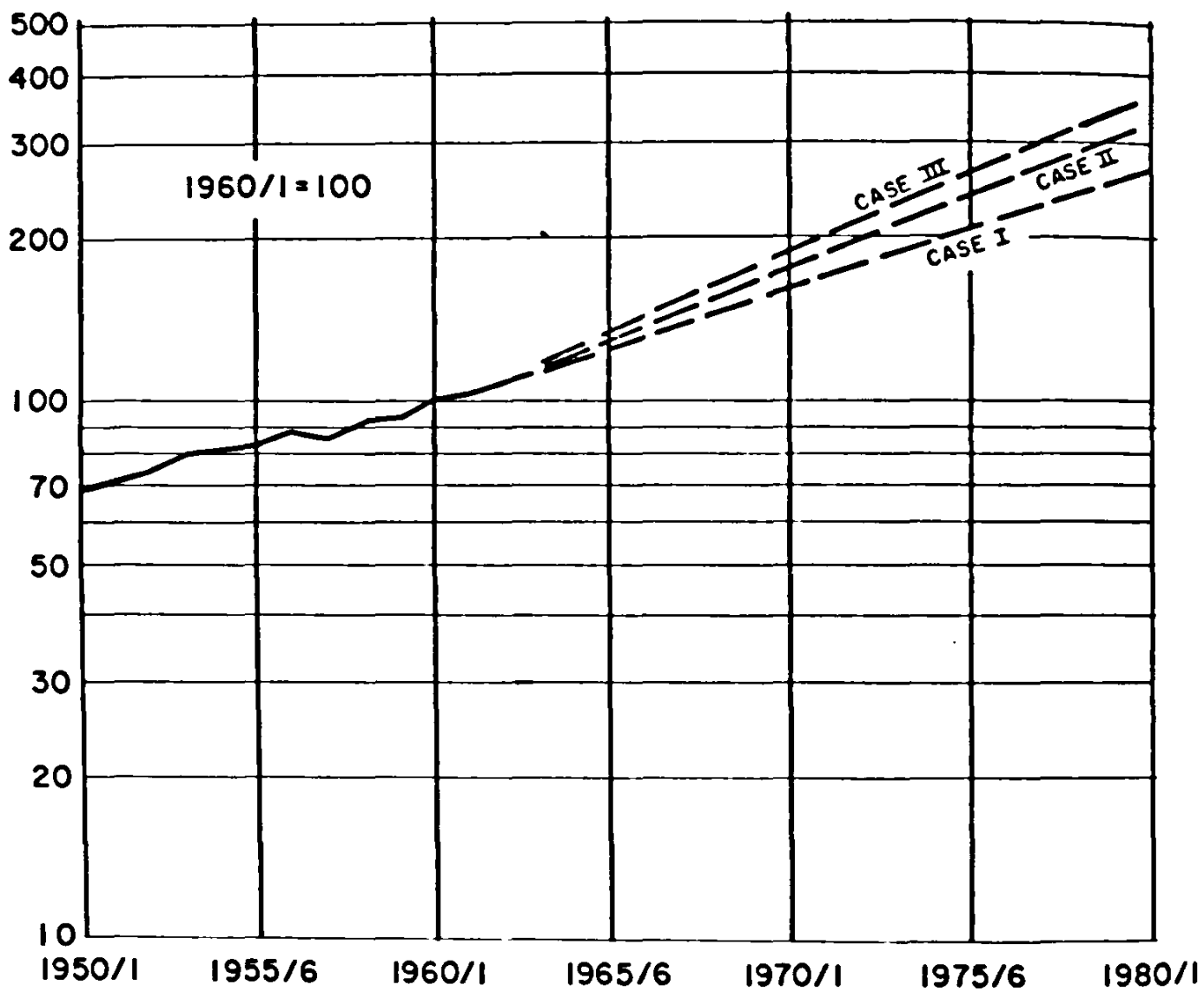

**FIGURE 1- INDICES OF NATIONAL INCOME AT 1960/1 PRICES
1950/1 TO 1980/1**

slightly lower growth rates to 1965/6 and thence forward growth rates of slightly more than 6% and 5% respectively, so that in each case the average growth rate to 1975/6 is at the level of 6% or 5%. From 1975/6 we assume continued growth at the same rate. Our assumed levels of national income for all three cases for the forecasted years and re-

cent past years are shown graphically in Figure 1.

50. On the basis that total demand for energy, commercial and non-commercial, may be expected to increase about proportionately to national income in future as in the past, the total demands at future dates might be expected to be approximately as follows:

TABLE 13

ESTIMATES OF FUTURE DEMANDS FOR TOTAL ENERGY
COMMERCIAL AND NON-COMMERCIAL

(based on possible national income trends)

(Million tonnes of coal replacement)

	1960/1	1970/1	1975/6	1980/1
CASE I (5%)	243	393	505	642
CASE II (6%)	243	424	581	779
CASE III (7%)	243	448	635	895

51. The assumed 7% growth rate of national income as a whole requires an average annual growth of industrial production (in large and small-scale industry together) of about 10%. For the same reasons that were described above the growth of industrial production between 1960/1 and 1965/6 is expected to average about 8.7% per year. From 1965/6 onwards to 1975/6 the assumed rate of growth of industrial production is about 11.2% per year, so that the average for the whole period 1960/1 to 1975/6 is about 10.3% per year. We have assumed continued growth of 10% per year from 1975/6 to 1980/1.

52. The two lower cases correspond approximately to 8½% industrial growth per year and 7% industrial growth per year and we so describe them. The actual average growth rates that we have assumed

are 8.6% and 7.1%. Again a slightly slower growth to 1965/6 is assumed in the 8½% case.

53. We have assumed that the growth rates of net output in agriculture that correspond to our three cases are as follows: Case I, 3.1%; Case II, 3.5%; Case III, 3.9% (The assumed increases of gross agricultural output are rather higher). In all three cases we assume lower growth rates to 1965/6.

54. On the basis that the growth of demand for commercial energy outside the domestic sector may be expected to increase in future about proportionately to the rate of growth of industrial production, estimates of demand for commercial energy alone may, as a check on other calculations, be estimated as follows:-

TABLE 14

ESTIMATES OF FUTURE DEMANDS FOR COMMERCIAL
FORMS OF ENERGY OUTSIDE THE DOMESTIC SECTOR

(based on possible trends of industrial production)

(Million tonnes of coal replacement)

	1960/1	1970/1	1975/6	1980/1
CASE I (7% industrial growth)	79	152	222	312
CASE II (8½% industrial growth)	79	180	272	410
CASE III (10% industrial growth)	79	214	345	532

CHAPTER 5

Forecasts Based on Sectoral Projections Transport

55. The energy used for purposes of transport amounted in 1960/1 to 31.0 million tonnes of coal re-

placement. The use of energy in transport in that year is shown in Table 15.

TABLE 15

ENERGY USED IN TRANSPORT 1960/1 (million tonnes of coal replacement)

	Non-Coking Coal	Coking Coal	Petroleum Products	Electricity	Total
Rail	14.2	1.3	0.5	0.8	16.8
Road (1)	—	—	11.3	—	11.3
Water (2)	0.5	—	0.6	—	1.1
Air	—	—	1.8	—	1.8
Total	14.7	1.3	14.2	0.8	31.0

(1) There was a small use of electricity in tramways which represented less than 0.1 million tonnes of coal replacement; 0.3 million tonnes of petroleum products are estimated to have been used in agricultural tractors.

(2) Internal waterways and coastal shipping only; excluding international bunkers.

CONSUMPTION BY RAILWAYS

56. Over the years 1953/4 to 1960/1 the tonne-kilometers of freight carried by the railways rose from 48.3 billions to 87.8 billions - an increase of

82%. In Table 16 we show the relation of an index of tonne-kilometers to the index of industrial production.

TABLE 16

RELATION BETWEEN INCREASES OF RAILWAY FREIGHT TRANSPORT AND INDUSTRIAL PRODUCTION

	1953/4	1954/5	1955/6	1956/7	1957/8	1958/9	1959/60	1960/1	1961/2	1962/3
Freight tonne-kilometers (billions)	48.3	52.5	59.6	65.8	74.6	78.5	82.0	87.7	91.2	101.0
1953/4 = 100	100	109	123	136	155 100	158	170	182	189	209 135
Index of Industrial Production	100	106	115	124	128 100	134	146	161	173	185 146
Freight tonne-kilometers per unit of Industrial Production	100	103	107	110	121	118	116	113	109	113

57. It can be seen that from 1953/4 down to 1957/8 the index of railway freight tonne-kilometers rose faster than the index of industrial production. Since 1957/8 it has been rising less fast. It is difficult to predict with certainty whether the present trend will continue. On the basis of the six years 1957/8 to 1962/3 it might appear proper to assume that railway freight tonne-kilometers will rise by about $\frac{1}{4}$ of the growth of industrial production. But if the period is extended even one year backwards, the indices of industrial production and of freight tonne-kilometers have risen almost equally between 1956/7 and 1962/3. For the moment, it is probably safest to assume that freight tonne-kilometers will rise rather less than proportionately to industrial production.

58. In looking ahead to the future there are three points that it is important to have in mind. First, in the recent past more than 75% of total goods tonne-kilometers have been carried by rail; as the fleet of road transport vehicles is built up and as coastal shipping is developed that proportion is likely to fall. Second, as industrial production increases and more complex and sophisticated manufactures are produced, the tonnage weight quantum of industrial production is likely to increase less than the quantum of output measured at constant

prices in an index of production. Third, a substantial part of the tonnage at present carried by the railways is composed of coal required either by the railways themselves or by electric power stations; if, as we forecast, a large part of the locomotive-kilometers are likely to be provided in the future by diesel or electric locomotives, this will have considerable repercussions on the tonne-kilometers of railway coal to be carried; if, again, the generation of electricity is, as we expect, increasingly located near the coal mines or coal washeries and electricity is transmitted by extra high voltage transmission lines, this also will have repercussions on the tonnages to be carried by rail.

59. We have considered in the light of these factors and in consultation with the Mission from the World Bank that was examining the problems of railway operation, the probable tonne-kilometers of goods likely to require to be carried, the probable locomotive-kilometers of diesel, electric and steam respectively and the consumption of different forms of energy implied. The estimates of the World Bank Mission correspond most nearly to our Case I. We ourselves take responsibility for estimating the other two Cases; for Case III, our estimates are close to similar estimates made in Notes on Perspective of Development. We give our estimates in Table 17.

TABLE 17
PROJECTIONS OF RAILWAY FREIGHT TONNE-KILOMETERS
(1960/1 - 100)

	1960/1	1965/8	1970/1	1975/8	1980/1
CASE I (7% industrial growth)					
Index of Production	100	159	227	334	501
Index of Total Goods Tonne-Kilometers	100	149	203	288	415
Percentages estimated to be carried by:					
Railway	78	74	72	70	68
Road	22	24	26	27	28
Others	2	2	2	3	4
Index of Railway Tonne-Kilometers	100	145	193	265	372
CASE II (8½% industrial growth)					
Index of Production	100	161	260	417	673
Index of Total Goods Tonne-Kilometers	100	151	232	358	554
Percentages estimated to be carried by:					
Railway	78	74	72	70	68
Road	22	24	28	27	28
Others	2	2	2	3	4
Index of Railway Tonne-Kilometers	100	147	220	328	497
CASE III (10% industrial growth)					
Index of Production	100	168	317	528	845
Index of Total Goods Tonne-Kilometers	100	157	280	447	693
Percentages estimated to be carried by:					
Railway	78	74	72	70	68
Road	22	24	28	27	28
Others	2	2	2	3	4
Index of Railway Tonne-Kilometers	100	153	268	412	621

60. We have made similar estimates for passenger-kilometers. Railway passenger-kilometers have risen during the period 1950/1 to 1960/1 less than in proportion to net national income; the latter had increased by 42%, the railway passenger-kilometers by 17%. Total passenger-kilometers by all forms of transport, including also road transport, had

increased (according to estimates given in **Third Five Year Plan**) by about 51% during the same period - about 1.2 times the growth of national income. If in future total passenger-kilometers are assumed to continue to increase in that relation to national income the alternative trends from 1960/1 to 1980/1 may be estimated as follows:

TABLE 18
PROJECTIONS OF RAILWAY PASSENGER-KILOMETERS
(1960/1 - 100)

	1960/1	1965/6	1970/1	1975/6	1980/1
CASE I (5% national income growth)					
National Income	100	123	162	208	265
Total Passenger-Kilometers	100	128	177	233	304
Percentages estimated to be carried by					
Railways	58	53	48	43	38
Road	41	46	51	56	61
Other	1	1	1	1	1
Index of Railway Passenger-Kilometers	100	117	147	172	200
CASE II (6% national income growth)					
National Income	100	125	175	240	321
Total Passenger-Kilometers	100	130	191	269	368
Percentages estimated to be carried by:					
Railways	58	53	48	43	38
Road	41	46	51	56	61
Other	1	1	1	1	1
Index of Railway Passenger-Kilometers	100	119	159	200	241
CASE III (7% national income growth)					
National Income	100	127	184	262	369
Total Passenger-Kilometers	100	132	201	294	423
Percentages estimated to be carried by:					
Railways	58	53	48	43	38
Road	41	46	51	56	61
Other	1	1	1	1	1
Index of Railway Passenger-Kilometers	100	121	166	217	278

61. A weighted average of the estimated increases of freight and passenger-kilometers shows

the following estimated increases of total railway traffic and use of energy:

TABLE 19
PROJECTIONS OF USE OF ENERGY BY RAILWAYS

	1960/1	1965/6	1970/1	1975/8	1980/1
Weighted Indices of Total Traffic					
CASE I	100	136	178	235	317
CASE II	100	139	200	287	416
CASE III	100	143	234	553	513
Assumed Energy Consumption per unit of Traffic-kilometers					
	100	98	96	94	92
Indices of Energy required for Traction					
CASE I	100	133	171	221	292
CASE II	100	136	192	270	383
CASE III	100	140	225	330	472

62. In estimating in terms of tonnes of coal replacement the probable use of energy by the railways, it has been assumed that consumption per unit of traffic will fall by about 2% per five years. It must be remembered that, in making the replacement ratio of oil to coal 6.5, it has implicitly been assumed that oil will normally be used with nearly 4 times the thermal efficiency of coal. Thus, in terms of tonnes of coal replacement, the gain in thermal efficiency which may arise from replacement of steam by diesel operation has already been included and must not be counted a second time. Some allowance

has been made, however, for marginal improvements that may be expected to result from better equipment, operation of longer and better fitted trains and the like.

63. After consultation with the Railway Board and the World Bank Mission which is investigating the operation of the railways, we think that it is probably reasonable to assume for our working purposes the following trends in the proportions of the total gross tonne-kilometers of goods and passengers together which will be hauled by locomotives using different types of energy:

TABLE 20

**ASSUMED PERCENTAGES OF TOTAL TONNE-KILOMETERS
BY DIFFERENT TYPES OF HAULAGE**

	1960/1	1970/1	1975/8	1980/1
Steam	97.5	52	38	27
Diesel	2.2	28	34	40
Electric	0.3	20	28	33

64. On the basis of these assumptions, we have estimated the total use of energy by the railways

(including energy used for purposes other than traction) as follows:

TABLE 21
ESTIMATED TOTAL USE OF ENERGY
BY RAILWAYS
 (original units)

	1960/1	1970/1	1975/6	1980/1
Coal (million tonnes)				
CASE I	15.5	16.4	18.1	15.9
CASE II	15.5	18.1	19.1	20.1
CASE III	15.5	20.9	22.9	24.0
Oil Products (million tonnes)				
CASE I	0.1	0.8	1.1	1.8
CASE II	0.1	0.7	1.4	2.3
CASE III	0.1	0.8	1.7	2.9
Electricity (TWh)				
CASE I	0.8	4.4	7.1	10.3
CASE II	0.8	4.7	8.2	12.8
CASE III	0.8	5.2	8.6	15.5

65. We give in Table 22 the same estimates in terms of tonnes of coal replacement.

TABLE 22
ESTIMATED TOTAL USE OF ENERGY
BY RAILWAYS
 (million tonnes of coal replacement)

	1960/1	1970/1	1975/6	1980/1
CASE I				
Coal	15.5	16.4	16.1	15.9
Oil	0.5	3.9	7.1	11.7
Electricity	0.8	3.1	5.0	7.2
Total	16.8	23.4	28.2	34.8
CASE II				
Coal	15.5	18.1	19.1	20.1
Oil	0.5	4.8	9.1	14.9
Electricity	0.8	3.3	5.7	9.0
Total	16.8	26.0	33.9	44.0
CASE III				
Coal	15.5	20.9	22.9	24.0
Oil	0.5	5.2	11.0	18.7
Electricity	0.8	3.6	6.7	10.9
Total	16.8	29.7	40.6	53.6

CONSUMPTION BY ROAD TRANSPORT

66. In 1960/1, apart from some 50,000 tonnes of coal replacement used in the form of electricity for tramways, the whole of the energy devoted to road transport took the form of petroleum products. Making the best estimates we can of the uses of individual petroleum products by road transport rather than by other users of the same products, such as agricultural tractors, we have estimated that in 1960/1 a total of 11.0 million tonnes of coal replace-

ment (about 1.70 million tonnes of actual petroleum products) was consumed for this purpose.

67. Over the seven years 1953/4 to 1960/1 the consumption of energy by road transport is estimated to have increased by about 71%, equivalent to an annual average growth of 8%. In Table 23 we set out the trend of these years and compare the growth of energy consumption in road transport with that of net national income and industrial production.

TABLE 23

CONSUMPTION OF ENERGY IN ROAD TRANSPORT
1953/4 to 1960/1*
(million tonnes coal replacement)

	1953/4	1954/5	1955/6	1956/7	1957/8	1958/9	1959/60	1960/1
Use of Energy								
Oil products	6.5	6.9	7.5	8.2	8.9	9.5	10.2	11.3
Electricity	0.1	0.1	0.1	0.1	0.1	(a)	0.1	(a)
Total	6.6	7.0	7.6	8.3	9.0	9.5	10.3	11.3
1953/4 = 100	100	106	115	126	137	144	156	171
Net National Income	100	103	105	110	109	116	118	127
Index of Industrial Production	100	106	115	124	128	134	146	161

(a) Less than 50,000 tonnes.

* Including HSDO consumption of tractors used in agriculture.

68. Over the whole period of seven years, the volume of energy used in road transport increased by about 2.7 times the rate of growth of national income and about 1.2 times the rate of growth of industrial production. That is to say, there is a fairly high income elasticity of demand for road transportation, as in most countries. It must, moreover, be remembered that during this period there have been effective restrictions on the freedom to acquire private auto-

mobiles and that these, as well as price and income, have affected the demand for energy in this sector. In forecasting the future one is implicitly judging the permanence of these policies as well as the possible levels of effective demand.

69. Over the period 1953/4 to 1958/9, numbers of motor vehicles licensed in the last quarter increased as follows:

TABLE 24
NUMBERS OF MOTOR VEHICLES LICENSED
(thousands)

	1953/4	1958/9	% Increase
Private Cars	150.8	225.8	41
Motor Cycles	30.2	61.7	104
Buses etc.	40.3	47.1	17
Goods Vehicles	98.9	148.2	50

70. The targets for the Third Five Year Plan included an increase of 73% in the numbers of goods vehicles on the road between 1960/1 and 1965/6. This, if it had been fully achieved, would have represented an annual increase of about 8% and would have represented an increase in almost exactly the same proportion as the target increase of the index of industrial production (70%).

71. For the purposes of estimating energy consumption in road transport we think that it is reason-

able to assume that effective demand will increase in future, as in the past, somewhat faster than the rate of growth of industrial production. The main demand (but not of course the whole demand) for road transport derives from services rendered to the modern industrial economy and from incomes generated in that modern economy.

72. In the process of estimating the probable demands for railway transport we estimated the total goods-kilometers and passenger-kilometers and the

shares in each which were likely to be devoted to road transport. On the basis of those estimates we calculate the indices of road traffic as shown in Table 25. The estimated consumption of oil products in road transport in 1960/1 includes the consumption

in private motoring. We think that it is reasonable to assume that private motoring (which is not a large part of the total fuel consumption) will increase by about the same proportion as other road traffic.

TABLE 25

ESTIMATES OF ROAD TRAFFIC (1960/1 = 100)				
	1960/1	1970/1	1975/8	1980/1
CASE I				
Goods Traffic (84.3%)	100	240	354	527
Passenger Traffic (15.7%)	100	220	317	451
Weighted Average (100.0%)	100	238	348	517
CASE II				
Goods Traffic (84.3%)	100	274	437	705
Passenger Traffic (15.7%)	100	238	388	546
Weighted Average (100.0%)	100	268	428	681
CASE III				
Goods Traffic (84.3%)	100	331	550	882
Passenger Traffic (15.7%)	100	250	402	629
Weighted Average (100.0%)	100	318	527	843

73. In Table 26 we give estimates of the use of energy in road transport. We have assumed (see Table) some progressive reduction in the consumption

of fuel per tonne-kilometer. We present the estimates both in terms of tonnes of coal replacement and in original units.

TABLE 26

PROJECTIONS OF USE OF ENERGY BY ROAD TRANSPORT				
	1960/1*	1970/1	1975/8	1980/1
Million Tonnes Coal Replacement				
CASE I	11.0	25.0	38.1	52.3
CASE II	11.0	28.3	44.3	68.9
CASE III	11.0	33.8	54.5	85.3
Million Tonnes of Petroleum Products				
CASE I	1.70	3.85	5.55	8.05
CASE II	1.70	4.38	6.82	10.60
CASE III	1.70	5.17	8.39	13.13
Assumed Economies in Fuel Use (1960/1 = 100)				
	100	96	84	92

* excluding MSDO consumption of tractors used in agriculture.

CONSUMPTION BY AIR TRANSPORT

74. The consumption of petroleum products by air transport is estimated to have increased as follows:

TABLE 27
CONSUMPTION OF ENERGY
BY AIR TRANSPORT

(Million tonnes of coal replacement)							
1953/4	1954/5	1955/6	1956/7	1957/8	1958/9	1959/60	1960/1
0.6	0.6	0.8	0.9	1.1	1.3	1.5	1.8

Consumption doubled in the five year period 1953/4 to 1958/9; it increased 2¼ times in the five year period 1955/6 to 1960/1. We estimate, on the same

basis that we have used in relation to railway transport, that it may continue to increase in future rather more slowly, approximately as follows:

TABLE 28
PROJECTIONS OF ENERGY CONSUMPTION
BY AIR TRANSPORT

	(million tonnes of coal replacement)			
	1960/1	1970/1	1975/8	1980/1
CASE I	1.8	4.8	6.7	8.9
CASE II	1.8	5.1	7.7	10.7
CASE III	1.8	5.4	8.5	12.4

CONSUMPTION BY WATER TRANSPORT

75. Since our estimates are in general concerned with the internal consumption of energy in India we have confined our estimates in this particular sector to river and canal transport and to coastal shipping. We have excluded international tankers even when demanded by shipping of Indian flag on international services; the present Indian

flag consumption by such international services is not large; it amounted in 1960/1 to about 3.0 million tonnes of coal replacement.

76. The total energy consumption of water transport so defined during the years 1953/4 to 1960/1 has been estimated to have been approximately as follows:

TABLE 29
ENERGY CONSUMPTION BY WATER TRANSPORT
(million tonnes coal replacement)

	1953/4	1957/8	1960/1
Coal	0.2	0.3	0.5
Oil Products	0.4	0.5	0.6
Total	0.6	0.8	1.1

77. The amounts carried in the past by water have not been large. But there is reason to expect that in future larger volumes of coal, oil, mineral ores and other bulk cargoes will be carried by water, either on rivers and canals or by coastal shipping. Any forecast of a considerable increase in water-borne traffic must be somewhat uncertain. But it should be remembered that the estimates, like those

of railway and road traffic, are ultimately derived from an underlying estimate of the total tonne-kilometers to be moved. If the estimates of water-borne traffic prove to be too high, we should expect the corresponding estimates for railway and road traffic to be too low and to involve at least equivalent use of energy to carry them.

TABLE 30

PROJECTIONS OF ENERGY CONSUMPTION
BY WATER TRANSPORT

(million tonnes of coal replacement)

	1960/1	1970/1	1975/8	1980/1
CASE I				
Coal	0.5	1.0	2.0	3.0
Oil	0.6	1.1	2.5	4.6
Total	1.1	2.1	4.5	8.4
CASE II				
Coal	0.5	1.1	2.5	5.1
Oil	0.6	1.3	3.0	6.1
Total	1.1	2.4	5.5	11.2
CASE III				
Coal	0.5	1.4	3.1	6.4
Oil	0.6	1.6	3.8	7.6
Total	1.1	3.0	6.9	14.0

SUMMARY OF ALL TRANSPORT

78. We summarise in terms of coal replacement

the estimates that we have made for the various elements of the transport sector in Table 31 and Figure 2:

TABLE 31

SUMMARY OF PROJECTIONS
OF DEMANDS IN THE TRANSPORT SECTOR

(million tonnes of coal replacement)

	1960/1	1970/1	1975/8	1980/1
CASE I				
Rail	16.8	23.4	28.2	24.8
Road	11.0	25.0	36.1	52.3
Air	1.8	4.8	6.7	8.9
Water	1.1	2.1	4.5	8.4
Total	30.7	55.3	75.5	104.4
CASE II				
Rail	16.8	26.0	33.8	44.0
Road	11.0	28.3	44.3	68.9
Air	1.8	5.1	7.7	10.7
Water	1.1	2.4	5.5	11.2
Total	30.7	61.8	91.4	134.8
CASE III				
Rail	16.8	29.7	40.6	53.6
Road	11.0	33.6	54.5	85.3
Air	1.8	5.4	8.5	12.4
Water	1.1	3.0	6.9	14.0
Total	30.7	71.7	110.5	165.3

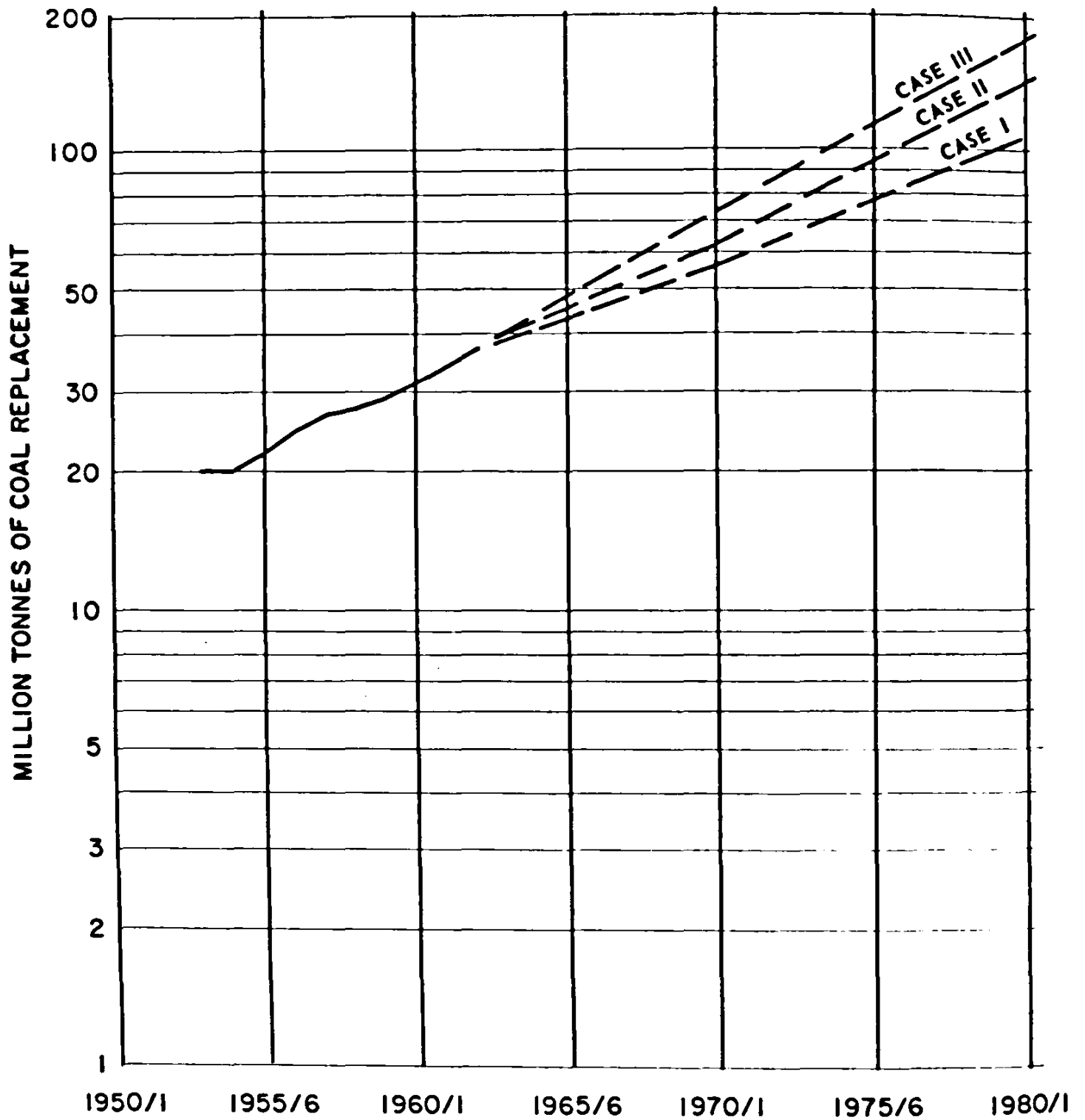

FIGURE 2-ESTIMATES OF ENERGY CONSUMED IN TRANSPORTATION
1953/4 TO 1980/1

79. In terms of the different types of energy, first measured in terms of million tonnes of coal replacement and then in their original units, we esti-

mate the total demands of the transport sector as follows:

TABLE 32
SUMMARY OF PROJECTIONS
OF DEMAND IN THE TRANSPORT SECTOR
FOR DIFFERENT TYPES OF ENERGY
(million tonnes of coal replacement)

	1960/1	1970/1	1975/8	1980/1
CASE I				
Non-Coking Coal as such (1)	18.0	17.4	18.1	19.7
Oil Products as such	13.9 ⁽²⁾	34.8	52.4	77.5
Electricity	0.8	3.1	5.0	7.2
Total	30.7⁽²⁾	55.3	75.5	104.4
CASE II				
Non Coking Coal as such (1)	18.0	19.2	21.8	25.2
Oil Products as such	13.9 ⁽²⁾	39.3	64.1	100.6
Electricity	0.8	3.3	5.7	9.0
Total	30.7⁽²⁾	61.8	91.4	134.8
CASE III				
Non-Coking Coal as such (1)	18.0	22.3	28.0	30.4
Oil Products as such	13.9 ⁽²⁾	45.8	77.8	124.0
Electricity	0.8	3.8	6.7	10.9
Total	30.7⁽²⁾	71.7	110.5	165.3
	(in original units)			
Oil (million tonnes)				
CASE I	2.2	5.4	8.1	11.9
CASE II	2.2	6.0	9.8	13.9
CASE III	2.2	7.1	12.0	19.1
Electricity (TWh)				
CASE I	0.8	4.4	7.1	10.3
CASE II	0.8	4.7	8.2	12.8
CASE III	0.8	5.2	9.8	15.5

(1) Includes in 1960/1 about 1.3 million tonnes of coking coal.

(2) Excluding consumption of agricultural tractors.

CHAPTER 6

Forecasts Based on Sectoral Projections Industry

80. In making a sectoral estimate of the use of energy by industry, we shall treat separately six large and energy-intensive industries: iron and steel; non-ferrous metals; fertilisers; heavy chemicals; cement; textiles. For the rest of industry we shall make a single estimate.

81. There are certain points that must be made by way of general introduction. Our practical problems in making sectoral projections have chiefly been two. First, the targets for future production are, in differing degrees in different industries, uncertain and in constant state of revision, and it has been very difficult to discover, in some cases, what target may be expected to be finally accepted. In the conditions of, say, Europe, where similar projections have been made, there are fairly steady patterns of growth, of which there is long experience, and the patterns of growth are reasonably stable and predictable. In India growth is rapid; the rate of growth that can be assumed as a basis for planning is still in some degree uncertain. Demands have in the past largely been met in some cases from import, and the rate of expansion is limited not by total growth of the market, but also by the possible extent of import-saving. Since we have wished to relate our estimates to alternative possible rates of growth, we have accepted most of the existing targets as corresponding to an average growth in industry as a whole of 10% per year in production over the whole period 1960/1 to 1980/1. In almost all cases we have treated the estimated targets included in the revised Perspective of Development as representing the levels of production in the industries concerned for which energy supplies should be planned under our Case III. We have made our own estimates to project the estimates made in Perspective of Development from 1975/6 to 1980/1. For Cases I and II we have made estimates of levels of the various industries concerned which, taken to-

gether with the estimate for "Other Industries", will be equivalent to an average growth in all industry of about 7% and about 8½%, respectively, and have used these levels as the bases for our estimates of energy consumption.

82. The second general problem has concerned the right assumptions to be made regarding trends of consumption of energy per unit of product. In conditions outside India, there is normally a downward trend of some 0.5% per year in consumption of energy per unit of product. In India the situation is more complex. There is the normal trend to use energy more efficiently. There is also a strong trend to use increased horse-power per head in mechanising and modernising industry. We have exercised our best judgment after detailed examination of the recent trends in each individual industry. But they are often difficult to judge and dangerous to extrapolate. We hope that we have shown no particular bias here and that inevitable errors in different cases will in total have gone a long way to cancel out. We think that we should draw attention to the fact that some of the other estimates of future energy consumption that we have seen make little or no allowance for economy of energy input per unit of output.

I. IRON AND STEEL

83. During the past two years the production of iron by the five major steel plants (Rourkela, Durgapur, Bhilai, T.I.S.C.O., I.I.S.C.O.) has accounted for 98.2% of the national total and an even larger proportion of all steel. The following analysis of output and use of energy is confined to those five plants.

84. Table 33 shows, for the five plants taken together, the aggregate outputs of iron and steel and the use of energy by them.

TABLE 33
PRODUCTION OF IRON AND STEEL
AND USE OF ENERGY BY FIVE MAJOR PLANTS

	1956/7	1957/8	1958/9	1959/60	1960/1	1961/2	1962/3
(I) Production of Pig Iron (million tonnes)	1.68	1.85	2.00	2.99	4.32	5.07	6.12
(II) Production of Finished Steel (million tonnes)	1.26	1.22	1.31	1.91	2.27	3.44	4.36
(III) Total Coke used in Blast Furnaces (million tonnes)	1.49	1.51	1.91	2.87	4.35	5.07	5.80
(IV) Total Coke Production corresponding to Blast Furnace Use (million tonnes)	1.70	1.73	2.23	3.40	5.15	5.93	6.78
(V) Total Coal corresponding to Coke used in Blast Furnaces (million tonnes)	2.22	2.23	2.87	4.36	6.74	7.76	8.76

85. In the process of making our estimates of future demand for coking coal by the steel industry, we have had a careful investigation made into the technical possibilities of future economies at each stage of the use of coal and coke by the iron and steel industry. Since these are of very considerable importance, both to future demands for coking coal and to the availabilities of the washery by-products

resulting from the consumption of washed coking coal by the iron and steel industry, we set them out in some detail.

86. During the same period of seven years the various relationships between coal, coke production, coke use by blast furnaces and pig iron output have been as follows:

TABLE 34
RELATIONSHIPS OF USE OF COAL AND COKE
TO PIG IRON PRODUCTION IN FIVE MAJOR PLANTS

	1956/7	1957/8	1958/9	1959/60	1960/1	1961/2	1962/3
Coal to Coke Ratio	1.31	1.29	1.29	1.28	1.31	1.31	1.30
Coke Production in Coke Ovens to Coke charged in Furnace Ratio	1.14	1.15	1.17	1.19	1.18	1.17	1.17
Blast Furnace Coke to Pig Iron Ratio	0.80	0.91	0.95	0.98	1.01	1.00	0.95
Overall Ratio Coal to Pig Iron	1.34	1.35	1.43	1.46	1.56	1.53	1.43

87. In 1962/3, it took an average of:

- (a) 0.95 tonne of 23% ash blast furnace coke, to produce 1 tonne of pig iron.
- (b) 1.11 tonnes of total coke to yield 0.95 tonne of 23% ash blast furnace coke.
- (c) 1.43 tonnes of 16-17% ash coal to yield 1.11 tonnes of 23% ash coke.
- (d) Or, in all, 1.43 tonnes of coal per tonne of pig iron.

88. These overall figures represent the totals required to make a combination of both basic pig iron, from which ingot steel is made, and foundry iron. The latter, which represented about 20% of output in 1962/3, requires, because of its necessary higher silicon content, about 20% more coke per tonne of iron.

89. By 1970/1, it is hoped that it will be possible to improve some of these ratios.

- (a) It is hoped to reduce the present ratio of 0.95 tonne of coke per tonne of iron to about 0.80 for basic iron in 1970/1 by using combinations of self-fluxing sinter, washed and sized ore, fuel injection, enrichment and increased temperature of the blast, etc. This assumes that 23% ash coke is still employed and that a large scale effort is made immediately to introduce the latest techniques. The corresponding ratio for foundry iron would be about 0.96 tonne of coke per tonne of iron.
- (b) It may be possible to reduce slightly the ratio of coke produced to coke actually used in the blast furnace (after allowance for quantities put to stock) from the present figure of 1.17 by accepting somewhat smaller sizes of coke, but (see Table 34) the ratio has shown little change in recent years.
- (c) It is expected that the ratio of washed coal to coke produced will remain at 1.3

tonnes of coal per tonne of coke; this ratio is chiefly determined by the amount of volatile matter in the coal.

(d) As a result of all these changes, it is hoped that the overall coal/pig iron ratio will be reduced to about 1.22 for basic iron and about 1.49 for foundry iron by 1970/1. The weighted average of the two would be about 1.27 compared with 1.43 in 1962/3.

90. We have adopted for purposes of our projections the ratios shown in Table 35. But the Working Group, which has studied these problems with great care and has consulted experts in the steel plants concerned, believes that it should be practicable, through the adoption of steel-making techniques already available, to reduce the coal to pig iron ratio in India below 1 tonne of coal per tonne of pig iron before 1980/1. This would imply a saving of 20 million tonnes of washed coking coal and some 40 million tonnes of raisings of coking coal as compared with the projections we have made. In view of the very great importance to India of making steel cheaply and competitively and at the same time of conserving coking coal and reducing the surplus of coking-coal by-products, we think that the steel plants should be given very strong encouragement to reduce the coke/pig iron ratio below the more conservative figures here used for purposes of our calculations.

91. For the years beyond 1970/1, we have assumed that there will be strong continuing pressures to adopt all practicable measures to economise coking coal. We expect that the steel industry will have to absorb in its payments for washed coking coal of 16-17% ash content, a substantially larger proportion than at present of the total cost of mining coking coal and delivering it to the washery and that this increasing cost of coal will reinforce the already existing desires to reduce the coal/pig iron ratio. We regard the following ratios for later years as technically possible and have made our estimates on the assumption that they will be achieved.

TABLE 35
ASSUMED COAL/PIG IRON RATIOS

	1962/3	1970/1	1975/6	1980/1
Coal per tonne of Pig Iron	1.43	1.27	1.20	1.10

92. Thus far we have been concerned wholly with the ratios of washed coal of 16-17% ash content to output of pig iron. To see the whole consequence of the demands of the iron and steel industry, it is necessary to have in mind also the ratio of the out-

turn from the washery of 16-17% ash content washed coal to the intake of run of the mine unwashed coking coal. This ratio is not determined by any such considerations of technical efficiency as we have discussed above, but by the natural characteristics of

the coal itself. The available coking coal, as mined, contains to-day an average of about 23% ash. This ash is, in practice, deeply interspersed into the coal itself and the washery operation can serve only to

separate those parts of the coal which are somewhat lower in ash content from those that are somewhat higher. In recent years the ratios of 16-17% ash content coal to total coal washed have been as follows:

TABLE 36
RATIOS OF COKING COAL USABLE BY IRON AND STEEL INDUSTRY
TO TOTAL INTAKE TO WASHERIES

	1960/1	1961/2	1962/3
(I) Total Intake of Raw Coking Coal (million tonnes)	2.83	4.15	5.80
(II) Average Ash Content	23%	23%	23%
(III) Total Output of Coking Coal usable by Iron & Steel Industry (million tonnes)	2.14	3.04	4.24
(IV) Average Ash Content	17%	17%	17%
(V) Total Output of Other saleable coals (Middling, By-products, etc.) (million tonnes)	0.48	0.78	1.08
(VI) Total of Rejects (million tonnes)	0.21	0.33	0.57
(VII) Average Ash Content of Middlings and Rejects	38.7%	39.4%	38.4%
(VIII) Ratio of (III) to (I)	75.6%	73.3%	71.9%
(IX) Ratio of (V) + (VI) to (I)	24.4%	28.7%	28.1%

The above figures show a surprisingly high yield of washed coal. They are explicable only if the ash content of the intaken coal was lower (which is improbable) or if the average ash content of the washed coking coal was more than 17% (as has been said).

93. The present hopes of the Department of Mines and Metals are that, by 1970/1, a yield of 59% of clean coal and 41% of by-product coal may be expected for every ton washed. This would imply that for each 10 million tonnes of clean coal suitable for the Iron and Steel Industry, it would be necessary to mine approximately 17 million tonnes of coal, and there would be approximately 7 million tonnes of middlings or by-product coals for other disposal. The Department also hopes to be able to supplement the washed coking coal from the washeries, temporarily at least, by using 3.3 million tonnes of unwashed coking coal in the coke ovens in 1970/1 and making a further 2.2 million tonnes of coking coal available to merchant cokeries in unwashed form. On this basis the needs of the iron and steel industry and of merchant cokeries can, it is hoped, be met by washing about 39.9 million tonnes of coking coal, yielding 23.5 m. tonnes of washed coal and 16.4 m. tonnes of

by-products, of which it is calculated that 13.5 m. tonnes (excluding rejects) may be available for other consumption. Our further calculations for 1970/1 make these assumptions. The Working Group, after considerable enquiry into these problems with the assistance of the Central Fuel Research Institute, would hesitate, however, to assume a higher yield of clean coal than 55%. The future trend of this ratio depends, as has been said, almost entirely on the average ash content of the coal that is likely to be mined in the future and on the degree of interspersion of the ash in the coal. They fear that, if 3.3 million tonnes of selected highest grade coking coal is supplied directly to the coke-ovens, the average ash content of the coal that goes to the washeries will be raised and bring down below 59% the washery yield of 17% ash content coal or increase the ash content of the washed coal above 17%. If the efficiency of the blast furnaces is not to be impaired, they would expect that in the longer run, if not before 1970/1, it will prove necessary to work on a basis of a 55% yield of washed coal, implying, in terms of 1970/1, the need to wash about 42.7 million tonnes of coal, to yield 23.5 million tonnes of washed

coal and some 19.2 million tonnes of by-products, of which (excluding rejects) some 16.3 million tonnes might be available for other consumption. They also feel doubtful whether it will in the event be practicable to use, as more than a very temporary expedient, unwashed coking coal in the coke-ovens. If it ultimately proves necessary to wash all the coking coal for the iron and steel industry this will raise the available usable by-product coals from 16.3 million tonnes to 19.4 million tonnes. The further implications of this will be discussed in Chapter 11. The Working Group would feel that there were dangers in basing longer term plans, particularly for electricity development too confidently on the hopes of higher washery yields and smaller amounts of by-products than they expect to be practicable in the event.

94. In regard to the forms of energy other than coking coal, it may reasonably be expected that Indian consumption per tonne of iron made (or correspondingly in steel-making and steel rolling) will

increase rather than diminish. The use of electricity in 1960/1 was 417 kWh/tonne of pig. In 1961 the average for the O.E.C.D. area of Europe was 620 kWh/tonne. The Indian figure is about 15% lower than the figure for Germany where conditions are more comparable. In recent years the consumption of electricity per tonne of pig has been falling, but it is assumed that with more manufacture of special steel, in electric furnaces and more mechanisation, consumption per tonne will slowly increase in future.

95. Practically no oil has been directly consumed in actual production processes in the major steel plants hitherto. We do not expect any large changes before 1970/1, but thereafter there may be considerable increases, if one of the oil products is injected to increase the through-put of furnaces and to economise scarce coking-coal.

96. The actual consumption of energy in various forms by the industry in the years 1953/4 to 1960/1 has been as follows:

TABLE 37

TOTAL CONSUMPTION OF ENERGY
BY IRON AND STEEL INDUSTRY
1953/54 TO 1960/1

	(million tonnes of coal replacement)							
	1953/4	1954/5	1955/6	1956/7	1957/8	1958/9	1959/60	1960/1
Coking Coal as such	0.8	0.6	0.5	0.6	0.7	0.9	0.4	1.3
Coke ^(a)	1.5	1.5	1.8	1.7	1.7	2.5	3.1	3.6
Blast Furnace Gas ^(b)	0.4	0.5	0.4	0.4	0.4	0.5	0.7	1.1
Coke Oven Gas	0.6	0.6	0.5	0.5	0.6	0.7	0.9	1.3
Oil Products	0.1	0.1	0.2	0.2	0.2	0.2	0.3	0.4
Electricity	0.8	0.7	0.8	0.8	0.9	1.0	1.4	1.8
Total	4.0	4.0	4.2	4.2	4.5	5.8	6.8	3.5

(a) excluding quantities estimated to have been transformed into blast furnace gas.

(b) excluding quantities used in non-utility electricity generation.

97. In projecting the demands for energy by the industry, it must be borne in mind that in the past a large part of India's requirements of steel have been met by import and that the future demands arise not only from increasing requirements of steel if the total industrial and investment activities are increased, but also from the need to reduce future de-

pendence on imports of ever-increasing quantities and even to reduce imports below present levels in order to increase the capacity to import other things.

98. The total consumption of steel in India in recent years, including any stock formation, has been as follows:

TABLE 38

TOTAL CONSUMPTION OF FINISHED STEEL IN INDIA
(million tonnes)

	1954	1955	1956	1957	1958	1959	1960	1961
Indian Production	1.28	1.30	1.36	1.37	1.33	1.64	2.06	2.90
Import	0.21	0.39	0.89	1.67	1.13	1.04	1.09	1.04
Steel Content of Imported Equipment	0.46	0.67	0.87	1.03	0.76	0.82	0.84	1.05
Total	1.95	2.36	3.12	4.07	3.22	3.50	3.99	4.99
1954 = 100	100	121	160	209	165	180	205	256

99. It will be seen that over this period, the total effective supplies of steel increased by 156%; over the same period the index of industrial production rose by 60%. It is, however, dangerous to attempt to draw any firm inferences from this relationship. Throughout the period, India has been short of steel, and this has in turn had repercussions on the levels of industrial production. What can more safely be argued is that demand had been increasing during this period at almost 15% per year.

100. Present intentions are that finished mild steel production shall increase by 1965-6 to about 5.8 million tonnes and by 1970-1 to about 13 million tonnes. The corresponding levels of production of pig-iron would be 7.6 million tonnes in 1965-6 and 19 million tonnes by 1970-1. The delays in respect of Bokaro are not expected to affect the 1970-1 figure.

101. The planned expansions down to 1970-1 will imply increases of Indian steel production averaging about 18% per annum. The volumes of steel concerned can probably be absorbed at any rate of industrial expansion that is probable, if imports are reduced and more heavy equipment is made in India.

102. In a mature industrialised economy, such as the United Kingdom, steel consumption increases just about proportionately to industrial production. While the special circumstances of India are likely to continue to make the absorption of steel increase considerably faster than industrial production, some slowing down of the rate of growth may be expected as time goes on. The 1975-6 estimated requirement of 22.8 million tonnes of mild steel for home consumption and export, related to the assumed industrial growth of about 10% per year, is based on a detailed input-output analysis, and can reasonably be accepted for that rate of growth; it shows that there is reason to expect continued rapid growth for some time ahead.

103. For the purposes of our estimates, we have assumed, as elsewhere, three alternative rates of growth of the industry corresponding to the alternatives that we have adopted throughout. We set out these estimates, and the amounts of various fuels that would be required for their production in Table 39 below; in the case of coking coal we have added to the requirements sufficient for merchant cokerries which produce coke for use in foundries and similar undertakings.

TABLE 30
PROJECTIONS OF DEMANDS FOR ENERGY
IN THE IRON AND STEEL INDUSTRY⁽¹⁾
(energy in million tonnes of coal replacement)

	1960/1	1970/1	1975/6	1980/1
CASE I (7% Basis)				
Assumed Production				
Pig Iron ⁽²⁾ (million tonnes)	4.4	12.7	21.7	32.1
Finished Steel (million tonnes)	2.4	8.8	14.6	21.6
Use of Energy				
Coking Coal	7.3	19.1	30.9	42.5
Oil Products	0.4	2.5	4.8	8.3
Electricity	1.8	3.8	6.7	10.2
Total	9.5	25.4	42.4	61.0
CASE II (8½% Basis)				
Assumed Production				
Pig Iron ⁽²⁾ (million tonnes)	4.4	14.6	26.8	42.6
Finished Steel (million tonnes)	2.4	10.0	18.0	28.6
Use of Energy				
Coking Coal	7.3	22.0	38.1	56.2
Oil Products	0.4	2.9	6.1	11.1
Electricity	1.8	4.4	8.2	13.4
Total	9.5	29.3	52.4	80.9
CASE III (10% Basis)				
Assumed Production				
Pig Iron ⁽²⁾ (million tonnes)	4.4	19.0	34.0	55.0
Finished Steel (million tonnes)	2.4	13.0	22.8	37.0
Use of Energy				
Coking Coal	7.3	28.7	48.3	72.6
Oil Products	0.4	3.7	7.7	14.3
Electricity	1.8	5.7	10.5	17.3
Total	9.5	38.1	66.5	104.2

(1) including Merchant Cokeries throughout; for which the following estimates of coking coal requirements are included:

CASE I	3.0	4.8	7.1
CASE II	3.5	5.9	8.4
CASE III	4.5	7.5	12.1

(2) the estimated production of pig iron includes that required to meet the demands for foundry iron as well as steel making.

II NON-FERROUS METALS

104. For the non-ferrous metals we hesitate to rely on the very uncertain figures that we have computed from the past data of supplies of coal, oil products and electricity. We prefer to tackle the pro-

blems of estimating the future energy demands more directly. The production of non-ferrous metals has been increasing rapidly in recent years. We show the main constituents below.

TABLE 40
PRODUCTION OF NON-FERROUS METALS
(million tonnes)

	1950/1	1955/6	1960/1
Aluminium	.004	.007	.018
Copper, Lead and Zinc	.008	.010	.013

105. The existing targets for production, which we relate to 10% growth of industrial production, are shown in Table 41 below; we have added estimates

for later years on the basis of the present target and rates of growth.

TABLE 41
PRODUCTION TARGETS FOR NON-FERROUS METALS
(million tonnes)

	1960/1 actual	1970/1	1975/6	1980/1
Aluminium	.018	.240	.360	.700
Copper, Lead and Zinc	.013	.155	.250	.355

106. The greater part of the energy used in the production of non-ferrous metals is used in the form of electricity. In 1950/1 the estimated use of electricity in the production of aluminium was approximately 23,000 kWh per tonne; for copper the use of electricity was 4600 kWh per tonne, during the past ten years there has been a decrease in the coal coefficient. We have assumed that in the future the

electricity coefficient will decrease about 1% per year; in the U.S.A., where the coefficient is currently about 20% less than in India, the annual decrease is about 0.5% a year. Thus, we assume that the gap will be somewhat reduced. On that basis we make the following estimates of kWh per tonne in future years.

TABLE 42
ESTIMATES OF ENERGY CONSUMPTION
PER TONNE OF PRODUCTION OF NON-FERROUS METALS

	1960/1	1970/1	1975/6	1980/1
Electricity (kWh per tonne)				
Aluminium Ingots	23,000	20,000	19,000	18,000
All Other Non-Ferrous Metals	4,600	4,000	3,800	3,600
Coal (tonnes per tonne)				
All Non-Ferrous Metals	1.00	0.62	0.47	0.38

107. On the basis of these assumed inputs, we have estimated the total consumption of energy in the production of non-ferrous metals. The estimate for 10% industrial growth assumes the levels of pro-

duction given in Table 41. For the two other cases we have assumed lower production levels, corresponding to 7% and 8½% industrial growth.

TABLE 43
PROJECTIONS OF DEMANDS FOR ENERGY
FOR PRODUCTION OF NON-FERROUS METALS
(million tonnes of coal replacement)

	1960/1	1970/1	1975/6	1980/1
CASE I (7% Growth Basis)				
Coal	.03	0.1	0.2	0.2
Electricity	.48	2.5	3.5	5.7
Total	.51	2.6	3.7	5.9
CASE II (8½% Growth Basis)				
Coal	.03	0.2	0.2	0.3
Electricity	.48	2.9	4.3	7.5
Total	.51	3.1	4.5	7.8
CASE III (10% Growth Basis)				
Coal	.03	0.2	0.3	0.4
Electricity	.48	3.8	5.5	9.7
Total	.51	4.0	5.8	10.1

III FERTILISERS

108. Of the various fertilisers manufactured, and to be manufactured in India, there are two basic nutrients, (N and P₂O₅) and only the nitrogen or

phosphatic content of the total fertiliser produced is considered in measuring output or setting targets.

109. Production in recent years has been as follows:

TABLE 44
PRODUCTION OF FERTILISERS
1950/1 to 1962/3
(million tonnes)

	1950/1	1955/6	1960/1	1961/2	1962/3
Nitrogenous (million tonnes of N)	.009	.079	.099	.134	.179
Phosphatic (million tonnes of P ₂ O ₅)	.009	.012	.054	.066	.081
Total	.018	.091	.153	.200	.260

110. The targets that we have assumed for future production are as follows:

TABLE 45
TARGETS FOR FUTURE PRODUCTION OF FERTILISERS

	(million tonnes)			
	1960/1	1970/1	1975/8	1980/1
Nitrogenous (million tonnes of N)	0.10	1.75	3.00	5.40
Phosphatic (million tonnes of P_2O_5)	.05	.88	1.70	2.80
Total	.15	2.63	4.70	8.00

Targets for fertilisers are, however, currently under discussion and proposals are being considered which might more than double fertiliser output in 1970/1 and increase considerably the targets for later years. These proposals might make significant differences in the total consumption both of electricity and of petroleum products.

111. The energy required for the production of nitrogenous fertilisers may be divided into two parts: that which is used as a feedstock and that which is needed for steam production and the power requirements of the manufacturing process. The steam (other than that used for electricity production) is required mainly as a heat source. The feedstock is used to produce NH_3 and can be either gas, coal or oil. NH_3 can also be produced with an electrolysis process. In India some NH_3 is at present being produced by this process; though considerably more expensive it can be associated with the production of heavy water for purposes of nuclear energy and research. It is reasonable to assume that the large scale production of nitrogenous fertilisers will be based partly on the use of surplus coke-oven gas, to the limited extent to which this may be available, but

principally on the use of naphtha if, as seems likely, Indian oil refineries have considerable amounts of this to dispose of; we assume that any further energy requirements, including those for steam, will be met mainly from coal supplies. We have assumed that the production of electrolytic nitrogenous fertilisers will continue at about its present level.

112. We have assumed that the phosphatic fertilisers will be made principally by treatment of phosphate rock with sulphuric acid. The energy required for the production of the sulphuric acid is included elsewhere, under the head of heavy chemicals, and is an exothermic process resulting in a heat gain. We have therefore assumed that the energy requirements of phosphatic fertilisers are limited to some 450 kWh per tonne required for manufacturing processes.

113. Making these technical assumptions, we have estimated the total energy requirements of fertilisers, including feedstocks, as shown in Table 46. The estimates for Case III (10% industrial growth) are based on the levels of production shown in Table 45. We give these estimates first in the original units of each of the alternative forms of energy.

TABLE 46
ESTIMATES OF ENERGY CONSUMPTION
IN THE MANUFACTURE OF FERTILISERS
(in original units)

	1960/1	1970/1	1975/8	1980/1
CASE III (10% Basis)				
Coking Coal (million tonnes)	0.3	0.3	0.3	0.3
Non-Coking coal (m. tonnes)	—	1.8	2.4	3.3
Oil (m. tonnes)	—	1.2	2.4	5.3
Electricity (TWh)	0.5	6.5	10.6	17.9
Coal Gas (10^9 m ³)	—	0.3	0.3	0.3
Lignite (m. tonnes)		1.0	1.0	1.0

114. In Table 47 we give the same estimates for Case III (10% Basis) in terms of tonnes of coal replacement. We give estimates also for the energy requirements of fertilisers at the somewhat lower levels of production which would correspond to our Cases I and II. To the extent that it has been possible to assume the use of surplus coke-oven gas from

the iron and steel industry we have not included that here, since the necessary output of coking coal has already been included in the estimates for that industry. But to that extent the figures given in Table 47 underestimate the total requirements of fertiliser production as such.

TABLE 47

**ESTIMATES OF ENERGY CONSUMPTION⁽¹⁾
IN THE MANUFACTURE OF FERTILISERS**
(million tonnes of coal replacement)

CASE I (7% Basis)	1960/1	1970/1	1975/6	1980/1
Production (1960/1 = 100)	100	1080	1950	3310
Coking Coal	0.3	0.3	0.3	0.3
Non-Coking Coal	—	1.0	1.5	2.1
Oil ⁽²⁾	—	5.1	9.9	21.8
Electricity	0.5	3.0	4.7	7.9
Total	0.8	9.4	16.4	32.1
CASE II (8½% Basis)				
Production (1960/1 = 100)	100	1245	2420	4370
Coking Coal	0.3	0.3	0.3	0.3
Non-Coking Coal	—	1.2	1.9	2.8
Oil ⁽²⁾	—	5.9	12.3	28.7
Electricity	0.5	3.5	5.8	10.4
Total	0.8	10.9	20.3	42.2
CASE III (10% Basis)				
Production (1960/1 = 100)	100	1650	3070	5230
Coking Coal	0.3	0.3	0.3	0.3
Non-Coking Coal	—	1.8	2.4	3.3
Oil ⁽²⁾	—	7.8	15.6	34.4
Electricity	0.5	4.8	7.4	12.5
Total	0.8	14.3	25.7	50.5

(1) Excluding surplus coal gas from coke-ovens (see Table 46) and excluding 0.5 m. tonnes coal replacement of lignite in all years after 1960/1.

(2) Mainly naphtha

IV HEAVY CHEMICALS

115. The group of heavy chemicals is composed

mainly of sulphuric acid, soda ash and caustic soda. Production has been as follows:

TABLE 48
PRODUCTION OF HEAVY CHEMICALS
(million tonnes)

	1950/1	1955/8	1960/1	1962/3
Sulphuric Acid	.099	.164	.354	.443
Soda Ash	.045	.081	.145	.222
Caustic Soda	.011	.035	.099	.124
Total	.155	.280	.598	.789

116. We have based our initial estimates on the following assumed production targets, which we take to correspond to the 10% growth basis:

TABLE 49
ASSUMED PRODUCTION TARGETS
FOR HEAVY CHEMICALS
(million tonnes)

	1960/1	1970/1	1975/8	1980/1
Sulphuric Acid	0.354	3.0	8.0	10.8
Soda Ash	0.145	0.7	1.0	1.5
Caustic Soda	0.099	0.8	1.0	1.7
Total	0.598	4.3	8.0	14.0

117. There are considerable difficulties in estimating from available data the amount of energy that will be required in future in this sector of industry. Sulphuric acid production is an exothermic process that yields sufficient heat to raise considerable amounts of steam for electric power generation. We

have assumed that by 1970/1 all sulphuric acid production will use only the electricity it generates internally and that no external energy inputs will be required. We have therefore assumed that the consumption of coal and oil should be related to caustic soda and soda ash production alone as follows:

TABLE 50
ESTIMATED REQUIREMENTS OF COAL AND OIL
FOR PRODUCTION OF HEAVY CHEMICALS
(in original units)

	1960/1	1970/1	1975/8	1980/1
Production of Soda Ash and Caustic Soda (million tonnes)	0.25	1.3	2.0	3.2
Coal Use (m. tonnes)	0.3	1.5	2.2	4.0
Oil Use (m. tonnes)	—	0.4	0.7	1.5

118. Present production plans indicate a changing product mix in which sulphuric acid production is growing far faster than the other heavy chemicals. Since the electricity needs of sulphuric acid pro-

duction are internally produced we would expect the following change in the electricity coefficient, based on the needs of the other heavy chemicals:

TABLE 51
ESTIMATED REQUIREMENTS OF ELECTRICITY
FOR PRODUCTION OF HEAVY CHEMICALS

	1960/1	1970/1	1975/6	1980/1
Production (m. tonnes)	0.6	4.3	8.0	14.0
Use of electricity per Tonne (kWh)	690	540	480	578
Total Electricity Consumption (TWh)	0.4	2.3	3.8	8.1

119. If we assume that the production estimates given in Table 51 correspond to our Case III (10% Basis), and make corresponding estimates for Cases

I and II, the total energy use in heavy chemicals may be estimated (in terms of coal replacement) to be as follows:

TABLE 52
ESTIMATED TOTAL REQUIREMENTS OF ENERGY
FOR PRODUCTION OF HEAVY CHEMICALS
(million tonnes of coal replacement)

	1960/1	1970/1	1975/6	1980/1
CASE I (7% Basis)				
Production Index (1960/1 = 100)	100	472	840	1350
Coal	0.3	1.0	1.4	2.3
Oil	0.5	1.7	2.9	5.8
Electricity	0.4	1.1	1.7	3.3
Total	1.2	3.8	6.0	11.4
CASE II (8½% Basis)				
Production Index (1960/1 = 100)	100	542	1040	1790
Coal	0.3	1.1	1.7	3.1
Oil	0.5	2.0	3.6	7.6
Electricity	0.4	1.2	2.1	4.4
Total	1.2	4.3	7.4	15.1
CASE III (10% Basis)				
Production Index (1960/1 = 100)	100	710	1320	2300
Coal	0.3	1.5	2.2	4.0
Oil	0.5	2.6	4.6	9.8
Electricity	0.4	1.6	2.7	9.8
Total	1.2	5.7	9.5	19.5

CEMENT

120. Production of cement has almost doubled during the period 1953/4 to 1960/1. In the latter year it absorbed about 3½ million tonnes of coal re-

placement. Two different processes are in use: the wet kiln and the dry kiln. The former, though it uses somewhat more energy, is probably the better suited to Indian conditions. By 1970/1 about 90% of all cement will be made by the wet kiln process.

TABLE 53

PRODUCTION OF CEMENT AND CONSUMPTION OF ENERGY (energy in millions of tonnes of coal replacement)								
	1953/4	1954/5	1955/6	1956/7	1957/8	1958/9	1959/60	1960/1
Production of Cement (million tonnes)	4.0	4.5	4.7	5.2	5.8	6.4	7.2	7.9
Consumption of Energy								
Non-Coking Coal	1.1	1.2	1.3	1.4	1.7	1.7	1.8	2.3
Oil Products	—	—	—	—	0.1	0.1	0.1	0.2
Electricity	0.4	0.5	0.5	0.8	0.6	0.8	0.9	0.9
Total	1.5	1.7	1.8	2.0	2.4	2.8	2.8	3.4

121. Partly because of concentration on the wet process, partly as the result of greater use of electricity for mechanisation, the use of electricity per tonne of production has been increasing about 4% a year.

122. Some conversion from coal to oil has been taking place. The rate of substitution has been limited by the preparedness of the Government of India to make oil (an import) available for this purpose. The manufacture of cement represents one of the industrial sectors in which there is rather likely to be increased pressure to make use of some of the lower grades of coal for which it is at present difficult to find sufficient outlets. We have assumed that the allocations of oil products to this industry

will be restricted after 1965/6. So that the proportion of energy derived from oil declines from 45% in 1965/6 to 30% in 1980/1.

123. We have assumed (following the estimates in Notes on Perspective of Development, April 1964) that, on the basis corresponding to the 10% growth of industrial production, output of cement will increase about 4½ times between 1960/1 and 1975/6 and about 6½ times between 1960/1 and 1980/1. We have assumed also somewhat lower growths of production of cement, corresponding to the assumptions of 7% and 8½% growths.

124. On these assumptions, we have estimated the future consumption of energy in the manufacture of cement as follows:

TABLE 54

PROJECTIONS OF CONSUMPTION OF ENERGY IN MANUFACTURE OF CEMENT (million tonnes of coal replacement)				
	1960/1	1970/1	1975/8	1980/1
CASE I (7% Basis)				
Production Index	100	191	288	388
Non-Coking Coal	2.3	4.0	5.5	8.0
Oil Products	0.2	2.2	5.0	5.3
Electricity	0.9	1.8	2.9	4.2
Total	3.4	8.0	13.4	17.5
CASE II (8½% Basis)				
Production Index	100	220	354	524
Non-Coking	2.3	4.8	8.8	10.8
Oil Products	0.2	2.5	6.1	7.1
Electricity	0.9	2.1	3.8	5.8
Total	3.4	9.2	18.5	23.3
CASE III (10% Basis)				
Production Index	100	288	450	675
Non-Coking Coal	2.3	8.0	8.8	13.7
Oil Products	0.2	3.3	7.8	9.1
Electricity	0.9	2.7	4.8	7.2
Total	3.4	12.0	21.0	30.0

VI TEXTILES

125. Though the use of energy per unit of output in textile manufacture is not especially high and the industries concerned are not, in the normal sense, "energy intensive", their scale in India is so great

that a special examination of their requirements is necessary. Over the past few years, the energy consumed by the textile industries has probably been approximately as follows (there is considerable difficulty in estimating at all exactly the past consumption of oil products):

TABLE 55
CONSUMPTION OF ENERGY
IN MANUFACTURE OF TEXTILES
(million tonnes of coal replacement)

	1956/7	1957/8	1958/9	1959/60	1960/1
Non-Coking Coal	1.8	1.8	1.8	1.7	1.8
Oil Products	2.0	2.2	2.4	2.6	2.9
Electricity	2.4	2.4	2.6	2.8	2.9
Total	6.2	6.4	6.8	7.1	7.6

126. The trends of consumption of coal, as such, per unit of product have been downward both

in the jute and in the cotton industries. The trends of consumption of electricity have been upward.

TABLE 56
TRENDS OF ENERGY CONSUMPTION
PER UNIT OF PRODUCT - JUTE TEXTILES
1951 = 100

	1951	1952	1953	1954	1955	1956	1957	1958
Jute Textiles								
Coal	100	89	110	82	77	70	70	52
Electricity	100	100	123	117	125	120	145	157

TABLE 57
TRENDS OF ENERGY CONSUMPTION
PER UNIT OF PRODUCT - COTTON TEXTILES
1951 = 100

Cotton Textiles	1951	1952	1953	1954	1955	1956	1957	1958
Coal	100	100	93	85	89	93	89	89
Electricity	100	91	95	105	110	114	110	123

127. In jute, there has been a decline of coal consumption per unit of product of almost 10% per year; there has been an increase of consumption of electricity per unit of product by about 6½% per year. In cotton, the trends have been less strong: the downward trend of coal consumption per unit in the earlier years did not continue during the last four years covered by the figures; this may possibly have been due to a changing "product mix" and more activity in the finishing sections which are large users of low-grade heat. The increase in electricity consumption per unit of product averaged about 4% per year over these years.

128. The production of mill-made cotton textiles is estimated in the revised Perspective of Develop-

ment to increase by about 2.1 times during the period 1960/1 to 1975/6 - from 4.6 billion metres to 9.5 billion; that of artificial silk materials by about 7 times - from 43 to 300 tonnes. The production of woollen textiles is estimated to increase 10 times. During the same period total consumers' expenditure was assumed to increase about 2.3 times. In terms of consumption per head, that of cotton textiles is estimated to increase by about 75% and consumption generally by 63%; an expenditure elasticity for cotton goods of about 1.2, which in Indian conditions is what one would expect. Production of jute manufactures, less closely related to Indian consumption, is expected to rise about 80%.

129. In the light of the recent trends of energy consumption per unit of output in textiles we think it is reasonable to assume the following coefficients of energy consumption in future. Coal consumption per unit of output is assumed to fall; electricity consumption per unit is expected to rise with increased electrification; oil consumption per unit of output is expected to remain little changed, with total oil

consumption rising about proportionately with output. We assume that, in total, energy consumption per unit of output will change little - the economies in the use of energy being offset by somewhat greater mechanisation and a rather higher ratio of heat-using finishing processes to total production. In Table 58 we set out the assumptions that have been made regarding the energy inputs per unit of output.

TABLE 58
ESTIMATED COEFFICIENTS OF ENERGY USE
PER UNIT OF OUTPUT IN TEXTILES
(1960/1 - 100)

	1960/1	1970/1	1975/8	1980/1
Coal	100	76	66	58
Oil	100	100	100	100
Electricity	100	143	171	208

130. On the basis of these estimates of consumption per unit and of the estimates of volumes of production included in the revised Perspective of Development we have calculated the probable con-

sumption of energy in our Case III (10% basis). We have made corresponding estimates for Cases I and II. The estimates are given in Table 59 below:

TABLE 59
PROJECTIONS OF ENERGY CONSUMPTION
IN THE TEXTILE INDUSTRIES
(million tonnes of coal replacement)

CASE I (7% Basis)	1960/1	1970/1	1975/8	1980/1
Assumed Indices of Production of Textiles	100	115	128	149
Energy Consumption				
Coal	1.8	1.6	1.6	1.6
Oil	2.9	3.3	3.7	4.3
Electricity	2.9	3.3	4.4	6.2
Total	7.6	8.2	9.7	12.1
CASE II (8½% Basis)				
Assumed Indices of Production of Textiles	100	125	158	187
Energy Consumption				
Coal	1.8	1.7	2.0	2.1
Oil	2.9	3.6	4.6	5.7
Electricity	2.9	3.6	5.4	8.2
Total	7.6	8.9	12.0	16.0
CASE III (10% Basis)				
Assumed Indices of Production of Textiles	100	143	202	253
Energy Consumption				
Coal	1.8	2.0	2.5	2.7
Oil	2.9	4.1	5.7	7.3
Electricity	2.9	4.1	8.6	10.5
Total	7.6	10.2	15.0	20.5

VII OTHER INDUSTRIES

131. There remain for consideration the industries other than the six large and energy-intensive industries that we have separately considered. The most important of these are the groups of engineering industries, some of which are "energy intensive" and the group of structural clay, pottery, glass and brickmaking. Because of limitations of evidence and the probable future changes of "product mix", which are difficult to estimate in sufficient detail, we have preferred to deal with these within the single group

of other industries.

132. During the four years that we have been able to analyse in detail, these "other industries" would appear to have absorbed about two-fifths of the total energy used in the whole of Indian industry. Owing to difficulties of allocating the consumption of oil products to individual industries there is some uncertainty about the estimates for the earlier years. In Table 60 we show the probable trends over the four years 1957/8 to 1960/1.

TABLE 60

CONSUMPTION OF ENERGY
IN "OTHER INDUSTRIES" (1)

(million tonnes of coal replacement)

	1957/8	1958/9	1959/60	1960/1
Total Energy used in All Industries	28.4	30.9	32.1	38.5
Energy consumed in "Other Industries" Total	13.2	13.5	12.9	15.5
Of which: Coal	8.2	8.0	4.4	5.0
Oil Products	4.0	4.0	4.5	5.9
Electricity	3.0	3.5	4.0	4.6
Ratio of Consumption of "Other Industries" to All Industries (%)	47	44	40	40

(1) Also including structural clay product and mining and quarrying.

133. The six industries already considered represent, in terms of the index of industrial production, about 48% of the total weights of all industry. Their average annual rate of growth, in the cases corresponding to 10% total assumed growth of all industry (Case III), is 10.6%. The remaining "other industries", representing 52% of all industry, would in these circumstances require to grow by an average of about 9.4% per year. For the case corresponding to the 10% total growth of industry as a whole that rate has been assumed for all "other industries". In the cases corresponding to an assumed 7% growth of all industry (Case I), the average annual rate of growth of the separately treated industries is assumed to be 7.7%. The corresponding

average growth of "other industries" would be about 6.5%; that rate has been assumed again for the estimation of energy demand in this case in all "other industries". The comparable rates in Case II are 9.2% for the selected industries and 8.0% for "other industries".

134. It is impossible to make detailed technical judgments of the probable trends in the division of demand between different energy sources for the whole group of "other industries". A continuation of the trends of 1957/8 to 1960/1 away from the direct use of coal and towards greater use of oil products and electricity is expected. The following percentage divisions of the total energy consumption in other industries have been assumed.

TABLE 61

**ASSUMED DISTRIBUTION OF ENERGY CONSUMPTION
IN "OTHER INDUSTRIES" BETWEEN SOURCES OF ENERGY**

	(percentages)			
CASE III	1960/1	1970/1	1975/6	1980/1
Coal	32.3	24.0	20.0	15.0
Oil	38.1	41.0	43.0	45.0
Electricity	29.6	35.0	37.0	40.0
Total	100.0	100.0	100.0	100.0

135. On these bases the following estimates of energy demand in "other industries" have been made

TABLE 62

**PROJECTION OF CONSUMPTION OF ENERGY
IN "OTHER INDUSTRIES"**

(million tonnes of coal replacement)

	1960/1	1970/1	1975/6	1980/1
CASE I (7% Growth)				
Total Consumption of Energy	15.5	27.3	39.8	54.8
Of which:				
Coal as such	5.0	6.5	8.0	8.2
Oil Products	5.9	11.2	17.1	24.6
Electricity	4.6	9.6	14.7	21.0
CASE II (8% Growth)				
Total Consumption of Energy	15.5	31.8	49.1	72.2
Of which:				
Coal as such	5.0	7.6	9.8	10.8
Oil Products	5.9	13.1	21.1	32.5
Electricity	4.6	11.1	18.2	28.9
CASE III (10% Growth)				
Total Consumption of Energy	15.5	35.5	60.9	93.5
Of which:				
Coal as such	5.0	8.5	12.2	14.0
Oil Products	5.9	14.8	28.2	42.1
Electricity	4.6	12.4	22.5	37.4

SUMMARY - ALL INDUSTRY

136. We now summarise all our estimates of industrial consumption of energy. For convenience

we bring together all the estimates made on the three different assumed rates of growth in separate tables:

TABLE 63
TOTALS OF PROJECTIONS OF ENERGY CONSUMPTION
IN INDUSTRY
(million tonnes of coal replacement)

CASE I	1960/1	1970/1	1975/6	1980/1
Assumed 7% Growth of Industrial Production				
Iron and Steel	9.5	25.4	42.4	61.0
Non-Ferrous Metals	0.5	2.6	3.7	5.9
Fertilisers	0.8	9.4	16.4	32.1
Heavy Chemicals	1.2	3.8	6.0	11.4
Cement	3.4	8.0	13.4	17.5
Textiles	7.6	8.2	9.7	12.1
Other Industries	15.5	27.3	39.8	54.6
Total	38.5	84.7	131.4	194.8
CASE II				
Assumed 8% Growth of Industrial Production				
Iron and Steel	9.5	29.3	52.4	80.7
Non-Ferrous Metals	0.5	3.1	4.5	7.8
Fertilisers	0.8	10.9	20.3	42.2
Heavy Chemicals	1.2	4.3	7.4	15.1
Cement	3.4	9.2	16.5	23.3
Textiles	7.6	8.9	12.0	16.0
Other Industries	15.5	31.8	49.1	72.2
Total	38.5	97.5	162.2	257.3
CASE III				
Assumed 10% Growth of Industrial Production				
Iron and Steel	9.5	38.1	66.5	104.2
Non-Ferrous Metals	0.5	4.0	5.8	10.1
Fertilisers	0.8	14.3	25.7	50.5
Heavy Chemicals	1.2	5.7	9.5	19.5
Cement	3.4	12.0	21.0	30.0
Textiles	7.6	10.2	15.0	20.5
Other Industries	15.5	35.5	60.9	93.5
Total	38.5	119.8	204.4	328.3

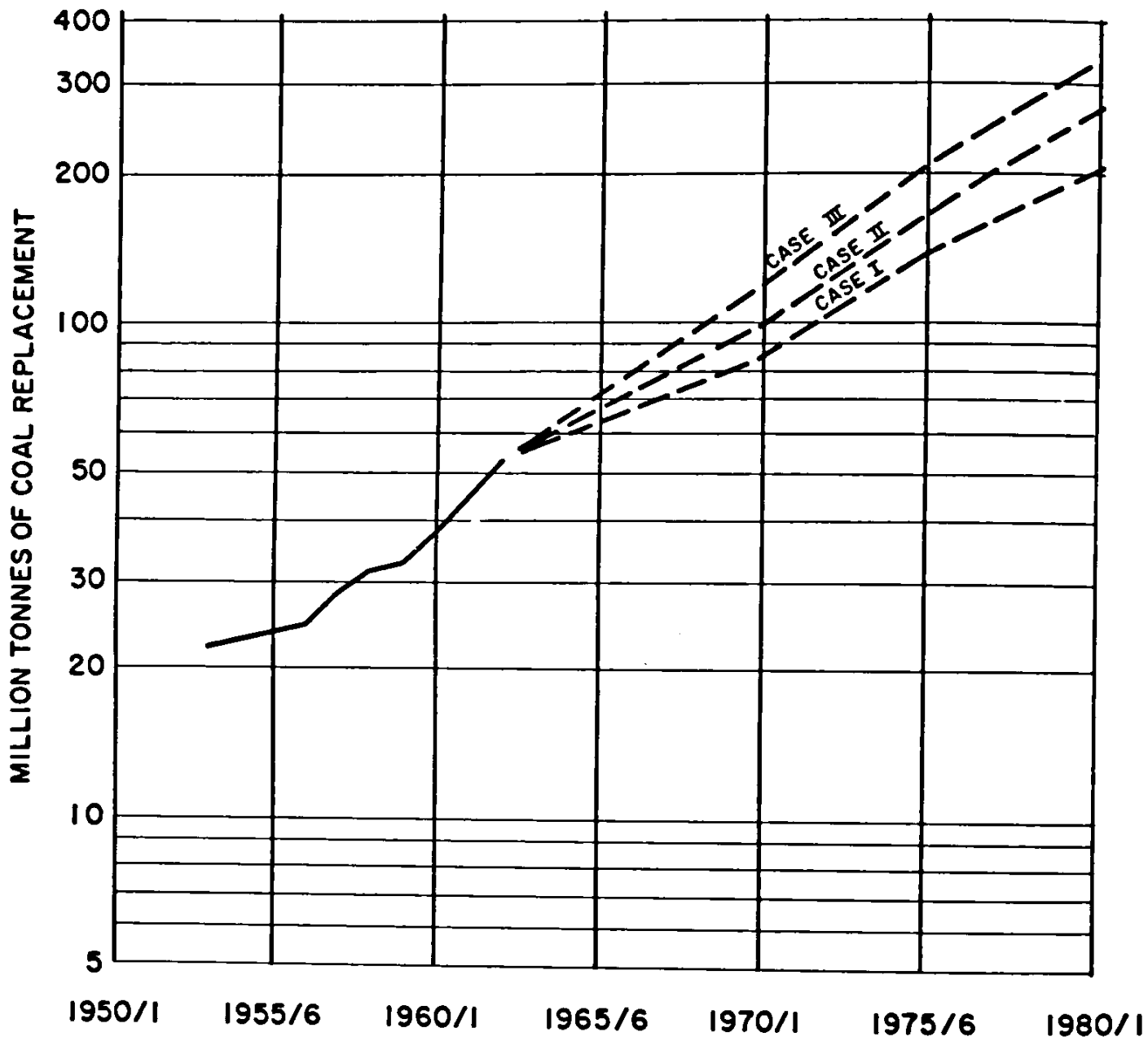

FIGURE 3-ESTIMATED DEMAND FOR ENERGY IN INDUSTRIAL SECTOR

TABLE 84
SUMMARY OF PROJECTIONS OF DEMANDS IN
INDUSTRY FOR DIFFERENT TYPES OF ENERGY:
(million tonnes of coal replacement)

	1960/1	1970/1	1975/8	1980/1
CASE I				
7% Growth Basis				
Coking Coal as such (a)	8.4	19.4	31.2	42.8
Non-Coking Coal as such	8.6	14.2	18.2	22.6
Oil Products	9.9	26.0	43.4	70.1
Electricity	11.6	25.1	38.6	59.3
Total	38.5	84.7	131.4	194.8
Oil Products (original Units)	1.5	4.0	6.7	10.8
Electricity (TWh)	11.8	35.9	55.1	84.8
CASE II				
8% Growth Basis				
Coking Coal as such (a)	8.4	22.3	38.4	58.5
Non-Coking Coal as such	8.6	16.4	22.4	29.7
Oil Products	9.9	30.0	53.8	92.7
Electricity	11.6	28.8	47.6	76.4
Total	38.5	97.5	182.2	257.3
Oil Products (original Units)	1.5	4.6	8.3	14.3
Electricity (TWh)	11.8	42.6	67.9	112.0
CASE III				
10% Growth Basis				
Coking Coal as such (a)	8.4	29.0	48.6	72.9
Non-Coking Coal as such	8.6	19.8	28.2	38.1
Oil Products	9.9	36.1	67.6	117.0
Electricity	11.6	34.9	60.0	90.3
Total	38.5	119.8	204.4	328.3
Oil Products (original units)	1.5	5.6	10.4	18.0
Electricity (TWh)	11.8	48.9	85.8	128.0

(a) Washed coking coal of 16-17% ash content.

CHAPTER 7

Energy Use in Agriculture

137. Agriculture has absorbed in India hitherto relatively small amounts of commercial energy. The main sources of energy, other than human effort, have, of course, been provided by animals and by the non-commercial sources of energy. The use of the latter has been included in our estimates of the do-

mestic sector. In recent years there has, however, been an appreciable increase in the consumption of commercial forms of energy. The total rose from about 1.7 million tonnes of coal replacement in 1953/4 to about 3.1 million in 1960/1. The recent trend is shown in Table 65.

TABLE 65
USE OF COMMERCIAL ENERGY IN AGRICULTURE
(Million tonnes of coal replacement)

	1953/4	1954/5	1955/6	1956/7	1957/58	1958/9	1959/60	1960/1
Petroleum Products as such.	1.3	1.4	1.5	1.7	1.9	2.0	2.0	2.1
Coal as such	0.2	0.2	0.3	0.3	0.3	0.4	0.3	0.2
Electricity	0.2	0.2	0.3	0.3	0.6	0.6	0.7	0.8
Total	1.7	1.8	2.1	2.3	2.8	3.0	3.0	3.1

138. It will be seen that over this period the use of petroleum products has increased by about 60%; the use of electricity has increased four-fold. The amount of coal required as such rose temporarily but has declined to about the original level. The total consumption has risen by about 80%, equivalent to about 9% a year.

139. In the future we must expect a continuation

of much the same trend as tractors come into somewhat more general use and electricity becomes available and more generally used for pumping and irrigation.

140. We believe that it may be proper to assume that agricultural use of commercial energy will increase approximately as follows:

TABLE 66
PROJECTED USE OF COMMERCIAL ENERGY
IN AGRICULTURE
(Million tonnes of coal replacement)

	1960/1	1970/1	1975/6	1980/1
Petroleum Products as such	2.1	5.6	8.7	12.9
Coal as such	0.2	0.2	0.2	0.2
Electricity	0.8	3.9	8.1	9.1
Total	3.1	9.7	15.0	22.2

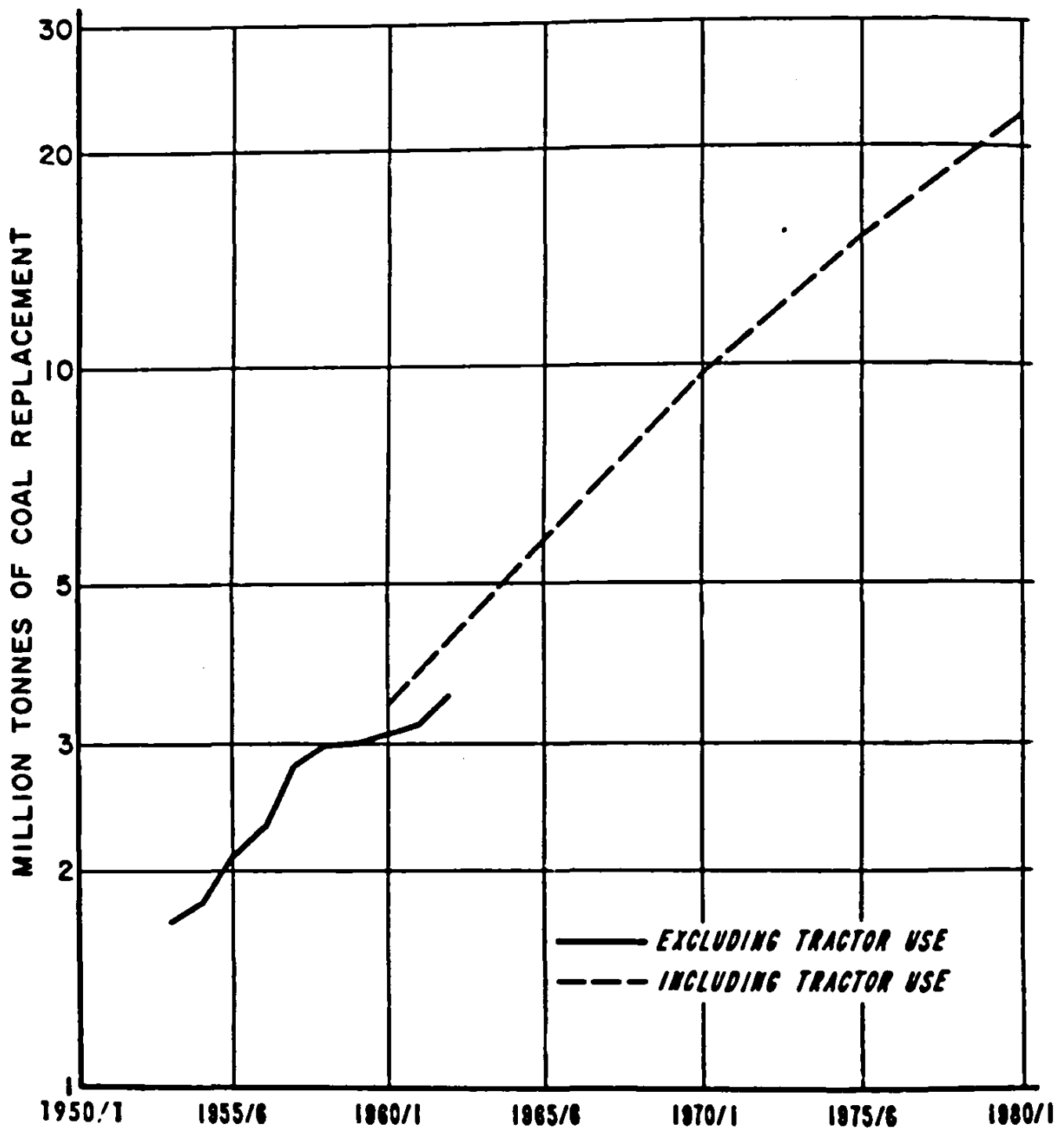

FIGURE 4 — ESTIMATED DEMAND FOR ENERGY IN AGRICULTURE 1953/4 TO 1980/1

141. We have not thought it proper to make alternative assumptions for different rates of growth. Indeed one might very well see a more active policy to mechanise agriculture if it turned out that agricultural production was lagging and reducing the

national growth rate.

142. The regional distribution of energy consumption in agriculture in 1960/1 is shown in Table 67.

TABLE 67
REGIONAL DISTRIBUTION OF ENERGY USE
IN AGRICULTURE
1960/1
(Million tonnes coal replacement)

	Non-coking Coal	Oil Products	Electricity	Total
All India	0.19	2.01	0.84	3.04
Eastern	0.02	0.20	0.02	0.24
Northern	0.10	0.28	0.08	0.44
Central	0.07	0.39	0.20	0.68
Western	-	0.59	0.04	0.63
Southern	-	0.44	0.50	0.94
Assam	-	0.13	-	0.13

143. For purposes of our estimates we have assumed that the regional distribution of energy re-

quirements in agriculture in 1970/1 will be approximately as follows:

TABLE 68
ESTIMATED REGIONAL DISTRIBUTION
OF ENERGY USE IN AGRICULTURE
1970/1
(Million tonnes coal replacement)

	Non-coking Coal	Oil Products	Electricity	Total
All India	0.20	5.80	3.90	9.70
Eastern	0.02	0.84	0.11	0.77
Northern	0.10	0.85	0.45	1.40
Central	0.08	1.02	1.01	2.11
Western	-	1.83	0.18	2.01
Southern	-	0.85	2.15	3.00
Assam	-	0.41	-	0.41

CHAPTER 8

The Domestic Sector

I. RECENT TRENDS

144. The domestic sector presents quite exceptional problems, both in terms of forecasting and in terms of the practical solutions of energy supply. A very large proportion of all the energy consumed in this sector (in terms of the replacement ratios that we have used, as much as 88% in 1960/1) comes from the great traditional noncommercial sources of energy - cow-dung, firewood and vegetable waste. And regarding these sources, the statistical evidence has in the past been very insufficient.

145. Fortunately, as it turns out, for our Survey, a large inquiry recently conducted by the National Council of Applied Economic Research into the expenditures and savings of rural families has brought together a great deal of important information regarding the amounts of various fuels used and the expenditures on them, where they were not freely available, by a stratified sample of about 9000 rural

households, distributed over the whole of India. We have made great use of the results of that inquiry, as well as of an earlier inquiry, made by the same body, into the energy consumption of families in the three largest cities - Delhi, Bombay and Calcutta.

146. This rural sample inquiry has revealed a much larger dependence of rural households on firewood and a somewhat smaller dependence on cow-dung than has usually been assumed in the past. The longer-term implications of this, which we shall consider later, are fully as serious as those which had been posed by the slightly greater assumed dependence on cow-dung.

147. In Table 69 we present the best estimates that we can make on the basis of the available data of the use of commercial and non-commercial sources of energy for domestic purposes. We give these first in the original units of the energy sources concerned.

TABLE 69
ESTIMATES OF RECENT TRENDS
OF DOMESTIC CONSUMPTION OF ENERGY

	1953/4	1958/9	1960/1	1962/3
Commercial Sources				
Oil Products (Million tonnes)	1.2	1.7	2.0	2.4
Soft Coke (Million tonnes)	1.5	2.1	1.9	1.7
Electricity (TWh)	0.7	1.2	1.5	1.7
Non-Commercial Sources				
Firewood and Charcoal (a) (Million tonnes)	86.3	92.7	100.0	101.6
Dung Cakes (Million tonnes)	46.4	52.7	54.0	54.9
Waste Products (Million tonnes)	28.4	29.9	30.7	31.1

(a) Charcoal in terms of firewood to produce it.

148. In Table 70 we present the same data in terms of millions of tonnes of coal replacement. In order that, in the literal sense of the words, the amounts of coke or kerosene shall be those which would replace in actual practice the amounts of firewood or dung concerned, the replacement ratios

take account of the different types of stove normally used and of the different thermal efficiencies with which the different fuels are normally consumed. The replacement ratios that we have used for the non-commercial sources of energy are based on the amounts of each non-commercial fuel required to re-

place a tonne of coke and on the amount of coal required to make that coke. The ratios employed have been as follows:

1 tonne of soft coke	requires for manufacture and thus = 1.50 tonnes of coal
1 tonne of dried dung	replaces 0.27 tonnes of soft coke = 0.40 tonnes of coal
1 tonne of firewood	replaces 0.63 tonnes of soft coke = 0.95 tonnes of coal
1 tonne of waste products	replaces 0.63 tonnes of soft coke = 0.95 tonnes of coal

1 tonne of kerosene replaces 4.33 tonnes of soft coke = 6.50 tonnes of coal

149. Table 70 thus presents the same data as was included in Table 69 in terms of tonnes of coal replacement. It will be seen that, of the total of energy used in the domestic sector in 1962/3, about 57% was represented by firewood, about 13% by dung cakes, and about 18% by waste products. The newer sources of commercial energy represented only about 12% in total; kerosene accounted for about 9% and domestic use of electricity for only 1%.

TABLE 70
ESTIMATES OF RECENT TRENDS
OF DOMESTIC CONSUMPTION OF ENERGY
(Million tonnes of coal replacement)

	1953/4	1958/9	1960/1	1962/3
Commercial Sources				
Oil Products	7.7	10.7	12.9	15.7
Soft Coke	2.2	3.1	2.8	2.6
Electricity	0.7	1.2	1.5	1.7
Total	10.6	15.0	17.2	20.0
Non-Commercial Sources				
Firewood and Charcoal (a)	82.2	88.3	95.3	98.8
Dung Cakes	18.6	21.1	21.8	22.0
Waste Products	25.1	28.4	29.2	29.8
Total	125.9	137.8	146.1	148.4
Grand Total	136.5	152.8	163.3	168.4

(a) Charcoal in terms of firewood to produce it.

150. It is of very great practical importance to be able to judge what has been happening in recent years to domestic consumption as a whole and to its composition. It has commonly been said that kerosene has in recent years been largely substituted for the non-commercial forms of energy.

151. Regarding recent trends of consumption of domestic energy there are no satisfactory direct statistical data. There are no earlier inquiries, comparable to those that we have used, which can throw certain light onto the trends. We do, however, have known data for the past nine years of the consumption in the domestic sector of the various commercial fuels - soft coke, kerosene and electricity. From their variations and from reasonable assumptions regarding the total consumption in the domestic sector, certain inferences can be drawn.

152. In Annex 1 we have set out in more detail the attempts that have been made to analyse the probable trends. Two alternative assumptions have been made: first, that total consumption of energy per head in the domestic sector has remained constant throughout the past nine years and total consumption has risen only in proportion to the increases of population; second, that the consumption per head in the domestic sector has risen by about 4½% during the nine year period - a rate that would about correspond to the income elasticity disclosed in the survey of energy consumption in the big cities.

153. The latter assumption seems to us the more probable one, and the estimates based on it have been used in our further analysis. It is supported by the following considerations. Even today, in the areas covered by the rural survey and corresponding

to the consumption habits of 365 millions out of the total population of about 445 millions in 1962/3, less than 4% of all kerosene bought was used for cooking; in the big cities, taken as a group (and greatly influenced by the widespread use of kerosene for cooking in Bombay), about 60% of kerosene bought in 1958, when that survey was made, was bought for cooking; but the total for the country represented only about 9% of all kerosene sold. Thus the greater part of the increase of 73% in consumption per head of kerosene and almost the whole of the 106% increase of the consumption per head of electricity since 1953/4, represented an addition to expenditure on lighting or on fans, air-conditioning and the like and not a substitution for the use of non-commercial fuels in cooking. One can at the same time set an upper limit to the probable increase of domestic consumption per head. The increase of consumption of kerosene and electricity beyond that necessary to balance the growth of population would represent an increase of a little over 7% in energy consumption per head. A part of this, however, was almost certainly used to replace non-commercial energy for cooking; thus the net increase of all consumption per head in all forms of energy, commercial and non-commercial, was likely to have been less than 7%.

154. On the basis of these estimates, total consumption of energy in the domestic sector is calculated to have increased over the nine years 1953/4 to 1962/3 by about 31.8 million tonnes. Of this, 9.4 million tonnes represents the increased consumption of commercial fuels; 8.0 million of this, as measured in tonnes of coal replacement, has taken

the form of kerosene, (which has increased its share in the total market from 5.6% to 9.7%). At the same time there would appear to have been a large increase, estimated at 22.4 million tonnes, in the consumption of non-commercial fuels. These have probably covered, that is to say, a little over two-thirds of the total increase. Any "substitution" of kerosene for non-commercial fuels has taken place only in the somewhat esoteric sense that the share of kerosene in the growing market is greater; it has not implied a reduction of the probable consumption of non-commercial fuels - far from it.

155. The consumption patterns of the rural and urban areas are markedly different. There are at the same time wide differences between different parts of the country. The rural areas depended in 1962/3 to the extent of 91% on non-commercial fuels; the biggest cities depended only to the extent of one-third on non-commercial fuels and to the extent of two thirds on commercial fuels; the smaller towns, about which less information is available, probably consumed about one fifth of their energy in commercial forms and four-fifths in non-commercial.

156. In terms of the differences between urban and rural consumption, our estimates for 1962/3 show the following patterns; we must emphasise that the pattern of consumption in the smaller towns is very much a matter of surmise, built on the known totals for the commercial fuels and the probable consumption per head that is consistent with the average of the rural areas on the one hand and the big cities on the other.

TABLE 71
ESTIMATED DOMESTIC CONSUMPTION PATTERNS
IN URBAN AND RURAL AREAS
1962/3

	(Million tonnes of coal replacement)							
	Delhi Bombay Calcutta		Other Urban Areas		Rural Areas		Total	
Commercial Fuels		%		%		%		%
Kerosene	1.20	29.9	3.80	13.9	10.70	7.8	15.70	9.3
Soft Coke	0.90	22.4	0.40	1.5	1.30	0.9	2.60	1.6
Electricity	0.58	14.5	0.89	3.3	0.23	0.2	1.70	1.0
Total	2.68	66.8	5.09	18.7	12.23	8.9	20.00	11.9
Non-Commercial Fuels								
Firewood & Charcoal	1.25	31.2	14.18	51.9	81.33	59.4	96.76	57.4
Dung Cakes	0.04	1.0	3.42	12.5	18.50	13.5	21.96	13.1
Waste Products	0.04	1.0	4.62	16.9	24.96	18.2	29.62	17.6
Total	1.33	33.2	22.22	81.3	124.79	91.1	148.34	88.1
Grand Total Consumption per Head ⁽¹⁾ (tonnes)	4.01	100.0	27.31	100.0	137.02	100.0	168.34	100.0
					0.38		0.38	

(1) For purposes of international comparison it may be useful to have in mind that, on the basis of the normal measurements of the kilocalorie content of all fuels concerned, and in terms also of coal with the average kilocalorie content of 7000 kcal/kg, used in the O.E.E.C. Report TOWARDS A NEW ENERGY PATTERN IN EUROPE, the average domestic consumption per head may be estimated to be as follows in terms of primary energy requirements:

big cities	0.24 tonne
other urban areas	0.26 tonne
rural areas	0.26 tonne
all India	0.26 tonne

157. There are wide differences also between the different regions. In Table 72 we present the best

estimates we can make of the regional distribution of domestic consumption in 1960/1.

TABLE 72
REGIONAL DISTRIBUTION OF ENERGY CONSUMPTION
IN THE DOMESTIC SECTOR
1960/1

Regions	(Million tonnes of coal replacement)							Total
	Coking Coal	Non-Coking Coal	Oil Products	Electricity	Firewood	Dung Cakes	Waste Products	
All India	1.31	1.56	12.90	1.50	95.30	21.60	29.20	163.37
Eastern	0.80	0.93	2.66	0.42	21.90	4.54	6.60	37.84
Northern	0.23	0.30	1.09	0.21	10.20	3.05	3.20	18.28
Central	0.12	0.15	1.82	0.17	17.80	7.34	7.10	34.50
Western	0.15	0.16	3.65	0.33	15.70	2.26	4.00	26.25
Southern	0.01	0.01	3.14	0.36	25.50	4.19	7.40	40.61
Assam	—	0.01	0.52	0.01	4.20	0.22	0.90	5.86

158. It will be seen from Table 73 that in general the consumptions per head of the various regions lie fairly close - in some cases very close indeed - to the national average. Only the Western Region, and the small Region of Assam, are at all considerably above the average. Only the Central Region is at all notably below the average. The differences between the rest are within the probable errors of the estimates themselves. The regions differ appreciably, however, in their dependence on commercial energy. At the top of the scale is the Western Region, which in and around Bombay de-

pends heavily in kerosene for cooking. The Eastern Region has a high dependence on commercial energy but, somewhat surprisingly, is not high in its total use of energy. At the bottom of the scale is the Southern Region, where, possibly as a consequence of climate, a slightly lower than average consumption per head of non-commercial fuels is associated not with a high but a low relative consumption of commercial fuels. The Central Region, lowest of all regions in average consumption per head, was low also in 1960/1 in the ratio of commercial energy per head.

TABLE 73
DOMESTIC CONSUMPTION, TOTAL AND PER HEAD,
IN DIFFERENT REGIONS
1960/1
(tonnes of coal replacement)

	Commercial Energy (total) (Million tonnes)	Commercial Energy per head (tonnes)	Non-Commercial Energy (total) (million tonnes)	Non-Commercial Energy per Head (tonnes)	Total Energy per head (tonnes)	Ratio of Commercial to Total Energy %
All India	17.27	0.040	146.10	0.335	0.375	10.6
Eastern	4.80	0.048	33.04	0.333	0.381	12.8
Northern	1.83	0.038	16.45	0.341	0.379	10.2
Central	2.26	0.021	32.24	0.304	0.325	6.7
Western	4.29	0.071	21.96	0.368	0.437	16.4
Southern	3.52	0.032	37.09	0.337	0.371	8.7
Assam	0.54	0.042	5.32	0.408	0.451	9.2

159. The difficulties of making forecasts for the future spring largely from difficulties in interpreting the full implications of the present pattern of consumption. Today India consumes in total some 102 million tonnes of firewood (measured in original units), equivalent to about 0.23 tonne per head, each year. The complete recorded yield of all timber of all kinds cut in the forests of India amounts to 15.6 million cubic metres, equivalent to about 11.4 million tonnes. Of this, naturally, only a fraction is available for firewood and charcoal making. The official statistics for 1957-8 show the equivalent of 8 million tonnes available for this purpose—only some 8% of the national consumption of firewood. Even if this greatly underestimates what actually comes from the forests, it is clear that the greater part of the firewood of India comes from the cutting of trees in open country or in areas not technically defined as forests and regarding which no statistics exist. No-one knows what may be the consequences to India of the continuous cutting of timber on the scale on which it has been going on now for many decades. No-one knows whether the present rate of cutting can be maintained only by progressive denudation of the Indian country-side.

160. We have attempted to discover how likely it may be that the growth of timber replaces the annual consumption. If one could assume that there was a widespread campaign to plant, for cutting as firewood, large areas with the quickly growing Australian blue gum (eucalyptus tree), we understand that a hectare of such trees, on a ten-year growing cycle will yield the equivalent of 6.2 tonnes a year. The present 102 million tonnes of consumption would require about 16 million hectares; a consumption of 160 million tonnes, such as might be expected in another 15 years, (see estimate in coal replacement in paragraph 179 below) would require about 25 million hectares. A village of 500 persons would need about 28 hectares to provide for it; a small town of 10,000 inhabitants about 570 hectares.

161. The total area required to meet India's prospective firewood requirements is formidably large, even on the optimistic assumption that firewood yields per acre can everywhere be raised to the standards achieved with these quick growing timbers under experimental conditions. The total present

area of forests technically classified as such is about 52 million hectares and that of culturable waste is recorded as about 21 million hectares. But of the forests about one quarter are defined as inaccessible for commercial purposes. And, as has been said in para. 159, the present yield of firewood per hectare, even if allowance is made for unrecorded cutting, is very far below the level assumed in the above calculation. It would be a task of many years and involve very strenuous efforts to raise the out-turn of the present forests to the point where the growth of timber, not only for firewood but also for all the other purposes for which India needs it, was adequate to cover consumption and to bring to a halt the progressive denudation which is now taking place. It will require, beyond question, the assignment to this purpose of considerable areas of more accessible land.

162. In the absence of a vigorous campaign to increase timber growing, it is clear that within a reasonably short period of time the nation will have to depend increasingly on other forms of energy and will, indeed, be forced to do so by progressive denudation.

163. The consumption of cattle dung now estimated is, as has been said, slightly smaller than had earlier been supposed. About 200 million cattle produce annually, it has been estimated, about 1160 million tonnes of wet dung, equivalent to about 230 million tonnes of dry dung. The 55 million tonnes used as fuel in the domestic sector would represent a recovery and use for this purpose of about 25%. It has long been the objective of Indian agricultural experts to secure more use of dung as a fertiliser and less as a fuel. Any continuing increase of use for the latter purpose would be regrettable.

164. The contribution of vegetable wastes of many different forms to the total of fuels is an important one, amounting to some 31 million tonnes, or about 18% of the whole. This is a source of energy that neither denudes the country side nor seriously impoverishes the soil and its use to supplement and relieve other forms of energy is welcome. The supply of vegetable waste may be expected to increase roughly in proportion to agricultural output and may double by 1975/6 if agricultural objectives are fulfilled.

II. PROJECTIONS OF FUTURE DEMAND

165. It is convenient to make the projections for the five year periods between 1960/1 and 1980/1 in two stages. Allowances must be made both for the effects of growth of population and for the effects of any increase in domestic energy consumption that is likely to be contingent on the increase of income and expenditure per head. The effects of population growth

will be considered first.

166. In Table 74 there are presented working estimates of total population growth, slightly modified from those set out in the Third Five Year Plan, and extended to 1981. These have been divided between urban and rural populations in accordance with the apparent trends of recent years.

TABLE 74
ESTIMATES OF FUTURE POPULATION

	1961	1971	1976	1981
Estimates (millions)				
Total	436	553	623	702
Urban	78	106	123	143
Rural	358	447	500	559
Assumed Division (percent)				
Total	100.0	100.0	100.0	100.0
Urban	17.8	18.9	19.3	19.8
Rural	82.2	81.1	80.7	80.2

167. Using approximately 0.39 tonnes per head for urban areas and 0.38 tonnes per head for rural areas, the total domestic energy consumption in each

of the above years, before making any allowance for higher consumption per head or greater efficiency in use, would be as follows:

TABLE 75
ESTIMATES OF DOMESTIC ENERGY CONSUMPTION ON THE BASIS OF CONSTANT CONSUMPTION PER HEAD (Million tonnes of coal replacement)

	1960/1	1970/1	1975/6	1980/1
Urban	30.4	41.3	48.0	55.6
Rural	132.9	168.6	191.8	215.1
Total	163.3	210.9	239.8	270.7

168. It is less easy to judge what allowance should be made for the effects of higher income per head. In the conditions of 1958, consumption per head increased (so far as can be judged from the

urban survey of the National Council of Applied Economic Research) hardly at all with increasing income at income below about Rs. 300. Above that level there was apparently an income elasticity of

about 0.4; a 10% increase of income and expenditure was likely to be associated with about 4% increase of expenditure on domestic energy. This upper range within which there were evidences of higher consumption with higher incomes affected about one quarter of total urban consumption.

169. In practice such income elasticity would appear to have been associated in 1958 with the use of electricity and other commercial forms of energy rather than with non-commercial forms, and probably also with the actual availability of electricity. Clearly the availability of electricity is to be expected at lower income levels in 1981 than in 1958, and direct inference from the 1958 data is dangerous.

170. By 1981 it is hoped that real consumption per head may be nearly doubled and electricity will

be more widely available in rural as well as in urban areas. If so, it may be reasonable to regard about 50% of the urban energy consumption as potentially falling by then into the area in which consumption rises with income. At the same time a smaller fraction of rural consumption is likely to be similarly situated. It will be assumed that this is true of 30% of rural consumption by 1981 and smaller proportions in earlier years. With more consumer durables using energy, the income elasticity may itself be higher; 0.5 has been assumed.

171. On the basis of these perhaps, somewhat conservative assumptions the following correction factors have been calculated to allow for the effects on increasing consumption per head.

TABLE 76
ESTIMATED PROVISIONS FOR INCREASED CONSUMPTION OF
DOMESTIC ENERGY PER HEAD
(1981 Consumption = 100)

	1960/1	1970/1	1975/6	1980/1
Urban	100	110	117	125
Rural	100	108	110	115

172. If the above provisions for higher domestic energy consumption per head are applied to the esti-

mates at constant consumption in Table 75, the following final estimates emerge.

TABLE 77
ESTIMATES OF DOMESTIC ENERGY CONSUMPTION WITH
INCREASING CONSUMPTION PER HEAD
(Million tonnes of coal replacement)

	1960/1	1970/1	1975/6	1980/1
Urban	30.4	45.4	56.9	69.5
Rural	132.9	179.8	211.0	247.4
Total	163.3	225.2	267.9	316.9
1981 = 100	100	138	164	194

173. In normal circumstances it would be proper to include also an estimate for the increasing efficiency in the use of the energy and the declining input of primary energy per unit of final product. In relation to domestic energy demands in this case no provision will be made for this. The calculation in terms of the coal replacement ratio does in effect imply that, if transfer is made from non-commercial sources to commercial, an economy of energy, as usually measured, will have been achieved. While

there is likely to be some downward trend in the input of coal per kWh used in the domestic sector, account is taken of this in another section of this survey.

174. It can be seen that the present rough estimates suggest that the domestic demand for energy may increase by about 95% during the next twenty years, and require an addition of more than 150 million tonnes of coal replacement to meet it.

III. FUTURE SOURCES OF DOMESTIC ENERGY

175. The sources from which these increased demands may be met involve matters of policy at least as much as of forecasting. We begin, however, by setting out certain minimum considerations.

176. We have estimated that, as a result of higher consumption of energy per head, the demands

will increase by an additional 14.3 million tonnes by 1970/1 and an additional 46.2 million tonnes of coal replacement by 1980/1 (see Table 75 and 77 above). Almost the whole of this additional demand is likely to be a demand for commercial sources of energy, principally electricity and kerosene. On the basis of population growth, moreover, the demands for these two will increase by about 3.9 million tonnes by 1970/1 and 8.8 million tonnes by 1980/1.

Table 78

MINIMUM INCREASE OF DEMANDS FOR KEROSENE AND ELECTRICITY IN THE DOMESTIC SECTOR			
(Million tonnes of coal replacement)			
	1960/1	1970/1	1980/1
Increases from population growth	—	3.9	8.8
Increases from higher consumption per head.	—	14.3	46.2
Total Increases	—	18.2	55.0
Actual 1960/1	14.4	14.4	14.4
Total	14.4	32.6	69.4
1960/1 = 100	100	226	482

177. These calculations take no account, however, as yet of the ways in which the main basic domestic demands for cooking may be met. These are issues, as we have said, of national policy.

178. If we confined ourselves to forecasting trends, we might reasonably estimate that the total demands for energy in the domestic sector might be

met by some such pattern of energy sources as those shown in Table 79 below. This pattern assumes that, following the trend of the past nine years, the amount of commercial energy doubles each ten years, while the remainder of the demand is met from non-commercial sources

TABLE 79

POSSIBLE TRENDS IN DOMESTIC ENERGY CONSUMPTION IN THE ABSENCE OF POLICY CHANGES			
(Million tonnes of coal replacement)			
	1960/1	1970/1	1980/1
Increases of Demands over 1960/1	—	62.0	153.7
Met from Increases of Commercial Sources	—	17.5	52.5
Met from Increases of Non-Commercial Sources	—	44.5	101.2
Total Demands			
Commercial	17.2	34.7	69.7
Non-Commercial	146.1	190.5	247.3
Total	163.3	225.2	317.0

179. If, for the moment, we may follow through the logic of this situation, it would involve approxi-

mately the following consequences for the individual sources of non-commercial energy:

TABLE 80
POSSIBLE IMPLICATIONS FOR INDIVIDUAL SOURCES
OF NON-COMMERCIAL ENERGY

	(Million tonnes of coal replacement)		
	1960/1	1970/1	1980/1
Firewood and Charcoal	95.3	121.8	154.6
Cattle Dung	21.6	27.8	35.1
Waste Products	29.2	41.4	58.4
Total	146.1	190.8	248.1

180. Waste products have been assumed to increase roughly in proportion to expected agricultural output. The other sources are assumed to be consumed in the proportions of 1962/3.

181. The amounts of firewood cut would increase by about 28% by 1970/1 and by more than 60% by 1980/1. On the basis of the present, and possibly excessive, cattle population, the recovery ratio of dung used as fuel to the estimated total of all dung would have to increase from about 25% in 1960/1 to about 33% in 1970/1 and to over 40% in 1980/1.

182. It is very clear that, long before such results come into effect, the ordinary economic forces of scarcity of firewood and dung cakes and the urgent need to find other means of cooking would enforce substitution of other fuels for the traditional fuels. But it is the task of policy to see such trends and dangers in advance and to take measures to avert them before they become so imminent as to be, in the short term, insurmountable.

183. We are convinced that the nation's domestic fuel policy should be addressed to the achievement of two objectives:

(i) Vigorous measures should be taken to secure that the growth of wood for use as firewood replaces the annual cutting of such wood. The responsibility for this should, we suggest, be placed unambiguously on the Ministry of Food and Agriculture, and a special division be added to the Ministry with responsibility for these matters. It should be instructed to examine, in consultation with the state governments, the area of commercially accessible forest which in each State would be necessary, having regard to other timber requirements, to meet the probable firewood needs of the State; to take all necessary measures to secure that a sufficient area shall be planted with suitable trees to meet this need; and to secure that a suitable organisation shall be established for the protection of the growing timber and the control of

its cutting.

(ii) Provision should be made for the substitution, wherever practicable, and in particular in the larger cities, of commercial forms of energy, based on the indigenous fuels of India, for the present non-commercial forms. Since it is unlikely that India will be able to afford the very large oil imports that would be implied in a widespread substitution of kerosene for firewood, all possible encouragement should be given to the further expansion of already existing policies of building low temperature carbonisation plants and of production and distribution of soft-coke, briquettes, and similar domestic fuels based on coal or lignite; research should be conducted with all possible urgency into the use for domestic purposes of any grades of coal likely to be surplus; present research to improve the efficiency of domestic cooking stoves should be intensified with particular emphasis on the design and development of domestic cooking stoves which can make use of such fuels; active measures should also be taken for the popularisation of such fuels.

184. There are various measures open to the Government of India to discourage the use of firewood, particularly in the towns, and to encourage the substitution of commercial fuels. Such measures include the possible uses of taxes or octroi duties on the one hand, and the stimulation and even the temporary subsidisation of alternative commercial sources of energy on the other hand.

185. It is difficult at this stage to predict how rapidly the measures for the increase of firewood supplies that we recommend will result in sufficient additions to the available supplies to meet the growing demands. We recommend that the situation be reviewed not later than in 1970/1, since any failure to expand firewood supplies is likely to have immediate repercussions on the plans to produce or import

commercial forms of energy. If the Government of India should not accept our recommendation for a very vigorous policy for the expansion of firewood supplies, steps will immediately be necessary to expand other forms of domestic energy.

186. Meanwhile we think that in making its own plans for the development of the industries providing the commercial fuels, the Government should assume that, beyond 1965-6, the upward trend of the non-commercial fuels will be restricted and that provision

must be made for meeting a greater part of the increases of domestic energy demands than in the past from commercial sources. The figures that we have included in Table 81 represent the greatest dependence on non-commercial sources and the least dependence on commercial sources that is possible with a very vigorous policy of firewood expansion. Making these assumptions, we have estimated the demands from different energy sources for meeting the total demand to be approximately as follows:

TABLE 81
ESTIMATED DEMANDS FOR VARIOUS SOURCES OF ENERGY
REQUIRED BY THE DOMESTIC SECTOR

(Million tonnes of coal replacement)

	1960/1	1970/1	1975/6	1980/1
Commercial Sources				
Oil Products	12.9	28.0	41.0	66.0
Coal and Coke	2.8	9.2	20.0	28.0
Electricity	1.5	5.1	8.0	14.0
Total	17.2	42.3	69.0	108.0
Non-Commercial Sources				
Firewood & Charcoal	95.3	115.7	124.0	125.0
Dung Cakes	21.6	24.0	25.0	25.0
Waste Products	29.2	43.0	50.0	59.0
Total	146.1	182.7	199.0	209.0
All Sources	163.3	225.0	268.0	317.0

187. In terms of the original units of these various sources the amounts estimated in Table 81 would be as follows:

TABLE 82
ESTIMATED DEMANDS OF THE DOMESTIC SECTOR

	1960/1	1970/1	1975/6	1980/1
Commercial Sources				
Oil Products (million tonnes)	2.0	4.3	6.3	10.2
Coal (million tonnes)	2.8	9.2	20.0	28.0
Electricity (TWh)	1.5	7.3	11.4	17.0
Non-Commercial Sources				
Firewood (million tonnes)	100.0	121.0	130.0	131.0
Dung Cakes (million tonnes)	54.0	60.0	63.0	63.0
Waste Products (million tonnes)	30.7	45.0	53.0	62.0

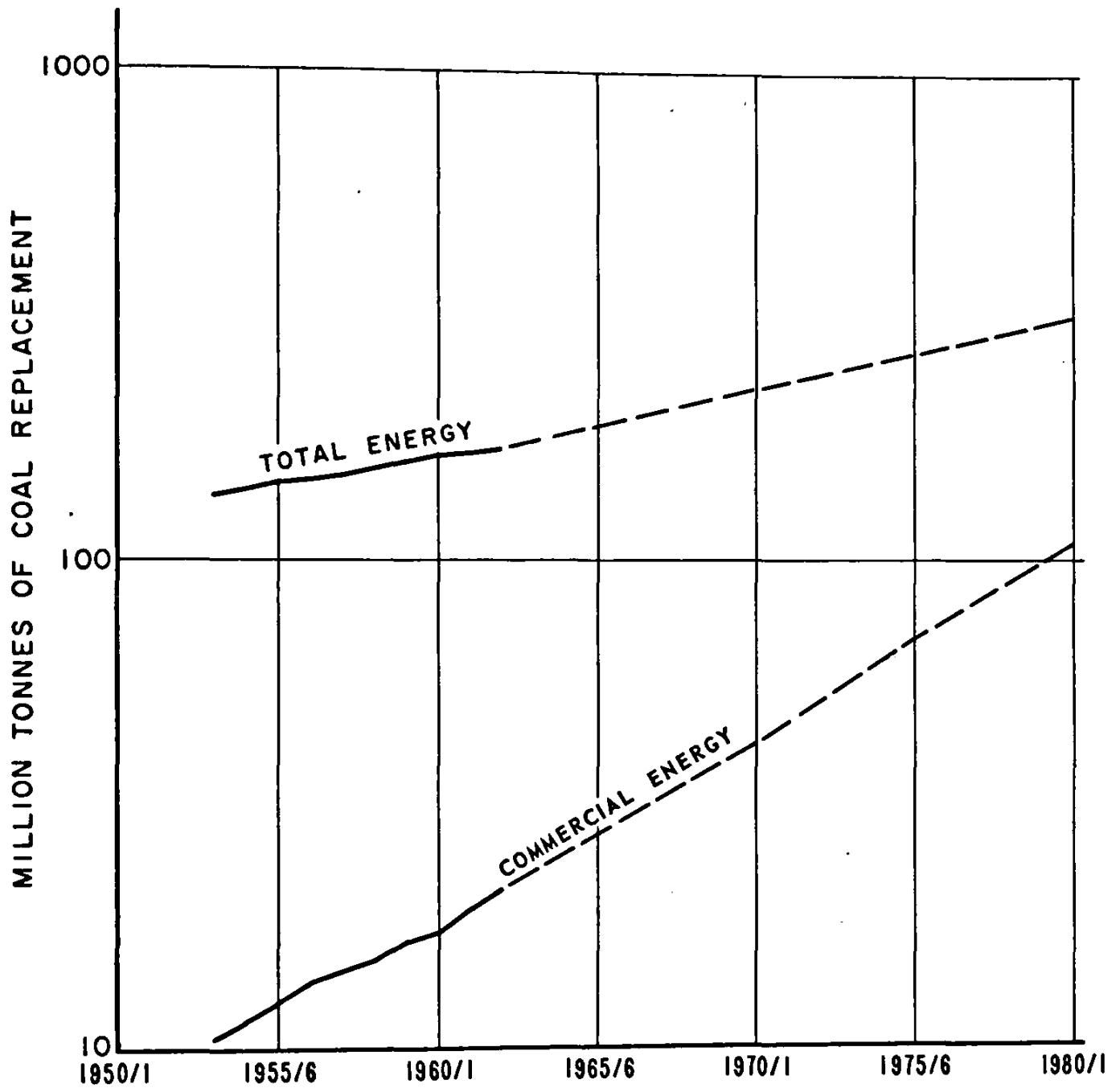

FIGURE 5 — ESTIMATED DEMAND FOR ENERGY IN DOMESTIC SECTOR 1953/4 TO 1980/1

188. We have not thought it necessary to present three alternative estimates of the demands for domestic energy, corresponding to the alternative rates of economic growth that we have considered in the case of other sectors. The growths of demand in the domestic sector spring very largely from increase of population. The element of increased consumption per head is only in part a consequence of increased income per head; it is partly a consequence of the increased availability of electricity and of changing consumption habits. While there is unquestionably some repercussion of differing rates of growth of personal expenditure on the consumption of domestic energy, the differences between the rates we are considering are probably not of such magnitude as greatly to modify the more general estimates we have made.

IV. REGIONAL PROJECTIONS OF DOMESTIC DEMANDS

189. If practical policies are to be worked out to deal with these emergent problems of the domestic sector, it is necessary to form some ideas of the volumes of demands for commercial energy that are likely to arise in different regions. We have at-

tempted, therefore, to make some estimates of the probable orders of magnitude.

190. To make such estimates we have made some necessary preliminary assumptions. We have assumed firstly, that, as supplies of firewood and dung cakes are reduced, they are reduced in the same proportions in each of the different regions. This is, we realise, unlikely to happen in practice, but, in the absence of a very detailed and lengthy research which was not practicable in the time at our disposal, we have thought this a reasonable assumption to establish rough orders of magnitude. Secondly, we have assumed that the levels of consumption will rise in about the same proportions in all regions. We have assumed a very slightly larger rise in the Central Region, where standards have been somewhat lower than elsewhere.

191. In Table 83 we have set out, for all the different regions, the assumed total consumptions per head of domestic energy, the estimated supplies from non-commercial sources, on the assumptions stated in the last paragraph, and the supplies from commercial sources that will be needed to fill the gaps.

TABLE 83
ESTIMATED REGIONAL REQUIREMENTS
OF DOMESTIC ENERGY FROM COMMERCIAL SOURCES

	Estimated Total Consumption of Domestic Energy Per Head	(tonnes of coal replacement) Estimated Supplies of non-Commer- cial Energy per Head	Required Supplies of Commer- cial Energy per Head	Estimated Population (millions)	Estimated Total Domestic Demand for Commercial Energy (million tonnes)
1970/1					
All India	.407	.330	.077	553	42.34
Eastern	.409	.330	.079	128	9.98
Northern	.407	.341	.065	81	3.98
Central	.369	.305	.064	134	8.59
Western	.470	.358	.114	76	8.89
Southern	.399	.334	.065	139	9.08
Assam	.488	.380	.120	17	2.84
1980/1					
All India	.452	.298	.154	702	108.00
Eastern	.455	.298	.157	160	24.75
Northern	.453	.308	.145	77	11.00
Central	.418	.275	.143	171	24.09
Western	.522	.319	.203	88	19.20
Southern	.442	.301	.141	177	25.58
Assam	.540	.329	.211	21	4.37

192. We have gone on to estimate, in the light of these aggregate requirements in each region, how the various regions would be likely, on the basis of recent experience to distribute their demands between the various commercial sources of energy - coal, oil products and electricity. On the basis of recent experience, we would expect to get distributions in 1970/1 and 1980/1 in about the proportions shown in Table 84.

193. The estimates given in Table 84 are designed only to establish rough orders of magnitude as

a general guide to policy. They are based on very static assumptions regarding the relative availabilities and popularities of particular fuels. If new coal mines, for example, are opened up in outlying regions, or if active measures are taken to make coal-based fuels more readily available and more acceptable, the proportions may be appreciably changed. But it must be remembered that the present distribution has a solid foundation in relative costs, reflecting costs of transport, and that changes are likely to be minor rather than dramatic.

TABLE 84
ESTIMATED DISTRIBUTIONS OF DOMESTIC DEMANDS
IN REGIONS BETWEEN DIFFERENT COMMERCIAL FUELS
1970/1 AND 1980/1

(Million tonnes of coal replacement)

	Coal	Oil Products	Electricity	Total
1970/1				
All India	9.18	28.00	5.14	42.32
Eastern	4.99	3.78	1.21	9.98
Northern	1.75	1.54	0.69	3.98
Central	1.50	6.14	0.95	8.59
Western	0.81	7.01	0.87	8.69
Southern	0.08	7.59	1.37	9.04
Assam	0.05	1.94	0.05	2.04
1980/1				
All India	28.00	66.00	14.00	108.00
Eastern	14.99	11.12	3.25	29.36
Northern	5.59	5.54	2.00	13.13
Central	4.87	15.89	2.75	23.51
Western	2.19	12.48	2.11	16.78
Southern	0.25	17.77	3.78	21.80
Assam	0.12	3.21	0.11	3.44

CHAPTER 9

Final Estimates of Demand

194. In the last chapters we have set out our estimates of the possible demands for energy in India on the basis of sector-wise calculations. We summarise the results of these calculations in Table 85 and Figure 6, in terms of the amounts of energy calculated to be demanded by the different sectors we have analysed.

195. Certain broad conclusions emerge, quite independently of the precise accuracy of individual figures. In 1953/4, the energy absorbed in the domestic sector, including non-commercial fuels, represented about 74% of total energy; by 1970/1, it is

estimated to represent only about a half of total energy, and by 1980/1 no more than two-fifths. In 1953/4 non-commercial energy represented 68% of the total of energy supplies; in 1970/1 it is estimated to represent a little less than one-half and by 1980/1 only about one-quarter of the total. Thus a revolution is taking place in the whole energy system of India. Industry and transport together, which form the two main users of energy by the modern economy, absorbed about 23% of total energy in 1953/4 and 29% in 1960/1; they are expected to absorb over 40% by 1970/1 and just under 60% by 1980/1.

TABLE 85

SUMMARY OF SECTOR-WISE ESTIMATES OF DEMANDS FOR ENERGY
(Million tonnes of coal replacement)

CASE I (5% growth)*	1960/1	1970/1	1975/6	1980/1
Transport (a)	30.7	55.3	75.5	104.4
Industry (b)	39.6	84.7	131.4	194.8
Domestic	163.3	225.0	268.0	317.0
Agriculture (a)	3.4	9.7	15.0	22.2
Others	2.4	4.2	5.6	7.5
Energy Sector (b)	3.1	5.1	7.6	10.2
Total All Fuels	242.5	384.0	503.1	656.1
Total Commercial Fuels	96.4	201.3	304.1	447.1
CASE II (6% growth)*				
Transport (a)	30.7	61.8	91.4	134.8
Industry (b)	39.6	97.5	162.2	257.3
Domestic	163.3	225.0	268.0	317.0
Agriculture (a)	3.4	9.7	15.0	22.2
Others	2.4	4.2	5.6	7.5
Energy Sector (b)	3.1	6.1	9.3	13.3
Total All Fuels	242.5	404.3	551.5	752.1
Total Commercial Fuels	96.4	221.6	352.5	543.1
CASE III (7% growth)*				
Transport (a)	30.7	71.7	110.5	165.3
Industry (b)	39.6	119.8	204.4	328.3
Domestic	163.3	225.0	268.0	317.0
Agriculture (a)	3.4	9.7	15.0	22.0
Others	2.4	4.2	5.6	7.5
Energy Sector (b)	3.1	8.2	12.1	17.0
Total All Fuels	242.5	438.6	615.6	857.3
Total Commercial Fuels	96.4	255.9	416.6	648.3

(a) Oil use in agricultural tractors (estimated to be 0.3 M. tonnes in 1960/1) has been transferred from road transport (where it is recorded in Chapter 3) to agriculture.

(b) For all years after 1960/1 the requirements of blast furnace gas and coke oven gas to underfire coke ovens have been treated as requirements of the iron and steel industry. In order to make 1960/1 comparable with the figures for subsequent years 1.1 m. tonnes of coal replacement has been added to the figures for industry and subtracted from those for the energy sector.

* Growth of national income

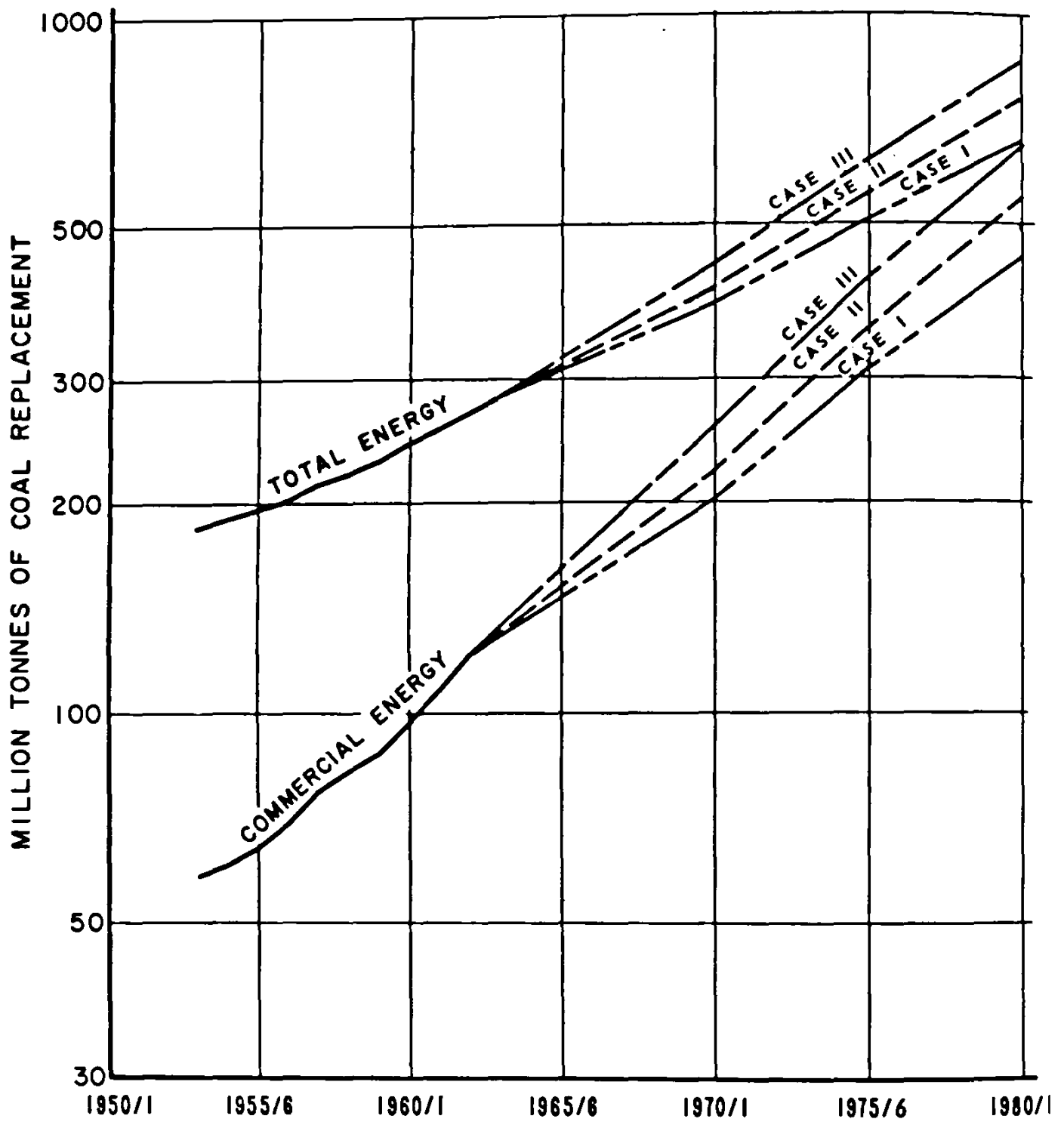

FIGURE 6—ESTIMATES OF DEMAND FOR ENERGY
1953/4 TO 1980/1

196. Table 86 shows the results of the same calculations in terms of demands for different types of energy. It must be made clear at once that, since the generation of electricity will require large quanti-

ties of coal and some smaller quantities of oil, these do not represent the total demands for coal or oil but those amounts of each which may be expected to be consumed as such.

TABLE 86
SUMMARY OF SECTOR-WISE ESTIMATES OF DEMANDS FOR DIFFERENT
TYPES OF ENERGY

	(Million tonnes of coal replacement)			
	1960/1	1970/1	1975/8	1980/1
CASE I				
Commercial Fuels				
Coking Coal & products	11.6	21.0	34.1	47.1
Non-Coking Coal & products	28.8	44.6	81.1	76.0
Oil Products as such	39.1	84.4	145.5	226.5
Electricity	18.9	41.3	83.4	97.5
Total Commercial	98.4	201.3	304.1	447.1
Non-Commercial Fuels				
Firewood	95.3	115.7	124.0	125.0
Dung Cakes	21.6	24.0	25.0	25.0
Waste Products	29.2	43.0	50.0	59.0
Total Non-Commercial	146.1	182.7	199.0	209.0
GRAND TOTAL ALL FUELS	242.5	384.0	503.1	656.1
CASE II				
Commercial Fuels				
Coking Coal & products	11.6	24.1	42.0	62.1
Non-Coking Coal & products	28.8	49.3	89.8	90.0
Oil Products as such	39.1	102.9	167.6	272.2
Electricity	18.9	45.3	73.3	118.8
Total Commercial	98.4	221.6	352.5	543.1
Non-Commercial Fuels				
Firewood	95.3	115.7	124.0	125.0
Dung Cakes	21.6	24.0	25.0	25.0
Waste Products	29.2	43.0	50.0	59.0
Total Non-commercial	146.1	182.7	199.0	209.0
GRAND TOTAL ALL FUELS	242.5	404.3	551.5	752.1
CASE III				
Commercial Fuels				
Coking Coal & products	11.6	31.4	53.2	80.1
Non-Coking Coal & products	28.8	57.2	81.4	105.3
Oil Products as such	39.1	115.5	195.1	319.9
Electricity	18.9	51.8	86.9	143.1
Total Commercial	98.4	255.9	416.6	648.3
Non-commercial Fuels				
Firewood	95.3	115.7	124.0	125.0
Dung Cakes	21.6	24.0	25.0	25.0
Waste Products	29.2	43.0	50.0	59.0
Total Non-commercial	146.1	182.7	199.0	209.0
GRAND TOTAL ALL FUELS	242.5	438.6	615.6	857.3

197. In order to make clearer the meaning of these estimates in terms of the actual fuels concerned we have translated the various elements of the estimates of commercial energy in Table 86 back into the original units of the types of energy concerned. The resulting figures are given in Table 87. Certain points need to be borne in mind in interpreting these figures. The figures for oil products represent final consumption of energy products only; they exclude all non-energy products such as lubricating oils; they exclude refinery consumption.

The figures for electricity represent TWh of electricity consumed by final consumers; they include no allowance for plant losses and distribution losses; they include both electricity generated by the utility stations, public and private, and that generated by non-utility plants for consumption in the associated industrial undertakings. We should again emphasise that the demands for coal, in particular, and for oil to a smaller extent, do not include the amounts used to generate electricity.

TABLE 87

SUMMARY OF SECTOR-WISE ESTIMATES OF DEMANDS
FOR DIFFERENT TYPES OF ENERGY
(in original units)

	1960/1	1970/1	1975/8	1980/1
Coking Coal & products (million tonnes)				
CASE I	11.6	21.0	34.1	47.1
CASE II	11.6	24.1	42.0	62.1
CASE III	11.6	31.4	53.2	80.1
Non-Coking Coal & products (million tonnes)				
CASE I	28.8	44.6	81.1	76.0
CASE II	28.8	49.3	69.6	90.0
CASE III	28.8	57.2	81.4	105.3
Oil Products as such (million tonnes of products)				
CASE I	6.0	14.5	22.4	34.8
CASE II	6.0	15.8	25.8	41.9
CASE III	6.0	17.8	30.0	49.2
Electricity (TWh)				
CASE I	16.9	59.0	90.8	139.3
CASE II	16.9	64.7	104.7	169.7
CASE III	16.9	74.0	124.1	204.4

198. The effect of the various assumptions that we have made and of the calculations built on those assumptions is to suggest that on the basis of de-

tailed sector-wise analysis, we could expect the total demands for energy to increase to the following extents:

TABLE 88
INCREASES OF ENERGY CONSUMPTION
INDICATED BY SECTOR-WISE ANALYSES
(million tonnes of coal replacement)

	1960/1	1970/1	1975/6	1980/1
CASE I				
5% per year national income growth and 7% per year industrial production growth				
	243	384	503	656
CASE II				
6% per year national income growth and 8½% per year industrial production growth				
	243	404	551	754
CASE III				
7% per year national income growth and 10% per year industrial production growth				
	243	439	616	857

199. It is natural that the differences between the compound growth rates should make themselves evident principally in the much more distant years.

200. It is useful at this stage to return to the macro-economic estimates made for purposes of a check in Chapter 4. On the basis of the relation

established between growth of national income and growth of energy consumption, the expected growths of energy consumption, with the alternative assumptions of national income increase were as follows:

TABLE 89
INCREASES OF ENERGY CONSUMPTION
INDICATED BY NATIONAL INCOME PROJECTION
(million tonnes of coal replacement)

	1960/1	1970/1	1975/6	1980/1
CASE I				
5% per year national income growth				
	243	393	505	642
CASE II				
6% per year national income growth				
	243	424	581	779
CASE III				
7% per year national income growth				
	243	446	635	895

201. The third method of projection established a relation between the non-domestic consumption of commercial energy and the growth of industrial pro-

duction as a whole. That method gave us the estimates for the commercial sources of energy alone.

TABLE 90

PERCENTAGE INCREASES OF COMMERCIAL ENERGY ALONE
INDICATED BY PROJECTIONS OF INDUSTRIAL PRODUCTION

	1960/1	1970/1	1975/6	1980/1
CASE I				
7% per year industrial production growth	79	152	222	312
Plus estimated requirements of domestic sector for commercial fuels	17	42	69	108
Total	96	194	291	420
CASE II				
8½% per year industrial production growth	79	180	272	410
Plus estimated requirements of domestic sector for commercial fuels	17	42	69	108
Total	96	222	341	518
CASE III				
10% per year industrial production growth	79	214	345	532
Plus estimated requirements of domestic sector for commercial fuels	17	42	69	108
Total	96	256	414	640

202. The sector-wise estimates in fact gave the following increases of consumption of commercial energy only (c.f. Table 85 above):

TABLE 91
ESTIMATED DEMANDS FOR COMMERCIAL ENERGY ALONE
INDICATED BY SECTOR-WISE ANALYSES
(million tonnes of coal replacement)

	1960/1	1970/1	1975/6	1980/1
CASE I	96	201	304	447
CASE II	96	222	353	543
CASE III	96	256	417	648

203. It will be seen that in each case the sector-wise analysis has resulted in estimates of the probable demands both for energy as a whole and for commercial energy alone very close indeed to the rather crude macro-economic estimates. While the macro-economic estimates are valuable as checks, the more searching sector-wise analyses are more to be trusted. We shall continue to use the results of those analyses in our further discussions.

204. It remains, therefore, to consider which of the alternative sets of assumptions represented by our three cases most nearly represents the probable

future trend of the Indian economy. The final decision regarding that is necessarily a decision for the Government of India, advised by the Planning Commission. It has, indeed, been our purpose in drafting this report to present alternative possibilities which may correspond to the needs of India whichever of various alternative growth paths is in fact adopted.

205. There are, however, some special considerations, relevant to the special problems of energy planning, to which it is proper that we should draw attention. The demand for commercial energy is increasing rapidly; over the five years 1957/8 to

1962/3 it increased by 49%, equivalent to over 8% a year. If planning proceeds at any moment slightly too fast, demand will overtake supply rapidly. On the other hand, the period of construction of plant is very long - in most cases eight to ten years. It is very difficult at short notice to remedy a shortfall. While the capital cost of construction of energy facilities is very high, it remains true that all studies that have been made of the relative costs to the nation of slightly surplus capacity on the one hand and of slightly inadequate capacity on the other have demonstrated the smaller cost incurred by construction slightly - but not, of course, excessively - in advance of demand.

206. This is particularly relevant to the circumstances of India. There has, for some years past, been both a shortage of electricity generating capacity and an inadequate distribution system. Part of any immediate investment will go in that industry to the overtaking of arrears of demand and to catching up with the stream of new demands that are constantly

arising.

207. The estimates that we have presented above represent in relation to electricity appreciably lower estimates than those on which the State Boards have collectively been working in planning their new developments. We hope that this will mean that by 1970/1 there will be more adequate gross margins between scheduled capability and peak load than have recently existed. If in fact the margins prove to be excessive, the rapid growth of demand that we foresee between 1970/1 and 1975/6 will quickly act as corrective, provided that over-investment is not continued.

208. In the light of our studies of demand, we believe that it would be wise for the time being to plan energy developments beyond 1970/1 on the basis that the total demands for energy are likely to be of the orders of magnitude set out below when measured in the terms of coal replacement that we have used:

TABLE 92
RECOMMENDED BASES FOR COMMERCIAL ENERGY PLANNING
(Million tonnes of coal replacement)

	1960/1	1970/1	1975/6	1980/1
CASE I				
Total Energy	243	385	500	650
Commercial Energy	98	200	300	445
CASE II				
Total Energy	243	400	550	750
Commercial Energy	98	220	350	540
CASE III				
Total Energy	243	440	615	850
Commercial Energy	98	255	415	645

209. The uncertainties surrounding the choice of the best basis for future energy planning arise predominantly from the uncertainties of the future rate of growth of the Indian economy which will be adopted by the Government of India on the advice of the Planning Commission. When a final decision has been reached, it would not be difficult on the basis of the analysis of this report to estimate the corresponding probable energy requirements.

210. Meanwhile we would suggest that, in relation to 1975/6, planning of commercial energy should proceed immediately on the basis that it is probable that demands will be not less than 350 million tonnes of coal replacement and may have to be met at the higher level of 415 million tonnes. Thus ministries concerned should be prepared with plans that can be brought forward rapidly to meet the higher level of demand if there are signs that it is

likely to arise. Similarly, in relation to 1980/1 we would suggest that planning of commercial energy should proceed immediately on the basis that it is probable that demands will not be less than 540 million tonnes of coal replacement and may have to be met at the higher level of 645 million tonnes.

211. If actual plans are to be made, they will have to be made in terms of the provision of the primary sources of energy supplies of coal, oil, hydro-electricity and nuclear energy. In order to do this it is necessary to anticipate at this point the discussions of the subsequent chapter on electricity. In the light of considerations which will be set out there in detail, we think that it should be assumed for planning purposes that at the different dates, demands for electricity (measured in kWh) will be met in the following proportions from the different alternative sources.

TABLE 83
PROBABLE PRIMARY SOURCES OF ELECTRICITY
(Percentages)

	1980/1	1970/1	1975/6	1980/1
CASE I				
Coal and lignite	52.8	39.2	46.0	46.7
Oil	5.6	4.3	4.6	6.3
Hydro	38.6	49.8	40.5	34.1
Nuclear	—	5.6	7.9	12.3
Natural gas & other (1) gases	3.2	1.3	1.0	0.6
TOTAL	100.0	100.0	100.0	100.0
CASE II				
Coal and lignite	52.8	43.8	47.2	47.8
Oil	5.6	4.4	4.4	8.4
Hydro	38.8	45.5	39.8	32.3
Nuclear	—	5.0	8.0	13.0
Natural & other (1) gases	3.2	1.3	0.8	0.5
TOTAL	100.0	100.0	100.0	100.0
CASE III				
Coal and lignite	52.8	48.2	47.8	48.3
Oil	5.6	4.4	4.0	6.5
Hydro	38.6	40.8	39.8	31.4
Nuclear	—	4.4	8.8	13.4
Natural & other (1) gases	3.2	1.2	0.7	0.4
TOTAL	100.0	100.0	100.0	100.0

(1) Blast furnace gas and coke oven gas.

212. On these bases, the alternative total demands for the primary sources of energy would, in the three cases we have considered, be as follows:

TABLE 94
DEMANDS FOR PRIMARY SOURCES OF ENERGY
(in original units)

	1960/1	1970/1	1975/8	1980/1
COAL				
Coal for electricity generation (million tonnes)				
CASE I	9.1	16.5	26.2	39.3
CASE II	9.1	19.0	31.0	49.3
CASE III	9.1	24.4	37.5	60.9
Coking coal & products (million tonnes)				
CASE I	11.6	21.0	34.1	47.1
CASE II	11.6	24.3	42.0	62.1
CASE III	11.6	31.4	53.2	80.1
Non-coking coal & products (million tonnes)				
CASE I	28.8	44.8	61.1	76.0
CASE II	28.8	49.3	69.6	90.0
CASE III	28.8	57.2	81.4	105.3
Lignite for electricity generation (million tonnes)				
CASE I	—	1.8	4.7	6.6
CASE II	—	3.7	4.0	6.6
CASE III	—	3.8	5.3	6.6
OIL				
Oil Products for electricity generation (million tonnes)				
CASE I	0.4	0.9	1.3	2.4
CASE II	0.4	1.0	1.4	3.0
CASE III	0.4	1.1	1.5	3.7
Oil Products as such (million tonnes)				
CASE I	6.0	14.5	22.4	34.8
CASE II	6.0	15.6	25.0	41.9
CASE III	6.0	17.8	30.0	49.2
HYDRO-ELECTRICITY				
Gross generation of electricity (TWh)				
CASE I	7.7	34.6	43.5	58.6
CASE II	7.7	34.9	49.2	65.4
CASE III	7.7	38.1	57.0	76.8
NUCLEAR				
Gross generation of electricity (TWh)				
CASE I	—	3.9	8.5	20.4
CASE II	—	3.9	9.8	28.3
CASE III	—	3.9	13.1	32.8

CHAPTER 10

The Regional Distribution of Demands

213. If the demands that we have set out in the last Chapter are to be met in terms of the development of actual resources, it is necessary to have some clear view as to the different parts of India in which different volumes of demand may emerge. In the process of making the sector-wise estimates discussed earlier, we have made regional estimates in each case to enable us to see the full implications.

214. In making these regional estimates, we have used such information as was available to us regarding the probable locations of the plants already planned in the main industries that we have separately analysed. Beyond the periods covered by existing planning we have necessarily depended on the judgment of those who have made the estimates. They have based their judgments of the probable lines of development upon the known resources and economies of particular industries. But in estimating the probable locations of developments in other industries, account has been taken of the likelihood that it will be the policy of the Government of India to stimulate development of those industries which are not heavy energy users in the parts of India in which, for the time being, there is relative backwardness in such factory industries. We are well aware that there are inevitable uncertainties in such estimates. We believe, none-the-less, that such an analysis can usefully establish probable orders of magnitude. But because of the uncertainties we have not thought it profitable to attempt to make estimates by States as well as by Regions.

215. For purposes of this analysis, we have taken six regions, following boundaries of States and corresponding to the regions which, in a broad sense reflect the different characteristics of energy supply in India. The six regions that we have taken are:

Eastern Region:	Bihar, Orissa, West Bengal.
Northern Region:	Punjab, Rajasthan, Delhi, Himachal Pradesh, Jammu and Kashmir.
Central Region:	Uttar Pradesh, Madhya Pradesh.
Western Region:	Maharashtra, Gujarat.
Southern Region:	Madras, Kerala, Mysore, Andhra Pradesh.
Assam Region:	Assam, Tripura, Manipur.

We have taken these regions, not only because at the time of the statistical work on this report they had seemed likely to form the Electricity Regions but also because they correspond in essentials to areas with and without access to certain coal fields, to possible common sources of hydro or thermal electricity, and to have common characteristics and problems. Since our statistical analysis was completed the final definition of the Electricity Regions has been made. There is no Central Region such as we had assumed. Madhya Pradesh has been added to the Western Region. Uttar Pradesh has been added to our Northern Region. Otherwise the Regions are as we had provisionally assumed.

216. We give, in Tables 95 and 96, figures indicating the main economic characteristics of the Regions. As is well known, the Eastern Region and the Western were in 1960/1 the largest consumers of energy. They contained more than two-thirds of all large factory industry and 80% or more of the iron and steel, non-ferrous and chemical industries.

TABLE 95
PERCENTAGE DISTRIBUTION OF POPULATION AND
ENERGY CONSUMPTION BY STATES AND REGIONS
1960/1

Eastern Region	Population	Area	All Commercial Energy	Electricity Consumption
Bihar	10.6	5.6	12.6	10.6
Orissa	4.0	5.0	2.6	4.4
West Bengal	8.0	2.8	16.8	18.7
Total	22.5	13.4	32.0	33.7
Northern Region				
Punjab	4.6	4.2	6.4	6.6
Rajasthan	4.6	11.0	2.6	1.4
Delhi	0.6	0.1	(a)	(a)
Himachal Pradesh	0.3	0.9	(a)	(a)
Jammu & Kashmir	0.8	6.5	0.2	0.3
Total	11.0	22.7	9.2	8.5
Central Region				
Uttar Pradesh	16.8	9.4	6.4	6.7
Madhya Pradesh	7.4	14.2	6.7	3.8
Total	24.2	23.6	15.2	10.5
Western Region				
Maharashtra	9.0	9.9	16.2	17.1
Gujarat	4.7	6.0	6.8	6.4
Total	13.7	15.9	23.0	23.5
Southern Region				
Madras	7.8	4.2	6.6	10.5
Kerala	3.8	1.3	2.4	2.9
Mysore	5.5	6.2	3.6	5.8
Andhra Pradesh	6.2	8.8	5.4	4.3
Total	25.3	20.5	18.0	23.6
Assam Region	3.3	3.9	2.5	0.3
Grand Total All India	100.0	100.0	100.0	100.0

(a) included in Punjab

TABLE 98

**DISTRIBUTION BY STATES
OF VALUE ADDED IN INDIAN INDUSTRIES
1980**

(In Factories of Size to be Included in Survey of Industries)

Regions	Iron & Steel	Non-Ferrous	All Chemicals	Cement	Textiles	Other Industries	All Industries
Eastern Region							
Bihar	37.1	27.5	4.0	17.7	0.4	6.3	7.1
Orissa	2.5	-	-	-	0.4	1.3	1.0
West Bengal	39.0	41.3	17.6	-	18.6	22.7	22.3
Total	78.6	68.6	21.6	17.7	19.4	30.3	30.4
Northern Region							
Punjab	1.1	0.3	0.1	11.2	2.2	1.9	1.9
Rajasthan	0.2	2.8	-	13.4	0.7	1.1	1.0
Delhi	0.4	-	1.3	-	2.8	1.2	1.6
Jammu & Kashmir	-	-	-	-	0.2	0.1	0.1
Himachal Pradesh	-	-	-	-	-	0.2	0.1
Total	1.7	3.1	1.4	24.6	5.9	4.5	4.7
Central Region							
Uttar Pradesh	1.8	0.7	3.4	-	6.3	7.9	6.4
Madhya Pradesh	0.1	-	0.3	10.1	3.8	2.1	2.4
Total	1.9	0.7	3.7	10.1	10.1	10.0	6.8
Western Region							
Maharashtra	9.6	16.6	44.2	-	33.8	25.5	27.7
Gujarat	1.2	0.6	14.2	9.6	24.3	3.4	10.1
Total	10.8	17.2	58.4	9.6	57.9	28.9	37.8
Southern Region							
Madras	3.1	1.7	6.2	20.3	1.2	10.8	7.1
Kerala	0.2	6.3	6.7	-	1.4	2.6	2.4
Mysore	2.7	0.3	1.5	7.6	2.4	3.9	3.0
Andhra Pradesh	1.0	-	0.5	9.7	1.7	5.5	2.7
Total	7.0	10.3	14.9	37.6	6.7	22.7	15.2
Assam Region	-	-	-	-	-	3.7	3.0
Grand Total All India	100.0	100.0	100.0	100.0	100.0	100.0	100.0

217. As a starting point, we have analysed in detail the use of energy in India in 1960/1, not only by region but also by consuming sector and source of energy. As on the national scale, we have attempted, with the help of the oil companies, to estimate the end-uses of the consumption of oil pro-

ducts; but information regarding this is scarce and our estimates of total oil consumption in each state are more reliable than the exact division of its use. We believe, none-the-less, the figures to be sufficiently good for our working purposes. We set out the results of this analysis in Table 97 below.

TABLE 97
DISTRIBUTION OF REGIONAL ENERGY CONSUMPTION BY CONSUMING SECTORS AND SOURCE OF ENERGY

Region/Consuming Sector	1960/1 (million tonnes of coal replacement)				Total
	Coking Coal & Products	Non-Coking Coal & Products	Oil Products	Electricity	
Eastern Region, Total	8.97	8.92	7.28	5.71	30.88
Transport	0.48	3.53	2.59	0.24	6.84
Industry	8.72	2.08	1.83	4.28	14.87
Agriculture	—	0.02	0.20	0.02	0.24
Domestic	0.03	1.70	2.68	0.41	4.80
Others (Commercial, etc.)	—	0.27	—	0.48	0.73
Energy Sector Consumption	1.74	1.34	—	0.32	3.40
Northern Region, Total	0.30	3.48	3.72	1.45	8.95
Transport	0.18	1.57	1.82	0.05	3.70
Industry	0.12	1.10	0.45	0.84	2.51
Agriculture	—	0.10	0.28	0.08	0.44
Domestic	0.02	0.51	1.08	0.21	1.83
Others (Commercial, etc.)	—	0.20	—	0.27	0.47
Energy Sector Consumption	—	—	—	—	—
Central Region, Total	1.68	6.65	4.56	1.77	14.66
Transport	0.34	4.18	1.90	0.07	6.49
Industry	1.24	1.71	0.45	1.08	4.48
Agriculture	—	0.07	0.39	0.20	0.66
Domestic	—	0.27	1.82	0.17	2.26
Others (Commercial, etc.)	—	0.10	—	0.21	0.31
Energy Sector Consumption	0.10	0.32	—	0.04	0.46
Western Region, Total	0.27	5.06	12.89	3.98	22.16
Transport	0.18	2.51	3.45	0.38	6.50
Industry	0.08	2.18	5.20	2.82	10.27
Agriculture	—	—	0.59	0.04	0.63
Domestic	0.02	0.29	3.85	0.33	4.29
Others (Commercial, etc.)	—	0.08	—	0.35	0.41
Energy Sector Consumption	—	0.04	—	0.04	0.08
Southern Region, Total	0.28	4.04	9.08	3.99	17.37
Transport	0.18	2.55	3.88	0.07	6.78
Industry	0.10	1.38	1.50	2.57	5.53
Agriculture	—	—	0.44	0.50	0.94
Domestic	—	0.02	3.14	0.38	3.52
Others (Commercial, etc.)	—	0.03	—	0.41	0.44
Energy Sector Consumption	—	0.08	—	0.08	0.16
Assam Region, Total	0.01	0.87	1.68	0.04	2.41
Transport	—	0.38	0.52	0.01	0.91
Industry	0.01	0.23	0.52	0.01	0.77
Agriculture	—	—	0.13	—	0.13
Domestic	—	0.01	0.52	0.01	0.54
Others (Commercial, etc.)	—	0.02	—	—	0.02
Energy Sector Consumption	—	0.03	—	0.01	0.04
ALL INDIA, TOTAL	11.51	28.82	39.20	18.82	98.45

218. We have made as part of our sector-wise analysis, detailed region-by-region estimates of probable demands for each industry and sector, for the years 1970/1, 1975/6 and 1980/1 which are important for planning purposes. We have also made

detailed estimates on each of the three assumptions regarding the growth of the economy.

219. In Tables 98 to 103 we set out our estimates of probable energy consumption on each of the three basic assumptions.

TABLE 98
SUMMARY OF ESTIMATES OF DEMAND
FOR COMMERCIAL ENERGY AS SUCH BY REGION
COKING COAL
(million tonnes of coal replacement)

	1960/1	1970/1	1975/6	1980/1
CASE I				
All India	11.6	21.0	34.1	47.1
Eastern	9.0	14.4	23.7	33.3
Northern	0.4	0.7	0.9	0.9
Central	1.7	3.6	5.3	7.1
Western	0.2	0.3	1.2	1.6
Southern	0.3	2.0	3.0	4.1
Assam	-	-	-	0.1
CASE II				
All India	11.6	24.1	42.0	62.1
Eastern	9.0	16.5	28.4	40.2
Northern	0.4	0.7	0.9	1.2
Central	1.7	4.2	6.4	10.3
Western	0.2	0.4	1.5	2.2
Southern	0.3	2.3	3.6	6.0
Assam	-	-	-	0.2
CASE III				
All India	11.6	31.4	53.2	80.1
Eastern	9.0	21.5	37.4	49.7
Northern	0.4	0.8	1.0	1.4
Central	1.7	5.3	6.1	15.0
Western	0.2	0.5	2.0	2.6
Southern	0.3	3.3	4.7	1.0
Assam	-	-	-	0.2

TABLE 99
SUMMARY OF ESTIMATES OF DEMAND
FOR COMMERCIAL ENERGY AS SUCH BY REGION
NON-COKING COAL

(Million tonnes of coal replacement)

	1969/1	1970/1	1975/8	1980/1
CASE I				
All India	28.8	44.8	81.1	76.0
Eastern	8.9	15.2	22.2	28.8
Northern	3.4	5.7	8.4	10.8
Central	8.7	10.2	13.1	15.9
Western	5.1	6.3	8.3	10.3
Southern	4.0	6.4	8.2	9.5
Assam	0.7	0.8	0.8	1.1
CASE II				
All India	28.8	49.3	89.6	90.0
Eastern	8.9	16.5	24.8	32.4
Northern	3.4	6.1	8.2	11.9
Central	8.7	11.4	15.4	19.1
Western	5.1	7.2	9.7	12.7
Southern	4.0	7.3	9.7	12.5
Assam	0.7	0.8	1.0	1.4
CASE III				
All India	28.8	57.2	81.4	105.3
Eastern	8.9	18.8	27.8	36.4
Northern	3.4	6.9	10.5	13.8
Central	8.7	13.3	17.8	22.8
Western	5.1	8.8	12.0	15.7
Southern	4.0	8.8	12.1	15.3
Assam	0.7	1.0	1.3	1.7

TABLE 100
SUMMARY OF ESTIMATES OF DEMAND
FOR COMMERCIAL ENERGY AS SUCH BY REGION
OIL PRODUCTS

(Million tonnes of coal replacement)

	1980/1	1970/1	1975/8	1980/1
CASE I				
All India	39.1	84.4	145.5	228.5
Eastern	7.3	18.8	25.9	40.3
Northern	3.7	9.3	15.9	24.8
Central	4.5	17.1	26.8	41.6
Western	12.9	20.4	29.4	45.7
Southern	9.0	27.2	42.7	66.0
Assam	1.7	3.8	5.0	7.8
CASE II				
All India	39.1	102.9	167.6	272.2
Eastern	7.3	18.1	30.1	48.8
Northern	3.7	10.0	18.8	30.4
Central	4.5	18.1	30.1	48.9
Western	12.9	22.6	33.7	54.7
Southern	9.0	30.0	49.5	80.5
Assam	1.7	4.1	5.8	8.8
CASE III				
All India	39.1	115.5	195.1	319.9
Eastern	7.3	20.7	35.4	58.0
Northern	3.7	11.2	21.7	35.9
Central	4.5	19.7	34.8	58.3
Western	12.9	25.4	39.2	64.0
Southern	9.0	34.2	60.0	95.3
Assam	1.7	4.3	6.2	10.4

TABLE 101
SUMMARY OF ESTIMATES OF DEMAND
FOR COMMERCIAL ENERGY AS SUCH BY REGION
ELECTRICITY

(Million tonnes of coal replacement)

	1980/1	1970/1	1975/8	1980/1
CASE I				
All India	18.8	41.3	63.4	97.5
Eastern	5.7	10.8	16.0	24.2
Northern	1.4	4.0	6.6	10.1
Central	1.8	6.5	10.2	15.9
Western	4.0	8.7	12.6	19.1
Southern	4.0	10.9	17.4	27.0
Assam	—	0.4	0.6	1.2
CASE II				
All India	18.8	45.3	73.3	118.8
Eastern	5.7	12.1	18.8	30.7
Northern	1.4	4.3	7.4	11.8
Central	1.8	7.0	11.7	18.8
Western	4.0	9.4	14.9	23.8
Southern	4.0	12.0	19.8	32.1
Assam	—	0.5	0.7	1.4
CASE III				
All India	18.8	51.8	86.9	143.0
Eastern	5.7	14.0	22.8	37.8
Northern	1.4	4.8	8.5	14.0
Central	1.8	6.0	13.8	22.5
Western	4.0	10.8	18.0	29.3
Southern	4.0	13.7	23.2	37.8
Assam	—	0.5	0.8	1.8

TABLE 102

SUMMARY OF ESTIMATES OF DEMAND
FOR COMMERCIAL ENERGY BY REGION

IN ORIGINAL UNITS

OIL PRODUCTS (1)

(Million tonnes of products)

	1960/1	1970/1	1975/8	1980/1
CASE I				
All India	6.0	14.5	22.4	34.8
Eastern	1.1	2.8	4.0	8.2
Northern	0.8	1.4	2.5	3.8
Central	0.7	2.7	4.1	6.4
Western	2.0	3.1	4.5	7.0
Southern	1.4	4.1	6.5	10.2
Assam	0.2	0.8	0.8	1.2
CASE II				
All India	6.0	15.8	25.8	41.9
Eastern	1.1	2.8	4.6	7.5
Northern	0.8	1.8	2.9	4.7
Central	0.7	2.8	4.6	7.5
Western	2.0	3.4	5.2	8.4
Southern	1.4	4.6	7.6	12.4
Assam	0.2	0.6	0.9	1.4
CASE III				
All India	6.0	17.8	30.0	49.2
Eastern	1.1	3.1	5.4	8.8
Northern	0.8	1.8	3.3	5.5
Central	0.7	3.1	5.3	8.7
Western	2.0	3.9	6.0	9.9
Southern	1.4	5.2	9.0	14.7
Assam	0.2	0.7	1.0	1.8

(1) exclusive of products used for bunkers,
electricity-generation and refinery losses.

TABLE 103

**SUMMARY OF ESTIMATES OF DEMAND
FOR COMMERCIAL ENERGY BY REGION**

IN ORIGINAL UNITS

ELECTRICITY (1)

(TWh)

	1960/1	1970/1	1975/6	1980/1
CASE I				
All India	18.9	59.0	90.8	139.3
Eastern	5.7	15.4	22.8	34.7
Northern	1.4	5.7	8.3	14.4
Central	1.8	8.3	14.7	22.8
Western	4.0	12.4	18.0	27.4
Southern	4.0	15.8	24.9	38.3
Assam	—	0.8	0.8	1.7
CASE II				
All India	18.9	64.7	104.7	169.7
Eastern	5.7	17.3	28.8	43.8
Northern	1.4	8.1	10.9	18.8
Central	1.8	10.0	18.7	27.0
Western	4.0	13.4	21.2	34.0
Southern	4.0	17.2	28.4	45.9
Assam	—	0.7	1.0	2.1
CASE III				
All India	18.9	74.0	124.1	204.4
Eastern	5.7	20.0	32.8	53.8
Northern	1.4	8.8	12.2	19.8
Central	1.8	11.4	18.5	32.2
Western	4.0	15.5	25.7	41.8
Southern	4.0	19.5	33.0	54.2
Assam	—	0.7	1.1	2.4

(1) Exclusive of transmission, distribution and station losses.

CHAPTER 11

Problems of Coal Supplies

I. INTRODUCTORY

220. In Chapter 9 the total demands for coal for internal consumption (a) were estimated at 84-116 million tonnes in 1970/1, at 125-176 million tonnes in 1975/6 and at 166-252 million tonnes in 1980/1. These wide differences of demands will be narrowed when the Government of India, on the advice of the Planning Commission, has decided what rates of industrial growth it may be proper to assume. To these figures must be added the requirements for exports and bunkers; these may be put at about 2.5 million tonnes in 1970/1, 3.5 million tonnes in 1975/6

and 3.5 - 5 million tonnes in 1980/1.

221. The estimates of demand, as set out in that Chapter, distinguished three different elements: the demand for coking coal as such; the demand for coals which do not need to have coking properties and which in many cases are better met by specifically non-coking coals; the demand for coal for the generation of electricity.

(a) including consumption for generation of electricity.

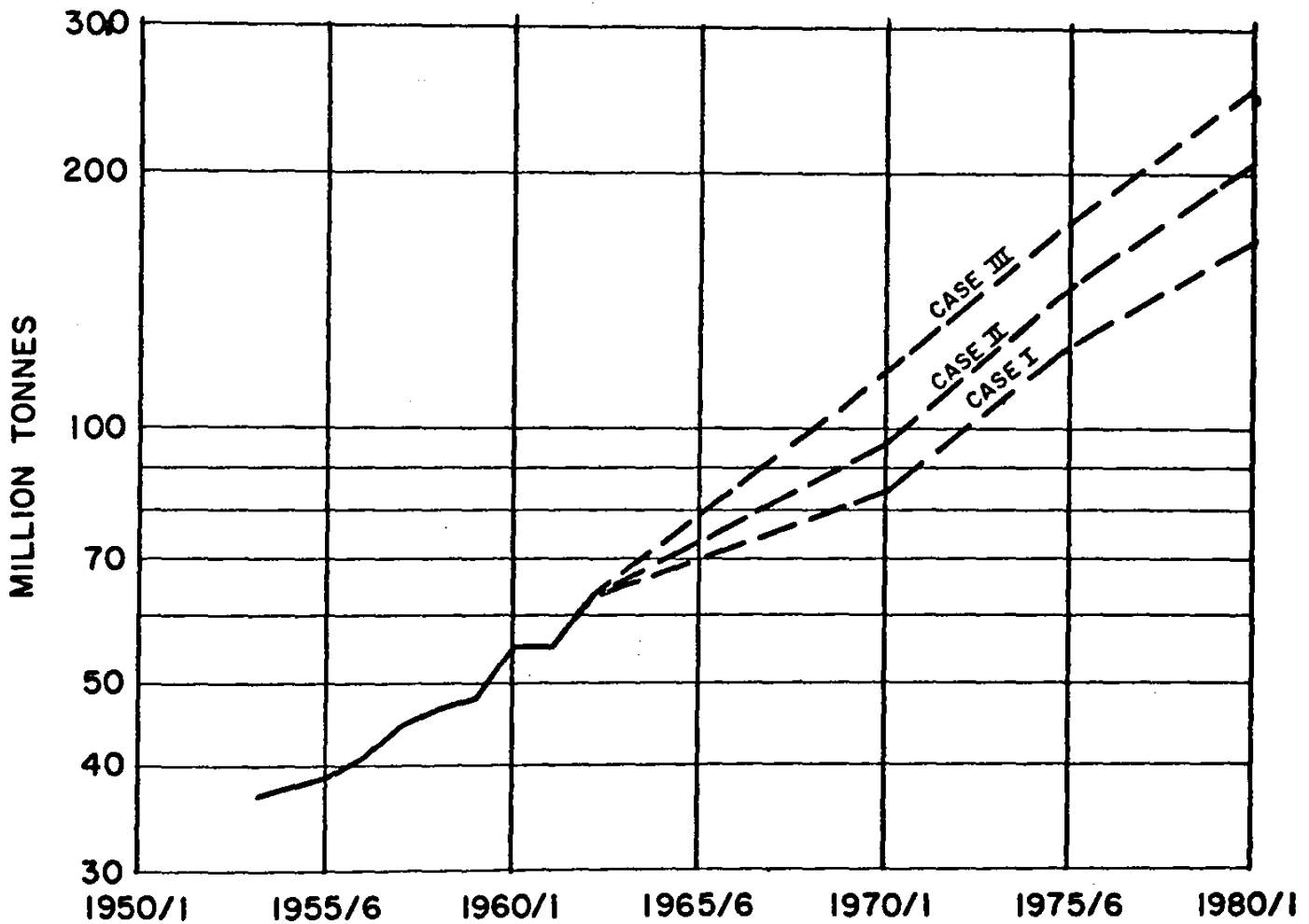

FIGURE 7-ESTIMATES OF COAL REQUIREMENTS 1953/4 TO 1980/1

TABLE 104

ESTIMATES OF REQUIREMENTS^(a) OF COAL
AT DIFFERENT RATES OF GROWTH
(million tonnes)

	1960/1	1970/1	1975/8	1980/1
CASE I (7% Growth)				
Coking Coal as such	11.8	21.0	34.1	47.1
Non-Coking Coal as such	28.8	44.6	61.1	76.0
Coal for electricity (b)	9.1	18.5	26.2	39.3
Total Internal Demand	49.5	82.1	121.4	162.4
Net Exports and Bunkers	1.4	2.2	3.3	3.5
Addition to stocks	4.2	—	—	—
Total Requirement (a)	55.1	84.3	124.7	165.9
CASE II (8½% Growth)				
Coking Coal as such	11.8	24.1	42.0	62.1
Non-Coking Coal as such	28.8	49.3	69.8	90.0
Coal for electricity (b)	9.1	19.0	31.0	49.3
Total Internal Demand	49.5	82.4	142.6	201.4
Net Exports and Bunkers	1.4	2.5	3.5	4.4
Addition to Stocks	4.2	—	—	—
Total Requirement (a)	55.1	94.9	146.1	205.8
CASE III (10% Growth)				
Coking Coal as such	11.8	31.4	53.2	80.1
Non-Coking Coal as such	28.8	57.2	81.4	105.3
Coal for electricity (b)	9.1	24.4	37.5	60.9
Total Internal Demand	49.5	113.0	172.1	246.3
Net Exports and Bunkers	1.4	2.8	4.0	5.3
Addition to stocks	4.2	—	—	—
Total Requirement (a)	55.1	115.8	176.1	251.6

(a) Production less rejects

(b) Utilities and auto-producers excluding lignite.

222. The demands for specifically coking coals come chiefly from the iron and steel industry, though on a smaller scale from one or two other industries. The remainder of the demand for coking coal comes from the needs of the mines themselves. The coking coals are principally required in industry to produce metallurgical coke, suitable for use in blast furnaces, and this implies an upper limit in the coal fed to the coke-ovens of about 17% ash content.

223. The peculiar problems of the Indian coal industry arise very largely from the high ash content of all coals and from the great difficulties of signi-

ficantly reducing ash content by washing, because the ash itself is deeply interspersed into the coal and not so readily separable as in most other coal-fields. The average ash content of all Indian coal raised in 1960/1 was about 25% and the average of ash content of the coking coal about 23%

224. The washeries can be operated either on a 2-product or on a 3-product basis. On a 2-product basis, giving washed coal of 17% ash, the by-products have about a 40% ash content. On this basis, our Working Group has estimated that the washery yield will be about 55% of washed coal for metal-

lurgical use and about 45% of by-products by 1970/1. On a 3-product basis, there will be again about 55% of washed coal, about 25% of middlings with about 30% ash content and about 20% of rejects. (The Department of Mines and Metals, as we have indicated earlier, hopes for a yield of 59% in 1970/1). We have investigated the economic advantages of the two alternative methods and are convinced that the balance of advantages lies with the 2-product system, so long as markets are available for the use of the by-products for electricity generation and other uses.

225. Thus, the amounts of coking coal shown as demanded in the various years can only in practice be provided by mining much larger amounts of coal,

washing the coal, selling the best washed coal to the industries concerned and finding other markets for the washery by-products. By 1970/1 some 15% of the raw coal washed is estimated to be blendable coal rather than parent coking coal and by 1980/1 it is hoped that this can be raised to about 25% in order to conserve the limited supplies of parent coking coal.

226. The amounts of washed coking coal shown in the demand estimates are expected to require the mining of the amounts of coking coal and blendable coal shown in Table 105 and will yield, in addition to the best washed coal, the amounts of by-product coals there shown.

TABLE 105
AMOUNTS OF COKING COAL REQUIRED (a)
TO BE MINED TO MEET DEMANDS FOR WASHED COAL
(million tonnes)

	Estimated Final Demands for Coking Coal	Of which demands for Washed Coal	Amount of Coking Coal needed to be raised (b)	Amount of Coking Coal needed to be washed (c)	Corresponding amount of Coking Coal By-Products Produced (d)
1970/1					
CASE I	21.0	19.4	34.5	32.9	13.5
CASE II	24.1	22.3	39.8	37.8	14.5
CASE III (e)	31.4	23.5	47.8	39.8	18.4
1975/8					
CASE I	34.1	31.2	61.8	58.9	27.7
CASE II	42.0	38.4	76.1	72.5	34.1
CASE III	53.2	48.6	96.4	91.8	43.2
1980/1					
CASE I	47.1	42.8	89.9	85.8	42.8
CASE II	82.1	58.5	118.8	113.0	56.5
CASE III	80.1	72.9	153.0	145.8	72.8

(a) Includes some blendable coals for metallurgical use.

(b) Including amount to cover needs of the coal mines.

(c) Assuming the following washery yields of clean coal: 1970/1, 59%; 1975/8, 53%; 1980/1, 50%.

(d) Includes the rejects of 3-product washeries.

(e) See paragraph 93, Chapter 6, describing the proposal to feed some unwashed coal to the coke ovens in 1970/1 for Case III.

227. Although we believe the 2-product wash to be more economic than the 3-product wash, 3-product washeries already built or under construction will not, of course, be abandoned. If it is economic to convert a 3-product washery over to the 2-product method, we assume this will be done. The by-products

shown in Table 105, therefore, include the rejects of the 3-product washeries. These rejects may amount to 15% of the total by-product expected in 1970/1, dropping probably to less than 5% by 1980/1 if new washery installations employ the 2-product method. (See Table 106).

TABLE 106

USABLE BY-PRODUCTS AVAILABLE
FROM WASHING COKING AND BLENDABLE COALS
(million tonnes)

	Total By-Products Available	Of which: Rejects	Usable By-Products
1970/71			
CASE I	13.5(16.6)	2.0(2.5)	11.5(14.1)
CASE II	14.5(18.2)	2.2(2.7)	12.3(15.5)
CASE III	16.4(22.8)	2.9(3.4)	13.5(19.4)
1975/6			
CASE I	27.7	2.8	24.9
CASE II	34.1	3.4	30.7
CASE III	43.2	4.4	38.8
1980/81			
CASE I	42.8	2.9	39.9
CASE II	56.5	3.5	53.0
CASE III	72.9	4.5	68.4

Note: Figures in brackets show the results if the washery yield is assumed to be 55% rather than 59% and if all coal for Iron and Steel is washed.

228. If as we indicate, there are likely to be 11-14 million tonnes of coking coal by-products in 1970/1 and possibly 25-39 million tonnes in 1975/6, how can these best be used to the advantage of the Indian economy? The washery by-products are not only high in ash content, they are also inevitably as the result of the washery process crushed to small size. There are relatively few uses to which in practice they can be put, almost all unfortunately outside the normal uses of coking coal: they can be used for thermal generation of electricity; they can be used for brick-making; they may be used, less advantageously, and with some difficulty for cement manufacture. Because of their small size and high ash content, the washery by-products cannot at all easily be used for making a domestic fuel.

It seems likely, therefore, that some of the normal and traditional markets for non-coking coals, will in fact be invaded during the coming years by the coking coal by-products.

229. The demands for non-coking coal are set out in Table 107. As here set out they include all the demands for coal which can be satisfied either by non-coking coal as such or by coking-coal by-

products. As we have said earlier, the market for the two is a single one.

230. There is a similar problem, however, in regard to the non-coking coals to that which we have just described in relation to coking coals. It is difficult or impossible to mine these without producing a relatively high proportion - generally put at about 30% - of small coal and slack which is not readily usable by ordinary consumers of non-coking coals. We will expand on this particular problem later in this Chapter. These lower grades of the non-coking coals would, in normal circumstances, have found possible markets in the same industrial uses - thermal generation of electricity, brick-making, cement manufacture - into which the coking coal by-products seem likely to force themselves.

231. It is already becoming evident that India is simultaneously short of higher grade coals and almost continuously in surplus of lower grade coals, slack and by-products. As the steel industry expands and this results in increasing volumes of by-products from coking coals, this problem is likely to become more acute.

TABLE 107

AMOUNTS OF NON-COKING COAL REQUIRED (a)

	(million tonnes)			
	1960/1	1970/1	1975/8	1980/1
CASE I (7% Growth)				
For Consumption as such	28.8	44.6	61.1	76.0
For Thermal Plants (b)	9.1	5.0	3.0	1.0
Net Export and Bunkers	1.4	2.2	3.3	3.5
Total Requirement	39.3 (c)	51.8	67.4	80.5
CASE II (8½% Growth)				
For Consumption as such	28.8	49.3	69.6	90.0
For Thermal Plants (b)	9.1	6.7	3.0	1.0
Net Exports and Bunkers	1.4	2.5	3.5	4.4
Total Requirement	39.3 (c)	58.5	76.1	95.4
CASE III (10% Growth)				
For Consumption as such	28.8	57.2	81.4	105.3
For Thermal Plants (b)	9.1	10.8	3.0	1.0
Net Exports and Bunkers	1.4	2.6	4.0	5.3
Total Requirement	39.3 (c)	70.7	88.4	111.6

(a) Assuming all slack coal to be utilized.

(b) Utilities and auto-producers excluding lignite.

(c) Excluding stock changes.

232. The problem can be solved, if at all, only by providing more powerful incentives than yet exist to induce not only power-station operators, but also all other industrial users of coal to install the suitable boilers and equipment to make use of the lowest grade coals, wherever that is technically possible, in preference to higher grade coals; the incentives must be sufficient to justify the not inconsiderable extra costs, in many cases, of using lower grade or high-ash-content coal. That will almost certainly require some very drastic rethinking of the pricing policies for coal to be adopted. If there is a prospect that the lowest grades of coals and by-products will be unsaleable, clearly the washed coal will have to bear all, or almost all, of the costs of mining, transportation to washery, washing and delivery. The by-product coals will have to sell for what they can command in the markets open to them. Since the work of our Committee began, we understand that steps have been taken to decontrol by-product coals and to allow their prices to find their own levels. This is exactly in accord with our thinking.

233. But if, as we believe, it is likely to be the case that there will sooner or later be a surplus, the opportunity cost of the by-product or waste coals to any industry or sector that can use them is, from a national point of view at least, zero or approaching zero. In the planning of electricity generation, for example, it may be proper, as we have done, to regard by-product coals as potentially available at zero cost when calculating the relative advantages of hydro

or thermal generation, if the conditions are such that there is likely to be a surplus of either by-products or waste non-coking coals.

234. Given an appropriate pricing policy, we believe that some of the problems of absorbing the prospective surpluses of small coals and by-product coals may prove to be less difficult than in the first stages of our enquiry we had come to suppose. Valuable evidence on this has been provided by an investigation made by the Coal Transport Study Team of the World Bank Mission. They have made a series of comparisons of the respective costs of meeting the coal demands of various power stations outside the Bengal area, on the one hand by mining and (where necessary) transporting the nearest coal from one of the outlying coal fields and on the other hand by transporting by-product coals from washeries in the Bihar-Bengal area. We have made minor adjustments to their calculations of both transport and mining costs to reflect the 10% rate of return and 33% surcharge on imported components which (see paras 342 and 343 below) we have assumed throughout our calculations. It will be seen that at a distance as great as that of Satpura (1100 km.) there is a difference of Rs 6.5 per tonne between local coals and by-products potentially available at zero cost in favour of the latter. Thus the competitive value that can be assigned to the by-product coal used at Satpura is approximately Rs. 6.5 per tonne. In other words, so long as there is a surplus of by-product coal it would be economic to use it not only at Satpura but also at

TABLE 108
COMPARATIVE COST OF UTILIZING BY-PRODUCT COAL AND COAL PRODUCED FROM
OUTLYING FIELDS IN SELECTED ELECTRIC POWER STATIONS
1970/1

(Rs per tonne unless otherwise specified)

Region & Station	Estimated quantity of by-product coal '000 tonnes	Cost of by-product coal from washeries		Name of Field	Cost of Coal from Outlying Fields				Competitive Washery Price of By-Product Coal Col. (10)-Col. (11)	
		Approx. Distance km	Rail Cost		Approx. Distance km	Rail Cost	Estimated Mining Cost 4)	Delivered Cost Col. (8)+(9)		
(1)	(2)	(3)	(4)	(5)	(6)	(7)	(8)	(9)	(10)	(11)
EASTERN										
Talcher	642	624	11.0	Talcher	-	-	24.5	24.5	13.5	
NORTHERN										
Delhi C.	472	1176	20.2	Singrauli	917	15.8	24.5	40.3	20.1	
CENTRAL										
Satpura 1)	338	118	4.1	Pench	50	2.9	24.5	27.4	23.3	
Satpura 1)	713	1100	18.8	Pench	50	1.4	24.5	25.9	7.0	
Korba	515	168	3.3	Korba	-	-	24.5	24.5	21.2	
Amarkantak 2)	155	169	5.0	Jhilimili	-	-	24.5	24.5	19.5	
Harda Ganj	231	1064	21.2	Singrauli	804	16.5	24.5	41.0	19.8	
Kanpur	154	742	15.4	Singrauli	483	10.7	24.5	35.2	19.8	
Singrauli	643	471	8.4	Singrauli	55	1.5	24.5	26.0	17.8	
Hind Al 3)	438	471	8.4	Singrauli	-	-	24.5	24.5	16.1	

Note: Unless specifically noted otherwise, the source of the by-product coal is the coking coal washeries in the Bihar-Bengal coal fields. For quantities above 400,000 tonnes per annum line haul costs of Rs 0.0167 per tonne/km and terminal costs of Rs 0.53 per tonne are based on special closed circuit rail operations. For quantities below 400,000 tonnes per annum the line haul costs are Rs 0.0226 per tonne/km and Rs 1.97/tonne for terminal costs. These rail costs are for broad gauge lines at 10% return on investment with no transshipment to narrower gauges.

1) The Satpura coal requirements in 1970/1 are 1,051,000 tonnes of by-product or local coal. The total projected output in 1970/1 of Pench Washery is 338,000 tonnes of by-product coal. This total output is assumed to be absorbed by Satpura. The balance of Satpura's coal requirements 713,000 tonnes of by-product or local coal is assumed to come from the Pench coal field.

2) By-product to be supplied from Jhilimili Washery.

3) It has been assumed that distance from washeries is same as for Singrauli Power Station.

4) Open cast public sector mines adjusted for 10% interest rate, 33% tax on foreign exchange and adding interest during construction at rate of 10%. We believe that this properly measures the true full cost of such coal to the Indian economy on the basis of the general assumptions we are making throughout this report. The figure is appreciably higher than the estimates of cost as normally calculated.

5) Calorific value of by-product and coal from outlying fields assumed both 4400 kcal/kg.

235. While there are these very serious problems of fully utilising the lower grades of available coal, both coking and non-coking, there are rapidly growing demands for higher grades. And even if a revision of pricing policy may succeed in making better use of the lower grades and thus direct some demand from the higher grades, the increases of outputs both of coking and of non-coking coals that will be needed are great and will require an energetic expansion of the industry.

II. THE PRESENT STRUCTURE OF THE INDUSTRY

236. In 1960/1 the Indian coal industry as a whole produced a little over 56 million tonnes of coal. Of this almost 16 million tonnes came from Public Sector mines and about 40 million tonnes from Private Sector mines. About 41 million tonnes came

from the Bengal-Bihar coal-field; about 14 million tonnes came from the outlying coal-fields. Of the latter, the biggest contributors were the coal-fields of Madhya Pradesh (6.2 million tonnes) and of Andhra (about 2.6 million tonnes); smaller coal-fields in Assam, Orissa, Maharashtra, Rajasthan and Jammu and Kashmir produced the remainder.

237. Thus the Eastern Region, as we have defined it, produced about three quarters of the nation's coal. It produced the whole of the nation's supply of coking coal.

238. Of the total supply, only 4.7% came from deep underground mines (at depths of over 305 metres); these deep mines were wholly in the Private Sector. Of the remaining 95.3%, shallow underground mines (at depths less than 305 metres) produced 74.5% and open-cast workings, in which the Public Sector predominates, produced 20.8%.

TABLE 109
COAL PRODUCTION (c)
1960/1
(million tonnes)

FIELD	COKING				NON-COKING				TOTAL			
	Open Cast	Shallow under-ground (a)	Deep under-ground (b)	Total	Open Cast	Shallow under-ground (a)	Deep under-ground (b)	Total	Open Cast	Shallow under-ground (a)	Deep under-ground (b)	Total
1. Bengal - Bihar												
a) Public Sector	3.57	0.72	—	4.29	2.5	3.19	—	5.69	6.07	3.91	—	9.98
b) Private Sector	0.68	11.92	—	12.60	0.86	15.18	2.60	18.74	1.64	27.10	2.60	31.34
Total for (1)	4.25	12.64	—	16.89	3.46	18.37	2.60	24.43	7.71	31.01	2.60	41.32
2. Outlying Fields												
a) Public Sector	—	—	—	—	1.15	4.64	—	5.79	1.15	4.64	—	5.79
b) Private Sector	—	—	—	—	2.74	8.85	—	8.59	2.74	5.85	—	8.59
Total for (2)	—	—	—	—	3.89	10.49	—	14.38	3.89	10.49	—	14.38
Total for (1) + (2)	4.25	12.64	—	16.89	7.35	28.86	2.60	38.81	11.60	41.50	2.60	55.70

(a) Shallow underground indicates less than 305 meter (1000') depth.

(b) Deep underground indicates over 305 meters (1000') depth.

(c) Compiled from data supplied by Coal Board.

239. More deep shaft mining will probably be required in future as better qualities of coal are required to satisfy the metallurgical needs and other special needs of industry. Deep shaft mining has not been appreciably expanded in the past and it is

probable that increased incentive will be required to encourage the private sector to make the heavy investments that are necessary; if such incentives are not to be provided, this type of mining will have to be undertaken by the public sector if the requirements

for these coals are to be satisfied. Pricing policies to create incentives for the right type of mining are discussed in Chapter 15.

240. The whole of the nation's coking coal, wherever consumed, came from the Bengal-Bihar coal-fields. The distribution of non-coking coal was, however, more complex. The figures for 1960/1 are set out in Table 110. It will be seen that no single region of India, regarded as a whole, was in surplus of non-coking coal except the Eastern Region. The Western Region, covering Maharashtra and Gujarat,

was heavily dependant - to the extent of 6.4 million tonnes, on imports from outside the Region. These could be partly, but by no means wholly, met by the whole surplus of Madhya Pradesh, amounting to about 2.9 million tonnes. But a large part of the deficit of the Western Region and the whole of the deficit of the Southern Region had to draw, directly or indirectly, on the supplies of the Bengal-Bihar coal-fields. Very long coal hauls were an inevitable consequence of the geographical distributions of demand on the one hand and of available coal on the other.

TABLE 110
REGIONAL DISTRIBUTION OF PRODUCTION
AND CONSUMPTION OF NON-COKING COAL
1960/1
(million tonnes)

Region	Production	Consumption	Stock change	Bunkers	Net Export from the Region (-) or Net Import from outside the Region (+)
Eastern	29.07	11.82	-2.01	-0.08	-15.18
Northern	0.05	3.64	-	-	+ 3.59
Central	6.74	7.99	-0.44	-	+ 1.69(a)
Western	0.82	7.20	-0.01	-0.01	+ 6.40
Southern	2.57	4.78	-0.01	-0.05	+ 2.25
Assam	0.70	0.67	+0.01	-	- 0.04

(a) Net import of Region as a whole, composed of net import by Uttar Pradesh of 4.58 million tonnes and net export by Madhya Pradesh of 2.89 million tonnes.

241. Mechanisation of the coal industry is still in its infancy in India and the problem of a very large number of small and fragmented holdings, of-

fering very little scope for intensive mechanisation, has contributed appreciably to the static level of productivity.

TABLE 111
DISTRIBUTION OF COAL MINES
BY SIZE 1962

Monthly Production in Tonnes	No. of Mines
- 100	148
101 - 300	39
301 - 600	58
601 - 1000	39
1001 - 2500	189
2501 - 5000	101
5001 - 10000	129
10001 - 20000	108
Above 20,000	59
Total	851

242. Labour supply as well as mechanisation has an important bearing on the achievement of expansion of coal production and also on economic mining of coal. Labour is inexpensive and plentiful in India as compared to other coal producing countries,

but because of the low level of mechanisation the productivity in Indian mining remains very low. Many of the physical problems of expanding coal mining could be greatly reduced if labour productivity could be increased.

TABLE 112
 OUTPUT PER MAN-SHIFT
 IN COAL MINES OF SELECTED COUNTRIES
 1963
 (tonnes per man-shift)

U.S.A. (a)	11.32
U. K.	2.16
France	1.99
West Germany	2.54
Belgium	1.88
Netherlands	2.24
India	0.50

(a) 1958; many mines have attained 50 tonnes and are aiming at 100 tonnes.

III. PROSPECTIVE PATTERN OF 1970/1

243. If one looks forward to 1970/1, one may regard the whole demand for non-coking coal as such together with that for coal for electricity, as forming one single market to be met by the total of supplies of non-coking coals and of the coking coal by-products. The total of demand that we have estimated on the basis of alternative rates of industrial growth may thus be compared with the potential supplies. In Table 113 we show the estimated total demands for

1970/1, the potential supplies of non-coking coal by-products in 1970/1, and the present working estimates of coal production in 1965/6; the gap, if any, between these figures and the potential demands indicates the scope for expansion before 1970/1. It will be seen that, on the supposition that all the coking coal by-products are to be absorbed and that all non-coking coal slack that is raised can be utilised, there is in reality little room for expansion of the non-coking coal production in even the most favourable case.

TABLE 113

ESTIMATED DEMANDS AND SUPPLIES FOR NON-COKING COAL AS SUCH
AND FOR/ELECTRICITY GENERATION BY REGION

	1970/1 (million tonnes)					
	Estimated Internal Demand for Non-Coking Coal as such.	Estimated Demand for Coal for Elec- tricity Generation	Total Demand	Estimated Supplies of Coking Coal By- Products in 1970/1	1963 Govern- ment Es- timates of Out- put of Non- Coking Coal in 1965/6	Difference between Col. 4 + 5 and Col. 3 Surplus + Deficit-
	(1)	(2)	(3)	(4)	(5)	(6)
CASE I						
All India	44.6	16.5	61.1	11.5	65.6	+ 16.0
Eastern	15.2	10.3	25.5	11.5	45.6	+ 31.6
Northern	5.7	0.6	6.3	-	0.1	- 8.2
Central	10.2	4.5	14.7	-	14.3	- 0.4
Western	6.3	1.1	7.4	-	0.9	- 6.5
Southern	6.4	-	6.4	-	4.0	- 2.4
Assam	0.8	-	0.8	-	0.7	- 0.1
CASE II						
All India	49.3	19.0	68.3	12.3	65.6	+ 9.8
Eastern	16.5	12.1	28.6	12.3	45.6	+ 29.3
Northern	6.1	0.9	7.0	-	0.1	- 8.0
Central	11.4	4.2	15.6	-	14.3	- 1.3
Western	7.2	1.8	9.0	-	0.9	- 8.1
Southern	7.3	-	7.3	-	4.0	- 3.3
Assam	0.8	-	0.8	-	0.7	- 0.1
CASE III						
All India	57.2	24.4	81.6	13.5	65.6	- 2.5
Eastern	18.6	17.7	36.3	13.5	45.6	+ 22.8
Northern	6.9	1.3	8.2	-	0.1	- 8.1
Central	13.3	3.6	16.9	-	14.3	- 2.6
Western	8.8	0.4	9.2	-	0.9	- 8.3
Southern	8.6	1.4	10.0	-	4.0	- 6.0
Assam	1.0	-	1.0	-	0.7	- 0.3

244. It is far from certain, however, that all the coking-coal by-products and the non-coking slack can find use. If necessary, as we have shown above, such coal can be competitive, if moved in closed-circuit train-loads, at distances as great as 1100 km from the coal-mine or washery. The present expectation is that all the coking-coal by-products will be absorbed within the limits of Bihar and West Bengal in 1970/1. But in aggregate the output of by-products

and non-coking slack coal is likely by 1970/1 to exceed the total demand for coal for generation of electricity and in subsequent years to exceed it by an increasing margin. In 1970/1 the by-product or slack coals together can supply roughly four-fifths of the coal requirements of thermal plants, assuming that all new plants are designed (as is now intended) to use high ash coal. But many of the older stations do not have boilers and boiler-house equipment that

is suitable. The question remains, therefore, of the use to which non-coking slack can be put, to the extent that it cannot be used in thermal electricity stations. The chief potential uses are brick-making and the manufacture of cement. Unfortunately the statistical evidence regarding use of coal for brick-

making is almost non-existent; at a low enough price perhaps 4 million tonnes can find its way into this use by 1970/1. We have made estimates of the probable absorption of slack coal in these and other uses. Our estimates are given in Table 114.

TABLE 114
UNUSED SLACK NON-COKING COAL AND
BY-PRODUCT COAL OF COKING COAL WASHERIES
(million tonnes)

	1970/1	1975/6	1980/1
CASE I			
Usable By-Product	11.5	24.9	39.9
Slack	15.8	20.2	24.2
Total	27.1	45.1	64.1
Estimated to be consumed (1)	25.4	38.3	55.4
Unused	2.7	6.8	8.7
CASE II			
Usable By-Product	12.3	30.7	53.0
Slack	17.5	22.8	28.6
Total	29.8	53.5	81.6
Estimated to be consumed (1)	29.1	45.7	70.5
Unused	0.7	7.8	11.1
CASE III			
Usable By-Product	13.5	38.8	68.4
Slack	21.2	26.5	33.5
Total	34.7	65.3	101.9
Estimated to be consumed (1)	34.7	55.4	86.7
Unused		9.9	15.2

(1) Thermal Plants, Brick Burning, Cement Plants and Other.

245. It will be seen that, assuming that every effort is made to increase the absorption of these lower grade coals by deliberate design of electricity generating stations to use them and by adopting price policies to encourage their use, the surplus in 1970/1 may be negligible. But by 1975/6 and 1980/1 we expect the problem to be increasingly serious. It will, moreover, be necessary to assume that a part

of the coal raised (if the slack ratio remains at 30% or increases) will not be suitable to meet the demand for non-coking coal and additional raisings will be necessary to cover this, and these raisings will in turn add to the surplus of slack coal. When allowance is made for this, we reach the estimates of raisings and of surplus by-products or slack non-coking coal shown in Table 115.

TABLE 115
TOTAL RAISINGS REQUIRED AND SURPLUS
(million tonnes)

	1970/1	1975/6	1980/1
CASE I			
Coking Raisings	34.5	61.8	89.9
Non-Coking Raisings	54.2	74.7	90.6
Total Raisings	88.7	136.5	180.5
Consumed	84.3	124.7	165.9
Surplus (a)	4.4	11.8	14.6
Of Which: Usable	2.4	9.0	11.7
CASE II			
Coking Raisings	39.6	76.1	118.6
Non-Coking Raisings	59.5	83.4	104.5
Total Raisings	99.1	159.5	223.1
Consumed	94.9	146.1	205.8
Surplus (a)	4.2	13.4	17.3
Of Which: Usable	2.0	11.0	13.6
CASE III			
Coking Raisings	47.8	96.4	153.0
Non-Coking Raisings	70.7	96.4	121.2
Total Raisings	118.5	192.8	274.2
Consumed	115.6	178.1	251.6
Surplus (a)	2.9	16.7	22.6
Of Which: Usable	—	12.3	18.1

(a) The surpluses shown include the rejects of coal washeries as shown in table 106.

246. Even if the fullest use of such coals is made for electricity generation, brick-making and manufacture of cement, we see no complete solution unless a satisfactory method can be evolved for enabling these coals to serve the growing domestic market that we expect. We recommend that the Central Fuel Research Institute be asked as a matter of urgency to study and report on all possible ways in which the needs of the domestic market might be served by some one of various alternative processes of briquetting, coke making, gasification or otherwise. We believe the problem should be capable of solution at prices competitive with other forms of domestic fuels. If this can be done, the problem of unused surplus coal may disappear. But we must emphasise that the magnitude of the problem very much depends on the requirements of the iron and steel industry for coking coal. Anything that can be done by that industry to reduce its demands for coking coal by re-

ducing the coke/pig iron ratio (see paras 86-91 above) will automatically reduce the surplus.

247. In order that normal users of higher grade non-coking coals may be adequately supplied, it will probably, therefore, be reasonable to plan for appreciably larger outputs than would give an exact balance in Table 113. But that Table serves to show the considerable strains that may be involved in fitting the prospective future volume of by-product coal into the market. There are certain features of that Table to which attention should be drawn.

248. As in 1960/1, the pattern seems likely, even with the higher production in the outlying fields, planned for 1965/6, to show all Regions apart from the Eastern Region in deficit. It again seems likely that, even if the separate surplus of Madhya Pradesh is of the order of 9 million tonnes, that the Western Region will need to draw substantially from the Eastern Region and that the Southern Region will

also have to depend, directly or indirectly on supplies from the Eastern Region. Thus long coal hauls seem certain to remain necessary for the marginal coal required to balance the demands and supplies of all Regions. It is in the Eastern Region, and in the nearer markets of Uttar Pradesh and the Northern Region, that the supply of coking coal by-products will make itself felt most acutely.

249. If, as we expect, by-product coal can be economically railed to thermal plants as far as Satpura and even further, the longer-term prospects of the programme to open the outlying coal fields for low quality non-coking coal will almost certainly need to be most carefully reconsidered. If India can find the opportunity to develop new energy intensive industries by the very cheap generation of electricity and its use, possibly on a high plant factor, to provide exports, then it may conceivably be possible for the by-products to be totally absorbed in the Bengal-Bihar region in the longer term as well as in the shorter; in these circumstances the prospects for opening the outlying coal fields to serve thermal electricity stations would be more favourable. A

cursory examination⁽¹⁾ of possible energy intensive industries has been made by a member of our team, and his study is available to the Government of India.

IV PROSPECTS FOR 1975/6

250. If one looks forward past 1970/1 the problems of absorbing coking coal by-products and competing low grade non-coking coals seem likely to continue, but the areas of manoeuvre are greater. It should be possible in the next phases of planning the development of electricity supplies to give even greater consideration to the siting of power plants where they can make full use of cheap by-product coal; consideration can also be given to the possibilities of long distance transmission of electricity rather than the raiing of by-product coal on the one hand or the use of non-coking coal from newly opened mines on the other. These are issues that will be discussed in Chapter 13 where we deal with electricity supply. Our final estimates of the consumption of coal in electric plants at different dates are given in Table 116 below.

TABLE 116
ESTIMATED CONSUMPTION OF COAL IN THERMAL PLANTS
(million tonnes)

	1960/1	1970/1	1975/6	1980/1
ALL INDIA				
CASE I				
Non-Coking		5.0	3.0	1.0
By-Product		11.5	23.2	38.3
Total	9.1	16.5	26.2	39.3
CASE II				
Non-Coking		6.7	3.0	1.0
By-Product		12.3	28.0	48.3
Total	9.1	19.0	31.0	49.3
CASE III				
Non-Coking		10.9	3.0	1.0
By-Product		13.5	34.5	59.9
Total	9.1	24.4	37.5	60.9

In addition, the Neyveli plant will require the following amounts of lignite:

TABLE 117
ESTIMATED CONSUMPTION OF LIGNITE IN THERMAL PLANTS
(million tonnes)

	1960/1	1970/1	1975/6	1980/1
CASE I	—	1.8	4.7	6.6
II	—	3.7	4.8	6.6
III	—	3.9	5.3	6.6

(1) Preliminary Examination of Selected Energy-Intensive Industries in India, 6 December 1963, Lowell J. Chawner.

251. Our estimates of the demand for coal for use in thermal plants are considerably less than those usually set forth in India, partly because of the lower electricity demands as estimated by us, but partly because there has been widespread use in India of an empirical formula which implies that it takes 4 tonnes of coal per kW of installed thermal capacity per year. The figure is misleading because it does not appear to take account of improved thermal efficiencies that are imminent and because of the confusion that sometimes exists between plant factor and load factor.

252. We have explored this subject exhaustively and, even under the most pessimistic conditions, we find that less than an average of 30 tonnes of coal per kW would be used in the next plan period in all coal-burning steam stations, old and new. We have assumed an average thermal plant factor (not load factor) as high as 55% as against 41% now and a gross thermal efficiency of 30% which we believe to be easily attainable having regard to the new plant that is expected to be installed. Our calculations are based on coal having an average calorific value of around 4500 Kcal. Even in 1960/1 with a thermal plant efficiency of only 20%, but with a lower plant factor and a higher calorific value of coal, less than 3 tonnes per kW were used. It is only in very extreme conditions, if an exceptionally well integrated thermal-plant/hydro-plant complex was installed with adequate interconnections which would permit the entire thermal plant system to operate at close to 75% plant factor, while the hydro system was used almost solely for peaking, that we would expect anything approaching 4 tonnes of coal per kW of installed thermal plant capacity. In our view any empirical formula expressing coal consumption per kW of installed capacity is not reliable and will yield misleading results; a simple but rigorous calculation, re-

lating coal use to kWh generated rather than to level of installed capacity, is required for each individual situation, in which the plant efficiency, kilowatt hours used and calorific value of the coal are all considered.

V. RESERVES OF COAL

253. While these problems of adaptation of the pattern of coal output to the changing needs of the nation are thus likely to continue, the problems of the Indian coal industry are not, as in so many countries, the problems of retreat in the face of the advance of the oil-based economy but rather the problems of orderly advance.

254. The best estimates that we can make, until the Planning Commission is able to determine the probable rate of growth to be used as a basis for planning, are that by 1975/6 the amounts of coal likely to be required are 150 ± 25 million tonnes, and that by 1980/1 there will be needed 200 ± 50 million tonnes.

255. Of the 1975/6 output about 80 ± 15 million tonnes will be required in the form of coking coal. Of the 1980/1 output about 120 ± 30 million tonnes of coking coal will be required.

256. The available reserves of coking coal are a matter of much dispute. There have been, and still are, grave fears that the reserves of coking coal are seriously inadequate to the growing needs of a modern, steel-based, economy. We set out, therefore, the essentials as we understand them, based on a recently completed Coal Board "seam by seam" analysis of the Jharia coal-field, which contains almost the whole of India's reserves of coking coal. Excluding the Barren Measures and the Raniganj series of the Jharia coal-fields, the following is an evaluation of the coking coal reserves:

TABLE 118
RESERVES OF COKING COAL

Seams IX/X to XVIII	(million tonnes)			
	Proved	Indicated	Inferred	Total
Down to 610 metres (2000 ft.)	2510	2504	786	5800
610 metres to 1220 metres (4000 ft.)	11	406	1820	2237
Total to 1220 metres (4000 ft.)	2521	2910	2606	8037

These estimates are inclusive of solid reserves, coal standing in pillars and locked up coal. Of the re-

serves above 610 metres the solid reserves represent about 80%.

257. What is most in dispute is what proportion of this coal can be mined. The coal occurs in very thick seams, which are difficult to mine, and it has in the past been customary to leave large amounts of coal in pillars. The present rate of recovery is only about 40%. It will clearly be necessary to make careful studies of possible ways in which, in the future, the rate of recovery may be increased and, if practicable, more coal may be removed from pillars in existing mines. We understand that attention is already being devoted to this, but we think we should emphasise its very great importance. We have already

drawn attention to the fact that, of the total of coking coal mined, only about 50% becomes available as washed coal for feeding to the coke-ovens.

258. It is, however, practicable to add to the coking coals an addition of 25% of washed blendable coals (which are treated for statistical purposes as non-coking coals). On that basis, and making the two assumptions of 50% recovery and 50% washery yield, the total available reserves down to 610 metres will provide the following out-turn of metallurgical coking coal of 17% ash content:

TABLE 119

USABLE RESERVES OF COKING COAL

Mined Coking Coal - 50% of 5,800 million tonnes	= 2,900 million tonnes
Washery yield - 50% of 2,900 million tonnes	= 1,450 million tonnes
Addition of Blendable Coal - 25% of 1,450 million tonnes	= 360 million tonnes
Total of Available metallurgical coking coal	= 1,810 million tonnes

This disregards the further reserves between 610 metres and 1220 metres.

259. We believe that it would be conservative to estimate an average use of 0.9 tonnes of washed coal per tonne of pig iron between the present and the year 2000. If over this period an average of 50 million tonnes a year of pig iron were produced, the amount of metallurgical washed and blended coal required would be about 1800 million tonnes, and would come near to exhausting the reserves above 610 metres on the perhaps conservative assumptions that we have made.

260. The Department of Mines and Metals are convinced that, with stowing, it will be possible to raise the recovery ratio to about 75%. If so, the above estimate of reserves would be increased by 50%, to about 2700 million tonnes, and they would cover, with growing demands, perhaps 70 years ahead.

261. There is a real problem of the adequacy of the coking coal reserves to maintain the Indian economy far into the next century and there is every reason to explore means of economising coking coal, of raising recovery rates and, if possible, evolving new methods of ash removal. But we do not feel grave fears for the next 60-70 years in view of the further reserves below 610 metres. Though the reserves of coking coal are far from plentiful, they are not as inadequate as has sometimes been suggested, even if no new coking coal measures are discovered.

262. The Government of India is understood to be giving thought already to the possible advantages of importing relatively small quantities of coking coal to meet the needs of steel plants in the South of India. If washed coking coal has in fact during

the coming years to bear almost the whole cost of the mining and washing, it becomes economic, or nearly economic, at present prices to import coke or coking coal from outside India rather than make it locally from Indian coals, even on the assumption that we have adopted elsewhere in this report that for planning purposes a foreign input should be valued with a 33% addition. If coke made from imported coal, with around 8% to 11% ash content in the coke, be substituted even at considerably higher cost for the Indian coke with 23% ash content, the increased throughput of furnaces, the decidedly lower coke rate and the lower limestone costs might give a net economy on the whole operation.

263. The reserves of non-coking coal are very much more ample. In total they probably amount to some 115,000 million tonnes. On any basis of probable consumption they do not present grounds for fear over the next century or more at all comparable to the fears that have been held regarding the adequacy of coking coal.

264. The known non-coking coals are, however, confined to certain limited areas of India, though these areas are being enlarged by new discoveries. The attached map, (Figure 8), marking the known coal-fields, shows clearly the way in which the coal-fields are in the main clustered round the area of Bihar, West Bengal, Orissa and Eastern Madhya Pradesh. There are further coal-fields in the Godavari Valley on the northern border of Andhra. But there is no known coal south of the River Krishna nor, except in negligible quantities, west of a line joining Delhi

FIGURE 8

INDIA
SHOWING COAL FIELDS

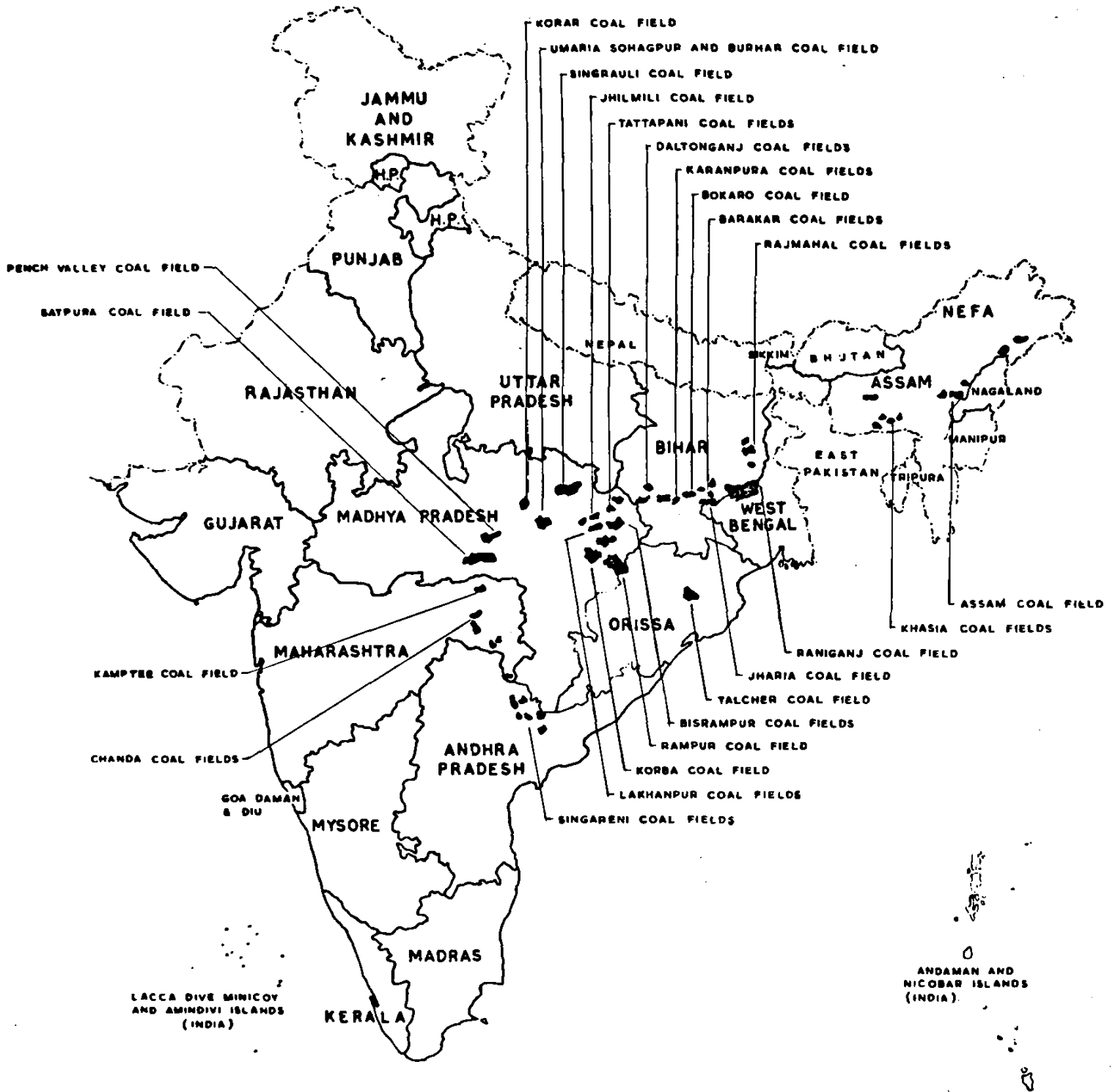

to Cape Comorin. Thus, even if known coal-fields are fully developed, large parts of industrial India are almost certainly condemned to remain remote from any coal-field.

265. The strategic longer term problems of coal development are principally those of expanding at an appropriate rate the production of coal in such quantities and areas as will best meet these longer term demands. The under-estimation of the extent to which the planned expansion of coking coal to meet the needs of the iron and steel industry might have repercussions on the demands for non-coking coal, and the over-estimation of the probable increases of other demands, have implied that, for a few years ahead, the planned expansions of non-coking coal output may need to be slowed down. But it is a matter only of timing. By 1975 and 1980 very much larger amounts of non-coking coal will be required. By that

time there can be no question of the advantage of expanding to the greatest practicable extent the production of the coal nearest to the growing markets of the South and West Regions.

266. But it will still remain true that the coking-coal washery by-products will be constantly available in rapidly increasing volume to provide a main source for covering the needs of electricity generation. They will, however, inevitably be available in the coking-coal areas of the Eastern Region. Decisions regarding the most economic methods and locations of electricity generation and transmission will have continually increasing repercussions on the relative advantages of developing the outlying coal-fields. We discuss them in more detail in a later chapter. These problems will need to be kept under continuous review.

CHAPTER 12

Problems of Oil Supplies

I SUPPLIES IN 1960/1

267. In terms of the replacement ratios which we have used and which we believe measure more accurately than other methods of conversion the effective contribution of each form of energy, India in 1960/1 derived about 40% of her commercial energy from oil products, and about 16% of her total energy, both commercial and non-commercial. Thus, already India has a much greater dependence on oil products than appears from the usual statistics.

268. By 1970/1, on the basis of our estimates, that dependence is likely to increase, if supplies

can be made available, to about 23% of total energy. By 1980/1, the dependence on oil products may rise further, again if supplies can be made available, to about 29% of total energy.

269. It becomes, therefore, very important to consider how far it is possible for India to rely on obtaining these increasing volumes of oil products.

270. In 1960/1 India had available for final consumption 6.02 million tonnes of petroleum products. Of this total, we estimate that the final consumption was distributed approximately as follows:

TABLE 120
FINAL CONSUMPTION OF PETROLEUM PRODUCTS

	1960/1 (million tonnes original units)				
	Transport	Industry	Domestic	Agriculture	Total
All India	2.20	1.53	1.98	0.31	6.02
Eastern Region	0.40	0.28	0.41	0.03	1.12
Northern Region	0.29	0.07	0.17	0.04	0.57
Central Region	0.29	0.07	0.28	0.06	0.70
Western Region	0.53	0.80	0.56	0.09	1.98
Southern Region	0.61	0.23	0.48	0.07	1.39
Assam Region	0.08	0.08	0.08	0.02	0.26

271. In addition, the oil refineries produce other (non-energy) products which are not included in the above figures. The refineries themselves also consume energy for their own operation. There are adjustments also to be made for exports and bunkers, for stock changes, and consumption in the generation of electricity. Thus the total input of crude oil

required to produce that volume of energy products, was 8.37 million tonnes. Table 121 sets out the figures for 1960/1.

272. In 1960/1, as much as 94.5% of all oil consumption was derived from imports either of crude oil or of oil products; only 5.5% was covered by indigenous production of oil.

TABLE 121
BALANCE OF SUPPLIES AND DEMANDS
OF OIL INDUSTRY
1960/1
(million tonnes original units)

Demands (a)	
Inland Consumption of Energy Products	6.40
Inland Consumption of Non-Energy Products	0.81
Refinery Consumption and Losses	0.34
Total of Above	7.55
Addition to Stocks of Energy Products	0.08
Addition to Stocks of Crude Petroleum	0.08
Exports and Bunkers	0.68
Grand Total	8.37
Supplies	
Indigenous Supplies of Crude Petroleum	0.46
Imported Crude Petroleum	5.78
Imported Petroleum Products	1.82
Imported Non-Energy Products	0.31
Grand Total	8.37

(a) Includes consumption for electricity generation.

273. Even if India had been more nearly self-sufficient in oil, it would have been difficult for the country to be wholly independent of foreign trade in oil products. The pattern of demand in India is such

that there is a heavy demand for kerosene and high speed diesel oil; currently there is a relatively low demand for motor spirit. The demands of 1950/1 and of 1960/1 were made up as follows:

TABLE 122
DISTRIBUTION OF DEMAND
BETWEEN DIFFERENT ENERGY PRODUCTS
(percentages)

	1950/1	1960/1
Kerosene	29.2	29.3
Motor Spirit	21.1	12.4
High Speed Diesel Oil	6.4	18.3
Light Diesel Oil	11.5	9.4
Fuel Oil	28.2	26.2
Aviation and Jet Fuel	2.4	4.0
Liquid Petroleum Gas	—	0.1
Others	1.2	0.3
Total	100.0	100.0

274. The production from crude oil in Indian refineries had, on the other hand, the following pattern in 1960/1.

275. The refinery output, on the basis of the crude oils available, can only be modified within rather narrow limits. Thus, if the present pattern of

TABLE 123
DISTRIBUTION OF REFINERY OUTPUT
BETWEEN DIFFERENT ENERGY PRODUCTS
1960/1

(percentages)	
Kerosene	17.9
Motor Spirit and naphtha	20.0
High Speed Diesel Oil	20.4
Light Diesel Oil	10.1
Fuel Oil	31.4
Aviation and Jet Fuel	-
Liquid Petroleum Gas	0.1
Others	0.1
Total	100.0

demand develops as we expect it to do, India is likely to be short of middle distillates and long of light-end products. It will probably be necessary to continue to import middle distillates and to develop new outlets or uses for the light-end products (for example in fertiliser production) and also for fuel oils, even if India becomes on balance self sufficient. Alternatively, if India develops refinery capacity adequate to meet her full middle distillate needs, it may be necessary to find large export markets for other products. The latter policy might be virtually impossible to achieve in practice.

II. ESTIMATED FUTURE DEMANDS

276. Our estimates of future demands for oil are set out in Table 124 and Figure 9. The estimates for energy consumption are based on the sector-wise analysis described in earlier chapters. Although feed-stocks to the fertiliser industry are, in the strictest sense, a non-energy product, we have included the naphtha or other oil used as a fertiliser feed-stock as an energy product since the quantities used are significant and essential to the Indian economy. We have made no special study of the Indian demands for non-energy products and our estimate of the demand for non-energy products is based on discussions with the ONGC and IIP. We have also assumed that bunker consumption will grow at the same rate as imports and exports and that there will be some substitution of bunker oil for bunker coal. The balance of trade in oil products is very difficult to predict as it is not yet clear whether the refining policy will be

aimed at a rough balance between surpluses of certain products and imports of others or at refining on a scale sufficient to meet the most difficult products with the export of surpluses, if this is possible. Our estimates correspond more nearly toward the former policy in which, for example, India may refine sufficient quantities to supply her kerosene requirements and find herself short of other middle distillates and long on fuel oil, gasolene and naphtha. We have also assumed that refinery consumption and losses will in the future be about 6% of the total demand for products on the basis that the refinery throughput may be approximately equal to the product demand and that surpluses and imports would very nearly be equal. (Table 124).

277. We have not attempted to convert our sectoral demands for energy into demands for actual products although we have broadly considered them in an attempt to measure the products that may become available for the various consuming sectors. That is a task that the specialists of the industry can best be trusted to undertake. But certain things are clear. Even if India installs sufficient refining capacity to equal her product demands, it may be necessary to import middle distillates, and there may be a surplus of naphtha, gasolene and possibly fuel oil unless new markets are developed, as is intended. It, therefore, appears wise policy to put less emphasis on the use of middle distillates in road transport and to transfer this demand to gasolene products to the extent they may be in surplus. It also appears clear that there need not be severe pressures to reduce the use of fuel oil since that product

TABLE 124

**ESTIMATED REQUIREMENTS
OF CRUDE PETROLEUM AND PETROLEUM PRODUCTS
1960/1 to 1980/1**

(million tonnes of petroleum)

	1960/1	1970/1	1975/6	1980/1
CASE I (7% growth)				
Energy Products for Internal Consumption as such	8.0	14.5	22.4	34.8
Oil Products for Electricity generation	0.4	0.9	1.3	2.4
Total Energy Products for Internal Consumption	6.4	15.4	23.7	37.2
Non-Energy Products	0.8	2.2	3.2	4.5
Bunkers	0.4	0.6	0.8	1.0
Refinery Consumption and Losses	0.3	1.2	1.8	2.7
Grand Total (a)	7.9	19.4	29.5	45.4
CASE II (8½% growth)				
Energy Products for Internal Consumption as such	6.0	15.8	25.8	41.9
Oil Products for Electricity generation	0.4	1.0	1.4	3.0
Total Energy Products for Internal Consumption	6.4	16.8	27.2	44.9
Non-Energy Products	0.8	2.7	3.9	5.9
Bunkers	0.4	0.7	0.9	1.1
Refinery Consumption and Losses	0.3	1.3	2.0	3.3
Grand Total (a)	7.9	21.5	34.0	55.2
CASE III (10% growth)				
Energy Products for Internal Consumption as such	8.0	17.8	30.0	49.2
Oil Products for Electricity generation	0.4	1.1	1.5	3.7
Total Energy Products for Internal Consumption	6.4	18.9	31.5	52.9
Non-Energy Products	0.8	2.8	4.9	7.7
Bunkers	0.4	0.8	1.0	1.2
Refinery Consumption and Losses	0.3	1.4	2.4	3.9
Grand Total (a)	7.9	23.9	39.8	65.7

(a) excluding additions to stocks in 1960/1 and exports throughout.

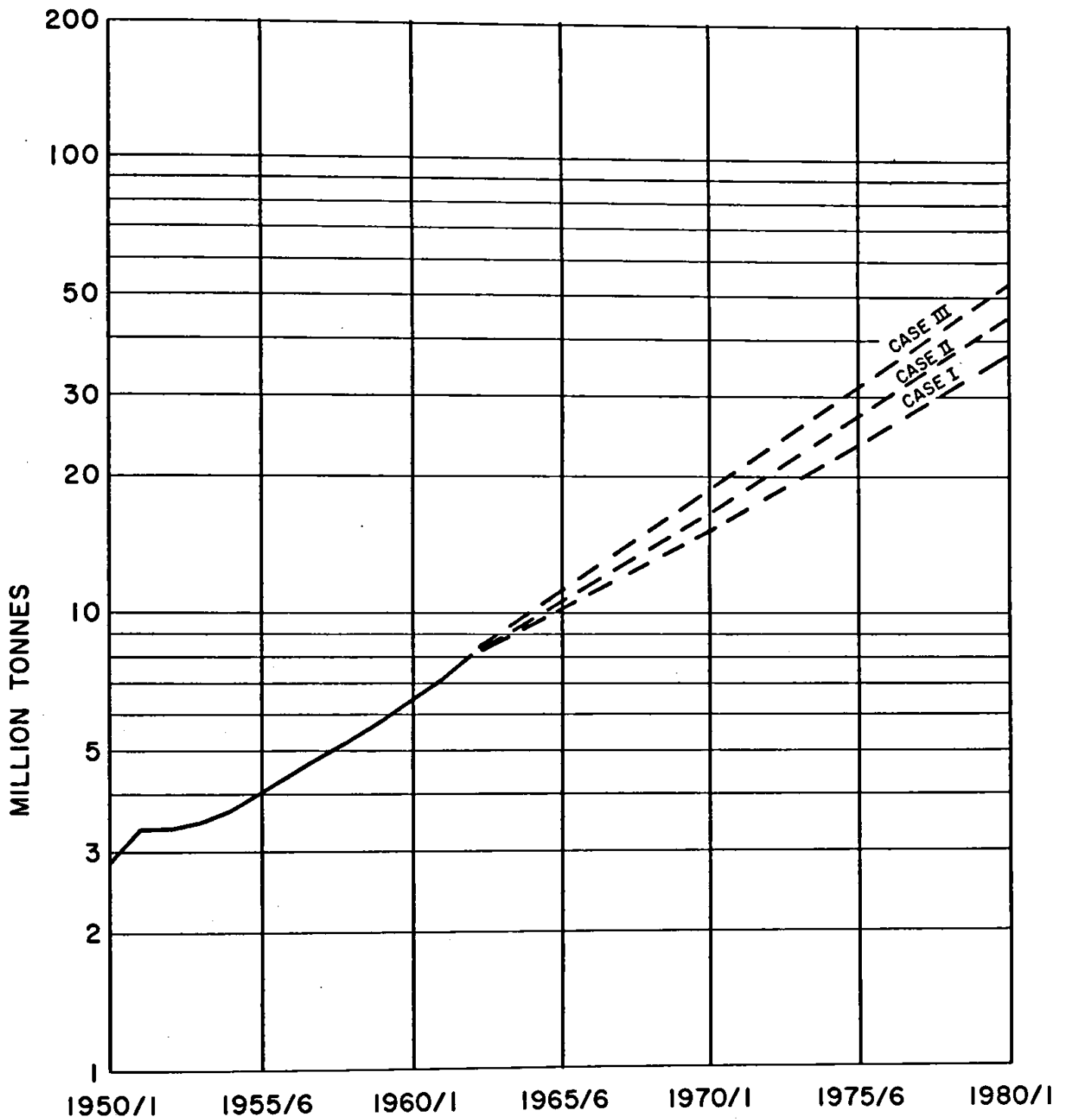

FIGURE 9-ESTIMATED INTERNAL CONSUMPTION OF PETROLEUM ENERGY PRODUCTS

may become plentiful in the neighbourhood of certain refineries. On the other hand, it appears necessary to find new uses for naphtha which may be significantly in surplus. Our estimates for the total demands for oil products show the following percentage increases on 1960/1. We compare these total in-

creases with the increases which we have estimated for the domestic sector, which absorbs almost the whole of the kerosene, and for the transport sector which absorbs much of motor spirit, and nearly all the H.S.D.O. supply.

TABLE 125
RELATIVE ESTIMATED INCREASES OF TOTAL DEMANDS
FOR OIL PRODUCTS AND OF DOMESTIC DEMANDS

	(1960/1 = 100) 1960/1	1970/1	1975/6	1980/1
Estimates of Total Demand for Oil Products (Case III)	100	303	504	844
Estimates of Domestic Demand for Oil Products	100	217	312	508
Estimates of Demand of Transport Sector for Oil Products (Case III)	100	323	546	868

278. It will be seen that the total estimated increase rises considerably faster than the estimated increase for the domestic sector; thus there is good reason to hope that the pattern of demand, with a large present kerosene component, will become easier to meet than in the past. On the other hand, the demands of the transport sector seem likely to increase faster than the average, and the H.S.D.O. shortage will, if nothing is done, become still greater, while the motor spirit and naphtha surpluses increase.

279. This problem is - we know - already being actively examined in order to find outlets, either in the iron and steel industry or in the manufacture of fertilisers and petrochemicals, for the surpluses already becoming manifest. We think it probable that longer term trends may accentuate rather than relieve the problem. It will certainly be advisable to consider further the question whether, in the special circumstances of India, it is really wise to provide tax incentives which discourage consumption of motor spirit and encourage not only the consumption of diesel oil, but also the acquisition at higher initial cost of vehicles which use the scarce forms of oil products; it may in fact be easier to provide larger quantities of motor spirit than smaller quantities of diesel oils. Further consideration of substitution of fuel oil for coal in locations remote from coalfields and near to oil refineries is also advisable, since fuel oil may otherwise become surplus. These problems can best be examined when the experts of the industry have made a more detailed product analysis of our petroleum demands.

280. The estimates of oil consumption in 1970/1 resulting from the above studies of the Working Group, are significantly lower than estimates for the same years made by the Ministry of Petroleum and Chemicals. Their estimates would suggest a total demand (corresponding to our Case III in Table

124) of approximately 27 million tonnes, including non-energy products and refinery fuel, as contrasted with our estimate of approximately 24 million tonnes. The differences here are to be explained almost wholly in terms of different underlying assumptions in the process of estimating. The Ministry has, quite properly, attempted to estimate what may be the probable demand for oil products, if present policies continue unchanged, in order that their refining capacity, import plans and handling facilities may be adequate to meet the demands that are likely to be encountered on that basis. Their estimated demands are in fact not widely different from estimates made by our Working Group at an earlier stage in our work on a similar basis. The present estimates included in this report are based on rather different assumptions. It has been assumed, in the light of the first estimates prepared for the Committee by the Working Group, that there is a danger that India's dependence on imported fuels will progressively become greater than the limits set by the Indian balance of payments can permit; that oil should be assumed to be available to meet the needs of those activities and industries in which it is essential; that increased pressure will have to be put on industries capable of using indigenous fuels to economise in their use of oil products. The two sets of estimates appear to differ comparatively little in respect of those uses in which oil is essential. They differ more widely in their assumptions regarding the freedom with which industries will be permitted to use fuel oils. While this is likely to be surplus in some regions in the neighbourhood of refineries, and plans will need to be made for its use, there are other regions particularly in Western India where there would appear likely to be, on the Ministry's calculations, a considerable deficit to be met by import. We think that the Government of India will need to consider whether or not it can afford to make larger amounts of oil

products than we have assumed available in practice, and also whether, in determining the location of new industrial developments, increased preference should be given to sites where indigenous rather than imported fuels can be used, or to sites where fuel oil is likely to be in surplus rather than deficit.

III. SUPPLIES OF CRUDE OIL

281. If, as our estimates suggest, the Indian economy is likely to need some 24 million tonnes of crude oil by 1970/1, some 30-40 million tonnes in 1975/6 and probably some 45-65 million tonnes by 1980/1, where is this to come from?

282. In 1960/1, the output of Indian oil wells was, as we have shown, about half a million tonnes. In 1963 this has risen to a little over 1.6 million tonnes. About three-fifths of this has come from Assam and the remaining two-fifths from Gujarat.

283. Exploration is currently being conducted with great vigour in various parts of India. India possesses an area of about one million square kilometres of sedimentary rocks which theoretically represent an oil potential; this constitutes nearly one-third of the country's total area. The attached map (Figure 10) shows the areas concerned.

284. As the available geological knowledge regarding several of these sedimentary basins is meagre and of a very general nature, it is for the moment impossible to make any firm assessment of possible petroleum reserves. Of the areas so far explored for oil much the most promising are those in Assam and Gujarat.

285. The figures given for estimated reserves are constantly changing in the light of new knowledge. Recent guesses - and they can be little more - are that proved reserves in Assam may amount to 50 million tonnes and those in Gujarat to another 50 million tonnes.

286. Both these areas are being intensively studied, with the aid of foreign experts, and at the same time other areas are being investigated. It is too soon to be at all certain what the total reserves may be. There are approximately 100 million tonnes of proved reserves; including possible inferred reserves, the total may conceivably reach 175 million tonnes in all.

287. Much of any new discoveries will have to go toward replacing the fields now in operation which will probably become exhausted within the period of our study.

288. We hesitate to be dogmatic about anything so uncertain as India's ultimate oil potential. Exploration and development on the basis of already proved reserves is being currently planned on the basis of reaching an annual output as high as 13 million tonnes. In the light of India's acute need for larger indigenous supplies of oil it is clearly wise to proceed vigorously. We do not think it safe, however, in advance of greater experience than is yet

available, to assume with confidence and as a basis of energy planning, that such a level will actually be achieved in practice by 1970/1. We think that it may be more reasonable for the moment to expect that annual output may reach some 10 million tonnes by 1975/6, when allowance is made for the progressive exhaustion of supplies in the older areas of Assam. There are those who hope that the figure may be as high as 15-20 million tonnes by 1980/1. But we would again not regard it as safe to assume for the time being for purposes of our calculations any figure much larger than 10-15 million tonnes, unless some startling new discovery is made of oil resources on a wholly different scale from those yet known.

289. If that is, in fact, a reasonably optimistic estimate of indigenous supplies, it means that India would need, on the basis of our Case III estimates, to be importing some 17 million tonnes of crude and products in 1970/1, about 30 million tonnes in 1975/6 and perhaps 50 million tonnes in 1980/1. These are very formidable amounts. They mean, in the first place, that India will depend for something approaching 30% of her commercial energy supplies on the goodwill and political stability of her oil suppliers; that is, of course, true of most European countries to-day. They mean secondly that India must find each year around 1975/6 some Rs. 200 crores to meet these imports alone. On the basis of estimates that have been made of Indian exports at that time, such oil imports might absorb almost one-third of total import capacity.

290. We have not regarded it as within our competence to determine whether this is too heavy a load on India's foreign trade. This is a subject to which we shall return at a later point in this report in connection with the imports of capital equipment as well as fuels for the energy sector. The estimates that we have made of demands have reflected, where they have been evident, what seemed to be the longer-term trends in various industries towards greater use of oil products and electricity. In revising the report, however, we have deliberately given a bias in our estimates towards use of indigenous fuels whenever this seemed practicable. It will be for the Government of India, on the advice of the Planning Commission, to consider whether the trends are likely to be dangerous to its longer term balance of payments policies and whether it may be wise to go even further in the direction of giving incentives to use Indian coal or electricity in preference to imported oil.

IV. NATURAL GAS

291. We are informed that the proved and inferred natural gas reserves, as estimated on the basis of present explorations, are 31.5 billion cubic metres or only about 50 million tonnes of coal equivalent determined on a calorific equivalent basis. We have not attempted to estimate how, if important

fields were discovered, they might fit in detail into the Indian energy economy. It is immensely to be hoped that such discoveries may be made and there are reasonable hopes that will happen, particularly in Rajasthan. There are possibilities also that if political relations become easier, India might draw on the ample supplies of natural gas just across the border. There are further possibilities that ways

may be found of making gas from the oil-fields of the Middle East countries available to Indian markets. But we have regarded all these possibilities for the moment at least as too uncertain for immediate planning calculations. If circumstances change, it might considerably modify the prospective energy economy of the Western and Central Regions of India.

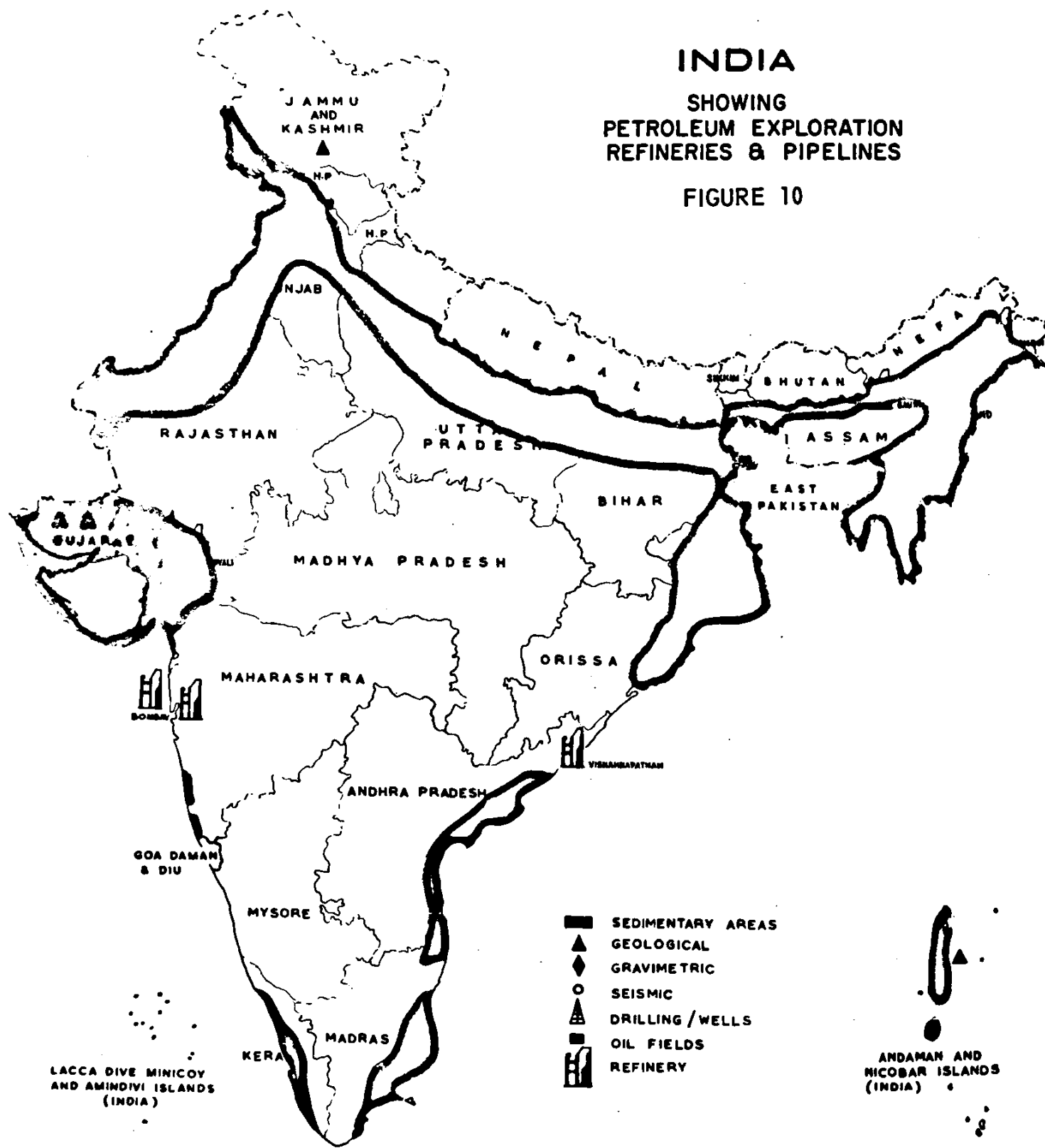

CHAPTER 13

Problems of Electricity Supply

I. THE BACKGROUND TO THE PROBLEM

292. Our estimates have shown that the demands in India for electricity by 1975/6 may be about seven times those of 1960/1 and by 1980/1 about twelve times those of 1960/1. This involves a tremendous expansion and modernisation of the whole organisation for electricity supply. This Chapter will be concerned with the main problems and implications of achieving this.

293. The electric utility industry today still possesses many features derived from its past history. It began, as elsewhere, with small isolated stations, mostly in the bigger towns, mostly in the first stages owned by private companies. Capacity has grown rapidly, but until recently has been relatively small.

TABLE 126
UTILITY GENERATING CAPACITY
1920-62

Year End	Megawatts			Total
	Steam	Hydel	Diesel	
1920	49	74	6	130
1940	624	469	115	1208
1951	1098	575	163	1835
1956	1596	1061	228	2886
1960/1	2436	1843	300	4579
1961/2	2466	2234	317	5017

294. Despite rapid progress in the post-Independence period, electricity is still provided by a large number of small stations — many of these very small and very old — by modern standards obsolete, operating at low fuel efficiency, and inadequately interconnected.

TABLE 127
ANALYSIS OF UTILITY GENERATING STATIONS

	Number	1962		Percentage of total Generation
		Installed Capacity	Generation Year 1961/2	
		End 1961/2 MW	GWh	
Steam				
Total	92	2466	9476	100
Over 50 MW	15	1687	6937	73
Diesel				
Total	641	317	380	100
Over 50 MW	—	—	—	—
Hydel				
Total	65	2234	9814	100
Over 50 MW	14	1593	6866	70
All Types				
Total	798	5017	19670	100
Over 50 MW	29	3280	13803	70

295. Thus, of 798 individual utility stations in 1962, only 29 were above 50 MW in size. The largest individual stations were Bokaro Steam Station with 255 MW and Bhakra Left Bank Hydro Station with 450 MW. Even these are not large stations by present standards elsewhere in the world.

296. Of the 2741 generating sets in service, only 16 were of 50 MW capacity or larger. The largest individual sets were three steam turbine sets of 75 MW each and five hydel turbine sets of 90 MW each.

297. Because of the small average size of steam generating units, efficiency has been, and is, very low. Average gross efficiency for various years during the last decade is given in Table 128:

TABLE 128
AVERAGE GROSS EFFICIENCY OF
UTILITY STEAM-ELECTRIC GENERATING STATIONS

	1951	1956	1959/60	1960/1	1961/2
Reported Gross Heat Rate(a)					
(Kcal/kWh)	5280	4740	4440	4375(b)	4285(b)
Gross Efficiency					
(%)	16.3	18.1	19.4	19.6(b)	20.1(b)

(a) Before deducting station use.

(b) Figures revised in the light of our own studies.

298. This technically ill-equipped and currently under-sized industry has been responsible for the supply of electricity to a sub-continent. Inevitably, and largely for historic reasons, the levels of electricity consumption per head and per square kilometer have been low by the standards of more advanced countries. Average consumption per head in India in 1960/1 was 38.9 kWh. In the Eastern and Western Regions, where industrial development is greater and electricity supply has long been available, the consumption is more than 50% above the national average. In the Southern Region it is close to the national average. In the Northern Region — principally the Punjab and Rajasthan — the figure is about three quarters of the national average. It is lowest in Uttar Pradesh and Madhya Pradesh — the Central Region — and in Assam. One of the problems of the future is the provision of better facilities in areas which have been backward for historical rather than economic reasons.

TABLE 129
ANALYSIS OF ELECTRICITY CONSUMED BY REGIONS - 1960/1

REGION	POPULATION millions	AREA 000' km ²	ELECTRICITY CONSUMED (c) million kWh	CONSUMPTION	
				Per head kWh	Per km ² kWh
All India	435.2(a)	3038.8(b)	16,922.4	38.9	5,569
Eastern	99.1	417.7	5,708.4	57.6	13,669
Northern	47.9	631.7	1,426.7	29.8	2,259
Central	106.2	737.2	1,783.0	16.8	2,419
Western	60.1	494.8	3,964.3	66.0	8,012
Southern	110.0	635.4	3,989.1	36.3	6,278
Assam	11.9	122.0	49.9	4.2	409

- (a) Excluding Union Territories other than Delhi and Himachal Pradesh;
 (b) Excluding the areas of Union Territories, other than Delhi and Himachal Pradesh, and the area occupied by Pakistan in Jammu & Kashmir State.
 (c) Consumption by ultimate consumers, ie, excluding generating station use & transmission & distribution losses.

299. The Indian generation per head is compared with that of some other countries in Table 130.

TABLE 130
GENERATION OF ELECTRICITY PER HEAD
IN VARIOUS COUNTRIES

Country	1960		Generation per head kWh
	Generation by utilities and Industry TWh	Populations millions	
India	23.2	435.2	53
Mexico	10.7	34.9	308
Brazil	22.9	71.0	322
Turkey	2.8	27.8	101
Portugal	3.3	8.9	366
U.S.A.	841.6	179.3	4680

300. During recent years the consumption of electricity has increased rapidly. Over the period 1953/4

to 1962/3 final consumption of electricity has risen as follows:

TABLE 131
FINAL CONSUMPTION OF ELECTRICITY (a)

Generated by:	TWh									
	1953/4	1954/5	1955/6	1956/7	1957/8	1958/9	1959/60	1960/1	1961/2	1962/3
Utilities	6.69	7.53	8.59	9.66	11.37	12.99	15.04	16.86	19.67	22.37
Auto-Producers	<u>2.07</u>	<u>2.12</u>	<u>2.28</u>	<u>2.29</u>	<u>2.39</u>	<u>2.53</u>	<u>2.88</u>	<u>3.29</u>	<u>3.57</u>	<u>3.94</u>
Total	8.76	9.65	10.87	11.95	13.76	15.52	17.92	20.15	23.24	26.31

(a) Includes generating station use and transmission and distribution losses.

301. The growth of electricity consumption since 1953/4 has averaged 12.8% per year. But it is not clear that this has represented the growth of demand rather than the growth of the available supplies. There have been restrictions of three kinds: firstly, restrictions from the cutting off of supplies during periods of excess demand; secondly, restrictions in the form of limitations on the amount of electricity that might

be taken by a customer who had been given connection; thirdly, restrictions in the form of refusals of applications for connection.

302. It is very clear that in recent years the limitations of electricity supply have not only caused interruptions from time to time to industrial production but also have involved refusals of electricity supply which, if available, would have made possible greater

increase of industrial production. It is currently a matter of great urgency to remove these limitations.

303. It is not easy to measure the extent of the present shortfall of electricity supply. That it exists as things are there can be no question. But it is very far from clear that it is entirely due to inadequacy of generating capacity in aggregate. The most serious shortfalls in 1963 were those in Madras, which was due to the results of quite abnormally low rainfall on a predominantly hydel system, and in Calcutta where a shortfall due to breakdown of Calcutta Electricity Supply Company equipment could not be made good by the West Bengal State Board. But more generally it seems clear that, while shortages did occur, they were largely to be ascribed to the absence of trans-

mission facilities whereby one station could have helped its neighbour, and possibly in some cases to lack of effective arrangements for co-operation.

304. Even with little or no transmission and a basic load factor (ratio of average load to peak load) of 0.60 and allowing a demand factor (ratio of peak load to capacity) of 0.75, it should be possible to achieve 4000 hours per year use of capacity. Actually, as can be seen from Table 132, in the two years 1960/1 and 1961/2 this level was reached only in the Western and Southern Regions which are better endowed with transmission lines than most regions. We believe that with more adequate transmission, the present shortages would not have been great.

TABLE 132
HOURS USE OF GENERATING CAPACITY (a)

Region	1960/1			1961/2		
	Generation TWh	Capacity GW	kWh/kW	Generation TWh	Capacity GW	kWh/kW
Eastern	4.40	1.24	3548	4.78	1.24	3850
Northern	1.44	.44	3288	2.38	.66	3590
Central	1.73	.66	2600	2.04	.77	2650
Western	4.54	1.09	4153	5.00	1.13	4412
Southern	4.70	1.12	4216	5.41	1.17	4630
Assam	.04	.03	1357	.05	.03	1640
All India	16.85	4.58	3680	19.67	5.02	3920

(a) Utilities only

305. The problems of increasing rapidly India's electricity supplies are great. The periods of construction of major electricity projects in India are long — far longer than in advanced countries with greater local industrial resources to facilitate rapid construction. The average period of construction of a hydel project in India is currently about nine years and that of a thermal project about five years. It is important to do all that is practicable to shorten these periods. But meanwhile the length of these periods of construction make it very important to plan more than normally far ahead. It is partly for that reason that the present survey has been conducted and has attempted to look as far ahead as 1980/1.

306. A rapid increase of supply is made much more difficult by two handicaps under which India labours. The capital costs of electricity supply, both on the side of generation and on that of transmission and distribution, are very high and capital investment of this complex type cannot be expanded greatly and rapidly in India. The import content of investment in electricity supply is, for the moment, also very high; it will only be reduced significantly as new manufacturing developments mature during the next ten years. We shall consider both these problems at a later stage.

II. THE INSTITUTIONAL FRAMEWORK

307. In the earlier stages of development in India, the various undertakings were mostly, as has been said, small. In the bigger cities they usually took the form of private companies. In some of the then existing Princely States, the State Government, or the Prince himself, pioneered development. A number of the smaller stations were associated with industrial undertakings, privately owned mines, plantations or estates. In some cases also Government establishments or local authorities set up plants of their own.

308. In the earliest years the Central Government exercised a modicum of control under the Indian Telegraph Act. In 1910, when it was felt that it was desirable to extend control over these various private concerns, the Indian Electricity Act was enacted. This provided, inter alia, for granting of licences to supply electrical energy in specified areas; for establishing the conditions under which the licensee was required to operate and conduct his business; and for defining the duties and mutual responsibilities of licensees, consumers and the Government. That Act provided for the creation of a Central Electricity Board, whose responsibility it was to promulgate in the public interest rules specifying service and safety conditions,

as well as the manner in which the licensee must make an annual report.

309. While it was clearly the intent of the 1910 Act, through its broad language, to include everything that concerned the supply of electric energy, it is clear also that, in harmony with the economic philosophy of the time, it was designed to regulate the actions of individual private undertakings rather than to form the framework for the effective co-ordination of these undertakings into regional systems of electricity supply throughout the whole of India.

310. It was already clear before 1945 that the 1910 Act was woefully inadequate to deal with this aspect of co-ordinated development. Already in 1945 the Government was aware of the necessity for new legislation. It is significant that, about this time, the Policy Committee on Electricity and Public Works of the Legislature recommended that "steps be taken to eradicate any factors that retarded the healthy economical growth of electrical development on regional lines whether in Provinces, States — or Local-Authority-owned, or in commercially-owned undertakings". At the same time the National Planning Committee had in mind the creation of regional Provincial (now State) Electricity Boards. In the light of this, the Government proceeded to draft an Electricity (Supply) Bill, which subsequently emerged as the Electricity (Supply) Act, 1948.

311. This Act, drafted with the assistance of experts from the United Kingdom, owed much to contemporary experience in the United Kingdom. The British Electricity (Supply) Act of 1919, had created a body of Electricity Commissioners charged with the duty of promoting, supervising and regulating the industry; it was the aim to secure voluntary participation in a plan to reduce the number of undertakings and concentrate generation in a smaller number of stations. The subsequent British Electricity (Supply) Act 1926 created a Central Electricity Board for the control of generation, without, however, ownership of the stations. It created also Electricity Commissioners to administer local distribution. The Board was given the responsibility of constructing an interconnecting grid system of main transmission lines. It was the intention to secure that electricity should be generated under the Board's instructions in what were termed "selected stations" and made available through the grid to the authorised local suppliers. While the Act resulted in some considerable economy through reduced standby capacity and through mutual assistance between supply areas, it did not prove adequate to achieve either complete pooling of generation or the selection of the most efficient and the elimination of marginal producers. It was, in effect, a half way political solution of the immediate difficulties created through the ownership of generating capacity by the distribution companies.

312. The Indian Electricity (Supply) Act, 1948, sought to apply to Indian conditions the basic ele-

ments of the United Kingdom legislation and to remedy thereby some of the defects of the 1910 Act. It was recognised that, because of the size of India and the probable difficulties of administration, it would not be possible to model the legislation on the very centralised system of the United Kingdom. What was needed, it was thought, was some provision for:

- (a) the building of grid systems on uniform lines; and
- (b) the creation of semi-autonomous bodies in the Provinces to administer the grid systems.

Within the framework of the 1910 Act it was impossible for the Provinces to constitute such quasi-commercial bodies. Consequently, the need for Central legislation was apparent both to permit creation of Provincial Boards and to enable the Central Government to co-ordinate the regional development of electricity providing for uniformity and control of existing licensees. A new term was employed in the preamble of the Indian Act of 1948 which has great significance since the use of the word "rationalisation" implied a far greater scope than the objective of the United Kingdom Act of 1926 on which the Indian Act was modelled.

313. The objectives of the 1948 Act were the "rationalisation" of the production and supply of generation and the development of an industry, in which there would be both private and public undertakings. When the Indian Electricity (Supply) Act of 1948 became effective, it was intended that both "rationalisation" and development of the electric supply industry should be on a regional basis because of the federal character of the Government of India and because "Electricity" is a concurrent subject under the Constitution of India, so that both Central and State Governments may legislate on the subject. Notwithstanding the implication of regional development, it was intended that there should be a national policy for co-ordinated development, to ensure optimum utilisation of the national resources by planning agencies whether Federal or State. The Act empowered the creation of the Central Electricity Authority (Federal) and at the same time, authorised the States to establish a State Electricity Board, a State Electricity Consultative Council, a Local Advisory Committee and a Rating Committee. The Act extended to all India except Jammu and Kashmir, exempted by Constitutional provisions.

314. The Act laid down specific functions for five bodies or groups of bodies:

- (i) The Central Electricity Authority, with responsibility, inter alia, to develop a sound, adequate and uniform national power policy and to co-ordinate the activities of the various planning agencies;

- (ii) State Electricity Boards, with responsibilities, inter alia, for preparing and carrying out schemes, for designating stations (in the language of the corresponding British Act) for generation for Board purposes, for inter-connections by main transmission lines, and for supplying electricity to owners of controlled stations or licensees;
- (iii) State Electricity Consultative Councils to advise the Board on major questions of policy.
- (iv) Local Advisory Committees which might be set up by State Governments.
- (v) Rating Committees which might be appointed by a State Government to examine the charges made for the supply of electricity.

315. The State Boards have generally become vigorous and effective bodies. In practice the responsibilities of the Central Electricity Authority have come to be discharged almost wholly by the Ministry of Irrigation and Power, and that Ministry rather than the Central Electricity Authority has become the co-ordinating authority.

316. Two further factors in addition to the Act of 1948 affect the system for the regulation of the electricity supply industry. Firstly, the Constitution of India, enacted in January 1950, divides legislative power between the Union Government and the State Governments. As has already been said, electricity is in the Concurrent List, so that it is possible for both the Union Government and the States to legislate on the subject. Secondly, the Industrial Policy Resolution of April 1956 set out a fresh statement of industrial policy, necessitated by the acceptance of a socialistic pattern of society. This defined, in Schedule A, thereto, the industries which would be the exclusive responsibility of the State and those, in Schedule B, which would be progressively state owned, but in which private enterprise would be expected to supplement the efforts of the State. The Schedule A list includes generation and supply of electricity.

III. THE PRIMARY RESOURCES FOR ELECTRIC ENERGY

(i) Hydro-electric Resources

317. There are four main primary resources on which electricity supply must depend: water resources; coal; oil; nuclear fuels. We have discussed in other chapters the coal and oil resources available to India. It remains to consider the resources of water power and of nuclear fuel.

318. The water power resources of India have been very fully surveyed over a considerable period of time. An excellent report on them by the Central Water & Power Commission has been available to us and is printed as Annex 3 to this report. We have not thought it necessary to conduct any separate in-

vestigation of our own. We summarise the results of that survey.

319. While India has limited resources of good coal and, so far as is yet known, only exiguous resources of oil, the country is relatively rich in water power resources, and in the ultimate industrial development of India, these must play a large part. The hydro-power potential is estimated in aggregate at about 41 million kW at 60% load factor, which corresponds to 216 TWh annual output on a firm basis. This ultimate potential maybe compared with the total electricity production by all public utilities, hydro and thermal, of 22.4 TWh in 1962/3.

320. But inevitably this hydro-power potential is very unevenly distributed. It may be summarised best in terms of the river systems on which it depends:

TABLE 133
HYDEL POTENTIALS OF VARIOUS RIVER BASINS

River Basin	Hydel Potential TWh
Ganga Basin	25.7
Central India Rivers	22.5
West flowing rivers of Southern India	22.6
East flowing rivers of Southern India	45.3
Brahmaputra Basin	65.6
Indus Basin	34.6
Total	216.4

Additional potential amounting to 48 TWh lies either in Sikkim or Nepal, or on rivers which form the boundary between India and one of those countries. These further resources could only be exploited by agreement with one of the countries concerned. But it may well be in the interest of both countries to do this.

321. If we consider these potentials in terms of the Regions in which we have analysed the energy demands and problems of India, the distribution is as follows:

TABLE 134
HYDEL POTENTIALS OF VARIOUS REGIONS OF INDIA

Regions	Hydel Potential		Percentage of Total Estimated Electricity Demand in 1980/1
	TWh	%	
All India	216.4	100.0	100.0
Eastern	14.2	6.5	26.4
Northern	36.6	16.9	9.6
Central	43.9	20.3	15.5
Western	13.6	6.3	21.5
Southern	42.6	19.7	26.1
Assam	65.5	30.3	0.9

322. While in general the hydro power potential serves to redress the lack of balance in the coal resources, it will be seen that 30% of the hydro potential is in the Assam Region, where less than 1% of the electricity demand is expected. Of this hydro-power

potential the proportion that had been exploited by 1962/3 was relatively small in total. But in individual regions – notably the Western and Southern regions – the proportion was higher.

TABLE 135
PROPORTIONS OF HYDEL POTENTIAL ALREADY EXPLOITED
(Hydel generation as % of potential)

	1960/1	1962/3
All India	3.6	5.5
Eastern	5.6	8.1
Northern	2.8	6.7
Central	1.1	2.9
Western	10.0	15.1
Southern	9.7	11.4
Assam	0.03	0.04

323. There is understood to be little reason to think that the sites already exploited are significantly more favourable than the remaining sites, or that the average capital cost of exploitation per kWh is likely to increase progressively as exploitation proceeds.

(ii) Resources of Nuclear Fuels

324. India's reserves of nuclear resources are to be found in two forms: uranium and thorium. The uranium can be used directly in reactors. The thorium cannot be used directly as a fuel in its natural form. But it is a fertile material in the sense that when it is placed in a reactor a variety of uranium – U-233 – is generated in it and this in turn is a nuclear fuel.

325. The Atomic Minerals Division of the Department of Atomic Energy has surveyed the country in search of uranium and thorium deposits and other materials of potential interest for atomic energy work. A number of deposits of uranium have been located in Bihar, Rajasthan and Madras. One of these, in Bihar, has been quantitatively assessed for its uranium content. This is estimated to contain some 2.8 million tonnes of ore of an average grade, so far, of .076 – a little under 0.1% of U_3O_8 . In addition to that, about 1.12 million tonnes of this ore contains about 0.1% of U_3O_8 . This implies that the total amount of uranium definitely contained in the deposit is above 2,000 tonnes. There is ground for hoping that the quantity is in fact greater since the quality appears to rise as mining proceeds.*

326. It has been estimated that these 2000 tonnes of uranium, yielding in the Candu type reactor some 10,000 MW-days per tonne should be sufficient to provide nearly 1 million kilowatts of nuclear power for 20 years, or the full life of a reactor at 75% load factor.

*The Department of Atomic Energy has since indicated that recent investigations have shown that in addition to the deposits in Bihar the indicated and inferred reserves in the neighbouring deposits contain over 10,000 tonnes of uranium.

Facilities are being created to treat about 1000 tonnes of ore a day and yield about 200-300 tonnes of uranium metal per year. Even without further discoveries of uranium (for which there is reasonable hope) the present supply could enable India to provide, from indigenous resources, for the first group of stations that might be built, up to a total of 1½ to 2 million kilowatts. The monazite sands of Kerala (see para 327) probably contain an additional 30,000 tonnes of uranium which can be recovered at the same time as the thorium which they contain.

327. In the longer view, as it now appears, Indian developments of nuclear energy must probably depend on the use of thorium. In respect of this India is very well endowed. There are some 500,000 tonnes of thorium, mainly in two deposits. About 200,000 tonnes are contained in a very rich (9% concentration) in the monazite beach sands of Kerala. This deposit has been known for some fifty years past. During the past ten years a second source has been discovered by the Atomic Minerals Division in an even larger deposit in the Ranchi Plateau, partly in Bihar and partly in Bengal. This contains some 300,000 tonnes of thorium in monazite of a concentration of 10%. The 500,000 tonnes of thorium has been described as equivalent to all the world's known uranium in ore containing .1% and above.

328. But while there is no question that ultimately this thorium can be used for the production of nuclear energy, its use requires the solution of a number of problems. The thorium cannot, as has been said, be used directly but must first be used, with other fissionable material, in a reactor to generate U-233. It is believed that the conversion of thorium could best be done in a breeder-type reactor but that it is also possible in a thermal-type reactor. When these processes have been developed, and especially when suitable breeder-type reactors are commercially available, India will be richly endowed with nuclear fuels.

IV. TRANSMISSION AND DISTRIBUTION

329. In general terms it is not as possible to describe statistically the present state of the transmission and distribution systems of India as to describe the generating capacity. In very general terms it can be said that the rapid growth of demand for electricity has led to infinite improvisation to enable an already inadequate system of distribution to carry slightly more load. In most of the cities the present distribution system is both out-of-date and very seriously over-loaded.

330. In most of the advanced countries investment in transmission and distribution is normally about equal in scale to the investment in generation. While great efforts have been made in recent years in some parts of India, in general the country stands in urgent need of heavy investment in facilities for distribution.

331. For the year 1959/60 the value of assets in generation in India, as compared with those in transmission and distribution was estimated (see Table 136) to be as follows:

TABLE 136
VALUE OF ASSETS OF ELECTRIC UTILITY UNDERTAKINGS
FOR GENERATION AND DISTRIBUTION
1959/60

	Rs. million
Investment in Generation	
Steam	1415
Diesel	237
Hydel	1801
Total	3453
Investment in Transmission and Distribution	
Transmission	762
Distribution	2427
Total	3189

It will be seen that the ratio of assets in India is comparable with that of more advanced countries; it must, however, be remembered that the density of consumption in India is of entirely different order from that in the more advanced countries.

332. The existing transmission lines are shown on the map (Figure 11) attached to this report. While the total length of lines has been more than doubled during the past ten years they are very insufficient to present needs.

TABLE 137
LENGTH OF TRANSMISSION LINES
(circuit km)

Voltage Range kV	1951	1961/2
37.5 - 44	1530	989
66 - 78	6540	12238
90 - 110	2204	6184
132	584	7049
220		654
230		445

333. The advantages and economies of interconnection are familiar: they make it possible for load to be met at the lowest overall production cost; they enable mutual assistance to be given in case of

break-down; they make possible a lower installed and spinning reserve capacity; they make it possible for larger generating units to be installed with corresponding economies of capital and operating costs; if the peaks of two adjacent systems are not simultaneous, they make it possible to exchange power to mutual advantage; they permit the integration of thermal, nuclear and hydro systems; they enable facilities to be scheduled for maintenance; they make it possible to avoid spilling water from a hydel reservoir without financial return.

334. In European conditions, a high degree of interconnection organised through the U.C.P.T.E. has very greatly reduced the stand-by plant now considered necessary. In Germany a generating margin of 6% is now considered adequate. In Switzerland, 30-40% of the night load has been imported from Federal Germany. Though the amounts transferred only represent about 3.5% of total output, the economies and advantages conferred by closer interconnection have been incalculable.

335. In Indian conditions, the absence of sufficient interconnection has not only involved interruption of supplies in conditions in which, with interconnection, this might have been avoided, but has also precluded the obtaining of the potential economies, especially of stand-by plant, inherent in integrated systems. Many Indian stations are completely isolated from other stations and are incapable of being assisted in case of accidental outage.

336. Provisions have been made for improving transmission and distribution in the Third Plan, but we do not believe that in present circumstances the amounts available, representing appreciably less than 50% of the planned expenditure on generation, are at all sufficient. With the developments of the next few years, the problems of the integration into the system of the large nuclear stations will arise. It will not be possible to operate them on 75% load factor unless surrounding thermal or hydel stations can be closed down during periods of low system demand and their load taken over; this cannot be done without a sufficient investment in transmission.

337. We discuss in a later section of this chapter the problems of the relative economies of transfer of energy by rail and by transmission line. The long-term advantages of transmission seem clear, if the system can be properly designed to make full use of it.

338. There is one final consideration that is particularly relevant to Indian conditions. Investment in transmission can save very considerable amounts of investment in generation. The investment in transmission now has a high indigenous-content and a low import-content. The reverse is true, and likely for some time to remain true, of investment in generation. We think that in the plans for the next periods the investment in transmission should be assumed to be not less than 100% of the investment in generation.

FIGURE 11

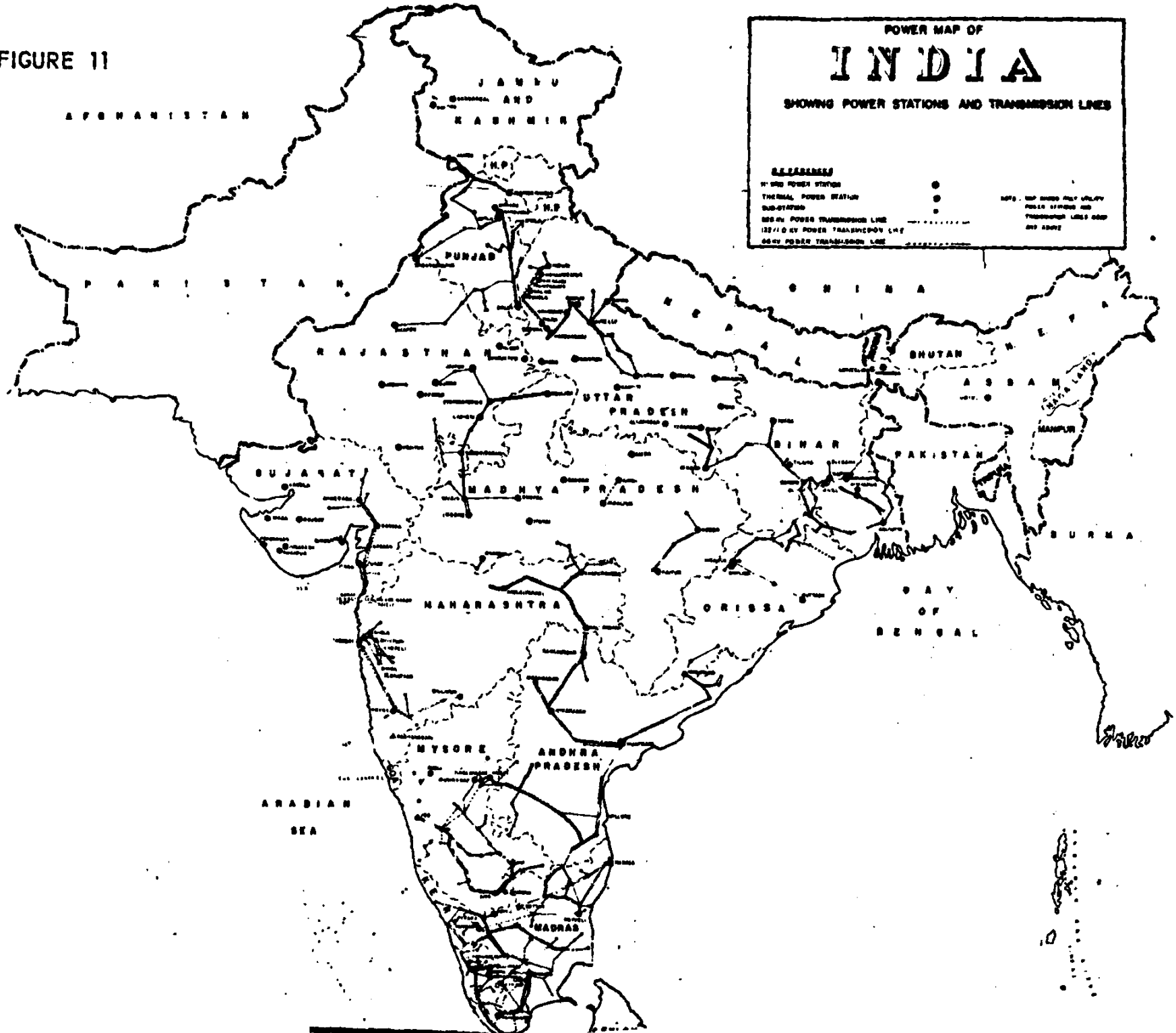

V. MAJOR PROBLEMS OF ELECTRICITY POLICY

339. There are, in our view, six major problems of electricity policy:

- (i) the choice between different methods of generating electricity – thermal, hydel, nuclear;
- (ii) the choice between different locations of generation – at or near the coal-field or near the centre of consumption;
- (iii) the choice of size of generating units;
- (iv) the future policy regarding rural electrification;
- (v) the organisation by which decisions are in future to be made and implemented;
- (vi) problems of increasing efficiency.

We propose to discuss each of these issues in turn.

(i) Methods of Generation

340. The choice between different methods of generation must always be a particular solution of the problems presented by a particular set of circumstances. In general terms it is only possible to lay down the framework within which each individual case should be examined and solved.

341. The solution in the individual case will be affected, firstly, by the relative prices of different fuels as delivered at the point of use. If the best solution is to be reached from a national point of view it is important that the fuel cost should truly represent the scarcity value of the fuel and that the delivery cost should represent the true cost of transport. We have given reasons in an earlier chapter for treating by-product coals as having zero value for planning purposes, so long as there is any likelihood of there being a surplus of them.

342. The achievement of the solution will depend, secondly, on the right choice between more and less capital-intensive methods of producing the energy itself, or in this case, the capital equipment. We are convinced that in Indian conditions, where the facilities for complex capital projects are limited, excessive use of such facilities should be discouraged by a sufficiently high rate of interest. At the same time we think it is desirable, for reasons we shall discuss more fully in a later chapter dealing with the problems of pricing, that State Boards should aim to finance a considerable part of their investment out of their retained earnings and depreciation funds. We, therefore, recommend that, in the planning of projects, a rate of return of 10% should be made the basis of all calculations.* We have treated the 10% as inclusive of the return that may be necessary to cover any tax element. We have assumed that interest at that rate, as reflecting the opportunity cost of using capital in India, should be incurred during the period of construction, in our subsequent calculations we have used that rate throughout; if that method of calculation is regarded as too severe, we suggest that, as a minimum, the current rate of interest should be used.

*Our recommendations that the rate of return of 10% should be made the basis of all calculations is not to be regarded as limited only to electricity projects. We feel that this rate of return may be regarded as applicable to all projects of public utility category and the public enterprise category.

343. The achievement of a right solution will depend, thirdly, on holding the right balance between use of imported resources and use of indigenous Indian resources. In practice it is necessary, even when an import duty of some 18% is chargeable, to give some measure of further preference to equipment which can be secured from Indian sources, in order that, within the agreed policies, the demands for foreign currencies shall not greatly exceed the available supplies. In planning projects, there is clearly advantage in giving preference to those solutions of a technical problem which make less call on imports and have a lower import-content. In our calculations we have assumed that the desirable preference will be secured by adding a tax of 33% to the import element of cost. This 33% has been assumed to include the actual duties now paid. We recommend that such an addition to the cost should be added in any actual calculation.

344. We have made estimates of the relative costs of electricity generation in hydro, thermal and nuclear stations on certain assumptions. We have used in each case, as we recommend should be done in practice in any actual case, a rate of 10%. We have applied that rate throughout and have implicitly assumed that a State Board can invest depreciation funds in its own operations to bring that rate of return. We have assumed in each case a 33% addition to the import element of capital cost.

345. The construction costs which we have used represent as nearly as possible the currently estimated cost of construction of an actual project. For the figures that we have used, which are in some cases slightly higher than estimates presented to us, and deliberately err, if at all, on the side of caution, we must take the responsibility.

346. We set out the results of our calculations in Table 138. We must emphasise at once that some of the possible alternatives that we have presented are not alternatives that could ever be considered or adopted in practice. But they serve to demonstrate the peculiar advantages or limitations of the particular method of generation under consideration. Since the possible import contents are likely to be different during 1970/5 from those of 1965/70 and the costs per kW of thermal and nuclear power stations are expected to decrease (in terms of constant input prices), we present two sets of estimates. In Tables 139(A) & 139(B) we show the relative operating costs on three assumptions of plant factor.

347. In the case of the thermal stations we make three alternative assumptions regarding the cost of coal. The first represents in effect the cost at or near the washery of generating electricity with by-product which would otherwise be surplus. The second represents coal at a price of Rs. 24.5 per tonne of 4400 kcal/kg; this is equivalent to pithead cost at outlying coal-fields; it is alternatively equal to zero cost by-product coal plus freight charges at existing rail tariffs at a distance of about 1500 kilometers from the coal source. The third and highest cost represents a cost of Rs. 53 per tonne of coal of 4400 kcal/kg., equivalent to a pithead price of Rs. 24.5 a tonne with nearly 1500 km of rail transport.

TABLE 138
COMPARISONS OF COSTS OF ELECTRICITY GENERATION IN TYPICAL HYDEL, THERMAL AND NUCLEAR STATIONS
I. CAPITAL COST
 (Approximate plant size 300-700 mW)
 PERIOD 1965/6 TO 1970/1

	Rs. per kW of capacity				
	Storage Hydel plant designed for 75% Plant Factor	Storage Hydel plant designed for 60% Plant Factor	Storage Hydel plant designed for 30% Plant Factor	Thermal Plant	Nuclear Plant
Indigenous Investment	905	776	516	380	750
Imported equipment	201	194	180	570	750
Assumed tax on imported equipment	66	64	59	188	248
Interest during period of construction	387	341	249	205	474
Total Investment per kW capacity	1559	1375	1004	1343	2222
PERIOD 1970/1 TO 1975/6					
Indigenous investment	956	824	561	595	1100
Imported equipment	152	146	135	255	300
Assumed tax on imported equipment	50	48	45	84	99
Interest during period of construction	382	336	244	168	405
Total Investment per kW capacity	1540	1354	985	1102	1904

TABLE 139(A)
COMPARISONS OF COSTS OF ELECTRICITY GENERATION IN TYPICAL HYDEL, THERMAL AND NUCLEAR STATIONS
II. OPERATING COSTS
 STATIONS CONSTRUCTED DURING PERIOD 1965/6 TO 1970/1

	STORAGE HYDEL			THERMAL									NUCLEAR		
				Zero Cost Coal			Medium Cost Coal			High Cost Coal					
	Assumed Plant Factor	75%	60%	30%	75%	60%	30%	75%	60%	30%	75%	60%	30%	75%	60%
Financial charges	2.4	2.7	4.0	2.3	2.8	5.6	2.3	2.8	5.6	2.3	2.8	5.6	3.7	4.7	9.3
Fuel costs	—	—	—	0.1	0.1	0.1	1.5	1.5	1.5	3.2	3.2	3.2	0.6	0.6	0.6
Operation & maintenance	0.2	0.2	0.3	0.2	0.3	0.5	0.2	0.3	0.5	0.2	0.3	0.5	0.3	0.4	0.7
Special Insurance	—	—	—	—	—	—	—	—	—	—	—	—	0.1	0.1	0.2
Total cost per kWh	2.6	2.9	4.3	2.6	3.2	6.2	4.0	4.6	7.6	5.7	6.3	9.3	4.7	5.8	10.8

NOTE: These estimates (see paras 342 & 343) include notional items of cost that are not normally included in similar estimates of the cost of particular types of generation.

TABLE 139 (B)
COMPARISONS OF COSTS OF ELECTRICITY GENERATION IN TYPICAL HYDEL, THERMAL AND NUCLEAR STATIONS
II. OPERATING COSTS
 STATIONS CONSTRUCTED DURING PERIOD 1970/1 TO 1975/6

	STORAGE HYDEL			THERMAL									NUCLEAR		
				Zero Cost Coal			Medium Cost Coal			High Cost Coal					
	Assumed Plant Factor	75%	60%	30%	75%	60%	30%	75%	60%	30%	75%	60%	30%	75%	60%
Financial charges	2.4	2.6	3.9	1.9	2.3	4.6	1.9	2.3	4.6	1.9	2.3	4.6	3.2	4.0	8.0
Fuel costs	—	—	—	0.1	0.1	0.1	1.4	1.4	1.4	3.0	3.0	3.0	0.5	0.5	0.5
Operation and maintenance	0.2	0.2	0.3	0.2	0.3	0.5	0.2	0.3	0.5	0.2	0.3	0.5	0.3	0.5	0.7
Special Insurance	—	—	—	—	—	—	—	—	—	—	—	—	0.1	0.1	0.2
Total cost per kWh	2.6	2.8	4.2	2.2	2.7	5.2	3.5	4.0	6.5	5.1	5.6	8.1	4.1	5.0	9.4

NOTE: These estimates (see paras 342 & 343) include notional items of cost that are not normally included in similar estimates of the cost of particular types of generation.

- (1) Calculations throughout are at constant costs of 1963/4.
- (2) It has been assumed that all the stations concerned have a life, exclusive of civil works in hydro, of 25 years and depreciation has been calculated on that basis.
- (3) Throughout the calculation of these estimates a rate of 10% has been assumed. This rate has been applied not only to the estimation of the interest element in financial charges, but also to the assumed rate of earnings of any depreciation funds; it has, in effect, been assumed that an Electricity Board or other electricity authority can invest liquid funds in its own operations to secure that rate of return; the same rate of interest has been calculated and charged on the already outstanding investment during the period of construction.
- (4) The 10% rate of return has been assumed to be inclusive of any taxes borne by the electricity authority itself, and it has been assumed that tax payments and receipts between different branches of the Government of India can reasonably be neglected.
- (5) The construction periods assumed have been as follows: hydel plant, 9 years; thermal plant, 5 years; nuclear plant, 5.5 years. It has been assumed that expenditures both on indigenous and imported equipment are made at similar rates over the significant part of the period of construction; this appears to be reasonably consistent with available evidence.
- (6) It has been assumed (see para 343) that, in the interest of import saving, preference should be given to indigenous equipment or construction to the extent of 33%.
- (7) In calculating the relative costs of hydel plant on a supposed base load of 75%, it has been assumed that the water conductor system, penstocks, power-house, turbines, generators, transformers and switch-gear are limited to those necessary if the hydel plant were so loaded.
- (8) The assumed capacity of the hydel plant

represents the firm power available in all but very exceptional years. In calculating the relative cost of hydel plant, for instance on a supposed plant factor of 30%, it has been assumed that the water conductor system, penstocks, power-house turbines, generators, transformers and switch-gear have been built on a scale to provide for this, and similarly in the case of 60%. An average life of 60 years has been assumed for civil engineering works; the normal 25 year life has been assumed for all other equipment.

- (9) In calculating the relative costs of coal-fired thermal stations, the following assumptions have been made about coal prices; (1) Zero Cost Coal: It has been assumed that surplus washery by-products would otherwise be wasted, and are potentially available to be used at zero cost (we include a small element of handling cost); (2) Medium Cost Coal: it is assumed that the cost of coal is equivalent to Rs. 24.5 per tonne of coal of 4400 kcal/kg; this would be either the pithead cost of such coal in an outlying coal-field or alternatively the delivered cost of 4400 kcal/kg by-product coal at a distance of about 1500 km from source; (3) High Cost Coal: it is assumed that the cost of coal is Rs. 53 per tonne of coal of 4400 kcal/kg; this, which is equivalent to the highest price per kcal paid for of coal by a thermal plant in 1961/2, corresponds to coal of 4400 kcal/kg; at a pithead price of Rs. 24.5 a tonne with nearly 1500 kilometers of rail transport.
- (10) In calculating the relative costs of nuclear energy the following assumptions have been made: the hypothetical station is of Candu type; no amortization has been assumed for the heavy water: Taking account of international experience, we have preferred to take the upper range of the estimates of fuel costs presented to us. In the light of American and European practice, we have assumed higher operation and maintenance cost than for thermal plant. Following practice in similar calculations in Europe, we have assumed that, even if the State would bear the cost of any compensation, it is proper to include a special insurance against it as part of the costing.

348. Certain conclusions leap to the eye. Nuclear energy, on the basis of these calculations of cost, is competitive with a thermal station using high cost coal or coal midway between high and medium costs at

75% plant factor; it is competitive only in more limited areas at 60% plant factor (which is very far above the average plant factor for any Indian system as a whole). It is unthinkable that one should incur the capital

cost of a nuclear plant in order to operate it at 30% plant factor. The break-even point, on the basis of our estimates of cost is at about Rs. 36 per tonne for coal at 75% plant factor and about Rs. 44 at 60% plant factor. Its full economy can be secured if it can be worked into the system at 75% plant factor or close to that.

349. Storage hydel is incomparably the cheapest method of generating electricity in the conditions for which it is most suited, so long as favourable sites can be discovered. But in particular it has an immense advantage over the other methods of generation at low plant factors. While it is not cheaper than a low cost coal station at an artificially high (and most improbable) plant factor, it is far cheaper at 30% plant factor. Much the cheapest method, that is to say, of carrying the peak loads is to use hydel for this purpose and to construct hydel schemes with the additional penstocks, turbines and generating units to meet peak demands.

350. A low coal-cost thermal station, such as can be constructed to burn by-product or waste coals at the coal-field, if operated at a plant factor of 60% or better is probably the cheapest method of generation of all. Thus the combination of the economies of large thermal stations or nuclear stations operated at high plant factor and hydel stations carrying the peak loads probably presents the greatest potential economies of all. This will be possible, however, only with the construction of transmission lines and interconnections which will permit the most effective use of hydel, nuclear and thermal plants in conjunction with each other.

351. In the light of these estimates, it seems clear that India will be well advised to continue to exploit hydel resources wherever there are suitable sites available. In the neighbourhood of Bengal-Bihar coal-field and the coal washeries serving it, it will be possible to produce very cheap electricity if, as we assume, the by-product prices are necessarily reduced to secure their full absorption. In areas where coal must bear a high transport cost and hydel is not available, there is clearly likely to be scope even at present costs of nuclear energy, if subsequent stations can be built at costs given in tables 138-9. The longer term place of nuclear energy in the Indian energy economy must wait the development of economic methods for using thorium. We may hope that these methods may be available by the 1970's.

(ii) Methods of Transport of Energy

352. It is clear that in future a large proportion of all the electric energy of India will be derived from the by-product coking coals associated with the iron and steel industry. Even if this is partly located elsewhere, the washeries are likely to be built near the coal-field. It is clearly necessary to examine the

question whether it is likely to be more economic to carry the energy in the form of high ash content by-products by rail to generating stations to be built near the consuming centres, or to generate near the washeries and carry electricity by extra-high-voltage transmission lines to points near the consuming centres.

353. We have made a very detailed and careful inquiry into this question and have been assisted in our examination of it by experts in Belgium and elsewhere who have helped us to work out the probable capital costs of suitable EHV lines.

354. The average unit costs of existing transmission lines in India are considerably below those in most other parts of the world. The reasons appear to be that right-of-way costs for land and the clearing of the land are low, and that labour costs are low. On the other hand the unit costs of steel, conductor, insulators and other equipment are probably higher. Indian lines have the advantage that they are not susceptible to ice loading which is a critical parameter in countries that we have used for purposes of comparison; this may permit lighter structures and lower cost for steel. The actual or estimated installed costs of lines of various voltages are given in Table 140.

TABLE 140
AVERAGE INSTALLED COSTS PER KILOMETER FOR
LINES OF VARIOUS VOLTAGES

Voltage, kV	(Rs. 000's per km)			
	Belgium (a)	United (a) Kingdom	U.S.A. (a)	India
A. DOUBLE CIRCUIT LINES ON STEEL TOWERS				
66	—	—	106	41
132	—	87 - 134	154	69
220	—	—	204	129
275	—	141 - 224	—	—
345	—	—	236	—
400	194 - 304	240 - 448	—	—
B. SINGLE CIRCUIT LINES ON STEEL TOWERS				
66	—	—	68	27
132	—	—	98	42
220	—	—	132	77
345	—	—	162	—
380	—	—	—	120(b)
400	—	—	—	123(c)
500	—	—	210	155(d)

(a) excluding right-of-way and clearing costs

(b) estimate by S. A. Quader, Chief Engineer, Andhra State Electricity Board.

(c) estimate by R. D. Jain, D. D., Transmission, C.W.P.C.

(d) estimate by G. S. Bains, Executive Engineer, Punjab State Electricity Board for 500 kV line insulated initially for 400 kV.

NOTE: Range of costs for Belgian and British lines dependant on capacity of line.

355. These relationships suggest that Indian costs for a 500 kV line may be expected to be approximately Rs. 50,000 per kilometer less than a corresponding American line, excluding in the latter case right-of-way and clearing costs. It should be noted that the estimate made for the Indian 500 kV line is for a line to be initially insulated for 400 kV which could later be reinsulated for 500 kV. This would add some Rs. 1500 to 2000 per kilometer to the cost. Thus it seems to us right to assume that a reasonable estimate of the cost of constructing a 500 kV line in India is about Rs. 160,000 per kilometer.

356. We have estimated also the other transmission investment which comprises sending and receiving end transformers, switch-gear, lightning arresters, voltage control gear and other equipment. For long transmission lines, such as we are here considering, these form a relatively minor part of the whole. In an American case the line, excluding terminal facilities, might cost something like 80% of the total. In India it seems reasonable to assume that the costs would be about the same as in the U.S.A., with lower installation costs about off-setting higher equipment costs.

357. The transmission costs per kWh delivered will be made up of fixed financial charges, operation and maintenance and losses. We assume a 10% interest rate, and a 35-year life. Making what seem to us proper allowances for losses, we have calculated as an example, the cost, with a simplified transmission system of two lines and suitable terminal equipment, of delivering 750 MW at a load factor of 0.7 over a distance of 600 km (373 miles). The lines might cost Rs. 192 million; the terminal equipment might cost Rs. 85 millions, making a total investment of Rs. 277 millions. We would estimate the annual charges as follows:

TABLE 141
ANNUAL COSTS OF 500 KV TRANSMISSION SYSTEM OF
600 KILOMETERS TO DELIVER 750 MW (a)

	Rs. millions
Financial charges including depreciation	28.8
Operation and maintenance	2.7
Losses	7.5
Total	39.0

(a) At assumed load factor of 0.7

Transmission costs would thus amount to Rs. 52.0 per kW per year, or at 0.7 load factor, to nP 0.85 per kWh delivered.

358. We have approached the same problem in another way also. An intensive study of optimised transmission costs for various loads and various distances has been made in Sweden, attempting to suit the voltage and conductor size to the circumstances. While Swedish values cannot be used directly in India, it is possible to make an adjustment that may be broadly appropriate to Indian conditions. The principal adjustment that we have made is for the rate of

interest which is the important determinant of annual cost.

TABLE 142
OPTIMISED ANNUAL COSTS FOR POINT TO POINT
TRANSMISSION OF VARIOUS AMOUNTS
OF POWER FOR VARIOUS DISTANCES

POWER MW	DISTANCE km	ANNUAL COSTS PER kW		INDIAN COSTS/kWh at 0.7 annual load factor nP
		SWEDISH(1) Rs.	INDIAN(2) Rs.	
100	50	13.3	19.1	0.31
	200	32.0	46.1	0.75
	600	76.8	110.6	1.80
200	50	9.6	13.8	0.22
	200	22.6	32.5	0.53
	600	52.8	76.0	1.24
300	50	8.4	12.2	0.20
	200	18.4	26.4	0.43
	600	43.8	62.2	1.01
500	50	7.3	10.5	0.17
	200	14.8	21.3	0.35
	600	33.6	48.4	0.79
750	600	27.6	39.6	0.64
1000	200	11.2	16.1	0.26
	600	23.4	33.7	0.55

(1) Source: The Swedish 380 kv system, p.21, Fig. 4.

(2) Adjusted to reflect capital charges of 10.8% per annum.

359. It can be seen that the Swedish estimates, even when adjusted to the assumed Indian rate of interest, are appreciably below the direct estimate we have made. However, since the Swedish estimates are founded on extensive experience, we are inclined to put more credence in them than in the limited studies made in India for us and will therefore use them as being roughly representative of what may be achieved in India.

360. May we now compare these estimated costs with those for transporting similar amounts of energy by rail? We have been given rail transportation costs for coal by the World Bank Mission now investigating methods of improving the capacity of the Indian Railways. The average cost per tonne for car-load lots is according to their estimates Rs. $(3.43 + 0.0298 \times \text{km})$. This cost includes a return of 6.25% on the capital base plus the cost of transshipment to metre gauge lines plus the assumed extra cost of movement on metre gauge lines. Their average cost in closed circuit operation (full train loads), not including transshipment or movement on metre gauge lines, again at 6.25% return on capital, is: Rs. $(0.46 + 0.014 \times \text{km})$. Since we have used in our studies a return rate on capital of 10%, we have adjusted the World Bank Mission's costs to our own assumption. Our adjusted cost including an adjustment to reflect our assumption of 33% tax on imported components (as contrasted with World Bank's 50%) is: Rs. $(3.94 + 0.0343 \times \text{km})$ for full wagon loads and Rs. $(0.53 + 0.0167 \times \text{km})$ for

closed-circuit loads.

361. Our adjusted costs compare with existing rail tariffs as follows for selected distances:

TABLE 143
FULL COSTS WITH 10% RETURN OF MOVING COAL IN CAR
LOAD LOTS COMPARED WITH RAIL TARIFFS ON COAL
AT OCTOBER 1963

Distance km	Rate per tonne of existing tariff including present surcharge	Full Costs Including 10% Return on Capital	
	Rs	Car-load lots Rs	closed circuit trains Rs
50	6.16	5.66	1.37
100	7.33	7.37	2.20
200	9.90	10.80	3.87
300	13.28	14.23	5.54
400	15.33	17.66	7.21
500	17.13	21.09	8.88
600	18.82	24.52	10.55
700	20.33	27.95	12.22
800	21.66	31.38	13.89
1000	24.58	38.24	17.23
2000	34.73	72.54	33.93

362. As always, neither the costs nor the rates for car-load lots are directly proportionate to distance. The rates are above the estimated full costs for distances of about 100 km but are below the estimated full costs for very long hauls. There is at present no existing tariff for closed circuit operations but, on the basis of the costs supplied to us, such operations may offer very considerable advantage, especially in circumstances where the amounts of coal to be moved are large. We understand that the minimum quantity for such an operation would be about 400,000 tonnes per year.

363. The implied costs of hauling coal per million kilocalories and per kWh sent out can be readily calculated. For the illustration that we have taken we have assumed by-product coal from the washeries at 4,400 kilocalories per tonne. We have assumed a net specific consumption of 2640 kcal/kWh (equivalent to 32.5% net efficiency). We set out the costs on those assumptions in Table 144.

TABLE 144
RAIL COSTS PER kWh SENT OUT FOR SELECTED DISTANCES

Distance km	Cost per tonne	Cost per million Kilocalories	Cost per kWh
	Rs	Rs	np
A. Car-load lots (10% return including transshipment etc.)			
50	5.66	1.29	0.34
100	7.37	1.68	0.44
200	10.80	2.46	0.65
300	14.23	3.23	0.85
600	24.52	5.57	1.47
1000	38.24	8.69	2.29
2000	72.54	16.49	4.35

B. Closed circuit full trains (10% return, no transshipment)

50	1.37	0.31	0.08
100	2.20	0.50	0.13
200	3.87	0.88	0.23
300	5.54	1.26	0.33
600	10.55	2.40	0.63
1000	17.23	3.92	1.03
2000	33.93	7.71	2.04

364. The above figures do not include any allowance for loading or unloading, or other costs which may be common to operation both in a washery-located and a consumer-located station.

365. It will be seen that in circumstances where a closed circuit operation is feasible transport costs are far below those for car-load lots. They are also far below existing tariffs for distances less than 2000 kilometres. It follows, therefore, that a closed circuit operation should be thoroughly investigated for certain large scale power plants that are now in being or under construction. If the costs of such operation are as low as is indicated above, such operation may provide an economic outlet for the surplus by-product coal that we foresee in the Bihar-West Bengal area. We have already referred to this possibility in a previous section.

366. The relative costs of rail transport and extra high voltage transmission depend, therefore, on a number of complex factors and it seems probable that each individual case will have to be considered on its own merits. The relative costs are presented in Figure 12, which shows the adjusted Swedish data on transmission costs in relation to rail costs for wagon-lots and closed-circuit full train loads. The latter may be viewed as the upper and lower limits of rail transport costs with an actual case falling somewhere between these limits. One practical consideration is that actual route distance between the two given points is usually greater than air-line distance; we have examined some situations where route distance would exceed air-line distance by more than 35%; in the majority of situations the difference will, of course, be less than this. We have provided for this complication in the diagram by inflating the distance-related component of rail costs by 15% (an actual case may require more or less adjustment). On this basis it can be seen that the closed-circuit operation to load-centred power stations may be the economic choice for stations of less than 500 MW. For larger stations the advantage may lie with EHV transmission. But, as we have made clear, each particular case will have to be decided on its own merits.

367. It will be necessary to examine with great care the implications of this for Indian policy. In the short term it will not be easy to frame policies so as to take full advantage of the potential economies of electricity transmission. If these are to be economically exploited, large amounts of energy at a high load factor will be needed. For the time being the planning

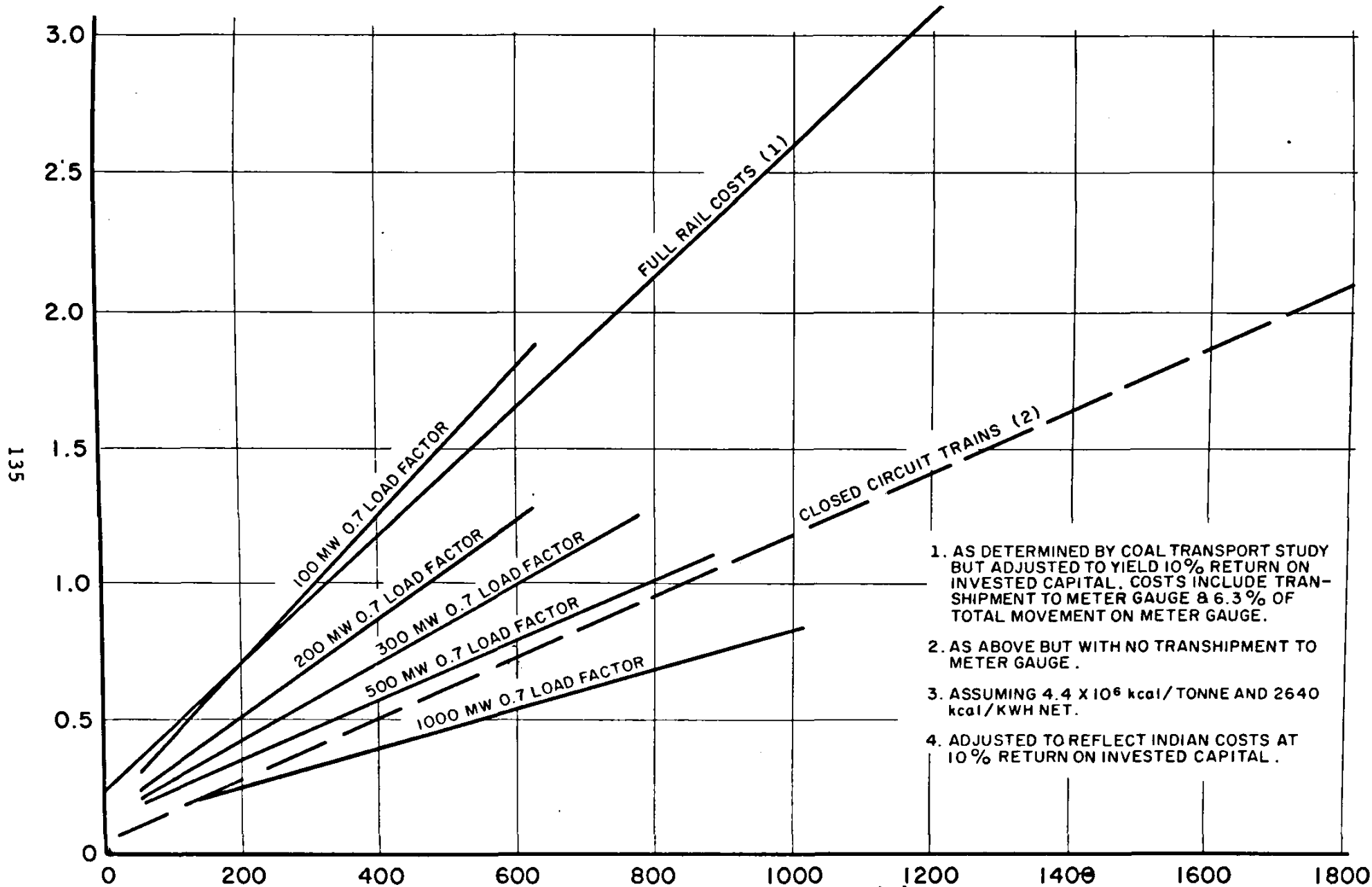

FIGURE 12-RAIL FREIGHT AT 1962/3 COSTS IN np / KWH⁽³⁾ VS. EHV TRANSMISSION COSTS IN np/KWH⁽⁴⁾

of electricity has been pushed far ahead on the basis of consumer-located generation. The area of manoeuvre before 1970/1 is negligible except in one area in central India where we see a possibility of substituting a high capacity EHV line from the Bihar-West Bengal area to provide the capacity that is being considered (but not yet finalized) in eastern Madhya Pradesh and Maharashtra. After 1970/1 the possibilities are greater but the real opportunities will present themselves in the later years of the Fifth Plan. Thus, the discovery of areas with a sufficient unallocated load to justify the immediate building of an EHV line is difficult in terms of short-period policy. But there is a real danger that short-sighted short period policies may become an obstacle to the best long-period planning. It may be desirable to invest in a limited network of EHV lines during the next ten years which will only justify themselves fully in a longer period, but which will permit a beginning to be made with the washery-located generation and long-distance transmission which is clearly the right long-term solution.

(iii) Size of generating units

368. India will be faced with the problem of the best size of unit to manufacture and install in new thermal stations. The decision may not be an easy one. In an advanced economy, a unit of 100 MW probably represents the lowest reasonably economic size. There may, in the circumstances of an advanced economy, be savings as great as 15% in the capital costs of generating equipment by going up to 250 MW. There may, in addition, be savings in fuel costs per kWh of about 8%. Beyond that size, the further advantages of scale, though not negligible, are relatively marginal. As shown in Table 145, the econo-

mies come from savings both in capital costs and in fuel; the relative importance of the two depends on the cost of fuel and the plant factor; there are also economies, though smaller, of operation and maintenance.

369. In a larger advanced economy these savings can be secured because there are available all the resources and experience of manufacturing and the experience of the difficulties of maintaining similar large units. In Indian conditions, it will be necessary, in the first stages, to import at very considerable cost in foreign exchange, those parts of the larger units (such as shaft forgings) which India is not yet equipped to produce. Thus, for some years to come it is conceivable that the cost of plant per kW may be less for a smaller unit made from Indian resources than for a larger unit with difficulties of manufacture and a large import-content, if the latter is valued as we recommended earlier.

370. The question of the size of units is complicated in Indian conditions by the limitations of local demand. In the practice of an advanced country with a dense population and high consumption per head, it is possible to include fairly numerous stations of the largest size in the system planning without grave risk. But in a country where demand per square kilometer is much lower, a unit of as large size as 250 MW will carry the whole load of a very considerable area. If it is regarded, as it should be, as good practice to carry stand-by plant equivalent in size of the largest unit of the system, to plan in very large units may involve an undesirably large proportion of stand-by plant. Having regard to this, as well as other considerations, there are some of us who think that it may be to India's best advantage to concentrate during the next ten or fifteen years on units of somewhat smaller size, rather than attempt

TABLE 145
ADVANTAGE OF SCALE IN GENERATING EQUIPMENT
Typical trends in the United Kingdom, France and U.S.A.

STATION CHARACTERISTICS (5)	INITIAL COST PER kW				FUEL CONSUMPTION PER kWh			
	U.K.(2)	U.S.A.(3)	U.S.A.(4)	Average	U.K.(1)	France(1)	U.S.A.(4)	Average
2 x 30 MW	123	121	..	(122)	120	
2 x 60 - 70 MW	100	100	100	100	100	100	100	100
2 x 125 MW	97	85	92	91	92	93	96	94
2 x 250 MW	82	74	88	80	86	89	91	89
2 x 500 MW	..	65	82	(71)	86	..	88	87

(1) Sources: O.E.E.C. 11th Survey, O.E.C.D. 14th Survey of Electric Power Equipment.

(2) Source: Information from U.K. Ministry of Power. Stations containing four units would be between 5 and 10 per cent cheaper.

(3) Source: Kan Chen and W.K. Linvilli: Some Special Problems of Electric Power Expansion in Developing Countries.

(4) Source: Federal Power Commission; Bureau of Power; Technical Memorandum No. 1: "Instructions for Estimating Electrical Power Costs and Values". Revised March 1960. Since the values scatter a great deal, the average trend emerging is not very convincing. This column has therefore only been counted with 1/2 weight in the average.

(5) One unit should be about 10% more expensive, 4 units 5 to 10% less expensive per kW. See also footnote (2).

immediately to proceed to units of the largest size. There are others of us who think that in view of the rapid progress currently being made in the formation of regional grids, and especially in view of the rapid growth in density of demand foreseen in the next several decades, India should proceed boldly with the manufacture of the large equipment that is now accepted by the more advanced countries. There are, however, two issues which need to be clearly distinguished. There are the economies of scale proper, which we have set out in Table 145. But in advanced countries there tends to be progress simultaneously not only in respect of size but also in respect of steam pressures and temperatures which involve difficult problems both of manufacture and of maintenance; in practice some of the advanced countries are currently encountering difficulties with new large stations in respect of these aspects of progress. In Indian conditions very high pressures and temperatures, designed to reduce fuel consumption, are not important. Coal is relatively cheap, coal mining labour is not scarce and the particular by-products and slack coals that can be used for electricity may well be in surplus. Thus the right course for India is to be bold in respect of pure size, but cautious in respect of pressures and temperatures. The right policy is almost certainly to advance in size as rapidly, but no more rapidly, than is consistent with a low import-content of plant built in India. An example of simplified design, such as we have in mind, was presented to the Committee at one of its December (1963) meetings. This is a matter that will need to be investigated further.

(iv) Rural Electrification

371. Rural electrification cannot be regarded as a strictly economic activity. It has indeed many of the characteristics of a social service. But it has an important place in Indian development policy and it is necessary to consider the implications for the electricity supply industry.

372. Of the total Indian population of about 445 millions, over 80% live in rural areas. There are in all some 560,000 "places" in India, including all towns and villages. Of these, only 1,441 have populations of over 10,000. Of the total 560,000 "places", by end-1962/3, the following proportions had been electrified:

TABLE 146
THE EXTENT OF RURAL ELECTRIFICATION
End-March 1963

Size of "Place"	Number of Places	Percentage Electrified	Number not Electrified
Over 50,000	184	100.0	—
20,001 — 50,000	398	97.0	12
10,001 — 20,000	853	89.4	90
5,001 — 10,000	3,081	59.6	1,244
2,001 — 5,000	20,374	26.1	15,067
1,001 — 2,000	51,478	11.3	45,666
501 — 1,000	103,639	4.8	98,616
0 — 500	367,027	1.5	361,385

373. Rural electrification has proceeded at substantially different speeds in different parts of India. We set out in Table 147, the percentages of places of different sizes that had been electrified by 1961 in different States and Regions. It is clear that in different States very different policies have been followed. In some States there was in 1961 a high degree of electrification throughout all sizes of places; in others a relatively low degree. Some States have almost complete electrification down to places of 5,000 but have relatively little electrification of smaller places; others again have relatively high electrification of smaller places, but far from complete electrification of 5,000 and above.

TABLE 147
PERCENTAGES OF PLACES OF DIFFERENT SIZES
ELECTRIFIED IN DIFFERENT STATES
1961

Regions	Places of 0 — 500	Places of 501 — 1000	Places of 1001 — 2000	Places of 2001 — 5000	Places of 5001 — 10,000
Eastern Region					
Bihar	0.9	3.3	7.2	14.0	42.7
Orissa	0.1	0.5	1.1	10.9	88.5
West Bengal	0.2	1.0	2.6	8.1	22.9
Northern Region					
Punjab	6.5	14.0	26.8	64.5	94.9
Rajasthan	0.1	0.2	0.4	2.8	48.2
Jammu & Kashmir
Central Region					
Uttar Pradesh	2.2	5.0	8.2	15.9	50.1
Madhya Pradesh	0.2	0.7	2.6	12.6	61.4
Western Region					
Maharashtra	0.9	1.8	4.1	10.5	39.7
Gujarat	0.6	2.6	9.0	29.0	62.9
Southern Region					
Madras	14.2	27.6	37.5	51.4	87.8
Mysore	0.7	12.8	17.3	24.4	43.8
Kerala	8.8	15.3	31.0	41.6	59.3
Andhra Pradesh	1.4	5.3	12.0	26.0	67.1
Assam Region	0.1	0.2	0.7	3.1	69.2
All India	1.6	4.9	11.3	26.0	59.6

374. In 1951 only 4,000 places of all sizes had electricity. By the beginning of the Third Plan, the total of places electrified was 25,640. By the end of the Third Plan it is hoped that the number will have been increased to 45,640 - an addition of 20,000 places. The intention is that all places with populations over 5000 shall have electricity, and in addition some 41,000 of the 543,000 places with populations under 5000, as compared with 22,665 in 1961.

375. In very few cases is the supply of electricity to small villages truly economic. The main elements of the load in rural areas are irrigation pumping; small industrial purposes (principally processing industries associated with agriculture); the provision of drinking water supply; street light-

ing. The domestic lighting load is seldom more than minimal.

376. The contribution of rural electrification to national development may be partly a matter of welfare and of a psychological feeling of advance, but it will partly be a matter of actual economic efficiency. It is by no means easy at present to measure the extent to which the multiplication of electrified wells is contributing to agricultural progress. It is well known that the great annual differences due to the monsoon mean that it is only over a long run of years that progress can be at all accurately measured. The area irrigated by wells has increased greatly. In 1958/9, of a total irrigated area of 23.4 m. hectares, 6.7 m. or 30% were irrigated by wells. The amount of electricity sold for irrigation and dewatering purposes increased a little more than four-fold between 1950/1 and 1960/1.

377. There is little question that at present changes the substitution of electricity for animal power provides a great saving in costs to the cultivator. It has been estimated that the irrigation cost per hectare per crop of paddy is reduced from Rs. 1230 with bullocks to Rs. 205 with a diesel engine pump and to Rs. 138 with an electric pump. This means, once experience has spread in an area, there is a pressing demand for electricity.

378. The rates fixed for agricultural consumers have been made exceptionally favourable. They are in most States equal to or less than the rate for small industrial power and only a half to a quarter of the normal rates charged to domestic consumers. State Electricity Boards have also been generous with concessions to rural consumers, in provision of free service connections, in waiving minimum charges in periods of drought, or when use of electricity has been precluded for other reasons.

379. The provision of electricity has also considerably assisted the setting up of small-scale industries in rural areas and the contribution that has made to improving employment prospects in rural areas.

380. In all these ways, rural electrification has undoubtedly provided a real and valuable service. But the extension of electricity to these areas is scarcely ever a paying commercial proposition, at least in the early years of development. From the point of view of the electricity supply services of India what is important is to judge just how far this service can properly be extended, without imposing on the industry excessive financial handicaps in pursuing its major objectives: those of extending its generating capacity, improving its transmission and distribution systems, and serving the pressing needs of productive industry. The test of the rate of further rural electrification beyond the stage that will be reached at the end of the Third Plan should, in our view, be the same sort of test that should be applied to a social service—health, education or welfare—generally: How much of this service can the nation afford at its present income

level? The fact that the service has hitherto been provided at the expense of other electricity consumers should not obscure the need to ask this question. The nation will, we expect, be asking electricity consumers in any case to bear a significant part of the cost of extending the national system, in the interest of others as well as themselves: thus there may be a case for regarding rural electrification as similar to a social service in the more normal sense that it should be financed, partly at least, by payments made from the general revenues of India or the States.

381. Whatever decision may be made regarding the future scale of rural electrification, and whether or not slightly more severe tests of probable load should be imposed before electrification is granted, we are convinced that slightly lower standards of construction for rural areas might be accepted without danger. The relatively small reductions in standards concerned include: lower factors of safety for metal and wood supports, lower ground clearances in sparsely built rural areas, the omission of the guard cradle between high and low voltage lines and the somewhat more limited use of protective devices. We are convinced that many of the specifications used hitherto have been unnecessarily high and consequently much too expensive for Indian conditions. Everywhere, or almost everywhere, in India the expensive three-phase system has been used. Elsewhere in the world large areas have been electrified using much cheaper single-phase construction. We are not convinced that the three-phase system is justified even though irrigation pumping and industrial motors are involved. Rural electrification could proceed both more rapidly and more economically if the present somewhat extravagant standards were reviewed to save cost in every possible way and to adapt them effectively to Indian conditions.*

(v) The Future Organization and Regulation of Electricity Supply.

382. The need for some further rethinking of the institutional framework of the electricity supply has come, as before, from changes in the technological background. Most noteworthy of these have been the economies of scale due to the availability of much larger generating units and the substantial advances in the art of electricity transmission. Together, these changes provide the elements of a supply system entirely different from the historic small generating station at every load centre. They also provide the means for minimising the amount of necessary standby plant. But effective use of large generating units and implementation of extensive transmission and inter-connection implies larger units of organisation, or close and effective collaboration between smaller units.

383. A second need for rethinking has derived from the increasing importance of large hydro-electric-

*Shri C.S. Krishna Moorthi a member of the Committee feels that the conclusion of the case as expressed in Chapter 16, para 508, on the summary and conclusions gives a better presentation of the proper view on rural electrification.

ity schemes which use the waters of rivers which flow through two or more States or form the boundaries between them, so that fully effective exploitation is not possible except by some co-ordinated policy.

384. A third ground for rethinking will, we believe, make itself increasingly felt during the next few years. Very large amounts of coking-coal by-products will become available for electricity generation in the Eastern Region. The most economic use of these, as we have shown earlier in this Chapter, will be to generate electricity near the washery and transmit it by high-voltage power lines to the consuming areas. Thus, it seems to us certain that States will come to depend increasingly on electricity generated outside their own borders.

385. A fourth ground is inherent in the rapidly developing nuclear technology which, if further stations can be built at the costs given in tables 138-9, promises that large nuclear generating stations will soon be competitive with conventional thermal stations in areas far from cheap fossil fuels.

386. It is clear that all these grounds for rethinking the organisational structure of the industry emphasise the need to introduce into the structure more consideration of the wider regional - or national-scale aspects of the problems of planning and operating an all-India electricity system. Without such regional or national-scale planning and operation India cannot enjoy the full benefits of a modern efficient electricity supply and will be handicapped in organising economic development.

387. The problems of the best basis for organisation are significantly different in relation to generation and long-distance transmission on the one hand and in relation to distribution on the other hand. The problems of distribution are local problems, requiring detailed local knowledge and experience and detailed decisions. There can, in our view, be no doubt that the present State Electricity Boards are better equipped to perform these local functions than any larger organisations. On the other hand, the planning of a national generating system and the designing of its accompanying long distance transmission lines, so as to secure the fullest advantage of the cheapest fuel sources and the best siting of power stations to use these fuels and to serve a wide area of consumers, raise problems that require central co-ordination and action guided by national rather than State or regional considerations. Somewhat similar problems are likely to arise in relation to day-by-day operation. It will be necessary to operate large nuclear and thermal stations located in one State partly in the interest of consumers located in other States; and these consumers and the distribution organisation serving them must be in a position to know with certainty that their needs will not be subordinated to the needs of consumers who happen to be located in the same State as the power station. Also, with a view to the optimum utilization of generating capacity and natural resources, the

nuclear and thermal power stations located in one State may need to be operated in conjunction with hydel stations in another State. All this argues the advantage of some central and co-ordinating organisation with a large measure of responsibility and control over generation and long-distance transmission.

388. The first stage in achieving this larger scale organisation of generation and long-distance transmission has been the creation of five electricity supply regions, implying in all cases the collaboration in a regional organisation of a group of States or other political units, with common boundaries and common regional problems of the development and use of potential energy resources. In each region there is being created a regional Board, composed of representatives of State Electricity Boards and of the Central Government, and a regional load despatch centre which, operating under the regional Board, will secure that the best use is made of the generating capacity of the region in the interests of the region as a whole. For the moment, the regional Boards represent a form of voluntary collaboration of the various States concerned. The regional Boards possess no-legal or financial status and their decisions must be implemented through the actions of the individual State Boards.

389. It remains for the moment uncertain whether such voluntary collaboration can or cannot succeed in providing the means of effective reorganisation and efficient operation. The voluntary collaboration can in the end be sufficient only if the State Electricity Boards are prepared to make their full and effective contributions to regional developments and to act quickly and decisively where the regional development requires action by a particular State. There have been some instances in which action in such cases has not been as prompt or effective as it should have been.

390. It would seem likely that some legislation will be required in any case to give more formal legal and financial status to regional Boards, to define their powers and possibly to give them the power to own and operate generating stations and transmission lines, designed to serve the interests of the region as a whole. If legislation is in fact likely to be necessary, it is proper to ask whether the right basis of any more centralised organisation should be the region or the nation as a whole. There are considered in this report a number of possible lines of development which cut across the boundaries of regions and imply the use of hydel stations, large washery-based thermal stations, and nuclear stations to meet in part the needs of more than one region. It seems likely that in the long-run it will be found necessary to organise more formally the collaboration of the regions in a national system as well as the States in a series of regional organisations.

391. Whatever may be the form of organisation of the next few years, the voluntary collaboration of

States within regions and of regions within a national system, or a more formal reorganisation on a national basis - certain essential requirements of operating efficiency need to be emphasised. Clearly the responsible body, if it is to exercise the effective powers that we have in mind, must be in a position to determine the policy with regard to all generation and to determine, through those who carry the decentralised local responsibilities, in actual day-to-day operation, what stations shall carry the load and, if the large nuclear and thermal stations are to operate efficiently on a high plant factor, which local stations are to be shut down when necessary. It must exercise authority over electricity development within States and not merely over movements of energy from State to State.

392. Centralisation of the planning and strategic organisation of the industry cannot, however, imply centralised day-to-day execution of the centrally determined policy in all its details. It is unthinkable that the Indian electricity supply system should be run in practice as a single unit. The areas covered are too vast. Thus even if there were central ownership and strategic control, there would have to be decentralisation of the detailed day-to-day execution.

393. If a policy of centralised responsibility is accepted, this could be achieved, as it was under the United Kingdom Act of 1926, by permitting the State Electricity Boards to retain the ownership of existing stations and to operate them under the instructions of a Central Electricity Generating Board, while providing that future stations would be constructed and owned by the Central Electricity Generating Board. It could alternatively be achieved by the transfer of ownership and operation of all existing and future generating stations and long-distance transmission lines to the Central Electricity Generating Board, as has been done under the subsequent United Kingdom legislation

394. Such a reorganisation would leave the State Electricity Boards with all responsibility for the distribution of electricity within each State; they would purchase electricity on agreed terms from the Central Electricity Generating Board, and possibly, if so decided, operate selected stations under instructions from the Central Electricity Generating Board. But in all other respects we suggest that operation and control of State systems, to the extent that such powers remain with the States, be vested primarily in the State Electricity Boards. At present in some parts of India, State Governments continue to own and operate generating Stations and direct distributive agencies. We suggest that so far as possible, in each State the State Board should become the authority responsible for operating any generating stations which remain the responsibility of the State Government and all public sector distribution systems.

395. It will be necessary to work out an equitable basis for the charging of electricity from any Central Electricity Generating Board to the State

Electricity Boards, which buy and distribute; analogies can be found in the experience of a number of countries. If the Central Electricity Generating Board finds it desirable in some circumstances to buy surplus electricity from high-cost producers, the electricity should be sold at a price related to all the operations of the Board and not to the cost to it of this particular block of energy.

396. We suggest finally that the State Electricity Boards should be regarded everywhere as bodies with a predominantly economic responsibility to generate electricity (if that remains their responsibility) and to distribute it as efficiently and economically as possible; that the criteria governing all their decisions should be economic in the broadest sense, and having regard to national as well as local and regional interests, rather than political. State Government officials who may serve on State Boards should accept these criteria and not use their influence to impose political decisions.

397. There remains the problem of the future of the large and well established private utilities operating in some of the great cities. We realize that their future cannot be dissociated from the general political policies of the Government of India with regard to the limits of the public and the private sectors. But many of us feel grave concern that the present uncertainties are making it difficult to plan and finance the expansion of electric supplies on the scale which is very urgently needed for development in these cities. Some of us feel that, in view of the controls that already exist over their operations, no great harm would be done and considerable advantage gained by allowing them to expand their operations to the extent that conforms to the broad national and regional electricity policy.

(vi) Some Problems of Increasing Efficiency.

398. We wish to conclude this Section by considering the ways in which the efficiency of the electricity supply industry in India may be increased. While efficiency in some respects and in some places is already high, and the industry owes much to the devotion and enthusiasm of many individuals, there is still scope for improvement and for a levelling up towards the efficiency of the best.

399. We are convinced that the Power Survey, initiated a few months ago, has a very valuable contribution to make by enabling all concerned on State Boards, in the States and in private undertakings to see how they and the neighbouring systems on which they may have to depend for assistance are likely to stand, and how, over a comparatively short period, load on the one hand and capacity on the other hand are likely to grow. We hope that the Power Survey will remain a permanent feature of electricity operation in India.

400. Its value must depend on very honest and very frank appraisal of the situation - on very realistic

estimates both of load and of dates at which capacity may in fact become available. Its value would very easily disappear if it became a marriage of unrealistic load estimates with unrealistic capacity estimates.

401. But we believe that it will never be easy to make good demand estimates for periods so far as ten years ahead merely on the basis of local expectations. At intervals, as a check on these, it will almost certainly be necessary to conduct such a general examination of longer-term prospective demands as we have been engaged in making. With increasing experience, both of the longer term growth rates of the Indian economy and of the tasks of estimating, it should become possible to make better estimates.

402. There remain, we believe, certain planning tasks for which provision even now is inadequate. The tasks of system planning - of fitting the right next developments of large hydel, thermal, or particularly nuclear plants into the system as a whole, with all the inevitable repercussions on existing plants - are tasks which require very full collaboration on a basis which will increasingly be wider than either the State or the Region. Thought will need to be given to the best ways of organising this collaboration.

403. Finally, we must emphasise the need for more and better training. The industry, growing as rapidly as it has, is very seriously short of well-trained manpower, equipped with knowledge and experience to take over full responsibility for some of the new large units that are coming into service. We think that very careful thought should be given well in advance to the personnel who are to take charge and operate a new station. Where comparable units do not exist in India, arrangements could very probably be made in the United States, the United Kingdom or elsewhere for some of those appointed to take over to obtain experience on identical or very similar units in plants in those countries. It is important to have in mind the very big differences between most of the new plant that is being installed and the old small-sized units on which many of those in the industry have gained their experience. Even those of considerable experience will be confronted by a major problem of adaptation. Consideration should also be given to the employment of experienced foreign experts to assist on-site training during the first five to ten years of operation of new projects.

VI. THE PROBLEMS OF MEETING THE DEMANDS FOR ELECTRICITY 1970/1 TO 1980/1

404. The estimates that we have presented in earlier Chapters of this report indicate that, on the basis of our forecasts, the final consumption of electricity may be expected to increase approximately as follows:

TABLE 148
ESTIMATES OF DEMAND FOR FINAL CONSUMPTION OF ELECTRICITY (TWh)

	1960/1	1970/1	1975/6	1980/1
Case I	16.9	59.0	90.6	139.3
Case II	16.9	64.7	104.7	169.7
Case III	16.9	74.0	124.1	204.4

405. These are estimates of final consumption, and exclude losses in transmission and distribution and the station consumptions of electricity. If suitable allowances are made for these, the gross generation required to meet these final demands may be estimated to be as follows: (See also Figure 13)

TABLE 149
ESTIMATES OF GROSS GENERATION OF ELECTRICITY (TWh)

	1960/1	1970/1	1975/6	1980/1
Case I	20.15	69.7	107.5	166.0
Case II	20.15	76.6	124.4	202.3
Case III	20.15	88.3	147.5	244.0

406. A detailed study has been made by Mr. Bush of the Detroit Edison Co., Chairman of the Working Group of the Energy Survey Committee, of the problems of providing these amounts of gross generation; this is printed as Annex 2 of this report. His estimates are based on an assumed system plant factor in 1970/1, measured in terms of gross generation, of 48%, rising in 1975/6 and 1980/1 to 51% (apart from the Assam Region) as the result of closer integration of facilities through improved transmission nets. Mr. Bush's calculations have assumed that a 48% system plant factor in 1970/1 should meet the needs on the basis of a load factor (ratio of average load to maximum load) of 60% and a demand factor (ratio of peak gross load to gross generating capacity) of 80%. His 51% factor in later years is based on a load factor of 60% and demand factor of 85%. Measured in terms of gross generating capacity, Mr. Bush's calculations (which are given in Tables 2-8 & 2-9 of Annex 2) suggest the need for gross generating capacities including an allowance for non-dependable capacity in the various years as shown in Table 150.

TABLE 150
MR. BUSH'S ESTIMATES OF REQUIRED GROSS GENERATING CAPACITY AT VARIOUS DATES (GW)

	1960/1	1970/1	1975/6	1980/1
Case I	5.6	18.4	24.8	38.0
Case II	5.6	19.2	28.7	46.2
Case III	5.6	21.4	33.9	55.7

407. Mr. Bush's calculations assume a margin in 1970/1 of 20% between peak load and dependable installed capacity. Estimates of required capacity made for the Central Water and Power Commission have assumed for 1970/1 a rather larger margin - of the order of 21.4%, and on the basis of similar estimates of load would calculate a somewhat larger requirement for installed capacity.

408. The estimates of the Central Water and Power Commission have also assumed a somewhat larger load than is indicated by the calculations pre-

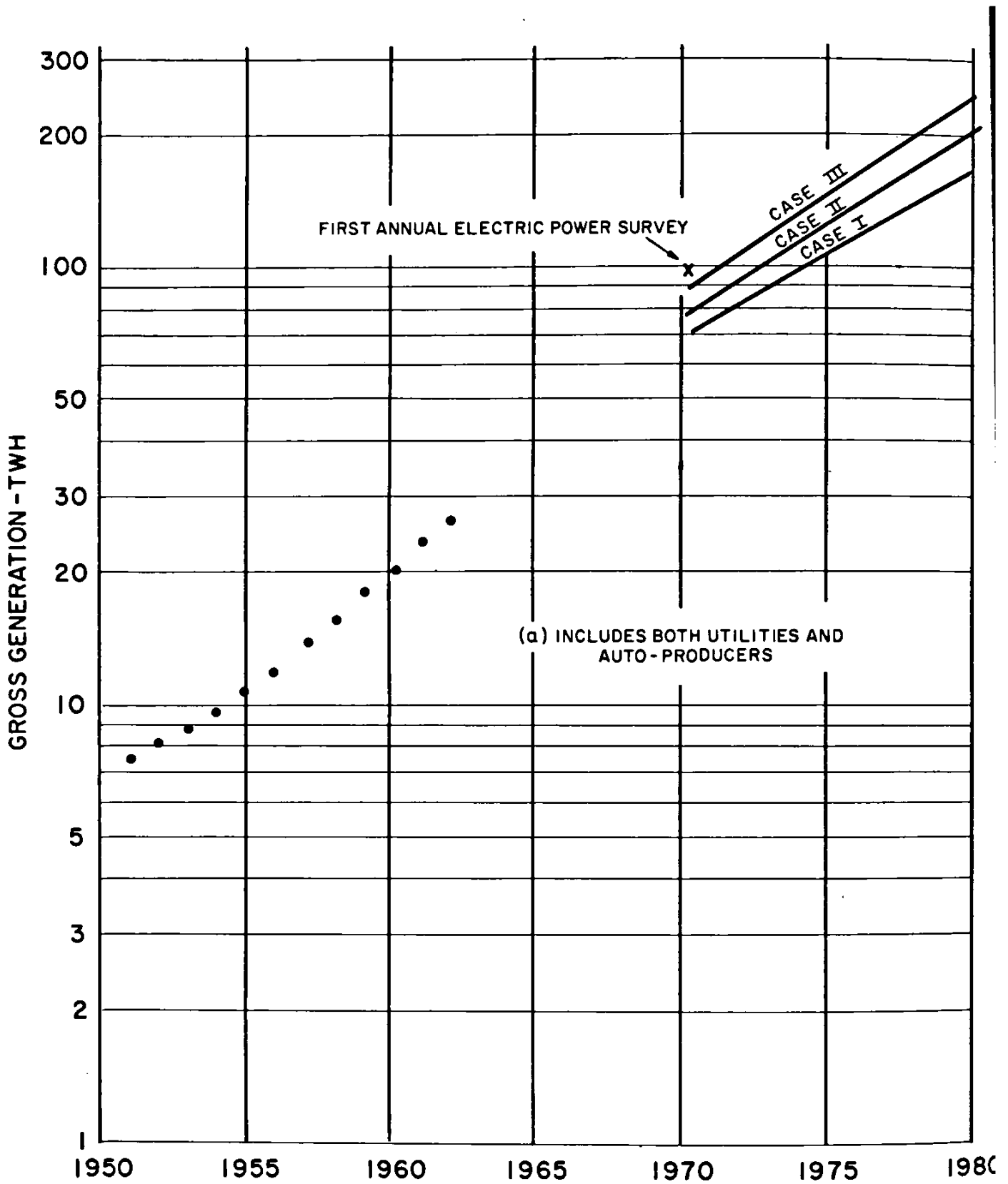

FIGURE 13-ESTIMATED ELECTRICITY REQUIREMENTS (a)
1951 TO 1980/1 (GROSS GENERATION TWH)

sented in this report. The first annual report of the Power Survey included estimates of energy requirements for 1970/1 amounting to 95.1 TWh for public utilities and a further 1.4 TWh for non-utilities, making 96.5 TWh in total. Other estimates made by the Perspective Planning Division have suggested a total requirement of 95.1 TWh. Calculations based on the assumed load of the First Power Survey and using the same margins as those proposed by Mr. Bush, would indicate the need for about 23.6 GW of installed capacity, to be available at the time of peak load in 1970/1.

409. In Table 151 we show the estimates of consumption per head which have emerged from the very different methods of estimation used by the Power Survey and this Energy Survey. The Power Survey estimates for the earlier years of the period 1960/1 to 1970/1 were based on known intentions and demands of specific consumers in specific states or areas estimated in terms of the kilowatts of capacity they were understood to need. The kilowatthours of consumption were calculated on assumptions of the probable hours of use of the capacity. For the later years covered by the First Power Survey (including 1970/1), there was inevitably an element of uncertainty regarding intentions to construct particular new enterprises and regarding their probable requirements and, very properly, some element of provision was made for possible currently unknown additions. While the projects included in the Power Survey were based on known intentions of Ministries, there was no automatic method of ensuring that the aggregate of projects included, together with the provisions for unknown additions, would in total represent the particular rate of growth of the Indian economy which we have accepted as our Case III. The latter, based on estimates of outputs made in the Perspective Planning Division, represents one solution of growth at a specific rate. If certain elements have been underestimated, certain other elements have been over estimated. For the rates of growths we have assumed, we believe that the Energy Survey estimates represent a reasonable estimate of the energy required. But we cannot say with certainty that they relate to the same rate of growth that is implicit in the Power Survey estimates, including the provisions in the latter for unknown additions.

410. The differences between the estimates for 1970/1 presented in this report and those of the Power Survey are small for most of the regions concerned and are apparently concentrated in a small number of States. We think that the Central Water and Power Commission will be well advised to re-examine some of the estimates included in the first Power Survey in the light of the new information and consider, in the light of experience of how load is developing, whether the higher estimates are justified or not.

TABLE 151
COMPARISON OF ESTIMATES OF DEMANDS FOR ELECTRICITY
IN 1970/1 MADE BY FIRST POWER SURVEY
AND PRESENT REPORT

(kWh of gross generation per head)

Regions	1960/1 Actual	1970/1 Power Survey	1970/1 Present Report	1970/1 as % of 1960/1 Power Survey	1970/1 as % of 1960/1 Present Report
	kwh	kwh	kwh		
All India	46	172	160	374	348
Eastern	64	192	191	300	298
Northern	37	193	136	522	368
Central	20	102	102	510	510
Western	80	232	243	290	304
Southern	46	191	167	415	363
Assam	4	82	49	2050	1225

411. The estimates made by the Perspective Planning Division for 1970/1 also show slightly higher estimates than our own: their estimate of 95.1 TWh of gross generation is about 7.7% higher. We believe that a large part of this difference is due to the fact that their calculation is (we understand) based on constant norms of electricity consumption per unit of output, whereas our own assume declining, or more rapidly declining, norms. In most European countries the average input of energy per unit of output declines by about 0.5% a year. A failure to make allowance for this in European countries has led to overestimation of demands. For the period 1960/1 to 1970/1 a similar improvement in the techniques of using energy, such as one might currently expect in India, might perhaps account for about 5.1% out of the difference of 7.7% between the two estimates.

412. The calculations of the Central Water and Power Commission, when allowing for the slightly greater margins that they have assumed, suggest the need for 24.0 GW of gross generating capacity including non-utilities in 1970/1. When account is taken of the fact that final consumption of electricity is growing about 12% a year and that it is desirable to have installed by the end of 1970/1 sufficient capacity to meet higher demands in 1971/2, that amount of installed capacity is not disproportionate to the higher load on which their calculations have been based. But we emphasise the need for re-examination of the underlying load assumption.

413. On these alternative assumptions of load and of installed capacity it is possible to calculate the fuel requirements. We shall assume the following alternative amounts of installed capacity of different types.

TABLE 152
ESTIMATES OF INSTALLED CAPACITY
AND GROSS GENERATION
1970/1

	Hydel	Steam	Diesel	Nuclear	Total
I. Mr. Bush's estimates (Case III only)					
Installed Capacity	10.5	10.0	0.4	0.6	21.4
Gross Generation, TWh	36.1	47.9	0.4	3.9	88.2
Hours of Use, hrs	3406	4790	1110	6570	4088
Plant Factor, %	38.9	54.7	11.4	75.0	46.7
II. Alternative Estimates (C.W.P.C.)					
Installed Capacity, GW	10.0	13.0	0.4	0.6	24.0
Gross Generation, TWh	30.0	61.4	1.1	4.0	96.5
Hours of Use, hrs	3000	4720	2600	7000	3939
Plant Factor, %	34.2	53.9	29.7	79.9	45.0

414. It will be seen that Mr. Bush calculates that a total of 47.9 TWh will be generated in thermal stations; the alternative calculations would give 61.4 TWh. On the alternative assumptions, the amounts of coal required in 1970/1 for the generation of electricity, assuming an average thermal efficiency of 32.5% in new steam plants and about 20% in older steam plants, may be calculated as follows:

TABLE 153
COAL REQUIREMENTS FOR ELECTRICITY GENERATION
1970/1

	Assumed Total of Gross Generation TWh	Assumed Gross Generation in Thermal Stations TWh	Coal Required m. tonnes
Mr. Bush's calculations	88.2	47.9	24.4
C.W.P.C. calculations	96.5	61.4	34.7
Alternative calculation	96.5	55.3	28.8

415. Both the above calculations assume that a fraction of the generation in thermal stations will be provided by oil, natural gas or lignite. It will be seen that Mr. Bush expects that the hydel capacity will be able to be used for a larger number of hours in a year than has been assumed in the C.W.P.C. calculations. If, still making the assumption of a total demand for 96.5 TWh, it were assumed that the hydel capacity could generate, as Mr. Bush has calculated, 36.1 TWh, the amount to be generated in steam stations and the coal required would be as shown in the alternative calculation. For purposes of this report we shall continue to assume a total of 88.3 TWh of gross generation in Case III in 1970/1 and a coal consumption of 24.4m. tonnes.

416. For the later years estimates based on similar illustrative calculations by Mr. Bush are presented in Table 154.

TABLE 154
SOME ESTIMATES OF A POSSIBLE PATTERN OF INSTALLED
CAPACITY AND GROSS GENERATION
ALL INDIA: CASE III

Year	Hydel	Steam and Gas Turbines	Diesel	Nuclear	Total
1960/1					
Installed capacity, GW	1.9	8.4	0.3	—	5.6
Gross Generation, Twh	7.8	11.9	0.5	—	20.2
Hours use of Capacity, hrs	4200	3500	1529	—	3611
Plant Factor, %	47.9	40.0	17.5	—	41.2
Gross spec. cons. kcal/kwh	—	4580	—	—	—
1970/1					
Installed capacity, GW	10.5	10.0	0.4	0.6	21.4
Gross Generation, Twh	36.1	47.9	0.4	3.9	88.2
Hours use of Capacity, hrs	3406	4790	1110	6570	4088
Plant Factor, %	38.9	54.7	11.4	75.0	46.7
Gross spec. cons. kcal/kwh	—	2876	—	—	—
1975/6					
Installed capacity, GW	17.5	14.1	0.3	2.0	33.9
Gross Generation, Twh	57.0	77.1	0.3	13.1	147.5
Hours use of Capacity, hrs	3257	5468	1000	6570	4351
Plant Factor, %	37.2	62.4	11.4	75.0	49.7
Gross spec. cons. kcal/kwh	—	2632	—	—	—
1980/1					
Installed capacity, GW	28.6	21.9	0.2	5.0	55.7
Gross Generation, Twh	76.6	134.4	0.2	32.8	244.0
Hours use of Capacity, hrs	2680	6140	1000	6570	4380
Plant Factor, %	30.6	70.1	11.4	75.0	50.0
Gross spec. cons. kcal/kwh	—	2444	—	—	—

- (a) Hydel Capacity includes an allowance for non-dependable capacity as follows: 1970/1 - 0.6 GW; 1975/6 - 0.9 GW; 1980/1 - 1.1 GW.
- (b) Since the report was drafted, in addition to 0.6 GW of nuclear installed capacity for 1970/1, another 0.6 GW has been approved by Government of India.
- (c) Since nuclear energy is already competitive in certain regions of the country under the conditions set out in this report, the Department of Atomic Energy is of the opinion that there is justification for higher targets for nuclear energy in 1975/6 and 1980/1 as compared with the figures given in the table above, and some other members of the Committee also share this view.

417. In planning future electricity development, there are certain rather broad principles of policy which have been evolved by the Central Water and Power Commission and which our investigations have served to confirm. They may be summarised as follows:

- (i) Seasonal storage hydel projects should in general be designed as low plant factor peaking plants, or should be so designed and constructed that they may be later converted to this purpose.
- (ii) Base load requirements should be met, so far as possible, by pit-head plants designed to burn low grade coals. This is particularly important in the areas where the washing of coal will result in the availability of large amounts of low-grade by-product coals.

418. In the areas that have large demands for electricity, but are remote from any coal field there are various alternative possibilities:

- (i) The development of available hydel resources.
- (ii) Transmission of the required power by EHV lines from the nearest outlying coal field.

- (iii) Transport of coal to the area by closed-circuit railway operations.
- (iv) The building of nuclear plants.
- (v) The building of thermal plants to burn oil refinery waste products, such as petroleum pitch or refinery gas.

Each individual situation will need to be examined in detail to see which of these is likely to provide the most economic solution.

419. In the areas where coal is produced, and particularly in the areas where there are coking-coal washeries and available by-product coals, it will almost always be cheapest to meet base-load requirements with coal-burning thermal stations. These are likely to have a lower cost of generation than that of any of the alternatives open to an area remote from a coal field. Thus, industries which are highly energy-intensive should in general be located in coal producing areas. Industries most suitable for areas remote from coal are those that are labour-intensive but not energy-intensive.

CHAPTER 14

Capital Investment In Energy

420. We have attempted to estimate the capital required to cover the expansion of the energy-supplying industries during the period 1965/6 to 1980/1. We cannot hope to do this with complete accuracy. We have adopted the method used in the similar study made by the Energy Advisory Commission of the O.E.E.C. in 1959: we have estimated the probable average unit cost of investment in each form of energy at the prices of 1963/4 and have calculated from that and our estimated demands for energy the probable investment cost in each Plan Period. We have concerned ourselves with gross investment, including that needed to replace exhausted or worn-out capacity and partly or wholly financed from depreciation funds. We have presented our estimates only in terms of Case III (10% industrial growth). The calculations can readily be extended to cover any of the other cases.

421. We have confined our estimates to the requirements of capital investment in the energy sector itself. It is difficult or impossible to pursue the full implications of this investment into all the ramifications of its possible further consequences for investment in the expansion of the iron and steel industries, the expansion of the industries providing the energy sector with its capital and so forth. But these further implications need to be borne in mind. In particular it needs to be borne in mind that investments in some forms in the energy sector — and included in our estimates in transmission lines or in nuclear power stations at sites removed from coal-fields, for instance — may save investment in the improvements of railway communications and in expansions of the iron and steel industry and in locomotive building which would have been necessary for the alternative solution of the same problem and which have not been included in our figures. It cannot be inferred without further examination that an investment which is more capital-using, as compared with alternatives within the energy sector itself, is necessarily more capital-using in total from the point of view of the national economy when all these further repercussions have been taken into account. Each case must be considered individually

and with its full implications.

422. There are complications also regarding the timing of investment. If capital equipment in the energy sector is to be available to meet the demands of, say, 1972/3 it must have been completed before the beginning of that year and, since a part of the investment in the energy sector has a long period of construction the investment must have been taking place progressively during the previous four or five years. This implies that the level of investment in, say, 1970/1 is related to the needs of 1972/3 and so on. This would not be of great importance to the cost of investment in each Plan Period if the demand for energy were not rising rather rapidly. But, because of the rapid rise of energy demand and this period of lag between the inputs of the expenditures on construction of capital and the final output of available energy, it is necessary to make a quite significant addition to figures of investment derived, as ours have been, from levels of demand at particular dates and unit costs of investment. Over the whole field of energy an addition of about 9% — we estimate — is needed to adjust figures of completed investment calculated on the growth of consumption and unit costs to cover the additional inputs of investment required to meet part of the needs of the next Plan Period ahead.

I COAL

423. The investment required in the coal industry is principally of two kinds: that needed to raise the coal and that needed, in the form of washeries, to prepare the coal for sale to consumers who require washed coal. The major part of the investment is needed to provide for the expansion of output. A minor part of the total is needed for replacement of pre-1960/1 equipment when it wears out. We understand that the average life of mining capital of all kinds, including both very long-lived investment in shafts and short-lived mining equipment may be taken to be 15 years.

424. The unit costs of coal-mining capacity are best estimated at the following figures:

TABLE 155
ESTIMATE OF CAPITAL INVESTMENT
PER TONNE IN COAL MINING
(at prices of 1963/4)

	Open Cast Rs. per tonne	Shallow underground Rs. per tonne	Deep underground Rs. per tonne
Expansion of Existing Mine	32	46	69
New Mine	40	58	92

425. We have estimated the extent to which it is likely that in different periods additional coal will have to be produced in the various coal-fields by dif-

ferent methods of coal raising. On the basis of this examination we have assumed the following pattern of development during the next twenty years.

TABLE 156
ESTIMATED METHODS OF MINING COAL
1960/1 TO 1980/1

	1960/1 %	1965/6 %	1970/1 %	1975/6 %	1980/1 %
Open Cast	21	22	24.5	27	28
Shallow Underground	74	73	66.5	61	58
Deep Underground	5	5	9	12	13

426. Within these three methods of mining, we think that expansion in each sector may for purposes

of our estimates reasonably be assumed to take the following forms at different dates.

TABLE 157
ASSUMED METHODS OF MEETING COAL DEMANDS

	1965/6 %	1970/1 %	1975/6 %	1980/1 %
OPEN CAST				
From workings already developed	65	61	56	65
From expansion of existing workings	11	11	14	11
From new workings	24	28	30	24
	<u>100</u>	<u>100</u>	<u>100</u>	<u>100</u>
SHALLOW UNDERGROUND				
From workings already developed	70	75	69	71
From expansion of existing workings	22	10	14	12
From new workings	8	15	17	17
	<u>100</u>	<u>100</u>	<u>100</u>	<u>100</u>
DEEP UNDERGROUND				
From workings already developed	60	39	49	58
From expansion of existing workings	35	15	9	8
From new workings	5	46	42	34
	<u>100</u>	<u>100</u>	<u>100</u>	<u>100</u>

427. On these assumptions, which seem to us to be probable, the total gross investment in coal mining that we estimate is set out in Table 158 below:

TABLE 158
ESTIMATED GROSS INVESTMENT
IN COAL MINING (a)

Rs. crores at prices of 1963/4

	1965/6- 1970/1	1970/1- 1975/6	1975/6- 1980/1
Investment Required to cover Expansion			
Mining	270	390	440
Washerries	38	91	95
Investment Required to replace exhausted Mines or Worn-out Equipment in Mines and Washerries	211	296	382
Total	520	777	916

(a) These figures do not include preparatory action for the following Plan Period likely to be taken in each preceding Plan Period.

(ii) OIL

428. The capital costs of oil production and distribution are made up of four principal elements: the capital costs of exploration and production; the

capital costs of refinery capacity; the fixed capital required for marketing and distribution; the capital cost of pipe lines.

429. We have taken the unit capital costs per tonne of oil to be as follows:

TABLE 159
ESTIMATES OF CAPITAL COST
PER TONNE OF OIL

	Rs.
Exploration and Production	300
Refining	80
Marketing and Distribution	70
Total (excluding pipelines)	450

430. The probable capital cost of pipelines has been separately estimated, since it is not directly related to the tonnage of oil to be produced, refined and marketed. We have assumed that the average life of equipment is 15 years and have calculated the element of gross investment required for replacement on that basis.

431. On these assumptions, the total gross investment in oil production that we calculate to meet

the demands estimated in Case III (10% industrial growth) is as follows; we do not include the working capital in stocks of oil and products, which will require to be raised from about Rs. 20 crores to about Rs. 153 crores between 1960/1 and 1980/1, and we do not include any part of the capital required outside India to provide for oil to be imported from abroad into India. (See Table 160).

TABLE 160
ESTIMATED GROSS INVESTMENT
IN PRODUCTION AND DISTRIBUTION OF OIL (a)

Rs. crores at prices of 1963/4

	1965/6 to 1970/1	1970/1 to 1975/6	1975/6 to 1980/1
Exploration and Production			
for expansion	154	140	80
for replacement	11	14	56
Refining			
for expansion	82	127	199
for replacement	29	51	101
Marketing and Distribution			
for expansion	72	111	174
for replacement	35	56	99
Pipelines	25	25	25
Grand Total of Investment in Oil	408	524	734

(a) These figures do not include preparatory action for the following Plan Period likely to be taken in each preceding Plan Period

(iii) ELECTRICITY

432. The unit costs of capital investment in electricity generation which we have assumed are those which we calculated in an earlier chapter for purposes of the comparison of the costs of generation in hydel,

thermal and nuclear plants. Including the estimated interest charges during the period of construction and the preference tax assumed to be imposed on imported equipment, the unit costs per kW of capacity are as follows:

TABLE 161
COST OF ELECTRICITY GENERATING PLANT
PER kW OF CAPACITY
Rs. at prices of 1963/4

	Typical Storage Hydel for 60% Plant Factor	Typical Storage Hydel for 15% Plant Factor	Thermal Plant	Nuclear Plant
Including Assumed 33% Tax				
Period 1965/6 to 1970/1	1375	789	1343	2222
Period 1970/1 to 1980/1	1354	773	1102	1904
Excluding Assumed 33% Tax				
Period 1965/6 to 1970/1	1290	717	1121	1905
Period 1970/1 to 1980/1	1290	717	1003	1778

433. For purposes of estimating the total gross investment requiring to be financed from a national point of view, we think that the element of tax which, if imposed, would be transferred from one element of the Government of India to another, may properly be excluded from the calculation. Thus, the subsequent estimates are made exclusive of tax. The estimates here presented are, again, those that apply to our Case III (10% industrial growth).

434. The estimates for investment in generation have been made directly, on the basis of the proposed

pattern of electricity development set out in Annex 2. The estimates for transmission and distribution assume that India's needs in this field can only be met during the period of Plan IV by investment equal to that in generation; for the period of Plan V investment in transmission and distribution equal to 90% of that in generation is assumed; for Plan VI, 80% of that in generation.

435. On these assumptions our estimates are as follows:

TABLE 162
ESTIMATED GROSS INVESTMENT
IN ELECTRICITY (a)

	Rs. crores at prices of 1963/4		
	1965/6 to 1970/1	1970/1 to 1975/6	1975/6 to 1980/1
PRODUCTION FACILITIES			
1. Thermal	367	438	843
2. Hydel (normal)	511	390	310
3. Hydel (15% plant factor)	104	262	602
4. Nuclear (b)	105	236	498
TOTAL PRODUCTION	1087	1326	2253
TRANSMISSION AND DISTRIBUTION	1083	1194	1797
GRAND TOTAL (c)	2170	2520	4050

(a) Including auto-producers.

(b) These figures do not include investment required for preparation of nuclear fuels; the actual costs of investment may differ somewhat from these estimates because of the terms on which contracts are made and loans are received in practice in individual cases.

(c) These figures do not include work in progress on stations and transmission facilities which will not be completed before the end of the last year of each Plan Period. This is added in Table 163.

(iv) TOTAL CAPITAL INVESTMENT

436. The total capital investment that we estimate for the energy sector in order to meet the demands that we have calculated on the basis of Case III (10% per year industrial growth) is summarised in Table 163.

437. Over the fifteen years 1965/6 to 1980/1 we estimate that a total of some Rs. 13,800 crores (about U.S. \$ 29 billions) of investment will be required by the energy sector to provide for the demands estimated on the basis of 10% per year industrial growth. This would imply the following average annual rates of investment during the various Plan Periods: (See Table 164).

TABLE 163
ESTIMATE OF TOTAL GROSS INVESTMENT
IN ENERGY REQUIRED TO PROVIDE
FOR 10 PER CENT ANNUAL GROWTH OF
INDUSTRIAL PRODUCTION

	Rs. crores at prices of 1963/4		
	1965/6 to 1970/1	1970/1 to 1975/6	1975/6 to 1980/1
Coal	520	777	916
Oil	408	524	734
Electricity	2170	2520	4050
Addition for Work in Progress	<u>177</u>	<u>465</u>	<u>499</u>
Total	3275	4286	6199

TABLE 164
REQUIRED AVERAGE ANNUAL RATES OF INVESTMENT
IN ENERGY (a)

	Rs. crores at prices of 1963/4		
	1965/6 to 1970/1	1970/1 to 1975/6	1975/6 to 1980/1
Average Annual Rate during Plan Period	655	857	1240
Approximate Rate of Last Year of Plan	755	1050	1440

(a) Estimates have been rounded

438. It is not for us to pronounce on the question whether such a scale of investment lies within the probable capacity of India. On the assumptions that we have used for 10% per year industrial growth and 7% per year growth of national income, the trends of national income would be as shown in Table 165. We have added estimates of what might be the volume of

total gross investment of all kinds on what may be reasonable assumptions of the latter to national income at various dates. We set against these estimates our own calculations of investment in energy and show the implied relation of the investment in energy to the total.

TABLE 165
RELATION OF ESTIMATED GROSS INVESTMENT IN ENERGY
TO ESTIMATES OF NATIONAL INCOME AND
TOTAL GROSS INVESTMENT

	Rs. crores at 1963/4 prices			
	1960/1	1970/1	1975/6	1980/1
Estimated National Income	14,700	27,600	38,600	54,000
Estimated Total of Gross Investment (a)	1,750	5,900	8,600	12,700
Estimated Gross Investment in Energy		755	1,050	1,440
Ratio of Investment in Energy to All Investment (%)		12.8	12.2	11.3

(a) The following ratios of gross investment to net national income have been assumed:
1960/1, 12%; 1970/1, 21.4%; 1975/6, 22.3%;
1980/1, 23.5%.

439. These estimates for later years are very near indeed to similar estimates made by some of us in the similar inquiry in Europe.(b) For Europe the estimates ranged from 12.2% to 12.6%, according as one did or did not assume large investment in rapid nuclear development.

440. It is important to be able to estimate the proportion of this capital investment which is likely to take the form of imported equipment, requiring to be financed in foreign exchange. Our estimates of this, again on the basis of Case III, are shown in Table 166.

TABLE 166
ESTIMATED IMPORT COMPONENT
OF GROSS CAPITAL INVESTMENT IN ENERGY (a)

	Rs. crores at prices of 1963/4		
	1965/6 to 1970/1	1970/1 to 1975/6	1975/6 to 1980/1
Coal	208	262	229
Oil	184	157	183
Electricity	360	260	465
Work in Progress	43	83	76
Total	795	762	953
Annual Average of Periods	159	152	191
Annual Average of Periods (U.S. \$ million)	335	320	400

(a) excluding assumed surcharge on imported components.

441. If one adds to the estimated import component of capital investment, the expenditure on imported oil that we have estimated in an earlier chapter, but makes no allowance for possible imports

of metallurgical coke, the total of the import requirements of the energy field would be as follows (again on the basis of Case III):

TABLE 167
ESTIMATED IMPORT REQUIREMENTS OF THE ENERGY SECTOR
AVERAGE ANNUAL RATES OF DIFFERENT PERIODS

Annual Average of	Rs. crores at 1963/4 prices		
	1965/6 to 1970/1	1970/1 to 1975/6	1975/6 to 1980/1
Capital Equipment	159	152	191
Import of Crude Oil and Products	100	156	290
Total	259	308	481
Total (U.S. \$ million)	545	645	1010

(b) Towards a New Energy Pattern in Europe:
Chapter VIII, pp. 67-72. (OECC - 1960)

CHAPTER 15

The Pricing of Energy

442. There have been, within the past year or two, excellent and detailed reports on the pricing of oil(1), of coal(2) and of electricity(3). We do not think that our most valuable contribution can be made by traversing again and in detail the fields that they have very adequately covered. The major problems of energy pricing are not, we believe, problems of detailed application of prices, but of the broad strategy of the use of prices in the energy field.

443. In the course of this survey we have found ourselves increasingly concerned with the probability of the emergence of short-term surpluses of certain types of energy – particularly coal – in a situation in which the major problem is to achieve a sufficient long-term expansion. Put differently, this means that there is an emerging situation in which the relative incentives to use different forms of energy are not such that the market is cleared. We have been concerned also about the extent to which the energy industries are likely to command the resources to which the choice between different forms of energy is consistent with the national interest of India. All these issues are ultimately issues of pricing and of the success or failure of present pricing policies in working out a satisfactory energy system.

444. May we begin, therefore, by considering what are the broad functions of a satisfactorily operating system of prices in the field of energy. They include principally the following functions:

A. From the point of view of the Producer

- (i) They give the producer of energy the incentive to produce that form of energy – coal, oil, electricity or whatever it may be – in the necessary volume.
- (ii) They give indication to the manager of the individual undertaking as to the volume of output he should attempt to extract from the undertaking.
- (iii) They assure to the efficient undertaking the prospects of regular production which can make possible the minimisation of costs.
- (iv) They put pressure on the manager to minimise these costs and operate with maximum efficiency.

(1) *The (Damle) Report of the Oil Price Enquiry Committee, 1961.*

(2) *Price Policy for Coal Undertakings - Report of the Planning Unit of the Indian Statistical Institute, New Delhi, February, 1963.*

(3) *The Pricing of Electricity - Report of the Planning Unit of the Indian Statistical Institute, New Delhi, June, 1962.*

- (v) They indicate which undertakings should continue to operate; which should be expanded; which should be closed down.
- (vi) They encourage the production of higher qualities or grades (of coal for example) and discourage production of lower qualities.
- (vii) They encourage the production of energy in those regions where energy is most needed and discourage it in locations that are less economic.
- (viii) They discourage wasteful production of energy and the exhaustion of nationally valuable resources.
- (ix) They provide to efficient undertakings both in the public and the private sector profits which can be used for the further development of the industry and for a longer-term policy of exploration, technical research and training.

B. From the point of view of the Consumer

- (x) They encourage him to use the type of energy that best suits his particular needs, having regard to the real cost of supplying the energy.
- (xi) They encourage the consumption of those types of energy which are in surplus supply and discourage the consumption of those types of energy that are in short supply.
- (xii) They encourage the consumer to draw his energy from the source that is nearest to him or from which he can most economically be supplied and discourage the use of sources involving heavy costs of transport, except so far as a cheaper source of energy makes it economic.
- (xiii) They encourage a consumer to increase his consumption in all circumstances in which the additional value to him of additional consumption exceeds the additional cost of providing that additional energy; they discourage him from demanding additional energy in all circumstances in which the additional real cost of providing it exceeds the additional value of it to him.
- (xiv) They assure to the consumer a sufficient supply of energy of the required quality at the minimum cost at which it can be made available.

C. From a National Point of View

- (xv) They should be such that successful efforts are sufficiently rewarded, without yielding to any group of the community earnings or

profits on a scale or of a kind that are repugnant to national policies.

445. It need hardly be said that it scarcely ever happens in practice that a price system works with perfection simultaneously in all these respects. Many of the actual problems created by the unsatisfactory operation of prices in India in the field of energy would appear to arise because the pricing policies seem to have been concerned, possibly to an excessive extent, with one individual function of a satisfactory pricing system and, in making prices more effective from that individual point of view, have made them markedly less satisfactory and effective from other points of view.

446. We think that this can best be seen by considering successively some of the pricing problems of the different sectors of the energy system.

I. PRICING POLICY FOR COAL

447. Pricing policy for coal in India has, we believe, been principally, though not of course exclusively, concerned with the last of the functions we set out above: the prevention of the emergence of abnormal profits to private sector coal-owners in a situation in which coal was relatively scarce and prices, in the absence of regulation, might have been so high as to cause serious ill-feeling and political unrest. Those were real problems with which the Government of India had clearly to concern itself.

448. The admirable work of the Coal Price Revision Committee was aimed to secure for producers, particularly in the Private Sector, adequate but not excessive profits, and to secure to the consumer reasonable prices. These were, and are extremely important objectives. But they were not objectives that it is really possible to achieve exclusively by means of price regulation consistently with the other equally important objectives of giving the right relative prices to different grades of coal and the right incentives to expand production, where it is in the national interest that it should be expanded.

449. The Coal Price Revision Committee has worked out, with great care, the best means of calculating a fair return to an undertaking operated with normal efficiency, by analysing the costs of what might be regarded as representative undertakings in different situations. But the concept of fair return to the representative undertaking, which was first conceived in terms of undertakings in manufacturing industry where differences of costs due to differences of resources and conditions are small, is applicable only with substantial qualifications to the problems of coal mining.

450. A central problem in the economics of mining, as of agriculture, is that of differences of the quality of resources. In the case of mining this takes the two-fold form of differences of the difficulty of extracting the mineral and differences of the quality and

saleability of the mineral when extracted. In the classical liberal economics, royalties in mining played the same role as rent in agriculture, in that they were assumed to absorb, as a form of income to the owners of the minerals, the surplus earned by operating in more favourable conditions.

451. There is some danger that repugnance to mining royalties as a form of private income had led to a misunderstanding of its significance and function as a form of equalisation between operators in different conditions.

452. The problems of coal pricing in India have largely arisen because of hesitation to permit coal prices to rise to the point where, consistently with classical theory, they would cover the normal costs of raising coal in the most unfavourable circumstances and of the lowest quality required to meet current demand fully. And because of hesitation to permit prices to rise to this level, there seem to have been inadequate incentives to expand private sector mining or to expand output within the already existing mine to the extent that is desirable.

453. We believe that a satisfactory structure of coal prices requires bigger differentials than now exist between the prices to be paid for the best coal and for the lower grades. If lower grades of coal are, nevertheless, to be mined profitably, that involves higher initial profits to the mines producing higher grade coal. If, as we think probable, the Government of India holds that such profits, based on the ownership of or the right to mine certain coals, do not represent a form of increased income that should remain in private hands, the situation is very much better rectified by the imposition of a special levy, corresponding to the royalty payment of a system of private-ownership of minerals, than by artificial limitation of coal prices. We would see no reason why public sector undertakings should not be expected to pay similar levy-royalties if they produce high-grade coals, and price their coals on the basis of that addition to cost. Any levy-royalties would need to be assessed in terms of the current levels of demand and marginal costs and in terms of the current prices. The proceeds of the levy might with great advantage to the industry be paid into a central fund to assist in financing the development of the industry.

454. Thus far we have been concerned with the prices of the different grades of coal in circumstances in which a mine produces coal predominantly of one single grade. There is the second problem also of the pricing of washed and by-product coals from coking-coal washeries, and of the main grade of coal and the slack and small coal that will be produced by a non-coking coal mine. Again we believe that the right policy is likely to be one in which the scarcity of the washed coking-coals or the best non-coking coals are fully reflected in their prices. Coking coals are relatively scarce in India and there should be a strong disincentive to use them wastefully. We think that

coking coal prices should be permitted to rise to appreciably higher prices than non-coking. The by-product coals and the slack coals should be priced, in our view, low enough to ensure them a market. As we have argued in an earlier chapter, there are added costs of using these high-ash content coals. The price should be low enough to yield a strong incentive to a power-station manager or the manager of an industrial enterprise to install the more expensive equipment necessary to use them.

455. If all the by-product and waste coals are to be disposed of, it will be necessary for some years ahead to find markets for them at a considerable distance – probably up to as much as 1000 km – from the coal-fields. Thus, thought needs to be given to the effective relative prices not only at the coal field, but also at a distance from it. In the summer of 1963, the relative prices were such that coking coal middlings had a delivered cost per kilocalorie about 9% less at pithead than Selected B run-of-the-mine non-coking coal. At 400 km from pithead they cost 4% more; at 1000 km they cost some 8% more. It is doubtful whether the incentive at pithead was sufficient to secure substitution of the middlings with their higher ash-content and special problems of handling. At anything above 100 km distance there was a positive disincentive to use them. Table 168 shows the relative costs per kilocalorie when transport cost to various distances is added.

TABLE 168
RELATIVE DELIVERED PRICES OF DIFFERENT COALS
AT DIFFERENT DISTANCES FROM PITHEAD OR
WASHERY PER KILOCALORIE

1963		
Distances from Pithead or Washery km	Selected B Run-of-the-Mine Non-Coking Coal(1)	Coking Coal Middlings(2)
0	100	91
100	100	99
200	100	101
300	100	103
400	100	104
500	100	105
1000	100	108
2000	100	111

(1) 6590 kcal/kg

(2) 5310 kcal/kg

456. It can be seen that, if one assumes that the effective incentive to substitute middlings or by-products coal is a differential of not less than 10%, to cover the extra costs of handling and equipment, the differential was nowhere sufficient. But it would have needed a large reduction to give a 10% differential at 1000 km. In the future it is likely to be necessary to open the fan of prices much wider, trusting, we hope, to the equivalent of a royalties tax to restore the equitable distribution of income.

457. If within the public sector this implies low cost mines possibly making handsome profits, and high cost mines making losses, it needs to be asked whether the profits should be used to cover the losses and to enable the high cost mines to be kept in operation at coal prices which cover the average cost of all public sector mines but not the costs of the marginal mines or coalfields.

458. In the United Kingdom, since nationalisation a practice of offsetting losses by profits has been followed. Substantial losses in, for example, the Scottish and South Wales coal-fields, have been partly or wholly covered by profits in the more modern coal-fields of Yorkshire and Nottinghamshire. In France a rather similar practice has been followed. The reasons in both countries have been social and political rather than economic. There have been grave social and political problems of closing down large numbers of pits in coal-fields with a long history and a large population and transferring them elsewhere. But we do not think that in India, where coal production is rapidly increasing, the arguments for using profits to cover losses consequent on low prices are valid. In general it is desirable that energy consumers should pay prices such that the marginal value to the consumer is at least equivalent to the marginal cost of producing the energy. With a system of balancing low cost profits against high cost losses that ceases to be true. It becomes much more difficult to know whether high cost production is within limits that should be accepted, or beyond limits which justify closing down.

459. If pricing is in general such that fully efficient producers working marginal resources are enabled to cover their costs, the favourably placed public sector mines should make good profits. We would prefer to see the greater part of those profits used to assist the capital development of the industry, rather than dissipated in covering losses.

460. The policy we suggest involves a system of coal prices such that all except the inefficient marginal producers can cover their costs and have, where appropriate, an incentive to expand output and normal profits which can contribute to their expansion. We believe that from a longer term point of view an efficient group of energy industries, expanding production and fully meeting demands, is more in the national interest than an impoverished industry, short of funds for development and engaged in "slaughter mining". The best safeguard against excessive prices caused by scarcity is a vigorous expanding industry, keeping up with the growth of demand. We do not think that there is a strong case for subsidising marginal production and marginal consumption. In India, the greatest part of coal consumption is industrial. In very few industries does energy consumption represent more than 2-3% of costs; plentiful and reliable energy supplies are more important than subsidised supplies, which in many cases will serve no greater purpose than enlarging industrial profits.

461. But while coal prices should, so far as is proper take account of these needs, it remains important that an over-generous pricing policy, unaccompanied by a sufficient royalty-levy, shall not make profits too easily earned and remove reasonable pressure to achieve efficiency.

II. PRICING OF OIL

462. In view of the very thorough and searching enquiry by the Damle Committee into the pricing of oil we have not thought it necessary to devote to this subject as much attention, in the limited time at our disposal, as we have to the pricing of coal and electricity. We confine our comments to some of the general issues involved.

463. The investigation by the Damle Committee was primarily concerned with the major issue whether prices paid for imports of crude oil and passed on to consumers in terms of prices of oil products were excessive. It was inevitably much less involved with the issue in which we are greatly concerned: whether relative prices of different types of energy are such that the best interests of Indian development will be served.

464. We emphasise again the extent to which our inquiries have shown a trend towards increased use of oil. Technically that is in accordance with the trends of almost all advanced and advancing countries. But we have drawn attention to the burdens that this will impose on India's probably limited capacities to make payments abroad. It may well turn out that, when the problem is fully examined by the Planning Commission, they will feel driven to the view that some brake should be imposed on this trend by enhanced rates of taxation.

465. If they do take that view, it will be important that the tax rates shall be so framed that they do not further complicate the already difficult problem of the imbalance between the practicable pattern of refinery output from the most readily available crude oils and the pattern of Indian consumption. It has already been pointed out that India is likely to be long of gasoline and short of the middle distillates. Uniformly higher taxation inevitably puts greater emphasis on fuel economy and leads to greater consumption of diesel fuels and of kerosene and lower consumption of gasoline.

III. PRICING OF ELECTRICITY

466. The study of Price Policy for Electricity Undertakings examined the general problems involved in fixing tariffs for electricity at levels which would ensure that the undertakings not only covered their costs but also earned a rate of return appropriate to a low-risk industry in Indian conditions.

467. The average rate of return to all electricity undertakings in 1958/9 was 3.3%. This was made up

of an average return of 6.7% to the mature and somewhat more slowly expanding private companies in the big cities where electricity supply was first introduced, and an average return of 2.6% in the rapidly expanding public sector undertakings. That rate of average return has been generally held to be inadequate to Indian conditions. The gross return to capital in Indian industry, admittedly with a higher potential risk, has been variously measured according to the definition used at 10-15%. The rates of earnings made and expected are believed in many cases to be substantially higher than that in practice.

468. A majority of the Committee holds the view that for a relatively risk free public utility in India the rate of return should be not less than 10% and are glad to know that State Boards are being encouraged to aim at that rate of return on their investments when fixing their rates. This will, we hope, enable them to put to reserve for further expansion enough of their current earnings to finance a substantial part of that expansion. It would, we think, be a good rule in Indian conditions that 35% - 40% at least of the following year's construction requirements should be met in this way from depreciation funds and retained earnings.

469. It is necessary to ask what this may imply for electricity charges. The report on Price Policy for Electricity Undertakings estimated that, if the average price of electricity was to equal the average cost including a 10% return on capital, including the necessary interest charges during the construction period, an average price of 11.56 nP per kWh was necessary. They recommended that this should be distributed between various users by taking into account the specific costs of providing service to these users. The average prices that they recommended were as follows:

TABLE 169
AVERAGE PRICES FOR PROVIDING ELECTRICITY
TO VARIOUS CONSUMER GROUPS RECOMMENDED IN
"PRICE POLICY FOR ELECTRICITY UNDERTAKINGS"

	nP/kWh
Industrial Power	7.5
Small Industrial Power	11.2
Domestic Light and Power	32.1
Commercial, Irrigation and Public Lighting.	20.1
Average for all Groups	11.56

470. The recommended average price of 11.56 nP would have represented an average increase of about 32% in electricity tariffs over the average of 8.75 nP/kWh to final consumers prevailing in 1959/60. A very careful study has been made on behalf of the

present Committee of the implications for electricity costs and prices of the expansions that we have in mind. While we think that the earlier study was right in its general principles and in the policies it recommended, we think that it took too little account of the very considerable cost reductions which we envisage as the result of higher thermal efficiencies, larger plants and fuller use of transmission and distribution systems. The calculations made for us suggest that, consistently with earning a 10% return, it should be possible to generate electricity and provide all the services of distribution at an average cost of 10.8 nP/kWh. This would imply an increase above 1959/60 prices of about 23%

471. While we believe that it is important that the industry shall make profits sufficient to enable it to finance part of its expansion, it is equally important that higher tariffs shall not create an atmosphere of relaxation and lack of effort to push up efficiency in every way. There are other ways than price-pressure of achieving this. In many countries the most detailed annual publication of the operating results of individual stations creates a strong incentive throughout the whole working staff to achieve the best results and becomes in effect an argument for personal promotion. We think that India should annually publish in detail such operating statistics as an incentive as well as a valuable basis for planning and price-making.

472. If we turn to wider problems of tariff policy, we would emphasise again the importance of regarding tariffs not only as means of payment for services but also as incentives to use energy economically. If, as we hope, electricity becomes less scarce over the coming years, there will clearly be a danger that customers will feel less pressure to take their energy at times of day and night that permit maximum economy of plant and minimum cost. In many countries, it has become a central feature of tariff policy to devise incentives to minimise peaks and maximise off-peak consumption.

473. While a majority of consumers in India will almost certainly have to be charged on kilowatthour rates, for consumers above, say 50 kW, very serious consideration should be given to tariffs which reflect both the fixed costs involved in the service and the marginal costs of providing marginal consumption. Since the fixed costs are closely related to the highest rate of consumption, there is very much to be said for maximum demand tariffs. These are more readily calculable than individual consumers' load factors, as suggested by the Study of Electricity Pricing, which are likely to vary from year to year. There is the added advantage that it is possible to take account (as it is theoretically desirable to do) of the time of day at which maximum demand arises, and vary the fixed charge accordingly, and even to disregard maximum demand where it occurs at a period that is off-peak for both generation and distribution.

IV. GENERAL CONCLUSIONS RELATING TO PRICING

474. May we sum up the discussion of this chapter by reverting to the general issues with which we started? We think it is most important in all price-fixing to have in mind the whole range of functions that prices perform in the energy field and not to allow a great concern with one aspect to lead to the fixing of prices which are likely to be unsatisfactory from other, and possibly more important, points of view.

475. While there are many ways in which a socialist state can remedy the potential consequences of mal-distribution of income, it is very much more difficult to regulate the actions of 450 million consumers if they are obeying the promptings of misleading prices, which do not reflect the true economies of providing energy of different sorts. We are convinced that in pricing energy products, a very strong emphasis should always be put on securing the right incentive to consumers as well as producers.

CHAPTER 16

Summary and Conclusions

I GENERAL

476. In this final chapter we bring together the principal conclusions and recommendations of our Survey. We begin with general considerations and then go on to present our principal conclusions regarding each of the main sectors of demand and sources of energy.

477. The total energy resources of India (See paras 2-6, 253-66, 281-91 and 317-28) are adequate but not abundant for the present stage of Indian economic development. Much of the coal is made difficult to use by its high ash content. The indigenous oil supplies are not sufficient to meet more than a relatively small fraction of India's prospective requirements and, unless new discoveries are wholly different in scale from those yet known, a large part of the demand for oil will have to be met by import.

478. Much of the coal, and all of the coking coal, is moreover situated in the Bihar/West Bengal coal field in North East India. While other coal exists and is likely to be increasingly developed as time goes on, there are large parts of Southern, Western and North Western India that are distant from any coal supplies (See paras 7-10, 256 and 264-6).

479. The limitations imposed by the geographical distribution of the coal fields are in considerable degree mitigated by the fact that the hydro resources of India are largely in those parts of Southern, Western and North Western India which are distant from coal resources, (See paras 7-10 and 317-23).

480. In planning the economic development of India it will be important to have clearly in mind these geographical limitations of the fuel supplies. In all advanced countries energy supplies have been very powerful factors in determining the location and development of industries. The costs, efficiency and competitive position of the heavy metallurgical industries are particularly sensitive to the delivered prices of their materials and fuels, including transport costs. The iron and steel industries have tended to grow up either where coal has been available on the spot (as in the Ruhr and in most of the traditional locations in the United Kingdom), or where coal could be very cheaply transported, usually by ship or barge, to the source of the iron ore. In India the location of all coking coal in the Bihar/West Bengal area will impose limitations on the choice of sites where costs in the iron and steel industry are generally competitive. If other more distant sites are to be adopted, it will be necessary to consider very carefully in advance the possible methods of economic transport of

coal or coke to the site concerned. Our investigations suggest that for some of these sites imported coke or coking coal may possibly be more economic than Indian supplies.

481. But in a broader sense the most economic use of India's natural resources and energy resources may require recognition of the advantages of locating in fairly close proximity to the coking coalfields those industries which are energy intensive and must depend on actual direct use of coking coal and on the other hand locating in those parts of India which are more remote from such coal resources a larger share of the industries which are not energy intensive. The availability of cheap energy in the Bihar/West Bengal area in the form of by-product coals from the washeries (see para 485-6 below) may give opportunities to locate in that region energy-intensive industries producing cheaply for export markets.

482. The pattern of the Indian energy economy will be dictated by the relative advantages and relative costs of different fuels. The trend of almost all of the economically advanced countries is at present towards an oil-based energy economy. There are evident signs in India of a similar trend; but some caution is needed before assuming that this trend should be accepted and encouraged in Indian conditions. Oil is an indigenous and very plentiful fuel both in the U.S.A. and in the U.S.S.R. The trend towards oil is moving much more slowly in most of the European countries which are more similar to India in having little or no indigenous oil and in being necessarily concerned with the possible effects on the balance of payments of large imports of oil.

483. In the case of India our first estimates suggested a very high future dependence on oil, more particularly if one had assumed that some of the difficulties of supplies of domestic energy that we foresee would be solved by very substantial increase of the use of kerosene. But even on the basis of the revised estimates that we have presented in this Report, the share of energy imports (including both crude oil and products and all the capital equipment used in the energy sector) in the total of imports increase from about 19% in 1970/1, to 24% in 1975/6 and to 38% in 1980/1. These represent a very formidable charge on India's prospective imports and we feel serious doubts whether the Government of India would be in any position to provide for larger oil imports than we have assumed.

484. We have estimated the demands for energy both in total and in all forms. The amount of energy

that will be required for Indian development will clearly depend on the rate of that development. At the time of our Survey the Planning Commission had not completed its work on the next Plan Period nor had it officially formulated assumptions about more distant periods. We have therefore thought it best to present alternative calculations, based on alternative assumed rates of growth. These are presented in detail (see paras 194-212). In view of the high cost of investment in energy it will be important to secure that, while keeping abreast and actually developing needs, it does not run far ahead of the realities and actual development in practice.

II COAL

485. While supplies of non-coking coal are (as was said above) abundant in quantity, supplies of coking coal are not abundant, though probably sufficient to meet needs until the end of this century. Economy of coking coal is most important. At present, only about 40% of the coking coal that is in the ground in the seams that are being worked is recovered and brought to the surface; only about 60% at most of what is recovered from the mine is delivered as 17% ash content washed coal from the washeries to the coke-ovens. Thus in total less than 25% of the potential coking coal is actually available to be used for the purposes for which it is essential. It is important that improvement of this performance should be sought in every way: through economy of coke in the blast furnaces; through acceptance of as large a fraction of the total as is practicable by the coke-ovens from the washeries; but above all through recovery from the mine of a substantially larger proportion of all coal that is available in the seams. We know that all these problems are being actively examined by the Department of Mines and Metals and that there is hope of a significant increase in the recovery rate and of lower ratios of coke to pig-iron. But the matter is so important that we hope even greater efforts will be made to achieve economies. We recommend that any necessary resources be made available to put into practice both the improved mining methods and even greater economy of use of coke that is proposed. (See paras (253-62 and 86-91).

486. Whatever may be done to conserve coking coal, it is clear that with the progressive expansion of the iron and steel industry there will be increasing demands for washed coking coal and increasing supplies of coking coal by-products. We have examined with care the relative economies of using two-product and three-product washery processes. We are convinced that the two-product process will produce by-product coals which can find an economic market, principally for thermal electricity and that this process is to be preferred (see paras 223-9).

487. We have examined with care (see paras 234-5) the economic problems of transporting these by-product coals and using them economically. We

are satisfied that, if suitably priced, a market can be found for all the by-product coals that are likely to be produced.

488. These coking coal by-products are likely, however, to find markets principally in uses which are normally met by non-coking coals. Having regard to the substantial amounts likely to be available, there may be no more than a small additional requirement for non-coking coals in the next Plan Period. By-product coking coals, if suitably priced and transported in closed-circuit train loads, can meet the requirements for coal for thermal electricity stations and other purposes at points as far as and beyond most of the outlying coalfields that it had been proposed to develop. We suggest that the wisdom of developing in the near future some of these outlying coalfields be re-examined. (See paras 243-9).

489. In addition to the problems created by the by-product coking coals there are further problems created by the large amounts of slack coal that are produced as part of the process of mining the non-coking coals. More incentive is desirable to encourage mining methods which will reduce the proportion of slack to a minimum. But a considerable output of slack is inevitable. We recommend that this be priced at levels that will encourage its consumption in all uses for which it is suitable. We recommend also the urgent examination by the Central Fuel Research Institute of the possibilities of producing from this slack a domestic fuel that will relieve the present excessive pressure of the demand for firewood. (see paras 230-3 and 243-49).

490. The long-term success and prosperity of the coal industry must depend on increasing the efficiency of coal-mining. The output per head is at present very low in many of the older private-sector mines. All that is possible should be done to increase their productivity (See paras 241-2).

491. The demands for coal estimated in this Survey are appreciably below other estimates that have been made. One important source of difference has been the use of existing inputs of energy to calculate requirements in later years. While this is a normal and proper procedure, some allowance needs to be made for the progressive economies of the use of fuel which have greatly affected the trends of demand in more advanced countries. Some of the error has been due to use of "ready reckoners" of demand for coal in thermal generation of electricity which seriously exaggerate the probable requirement (see paras 250-2).

III. OIL

492. There is a strong trend towards greater dependence on oil as a source of energy. It will be desirable to explore all possible ways in which India's oil supplies can be increased. Much is already being done to explore the possibilities of further indigenous supplies. But unless discoveries

are made on a scale wholly different from any hitherto, a very large proportion of Indian oil supplies will have to be imported (we estimate the proportion in 1975/6 as about 75%). It is of great importance to explore all possible ways, by trade agreements and otherwise, of increasing and making more certain India's power to purchase these necessary supplies.

493. At present relative costs of coal and oil, the use of oil is more economic in the highly industrialised regions of Western and Southern India. There is a likelihood that demands may increase in those and other regions, even beyond India's capacity to finance imports, and it may at some stage prove necessary to take measures which will make the use of indigenous fuels more attractive.

494. The principal increases of demand for energy in the form of oil seem likely to arise in transport (where both the growth of road transport and the proposed dieselisation policy of the railways will substantially increase demand) and in the domestic sector (if the shortage of firewood that we foresee leads to increased dependence on kerosene). The longer-term repercussions of a dieselisation policy on the balance of payments will need to be considered in advance.

495. The pattern of Indian consumption of oil products does not accord easily with the potential out-turn of Indian refineries from the most easily available crude oils. In the past India has been short of kerosene. In future India seems likely to be short of middle distillates generally as the result of the prospective growth of demands for diesel oils. On the other hand India is likely, on the present and prospective pattern of demand in the absence of policy changes, to have surplus supplies of gasoline and naphtha at one end and possibly of fuel oil at the other end, even when the out-turn of refineries have been adjusted so far as possible to meet the changing pattern of demand. It may not be easy to export the surplus gasoline at reasonable prices to neighbouring markets or to acquire considerable additional supplies of middle distillates. Thus more consideration needs to be given to the wisdom of present taxation policies, which tend to discourage consumption of gasoline and encourage consumption of diesel oils. (See paras 277-9).

496. The net effect of a continuation of the present taxation is likely to be an increase rather than a decrease of the total required net cost of imports of oil and oil products, even when allowance is made for the lower consumption per kilometer of road transport using diesel oils. It is probably in the national interest to encourage gasoline consumption in all forms of transport that can reasonably use it to take advantage of the cheaper initial cost of internal-combustion engines designed to use gasoline.

497. There is also likely, in the absence of changes of policy, to be a surplus of naphtha. This can probably be absorbed without great difficulty by

suitable planning of fertiliser and petro-chemicals production and possibly by use to economise coke in the iron and steel industry.

498. If there is not to be a surplus of fuel oil, it is desirable to encourage its consumption in those areas near to refineries and distant from coal fields where it is likely to be an economic source of energy in industry or the generation of thermal electricity. (See paras 277-9).

IV ELECTRICITY

499. Policy in the planning of electricity needs to be co-ordinated completely into a national and regional energy policy. The location of thermal power stations should be made with full consideration not only of the trends in the development and location of demand but also of the availability and location of the cheapest sources of primary energy. The large volumes of coking coal by-products in the regions of the iron and steel industry washeries will exercise a very important effect on the desirable locations, which are likely to be increasingly supply-oriented rather than demand-oriented.

500. Examination has been made (see paras 234-5) of the relative costs of using newly developed coal mines nearer to the demand-centre or by-product coals carried by rail in a closed-circuit operation. This has shown that at distances up to and above 1000 kilometres it is likely to be more economical to use the by-product coals. Examination has also been made (see paras 352-67) of the relative costs of carrying coal by rail to a demand-oriented power station and of carrying electricity by extra-high-voltage transmission lines from a supply-oriented power station near to the coal washery. This has shown that for large blocks of energy there is an economy in constructing such transmission lines and adopting the washery location.

501. Examination has been made (see paras 368-70) of the relative economies of generating plant of different sizes. The economies are such that there is advantage in a progressive move towards larger size, but not necessarily towards greater complexity, so far as this is achievable with the present experience and resources of the heavy electricals industry.

502. The relative costs of generating electricity in thermal, hydro and nuclear stations have been analysed in detail and in terms of the prospective costs of constructing and providing fuels for each in Indian conditions. (See paras 340-51). This analysis shows that, in certain locations at a distance from cheap coal supplies and where hydro is not available, nuclear energy is already competitive. For the next ten to fifteen years while experience is being gained with nuclear energy, there are adequate other sources of energy available if required. Thus, the decision to build nuclear stations should be reached on purely economic grounds. During the 1970's, when the prob-

lems of using thorium have been satisfactorily resolved, nuclear energy is likely to become increasingly competitive.

503. The same analysis makes it clear that the best ultimate strategy of electricity generation is to use hydel increasingly to meet peak loads and to carry the base loads on steam plant, using wherever available by-product coals, and in some regions on nuclear plant. There are likely to be some regions, particularly in Northern India, where the development should probably be based wholly on hydel. (See paras 417-9).

504. The full and effective use of large thermal and nuclear stations and their integration with hydel stations is impossible unless transmission lines are available to the necessary extent. Indian investment in transmission and distribution has been inadequate and a large investment is necessary in the next Plan Period if full use is to be made of nuclear and other generating plant already planned and beginning construction. A beginning with the construction of extra-high-voltage transmission lines is recommended before 1970/1. (See para 367).

505. Careful consideration has been given to the organisation of electricity supply that is most appropriate to the changing technical conditions and to the need for greater integration than has existed in the past. We welcome the creation of Electricity Supply Regions. We hope that this very necessary integration of the planning and operation of the generation of electricity may be achieved without any formal reorganisation and by the voluntary co-operation of the State Boards within the various Regions and of the Regions themselves. It will, however, be necessary to watch carefully the progress of co-operation on this basis, and it may at some stage be necessary to consider whether a greater degree of central ownership and control of generating is a necessary condition of an effective generating policy. If that should sometime become necessary, it will remain desirable that State Boards should be responsible for all distribution. And in any new organisation that may be worked out, effective decentralisation of day-by-day operations will be absolutely essential. We make certain subsidiary proposals for the strengthening of the State Boards. (See paras 386-96).

506. We have considered the problems of the pricing of electricity. We recommend that every effort should be made to reduce costs and to make prices as low as is compatible with an efficient and healthy industry. But we recommend that the State Boards should be encouraged to earn a reasonable economical return (which we estimate at 10%) on their invested capital and to provide from their retained earnings and depreciation funds a substantial part of the capital funds needed for expansion. (See paras 466-73).

507. In the interest of improved efficiency we suggest that careful attention be given well in ad-

vance to the training of the technical staff that will be necessary. We believe that overseas suppliers of equipment would be prepared to collaborate in such training both in India and, where appropriate, in similar large stations abroad. (See para 403).

508. Rural electrification should be expanded as rapidly as possible to all places of suitable size in rural areas. It is not likely to be possible to carry out rural electrification on a strictly commercial basis. Having regard to the very large rural population of India and the importance of the electricity supply industry retaining adequate funds for the expansion of its general activities, it is not likely to be possible for rural electrification on a large scale to be subsidised to the extent that it is in most advanced countries by urban electrification. We recommend that rural electrification be regarded more nearly as a social service than as a strictly economic enterprise and possibly financed in part from general revenues. (See paras 371-81).

V. THE DOMESTIC DEMAND

509. There are grounds for very serious concern regarding the supplies of energy to the domestic sector, principally for cooking but partly also for lighting, fans and air-conditioning and other purposes. The domestic demands have largely been met from traditional non-commercial sources, including firewood, cattle dung and waste products, but partly also in recent years from kerosene and electricity. The statistics are inevitably somewhat uncertain but recent inquiries have made it possible to present more accurate estimates. In 1960/1, non-commercial forms of energy probably provided about three-fifths of the total energy used in India and about nine-tenths of the energy used in the domestic sector. (See paras 144-58).

510. This large supply of non-commercial energy has only been made possible by the cutting annually of about 100 million tonnes of firewood. This almost certainly exceeds the growth of available timber and involves the progressive deforestation of India. The growth of demand in the domestic sector that we forecast will, if nothing is done, rapidly denude increasing areas of India. (See paras 159-64).

511. We fear that, if there are no immediate steps taken, shortage of firewood will cause grave hardship and lead to much larger demands for kerosene than Indian potential imports are likely to be able to provide. We recommend that immediate and active measures be taken jointly by the Government of India and the State Governments to formulate and implement a policy for expanding the growth of quick-growing timber suitable for use as firewood; this will require the assignment to this use of considerable areas of land. (See paras 175-83).

512. In addition we recommend that measures be taken to produce and popularise the use for domestic

purposes of commercial fuels based on indigenous coal supplies. (See paras 183-6).

VI. THE PRICING OF ENERGY

513. A satisfactory national policy for energy requires that all consumers of energy shall use those forms of energy which, having regard to the circumstances of India, can be most economically provided to meet their needs. It is of the essence of a satisfactory energy policy that consumers shall have the right incentives to use the right fuels. We have set out what we believe to be the essentials of an energy pricing policy. We recommend that the various bodies concerned in the making of prices for energy products take full account of the importance of establishing the right incentives for consumers to use the most economic fuels. (See paras 442-6).

514. If the present pricing policies are not revised, we foresee serious surpluses of unsaleable coking coal by-products and non-coking coal slacks. The disposal of these would cost considerable sums and be a grave waste of valuable national resources. From a national planning point of view these surpluses are available at zero cost. They should be priced at levels which will ensure their use and clear the market. At present the incentives to use them are inadequate.

515. There are likely to be similar problems in the pricing of oil products, which in this case are affected by taxation policies. We recommend that taxation policies (see para 495 above) should take account of the probable deficits and surpluses of different types of oil products.

VII. INVESTMENT IN ENERGY

516. We have estimated the probable investment required in energy at different dates down to 1980/1. The ratio of investment in energy to total investment is about that which might be expected on the basis of similar inquiries in European countries. (See paras 420-39).

517. We have estimated also the proportion of the gross investment which is likely to take the form of imports on the basis of present trends. We think that it will be important that India shall as rapidly as possible reduce the dependence on imported equipment to a minimum, so as to reduce also the necessary foreign expenditures below those that we have estimated. Part of the large dependence on imports appears to result from the desire to progress in respect of installation of types of equipment rather more rapidly than Indian capacity is likely to be able to progress in respect of their manufacture. It will be necessary to hold a balance and to put heavy emphasis on the manufacture in India of types of equipment

which at each stage can be produced with a low import-content.

518. Plans for investment in energy need to be based on the best possible estimates of the future requirements for energy. In the case of electricity such estimates are provided both by the recently established Annual Electric Power Survey of India and by such studies as have been made on behalf of our Energy Survey. We have found discrepancies in respect of 1970/1 between our own estimates based on the probable requirements of kWh in different industries in India as a whole and the estimates of the Power Survey. We believe that both the methods of estimation of future requirements are valuable. But we take the view that better short-term estimates extending over two or three years ahead can be provided (as does the Electric Power Survey) by building up detailed local estimates of future connected loads. We take the view that estimates for more distant dates can better be made, and better escape errors of duplication, by making estimates of total output of different industries and the corresponding energy requirements. Each method provides for intermediate dates a valuable check on the other.

VIII. THE MAKING OF ENERGY POLICY

519. We are convinced that it will be desirable to keep constantly under review the trends of energy consumption and to re-formulate policies as circumstances change. We greatly welcome the establishment within the Planning Commission of a unit that will be concerned under one Member of the Commission with energy problems. We recommend (see paras 23-4) that this unit be charged with the responsibility for the collection and organisation of the statistics that are essential to any such work.

520. We would expect that it will be desirable to repeat at intervals of about five years some such survey as we have undertaken, in order that it may be seen whether circumstances have so changed that a change of policies is required. We hesitate at this stage to recommend that it should be conducted on the same basis as this survey has been. But we would emphasise the advantages that this survey has enjoyed through the close cooperation of representatives of the several Ministries under which energy problems are divided at present and of experts drawn from a number of fields in India and abroad and possessing a wide variety of relevant experience.

521. In the intervals between such reviews, we suggest that great advantage could be secured by provision of inter-departmental arrangements for regular consultation between the Secretaries of the various Ministries concerned with energy problems. We understand that such provision has already been made.

Signed 27th July 1965

M. S. Thacker	-	Chairman
Walker L. Cisler	-	Jt. Chairman
E. A. G. Robinson	-	Jt. Chairman
S. Bose	-	Member
M. N. Chakravarti	-	"
K. R. Damle	-	"
Louis de Heem	-	"
Jacques Desrousseaux	-	"
A. B. Guha	-	"
C. S. Krishna Moorthy	-	"
S. S. Kumar	-	"
P. S. Lokanathan	-	"
B. S. Nag	-	"
K. P. S. Nair	-	"
V. Nanjappa	-	"
P. R. Nayak	-	"
Pitamber Pant	-	"
V. K. R. V. Rao	-	"

ANNEX I

Statistical Note on Domestic Consumption

By E. A. G. Robinson

1. The main report (paras. 144-150) stresses the difficulties of interpreting with certainty the data relating to domestic consumption of energy in India. The purpose of this note is to set out in rather more detail the evidence on which the conclusions regarding the probable trends of energy consumption in recent years were based.

2. The basic evidence available to us consisted principally of the results of two inquiries conducted by the National Council for Applied Economic Research. The first of these was conducted in 1958 into the domestic consumption of energy in Bombay, Calcutta and Delhi. The second was conducted in 1962 into the domestic consumption of a stratified sample of approximately 9000 rural households distributed over the whole of India.

3. We possessed no direct evidence for the consumption patterns of the towns of various sizes intervening between the villages of the rural sample and the three big cities and containing some 70 millions of population in 1962/3 out of a total for

all India of 445 millions. For these it was clearly necessary to make some reasonable assumptions regarding both the total of domestic consumption per head and its probable division between different fuels.

4. Apart from the evidence of the two N.C.A.E.R. inquiries we possessed more direct evidence from data relating to coal production and distribution of the volumes of consumption of domestic coke in different years. With the assistance of the various oil companies we were able to make more direct estimates of the total kerosene consumption for domestic purposes in different years. From data relating to electricity distribution we were able to make more direct estimates of electricity consumption for domestic purposes. We were thus able to estimate directly the total growth of consumption for domestic purposes of all forms of commercial energy.

5. The trend of total consumption of commercial energy for domestic purpose during the period 1953/4 to 1962/3 has been as follows:

TABLE 1-1

DOMESTIC CONSUMPTION
OF COMMERCIAL SOURCES OF ENERGY
1953/4 to 1962/3
(million tonnes of coal replacement)

	1953/4	1958/9	1960/1	1962/3
Soft Coke	2.20	3.10	2.80	2.80
Kerosene	7.70	10.80	12.90	15.70
Electricity	0.70	1.20	1.50	1.70
Total	10.60	15.10	17.20	20.00

6. It was possible, on the basis of the evidence of the consumption of commercial energy in the three big cities in 1958/9 and in the rural areas in 1962/3 and of the estimated changes in population to make approximate allocations of the commercial energy to the big cities, the rural areas and the other towns. While these cannot be more than approximate, it is thought that the errors are probably not large.

7. It was possible also on the basis of the evidence of the big cities for 1958/9 and of the rural areas for 1962/3 to make estimates of the consumption of the non-commercial fuels.

8. The two inquiries showed that, in terms of coal replacement, the average rural consumption in 1962/3 was 0.38 tonnes per head; the average big city consumption in 1958/9 was 0.40 tonnes per head. It seemed reasonable to assume that the con-

sumption per head in the other towns was at a level between these two figures.

9. Two estimates were then made for the years 1953/4, 1958/9, 1960/1 and 1962/3 of the pattern of consumption in each of the three sectors - big cities, other towns, rural areas. The first of these estimates (given in Table 1-3 below) assumed that consumption per head remained constant throughout the period and total consumption (including both commercial and non-commercial sources of energy) increased in proportion to population in each sector. In this estimate the consumption per head was assumed in all

years to be 0.40 tonnes per head in the big cities; 0.39 tonnes per head in the other towns; 0.38 tonnes per head in the rural areas.

10. The second estimate (given in Table 1-5 below) assumed that consumption per head had increased slowly over the period, reflecting the relatively low income elasticities shown in the N.C.A.E.R. inquiry into domestic consumption in the big cities. It remained true, none-the-less, that the main cause of increased consumption was the increases of populations. The assumed consumptions per head over the relevant years were as follows:

TABLE 1-2
ASSUMED INCREASES OF CONSUMPTION PER HEAD
IN TABLE 1-5

	(tonnes coal replacement)			
	1953/4	1958/9	1960/1	1962/3
Three Big Cities	0.39	0.40	0.40	0.41
Other Towns	0.37	0.38	0.39	0.39
Rural Areas	0.36	0.37	0.37	0.38

TABLE 1-3
ESTIMATES OF CONSUMPTION OF DOMESTIC SECTOR: I
(Assuming constant consumption per head)
(million tonnes coal replacement)

	1953/4				1958/9				1960/1		
	Three Big Cities	Other Urban Areas	Rural Areas	Total	Three Big Cities	Other Urban Areas	Rural Areas	Total	Three Big Cities	Other Urban Areas	Rural Areas
Populations (M.)	8	58	311	377	9	64	338	410	10	68	359
Commercial Sources											
Soft Coke	0.75	0.50	0.95	2.20	1.04	0.56	1.50	3.10	1.00	0.50	1.30
Kerosene	0.70	2.50	4.50	7.70	0.86	3.53	6.41	10.80	1.05	3.65	8.20
Electricity	0.30	0.33	0.07	0.70	0.40	0.65	0.15	1.20	0.50	0.80	0.20
Total	1.75	3.33	5.52	10.60	2.30	4.74	8.06	15.10	2.55	4.95	9.70
Non-Commercial Sources											
Firewood and Charcoal	1.34	12.29	73.41	87.04	1.15	12.96	77.08	91.17	1.26	13.78	81.49
Dung Cakes	0.05	2.87	16.70	19.72	0.04	3.14	18.60	21.78	0.04	3.32	18.54
Waste Products	0.05	4.01	22.55	26.61	0.04	4.22	25.12	29.38	0.04	4.48	25.01
Total	1.44	19.28	112.66	133.38	1.23	20.32	120.78	142.33	1.34	21.58	125.04
All Fuels	3.19	22.61	118.18	143.98	3.53	25.08	128.84	157.43	3.89	26.53	134.74
All Fuels per Head	0.40	0.39	0.38	0.38	0.40	0.39	0.38	0.38	0.40	0.39	0.38

11. For purposes of international comparison it may be helpful to have in mind that, on the basis of the normal measurements of the kilocalorie content of all the fuels concerned, and in terms of coal with the average kilocalorie content of 7000 kcal/kg used in the O.E.E.C. Report **Towards a New Energy Pattern in Europe** the average domestic consumption per head shown for 1962/3 in Table 1-2 is equivalent to:

Big Cities	0.24 tonne
Other Urban Areas	0.26 tonne
Rural Areas	0.26 tonne
All India	0.26 tonne

The relatively higher consumption in rural areas and lower consumption in the big cities shown by the kilocalorie measurements is due to the fact that the latter takes no account, while the coal replacement method does take account, of the different thermal efficiencies in the use of kerosene and of non-commercial fuels. At the same time, a larger proportion of rural consumption is in the form of non-commercial energy for which, since in most cases no payment has to be made, the consumption is less restrained

by economic considerations.

12. On the basis of the assumption of constant consumption per head made in the estimates given in Table 1-3, it will be seen (see Table 1-4) that there is implied a total increase of consumption between 1953/4 and 1962/3 of 24.26 m. tonnes of coal replacement of which 9.40 m. tonnes was covered by increased consumption of commercial fuels and 14.86 m. tonnes by increased consumption of non-commercial fuels.

13. In Table 1-5 are presented the similar estimates for the three sectors on the assumption of rising consumption of energy per head. It is assumed that between 1953/4 and 1962/3 domestic consumption of energy per head in India as a whole rose by about 4½%. During the same period total personal consumption per head rose by about 10%.

14. On the basis of the assumptions made in the estimates given in Table 1-5, the implied total increase of consumption between 1953/4 and 1962/3 (see Table 1-6) was 31.8 m. tonnes; of this it is estimated that 9.4 m. tonnes was covered by increased supplies of commercial fuels; 22.4 m. tonnes was covered by increased consumption of non-commercial fuels.

TABLE 1-4

DOMESTIC CONSUMPTION

CHANGES 1953/4 TO 1962/3

ON ASSUMPTION OF
CONSTANT CONSUMPTION PER HEAD
(million tonnes coal replacement)

Total Consumption	1962/3	168.24	
Total Consumption	1953/4	143.98	
Increase		24.26	
Commercial Sources	1962/3	20.00	
Commercial Sources	1953/4	10.60	
Increase		9.40	
Non-Commercial Sources	1962/3	148.24	
Non-Commercial Sources	1953/4	133.38	
Increase		14.86	
Total Increase		24.26	100.0%
Covered from Commercial Sources		9.40	38.8%
Non-Commercial Sources		14.86	61.2%

Total	1962/3			Total
	Three Big Cities	Other Urban Areas	Rural Areas	
436	10	70	365	445
2.80	0.90	0.40	1.30	2.60
12.90	1.20	3.80	10.70	15.70
1.50	0.58	0.89	0.23	1.70
17.20	2.68	5.09	12.23	20.00
96.53	1.15	14.18	81.33	96.66
21.90	0.04	3.42	18.50	21.98
29.53	0.04	4.62	24.86	29.82
147.98	1.23	22.22	124.79	148.24
165.18	3.91	27.31	137.02	168.24
0.38	0.40	0.39	0.38	0.38

TABLE 1-5

ESTIMATES OF CONSUMPTION OF DOMESTIC SECTOR: II
 (Assuming rising consumption per head)
 (million tonnes coal replacement)

	1953/4				1958/9				1980/1		
	Three Big Cities	Other Urban Areas	Rural Areas	Total	Three Big Cities	Other Urban Areas	Rural Areas	Total	Three Big Cities	Other Urban Areas	Rural Areas
Populations (Millions) 8	58	311	377	9	64	338	410	10	68	358	
Commercial Sources											
Soft Coke	0.75	0.50	0.95	2.20	1.04	0.58	1.50	3.10	1.00	0.50	1.30
Kerosene	0.70	2.50	4.50	7.70	0.86	3.53	6.41	10.80	1.05	3.65	8.20
Electricity	0.30	0.33	0.07	0.70	0.40	0.65	0.15	1.20	0.50	0.80	0.20
Total	1.75	3.33	5.52	10.80	2.30	4.74	8.06	15.10	2.55	4.95	9.70
Non-Commercial Sources											
Firewood and Charcoal	1.28	11.56	69.36	82.20	1.15	12.49	74.65	88.29	1.26	13.77	80.25
Dung Cakes	0.04	2.79	15.78	18.61	0.04	3.02	18.02	21.08	0.04	3.32	18.25
Waste Products	0.04	3.77	21.30	25.11	0.04	4.07	24.33	28.44	0.04	4.48	24.63
Total	1.36	18.13	106.44	125.92	1.23	19.58	117.00	137.81	1.34	21.57	123.13
All Fuels	3.11	21.45	111.96	136.52	3.53	24.32	125.06	152.91	3.89	26.52	132.83
All Fuels per Head	0.39	0.37	0.36	0.36	0.40	0.38	0.37	0.37	0.40	0.39	0.37

15. It will be seen that, whichever assumption is made - that of constant consumption per head or that of slowly rising consumption per head - there seems likely to have been a quite considerable increase of consumption of the non-commercial fuels between 1953/4 and 1962/3; even on the basis of no increase of consumption per head, the figure was probably not far short of 15 m. tonnes; on the much more probable basis of slowly rising consumption per head it was probably nearer to 22 m. tonnes.

16. Of the two assumptions it is believed that that of slowly rising consumption per head more accurately reflects the probable past trend. The assumption of constant consumption per head was, indeed, only introduced in order to demonstrate that, even on that basis, with the actual growth of Indian population there has almost certainly not been an actual substitution (as has often been claimed) of commercial fuels for non-commercial fuels. Con-

sumption of non-commercial fuels has continued to rise. Substitution, in the more esoteric sense of an increasing proportion of all energy consumed in the commercial forms, has merely diminished somewhat the rate of increase of consumption of non-commercial fuels.

17. The estimates made in this note need to be treated with caution. While it is believed that we now know considerably more accurately than in the past the probable orders of magnitude of domestic consumption and its division between commercial and non-commercial sources, there inevitably remain uncertainties which can only be removed by further field inquiries. None-the-less the figures are now sufficiently good to make it possible to see with much more clarity the issues of policy involved. It is not likely that the remaining errors are such as to invalidate broad conclusions of policy based on the present data.

TABLE 1-6
DOMESTIC CONSUMPTION

Changes 1953/4 to 1962/3
on assumption of
Rising Consumption per Head

(million tonnes coal replacement)

Total Consumption	1962/3	168.34	
Total Consumption	1953/4	136.52	
Increase		31.82	
Commercial Sources	1962/3	20.00	
Commercial Sources	1953/4	10.60	
Increase		9.40	
Non-Commercial Sources	1962/3	148.34	
Non-Commercial Sources	1953/4	125.92	
Increase		22.42	
Total Increase		31.82	100.0
Covered from Commercial Sources		9.40	29.5
Non-Commercial Sources		22.42	70.5

Total	1962/3			Total
	Three Big Cities	Other Urban Areas	Rural Areas	
436	10	70	365	445
2.80	0.90	0.40	1.30	2.60
12.90	1.20	3.80	10.70	15.70
1.50	0.58	0.88	0.23	1.70
17.20	2.68	5.09	12.23	20.00
95.28	1.25	14.18	81.33	96.76
21.61	0.04	3.42	18.50	21.96
28.15	0.04	4.62	24.98	29.62
146.04	1.33	22.22	124.79	148.34
183.24	4.01	27.31	137.02	168.34
0.37	0.41	0.39	0.38	0.38

ANNEX 2

An Examination of The Development of Generating Facilities by Regions ⁽¹⁾

By A. E. Bush

1. An examination has been made of a possible plan for development of electricity generating facilities by regions. This examination was made primarily for the purpose of estimating fuel requirements in the terminal years of Plans IV, V and VI. It has been used also for estimating capital outlays for electricity supply facilities during Plans IV, V and VI. Although the plans selected were based on some consideration of available primary resources in each region and the relative economies of alternative plans, other plans certainly are possible and on more detailed examination may prove preferable.

2. This examination does not purport to be a detailed blueprint for development. Obviously, a regional development plan must consider the specific resources available in the region, particularly with regard to cost and to location. However, it may be useful as a crude beginning of more comprehensive regional studies.

REGIONAL RESOURCES

3. Each region was examined separately and the plan selected in each case was based on known resources of the region.

4. In considering such resources some attention was given to what may be called the strategy of development. Thus, available information suggests that wherever hydel resources are available they will provide the cheapest power (aside from areas where very cheap fossil fuel may be available). It would

(1) This Annex was prepared by Mr. A.E. Bush, Chairman of the Working Group, to assist the Committee in discharging the obligation under its terms of reference to study the development of power resources and to make recommendations as to the phasing in which these should be brought into use progressively. The Committee is grateful to Mr. Bush for his very thorough and searching study. Mr. Bush's examination, as he emphasises, is not intended to be a detailed blueprint; other plans, as he says, certainly are possible, and on more detailed examination, may prove preferable. Thus the Committee, in including this Annex in its report, would not wish it to be regarded as representing in any sense the Committee's collective and agreed recommendation of a single and unchangeable scheme for power development. But it would wish to draw attention to the broad strategies of regional development which Mr. Bush has outlined.

seem prudent, however, that, if available hydel will be fully exploited in the foreseeable future, a beginning be made on exploitation of alternative sources. Actually, in this study hydel resources have not been used to supply base load except in Southern Region in Plan V and in all Plan Periods in Northern Region, but have been used to supply peaking power at 15% plant factor. An obvious alternative would be the development of remaining hydel to supply base load in early years with provision for conversion to low plant factor operation in later years through addition of more generating capacity.

5. As to coal and lignite resources the position adopted was that only 15% of available reserves should be allocated to power and that thermal capacity should not be expanded to the point where remaining reserves would not supply full requirements of coal for a period well beyond the life of generating facilities to be supplied by them.

6. The assumption has been made also that, as petroleum refining expands, a certain amount of petroleum pitch and refinery gases will be available for thermal plants. Since these products have other uses, the proportion assigned to thermal plants was about half of the total available. Such amounts are small compared to prospective needs of fossil fuel. Some additional generation from fuel oil has been assumed for Southern Region in 1980/1. This generation might alternatively be from coal or nuclear fuels.

7. As to nuclear plants, I have made the provisional assumption that the necessary more detailed enquiry will show that about half of the base load (0.75 plant factor) requirements during Plans V and VI in Western and Southern Regions will be most economically met by such plants. This assumption is wholly provisional; it would be technically possible that all base load requirements should be met either by pit-head plants or by nuclear plants, both with EHV transmission. The final judgment as to which of the forms of generation will be cheaper can only be made when actual experience is available of the achieved costs of such nuclear plants of the Candu type in Indian conditions both for construction and operation; on the basis of pre-construction estimates supplied to us, nuclear plants would currently be competitive with the alternatives available in certain locations in those Regions and on certain reasonable assumptions of the delivered costs of coal. Probably

the important point is that, if experience shows that the pre-construction estimates cannot be achieved for the time being in practice, India is under no immediate compulsion to begin a large programme of nuclear stations now; that on the basis of our forecasts, existing hydel and fossil fuel reserves are quite adequate to support, if necessary, all expansion to 1980/1. Thus the scale of the nuclear programme can be determined by purely economic considerations. I am, however, convinced that India should, in any case, make a start with at least a few nuclear stations, so as to be ready to proceed with a larger programme once the economic justification of such stations has been clearly demonstrated.

8. With regard to by-product coal our studies

indicate that, as a necessary result of washing coking coal for the iron and steel industry, large amounts of this fuel will be available in Eastern Region. The volume of such fuel after 1970/1 will be far beyond the needs for Eastern Region. In these circumstances, it seems probable that the price of by-product must be very low and therefore the cheapest source of energy, not only for Eastern Region, but for Central Region as well. So, base load for these Regions has been supplied entirely from plants burning by-product with peaking capacity supplied by hydel plants.

9. The resources considered in each Region are listed in Table 2-1.

TABLE 2-1
ENERGY RESOURCES OF INDIA BY REGIONS

REGION	ESTIMATED RESERVES OF FOSSIL FUELS				HYDRO RESOURCES	
	Coal	Lignite	Crude Oil	Nat. Gas	TWh	% Developed
	10 ⁹ t.	10 ⁹ t.	10 ⁹ t.	10 ⁹ M ³		1962/3
Eastern	77.5	-	-	-	14.2	8.1%
Northern	0.1	0.12	-	-	36.6	6.7
Central	37.6	-	-	-	43.9	2.9
Western	5.7	-	.035	10.0	13.6	15.1
Southern	5.6	2.1	-	-	42.6	11.4
Assam	3.9	-	.048	21.5	65.5	.04
All India	130.4	2.22	.083	31.5	218.4	5.5

OTHER ASSUMPTIONS

10. A basic assumption was made that system plant factor by end of Plan IV would be 0.48. This assumption is based on a load factor of 0.60 (ratio of average load to maximum load) and on demand factor of 0.80 (ratio of peak load to dependable net generating capacity). The assumption with regard to the terminal year of Plans V and VI was that plant factor would be 0.51 except in the case of Assam Region where 0.48 was continued for all periods. These assumptions seem to be clearly attainable mostly by integration of facilities through improved transmission nets. In my opinion they provide adequate allowance for errors of estimate, forced outages, scheduled maintenance, etc.

11. Another basic assumption is that proper use will be made of existing generating capacity in each Region which, with the additional capacity to be added, will meet the requirements stipulated above. Generally, added thermal and/or nuclear stations are assumed to be base-loaded, at plant factor of 0.75. Additional capacity above that added at 0.75 plant

factor has generally been low load factor hydel. This latter could be accomplished either through adding additional capacity to existing stations or by adding additional stations. The latter has been assumed in all cases although some capacity can surely be added at lower cost in the former way.

12. It has been assumed that gross capability will be the same as installed capacity except for foot-of-dam hydel plants where the amount of water turbined is controlled by irrigation or other non-power purpose. In such cases, since dependable capacity is usually less at low head than at high head, I have counted only the low-head capacity insofar as this information was available to me. However, gross installed capacity (including non-dependable capacity) is given in the tables shown later in this analysis. It has also been assumed that capacity available for transmission will be less than dependable generating capacity by 1% in the case of hydro plants and 6.5% in the case of all others.

13. The analysis for each Region has been made

on a step by step basis beginning with 1970/1 and proceeding to 1975/6 and 1980/1, the terminal years of Plans V and VI, respectively. On the basis of our forecasts of final demand for electricity the required capacity at the end of each Plan period has been estimated. Then in the light of available resources a plausible plan was devised.

14. In each case a primary consideration was the selection of plant that would minimize both capital outlay and annual expenses. In assessing relative capital outlay and annual expense I relied on generalised studies of a number of current projects which are not necessarily representative of any particular project or any particular Region. Obviously, the outlay and expense for a specific project may be materially different from the averages I have used.

15. In each Region there are a number of auto-producers who not only supply part or all of their own requirements but, in some cases, provide substantial amounts for the public supply. However, no attempt has been made to separate such producers from the total.

16. Specific consumption by "old" steam plant in service in the terminal year of each Plan period has been assumed as follows. By "old" steam plant I mean here all of the capacity that was in service at the end of 1960/1, plus a number of small steam units that have since been commissioned or shortly will be. (In the detailed analysis of each Region for 1970/1 a reduction of generation by "old" steam plants was necessary in some regions either to avoid spilling water at hydel plants or to avoid reducing generation at more modern and efficient steam plants).

TABLE 2-2

SPECIFIC CONSUMPTION OF
"OLD" STEAM GENERATING CAPACITY REMAINING IN
SERVICE IN TERMINAL YEARS OF FUTURE PLAN PERIODS

YEAR	1970/1	1975/8	1980/1
Capacity in Service, GW	3.28	2.82	1.48
Aggregate Gross Generation, TWh	8.05	8.50	3.38
Gross Spec. Cons, kcal/kWh	4580	3780	3680

17. Specific consumption by diesel generating plant has been assumed to be 0.350 kg of LDO per gross kWh generated. This is above the national average consumption in 1960/1 but is believed appropriate in view of the low plant factors I have as-

sumed for diesel plant.

18. Specific consumption of new steam generating plant has been assumed as follows for plant additions in each of the Plan periods.

TABLE 2-3

GROSS SPECIFIC CONSUMPTION OF STEAM POWER STATIONS
TO BE INSTALLED IN FUTURE PLAN PERIODS

PLAN	GROSS SPEC. CONS. kcal/kWh
III	2840
IV	2480
V	2300
VI	2300

These levels are well above what is now being achieved in more advanced countries but are believed reasonable in the light of current and prospective conditions in India, especially if, as we have proposed, the price of by-products be set at a

low level. Moreover, they have not been invariably applied to all plant additions. For a number of small future additions the assumed specific consumption has been 2640 kcal/kWh even in the later plan periods.

19. Plant auxiliaries are estimated to require some 6½% of gross output from steam, nuclear and diesel plants and 1% of gross output from hydro plants.

20. The following calorific values have been used for the various fuels that will be consumed in steam power stations:

TABLE 2-4
CALORIFIC VALUE ASSUMED FOR VARIOUS FUELS FOR
STEAM POWER PLANTS
(kilocalories)

	1970/1	1975/6	1980/1
By-product coal/kg	4400	4300	4250
Coal for old steam plants/kg	5500	5500	5500
Coal for new pithead plants at outlying fields/kg	4400	4300	4250
Oil products/kg	10000	10000	10000
Blast Furnace Gas/M ³	950	950	950
Coke Oven Gas/M ³	4500	4500	4500
Lignite/kg	3060	3060	3060

21. Provision has been made for retirement by 1980/1 of all steam and diesel generating capacity that was in service at the end of 1955/6. The amount

and regional distribution of these retirements is shown in Table 2-5. No specific provision has been made for retirement of hydro capacity.

TABLE 2-5

ASSUMED RETIREMENTS OF STEAM AND DIESEL GENERATING CAPACITY
BY PLAN PERIODS AND BY REGION: MW

REGION	PLAN IV		PLAN V		PLAN VI	
	Steam	Diesel	Steam	Diesel	Steam	Diesel
All India	300	40	642	80	1161	144
Eastern	69	5	208	12	374	23
Northern	27	7	52	16	95	31
Central	78	8	142	16	258	30
Western	82	13	166	22	299	38
Southern	43	5	73	11	129	18
Assam	1	1	1	3	6	4

22. Gross additions to generating capacity must provide not only for load growth, but for the replacement of capacity retired. It has been assumed that capacity commissioned in Plan III will be as forecast in the First Annual Power Survey. (I have modified Survey results in light of more recent information insofar as that was available to me.) It has been as-

sumed also that all fully approved capacity for Plan IV will be commissioned, again as indicated by the Power Survey (modified in some cases).

23. The resulting gross additions to generating capacity in future plan periods are summarized in Table 2-6:

TABLE 2-8
SUMMARY OF ADDITIONS TO GENERATING CAPACITY OF UTILITIES &
AUTO-PRODUCERS BY PRIME MOVER & BY PLAN PERIOD-6W
 (including allowance for replacements)

PERIOD	HYDEL			STEAM	NUCLEAR	TOTAL
	Normal	15% PF	Total			
A. Net Capacity Additions						
Plan IV						
CASE I	3.85	.67	4.52	1.33	.55	6.40
CASE II	3.85	.91	4.76	1.85	.55	7.16
CASE III	3.96	1.45	5.41	3.27	.55	9.23
Plan V						
CASE I	1.06	1.86	2.92	3.04	.67	8.63
CASE II	1.97	2.78	4.75	3.92	.86	9.53
CASE III	3.02	3.66	6.68	4.37	1.33	12.38
Plan VI						
CASE I	1.6	5.4	7.0	5.1	1.7	13.8
CASE II	2.0	6.9	8.9	6.7	2.3	17.9
CASE III	2.4	8.4	10.8	8.4	2.8	22.0
B. Gross Capacity Additions - Plan IV Only (Excluding non-dependable capacity)						
CASE I			4.57	1.42	.58	6.57
CASE II			4.81	1.98	.58	7.37
CASE III			5.46	3.50	.58	9.54

24. The fundamental plan of power supply adopted for each Region is as follows:

EASTERN REGION - base load supply from thermal plants burning by-product coal; "peaking" power supply from low-load factor hydel plants. This pattern of development possibly cannot be begun in reality until Fifth Plan Period because sufficient capacity to supply this region is said to be almost all fully approved. However, it seems possible and desirable to provide excess thermal capacity in this region during Fourth Plan to export power via EHV transmission lines to eastern Maharashtra and Madhya Pradesh.

NORTHERN REGION - entire supply from hydel plants designed for 60% plant factor. Strong transmission ties to networks of Uttar Pradesh and Madhya Pradesh would be most desirable.

CENTRAL REGION - base load supply from thermal plants burning by-product coal supplemented by transfer of large blocks of power from Eastern Region; "peaking" power supply from low load factor hydel plants. As mentioned above, it would appear possible and desirable to make a beginning with EHV trans-

mission during Fourth Plan. The initial project might be two single circuit 400 kv lines with capacity of 1000 MW to deliver power from washery area of Eastern Region to vicinity of Nagpur where it would feed 220 kv grids of Maharashtra and Madhya Pradesh. This could be expanded in later plans. Third and Fourth Plan steam stations in region already constructed or fully approved may be supplied with by-product coal by "closed circuit" rail operations from Eastern washeries.

WESTERN REGION - base load supply from pithead steam plants or from nuclear plants; "peaking" power supply from low load factor hydel plants. Base load should be supplied from load-oriented plants, like Dhuvran, only if an economic fuel supply can be provided, as, for example, by "closed circuit" trains from outlying coalfields, or by provision of refinery wastes such as petroleum pitch, refinery gas etc.

SOUTHERN REGION - generally similar to Western Region, except that large undeveloped hydel resources suggest that considerable base load growth should be met by development of these resources at

60% plant factor through Fifth Plan period. In the model actually used considerable use has been made of oil products from refineries to be built in this region.

ASSAM REGION - a balanced supply from thermal

and hydro resources has been adopted.

25. Installed capacity by prime mover is shown in Tables 2-7, 2-8 & 2-9 for 1960/1, 1970/1, 1975/6 and 1980/1 respectively. Regional data are shown only for 1960/1 and 1970/1.

TABLE 2-7

INSTALLED GROSS GENERATING CAPACITY FOR ELECTRIC UTILITIES AND AUTO-PRODUCERS, BY REGION, at 31 MARCH 1961, GW

	HYDEL	STEAM	DIESEL	TOTAL
UTILITIES				
All India	1.843	2.436	0.300	4.579
Eastern	.234	.971	.035	1.241
Northern	.263	.109	.065	.437
Central	.162	.441	.063	.665
Western	.282	.724	.087	1.093
Southern	.892	.185	.038	1.116
Assam	.010	.006	.012	.028
AUTO-PRODUCERS (1)				
All India	0.003 ⁽²⁾	0.954	0.044	1.001
Eastern	00	.556	.017	.573
Northern	00	.085	.006	.092
Central	00	.127	.008	.134
Western	00	.099	.008	.107
Southern	00	.088	.006	.092
Assam	00	.003	.001	.004
UTILITIES AND AUTO PRODUCERS				
All India	1.846	3.390	0.344	5.580
Eastern	.234	1.527	.052	1.814
Northern	.263	.194	.071	.529
Central	.162	.568	.071	.799
Western	.282	.823	.095	1.200
Southern	.892	.271	.044	1.208
Assam	.010	.009	.013	.032

(1) Regional breakdown by type of prime mover estimated

(2) Location unknown; included only in All India total.

TABLE 2-8

**INSTALLED GROSS GENERATING CAPACITY* FOR ELECTRIC
UTILITIES & AUTO-PRODUCERS-BY REGION & BY PRIME MOVER
-AT 31/3/71 GW**

Region	Hydel	Steam & Gas Turbines	Diesel	Nuclear	Total
CASE I					
All India	9.58	7.89	.38	.58	18.43
Eastern	1.29	3.12 ⁽¹⁾	.08	-	4.47 ⁽¹⁾
Northern	1.46	.46	.08	.20	2.20
Central	1.42 ⁽²⁾	1.74	.07	-	3.23 ⁽²⁾
Western	1.27	1.39	.09	.38	3.13
Southern	4.05	1.08	.05	-	5.18
Assam	.09	.10	.03	-	.22
(1) Includes .09 GW for Central					
(2) Includes .58 GW for Western					
CASE II					
All India	9.83	8.45	.38	.58	19.24
Eastern	1.54	3.68 ⁽¹⁾	.08	-	5.28 ⁽¹⁾
Northern	1.46	.46	.08	.20	2.20
Central	1.42 ⁽²⁾	1.74	.07	-	3.23 ⁽²⁾
Western	1.27	1.39	.09	.38	3.13
Southern	4.05	1.08	.05	-	5.18
Assam	.09	.10	.03	-	.22
(1) Includes .31 GW for Central; .05 GW for Western					
(2) Includes .58 GW for Western;					
CASE III					
All India	10.48	9.97	.38	.58	21.41
Eastern	1.87	5.20 ⁽¹⁾	.08	-	7.13 ⁽¹⁾
Northern	1.57	.46	.08	.20	2.31
Central	1.42 ⁽²⁾	1.74	.07	-	3.23 ⁽²⁾
Western	1.27	1.39	.09	.38	3.13
Southern	4.26	1.08	.05	-	5.39
Assam	.09	.10	.03	-	.22
(1) Includes 0.75 GW for Central; 0.70 GW for Western					
(2) Includes 0.58 GW for Western					

* Includes non-dependable hydel capacity of 0.40 GW in Northern, 0.23 in Central

TABLE 2-9

**INSTALLED GROSS GENERATING CAPACITY FOR ELECTRIC UTILITIES
& AUTO-PRODUCERS BY PRIME MOVER AT 31 MARCH 1976 AND
31 MARCH 1981, GW. ALL INDIA**

	Hydel*	Gas & Steam Turbines	Diesel	Nuclear	Total*
31 March 1976					
Case I	12.6	10.6	.3	1.3	24.8
Case II	14.8	12.1	.3	1.5	28.7
Case III	17.5	14.7	.3	2.0	33.9
* Non-dependable capacity: Case I-0.76GW; Case II-0.8GW; Case III-0.96W.					
31 MARCH 1981					
Case I	19.8	14.9	.2	3.1	38.0
Case II	23.9	18.1	.2	4.0	46.2
Case III	28.6	21.9	.2	5.0	55.7
* Non-dependable capacity: Case I-0.86GW; Case II-0.96W; Case III-1.1 GW.					

27. Gross generation comparable to installed capacity is shown in Tables 2-10 to 2-12.

corresponding to gross generation is shown in Tables 2-13 to 2-15.

28. Fuel consumption by steam and diesel plants

**TABLE 2-10
GROSS GENERATION BY ELECTRIC UTILITIES AND AUTO-PRODUCERS
BY REGIONS, 1980/1, TWh**

	HYDEL	STEAM	DIESEL	TOTAL
UTILITIES				
All India	7.764	8.723	0.387	16.853
Eastern	.788	3.559	.058	4.404
Northern	1.010	.341	.086	1.437
Central	.463	1.218	.050	1.729
Western	1.385	3.044	.131	4.539
Southern	4.117	.564	.025	4.705
Assam	.021	-	.017	.038
AUTO-PRODUCERS (a)				
All India	0.008 (b)	3.133	.152	3.293
Eastern	-	1.925	.068	1.991
Northern	-	.298	.023	.321
Central	-	.377	.023	.400
Western	-	.243	.018	.261
Southern	-	.273	.021	.294
Assam	-	.017	.001	.018
UTILITIES AND AUTO-PRODUCERS				
All India	7.770	11.858	.519	20.148
Eastern	.788	5.484	.124	6.395
Northern	1.010	.639	.109	1.758
Central	.463	1.593	.073	2.129
Western	1.385	3.287	.149	4.800
Southern	4.117	.837	.046	4.999
Assam	.021	.017	.018	.056

(a) Generation by type of prime mover estimated

(b) Location unknown; included only in all-India total

TABLE 2-11

GROSS GENERATION BY ELECTRIC UTILITIES & AUTO-PRODUCERS
BY REGION & BY PRIME MOVER, 1970/1; TWh

CASE	REGION	HYDEL	GAS TURB. & STEAM	DIESEL	NUCLEAR	TOTAL
I	All India	34.56	30.87	.40	3.87	69.70
	Eastern	3.37	15.68 ⁽¹⁾	.06	-	19.11
	Northern	4.24	1.02	.09	1.34	6.69
	Central	5.31 ⁽²⁾	7.51	.06	-	12.88
	Western	5.07	4.81	.10	2.53	12.31
	Southern	16.20	1.76	.04	-	18.00
	Assam	.37	.29	.05	-	.71
	1) Includes 0.80 TWh for Central					
	2) Includes 2.32 TWh for Western					
II	All India	34.88	37.46	.40	3.87	76.61
	Eastern	3.70	19.33 ⁽¹⁾	.06	-	23.09
	Northern	4.24	1.50	.09	1.34	7.17
	Central	5.31 ⁽²⁾	7.03	.06	-	12.40
	Western	5.07	5.55	.10	2.53	13.25
	Southern	16.20	3.70	.04	-	19.94
	Assam	.37	.35	.05	-	.77
	1) Includes 1.99 TWh for Central; 0.28 TWh for Western					
	2) Includes 2.32 TWh for Western					
III	All India	36.06	47.94	.40	3.87	88.27
	Eastern	4.14	29.19 ⁽¹⁾	.06	-	33.39
	Northern	4.69	2.00	.09	1.34	8.12
	Central	5.31 ⁽²⁾	6.05	.06	-	11.42
	Western	5.07	4.09	.10	2.53	11.79
	Southern	16.48	6.20	.04	-	22.72
	Assam	.37	.41	.05	-	.83
	1) Includes 4.81 TWh for Central; 4.52 TWh for Western					
	2) Includes 2.32 TWh for Western					

TABLE 2-12

GROSS GENERATION BY ELECTRIC UTILITIES & AUTO-PRODUCERS
BY PRIME MOVER: ALL INDIA, 1975/6 & 1980/1 TWh

	HYDEL	STEAM & GAS TURBINES	DIESEL	NUCLEAR	TOTAL
A. 1975/6					
CASE I	43.5	55.2	.3	8.5	107.5
CASE II	49.2	65.0	.3	9.9	124.4
CASE III	57.0	77.1	.3	13.1	147.5
B. 1980/1					
CASE I	56.8	88.8	.2	20.4	166.0
CASE II	65.4	110.4	.2	26.3	202.3
CASE III	76.6	134.4	.2	32.8	244.0

TABLE 2-13
FUELS CONSUMED BY ELECTRIC UTILITIES AND AUTO-PRODUCERS

REGION	BY REGIONS, 1960/1 (million tonnes)					
	LDO(2) (Diesel)	Coking Coal	Non-Coking Coal	Coke	Fuel Oil	Blast Fur. & C.O. Gas(1)
All India	0.166	0.47	8.11	0.03	0.278	0.53
Eastern	.044	.46	3.17	.03	.003	.48
Northern	.033	—	.67	—	.002	—
Central	.024	.01	1.81	—	.002	.05
Western	.044	—	1.94 ⁽³⁾	—	.259	—
Southern	.016	—	.74	—	.099	—
Assam	.006	—	—	—	.001	—

- (1) In equivalent million tonnes of coal of 5660 kcal/kg
- (2) Consumption of LDO by auto-producers wholly estimated both as to amount and as to regional breakdown. Such consumption is included in "Industry other" in basic statistics in Annex 4. Total amount for all India is believed to have been about 0.054 million tonnes.
- (3) Adjusted from value in basic statistics to exclude coal equivalent of oil consumed for generation in Western Region.

TABLE 2-14
ESTIMATE OF FUELS CONSUMED IN STEAM & DIESEL POWER STATIONS OF UTILITIES & AUTO-PRODUCERS BY FUEL & BY REGION IN 1970/1
(million tonnes)

CASE	Region	LDO (Diesel)	Coal		Lignite	Fuel Oil	Gas & (1) Waste Prod.
			5500 kcal/kg	4400 kcal/kg			
I	All India	.14	3.18	13.34	1.76	.77	.74
	Eastern	.02	2.67	7.60	—	.03	.49
	Northern	.03	—	.61	—	—	—
	Central	.02	.04	4.44	—	—	.05
	Western	.04	.45	.69	—	.73	—
	Southern	.01	—	—	1.76	—	—
	Assam	.02	.02	—	—	.01	.20
II	All India	.14	3.98	15.06	3.70	.87	.79
	Eastern	.02	2.67	9.45	—	.03	.49
	Northern	.03	—	.90	—	—	—
	Central	.02	.04	4.15	—	—	.05
	Western	.04	1.23	.56	—	.83	—
	Southern	.01	—	—	3.70	—	—
	Assam	.02	.02	—	—	.01	.25
III	All India	.14	3.61	20.77	3.83	.99	.85
	Eastern	.02	2.67	14.96	—	.03	.49
	Northern	.03	.49	.84	—	—	—
	Central	.02	.04	3.57	—	—	.05
	Western	.04	.01	.35	—	.92	—
	Southern	.01	.38	1.05	3.93	.03	—
	Assam	.02	.02	—	—	.01	.31

(1) In million tonnes of coal equivalent of 5500 kcal/kg.

TABLE 2-15

ESTIMATE OF FUELS CONSUMED IN STEAM AND DIESEL POWER STATIONS OF UTILITIES &
 AUTO-PRODUCERS BY FUEL, ALL INDIA, 1975/6 & 1980/1
 (million tonnes)

	LDO (Diesel)	Coal 5500 kcal/kg	Coal ⁽¹⁾ Low Grade	Lignite	Fuel Oil	Gas & Waste Products (2)
1975/6						
CASE I	.10	2.5	23.7	4.7	1.25	.8
CASE II	.10	2.5	28.5	4.9	1.36	.8
CASE III	.10	2.5	35.0	5.3	1.47	.9
1980/1						
CASE I	.07	.6	38.7	6.6	2.51	1.1
CASE II	.07	.6	48.7	6.6	3.03	1.2
CASE III	.07	.6	60.3	6.6	3.45	1.2

(1) 4300 kcal/kg in 1975/6; 4250 kcal/kg in 1980/1

(2) In million tonnes of coal equivalent of coal with 5500 kcal/kg.

29. Some general implications for the development of regional electricity supplies:

1.) Construction and extension of regional transmission grids.

An important basic assumption in this study is that regional transmission grids will be constructed and/or developed to such a level as will permit the optimum use of generating facilities. I understand that high voltage transmission lines are planned by all state electricity boards. I see much merit in extending and strengthening these grids so as to permit the effective integration of all major generating facilities on a regional basis.

2.) Inter-regional transmission ties.

I also see much merit in starting immediately a limited number of high capacity EHV transmission lines to: a) move energy from Eastern Region to the eastern portions of Central and Western Regions so as to minimize the rail transport of high ash by-product coals; and b) supplement the predominantly hydro resources of Northern Region from the thermal systems of Uttar and Madhya Pradesh.

3.) Impact of by-product coal on development of outlying coal fields.

This study shows very clearly that the by-product coals that will result from washing coking coal for the steel industry will supply the major portion of the coal required for thermal generation during the period I have reviewed. This by-product can be used either in power stations located in the

washery area or in new power stations located in outlying areas. Any particular solution would depend on the relative costs of EHV transmission versus "closed-circuit" rail transport. But, in either case, fresh coal cannot profitably be mined even as far away as Satpura at any time when by-product coal exceeds the requirements of power plants in the Bihar-Bengal area.

4.) Pit-Head Plants

The construction of pit-head plants probably should be influenced by the availability of by-product coal. On the basis of the projected tonnages of such fuel, it seems that by-product will supply the requirements of electric power plants only in the Eastern Region in 1970/1, but will supply such requirements for substantially all of India in later years. In view of the long life of power plants, as well as the high cost of developing new coal mining capacity, it would seem that power-plant sites should be so chosen as to make optimum use of by-product in the long view. Such considerations suggest that the tentative plans for expansion of pit-head plants at intermediate coal fields like Singrauli, Korba and Talcher might be re-examined in the light of the long run outlook. For example, it seems obvious that an alternative choice is the construction of such additional capacity in the washery area with transmission of electricity rather than transport of high ash by-product.

In the case of the outlying coal-fields, however, the problem is further modified by the possibility that India may be able to achieve considerably bet-

ter coal to pig iron ratios than are forecast in this report. If such a favourable development should occur (as our Working Group and most Indian steel experts expect), the available quantities of by-product will be less than are now projected and pit-head plants at coal fields like Satpura, Chanda and Singareni would be supplied entirely by local coals. Hence, as additional steam plant capacity is needed in these regions, I would recommend the construction of pit-head plants.

5.) The future role of hydro resources.

Since most of the hydro resources of India (outside of Assam Region) require large seasonal storage reservoirs it seems obvious that, except in Northern Region, where the undeveloped resources are very large, all hydro projects be designed to

provide for future conversion to peaking (low plant factor) operation. I am pleased to note that this is, in fact, the adopted policy of Central Water and Power Commission. I see much merit in thus providing for "peaking capacity" at a low cost-per kilowatt.

6.) Load-oriented plants.

I see little merit in extending existing stations at load centres or in building new ones except in those cases where it is clearly economic to do so. For example, if the "closed-circuit" railway operative proves to be feasible for large volumes of coal, a load-oriented plant may be preferable to a pit-head plant with extensive transmission. Other exceptions may be steam plants using refinery wastes and nuclear plants.

ANNEX 3

India's Hydro-Electric Resources ⁽¹⁾

1. INTRODUCTION

1.1 A systematic appraisal of India's hydro-electric resources is important from the point of view of an overall energy study. That India's reserves of high grade coal are limited is well known and these have to be conserved for metallurgical purposes. The country has sizeable resources of relatively poor quality coal. Their utilisation for electricity generation through large mine-head thermal stations has already been initiated and these together with washery oriented plants will form the mainstay of future coal-based thermal generation. However, these resources are restricted to a few coal-bearing regions and therefore coal-based thermal generation cannot be expected to play as predominant a part in overall power production in India as in U.S.A., the U.K. and the U.S.S.R. India's proven oil and gas resources are so meagre that they are not even sufficient to meet the numerous high priority requirements in the fields of transportation, chemical industry etc. Compared with the vast reserves of economically utilisable, hydro power potential of about 40 million kW at 60% load factor (corresponding to 216 TWh - billion kWh - annual output on a firm basis), the actual current development of about 2.5 million kW ⁽²⁾ (corresponding to 13 TWh annual output) is indicative of the tremendous scope for further development of hydro power. It is of special importance in the field of electricity development in India due to its inherent economy and relatively low foreign exchange requirements. This paper presents the extent and location of economically utilisable hydro-electric resources in the country.

2. APPROACH TO THE PROBLEM OF ASSESSMENT OF HYDRO-ELECTRIC POTENTIAL.

2.1 The common approach to the problem of assessing the hydro-electric power potential is first to estimate the "theoretical limit" and then to derive the "technical" and "economic" limits by applying to the theoretical limits certain factors determined by experience from situations where all these limits have been worked out individually with fair accuracy by detailed studies. This has been done in Europe by E.C.E. and elsewhere. There are some serious

limitations in applying such an approach and they are outlined below.

(i) It gives no precise indication of the actual location of the potentially useful hydro resources, and the characteristics of the individual sites that constitute the total potential.

(ii) The flows of Indian rivers vary very widely from several thousands of cubic metres per second (m^3/s) during the monsoon period to a few m^3/s in the dry weather. For reliable firm power generation, these variations have to be regulated. The limits of regulation that can be provided with reservoirs are set by topography and requirements of flood control, problems of submergence etc. These factors vary enormously across the country and it is therefore difficult to derive "technical" and "economic" limits from "theoretical" limits in a realistic manner. Attempts to do so without detailed study of individual projects in different basins would be misleading.

(iii) Further, in some cases there are restrictions imposed by irrigation and other priority uses which again depend on topography, climate etc. and impose in turn restrictions on available waters and storages. These cannot be taken into account with any reasonable degree of accuracy in overall theoretical estimate and derivations therefrom.

2.2 In view of the above limitations, the C.W.& P.C., when it initiated a survey of the hydro potential of the entire country in the year 1953, felt that the study should be based on specific schemes of development which would incidentally provide the necessary data for forward planning. Such a study to be realistic required systematic collection and examination of all available topographical, hydrological and other data. In regard to the topographical data, contoured topographical maps in the scale of 1" = 1 mile and 1/2" = 1 mile with contour intervals at 50 ft. and 100 ft. respectively are available for almost all areas of the country. These maps have proved to be of reliable accuracy for preliminary studies and were used to select potential sites for storages and development of head. On the hydrological side, actual runoff data is, no doubt, meagre for most of the sites in the upper reaches. However, fairly good rainfall data is available for most of the areas and thanks to the early start which the country had in initiating river valley projects for irrigation and power, some runoff data is invariably available either lower down the basin or in similarly situated neighbouring basins. With this data, hydrological studies of suf-

(1) Prepared by CWPC (Power Wing) .

(2) The details of existing hydro-electric development are outlined in Table 3-1.

ficient accuracy were possible. With the advanced state of development of irrigation in the country and the programme of investigation of future potential sites underway, data regarding the existing and future requirements of irrigation could be obtained. On the basis of the above data, specific schemes were evolved for developing the resources of each basin taking into account technical and economic limitations. All possibilities of development in each basin were examined and the most economic alternatives chosen from considerations of the physical proportions of the civil works required in relation to the benefits assured. The prima facie economic feasibility were judged on the basis of prevailing yardsticks of costs and construction techniques.

2.3 Before passing on to the details of hydro-electric resources it would be useful to describe briefly the physical features of the country, its geological features, pattern of rainfall and its river systems. For, the hydro-electric potential of a river is basically created by the quantity of water it carries and the relief of the terrain over which it flows.

3. PHYSICAL FEATURES

3.1 India may be divided into three well-defined geomorphological regions: (i) the great mountain zone of the Himalayas, (ii) the Indo-Gangetic plain and (iii) the southern Peninsula.

3.2 The Himalayas.

3.2.1 The Himalayas comprise three almost parallel ranges interspersed with plateaus and valleys some of which, like the Kashmir and Kulu valleys, are fertile, extensive and of great scenic beauty. The Greater Himalayan mountain range, which forms the axis of the mountain mass extends over a distance of about 2400 km with varying depths between the Indus River in the west to the Brahmaputra in the east. At its western extremity lies the Nanga Parbat (8116.5 m) and at its eastern end stands Namcha Barwa (7755.6 m) - and in between lie numerous peaks over 6100 m high including the magnificent culmination of Mount Everest (8882m). South of the great Himalayas run the ranges collectively known as the "lesser Himalayas". The greater and lesser Himalayas are extensively covered with glaciers and the snow fields functioning as vast natural reservoirs feed practically every major Himalayan river. The last rank of the Himalayan massif is provided by the Siwalik range, running south of the lesser Himalayas, between it and the Indo-Gangetic plains and extending from Jhelum to the west and Kosi in the east. These ranges are not very high, rarely exceeding 610 m.

3.2.2 The courses of the Himalayan rivers through the Siwaliks, and through the Duns behind them, provide the maximum interest for hydro-power generation, in view of the fact that they afford the only pos-

sibilities in this entire mountain region for construction of large reservoirs for control of the flows of these rivers. The courses of the rivers through the lesser Himalayas are also of interest, though to a lesser extent. Some of the main streams follow steeply dipping and winding courses across the valleys between the main ranges, to provide concentrated drops for run-of-the-river hydro development. Behind the lesser Himalayas the water courses are hardly, if ever, of interest from the point of view of hydro development, on account of the dispersion of the main river into numerous streams, inadequate river flows during the winter, lack of possibilities for regulation of river flow and their general remoteness.

3.2.3 At the eastern end beyond the so-called north-eastern syntaxis, the Himalayas join on the hills of the Assam-Burma ranges. The hill ranges are much lower. The main streams in this region also follow steep winding courses which are topographically favourable for run-of-the-river hydro-electric development.

3.3 The Indo-Gangetic Plain.

3.3.1 The Indo-Gangetic plain, 2400 km. long and 240 to 320 km broad, is one of the world's greatest stretches of flat alluvium and also one of the most densely populated areas on earth. There is hardly any variation in relief. Between the Yamuna River at Delhi and the Bay of Bengal nearly 1600 km. away, there is a drop of only 200 m. in elevation. This area has little significance from the point of view of hydro-electric development.

3.4 The Peninsular Plateau.

3.4.1 The Peninsular plateau is marked off from the Indo-Gangetic plain by a mass of mountain and hill ranges, varying from 500 to 1300 m. in height. The more prominent among these are the Aravali, the Vindhya, the Satpura, the Maikal and the Ajanta. The Peninsular plateau is flanked on one side by the Eastern Ghats, where the average elevation is about 800 m. and on the other by the Western Ghats where it is from 1000 to 1300 m. rising in places to over 2400 m. Between the Western Ghats and the Arabian Sea lies a narrow coastal strip, while between the Eastern Ghats and the Bay of Bengal there is broader coastal area. The southern point of the plateau is formed by the Nilgiri hills where the Eastern and Western Ghats meet. The Anaimalai and the Cardamom Hills lying further south may be regarded as a continuation of the Western Ghats.

3.4.2 The surface of the plateau has been deeply dissected by river erosion. In the north-west, the Narmada occupies the trough between the Satpura and the Vindhya ranges, the Tapi the trough between Satpura and Ajanta ranges, both the rivers emptying into the Arabian sea. North of the Vindhya range, the

drainage is almost entirely to the Ganga. South of the Ajanta range and the central highlands the general easterly slope of the plateau is reflected in the direction of the rivers with the Western Ghats forming the main water-parting. The Godavari, the Krishna and the Cauveri rivers with many of their tributaries take their rise on the eastern slope of the Western Ghats and flow towards the Bay of Bengal. The Mahanadi, the Brahmani, the Baitarani and the Subaranrekha which drain the north eastern part of the plateau also find their way to the Bay of Bengal. In general the course of the east flowing rivers through the Eastern Ghats is marked by a stretch of rapids. The upper reaches of all these rivers, particularly the ones which flow from the Eastern Ghats westwards into the Godavari, and the reaches where the east flowing rivers of the plateau break through the Eastern Ghats provide considerable scope for hydro-electric development.

3.4.3 The west flowing rivers of the Western Ghats north of Goa have a steep course and provide no facilities for storages necessary for hydro development on a dependable basis. However, the major west flowing rivers south of Goa, run almost parallel to the range at general elevations of about 450 to 600 m. and cut through the Western Ghats in a series of rapids or falls before they flow into the Arabian Sea. These constitute ideal sites for cheap high-head hydro electric development.

3.4.4 The hilly region of Central Assam, comprising the Shillong Plateau and the Mikir Hills, is an outlying part of the Peninsular India, connected to it by a submerged hill under the Rajmahal gap, through which the Ganges and the Brahmaputra find their outlets to the sea. The Shillong plateau is at a general elevation of 1500 to 1800 metres and is subject to the heaviest rainfall in the world. The northern face of the plateau is drained by rivers flowing into the Brahmaputra and the southern face by the tributaries of the Surma. These rivers have facilities for storage in the plateau region and their steep courses provide attractive sites for high and medium head hydro-electric development.

4. GEOLOGICAL STRUCTURE

4.1 Geologically also, India consists of the same three distinct units, namely, the Himalayas and their associated group of young-fold mountains, the Indo-Gangetic plain and the ancient block of the Peninsula.

4.2 The geological sequence in the Himalayas has been almost entirely marine and there is little doubt that the area now occupied by the great mountains was a deep sea till a late period in the geological history of the area. Much of the area is still very imperfectly known geologically, especially in the east, and some aspects of its history are still controversial.

4.3 The Indo-Gangetic plain is a macro-region of alluvium, the thickness of the alluvial deposits not having been ascertained so far. Topographically the plains are remarkably homogeneous with little relief for hundred of kilometers.

4.4 The Peninsula is a region of great geological stability and is remarkably immune from seismic disturbances of any intensity. The basal complex of the larger part of the Peninsula consists of highly metamorphosed rocks of the earliest periods.

5. CLIMATE & RAINFALL

5.1 The Indian Meteorological Department recognises four seasons: (i) the cold weather season (December-March), (ii) the hot weather season (April-May), (iii) the rainy season (south-west monsoon) (June-September); and (iv) the Season of the retreating south-west monsoon (October-November).

5.2 There are four broad climatic regions based on rainfall. Practically the whole of Assam and the West Coast of India lying west of the ridge of the Western Ghats and extending from north of Bombay to Trivandrum are areas of very heavy rainfall. In contrast to these, the Rajasthan desert extending to Kutch, and the high Ladakh plateau of Kashmir extending westward to Gilgit are regions of low precipitation. In between these areas at the extreme ends of the rainfall range are two areas of moderately high and low rainfall respectively. The former consists of a broad belt in the eastern part of the Peninsula merging northward with the north India plains and southward with the eastern coastal plains. The latter comprises a belt extending from the Punjab plains across the Vindhya mountains into the western part of the Deccan, widening considerably in the Mysore plateau.

5.3 Each of the four seasons contributes to the rainfall pattern of the country, but the most important from the view of point of general precipitation is the period from mid June to September, when the South-west monsoon is most active and this period is universally referred to as the monsoon season. In practically all areas of the country, the rainfall in this period is more than 80% of the total for the year. The contributions of rainfall during the other three seasons are limited to certain areas and are of considerable importance to these areas. For instance, the rainfall during November and December caused by the North-east monsoon is limited to Madras and Andhra coasts and this is very important to these areas as they get very little contribution from the South-west monsoon being on the leeward side of the Western Ghats.

5.4 The attached isohyetal map of India (Map No. 3-1) shows the distribution of annual rainfall over the country.

6. RIVER SYSTEMS OF INDIA

6.1 The entire drainage of the Himalayas and associated mountains flows through the Indus and the Ganga-Brahmaputra River systems. The Peninsula is drained to the north by the southern tributaries of the Ganga, to the east mainly by the Cauvery, the Krishna, the Godavari, the Mahanadi, the Brahmani, the Baitarani and the Subarnarekha and to the west by the Mahi, the Narmada, the Tapi and a large number of smaller West-Flowing rivers draining the Western Ghats. The Narmada on the west, and the Krishna, the Godavari and the Mahanadi on the east, account for the bulk of the drainage of the Peninsula. The rivers of India have been estimated to drain approximately 1,670 billion cubic-metres (1,356 million acre-ft.), on an average, to the Arabian sea and the Bay of Bengal.

6.2 The general pattern of stream-flow is similar all over the country, characterised by a short spell of heavy river discharges during the monsoon period, followed by long periods of lean flow. Except in the case of the Himalayan rivers, where snow storages and glacier melts contribute significantly to the post-monsoon river discharges, the bulk of the dry-weather flow of the rivers of India are derived from ground water storages. The total quantity of dry-weather flow is, therefore, dependant both on the strength of the monsoon, and the river basin characteristics, dry-weather flow following the usual decrement pattern of ground water flows. The flows of most Peninsular rivers, dwindle down to a trickle in the pre-monsoon months of April, May and June. For example, the flows of the main Godavari river have been observed to fall as low as 8.5 cubic metre per second (300 cusecs) from its entire 284,900 sq. kilometre (110,000 sq. miles) drainage basin. Variations of mean monthly flow of the order of 1 to 300 are not uncommon for even large rivers of the region such as the Narmada. With such large variations in flow, hydro-electric developments of these rivers can only be contemplated on the basis of large storage reservoirs.

6.3 The fact that the Himalayan rivers, unlike the Peninsula rivers, carry large discharges even during the critical winter and pre-monsoon months, however, permit construction of hydro-electric plants which can rely on the unregulated flows of these rivers. These flows vary considerably depending upon the extent of the catchment, the precipitation pattern and to a large extent on the type of terrain and vegetation. It has generally been observed that the dry-weather flows of Himalayan rivers tend to increase towards the east, the flows of the Assam rivers being the highest - attributable to the heavy and prolonged precipitation over the Assam Himalayas, the well forested nature of the terrain and lower latitudes.

6.4 From the point of view of hydro power potential, the river systems of the country are best studied

under the following classification which takes into account, the associated, orographic and hydrological features:

- (a) The west flowing rivers of southern India, covering the Western Ghats and the narrow coastal strip from Goa to the Cape.
- (b) The east flowing rivers of southern India, covering the drainage systems of the Deccan.
- (c) The rivers of Central India, covering the rest of the drainage of the Peninsula south of the Vindhyas, which flow both to the east and to the west.
- (d) The Ganga basin, including its Himalayan and Peninsular tributaries.
- (e) The Brahmaputra basin and neighbouring drainage areas in Assam and Manipur, and
- (f) The Indus basin, covering the tributaries of the Indus in India.

7. HYDRO-ELECTRIC POTENTIAL

7.1 West Flowing Rivers of Southern India.

7.1.1 The western face of the Western Ghats rises steeply from the narrow coastal plains, which at some places is only a few kilometres wide and rarely exceeds 60 kilometres in width. The heaviest precipitation from the south west monsoon occurs in the general neighbourhood of the dividing range and is drained either eastward across the Deccan plateau to the Bay of Bengal or westward in swift mountain torrent to the Arabian Sea. The runoffs of both the east flowing (e.g. existing Tata Hydro and the Koyna stations in Maharashtra) and the west flowing streams (e.g. existing Jog Station in Mysore and the Pallivasal, Sengulam, Poringalkuthu and Neriamangalam stations in Kerala) can be utilised for power generation at the high heads available on the western face. The utilisation of the east flowing rivers by westward diversion depends on the unified developments of these rivers and as such they are considered with the east flowing rivers. The west flowing rivers of the Western Ghats north of Goa have a steep course and do not offer facilities for any storage. Consequently, power generation on these rivers is not possible on a dependable basis. However, almost all the major west flowing rivers south of Goa flow fairly level parallel to the ridge at a general elevation of 450 to 600 m. in their upper reaches where it is possible to provide adequate regulation with relatively small dams. Even though the catchment areas that are commanded by these regulatory works are small, because of the heavy precipitation and the high heads that can be developed with relatively short stretches of water conductor systems, these constitute major sources of cheap hydro developments in the country. The total potential of these rivers has been estimated at 4.35 million kW at 60% load factor (corresponding to about

123 TWh annual output). One important feature of these sources is that they do not clash with other priority uses of water as irrigation in the narrow coastal plains is limited. Map No. 3-2 attached indicates the details of these potentials.

7.2 East Flowing Rivers of Southern India.

7.2.1 The most important east flowing rivers in southern India from the point of power development are the Godavari, the Krishna and the Cauvery. These rivers, excepting some of the tributaries of the Godavari, take their rise in the Western Ghats and traverse almost the full width of the Deccan plateau to fall into the Bay of Bengal. They command considerable irrigation potential and plans for power development have to be integrated with development of irrigation. For instance, there are a number of possibilities of storing the waters of tributaries of the Godavari and the Krishna in the upper reaches in Western Ghats and diverting them westwards where they can be utilised for power generation at heads of 450 to 600 m. At present, plans to use the waters of these rivers for irrigation along their natural courses are under consideration and westward diversion beyond what is used at the Tata Hydro and Koyna Stations can be considered only after these studies are completed. The power potentials of these rivers are restricted to that corresponding to using of the waters, reserved for irrigation developments in the lower reaches of the river. There are a few possibilities of high head development on the tributaries of the Cauvery, which take their rise at elevations of over 2000 m. in the Nilgiri Hills and descend rapidly to elevations of 500 m. These have been developed to a substantial degree by the Madras State.

7.2.2 The Godavari has three important tributaries, viz. the Pranhita, the Indravati and the Sabari which join it before it breaks through the Eastern Ghats to join the Bay of Bengal. The Pranhita takes its rise in the Maikal Range and Mahadeo Hills of the Central Plateau and drains a large catchment area. The Indravati and the Sabari take their rise on the western slopes of Eastern Ghats and flow westwards to join the Godavari. These rivers have very little irrigation potential and their sizeable discharges are much in excess of what can be used for irrigation in the lower reaches of the Godavari River. Consequently, these rivers can be developed purely in the interest of power generation. Further, the regulated discharges from these developments can be used along the course of the Godavari through the Eastern Ghats for power generation. These with a potential of about 6 million kW at 60% load factor (32 TWh annual output) constitute a major and important source of hydro development in this region.

7.2.3 The total firm power potential of the East Flowing Rivers of Southern India has been assessed at 8.63 million kW at 60% load factor (corresponding

to about 45 TWh annual output). The location and potential of the various sites are indicated in Map No. 3-3.

7.3 Rivers of Central India.

7.3.1 Among the rivers that drain the Central Plateau into the Arabian Sea and the Bay of Bengal, the most important ones from the point of view of power development are the Baitarani, the Brahmani and the Mahanadi. The power development of these rivers are to be co-ordinated with the irrigation development and they depend mainly on the storage capacity that would be available after allowing for irrigation and flood control requirements.

7.3.2 In the Baitarani and the Brahmani basins, the power potentials are concentrated in the upper reaches, where the irrigation possibilities appear to be negligible. Hence, the hydro-electric developments in these basins can be undertaken purely in the interest of power. The regulated discharges from the power schemes can be used for irrigation in the large command available in the lower reaches of these river basins and this would add to the economic soundness of power development.

7.3.3 The Mahanadi, one of the major rivers of India, runs through relatively flat country in its upper reaches and there are practically no sites for major power development. In its middle and lower reaches it cuts through the Eastern Ghats where construction of dams for storage and development of the river for irrigation and power are possible. Hirakud Project nearing completion in Orissa marks the beginning of the unified development of this valley for irrigation, power generation and flood control.

7.3.4 By far the greatest concentration of hydro power in this group is in the middle and lower reaches of Narmada, where the river flows alternately through plains and narrow gorges in a trough between the Vindhya and Satpura Ranges. Here with the main regulation provided at a damsite near Punassa village and at a few upstream power developments, it will be possible to generate nearly 1.6 million kW at 60% load factor (corresponding to 8.4 TWh annual output) at Punassa Dam and a cascade of two or three power stations downstream.

7.3.5 The total power potential of this group of rivers has been estimated at about 4.3 million kW at 60% load factor (corresponding to 23 TWh annual output). The details of these potentials are shown in Map No. 3-4.

7.4 The Ganga Basin.

7.4.1 The Ganga basin constitutes the largest river system in the country and is formed by the rivers which drain the Great Himalayan Range on the north - viz. the Yamuna, the Upper Ganga, the Gogra, the Gandak and the Kosi and those rivers that drain the northern part of the Central Plateau - viz. the

Chambal, the Betwa, the Ken, the Tons and the Sone.

7.4.2 The hydro-potential of the southern tributaries are concentrated in their upper reaches before they flow from the Peninsular plateau into the plains, the most important ones being in the Sone Valley.

7.4.3 In the case of the Himalayan rivers, as with the other rivers of the country, firm power potentials depend critically on the extent of regulation of river flows possible with reservoirs, though major possibilities of run-of-the-river developments also exist, in view of their relatively large minimum uncontrolled discharges. Apart from a few sites in the foot hills of the Himalayan Range, such as at Bhakra, the general topography excludes possibilities of very large storages, the valleys being steep and narrow. Dams of the order of 160-200 m. (500 to 600 feet) above bed level, have to be envisaged to provide storage to any appreciable extent, and these are feasible only at a few favourable gorge sites. However, large snow-fed catchment areas ensure high runoffs in all except the worst winter months and consequently, wherever storage developments appear feasible, even comparatively small storages would increase the power draft considerably above the minimum winter discharges, large as they are. Not only do these discharges constitute large power potentials at the dam-sites, but they invariably enable better utilisation of the drops below the point of regulation. In general, the enormous power potentials afforded clearly outweigh difficulties such as those of access to the sites, etc. It is important to note that even these storages provided by high dams being of limited capacity cannot generally ensure full utilisation of the runoffs even of minimum years.

7.4.4 Run-of-the-river projects on the Himalayan rivers have been considered on the basis of the minimum discharges that can be expected during the winter months. Consideration has been given only to major possibilities of high-head schemes in the precipitous middle reaches, and the medium-head schemes in the lower reaches, where the gradients are gentler, but higher minimum discharges can be expected. It is believed that the scope for economic developments of smaller scale run-of-the-river projects not considered is small relative to the potentials of the larger schemes.

7.4.5 The hydro potential of the Ganga basin has been estimated at about 13.1 million kW at 60% load factor (about 69 TWh annual output) of which about 4.8 million (about 25 TWh annual output) is within India, and 1.542 million kW (8 TWh) lie on the border between India and Nepal. The details of these potentials are shown in the Map No. 3-5.

7.5 Brahmaputra basin and other rivers of Assam, Manipur and Tripura.

7.5.1 There are practically no possibilities of providing storages on the Himalayan tributaries of the Brahmaputra. However, the large dependable discharges of the Dihang (as Brahmaputra is called in its course through the Himalayas) and its two major tributaries, the Lohit and the Dihang, contributed by the snow covered catchments that they drain, and the steep course that these rivers traverse through the Himalayas constitute some of the major possibilities of run-of-the-river developments in the world. The southern tributaries of the Brahmaputra drain the northern face of the Shillong Plateau which slopes gently with intermittent steep stretches towards the Brahmaputra plains. There are attractive possibilities of high and medium head hydro developments on these rivers. The southern face of the Shillong Plateau is drained by rivers which forms tributaries of the Surma. These have a flat course in their upper reaches providing facilities for storage. In their middle reaches they flow into the Surma in a series of rapids and falls, dropping rapidly in elevation by about 1300 m. Even though the catchment areas above the level stretches of these rivers in their upper reaches are small, because of the high rainfall (highest in the world) that this area is subjected to and the high heads that can be developed on these rivers with short stretches of water conductor systems, major hydro-electric development are possible on these rivers. Barak and Manipur Rivers in the Manipur State have important possibilities of hydro-electric developments. Since irrigation possibilities in this region are practically negligible, these hydro-electric resources are of the single purpose type and can be developed in the interest of their power potentials only. The total power potential of this group is estimated at about 13.4 million kW at 60% load factor (about 70 TWh annual output) out of which 12.5 million kW (about 65 TWh annual output) is in India and constitutes the greatest concentration hydro resources in the country. The details of the hydro-electric potential of this region are shown in the Map No. 3-6.

7.6 The Indus Basin.

7.6.1 The hydro-electric survey conducted by the C.W.&P.C. covers only the portion of the Indus Basin which lies within the territorial limits of the Indian Union. The waters of Indus basin (Indus and its five tributaries Jhelum, Chenab, Ravi, Beas and Sutlej) are being used extensively for irrigation in India and Pakistan and the question of further development of the water resources of the Indus basin has been settled between India and Pakistan under the Indus Water Treaty. The power potentials of the rivers of this basin have therefore been studied on the basis of the allocation of waters and storages as outlined in the Indus Water Treaty and present and future patterns of irrigation.

7.6.2 The upper reaches of Indus River are remote and relatively inaccessible. Possibilities of major hydro development in these mountainous and snow-bound ranges have not been considered in this assessment of the practical limit of utilisable hydro power potential. The most important tributary from the point of view of hydro potential is the Chenab which drops about 2500 m. in its middle stretch of 300 km. Its minimum discharges augmented by a storage reservoir in its upper reaches can be utilised at a total head of about 1800 m. to generate about 3.25 million kW. at 60% load factor (17 TWh annual production). Unified development of the Beas and the Sutlej, of which the Bhakra-Nangal Project marks the beginning, is estimated to yield about 2.35 million kW at 60% load factor (12 TWh annual output), besides providing waters for irrigating extensive areas in Punjab, and Rajasthan. There are important possibilities on Jhelum River also which can contribute about 800,000 kW at 60% load factor (4 TWh annual output), to the potential of the Indus Basin.

7.6.3 Thus, Indus Basin with the limitations on storage and its water uses has a total potential of about 6.6 million kW at 60% load factor (corresponding to 35 TWh annual output). These potential resources are indicated in Map No. 3-7

8. RESULTS AND CONCLUSIONS

8.1 On the basis of about 260 existing and possible schemes the economically utilisable power potential of the various river basins covered under the preliminary hydro-electric survey of the C.W. & P.C. has been estimated at 50.346 million kW at 60% load factor (264 TWh annual production). Of these, 8.42 million kilowatts (44 TWh annual output) representing the potential of the Kosi, the Karnali, the Gandak and the Tista basins lie just beyond the boundaries of India in Nepal and Sikkim. A further 1.542 million kW (8 TWh annual output) lies on the Sarda River, which forms the boundaries between India and Nepal. Assuming that half of the potential of the Sarda would be available to India, the economically utilisable hydro power potential of the territories of the Indian Union aggregate to 41.155 million kW at 60% load factor (corresponding to about 216 TWh annual output). The location and the magnitudes of these resources are shown on the accompanying Map No. 3-8. The basin-wise and state-wise distribution of the hydro-electric potential of India is given in Annex's Supplement, Tables 3-4 & 3-5.

8.2 Of the country's total power potential, about 10.3 million kW (54 TWh) represents potential of simple "run-of-the-river type projects" in the Himalayan ranges and the rest of "storage projects". Again, "high head" type projects - utilising drops over 300 m. (1,000 ft.) - account for about 13.63 million kW (71 TWh); "medium-head" projects - in a head range from 30 to 300 m. (100 ft. to 1,000 ft.) account for 23.86 million kW (126 TWh) the bulk of the

total; and "low-head projects" ranging from 8 to 30 m. (25 ft. to 100 ft.), mainly comprising "lift" dams below the major reservoirs, form the smallest category with a total of about 3.66 million kW (19 TWh).

8.3 These hydro-electric resources, it would be seen from Map No. 3-8, are fairly evenly distributed all over the country, there being few regions of the country which are situated more than 500 km from major concentrations of hydro power. The bulk of the utilisable power potential of the Himalayan rivers are located along the foot hills, and distributed as they are, command the entire Indo-Gangetic and Brahmaputra plains. Outside the region of influence of these Himalayan sources and that of the Shillong Plateau of Assam, the most important concentration of potential hydro power lies in the Eastern Ghat Hills with an aggregate potential of 6.148 million kW (32 TWh). The Western Ghat region has three main concentrations, viz. about 0.7 million kW (3.5 TWh) located in Maharashtra, north of Goa, 2.695 million kW (14 TWh) to the northwest of Mysore State and about 2.09 million kW (11 TWh) in the Nilgiri and Anamalai hills in Madras, Kerala and Mysore. Besides these schemes which largely utilise the natural advantages of the main mountain ranges, there are a number of schemes in the middle and lower reaches of the river basins deriving their potentials from topographic characteristics which permit construction of very large reservoirs capable of regulating the enormous flows of these rivers for utilisation at a cascade of power stations located below the points of regulation. Developments on the Narmada in Madhya Pradesh, Maharashtra and Gujarat, the Chambal in Madhya Pradesh and Rajasthan, the Mahanadi in Orissa, the Sone in Madhya Pradesh and Uttar Pradesh and the Godavari in Maharashtra, Madhya Pradesh, Orissa and Andhra fall in this category.

8.4 The assessment of power potential made by the C.W. & P.C. during the period from 1953 to 1958 have been well confirmed by subsequent detailed investigations of a large number of schemes by Central and State authorities in different States of the country. In all cases, the practical feasibility of the schemes as outlined under the survey was confirmed and the estimates of water and power potential substantiated. The main features of the schemes, such as location of the dam, alignment of water conductor system and power stations have emerged, after detailed investigations substantially as outlined in the survey reports. Schemes which are currently in operation, under construction and whose investigations have been completed cover a total potential of about 11.6 million kW at 60% load factor (61 TWh annual output). Of the country's remaining potential of 29.6 million kW (155 TWh) which has yet to be established by field investigations, about 9.7 million kW (51 TWh) represents the potential of "run-of-the-river type projects" which involve construction of mere diversion structures, with tunnels forming their water conductor system.

Their practical feasibility depends more on the dependable power draft that can be expected, since the civil works, being of a simple nature are relatively free from the practical difficulties inherent in large storage type projects. The dependable power drafts for these "run-of-the-river type projects" have been estimated on the basis of gauged data available for the Himalayan rivers for fairly long periods. The potential of these "run-of-the-river type projects" aggregating to 9.7 million kW (51 TWh) does not therefore require extensive investigations for their proof. Thus schemes with a total potential of about 20 million kW (115 TWh) have to be investigated in detail for final substantiation. On the basis of experiences that have been gathered of similar schemes in neighbouring regions the inference can be confidently drawn that even these potentialities would be found to be capable of comparatively easy development when demands arise for their large outputs.

8.5 The scope for possible upward revision of these estimates of power potential is confined almost entirely to the Himalayan region of the country. This is because in the Peninsula region the assessment has already been made on the basis of utilising almost the entire average flows of the rivers available for power generation, at the full drops capable of development below the points of regulation. This applies also to the Shillong plateau of Assam and its environs. In these areas, which contain about 23 million kW (121 TWh annual output) of the total hydro resources, the estimates of potential of hydro power would therefore only be capable of slight marginal adjustments in future. In the Himalayas there are certain river basins, e.g., the Gandak, the Upper Subansiri, the Amo, the Raidak, the Manas etc. which have not been studied, since topographical maps of the required accuracy were not available. It is possible that these basins would also have significant power potentialities, but since they lie in Nepal and Bhutan they would not affect the assessment of India's total power potential. In Indian territory of Himalayas, upward assessment of power estimates would depend and only on the basis of further degree of regulation of river flow at selected sites, since the current survey has exhaustively covered all potentialities for major run-of-the-river type schemes - the only feasible method of harnessing the potentialities of Himalayan rivers in their upper and middle reaches. In most cases, the increases in power potential by providing larger reservoirs than that proposed under the survey would not be very large, since the total drop capable of use under these schemes is only of the order of 300 m. Since the present estimates have been based on construction of the dams of the order of 180 m. in height across the narrow gorges in the foot hills of the Himalayas it would be appreciated that while some upward revisions are, of course, possible, by increasing the height of dams, they would not constitute any major additions.

8.6 The above estimates take into account only the energy potential that would be available on a firm basis for nearly all the time and does not include the seasonal energy that would be available at various sites and which can either be "firmed up" or sold to interested consumers at cheap rates. In Peninsular India, such seasonal energy would be available at sites which can be developed for multi-purpose benefits, the magnitude being small compared to the total dependable resources of this area. In the case of Himalayan rivers, where the river flows are considerable during most part of the year, and where firm potentials have been worked out on the basis of dependable discharges during the winter months, such seasonal energy would be available in large amounts during all but winter months at all the proposed sites for power development. It is not possible to estimate at this stage as to how much of this energy can be "firmed up" or used. However, it would be appreciated that the cost of energy production at these sites would be reduced to the extent the secondary energy can be used.

8.7 An economic appraisal of the Country's hydel resources is considerably influenced by construction costs and other variable economic factors at the time of assessment which need very careful and extensive study. These complexities are further increased where generation of hydel power forms the part of a multiple-purpose development. For the purpose of this survey, the economics of hydel development have been examined both in the context of prevailing yardsticks and foreseeable future trends, bearing in mind the comparison of the cost of energy production by alternative sources, e.g., thermal and nuclear power. The cost of hydro energy production, on the basis of annual charges at 7.5% works out to roughly 1.5 *np* per unit per Rs. 1000 of capital outlay per kW of firm power at the normal annual system load factor at 60%. During the period from 1900 to 1950, the capital outlays on various hydro schemes constructed, varied from about Rs. 600 per kW of firm power at the Tatas Hydro Stations of Bombay to about Rs. 900 per kW at Jogindernagar, the cost of other schemes, e.g., Pykara and Moyar of Madras, Palivasal and Sengulam of Kerala and Jog of Mysore falling within this range. The cost of energy production from these schemes constructed at the low cost levels of the early decades of the century ranged from about 0.9 *np* per unit at the Tata and Jog Stations to about 1.35 *np* at Jogindernagar.

8.8 During the period from 1950-1960 there has been considerable increase in the activities in the field of hydel generation, witnessing construction of a large number of schemes both single-purpose and multi-purpose. It would be seen from Table 3-6 that the capital cost of single-purpose schemes currently under implementation would range from about Rs. 915 per kW of firm power at Sharavathi to

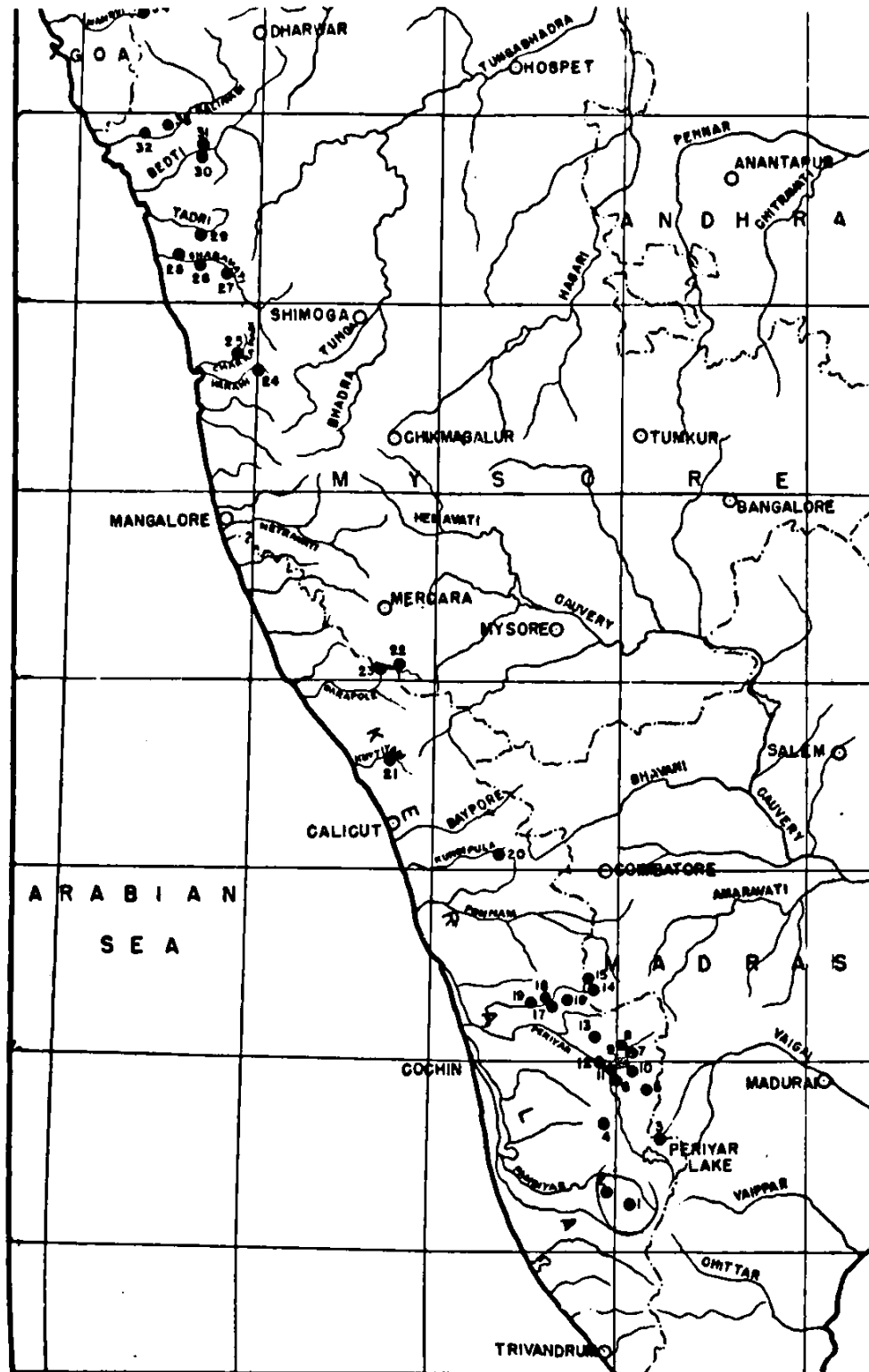

REF. NO.	POWER STATION	RIVER	POWER DRAFT (GUSECS)	HEAD FEET	POWER OUTPUT KW AT 60% L.F.
1	PAMBA-KAKKI	PAMBIYAR-KAKKIAN	830	2448	228,000
2	KAKKAD	PAMBIYAR	1180	380	80,000
3	PERIYAR	PERIYAR	730	1260	108,700
4	IDDIKI	PERIYAR	1440	2175	348,000
5	KELLAR	KELLAR	230	700	18,000
6	PERINJAKUTTI	PERINJAKUTTI	935	1180	120,000
7	PALLIVASAL	MUDIRA PUZHA	240	2000	83,800
8	LAKSHMI	MUDIRA PUZHA	135	1980	80,000
9	SENGULAM	MUDIRA PUZHA	420	1180	88,000
10	PANNIAR	PANNIAR	300	780	28,000
11	NERIAMBALAM	MUDIRA PUZHA	840	850	88,900
12	LOWER PERIYAR	PERIYAR	1745	470	91,000
13	PUYANKUTTI	PUYANKUTTI	310	720	28,000
14	SHOLAYAR(MADRAS)	SHOLAIAR		1300	34,000
15	SARKARPATHI	PARAMBIKULAM		300	28,000
16	SHOLMAR(KERALA)	SHOLAIAR	380	982	41,500
17	PORINGALKUTHU L.B.	CHALAKUDI	380	598	25,000
18	PORINGALKUTHU R.B.	CHALAKUDI	1030	800	92,000
19	LOWER CHALAKUDI	CHALAKUDI	1410	500	78,500
20	SILENT VALLEY	KUNDI PULA	290	2800	78,000
21	GORAKUZHI(KUTTIYADI)	KUTTIYADI(MURAT)	290	2100	87,700
22	BARAPOLE I	BARAPOLE	780	1727	144,000
23	BARAPOLE II	BARAPOLE	870	580	88,000
24	VARAM	VARAM	880	1875	150,000
25	GHAKRANADI	GHAKRANADI	134	1350	20,000
26	SHARAVATI	SHARAVATI	8300	1518	880,000
27	SHARAVATI DAM	SHARAVATI	5800	79	48,300
28	SHARAVATI TAILRAGE	SHARAVATI	5300	100	89,000
29	ASHANASHINI	ASHANASHINITADRI	1850	1425	214,000
30	SONDA	SONDAPATYADNA LLA	950	1258	132,000
31	BEDTI	BEDTI	1990	1300	288,000
32	KALINADI	KALINADI	3700	1480	585,000
33	SUPA - KANERI	KALINADI	2880	175	81,000
34	MAHADAYI	MAHADAYI (MANDVI)	270	1800	48,000

TOTAL = 4,345,800

Map 3-2
WEST FLOWING RIVERS
OF
SOUTHERN INDIA

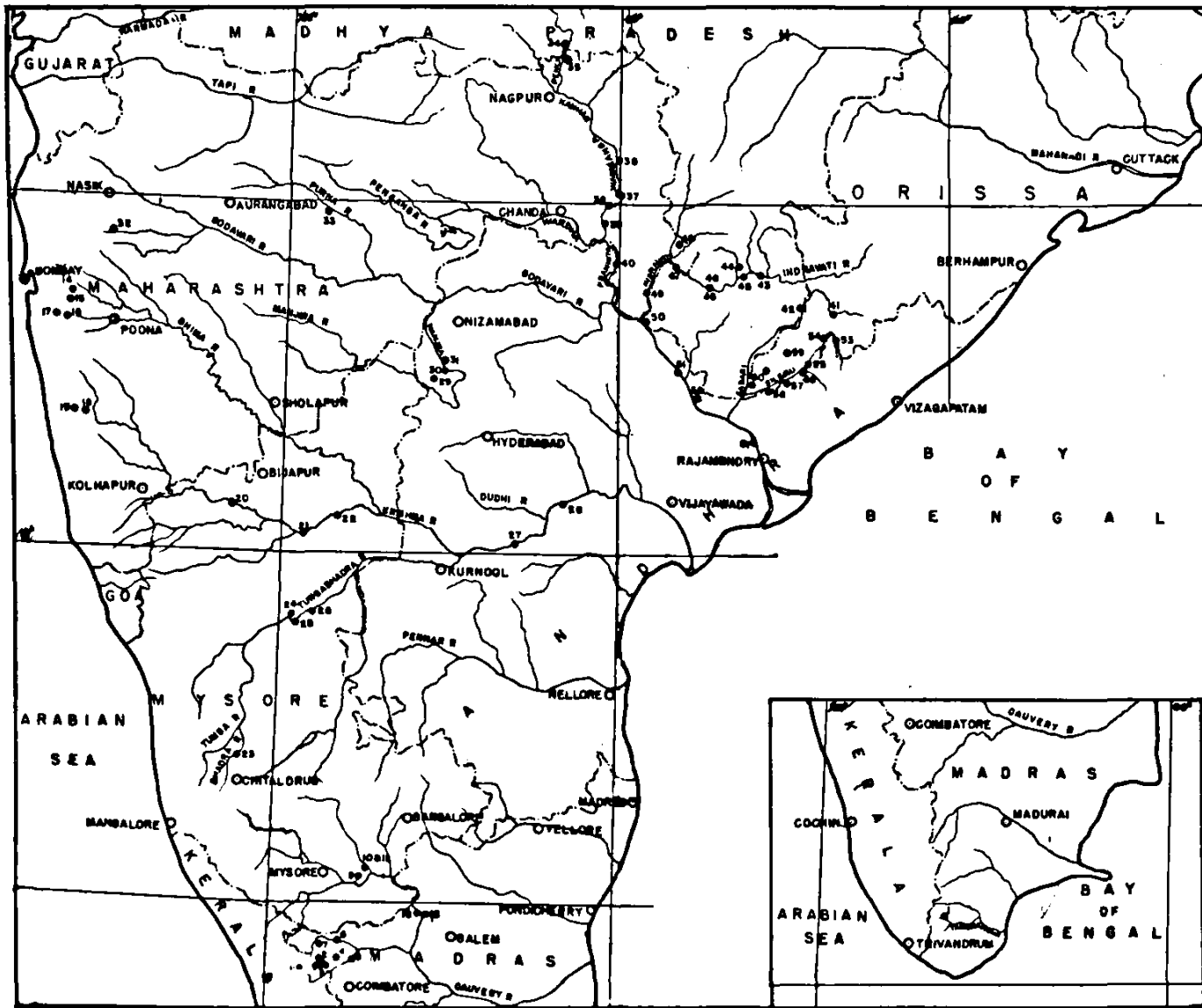

POWER POTENTIAL

REF NO.	POWER STATION	RIVER	POWER DRAFT (CUSECS)	HEAD FEET	POWER OUTPUT KWAT 80% L.F.
1	PAPANASAB	TAMBRAPARNE		800	81,000
2	KUNDAM PELAM	KUNDAM	400	1,125	
3	PEGUMMALA	KUNDAM	539	2,470	
4	LOWER KUNDAM	KUNDAM	808	1,480	342,000
5	PILLUR DAM	KUNDAM	1,200	210	
6	KUNDAM AUX.	KUNDAM	154	800	
7	PYKARA	PYKARA	180	2,084	25,000
8	GOVAR	PYKARA	180	1,880	23,000
9	SIVASAMUDRAM	CAUVERY		450	
10	SHIMSHA	CAUVERY	900	630	67,000
11	SHRINAGSARALI	CAUVERY		630	175,000
12	NETTUR	CAUVERY		80/60	40,000
13	NETTUR (TUNNEL)	CAUVERY		80/60	80,000
14	SHIVPURI	ANDHRA		1,710	230,000
15	SHIPOLI	ANDHRA		1,725	
16	SHIRA	SHIRA		1,285	
17	KUNDALKA	KUNDALKA	1,800	500	35,000
18	KOYNA MAN	KOYNA	2,140	1,400	408,000
19	KOYNA TAILRADE	KOYNA	2,140	280	68,000
20	BIDRI	KRISHNA	2,100	80	75,000
21	MURUMTI	KRISHNA	11,350	86	85,000
22	JALDHUS	KRISHNA	10,000	70	80,000
23	SHARDA	TUNGABHADRA		80	25,000
24	TUNGABHADRA (L.S.)	TUNGABHADRA		70	75,000
25	TUNGABHADRA (R.S.)	TUNGABHADRA		110	
26	NARPI	TUNGABHADRA		110	
27	SHIBAILAM	KRISHNA		300	260,000
28	SHANKHONDA	KRISHNA		500	100,000
29	DEVNOR - I	SAVITRI	1,200	175	24,000
30	DEVNOR - II	SAVITRI	1,200	115	16,000
31	SHANSAVAR	SAVITRI		80	75,000
32	SHANSAVARA	SAVITRI	300	300	15,000
33	PURNA	PURNA		75/25	7,500
34	UPPER PERCH	PERCH	1,120	110	15,500
35	LOWER PERCH	PERCH	1,120	225	40,500
36	SHRANGA DAM	SHRANGA	23,500	120	314,000
37	SARMA	SHRANGA	23,500	45	117,000
38	SHARASAB	SHRANGA	23,500	80	150,000
39	SURABIA	SHRANGA	23,500	85	143,000
40	PERANTA	PERANTA	15,000	55	204,500
41	UPPER KOLAB	KOLAB	1,200	800	120,000
42	LOWER KOLAB	KOLAB	1,750	560	107,000
43	CHITRADOT	INDRANITI	2,700	250	144,000
44	SUDRA	QUORA	1,050	225	29,500
45	SODHAT	INDRANITI	15,050	120	440,000
46	UTRU	INDRANITI	19,150	120	277,000
47	MAJ - MEMRI	INDRANITI	19,150	375	900,000
48	KOTRI - BIRBI	KOTRI & BIRBI	5,000	485	230,000
49	SHOPALAPITRAM	INDRANITI	50,000	90	900,000
50	MECHAPALLI	SODAYARI	82,800	180	420,000
51	SHARADU	SODAYARI	82,800	55	240,000
52	LAKSHMIPURAM	SODAYARI	82,800	75	225,000
53	JALAPUT	SACHUND	1,200	115	15,000
54	SACHUND	SACHUND	1,400	904	140,000
55	UPPER SILERU DAM PH	SILERU	2,100	285	35,000
56	UPPER SILERU	SILERU	2,100	315	75,000
57	LOWER SILERU DAM PA	SILERU		780	100,000
58	LOWER SILERU	SILERU	2,100	780	100,000
59	SALMELA	SILERU	2,100	940	200,000
60	SALMELA TAILRADE	SILERU	1,800	300	55,500
61	POANERAM	SODAYARI	45,500	45	201,000

TOTAL 6,225,000

Map 3-3
**EAST FLOWING RIVERS
 OF
 SOUTHERN INDIA**

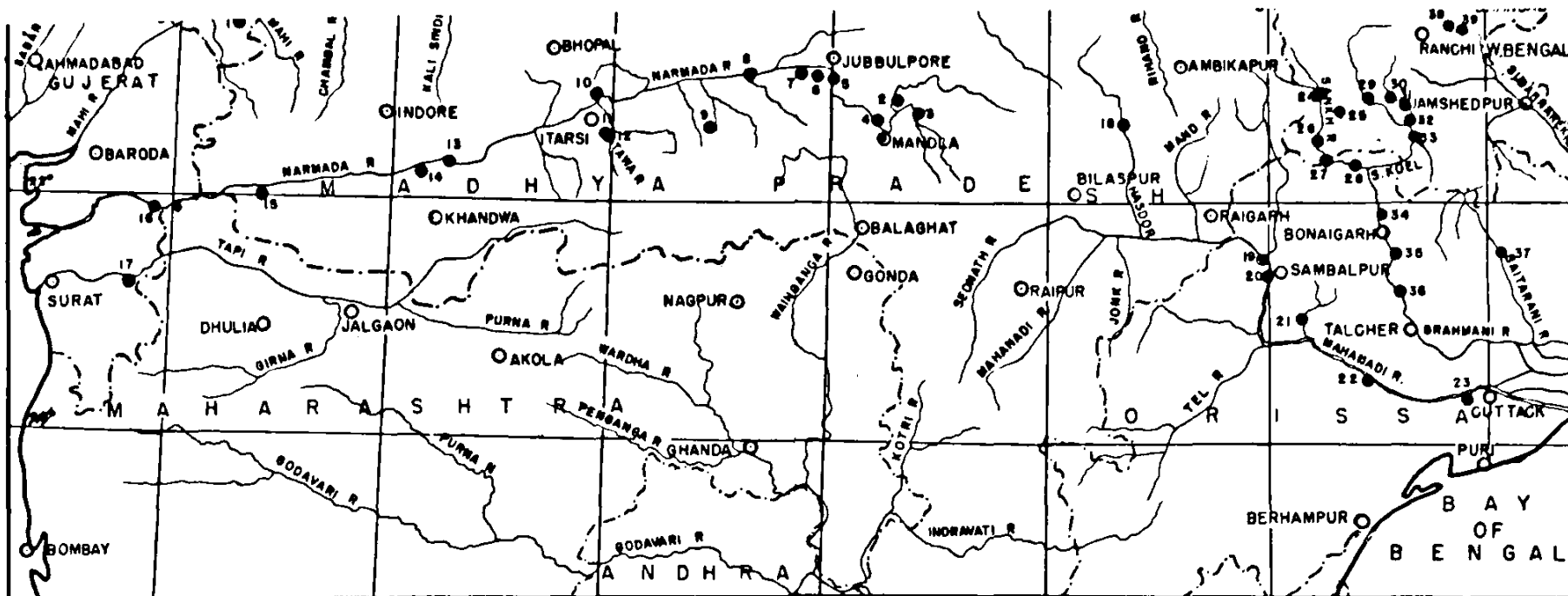

P O W E R P O T E N T I A L

REF. NO.	POWER STATION	RIVER	POWER DRAFT (GUSECS)	HEAD FEET	POWER OUTPUT KW AT 60% L.F.
1	MAHI P.M.S.	MAHI	1,000	298	33,000
2	ROSRA	NARMADA	1,930	200	43,000
3	BURNER	NARMADA	1,350	140	21,000
4	PANDARIA	NARMADA	3,280	135	49,000
5	BARGI	NARMADA	5,450	85	33,000
6	JHIRI	NARMADA	9,450	85	15,000
7	SABRA	NARMADA	9,450	55	33,000
8	CHINKI	NARMADA	5,450	90	54,500
9	SITAREWA	SITAREWA	130	750	11,000
10	HOSHANGABAD	NARMADA	5,450	80	48,500
11	TAWA P.M. I	TAWA		70	20,000
12	TAWA P.M. II	TAWA		75	
13	PUNASA	NARMADA	16,800	190	442,000
14	BARWAHA	NARMADA	16,800	100	224,000
15	HARINPHAL	NARMADA	25,000	150	446,000
16	NAVAM	NARMADA			587,000
17	UKAI	TAPI		160	90,000
18	HASDO	HASDO	3,780	150	82,800
19	HIRAKUD MAIN	MAHANADI		89	
20	HIRAKUD SUB	MAHANADI		77	212,000
21	SURUBALI	MAHANADI	10,000	100	115,000
22	TIKKARAPARA	MAHANADI	22,000	128	333,000
23	NARAJ	MAHANADI	31,400	60	225,000

REF. NO.	POWER STATION	RIVER	POWER DRAFT (GUSECS)	HEAD FEET	POWER OUTPUT KW AT 60% L.F.
24	JURTLA	SANKH	1,250	140	19,500
25	SARUBERA	SANKH	1,250	500	70,000
26	PORALTOLI	SANKH	2,600	380	110,000
27	CHINDA	SANKH	2,600	100	29,000
28	MANDRIA	SANKH	2,600	100	29,000
29	BASIA	S.KOEL	2,000	115	29,000
30	BETARKARA	S.KOEL	2,100	78	18,000
31	UPPER KARO	S.KOEL	2,850	870	180,000
32	LOWER KARO	S.KOEL	2,850	90	28,500
33	KOEL	KARO-S.KOEL	2,850	70	22,500
34	UPPER BRAHMANI	BRAHMANI	5,250	70	40,000
35	BARAKOT	BRAHMANI	7,000	70	55,000
36	LOWER BRAHMANI	BRAHMANI	12,000	110	180,000
37	BAITARANI P.M.S.	BAITARANI	3,200	998	368,000
38	SUBARNAREKHA P.M. I	SUBARNAREKHA	350	440	17,000
39	SUBARNAREKHA P.M. II	SUBARNAREKHA	350	470	16,000

TOTAL 4,287,000

CENTRAL INDIAN RIVERS

Map 3-4

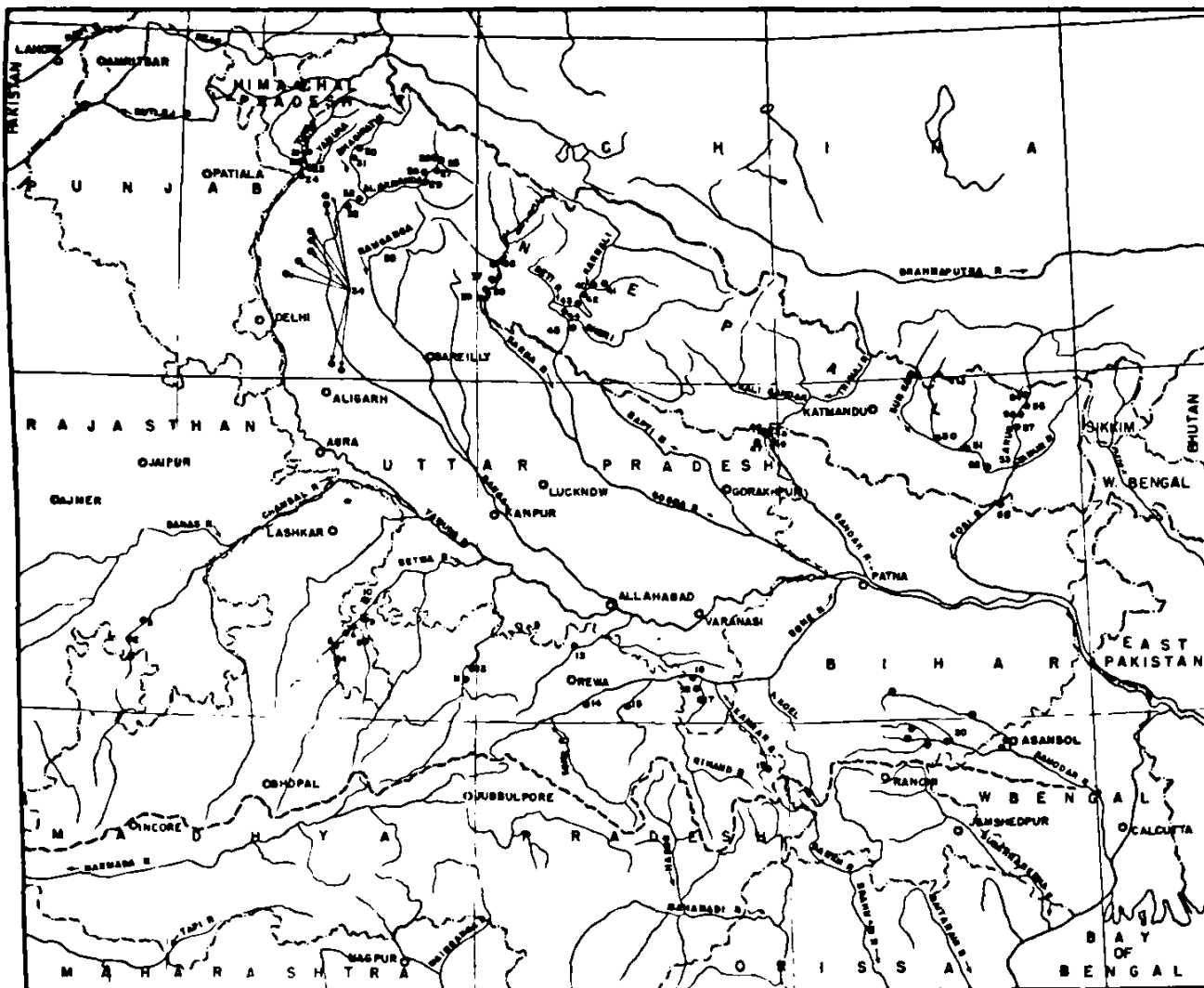

POWER POTENTIAL

SER NO.	POWER STATION	RIVER	POWER CAPT (CUMES)	HEAD (FEET)	POWER OUTPUT (MW AT 80% L.F.)
1	GANGHAR	GANGAL	4,200	140	
2	BANAPATAP	GANGAL	5,100	100	220,000
3	SOTA N	GANGAL	3,100	11.2	
4	KAJHAT	SETVA	2,500	11.5	40,000
5	ONUR WARI	SETVA	2,300	80	20,000
6	METIILA	SETVA	4,000	80	44,000
7	SHRINAG	SETVA	4,000	63	20,000
8	JAMN	SETVA	1,200	70	10,000
9	LAKAR	SETVA	2,000	80	20,000
10	SHCHNA	SETVA	2,000	100	20,000
11	NEH	NEH	4,000	210	110,000
12	RAPUSA	NEH	4,000	75	40,000
13	TUNG	TUNG	1,500	80	20,000
14	SENG	SENG	7,000	100	100,000
15	SOPT	SOPT	1,700	100	20,000
16	SHANG	SHANG	2,000	200	207,000
17	SHANG	SHANG	2,000	220	170,000
18	SERA	SHANG	2,000	60	20,000
19	KAMAR	KAMAR	500	200	20,000
20	DANDAR				10,000
21	SIGMA	TOBE-YAMUNA	4,000	450	210,000
22	KHORI	TOBE-YAMUNA	4,000	500	220,000
23	YAMUNA P. N. 1	YAMUNA	4,700	80	24,000
24	YAMUNA P. N.	YAMUNA	4,700	100	20,000
25	DHULABARA	DHULABARA	410	2,000	100,000
26	ALAKHARA	ALAKHARA	200	2,270	20,000
27	LAKSI	ALAKHARA	950	950	100,000
28	BARDA PRYAG	ALAKHARA	1,100	370	71,000
29	LAKHARU	ALAKHARA	1,200	400	71,000
30	UTTAR KAM	SHARAYIN	700	200	40,000
31	SWALI	SHARAYIN	700	470	200,000
32	KOTLIMEL	SARSA	10,000	320	370,000
33	KURAI	SARSA	10,000	320	370,000
34	SARSA CANAL	SARSA			
35	KANARSA	KANARSA			50,000
36	INCHENWAR	SARSA	12,000	470	720,000
37	GARHED	SARSA	12,000	520	810,000
38	ORP NEAR TAMPUR	SARSA	12,000	100	200,000
39	KHATHA	SARSA		60	70,000
40	SOBANA	FILA	600	1,500	27,000
41	POBILM	FILA	700	1,500	27,000
42	TOLICHAKA	KARNALI	2,000	700	130,000
43	RA	KARNALI	4,000	300	147,000
44	BAJORA	KARNALI	10,000	300	1,000,000
45	SHRAPANI	KARNALI	21,000	100	270,000
46	SANDAR P. N. 1	SANDAR WESTERN CANAL	5,000	20	
47	SANDAR P. N. 2			20	40,000
48	SANDAR P. N. 3			20	
49	SANDAR P. N. 4	SANDAR EASTERN CANAL	4,000	20	
50	DEHESHT	SUNDOI	7,000	270	230,000
51	SHULI	SUNDOI	10,000	270	710,000
52	SHUMI	SUNDOI	10,000	270	710,000
53	THAKI	SUNDOI	10,000	270	710,000
54	HATA	ARUN	3,170	1,000	700,000
55	SHRUNG	ARUN	3,400	1,000	100,000
56	SHILM	ARUN	3,100	1,100	200,000
57	NATHSUNDE	ARUN	3,300	1,000	400,000
58	EASTERN KORN	KORN	7,000	20	10,700

TOTAL 10,075,700

Map 3-5

GANGA BASIN GAN.2

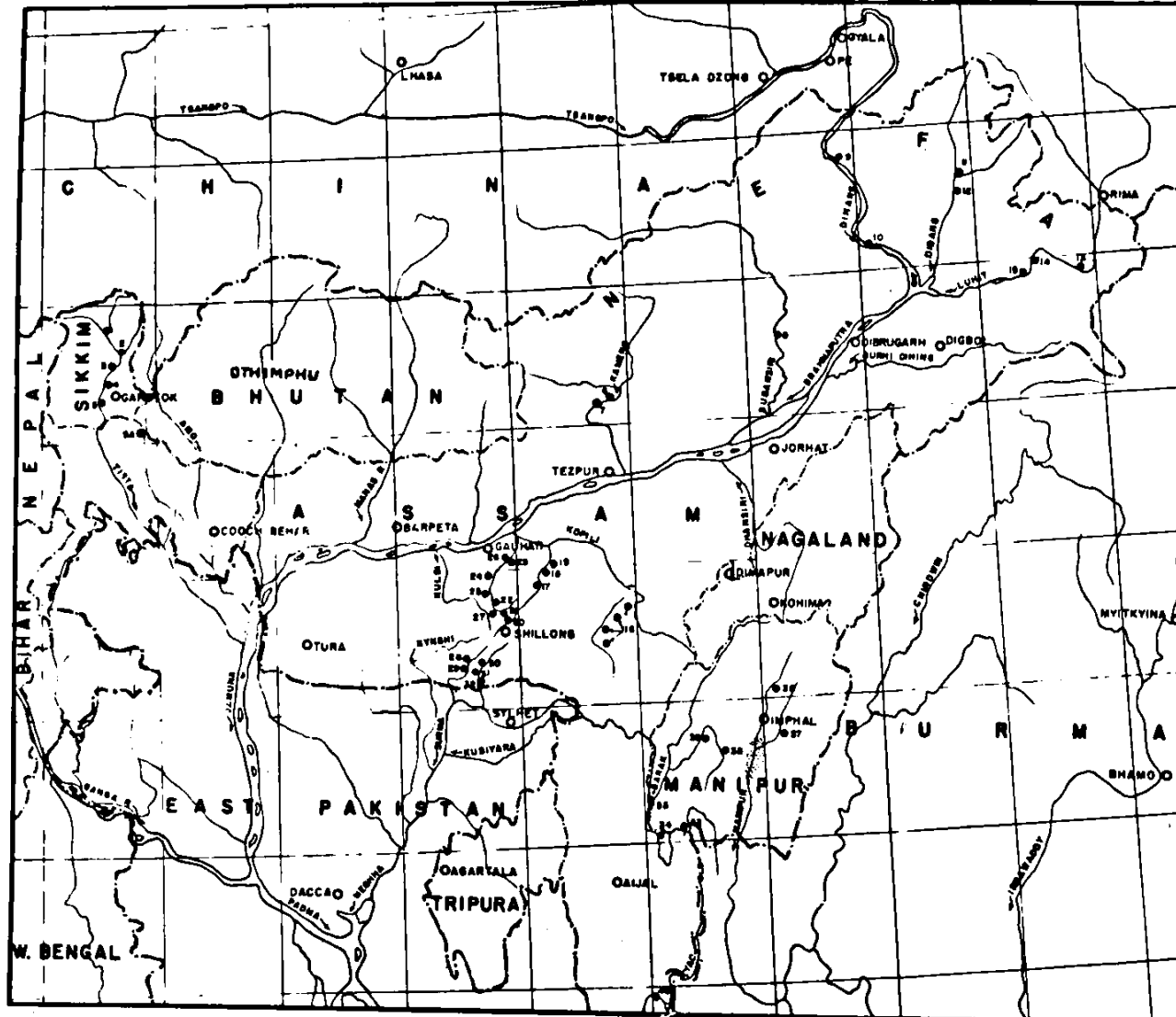

POWER POTENTIAL

SR. NO.	POWER STATION	RIVER	POWER DRAFT (MW)	HEAD FEET	POWER OUTPUT (MW @ 85% L.R.)
1	ZEMA	TISTA	825	2,850	122,000
2	SHUNTHANG	TISTA	800	2,850	242,000
3	BIRCHU	TISTA	950	2,840	222,000
4	DIBCHU	TISTA	1,300	800	92,000
5	BRITAN	TISTA	1,300	750	122,000
6A	JALDHARA STAGE I	JALDHARA	-	750	22,000
7	UPPER KANEH	KANEH	2,300	600	142,000
8	SOSA SORE	KANEH	1,925	2,140	422,000
9	SUGARIRI	SUGARIRI	10,000	150	122,000
10	RIKOR	DIBANG	22,000	650	2,400,000
11	PARO-I	DIBANG	26,000	400	1,222,000
12	ETALM	TARONG	2,640	1,500	222,000
13	IDIPO	TARONG	2,225	620	222,000
14	BARONS	TELU	2,500	1,250	1,222,000
15	SUITON	TELU	10,700	1,220	1,222,000
16	DEWE	TELU	11,000	900	222,000
17	KOPLI	KOPLI	1,720	2,120	422,000
18	UMBI	UMBI & UMBHEN	1,000	240	22,000
19	RAMPHANG	UMBI & UMBHEN	1,200	1,220	122,000
20	THEMRAK	UMBI & UMBHEN	1,200	470	22,000
21	SUMER P.H. I	UMBI	222	240	22,000
22	UPPER UMTRU P.H. I	UMTRU	722	420	22,000
23	UPPER UMTRU P.H. II	UMTRU	722	420	22,000
24	UPPER UMTRU P.H. III	UMTRU	945	900	22,000
25	MAKARI P.H.	UMTRU	1,320	645	22,000
26	UMTRU (EXISTING)	UMTRU	-	122	-
27	UMHAW P.H.	UMHAW	222	270	22,000
28	RAHMAN	KYNSHI	1,120	1,220	222,000
29	SYTEN	KYNSHI	1,120	1,220	222,000
30	TANLANG	UMBI & UMBHEN	800	2,220	222,000
31	NONSTEIN	UMBI & UMBHEN	4,020	1,020	222,000
32	NONLINGHEIN	UMBI & UMBHEN	2,020	415	22,000
33	ENKONON	TUVAI	2,000	270	22,000
34	TATGI	TUVAI	2,000	270	22,000
35	BARAK	BARAK & MANIPUR	2,200	120	22,000
36	ARSAK	IRIL	200	100	22,000
37	THOUBAL	THOUBAL	200	120	22,000
38	NUMPI	MANIPUR DIVERSION	2,000	1,200	222,000
39	LONGWAL LOC	MANIPUR DIVERSION	2,000	220	222,000
40	LUNLENG	TYAD	2,200	1,200	222,000

* TOTAL HEAD

TOTAL 12,222,000

Map 3-6
BRAHMAPUTRA BASIN

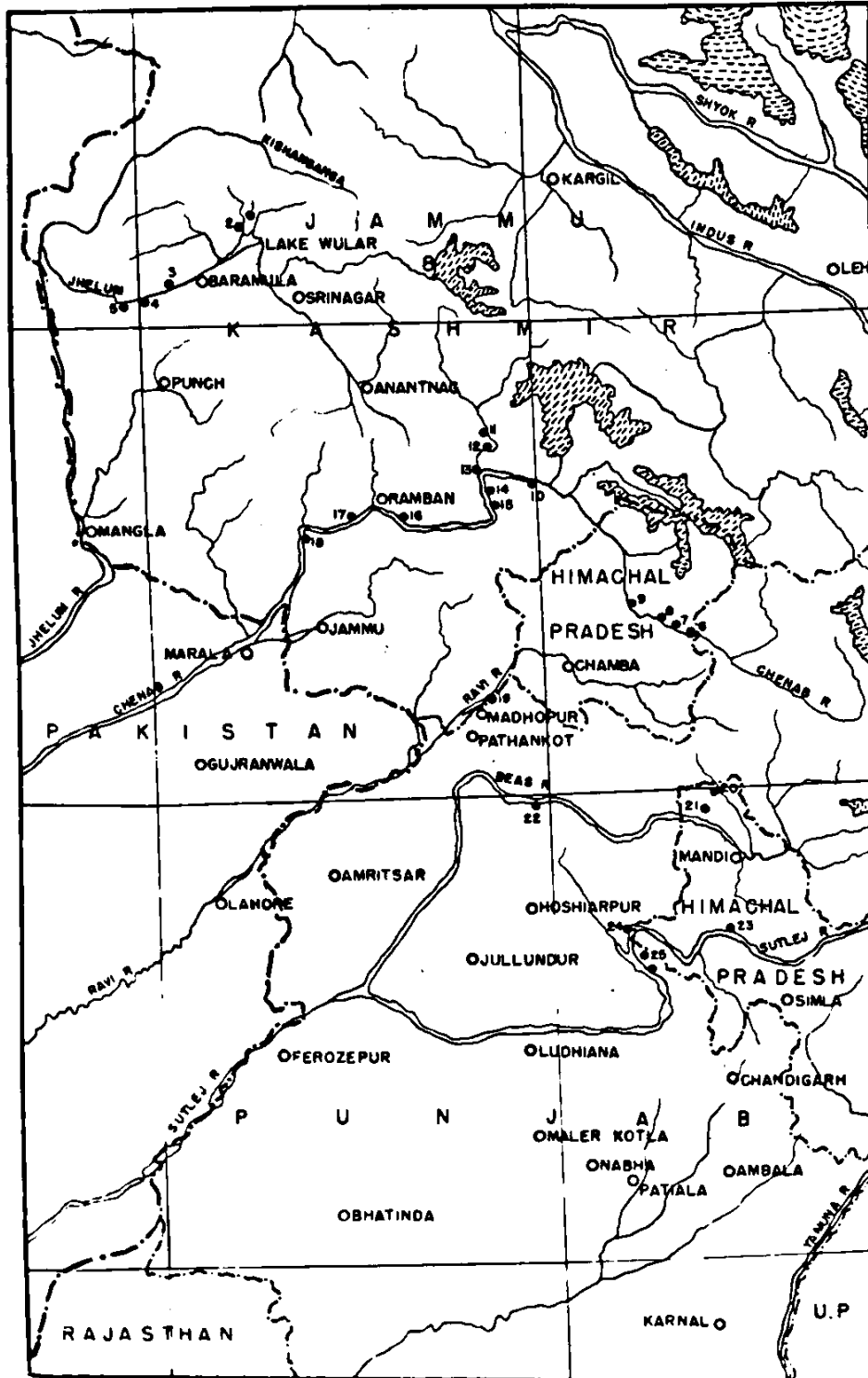

POWER POTENTIAL

REF. NO.	POWER STATION	RIVER	AV. POWER DRAFT (CUSECS)	HEAD FEET	POWER OUTPUT KW. AT 90% L.F.
1	KARALPUR	KISHANGANGA	1,000	2,440	272,000
2	WANGAM	KISHANGANGA	1,000	300	33,000
3	SHANKOT	JHELUM	2,800	260	77,800
4	URI	JHELUM	2,800	775	241,000
5	CHAKOTHI	JHELUM	2,900	600	187,000
6	THIROT	CHENAB	2,350	466	119,000
7	BARDANG	CHENAB	2,430	200	54,000
8	SELI	CHENAB	2,610	300	87,000
9	RAOLI	CHENAB	2,650	1,000	296,000
10	NAURAT	CHENAB	3,290	900	325,000
11	NATAR	MARUSUDAR	2,000	935	208,000
12	IKHALE	MARUSUDAR	2,015	1,530	343,000
13	BHANDALKUT	MARUSUDAR	2,180	1,080	282,000
14	SUNDRAMAN	CHENAB	2,415	170	48,000
15	BANNADI	CHENAB	3,330	1,625	654,000
16	KILLAGAJPAT	CHENAB	2,450	200	30,000
17	SAWALKOT	CHENAB	6,150	580	410,000
18	DHIANGARN (SALAJ)	CHENAB	6,480	200	145,000
19	TREIN	RAVI	5,500	288	156,000
20	JUGINDERNAGAR	UHL	130	1,800	25,000
21	BASI	UHL	130	1,150	18,500
22	PANG	BEAS	5,000	230	128,000
23	DEHAR			1,100	
24	BHAKRA	BEAS-SUTLEJ		400	2,188,000
25	MANGAL			198	
				TOTAL	6,582,000

Map 3-7

INDUS BASIN

HYDRO-ELECTRIC RESOURCES



200

REF NO.	HYDEL RESOURCES	FIRM POWER IN MW. AT 60% L.F.
1	PAMBIYAR, PAPANASAM	297.0
2	PERIYAR	931.8
3	OMALAKUDI	297.0
4	MILGIRI	699.9
5	BARAPOLE & GORAKUSHI	267.7
6	SHARAVATI, AGMANASHNI VARAHI, CHAKRANADI, BHADRA	1406.3
7	KALINADI, BEDTI ETC.	1114.0
8	CAUVERY	338.0
9	TATA GROUP	270.0
10	KOYNA	474.0
11	UPPER KRISHNA	607.0
12	LOWER KRISHNA	340.0
13	SILERU	723.0
14	INDRAVATI & KOLAB	2458.3
15	PRANHITA	1023.0
16	UPPER BODAVARI	19.5
17	MANJRA	43.0
18	LOWER BODAVARI	1943.0
19	MAHI	33.0
20	NARMADA UPPER	328.0
21	MIDDLE NARMADA	668.0
22	LOWER NARMADA	1033.0
23	TAPI	90.0
24	UPPER MAHANADI	389.5
25	LOWER MAHANADI	558.0
26	UPPER BRAHMANI	531.6
27	LOWER BRAHMANI	255.0
28	BAITARANI	368.0
29	SUBARNAREKHA	35.0
30	CHAMBAL	232.0
31	BETWA	295.0
32	KEN	160.0
33	TONS & SOME	604.0
34	DOMODAR	20.0
35	YANUNA	559.0
36	ALAKNANDA	448.5
37	BHAGIRATHI	105.0
38	UPPER GANGA & RAMGANGA	1094.0
39	SARDA	1648.0
40	KARNALI	2745.0
41	GANDAK	45.5
42	SUNKOSI	2360.0
43	ARUN	2369.0
44	KOSI CANAL	18.7
45	TISTA & JALDHAKA	982.0
46	KAMENG	605.0
47	SUBANSIRI	166.0
48	DIHANG	4055.0
49	DIBANG	930.0
50	LUNIT	3270.0
51	K & J HILLS (NORTH)	948.4
52	K & J HILLS (SOUTH)	1064.0
53	BARAK, MAMPUR	1060.0
54	TYAO	378.0
55	UPPER JHELUM	305.0
56	LOWER JHELUM	505.8
57	UPPER CHENAB	555.0
58	MIDDLE CHENAB	1025.0
59	MARUSUDAR	813.0
60	LOWER CHENAB	883.0
61	RAVI & LOWER BEAS	288.0
62	BEAS, SUTLEJ LINK, BHAKRA NANGAL & UHL	2229.8

TOTAL 50,346,500

TOTAL FOR INDIA 4,155,810

Map 3-8

about Rs. 1,750 per kW at Rihand, the representative average being about Rs. 1200 per kW. The corresponding range of cost of energy production varies from about 1.4 *np* to about 2.6 *np* per kWh, the representative average being 1.8 *np* per unit.* If the common costs of storage are allocated to the benefits conferred on other projects and other fields, like the irrigation, the above costs would be correspondingly reduced. The capital cost associated with multipurpose projects including common costs allocated to power are higher than those of single-purpose projects, mainly because they are constructed at sites more suitable from the point of view of multi-purpose development. A study of the relative economics of schemes constructed prior to 1950 and those implemented during the last decade indicates that the prevailing range of capital cost per kW of firm power of single-benefit power schemes appears very favourable even with the cost levels of earlier decades notwithstanding the substantial increases in construction cost in the intervening period. This is mainly attributed to the small magnitudes of the earlier schemes, when the 'intrinsically more economic hydel resources - constituted by the larger schemes - could not be implemented. The other conclusion of importance is that, contradictory of common notion, capital investment associated with the power aspect of multipurpose scheme would be substantially higher than those of single-purpose schemes even in cases where the entire costs are charged to power. This is important to note since the C.W.&P.C.'s hydro-electric survey has indicated that the bulk of future hydel development in the country would be derived from single-benefit hydel

power projects. The high costs of multi-purpose projects is attributable to the fact that, basically, the multi-purpose schemes, unlike purely power projects, are not located at sites where they afford the best economy from the point of view of power potential but represent compromise solutions with the often conflicting considerations of flood control and irrigation.

* *The average cost of hydro power production have been arrived at, following the principle at present in vogue in India and as set out in Indian Electricity (Supply) Act. The Interest charges are assumed at prevailing market rates for raising capital. Charges for depreciation have been calculated on the basis of a compound interest rate of 3 per cent per annum, as directed in the Indian Electricity (Supply) Act. The question of gross return on the capital from all round considerations is currently under examination by a Electricity Price Policy Committee appointed by the Planning Commission and their report may be awaited. However, if a return of 10% on capital before taxes is to be realised, then the prices of hydro energy at power station busbars will vary between 1.9 *np* to 3.5 *np* per kWh, the representative average being 2.5 *np* per kWh. In arriving at these figures the charges for depreciation have been adjusted suitably for 10% return. Also, relatively speaking, the magnitudes of common civil works and associated expenditure, in the case of multi-purpose schemes are very large compared with their power benefits and even the direct charges associated with the low-head type development - characteristic of multi-purpose schemes - are high.*

ANNEX 3 SUPPLEMENT

A Short History and Present Status of Hydro-Electric Development in India

1. Early Developments.

Hydro-electric development was initiated in India in 1897 with a small run-of-the-river scheme near Darjeeling. The first major hydro-development was the construction in 1902 of the Sivasamudram Hydro-electric Scheme, with an installed capacity of 4500 kW undertaken by the State of Mysore primarily for the supply of power to the gold mines at Kolar. This was followed by the Khopoli Hydro-electric scheme in 1914, with an installed capacity of 50,000 kW. This scheme was developed by Tatas, the pioneering industrial magnates of the country, for distribution of power to the metropolitan areas of Bombay and Poona.

2. Pre-Independence Era.

There was a spurt in industrial and other developmental activities in the country, shortly after the first World War and power development kept pace with these activities. The Tatas followed their Khopoli Hydro-electric Scheme with the Bhivpuri Hydro Scheme (72,000 kW) in 1920 and the Bhira Scheme (110,000 kW) in 1927. This power was mainly intended to meet the demands of textile and other industrial users, for electric traction and domestic demands in the city of Bombay. In the State of Mysore the installed capacity of Sivasamudram Power Station was increased to 42,000 kW and the Shimsha Hydel Scheme was implemented with an installed capacity of 17,200 kW. During this period between the two World Wars, some of the Provinces and Princely States in the country, viz. Punjab, United Provinces (present Uttar Pradesh), Madras and Travancore (present Kerala) took an interest in the field of power development and several state owned hydro-electric stations like Jogindernagar in the Punjab (48,000 kW), the Ganga Canal Power Stations in Uttar Pradesh (17,400 kW), Pykara (38,750 kW) and Mettur (30,000 kW) in the Madras State and the Pallivasal Scheme in Travancore (13,500 kW), were commissioned. These developments necessitated construction of long high-voltage transmission lines

to convey the power to important load centres. In some States like Madras and Mysore, advantage was taken of these power systems to extend benefits of electricity to as large an area as possible and embark on programmes of rural electrification.

Hydro-electric installations increased from about 74,000 kW in 1920 to about 470,000 kW in 1940. It is important to observe here that thermal and diesel electric installations registered greater progress during this period. Steam electric plant increased from 49,245 kW to 624,152 kW and diesel plant from 6,320 to 115,291 kW. Extensive use of thermal generation in this period can be attributed to the facts that (i) the industrial ventures were limited, (ii) the main demands for power were still small and centred around the important cities far from the important hydro sources and (iii) the total demands for power were well below the range of economy of large hydel schemes.

During the period 1940-47, very little progress was made in the field of power development due to the second World War. Only two hydro-electric installations, viz. Papanasam (21,000 kW) in Madras and Jog (48,000 kW) in Mysore, were added in the Country during this period.

3. Post-Independence Era.

After the attainment of political independence in 1947, the Indian Government initiated a programme of planned development. The Central and State Governments embarked on several ambitious multiple-purpose projects to surmount the acute shortage of food in the Country and meet the pent-up power demands of the War years. Amongst these were the Damodar Valley development in the States of Bihar and West Bengal, the Bhakra-Nangal Project, in the State of Punjab with benefits extending to the neighbouring States of Rajasthan and Delhi, the Hirakud Dam Project in Orissa, the Chambal Valley Development in Madhya Pradesh and Rajasthan and the Tungabhadra Project in Andhra Pradesh and Mysore. A number of single-purpose hydro-electric develop-

ments were also undertaken in various parts of the Country. The country-wide demands for power called for extension of grids to industrial and rural areas and as the magnitude of demands increased, hydro with its inherent economy attracted the attention of the authorities in charge of power development. Further, conservation of our limited resources of high grade coal became necessary and transportation of low grade coals over long distances became more expensive and also difficult. This resulted in considerable expansion of hydro during the post-independence period.

Hydro development has made significant progress registering an increase in installed capacity

from 0.5 million kW in 1947 to 2.6 million kW in 1963, and contributing at present nearly 50% to the total electrical energy generation in the Country. Several hydro projects are under construction and it is expected that the installed capacity will increase to over 5 million kW at the end of the Third Plan Period. The hydro projects completed during the First and the Second Five-Year Plan Periods and the first two years of the Third Five-Year Plan period are listed in Table 3-1, Table 3-2 gives the salient features of all important hydro installations in the Country. The pattern of energy generation during 1961-62 in some of the important hydro stations is indicated in Table 3-3.

~~ANNEX 3 - SUPPLEMENT~~
TABLE 3-1

HYDRO-ELECTRIC POWER STATIONS COMMISSIONED
DURING THE FIRST AND SECOND PLANS AND THE
FIRST TWO YEARS OF THIRD PLAN.

No.	Name of Scheme	Installed Capacity kW.
FIRST PLAN		
1.	Nizamsagar (Andhra Pradesh)	15,000
2.	Machkund (Andhra Pradesh & Orissa)	34,000
3.	Sengulam (Kerala)	48,000
4.	Moyar (Madras)	38,000
5.	Pykara Extensions (Madras)	27,000
6.	Bhira Extensions (Tatas-Maharashtra)	22,000
7.	Jog Extensions (Mysore)	72,000
8.	Ganguwal (Punjab)	48,000
9.	Pathri (Uttar Pradesh)	20,000
10.	Sarda (Uttar Pradesh)	41,400
SECOND PLAN		
1.	Machkund Extensions (Andhra Pradesh and Orissa)	81,000
2.	Tungabhadra (Andhra Pradesh & Mysore)	38,000
3.	Umtru (Assam)	8,000
4.	Maithon (D.V.C.-Bihar)	60,000
5.	Panchet Hill (D.V.C.-Bihar)	40,000
6.	Poringalkuthu (Kerala)	32,000
7.	Neriamangalam (Kerala)	30,000
8.	Gandhisagar (Madhya Pradesh & Rajasthan)	68,000
9.	Periyar (Madras)	105,000
10.	Kundah (Madras)	145,000
11.	Tungabhadra Extensions (Mysore)	8,000
12.	Hirakud (Orissa)	123,000
13.	Kotla (Punjab)	48,000
14.	Bhakra (Punjab)	270,000
THIRD PLAN		
1.	Kundah Extensions (Madras)	35,000
2.	Tungabhadra Extensions (Mysore)	8,000
3.	Koyna (Maharashtra)	240,000
4.	Hirakud (Orissa)	75,000
5.	Chiplima-Hirakud (Orissa)	72,000
6.	Ganguwal (Punjab)	29,000
7.	Kotla (Punjab)	29,000
8.	Bhakra Extensions (Punjab)	180,000
9.	Mohora Extensions (Jammu & Kashmir)	8,000
10.	Rihand (Uttar Pradesh)	250,000

ANNEX 3 SUPPLEMENT

TABLE 3-2

SALIENT FEATURES OF EXISTING MAJOR HYDRO STATIONS

No.	Power Station	State	Period of construction.	Particulars of Dam	Height metres	Dams & Reservoirs Height at metres	Effective reservoir capacity million cubic metres	Details of Water Conductor System.
1.	2.	3.	4.	5.	6.	7.	8.	9.
SINGLE-PURPOSE SCHEMES:								
1.	Palivasal	Kerala	1933-55	(Kundale (Madupatty	26.2 47	250 244	7.6 54	Tunnel 4.6 sq.m.x 3120 m. long
2.	Sengulam	Kerala	1947-55	-	-	-	-	Tunnel 6.7 sq.m.x 3566 m. long
3.	Poringal-kuthu.	-do-	1946-60	Poringal-kuthu	26.2	366	32	Tunnel 13.5 sq.m.x 1168m. long.
4.	Neriamangalam	-do-	1954-	-	-	-	-	Tunnel 11.1 sq.m.x 3505 m.
5.	Pykara	Madras	1930-54	(Mukurti (Pykara	29 49	162 215	51) 57)	Open flume-2134 m. long.
6.	Moyar	-do-	1948-54	-	-	-	-	Open flume-8839 m. long.
7.	Kundah I	-do-	1956-	(Avalanche (Emerald (Upper (Bhavani	54.3 57.9 65.8	366) 323)	153 86	Tunnel 7.4 sq. m. x 4450 m. long.
8.	Kundah II	-do-	1958-	-	-	-	-	Tunnel 8.5 sq.m.x 3651 m. long.
9.	Khopoli	Mahara-shtra.	1910-20	Lonavla Walwhan Shirawta	10.6 21.6 26.3	906 1356 2316	12 72 188	Tunnel 8.7 sq.m.x 6965 m. long.
10.	Bhivpuri	-do-	1918-22	Thokewadi	57.9	572	365	Tunnel-7.6 sq.m.x 2652 m. long.
11.	Bhira	-do-	1921-29	Mulshi	44.5	1555	524	Tunnel-13.0 sq.m.x 4770 m. long.
12.	Koyna	-do-	1954	Koyna	97.5	853	2500	Tunnel-32.5 sq.m.x 3658 m. long.
13.	Jog	Mysore	1940-52	Hirebhas-gar.	34.7	350	765	Open flume-537 m. long.
14.	Jogindernagar	Punjab	1931-39	-	-	-	-	Tunnel
15.	Rihand	Uttar Pradesh	1952-62	Rihand (Pipri)	82.3	957	9010	Dam Power House
16.	Machkund	Orissa & Andhra	1946-50	Jalaput	52.7	427	890	Tunnel 12 sq.m.x 1222 m. long. -19.2 sq.m.x 914 m. long.

Average Gross Head metres	Energy potential corresponding to Eff. storage capacity. 10^6 kWh.	Firm energy potential 10^6 kWh.	Installed capacity kW.	Remarks
10.	11.	12.	13.	14.
610))		36,000	
))			
)	132	472		
360))		48,000	Uses tailrace discharges of Pallivasal. P.H.
))			
181	12.8	70	32,000	
198	27.0	142	30,000	Designed to use tailrace waters of existing Pallivasal and Sengulam and Pannier under construction. Ultimate installed capacity 45,000 kW.
940	224	290	70,000	
394	94.5	121	36,000	Uses tailrace discharges of Pykara P.H.
343))		40,000	
))			
)	587	700		
753))		140,000	Uses tailrace waters of Kundah P.H.
))			
528	315		70,000	
524	423	1200	72,000	
508	587		132,000	
488	2710	2150	240,000	Figures under columns 11 & 12 correspond to ultimate conditions. Ultimate installed capacity 540,000 kW.
368	620	800	120,000	
549	-	131	48,000	Run-of-the-river project.
69	1380	920	250,000	
260	525	730	114,000	

ANNEX 3 SUPPLEMENT

TABLE 3-2 (cont.)

SALIENT FEATURES OF EXISTING MAJOR HYDRO STATIONS

Sl. No.	Power Station	State	Period of construction.	Particulars of Dam	Height metres	Dams & Reservoirs Height at crest metres	Effective reservoir capacity million cubic metres	Details of Water Conductor System.
1.	2.	3.	4.	5.	6.	7.	8.	9.
MULTIPLE-PURPOSE SCHEMES:								
1.	Nizamsagar	Andhra	1923-37	Nizamsagar.	48.2	3155	736	Dam P.H.
2.	Tilaya	Bihar	1950-53	Tilaya	37.2	366	320	Dam P.H.
3.	Maithon	-do-	1951-58	Maithon	55.5	(364 Concrete (628 earth)	1150	Underground P.H.
4.	Panchet Hill	-do-	1952-59	Panchet	47.9	(374 Concrete (2175 earth)	1325	Dam P.H.
5.	Papanasam	Madras	1938-45	Tambra- parni	65.8	337	158	
6.	Mettur Dam	-do-	1927-37	Mettur	48.2	3155	2670	Dam P.H.
7.	Periyar	-do-	1954-59	Periyar	46.3	329.5	283	Tunnel 14.3 sq.m x 1450 m. long.
8.	Siva	Mysore	1902-38)	Krishna- rajasagar	44.5	2621	1250	Open channel-5474
9.	Shimsha	-do-	1940)					Open channel-9144
10.	Tungabhadra LB	-do-	1945-)	Tungabha- dra	49	810 con- crete, 1831 maso- nry.	3735	Dam P.H.
11.	Tungabhadra RB	-do-	1945-)					Dam P.H.
12.	Tungabhadra Canal.	-do-	1945-)					Canal P.H.
13.	Hirakud	Orissa	1948-	Hirakud	49	4800+ 27.4 km dykes.	5870	Dam P.H.
14.	Chiplime	-do-	1948-	-	-	-	-	27.4 km. Power channel
15.	Bhakra L.B.	Punjab	1946	Bhakra	225.6	518	660	Dam P.H.
16.	Ganguwal	-do-	1946-55	-	-	-	-	19 km. Power chann
17.	Kotla	-do-	1946-55	-	-	-	-	11 km. Power chann
18.	Gandhisagar	M.P.& Rajas- than.	1962	Gandhi- sagar.	64.6	512	6300	Dam P.H.

NOTE: - As storage capacity in the case of Multipurpose Projects is used for all the benefits, energy potential corresponding to effective storage capacity (col. 11) will not represent any definite relationship. As such column 11 in the case of multipurpose projects has been left blank.

Average Gross Head metres	Energy potential corresponding to Eff. storage capacity 10 ⁶ kWh.	Firm energy potential 10 ⁶ kWh.	Installed capacity kW.	REMARKS
10.	11.	12.	13.	14.
19.5	-	28	15,000	
19.5)	-		4,000	
32.3)	-	80	60,000	
24.0)	-		40,000	
100	-	110*	28,000	
18 to 49	-	210*	40,000	*Based on co-ordinated operation with other hydro stations (viz. Pykara, Moyar and Kundah) in the grid. Ultimate installed capacity at Periyar - 140,000 kW.
385	-	550*	105,000	
128	-	148	42,000	
102	-	108	17,000	
10.8)	-		18,000	Benefits being shared by Andhra & Mysore. The ultimate capacity at Tungabhadra R.B. & Canal P.Hs. - 36,000 kW & 36,000 kW respectively.
12.8)	-	168	18,000	
33.5)	-		18,000	
28.8	-)		180,500	Ultimate installed capacity-198,000 kW.
28.5	-)	1140	48,000	Uses tailrace discharges of Hirakud P.H. Project under completion. Ultimate installed capacity - 98,000 kW.
121.8	-)		265,000*	*At lowest head-ultimate installed capacity-when the R.B. power house is commissioned (615,000 kW at lowest head).
	-)		450,000	
29.3	-)	3200	77,000	Uses discharges from Bhakra.
29.3	-)		77,000	
49.4	-	420	92,000	Ultimate installed capacity 115,000 kW.

ANNEX 3 SUPPLEMENT

TABLE 3-3

ACTUAL ANNUAL AND MONTHLY GENERATION AT MAJOR HYDRO STATION DURING 1961-62

MONTHLY GENERATION AS A % OF ANNUAL GENERATION

Name of Station		Total Annual generation in million kWh	April	May	June	July	August	September
1.	2.	3.	4.	5.	6.	7.	8.	9.
1.	Pallivasal	226	9.9	8.2	8.2	7.2	7.2	7.5
2.	Sengulam	132	13.2	8.0	6.0	6.6	4.8	6.1
3.	Poringalkuthu	163	7.6	8.8	8.3	10.1	8.3	10.1
4.	Tilaya	16	4.8	6.0	7.4	15.5	18.2	17.7
5.	Maithon	131	3.5	3.1	1.7	8.0	18.3	26.0
6.	Panchet Hill	153	3.0	1.1	9.6	18.2	19.1	18.8
7.	Pykara	403	10.8	11.0	10.0	3.9	6.0	9.2
8.	Moyar	174	10.6	10.8	9.8	6.0	6.5	9.1
9.	Mettur	258	3.8	3.5	6.8	10.6	10.0	8.9
10.	Periyar	668	9.4	6.9	6.8	8.4	6.1	10.0
11.	Papanasam	170	5.4	3.5	10.4	11.0	10.0	8.0
12.	Kundah I & II	76	5.2	3.0	4.0	6.4	-	8.3
13.	Khopoli)							
14.	Bhivpuri)	1510	5.9	7.2	6.8	10.1	9.4	9.1
15.	Bhira)							
16.	Sivasamudram	182	8.6	8.5	8.2	8.4	8.7	8.5
17.	Shimsha	104	7.1	8.5	8.3	8.7	8.5	8.5
18.	Jog	788	8.3	8.2	8.1	8.2	8.7	8.5
19.	Hirakud	595	8.8	8.2	8.2	8.0	7.4	7.1
20.	Bhakra)							
21.	Ganguwal)	1647	5.9	7.8	7.5	7.4	8.7	8.9
22.	Kotla)							
23.	Jogindernagar	192	9.2	11.1	10.3	8.6	7.6	7.3
24.	Sarda (Khathma)	210*	8.4	10.0	9.4	9.0	8.7	8.4
25.	Machkund (for '60-'61)	512	8.4	8.3	8.4	8.6	9.6	7.9

October	November	December	January	February	March	Remarks
10.	11.	12.	13.	14.	15.	16.
7.0	7.7	8.7	10.5	9.5	8.4	
4.6	5.5	9.7	12.5	11.8	11.2	
13.5	13.0	8.4	4.9	4.4	2.8	
11.1	2.8	3.5	3.5	3.3	6.4	
24.1	2.8	3.5	3.4	2.3	3.5	
15.7	3.8	2.8	1.4	2.8	3.1	
8.0	5.8	7.0	8.0	9.2	11.0	
8.0	5.8	8.8	7.5	8.8	10.6	
10.8	10.8	11.4	10.4	7.4	5.8	
10.7	10.5	10.7	10.8	6.4	3.3	
9.0	8.5	10.7	9.4	5.0	9.1	
4.0	4.7	8.2	9.5	18.0	32.7	
8.4	7.0	8.8	9.3	8.8	9.3	
8.0	8.0	8.3	8.3	7.7	8.8	
8.3	8.3	8.5	8.8	7.7	8.8	
8.4	8.1	8.8	8.4	7.5	8.8	
8.8	8.7	8.8	10.0	9.8	10.4	
7.3	8.8	9.8	10.3	8.6	9.8	(Addns to ins- talled capacity (during the year. (July '61--119 MW. (Nov. '61--90 MW. (Dec. '61--119 MW.
8.0	7.8	8.8	8.8	8.8	7.8	
8.8	10.0	11.0	8.5	7.8	NA	*for 11 months.
8.8	7.4	7.0	8.8	8.0	11.0	

**ANNEX 3 SUPPLEMENT
TABLE 3-4**

**BASIN-WISE DISTRIBUTION OF HYDRO
POWER POTENTIAL.**

Sl. No.	River Basin	Power potential at 60% load factor (kW)	
		Total	in India.
I. WEST FLOWING RIVERS OF SOUTHERN INDIA.			
1.	Pambiyar	276,000	
2.	Periyar	931,500	
3.	Chalakkudi	297,000	
4.	Kundipula	78,000	
5.	Kuttiyadi	67,700	
6.	Barapole	200,000	
7.	Varahi	150,000	
8.	Chakranadi	20,000	
9.	Sharavathi	997,300	
10.	Tadri (Aganashini)	214,000	
11.	Bedti	420,000	
12.	Kalinadi	646,000	
13.	Mahadayi (Mandvi)	not included	
	Sub-Total:	4,297,500	4,297,500
II. EAST FLOWING RIVERS OF SOUTHERN INDIA			
1.	Tamraparni	21,000	
2.	Cauvery	758,500	
3.	Krishna	1,636,000	
4.	Godavari:-		
	i) Upper Godavari	62,500	
	ii) Pranhita	1,023,800	
	iii) Indravati & Kolab	2,458,300	
	iv) Sileru	723,000	
	v) Lower Godavari	1,943,000	
	Sub-Total:	8,625,900	8,625,900
III. CENTRAL INDIAN RIVERS			
1.	Mahi	33,000	
2.	Narmada	2,027,000	
3.	Tapi	90,000	
4.	Mahanadi	947,500	
5.	Brashmani	786,500	
6.	Baitarani	368,000	
7.	Subarnarekha	35,000	
	Sub-Total:	4,287,000	4,287,000

ANNEX 3 SUPPLEMENT
TABLE 3-4 (cont'd)

BASIN-WISE DISTRIBUTION OF HYDRO
POWER POTENTIAL

Sl. No.	River Basin	Power potential at 60% load factor (kW)	
		Total	in India
IV. GANGA BASIN			
1.	Chambal	232,000	
2.	Batwa	295,000	
3.	Ken	150,000	
4.	Sone & Tons	804,000	
5.	Damodar	20,000	
6.	Yamuna	559,000	
7.	Alaknanda	446,500	
8.	Bhagirathi	105,000	
9.	Upper Ganga	970,000	
10.	Ganga Canal	70,000	
11.	Ramganga	54,000	
12.	Sarda	1,842,000	
13.	Karnali	2,745,000	
14.	Gandak	45,500	
15.	Sun Kosi	2,360,000	
16.	Arun	2,365,000	
17.	Kosi	18,700	
	Sub-Total:	13,078,700	4,888,700
V. BRAHMAPUTRA BASIN			
(a) Tributaries			
1.	Tista	840,000	
2.	Jaldhaka	22,000	
3.	Kameng	605,000	
4.	Subansiri	188,000	
5.	Dihang	4,055,000	
6.	Dibang	930,000	
7.	Luhit (Telu)	3,270,000	
8.	Kelang & Iulsi	946,400	
9.	Kynshi, Umngi & Umi	1,084,000	
10.	Barak (with Manipur Diversion).	1,034,000	
	(b) Manipur river	16,000	
	(c) Tyao	378,000	
	Sub-Total:	13,426,400	12,488,400
VI. INDUS BASIN			
1.	Jhelum	810,500	
2.	Chenab	3,256,000	
3.	Ravi	158,000	
4.	Beas & Sutlej	2,357,500	
	Sub-Total:	6,582,000	6,582,000
	Grand Total:	50,298,500	41,167,500

**ANNEX 3 SUPPLEMENT
TABLE 3-5**

STATE-WISE DISTRIBUTION OF POWER POTENTIAL

Sl. No.	State	kW at 60% load factor
1.	Andhra	2,478,500
2.	Assam	11,599,400
3.	Bihar	809,700
4.	Gujarat	877,000
5.	Jammu & Kashmir	3,590,500
6.	Kerala	1,539,500
7.	Madhya Pradesh	4,582,300
8.	Madras	708,200
9.	Maharashtra	1,909,600
10.	Mysore	3,372,800
11.	Orissa	2,062,000
12.	Punjab	1,380,500
13.	Rajasthan	149,000
14.	Uttar Pradesh	3,784,000
15.	West Bengal	22,000
UNION TERRITORIES		
1.	Himachal Pradesh	1,887,500
2.	Manipur	885,000
TOTAL:		41,155,500

ANNEX 3 SUPPLEMENT TABLE 3-8

**ESTIMATED COSTS OF SINGLE-PURPOSE HYDRO-ELECTRIC
SCHEMES UNDER CONSTRUCTION/**

Sl. No.	Scheme	Capital outlay on Generation Rs. lacs.	COMPLETION		Firm power potential at 80% load factor	Cost/kW of installed capacity. Rs.	Cost/kW of firm power. Rs
			Installed capacity kW.				
1.	Pamba	2252.00	300,000		228,000	751	1000
2.	Panniar	324.00	30,000		28,000	1080	1245
3.	Idikki	4749.00	500,000		355,000	950	1330
4.	Neriamangalam	299.75	45,000		27,000	665	1110
5.	Shelayar	425.00	54,000		41,500	785	1002
6.	Kundah	4948.00	420,000)	449,000	1015	1265
7.	Periyar	734.85	140,000				
8.	Sharavathi	8163.50	890,000		890,000	915	915
9.	Koyna	4087.00	540,000		408,000	750	1000
10.	Rihand	3089.50	250,000		175,000	1235	1785
11.	Obra	1197.52	100,000		55,000	1198	2176
12.	Kuttiyadi	498.00	75,000		46,000	885	1080
13.	Uhl - Stage II	472.28	30,000		30,000	1574	1574
14.	Srisaifam	3038.00	330,000		260,000	920	1186

ANNEX 4

Basic Energy Statistics in Original Units

CONTENTS

INTRODUCTION

ENERGY FLOW CHART

PRODUCTION – TRADE – TRANSFORMATION –
CONSUMPTION

Table No.

- | | |
|---|---|
| <p>4-1. Coking Coal – All India – 1953/4 to 1962/3</p> <p>4-2. Coking Coal – By States – 1960/1</p> <p>4-3. Non-coking Coal – All India – 1953/4 to 1962/3</p> <p>4-3A to 3J. Elimination of Double Counting of Non-coking Coal used in industry for power generation from 1953/4 to 1962/3</p> <p>4-4. Non-coking Coal – By States – 1960/1</p> <p>4-5. Metallurgical Coke – All India – 1953/4 to 1962/3</p> <p>4-6. Metallurgical Coke – By States – 1960/1</p> <p>4-7. Non-Metallurgical Coke – All India – 1953/4 to 1962/3</p> <p>4-8. Non-Metallurgical Coke – By States – 1960/1</p> <p>4-9. Crude Petroleum – All India – 1950/1 to 1962/3</p> <p>4-10. Petroleum Products (Production) – All India – 1950/1 to 1962/3</p> <p>4-11. Petroleum Energy Products – All India – 1950/1 to 1962/3</p> <p>4-11A. Petroleum Energy Products – All India – Breakdown by Product – 1950/1 to 1962/3</p> <p style="padding-left: 20px;">A. Motor Spirit</p> <p style="padding-left: 20px;">B. Aviation and Jet Fuel</p> <p style="padding-left: 20px;">C. High Speed Diesel Oil</p> <p style="padding-left: 20px;">D. Light Diesel Oil</p> <p style="padding-left: 20px;">E. Fuel Oil</p> <p style="padding-left: 20px;">F. Kerosene</p> <p style="padding-left: 20px;">G. Liquefied Petroleum Gas</p> <p style="padding-left: 20px;">H. Naphtha</p> <p style="padding-left: 20px;">I. Refinery Gas</p> <p style="padding-left: 20px;">J. Other Petroleum Energy Products</p> <p>4-12. Petroleum Energy Products – By States – 1960/1</p> <p>4-13. Petroleum Energy Products – By States and By Sectors – 1960/1</p> <p>4-14. Blast Furnace Gas – All India – 1953/4 to 1962/3</p> <p>4-15. Blast Furnace Gas – By States – 1960/1</p> <p>4-16. Gas Work Gas, Coke Oven Gas, Merchant Coke Oven Gas – All India – 1953/4 to 1962/3</p> <p>4-17. Gas Work Gas, Coke Oven Gas, Merchant Coke Oven Gas – By States – 1960/1</p> <p>4-18. Utility Electricity – All India – 1951 to 1962/3</p> <p>4-19. Utility Electricity – By States – 1960/1</p> | <p>4-20. Non-Utility Electricity (Self Generation) – All India – 1951 to 1962/3</p> <p>4-21. Non-Utility Electricity (Self Generation) – By States – 1960/1</p> <p>4-22. Thermal and Diesel Electricity Generation – All India – Fuel Inputs – 1960/1</p> <p>4-23. Utility Electricity + Non-Utility Electricity – All India – 1951 to 1962/3</p> <p>4-24. Production and Uses of Energy Sources – All India – 1953/4</p> <p>4-25. Production and Uses of Energy Sources – All India – 1954/5</p> <p>4-26. Production and Uses of Energy Sources – All India – 1955/6</p> <p>4-27. Production and Uses of Energy Sources – All India – 1956/7</p> <p>4-28. Production and Uses of Energy Sources – All India – 1957/8</p> <p>4-29. Production and Uses of Energy Sources – All India – 1958/9</p> <p>4-30. Production and Uses of Energy Sources – All India – 1959/60</p> <p>4-31. Production and Uses of Energy Sources – All India – 1960/1</p> <p>4-32. Production and Uses of Energy Sources – All India – 1961/2</p> <p>4-33. Production and Uses of Energy Sources – All India – 1962/3</p> <p>4-34. Production and Uses of Energy Sources – Andhra Pradesh – 1960/1</p> <p>4-35. Production and Uses of Energy Sources – Assam – 1960/1</p> <p>4-36. Production and Uses of Energy Sources – Bihar – 1960/1</p> <p>4-37. Production and Uses of Energy Sources – Gujarat – 1960/1</p> <p>4-38. Production and Uses of Energy Sources – Jammu & Kashmir – 1960/1</p> <p>4-39. Production and Uses of Energy Sources – Kerala – 1960/1</p> <p>4-40. Production and Uses of Energy Sources – Madhya Pradesh – 1960/1</p> <p>4-41. Production and Uses of Energy Sources – Madras – 1960/1</p> <p>4-42. Production and Uses of Energy Sources – Maharashtra – 1960/1</p> <p>4-43. Production and Uses of Energy Sources – Mysore – 1960/1</p> <p>4-44. Production and Uses of Energy Sources – Orissa – 1960/1</p> <p>4-45. Production and Uses of Energy Sources – Punjab – 1960/1</p> <p>4-46. Production and Uses of Energy Sources – Rajasthan – 1960/1</p> <p>4-47. Production and Uses of Energy Sources – Uttar Pradesh – 1960/1</p> <p>4-48. Production and Uses of Energy Sources – West Bengal – 1960/1</p> |
|---|---|

INTRODUCTION

1. The study of the energy economy in India requires detailed statistics of production, trade, consumption, etc., for each source of energy. Furthermore, the statistics relating to individual sources of energy must be so arranged as to form a coherent pattern covering all sources. The 1961 edition of the "Basic Statistics of Energy" published by the "Organisation for Economic Co-operation & Development (OECD)" has been used as the guide for the statistical energy tables covering the India energy study. The OECD methods have been tested and successfully used as an easy, understandable means for gathering energy statistics. The tables prepared for India follow the OECD pattern as well as the "Energy Flow Diagram" prepared by the India Energy Study team for India.

The following notes have mainly been taken from the 1961 OECD publication and have been modified as necessary for India.

I. GENERAL NOTES

2. The statistical tables can be used to make an energy balance-sheet in which all sources of energy are expressed in terms of a common unit. There are, in fact, various methods of drawing up such balance-sheets, differing as to the common unit chosen and the coefficients used to express different sources in that unit. These data can be used for preparing an energy balance-sheet of any specific type.

3. All the data supplied are, therefore, expressed in original units, i.e. in the quantitative units normally corresponding to the source of energy concerned: metric tonnes, kilowatt-hour, cubic metres of gas of a certain calorific content, etc. The years covered for the India Energy Study are fiscal years 1953/4 through 1962/3, i.e. the twelve months ending 31st March in the last year indicated. India has been treated by individual State as well as All India. The All India tables have been prepared for each type of energy by source for the ten years described, with one table for each type of energy being prepared by State for 1960/1 which is taken as the base year for the study (Tables 4-1 to 4-23). Further, yearly tables have been prepared, one for each year and All India, that summarise the data relating to all sources of energy for the year concerned (Tables 4-24 to 4-33). The attached Energy Flow Chart illustrates the inter-relation between the various sources of energy in India in 1961.

4. Finally, one table has been prepared for each State summarising the data relating to all sources of energy for 1960/1. The breakdown is as follows:

Table 4-34	– Andhra Pradesh
“ 4-35	– Assam*
“ 4-36	– Bihar
“ 4-37	– Gujarat
“ 4-38	– Jammu & Kashmir

“ 4-39	– Kerala
“ 4-40	– Madhya Pradesh
“ 4-41	– Madras (including Pondicherry)
“ 4-42	– Maharashtra
“ 4-43	– Mysore (including Goa)
“ 4-44	– Orissa
“ 4-45	– Punjab (including Himachal Pradesh & Delhi)
“ 4-46	– Rajasthan
“ 4-47	– Uttar Pradesh
“ 4-48	– West Bengal.

*Including NEFA, Tripura and Manipur

5. In compiling the data in these tables, estimates have had to be used in some cases. These estimates vary in significance with the sources of energy, consuming sector and areas concerned. The data cannot therefore be regarded as strictly accurate. Generally speaking, it may be taken that the margin of error for data relating to production and trade is small, but probably is greater for data on the shares of consumption between different sectors such as Transport, Industry and Domestic. In particular the breakdown of oil products between sub-sectors within industry has been a very difficult task. It has only been done for 1960/1 and the corresponding figures should be used with caution. With regard to the data on changes in stocks, the field covered is specified in the notes on the specific tables (Section IV, page 218).

II. TABLES BY COMMERCIAL SOURCE OF ENERGY (1)

6. Each of these tables relates to a specific source of energy (or group of sources) and contains all of the relevant statistics for the years studied.

7. The sources of energy covered by the various tables are as follows:

Tables 4-1 & 4-2	– Coking Coal
“ 4-3 & 4-4	– Non-coking Coal
“ 4-5 & 4-6	– Metallurgical Coke
“ 4-7 & 4-8	– Non-metallurgical Coke
“ 4-9	– Crude Petroleum (All India)
“ 4-10	– Petroleum Products (Total, All India)
“ 4-11 & 4-11A	– Petroleum Energy Products (All India) and By Product viz: Motor Spirit, Aviation & Jet Fuel, High Speed Diesel Oil, Light Diesel Oil, Fuel Oil, Kerosene, Liquefied Petroleum Gas, Naphtha, Refinery Gas and Others)
“ 4-12	– Statewise Consumption of Petroleum Products in 1960/1
“ 4-13	– Statewise Consumption of Petroleum Products by Sector in 1960/1
“ 4-14 & 4-15	– Blast Furnace Gas

Table 4-16 & 4-17	- Gas Work Gas, Coke Oven Gas (Steel Plants), Merchant Coke Oven Gas
" 4-18 & 4-19	- Utility Electricity
" 4-20 & 4-21	- Non-Utility Electricity (Self Generation)
" 4-22	- Thermal & Diesel Electricity Generation, Fuel Inputs, 1960/1
" 4-23	- Utility Electricity + Non-Utility Electricity.

8. These tables cover the commercial sources of energy, comprising the primary sources and their derivatives (secondary sources). Except for petroleum products, all the tables of individual sources have been given in similar form. They have been divided into two parts, the first being designed to show how "Internal Final Consumption" is defined and the second to show the breakdown of this Internal Final Consumption by consuming sector.

9. Internal Final Consumption is usually determined in the following way, all elements being given in the tables.

Production

- ± Net Balance of External Trade
- Bunkers
- ± Stock Changes (Minus means put to stock)
- = Total Internal Consumption
- Quantities Transformed
- = Internal Final Consumption.

10. The term "Internal" has been used because bunkers (supplies for ships and aircraft of all nationality leaving the country) are not included. However, supplies used for interstate traffic by road, air, rail and water will be considered as consumption at the place of delivery of these supplies rather than bunkers.

11. The term "Final" implies that amounts used for transformation into other sources of energy are not included. In other words, Internal Final Consumption of an energy source corresponds to the amount of that particular source of energy used directly (i.e. as such) within the territory concerned. If, for a given territory, Internal Final Consumption of all energy sources is reduced to a common unit and then totalled, the figure obtained is free of any duplication because the quantities used for conversion have been excluded.

12. Thus, "Internal Final Energy Consumption" includes both the amounts of primary and secondary energy directly consumed by final user sectors, such as transport, industry and agriculture in the form of, for example, coal, coke, petroleum products, gas and electricity. It should be noted that final energy consumption excludes transformation losses and non-energy products but includes consumption by the energy sector such as in power plants and in distribution losses.

(1) The non-commercial sources have been fully dealt with in the main body of the Report. See in particular Table 2 and Chapters 3 and 8 of the Report. See also Tables 4-24 to 4-33 of this Annex 4.

13. In the case of industry, the term "Final Energy Consumption" must be more clearly defined to avoid double counting. Part of the coal delivered to industry, for instance, is used for non-utility power production and some of this electricity is delivered to public networks. Following common practice, the coal used for non-utility power production has been deducted from the industrial sector and is shown as delivered to power plants. Similarly, a part of the energy contained in the coke delivered to the iron and steel industry takes the form of blast furnace gas, part of which is used for electricity production. Following the methods used in the OECD "Basic Statistics of Energy", the necessary deductions have been made in the coke deliveries. The blast furnace gas has thus been counted as a separate secondary energy source, part of which is used for electricity production (transformation) the rest being used by the coke ovens and by the iron and steel industry itself.

14. To allow for "Stock Changes" is somewhat complicated because statistics in this field are invariably seriously inadequate. It has not been possible to do more than to take into account the changes in certain categories of stocks, usually fiscal year end stocks, held by producer firms and, occasionally, by processing firms. The exact scope of the stock change figures has been stated for individual sources of energy in Section IV "Notes on the Specific Tables". As it usually is not possible to allow for changes of stocks held by final consumers, "Consumption" figures actually represent "deliveries to the Consumers" except in those cases where the stocks at large consumers are known. Owing to the layout adopted for the tables, a minus sign before the figure means that the indicated quantity has been put to stocks; it denotes, in actual fact, a reduction in the quantities available for consumption.

15. The breakdown by sector of Internal Final Consumption is given in a standard form for each table. The first heading covers the consumption within the "Energy Sector" (for purposes other than transformation into other sources of energy). The "Energy Sector" covers all undertakings producing primary energy or converting it into some other form. For each source of energy, the tables indicate which parts of the Energy Sector are final consumers. In many cases, consumption takes the form of auto-consumption by the producer firms. Transmission and distribution losses of gas and electric power are shown under the separate heading "Losses".

16. Final consumption outside the "Energy Sector" has been sub-divided as follows:

- Transportation
 - Road
 - Railways
 - Waterways
 - Air
- Industry (see description that follows)
 - Mining & Quarrying

- Fertilizer
- Heavy Chemical
- Structural Clay Products
- Cement
- Iron & Steel
- Non-Ferrous
- Textiles
- Other

Agriculture
 Domestic (1)
 Commercial (1)
 Government (1) (other than public sector industrial enterprises and including military)
 Other Sectors

III. DESCRIPTION OF INDUSTRY ACCORDING TO THE STANDARD CLASSIFICATION OF INDIAN INDUSTRIES

17. Mining and Quarrying includes:
- 121 Iron Ore Mining
 - 122 Metal Mining except Iron Ore
 - 140 Stone Quarrying, Clay and Sand pits
 - 191 Salt Mining and Quarrying
 - 192 Chemical and Fertiliser mineral mining
 - 199 Non-metallic mining and quarrying not elsewhere classified

Note: Coal, Lignite, Petroleum and Gas operations are not included since these are in the energy sector rather than the industrial sector.

18. Fertilisers (311-1) include:
- 311-1.1 Inorganic
 - 311-1.2 Organic
 - 311-1.3 Mixed
19. Heavy Chemicals (311-2) include:
- 311-2.1 Inorganic
 - 311-2.2 Organic
20. Structural Clay Products (331) include:
- 331-1 Fire Bricks
 - 331-2 Refractories
 - 331-3 Furnace Lining Bricks
 - 331-4 Tiles
21. Cement (334)
22. Iron and Steel (341) includes:
- 341-1 Iron & Steel (metal) excepting blast furnaces for which see tables 4-14 and 4-15
 - 341-2 Ferro-alloys
 - 341-3 Iron & Steel Castings and Forgings
 - 341-4 Iron & Steel Structural
 - 341-5 Iron & Steel Pipes
 - 341-6 Special Steels

23. Non-ferrous basic metal industries (342)

(1) The breakdown between "Domestic", "Commercial" and "Government" is not satisfactory for all sources of energy. Unless this can be improved in future statistics, these three sectors should be shown combined.

24. Textiles
25. "Other" includes all other industrial classifications not shown above except:
- 110 Coal Mining (Coal and Lignite)
 - 130 Crude Petroleum and Natural Gas
 - 321 Petroleum Refineries
 - 511 Electric Light & Power
 - 512 Gas Manufacture and distribution which are in the energy sector; and
 - 521 Water Supply
 - 522 Sanitary Services which are usually in the Government sector; and
 - 852 Restaurants
 - 853 Hotels
 - 854 Laundries which are usually in the commercial sector even though publicly-owned

IV. NOTES ON THE SPECIFIC TABLES

COKING COAL (Tables 4-1 and 4-2)

26. Only pit-head stocks and those held by large distributors, coke manufacturers, gas works, and very large consumers have been considered.

Coal Mines' Consumption

27. This heading covers only coking and blending (coking use) coal used as a direct source of energy by mines; it does not include such coal consumed by pit-head power plants (none now exist in India), and does not include middlings.

NON-COKING COAL (Tables 4-3, 4-3A to 4-3J and 4-4)

Stock Changes

28. Only pit-head stocks and those held by large distributors, coke manufacturers, gas works and very large consumers, have been considered.

Transformation

29. Tables 4-3A to 4-3J set out detailed assumptions about the non-coking coal used in non-utility power generation. These quantities are not included under the final consumption of non-coking coal in industry.

Coal Mines' Consumption

30. This heading covers only non-coking, blending (non-coking use), and middling coal used as a direct source of energy by the mines; it does not include such coal consumed by pit-head power plants (none now exist in India).

METALLURGICAL COKE (Tables 4-5 and 4-6)

Stock Changes

31. Stocks held at coke manufacturers, gas works, and very large consumers.

Consumption for Transformation

32. Part of the coke burned in the blast furnace is transformed into blast furnace gas, which is recovered and used as a source of energy for various purposes. Coke consumption at the blast furnaces must, therefore, be partly regarded as a case of "Transformation" and accordingly included under "Consumption for Transformation". To do this the figures for production of blast furnace gas (950 kcal/m³) are expressed in terms of coke on the basis of a calorific content of 6100 kcal/kg of coke. No losses have been attributed to the blast furnace gas production. The balance of coke fed into Blast Furnaces has been shown as final consumption by the Iron & Steel Industry.

Consumption by the Energy Sector

33. The figures correspond to self consumption in gas works, and other coke making facilities.

Iron & Steel Industry

34. This includes all coke used in the Iron & Steel Industry excluding the quantity considered as transformed into blast furnace gas and excluding that already accounted for in coke ovens in "Consumption by the Energy Sector".

NON-METALLURGICAL COKE (Tables 4-7 and 4-8)

Stock Changes

35. Only stocks held at coke manufacturing plants and very large consumers have been taken into account.

CRUDE PETROLEUM (All India, Table 4-9)

Internal Final Consumption

36. All crude oil is consumed at the refineries, and none is used directly at this time.

PETROLEUM PRODUCTS (Table 4-10)

37. This is a special table differing from the standard form of other tables in this part. It is merely intended to give a general view of refining operations and total output of oil products.

Crude Oil Treated at the Refinery

38. The figures correspond to those for consumption of crude oil at the refineries as given in the crude oil table.

Refinery Losses

39. The figures include changes in the stocks of unfinished products in the refinery.

Refinery Fuel Used at the Refinery

40. This corresponds to total auto-consumption at the refinery, whether of unfinished products, as is most often the case, or of finished products.

Substitute Fuels

41. These are similar to oil products, but are obtained from hard coal, coal distillation products (tar, benzol) or distillation of other products (alcohols) or from natural gasoline. At present none is transformed at the refineries.

Production Breakdown

42. Entries under this heading show how the total output of petroleum products (including refinery and substitute fuels) is distributed among the different energy products (Motor Spirit, Aviation & Jet Fuel, HSDO, LDO, Kerosene, LPG, Fuel Oil, Other, including refinery and vaporising oil and the non-energy products (lubricants, bitumens, chemical feed stock, petroleum coke, paraffin, wax, etc.)

PETROLEUM ENERGY PRODUCTS (Table 4-11)

43. This table gives for energy products combined production from crude oil and substitute fuel, the balance of trade, bunkers, stock changes, consumption for transformation and total internal final consumption.

PETROLEUM ENERGY PRODUCTS - BREAKDOWN BY PRODUCT (Table 4-11A)

A. MOTOR SPIRIT

Production

44. The breakdown between products derived from crude oil and substitute fuels is shown.

Stock Changes

45. Only stocks held by refineries and large storage depots are accounted for.

B. AVIATION & JET FUEL

Production

46. Includes aviation gasoline used for air travel as well as the jet fuels (ATF).

Stock Changes

47. Only stocks held by refineries and large storage depots are accounted for.

C. HIGH SPEED DIESEL OIL (HSDO)

D. LIGHT DIESEL OIL (LDO)

E. FUEL OIL (Furnace Oil, EHFO, LSFO, etc.)

Stock Changes (C, D & E)

48. Only stocks held by refineries and large storage depots are accounted for.

F. KEROSENE (Inferior and Superior)

G. LIQUIFIED PETROLEUM GAS (LPG)

49. The figures refer to butane and propane, and are the LPGs used for energy uses.

H. NAPHTHA

I. REFINERY GAS

J. OTHER PETROLEUM ENERGY PRODUCTS

Production

50. Includes vaporising oil, and other energy products not accounted for in items A to I.

CONSUMPTION OF PETROLEUM PRODUCTS IN 1960/1 BY STATE (Table 4-12)

CONSUMPTION OF PETROLEUM PRODUCTS IN 1960/1 BY SECTOR (Table 4-13)

51. The breakdown between States and Sectors is an estimate based on data provided by oil companies.

BLAST FURNACE GAS (Tables 4-14 and 4-15)

52. Blast Furnace Gas is a by-product of the reduction of iron ore by coke oven coke in blast furnaces. It is recovered on leaving the furnace; part of it is used in the blast furnace itself and in the ancillary plant, and the remainder used in the iron and steel industry as well as thermal electric plants especially adapted for this type of fuel. It has been deemed advisable, nevertheless, to devote a special table to blast furnace gas in million cubic metres at 950 kcal/m³. The amounts produced are large and the gas is of a type that is not mixed with other gases, but must be used for its own specific purposes.

GAS WORK GAS, COKE OVEN GAS (STEEL PLANTS), MERCHANT COKE OVEN GAS (Tables 4-16 and 4-17)

53. This table collates data concerning different categories of gas: Gas Work Gas, Merchant Coke Oven

Gas, Coke Oven Gas, but excludes blast furnace gas which is tabulated in a separate table. The figures for these gases have been shown together in terms of million cubic metres since their heat value do not differ much (Coke Oven Gas 4500 kcal/m³, Gas Work Gas and Merchant Coke Oven Gas 4200 kcal/m³). In Tables 4-24 to 4-33 a distinction has been made between Coke Oven Gas and Gas Work Gas.

54. Refinery gas is not shown in this table and has been included in refinery fuel.

UTILITY ELECTRICITY (Tables 4-18 and 4-19)

55. This category includes electricity that is generated, purchased, and distributed by public and private undertakings whose primary business is the sale of electricity to the general public.

Production

56. The production figures quoted refer to gross output, i.e. at alternator terminals (instead of "Net" output measured at station terminals, i.e. after deduction of power absorbed by the station itself and its ancillary installations).

57. The use of gross output rather than "Net" output usually given in electricity statistics preserves uniformity with the statistics for the other sources of energy. As gross output figures are not always available, they have been arrived by adding 6 per cent to the net output for thermal plants and 5 per cent to the net output for diesel plants, when the specific information is not available. The difference between the gross and net production appears as "Consumption by Electric Plants" in Internal Final Consumption.

NON-UTILITY ELECTRICITY (Tables 4-20 and 4-21)

58. This category includes electricity that is primarily generated for use in Industry by Industry or sold by Industry to Utilities.

Production

59. The production figures quoted refer to gross output, i.e. at alternator terminals (instead of "Net" output measured at station terminals, i.e. after deduction of power absorbed by the station itself and its ancillary installations).

60. The use of gross output rather than "Net" output usually given in electricity statistics preserves uniformity with the statistics for the other sources of energy. As gross output figures are not always available, they have been arrived at by adding 6 per cent to the net output for thermal electricity and 5 per cent to the net output of diesel plants when the specific information is not available. The difference between gross and net production appears as "Con-

sumption by Electric Plants" in Internal Final Consumption.

FUEL INPUTS FOR THERMAL & DIESEL GENERATION IN 1960/1 (Table 4-22)

61. This table gives the inputs of the different fuels for Thermal & Diesel Electricity Generation in 1960/1 under Utilities and Non-Utilities.

UTILITY ELECTRICITY + NON-UTILITY ELECTRICITY (Table 4-23)

62. This category gives total of electricity generated and sold in all India by Utilities and Non-utilities given under tables 4-18 and 4-20 respectively.

YEARLY TABLES (Tables 4-24 to 4-33)

63. Each of these tables covers a single year in the period 1953/4 to 1960/1 and includes statistics relating to all sources of energy for that year.

64. The figures in these tables are extracted from the tables by Commercial Sources of Energy (Tables 4-1 to 4-23). As, however, it has occasionally been necessary to condense data so as to bring together in a common framework statistics concerning all sources of energy, these tables do not necessarily include all the details given in the tables drawn up for the separate sources of energy.

65. The annual tables like those for the individual sources have been divided into two parts, the first of which is intended to show total internal final consumption and the second the breakdown of consumption by sector. The layout is practically the same as for the other tables.

66. The first part of the tables has separate sections for Primary and for Secondary Sources of Energy. The following are classified as Primary:

Coking Coal, Non-coking Coal, Crude Oil,
Hydro Power and Non-Commercial Fuels.

67. Power Alcohol, a substitute fuel derived from Molasses has been shown under "Motor Spirit" against space reserved for "Primary" Source of Energy for convenience. Similarly, the production of electricity from primary hydro power has been shown in the space reserved for "Primary" sources under "Utility Electricity".

68. The sale of energy by Electricity Non-Utility Undertakings to Utilities has been shown against the column "Balance of External Trade" under Secondary Sources of Energy for convenience.

69. The figures relating to Non-Commercial Sources of Energy, which, have been fully dealt with in the Report, have mainly been extracted from Table 2 of the Report.

TABLES BY STATE (4-34 to 4-48)

70. These tables set out for each State, statistics relating to all sources of energy. The figures have been extracted from By State Tables in the series 4-1 to 4-23. In these tables 4-34 to 4-48 the consumption of oil products by Sector has been shown separately, adopting 1000 tonnes as the unit as the consumption figures of individual products are small compared to the other fuels. See also the remarks relating to the "Yearly Tables" in paragraph 63 to 69 above.

V. SYMBOLS USED

- Nil, or less than half the final digit shown.
- () Estimate.
- Value impossible to isolate and included in the figure indicated by the arrow.

NA Not available

1961 INDIA ENERGY FLOW

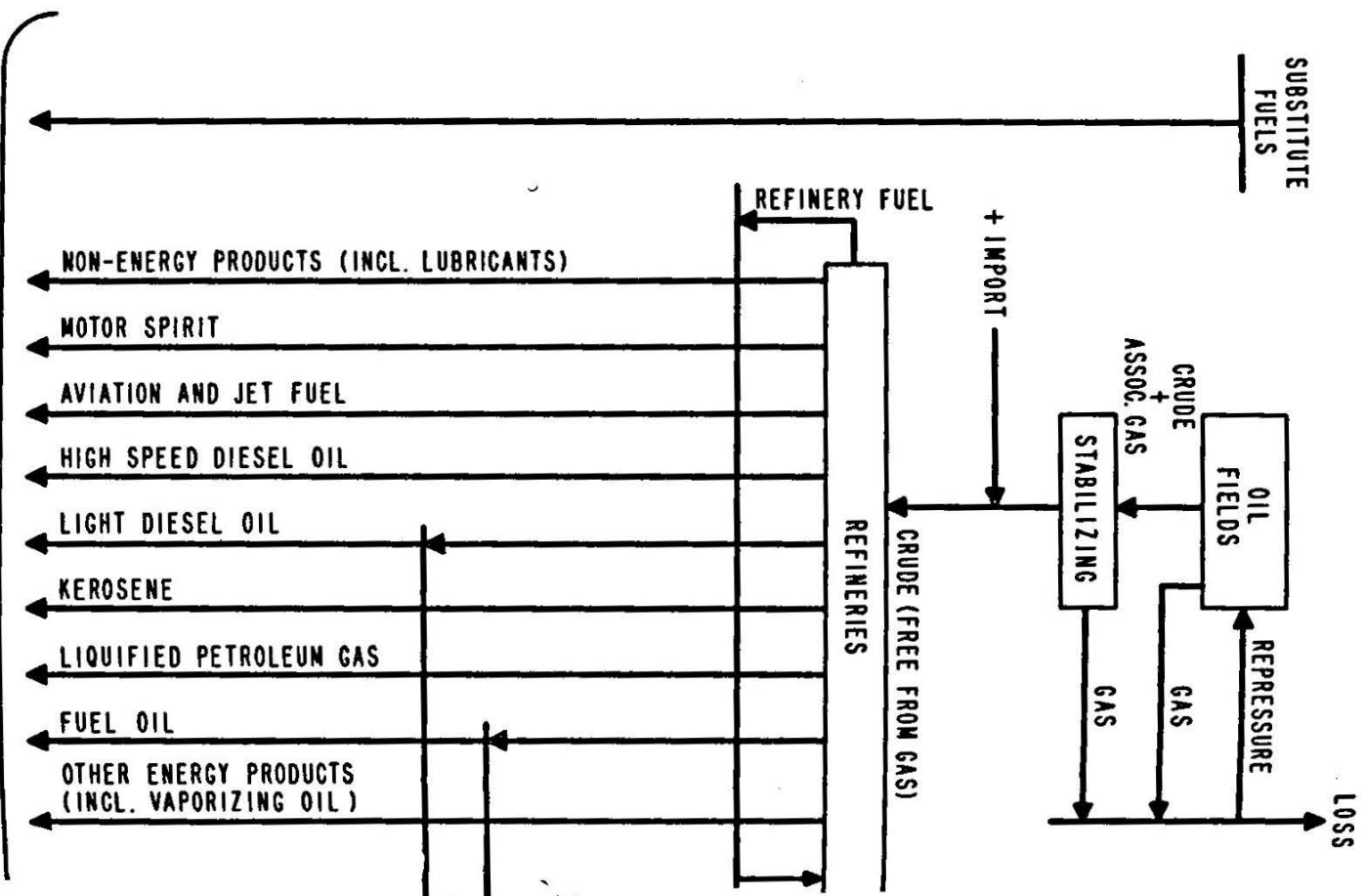

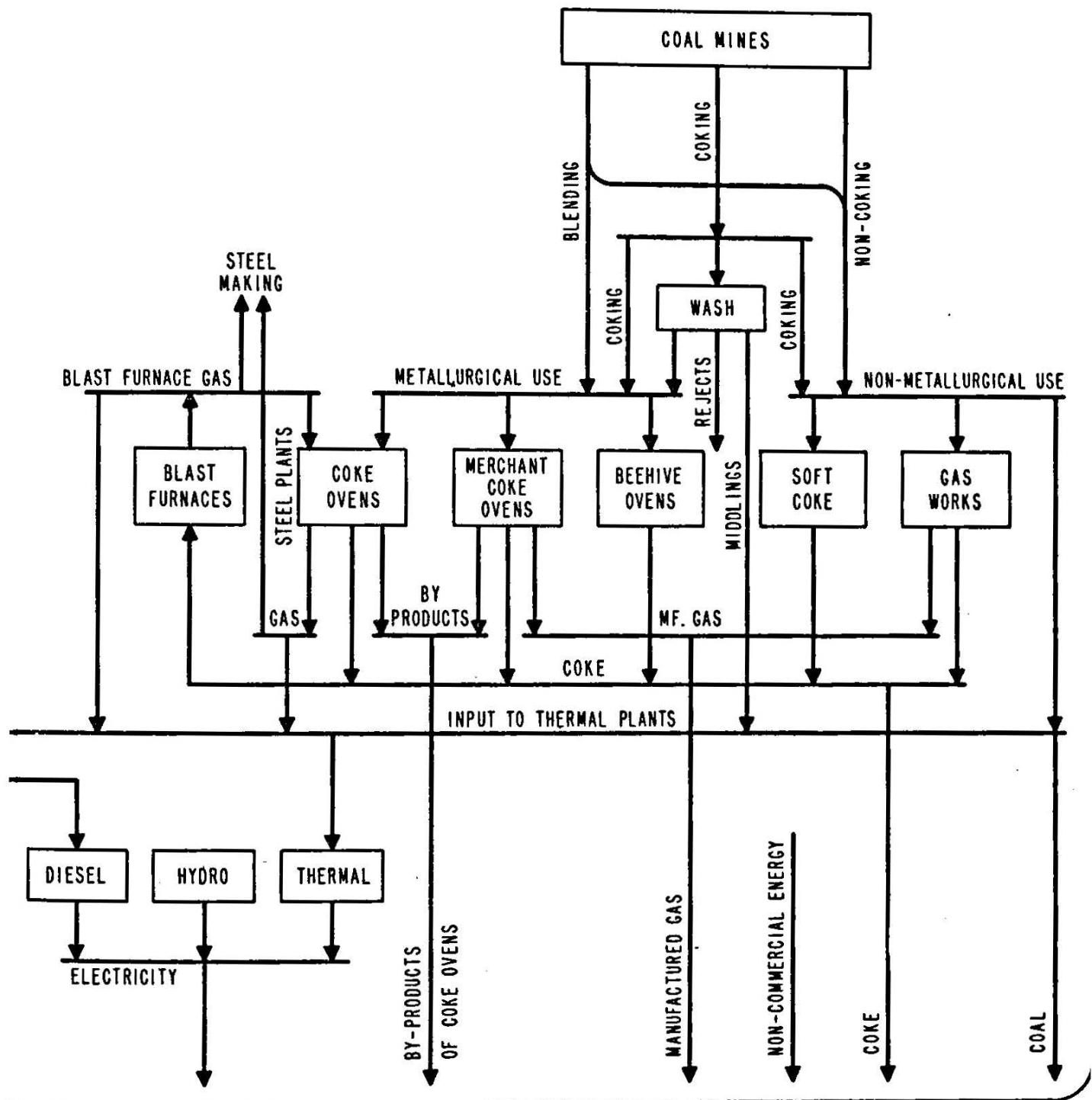

INTERNAL FINAL CONSUMPTION

NOTE - ALL LOSSES NOT SHOWN. NEITHER HAVE EXTERNAL TRADE, EXCEPT IN ONE CASE, STOCK CHANGES AND BUNKERS BEEN SHOWN.

TABLE 4-1
COKING COAL - ALL INDIA
(Million Tonnes)
PRODUCTION - TRADE - TRANSFORMATION - CONSUMPTION

	1953/4	1954/5	1955/6
PRODUCTION	13.93	13.77	13.68
Less: Middlings & Rejects	-0.14	-0.19	-0.21
STOCK CHANGES⁽¹⁾	-0.88	-0.80	-0.74
TOTAL INTERNAL CONSUMPTION	12.91	12.78	12.73
CONSUMPTION FOR TRANSFORMATION	-5.00	-5.41	-5.69
Of which: Coke Ovens⁽²⁾	2.56	2.96	3.08
Merchant ovens	0.35	0.30	0.35
Beehive ovens	0.19	0.25	0.27
Soft Coke Manufacture	1.37	1.34	1.51
Gas Works	0.16	0.18	0.17
Thermal Plants	0.37	0.38	0.33
TOTAL INTERNAL FINAL CONSUMPTION	7.91	7.37	7.04
BREAKDOWN OF INTERNAL FINAL			
A. CONSUMPTION BY THE ENERGY SECTOR.			
Coal Mines	0.69	0.68	0.73
B. CONSUMPTION BY OTHER SECTORS.			
TRANSPORTATION - Railways	5.03	4.86	5.24
INDUSTRY	2.19	1.83	1.07
Of which: Iron & Steel	0.80	0.65	0.44
Others	1.39	1.18	0.63
TOTAL INTERNAL FINAL CONSUMPTION	7.91	7.37	7.04

(1)- Means increase in stock

(2) Represent coal fed with coke ovens

1956/7	1957/8	1958/9	1959/60	1960/1	1961/2	1962/3
14.38	15.37	15.33	14.75	16.24	16.99	17.32
-0.25	-0.26	-0.28	-0.50	-0.67	-1.05	-1.59
-0.62	-0.70	-0.71	-0.25	-1.78	-1.12	+0.59
13.49	14.41	14.34	13.94	13.81	14.82	16.32
-5.69	-6.20	-7.23	-8.68	-8.56	-10.97	-11.80
2.96	3.08	3.82	5.36	6.64	8.28	9.35
0.36	0.47	0.51	0.58	0.78	0.99	1.10
0.37	0.47	0.59	0.48	0.28	0.42	0.48
1.52	1.66	1.73	1.66	1.19	1.05	0.48
0.18	0.19	0.20	0.19	0.20	0.20	0.20
0.30	0.35	0.38	0.41	0.47	0.03	0.01
7.80	8.21	7.11	5.26	4.25	3.85	4.72
CONSUMPTION						
0.72	0.77	0.77	0.73	0.81	0.85	0.91
5.70	5.70	4.57	3.90	1.32	1.39	2.11
1.38	1.74	1.77	0.63	2.12	1.61	1.70
0.62	0.71	0.90	0.43	1.31	1.21	1.20
0.76	1.03	0.87	0.20	0.81	0.40	0.50
7.80	8.21	7.11	5.26	4.25	3.85	4.72

TABLE 4-2
COKING COAL 1960/1 - BY STATES
 (Million Tonnes)
PRODUCTION - TRADE - TRANSFORMATION - CONSUMPTION

	All India	Andhra Pradesh	West Bengal	Bihar	Gujarat	Kerala
PRODUCTION	16.24		0.68	15.56		
Less: Middlings & Rejects	-0.67			-0.67		
BALANCE OF EXTERNAL TRADE	-	+0.05	+3.18	-6.16	+0.02	+0.02
STOCK CHANGES⁽¹⁾	-1.76		-0.07	-1.69		
TOTAL INTERNAL CONSUMPTION	13.81	0.05	3.79	7.04	0.02	0.02
CONSUMPTION FOR TRANSFORMATION	-9.56	-	-2.76	-4.82		
Of which: Coke Ovens ⁽²⁾	6.64		2.19	2.60 ⁽³⁾		
Merchant Ovens	0.78		0.39 ⁽⁴⁾	0.39		
Beehive Ovens	0.28			0.28		
Soft Coke Manufacturing.	1.19		0.08	1.11		
Gas Works	0.20		0.10			
Thermal Plants	0.47			0.44		
TOTAL INTERNAL FINAL CONSUMPTION	4.25	0.05	1.03	2.22	0.02	0.02
BREAKDOWN OF INTERNAL FINAL CONSUMPTION						
A. CONSUMPTION BY THE ENERGY SECTOR						
Coal mines	0.81		0.03	0.78		
B. CONSUMPTION BY OTHER SECTORS						
TRANSPORTATION - Railways	1.32	0.05	0.24	0.23	0.02	0.02
INDUSTRIES	2.12	-	0.76	1.21	-	
Of which: Iron & Steel	1.31	-	0.76 ⁽⁵⁾	0.40		
Other Industry	0.81	-	-	0.81		
TOTAL INTERNAL FINAL CONSUMPTION.	4.25	0.05	1.03	2.22	0.02	0.02

(1) - means increase in stocks

(2) represents coal fed into coke ovens.

(3) includes 0.33 million tonnes for Sindri.

(4) Probably includes 0.11 million tonnes of Non-Coking Coal used for power generation in the Durgapur Coke oven power plant.

(5) Includes 0.13 million tonnes used for power generation

Maharashtra	Madhya Pradesh	Madras	Mysore	Orissa	Punjab	Rajasthan	Uttar Pradesh	Delhi
+0.24	+1.29	+0.07	+0.04	+0.87	+0.08	+0.08	+0.22	
0.24	1.29	0.07	0.04	0.87	0.08	0.08	0.22	
-0.10	-1.02			-0.86				
	1.01			0.84				
0.10								
	0.01			0.02				
0.14	0.27	0.07	0.04	0.01	0.08	0.08	0.22	
0.14	0.12	0.07	0.04	0.01	0.08	0.08	0.22	
	0.15							
	0.15							
	-							
0.14	0.27	0.07	0.04	0.01	0.08	0.08	0.22	

TABLE 4-3

NON COKING COAL - ALL INDIA
(Million Tonnes)

PRODUCTION - TRADE - TRANSFORMATION - CONSUMPTION

	1953/4	1954/5	1955/6
PRODUCTION	22.94	24.05	25.47
Of which: Middlings	0.08	0.11	0.12
BALANCE OF EXTERNAL TRADE	-1.99	-1.89	-1.60
STOCK CHANGES ⁽¹⁾	0.68	-0.36	-1.25
BUNKERS	-0.41	-0.36	-0.24
TOTAL INTERNAL CONSUMPTION	21.22	21.44	22.38
CONSUMPTION FOR TRANSFORMATION	-5.65	-5.81	-6.35
Of which: Thermal Plants ⁽²⁾	4.73	4.85	5.35
Soft Coke Manufacture	0.92	0.96	1.00
TOTAL INTERNAL FINAL CONSUMPTION ⁽³⁾	15.57	15.63	16.03

BREAKDOWN OF INTERNAL FINAL CONSUMPTION

A. CONSUMPTION BY ENERGY SECTOR			
Coal Mines ⁽³⁾	1.02	1.08	1.14
B. CONSUMPTION BY OTHER SECTORS			
TRANSPORTATION	7.13	6.79	7.16
Of which: Railways ⁽³⁾	6.89	6.51	6.84
Waterways	0.24	0.28	0.32
INDUSTRY	6.63	6.87	6.74
of which:			
Mining and Quarrying	-	-	-
Fertilizer & Chemicals ⁽³⁾	-	-	0.01
Structural Clay products & brick burning ⁽³⁾	0.08 ⁽⁶⁾	0.08 ⁽⁶⁾	0.08 ⁽⁶⁾
Cement ⁽³⁾	1.12	1.17	1.29
Iron & Steel	-	-	-
Non-ferrous ⁽³⁾ (copper only)	0.05 ⁽⁴⁾	0.04 ⁽⁴⁾	0.06 ⁽⁴⁾
Textiles	-	-	-
Others ⁽³⁾	5.38 ⁽⁵⁾	5.58 ⁽⁵⁾	5.30 ⁽⁵⁾
AGRICULTURE	0.17	0.22	0.32
DOMESTIC			
COMMERCIAL	0.14	0.13	0.12
GOVERNMENT	0.48	0.54	0.55
TOTAL INTERNAL FINAL CONSUMPTION	15.57	15.63	16.03

(1) - means increase in stocks

(2) Both utility and non-utility. For details see Tables 3A to 3J

(3) Excluding non-coking coal used in non-utility power generation.
See details in Tables 3A to 3J

(4) Includes lime stone burning.

(5) Includes textiles.

(6) Excludes brickburning.

(7) Includes 0.35 million tonnes lignite mined in Madras State

1956/7	1957/8	1958/9	1959/60	1960/1	1961/2	1962/3
26.74	29.54	31.71	34.21	39.95	38.97	47.56 ⁽⁷⁾
0.15	0.15	0.20	0.37	0.46	0.73	1.05
-1.71	-1.73	-1.71	-1.39	-1.26	-1.31	-1.26
-1.21	-0.41	-0.62	-2.70	-2.46	+2.03	-2.93
-0.23	-0.20	-0.14	-0.15	-0.12	-0.13	-0.13
23.59	27.20	29.24	29.97	36.11	39.56	43.24 ⁽⁷⁾
-6.67	-6.85	-7.69	-8.00	-10.07	-11.97	-13.03 ⁽⁷⁾
5.65	5.92	6.57	6.92	8.62	10.26	10.26 ⁽⁷⁾
1.02	0.93	1.12	1.08	1.45	1.71	2.77
16.92	20.35	21.55	21.97	26.04	27.59	30.21
1.20	1.34	1.26	1.55	1.81	2.13	2.60
7.97	8.96	10.18	11.34	14.72	15.29	15.24
7.67	8.64	9.83	11.01	14.26	14.97	14.92
0.30	0.32	0.35	0.33	0.46	0.32	0.32
6.71	9.23	9.06	8.11	8.64	9.79	11.85
-	-	-	-	0.02	0.04	0.04
0.31	0.37	0.36	0.26	0.35	-	-
1.55	1.51	1.95	1.82	1.05	1.46	1.80
1.44	1.75	1.74	1.82	2.28	2.49	2.43
-	-	-	-	-	0.13	0.14
0.03	0.03	0.04	0.05	0.04	-	-
1.77	1.81	1.77	1.72	1.83	2.10	2.21
1.61	3.76	3.20	2.44	3.07	3.57	5.23
0.29	0.28	0.42	0.30	0.19	0.04	0.06
				0.01	-	
0.12	0.09	0.09	0.08	0.07	0.07	0.09
0.63	0.45	0.54	0.59	0.60	0.27	0.37
16.92	20.35	21.55	21.97	26.04	27.59	30.21

TABLES 4-3A to 4-3J
NON-COKING COAL - ALL INDIA

ELIMINATION OF DOUBLE COUNTING OF NON-COKING COAL USED IN INDUSTRY FOR POWER GENERATION

1953/4	TABLE 3A			
	Deliveries of non- coking coal	Power Production from non- coking coal	mt Non-coking coal requi- red for power production at	Use of non- coking coal for purposes other than power gene- ration
	mt	TWh	1 mt/TWh	mt
A. INDUSTRY				
Mining & Quarrying	-	-	-	-
Fertilizers & Chemicals	-	-	-	-
Cement	1.45	0.33	0.33	1.12
Non-ferrous	0.14	0.09	0.09	0.05
Other (incl. Textiles)	5.95	0.57	0.57	5.38
TOTAL (A)	7.54	0.99	0.99	6.55
B. RAILWAYS	7.01	0.12	0.12	6.89
C. COAL MINES	1.14	0.12	0.12	1.02
TOTAL (A+B+C)	15.69	1.23	1.23	14.46

1955/6	TABLE 3C			
	Deliveries of non- coking coal	Power Production from non- coking coal	mt Non-coking coal requi- red for power production at	Use of non- coking coal for purposes other than power gene- ration
	mt	TWh	1 mt/TWh	mt
A. INDUSTRY				
Mining & Quarrying	-	-	-	-
Fertilizer & Chemicals	0.35	0.34	0.34	0.01
Cement	1.65	0.36	0.36	1.29
Non-Ferrous	0.15	0.09	0.09	0.06
Other (incl. Textiles)	6.05	0.75	0.75	5.30
TOTAL (A)	8.20	1.54	1.54	6.66
B. RAILWAYS	7.30	0.14	0.14	7.16
C. COAL MINES	1.27	0.13	0.13	1.14
TOTAL (A+B+C)	16.77	1.81	1.81	14.96

1954/5

TABLE 3B

	Deliveries of non-cok- ing coal	Power Production from non- coking coal	mt Non-coking coal requi- red for power production at	Use of non- coking coal for purposes other than power generation
	mt	TWh	1 mt/TWh	mt
A. INDUSTRY				
Mining & Quarrying	—	—	—	—
Fertilizers & Chemicals	—	—	—	—
Cement	1.51	0.34	0.34	1.17
Non-ferrous	0.14	0.10	0.10	0.04
Other (incl. Textiles)	6.20	0.62	0.62	5.58
TOTAL (A)	7.85	1.06	1.06	6.78
B. RAILWAYS	6.62	0.11	0.11	6.51
C. COAL MINES	1.20	0.12	0.12	1.06
TOTAL (A+B+C)	15.67	1.29	1.28	14.38

1956/7

TABLE 3D

	Deliveries of non-cok- ing coal	Power Production from non- coking coal	mt Non-coking coal requi- red for power production at	Use of non- coking coal for purposes other than power generation
	mt	TWh	1 mt/TWh	mt
A. INDUSTRY				
Mining & Quarrying	—	—	—	—
Fertilizer & Chemicals	0.67	0.36	0.36	0.31
Cement	1.84	0.40	0.40	1.44
Non-ferrous	0.18	0.08	0.08	0.10
Other (incl. Textiles)	5.57	0.77	0.77	4.80
TOTAL (A)	8.26	1.61	1.61	6.65
B. RAILWAYS	7.80	0.13	0.13	7.67
C. COAL MINES	1.33	0.13	0.13	1.20
TOTAL (A+B+C)	17.39	1.87	1.87	15.52

(continued)

TABLE 4-3A to 4-3J (continued)

NON-COKING COAL - ALL INDIA

ELIMINATION OF DOUBLE COUNTING OF NON-COKING COAL USED IN INDUSTRY FOR POWER GENERATION

1957/8

TABLE 3E

	Deliveries of non- coking coal	Power Production from non- coking coal	mt Non-coking coal requi- red for power production at	Use of non- coking coal for purposes other than power gene- ration
	mt	TWh	1 mt/TWh	mt
A. INDUSTRY				
Mining & Quarrying	—	—	—	—
Fertilizer & chemicals	0.73	0.36	0.36	0.37
Cement	2.12	0.47	0.47	1.65
Non-ferrous	0.23	0.08	0.08	0.15
Other (incl. Textiles)	6.19	0.74	0.74	5.45
TOTAL (A)	9.27	1.65	1.65	7.62
B. RAILWAYS	8.79	0.15	0.15	8.64
C. COAL MINES	1.47	0.13	0.13	1.34
TOTAL (A+B+C)	19.53	1.93	1.93	17.60

1958/60

TABLE 3G

	Deliveries of non- coking coal	Power Production from non- coking coal	mt Non-coking coal requi- red for power production at	Use of non- coking coal for purposes other than power gene- ration
	mt	TWh	1 mt/TWh	mt
A. INDUSTRY				
Mining & Quarrying	—	—	—	—
Fertilizer & Chemicals	0.73	0.47	0.47	0.26
Cement	2.33	0.51	0.51	1.82
Non-ferrous	0.22	0.09	0.09	0.13
Other (incl. Textiles)	5.80	0.72	0.72	5.08
TOTAL (A)	9.08	1.79	1.79	7.29
B. RAILWAYS	11.13	0.12	0.12	11.01
C. COAL MINES	1.69	0.14	0.14	1.55
TOTAL (A+B+C)	21.90	2.05	2.05	19.85

1958/9

TABLE 3F

	Deliveries of non-cok- ing coal	Power Production from non- coking coal	mt Non-coking coal requi- red for power production at	Use of non- coking coal for purposes other than power generation
	mt	TWh	1 mt/TWh	mt
A. INDUSTRY				
Mining & Quarrying	—	—	—	—
Fertilizers & chemicals	0.77	0.41	0.41	0.38
Cement	2.15	0.41	0.41	1.74
Non-ferrous	0.23	0.09	0.09	0.14
Other (incl. Textiles)	5.55	0.68	0.68	4.87
TOTAL (A)	8.70	1.59	1.59	7.11
B. RAILWAYS	9.99	0.16	0.16	9.83
C. COAL MINES	1.58	0.32	0.32	1.28
TOTAL (A+B+C)	20.27	2.07	2.07	18.20

1960/1

TABLE 3H

A. INDUSTRY				
Mining & Quarrying	0.02	—	—	0.02
Fertilizer & chemicals	0.89	0.54	0.54	0.35
Cement	2.77	0.49	0.49	2.28
Non-ferrous	0.18	0.08	0.08	0.10
Other (incl. Textiles)	5.60	0.78	0.78 ⁽¹⁾	4.82
TOTAL (A)	9.46	1.89	1.89	7.57
B. RAILWAYS	14.43	0.11	0.17 ⁽²⁾	14.26
C. COAL MINES	1.96	0.15	0.15	1.81
TOTAL (A+B+C)	25.85	2.15	2.21	23.64

(1) Approximate figure; specific consumption works out to 1.07 kg/kWh

(2) Actual figure; specific consumption works out at 1.55 kg/kWh.

(continued)

TABLE 4-3A to 4-3J (continued)

NON-COKING COAL - ALL INDIA

ELIMINATION OF DOUBLE COUNTING OF NON-COKING COAL USED IN INDUSTRY FOR POWER GENERATION

1961/2				
TABLE 3I				
	Deliveries of non- coking coal	Power Production from non- coking coal	mt Non-coking coal requi- red for power production at	Use of non- coking coal for purposes other than power gene- ration
	mt	TWh	1 mt/TWh	mt
A. INDUSTRY				
Mining & Quarrying	0.04	—	—	0.04
Fertilizer & Chemicals	0.71	0.71	0.71	—
Cement	2.98	0.47	0.47	2.49
Non-Ferrous	0.08	0.08	0.09	—
Other (including tex- tiles)	6.57	0.90	0.90	5.67
TOTAL (A)	10.37	2.17	2.17	8.20
B. RAILWAYS	15.05	0.08	0.08	14.97
C. COAL MINES	2.29	0.16	0.16	2.13
TOTAL (A+B+C)	27.71	2.41	2.41	25.30

1962/3

TABLE 3J

	Deliveries of non-cok- ing coal	Power Production from non- coking coal	mt Non-coking coal requi- red for power production at	Use of non- coking coal for purposes other than power generation
	mt	TWh	mt/TWh	mt
A. INDUSTRY				
Mining & Quarrying	0.04	—	—	0.04
Fertilizer & Chemicals	0.74	0.74	0.74	—
Cement	2.85	0.42	0.42	2.43
Non-Ferrous	0.08	0.08	0.08	—
Other (including Textiles)	8.39	0.98	0.98	7.41
TOTAL (A)	12.10	2.22	2.22	9.88
B. RAILWAYS	15.03	0.08	0.08	14.85
C. COAL MINES	2.80	0.20	0.20	2.60
TOTAL (A+B+C)	29.93	2.50	2.50	27.43

TABLE 4-4

NON-COKING COAL - 1960/1 - BY STATES

(Million Tonnes)

PRODUCTION- TRADE - TRANSFORMATION - CONSUMPTION

	All India	Andhra Pradesh	Assam	West Bengal	Bihar	Gujarat	Kerala	Maharashtra	Madhya Pradesh	Madras	Mysore	Orissa	Punjab	Rajasthan	Uttar Pradesh	Delhi	Tripura
PRODUCTION	39.95	2.57	0.70	16.23	11.94			0.82	6.74			0.90		0.05			
Of which: Middlings.	0.46				0.48				-0.02 ⁽¹⁾								
BALANCE OF EXTERNAL TRADE	-1.26	-0.20	-0.04	-10.12	-4.81	+3.67	+0.14	+2.73	-2.89	+1.63	+0.68	-0.25	+1.63	+1.42	+4.58	+0.54	+0.01
STOCK CHANGES ⁽²⁾	-2.46	-0.01	+0.01	-0.35	-1.61			-0.01	-0.44			-0.05					
BUNKERS	-0.12	-0.04		-0.06				-0.01		-0.01							
TOTAL INTERNAL CONSUMPTION	36.11	2.32	0.67	5.70	5.52	3.67	0.14	3.53	3.41	1.62	0.68	0.60	1.63	1.47	4.58	0.54	0.01
CONSUMPTION FOR TRANSFORMATION	-10.07	-0.29		-1.76	-2.74	-1.19		-1.24	-0.66	-0.35	-0.10	-0.10	-0.12	-0.24	-0.95	-0.31	
Of which: Thermal Plants	8.62	0.29		1.68	1.39	1.19		1.24	0.66	0.35	0.10	0.10	0.12	0.24	0.95	0.31	
Soft Coke																	
Manufacturing	1.45			0.10	1.35												
TOTAL INTERNAL FINAL CONSUMPTION.	26.04	2.03	0.67	3.94	2.78	2.48	0.14	2.29	2.75	1.27	0.58	0.50	1.51	1.23	3.63	0.23	0.01
								FINAL CONSUMPTION									
								BREAKDOWN OF INTERNAL									
A. CONSUMPTION BY ENERGY SECTOR								0.04	0.32			0.04					
Coal Mines	1.81	0.08	0.03	0.80	0.50												
B. CONSUMPTION BY OTHER SECTORS								1.41	1.70	0.82	0.41	0.30	0.74	0.83	2.48	-	-
TRANSPORTATION	14.72	1.20	0.38	1.74	1.49	1.10	0.12	1.41	1.70	0.82	0.41	0.30	0.74	0.83	2.48	-	-
Of which: Railways.	14.26	1.20	0.23	1.50	1.42	1.10	0.12	1.41	1.70	0.82	0.41	0.30	0.74	0.83	2.48	-	-
Waterways	0.46		0.15	0.24	0.07												
INDUSTRY	8.64	0.73	0.23	1.18	0.72	1.37	0.02	0.79	0.71	0.44	0.17	0.16	0.55	0.34	1.00	0.21	0.01
Of which: Mining & Quarrying	0.02				0.02												
Fertilizer & Chemicals	0.35	0.02		0.02		0.14				0.01		0.01	0.01	0.02	0.09	0.03	
Structural Clay Products	1.05	0.03	0.05	0.14	0.07	0.04		0.04	0.06	0.06		0.05	0.16	0.01	0.28	0.05	0.01
Cement	2.28	0.22			0.29	0.47	0.01		0.27	0.32	0.16	0.08	0.15	0.24	0.07		
Non-Ferrous	0.04				0.04												
Textiles	1.83	0.12		0.06		0.71		0.30	0.27	0.01	0.01	0.01	0.06	0.04	0.17	0.07	0.01
Other	3.07	0.34	0.18	0.96	0.30	0.01	0.01	0.45	0.11	0.04		0.01	0.17	0.03	0.39	0.06	0.01
AGRICULTURE.	0.19				0.02												
DOMESTIC	0.01		0.01														
COMMERCIAL	0.07			0.07				0.05	0.02	0.01			0.14	0.04	0.08	0.01	
GOVERNMENT	0.60	0.02	0.02	0.15	0.05	0.01											
TOTAL INTERNAL FINAL CONSUMPTION	26.04	2.03	0.67	3.94	2.78	2.48	0.14	2.29	2.75	1.27	0.58	0.50	1.51	1.23	3.63	0.23	0.01

(1) Represents washery losses (rejects).

(2) - means increase in stocks.

TABLE 4-5
METALLURGICAL COKE - ALL INDIA

(Million Tonnes)

PRODUCTION - TRADE - TRANSFORMATION - CONSUMPTION

	1953/4	1954/5	1955/6	1956/7	1957/8	1958/9	1959/60	1960/1	1961/2	1962/3
PRODUCTION	2.17	2.43	2.59	2.55	2.69	3.33	4.41	5.21	7.12	7.99
Of Which: Coke Ovens (1)	1.74	2.01	2.08	2.01	2.08	2.60	3.65	4.50	6.23	7.03
Merchant Coke Ovens	0.28	0.23	0.28	0.27	0.30	0.34	0.44	0.52	0.81	0.64
Beehive Ovens	0.15	0.19	0.23	0.27	0.31	0.39	0.32	0.19	0.29	0.32
BALANCE OF EXTERNAL TRADE	-0.03	-0.03	-0.02	-0.02	-0.04	-0.03	-0.03	-0.01	-0.01	-0.01
STOCK CHANGES (2)	-0.07	-0.20	-0.16	-0.20	-0.31	-0.11	-0.21	+0.05	-0.08	-0.05
TOTAL INTERNAL CONSUMPTION	2.07	2.20	2.41	2.33	2.34	3.19	4.17	5.25	7.03	7.93
CONSUMPTION FOR TRANSFORMATION	-0.61	-0.66	-0.63	-0.63	-0.66	-0.82	-1.23	-1.91	-2.13	-2.37
In Blast furnaces (3)	0.61	0.66	0.63	0.63	0.66	0.82	1.23	1.88	2.13	2.37
In Thermal Plants								0.03		
TOTAL INTERNAL FINAL CONSUMPTION	1.46	1.54	1.78	1.70	1.68	2.37	2.94	3.34	4.90	5.58
BREAKDOWN OF INTERNAL FINAL CONSUMPTION-										
RAILWAYS									0.04	0.05
INDUSTRY	1.46	1.54	1.78	1.70	1.68	2.37	2.94	3.34	4.86	5.51
Of Which: Fertilizers(4)	(0.16)	(0.20)	(0.20)	(0.20)	(0.20)	(0.20)	0.22	0.22	0.23	0.23
Iron & Steel (5)	1.30	1.34	1.58	1.50	1.48	2.17	2.72	3.12	4.63	5.28
TOTAL INTERNAL FINAL CONSUMPTION	1.46	1.54	1.78	1.70	1.68	2.37	2.94	3.34	4.90	5.58

(1) Steel Plants and Sindri

(2) - Means increase in stock

(3) Represents coke equivalent of Blast Furnace Gas produced

(4) Sindri

(5) Excluding the quantities considered as transformed into blast furnace gas (Cf note 3)

() Means estimated figures.

TABLE 4-6

METALLURGICAL COKE - 1960/1 - BY STATES

(Million Tonnes)

PRODUCTION - TRADE - TRANSFORMATION - CONSUMPTION

	All India	Andhra Pradesh	Assam	West Bengal	Bihar	Gujarat	Maharashtra	Madhya Pradesh	Madras	Mysore	Orissa	Punjab	Rajasthan	Uttar Pradesh	Delhi
PRODUCTION	5.21	-		1.75	2.22			0.67			0.57(9)				
Of which: Coke Ovens (1)	4.50			1.49(4)	1.77(6)			0.67(8)			0.57(9)				
Merchant Coke Ovens	0.52			0.26(5)	0.26(7)										
Bhive Ovens	0.19			-	0.19										
BALANCE OF EXTERNAL TRADE	-0.01	+0.01	+0.01	-0.05	-0.40	+0.03	+0.05	+0.09	+0.02	+0.09	-0.07	+0.10	+0.01	+0.09	+0.01
STOCK CHANGES (2)	+0.05			+0.02	+0.03										
TOTAL INTERNAL CONSUMPTION	5.25	0.01	0.01	1.72	1.85	0.03	0.05	0.76	0.02	0.09	0.50	0.10	0.01	0.09	0.01
CONSUMPTION FOR TRANSFORMATION	-1.91	-	-	-0.73	-0.67	-		-0.30		-0.03	-0.18				
Of which: In Blast Furnaces (3)	1.88	-	-	0.71	0.67	-		0.30		0.03	0.17				
In Thermal Plants	0.03	-	-	0.02	-	-					0.01				
TOTAL INTERNAL FINAL CONSUMPTION	3.34	0.01	0.01	0.99	1.18	0.03	0.05	0.46	0.02	0.06	0.32	0.10	0.01	0.09	0.01
BREAKDOWN OF INTERNAL FINAL CONSUMPTION															
RAILWAYS (10)															
INDUSTRY	3.34	0.01	0.01	0.99	1.18	0.03	0.05	0.46	0.02	0.06	0.32	0.10	0.01	0.09	0.01
Of which: Fertilizers	0.22	-	-	-	0.22(11)	-	-	-	-	-	-	-	-	-	-
Iron & Steel (12)	3.12	0.01	0.01	0.99	0.96	0.03	0.05	0.46	0.02	0.06	0.32	0.10	0.01	0.09	0.01
TOTAL INTERNAL FINAL CONSUMPTION	3.34	0.01	0.01	0.99	1.18	0.03	0.05	0.46	0.02	0.06	0.32	0.10	0.01	0.09	0.01

(1) Steel plants & Sindri

(2) - means increase in stocks

(3) Represents the coke equivalent of Blast furnace gas produced.

(4) Durgapur Steel Plant & Indian Iron and Steel Co.

(5) Durgapur Coke Oven

(6) Tata Iron & Steel Co. and Sindri Fertilizers.

(7) Giridih Coke Plant, Bararea Coke Plant, Lodna Coke Plant, Loyabadi Coke Plant.

(8) Bhilai Steel Plant

(9) Rourkela Steel Plant

(10) Railways consumed 0.04 million tonnes of coke during the year and this quantity is included in the figures against "Iron & Steel" as break-up figures for the States are too small to be exhibited separately.

(11) Sindri Fertilizers

(12) Excluding the quantities considered as transformed into blast furnace gas.

TABLE 4-7
NON-METALLURGICAL COKE - ALL INDIA
(Million Tonne)
PRODUCTION - TRADE - CONSUMPTION

	1953/4	1954/5	1955/6	1956/7	1957/8	1958/9	1959/60	1960/1	1961/2	1962/3
PRODUCTION	1.64	1.75	1.81	1.82	1.87	2.03	1.95	1.89	1.98	2.27
Of which: Gas Works	(0.10)	(0.12)	(0.11)	(0.12)	0.11	0.12	0.12	0.13	0.13	0.12
Soft Coke Manufacture	1.54	1.63	1.70	1.70	1.76	1.91	1.83	1.76	1.85	2.15
BALANCE OF EXTERNAL TRADE	-0.01	-0.02	0.02	-0.03	-0.03	-0.03	-0.03	-0.02	-0.04	-0.03
STOCK CHANGES ⁽¹⁾	-0.20	-0.17	0.10	+0.16	+0.04	+0.06	+0.06	-0.03	-0.08	-0.10
TOTAL INTERNAL FINAL CONSUMPTION	1.43	1.56	1.69	1.95	1.88	2.06	1.98	1.84	1.86	2.14
BREAKDOWN OF INTERNAL FINAL CONSUMPTION										
DOMESTIC	1.43	1.56	1.69	1.95	1.88	2.06	1.98	1.84	1.86	2.14
TOTAL INTERNAL FINAL CONSUMPTION	1.43	1.56	1.69	1.95	1.88	2.06	1.98	1.84	1.86	2.14
(1) - means increase in stocks () means estimated figures										

TABLE 4-8
NON-METALLURGICAL COKE - 1960/1 - BY STATES
(Million Tonnes)
PRODUCTION - TRADE - CONSUMPTION

	All India	West Bengal	Bihar	Gujarat	Maharashtra	Madhya Pradesh	Madras	Orissa	Punjab	Rajasthan	Uttar Pradesh	Delhi
PRODUCTION:	1.89	0.18	1.64		0.07							
Of which: Gas Works	0.13	0.06 ⁽²⁾	-		0.07 ⁽³⁾							
Soft Coke Manufacture	1.76	0.12	1.64									
BALANCE OF EXTERNAL TRADE	-0.02	+0.83	-1.50	+0.04	+0.08	+0.02	+0.01	+0.01	+0.02	+0.02	+0.16	+0.29
STOCK CHANGES ⁽¹⁾	-0.03	-	-0.03	-	-							
TOTAL INTERNAL FINAL CONSUMPTION	1.84	1.01 ⁽⁴⁾	0.11 ⁽⁴⁾	0.04	0.15	0.02	0.01	0.01	0.02	0.02	0.16	0.29
BREAKDOWN OF INTERNAL FINAL CONSUMPTION												
DOMESTIC	1.84	1.01	0.11	0.04	0.15	0.02	0.01	0.01	0.02	0.02	0.16	0.29
TOTAL INTERNAL FINAL CONSUMPTION	1.84	1.01	0.11	0.04	0.15	0.02	0.01	0.01	0.02	0.02	0.16	0.29
(1) - means increase in stocks (2) Oriental Gas Company, Calcutta. (3) Bombay Gas Company, Bombay. (4) Includes despatches by Road.												

TABLE 4-9
CRUDE PETROLEUM - ALL INDIA
(Thousand Tonnes)
PRODUCTION - TRADE - TRANSFORMATION - CONSUMPTION

	1950/1		1951/2										
	1	2	1952/3	1953/4	1954/5	1955/6	1956/7	1957/8	1958/9	1959/60	1960/1	1961/2	1962/3
PRODUCTION													
Crude plus associated Gas													
Associated Gas													
Crude Production (free from Gas)	254	263											
Import	-	-	259	273	313	365	411	439	444	452	459	598	1164
Exports	-	-	-	-	1260	3211	3936	4499	4763	5185	5784	5981	5963
Stock Changes	*	*	-	-	-	-	-	-	-	-	-	-	-
Total Internal Consumption	254	263	*	*	*	-22	+20	-32	+3	-37	-77	+4	-2
Consumption for Transformation	-254	-263	259	273	1573	3554	4367	4906	5210	5600	6166	6581	7125
TOTAL INTERNAL FINAL CONSUMPTION (including refinery fuel & losses)	-	-	-259	-273	-1573	-3554	-4367	-4906	-5210	-5600	-6166	-6581	-7125
* Stock changes included in consumption for transformation			-	-	-	-	-	-	-	-	-	-	-

TABLE 4-10
PETROLEUM PRODUCTS - ALL INDIA
(Thousand Tonnes)
PRODUCTION

	1950/1		1951/2										
	1	2	1952/3	1953/4	1954/5	1955/6	1956/7	1957/8	1958/9	1959/60	1960/1	1961/2	1962/3
PRODUCTION													
Crude Oil Treated in Refineries	254	263											
Refinery fuels and losses	-34	-17	259	273	1573	3554	4367	4906	5210	5600	6166	6581	7125
Total Production of Products (excluding refinery fuel)	220	246	-21	-19	-232	-313	-337	-378	-343	-299	-339	-367	-415
Substitute Fuels (Power Alcohol & Benzol)	-	-	238	254	1341	3241	4030	4528	4867	5301	5827	6214	6710
TOTAL PRODUCTION OF PRODUCTS (excluding refinery fuel)	220	246	-	-	-	-	-	28	25	22	20	18	17
			238	254	1341	3241	4030	4556	4892	5323	5847	6232	6727
A. ENERGY PRODUCTS			PRODUCTION BREAKDOWN										
Motor Spirit (1)	50	49											
Aviation & Jet fuel	-	-	45	51	347	838	982	1053	998	988	1061	1091	1173
High Speed Diesel Oil (HSDO)	18	18	-	-	-	-	2	7	-	-	-	-	-
Light Diesel Oil (LDO)	25	26	18	18	140	346	480	636	806	980	1079	1094	1131
Fuel Oil	16	18	29	31	130	276	286	357	441	481	534	602	671
Kerosene	52	52	20	16	432	1107	1456	1602	1646	1664	1665	1765	1906
Liquified Petroleum Gas (LPG)	-	-	51	61	187	473	561	617	665	783	948	1053	1206
Naphtha	-	-	-	-	-	-	1	2	4	6	9	12	16
Others (include vaporizing & substitute fuels)	4	6	-	-	-	-	-	-	-	-	-	2	9
Total Energy Products	165	169	5	5	5	7	7	6	5	4	3	20	38
B. NON-ENERGY PRODUCTS			168	182	1241	3047	3775	4280	4565	4906	5299	5639	6150
Lubricating Oils	16	22											
Other	39	55	16	15	17	17	17	17	19	21	22	25	28
Total Non-Energy Products	55	77	54	57	83	177	238	259	308	396	526	568	549
TOTAL PRODUCTION OF PETROLEUM PRODUCTS (excluding refinery fuel)	220	246	70	72	100	194	255	276	327	417	548	593	577
			238	254	1341	3241	4030	4556	4892	5323	5847	6232	6727

(1) Including Power Alcohol and Benzol, 1957/8 to 1962/3

TABLE 4-11

PETROLEUM ENERGY PRODUCTS - ALL INDIA
(Thousand Tonnes)
PRODUCTION - TRADE - TRANSFORMATION - CONSUMPTION

	1950/1	1951/2	1952/3	1953/4	1954/5	1955/6	1956/7	1957/8	1958/9	1959/60	1960/1	1961/2	1962/3
	1	2	3	4	5	6	7	8	9	10	11	12	13
PRODUCTION													
From Crude oil	165	169	168	182	1241	3047	3775	4252	4540	4884	5279	5621	6133
From Substitute fuels	NA	NA	NA	NA	NA	NA	NA	28	25	22	20	18	17
Total	165	169	168	182	1241	3047	3775	4280	4565	4906	5299	5639	6150
Balance of External Trade	+3042	+3341	+3351	+3399	+2857	+1383	+1096	+1116	+1239	+1492	+1621	+2076	+2527
Stock Changes	+3	+16	-56	+53	-243	-203	-87	-123	-160	-200	-76	-169	-98
International Bunkers	-332	-298	-241	-262	-265	-293	-373	-427	-414	-373	-438	-441	-478
Total Internal Consumption	2878	3313 ⁽¹⁾	3310 ⁽¹⁾	3465 ⁽¹⁾	3693 ⁽¹⁾	4053 ⁽¹⁾	4411	4846	5230	5825	6406	7105	8101
Consumption for Transformation (Diesel & Thermal Electric Plants)	-63	-73	-72	-72	-76	-77	-110	-202	-251	-335	-388	-432	-453
TOTAL INTERNAL FINAL CONSUMPTION	2815	3240	3238	3393	3617	3976	4301	4644	4979	5490	6018	6673	7648

(1) Includes consumption figure of aviation & jet fuel which is not included either in Balance of External Trade or Stock Changes as the source is not known.

TABLE 4-11A

PETROLEUM ENERGY PRODUCTS - ALL INDIA
BREAKDOWN BY PRODUCT
(Thousand Tonnes)
PRODUCTION - TRADE - TRANSFORMATION - CONSUMPTION

	1950/1	1951/2	1952/3	1953/4	1954/5	1955/6	1956/7	1957/8	1958/9	1959/60	1960/1	1961/2	1962/3
	1	2	3	4	5	6	7	8	9	10	11	12	13
A. MOTOR SPIRIT													
PRODUCTION													
From Crude Oil	50	49	45	51	347	838	982	1025	973	966	1041	1073	1156
From Substitute Fuel (Power Alcohol & Benzol)	NA	NA	NA	NA	NA	NA	NA	+28	+25	+22	+20	+18	+17
Total								1053	998	988	1061	1001	1173
Balance of External Trade	+620	+755	+797	+737	+546	+20	-110	-208	-204	-183	-203	-197	-237
Stock Changes	+8	+38	-8	+20	-73	-5	-13	-8	+4	-5	-7	-4	+6
TOTAL INTERNAL CONSUMPTION	678	842	834	808	820	853	859	837	798	800	851	890	942
B. AVIATION & JET FUEL													
PRODUCTION													
From Crude Oil	-	-	-	-	-	-	2	7	-	-	-	-	-
Balance of External Trade	+77	NA	+88	+93	+103	+119	+113	+127	+119	+145	+205	+367	+548
Stock Changes	-1	NA	NA	NA	NA	NA	+25	+35	+74	+86	+71	-47	-201
TOTAL INTERNAL CONSUMPTION	76	85	88	93	103	119	140	169	193	231	276	320	347
C. HIGH SPEED DIESEL OIL (HSDO)													
PRODUCTION													
From Crude Oil	18	18	16	18	140	346	480	636	806	980	1079	1094	1131
Balance of External Trade	+202	+262	+256	+283	+275	+136	+95	+125	+204	+181	+210	+380	+600
Stock Changes	-15	-12	-2	+11	-43	-23	+12	+11	-56	-62	-35	-19	-26
International Bunker	-2	-2	-1	-1	-1	-1	-1	-1	-1	-2	-2	-4	-6
TOTAL INTERNAL FINAL CONSUMPTION	203	266	269	311	371	458	586	771	953	1097	1252	1451	1699

TABLE 4-11A(Cont.)

	1950/1	1951/2	1952/3	1953/4	1954/5	1955/6	1956/7	1957/8	1958/9	1959/60	1960/1	1961/2	1962/3
	1	2	3	4	5	6	7	8	9	10	11	12	13
D. LIGHT DIESEL OIL (LDO)													
PRODUCTION													
From Crude Oil	25	28	29	31	130	278	288	357	441	481	534	602	671
Balance of External Trade	+382	+411	+402	+408	+323	+199	+221	+151	+104	+127	+119	+69	+10
Stock changes	-38	+1	-14	-8	-21	-24	-35	+1	-18	-24	-12	-18	+28
International Bunkers	-17	-33	-13	-13	-11	-19	-25	-36	-28	-23	-29	-28	-36
TOTAL INTERNAL CONSUMPTION	352	405	404	416	421	432	447	473	503	561	612	625	673
Consumption for Transformation (Diesel Electric Plant)	-63	-73	-72	-72	-78	-77	-80	-82	-91	-100	-112	-118	-119
TOTAL INTERNAL FINAL CONSUMPTION	289	332	332	344	345	355	367	391	412	461	500	507	554
E. FUEL OIL													
PRODUCTION													
From Crude Oil	16	18	20	18	432	1107	1456	1602	1646	1664	1665	1785	1808
Balance of External Trade	+867	+898	+818	+792	+530	-75	-250	-189	-133	-3	+123	+285	+413
Stock changes	+22	-37	-21	+46	-62	-57	-84	-98	-59	-94	+1	-72	+39
International Bunkers	-313	-263	-227	-248	-253	-273	-347	-390	-387	-348	-407	-409	-436
TOTAL INTERNAL CONSUMPTION	592	616	588	606	647	702	775	925	1067	1219	1382	1549	1822
Consumption for Transformation (Thermal Electric Plants)	-	-	-	-	-	-	-30	-120	-160	-235	-276	-300	-300
TOTAL INTERNAL FINAL CONSUMPTION	592	616	588	606	647	702	745	805	907	984	1108	1249	1622
F. KEROSENE													
PRODUCTION													
From Crude Oil	52	52	53	61	187	473	561	617	665	783	848	1053	1208
Balance of External Trade	+858	+984	+1048	+1142	+1137	+1056	+985	+1070	+1111	+1193	+1148	+1185	+1185
Stock Changes	+29	+24	-10	-14	-43	-95	+3	-66	-106	-99	-94	-12	+57
TOTAL INTERNAL FINAL CONSUMPTION	939	1060	1091	1189	1281	1434	1549	1621	1670	1877	2002	2228	2448
G. LIQUIFIED PETROLEUM GAS													
PRODUCTION													
From Crude Oil	-	-	-	-	-	-	1	2	4	6	8	12	16
Stock Changes	-	-	-	-	-	-	-	-	-1	-	-	-	-1
TOTAL INTERNAL FINAL CONSUMPTION	-	-	-	-	-	-	1	2	3	6	8	12	15
H. NAPHTHA - ALL INDIA													
PRODUCTION												2	9
From Crude Oil												-	-
Balance of External Trade												-1	-1
Stock Changes												1	8
TOTAL INTERNAL FINAL CONSUMPTION													
I. REFINERY GAS													
PRODUCTION												17	35
From Crude Oil												-	-
Balance of External Trade												-3 ^x	-1 ^x
Stock Changes												14	34
TOTAL INTERNAL FINAL CONSUMPTION													
J. OTHER PETROLEUM ENERGY PRODUCTS (includes vaporising oil)													
PRODUCTION												3	3
From Crude Oil	4	6	5	5	5	7	7	6	5	4	3	3	3
Balance of External Trade	+36	+31	+32	+39	+46	+47	+42	+40	+38	+32	+19	+7	+8
Stock Changes	-2	+2	-1	-2	-1	+1	+5	+2	-	-2	-	+7	+2
TOTAL INTERNAL FINAL CONSUMPTION	38	39	36	42	50	55	54	48	43	34	22	17	13

^xRepresents losses and not stock changes.

TABLE 4-12
 PETROLEUM ENERGY PRODUCTS - BY STATES
 TOTAL INTERNAL FINAL CONSUMPTION - 1960/1
 (Thousand Tonnes)

Sl. No.	STATE	Motor Spirit	Aviation & Jet Fuel	HSDD	LDO	Fuel Oil	Kerosene	LPG	Other (including vapourising oil)	Total Energy Products
1	2	3	4	5	6	7	8	9	10	11
1	Andhra Pradesh	40	11	109	30	27	140	-	1	358
2	Assam (including NEFA Manipur & Tripura)	60	7	28	22	61	80	-	2	260
3	West Bengal	120	59	106	27	108	215	-	2	637
4	Bihar	53	2	86	19	74	165	-	2	401
5	Gujarat	53	10	65	95	66	152	-	2	443
6	Jammu & Kashmir	5	2	10	-	-	5	-	-	22
7	Kerala	33	-	57	6	72	80	-	1	249
8	Maharashtra	169	82	170	121	574	414	6	2	1538
9	Madhya Pradesh	41	8	76	25	2	105	-	1	258
10	Madras (including Pondichery)	62	7	159	25	79	165	-	1	498
11	Mysore (excluding Goa)	39	5	97	25	15	100	-	1	282
12	Orissa	18	-	19	4	3	40	-	-	84
13	Punjab (including Delhi & Himachal Pradesh)	77	42	123	34	12	113	3	3	407
14	Rajasthan	30	1	35	18	8	45	-	2	139
15	Uttar Pradesh	51	40	112	49	5	183	-	2	442
	ALL INDIA	851	276	1252	500	1106	2002	9	22	6018

Note: The figures above exclude consumption by International Bunkers and Products consumed for transformation and consumption by the Energy Sector.

TABLE 4-13
 PETROLEUM ENERGY PRODUCTS - BY STATES AND BY SECTORS
 TOTAL INTERNAL FINAL CONSUMPTION - 1960/1⁽¹⁾(2)
 (Thousand Tonnes)

Sl. No.	STATE	Motor Spirit		Aviation & Jet Fuel		HSDO				LDO				Fuel Oil				Kerosene						
		Road Transport	Total	Air transport	Total	Water ways	Road transport	Railways	Indu ⁽³⁾	Agri-culture & other	Total	Water ways	Power ⁽⁵⁾ generation	Indu ⁽³⁾	Agri-culture & other	Total	Water ways	Power ⁽⁵⁾ generation	Railways	Indu ⁽³⁾	Total	Indu ⁽³⁾ Domestic	Total	
1	Andhra Pradesh	40	40	11	11	-	94	4	4	7	109	-	2	17	13	32	3	1	-	24	28	-	140	140
2	Assam (including NEFA, Manipur and Tripura)	60	60	7	7	-	17	-	7	4	28	-	5	10	12	27	-	1	-	61	62	-	80	80
3	West Bengal	120	120	59	59	2	66	-	27	11	106	1	3	15	11	30	1	2	1	108	110	2	213	215
4	Bihar	53	53	2	2	-	8	41	30	7	86	1	13	12	6	32	-	1	2	72	75	2	183	185
5	Gujarat	53	53	10	10	-	48	2	5	10	65	-	17	64	31	112	-	18	-	66	84	1	151	152
6	Jammu & Kashmir	5	5	2	2	-	9	-	-	1	10	-	-	-	-	-	-	-	-	-	-	-	5	5
7	Kerala	33	33	-	-	2	45	-	2	8	57	1	-	3	2	6	14	-	-	58	72	-	80	80
8	Maharashtra	169	169	82	82	1	105	2	49	13	78	2	22	81	38	143	50	241	-	524	815	7	407	414
9	Madhya Pradesh	41	41	8	8	-	56	-	13	7	78	-	9	13	12	34	-	1	-	2	3	1	104	105
10	Madras (including Pondichery)	62	62	7	7	-	147	-	5	7	97	-	8	14	11	33	-	-	-	15	15	1	89	100
11	Mysore (including Goa)	39	39	5	5	1	85	-	3	8	119	-	1	2	2	5	-	-	-	3	3	-	40	40
12	Orissa	18	18	-	-	-	14	-	2	3	23	-	13	22	12	47	-	1	-	12	13	2	111	113
13	Punjab (including Delhi & Himachal Pradesh)	77	77	42	42	-	92	3	13	15	35	-	11	7	11	28	-	1	-	8	9	-	45	45
14	Rajasthan	30	30	1	1	-	29	1	5	-	12	1	8	26	22	57	-	1	1	4	6	2	181	183
15	Uttar Pradesh	51	51	40	40	-	80	10	10	12	252	6	112	306 ⁽⁴⁾	188	612	77	276	7	1022	1382	20	1982	2002
	ALL INDIA	851	851	276	276	6	895	63	175	113														

Note: (1) The figures above exclude consumption by International Bunkers and the Energy sector but includes the consumption for transformation.
 (2) A further breakdown between industrial sectors will be found for All India in Table 4-31

2) Vapourising oil shown in col. 10 Table 4-12 is used in agricultural sector only 75% LPG shown in col. 8 Table 4-12 is used in Domestic sector and 25% in Commercial sector.

4) Probably includes about 19 x 10³ tonnes consumed by auto producers for generation of Electricity.

5) These quantities are not included in Table 4-12.

TABLE 4-14
BLAST FURNACE GAS - ALL INDIA
(Million Cubic Metres)
PRODUCTION - TRADE - TRANSFORMATION - CONSUMPTION

	1953/4	1954/5	55/6	1956/7	1957/8	1958/9	1959/60	1960/1	1961/2	1962/3
PRODUCTION	3899	4207	030	4063	4239	5233	7879	12086	14768	16447
Total Internal Consumption	3899	4207	030	4063	4239	5233	7879	12086	14768	16447
- Consumption for transformation thermal electric plants	691	768	723	718	668	1130	1686	2337	2896	3134
TOTAL INTERNAL FINAL CONSUMPTION	3208	3439	307	3345	3571	4103	6193	9749	11872	13313
BREAKDOWN OF INTERNAL FINAL CONSUMPTION										
A. CONSUMPTION BY THE ENERGY SECTORS										
Coke Ovens (Steel Plants)	674	534	619	594	734	771	1220	1910	3110	3719
Losses	192	240	219	308	491	658	1088	1755	1141	1218
B. CONSUMPTION BY THE OTHER SECTORS										
Industry	2342	2665	469	2443	2346	2674	3885	6084	7621	8376
Of which: Iron & Steel (Steel Plants).	2342	2665	469	2443	2346	2674	3885	6084	7621	8076
TOTAL INTERNAL FINAL CONSUMPTION	3208	3439	307	3345	3571	4103	6193	9749	11872	13313

TABLE 4-15
BLAST FURNACE GAS - 1960/1 - BY STATES
(Million Cubic Metres)
PRODUCTION - TRADE - TRANSFORMATION - CONSUMPTION

	All India	Andhra	Assam	West Bengal	Bihar	Gujarat	Maharashtra	Madhya Pradesh	Madras	Mysore	Orissa	Punjab	Rajasthan	Uttar Pradesh	Delhi
PRODUCTION	12086	-	-	4679	3993	-	-	2050	-	-	1364	-	-	-	-
Total Internal Consumption	12086	-	-	4679	3993	-	-	2050	-	-	1364	-	-	-	-
- Consumption for Transformation Thermal Electric Plants	2337	-	-	1323	363	-	-	183	-	-	468	-	-	-	-
TOTAL INTERNAL FINAL CONSUMPTION	9749	-	-	3356	3630	-	-	1867	-	-	896	-	-	-	-
BREAKDOWN OF INTERNAL FINAL CONSUMPTION															
A. CONSUMPTION BY THE ENERGY SECTORS															
COKE OVENS (Steel Plants)	1910	-	-	344	1184	-	-	232	-	-	150	-	-	-	-
Losses	1755	-	-	1065	60	-	-	211	-	-	419	-	-	-	-
B. CONSUMPTION BY THE OTHER SECTORS															
Industry	6084	-	-	1947	2386	-	-	1424	-	-	327	-	-	-	-
of which: Iron & Steel (Steel Plants)	6084	-	-	1947	2386	-	-	1424	-	-	327	-	-	-	-
TOTAL INTERNAL FINAL CONSUMPTION	9749	-	-	3356	3630	-	-	1867	-	-	896	-	-	-	-

TABLE 4-16
GAS WORK GAS, COKE OVEN GAS, MERCHANT COKE OVEN GAS - ALL INDIA
(Million Cubic Metres)

PRODUCTION - TRADE - TRANSFORMATION - CONSUMPTION

	1953/4	1954/5	1955/6	1956/7	1957/8	1958/9	1959/60	1960/1	1961/2	1962/3
PRODUCTION	836	929	893	856	917	1161	1530	2239	2629	2918
Of which: Gas Works,	50	50	50	50	50	60	60	60	60	60
Merchant coke oven	90	80	90	90	130	140	160	220	278	308
Coke Oven	696	799	753	716	737	961	1310	1959	2291	2550
TOTAL INTERNAL CONSUMPTION	836	929	893	856	917	1161	1530	2239	2629	2918
- CONSUMPTION FOR TRANSFORMATION THERMAL ELECTRIC PLANTS FROM:										
Coke Oven gas	34	35	6	-	-	25	64	139	116	104
Merchant coke oven gas	-	-	-	-	-	-	28 ⁽¹⁾	28 ⁽¹⁾	(28)	(32)
TOTAL INTERNAL FINAL CONSUMPTION	802	894	887	856	917	1136	1438	2072	2485	2782
BREAKDOWN OF INTERNAL FINAL CONSUMPTION										
A. CONSUMPTION BY THE ENERGY SECTOR										
Merchant Coke Ovens	20	20	20	20	30	30	30	40	60	60
Losses	130	126	156	137	188	247	269	411	625	592
B. CONSUMPTION BY THE OTHER SECTORS										
INDUSTRY	602	698	661	649	649	799	1079	1561	1740	2070
Of which: Iron & Steel (Steel Plants) ⁽²⁾	602	698	661	649	649	799	1079	1561	1740	2070
DOMESTIC	50	50	50	50	50	60	60	60	60	60
TOTAL INTERNAL FINAL CONSUMPTION	802	894	887	856	917	1136	1438	2072	2485	2782

(1) See footnote (1) in Table 4-17

(2) This includes coke oven gas used for underfiring of coke ovens in the Steel Plants as the separate figures for this are not available.

() Estimated

TABLE 4-17
GAS WORKS GAS, COKE OVEN GAS, MERCHANT COKE OVEN GAS - 1960/1 - BY STATES
(Million Cubic Metres)

PRODUCTION - TRADE - TRANSFORMATION - CONSUMPTION

	All India	Andhra	Assam	West Bengal	Bihar	Gujarat	Maha-rashtra	Madhya Pradesh	Madras	Mysore	Orissa	Punjab	Rajasthan	Uttar Pradesh	Delhi
PRODUCTION	2239	-	-	915	768	-	30	288	-	-	238	-	-	-	-
Of which: Gas Works	60	-	-	30	-	-	30	-	-	-	-	-	-	-	-
Merchant coke ovens	220	-	-	110	110	-	-	-	-	-	-	-	-	-	-
Coke ovens	1959	-	-	775	858	-	-	288	-	-	238	-	-	-	-
TOTAL INTERNAL CONSUMPTION	2239	-	-	915	768	-	30	288	-	-	238	-	-	-	-
- CONSUMPTION FOR TRANSFORMATION THERMAL ELECTRIC PLANTS FROM:															
Coke Oven gas	139	-	-	56	-	-	-	18	-	-	65	-	-	-	-
Merchant coke ovens	28	-	-	28 ⁽¹⁾	-	-	-	-	-	-	-	-	-	-	-
TOTAL INTERNAL FINAL CONSUMPTION	2072	-	-	831	768	-	30	270	-	-	173	-	-	-	-
BREAKDOWN OF INTERNAL FINAL CONSUMPTION															
A. CONSUMPTION BY THE ENERGY SECTOR															
Merchant Coke Ovens	40	-	-	20	20	-	-	-	-	-	-	-	-	-	-
Losses	411	-	-	138	224	-	-	21	-	-	28	-	-	-	-
B. CONSUMPTION BY THE OTHER SECTORS															
INDUSTRY	1581	-	-	643	524	-	-	249	-	-	145	-	-	-	-
Of which: Iron & Steel (Steel Plants) ⁽²⁾	1581	-	-	643	524	-	-	249	-	-	145	-	-	-	-
DOMESTIC	60	-	-	30	-	-	30	-	-	-	-	-	-	-	-
TOTAL INTERNAL FINAL CONSUMPTION	2072	-	-	831	768	-	30	270	-	-	173	-	-	-	-

(1) Originally estimated. Since checked that no gas was used for power generation; 28 million cubic metres shown here may be treated as losses.

(2) This includes Coke Oven gas used for underfiring of coke ovens in Steel Plants as the separate figures for this are not available.

TABLE 4-18
UTILITY ELECTRICITY - ALL INDIA
(Million kwh)

	1951	1952	1953	1954	1955	1956	1957/8	1958/9	1959/60	1960/1	1961/2	1962/3
	1	2	3	4	5	6	7	8	9	10	11	12
PRODUCTION - TRADE - CONSUMPTION												
PRODUCTION (GROSS)												
Hydro	2859.7	2799.1	2913.9	3238.5	3742.2	4294.9	5072.2	5848.1	7027.4	7763.6	9814.4	11804.5
Diesel	219.6	218.8	210.5	227.1	231.4	233.4	254.4	298.1	327.1	368.7	379.7	383.6
Thermal	2779.1	3102.4	3572.8	4057.8	4618.9	5133.9	6042.5	6847.7	7678.4	8724.3	9475.8	10176.9
Of which: Coal	2779.1	3102.4	3572.8	4057.8	4618.9	5026.9	5872.5	6269.7	6946.4	7905.2	8711.4	9165.4
Fuel oil	-	-	-	-	-	(107.0)	(370.0)	(578.0)	(732.0)	819.1	764.5	803.3
Gas	-	-	-	-	-	-	-	-	-	-	-	208.2
TOTAL PRODUCTION	5858.4	6120.3	6697.2	7521.7	8592.5	9662.2	11369.1	12993.9	15032.9	16854.6	19670.0	22365.0
Purchase from Non-Utilities	17.7	83.1	86.5	25.1	17.2	18.6	40.4	35.2	34.4	224.1	367.4	471.2
TOTAL INTERNAL FINAL CONSUMPTION	5876.1	6203.4	6783.7	7546.8	8609.7	9680.8	11409.5	13029.1	15067.3	17078.7	20037.4	22836.2
BREAKDOWN OF INTERNAL FINAL CONSUMPTION												
A. CONSUMPTION BY THE ENERGY SECTOR												
Coal Mines & Washeries	141.4	155.4	181.4	189.2	205.2	219.2	260.3	267.5	256.0	262.0	277.3	284.4
Oil Fields & Refineries	-	-	-	-	-	-	-	-	60.0	58.6	62.4	63.6
Power Station Consumption	218.3	235.4	272.8	311.0	339.4	386.4	455.5	539.8	600.7	693.3	813.6	912.6
Transmission & Distribution losses	864.5	962.4	913.8	983.3	159.3	1335.0	1523.9	1770.6	2059.7	2536.5	2775.4	3244.7
B. CONSUMPTION BY OTHER SECTORS												
TRANSPORTATION												
Of which: Railways	357.1	383.6	432.3	453.6	496.1	525.6	563.0	620.3	652.3	664.5	701.2	722.3
Tramways	52.9	56.0	52.8	57.8	59.2	57.5	58.3	53.7	55.8	58.1	58.1	58.1
INDUSTRY	2832.9	2936.2	3305.1	3753.7	4340.6	4926.0	5769.5	6724.2	7872.0	9003.3	11030.9	12705.5
Of which: Mining & Quarrying (Gold only)	119.4	119.0	104.6	103.8	102.9	107.4	114.2	117.1	116.3	113.0	112.2	110.3
Fertilizer	39.6	41.5	39.0	44.4	47.9	51.9	46.9	52.8	53.7	95.9	918.0	1170.7
Heavy Chemicals	17.1	19.3	26.7	29.4	59.8	75.2	78.9	109.9	204.0	248.2	274.7	326.6
Cement	97.8	105.0	104.2	138.6	137.8	158.2	215.6	255.9	337.0	441.8	518.3	589.5
Iron & Steel	108.7	102.4	120.8	215.6	369.6	460.6	529.0	626.7	839.0	1101.0	1571.5	1777.8
Non-ferrous	60.2	65.5	49.1	79.1	139.0	155.2	176.9	224.2	384.3	403.7	426.8	569.2
Textiles	1280.3	1313.6	1450.0	1579.1	1745.0	1962.1	2045.3	2222.5	2430.1	2469.2	2570.7	2849.0
Other	1109.8	1169.9	1410.7	1563.1	1738.6	1955.4	2562.7	3115.1	3507.6	4130.5	4638.7	5312.4
AGRICULTURE	203.0	215.2	214.1	231.4	254.8	316.2	565.8	583.5	754.0	832.9	991.1	1103.4
DOMESTIC	595.0	628.9	690.5	759.2	850.4	934.1	1094.6	1238.0	1378.5	1492.3	1698.1	1917.8
COMMERCIAL	331.5	336.6	399.1	446.2	514.4	545.9	611.5	682.8	766.2	847.8	934.1	1048.4
GOVERNMENT	279.5	293.7	321.8	361.4	390.3	434.9	507.1	548.7	612.1	629.4	695.2	775.4
TOTAL INTERNAL FINAL CONSUMPTION	5876.1	6203.4	6783.7	7546.8	8609.7	9680.8	11409.5	13029.1	15067.3	17078.7	20037.4	22836.2

() Estimated figures.

TABLE 4-19
UTILITY ELECTRICITY - 1980/1 - BY STATES
(million kWh)

	All India	Andaman & Nicobar	Andhra Pradesh	Assam including Manipur & Tripura	Bihar	Gujarat	Jammu & Kashmir	Kerala	Maharashtra	Madhya Pradesh	Madras including Pondicherry	Mysore	Orissa	Punjab including Himachal Pradesh & Delhi	Rajasthan	Uttar Pradesh	West Bengal
	1	2	3	4	5	6	7	8	9	10	11	12	13	14	15	16	17
PRODUCTION - TRADE - CONSUMPTION																	
PRODUCTION (GROSS)																	
Hydro	7763.6	—	748.8	20.9	143.7	—	43.5	11.8	1365.0	23.3	1782.8	1003.4	483.8	986.5	—	440.1	180.0
Diesel	366.7	—	5.5	17.0	43.8	82.3	0.1	—	68.3	24.1	—	18.3	6.0	47.9	38.1	28.1	8.2
Thermal	8724.3	1.5	145.8	—	1408.5	1209.1	—	—	1834.7	429.6	418.0	—	—	278.6	62.2	786.2	2150.1
TOTAL PRODUCTION	16854.6	1.5	900.1	37.9	1596.0	1271.4	43.6	11.8	3268.0	477.0	2200.8	1022.7	489.8	1293.0	100.3	1252.4	2318.3
Purchase from Non-Utilities	224.1	—	—	—	175.9	1.0	—	—	2.2	—	—	—	44.8	—	0.2	—	—
Balance of External Trade (Interstate sales)	—	—	-121.1	—	-448.8	—	+17.5	6.3	-31.4	+27.0	-25.3	+50.0	+35.0	-39.7	+22.7	—	+471.8
TOTAL INTERNAL FINAL CONSUMPTION	17078.7	1.5	779.0	37.9	1325.0	1272.4	61.1	18.1	3238.8	504.0	2175.5	1072.7	569.8	1257.3	123.2	1252.4	2790.2
BREAKDOWN OF INTERNAL FINAL CONSUMPTION																	
A. CONSUMPTION BY THE ENERGY SECTOR	3550.4	0.3	228.7	7.3	557.1	289.1	10.0	24.9	561.7	112.3	442.4	176.3	73.0	297.5	29.5	276.6	363.7
Coal Mines & Washeries	262.0	—	5.4	—	121.5	—	—	—	1.8	14.1	—	—	2.0	—	—	—	117.2
Oilfields & Refineries	58.6	—	15.9	—	—	—	—	—	41.7	—	—	—	—	—	—	—	1.0
Power Station Consumption	693.3	0.2	23.3	1.3	99.6	82.3	0.5	18.9	135.8	31.0	62.5	14.8	3.7	28.7	4.3	59.8	130.7
Transmission & Distribution	2538.5	0.1	184.1	6.0	336.0	206.8	9.5	6.0	382.3	67.2	378.9	161.5	67.3	270.8	25.2	217.0	114.8
B. CONSUMPTION BY OTHER SECTORS																	
TRANSPORTATION	722.6	—	14.2	3.9	22.4	16.7	—	2.4	355.5	7.7	50.4	6.3	1.6	24.2	8.1	39.8	169.4
Of which:																	
Railways	664.5	—	14.2	3.9	22.4	16.7	—	2.4	345.5	7.7	50.4	6.3	1.6	24.2	8.1	39.8	121.3
Tramways	58.1	—	—	—	—	—	—	—	10.0	—	—	—	—	—	—	—	48.1
INDUSTRY	8003.3	0.6	358.0	8.1	637.1	788.8	22.1	101.3	1792.4	279.5	931.7	667.0	464.2	480.0	20.8	484.1	1667.8
Of which:																	
Mining & Quarrying (Gold only)	113.0	—	—	—	—	—	—	—	—	—	—	113.0	—	—	—	—	—
Fertilizer	95.9	—	—	—	—	—	—	68.0	—	—	—	27.9	—	—	—	—	—
Heavy Chemical	248.2	—	—	—	2.4	13.6	—	47.4	48.4	—	28.9	0.7	—	1.8	—	1.4	107.8
Cement	441.8	—	47.7	—	122.6	44.0	—	8.2	5.2	4.8	118.7	6.2	36.9	39.0	—	1.0	7.5
Iron & Steel	1101.0	—	18.9	—	371.5	—	—	—	72.2	115.7	4.0	279.7	107.8	—	—	9.4	120.8
Non-Ferrous	403.7	—	—	—	29.3	—	—	30.8	2.9	0.1	—	—	220.4	—	—	—	20.2
Textiles	2469.2	—	46.1	—	1.4	454.7	0.1	6.4	864.2	36.7	228.3	52.0	0.4	37.0	5.7	147.1	587.1
Other	4130.5	0.6	244.3	8.1	109.9	276.5	22.0	42.5	799.5	122.2	551.8	207.5	98.7	402.2	14.9	305.2	824.6
AGRICULTURE	832.9	—	54.8	—	18.3	18.6	0.7	18.3	14.8	3.9	389.0	28.7	0.8	79.8	3.6	200.0	0.8
DOMESTIC	1492.3	0.4	70.8	11.0	44.3	71.6	22.5	51.1	261.1	45.4	155.7	75.3	18.3	167.9	20.7	122.7	353.5
COMMERCIAL	847.8	0.1	30.2	4.4	29.9	31.7	1.0	3.9	198.3	20.8	156.8	21.3	7.9	135.0	15.9	74.8	115.8
GOVERNMENT	629.4	0.1	22.3	3.2	15.9	54.9	4.8	18.2	55.0	34.4	49.5	77.6	3.8	72.9	24.8	74.4	119.4
TOTAL INTERNAL FINAL CONSUMPTION	17078.7	1.5	779.0	37.9	1325.0	1272.4	61.1	18.1	3238.8	504.0	2175.5	1072.7	569.8	1257.3	123.2	1252.4	2790.2

TABLE 4-20
NON-UTILITY ELECTRICITY (SELF-GENERATION) - ALL INDIA
(Million kWh)

	1951	1952	1953	1954	1955	1956	1957/8	1958/9	1959/60	1960/1	1961/2	1962/3
	1	2	3	4	5	6	7	8	9	10	11	12
PRODUCTION - TRADE - CONSUMPTION												
TOTAL PRODUCTION ⁽¹⁾	1732.3	1962.6	2066.3	2122.1	2278.4	2287.9	2386.8	2528.1	2881.1	3292.6 ⁽²⁾	3567.2	3941.5
- Sales to Utilities	-17.7	-83.1	-86.5	-25.0	-17.3	-18.6	-38.9	-30.0	-21.4	-217.9 ⁽³⁾	-367.4	-471.2
TOTAL INTERNAL FINAL CONSUMPTION	1714.6	1879.5	1979.8	2097.1	2261.1	2269.3	2347.9	2498.1	2859.7	3074.7	3199.9	3470.3
BREAKDOWN OF INTERNAL FINAL CONSUMPTION												
A. CONSUMPTION BY THE ENERGY SECTOR & LOSSES									157.4	161.3	180.6	218.6
Coal Mines	120.9	125.7	126.0	124.8	126.7	133.2	129.9	132.1	145.4	148.1	165.2	202.1
Oilfields & Refineries	-	-	-	-	-	-	-	-	12.0	13.2	15.4	16.5
B. CONSUMPTION BY THE OTHER SECTORS												
TRANSPORTATION												
Railways	76.8	79.0	82.4	67.4	93.6	78.4	98.5	107.4	120.2	106.5	79.1	79.1
INDUSTRY	1449.3	1580.7	1687.5	1798.8	1920.6	1982.1	1979.4	2092.0	2384.4	2597.3	2940.2	3172.6
Of which: Mining & Quarrying (Gold only)	-	-	0.4	-	-	-	0.1	0.1	0.1	0.1		
Fertilizer	42.4	145.6	230.7	246.9	274.6	283.4	282.9	319.6	350.8	381.3	375.9	431.1
Heavy Chemical	45.0	44.7	50.4	51.3	61.2	71.9	80.0	88.7	120.4	156.1	330.2	309.9
Cement	261.6	293.9	320.7	340.7	345.9	401.3	417.2	499.5	513.9	494.6	465.2	424.7
Iron & Steel	457.8	460.2	439.7	479.1	400.8	359.9	375.6	408.4	588.0	702.7	772.3	945.0
Non-ferrous	91.7	83.4	86.8	98.2	94.8	85.4	78.8	90.3	91.9	84.9	89.9	78.6
Textiles	326.5	319.7	323.9	328.3	398.1	414.3	385.0	365.3	371.2	378.7	371.5	369.2
Other	224.3	233.2	234.9	254.3	345.2	365.9	359.8	320.1	348.1	398.9	535.2	614.1
OTHER SECTORS	67.6	94.1	83.9	106.1	120.2	75.6	140.1	166.6	197.7	209.6	-	-
TOTAL INTERNAL FINAL CONSUMPTION	1714.6	1879.5	1979.8	2097.1	2261.1	2269.3	2347.9	2498.1	2859.7	3074.7	3199.9	3470.3

(1) Includes the generation at Durgapur (West Bengal) Coke oven plant; major steel plant, Hindusthan Aluminium Plant and Neyveli Thermal Station from the year of operation

(2) Of which Thermal is 3239.6 and diesel 53.0 GWh

(3) Actually 224.1 GWh were sold to the utilities. The difference is due to non-reporting by some industries.

TABLE 4-21
NON-UTILITY ELECTRICITY (SELF-GENERATING) - 1960/1 - BY STATES
(Million kWh)

	All India	Andhra Pradesh	Assam including Manipur & Tripura & NEFA	Bihar	Gujarat	Jammu & Kashmir	Kerala	Maharashtra	Madhya Pradesh	Madras including Pondicherry	Mysore	Orissa	Punjab including Himachal Pradesh & Delhi	Rajasthan	Uttar Pradesh	West Bengal
	1	2	3	4	5	6	7	8	9	10	11	12	13	14	15	16
PRODUCTION - TRADE - CONSUMPTION																
TOTAL PRODUCTION	3292.6	151.5	19.3	1067.6	97.6	-	0.6	164.9	240.6	33.5	109.2	301.8	176.8	145.3	180.8	623.1
- Sales to Utilities	-217.9	-	-	-175.9	-	-	-	-2.1	-	-	-	-38.9	-	-	-	-
TOTAL INTERNAL FINAL CONSUMPTION	3074.7	151.5	19.3	891.7	97.6	-	0.6	162.8	240.6	33.5	109.2	261.9	176.8	145.3	180.8	623.1
BREAKDOWN OF INTERNAL FINAL CONSUMPTION																
A. CONSUMPTION BY THE ENERGY SECTOR & LOSSES																
Coal Mines	148.1	54.0	-	60.6	-	-	-	-	21.9	-	-	4.1	-	-	-	7.5
Oilfields & Refineries	13.2	-	13.2	-	-	-	-	-	-	-	-	-	-	-	-	-
B. CONSUMPTION BY OTHER SECTORS																
TRANSPORTATION																
Railways	106.5	0.1	5.8	18.9	7.6	-	-	8.2	2.9	1.9	1.8	0.1	0.2	11.0	22.8	25.2
INDUSTRY	2597.3	63.6	-	610.8	89.4	-	0.6	154.6	207.1	31.6	106.4	257.7	176.8	134.0	137.9	427.0
Of which: Mining & Quarrying (Gold only)	0.1	-	-	-	-	-	-	-	-	-	0.1	-	-	-	-	-
Fertilizer	381.3	-	-	381.2	-	-	-	-	-	-	-	-	-	0.1	-	-
Heavy Chemical	158.1	-	-	-	-	-	-	51.8	-	-	-	-	51.1	-	27.5	25.6
Cement	494.6	-	-	135.7	47.3	-	-	1.0	61.8	0.1	55.4	-	38.1	122.4	32.8	-
Iron & Steel	702.7	-	-	248.5	-	-	-	-	84.2	-	-	175.4	-	0.2	0.2	184.2
Non-Ferrous	84.9	-	-	18.4	-	-	-	-	-	-	-	-	-	-	-	66.5
Textiles	378.7	10.5	-	12.3	42.1	-	0.4	68.7	56.9	24.3	20.0	10.4	59.2	10.7	9.5	53.7
Other	388.9	53.1	-	14.7	-	-	0.2	33.0	4.2	7.2	30.9	71.9	28.2	0.8	67.9	87.0
OTHER SECTORS	209.8	33.8	0.3	1.4	0.6	-	-	-	8.7	-	1.0	-	-	0.3	0.1	163.4
TOTAL INTERNAL FINAL CONSUMPTION	3074.7	151.5	19.3	891.7	97.6	-	0.6	162.8	240.6	33.5	109.2	261.9	176.8	145.3	180.8	623.1

TABLE 4-22
THERMAL AND DIESEL ELECTRICITY
GENERATION - 1960/1 - ALL INDIA

FUEL INPUTS				UTILITIES		NON-UTILITIES	
UTILITIES		NON-UTILITIES (Auto Producers)		Fuel Inputs	Electricity Generation TWh	Fuel Inputs	Electricity Generation TWh
Fuel Inputs	Electricity Generation TWh	Fuel Inputs	Electricity Generation TWh				
1. Coking Coal		0.60 ⁽¹⁾ million tonnes	0.95 (Steel Plants)	4. Non-Coking Coal ⁽²⁾	6.41 million tonnes	0.17 million tonnes	Railways 0.11
2. Blast Furnace Gas		2337 million m ³		5. Fuel Oil	0.28 million tonnes	0.11 million tonnes	Durgapur 0.18
3. Coke Oven Gas		139 million m ³		6. LDO	0.11 million tonnes	2.04 million tonnes	Coke Oven 0.18
				7. Refinery Gas		Negligible	Others 1.99
				TOTAL	9.09		

(1) 0.47 mt + 0.13 mt (cf. footnote 5 in Table 4-2)
(2) Total input under utility and non-utility is 8.73 million tonnes of which 8.62 million tonnes is accounted for in Table 4-4 and 0.11 million tonnes is for Durgapur coke oven plant (cf. footnote 4 in Table 4-2).
(3) cf. footnote (13) in ALL INDIA TABLE 4-31

TABLE 4-23
UTILITY ELECTRICITY + NON-UTILITY ELECTRICITY - ALL INDIA
Million kWh

	1951	1952	1953	1954	1955	1956	1957/8	1958/9	1959/60	1960/1	1961/2	1962/3
	1	2	3	4	5	6	7	8	9	10	11	12
PRODUCTION - TRADE - CONSUMPTION												
TOTAL PRODUCTION (GROSS)	7590.7	8082.9	8763.5	9643.9	10870.8	11950.1	13757.4	15527.2	17927.0	20153.4	23237.2	26304.7
TOTAL INTERNAL FINAL CONSUMPTION	7590.7	8082.9	8763.5	9643.9	10870.8	11950.1	13757.4	15527.2	17927.0	20153.4	23237.2	26304.7
BREAKDOWN OF INTERNAL FINAL CONSUMPTION												
A. CONSUMPTION BY THE ENERGY SECTOR	1345.1	1478.9	1494.0	1608.3	1830.6	2073.8	2369.6	2710.0	3133.8	3711.7	4109.0	4723.5
Coal Mines & Washeries	262.3	281.1	307.4	314.0	331.9	352.4	390.2	399.6	401.4	410.1	442.5	486.5
Oilfields & Refineries	-	-	-	-	-	-	-	-	72.0	71.8	77.8	80.1
Power Stations Consumption	218.3	235.4	272.8	311.0	339.4	386.4	455.5	539.8	600.7	693.3	813.4	912.4
Transmission & Distribution Losses	864.5	962.4	913.8	983.3	1159.3	1335.0	1523.9	1770.6	2059.7	2536.5	2775.3	3244.5
B. CONSUMPTION BY OTHER SECTORS												
TRANSPORTATION	486.8	518.6	567.5	578.8	648.9	661.5	719.8	781.4	828.3	829.1	838.4	859.5
Of which: Railways	433.9	462.6	514.7	521.0	589.7	604.0	661.5	727.7	772.5	771.0	780.3	801.4
Tramways	52.9	56.0	52.8	57.8	59.2	57.5	58.3	53.7	55.8	58.1	58.1	58.1
INDUSTRY												
Of which: Mining & Quarrying (Gold only)	119.4	119.0	105.0	103.8	102.9	107.4	114.3	117.2	116.4	113.1	112.2	110.3
Fertilizer	82.0	187.1	269.7	291.3	322.5	335.3	329.8	372.4	404.5	477.2	1293.9	1601.8
Heavy Chemical	62.1	64.0	77.1	80.7	121.0	147.1	158.9	198.6	324.4	404.3	604.9	636.5
Cement	359.4	398.9	424.9	479.3	483.7	559.5	632.8	755.4	850.9	936.4	983.5	1014.2
Iron & Steel	566.5	582.6	560.5	694.7	770.4	820.5	904.6	1035.1	1427.0	1803.7	2343.8	2722.8
Non-Ferrous	151.9	148.9	135.9	177.3	233.8	240.6	255.7	314.5	476.2	488.6	516.7	647.8
Textiles	1606.8	1633.3	1773.9	1908.0	2143.1	2376.4	2430.3	2587.8	2801.3	2847.9	2942.2	3218.2
Other	1334.1	1403.1	1645.6	1817.4	2083.8	2321.3	2922.5	3435.2	3855.7	4529.4	5173.9	5925.9
TOTAL INDUSTRY	4282.2	4516.9	4992.6	5552.5	6261.2	6908.1	7748.9	8816.2	10256.4	11600.6	13971.1	15877.5
AGRICULTURE	203.0	215.2	214.1	231.4	254.8	316.2	565.8	583.5	754.0	832.9	991.1	1103.4
DOMESTIC	595.0	628.9	690.5	759.2	850.4	934.1	1094.6	1238.0	1378.5	1492.3	1698.1	1917.2
COMMERCIAL	331.5	336.6	399.1	446.2	514.4	545.9	611.5	682.8	766.2	847.8	934.1	1048.3
GOVERNMENT	279.5	293.7	321.8	361.4	390.3	434.9	507.1	548.7	612.1	629.4	695.2	775.3
OTHER	67.6	94.1	83.9	106.1	120.2	75.6	140.1	166.6	197.7	209.6	-	-
TOTAL INTERNAL FINAL CONSUMPTION	7590.7	8082.9	8763.5	9643.9	10870.8	11950.1	13757.4	15527.2	17927.0	20153.4	23237.2	26304.7

TABLE 4-24
PRODUCTION AND USES OF ENERGY SOURCES - 1953/4 - ALL INDIA

	Coking Coal	Non-Coking Coal	Metallurgical Coke	Non-Metallurgical coke	Crude Oil	Total Oil Products	Motor Spirit	Aviation & Jet Fuel	HSDO	LDO	Kerosene	LPG	Fuel Oil	Vapourising Oil & Refinery Fuel	Manufactured Gas			Electricity(5)		Non-commercial Fuels		
	1	2	3	4	5	6	7	8	9	10	11	12	13	14	10 ⁹ x Cubic Metres			10 ⁹ x kWh = TWh		Million Tonnes		
															15	16	17	18	19	20	21	22
PRODUCTION AND CONSUMPTION																						
A. PRIMARY SOURCES OF ENERGY																						
PRODUCTION	13.79	22.94			0.27													2.91 ⁽¹⁾		(13)	(13)	(13)
NET BALANCE OF EXTERNAL TRADE	-	-1.89			-													-		48.40	88.30	26.40
BUNKERS	-	-0.41			-													-		-	-	-
STOCK CHANGES	-0.88	+0.68			-													-		-	-	-
TOTAL CONSUMPTION	12.91	21.22			0.27 ⁽¹²⁾													2.91		48.40	88.30	26.40
QUANTITIES TRANSFORMED	-5.00	-5.65			-0.27 ⁽¹²⁾													-		-	-	-
INTERNAL FINAL CONSUMPTION	7.91	15.57			-													2.91		48.40	88.30	26.40
B. SECONDARY SOURCES OF ENERGY																						
PRODUCTION			2.17	1.64		0.20	0.05	-	0.02	0.03	0.06	-	0.02	0.02	3.90	0.78	0.05	3.78 ⁽²⁾	2.07 ⁽³⁾			
NET BALANCE OF EXTERNAL TRADE			-0.03	-0.01		3.48	+0.74	+0.09	+0.28	+0.40	+1.14	-	+0.79	+0.04	-	-	-	+0.09 ⁽²⁾	-0.09 ⁽³⁾			
BUNKERS			-	-		-0.26	-	-	-	-0.01	-	-	-0.25	-	-	-	-	-	-	-	-	-
STOCK CHANGES			-0.07	-0.20		+0.06	+0.02	-	+0.01	-0.01	-0.01	-	+0.05	-	-	-	-	-	-	-	-	-
TOTAL CONSUMPTION			2.07 ⁽⁹⁾	1.43		3.48	0.81	0.09	0.31	0.41	1.19	-	0.61	0.08	3.90	0.78	0.05	3.87	1.98			
QUANTITIES TRANSFORMED			-0.61 ⁽⁹⁾	-		-0.07	-	-	-	-0.07	-	-	-	-	-0.89	-0.03	-	-	-	-	-	-
INTERNAL FINAL CONSUMPTION			1.46	1.43		3.41	0.81	0.09	0.31	0.34	1.19	-	0.61	0.06	3.21	0.75	0.05	3.87	1.98			
TOTAL INTERNAL FINAL CONSUMPTION	7.91	15.57 ⁽¹¹⁾	1.46	1.43		3.41	0.81	0.09	0.31	0.34	1.19	-	0.61	0.06	3.21	0.75	0.05	6.78	1.98	46.40	86.30	26.40
BREAKDOWN OF INTERNAL FINAL CONSUMPTION																						
A. CONSUMPTION BY THE ENERGY SECTOR AND LOSSES																						
	0.69	1.02				0.02								0.02	0.87	0.15		1.36	0.13			
Of which: Coal Mines & Washeries	0.69	1.02																0.18	0.13			
Electric Power Plants																		0.27	-			
Coke Ovens															0.68	0.02						
Gas Works																						
Oil Refineries & Field Operation						0.02								0.02	0.19	0.13		0.81				
Losses																						
B. CONSUMPTION BY THE OTHER SECTORS																						
TRANSPORTATION	5.03	7.13				1.17	0.81	0.09	0.21				0.06						0.48	0.08		
Of which: Road						1.01	0.81		0.20													
Railroads	5.03	6.89				0.01			0.01										0.43	0.08		
Tramways																			0.05			
Waterways		0.24				0.06							0.06									
Air						0.09		0.09														
INDUSTRY	2.19	6.63	1.46			0.83			0.07	0.20	0.01		0.55		2.34	0.60		3.31	1.69			
Of which: Mining & Quarrying																		0.11	-			
Fertilizer			0.16															0.04	0.23			
Heavy Chemical																		0.03	0.05			
Structural Clay Products		0.08																-	-			
Cement		1.12																	0.10	0.32		
Iron & Steel	0.80	- ⁽⁷⁾	1.30 ⁽¹⁰⁾												2.34	0.60 ⁽⁸⁾		0.12	0.44			
Non-Ferrous		0.05 ⁽⁷⁾																0.05	0.09			
Textiles																		1.45	0.32			
Other	1.39	5.38 ⁽⁸⁾																1.41	0.24			
AGRICULTURE	-	0.17				0.21			0.03	0.14				0.04				0.22				
DOMESTIC				1.43		1.18					1.18											
COMMERCIAL		0.14															0.05	0.69		48.40	86.30	26.40
GOVERNMENT		0.48																0.40				
OTHERS																		0.32				
TOTAL INTERNAL FINAL CONSUMPTION	7.91	15.57	1.46	1.43	-	3.41	0.81	0.09	0.31	0.34	1.19	-	0.61	0.06	3.21	0.75	0.05	6.78	1.98	48.40	86.30	26.40

- (1) Production of electricity from primary hydro power has been shown here for the sake of convenience.
 (2) Purchase from Non-Utilities.
 (3) Sale to Utilities.
 (4) Sale to other agencies excluding utilities, break-up of which is not available.
 (5) Figures for the calendar year 1953 are used for fiscal year 1953/54.
 (6) This includes the coke oven gas used for underfiring of the coke ovens, as separate figures are not available.
 (7) Includes limestone burning.
 (8) Including textiles.
 (9) Represents the coke equivalent of blast furnace gas produced.
 (10) Excluding the quantities considered as transformed into blast furnace gas (cf note 9).
 (11) Excluding non-coking coal used in coal mines, railways and industries for power generation.
 (12) Covering also non-energy products. See Table 4-9.
 (13) For our purposes, we have assumed production of non-commercial fuels as equal to final consumption for Energy uses only.

- (1) Production of electricity from primary hydro power has been shown here for the sake of convenience.
 (2) Purchase from Non-Utilities.
 (3) Sale to Utilities.
 (4) Sale to other agencies excluding utilities, break-up of which is not available.
 (5) Figures for the calendar year 1953 are used for fiscal year 1953/54.
 (6) This includes the coke oven gas used for underfiring of the coke ovens, as separate figures are not available.
 (7) Includes limestone burning.
 (8) Including textiles.
 (9) Represents the coke equivalent of blast furnace gas produced.
 (10) Excluding the quantities considered as transformed into blast furnace gas (cf note 9).
 (11) Excluding non-coking coal used in coal mines, railways and industries for power generation.
 (12) Covering also non-energy products. See Table 4-9.
 (13) For our purposes, we have assumed production of non-commercial fuels as equal to final consumption for Energy uses only.

NOTE: Quantities less than 5000 tonnes not shown.

Value not possible to isolate and included in these figures.

TABLE 4-25

PRODUCTION AND USES OF ENERGY SOURCES - 1954/5 - ALL INDIA

	Coking Coal	Non-Coking Coal	Metallurgical coke	Non-Metallurgical Coke	Crude Oil	Total Oil Products	Motor Spirit	Aviation & Jet Fuel	HSDO	LDO	Kerosene	LPG	Fuel Oil	Vapourising Oil & Refinery Fuel	Manufactured Gas			Electricity(5)		Non-commercial Fuels			
	1	2	3	4	5	6	7	8	9	10	11	12	13	14	10 ⁹ x Cubic Metres			10 ⁹ x kWh = TWh		Million Tonnes			
PRODUCTION AND CONSUMPTION																							
A. PRIMARY SOURCES OF ENERGY																							
PRODUCTION	13.58	24.05			0.31																		
NET BALANCE OF EXTERNAL TRADE	-	-1.89			1.26														3.24 ⁽¹⁾		47.60 ⁽¹³⁾	87.50 ⁽¹³⁾	27.00 ⁽¹³⁾
BUNKERS	-	-0.36			-														-		-	-	
STOCK CHANGES	-0.80	-0.36			-														-		-	-	
TOTAL CONSUMPTION	12.78	21.44			1.57 ⁽¹²⁾														-		-	-	
QUANTITIES TRANSFORMED	-5.41	-5.81			-1.57 ⁽¹²⁾														3.24		47.60	87.50	27.00
INTERNAL FINAL CONSUMPTION	7.37	15.63			-														3.24		47.60	87.50	27.00
B. SECONDARY SOURCES OF ENERGY																							
PRODUCTION			2.43	1.75		1.48	0.35	-	0.14	0.13	0.19	-	0.43	0.24	4.21	0.88	0.05	4.29 ⁽²⁾	2.12 ⁽³⁾				
NET BALANCE OF EXTERNAL TRADE			-0.03	-0.02		2.93	+0.54	+0.10	+0.27	+0.32	-1.13	-	+0.53	+0.04	-	-	-	+0.02 ⁽²⁾	-0.02 ⁽³⁾				
BUNKERS			-	-		-0.26	-	-	-	-0.01	-	-	-0.25	-	-	-	-	-	-	-	-	-	
STOCK CHANGES			-0.20	-0.17		-0.23	-0.07	-	-0.04	-0.02	-0.04	-	-0.06	-	-	-	-	-	-	-	-	-	
TOTAL CONSUMPTION			2.20 ⁽⁹⁾	1.56		3.92	0.82	0.10	0.37	0.42	1.28	-	0.65	0.28	4.21	0.88	0.05	4.31	2.10				
QUANTITIES TRANSFORMED			-0.66 ⁽⁹⁾	-		-0.08	-	-	-	-0.08	-	-	-	-	-0.77	-0.03	-	-	-	-	-	-	
INTERNAL FINAL CONSUMPTION			1.54	1.56		3.84	0.82	0.10	0.37	0.34	1.28	-	0.65	0.28	3.44	0.85	0.05	4.31	2.10				
TOTAL INTERNAL FINAL CONSUMPTION	7.37	15.63 ⁽¹¹⁾	1.54	1.56	-	3.84	0.82	0.10	0.37	0.34	1.28	-	0.65	0.28	3.44	0.85	0.05	7.55	2.10	47.60	87.50	27.00	
BREAKDOWN OF INTERNAL FINAL CONSUMPTION																							
A. CONSUMPTION BY THE ENERGY SECTOR AND LOSSES																							
Of which:	0.68	1.08				0.23								0.23	0.77	0.15		1.48	0.12				
Coal Mines & Washeries	0.68	1.08																0.19	0.12				
Electric Power Plants																		0.31	-				
Coke Ovens															0.53	0.02			-				
Gas Works																							
Oil Refineries & Field Operation						0.23								0.23									
Losses															0.24	0.13		0.98					
B. CONSUMPTION BY THE OTHER SECTORS																							
TRANSPORTATION																							
Of which:	4.86	6.79				1.24	0.82	0.10	0.26				0.06						0.52	0.07			
Road						1.06	0.82		0.24														
Railroads	4.86	6.51				0.02			0.02														
Tramways																							
Waterways		0.28				0.06			-				0.06						0.06				
Air						0.10		0.10															
INDUSTRY																							
Of which:	1.83	6.87	1.54			0.88			0.08	0.20	0.01		0.59		2.67	0.70		3.75	1.80				
Mining & Quarrying																		0.10	-				
Fertilizer																		0.04	0.25				
Heavy Chemical			0.20															0.03	0.05				
Structural Clay Products		0.08																					
Cement		1.17																					
Iron & Steel	0.65																		0.14	0.34			
Non-Ferrous		0.04 ⁽⁷⁾													2.67	0.70 ⁽⁶⁾		0.22	0.48				
Textiles																		0.08	0.10				
Other ⁽⁸⁾	1.18	5.58 ⁽⁸⁾																1.58	0.33				
AGRICULTURE		0.22				0.22			0.03	0.14				0.05					0.23				
DOMESTIC		-																	-				
COMMERCIAL		0.13		1.56		1.27					1.27							0.05	0.76		47.60	87.50	27.00
GOVERNMENT																			0.45				
OTHERS		0.54																	0.36				
TOTAL INTERNAL FINAL CONSUMPTION	7.37	15.63	1.54	1.56	-	3.84	0.82	0.10	0.37	0.34	1.28	-	0.65	0.28	3.44	0.85	0.05	7.55	2.10	47.60	87.50	27.00	

(1) Production of electricity from primary hydro power has been shown here for the sake of convenience.

(3) Sale to Utilities.

(5) Figures for the calendar year 1954 are used for fiscal year 1954-55.

(7) Includes lime stone burning.

(9) Represents coke equivalent of blast furnace gas produced.

(11) Excluding non-coking coal used in coalmines, railways and industries for power generation.

(13) For our purposes we have assumed production of non-commercial fuels as equal to final consumption for Energy uses only.

(2) Purchase from Non-utilities.

(4) Sale to other agencies excluding utilities, break-up of which is not available.

(6) This includes the coke oven gas used for underfiring of the coke ovens, as separate figures are not available.

(8) Including textiles.

(10) Excluding the quantities considered as transformed into blast furnace gas. (cf note 9)

(12) Covering also non-energy products. See Table 4-9

NOTE: Quantities less than 5000 tonnes not shown.

Value not possible to isolate and included in these figures.

TABLE 4-26
PRODUCTION AND USES OF ENERGY SOURCES-1955/6-ALL INDIA

	Coking Coal	Non-Coking Coal	Metallurgical Coke	Non-Metallurgical Coke	Crude Oil	Total Oil Products	Motor Spirit	Aviation & Jet Fuel	HSDO	LDO	Kerosene	LPG	Fuel Oil	Vapourising Oil & Refinery Fuel	Manufactured Gas			Electricity(5)		Non-commercial Fuels				
	1	2	3	4	5	6	7	8	9	10	11	12	13	14	10 ⁹ x Cubic Metres			10 ⁹ x kWh = Twh		Million Tonnes				
PRODUCTION AND CONSUMPTION																								
A. PRIMARY SOURCES OF ENERGY																								
PRODUCTION	13.47	25.47			0.36																			
NET BALANCE OF EXTERNAL TRADE	-	-1.60			3.21														3.74 ⁽¹⁾		48.80 ⁽¹³⁾	88.80 ⁽¹³⁾	27.70 ⁽¹³⁾	
BUNKERS	-	-0.24			-														-		-	-		
STOCK CHANGES	-0.74	-1.25			-0.02														-		-	-		
TOTAL CONSUMPTION	12.73	22.38			3.55 ⁽¹²⁾														-		-	-		
QUANTITIES TRANSFORMED	-5.69	-6.35			-3.55 ⁽¹²⁾														3.74		48.80	88.80	27.70	
INTERNAL FINAL CONSUMPTION	7.04	16.03			-														3.74		48.80	88.80	27.70	
B. SECONDARY SOURCES OF ENERGY																								
PRODUCTION			2.58	1.81		3.34	0.84	-	0.34	0.27	0.47	-	1.10	0.32	4.03	0.84	0.05	4.85 ⁽²⁾	2.28 ⁽³⁾					
NET BALANCE OF EXTERNAL TRADE			-0.02	-0.02		1.52	+0.02	+0.12	+0.14	+0.20	+1.06	-	-0.07	+0.05	-	-	-	+0.02 ⁽²⁾	-0.02 ⁽³⁾					
BUNKERS			-	-		-0.29	-	-	-	-0.02	-	-	-0.27	-	-	-	-	-	-	-	-	-		
STOCK CHANGES			-0.16	-0.10		-0.21	-0.01	-	-0.02	-0.02	-0.10	-	-0.06	-	-	-	-	-	-	-	-	-		
TOTAL CONSUMPTION			2.41 ⁽⁹⁾	1.69		4.36	0.85	0.12	-0.02	-0.02	-0.10	-	-0.06	-	-	-	-	-	-	-	-	-		
QUANTITIES TRANSFORMED			-0.63 ⁽⁹⁾	-		-0.08	-	-	0.46	0.43	1.43	-	0.70	0.37	4.03	0.84	0.05	4.87	2.26					
INTERNAL FINAL CONSUMPTION			1.78	1.69		4.28	0.85	0.12	0.46	0.35	1.43	-	0.70	0.37	-0.72	0.84	0.05	4.87	2.26					
TOTAL INTERNAL FINAL CONSUMPTION	7.04	16.03 ⁽¹¹⁾	1.78	1.69	-	4.28	0.85	0.12	0.46	0.35	1.43	-	0.70	0.37	3.31	0.84	0.05	8.61	2.26	48.80	88.80	27.70		
BREAKDOWN OF INTERNAL FINAL CONSUMPTION																								
A. CONSUMPTION BY THE ENERGY SECTOR AND LOSSES																								
	0.73	1.14				0.32									0.32	0.84	0.18	1.71	0.13					
Of which:																								
Coal Mines & Washeries	0.73	1.14																						
Electric Power Plants																			0.21	0.13				
Coke Ovens																			0.34					
Gas Works																								
Oil Refineries & Field Operation						0.32																		
Losses															0.32									
B. CONSUMPTION BY THE OTHER SECTORS																								
TRANSPORTATION																								
	5.24	7.16	-	-	-	1.38	0.85	0.12	0.33				0.06							0.56	0.09			
Of which:																								
Road																								
Railroads	5.24	6.84				0.02	0.85		0.31															
Tramways									0.02															
Waterways		0.32				0.06														0.50	0.09			
Air						0.12		0.12					0.06							0.06				
INDUSTRY																								
	1.07	6.74	1.78			0.95			0.09	0.21	0.01		0.64		2.47	0.66		4.34	1.92					
Of which:																								
Mining & Quarrying																								
Fertilizer			0.20																0.10	-				
Heavy Chemical		0.01																	0.05	0.27				
Structural Clay Products		0.08																	0.06	0.06				
Cement		1.29																	-	-				
Iron & Steel	0.44	-	1.58 ⁽¹⁰⁾																					
Non-Ferrous		0.06 ⁽⁷⁾																		0.14	0.35			
Textiles																				0.37	0.40			
Other	0.63	5.30 ⁽⁸⁾														2.47	0.66 ⁽⁶⁾			0.14	0.09			
AGRICULTURE		0.32																		1.74	0.40			
DOMESTIC		-		1.69		1.42			0.04	0.14	1.42			0.05						1.74	0.35			
COMMERCIAL		0.12																		0.25				
GOVERNMENT		0.55																		0.85		48.80	88.80	27.70
OTHERS																				0.51				
TOTAL INTERNAL FINAL CONSUMPTION	7.04	16.03	1.78	1.69	-	4.28	0.85	0.12	0.46	0.35	1.43	-	0.70	0.37	3.31	0.84	0.05	8.61	2.26	48.80	88.80	27.70		

(1) Production of electricity from primary hydro power has been shown for the sake of convenience.
(2) Purchase from Non-Utilities.
(3) Sale to Utilities.
(4) Sale to other agencies excluding utilities, break-up of which is not available.
(5) Figures for the calendar year 1955 are used for fiscal year 1955-58.
(6) This includes the coke oven gas used for underfiring of the coke ovens, as separate figures are not available.
(7) Includes lime stone burning.
(8) Including textiles.
(9) Represents coke equivalent of blast furnace gas produced.
(10) Excluding the quantities considered as transformed into blast furnace gas. (cf note 9)
(11) Excluding non-coking coal used in coal mines, railways and industries for power generation.
(12) Covering also non-energy products. See Table 4-9
(13) For our purposes we have assumed production of non-commercial fuels as equal to final consumption for Energy uses only.

(1) Production of electricity from primary hydro power has been shown for the sake of convenience.
(2) Purchase from Non-Utilities.
(3) Sale to Utilities.
(4) Sale to other agencies excluding utilities, break-up of which is not available.
(5) Figures for the calendar year 1955 are used for fiscal year 1955-58.
(6) This includes the coke oven gas used for underfiring of the coke ovens, as separate figures are not available.
(7) Includes lime stone burning.
(8) Including textiles.
(9) Represents coke equivalent of blast furnace gas produced.
(10) Excluding the quantities considered as transformed into blast furnace gas. (cf note 9)
(11) Excluding non-coking coal used in coal mines, railways and industries for power generation.
(12) Covering also non-energy products. See Table 4-9
(13) For our purposes we have assumed production of non-commercial fuels as equal to final consumption for Energy uses only.

NOTE: Quantities less than 5000 tonnes not shown
Value not possible to isolate and included in these figures.

TABLE 4-27

PRODUCTION AND USES OF ENERGY - 1956/7 - ALL INDIA

	Coking Coal	Non-Coking Coal	Metallurgical Coke	Non-Metallurgical Coke	Crude Oil	Total Oil Products	Motor Spirit	Aviation & Jet Fuel	MSDO	LDO	Kerosene	LPG	Fuel Oil	Vapourising Oil & Refinery Fuel	Manufactured Gas			Electricity(5)		Non-commercial Fuels			
	1	2	3	4	5	6	7	8	9	10	11	12	13	14	15	16	17	18	19	20	21	22	
Million Tonnes																							
PRODUCTION AND CONSUMPTION																							
A. PRIMARY SOURCES OF ENERGY																							
PRODUCTION	14.11	28.74			0.41																		
NET BALANCE OF EXTERNAL TRADE BUNKERS	-	-1.71			3.94													4.29 ⁽¹⁾		50.10 ⁽¹¹⁾	90.10 ⁽¹¹⁾	28.40 ⁽¹¹⁾	
STOCK CHANGES	-0.62	-1.21			+0.02 ⁽¹⁰⁾													-		-	-	-	
TOTAL CONSUMPTION	13.49	23.59			4.37 ⁽¹⁰⁾													-		-	-	-	
QUANTITIES TRANSFORMED	-5.69	-6.67			-4.37 ⁽¹⁰⁾													4.29		50.10	90.10	28.40	
INTERNAL FINAL CONSUMPTION	7.80	16.92			-													4.29		50.10	90.10	28.40	
B. SECONDARY SOURCES OF ENERGY																							
PRODUCTION			2.55	1.82		4.11	0.98	-	0.48	0.29	0.56	-	1.46	0.34	4.06	0.81	0.05	5.37 ⁽²⁾	2.29 ⁽³⁾				
NET BALANCE OF EXTERNAL TRADE BUNKERS			-0.02	-0.03		+1.10	-0.11	+0.11	+0.10	+0.22	+0.99	-	-0.25	+0.04	-	-	-	+0.02 ⁽²⁾	-0.02 ⁽³⁾				
STOCK CHANGES			-0.20	+0.16		-0.07	-0.01	+0.03	+0.01	-0.03	-	-	-0.35	-	-	-	-	-	-				
TOTAL CONSUMPTION			2.33 ⁽⁶⁾	1.85		4.76	0.86	0.14	0.59	0.45	1.55	-	0.78	0.39	4.06	0.81	0.05	5.39	2.27				
QUANTITIES TRANSFORMED			-0.83 ⁽⁶⁾	-		-0.11	-	-	-	-0.08	-	-	-0.08	-0.01	-	-	-	-	-				
INTERNAL FINAL CONSUMPTION			1.70	1.95		4.65	0.86	0.14	0.59	0.37	1.55	-	0.75	0.39	3.34	0.81	0.05	5.39	2.27	50.10	90.10	28.40	
TOTAL INTERNAL FINAL CONSUMPTION	7.80	16.92 ⁽⁹⁾	1.70	1.95	-	4.65	0.86	0.14	0.59	0.37	1.55	-	0.75	0.39	3.34	0.81	0.05	9.68	2.27	50.10	90.10	28.40	
BREAKDOWN OF INTERNAL FINAL CONSUMPTION																							
A. CONSUMPTION BY THE ENERGY SECTOR AND LOSSES																							
Of which:	0.72	1.20				0.34								0.34	0.90	0.18		1.94	0.13				
Coal Mines & Washeries	0.72	1.20																0.22	0.13				
Electric Power Plants																		0.39	-				
Coke Ovens															0.59	0.02							
Gas Works																							
Oil Refineries & Field Operation Losses						0.34								0.34									
B. CONSUMPTION BY THE OTHER SECTORS																							
TRANSPORTATION																							
Of which:	5.70	7.87				1.50	0.86	0.14	0.43				0.07										
Road						1.26	0.86		0.40											0.59	0.08		
Railroads	5.70	7.87				0.04			0.03				0.01							0.53	0.08		
Tramways																				0.06	-		
Waterways		0.30				0.06							0.06										
Air						0.14		0.14															
INDUSTRY																							
Of which:	1.38	6.71	1.70			1.02			0.10	0.22	0.02		0.68		2.44	0.65		4.93	1.98				
Mining & Quarrying																			0.11	-			
Fertilizer																			0.05	0.28			
Heavy Chemical		0.31	0.20																0.08	0.07			
Structural Clay Products		1.55 ⁽⁸⁾																					
Cement		1.44																		0.16	0.40		
Iron & Steel	0.62		1.50 ⁽⁷⁾																	0.46	0.36		
Non-Ferrous		0.03																		0.18	0.09		
Textiles		1.77																		1.96	0.41		
Other	0.76	1.81																		1.95	0.37		
AGRICULTURE																							
DOMESTIC		0.28				0.28			0.06	0.15				0.05			0.05		0.32	-			
COMMERCIAL				1.95		1.53					1.53								0.93	-	50.10	90.10	28.40
GOVERNMENT		0.12																	0.54	-			
OTHERS		0.63																	0.43	-			
TOTAL INTERNAL FINAL CONSUMPTION	7.80	16.92	1.70	1.95	-	4.65	0.86	0.14	0.59	0.37	1.55	-	0.75	0.39	3.34	0.81	0.05	9.68	2.27	50.10	90.10	28.40	

(1) Production of electricity from primary hydro power has been shown here for the sake of convenience.

(2) Purchase from Non-Utilities.

(3) Sale to Utilities.

(4) Sale to other agencies excluding utilities, break-up of which is not available.

(5) Figures for the calendar year 1956 are used for fiscal year 1956/7.

(6) Represents coke equivalent of blast furnace gas produced.

(7) Excluding the quantities considered as transformed into blast furnace gas (cf note 6).

(8) Includes brick burning.

(9) Excluding non-coking coal used in coal mines, railways and industries for power generation.

(10) Covering also non-energy products. See Table 4-9.

(11) This includes the coke oven gas used for underfiring of the coke ovens as separate figures are not available.

(12) For our purposes we have assumed production of non-commercial fuels as equal to final consumption for Energy uses only.

NOTE: Quantities less than 5000 tonnes not shown.

Value not possible to isolate and included in these figures.

TABLE 4-27
PRODUCTION AND USES OF ENERGY - 1956/7 - ALL INDIA

	Coking Coal	Non-Coking Coal	Metallurgical Coke	Non-Metallurgical Coke	Crude Oil	Total Oil Products	Motor Spirit	Aviation & Jet Fuel	HSDO	LDO	Kerosene	LPG	Fuel Oil	Vapourising Oil & Refinery Fuel	Manufactured Gas			Electricity(5)		Non-commercial Fuels			
	1	2	3	4	5	6	7	8	9	10	11	12	13	14	10 ⁹ x Cubic Metres			10 ⁹ x kWh = TWh		Million Tonnes			
PRODUCTION AND CONSUMPTION																							
A. PRIMARY SOURCES OF ENERGY																							
PRODUCTION	14.11	28.74			0.41																		
NET BALANCE OF EXTERNAL TRADE	-	-1.71			3.94														4.29 ⁽¹⁾		50.10 ⁽¹¹⁾	90.10 ⁽¹¹⁾	28.40 ⁽¹¹⁾
BUNKERS	-	-0.23			-														-		-	-	-
STOCK CHANGES	-0.62	-1.21			+0.02														-		-	-	-
TOTAL CONSUMPTION	13.49	23.59			4.37 ⁽¹⁰⁾														-		-	-	-
QUANTITIES TRANSFORMED	-5.69	-6.67			-4.37 ⁽¹⁰⁾														4.29		50.10	90.10	28.40
INTERNAL FINAL CONSUMPTION	7.80	16.92			-														4.29		50.10	90.10	28.40
B. SECONDARY SOURCES OF ENERGY																							
PRODUCTION			2.55	1.82		4.11	0.88	-	0.48	0.29	0.58	-	1.46	0.34	4.08	0.81	0.05						
NET BALANCE OF EXTERNAL TRADE			-0.02	-0.03		+1.10	-0.11	+0.11	+0.10	+0.22	+0.89	-	-0.25	+0.04	-	-	0.05		5.37 ⁽²⁾	2.29 ⁽³⁾			
BUNKERS			-	-		-0.38	-	-	-	-0.03	-	-	-0.35	-	-	-	-		+0.02 ⁽²⁾	-0.02 ⁽³⁾			
STOCK CHANGES			-0.20	+0.16		-0.07	-0.01	+0.03	+0.01	-0.03	-	-	-0.08	-0.01	-	-	-		-	-			
TOTAL CONSUMPTION			2.33 ⁽⁶⁾	1.95		4.78	0.86	0.14	0.59	0.45	1.55	-	0.78	0.39	4.08	0.81	0.05		5.39	2.27			
QUANTITIES TRANSFORMED			-0.63 ⁽⁶⁾	-		-0.11	-	-	-	-0.08	-	-	-0.03	-	-0.72	-	-		-	-			
INTERNAL FINAL CONSUMPTION			1.70	1.95		4.65	0.86	0.14	0.59	0.37	1.55	-	0.75	0.39	3.34	0.81	0.05		5.39	2.27			
TOTAL INTERNAL FINAL CONSUMPTION	7.80	16.92 ⁽⁹⁾	1.70	1.95	-	4.65	0.88	0.14	0.58	0.37	1.55	-	0.75	0.39	3.34	0.81	0.05		9.68	2.27	50.10	90.10	28.40
BREAKDOWN OF INTERNAL FINAL CONSUMPTION																							
A. CONSUMPTION BY THE ENERGY SECTOR AND LOSSES																							
	0.72	1.20				0.34								0.34	0.90	0.18			1.94	0.13			
Of which: Coal Mines & Washeries	0.72	1.20																	0.22	0.13			
Electric Power Plants																			0.39	-			
Coke Ovens															0.59	0.02			-	-			
Gas Works																			-	-			
Oil Refineries & Field Operation						0.34								0.34					-	-			
Losses															0.31	0.14			1.33	-			
B. CONSUMPTION BY THE OTHER SECTORS																							
TRANSPORTATION																							
	5.70	7.97				1.50	0.88	0.14	0.43				0.07							0.59	0.08		
Of which: Road																							
Railroads	5.70	7.87				1.28	0.86		0.40														
Tramways						0.04			0.03											0.53	0.08		
Waterways																			0.06	-			
Air		0.30				0.06		0.14					0.06										
INDUSTRY																							
	1.38	6.71	1.70			1.02			0.10	0.22	0.02		0.68		2.44	0.65			4.93	1.98			
Of which: Mining & Quarrying																			0.11	-			
Fertilizer																			0.05	0.28			
Heavy Chemical		0.31	0.20																0.08	0.07			
Structural Clay Products		1.55 ⁽⁸⁾																	-	-			
Cement		1.44																	0.16	0.40			
Iron & Steel	0.62	-	1.50 ⁽⁷⁾												2.44	0.65 ⁽¹²⁾			0.46	0.36			
Non-Ferrous		0.03																	0.16	0.09			
Textiles		1.77																	1.96	0.41			
Other	0.76	1.81																	1.95	0.37			
AGRICULTURE																							
DOMESTIC																							
				1.95		0.28			0.06	0.15				0.05					0.32	-			
COMMERCIAL																							
		0.12				1.53					1.53								0.83	-	50.10	90.10	28.40
GOVERNMENT																							
		0.63																	0.54	-			
OTHERS																							
																			0.43	-			
TOTAL INTERNAL FINAL CONSUMPTION	7.80	16.92	1.70	1.95	-	4.65	0.88	0.14	0.59	0.37	1.55	-	0.75	0.39	3.34	0.81	0.05		9.68	2.27	50.10	90.10	28.40

(1) Production of electricity from primary hydro power has been shown here for the sake of convenience.
 (3) Sale to Utilities.
 (5) Figures for the calendar year 1956 are used for fiscal year 1956/7.
 (7) Excluding the quantities considered as transformed into blast furnace gas (cf note 6)
 (9) Excluding non-coking coal used in coal mines, railways and industries for power generation.
 (11) For our purposes we have assumed production of non-commercial fuels as equal to final consumption for Energy uses only.

(2) Purchase from Non-Utilities.
 (4) Sale to other agencies excluding utilities, break-up of which is not available.
 (6) Represents coke equivalent of blast furnace gas produced.
 (8) Includes brick burning.
 (10) Covering also non-energy products. See Table 4-9
 (12) This includes the coke oven gas used for underfiring of the coke ovens as separate figures are not available.

NOTE: Quantities less than 5000 tonnes not shown.
 Value not possible to isolate and included in these figures.

TABLE 4-28

PRODUCTION AND USES OF ENERGY - 1957/8 - ALL INDIA

	Coking Coal	Non-Coking Coal	Metallurgical Coke	Non-Metallurgical Coke	Crude Oil	Total Oil Products	Motor Spirit	Aviation & Jet Fuel	MSDO	LDO	Kerosene	LPG	Fuel Oil	Vapourising Oil & Refinery Fuel	Manufactured Gas		Electricity		Non-commercial Fuels				
	1	2	3	4	5	6	7	8	9	10	11	12	13	14	10 ⁹ x Cubic Metres		10 ⁹ x kWh = TWh		Million Tonnes				
PRODUCTION AND CONSUMPTION																							
A. PRIMARY SOURCES OF ENERGY																							
PRODUCTION	15.11	29.54			0.44	0.03	0.03 ⁽⁵⁾																
NET BALANCE OF EXTERNAL TRADE		-1.73			4.50													5.07 ⁽¹⁾		51.40 ⁽¹¹⁾	91.40 ⁽¹¹⁾	29.10 ⁽¹¹⁾	
BUNKERS		-0.20																					
STOCK CHANGES	-0.70	-0.41			-0.03																		
TOTAL CONSUMPTION	14.41	27.20			4.91 ⁽¹⁰⁾	0.03	0.03																
QUANTITIES TRANSFORMED	-6.20	-6.85			-4.91																		
INTERNAL FINAL CONSUMPTION	8.21	20.35				0.03	0.03											5.07		51.40	91.40	29.10	
B. SECONDARY SOURCES OF ENERGY																							
PRODUCTION			2.69	1.87		4.64	1.03	0.01															
NET BALANCE OF EXTERNAL TRADE			-0.04	-0.03		1.12	-0.21	+0.13	0.84	0.36	0.62		1.60	0.38	4.24	0.87	0.05	6.30	2.39				
BUNKERS						-0.43	-0.01	+0.03	+0.12	+0.15	+1.07		-0.18	+0.04				0.04 ⁽²⁾	-0.04 ⁽³⁾				
STOCK CHANGES			-0.31	+0.04		-0.14	-0.01	+0.03		-0.04			-0.39										
TOTAL CONSUMPTION			2.34	1.88		5.19	0.81	0.17	+0.01	-0.04	-0.07		-0.10										
QUANTITIES TRANSFORMED			-0.66 ⁽⁶⁾			-0.20			0.77	0.47	1.82		0.93	0.42	4.24	0.87	0.05	6.34	2.35				
INTERNAL FINAL CONSUMPTION			1.68	1.88		4.99	0.81	0.17		-0.08			-0.12		-0.67	0.87	0.05	6.34	2.35				
TOTAL INTERNAL FINAL CONSUMPTION	8.21	20.35 ⁽⁹⁾	1.68	1.88		5.02	0.84	0.17	0.77	0.39	1.62		0.81	0.42	3.57	0.87	0.05	11.41	2.35	51.40	91.40	29.10	
BREAKDOWN OF INTERNAL FINAL CONSUMPTION																							
A. CONSUMPTION BY THE ENERGY SECTOR AND LOSSES																							
Of which:																							
Coal Mines & Washeries	0.77	1.34				0.37								0.37	1.22	0.22		2.24	0.13				
Electric Power Plants	0.77	1.34																0.26	0.13				
Coke Ovens																		0.46					
Gas Works															0.73	0.03							
Oil Refineries & Field Operation						0.37																	
Losses														0.37									
B. CONSUMPTION BY OTHER SECTORS																							
TRANSPORTATION																							
Of which:																							
Road	5.70	8.86				1.66	0.84	0.17	0.57	0.01										0.62	0.10		
Railroads	5.70	8.64				0.05	0.84		0.53														
Tramways									0.04											0.56	0.10		
Waterways																				0.06			
Air						0.07		0.17															
INDUSTRY	1.74	9.23	1.68			1.11			0.12	0.23	0.02		0.74		2.35	0.65		5.77	1.98				
Of which:																							
Mining & Quarrying																							
Fertilizer				0.20															0.11				
Heavy Chemical																			0.05	0.28			
Structural Clay Products																			0.08	0.08			
Cement																							
Iron & Steel	0.71		1.48 ⁽⁷⁾																	0.22	0.42		
Non-Ferrous															2.35	0.65 ⁽¹²⁾			0.53	0.38			
Textiles																			0.18	0.08			
Other	1.03	3.76																	2.04	0.38			
AGRICULTURE																			2.56	0.36			
DOMESTIC						0.28			0.08	0.15				0.05					0.57				
COMMERCIAL				1.88		1.60					1.60							0.05	1.09		51.40	91.40	29.10
GOVERNMENT																			0.61				
OTHERS																			0.51				
TOTAL INTERNAL FINAL CONSUMPTION	8.21	20.35	1.68	1.88		5.02	0.84	0.17	0.77	0.39	1.62		0.81	0.42	3.57	0.87	0.05	11.41	2.35	51.40	91.40	29.10	

(1) Production of electricity from primary hydro power has been shown here for the sake of convenience.
(3) Sale to Utilities.

(5) This represents production of power alcohol, a substitute fuel derived from molasses.
(7) Excluding the quantities considered as transformed into blast furnace gas (cf note 6)

(9) Excluding non-coking coal used in coal mines, railways and industries for power generation.
(11) For our purposes we have assumed production of non-commercial fuels as equal to final consumption for Energy uses only.

(2) Purchase from Non-utilities.

(4) Sale to other agencies excluding utilities, break up of which is not available.

(6) Represents coke equivalent of blast furnace gas produced.

(8) Includes brick burning.

(10) Covering also non-energy products. See Table 4-9

(12) This includes the Coke oven gas used for underfiring of the coke ovens as separate figures are not available.

NOTE: Quantities less than 5000 tonnes not shown.

Value not possible to isolate and included in these figures.

TABLE 4-29
PRODUCTION AND USES OF ENERGY - 1958/9 - ALL INDIA

	Coking Coal	Non-Coking Coal	Metallurgical Coke	Non-Metallurgical Coke	Crude Oil	Total Oil Products	Motor Spirit	Aviation & Jet Fuel	HSDO	LDO	Kerosene	LPG	Fuel Oil	Vapourising Oil & Refinery Fuel	Manufactured Gas			Electricity		Non-commercial Fuels			
	1	2	3	4	5	6	7	8	9	10	11	12	13	14	10 ⁹ x Cubic Metres			10 ⁹ x kWh = TWh		Million Tonnes			
PRODUCTION AND CONSUMPTION																							
A. PRIMARY SOURCES OF ENERGY																							
PRODUCTION	15.05	31.71			0.45	0.03	0.03 ⁽⁵⁾												5.85 ⁽¹⁾		52.70 ⁽¹¹⁾	92.70 ⁽¹¹⁾	29.90 ⁽¹¹⁾
NET BALANCE OF EXTERNAL TRADE	-	-1.71			4.76	-													-		-	-	-
BUNKERS	-	-0.14			-	-													-		-	-	-
STOCK CHANGES	-0.71	-0.62																	-		-	-	-
TOTAL CONSUMPTION	14.34	29.24			5.21 ⁽¹⁰⁾	0.03	0.03												5.85		52.70	92.70	29.90
QUANTITIES TRANSFORMED	-7.23	-7.69			-5.21 ⁽¹⁰⁾	-													-		-	-	-
INTERNAL FINAL CONSUMPTION	7.11	21.55			-	0.03	0.03												5.85		52.70	92.70	29.90
B. SECONDARY SOURCES OF ENERGY																							
PRODUCTION			3.33	2.03		4.89	0.97	-	0.81	0.44	0.67	-	1.65	0.35	5.23	1.10	0.06	7.14 ⁽²⁾	2.53 ⁽³⁾				
NET BALANCE OF EXTERNAL TRADE			-0.03	-0.03		1.24	-0.20	+0.12	+0.20	+0.10	+1.11		-0.13	+0.04	-	-	-	+0.04 ⁽²⁾	-0.04 ⁽³⁾				
BUNKERS						-0.41	-		-	-0.02	-		-0.39	-	-	-	-	-	-	-	-	-	-
STOCK CHANGES			-0.11	+0.06		-0.18	-	+0.07	-0.08	-0.02	-0.11		-0.08	-	-	-	-	-	-	-	-	-	-
TOTAL CONSUMPTION			3.19	2.06		5.54	0.77	0.19	0.95	0.50	1.67		1.07	0.39	5.23	1.10	0.06	7.18	2.49				
QUANTITIES TRANSFORMED			-0.82 ⁽⁶⁾	-		-0.25	-		-	-0.09	-		-0.16	-	-1.13	-0.02	-	-	-	-	-	-	-
INTERNAL FINAL CONSUMPTION			2.37	2.06		5.29	0.77	0.19	0.95	0.41	1.67		0.91	0.39	4.10	1.08	0.06	7.18	2.49				
TOTAL INTERNAL FINAL CONSUMPTION	7.11	21.55 ⁽⁹⁾	2.37	2.06	-	5.32	0.80	0.19	0.95	0.41	1.67	-	0.91	0.39	4.10	1.08	0.06	13.03	2.49	52.70	92.70	29.90	
BREAKDOWN OF INTERNAL FINAL CONSUMPTION																							
A. CONSUMPTION BY THE ENERGY SECTOR AND LOSSES																							
	0.77	1.26				0.34								0.34	1.43	0.28		2.58	0.13				
Of which: Coal Mines & Washeries	0.77	1.26																0.27	0.13				
Electric Power Plants																		0.54	-				
Coke Ovens															0.77	0.03		-	-				
Gas Works																		-	-				
Oil Refineries & Field Operation						0.34								0.34				-	-				
Losses															0.66	0.25		1.77	-				
B. CONSUMPTION BY THE OTHER SECTORS																							
TRANSPORTATION	4.57	10.18				1.79	0.80	0.19	0.72	0.01			0.07						0.67	0.11			
Of which: Road						1.46	0.80		0.66										0.62	0.11			
Railroads	4.57	9.83				0.06			0.05				0.01						0.05	-			
Tramways																			-	-			
Waterways		0.35				0.08			0.01	0.01			0.06						-	-			
Air						0.19		0.19											-	-			
INDUSTRY	1.77	9.06	2.37			1.24			0.14	0.24	0.02		0.84		2.67	0.80		6.73	2.09				
Of which: Mining & Quarrying																		0.12	-				
Fertilizer																		0.05	0.32				
Heavy Chemical		0.36	0.20															0.11	0.09				
Structural Clay Products		1.95 ⁽⁸⁾																-	-				
Cement		1.74																0.26	0.50				
Iron & Steel	0.90														2.67	0.80 ⁽¹²⁾		0.63	0.41				
Non-Ferrous		0.04	2.17 ⁽⁷⁾															0.22	0.09				
Textiles		1.77																2.22	0.36				
Other	0.87	3.20																3.12	0.32				
AGRICULTURE	-	0.42				0.30			0.09	0.16				0.05				0.58	-				
DOMESTIC		-		2.06		1.65					1.65						0.06	1.24	-	52.70	92.70	29.90	
COMMERCIAL		0.09																0.68	-				
GOVERNMENT		0.54																0.55	-				
OTHERS																		-	-	0.16 ⁽⁴⁾			
TOTAL INTERNAL FINAL CONSUMPTION	7.11	21.55	2.37	2.06	-	5.32	0.80	0.19	0.95	0.41	1.67	-	0.91	0.39	4.10	1.08	0.06	13.03	2.49	52.70	92.70	29.90	

(1) Production of electricity from primary hydro power has been shown here for the sake of convenience.

(3) Sale to utilities.

(5) This represents production of power-alcohol, a substitute fuel derived from molasses.

(7) Excluding the quantities considered as transformed into blast furnace gas (cf note 6)

(9) Excluding non-coking coal used in coal mines, railways and industry for power generation.

(11) For our purpose, we have assumed production of non-commercial fuels as equal to final consumption for Energy uses only.

(2) Purchase from Non-utilities.

(4) Sale to other agencies excluding utilities, break up of which is not available.

(6) Represents coke equivalent of blast furnace gas produced.

(8) Includes brick burning.

(10) Covering also non-energy products. See Table 4-9

(12) This includes the coke oven gas used for underfiring of the coke ovens, as separate figures are not available.

NOTE: Quantities less than 5000 tonnes not shown.

Value not possible to isolate and included in these figures.

TABLE 4-30
PRODUCTION AND USES OF ENERGY SOURCES - 1959/60 - ALL INDIA

	Coking Coal	Non-Coking Coal	Metallurgical Coke	Non-Metallurgical Coke	Crude Oil	Total Oil Products	Motor Spirit	Aviation & Jet Fuel	HSDO	LDO	Kerosene	LPG	Fuel Oil	Vapourising Oil & Refinery Fuel	Manufactured Gas			Electricity		Non-commercial Fuels			
															Blast Furnace	Coke Oven	Gas Works	Utility	Non-Utility	Dung (dry)	Fire-wood	Waste Products	
	Million Tonnes																						
	1	2	3	4	5	6	7	8	9	10	11	12	13	14	10 ⁹ x Cubic Metres			10 ⁹ x kWh = TWh		Million Tonnes			
	PRODUCTION AND CONSUMPTION																						
A. PRIMARY SOURCES OF ENERGY																							
PRODUCTION	14.19	34.21			0.45	0.02	0.02 ⁽⁵⁾											7.03 ⁽¹⁾		53.30 ⁽¹¹⁾	96.30 ⁽¹¹⁾	30.20 ⁽¹¹⁾	
NET BALANCE OF EXTERNAL TRADE	-	-1.39			5.19	-	-											-		-	-	-	
BUNKERS	-	-0.15			-	-	-											-		-	-	-	
STOCK CHANGES	-0.25	-2.70			-0.04	-	-											-		-	-	-	
TOTAL CONSUMPTION	13.84	29.97			5.60 ⁽¹⁰⁾	0.02	0.02											7.03		53.30	96.30	30.20	
QUANTITIES TRANSFORMED	-8.68	-8.00			-5.60 ⁽¹⁰⁾	-	-											-		-	-	-	
INTERNAL FINAL CONSUMPTION	5.26	21.97			-	0.02	0.02											7.03		53.30	96.30	30.20	
B. SECONDARY SOURCES OF ENERGY																							
PRODUCTION			4.41	1.95		5.18	0.97	-	0.98	0.48	0.78	0.01	1.66	0.30	7.88	1.47	0.06	8.01	2.88 ⁽³⁾				
NET BALANCE OF EXTERNAL TRADE			-0.03	-0.03		1.49	-0.18	+0.14	0.18	+0.12	+1.20	-	-0.35	+0.03	-	-	-	+0.03 ⁽²⁾	-0.03 ⁽³⁾				
BUNKERS			-	-		-0.37	-	-	-	-0.02	-	-	-	-	-	-	-	-	-	-	-	-	
STOCK CHANGES			-0.21	+0.06		-0.19	-0.01	+0.09	0.06	-0.02	-0.10	-	-0.09	-	-	-	-	-	-	-	-	-	
TOTAL CONSUMPTION			4.17	1.98		6.11	0.78	0.23	1.10	0.56	1.88	0.01	1.22	0.33	7.88	1.47	0.06	8.04	2.85				
QUANTITIES TRANSFORMED			-1.23 ⁽⁶⁾	-		-0.34	-	-	-	-0.10	-	-	-0.24	-	-1.69	-0.09	-	-	-	-	-	-	
INTERNAL FINAL CONSUMPTION			2.94	1.98		5.77	0.78	0.23	1.10	0.46	1.88	0.01	0.98	0.33	6.19	1.38	0.06	8.04	2.85				
TOTAL INTERNAL FINAL CONSUMPTION	5.26	21.97 ⁽⁹⁾	2.94	1.98	-	5.79	0.80	0.23	1.10	0.46	1.88	0.01	0.98	0.33	6.19	1.38	0.06	15.07	2.85	53.30	96.30	30.20	
BREAKDOWN OF INTERNAL FINAL CONSUMPTION																							
A. CONSUMPTION BY THE ENERGY SECTOR AND LOSSES																							
	0.73	1.55				0.30								0.30	2.31	0.30		2.98	0.16				
Of which:	Coal Mines & Washeries		0.73		1.55														0.26		0.15		
	Electric Power Plants														1.22		0.03		0.60				
	Coke Ovens																						
	Gas Works																						
	Oil Refineries & Field Operation				0.30								0.30		1.09		0.27		0.08		0.01		
	Losses																		2.06				
B. CONSUMPTION BY THE OTHER SECTORS																							
TRANSPORTATION																							
	3.90	11.34				1.96	0.80	0.23	0.23	0.01			0.08					0.71	0.12				
Of which:	Road																						
	Railroads				1.57		0.80		0.77										0.65		0.12		
	Tramways				0.07				0.06										0.06				
	Waterways		0.33						0.01		0.01		0.07										
	Air				0.09				0.23														
					0.23																		
INDUSTRY																							
	0.63	8.11	2.94			1.35			0.15	0.28	0.02		0.90		3.88	1.08		7.87	2.38				
Of which:	Mining & Quarrying																		0.12				
	Fertilizer																		0.05		0.35		
	Heavy Chemical		0.26		0.22														0.20		0.12		
	Structural Clay Products		1.82 ⁽⁸⁾																				
	Cement		1.82																0.34		0.51		
	Iron & Steel		0.43		2.72 ⁽⁷⁾										3.88		1.08 ⁽¹²⁾		0.84		0.59		
	Non-Ferrous																		0.38		0.09		
	Textiles																		2.43		0.37		
	Other		0.20		2.44														3.51		0.35		
AGRICULTURE																							
DOMESTIC																							
		0.30				0.31			0.11	0.17				0.03				0.75	-				
COMMERCIAL																							
		0.08		1.98		1.87					1.86	0.01						0.06	1.38		53.30	96.30	30.20
GOVERNMENT																							
		0.59																0.61	-				
OTHER SECTORS																							
																			0.19 ⁽⁴⁾				
TOTAL INTERNAL FINAL CONSUMPTION	5.26	21.97	2.94	1.98	-	5.79	0.80	0.23	1.10	0.46	1.88	0.01	0.98	0.33	6.19	1.38	0.06	15.07	2.85	53.30	96.30	30.20	

(1) Production of electricity from primary hydro power has been shown here for the sake of convenience.

(3) Sale to Utilities.

(5) This represents production of power alcohol, a substitute fuel derived from molasses.

(7) Excluding the quantities considered as transformed into blast furnace gas (cf note 6)

(9) Excluding non-coking coal used in coal mines, railways and industry for power generation.

(11) For our purposes, we have assumed production of non-commercial fuels as equal to final consumption for energy uses only.

(2) Purchase from Non-Utilities

(4) Sale to other agencies excluding Utilities, break up of which is not available.

(6) Represents coke equivalent of blast furnace gas produced.

(8) Includes brick burning.

(10) Covering also non-energy products. See Table 4-9

(12) This includes coke oven gas used for underfiring of coke ovens.

NOTE: Quantities less than 5000 tonnes not shown.

Value not possible to isolate and included in these figures.

TABLE 4-31
PRODUCTION AND USES OF ENERGY SOURCES - 1960/1 - ALL INDIA

	Coking Coal	Non-Coking Coal	Metallurgical Coke	Non-Metallurgical Coke	Crude Oil	Total Oil Products	Motor Spirit	Aviation & Jet Fuel	HSDO	LDO	Kerosene	LPG	Fuel Oil	Vapourising Oil & Refinery Fuel	Manufactured Gas			Electricity		Non-commercial Fuels			
	1	2	3	4	5	6	7	8	9	10	11	12	13	14	10 ⁹ x Cubic Metres			10 ⁹ x kWh = TWh		Million Tonnes			
PRODUCTION AND CONSUMPTION																							
A. PRIMARY SOURCES OF ENERGY																							
PRODUCTION	15.57	39.95			0.46	0.02	0.02 ⁽⁵⁾																
NET BALANCE OF EXTERNAL TRADE	-	-1.26			5.78	-	-												7.77 ⁽¹⁾		54.00 ⁽¹¹⁾	100.00 ⁽¹¹⁾	30.70 ⁽¹¹⁾
BUNKERS	-	-0.12			-	-	-																
STOCK CHANGES	-1.76	-2.46			-0.08	-	-																
TOTAL CONSUMPTION	13.81	36.11			6.16 ⁽¹⁰⁾	0.02	0.02												7.77		54.00	100.00	30.70
QUANTITIES TRANSFORMED	-9.56	-10.07			-6.16	-	-												7.77		54.00	100.00	30.70
INTERNAL FINAL CONSUMPTION	4.25	26.04			-	0.02	0.02												7.77		54.00	100.00	30.70
B. SECONDARY SOURCES OF ENERGY																							
PRODUCTION			5.21	1.89		5.61	1.04																
NET BALANCE OF EXTERNAL TRADE			-0.01	-0.02		+1.63	-0.20	0.21	1.08	0.53	0.94	0.01	1.87	0.34	12.09	2.18	0.08	9.09 ⁽²⁾	3.29 ⁽³⁾				
BUNKERS			-	-		-0.44	-	-	0.21	0.12	1.15	-	0.12	0.02	-	-	-	0.22 ⁽²⁾	-0.22 ⁽³⁾				
STOCK CHANGES			+0.05	-0.03		-0.08	-0.01	0.07	-	-0.03	-	-	-0.41	-	-	-	-	-	-				
TOTAL CONSUMPTION			5.25 ⁽⁶⁾	1.84		6.72	0.83	0.28	-0.04	-0.01	-0.09	0.01	1.38	0.36	12.09	2.18	0.06	9.31	3.07				
QUANTITIES TRANSFORMED			-1.91 ⁽⁶⁾	-		-0.39	-	-	1.25	0.61	2.00	0.01	1.38	0.36	12.09	2.18	0.06	9.31	3.07				
INTERNAL FINAL CONSUMPTION			3.34	1.84		6.33	0.83	0.28	-0.04	-0.11	-	-	-0.28	-	-2.34	-0.16	-	8.31	3.07				
TOTAL INTERNAL FINAL CONSUMPTION	4.25	26.04 ⁽⁸⁾	3.34	1.84	-	6.35	0.85	0.28	1.25	0.50	2.00	0.01	1.10	0.36	9.75	2.02	0.06	17.08	3.07	54.00	100.00	30.70	
BREAKDOWN OF INTERNAL FINAL CONSUMPTION																							
A. CONSUMPTION BY THE ENERGY SECTOR AND LOSSES																							
Of which: Coal Mines & Washeries	0.81	1.81				0.34								0.34	3.67	0.45		3.55	0.16				
Electric Power Plants																		0.28	0.15				
Coke Ovens															1.91	0.04		0.68					
Gas Works																							
Oil Refineries & Field operation						0.34								0.34	1.76	0.41		0.08	0.01				
Losses																		2.54					
B. CONSUMPTION BY THE OTHER SECTORS																							
TRANSPORTATION																							
Of which: Road	1.32	14.72				2.18	0.85	0.28	0.88	0.01			0.08						0.73	0.11			
Railroads	1.32	14.28				1.74	0.85		0.89										0.87	0.11			
Tramways						0.07			0.08										0.06	-			
Waterways		0.46				0.09																	
Air						0.28		0.28	0.01	0.01			0.07										
INDUSTRY																							
Of which: Mining & Quarrying	2.12	8.64	3.34			1.52			0.18	0.30	0.02		1.02		6.08	1.57 ⁽¹²⁾		9.00	2.60				
Fertilizer		0.02				0.02			0.01	0.01			-					0.11	-				
Heavy Chemical			0.22										-					0.10	0.38				
Structural Clay Products			0.35 ⁽⁸⁾			0.07							0.07					0.25	0.16				
Cement			1.05 ⁽⁸⁾			0.05			0.01	0.01			0.03										
Iron & Steel	1.31	2.28				0.03			0.01	0.01			0.01					0.44	0.50				
Non-Ferrous		0.04				0.06			0.01	0.01			0.06		6.08	1.57		1.10	0.70				
Textiles		1.83											0.34					2.47	0.38				
Others	0.81	3.07				0.44			0.03	0.07 ⁽¹³⁾	0.02		0.51					4.13	0.40				
AGRICULTURE																							
DOMESTIC																							
COMMERCIAL		0.01		1.84		1.99			0.11	0.19				0.02				0.83	-				
GOVERNMENT		0.07									1.98	0.01					0.06	1.49	-	54.00	100.00	30.70	
OTHER		0.60																0.85	-				
TOTAL INTERNAL FINAL CONSUMPTION	4.25	26.04	3.34	1.84	-	6.35	0.85	0.28	1.25	0.50	2.00	0.01	1.10	0.36	9.75	2.02	0.06	17.08	3.07	54.00	100.00	30.70	

(1) Production of electricity from primary hydro power has been shown here for the sake of convenience.

(3) Sale to Utilities.

(5) This represents production of power alcohol which is a substitute fuel derived from molasses.

(7) Excluding the quantities considered as transformed into blast furnace gas (cf note 6)

(9) Excluding non-coking coal used in coalmines, Railways and industry for power generation.

(11) For our purposes, we have assumed production of non-commercial fuels as equal to final consumption for Energy uses only.

(13) Probably includes about 0.02 mt consumed by auto producers for generation of Electricity.

(2) Purchase from Non-utilities.

(4) Sale to other agencies excluding utilities, break-up of which is not available.

(6) Represents coke equivalent of blast furnace gas produced.

(8) Including 0.96 million tonnes for brick burning.

(10) Covering also non-energy products. See Table 4-9

(12) This includes coke oven gas used for underfiring of coke ovens.

NOTE: Quantities less than 5000 tonnes not shown.

TABLE 4-32
PRODUCTION AND USES OF ENERGY SOURCES - 1961/2 - ALL INDIA

	Coking Coal	Non-Coking Coal	Metal-lurgical Coke	Non-Metal-lurgical Coke	Crude Oil	Total Oil Products	Motor Spirit	Aviation & Jet Fuel	HSDO	LDO	Kerosene	LPG	Naptha	Fuel Oil	Vapourising Oil Refinery Fuel & Gas	Manufactured Gas			Electricity		Non-commercial Fuels		
																Blast Furnace	Coke Oven	Gas Works	Utility	Non-Utility	Dung (dry)	Fire-wood	Waste Products
	Million Tonnes															10 ⁹ x Cubic Metres			10 ⁹ x kWh = TWh		Million Tonnes		
	1	2	3	4	5	6	7	8	9	10	11	12	13	14	15	16	17	18	19	20	21	22	23
PRODUCTION AND CONSUMPTION																							
A. PRIMARY SOURCES OF ENERGY																							
PRODUCTION	15.94	38.97			0.60	0.02	0.02 ⁽⁶⁾												9.81 ⁽¹⁾		54.50 ⁽¹³⁾	100.80 ⁽¹³⁾	30.90 ⁽¹³⁾
NET BALANCE OF EXTERNAL TRADE		-1.31			+5.98																		
BUNKERS		-0.13																					
STOCK CHANGES	-1.12	+2.03																					
TOTAL CONSUMPTION	14.82	39.56			6.58 ⁽¹¹⁾	0.02	0.02												9.81		54.50	100.80	30.90
QUANTITIES TRANSFORMED	-10.97	-11.97			-6.58 ⁽¹¹⁾																		
INTERNAL FINAL CONSUMPTION	3.85	27.59				0.02	0.02												9.81		54.50	100.80	30.90
B. SECONDARY SOURCES OF ENERGY																							
PRODUCTION			7.12	1.98		5.98	1.07		1.09	0.60	1.05	0.01		1.77	0.39	14.77	2.57	0.06	9.86 ⁽²⁾	3.57 ⁽⁴⁾			
NET BALANCE OF EXTERNAL TRADE			-0.01	-0.04		+2.08	-0.20		+0.37	+0.38	+1.19			+0.26	+0.01				-0.37 ⁽³⁾	+0.37 ⁽⁴⁾			
BUNKERS						-0.44								-0.41									
STOCK CHANGES			-0.08	-0.08		-0.17			-0.05	-0.02	-0.01			-0.07									
TOTAL CONSUMPTION			7.03 ⁽⁹⁾	1.86		7.45	0.87		0.32	1.45	2.23	0.01		1.55	0.40	14.77	2.57	0.06	10.23	3.20			
QUANTITIES TRANSFORMED			-2.13 ⁽⁹⁾			-0.43								-0.30	-0.01	-2.90	-0.14						
INTERNAL FINAL CONSUMPTION			4.90	1.86		7.02	0.87		0.32	1.45	2.23	0.01		1.25	0.39	11.87	2.43	0.06	10.23	3.20			
TOTAL INTERNAL FINAL CONSUMPTION	3.85	27.59 ⁽⁷⁾	4.90	1.86		7.04	0.89	0.32	1.45	0.50	2.23	0.01		1.25	0.39	11.87	2.43	0.06	20.04	3.20	54.50	100.80	30.90
BREAKDOWN OF INTERNAL FINAL CONSUMPTION																							
A. CONSUMPTION BY THE ENERGY SECTOR & LOSSES																							
	0.85	2.13				0.37									0.37	4.25	0.69		3.93	0.18			
Of which: Coal Mines & Washeries	0.85	2.13																	0.28	0.16			
Electric Power Plants																			0.81				
Coke Ovens																3.11	0.06						
Gas Works																							
Oil Refineries & Field Operation						0.37									0.37	1.14	0.63		0.06	0.02			
Losses																			2.78				
B. CONSUMPTION BY THE OTHER SECTORS																							
TRANSPORTATION	1.39	15.29	0.04			2.45	0.89	0.32	1.12	0.01					0.11					0.76	0.08		
Of which: Road						1.93	0.89		1.04														
Railroads	1.39	14.97	0.04			0.08			0.07						0.01					0.70	0.08		
Tramways																				0.06			
Waterways		0.32				0.12			0.01	0.01					0.10								
Air						0.32		0.32	0.01														
INDUSTRY	1.61	9.79	4.86			1.66			0.20	0.30	0.02			1.14		7.62	1.74 ⁽¹²⁾		11.03	2.94			
Of which: Mining & Quarrying		0.04				0.02			0.01	0.01									0.11				
Fertiliser			0.23																0.92	0.38			
Heavy Chemical						0.08								0.08					0.28	0.33			
Structural Clay Products		1.46 ⁽⁸⁾				0.05			0.01	0.01				0.03									
Cement		2.49				0.05			0.01	0.01				0.03					0.52	0.47			
Iron & Steel	1.21	0.13	4.63 ⁽¹⁰⁾			0.08			0.01	0.01				0.08		7.62	1.74		1.57	0.77			
Non-Ferrous																			0.43	0.09			
Textiles		2.10				0.49			0.04	0.06				0.39					2.57	0.37 ⁽⁵⁾			
Other	0.40	3.57				0.89			0.13	0.21	0.02			0.53					4.63	0.53 ⁽⁵⁾			
AGRICULTURE		0.04				0.34			0.13	0.19					0.02				0.99				
DOMESTIC				1.86		2.22					2.21	0.01							0.06	1.70	54.50	100.80	30.90
COMMERCIAL		0.07																	0.93				
GOVERNMENT		0.27																	0.70				
OTHER																							
TOTAL INTERNAL FINAL CONSUMPTION	3.85	27.59	4.90	1.86		7.04	0.89	0.32	1.45	0.50	2.23	0.01		1.25	0.39	11.87	2.43	0.06	20.04	3.20	54.50	100.80	30.90

(1) Production of electricity from primary hydro power has been shown here for the sake of convenience.

(3) Purchased from non-utilities

(5) Sales to other agencies to the extent of 0.29 TWh, break-up of which is not available, is included in this.

(9) Represents coke equivalent of blast furnace gas produced.

(11) Includes 0.59 million tonnes of non-energy products also.

(13) The production of non-commercial fuels has been assumed to be equal to final consumption for Energy uses only.

(2) Of which steam generation is 9.48 and oil 0.38 TWh.

(4) Sold to non-utilities.

(6) Represents production of power alcohol which is a substitute fuel derived from molasses.

(8) Including 1.40 million tonnes used for brick burning.

(10) Excluding the quantities considered as transformed into blast furnace gas (cf note 9).

(12) Includes coke oven gas used for under-firing of coke ovens.

NOTE: Quantities less than 5000 tonnes not shown.

TABLE 4-33
PRODUCTION AND USES OF ENERGY SOURCES - 1962/3 - ALL INDIA

		Coking Coal	Non-Coking Coal	Metal-lurgical Coke	Non-Metal-lurgical Coke	Crude Oil	Total Oil Products	Motor Spirit	Aviation & Jet Fuel	Kerosene	LPG	Naptha	Fuel Oil	Vapourising Oil Refinery fuel & Gas	Manufactured Gas			Electricity		Non-commercial Fuels					
		1	2	3	4	5	6	7	8	9	10	11	12	13	14	15	10 ⁹ x Cubic Metres			10 ⁹ x kWh = TWh		Million Tonnes			
		Million Tonnes																							
PRODUCTION AND CONSUMPTION																									
A. PRIMARY SOURCES OF ENERGY		PRODUCTION	15.73	47.56		1.17	0.01	0.01 ⁽⁶⁾																	
NET BALANCE OF EXTERNAL TRADE			-1.26			+5.96																			
BUNKERS			-0.13																						
STOCK CHANGES			-2.93																						
TOTAL CONSUMPTION		16.32	43.24			7.13 ⁽¹¹⁾	0.01	0.01																	
QUANTITIES TRANSFORMED		-11.60	-13.03			-7.13 ⁽¹¹⁾																			
INTERNAL FINAL CONSUMPTION		4.72	30.21				0.01	0.01																	
B. SECONDARY SOURCES OF ENERGY		PRODUCTION		7.99	2.27		6.56	1.18		0.57	1.21	0.02	0.01	1.81	0.45	16.45	2.88	0.06	10.57 ⁽²⁾	3.94 ⁽⁴⁾					
NET BALANCE OF EXTERNAL TRADE			-0.01	-0.03		+2.53	-0.24	+0.55		+0.91	+1.19			+0.41	+0.01				+0.47 ⁽³⁾	-0.47 ⁽⁴⁾					
BUNKERS						-0.48				-0.04				-0.44											
STOCK CHANGES			-0.05	-0.10		-0.10	+0.01	-0.20		-0.03	+0.05			+0.04											
TOTAL CONSUMPTION		16.32	43.24			7.93 ⁽⁹⁾	2.14	0.93	0.35	0.57	2.45	0.02	0.01	1.82	0.46	16.45	2.88	0.06	11.04	3.47					
QUANTITIES TRANSFORMED		-11.60	-13.03			-2.37 ⁽⁹⁾		-0.45		-0.12				-0.30	-0.03	-3.13	-0.14								
INTERNAL FINAL CONSUMPTION		4.72	30.21 ⁽⁷⁾	5.56	2.14		8.06	0.93	0.35	0.55	2.45	0.02	0.01	1.82	0.43	13.32	2.72	0.06	11.04	3.47					
TOTAL INTERNAL FINAL CONSUMPTION		4.72	30.21 ⁽⁷⁾	5.56	2.14		8.07	0.94	0.35	0.55	2.45	0.02	0.01	1.82	0.43	13.32	2.72	0.06	22.84	3.47	54.90	101.60	31.10		
BREAKDOWN OF INTERNAL FINAL CONSUMPTION																									
A. CONSUMPTION BY THE ENERGY SECTOR AND LOSSES		0.91	2.60				0.42									0.42	4.84	0.85	4.50	0.22					
Of which: Coal Mines & Washeries		0.91	2.60																0.29	0.20					
Electric Power Plants																			0.91						
Coke Ovens																									
Gas Works																									
Oil Refineries & Field Operation							0.42												0.06	0.02					
Losses																			3.24						
B. CONSUMPTION BY THE OTHER SECTORS		TRANSPORTATION	2.11	15.27	0.05		2.72	0.94	0.35	0.91				0.11					0.78	0.08					
Of which: Road							2.15	0.94											0.72	0.08					
Railroads		2.11	14.95	0.05		0.10								0.01					0.06						
Tramways																									
Waterways			0.32			0.12								0.10											
Air						0.35			0.35																
INDUSTRY		1.70	11.82	5.51		2.13				0.34	0.03		0.01	1.51		8.38	2.07 ⁽¹²⁾		12.71	3.17					
Of which: Mining & Quarrying			0.04			0.02													0.11						
Fertilizer				0.23		0.01													1.17	0.43					
Heavy Chemical						0.11								0.11					0.33	0.31					
Structural Clay Products			1.80 ⁽⁸⁾			0.08								0.06											
Cement			2.43			0.09								0.06					0.58	0.42					
Iron & Steel		1.20	0.14	5.28 ⁽¹⁰⁾		0.12								0.12		8.38	2.07		1.78	0.85					
Non-Ferrous																			0.57	0.08					
Textiles			2.21											0.45					2.85	0.37 ⁽⁵⁾					
Other		0.50	5.20			1.12				0.78				0.71					5.31	0.61					
AGRICULTURE			0.08			0.36				0.20									1.10						
DOMESTIC					2.14	2.44					2.42	0.02							1.92		54.90	101.60	31.10		
COMMERCIAL			0.09																1.05						
GOVERNMENT			0.37																0.78						
OTHER																									
TOTAL		4.72	30.21	5.56	2.14		8.07	0.94	0.35	0.55	2.45	0.02	0.01	1.82	0.43	13.32	2.72	0.06	22.84	3.47	54.90	101.60	31.10		

(1) Production of electricity from primary hydro power has been shown here for the sake of convenience.

(2) Of which steam generation is 10.18 and oil 0.39 TWh.

(3) Purchased from non-utilities.

(4) Sold to non-utilities.

(5) Sales to other agencies to the extent of 0.18 included in this.

(6) Represents production of power alcohol which is a substitute fuel derived from molasses.

(7) Excluding non-coking coal used in coal mines, railways and industry for power generation.

(8) Including 1.73-million tonnes used for brick burning.

(9) Represents coke equivalent of blast furnace gas produced.

(10) Excluding the quantities considered as transformed into blast furnace gas (cf. note 9)

(11) Includes 0.57 million tonnes of non-energy products also

(12) Includes coke oven gas used for underfiring of coke ovens.

(13) The production of non-commercial fuels has been assumed to be equal to final consumption for energy uses only

NOTE: Quantities less than 5000 tonnes not shown.

TABLE 4-34

PRODUCTION AND USES OF ENERGY SOURCES - ANDHRA PRADESH - 1960/1

	Coking Coal	Non-Coking Coal	Metal-lurgical Coke	Non-Metal-lurgical Coke	Crude Oil	Total Oil Products	Manufactured Gas Blast Furnace	Gas Coke Oven & Gas Works	Electricity Utility	Non-Utility	Non-Commercial Dung dry	Commercial Firewood	Fuels Waste Products
	1	2	3	4	5	6	7	8	9	10	11	12	13
	Tonnes x 10 ⁶						Cubic Metres 10 ⁶		kWh x 10 ⁶ - GWh		Tonnes x 10 ⁶		
A. PRIMARY SOURCES OF ENERGY													
PRODUCTION		2.57											
NET BALANCE OF EXTERNAL TRADE	+0.05	-0.20											
BUNKERS		-0.04									4.0	9.0	2.6
STOCK CHANGES		-0.01											
TOTAL CONSUMPTION	0.05	2.32											
QUANTITIES TRANSFORMED		-0.29									4.0	9.0	2.6
INTERNAL FINAL CONSUMPTION	0.05	2.03									4.0	9.0	2.6
B. SECONDARY SOURCES OF ENERGY													
PRODUCTION													
NET BALANCE OF EXTERNAL TRADE			+0.01			0.90			900.1	151.5			
BUNKERS						-0.39			-121.1				
STOCK CHANGES						-0.09							
TOTAL CONSUMPTION			0.01			-0.02							
QUANTITIES TRANSFORMED						0.40			779.0	151.5			
INTERNAL FINAL CONSUMPTION			0.01			0.40			779.0	151.5			
TOTAL INTERNAL FINAL CONSUMPTION	0.05	2.03	0.01			0.40			779.0	151.5	4.0	9.0	2.6
BREAKDOWN OF INTERNAL FINAL CONSUMPTION													
A. CONSUMPTION BY THE ENERGY SECTOR & LOSSES													
Of which: Coal Mines and Washeries		0.08				0.04			228.7	54.0			
Electric Power Plants		0.08							5.4	54.0			
Coke Ovens									23.3				
Oil Refineries and Field Operation						0.04			15.9				
Losses									184.1				
B. CONSUMPTION BY OTHER SECTORS													
TRANSPORTATION	0.05	1.20				0.36 ⁽¹⁾							
Of which: Road and Tramways	0.05	1.20				0.15			14.2	0.1			
Railroads						0.13			14.2	0.1			
Waterways						0.01							
Air						0.01							
INDUSTRY		0.73	0.01			0.05			358.0	63.6			
Of which: Mining & Quarrying													
Fertilizer & Heavy Chemical		0.02											
Structural Clay Products		0.03											
Cement		0.22											
Iron & Steel			0.01						47.7				
Non-Ferrous									19.9				
Textiles		0.12							46.1	10.5			
Other		0.34							244.3	53.1			
AGRICULTURE						0.02			54.8				
DOMESTIC						0.14			70.8		4.0	9.0	2.6
COMMERCIAL									30.2				
GOVERNMENT		0.02							22.3				
OTHERS													
TOTAL INTERNAL FINAL CONSUMPTION	0.05	2.03	0.01			0.40			779.0	151.5	4.0	9.0	2.6

← Values not possible to isolate and included in this figure.

(1) Break up of Total Internal Final Consumption of Oil Products (excluding Refinery Fuel Consumption). ('000 Tonnes)

Consumption by	Motor Spirit	Aviation & Jet Fuel	MSDO (Kerosene)	Fuel Oil	Others	Total Oil Products
Transportation:						
Road & Tramways	40		94			134
Railroads			4			4
Waterways				3		3
Air		11				11
Industry (Total)			4	24		45
Agriculture			7			20
Domestic					1	141
Total Internal Final Consumption.	40	11	109	27	1	358

TABLE 4-35

PRODUCTION AND USES OF ENERGY SOURCES - ASSAM - 1960/1

	Coking Coal	Non-Coking Coal	Metal-lurgical Coke	Non-Metal-lurgical Coke	Crude Oil	Total Oil Products (1)	Manufactured Gas		Electricity		Non-commercial Fuels		
	1	2	3	4	5	6	Blast Furnace	Coke Oven & Gas Works	Utility (2)	Non-Utility (3)	Dung dry	Firewood	Waste Products
	Tonnes x 10 ⁶						Cubic Metres 10 ⁶		kWh x 10 ⁶ - GWh		Tonnes x 10 ⁶		
A. PRIMARY SOURCES OF ENERGY													
PRODUCTION		0.70									0.5	4.4	0.9
NET BALANCE OF EXTERNAL TRADE BUNKERS		-0.04											
STOCK CHANGES		+0.01											
TOTAL CONSUMPTION		0.67									0.5	4.4	0.9
QUANTITIES TRANSFORMED													
INTERNAL FINAL CONSUMPTION		0.67									0.5	4.4	0.9
B. SECONDARY SOURCES OF ENERGY													
PRODUCTION						0.35			37.9	19.3			
NET BALANCE OF EXTERNAL TRADE BUNKERS			-0.01			-0.06							
STOCK CHANGES													
TOTAL CONSUMPTION			0.01			0.29			37.9	19.3			
QUANTITIES TRANSFORMED													
INTERNAL FINAL CONSUMPTION			0.01			0.29			37.9	19.3			
TOTAL INTERNAL FINAL CONSUMPTION		0.67	0.01			0.29			37.9	19.3	0.5	4.4	0.9
BREAKDOWN OF INTERNAL FINAL CONSUMPTION													
A. CONSUMPTION BY THE ENERGY SECTOR & LOSSES		0.03				0.03			7.3	13.2			
Of which: Coal Mines and Washeries		0.03							1.3				
Electric Power Plants													
Coke Ovens													
Oil Refineries and Field Operation Losses						0.03			6.0	13.2			
B. CONSUMPTION BY OTHER SECTORS						0.26 ⁽⁵⁾							
TRANSPORTATION		0.38				0.08			3.9	5.8			
Of which: Road and Tramways						0.07							
Railroads		0.23							3.9	5.8			
Waterways		0.15				0.01							
Air													
INDUSTRY		0.23	0.01			0.08			8.1				
Of which: Mining & Quarrying													
Fertilizer & Heavy Chemical													
Structural Clay Products		0.05											
Cement													
Iron & Steel			0.01										
Non-Ferrous													
Textiles													
Other		0.18							8.1				
AGRICULTURE						0.02							
DOMESTIC		0.01				0.08			11.0		0.5	4.4	0.9
COMMERCIAL									4.4				
GOVERNMENT		0.02							3.2				
OTHERS										0.3 ⁽⁴⁾			
TOTAL INTERNAL FINAL CONSUMPTION		0.67	0.01			0.29			37.9	19.3	0.5	4.4	0.9

(1) Includes NEFA & Manipur.

(2) Includes Manipur & Tripura.

(3) Includes Manipur Tripura & NEFA.

(4) Represents sales to other Agencies.

→ Values not possible to isolate and included in this figure.

(5) Break up of Total Internal Final Consumption of Oil

(Excluding Refinery Fuel Consumption). ('000 Tonnes)

Consumption by	Motor Spirit	Aviation & Jet Fuel	Kerosene	Fuel Oil	Others	Total Oil Products
Transportation:						77
Road and Tramways	60					—
Railroads						—
Waterways						7
Air		7				78
Industry (Total)				61		16
Agriculture						82
Domestic			80		2	—
Total Internal Final Consumption	60	7	80	61	2	260

TABLE 4-36
PRODUCTION AND USES OF ENERGY SOURCES - BIHAR - 1980/1

	Coking Coal	Non-Coking Coal	Metal-lurgical Coke	Non-Metal-lurgical Coke	Total Oil Products	Manufactured Gas		Electricity		Non-Commercial Fuels		
	1	2	3	Tonnes x 10 ⁶		Blast Furnace	Coke Oven & Gas Works	Utility	Non-Utility	Dung dry	Firewood	Waste Products
					6	Cubic Metres 10 ⁶	8	kWh x 10 ⁶ = GWh	10	11	12	13
A. PRIMARY SOURCES OF ENERGY												
PRODUCTION	15.56	11.94										
LESS MIDDINGS & REJECTS	-0.67											
NET BALANCE OF EXTERNAL TRADE	-8.16	-4.81								7.5	7.2	3.3
BUNKERS												
STOCK CHANGES	-1.69	-1.61										
TOTAL CONSUMPTION	7.04	5.52										
QUANTITIES TRANSFORMED	-4.82	-2.74										
INTERNAL FINAL CONSUMPTION	2.22	2.78								7.5	7.2	3.3
B. SECONDARY SOURCES OF ENERGY												
PRODUCTION			2.22	1.81								
NET BALANCE OF EXTERNAL TRADE			-0.40	-1.50		0.42	3993	768	1596.0	1067.6		
BUNKERS									175.9 1/	-175.9 3/		
STOCK CHANGES			+0.03	-0.03					-446.9 2/			
TOTAL CONSUMPTION			1.85	0.11		0.42	3993	768	1325.0	891.7		
QUANTITIES TRANSFORMED			-0.67			-0.02	-363					
INTERNAL FINAL CONSUMPTION			1.18	0.11		0.40	3630	768	1325.0	891.7	7.5	7.2
TOTAL INTERNAL FINAL CONSUMPTION	2.22	2.78	1.18	0.11	0.40	3630	768	1325.0	891.7	7.5	7.2	3.3
BREAKDOWN OF INTERNAL FINAL CONSUMPTION												
A. CONSUMPTION BY THE ENERGY SECTOR & LOSSES												
Of which: Coal Mines and Washeries	0.78	0.50					1244	244	557.1	60.6		
Electric Power Plants									121.5	60.6		
Coke Ovens									99.6			
Oil Refineries and Field Operation							1184	20				
Losses							60	224	336.0			
B. CONSUMPTION BY OTHER SECTORS												
TRANSPORTATION	0.23	1.49			0.40 ⁽⁵⁾							
Of which: Road and Tramways					0.11				22.4	18.9		
Railroads	0.23	1.42			0.06							
Waterways		0.07			0.05				22.4	18.9		
Air												
INDUSTRY	1.21	0.72	1.18		0.12	2386	524	637.1	810.8			
Of which: Mining & Quarrying		0.02										
Fertilizer & Heavy Chemical			0.22						2.4	381.2		
Structural Clay Products		0.07										
Cement		0.29							122.6	135.7		
Iron & Steel	0.40		0.96			2386	524		371.5	248.5		
Non-Ferrous		0.04							29.3	18.4		
Textiles									1.4	12.3		
Other	0.81	0.30							109.9	14.7		
AGRICULTURE		0.02			0.01				18.3			
DOMESTIC				0.11	0.16				44.3		7.5	7.2
COMMERCIAL									29.9			3.3
GOVERNMENT		0.05							15.9			
OTHERS												
TOTAL INTERNAL FINAL CONSUMPTION	2.22	2.78	1.18	0.11	0.40	3630	768	1325	891.7	7.5	7.2	3.3

- 1/ Purchased from Non Utilities.
2/ Net balance of External Trade.
3/ Sale to Utilities.
4/ Sale to other agencies

— Values not possible to isolate and included in this figure.

5) Break up of Total Internal Consumption of Oil Products. (000 Tonnes)

Consumption by	Motor Spirit	Aviation Jet	HSDD	LDO	Kerosene	Fuel Oil	Others	Total Oil Products
Transportation:								
Road & Tramways	53	8						61
Railroads		41				2		43
Waterways				1				1
Air		2						2
Industry (Total)		20		12	2	72		116
Agriculture				6				13
Domestic					163		2	165
Total Internal Final Consumption	53	286		19	165	74	2	401

TABLE 4-37
PRODUCTION AND USES OF ENERGY SOURCES - GUJARAT - 1960/1

	Coking Coal	Non-Coking Coal	Metal-lurgical Coke	Non-Metallurgical Coke	Crude Oil	Total Oil Products	Manufactured Gas		Electricity		Non-Commercial Fuels		
							Blast Furnace	Coke Oven & Gas Works	Utility	Non-Utility	Dung dry	Firewood	Waste Products
	1	2	3	4	5	6	7	8	9	10	11	12	13
A. PRIMARY SOURCES OF ENERGY													
PRODUCTION													
NET BALANCE OF EXTERNAL TRADE	+0.02	+3.67									2.0	6.0	1.5
BUNKERS													
STOCK CHANGES													
TOTAL CONSUMPTION	0.02	3.67									2.0	6.0	1.5
QUANTITIES TRANSFORMED		-1.19											
INTERNAL FINAL CONSUMPTION	0.02	2.48									2.0	6.0	1.5
B. SECONDARY SOURCES OF ENERGY													
PRODUCTION													
NET BALANCE OF EXTERNAL TRADE			+0.03	+0.04		+0.48			1271.4	97.6			
BUNKERS									1.0 1/				
STOCK CHANGES													
TOTAL CONSUMPTION			0.03	0.04		0.48			1272.4	97.6			
QUANTITIES TRANSFORMED						-0.04							
INTERNAL FINAL CONSUMPTION			0.03	0.04		0.44			1272.4	97.6			
TOTAL INTERNAL FINAL CONSUMPTION	0.02	2.48	0.03	0.04		0.44			1272.4	97.6	2.0	6.0	1.5

BREAKDOWN OF INTERNAL FINAL CONSUMPTION

A. CONSUMPTION BY THE ENERGY SECTOR & LOSSES													
Of which:										289.1			
Coal Mines and Washeries													
Electric Power Plants										82.3			
Coke Ovens													
Oil Refineries and Field Operation													
Losses										206.8			
B. CONSUMPTION BY OTHER SECTORS													
TRANSPORTATION	0.02	1.10				0.44 ⁽³⁾							
Of which:													
Road and Tramways						0.11			16.7	7.6			
Railroads						0.10			16.7	7.6			
Waterways													
Air						0.01							
INDUSTRY		1.37	0.03			0.14			788.8	89.4			
Of which:													
Mining & Quarrying													
Fertilizer & Heavy Chemical		0.14							13.6				
Structural Clay Products		0.04											
Cement		0.47							44.0	47.3			
Iron & Steel			0.03						454.7	42.1			
Non-ferrous									276.5				
Textiles		0.71											
Other		0.01											
AGRICULTURE						0.04			19.6				
DOMESTIC				0.04		0.15			71.6		2.0	6.0	1.5
COMMERCIAL									31.7				
GOVERNMENT		0.01							54.9				
OTHER										0.6 ⁽²⁾			
TOTAL INTERNAL FINAL CONSUMPTION	0.02	2.48	0.03	0.04		0.44			1272.4	97.6	2.0	6.0	1.5

1/ Purchased from Non-Utilities.

2/ Sales to other agencies

3/ Break up of Total Internal Final Consumption of Oil Products. ('000 Tonnes)

Consumption by	Motor Spirit	Aviation Jet Fuel	HSDD	LDO	Kerosene	Fuel Oil	Others	Total Oil Products
Electric Power Plants								
Transportation								
Road & Tramways	53		48					101
Railroads			2					2
Waterways								
Air		10						10
Industry (Total)			5	84	1	66		136
Agriculture			10	31				12
Domestic					151		2	153
Total Internal Final Consumption	53	10	65	95	152	66	2	443

→ Values not possible to isolate and included in the figure.

TABLE 4-38

PRODUCTION AND USES OF ENERGY SOURCES - JAMMU & KASHMIR - 1960/1

	Coking Coal	Non-Coking Coal	Metal-lurgical Coke	Non-Metal-lurgical Coke	Crude Oil	Total Oil Products	Manufactured Gas		Electricity		Non-Commercial Fuels			
	1	2	3	4	5	6	Blast Furnace	Coke Oven & Gas Works	Utility	Non-Utility	Dung dry	Firewood	Waste Products	
	Tonnes x 10 ⁸						Cubic Metres x 10 ⁶		kWh x 10 ⁶ = GWh		Tonnes x 10 ⁶			
A. PRIMARY SOURCES OF ENERGY														
PRODUCTION												0.2	0.1	0.3
NET BALANCE OF EXTERNAL TRADE														
BUNKERS														
TOTAL CONSUMPTION												0.2	0.1	0.3
QUANTITIES TRANSFORMED														
INTERNAL FINAL CONSUMPTION												0.2	0.1	0.3
B. SECONDARY SOURCES OF ENERGY														
PRODUCTION									43.6					
NET BALANCE OF EXTERNAL TRADE						+0.02			+17.5					
BUNKERS														
STOCK CHANGES														
TOTAL CONSUMPTION						0.02			61.1					
QUANTITIES TRANSFORMED						0.02			61.1					
INTERNAL FINAL CONSUMPTION						0.02			61.1			0.2	0.1	0.3
TOTAL INTERNAL FINAL CONSUMPTION														
BREAKDOWN OF INTERNAL FINAL CONSUMPTION														
A. CONSUMPTION BY THE ENERGY SECTOR & LOSSES										10.0				
Of which: Coal Mines & Washeries														
Electric Power Plants										0.5				
Coke Ovens														
Oil Refineries & Field Operation										9.5				
Losses														
B. CONSUMPTION BY THE OTHER SECTORS														
TRANSPORTATION														
Of which: Road and Tramways														
Railroads														
Waterways														
Air														
INDUSTRY														
Of which: Mining & Quarrying														
Fertilizer & Heavy Chemical														
Structural Clay Products														
Cement														
Iron & Steel														
Non-Ferrous														
Textiles														
Others										0.1				
AGRICULTURE										22.0				
DOMESTIC										0.7				
COMMERCIAL										22.5		0.2	0.1	0.3
GOVERNMENT										1.0				
OTHERS										4.8				
TOTAL INTERNAL FINAL CONSUMPTION						0.02			61.1			0.2	0.1	0.3

(1) Break Up of Total

Consumption by	(1) Break Up of Total		Internal Final Consumption ('000 Tonnes)		
	Motor Spirit	Aviation & Jet Fuel	HSDO	Kerosene	Total Oil Products
Transportation					
Roads	5		9		14
Air		2			2
Agriculture			1		1
Domestic				5	5
Total	5	2	10	5	22

TABLE 4-39
 PRODUCTION AND USES OF ENERGY SOURCES - KERALA - 1960/1

	Coking Coal	Non-Coking Coal	Metal-lurgical Coke	Non-Metal-lurgical Coke	Crude Oil	Manufactured Gas		Electricity		Non-Commercial Fuels			
	1	2	3	4	5	Total Oil Products	Blast Furnace	Coke Oven & Gas Works	Utility	Non-Utility	Dung dry	Firewood	Waste Products
	Tonnes x 10 ⁶					Cubic Metres x 10 ⁶		kWh x 10 ⁶ = GWh		Tonnes x 10 ⁶			
A. PRIMARY SOURCES OF ENERGY													
PRODUCTION													
NET BALANCE OF EXTERNAL TRADE	+0.02	+0.14											
BUNKERS											1.0	3.7	1.3
STOCK CHANGES													
TOTAL CONSUMPTION	0.02	0.14									1.0	3.7	1.3
QUANTITIES TRANSFORMED													
INTERNAL FINAL CONSUMPTION	0.02	0.14									1.0	3.7	1.3
B. SECONDARY SOURCES OF ENERGY													
PRODUCTION									581.8	0.6			
NET BALANCE OF EXTERNAL TRADE									+36.3				
BUNKERS													
STOCK CHANGES													
TOTAL CONSUMPTION									618.1	0.6			
QUANTITIES TRANSFORMED													
INTERNAL FINAL CONSUMPTION									618.1	0.6			
TOTAL INTERNAL FINAL CONSUMPTION	0.02	0.14				0.25			618.1	0.6	1.0	3.7	1.3

BREAKDOWN OF INTERNAL FINAL CONSUMPTION

A. CONSUMPTION BY THE ENERGY SECTOR & LOSSES															
Of which:									124.9						
Coal Mines and Washeries									16.9						
Electric Power Plants															
Coke Ovens															
Oil Refineries and Field Operation Losses									108.0						
B. CONSUMPTION BY OTHER SECTORS															
TRANSPORTATION	0.02	0.12				0.25 ⁽¹⁾			2.4						
Of which:									0.10						
Road and Tramways									0.08						
Railroads	0.02	0.12							2.4						
Waterways									0.02						
Air															
INDUSTRY			0.02				0.06			401.3	0.6				
Of which:															
Mining & Quarrying															
Fertilizer and Heavy Chemical															
Structural Clay Products															
Cement			0.01							8.2					
Iron & Steel															
Non-Ferrous															
Textiles										130.8					
Other			0.01							8.4	0.4				
AGRICULTURE									0.01			18.3			
DOMESTIC									0.08			51.1	1.0 3.7 1.3		
COMMERCIAL												3.9			
GOVERNMENT												16.2			
OTHERS															
TOTAL INTERNAL FINAL CONSUMPTION	0.02	0.14				0.25			618.1	0.6	1.0	3.7	1.3		

(1) Break up of Total Consumption of Oil Products. ('000 Tonnes)

Consumption by	Motor Spirit	Aviation & Jet Fuel	HSDO	LDO	Kerosene	Fuel Oil	Other	Total Oil Products
Transportation:								
Road & Tramways	33		45					78
Railroads			2					2
Waterways				1		14		15
Air								
Industry (Total)								
Agriculture			2	3		58		63
Domestic			8	2				10
					80		1	81
Total Internal Final Consumption	33		57	6	80	72	1	249

→ Values not possible to isolate and included in this figure.

TABLE 4-40
PRODUCTION AND USES OF ENERGY SOURCES - MADHYA PRADESH - 1960/1

	Coking Coal	Non-Coking Coal	Metal-lurgical Coke	Non-Metal-lurgical Coke	Crude Oil	Total Oil Products	Manufactured Gas		Electricity		Non-Commercial Fuels		
	1	2	3	4	5	6	Blast Furnace	Coke Oven & Gas Works	Utility	Non-Utility	Dung dry	Firewood	Waste Products
	Tonnes x 10 ⁸						Cubic Metres x 10 ⁶		kWh x 10 ⁶ = GWh		Tonnes x 10 ⁶		
A. PRIMARY SOURCES OF ENERGY													
PRODUCTION		6.74									3.7	6.5	2.2
NET BALANCE OF EXTERNAL TRADE BUNKERS	+1.29	-2.89											
STOCK CHANGES		-0.44											
TOTAL CONSUMPTION	1.29	3.41									3.7	6.5	2.2
QUANTITIES TRANSFORMED	-1.02	-0.66											
INTERNAL FINAL CONSUMPTION	0.27	2.75									3.7	6.5	2.2
B. SECONDARY SOURCES OF ENERGY													
PRODUCTION			0.67				2050	288	477.0	240.6			
NET BALANCE OF EXTERNAL TRADE BUNKERS			+0.09	+0.02		+0.27			+27.0				
STOCK CHANGES													
TOTAL CONSUMPTION			0.76	0.02		0.27	2050	288	504.0	240.6			
QUANTITIES TRANSFORMED			-0.30			-0.01	-183	-18					
INTERNAL FINAL CONSUMPTION			0.46	0.02		0.26	1867	270	504.0	240.6	3.7	6.5	2.2
TOTAL INTERNAL FINAL CONSUMPTION	0.27	2.75	0.46	0.02		0.26	1867	270	504.0	240.6	3.7	6.5	2.2
BREAKDOWN OF INTERNAL FINAL CONSUMPTION													
A. CONSUMPTION BY THE ENERGY SECTOR & LOSSES													
Of which:		0.32					443	21	112.3	21.9			
Coal Mines and Washeries		0.32							14.1	21.9			
Electric Power Plants									31.0				
Coke Ovens							232						
Oil Refineries and Field Operation Losses							211	21	87.2				
B. CONSUMPTION BY OTHER SECTORS													
TRANSPORTATION						0.26 ⁽²⁾							
Of which:	0.12	1.70				0.11			7.7	2.9			
Road and Tramways						0.10			7.7	2.9			
Railroads	0.12	1.70											
Waterways													
Air						0.01							
INDUSTRY	0.15	0.71	0.46			0.03	1424	249	279.5	207.1			
Of which:													
Mining & Quarrying													
Fertilizer & Heavy Chemical													
Structural Clay Products													
Cement		0.06							4.8	61.8			
Iron & Steel	0.15	0.27	0.46				1424	249	115.7	84.2			
Non-Ferrous									0.1	56.9			
Textiles		0.27							36.7	4.2			
Other		0.11							122.2				
AGRICULTURE						0.02			3.9				
DOMESTIC						0.10			45.4		3.7	6.5	2.2
COMMERCIAL				0.02					20.8				
GOVERNMENT													
OTHERS		0.02							34.4	8.7 ⁽¹⁾			
TOTAL INTERNAL FINAL CONSUMPTION	0.27	2.75	0.46	0.02		0.26	1867	270	504.0	240.6	3.7	6.5	2.2

(1) Sales to other agencies
(2) Break up of Total Internal Final Consumption by Motor Spirit, Aviation & Jet Fuel

→ Values not possible to isolate and included in this figure.

Consumption by	Consumption of Oil Products ('000 Tonnes)						
	Motor Spirit	Aviation & Jet Fuel	HSDD	LDO	Kerosene	Fuel Oil	Others
Transportation:							
Road & Tramways	41		56				97
Railroads							-
Waterways							8
Air		8	13	13	1	2	29
Industry			7	12			19
Agriculture					104		105
Domestic							
Total Internal Final Consumption	41	8	78	25	105	2	258

TABLE 4-41
PRODUCTION AND USES OF ENERGY SOURCES - MADRAS⁽¹⁾ - 1980/1

	Coking Coal	Non-Coking Coal	Metal-lurgical Coke	Non-Metal-lurgical Coke	Crude Oil	Total Oil Products	Manufactured Gas		Electricity		Non-Commercial Fuels		
	1	2	3	4	5	6	Blast Furnace	Coke Oven & Gas Works	Utility	Non-Utility	Dung dry	Firewood	Waste Products
	Tonnes x 10 ⁶						Cubic Metres x 10		kWh x 10 ⁶ = GWh		Tonnes x 10 ⁶		
							7	8	9	10	11	12	13
A. PRIMARY SOURCES OF ENERGY													
PRODUCTION													
NET BALANCE OF EXTERNAL TRADE	+0.07	+1.63									3.0	7.1	2.2
BUNKERS		-0.01											
STOCK CHANGES													
TOTAL CONSUMPTION	0.07	1.62									3.0	7.1	2.2
QUANTITIES TRANSFORMED		-0.35											
INTERNAL FINAL CONSUMPTION	0.07	1.27									3.0	7.1	2.2
B. SECONDARY SOURCES OF ENERGY													
PRODUCTION									2200.8	33.5			
NET BALANCE OF EXTERNAL TRADE			+0.02	+0.01		+0.58			-25.3	-			
BUNKERS						-0.07							
STOCK CHANGES													
TOTAL CONSUMPTION			0.02	0.01		0.51			2175.5	33.5			
QUANTITIES TRANSFORMED						-0.01							
INTERNAL FINAL CONSUMPTION			0.02	0.01		0.50			2175.5	33.5			
TOTAL INTERNAL FINAL CONSUMPTION	0.07	1.27	0.02	0.01		0.50			2175.5	33.5	3.0	7.1	2.2
BREAKDOWN OF INTERNAL FINAL CONSUMPTION													
A. CONSUMPTION BY THE ENERGY SECTOR & LOSSES													
Of which:									442.4				
Coal Mines & Washeries									62.5				
Electric Power Plants									379.9				
Coke Ovens													
Oil Refineries and Field Operation Losses													
B. CONSUMPTION BY OTHER SECTORS													
TRANSPORTATION	0.07	0.82				0.50 ⁽²⁾							
Of which:									50.4	1.9			
Road and Tramways									50.4	1.9			
Railroads	0.07	0.82											
Waterways									0.01				
Air									0.01				
INDUSTRY		0.44	0.02			0.09			931.7	31.8			
Of which:									28.9				
Mining & Quarrying													
Fertilizer & Heavy Chemical													
Structural Clay Products													
Cement									118.7	0.1			
Iron & Steel									4.0				
Non-Ferrous													
Textiles									228.3	24.3			
Other									551.8	7.2			
AGRICULTURE									0.01				
DOMESTIC									0.01				
COMMERCIAL									0.17				
GOVERNMENT													
OTHERS													
TOTAL INTERNAL FINAL CONSUMPTION	0.07	1.27	0.02	0.01		0.50			2175.5	33.5	3.0	7.1	2.2

(1) The combined figures for Madras and Pondicherry are given.

→ Values not possible to isolate and included in this figure.

(2) Break up of Total Internal Consumption	Consumption by		of Oil Products.		('000 Tonnes)		Total Oil Products
	Motor Spirit	Aviation & Jet Fuel	HSDO	LDO	Fuel Oil	Others	
Transportation:							
Road & Tramways	62		147				209
Railroads					3		3
Waterways					9		9
Air		7					7
Industry (Total)			5	20	67		94
Agriculture				5			12
Domestic						1	164
Total Internal Final Consumption	62	7	159	25	165	1	498

TABLE 4-42
PRODUCTION AND USES OF ENERGY SOURCES - MAHARASHTRA - 1960/1

	Coking Coal	Non-Coking Coal	Metal-lurgical Coke	Non-Metal-lurgical Coke	Crude Oil	Total Oil Products	Manufactured Gas		Electricity		Non-Commercial Fuels		
	1	2	3	4	5	6	Blast Furnace Cubic Metres x 10 ⁶	Coke Oven & Gas Works	Utility kWh x 10 ⁶ = GWh	Non-Utility	Dung dry Tonnes x 10 ⁶	Firewood Tonnes x 10 ⁶	Waste Products
A. PRIMARY SOURCES OF ENERGY													
PRODUCTION		0.82									3.8	10.5	2.7
NET BALANCE OF EXTERNAL TRADE	+0.24	+2.73											
BUNKERS		-0.01											
STOCK CHANGES		-0.01											
TOTAL CONSUMPTION	0.24	3.53									3.8	10.5	2.7
QUANTITIES TRANSFORMED	-0.10	-1.24											
INTERNAL FINAL CONSUMPTION	0.14	2.29									3.8	10.5	2.7
B. SECONDARY SOURCES OF ENERGY													
PRODUCTION			+0.05	0.07		4.38		30	3268.0	164.9			
NET BALANCE OF EXTERNAL TRADE				+0.08		-2.12			-31.4				
BUNKERS						-0.13			2.2(1)	-2.1(3)			
STOCK CHANGES			0.05	0.15		-0.08							
TOTAL CONSUMPTION			0.05	0.15		2.07		30	3238.8	162.8			
QUANTITIES TRANSFORMED			0.05	0.15		-0.28							
INTERNAL FINAL CONSUMPTION			0.05	0.15		1.81		30	3238.8	162.8			
TOTAL INTERNAL FINAL CONSUMPTION	0.14	2.29	0.05	0.15		1.81		30	3238.8	162.8	3.8	10.5	2.7

BREAKDOWN OF INTERNAL FINAL CONSUMPTION

A. CONSUMPTION BY THE ENERGY SECTOR & LOSSES

Of which: Coal Mines and Washeries		0.04				0.27			581.7				
Electric Power Plants		0.04							1.8				
Coke Ovens									135.9				
Oil Refineries and Field Operation						0.27			41.7				
Losses									382.3				

B. CONSUMPTION BY OTHER SECTORS

TRANSPORTATION

Of which: Road and Tramways	0.14	1.41				0.41			355.5	8.2			
Railroads	0.14	1.41				0.28			10.0(2)				
Waterways						0.05			345.5	8.2			
Air			0.79	0.05		0.66					1792.4	154.8	

INDUSTRY

Of which: Mining & Quarrying									48.4	51.9			
Fertilizer & Heavy Chemical			0.04						5.2	1.0			
Structural Clay Products									72.2				
Cement				0.05					2.9	88.7			
Iron & Steel									864.2				
Non-Ferrous		0.30							799.5				
Textiles		0.45								33.0			
Others						0.05			14.8				

AGRICULTURE

DOMESTIC

COMMERCIAL

GOVERNMENT

OTHERS

TOTAL INTERNAL FINAL CONSUMPTION

AGRICULTURE				0.15		0.42		30	261.1		3.8	10.5	2.7
DOMESTIC									198.3				
COMMERCIAL			0.05						55.0				
GOVERNMENT													
OTHERS													
TOTAL INTERNAL FINAL CONSUMPTION	0.14	2.29	0.05	0.15		1.81		30	3238.8	162.8	3.8	10.5	1.7.

(4) Break up of Total Internal Final Consumption by Motor Spirit and Aviation & Jet Fuel

Transportation:				
Road & Tramways	169			
Railroads				
Waterways				
Air		82		
Industry (Total)				
Agriculture				
Domestic				
Total Internal Final Consumption	169	82		

Consumption of Oil Products (Excluding Oil Refineries Consumption) ('000 Tonnes)

HSDO	LDO	Kerosene	Fuel Oil	Others	Total Oil Products
					274
105					2
2					53
1	2		50		82
49	81	7	524		881
13	38				51
		407		8	415
170	121	414	574	8	1538

(1) Purchased from utilities.

(2) Tramways consumption.

(3) Sales to utilities.

← Values not possible to isolate and included in this figure.

TABLE 4-43
PRODUCTION AND USES OF ENERGY SOURCES - MYSORE - 1980/1

	Coking Coal	Non-Coking Coal	Metal-lurgical Coke	Non-Metal-lurgical Coke	Crude Oil	Total Oil Products	Manufactured Gas Blast Furnace	Gas Coke Oven & Gas Works	Electricity Utility	Non-Utility	Dung dry	Firewood	Waste Products
	1	2	3	4	5	6	7	8	9	10	11	12	13
	Tonnes x 10 ⁸						Cubic Metres x 10 ⁶		kWh x 10 ⁶ = GWh		Tonnes x 10 ⁶		
A. PRIMARY SOURCES OF ENERGY													
PRODUCTION													
NET BALANCE OF EXTERNAL TRADE	+0.04	+0.88											
BUNKERS											2.5	6.9	1.7
STOCK CHANGES													
TOTAL CONSUMPTION	0.04	0.68											
QUANTITIES TRANSFORMED		-0.10											
INTERNAL FINAL CONSUMPTION	0.04	0.58									2.5	6.9	1.7
B. SECONDARY SOURCES OF ENERGY													
PRODUCTION													
NET BALANCE OF EXTERNAL TRADE			+0.09						1022.7	109.2			
BUNKERS						+0.29			+50.0				
STOCK CHANGES													
TOTAL CONSUMPTION			0.09										
QUANTITIES TRANSFORMED			-0.03			0.29			1072.7	109.2			
INTERNAL FINAL CONSUMPTION			0.06			-0.01			1072.7	109.2			
TOTAL INTERNAL FINAL CONSUMPTION	0.04	0.58	0.06			0.28			1072.7	109.2	2.5	6.9	1.7
BREAKDOWN OF INTERNAL FINAL CONSUMPTION													
A. CONSUMPTION BY THE ENERGY SECTOR & LOSSES													
Of which:									176.3				
Coal Mines and Washeries													
Electric Power Plants													
Coke Ovens													
Oil Refineries and Field Operation Losses									14.8				
B. CONSUMPTION BY OTHER SECTORS													
TRANSPORTATION	0.04	0.41				0.28 (1)							
Of which:													
Road & Tramways						0.13			6.3	1.8			
Railroads	0.04	0.41				0.12			6.3	1.8			
Waterways													
Air													
INDUSTRY		0.17	0.06			0.01							
Of which:						0.03			687.0	106.4			
Mining & Quarrying									113.0	0.1			
Fertilizer & Heavy Chemical									28.6	-			
Structural Clay Products													
Cement		0.16							6.2	55.4			
Iron & Steel			0.06						279.7	-			
Non-Ferrous													
Textiles		0.01							52.0	20.0			
Other									207.5	30.9			
AGRICULTURE						0.02			28.7				
DOMESTIC						0.10			75.3		2.5	6.9	1.7
COMMERCIAL									21.3				
GOVERNMENT									77.8				
OTHERS													
TOTAL INTERNAL FINAL CONSUMPTION	0.04	0.58	0.06			0.28			1072.7	109.2	2.5	6.9	1.7

→ Values not possible to isolate and included in this figure.

Consumption by	(i) Break up of Total Internal Final Consumption		Consumption of Oil Products. ('000 Tonnes)					Total Oil Products
	Motor Spirit	Aviation & Jet Fuel	HSDD	LDO	Kerosene	Fuel Oil	Others	
Transportation:								
Road & Tramways	39		85					124
Railroads			1					1
Waterways								
Air		5						5
Industry			7	14	1	15		33
Agriculture			8	11				19
Domestic					99		1	100
Total Internal Final Consumption	39	5	87	25	100	15	1	282

TABLE 4-44
PRODUCTION AND USES OF ENERGY SOURCES - ORISSA - 1980/1

	Coking Coal	Non-Coking Coal	Metal-lurgical Coke	Non-Metal-lurgical Coke	Crude Oil	Total Oil Products	Manufactured Gas		Electricity		Non-Commercial Fuel		
	1	2	3	4	5	6	Blast Furnace	Coke Oven & Gas Works	Utility	Non-Utility	Dung dry	Firewood	Waste Products
	Tonnes x 10 ⁶						Cubic Metres x 10 ⁶		kWh x 10 ⁶ = GWh		Tonnes x 10 ⁶		
A. PRIMARY SOURCES OF ENERGY													
PRODUCTION		0.90											
NET BALANCE OF EXTERNAL TRADE	+0.87	-0.25											
BUNKERS											0.8	7.8	1.4
STOCK CHANGES		-0.05											
TOTAL CONSUMPTION	0.87	0.60											
QUANTITIES TRANSFORMED	-0.86	-0.10											
INTERNAL FINAL CONSUMPTION	0.01	0.50									0.8	7.8	1.4
B. SECONDARY SOURCES OF ENERGY													
PRODUCTION			0.57										
NET BALANCE OF EXTERNAL TRADE			-0.07	+0.01		+0.08	1364	238	489.9	306.7			
BUNKERS									+35.0	1/			
STOCK CHANGES									+44.8	2/	-44.8	3/	
TOTAL CONSUMPTION			0.50	0.01		0.08	1364	238	569.6		261.9		
QUANTITIES TRANSFORMED			-0.17				-468	-65					
INTERNAL FINAL CONSUMPTION			0.33	0.01		0.08	896	173	569.6		261.9		
TOTAL INTERNAL FINAL CONSUMPTION	0.01	0.50	0.33	0.01		0.08	896	173	569.6		261.9	0.8	7.8
BREAKDOWN OF INTERNAL FINAL CONSUMPTION													
A. CONSUMPTION BY THE ENERGY SECTOR & LOSSES													
Of which:		0.04											
Coal Mines & Washeries		0.04											
Electric Power Plants									73.0	4.1			
Coke Ovens (Steel Plants)									2.0	4.1			
Oil Refineries & Field Operation							150		3.7				
Losses							419	28	67.3				
B. CONSUMPTION BY OTHER SECTORS													
TRANSPORTATION	0.01	0.30				0.08							
Of which:						0.03							
Road and Tramways						0.03			1.6	0.1			
Railroads	0.01	0.30											
Waterways									1.6	0.1			
Air													
INDUSTRY		0.16	0.33			0.01	327	145	464.2	257.7			
Of which:													
Mining & Quarrying													
Fertilizer & Heavy Chemical		0.01											
Structural Clay Products		0.05											
Cement		0.08											
Iron & Steel			0.33				327	145	36.9				
Non-Ferrous									107.8	175.4			
Textiles		0.01							220.4				
Others		0.01							0.4	10.4			
AGRICULTURE									98.7	71.9			
DOMESTIC				0.01		0.04				0.8			
COMMERCIAL									18.3		0.8	7.8	1.4
GOVERNMENT									7.9				
TOTAL INTERNAL FINAL CONSUMPTION	0.01	0.50	0.33	0.01		0.08	896	173	569.6	261.9	0.8	7.8	1.4

1/ Inter-State purchases.

2/ Purchased from Non-Utilities.

3/ Sales from Non-Utilities.

→ Values not possible to isolate and included in this figure.

4/ Break up of Total Internal Final

Consumption by Motor Spirit Aviation & Jet Fuel

Transportation:		
Road & Tramways	18	
Railroads		
Waterways		
Air		
Industry (Total)		2
Agriculture		2
Domestic		40
Total Internal Final Consumption	18	44

Consumption of Oil Products. ('000 Tonnes)

HSOO LDO Kerosene Fuel Oil Total Oil Products

Transportation:	14				32
Industry (Total)	2	2		3	7
Agriculture					5
Domestic			40		40
Total Internal Final Consumption	19	4	40	3	84

TABLE 4-45
PRODUCTION AND USES OF ENERGY SOURCES - PUNJAB - 1960/1 1/

	Coking Coal	Non-Coking Coal	Metal-lurgical Coke	Non-Metal-lurgical Coke	Crude Oil	Total Oil Products	Manufactured Gas		Electricity		Non-Commercial Fuels			
	1	2	3	4	5	6	Blast Furnace	Coke Oven & Gas Works	Utility	Non-Utility	Dung dry	Firewood	Waste Products	
			Tonnes x 10 ⁶				Cubic Metres x 10 ⁶		kWh x 10 ⁶ = GWh		Tonnes x 10 ⁶			
A. PRIMARY SOURCES OF ENERGY														
PRODUCTION														
NET BALANCE OF EXTERNAL TRADE	+0.08	+2.17										5.2	5.4	1.5
BUNKERS														
STOCK CHANGES														
TOTAL CONSUMPTION	0.08	2.17												
QUANTITIES TRANSFORMED		-0.43												
INTERNAL FINAL CONSUMPTION	0.08	1.74										5.2	5.4	1.5
B. SECONDARY SOURCES OF ENERGY														
PRODUCTION														
NET BALANCE OF EXTERNAL TRADE			+0.11	+0.31		+0.42			1293.0	176.8				
BUNKERS									-35.7					
STOCK CHANGES														
TOTAL CONSUMPTION			0.11	0.31		0.42								
QUANTITIES TRANSFORMED						-0.01			1257.3	176.8				
INTERNAL FINAL CONSUMPTION			0.11	0.31		0.41			1257.3	176.8				
TOTAL INTERNAL FINAL CONSUMPTION	0.08	1.74	0.11	0.31		0.41			1257.3	176.8	5.2	5.4	1.5	
BREAKDOWN OF INTERNAL FINAL CONSUMPTION														
A. CONSUMPTION BY THE ENERGY SECTOR & LOSSES														
Of which: Coal Mines and Washeries										297.5				
Electric Power Plants										26.7				
Coke Ovens														
Oil Refineries & Field Operations														
Losses										270.8				
B. CONSUMPTION BY THE OTHER SECTORS														
TRANSPORTATION	0.08	0.74				0.41 2/								
Of which: Road and Tramways						0.21			24.2	0.2				
Railroads	0.08	0.74				0.17			24.2	0.2				
Waterways														
Air						0.04								
INDUSTRY		0.76	0.11			0.05			480.0	176.6				
Of which: Mining and Quarrying														
Fertilizer and Heavy Chemical		0.04							1.8	51.1				
Structural Clay Products		0.21												
Cement		0.15							39.0	38.1				
Iron & Steel			0.11											
Non-Ferrous														
Textiles		0.13							37.0	59.2				
Others		0.23							402.2	28.2				
AGRICULTURE		0.08		0.03		0.03			79.8					
DOMESTIC				0.31		0.12			167.9		5.2	5.4	1.5	
COMMERCIAL									135.0					
GOVERNMENT		0.16							72.9					
OTHERS														
TOTAL INTERNAL FINAL CONSUMPTION	0.08	1.74	0.11	0.31		0.41			1257.3	176.8	5.2	5.4	1.5	

2/ Break up of Total Internal Final Consumption of Oil Products ('000 Tonnes)

Consumption by	Motor Spirit	Aviation & Jet Fuel	HSDO	LDO	Kerosene	Fuel Oil	Others	Total Oil Products
Transportation:								
Road & Tramways	77		92					169
Railroads			3					3
Waterways								-
Air		42						42
Industry (Total)			13	22	2	12		49
Agriculture			15	12				27
Domestic					111		6	117
Total Internal Final Consumption	77	42	123	34	113	12	6	407

1/ Includes figures for Himachal Pradesh and Delhi.

→ Values not possible to isolate and included in this figure.

TABLE 4-48
PRODUCTION AND USES OF ENERGY SOURCES - RAJASTHAN - 1960/1

	Coking Coal	Non-Coking Coal	Metal-lurgical Coke	Non-Metal-lurgical Coke	Crude Oil	Total Oil Products	Manufactured Gas Blast Furnace	Coke Oven & Gas Works	Electricity Utility	Non-Utility	Dung dry	Firewood	Waste Products
	1	2	3	4	5	6	7	8	9	10	11	12	13
	Tonnes x 10 ⁶						Cubic Metres x 10 ⁶		kWh x 10 ⁸ = GWh		Tonnes x 10 ⁶		
A. PRIMARY SOURCES OF ENERGY													
PRODUCTION		0.05											
NET BALANCE OF EXTERNAL TRADE	+0.8	+1.42									2.3	5.2	1.8
BUNKERS													
STOCK CHANGES													
TOTAL CONSUMPTION	0.8	1.47									2.3	5.2	1.8
QUANTITIES TRANSFORMED		-0.24											
INTERNAL FINAL CONSUMPTION	0.8	1.23									2.3	5.2	1.8
B. SECONDARY SOURCES OF ENERGY													
PRODUCTION													
NET BALANCE OF EXTERNAL TRADE			+0.01	+0.02		+0.15			100.3	145.3			
BUNKERS									+22.7				
STOCK CHANGES									0.2	1/			
TOTAL CONSUMPTION			0.01	0.02		0.15			123.2	145.3			
QUANTITIES TRANSFORMED						-0.01							
INTERNAL FINAL CONSUMPTION			0.01	0.02		0.14			123.2	145.3			
TOTAL INTERNAL FINAL CONSUMPTION	0.8	1.23	0.01	0.02		0.14			123.2	145.3	2.3	5.2	1.8
BREAKDOWN OF INTERNAL FINAL CONSUMPTION													
A. CONSUMPTION BY THE ENERGY SECTOR & LOSSES													
Of which: Coal Mines and Washeries									29.5				
Electric Power Plants									4.3				
Coke Ovens													
Oil Refineries and Field Operation													
Losses									25.2				
B. CONSUMPTION BY OTHER SECTORS													
TRANSPORTATION	0.8	0.83				0.14 3/			0.08		8.1	11.0	
Of which: Road and Tramways									0.08		8.1	11.0	
Railroads	0.8	0.83											
Waterways													
Air													
INDUSTRY		0.34	0.01			0.02			20.6	134.0			
Of which: Mining & Quarrying										0.1			
Fertilizer & Heavy Chemical		0.02											
Structural Clay Products		0.01											
Cement		0.24								122.4			
Iron & Steel			0.01							0.2			
Non-Ferrous													
Textiles		0.04							5.7	10.7			
Others		0.03							14.9	0.6			
AGRICULTURE		0.02				0.01			3.6				
DOMESTIC				0.02		0.05			20.7		2.3	5.2	1.8
COMMERCIAL									15.9				
GOVERNMENT		0.04							24.8				
OTHERS										0.3 2/			
TOTAL INTERNAL FINAL CONSUMPTION	0.8	1.23	0.01	0.02		0.14			123.2	145.3	2.3	5.2	1.8

3/ Break up of Total Internal Final Consumption of Oil Products. ('000 Tonnes)

Consumption by	Motor Spirit	Aviation & Jet Fuel	SFO	LDO	Kerosene	Fuel Oil	Others	Total Oil Products
Transportation:								
Road & Tramways	30		29					59
Railroads			1					1
Waterways								
Air		1						1
Industry (Total)			5	7		8		20
Agriculture				11				11
Domestic					45		2	47
Total Internal Final Consumption	30	1	35	18	45	8	2	139

1/ Purchase from non-utility

2/ Sales to other agencies

← Values not possible to isolate and included in this figure.

TABLE 4-47
PRODUCTION AND USES OF ENERGY SOURCES - UTTAR PRADESH - 1960/1

	Coking Coal	Non-Coking Coal	Metal-lurgical Coke	Non-Metal-lurgical Coke	Crude Oil	Total Oil Products	Manufactured Gas Blast Furnace & Gas Works	Coke Oven & Gas Works	Electricity Utility Non-Utility	Non-Commercial Fuels				
	1	2	3	4	5	6	7	8	9	10	11	12	13	
	Tonnes x 10 ⁶						Cubic Metres x 10 ⁶		kWh x 10 ⁶ - GWh		Tonnes x 10 ⁶			
A. PRIMARY SOURCES OF ENERGY														
PRODUCTION														
NET BALANCE OF EXTERNAL TRADE	+0.22	+4.58									14.5	12.2	5.3	
BUNKERS														
STOCK CHANGES														
TOTAL CONSUMPTION	0.22	4.58									14.5	12.2	5.3	
QUANTITIES TRANSFORMED		-0.95												
INTERNAL FINAL CONSUMPTION	0.22	3.63									14.5	12.2	5.3	
B. SECONDARY SOURCES OF ENERGY														
PRODUCTION														
NET BALANCE OF EXTERNAL TRADE			+0.09	+0.16		+0.45			1252.4	160.8				
BUNKERS														
STOCK CHANGES														
TOTAL CONSUMPTION			0.09	0.16		0.45			1252.4	160.8				
QUANTITIES TRANSFORMED						-0.01								
INTERNAL FINAL CONSUMPTION			0.09	0.16		0.44			1252.4	160.8				
TOTAL INTERNAL FINAL CONSUMPTION	0.22	3.63	0.09	0.16		0.44			1252.4	160.8	14.5	12.2	5.3	
BREAKDOWN OF INTERNAL FINAL CONSUMPTION														
A. CONSUMPTION BY THE ENERGY SECTOR & LOSSES														
Of which:										276.6				
Coal Mines and Washeries														
Electric Power Plants										59.8				
Coke Ovens														
Oil Refineries and Field Operation														
Losses										217.0				
B. CONSUMPTION BY OTHER SECTORS														
TRANSPORTATION	0.22	2.48				0.44 (2)								
Of which:										0.18	39.8	22.8		
Road and Tramways										0.13				
Railroads	0.22	2.48				0.01			39.8	22.8				
Waterways														
Air										0.04				
INDUSTRY		1.00	0.09			0.04			464.1	137.9				
Of which:											1.4	27.5		
Mining & Quarrying														
Fertilizer & Heavy Chemical											0.09			
Structural Clay Products											0.28			
Cement											0.07			
Iron & Steel												0.09		
Non-Ferrous														
Textiles											0.17		147.1	9.5
Others											0.39		305.2	67.9
AGRICULTURE		0.07				0.04			200.0					
DOMESTIC				0.16		0.18			122.7		14.5	12.2	5.3	
COMMERCIAL									74.8					
GOVERNMENT		0.08							74.4					
OTHERS										0.1 (1)				
TOTAL INTERNAL FINAL CONSUMPTION	0.22	3.63	0.09	0.16		0.44			1252.4	160.8	14.5	12.2	5.3	

(1) Sales to other agencies
 Values not possible to isolate and included in this figure.

(2) Break up of Total Internal Final Consumption of Oil Products ('000 Tonnes)

Consumption by	Motor Spirit	Aviation & Jet Fuel	SDO	LDO	Kerosene	Fuel Oil	Others	Total Oil Products
Transportation:								
Road & Tramways	51		10			1		131
Railroads			10					11
Waterways				1				1
Air		40	10					40
Industry (Total)			12	26	2	4		42
Agriculture				22				34
Domestic					181		2	183
Total Internal Final Consumption	51	40	22	49	183	5	2	442

TABLE 4-48
PRODUCTION AND USES OF ENERGY SOURCES - WEST BENGAL - 1980/1

	Coking Coal	Non-Coking Coal	Metal-lurgical Coke	Non-Metal-lurgical Coke	Total Oil Products	Manufactured Gas Blast Furnace	Manufactured Gas Coke Oven & Gas Works	Electricity Utility	Electricity Non-Utility	Dung dry	Firewood	Waste Products	
	1	2	3	4	5	6	7	8	9	10	11	12	13
	Tonnes x 10 ⁶					Cubic Metres x 10 ⁶		kWh x 10 ⁶ = GWh		Tonnes x 10 ⁶			
A. PRIMARY SOURCES OF ENERGY													
PRODUCTION	0.88	18.23											
NET BALANCE OF EXTERNAL TRADE	+3.18	-10.12									3.0	8.0	2.2
BUNKERS		-0.08											
STOCK CHANGES	-0.07	-0.35											
TOTAL CONSUMPTION	3.78	5.70											
QUANTITIES TRANSFORMED	-2.78	-1.78									3.0	8.0	2.2
INTERNAL FINAL CONSUMPTION	1.03	3.94									3.0	8.0	2.2
B. SECONDARY SOURCES OF ENERGY													
PRODUCTION			1.75	0.18		4679	915	2318.3	623.1				
NET BALANCE OF EXTERNAL TRADE			-0.05	+0.83	+0.72			+471.9					
BUNKERS					-0.07								
STOCK CHANGES			+0.02										
TOTAL CONSUMPTION			1.72	1.01	0.85	4679	915	2790.2	623.1				
QUANTITIES TRANSFORMED			-0.73		-0.01	-1323	-84						
INTERNAL FINAL CONSUMPTION			0.99	1.01	0.84	3356	831	2790.2	623.1				
TOTAL INTERNAL FINAL CONSUMPTION	1.03	3.94	0.99	1.01	0.84	3356	831	2790.2	623.1	3.0	8.0	2.2	
BREAKDOWN OF INTERNAL FINAL CONSUMPTION													
A. CONSUMPTION BY THE ENERGY SECTOR & LOSSES													
Of which: Coal Mines and Washeries	0.03	0.8				1408	158	363.7	7.5				
Electric Power Plants	0.03	0.8						117.2	7.5				
Coke Ovens						344	20	130.7					
Oil Refineries and Field Operation								1.0					
Losses						1065	138	114.8					
B. CONSUMPTION BY THE OTHER SECTORS													
TRANSPORTATION	0.24	1.74			0.64 3/			169.4	25.2				
Of which: Road and Tramways					0.25								
Railroads	0.24	1.50			0.19			48.1 1/					
Waterways		0.24						121.3	25.2				
Air					0.06								
INDUSTRY	0.78	1.18	0.99		0.15	1947	643	1667.8	427.0				
Of which: Mining & Quarrying													
Fertilizer & Heavy Chemical		0.02						107.6	25.8				
Structural Clay Products		0.14											
Cement								7.5					
Iron & Steel	0.78		0.99			1947	643	120.8	194.2				
Non-Ferrous								20.2	66.5				
Textiles		0.06						587.1	53.7				
Others		0.96						824.6	87.0				
AGRICULTURE					0.02			0.6					
DOMESTIC				1.01	0.22		30	353.5		3.0	8.0	2.2	
COMMERCIAL		0.07						115.8	163.4 ²⁾				
GOVERNMENT		0.15						119.4	623.1				
OTHERS													
TOTAL INTERNAL FINAL CONSUMPTION	1.03	3.94	0.99	1.01	0.64	3356	831	2790.2	623.1	3.0	8.0	2.2	

1/ Tramways Consumption
2/ Sales to other agencies
→ Values not possible to isolate included in this figure.

3/ Break up of Total Internal Final Consumption of Oil Products. ('000 Tonnes)

Consumption by	Motor Spirit	Aviation Jet Fuel	HSDO	LDO	Kerosene	Fuel Oil	Others	Total Oil Products
Transportation:			66					
Road & Tramways	120							186
Railroads			2	1		1		4
Waterways								
Air		59	27	15	2	106		59
Industry (Total)			77	11				150
Agriculture								22
Domestic					213		2	215
Total Internal Final Consumption	120	59	108	27	215	108	2	637

ANNEX 5

Basic Energy Statistics in Coal Replacement Units

CONTENTS

CONTENTS	Table No.
I. Replacement and conversion factors used in the India Energy Study.	5-21 Orissa
II. Notes concerning the tables.	5-22 Punjab
APPENDIX I. - Note on coal replacement of thermal power	5-23 Rajasthan
APPENDIX II. - Gross efficiency of coke & gas manufacture	5-24 Uttar Pradesh
APPENDIX III. - Comparison of coal replacement of Internal Consumption of energy sources deriving from coal with actual input of coal in 1960/1.	5-25 West Bengal
III. Tables in coal replacement.	
Table No.	Trends of Energy Consumption in Different Sectors of Final Consumption - All India - 1953/4 to 1960/1.
Total Internal Final Energy Consumption Broken down by Sector of Consumption and Source of Energy and Total Final Energy Consumption of Oil Products Broken Down by Sector of Consumption	5-26 A Transport - Road and Tramway
	B Transport - Rail-road
	C Transport - Waterway
	D Transport - Airways
	E Industry - Iron & Steel
	F Industry - Fertiliser
	G Industry - Heavy Chemicals
	H Industry - Structural Clay Products
	I Industry - Cement
	J Industry - Mining and Quarrying
	K Industry - Non-Ferrous Metals
	L Industry - Textiles
	M Industry - Others
	N Agriculture
	O Domestic
	P Commercial
	Q Government
	R Other Sectors
	S Energy Sector and Losses
5-1. & 1A All India 1953/4	5-27 Energy Consumption in India by State in 1960/1 expressed in terms of primary sources.
5-2. & 2A All India 1954/5	5-28 Contribution of the various forms of primary energy to the total consumption of primary energy in the various States in India during 1960/1.
5-3. & 3A All India 1955/6	5-29 Energy Consumption in India by State in 1960/1 expressed in terms of indigenous primary sources and imports.
5-4. & 4A All India 1956/7	5-30 Final Consumption of various forms of energy by State in 1960/1.
5-5. & 5A All India 1957/8	5-31 Contribution of the various forms of Primary and Secondary Energy to the Total Consumption of Energy for each State during 1960/1.
5-6. & 6A All India 1958/9	
5-7. & 7A All India 1959/60	
5-8. & 8A All India 1960/1	
5-9. & 9A All India 1961/2	
5-10 & 10A All India 1962/3	
Total Final Energy Consumption Broken Down By Sector of Consumption and Source of Energy in 1960/1	
5-11 Andhra Pradesh	
5-12 Assam	
5-13 Bihar	
5-14 Gujarat	
5-15 Jammu & Kashmir	
5-16 Kerala	
5-17 Madhya Pradesh	
5-18 Madras	
5-19 Maharashtra	
5-20 Mysore	

I. REPLACEMENT AND CONVERSION FACTORS USED IN THE INDIA ENERGY STUDY

A. Basic assumptions

1. In trying to express the Indian energy economy as simply as possible in terms of coal, the following basic assumptions have been made:

- (a) The coal replacement should give a fair idea of the amount of coal required to substitute or produce other sources of energy.
- (b) "Substitution of coal for coal" should be avoided. Actual quantities of coal should be stated wherever possible without attempting e.g. to express tonnes of coal at 4400 kcal/kg in terms of equivalent tonnes of the average 6440 kcal/kg. Such a procedure would cause confusion and would jeopardise a major advantage of "coal replacement" namely to leave the figures for the major source as they are.
- (c) The replacement factors will in many cases be arbitrary since a great variety of substitution patterns are possible. Since the coal replacement figures are mainly going to be used in forecasting future energy requirements, the choice of substitution factor should take account of average re-

placement trends expected in the future rather than past or present averages.

- (d) The set of substitution and conversion factors should be simplified as far as possible without causing major distortions.

B. Coal required for electricity production

2. A detailed study has been made on past and foreseeable future efficiencies of utility thermal electric plant. With plant losses of 6 per cent of units generated and transmission and distribution losses of 12 per cent of units sent out, the average coal input per kWh finally consumed is on the average 0.95 kg for the period 1955 to 1961/2 varying only between 0.90 and 0.98.

3. A complete calculation of all the fuel inputs to electricity generation, using the basic statistics for 1960/1 and also taking account of industrial self-generation, gives a factor of 1 kg/kWh finally consumed (see Appendix I.). This figure should be adequate for past statistics

4. Although average efficiency in utility thermal plant is expected to increase by one fifth from 29.2 to 35.1 per cent between 1965/6 and 1980/1, per unit consumption of coal will only decrease by about 7 per cent due to the downward trend in its average heat value. The table below sets out the assumption made for various future years:

FUTURE CONVERSION FACTORS FOR ELECTRICITY
PRODUCED IN UTILITY THERMAL PLANT

	1965/6	1970/1	1975/6	1980/1
Average efficiency	29.2%	32.8%	34.2%	35.1%
kcal/kWh	2950	2625	2520	2450
Heat value coal kcal/kg (1)	4850	4500	4400	4350
kg coal/kWh:				
(a) Generated	0.608	0.583	0.573	0.563
(b) Plant output (2)	0.647	0.620	0.610	0.599
(a) (.94)				
(c) Consumed (3)	0.735	0.704	0.693	0.681
(a) (.827)				

(1) average of all coal used;

(2) based on 6% of units generated as plant's own use;

(3) based on 12% of units sent out as system losses.

5. The conversion ratios vary little between 1965/6 and 1980/1 and it is therefore felt that the average rate of 0.7 kg coal per kWh consumed would be an acceptable figure for the whole forecast period concerned. This factor does not take account of industrial self-production where the average rate will probably remain somewhat higher. It is, however, not expected that this form of generation will develop on the same scale as utility power production. The factor of 0.7 has therefore been retained for all future thermal generation, bearing in mind that individual new plants coming into operation between 1970 and 1976 will in fact only require about 0.6kg of coal per unit consumed.

C. Oil

6. Depending on the process in question, 1 tonne of oil may replace two to four tonnes of coal in industry according to European experience. A factor of 2 would seem on the lower side allowing only for about the same efficiency as coal (1).

7. In the domestic sector a replacement factor of 8.3 tonnes of coal/per tonne of kerosene has been worked out on the basis of experiments carried out by the Central Fuel Research Institute (2). Although this substitution ratio strictly applies only to kerosene used for cooking in the domestic sector, it has

been applied to all uses of kerosene. LPG is used with an efficiency similar to that of kerosene and could be assigned the same replacement factor in view of the small quantity involved.

8. According to the Report of the Expert Committee on Coal Consumption in Railways (3) the theoretical ratio of coal consumption in steam locomotives to oil consumption in diesel locomotives works out to 8:1. Actual performance of diesel and steam locomotives hauling goods show the slightly higher ratio of 9:1. This replacement factor is used in the Monthly Railway Statistics (4) and in the annual Reports by the Railway Board (5) to express total fuel consumption in terms of coal. The same factor has been chosen for the Energy Study and its use has been extended to the consumption of diesel oil for other purposes such as road transport where no substitution is actually taking place.

9. According to the two last sources referred to in paragraph 8, it takes 7.5 tonnes of coal to do the job of 1 tonne of motor spirit in railway traction. This factor has been adopted for road and air transport where no actual substitution pattern is available.

10. In Table below the total coal replacement of oil products consumed in 1960/1 has been calculated on the basis of the factors mentioned in paragraphs 6 to 9:

COAL REPLACEMENT OF OIL PRODUCTS CONSUMED IN 1960/1

Oil Product	Fuel Consumption in 1960/61 Mt	Replacement factor	
		MtCR/Mt	MtCR
Black products (1)	1.50	2.0	3.0
Kerosene & LPG	2.01	8.3	16.7
HSDO & LDO	1.75	9.0	15.7
Motor spirit, aviation and jet fuel	1.13	7.5	8.5
	6.39		43.9

(1) Fuel oil, Vapourising oil and Refinery fuel.

(1) The same efficiency if measured with coal of 5000 kcal/kg; 12% lower efficiency if measured with by-product coal and about 30% higher efficiency if measured with high grade coal of 6500 kcal/kg, as against an average of 10,000 kcal/kg for petroleum products;

(2) Cooking efficiency for kerosene of 11,000 kcal/kg, about 51%; for soft coke of 5770 kcal/kg, about 18%. As it takes about 1.5 tonnes of coal to produce 1 tonne of soft coke, the resulting replacement factor is 8.3 tonnes of coal

per tonne of kerosene.

(3) Government of India, Ministry of Railways, 1958, page 85, paragraph 98.

(4) Government of India, Ministry of Railways (Railway Board), Part III, Table 9 - Fuel Consumption, Government of Railways.

(5) Volume III, Statistics: See e.g. footnote to Table 27 (a): Statement of fuel consumption by classes of fuel on Government Railways.

11. The resulting average replacement factor is 6.9 tonnes of coal per tonne of oil product. Since the black products only account for about 23 per cent of the total product mix, the average factor is not very sensitive to changes in the rate chosen for fuel oil. In fact, a ratio of 3 instead of 2 would only bring the average factor up to 7.1.

12. A possible future product mix of 37 per cent black and 63 per cent white products would bring the average factor down to 6. The choice of a higher replacement factor for black products, however, would partially offset this decrease. A ratio of 3 instead of 2 would in fact bring the average factor back to 6.4.

13. On the whole it is believed that an average replacement factor of 6.5 would make sufficient allowance for a possible under-estimate of the future relative importance of black products, it should give a fair reflection of the higher efficiency, flexibility and value of petroleum products as compared to coal. It means, in fact, that on the average oil is used by final consumers with an efficiency 3 to 4 times higher than that of coal.

D. Coke and Gas

14. A factor of 1.5 tonnes of coal per tonne of soft coke results from data supplied by the Central Fuel Research Institute and is consistent with the basic statistics. Unfortunately, a similar factor cannot be used for the bulk of the hard coke production since it would mean a double counting of the gas output. In fact, 1.5 tonnes of coal produce 1.0 tonne of hard coke as well as about 400 m³ gas which is recovered.

15. The gross efficiency of gas and coke making in India is 81 per cent, leaving aside the soft coke manufacture (1). In calculating coal equivalents for coke and gas, we can simplify by counting gas work together with coke oven gas, since the consumption of the former was only about 4% of the latter in 1960/1.

16. We then got the following factor for coke, (excluding soft coke):

$$\frac{6100 \text{ kcal/kg coke}}{0.81 \times 6640 \text{ kcal/kg coal}} = 1.13 \text{ kg coal/kg coke}$$

i.e. it takes 1.13 tonnes of coal to provide the energy contained in one tonne of coke.

17. For manufactured gas (2) we find the following factor:

$$\frac{4500 \text{ kcal/m}^3 \text{ gas}}{0.81 \times 6640 \text{ kcal/kg coal}} = 0.83 \text{ kg coal/m}^3 \text{ gas}$$

Or in other words, 0.83 million tonnes of coal are required to provide the heat content of 1000 million

m³ manufactured gas.

18. For blast furnace gas we get the following factor:

$$\frac{950 \text{ kcal/m}^3 \text{ B F G}}{0.81 \times 6640 \text{ kcal/kg coking coal}} = 0.18 \text{ kg coal/m}^3 \text{ B F G}$$

Or in other words, it takes 0.18 million tonnes of coking coal to provide the heat content of 1000 million m³ blast furnace gas (3).

E. Non-Commercial sources of energy (4)

19. The following replacement ratios are based on experiments carried out by the Central Fuel Research Institute:

1 tonne of dry dung is replaced by 0.4 tonne of coal.

1 tonne of firewood or waste is replaced by 0.95 tonne of coal.

F. Summary

20. The various replacement and conversion ratios calculated above are set out in the summary table below. The factors for oil products, dry dung and firewood are replacement ratios expressing the amount of coal needed to substitute their final use taking account of relative efficiencies involved. The factors for coke and gas are purely technical conversion factors permitting the expression of final consumption of these fuels in terms of the primary input of coal actually needed. This would also be true for electricity if only thermal generation were considered. However, when applied to the total consumption of electricity, the ratios are in fact replacement factors permitting its expression in terms of the amount of coal that would have been needed if no hydro, oil or nuclear generation were available.

(1) See detailed calculation in Appendix II.

(2) Coke oven gas and gas work gas.

(3) This tacitly implies that the conversion of coke into blast furnace gas takes place at 100% efficiency. It should also be noted that the consumption of blast furnace gas and coke oven gas in coke ovens and losses of blast furnace gas and coke oven gas has been counted under the heading "Consumption by the energy sector and losses" in the statistical tables.

(4) See also Chapter 8 of the Report

SUMMARY TABLE
REPLACEMENT AND CONVERSION FACTORS (1)

Amount of coal required to replace or produce
other sources of energy taking account of
relative efficiencies in typical cases of re-
placement or conversion (2)

	Million tonnes Coal Replacement (MtCR)
10 ⁹ kWh electricity (3) 1953/4 to 1960/1	1
1965/6 to 1980/1	0.7
1 million tonnes of oil products	6.5
1 million tonnes of soft coke	1.5
1 million tonnes of coke other than soft coke (4)	1.13
1000 million m3 manufactured gas (5)	0.83
1000 million m3 blast furnace gas (6)	0.18
1 million tonnes of dry dung	0.4
1 million tonnes of fire-wood or waste	0.95

- (1) These factors only apply to the Indian Energy Economy and to the period 1953/4 to 1980/1.
- (2) The coefficients for electricity, coke, manufactured gas and blast furnace gas have been checked by comparing coal replacement figures of final consumption of energy sources deriving from coal with actual input of coal in 1960/1 (see Appendix III).
- (3) Measured at the stage of final consumption this factor takes account of power plants' own use (6% of units generated) as well as transmission and distribution losses (12% of units sent out).
- (4) This factor is lower than that applied for soft coke since it gives credit to gas recovery.
- (5) This conversion factor gives credit to coke production; it only represents the primary input of coal needed to provide the heat content of the gas produced.
- (6) This conversion factor only reflects the primary input of coal needed to cover the heat value of the blast furnace gas produced.

21. These replacement ratios constitute, in fact, a simplified substitution model and have been chosen for their great convenience when used in forecasting. They permit an easy expression of different energy

quantities finally consumed in terms of primary energy input needed in the form of one source of energy, namely coal. These factors therefore, strictly speaking, only apply to the final consumption pattern and

may only in special cases be used at the supply and transformation stages (1). They further only apply to the India Energy Economy and to the period under review, i.e. 1953-4 to 1980-1 and should not be used for other purposes.

22. Complete tables in original units and in kilocalories have been made available to the technically interested reader in Annexes 4 and 6. From these tables he will be able to extract any detailed information needed as to the actual amount of energy involved in every stage of supply, transformation and final consumption of the different sources of energy.

II. NOTES CONCERNING THE TABLES

23. As a general rule, the tables in coal replacement appearing in the main Report have not been re-

peated here. Certain tables showing the past trends of energy consumption in different sectors have, however, been reproduced in this Annex in order to give the complete sequence. It should be noted that, following the pattern of the basic statistics in original units, the final consumption of oil products in various sub-sectors of industry has not been broken down except for 1960/1. In the Report, however, special estimates have been made for earlier years in the case of certain industries such as Iron and Steel and Textiles.

(1) Any detailed consideration of these stages should be made on the basis of tables in original units and kilocalories. Appendices I, II and III to this Annex are typical examples of such considerations.

APPENDIX I
NOTE ON COAL REPLACEMENT OF THERMAL POWER
(India 1960/1)
(Based on the net power sold)

Input to Thermal Plants (both Utility and Non-Utility)

	Quantity input	Replacement or Conversion factor	Million tonnes Coal Replacement (MtCR)
	(i)	(ii)	(i x ii)
(a) Coking Coal	0.47 Mt	-	0.47
(b) Non-coking Coal	8.62 Mt	-	8.62
(c) Metallurgical Coke	0.03 Mt	1.13	0.03
(d) Fuel Oil	0.276 Mt	2 ⁽¹⁾	0.55
(e) L.D.O.	0.112 Mt	3 ⁽¹⁾	0.34
(f) Blast Furnace Gas	$2.337 \times 10^9 \text{m}^3$	0.18	0.42
(g) Coke Oven and Merchant Oven Gas	$0.167 \times 10^9 \text{m}^3$	0.83	0.14

(A) Total input in Coal Replacement = 10.57

Output of the Thermal Plants in 10^9 units or TWh:

a) Unit Generated: (i) Utility = 9.09
(ii) Non-Utility = 3.29
12.38

b) Losses Transmission & Distribution 1.37⁽²⁾

c) Auxiliary use; Plant's own consumption 0.69

(B) ∴ Units sold = a - (b plus c) = 10.32

Coal required/unit sold = $\frac{A}{B} = \frac{10.57}{10.32} = 1.024 \text{ kg/kWh}$

say 1 kg/unit sold

(1) The factor of 6.5 tonnes of coal to replace one tonne of petroleum product is a weighted average replacement ratio for the final consumption stage; it cannot be used for the thermal production of power.

(2) This is a part of total transmission and distribution losses taken in proportion with the units generated by thermal plants.

APPENDIX II
GROSS EFFICIENCY OF COKE AND GAS MANUFACTURE
(Excluding Soft Coke) for the year 1960/1

Coking Coal Input

		Million tonnes
Coke Ovens	=	6.64
Merchant Ovens	=	0.78
Beehive Ovens	=	0.28
Gas Works	=	<u>0.20</u>
Total	=	7.90

Total heat value of input coking coal
(assuming calorific value of coking
coal as 6640 kcal/kg). = 7.90 x 6640
= 52.46 x 10¹² kcal

Output	Calorific value/unit	Total Heat Value 10 ¹² kcal
Metallurgical Coke 5.21 Mt	6100 kcal/kg	31.70
Non-Metallurgical Coke (Gas Works Coke) 0.31 Mt	6100 kcal/kg	0.79
Coke Oven Gas 2.18 x 10 ⁹ m ³	4500 kcal/m ³	9.80
Gas Works Gas 0.06 x 10 ⁹ m ³	4200 kcal/m ³	<u>0.25</u>
Total heat output =		42.54
Efficiency	= $\frac{\text{output}}{\text{input}}$ = $\frac{42.54}{52.46}$	= 81%

NOTE: In calculating the above gross efficiency, other products such as tar and benzol have been counted as losses. Further, the calculation does not take account of the following items which appear under the heading "Consumption by the energy sector and losses":

- Consumption of blast furnace gas and coke oven gas in coke ovens, and
- losses of blast furnace and coke oven gas.

APPENDIX III
COMPARISON OF COAL REPLACEMENT OF INTERNAL CONSUMPTION
OF ENERGY SOURCES DERIVING FROM COAL WITH ACTUAL
INPUT OF COAL IN 1960/1

	Million tonnes of coal replacement
Transformation:	
Electricity derived from other sources than coal:	
Hydel: 7.7 TWh, measured at consumption side after 12% losses:	
6.77 TWh x 1 MtCR/TWh =	6.77
0.112 Mt LDO x 3 ⁽¹⁾ MtCR/Mt =	0.33
0.276 Mt Fuel Oil x 2 MtCR/Mt =	<u>0.55</u>
Electricity derived from other sources than coal	7.65
Coal replacement of total final electricity consumption	16.92
Less electricity derived from other sources than coal	<u>7.65</u>
Electricity derived from coal	9.27
Final Consumption of:	
Coking coal	4.25
Non-coking coal	26.04
Coke excluding soft coke	3.93
Soft coke	2.76
Blast furnace gas	1.75
Coke oven and gas works gas	<u>1.71</u>
Total energy supply from coal calculated from the final consumption side and using conversion and replacement factors adopted	49.71
Total input of coal:	
Coking coal	13.81
Non-coking coal	<u>36.11</u>
	49.92
The difference of 0.21 represents less than 0.4%	

(1) The factor of 6.5 tonnes of coal per tonne of petroleum products is only valid for the final consumption stage; it does not apply to thermal production.

TABLE 5-1
ALL INDIA 1953/4
TOTAL INTERNAL FINAL ENERGY CONSUMPTION BROKEN DOWN BY SECTOR OF CONSUMPTION AND SOURCE OF ENERGY
(Million Tonnes of Coal Replacement)***

	Coking Coal	Non-Coking Coal	Coke Excluding Soft Coke	Soft Coke	Total Oil Products (3)	Blast Furnace Gas	Coke Oven & Gas Work Gas	Electricity	Total Commercial Sources of Energy	Dung (Dry)	Fire-wood	Waste Products	Total Non-Commercial Energy	Total Internal Final Consumption
Total Transportation of which	5.0	7.1	-		7.6			0.6	20.3	-	-	-	-	20.3
Road and Tramways					6.5			0.1	6.6					6.6
Railroads	5.0	6.9			0.1			0.5	12.5					12.5
Waterways		0.2			0.4				0.6					0.6
Air					0.6				0.6					0.6
Total Industry of which	2.2	6.7(1)	1.7		5.4(1)	0.4(1)	0.6	5.0	22.0	-	-	-	-	22.0
Iron & Steel	0.8		1.5(2)			0.4(1)	0.6	0.6						
Fertilizer			0.2					0.3						
Heavy Chemical								0.1						
Structural Clay Products		0.1(5)						0.4						
Cement		1.1						0.1						
Mining & Quarrying								0.1						
Non-Ferrous (7)		0.1						0.1						
Textiles								1.8						
Others	1.4	5.4(6)						1.6						
Total Other Sectors		0.8		2.2	9.0			1.7	13.7	18.6	82.2	25.1	125.9	139.6
Agriculture		0.2			1.3			0.2	1.7					1.7
Domestic				2.2	7.7			0.7	10.6	18.6	82.2	25.1	125.9	136.5
Commercial		0.1						0.4	0.5					0.5
Government		0.5						0.3	0.8					0.8
Other								0.1	0.1					0.1
Consumption by the Energy Sector and Losses (4)	0.7	1.0				0.2	0.1	0.3	2.5					2.3
TOTAL INTERNAL FINAL CONSUMPTION	7.9	15.6	1.7	2.2	22.0	0.6	0.7	7.6	58.3	18.6	82.2	25.1	125.9	184.2

- (1) Excluding quantities used in non-utility electricity generation.
- (2) Excluding quantities considered as transformed into blast furnace gas.
- (3) Including a very small quantity of power alcohol derived from molasses.
- (4) Mainly mines own consumption including miners' coal. Excludes losses in electricity sector and refineries which are accounted in coal replacement factor applied to final consumption.
- (5) Does not include brick burning.
- (6) Including brick burning and textiles.
- (7) Including copper and limestone burning only.

Note: Quantities less than 0.05 MtCR are not shown.
→ Value not yet broken down and included in these figures.

(***)

The factors used for oil products, dung and firewood are replacement ratios expressing the amount of coal needed to substitute their final use taking account of relative efficiencies involved in typical cases of substitution. The factors for coke and gas are purely technical conversion factors permitting the expression of final consumption of these fuels in terms of the primary input of coal actually needed. The replacement factor used for final electricity consumption permits its expression in terms of the amount of coal that would have been needed if no hydel or oil generation were available.

Million Tonnes of Coal Replacement of other Sources:

10 ⁹ kWh electricity (Twh)	1	1 Mt hard coke	1.13
1953/54 - 1960/61	1	1000 million m ³ manufactured gas.	0.83
1965/66 - 1980/81	0.7	1000 million m ³ blast furnace gas	0.18
1 Mt oil product	6.5	1 Mt dry dung	0.4
1 Mt soft coke	1.5	1 Mt firewood & waste products	0.95

TABLE 5-1A
OIL PRODUCTS - ALL INDIA - 1953/4
TOTAL INTERNAL FINAL ENERGY CONSUMPTION OF OIL PRODUCTS BROKEN DOWN BY SECTOR OF CONSUMPTION
(Million tonnes of coal replacement) 1/

	Total Oil Products 2/	Motor Spirit	Aviation & Fuel	HSDO	LDO	Kerosene	LPG	Fuel Oil	Vapourising Oil
TOTAL TRANSPORTATION	7.6	5.2	0.6	1.4	-	-	-	0.4	-
Of which: Road and tramways	6.5	5.2	-	1.3	-	-	-	-	-
Railroads	0.1	-	-	0.1	-	-	-	-	-
Waterways	0.4	-	-	-	-	-	-	0.4	-
Air	0.6	-	0.6	-	-	-	-	-	-
TOTAL INDUSTRY	5.4	-	-	0.5	1.3	0.1	-	3.5	-
Of which: Iron & Steel									
Fertilizer									
Heavy Chemical									
Structural Clay Products									
Cement									
Mining & Quarrying									
Non-ferrous									
Textiles									
Others									
TOTAL OTHER SECTORS	9.0	-	-	0.2	0.9	7.7	-	-	0.2
Of which: Agriculture	1.3	-	-	0.2	0.9	-	-	-	0.2
Domestic	7.7	-	-	-	-	7.7	-	-	-
Commercial									
Government									
Other									
TOTAL INTERNAL FINAL CONSUMPTION	22.0	5.2	0.6	2.1	2.2	7.8	-	3.9	0.2

1/ The factor used for oil products is 6.5 MtCR for 1 Mt oil products. The factor used is the replacement ratio expressing the amount of coal needed to substitute the final use, taking account of relative efficiencies involved in typical cases of substitution.

2/ Including a very small quantity of power alcohol derived from molasses.

Note: Quantities less than 0.05 MtCR are not shown.

→ Value not yet broken down and included in these figures.

TABLE 5-2
ALL INDIA 1954/5
TOTAL INTERNAL FINAL ENERGY CONSUMPTION BROKEN DOWN BY SECTOR OF CONSUMPTION AND SOURCE OF ENERGY
(Million Tonnes of Coal Replacement)***

	Coking Coal	Non-Coking Coal	Coke Excluding Soft Coke	Soft Coke	Total Oil Products (3)	Blast Furnace Gas	Coke Oven & Gas Work Gas	Electricity	Total Commercial Sources Energy	Dung (4)	Fire-wood	Waste Products	Total Non-Commercial Energy	Total Internal Final Consumption
Total Transportation of which	4.9	6.8			8.0			0.6	20.3					20.3
Road and Tramways					6.9			0.1	7.0					7.0
Railroads	4.9	6.5			0.1			0.5	12.0					12.0
Waterways		0.3			0.4				0.7					0.7
Air					0.6				0.6					0.6
Total Industry of which	1.8	6.9(1)	1.8		5.7(1)	0.5(1)	0.6	5.6	22.9					22.9
Iron & Steel	0.6		1.5(2)			0.5(1)	0.6	0.7						
Fertilizer			0.3					0.3						
Heavy Chemical								0.1						
Structural Clay Products		0.1(5)						0.1						
Cement		1.2						0.5						
Mining & Quarrying								0.1						
Non-Ferrous (7)								0.2						
Textiles								1.9						
Other	1.2	5.6(6)						1.8						
Total Other Sectors		0.8		2.4	9.7			1.9	14.8	19.1	83.3	25.6	128.0	142.8
Agriculture		0.2			1.4			0.2	1.8	19.1	83.3	25.6	128.0	1.8
Domestic				2.4	8.3			0.8	11.1					0.5
Commercial		0.1						0.4	0.5					0.9
Government		0.5						0.4	0.9					0.1
Other								0.1	0.1					
Consumption by the Energy Sector and Losses (4).	0.7	1.1				0.1	0.1	0.3	2.3	1.1	83.3	25.6	128.0	2.3
TOTAL INTERNAL FINAL CONSUMPTION	7.4	15.6	1.8	2.4	23.4	0.6	0.7	8.4	60.3					188.3

- (1) Excluding quantities used in non-utility electricity generation.
- (2) Excluding quantities considered as transformed into blast furnace gas.
- (3) Including a very small quantity of power alcohol derived from molasses.
- (4) Mainly mines own consumption including miners' coal. Excludes losses in electricity sector and refineries which are accounted in coal replacement factor applied to final consumption.
- (5) Does not include brick burning.
- (6) Includes brick burning and textiles.
- (7) Includes copper and limestone burning only.

Note: Quantities less than 0.05 MtCR are not shown.
→ Value not yet broken down and included in these figures.

(***)

The factors used for oil products, dung and firewood are replacement ratios expressing the amount of coal needed to substitute their final use taking account of relative efficiencies involved in typical cases of substitution. The factors for coke and gas are purely technical conversion factors permitting the expression of final consumption of these fuels in terms of the primary input of coal actually needed. The replacement factor used for final electricity consumption permits its expression in terms of the amount of coal that would have been needed if no hydel or oil generation were available.

Million Tonnes of Coal Replacement of other Sources:

10 ⁹ kWh electricity (TWh)		1 Mt hard coke	1.13
1953-54 - 1960-61	1	1000 million m ³ manufactured gas	0.83
1965-66 - 1980-81	0.7	1000 million m ³ blast furnace gas	0.18
1 Mt oil product	6.5	1 Mt dry dung	0.4
1 Mt soft coke	1.5	1 Mt firewood and waste products.	0.95

TABLE 5-2A
OIL PRODUCTS - ALL INDIA - 1954/5
TOTAL INTERNAL FINAL ENERGY CONSUMPTION OF OIL PRODUCTS
BROKEN DOWN BY SECTOR OF CONSUMPTION
(Million tonnes of coal replacement)1/

	Total oil Products 2/	Motor Spirit	Aviation & Jet Fuel	HSDD	LDO	Kerosene	LPG	Fuel Oil	Vapourising Oil
TOTAL TRANSPORTATION	8.0	5.3	0.6	1.7				0.4	
Of which: Road and Tramways	6.9	5.3		1.6					
Railroads	0.1			0.1				0.4	
Waterways	0.4		0.6						
Air	0.6								
TOTAL INDUSTRY	5.7			0.5	1.3	0.1		3.8	
Of which: Iron & Steel									
Fertilizer									
Heavy Chemical									
Structural Clay Products									
Cement									
Mining & Quarrying									
Non-ferrous									
Textiles				0.2	0.9	8.3			0.3
Others									
TOTAL OTHER SECTORS	9.7			0.2	0.9	8.3			0.3
Of which: Agriculture	1.4								
Domestic	8.3								
Commercial									
Government									
Other			0.6	2.4	2.2	8.4		4.2	0.3
TOTAL INTERNAL FINAL CONSUMPTION	23.4	5.3							

1/ The factor used for oil products is 6.5 MtCR for 1 Mt oil products. The factor used is the replacement ratio expressing the amount of coal needed to substitute the final use taking account of relative efficiencies involved in typical cases of substitution.
2/ Including a very small quantity of power alcohol derived from molasses.
Note: Quantities less than 0.05 MtCR are not shown.
→ Value not yet broken down and included in these figures.

TABLE 5-3
ALL INDIA 1955/6
TOTAL INTERNAL FINAL ENERGY CONSUMPTION BROKEN DOWN BY SECTOR OF CONSUMPTION AND SOURCE OF ENERGY

	Coking Coal	Non-Coking Coal	Coke Excluding Soft Coke	Soft Coke	Total Oil Products (3)	Blast Furnace Gas	Coke Oven & Gas Work Gas	Electricity	Total Commercial Sources of Energy	Firewood	Waste Products	Total Non-Commercial Energy	Total Internal Final Consumption
Total Transportation of which	5.2	7.1			8.8			0.7	21.8				21.8
Road and Tramways					7.5			0.1	7.6				7.6
Railroads	5.2	6.8			0.1			0.6	12.7				12.7
Waterways		0.3			0.4				0.7				0.7
Air					0.8				0.8				0.8
Total Industry of which	1.1	6.8(1)	2.0		6.2(1)	0.4(1)	0.5	6.3	23.3				23.3
Iron & Steel	0.5		1.8(2)			0.4(1)	0.5	0.8					
Fertilizer			0.2					0.3					
Heavy Chemical								0.1					
Structural Clay Products		0.1(5)											
Cement		1.3						0.5					
Mining & Quarrying								0.1					
Non-Ferrous (7)		0.1						0.2					
Textiles								2.2					
Other	0.6	5.3(6)						2.1					
Total Other Sectors		1.0		2.5	10.7			2.1	16.3	84.4	26.3	130.3	146.6
Agriculture		0.3			1.5			0.3	2.1				2.1
Domestic				2.5	9.2			0.8	12.5	84.4	26.3	130.3	142.8
Commercial		0.1						0.5	0.6				0.6
Government		0.6						0.4	1.0				1.0
Other								0.1	0.1				0.1
Consumption by the Energy Sector and Losses (4)	0.7	1.1				0.2	0.2	0.3	2.5				2.5
TOTAL INTERNAL FINAL CONSUMPTION	7.0	16.0	2.0	2.5	25.7	0.6	0.7	9.4	63.9	84.4	26.3	130.3	194.2

- (1) Excluding quantities used in non-utility electricity generation.
- (2) Excluding quantities considered as transformed into blast furnace gas.
- (3) Including a very small quantity of power alcohol derived from molasses.
- (4) Mainly mines own consumption including miners' coal. Excludes losses in electricity sector and refineries which are accounted in coal replacement factor applied to final consumption.
- (5) Does not include brick burning.
- (6) Includes brick burning and textiles.
- (7) Includes copper and limestone burning only.

Note: Quantities less than 0.05 MtCR not shown.

Value not yet broken down and included in these figures.

(***)

The factors used for oil products, dung and firewood are replacement ratios expressing the amount of coal needed to substitute their final use taking account of relative efficiencies involved in typical cases of substitution. The factors for coke and gas are purely technical conversion factors permitting the expression of final consumption of these fuels in terms of the primary input of coal actually needed. The replacement factor used for final electricity consumption permits its expression in terms of the amount of coal that would have been needed if no hydel or oil generation were available.

Million Tonnes of Coal Replacement of other Sources:

10 ⁹ kWh electricity (TWh)	1 Mt hard coke	1.13
1953/54 - 1960/61	1000 million m ³ manufactured gas	0.83
1965/66 - 1980-81.	1000 million m ³ blast furnace gas	0.18
1 Mt oil product	1 Mt dry dung	0.4
1 Mt soft coke	1 Mt firewood & waste products	0.95

TABLE 5-3A
OIL PRODUCTS - ALL INDIA - 1955/6
TOTAL INTERNAL FINAL ENERGY CONSUMPTION OF OIL PRODUCTS
BROKEN DOWN BY SECTOR OF CONSUMPTION
(Million tonnes of coal replacement) 1/

	Total Oil Products 2/	Motor Spirit	aviation & Jet Fuel	MSDO	LDO	Kerosene	LPG	Fuel Oil	Vapourising Oil
TOTAL TRANSPORTATION	8.8	5.5	0.8	2.1				0.4	
Of which: Road and Tramways	7.5	5.5		2.0					
Railroads	0.1			0.1				0.4	
Waterways	0.4								
Air	0.8		0.8						
TOTAL INDUSTRY	6.2			0.6	1.4	0.1		4.1	
Of which: Iron & Steel									
Fertilizer									
Heavy Chemical									
Structural Clay Products									
Cement									
Mining & Quarrying									
Non-Ferrous									
Textiles									
Others									
TOTAL OTHER SECTORS	10.7			0.2	1.0	9.2			0.3
Of which: Agriculture	1.5			0.2	1.0				0.3
Domestic	9.2					9.2			
Commercial									
Government									
Other									
TOTAL INTERNAL FINAL CONSUMPTION	25.7	5.5	0.8	2.9	2.4	9.3		4.5	0.3

1/ The factor used for oil products is 6.5 MtCR for 1 Mt oil products. The factor used is the replacement ratio expressing the amount of coal needed to substitute the final use, taking account of relative efficiencies involved in typical cases of substitution.

2/ Including a very small quantity of power alcohol derived from molasses.
Note: Quantities less than 0.05 MtCR are not shown.

Value not yet broken down and included in these figures.

TABLE 5-4
ALL INDIA - 1956/7
TOTAL INTERNAL FINAL ENERGY CONSUMPTION BROKEN DOWN BY SECTOR OF CONSUMPTION AND SOURCE OF ENERGY
(Million Tonnes of Coal Replacement)***

	Coking Coal	Non-Coking	Coke Excluding Soft Coke	Soft Coke	Total Oil Products (3)	Blast Furnace Gas	Coke Oven & Gas Work Gas	Electricity	Total Commercial Sources of Energy	Dung (dry)	Fire-wood	Waste Products	Total Non-Commercial Energy	Total Internal Final Consumption
Total Transportation of which	5.7	8.0			9.8			0.7	24.2					
Road and Tramways					8.2			0.1	8.3					24.2
Railroads	5.7	7.7			0.3			0.6	14.3					8.3
Waterways		0.3			0.4				0.7					14.3
Air					0.9				0.9					0.7
Total Industry of which	1.4	6.7(1)	1.9		6.6(1)	0.4(1)	0.5	6.9	24.4					0.9
Iron & Steel	0.6		1.7(2)			0.4(1)	0.5	0.8						24.4
Fertilizer			0.2					0.3						
Heavy Chemical		0.3						0.2						
Structural Clay Products		1.6(5)						0.6						
Cement		1.4						0.1						
Mining & Quarrying								0.2						
Non-Ferrous (Copper only)								2.4						
Textiles		1.8						2.3						
Others	0.8	1.6						2.2						
Total Other Sectors		1.0		2.9	11.6			2.2	17.7					
Agriculture		0.3			1.7			0.3	2.3					
Domestic				2.9	9.9			0.9	13.7	0.1	85.6	27.0	132.7	150.4
Commercial		0.1						0.5	0.8					2.3
Government		0.6						0.4	1.0	0.1	85.6	27.0	132.7	148.4
Other								0.1	0.1					0.6
Consumption by the Energy Sector and Losses (4)	0.7	1.2				0.2	0.1	0.4	2.6					1.0
TOTAL INTERNAL FINAL CONSUMPTION	7.8	16.9	1.9	2.9	28.0	0.6	0.6	10.2	68.9	0.1	85.6	27.0	132.7	201.6

(1) Excluding quantities used in non-utility electricity generation.
(2) Excluding quantities considered as transformed into blast furnace gas.
(3) Including a very small quantity of power alcohol derived from molasses.
(4) Mainly mines own consumption including miners' coal. Excludes losses in electricity sector and refineries which are accounted in coal replacement factor applied to final consumption.
(5) Includes 1.49 million tonnes for brick burning.
Note: Quantities less than 0.05 MtCR not shown.
Value not yet broken down and included in these figures.

(***)

The factors used for oil products, dung and firewood are replacement ratios expressing the amount of coal needed to substitute their final use taking account of relative efficiencies involved in typical cases of substitution. The factors for coke and gas are purely technical conversion factors permitting the expression of final consumption of these fuels in terms of the primary input of coal actually needed. The replacement factor used for final electricity consumption permits expression in terms of the amount of coal that would have been needed if no hydel or oil generation were available.

Million Tonnes of Coal Replacement of other Sources:		
10 ⁹ kWh electricity (TWh)		
1953/54 - 1960/61	1	1 Mt hard coke 1.13
1965/66 - 1980/81	1	1000 million m ³ manufactured gas. 0.83
1 Mt oil product	0.7	1000 million m ³ Blast furnace gas 0.18
1 Mt soft coke	6.5	1 Mt dry dung 0.4
	1.5	1 Mt firewood and waste products. 0.95

TABLE 5-4A
OIL PRODUCTS - ALL INDIA - 1956/7
TOTAL INTERNAL FINAL ENERGY CONSUMPTION OF OIL PRODUCTS
BROKEN DOWN BY SECTOR OF CONSUMPTION
(Million tonnes of coal replacement) 1/

	Total Oil Products 2/		Motor Spirit						
	Total Oil Products 2/	Motor Spirit	Gasoline & Jet Fuel	HSDO	LDO	Kerosene	LPG	Fuel Oil	Vapourising Oil
TOTAL TRANSPORTATION	9.8	5.6							
Of which: Road and Tramways	8.2	5.6	0.8	2.8				0.5	
Railroads	0.3			2.6					
Waterways	0.4			0.2				0.1	
Air	0.9							0.4	
TOTAL INDUSTRY	6.6		0.9						
Of which: Iron & Steel				0.7	1.4	0.1		4.4	
Fertilizer									
Heavy Chemical									
Structural Clay Products									
Cement									
Mining & Quarrying									
Non-Ferrous									
Textiles									
Others									
TOTAL OTHER SECTORS	11.6								
Of which: Agriculture	1.7			0.4	1.0	9.9			0.3
Domestic	9.9			0.4	1.0	9.9			0.3
Commercial									
Government									
Other									
TOTAL INTERNAL FINAL CONSUMPTION	28.0	5.6	0.9	3.9	2.4	10.0		4.9	0.3

1/ The factor used for oil products is 6.5 MtCR for 1 Mt oil products. The factor used is the replacement ratio expressing the amount of coal needed to substitute the final use, taking account of relative efficiencies involved in typical cases of substitution.
2/ Including a very small quantity of power alcohol derived from molasses.

Note: Quantities less than 0.05 MtCR are not shown.
Value not yet broken down and included in these figures.

TABLE 5-5
ALL INDIA 1957/8
TOTAL INTERNAL FINAL ENERGY CONSUMPTION BROKEN DOWN BY SECTOR OF CONSUMPTION AND SOURCE OF ENERGY
(Million tonnes of Coal Replacement)***

	Coking Coal	Non-Coking Coal	Coke Excluding Soft Coke	Soft Coke	Total Oil Products (3)	Blast Furnace Gas	Coke Oven & Gas Work Gas	Electricity	Total Commercial Sources of Energy	Dung (Dry)	Fire-wood	Waste Products	Total Non-Commercial Energy	Total Internal Final Consumption
Total Transportation of which	5.7	9.0			10.8			0.8	26.3					26.3
Road and Tramways					8.9			0.1	9.0					9.0
Railroads	5.7	8.7			0.3			0.7	15.4					15.4
Waterways		0.3			0.5				0.8					0.8
Air					1.1				1.1					1.1
Total Industry of which	1.7	9.2(1)	1.9		7.2(1)	0.4(1)	0.6	7.7	28.7					28.7
Iron & Steel	0.7		1.7(2)			0.4(1)	0.6	0.9						
Fertilizer			0.2					0.3						
Heavy Chemical		0.4						0.2						
Structural Clay Products		1.5												
Cement		1.7(5)						0.6						
Mining & Quarrying								0.1						
Non-Ferrous (Copper only)								0.3						
Textiles		1.8						2.4						
Others	1.0	3.8						2.9						
Total Other Sectors		0.8		2.8	12.3			2.9	18.8	20.6	86.9	27.7	135.2	154.0
Agriculture		0.3			1.9			0.6	2.8					2.8
Domestic				2.8	10.4			1.1	14.3	20.6	86.9	27.7	135.2	149.5
Commercial		0.1						0.6	0.7					0.7
Government		0.4						0.5	0.9					0.9
Other								0.1	0.1					0.1
Consumption by the Energy Sector and Losses (4)	0.8	1.3				0.2	0.2	0.4	2.9					2.9
TOTAL INTERNAL FINAL CONSUMPTION	8.2	20.3	1.9	2.8	30.3	0.6	0.8	11.8	76.7	20.6	86.9	27.7	135.2	211.9

- (1) Excluding quantities used in non-utility electricity generation.
(2) Excluding quantities considered as transformed into blast furnace gas.
(3) Including a very small quantity of power alcohol derived from molasses.
(4) Mainly mines own consumption including miners' coal. Excluding losses in electricity sector and refineries which are accounted in coal replacement factor applied to final consumption.
(5) Includes 1.44 million tonnes for brick burning.

Note: Quantities less than 0.05 MtCR not shown.
→ Value not yet broken down and included in these figures.

(***)

The factors used for oil products, dung and firewood are replacement ratios expressing the amount of coal needed to substitute their final use taking account of relative efficiencies involved in typical cases of substitution. The factors for coke and gas are purely technical conversion factors permitting the expression of final consumption of those fuels in terms of the primary input of coal actually needed. The replacement factor used for final electricity consumption permits expression in terms of the amount of coal that would have been needed if no hydel or oil generation were available.

Million Tonnes of Coal Replacement of other Sources:

10 ⁹ kWh electricity (TWh)	1 Mt hard coke	1.13
1953/54 - 1960/61	1000 million m ³ manufactured gas	0.83
1965/66 - 1980/81	1000 million m ³ blast furnace gas	0.18
1 Mt oil product	1 Mt dry dung	0.4
1 Mt soft coke	1 Mt firewood and waste products	0.95

TABLE 5-5A
OIL PRODUCTS - ALL INDIA - 1957/8
TOTAL INTERNAL FINAL ENERGY CONSUMPTION OF OIL PRODUCTS
BROKEN DOWN BY SECTOR OF CONSUMPTION
(Million Tonnes of coal replacement) 1/

	Total Oil Products 2/	Motor Spirit	Aviation & Jet Fuel	MSDO	LDO	Kerosene	LPG	Fuel Oil	Vapourising Oil
TOTAL TRANSPORTATION	10.8	5.5	1.1	3.6	0.1	-	-	0.5	
Of which: Road & Tramways	8.9	5.5		3.4					
Railroads	0.3			0.2				0.1	
Waterways	0.5				0.1			0.4	
Air	1.1		1.1						
TOTAL INDUSTRY	7.2			0.8	1.5	0.1		4.8	
Of which: Iron & Steel									
Fertilizer									
Heavy Chemical									
Structural Clay Products									
Cement									
Mining & Quarrying									
Non-Ferrous									
Textiles									
Others									
TOTAL OTHER SECTORS	12.3			0.6	1.0	10.4			0.3
Of which: Agriculture	1.9			0.6	1.0	10.4			0.3
Domestic	10.4								
Commercial									
Government									
Other									
TOTAL INTERNAL FINAL CONSUMPTION	30.3	5.5	1.1	5.0	2.6	10.5		5.3	0.3

1/ The factor used for oil products is 6.5 MtCR for 1 Mt oil products. The factor used is the replacement ratio expressing the amount of coal needed to substitute the final use, taking account of relative efficiencies involved in typical cases of substitution.

2/ Including a very small quantity of power alcohol derived from molasses.

Note: Quantities less than 0.05 MtCR are not shown.

→ Value not yet broken down and included in these figures.

TABLE 5-6
ALL INDIA 1958/9
TOTAL INTERNAL FINAL ENERGY CONSUMPTION BROKEN DOWN BY SECTOR OF CONSUMPTION AND SOURCE OF ENERGY
(Million Tonnes of Coal Replacement)**

	Coking Coal	Non-Coking Coal	Coke Excluding Soft Coke	Soft Coke	Total Oil Products (3)	Blast Furnace Gas	Coke Oven & Gas Work Gas	Electricity	Total Commercial Sources of Energy	Dung (Dry)	Fire-wood	Waste Products	Total Non-Commercial Energy	Total Internal Final Consumption
Total Transportation of which	4.6	10.2			11.7			0.8	27.3	-	-	-	-	27.3
Road and Tramways	-	-			9.5			-	9.5	-	-	-	-	9.5
Railroads	4.6	9.8			0.4			0.8	15.6	-	-	-	-	15.6
Waterways		0.4			0.5				0.9	-	-	-	-	0.9
Air					1.3				1.3	-	-	-	-	1.3
Total Industry of which	1.8	9.1(1)	2.7		8.1(1)	0.5(1)	0.7	8.8	31.7	-	-	-	-	31.7
Iron & Steel	0.9		2.5(2)			0.5(1)	0.7	1.0						
Fertilizer			0.2					0.4						
Heavy Chemical		0.4						0.2						
Structural Clay Products		2.0(5)												
Cement		1.7						0.8						
Mining and Quarrying								0.1						
Non-Ferrous (Copper only)								0.3						
Textiles		1.8						2.6						
Others	0.9	3.2						3.4						
Total Other Sectors		1.0		3.1	12.7			3.2	20.0	21.1	88.3	28.4	137.8	157.8
Agriculture		0.4			2.0			0.6	3.0					3.0
Domestic				3.1	10.7			1.2	15.0	21.1	88.3	28.4	137.8	152.8
Commercial		0.1						0.7	0.8					0.8
Government		0.5						0.5	1.0					1.0
Other								0.2	0.2					0.2
Consumption by the Energy Sector and Losses. (4)	0.7	1.3				0.2	0.2	0.4	2.8					2.8
TOTAL INTERNAL FINAL CONSUMPTION	7.1	21.6	2.7	3.1	32.5	0.7	0.9	13.2	81.8	21.1	88.3	28.4	137.8	219.6

(1) Excluding quantities used in non-utility electricity generation.
(2) Excluding quantities considered as transformed into blast furnace gas.
(3) Including a very small quantity of power alcohol derived from molasses.
(4) Mainly mines own consumption including miners' coal. Excludes losses in electricity sector and refineries which are accounted in coal replacement factor applied to final consumption.
(5) Includes 1.87 million tonnes for brick burning
Note: Quantities less than 0.05 MtCR are not shown.
Value not yet broken down and included in these figures.

(...)

The factors used for oil products, dung and firewood are replacement ratios expressing the amount of coal needed to substitute their final use taking account of relative efficiencies involved in typical cases of substitution. The factors for coke and gas are purely technical conversion factors permitting the expression of final consumption of these fuels in terms of the primary input of coal actually needed. The replacement factor used for final electricity consumption permits its expression in terms of the amount of coal that would have been needed if no hydel or oil generation were available.

Million Tonnes of Coal Replacement of other Sources:

10 ⁹ kWh electricity (TWh)	1 Mt hard coke	1.13
1953/54 - 1960/61	1000 million m ³ manufactured gas	0.83
1965/66 - 1980/81	1000 million m ³ blast furnace gas.	0.18
1 Mt oil product	1 Mt dry dung	0.4
1 Mt soft coke	1 Mt firewood and waste products.	-0.85

TABLE 5-6A
OIL PRODUCTS - ALL INDIA - 1958/9
TOTAL INTERNAL FINAL ENERGY CONSUMPTION OF OIL PRODUCTS
BROKEN DOWN BY SECTOR OF CONSUMPTION
(Million Tonnes of Coal replacement) 1/

	Total Oil Products 2/	Motor Spirit	Aviation & Jet Fuel	HSDO	LDO	Kerosene	LPG	Fuel Oil	Vapourising Oil
TOTAL TRANSPORTATION	11.7	5.2	1.3	4.7	0.1	-	-	0.4	
Of which: Road and Tramways	9.5	5.2		4.3					
Railroads	0.4			0.3				0.1	
Waterways	0.5			0.1	0.1			0.3	
Air	1.3		1.3						
TOTAL INDUSTRY	8.1	0.1		0.9	1.5	0.1		5.5	
Of which: Iron & Steel									
Fertilizer									
Heavy Chemical									
Structural Clay Products									
Cement									
Mining & Quarrying									
Non-Ferrous									
Textiles									
Others									
TOTAL OTHER SECTORS	12.7			0.8	1.0	10.7			0.4
Of which: Agriculture	2.0			0.8	1.0	10.7			0.4
Domestic	10.7								
Commercial									
Government									
Other									
TOTAL INTERNAL FINAL CONSUMPTION	32.5	5.3	1.3	6.2	2.6	10.8	-	5.9	0.4

1/ The factor used for oil products is 6.5 MtCR for 1 Mt oil products. The factor used is the replacement ratio expressing the amount of coal needed to substitute the final use, taking account of relative efficiencies involved in typical cases of substitution.

2/ Including a very small quantity of power alcohol derived from molasses.
Note: Quantities less than 0.05 MtCR are not shown.

Value not yet broken down and included in these figures

TABLE 5-7
ALL INDIA 1959/60
TOTAL INTERNAL FINAL ENERGY CONSUMPTION BROKEN DOWN BY SECTOR OF CONSUMPTION AND SOURCE OF ENERGY
(Million Tonnes of Coal Replacement)***

	Coking Coal	Non-Coking Coal	Coke Excluding soft Coke	Soft Coke	Total Oil Products (3)	Blast Furnace Gas	Coke Oven & Gas Work	Electricity	Total Commercial Sources of Energy	Dung (Dry)	Firewood	Waste Products	Total Non-Commercial Energy	Total Internal Final Consumption
Total Transportation of which	3.9	11.3			12.7			0.9	28.8	-	-	-	-	28.8
Road and Tramways					10.2			0.1	10.3					10.3
Railroads	3.9	11.0			0.4			0.8	16.1					16.1
Waterways		0.3			0.6				0.9					0.9
Air					1.5				1.5					1.5
Total Industry of which	0.6	8.1(1)	3.3		8.8(1)	0.7(1)	0.9	10.3	32.7	-	-	-	-	32.7
Iron and Steel	0.4	-	3.1(2)			0.7(1)	0.9	1.4						
Fertilizer			0.2					0.4						
Heavy Chemical		0.3						0.3						
Structural Clay Products		1.8(5)												
Cement		1.8						0.9						
Mining & Quarrying		-						0.1						
Non-Ferrous (Copper only)		0.1						0.5						
Textiles		1.7						2.8						
Others	0.2	2.4						3.9						
Total Other Sectors		1.0	-	3.0	14.2			3.7	21.9	21.3	91.7	28.7	141.7	183.8
Agriculture		0.3			2.0			0.7	3.0					3.0
Domestic		-		3.0	12.2			1.4	16.6	21.3	91.7	28.7	141.7	158.3
Commercial		0.1						0.8	0.9					0.9
Government		0.6						1.2	1.2					1.2
Other								0.2	0.2					0.2
Consumption by the Energy Sector and Losses (4)	0.7	1.6				0.4	0.2	0.5	3.4					3.4
TOTAL INTERNAL FINAL CONSUMPTION	5.2	22.0	3.3	3.0	35.7	1.1	1.1	15.4	86.8	21.3	91.7	28.7	141.7	228.5

- (1) Excluding quantities used in non-utility electricity generation.
 (2) Excluding quantities considered as transformed into blast furnace gas.
 (3) Including a very small quantity of power alcohol derived from molasses.
 (4) Mainly mines own consumption including miners' coal. Excludes losses in electricity sector and refineries which are accounted in coal replacement factor applied to final consumption.
 (5) Includes 1.75 million tonnes for brick burning.
 Note: Quantities less than 0.05 MtCR are not shown.
 Value not yet broken down and included in these figures.

(***)

The factors used for oil products, dung and firewood are replacement ratios expressing the amount of coal needed to substitute their final use taking account of relative efficiencies involved in typical cases of substitution. The factors for coke and gas are purely technical conversion factors permitting the expression of final consumption of these fuels in terms of the primary input of coal actually needed. The replacement factor used for final electricity consumption permits its expression in terms of the amount of coal that would have been needed if no hydel or oil generation were available.

Million Tonnes of Coal Replacement of other Sources:

10 ⁹ kWh electricity (TWh)		1 Mt Hard coke	1.13
1953/54 - 1960/61	1	1000 million m ³ manufactured gas.	0.83
1965/66 - 1980/81	0.7	1000 million m ³ blast furnace gas.	0.18
1 Mt oil product	6.5	1 Mt Dry Dung	0.4
1 Mt soft coke	1.5	1 Mt Firewood & Waste Products	0.95

TABLE 5-7A
OIL PRODUCTS - ALL INDIA - 1959/60
TOTAL INTERNAL FINAL ENERGY CONSUMPTION OF OIL PRODUCTS
BROKEN DOWN BY SECTOR OF CONSUMPTION
(Million Tonnes of Coal Replacement) 1/

	Total Oil Products 2/	Motor Spirit	Aviation & Jet Fuel	HSDO	LDO	Kerosene	LPG	Fuel Oil	Vapourising Oil
TOTAL TRANSPORTATION	12.7	5.2	1.5	5.4	0.1	-	-	0.5	
Of which: Road and Tramways	10.2	5.2		5.0				0.1	
Railroads	0.4			0.3				0.4	
Waterways	0.6			0.1	0.1				
Air	1.5		1.5						
TOTAL INDUSTRY	8.8			1.0	1.8	0.1		5.9	
Of which: Iron & Steel									
Fertilizer									
Heavy Chemical									
Structural Clay Products									
Cement									
Mining & Quarrying									
Non-Ferrous									
Textiles									
Others									0.2
TOTAL OTHER SECTORS	14.2			0.7	1.1	12.1	0.1		0.2
Of which: Agriculture	2.0			0.7	1.1	12.1	0.1		
Domestic	12.2								
Commercial									
Government									
Other									
TOTAL INTERNAL FINAL CONSUMPTION	35.7	5.2	1.5	7.1	3.0	12.2	0.1	6.4	0.2

- 1/ The factor used for oil products is 6.5 MtCR for 1 Mt oil products. The factor used is the replacement ratio expressing the amount of coal needed to substitute the final use, taking account of relative efficiencies involved in typical cases of substitution.
 2/ Including a very small quantity of power alcohol derived from molasses.

Note: Quantities less than 0.05 MtCR are not shown.
 Value not yet broken down and included in these figures.

TABLE 5-8
ALL INDIA 1960/1
TOTAL INTERNAL FINAL ENERGY CONSUMPTION BROKEN DOWN BY SECTOR OF CONSUMPTION AND SOURCE OF ENERGY
(Million Tonnes of Coal Replacement)***

	Coking Coal	Non-Coking Coal	Coke Excluding Soft Coke	Soft Coke	Total Oil Products (3)	Blast Furnace Gas	Coke Oven & Gas Work Gas	Electricity	Total Commercial Sources of Energy	Dung (Dry)	Firewood	Waste Products	Total Non-Commercial Energy	Total Internal Final Consumption
Total Transportation of which	1.3	14.7	-	-	14.2	-	-	0.8	31.0	-	-	-	-	31.0
Road and Tramways	-	-	-	-	11.3	-	-	-	11.3	-	-	-	-	11.3
Railroads	1.3	14.2	-	-	0.5	-	-	0.8	16.8	-	-	-	-	16.8
Waterways	-	0.5	-	-	0.6	-	-	-	1.1	-	-	-	-	1.1
Air	-	-	-	-	1.8	-	-	-	1.8	-	-	-	-	1.8
Total Industry of which	2.1	8.6(1)	3.9	-	9.9(1)	1.1(1)	1.3	11.8	38.5	-	-	-	-	38.5
Iron & Steel	1.3	-	3.6(2)	-	0.4	1.1(1)	1.3	1.8	9.5	-	-	-	-	9.5
Fertilizer	(-)	-	0.3	-	-	-	-	0.5	0.8	-	-	-	-	0.8
Heavy Chemical	(-)	0.3	-	-	0.5	-	-	0.4	1.2	-	-	-	-	1.2
Structural Clay Products	-	1.1(5)	-	-	0.3	-	-	-	1.4	-	-	-	-	1.4
Cement	-	2.3	-	-	0.2	-	-	0.9	3.4	-	-	-	-	3.4
Mining & Quarrying	-	-	-	-	0.1	-	-	0.1	0.2	-	-	-	-	0.2
Non-Ferrous (Copper only)	-	-	-	-	-	-	-	0.5	0.5	-	-	-	-	0.5
Textiles	-	1.8	-	-	2.9	-	-	2.9	7.6	-	-	-	-	7.6
Others	0.8	3.1	-	-	5.5(6)	-	-	4.5	13.9	-	-	-	-	13.9
Total Other Sectors of which	-	0.9	-	2.8	15.0	-	-	4.0	22.7	21.6	95.3	29.2	146.1	168.8
Agriculture	-	0.2	-	-	2.1	-	-	0.8	3.1	-	-	-	-	3.1
Domestic	-	-	-	2.8	12.9	-	-	1.5	17.2	21.6	95.3	29.2	146.1	163.3
Commercial	-	0.1	-	-	-	-	-	0.9	1.0	-	-	-	-	1.0
Government	-	0.6	-	-	-	-	-	0.6	1.2	-	-	-	-	1.2
Other	-	-	-	-	-	-	-	0.2	0.2	-	-	-	-	0.2
Consumption by the Energy Sector and Losses (4).	0.8	1.8	-	-	-	0.7	0.4	0.5	4.2	-	-	-	-	4.2
TOTAL INTERNAL FINAL CONSUMPTION	4.2	26.0	3.9	2.8	39.1	1.8	1.7	16.9	96.4	21.6	95.3	29.2	146.1	242.5

- (1) Excluding quantities used in non-utility electricity generation.
(2) Excluding quantities considered as transformed into blast furnace gas.
(3) Including a very small quantity of power alcohol derived from molasses.
(4) Mainly mines' own consumption including miners' coal. Excludes losses in electricity sector and refineries which are accounted for in the coal replacement factor applied to final consumption.
(5) Includes 0.96 million tonnes for brick burning.
Note: Quantities less than 0.05 MtCR are not shown.

(6) Probably includes a small quantity corresponding to 0.02 million tonnes of LDO consumed by auto producers for electricity generation (c.f. Table 4-31, Footnote 13 and Table 4-13, Footnote 4)

(***)

The factors used for oil products, dung and firewood are replacement ratios expressing the amount of coal needed to substitute their final use taking account of relative efficiencies involved in typical cases of substitution. The factors for coke and gas are purely technical conversion factors permitting the expression of final consumption of these fuels in terms of the primary input of coal actually needed. The replacement factor used for final electricity consumption permits its expression in terms of the amount of coal that would have been needed if no hydel or oil generation were available.

Million Tonnes of Coal Replacement of other sources:

10 ⁹ kWh electricity (TWh)	1 Mt hard coke	1.13
1953/54 - 1960/81	1000 million m ³ manufactured gas	0.83
1965/66 - 1980/81	1000 million m ³ blast furnace gas	0.18
1 Mt oil product	1 Mt dry dung	0.4
1 Mt soft coke	1 Mt firewood and waste products.	0.95

TABLE 5-8A
OIL PRODUCTS - ALL INDIA - 1960/1
TOTAL INTERNAL FINAL ENERGY CONSUMPTION OF OIL PRODUCTS
BROKEN DOWN BY SECTOR OF CONSUMPTION
(Million Tonnes of Coal replacement)1/

	Total Oil Products 2/	Motor Spirit	Aviation & Jet Fuel	MSDO	LDO	Kerosene	LPG	Fuel Oil	Vapourising Oil
TOTAL TRANSPORTATION	14.2	5.5	1.8	6.3	0.1	-	-	0.5	-
Of which: Road & Tramways	11.3	5.5	-	5.8	-	-	-	-	-
Railroads	0.5	-	-	0.4	-	-	-	0.1	-
Waterways	0.6	-	-	0.1	0.1	-	-	0.4	-
Air	1.8	-	1.8	-	-	-	-	-	-
TOTAL INDUSTRY	9.9	-	-	1.2	1.9	0.1	-	6.7	-
Of which: Iron & Steel	0.4	-	-	-	-	-	-	0.4	-
Fertilizer	-	-	-	-	-	-	-	0.5	-
Heavy Chemical	0.5	-	-	0.1	-	-	-	0.2	-
Structural Clay Products	0.3	-	-	0.1	-	-	-	0.1	-
Cement	0.2	-	-	-	0.1	-	-	-	-
Mining & Quarrying	0.1	-	-	-	0.1	-	-	-	-
Non-Ferrous	-	-	-	0.2	0.5	-	-	2.2	-
Textiles	2.9	-	-	0.8	1.3	0.1	-	3.3	-
Others	5.5	-	-	0.7	1.3	12.8	0.1	-	0.1
TOTAL OTHER SECTORS	15.0	-	-	0.7	1.3	12.8	0.1	-	0.1
Of which: Agriculture	2.1	-	-	-	-	12.8	0.1	-	-
Domestic	12.9	-	-	-	-	-	-	-	-
Commercial	-	-	-	-	-	-	-	-	-
Government	-	-	-	-	-	-	-	-	-
Other	-	-	-	-	-	-	-	-	-
TOTAL INTERNAL FINAL CONSUMPTION	39.1	5.5	1.8	8.2	3.3	12.9	0.1	7.2	0.1

1/ The factor used for oil products is 6.5 MtCR for 1 Mt oil products. The factor used is the replacement ratio expressing the amount of coal needed to substitute the final use, taking account of relative efficiencies involved in typical cases of substitution.

2/ Including a very small quantity of power alcohol derived from molasses.

Note: Quantities less than 0.05 MtCR are not shown.

TABLE 5-9
ALL INDIA 1961/2
TOTAL INTERNAL FINAL ENERGY CONSUMPTION BROKEN DOWN BY SECTOR OF CONSUMPTION AND SOURCE OF ENERGY
(Million Tonnes of Coal Replacement)***

	Coking Coal	Non-Coking Coal	Metal-lurgical Coke	Soft Coke	Total Oil Products (3)	Blast Furnace Gas	Coke Oven & Gas Works Gas	Electricity	Total Commercial Sources of Energy	Dung (Dry)	Fire-wood	Waste Products	Total Non-commercial Energy	Total Internal Final Consumption
Total Transportation of which	1.4	15.3	-	-	15.9	-	-	0.9	33.5	-	-	-	-	33.5
Road and Tramways	-	-	-	-	12.5	-	-	0.1	12.6	-	-	-	-	12.6
Railroads	1.4	15.0	-	-	0.5	-	-	0.8	17.7	-	-	-	-	17.7
Waterways	-	0.3	-	-	0.8	-	-	-	1.1	-	-	-	-	1.1
Air	-	-	-	-	2.1	-	-	-	2.1	-	-	-	-	2.1
Total Industry of which	1.6	9.8 ⁽¹⁾	5.5	-	10.8	1.3 ⁽¹⁾	1.4	14.0	44.4	-	-	-	-	44.4
Iron and Steel	1.2	0.1	5.2 ⁽²⁾	-	0.6	1.3 ⁽¹⁾	1.4	2.4	12.2	-	-	-	-	12.2
Fertilizer	-	-	0.3	-	-	-	-	1.3	1.6	-	-	-	-	1.6
Heavy Chemical	-	-	-	-	0.5	-	-	0.6	1.1	-	-	-	-	1.1
Structural Clay Products	-	1.5 ⁽⁴⁾	-	-	0.3	-	-	-	1.8	-	-	-	-	1.8
Cement	-	2.5	-	-	0.3	-	-	1.0	3.8	-	-	-	-	3.8
Mining & Quarrying	-	-	-	-	0.1	-	-	0.1	0.2	-	-	-	-	0.2
Non-Ferrous (Copper only)	-	-	-	-	-	-	-	0.5	0.5	-	-	-	-	0.5
Textiles	-	2.1	-	-	3.2	-	-	2.9	8.2	-	-	-	-	8.2
Others	0.4	3.6	-	-	5.8	-	-	5.2	15.0	-	-	-	-	15.0
Total Other Sectors of which	-	0.4	-	2.8	16.7	-	0.1	4.3	24.3	21.8	95.8	29.4	147.0	171.3
Agriculture	-	-	-	-	2.2	-	-	1.0	3.2	-	-	-	-	3.2
Domestic	-	-	-	2.8	14.5	-	0.1	1.7	19.1	21.8	95.8	29.4	147.0	168.1
Commercial	-	0.1	-	-	-	-	-	0.9	1.0	-	-	-	-	1.0
Government	-	0.3	-	-	-	-	-	0.7	1.0	-	-	-	-	1.0
Consumption by the Energy Sector & Losses (5)	0.9	2.1	-	-	-	0.8	0.6	0.5	4.9	-	-	-	-	4.9
TOTAL INTERNAL FINAL CONSUMPTION	3.9	27.8	5.5	2.8	43.4	2.1	2.1	19.7	107.1	21.8	95.8	29.4	147.0	254.1

- (1) Excluding quantities used in non-utility generation.
(2) Excluding quantities considered as transformed into blast furnace gas.
(3) Including a very small quantity of power-alcohol derived from molasses.
(4) Includes 1.4 million tonnes used for brick-burning.
(5) Mainly mines own consumption including miners' coal. Excludes losses in electricity sector and refineries, which are accounted in coal replacement factor applied to final consumption.

Note: Quantities less than 0.05 MtCR are not shown.
- Negligible or less than half the final digit shown.

(***)

The factors used for oil products, dung and firewood are replacement ratios expressing the amount of coal needed to substitute their final use taking account of relative efficiencies involved in typical cases of substitution. The factors for coke and gas are purely technical conversion factors permitting the expression of final consumption of these fuels in terms of the primary input of coal actually needed. The replacement factor used for final electricity consumption permits its expression in terms of the amount of coal that would have been needed if no hydel or oil generation were available.

Million Tonnes of Coal Replacement

10 ⁹ kWh electricity (TWh)	1	1000 million m ³ manufactured gas	0.83
1 Mt Oil Product	6.5	1000 million m ³ blast furnace gas	0.18
1 Mt Mt Hard Coke	1.13	1 Mt dry dung	0.4
1 Mt Soft Coke	1.5	1 Mt firewood & waste products	0.95

TABLE 5-9A
OIL PRODUCT - ALL INDIA - 1961/2
TOTAL INTERNAL FINAL CONSUMPTION OF OIL PRODUCTS
BROKEN DOWN BY SECTOR OF CONSUMPTION
(Million Tonnes of Coal Replacement) 1/

	Total Oil Product 2/	Motor Spirit	Aviation & Jet Fuel	HSOO	LDO	Kerosene	LPG	Fuel Oil	Vapourising Oil & Refinery Gas
Transportation of which	15.93	5.78	2.08	7.28	0.06	-	-	0.73	-
Road & Tramways	12.54	5.78	-	6.76	-	-	-	-	-
Railroads	0.52	-	-	0.47	-	-	-	0.05	-
Waterways	0.79	-	-	0.05	0.06	-	-	0.68	-
Air	2.08	-	2.08	-	-	-	-	-	-
Industry of which	10.82	-	-	1.30	1.97	0.14	-	7.41	-
Iron & Steel	0.52	-	-	-	-	-	-	0.52	-
Fertiliser	-	-	-	-	-	-	-	-	-
Heavy Chemical	0.52	-	-	-	-	-	-	0.52	-
Structural Clay Products	0.33	-	-	0.06	0.07	-	-	0.20	-
Cement	0.33	-	-	0.06	0.07	-	-	0.20	-
Mining & Quarrying	0.14	-	-	0.07	0.07	-	-	-	-
Non-Ferrous	-	-	-	-	-	-	-	-	-
Textiles	3.18	-	-	0.26	0.39	-	-	2.53	-
Other	5.80	-	-	0.85	1.37	0.14	-	3.44	-
Other Sectors of which	18.61	-	-	0.85	1.25	14.32	0.08	-	0.11
Agriculture	2.21	-	-	0.85	1.25	-	-	-	0.11
Domestic	14.37	-	-	-	-	14.32	0.05	-	-
Commercial	0.03	-	-	-	-	-	0.03	-	-
TOTAL INTERNAL FINAL CONSUMPTION	43.36	5.78	2.08	9.43	3.28	14.46	0.08	8.14	0.11

1/ The factor used for oil products is 6.5 MtCR for 1 Mt oil products. The factor used is the replacement ratio expressing the amount of coal needed to substitute the final use, taking account of relative efficiencies involved in typical cases of substitution.

2/ Including a very small quantity of power alcohol derived from molasses.
- Negligible or less than half the final digit shown.

TABLE 5-10
ALL INDIA - 1962/3
TOTAL INTERNAL FINAL CONSUMPTION BROKEN DOWN BY SECTOR OF CONSUMPTION & SOURCE OF ENERGY
(Million Tonnes of Coal Replacement)**

	Coking Coal	Non-Coking Coal	Coke Excluding Soft Coke	Soft Coke	Total Oil Products (3)	Blast Furnace Gas	Coke Oven & Gas Works Gas	Electricity	Total Commercial Sources of Energy	Dung (dry)	Fire-wood	Waste products	Total Non-Commercial Energy	Total Internal Final Consumption
Total Transportation of which	2.1	15.2	0.1		17.7			0.8	36.0					36.0
Road and Tramways					14.0			0.1	14.1					14.1
Railroads	2.1	14.8	0.1		0.6			0.8	18.5					18.5
Waterways		0.3			0.8				1.1					1.1
Air					2.3				2.3					2.3
Total Industry of which	1.7	11.8 ⁽¹⁾	6.2		13.8	1.5 ⁽¹⁾	1.7	15.9	52.6					52.6
Iron & Steel	1.2	0.1	5.9 ⁽²⁾		0.8	1.5 ⁽¹⁾	1.7	2.7	13.9					13.9
Fertilizer			0.3		0.1			1.8	2.0					2.0
Heavy Chemical					0.7			0.7	1.4					1.4
Structural Clay Products		1.8 ⁽⁴⁾			0.5				2.3					2.3
Cement		2.4			0.6			1.0	4.0					4.0
Mining & Quarrying		0.1			0.1			0.1	0.3					0.3
Non-Ferrous (copper only)								0.7	0.7					0.7
Textiles		2.2			3.8			3.2	9.2					9.2
Others	0.5	5.2			7.2			5.9	18.8					18.8
Total Other Sectors of which		0.8		3.2	18.2		0.1	4.8	26.9	2.0	98.5	29.5	148.0	174.9
Agriculture		0.1			2.3			1.1	3.5					3.5
Domestic				3.2	15.9		0.1	1.9	21.1	22.0	98.5	29.5	148.0	169.1
Commercial		0.1						1.0	1.1					1.1
Government		0.4						0.8	1.2					1.2
Consumption by the Energy ⁽⁵⁾ Sector & Losses	0.9	2.6				0.9	0.5	0.6	5.5					5.5
TOTAL INTERNAL FINAL CONSUMPTION	4.7	30.2	6.3	3.2	49.7	2.4	2.3	22.2	121.0	2.0	98.5	29.5	148.0	269.0

- (1) Excluding quantities used in non-utility electricity generation.
- (2) Excluding quantities considered as transformed into blast furnace gas.
- (3) Including a very small quantity of power alcohol derived from molasses.
- (4) Includes 1.73 million tonnes used for brick-burning.
- (5) Mainly mines own consumption including miners' coal. Excepting losses in electricity sector and refineries which are accounted in coal replacement factor applied to final consumption.

- Negligible or less than half the final digit shown.

(***)

The factors used for oil products, dung and firewood are replacement ratios expressing the amount of coal needed to substitute their final use taking account of relative efficiencies involved in typical cases of substitution. The factors for coke and gas are purely technical conversion factors permitting the expression of final consumption of these fuels in terms of the primary input of coal actually needed. The replacement factor used for final electricity consumption permits its expression in terms of the amount of coal that would have been needed if no hydel or oil generation were available.

Million Tonnes of Coal Replacement

10 ⁹ kWh electricity (TWh)	1
1 Mt Oil product	6.5
1 Mt Hard Coke	1.13
1 Mt Soft Coke	1.5
1000 million m ³ manufactured gas	0.83
1000 million m ³ blast furnace gas	0.18
1 Mt dry Dung	0.4
1 Mt firewood and Waste Products	0.95

TABLE 5-10A
OIL PRODUCT - ALL INDIA - 1962/3
TOTAL INTERNAL FINAL CONSUMPTION OF OIL PRODUCTS
BROKEN DOWN BY SECTOR OF CONSUMPTION
(Million Tonnes of Coal Replacement) 1/

	Total Oil Products 2/	Motor Spirit	aviation & Jet Fuel	MSDO	LDO	Kerosene	LPG	Fuel Oil	Naptha	Vapourising Oil & Refinery Gas
Transportation of which	17.68	6.12	2.26	8.50	0.05			0.75		
Road & Tramways	14.01	6.12		7.89				0.07		
Railroads	0.62			0.55				0.68		
Waterways	0.79			0.06	0.05					
Air	2.26		2.26							
Industry of which	13.82			1.57	2.24	0.16		9.80	0.05	
Iron & Steel	0.78							0.78		
Fertilizer	0.05								0.05	
Heavy Chemical	0.71							0.71		
Structural Clay Products	0.53			0.07	0.07			0.39		
Cement	0.59			0.13	0.07			0.39		
Mining & Quarrying	0.14			0.07	0.07					
Non-Ferrous										
Textiles	3.76			0.32	0.52			2.92		
Other	7.25			0.98	1.51	0.16		4.61		
Other Sectors of which	18.21			0.97	1.31	15.75	0.10			0.08
Agriculture	2.36			0.97	1.31					0.08
Domestic	15.82					15.75	0.07			
Commercial	0.03						0.03			
TOTAL INTERNAL FINAL CONSUMPTION	49.71	6.12	2.26	11.04	3.60	15.91	0.10	10.55	0.05	0.08

1/ The factor used for oil products is 6.5 MtCR for one Mt oil products. The factor used is the replacement ratio expressing the amount of coal needed to substitute the final use, taking account of relative efficiencies involved in typical cases of substitution.

2/ Including a very small quantity of power alcohol derived from molasses.

- Negligible or less than half the final digit shown.

TABLE 5-11
 ANDHRA PRADESH 1960/1
 TOTAL INTERNAL FINAL ENERGY CONSUMPTION BROKEN DOWN BY SECTOR OF CONSUMPTION AND SOURCE OF ENERGY
 (In million tonnes of coal replacement)***

	Coking Coal	Non-Coking Coal	Coke excluding Soft Coke	Soft Coke	Total Oil Products	Blast Furnace	Coke Oven & Gas Work Gas	Electricity	Total Commercial Sources of Energy	Dung (dry)	Fire-wood	Waste Products	Total Non-Commercial Energy	Total Internal Final Consumption
TOTAL TRANSPORTATION of which	0.05	1.20			0.98			0.01	2.24					2.24
Road and Tramways								0.01						
Railroads	0.05	1.20												
Waterways														
Air														
TOTAL INDUSTRY of which		0.73	0.01		0.33			0.42	1.49					1.49
Iron & Steel			0.01					0.02						
Fertilizer		0.02												
Heavy Chemical														
Structural Clay Products		0.03						0.05						
Cement		0.22												
Mining & Quarrying														
Non-Ferrous								0.06						
Textiles		0.12						0.30						
Others		0.34												
OTHER SECTORS of which		0.02			1.04			0.21	1.27	1.8	8.6	2.5	12.7	13.97
Agriculture					0.13			0.05	0.18					
Domestic					0.91			0.07	0.98	1.8	8.6	2.5	12.7	
Commercial								0.03	0.03					
Government		0.02						0.02	0.04					
Other								0.03	0.03					
CONSUMPTION BY THE ENERGY SECTOR & LOSSES		0.08						0.08	0.16					0.16
TOTAL INTERNAL FINAL CONSUMPTION	0.05	2.03	0.01		2.35			0.72	5.16	1.6	8.6	2.5	12.7	17.88

Conversion and Replacement factors used are:

1 Mt Soft Coke	1.5 MtCR
1 Mt Coke other than Soft Coke	1.13 "
1 Mt Oil Products	6.50 "
1000 million (10 ⁹) m ³ manufactured gas	0.83 "
1000 million (10 ⁹) m ³ blast furnace gas.	0.18 "

10⁹ kWh electricity (TWh)
 1 Mt dry dung
 1 Mt firewood & waste

1 MtCR
 0.4 "
 0.95 "

(***) The factor used for oil products dung and firewood are replacement ratios expressing the amount of coal needed to substitute their final use taking account of relative efficiencies involved in typical cases of substitution. The factors for coke and gas are purely technical conversion factors permitting the expression of final consumption of these fuels in terms of the primary input of coal actually needed. The replacement factor used for final electricity consumption permits its expression in terms of the amount of coal that would have been needed if no hydel or oil generation were available.

TABLE 5-12
ASSAM 1960/1

TOTAL INTERNAL FINAL ENERGY CONSUMPTION BROKEN DOWN BY SECTOR OF CONSUMPTION AND SOURCE OF ENERGY
(In Million tonnes of coal replacement)***

	Coking Coal	Non-Coking Coal	Coke excluding Soft Coke	Soft coke	Total Oil products	Blast Furnace Gas	Coke Oven & Gas Work Gas	Electricity	Total Commercial Sources of Energy	Dung (dry)	Firewood	Waste Products	Total Non-Commercial Energy	Total Internal Final Consumption
TOTAL TRANSPORTATION of which		0.38			0.52			0.01	0.91					0.91
Road and Tramways								0.01						
Railroads		0.23												
Waterways		0.15												
Air								0.01	0.77					0.77
TOTAL INDUSTRY of which		0.23	0.01		0.52									
Iron & Steel			0.01											
Fertilizer			0.01											
Heavy Chemical														
Structural Clay Products		0.05												
Cement														
Mining & Quarrying														
Non-Ferrous								0.01						
Textiles								0.02	0.70	0.2	4.2	0.9	5.3	8.00
Other		0.18												
TOTAL OTHER SECTORS of which		0.03			0.65									
Agriculture					0.13			0.01	0.13	0.2	4.2	0.9		
Domestic		0.01			0.52			(0.54					
Commercial								(0.01	0.02					
Government		0.02						(0.01					
Other								(
CONSUMPTION BY THE ENERGY SECTOR AND LOSSES		0.03						0.01	0.04					0.04
TOTAL INTERNAL FINAL CONSUMPTION		0.67	0.01		1.69			0.05	2.42	0.2	4.2	0.9	5.3	7.72

Conversion and replacement factors used are:

1 Mt soft coke	1.5 MtCR	10 ⁹ kWh electricity (TWh)	1 MtCR
1 Mt coke other than soft coke	1.13 "	1 Mt dry dung	0.4 "
1 Mt oil products	6.50 "	1 Mt firewood & waste	0.95 "
1000 million (10 ⁹) m ³ manufactured gas	0.83 "		
-do- blast furnace gas	0.18 "		

(***) The factors used for oil products, dung and firewood are replacement ratios expressing the amount of coal needed to substitute their final use taking account of relative efficiencies involved in typical cases of substitution. The factors for coke and gas are purely technical conversion factors permitting the expression of final consumption of these fuels in terms of the primary input of coal actually needed. The replacement factor used for final electricity consumption permits its expression in terms of the amount of coal that would have been needed if no hydel or oil generation were available.

TABLE 5-13
BIHAR 1960/1

TOTAL INTERNAL FINAL ENERGY CONSUMPTION BROKEN DOWN BY SECTOR OF CONSUMPTION AND SOURCE OF ENERGY
(In million tonnes of coal replacement)***

	Coking Coal	Non-Coking Coal	Coke excluding soft coke	Soft Coke	Total Oil Products	Blast Furnace Gas	Coke Oven & Gas work Gas	Electricity	Total Commercial Sources of Energy	Dung (dry)	Fire-wood	Waste Products	Total Non-commercial Energy	Total Internal Final Consumption
TOTAL TRANSPORTATION of which	0.23	1.49			0.71			0.04	2.47					2.47
Road and tramways														
Railroads	0.23	1.42						0.04						
Waterways		0.07												
Air														
TOTAL INDUSTRY of which	1.21	0.72	1.34		0.78	0.43	0.44	1.45	6.37					6.37
Iron & Steel	0.40		1.09			0.43	0.44	0.62						
Fertilizer			0.25					0.38						
Heavy Chemical														
Structural Clay Products		0.07												
Cement		0.29												
Mining & Quarrying		0.02						0.26						
Non-ferrous		0.04												
Textiles								0.05						
Other	0.81	0.30						0.01						
TOTAL OTHER SECTORS of which		0.07		0.17	1.11			0.13						
Agriculture		0.02			0.07			0.11	1.46	3.0	6.8	3.2	13.0	14.46
Domestic				0.17	1.04			0.02	0.11					
Commercial								0.04	1.25	3.0	6.8	3.2		
Government		0.05						0.03	0.03					
Other								0.02	0.07					
CONSUMPTION BY THE ENERGY SECTOR AND LOSSES	0.78	0.50				0.22	0.20	0.18	1.88					1.88
TOTAL INTERNAL FINAL CONSUMPTION	2.22	2.78	1.34	0.17	2.60	0.65	0.64	1.78	12.18	3.0	6.8	3.2	13.0	25.18

Conversion and replacement factors used are:

1 Mt soft coke	1.5 MTCR	10 ⁹ kWh electricity (TWh)	1 MTCR
1 Mt coke other than soft coke	1.13 "	1 Mt dry dung	0.4 "
1 Mt oil products	6.50 "	1 Mt firewood & waste	0.95 "
1000 million (10 ⁹) m ³ manufactured gas	0.83 "		
-do- blast furnace gas	0.18 "		

(***) The factors used for oil products, dung and firewood are replacement ratios expressing the amount of coal needed to substitute their final use taking account of relative efficiencies involved in typical cases of substitution. The factors for coke and gas are purely technical conversion factors permitting the expression of final consumption of these fuels in terms of the primary input of coal actually needed. The replacement factor used for final electricity consumption permits its expression in terms of the amount of coal that would have been needed if no hydel or oil generation were available.

TABLE 5-14
GUJARAT 1960/1

TOTAL INTERNAL FINAL ENERGY CONSUMPTION BROKEN DOWN BY SECTOR OF CONSUMPTION & SOURCE OF ENERGY
(In million tonnes of coal replacement)***

	Coking Coal	Non-Coking Coal	Coke excluding Soft Coke	Soft Coke	Total oil Products	Blast Furnace Gas	Coke oven & Gas Work Gas	Electricity	Total Commercial Sources of Energy	Dung (dry)	Firewood	Waste Products	Total Non-commercial Energy	Total Internal Final Consumption
TOTAL TRANSPORTATION of which	0.02	1.10			0.72			0.02	1.86					1.86
Road and Tramways														
Railroads	0.02	1.10						0.02						
Waterways														
Air														
TOTAL INDUSTRY of which		1.37	0.03		0.91			0.88	3.19					3.18
Iron & Steel			0.03											
Fertilizer)														
Heavy Chemical)		0.14												
Structural Clay Products		0.04						0.01						
Cement		0.47						0.09						
Mining & Quarrying														
Non-ferrous														
Textiles		0.71						0.50						
Other		0.01						0.28						
TOTAL OTHER SECTORS of which				0.06	1.24			0.18	1.49	0.8	5.7	1.4	7.9	9.39
Agriculture					0.28			0.02	0.28					
Domestic				0.06	0.98			0.07	1.11	0.8	5.7	1.4		
Commercial								0.03	0.03					
Government		0.01						0.06	0.07					
Other														
CONSUMPTION BY THE ENERGY SECTOR & LOSSES														
TOTAL INTERNAL FINAL CONSUMPTION	0.02	2.48	0.03	0.06	2.87			1.08	6.54	0.8	5.7	1.4	7.9	14.44

Conversion and replacement factors used are:

1 Mt soft coke	1.5 MTCR	10 ⁹ kWh electricity (TWh)	1 MTCR
1 Mt coke other than soft coke	1.13 "	1 Mt dry dung	0.4 "
1 Mt oil products	6.50 "	1 Mt firewood & waste	0.95 "
1000 million (10 ⁹) m ³ manufactured gas	0.83 "		
-do- blast furnace gas	0.18 "		

(***) The factors used for oil products, dung and firewood are replacement ratios expressing the amount of coal needed to substitute their final use taking account of relative efficiencies involved in typical cases of substitution. The factors for coke and gas are purely technical conversion factors permitting the expression of final consumption of these fuels in terms of the primary input of coal actually needed. The replacement factor used for final electricity consumption permits its expression in terms of the amount of coal that would have been needed if no hydel or oil generation were available.

TABLE 5-15
JAMMU & KASHMIR 1960/1
TOTAL INTERNAL FINAL ENERGY CONSUMPTION BROKEN DOWN BY SECTORS OF CONSUMPTION AND SOURCES OF ENERGY
(In million tonnes of coal replacement)***

	Coking Coal	Non-Coking Coal	Coke excluding Soft Coke	Soft Coke	Total Oil Products	Blast Furnace Gas	Coke Oven & Gas Work Gas	Electricity	Total Commercial Sources of Energy	Dung (dry)	Firewood	Waste Products	Total Non-commercial Energy	Total Internal Final Consumption
TOTAL TRANSPORTATION of which					0.10				0.10					0.10
Road and Tramways														
Railroads														
Waterways														
Air														
TOTAL INDUSTRY of which								0.02	0.02					0.02
Iron & Steel														
Fertilizer														
Heavy Chemical														
Structural Clay Products														
Cement														
Mining & Quarrying														
Non-ferrous														
Textiles														
Other														
TOTAL OTHER SECTORS of which					0.04			0.02						
Agriculture								0.03	0.07	0.1	0.1	0.3	0.5	0.57
Domestic					0.04			0.02	0.06	0.1	0.1	0.3		
Commercial														
Government								0.01	0.01					
Other														
CONSUMPTION BY THE ENERGY SECTOR AND LOSSES														
TOTAL INTERNAL FINAL CONSUMPTION					0.14			0.05	0.19	0.1	0.1	0.3	0.5	0.69

Conversion and replacement factors used are:

1 Mt soft coke	1.5 MtCR	10 ⁹ kWh electricity (TWh)	1 MtCR
1 Mt coke other than soft coke	1.13 "	1 Mt dry dung	0.4 "
1 Mt oil products	6.50 "	1 Mt firewood and waste	0.95 "
1000 million (10 ⁹) m ³ manufactured gas	0.83 "		
-do- blast furnace gas	0.18 "		

(***) The factors used for oil products, dung and firewood are replacement ratios expressing the amount of coal needed to substitute their final use taking account of relative efficiencies involved in typical cases of substitution. The factors for coke and gas are purely technical conversion factors permitting the expression of final consumption of these fuels in terms of the primary input of coal actually needed. The replacement factor used for final electricity consumption permits its expression in terms of the amount of coal that would have been needed if no hydel or oil generation were available.

TABLE 5-16
KERALA 1960/1
TOTAL INTERNAL FINAL ENERGY CONSUMPTION BROKEN DOWN BY SECTORS OF CONSUMPTION & SOURCES OF ENERGY
(In million tonnes of coal replacement)***

	Coking Coal	Non-Coking Coal	Coke excluding soft Coke	Soft Coke	Total Oil Products	Blast Furnace Gas	Coke Oven & Gas Work Gas	Electricity	Total Commercial Sources of Energy	Dung (dry)	Firewood	Waste Products	Total Non-commercial Energy	Total Internal Final Consumption
TOTAL TRANSPORTATION of which	0.02	0.12			0.85				0.79					0.79
Road and tramways														
Railroads	0.02	0.12												
Waterways														
Air														
TOTAL INDUSTRY of which		0.02			0.39			0.40	0.81					0.81
Iron & Steel														
Fertilizer								0.07						
Heavy Chemical								0.04						
Structural Clay Products														
Cement		0.01						0.01						
Mining & Quarrying														
Non-ferrous								0.13						
Textiles								0.01						
Other		0.01						0.14						
TOTAL OTHER SECTORS of which					0.59			0.09	0.68	0.4	3.5	1.2	5.1	5.78
Agriculture					0.07			0.02	0.09					
Domestic					0.52			0.05	0.57	0.4	3.5	1.2		
Commercial														
Government								0.02	0.02					
Other														
CONSUMPTION BY THE ENERGY SECTOR & LOSSES														
TOTAL INTERNAL FINAL CONSUMPTION	0.02	0.14			1.63			0.49	2.28	0.4	3.5	1.2	5.1	7.38

Conversion and replacement factors used are:

1 Mt soft coke	1.5 MTCR	10 ⁹ kWh electricity (TWh)	1 MTCR
1 Mt coke other than soft coke	1.13 "	1 Mt dry dung	0.4 "
1 Mt oil products	6.50 "	1 Mt firewood & waste	0.95 "
1000 million (10 ⁹) m ³ manufactured gas	0.83 "		
-do- blast furnace gas	0.18 "		

(***) The factors used for oil products, dung and firewood are replacement ratios expressing the amount of coal needed to substitute their final use taking account of relative efficiencies involved in typical cases of substitution. The factors for coke and gas are purely technical conversion factors permitting the expression of final consumption of these fuels in terms of the primary input of coal actually needed. The replacement factor used for final electricity consumption permits its expression in terms of the amount of coal that would have been needed if no hydel or oil generation were available.

TABLE 5-17
MADHYA PRADESH 1960/1
TOTAL INTERNAL FINAL ENERGY CONSUMPTION BROKEN DOWN BY SECTORS OF CONSUMPTION AND SOURCE OF ENERGY
(In million tonnes of coal replacement)***

	Coking Coal	Non-Coking Coal	Coke excluding Soft Coke	Soft Coke	Total Oil Products	Blast Furnace Gas	Coke Oven & Gas Work Gas	Electricity	Total Commercial Sources of Energy	Dung (dry)	Firewood	Waste Products	Total Non-Commercial Energy	Total Internal Final Consumption
TOTAL TRANSPORTATION of which	0.12	1.70			0.73			0.01	2.58					2.58
Road and Tramways								0.01						
Railroads	0.12	1.70												
Waterways														
Air														
INDUSTRY of which	0.15	0.71	0.52		0.19	0.28	0.21	0.48	2.52					2.52
Iron & Steel	0.15		0.52			0.26	0.21	0.20						
Fertilizer														
Heavy Chemical														
Structural Clay Products		0.06												
Cement		0.27												
Mining & Quarrying														
Non-ferrous		0.27						0.06						
Textiles		0.11						0.13						
Other								0.11	0.94	1.5	8.2	2.1	9.8	10.74
ALL OTHER SECTORS of which		0.02		0.03	0.78				0.13					
Agriculture					0.13				0.73	1.5	8.2	2.1		
Domestic				0.03	0.65			0.05	0.02					
Commercial								0.02	0.02					
Government		0.02						0.03	0.05					
Other								0.01	0.01					
CONSUMPTION BY THE ENERGY SECTOR & LOSSES		0.32				0.08	0.02	0.04	0.46					0.48
TOTAL INTERNAL FINAL CONSUMPTION	0.27	2.75	0.52	0.03	1.70	0.34	0.23	0.64	6.48	1.5	8.2	2.1	9.8	16.28

Conversion and replacement factors used are:

1 Mt soft coke	1.5 MtCR	10 ⁹ kWh electricity (TWh)	1 MtCR
1 Mt coke other than soft coke	1.13 MtCR	1 Mt dry dung	0.4 "
1 Mt oil products	6.50 "	1 Mt firewood & waste	0.95 "
1000 million (10 ⁹) m ³ manufactured gas	0.83 "		
-do- blast furnace gas	0.18 "		

(***) The factors used for oil products, dung and firewood are replacement ratios expressing the amount of coal needed to substitute their final use taking account of relative efficiencies involved in typical cases of substitution. The factors for coke and gas are purely technical conversion factors permitting the expression of final consumption of these fuels in terms of the primary input of coal actually needed. The replacement factor used for final electricity consumption permits its expression in terms of the amount of coal that would have been needed if no hydel or oil generation were available.

TABLE 5-18
MADRAS 1960/1

TOTAL INTERNAL FINAL ENERGY CONSUMPTION BROKEN DOWN BY SECTORS OF CONSUMPTION & SOURCE OF ENERGY
(In million tonnes of coal replacement)***

	Coking Coal	Non-Coking Coal	Coke excluding Soft Coke	Soft Coke	Total Oil Products	Blast Furnace Gas	Coke Oven & Gas Work Gas	Electricity	Total Commercial Sources of Energy	Dung (dry)	Firewood	Waste Products	Total Non-commercial Energy	Total Internal Final Consumption
TOTAL TRANSPORTATION of which	0.07	0.82			1.50			0.05	2.44					2.44
Road and tramways														
Railroads	0.07	0.82						0.05						
Waterways														
Air														
TOTAL INDUSTRY of which		0.44	0.02		0.59			0.96	2.01					2.01
Iron & Steel			0.02											
Fertilizer)		0.01												
Heavy Chemicals)								0.03						
Structural Clay Products		0.08												
Cement		0.32						0.12						
Mining & Quarrying				0.02										
Non-ferrous														
Textiles		0.01						0.25						
Other		0.04						0.56						
TOTAL OTHER SECTORS of which		0.01		0.02	1.17			0.76	1.96	1.2	6.8	2.1	10.1	12.08
Agriculture		0.01			0.11			0.39	0.50					
Domestic				0.02	1.06			0.16	1.24	1.2	6.8	2.1		
Commercial								0.16	0.16					
Government		0.01						0.05	0.06					
Other														
CONSUMPTION BY THE ENERGY SECTOR & LOSSES														
TOTAL INTERNAL FINAL CONSUMPTION	0.07	1.27	0.02	0.02	3.28			1.77	6.41	1.2	6.8	2.1	10.1	16.51

Conversion and replacement factors used are:

1 Mt soft coke	1.5 MtCR	10 ⁹ kWh electricity (TWh)	1 MtCR
1 Mt coke other than soft coke	1.13 "	1 Mt dry dung	0.4 "
1 Mt oil products	6.50 "	1 Mt firewood & waste	0.95 "
1000 million (10 ⁹) m ³ manufactured gas	0.83 "		
-do- blast furnace gas	0.18 "		

(***) The factors used for oil products, dung and firewood are replacement ratios expressing the amount of coal needed to substitute their final use taking account of relative efficiencies involved in typical cases of substitution. The factors for coke and gas are purely technical conversion factors permitting the expression of final consumption of these fuels in terms of the primary input of coal actually needed. The replacement factor used for final electricity consumption permits its expression in terms of the amount of coal that would have been needed if no hydel or oil generation were available.

TABLE 5-19
MAHARASHTRA 1960/1

TOTAL INTERNAL FINAL ENERGY CONSUMPTION BROKEN DOWN BY SECTORS OF CONSUMPTION AND SOURCE OF ENERGY
(In million tonnes of coal replacement)***

	Coking Coal	Non-Coking Coal	Coke excluding Soft Coke	Soft Coke	Total Oil Products	Blast Furnace Gas	Coke Oven & Gas Work Gas	Electricity	Total Commercial Sources of Energy	Dung (dry)	Fire-wood	Waste Products	Total Non-Commercial Energy	Total Internal Final Consumption
TOTAL TRANSPORTATION of which	0.14	1.41			2.73			0.36	4.64					4.64
Road and tramways								0.01						
Railroads	0.14	1.41						0.35						
Waterways														
Air														
TOTAL INDUSTRY of which		0.79	0.06		4.29			1.94	7.08					7.08
Iron & Steel			0.06					0.07						
Fertilizer								0.10						
Heavy Chemical														
Structural Clay Products		0.04						0.01						
Cement														
Mining & Quarrying														
Non-ferrous		0.01						0.93						
Textiles								0.83						
Other		0.74												
TOTAL OTHER SECTORS of which		0.05		0.23	3.00		0.02	0.54	3.84	1.5	10.0	2.6	14.1	17.94
Agriculture														
Domestic				0.23	0.33		0.02	0.02	0.35					
Commercial					2.67			0.26	3.18	1.5	10.0	2.6		
Government								0.20	0.20					
Other		0.05						0.06	0.11					
CONSUMPTION BY THE ENERGY SECTOR & LOSSES		0.04						0.04	0.08					0.08
TOTAL INTERNAL FINAL CONSUMPTION	0.14	2.29	0.06	0.23	10.02		0.02	2.88	15.64	1.5	10.0	2.6	14.1	29.74

Conversion and replacement factors used are:

1 Mt soft coke	1.5 MtCR	10 ⁹ kWh electricity (TWh)	1 MtCR
1 Mt coke other than soft coke	1.13 "	1 Mt dry dung	0.4 "
1 Mt oil products	6.50 "	1 Mt firewood & waste	0.95 "
1000 million (10 ⁹) m ³ manufactured gas	0.83 "		
-do- blast furnace gas	0.18 "		

(***) The factors used for oil products, dung and firewood are replacement ratios expressing the amount of coal needed to substitute their final use taking account of relative efficiencies involved in typical cases of substitution. The factors for coke and gas are purely technical conversion factors permitting the expression of final consumption of these fuels in terms of the primary input of coal actually needed. The replacement factor used for final electricity consumption permits its expression in terms of the amount of coal that would have been needed if no hydel or oil generation were available.

TABLE 5-20
MYSORE 1960/1

TOTAL INTERNAL FINAL ENERGY CONSUMPTION BROKEN DOWN BY SECTORS OF CONSUMPTION & SOURCE OF ENERGY
(In million tonnes of coal replacement)***

	Coking Coal	Non-Coking Coal	Coke excluding Soft Coke	Soft Coke	Total Oil Products	Blast Furnace Gas	Coke Oven & Gas Work Gas	Electricity	Total Commercial Sources of Energy	Dung (dry)	Fire wood	Waste Products	Total Non-commercial Energy	Total Internal Final Consumption
TOTAL TRANSPORTATION of which	0.04	0.41			0.85			0.01	1.31					1.31
Road and tramways	0.04	-						0.01						
Railroads		0.41												
Waterways		-												
Air		-						0.79	1.22					1.22
TOTAL INDUSTRY of which		0.17	0.07		0.19			0.28						
Iron & Steel		-	0.07					0.03						
Fertilizer		-												
Heavy Chemical		-												
Structural Clay Products		-						0.08						
Cement		0.16						0.11						
Mining & Quarrying														
Non-ferrous								0.07						
Textiles		0.01						0.24						
Others								0.20	0.98	1.0	6.6	1.6	9.2	10.18
TOTAL OTHER SECTORS of which					0.78			0.03	0.16					
Agriculture					0.13			0.08	0.73	1.0	6.6	1.6		
Domestic		-			0.65			0.02						
Commercial		-						0.08						
Government		-												
Other		-												
CONSUMPTION BY THE ENERGY SECTOR & LOSSES								1.00	3.51	1.0	6.6	1.6	9.2	71
TOTAL INTERNAL FINAL CONSUMPTION	0.04	0.58	0.07		1.82									

Conversion and replacement factors used are:

1 Mt soft coke	1.5	MtCR	10 ⁹ kWh electrici	(TWh)	1	MtCR
1 Mt coke other than soft coke	1.13	"	1 Mt dry dung		0.4	"
1 Mt oil products	6.50	"	1 Mt firewood	in waste	0.95	"
1000 million (10 ⁹) m ³ manufactured gas	0.83	"				
-do- blast furnace gas	0.18	"				

(***)

The factors used for oil products, dung and firewood are replacement ratios expressing the amount of coal needed to substitute their final use taking account of relative efficiencies involved in typical cases of substitution. The factors for coke and gas are purely technical conversion factors permitting the expression of final consumption of these fuels in terms of the primary input of coal actually needed. The replacement factor used for final electricity consumption permits its expression in terms of the amount of coal that would have been needed if no hydel or oil generation were available.

TABLE 5-21
ORISSA 1960/1

TOTAL INTERNAL FINAL ENERGY CONSUMPTION BROKEN DOWN BY SECTORS OF CONSUMPTION & SOURCE OF ENERGY
(In million tonnes of coal replacement)***

	Coking Coal	Non-Coking Coal	Coke excluding Soft Coke	Soft Coke	Total Oil Products	Blast Furnace Gas	Coke Oven & Gas Work Gas	Electricity	Total Commercial Sources of Energy	Dung (dry)	Fire-wood	Waste Products	Total Non-commercial Energy	Total Internal Final Consumption
TOTAL TRANSPORTATION of which	0.01	0.30			0.19				0.50					0.50
Road and tramways														
Railroads	0.01	0.30												
Waterways														
Air														
TOTAL INDUSTRY of which		0.16	0.36		0.07	0.06	0.12	0.71	1.48					1.48
Iron & Steel			0.36			0.06	0.12	0.28						
Fertilizer)		0.01												
Heavy Chemical)														
Structural Clay Products		0.05												
Cement		0.08												
Mining & Quarrying								0.04						
Non-ferrous														
Textiles		0.01						0.22						
Others		0.01												
TOTAL OTHER SECTORS of which				0.02	0.26			0.03	0.31	0.3	7.4	1.3	9.0	9.31
Agriculture														
Domestic				0.02	0.26									
Commercial								0.02	0.30	0.3	7.4	1.3		
Government								0.01	0.01					
Other														
CONSUMPTION BY THE ENERGY SECTOR & LOSSES		0.04				0.10	0.02	0.01	0.17					0.17
TOTAL INTERNAL FINAL CONSUMPTION	0.01	0.50	0.36	0.02	0.52	0.16	0.14	0.75	2.48	0.3	7.4	1.3	9.0	11.46

(***)

The factors used for oil products, dung and firewood are replacement ratios expressing the amount of coal needed to substitute their final use taking account of relative efficiencies involved in typical cases of substitution. The factors for coke and gas are purely technical conversion factors permitting the expression of final consumption of these fuels in terms of the primary input of coal actually needed. The replacement factor used for final electricity consumption permits its expression in terms of the amount of coal that would have been needed if no hydel or oil generation were available.

Conversion and replacement factors used are:

1 Mt soft coke	1.5	MtCR	10 ⁹ kWh electricity (TWh)	1	MtCR
1 Mt coke other than soft coke	1.13	"	1 Mt dry dung	0.4	"
1 Mt oil products	6.50	"	1 Mt firewood & waste	0.95	"
1000 million (10 ⁹) m ³ manufactured gas	0.83	"			
-do- blast furnace gas	0.18	"			

TABLE 5-22
PUNJAB^{1/} 1960/1

TOTAL INTERNAL FINAL ENERGY CONSUMPTION BROKEN DOWN BY SECTORS OF CONSUMPTION & SOURCE OF ENERGY
(In million tonnes of coal replacement)***

	Coking Coal	Non-Coking Coal	Coke excluding Soft Coke	Soft Coke	Total Oil Products	Blast Furnace Gas	Coke Oven & Gas Work Gas	Electricity	Total Commercial Sources of Energy	Dung (dry)	Firewood	Waste Products	Total Non-commercial Energy	Total Internal Final Consumption
TOTAL TRANSPORTATION of which	0.08	0.74			1.43			0.02	2.27					2.27
Road and tramways														
Railroads	0.08	0.74						0.02						
Waterways														
Air														
TOTAL INDUSTRY of which		0.76	0.11		0.33			0.66	1.86					1.86
Iron & Steel			0.11											
Fertilizer)		0.04												
Heavy Chemical)								0.05						
Structural Clay Products		0.21												
Cement		0.15						0.08						
Mining & Quarrying														
Non-ferrous														
Textiles		0.06						0.10						
Others		0.30						0.43						
TOTAL OTHER SECTORS of which		0.24		0.47	0.91			0.46	2.08	2.1	5.1	1.4	8.6	10.68
Agriculture		0.08			0.19			0.08	0.35					
Domestic				0.47	0.72			0.17	1.36	2.1	5.1	1.4		
Commercial								0.14	0.14					
Government		0.16						0.07	0.23					
CONSUMPTION BY THE ENERGY SECTOR & LOSSES														
TOTAL INTERNAL FINAL CONSUMPTION	0.08	1.74	0.11	0.47	2.67			1.14	6.21	2.1	5.1	1.4	8.6	14.81

1/ Includes Delhi & Himachal Pradesh.

(***) The factors used for oil products, dung and firewood are replacement ratios expressing the amount of coal needed to substitute their final use taking account of relative efficiencies involved in typical cases of substitution. The factors for coke and gas are purely technical conversion factors permitting the expression of final consumption of these fuels in terms of the primary input of coal actually needed. The replacement factor used for final electricity consumption permits its expression in terms of the amount of coal that would have been needed if no hydel or oil generation were available.

Conversion and replacement factors used are:

1 Mt soft coke	1.5	MtCR	10 ⁹ kWh electricity (TWh)	1	MtCR
1 Mt coke other than soft coke	1.13	"	1 Mt dry dung	0.4	"
1 Mt oil products	6.50	"	1 Mt firewood & waste	0.95	"
1000 million (10 ⁹) m ³ manufactured gas	0.83	"			
blast furnace gas	0.18	"			

TABLE 5-23
RAJASTHAN 1960/1

TOTAL INTERNAL FINAL ENERGY CONSUMPTION BROKEN DOWN BY SECTORS OF CONSUMPTION & SOURCE OF ENERGY
(In million tonnes of coal replacement)***

	Coking Coal	Non-Coking Coal	Coke excluding Soft Coke	Soft Coke	Total Oil Products	Blast Furnace Gas	Coke Oven & Gas Work Gas	Electricity	Total Commercial Sources of Energy	Dung (dry)	Firewood	Waste Products	Total Non-commercial Energy	Total Internal Final Consumption
TOTAL TRANSPORTATION of which	0.08	0.83			0.39			0.02	1.32					1.32
Road and tramways														
Railroads	0.08	0.83						0.02						
Waterways														
Air														
TOTAL INDUSTRY of which		0.34	0.01		0.12			0.15	0.62					0.62
Iron & Steel			0.01											
Fertilizer)		0.02												
Heavy Chemical)														
Structural Clay Products		0.01												
Cement		0.24						0.12						
Mining & Quarrying				0.03	0.40			0.07	0.56	0.9	5.0	1.5	7.4	7.96
Non-ferrous		0.01												
Textiles		0.04						0.02						
Other		0.03						0.02						
TOTAL OTHER SECTORS of which		0.06			0.40			0.07	0.56	0.9	5.0	1.5	7.4	7.96
Agriculture		0.02			0.07				0.09					
Domestic					0.33			0.02	0.38	0.9	5.0	1.5		
Commercial								0.02	0.02					
Government		0.04						0.03	0.07					
Other														
CONSUMPTION BY THE ENERGY SECTOR & LOSSES														
TOTAL INTERNAL FINAL CONSUMPTION	0.08	1.23	0.01	0.03	0.91			0.24	2.50	0.9	5.0	1.5	7.4	9.90

(***)

The factors used for oil products, dung and firewood are replacement ratios expressing the amount of coal needed to substitute their final use taking account of relative efficiencies involved in typical cases of substitution. The factors for coke and gas are purely technical conversion factors permitting the expression of final consumption of these fuels in terms of the primary input of coal actually needed. The replacement factor used for final electricity consumption permits its expression in terms of the amount of coal that would have been needed if no hydel or oil generation were available.

Conversion and replacement factors used are:

1 Mt soft coke	1.5	MtCR	10 ⁹ kWh electricity (TWh)	1	MtCR
1 Mt coke other than soft coke	1.13	"	1 Mt dry dung	0.4	"
1 Mt oil products	6.50	"	1 Mt firewood and waste	0.95	"
1000 million (10 ⁹) m ³ manufactured gas	0.83	"			
-do- blast furnace gas	0.18	"			

TABLE 5-24
UTTAR PRADESH 1960/1
TOTAL INTERNAL FINAL ENERGY CONSUMPTION BROKEN DOWN BY SECTORS OF CONSUMPTION & SOURCE OF ENERGY
(In million tonnes of coal replacement)***

	Coking Coal	Non-Coking Coal	Coke excluding Soft Coke	Soft Coke	Total Oil Products	Blast Furnace Gas	Coke Oven & Gas Work Gas	Electricity	Total Commercial Sources of Energy	Dung (dry)	Firewood	Waste Products	Total Non-commercial Energy	Total Internal Final Consumption
TOTAL TRANSPORTATION of which	0.22	2.48			1.17			0.06	3.93					3.93
Road and tramways														
Railroads	0.22	2.48						0.06						
Waterways														
Air														
TOTAL INDUSTRY of which		1.00	0.10		0.26			0.60	1.96					1.96
Iron & Steel			0.10					0.01						
Fertilizer)		0.09												
Heavy Chemical)														
Structural Clay Products		0.28						0.03						
Cement		0.07						0.03						
Mining & Quarrying														
Non-ferrous														
Textiles		0.17						0.16						
Other		0.39						0.37						
TOTAL OTHER SECTORS of which		0.15		0.24	1.43			0.47	2.29	5.8	11.8	5.0	22.4	24.69
Agriculture		0.07			0.26			0.20	0.53					
Domestic				0.24	1.17			0.12	1.53	5.8	11.6	5.0		
Commercial								0.08	0.08					
Government		0.08						0.07	0.15					
Other														
CONSUMPTION BY THE ENERGY SECTOR & LOSSES														
TOTAL INTERNAL FINAL CONSUMPTION	0.22	3.63	0.10	0.24	2.86			1.13	8.18	5.8	11.6	5.0	22.4	30.58

(***)

The factors used for oil products, dung and firewood are replacement ratios expressing the amount of coal needed to substitute their final use taking account of relative efficiencies involved in typical cases of substitution. The factors for coke and blast furnace gas are purely technical conversion factors permitting the expression of final consumption of these fuels in terms of primary input of coal actually needed. The replacement factor used for final electricity consumption permits its expression in terms of the amount of coal that would have been needed if no hydel or oil generation were available.

Conversion and replacement factors used are:

1 Mt soft coke	1.5	MtCR	10 ⁹ kWh electricity (TWh)	1	MtCR
1 Mt coke other than soft coke	1.13	"	1 Mt dry dung	0.4	"
1 Mt oil products	6.50	"	1 Mt firewood & waste	0.95	"
1000 million (10 ⁹) m ³ manufactured gas	0.83	"			
-do- blast furnace gas	0.18	"			

TABLE 5-25
WEST BENGAL 1960/1

TOTAL INTERNAL FINAL ENERGY CONSUMPTION BROKEN DOWN BY SECTORS OF CONSUMPTION & SOURCE OF ENERGY
(In million tonnes of coal replacement)***

	Coking Coal	Non-Coking Coal	Coke excluding Soft Coke	Soft Coke	Total Oil Products	Blast furnace gas	Coke Oven & Gas Work Gas	Electricity	Total Commercial Sources of Energy	Dung (dry)	Firewood	Waste Products	Total Non-commercial Energy	Total Internal Final Consumption
TOTAL TRANSPORTATION of which	0.24	1.74			1.69			0.20	3.87					3.87
Road and tramways								0.05						
Railroads	0.24	1.50						0.15						
Waterways		0.24												
Air														
TOTAL INDUSTRY of which	0.76	1.18	1.12		0.98	0.35	0.53	2.09	7.01					7.01
Iron & Steel	0.76 ⁽¹⁾		1.12			0.35	0.53	0.32						
Fertilizer)		0.02												
Heavy Chemical)								0.13						
Structural Clay Products		0.14						0.01						
Cement								0.09						
Mining & Quarrying								0.64						
Non-ferrous		0.06						0.91						
Textiles		0.96												
Other														
TOTAL OTHER SECTORS of which		0.22		1.51	1.49		0.03	0.75	4.00	1.2	7.7	2.1	11.0	15.00
Agriculture					0.13				0.13					
Domestic				1.51	1.36		0.03	0.35	3.25	1.2	7.7	2.1		
Commercial		0.07						0.12	0.19					
Government		0.15						0.12	0.27					
Other								0.16	0.16					
CONSUMPTION BY THE ENERGY SECTOR & LOSSES	0.03	0.80				1.26	0.13	0.12	1.34					1.34
TOTAL INTERNAL FINAL CONSUMPTION	1.03	3.94	1.12	1.51	4.16	4.81	0.69	3.16	16.22	1.2	7.7	2.1	11.0	27.22

(1) Includes 0.13 million tonnes used for electricity generation

(***)

The factors used for oil products, dung and firewood are replacement ratios expressing the amount of coal needed to substitute their final use taking account of relative efficiencies involved in typical cases of substitution. The factors for coke and gas are purely technical conversion factors permitting the expression of final consumption of these fuels in terms of primary input of coal actually needed. The replacement factor used for final electricity consumption permits its expression in terms of the amount of coal that would have been needed if no hydal or oil generation were available.

Conversion and replacement factors used are:

1 Mt soft coke	1.5	MtCR	10 ⁹ kWh electricity (TWh)	1 MtCR
1 Mt coke other than soft coke	1.13	"	1 Mt dry dung	0.4 "
1 Mt oil products	6.50	"	1 Mt firewood & waste	0.95 "
1000 million (10 ⁹) m ³ manufactured gas	0.83	"		
-do- blast furnace gas	0.18	"		

TABLE 5-26
FINAL TRENDS OF ENERGY CONSUMPTION IN DIFFERENT SECTORS
ALL INDIA
(Million tonnes of coal replacement)⁽¹⁾

	1953/4	1954/5	1955/6	1956/7	1957/8	1958/9	1959/60	1960/1	1961/2	1962/3
A. TRANSPORT - ROAD & TRAMWAYS										
Commercial Energy	6.6	7.0	7.6	8.3	9.0	9.5	10.3	11.3	12.6	14.1
Of which: Oil Products	6.5	6.9	7.5	8.2	8.9	9.5	10.2	11.3	12.5	14.0
Electricity	0.1	0.1	0.1	0.1	0.1	-	0.1	-	0.1	0.1
Total Energy Consumption	6.6	7.0	7.6	8.3	9.0	9.5	10.3	11.3	12.6	14.1
B. TRANSPORT - RAILROAD										
Commercial Energy	12.5	12.0	12.7	14.3	15.4	15.6	16.1	16.8	17.7	18.5
Of which: Coking Coal	5.0	4.9	5.2	5.7	5.7	4.6	3.9	1.3	1.4	2.1
Non-Coking Coal	6.8	6.5	6.8	7.7	8.7	9.8	11.0	14.2	15.0	14.8
Coke excluding Soft Coke										0.1
Oil Products	0.1	0.1	0.1	0.3	0.3	0.4	0.4	0.5	0.5	0.8
Electricity	0.5	0.5	0.6	0.6	0.7	0.8	0.8	0.8	0.8	0.8
Total Energy Consumption	12.5	12.0	12.7	14.3	15.4	15.6	16.1	16.8	17.7	18.5
C. TRANSPORT - WATERWAYS										
Commercial Energy	0.6	0.7	0.7	0.7	0.8	0.9	0.9	1.1	1.1	1.1
Of which: Non-Coking Coal	0.2	0.3	0.3	0.3	0.3	0.4	0.3	0.5	0.3	0.3
Oil Products	0.4	0.4	0.4	0.4	0.5	0.5	0.6	0.6	0.8	0.8
Total Energy Consumption	0.6	0.7	0.7	0.7	0.8	0.9	0.9	1.1	1.1	1.1
D. TRANSPORT - AIRWAYS										
Commercial Energy	0.6	0.6	0.8	0.9	1.1	1.3	1.5	1.8	2.1	2.3
Of which: Oil Products	0.6	0.6	0.8	0.9	1.1	1.3	1.5	1.8	2.1	2.3
Total Energy Consumption	0.6	0.6	0.8	0.9	1.1	1.3	1.5	1.8	2.1	2.3
E. INDUSTRY - IRON & STEEL⁽²⁾										
Commercial Energy	3.9	3.9	4.0	4.0	4.3	5.6	6.5	9.5	12.2	13.9
Of which: Coking Coal	0.8	0.6	0.5	0.6	0.7	0.9	0.4	1.3	1.2	1.2
Non-Coking Coal									0.1	0.1
Coke excluding Soft Coke (3)	1.5	1.5	1.8	1.7	1.7	2.5	3.1	3.6	5.2	5.9
Oil Products (4)	-	-	-	-	-	-	-	0.4	0.6	0.8
Blast Furnace Gas	0.4	0.5	0.4	0.4	0.4	0.5	0.7	1.1	1.3	1.5
Coke Oven & Gas Work Gas	0.6	0.6	0.5	0.5	0.6	0.7	0.9	1.3	1.4	1.7
Electricity	0.6	0.7	0.8	0.8	0.9	1.0	1.4	1.8	2.4	2.7
Total Energy Consumption⁽²⁾	3.9	3.9	4.0	4.0	4.3	5.6	6.5	9.5	12.2	13.9
F. INDUSTRY - FERTILIZERS										
Commercial Energy (2)	0.5	0.6	0.5	0.5	0.5	0.6	0.6	0.8	1.6	2.0
Of which: Coke excluding Soft Coke	0.2	0.3	0.2	0.2	0.2	0.2	0.2	0.3	0.3	0.3
Oil Products	-	-	-	-	-	-	-	-	-	0.1
Electricity	0.3	0.3	0.3	0.3	0.3	0.4	0.4	0.5	1.3	1.6
Total Energy Consumption⁽²⁾	0.5	0.6	0.5	0.5	0.5	0.6	0.6	0.8	1.6	2.0
G. INDUSTRY - HEAVY CHEMICALS										
Commercial Energy (2)	0.1	0.1	0.1	0.5	0.6	0.6	0.6	1.2	1.1	1.4
Of which: Non-Coking Coal				0.3	0.4	0.4	0.3	0.3	0.3	0.3
Oil Products	-	-	-	-	-	-	-	0.5	0.5	0.7
Electricity	-	-	-	0.2	0.2	0.2	0.3	0.4	0.6	0.7
Total Energy Consumption⁽²⁾	0.1	0.1	0.1	0.5	0.6	0.6	0.6	1.2	1.1	1.4
H. INDUSTRY - STRUCTURAL CLAY PRODUCTS										
Commercial Energy (2)	0.1	0.1	0.1	1.6	1.5	2.0	1.8	1.4	1.8	2.3
Of which: Non-Coking Coal	0.1	0.1	0.1	1.6	1.5	2.0	1.8	1.1	1.5	1.8
Oil Products	-	-	-	-	-	-	-	0.3	0.3	0.5
Total Energy Consumption⁽²⁾	0.1	0.1	0.1	1.6	1.5	2.0	1.8	1.4	1.8	2.3
I. INDUSTRY - CEMENT										
Commercial Energy (2)	1.5	1.7	1.8	2.0	2.3	2.5	2.7	3.4	3.8	4.0
Of which: Non-Coking Coal	1.1	1.2	1.3	1.4	1.7	1.7	1.8	2.3	2.5	2.4
Oil Products (4)	-	-	-	-	-	-	-	0.2	0.3	0.6
Electricity	0.4	0.5	0.5	0.6	0.6	0.8	0.9	0.9	1.0	1.0
Total Energy Consumption⁽²⁾	1.5	1.7	1.8	2.0	2.3	2.5	2.7	3.4	3.8	4.0
J. INDUSTRY - MINING & QUARRYING										
Commercial Energy (2)	0.1	0.1	0.1	0.1	0.1	0.1	0.1	0.2	0.2	0.3
Of which: Non-Coking Coal										0.1
Oil Products	-	-	-	-	-	-	-	0.1	0.1	0.1
Electricity	0.1	0.1	0.1	0.1	0.1	0.1	0.1	0.1	0.1	0.1
Total Energy Consumption⁽²⁾	0.1	0.1	0.1	0.1	0.1	0.1	0.1	0.2	0.2	0.3
K. INDUSTRY - NON-FERROUS METALS										
Commercial Energy (2)	0.2	0.2	0.3	0.2	0.3	0.3	0.8	0.5	0.5	0.7
Of which: Non-Coking Coal	0.1	0.1	0.1	0.1	0.1	0.1	0.1	0.1	0.1	0.1
Oil Products	-	-	-	-	-	-	-	-	-	-
Electricity	0.1	0.2	0.2	0.2	0.3	0.3	0.5	0.5	0.5	0.7
Total Energy Consumption⁽²⁾	0.2	0.2	0.3	0.2	0.3	0.3	0.8	0.5	0.5	0.7

TABLE 5-28 (Cont.)
FINAL TRENDS OF ENERGY CONSUMPTIONS IN DIFFERENT SECTORS
ALL INDIA
(Million tonnes of Coal replacement)⁽¹⁾

	1953/4	1954/5	1955/6	1956/7	1957/8	1958/9	1959/60	1960/1	1961/2	1962/3
L. INDUSTRY - TEXTILES										
Commercial Energy ⁽²⁾	1.8	1.9	2.2	4.2	4.2	4.4	4.5	7.8	8.2	9.2
Of which: Non-Coking Coal				1.8	1.8	1.8	1.7	1.8	2.1	2.2
Oil Products (4)				Actual Figures Not Available				2.9	3.2	3.8
Electricity	1.8	1.9	2.2	2.4	2.4	2.6	2.8	2.9	2.9	3.2
Total Energy Consumption ⁽²⁾	1.8	1.9	2.2	4.2	4.2	4.4	4.5	7.6	8.2	9.2
M. INDUSTRY - OTHERS										
Commercial Energy ⁽²⁾	8.4	8.6	8.0	4.7	7.7	7.5	6.5	13.9	15.0	18.8
Of which: Coking Coal	1.4	1.2	0.8	0.8	1.0	0.9	0.2	0.8	0.4	0.5
Non-Coking Coal	5.4	5.6	5.3	1.6	3.8	3.2	2.4	3.1	3.6	5.2
Oil Products (4)				Actual Figures Not Available				5.5	5.8	7.2
Electricity	1.8	1.8	2.1	2.3	2.9	3.4	3.9	4.5	5.2	5.9
Total Energy Consumption ⁽²⁾	8.4	8.6	8.0	4.7	7.7	7.5	6.5	13.9	15.0	18.8
N. AGRICULTURE										
Commercial Energy	1.7	1.8	2.1	2.3	2.8	3.0	3.0	3.1	3.2	3.5
Of which: Non-Coking Coal	0.2	0.2	0.3	0.3	0.3	0.4	0.3	0.2	0.2	0.1
Oil Products	1.3	1.4	1.5	1.7	1.9	2.0	2.0	2.1	2.2	2.3
Electricity	0.2	0.2	0.3	0.3	0.6	0.6	0.7	0.8	1.0	1.1
Total Energy Consumption	1.7	1.8	2.1	2.3	2.8	3.0	3.0	3.1	3.2	3.5
O. DOMESTIC										
Commercial Energy	10.6	11.5	12.5	13.7	14.3	15.0	16.6	17.2	19.1	21.1
Of which: Coke Oven Gas									0.1	0.1
Soft Coke	2.2	2.4	2.5	2.9	2.8	3.1	3.0	2.8	2.8	3.2
Oil Products	7.7	8.3	9.2	8.9	10.4	10.7	12.2	12.9	14.5	15.9
Electricity	0.7	0.8	0.8	0.9	1.1	1.2	1.4	1.5	1.7	1.9
Non-Commercial Energy	125.9	128.0	130.3	132.7	135.2	137.8	141.7	146.1	147.0	148.0
Of which: Dung (dry)	18.6	19.1	19.6	20.1	20.6	21.1	21.3	21.6	21.8	22.0
Firewood	82.2	83.3	84.4	85.6	86.9	88.9	91.7	95.3	95.8	96.5
Waste Products	25.1	25.6	26.3	27.0	27.7	28.4	28.7	29.2	28.4	29.5
Total Energy Consumption	136.5	139.5	142.8	146.4	149.5	152.8	158.3	163.3	166.1	169.1
P. COMMERCIAL										
Commercial Energy	0.5	0.5	0.6	0.6	0.7	0.8	0.9	1.0	1.0	1.1
Of which: Non-Coking Coal	0.1	0.1	0.1	0.1	0.1	0.1	0.1	0.1	0.1	0.1
Electricity	0.4	0.4	0.5	0.5	0.6	0.7	0.8	0.9	0.9	1.0
Total Energy Consumption	0.5	0.5	0.6	0.6	0.7	0.8	0.9	1.0	1.0	1.1
Q. GOVERNMENT										
Commercial Energy	0.8	0.9	1.0	1.0	0.9	1.0	1.2	1.2	1.0	1.2
Of which: Non-Coking Coal	0.5	0.5	0.6	0.6	0.4	0.5	0.6	0.6	0.3	0.4
Electricity	0.3	0.4	0.4	0.4	0.5	0.5	0.6	0.6	0.7	0.8
Total Energy Consumption	0.8	0.9	1.0	1.0	0.9	1.0	1.2	1.2	1.0	1.2
R. OTHER SECTORS										
Commercial Energy	0.1	0.1	0.1	0.1	0.1	0.2	0.2	0.2	-	-
Of which: Electricity	0.1	0.1	0.1	0.1	0.1	0.2	0.2	0.2	-	-
Total Energy Consumption	0.1	0.1	0.1	0.1	0.1	0.2	0.2	0.2	-	-
S. ENERGY SECTOR & LOSSES										
Commercial Energy	2.3	2.3	2.5	2.6	2.9	2.8	3.4	4.2	4.9	5.5
Of which: Coking Coal	0.7	0.7	0.7	0.7	0.8	0.7	0.7	0.8	0.9	0.9
Non-Coking Coal	1.0	1.1	1.1	1.2	1.3	1.3	1.8	1.8	2.1	2.6
Blast Furnace Gas	0.2	0.1	0.2	0.2	0.2	0.2	0.4	0.7	0.8	0.9
Coke Oven Gas & Gas Work Gas	0.1	0.1	0.2	0.1	0.2	0.2	0.2	0.4	0.6	0.5
Electricity	0.3	0.3	0.3	0.4	0.4	0.4	0.5	0.5	0.5	0.6
Total Energy Consumption	2.3	2.3	2.5	2.6	2.9	2.8	3.4	4.2	4.9	5.5

(1) Actual tonnes of coal as well as the amount of coal needed to replace final use of other forms of energy, taking account of relative efficiencies involved. Details in Tables 5-1 to 5-10A.

(2) Do not include oil products for the years for which actual figures for oil products are not available.

(3) Excluding quantities considered as transformed into blast furnace gas.

(4) Actual figures are not available for the past years but estimated figures are included wherever possible in the corresponding table in the main report. Wherever estimated figures are given in the report the totals will differ from those given above in this table.

TABLE 5-27
Energy Consumption in India by State in 1960/1 expressed in
terms of primary sources (1)

(In million tonnes of coal replacement)

State	Coal	Oil (2)	Hydro Power (3)	Total Commer- cial	Dung (dry)	Fire- wood	Waste Pro- ducts	Total Non-com- mercial	Grand Total
Andhra Pradesh	2.4	2.4	0.7	5.5	1.6	8.6	2.5	12.7	18.2
Assam	0.7 ⁽⁴⁾	1.7	—	2.4	0.2	4.2	0.9	5.3	7.7
Bihar	12.5	2.6	0.1	15.2	3.0	6.8	3.2	13.0	28.2
Gujarat	3.7	2.9	—	6.6	0.8	5.7	1.4	7.9	14.5
Jammu & Kashmir	—	0.1	—	0.1	0.1	0.1	0.3	0.5	0.6
Kerala	0.2	1.6	0.5	2.3	0.4	3.5	1.2	5.1	7.4
Maharashtra	3.8	10.4	1.2	15.4	1.5	10.0	2.6	14.1	29.5
Madhya Pradesh	4.7	1.7	—	6.4	1.5	6.2	2.1	9.8	16.2
Madras	1.7	3.3	1.6	6.6	1.2	6.8	2.1	10.1	16.7
Mysore	0.7	1.8	0.9	3.4	1.0	6.6	1.6	9.2	12.6
Orissa	1.5	0.5	0.4	2.4	0.3	7.4	1.3	9.0	11.4
Punjab	2.2 ⁽⁵⁾	2.7	0.9 ⁽⁵⁾	5.8	2.1	5.1	1.4	8.6	14.4
Rajasthan	1.5	0.9	—	2.4	0.9	5.0	1.5	7.4	9.8
Uttar Pradesh	4.8	2.9	0.4	8.1	5.8	11.6	5.0	22.4	30.5
West Bengal	9.5	4.2	0.1	13.8	1.2	7.7	2.1	11.0	24.8
All India	49.9	39.7	6.8	96.4	21.6	95.3	29.2	146.1	242.5

(1) Total internal consumption excluding international ocean going vessels (bunkers) and taking account of the balance of foreign trade and stock changes in primary and secondary forms of energy.

(2) Coal replacement for oil is obtained by multiplying

- a) LDO consumption in power generation by 3
- b) Fuel oil consumption in power generation by 2, and
- c) Total internal final consumption excluding oil refineries consumption by 6.5

(3) Hydro power coal replacement is obtained by deducting transmission and distribution losses at 12% from hydro generation to arrive at units sold and taking one million tonnes coal replacement per TWh (10⁹kWh) sold

(4) Assam figures include Manipur, Tripura and NEFA.

(5) Punjab figures include Himachal Pradesh and Delhi.

TABLE 5-28
Contribution of the various forms of primary energy to the total consumption
of primary energy in the various States in India during 1960/1.
(Percentages)

State	Coal	Oil	Hydro Power	Other Non- commercial Forms	Grand Total
Andhra Pradesh	13.2	13.2	3.9	69.7	100
Assam	9.1	22.0	—	68.9	100
Bihar	44.3	9.2	0.4	46.1	100
Gujarat	25.5	20.0	—	54.5	100
Jammu & Kashmir	—	16.6	—	83.4	100
Kerala	2.7	21.8	6.8	68.9	100
Madhya Pradesh	29.0	10.5	—	60.5	100
Madras	10.2	19.8	9.6	60.4	100
Maharashtra	12.9	35.2	4.1	47.8	100
Mysore	5.8	14.3	7.1	73.0	100
Orissa	13.2	4.4	3.5	78.9	100
Punjab	12.2	19.4	6.5	61.9	100
Rajasthan	15.3	9.2	—	75.5	100
Uttar Pradesh	15.7	9.5	1.3	73.5	100
West Bengal	38.2	16.9	0.4	44.5	100
All India	20.6	16.4	2.8	60.2	100

TABLE 5-28
ENERGY CONSUMPTION IN INDIA BY STATE IN 1980/1 EXPRESSED IN TERMS OF
INDIGENOUS PRIMARY SOURCES AND IMPORTS (1)
(In million tonnes coal replacement)

STATE	Indigenous Production ⁽²⁾				Total	Net (3) Imports or Exports	Stock ⁽⁴⁾ Changes	Bunker	Total Consumption	Net Import as a % of total consumption
	Coal	Oil Products	Hydro Power	Other forms of energy						
Andhra Pradesh	2.8		0.7	12.7	16.0	+2.8		-0.6	18.0	14.4
Assam	0.7	3.1	—	5.3	9.1	-1.4			7.7	
Bihar	27.5		0.1	13.0	40.6	-8.5		-3.3	28.8	
Gujarat				7.9	7.9	+7.0			14.9	47.0
Jammu & Kashmir			—	0.5	0.5	+0.4			0.9	44.5
Kerala			0.5	5.1	5.6	+2.5		-0.5	7.6	32.9
Madhya Pradesh	6.7		—	9.8	16.5	+0.6		-0.4	16.7	3.6
Madras			1.6	10.1	11.7	+5.8		-0.4	16.9	33.1
Maharashtra	0.8		1.2	14.1	16.1	+12.7		-0.5	27.4	48.2
Mysore			0.9	9.2	10.1	+2.4			12.5	19.2
Orissa	0.9		0.4	9.0	10.3	+1.6		-0.1	11.6	13.6
Punjab			0.9	8.6	9.5	+4.4			13.9	31.8
Rajasthan	0.1			7.4	7.5	+2.9			10.4	27.9
Uttar Pradesh			0.4	22.4	22.8	+8.2			31.0	26.5
West Bengal	16.2		0.1	11.0	27.3	-2.3		-0.4	24.0	
All India	55.5	3.1	6.8	148.1	211.5	+38.7		-4.7	242.5	16.0

(1) Coal replacement of oil is obtained by multiplying total internal final consumption excluding oil refineries consumption by 8.5, LDO consumption of power generation (transformation) by 3 and fuel oil consumption in transformation by 2. Hydro power coal replacement is obtained by deducting transmission and transformation losses at 12% from hydro generation and taking 1 Mt coal replacement per TWh (10⁹kWh) sold

(2) Production figures are inclusive of bunkers.

(3) + indicates import and - indicates exports.

(4) - put to stocks.
+ taken from stocks.

TABLE 5-30

FINAL CONSUMPTION OF VARIOUS FORMS OF ENERGY BY STATE IN 1960/1⁽¹⁾

State	(Million tonnes of coal replacement)												
	Coking Coal	Non-Coking Coal	Hard Coke	Soft Coke	Oil Products	Manufactured gas	Electricity	Total Commercial Forms	Dung (dry)	Fire-wood	Waste Products	Total Non-commercial Sources (3)	Total final consumption
Andhra Pradesh	0.05	1.85	0.01		2.35		0.85	5.01	1.8	8.6	2.5	12.7	17.71
Assam (2)		0.64	0.01		1.89		0.04	2.38	0.2	4.2	0.9	5.3	7.66
Bihar	1.44	2.28	1.34	0.18	2.60	0.87	1.60	10.29	3.0	8.8	3.2	13.0	23.29
Gujarat	0.02	2.48	0.03	0.06	2.87		1.07	6.53	0.6	5.7	1.4	7.9	14.43
Jammu & Kashmir					0.14		0.05	0.19	0.1	0.1	0.3	0.5	0.69
Kerala	0.02	0.14			1.63		0.49	2.28	0.4	3.5	1.2	5.1	7.38
Madhya Pradesh	0.27	2.43	0.52	0.03	1.70	0.46	0.61	6.02	1.5	6.2	2.1	9.8	15.82
Madras	0.07	1.27	0.02	0.02	3.26		1.76	6.40	1.2	6.8	2.1	10.1	16.50
Maharashtra	0.14	2.25	0.06	0.23	10.02	0.02	2.84	15.56	1.5	10.0	2.6	14.1	29.66
Mysore	0.04	0.58	0.07		1.32		1.00	3.51	1.0	6.6	1.8	9.2	12.71
Orissa	0.01	0.46	0.36	0.02	0.52	0.18	0.75	2.30	0.3	7.4	1.3	9.0	11.30
Punjab (2)	0.08	1.75	0.12	0.47	2.87		1.14	6.23	2.1	5.1	1.4	8.6	14.83
Rajasthan	0.08	1.23	0.01	0.03	0.91		0.24	2.50	0.9	5.0	1.5	7.4	9.90
Uttar Pradesh	0.22	3.63	0.10	0.24	2.86		1.13	8.18	5.8	11.6	5.0	22.4	30.58
West Bengal	1.00	3.14	1.12	1.51	4.16	0.91	3.04	14.88	1.2	7.7	2.1	11.0	25.88
ALL INDIA	3.44	24.23	3.77	2.77	39.20	2.44	16.41	92.26	21.6	95.3	29.2	146.1	236.36

(1) Total internal final consumption excluding consumption by the energy sector and losses and consumption for transformation, i.e. the final coal consumption does not include the coal consumed in industrial auto producer's power and gas plants; the coke equivalent of the blast furnace gas produced has been deducted from the coke figures to arrive at final coke consumption in steel plants, the final gas consumption does not include the consumption and losses in blast furnaces and under firing of coke ovens.

(2) Assam figures include Manipur, Tripura and NEFA
Punjab figures include Himachal Pradesh and Delhi.

(3) Figures represent consumption in domestic sector.

TABLE 5-31

CONTRIBUTION OF THE VARIOUS FORMS OF PRIMARY AND SECONDARY ENERGY TO THE TOTAL
CONSUMPTION OF ENERGY FOR EACH STATE DURING 1980/1

State	Coking Coal	Non- Coking Coal	Metallur- gical Coke	Non- Metallurgical Coke	Liquid Fuels	Manufactured Gas	Electricity	Non- Commercial Fuels	TOTAL
Andhra	0.3	11.0	0.1		13.3		3.7	71.6	100
Assam		8.3	0.1		22.0		0.5	69.1	100
Bihar	8.2	9.8	5.8	0.7	11.1	3.7	8.9	55.8	100
Gujarat	0.1	17.2	0.2	0.4	19.9		7.4	54.8	100
Jammu & Kashmir					20.3		7.2	72.5	100
Kerala	0.3	1.9			22.0		8.8	69.2	100
Madhya Pradesh	1.7	15.4	3.3	0.2	10.6	2.9	3.9	61.8	100
Madras	0.4	7.7	0.1	0.1	19.8		10.7	61.2	100
Maharashtra	0.5	7.6		0.8	33.8	0.1	9.8	47.6	100
Mysore	0.3	4.6	0.8		14.4		7.9	72.2	100
Orissa	0.1	4.1	3.2	0.2	4.6	1.8	6.8	79.8	100
Punjab	0.6	10.7	0.8	0.2	18.8		8.1	60.8	100
Rajasthan	0.9	12.4	0.1	0.3	9.2		2.4	74.7	100
Uttar Pradesh	0.7	11.9	0.3	0.8	9.3		3.7	73.3	100
West Bengal	3.9	12.1	4.3	5.8	18.1	3.5	11.8	42.5	100
ALL INDIA	1.4	10.2	1.7	1.2	16.4	1.0	6.9	61.2	100

ANNEX 6

Basic Energy Statistics in Kilocalories

CONTENTS

A: INTRODUCTION

B: TABLES

Table

No.

6- 1.	Production and uses of energy sources – All India – 1953/4	
6- 2.	----- do -----	--- do --- – 1954/5
6- 3.	----- do -----	--- do --- – 1955/6
6- 4.	----- do -----	--- do --- – 1956/7
6- 5.	----- do -----	--- do --- – 1957/8
6- 6.	----- do -----	--- do --- – 1958/9
6- 7.	----- do -----	--- do --- – 1959/60
6- 8.	----- do -----	--- do --- – 1960/1
6- 9.	----- do -----	Andhra – 1960/1
6-10.	----- do -----	Assam – 1960/1
6-11.	----- do -----	Bihar – 1960/1
6-12.	----- do -----	Gujarat – 1960/1
6-13.	----- do -----	J. & K. – 1960/1
6-14.	----- do -----	Kerala – 1960/1
6-15.	----- do -----	M.P. – 1960/1
6-16.	----- do -----	Madras – 1960/1
6-17.	----- do -----	Maharashtra – 1960/1
6-18.	----- do -----	Mysore – 1960/1
6-19.	----- do -----	Orissa – 1960/1
6-20.	----- do -----	Punjab – 1960/1
6-21.	----- do -----	Rajasthan – 1960/1
6-22.	----- do -----	U.P. – 1960/1
6-23.	----- do -----	W. Bengal – 1960/1
6-24.	Energy consumption in India by primary source; 1953/4–1960/1	
6-25.	Contribution of the various forms of primary energy to the total consumption of primary energy in India; 1953/4–1960/1	
6-26.	Energy consumption in India by indigenous primary source and imports; 1953/4–1960/1	
6-27.	Final consumption of the various forms of primary and secondary energy in India; 1953/4–1960/1	
6-28.	Percentage of final consumption of the various forms of primary and secondary energy to the total final consumption in India; 1953/4–1960/1	

A. INTRODUCTION (1)

1. In the present Annex, the technically interested reader will find the most important energy supply and consumption data, both past and future, expressed in a common energy unit. The main feature of the following tables, however, is the fact that all sources have been measured by their real energy content. Thus, the actual input or output of energy whether primary or secondary, is measured at all stages of production, transformation and consumption.

2. For instance, whereas the figures for final consumption set out in the Report express the amount of primary energy needed in terms of one source of energy, namely coal, the final consumption figures of the following tables represent the net final consumption, excluding all transformation and distribution losses. A kilowatt-hour is thus counted at 861 kilocalories and the relevant amount of energy needed for its production and transmission appear under "Transformation" and "Losses of the Energy Sector". Similarly coke and gas supplies to final consumers are measured at their actual heat value, the amounts of coal involved in their production appearing at another stage of the energy balance sheet. It should also be noted that, when measuring the actual quantities of energy consumed at the final stage, no attempt has been made to estimate the efficiencies with which the various sources are ultimately used.

3. Thus, the following tables are mainly intended to give a factual statement of the actual amounts of energy involved at each stage of supply, transformation, transmission and consumption. Assuming that the basic statistics are right, the margins of error should be relatively small. A certain amount of estimation has been involved in determining the various heat values used for different grades of coal and the primary energy contained in the falling water has been measured by applying an average hydel power plant efficiency of 85 per cent.

4. Since there is a fundamental difference of definition between the coal replacement and the energy content methods, the tables giving percentage contributions by different sources of energy cannot show the same figures. Whereas the coal replacement figures to a large extent reflect, on the primary side, relative efficiencies in transformation and consumption, the energy content figures state the actual input of different sources at various stages of production, transformation and consumption.

5. The kilocalorie has been chosen although it is recognised that it is not a perfect energy unit and that others might have been chosen. It is a convenient unit, since the heat values of fuels are commonly

known in kilocalories. When used to express total energy demand or supply, kilocalorie figures have the further advantage that they are not likely to be confused with figures relating to an individual source of energy, such as coal or electricity. The kilocalorie has, however, two demerits. The first is that to most readers it implies heat rather than energy in general. The second is that it is a very small unit; for the purpose of the India Energy Study a million million kilocalories (1000 Tcal or 10^{12} kcal) had to be used. This represents the energy content of about 100,000 tonnes of petroleum fuels.

6. The table below sets out the various heat values used in this Annex. Following common practice, only one value has been assigned to liquid fuels. Indian coal constitutes a special problem and it has been thought best to get as close as possible to the actual quantities of energy involved by adopting a series of values varying with product, sector of consumption and time.

CALORIFIC VALUES ASSUMED FOR THE TABLES IN KILOCALORIES

Coal

Coal used in Metallurgical Coke Production:

6640 kcal/kg.

Non-coking Coal used in Utility Power Plants:

Past Years		Forecast
1955:	6040 kcal/kg	1965/6: 4850 kcal/kg
1956:	6000 "	1970/1: 4500 "
1957/8:	5900 "	1975/6: 4400 "
1958/9:	5910 "	1980/1: 4350 "
1959/0:	5780 "	
1960/1:	5660 "	
1961/2:	5640 "	

Non-coking Coal used in Final Consumption:

1953:	6410 kcal/kg
1954:	6400 "
1955:	6430 "
1956:	6440 "
1957/8:	6460 "
1958/9:	6470 "
1959/0:	6540 "
1960/1:	6580 "

Average Value applied for coal if no precise information available: 6440 kcal/kg.

Other Fuels

Hard Coke	6100 kcal/kg
Soft Coke	5000 kcal/kg
Oil	10000 kcal/kg
Blast Furnace Gas	950 kcal/m ³
Coke Oven Gas	4500 kcal/m ³
Gas Work Gas	4200 kcal/m ³
Electricity	861 kcal/kWh
Power Alcohol	4730 kcal/kg
Dry Dung	2400 kcal/kg
Firewood and Waste	4700 kcal/kg

(1) The following notes and tables have been adapted to conditions in India from Annex-1 of the Report, "Towards a New Energy Pattern in Europe" by the Energy Advisory Commission of O.F.E.C., Paris, 1960.

PRODUCTION AND USES OF ENERGY SOURCES - ALL INDIA - 1953

10¹² KILOCALORIES

	Coking Coal	Non-Coking Coal	Metal-lurgical Coke	Non-Metal-lurgical Coke	Crude Oil ⁶	Total Oil Products ⁶	Motor Spirit	Aviation and Jet Fuel	HSDG	LDO	Kerosene	LPG	Fuel Oil	Vaporizing Oil & Ref. Fuel	Manufactured Gas			Electricity		Non-Comml. Energy			Grand Total
	1	2	3	4	5	6	7	8	9	10	11	12	13	14	15	16	17	18	19	20	21	22	23
PRODUCTION AND CONSUMPTION																							
A. PRIMARY SOURCES OF ENERGY																							
PRODUCTION	91.5	144.6			2.0													2.9 ¹		111.2 ⁷	406.0 ⁷	124.0 ⁷	882.2
NET BALANCE OF EXTERNAL TRADE		-12.5																					-12.5
BUNKERS		-2.6																					-2.6
STOCK CHANGES	-5.8	+4.3																					-1.5
TOTAL CONSUMPTION	85.7	133.8			2.0													2.9		111.2	406.0	124.0	865.6
QUANTITIES TRANSFORMED	-33.2	-33.9			-2.0													-2.9					-72.0
INTERNAL FINAL CONSUMPTION	52.5	99.9																		111.2	406.0	124.0	793.6
B. SECONDARY SOURCES OF ENERGY																							
PRODUCTION			13.2	8.2		2.0	0.5		0.3	0.6			0.2	0.2	3.7	3.5	0.2	5.8 ²	1.8				38.4
NET BALANCE OF EXTERNAL TRADE			-0.2	-0.1		+34.8	+7.4	+0.9	+2.8	+4.0	+11.4		+7.9	+0.4				+0.1 ³	-0.1 ⁴				34.5
BUNKERS						-2.6							-2.5										-2.6
STOCK CHANGES			-0.4	-1.0		+0.6	+0.2		+0.1	-0.1	-0.1		+0.5										-0.8
TOTAL CONSUMPTION			12.6	7.1		34.8	8.1	0.9	3.1	4.1	11.9		6.1	0.6	3.7	3.5	0.2	5.9	1.7				69.5
QUANTITIES TRANSFORMED			-3.7			-0.7				-0.7					-0.6	-0.1							-5.1
INTERNAL FINAL CONSUMPTION			8.9	7.1		34.1	8.1	0.9	3.1	3.4	11.9		6.1	0.6	3.1	3.4	0.2	5.9	1.7				64.4
TOTAL INTERNAL FINAL CONSUMPTION	52.5	99.9	8.9	7.1		34.1	8.1	0.9	3.1	3.4	11.9		6.1	0.6	3.1	3.4	0.2	5.9	1.7	111.2	406.0	124.0	858.0
BREAKDOWN OF INTERNAL FINAL CONSUMPTION																							
A. CONSUMPTION BY THE ENERGY																							
SECTOR AND LOSSES	4.6	6.6				0.2								0.2	0.9	0.7		1.3	0.1				14.4
of which Cool Mines & Washeries	4.6	6.6																0.2	0.1				11.5
Electric Power Plants*															0.7	0.1		0.3					0.3
Coke Ovens														0.2									0.8
Oil Refineries & Field Operation						0.2									0.2	0.6		0.8					0.2
Losses																							1.6
B. CONSUMPTION BY OTHER SECTORS																							
TRANSPORTATION	33.4	45.7				11.7	8.1	0.9	2.1				0.6					0.4	0.1				91.3
of which Road						10.1	8.1		2.0									0.4	0.1				10.1
Railroads	33.4	44.2				0.1			0.1														78.2
Tramways													0.6										2.1
Waterways		1.5				0.6							0.6										0.9
Air						0.9		0.9															83.3
INDUSTRY	14.5	42.5	8.9			8.3			0.7	2.0	0.1		5.5		2.2	2.7		2.8	1.4				83.3
of which Mining & Quarrying																		0.1	0.2				0.1
Fertilizer				1.0																			
Heavy Chemical																							
Structural Clay Products		0.5																0.1	0.3				
Cement		7.2													2.2	2.7		0.1	0.3				
Iron and Steel	5.3		7.9																				
Non-ferrous		0.3																1.3	0.3				
Textiles																		1.2	0.2				
Other	9.2	34.5							0.3	1.4								0.2					3.4
AGRICULTURE		1.1				2.1												0.6		111.2	406.0	124.0	660.9
DOMESTIC				7.1		11.8					11.8							0.3					1.2
COMMERCIAL		0.9																0.3					3.4
GOVERNMENT		3.1																	0.1 ⁵				0.1
OTHERS																							
TOTAL INTERNAL FINAL CONSUMPTION	52.5	99.9	8.9	7.1		34.1	8.1	0.9	3.1	3.4	11.9		6.1	0.6	3.1	3.4	0.2	5.9	1.7	111.2	406.0	124.0	858.0

Note: Quantity less than 5 x 10¹⁰ not shown

↑ Value not yet isolated.

- (1) Energy content of the falling water, assuming an average efficiency of 85%
- (2) Of which, hydel production 2.5, thermal production 3.3
- (3) Purchase from Non-Utilities. (4) Sale to Utilities
- (5) Sale to other agencies excluding utilities, break-up of which is not available.
- (6) Only quantities needed for energy purposes.
- (7) For our purposes we have assumed production of non-commercial fuels as equal to final consumption for energy purposes.

* Covering only losses in auxiliaries of power plant. The actual transformation losses can be calculated by the difference between input and output on hydel

PRODUCTION AND USES OF ENERGY SOURCES - ALL INDIA - 1954/5
10¹² KILOCALORIES

	Coking Coal	Non-Coking Coal	Metal-lurgical Coke	Non-Metal-lurgical Coke	Crude Oil ¹	Total Oil Products ⁴	Motor Spirit	Aviation and Jet Fuel	HSDO	LDO	Kerosene	LPG	Fuel Oil	Vaporizing Oil & Ref. Fuel	Manufactured Gas			Electricity		Non-Comm. Energy			Grand Total	
	1	2	3	4	5	6	7	8	9	10	11	12	13	14	Blast Furnace	Coke Oven	Gas Works	Utility	Non-Utility	Dung (Dry)	Fire-wood	Waste Products	23	
PRODUCTION AND CONSUMPTION																								
A. PRIMARY SOURCES OF ENERGY																								
PRODUCTION	90.1	151.8			3.1																			
NET BALANCE OF EXTERNAL TRADE		-11.9			11.7													3.3 ¹		114.2 ⁵	412.0 ⁵	127.0 ⁵	901.5	
BUNKERS		-2.3																					-0.2	
STOCK CHANGES	-5.3	-2.3																					-2.3	
TOTAL CONSUMPTION	84.8	135.3			14.8																		-7.6	
QUANTITIES TRANSFORMED	-35.8	-35.1			-14.8													3.3		114.2	412.0	127.0	891.4	
INTERNAL FINAL CONSUMPTION	49.0	100.2																-3.3		114.2	412.0	127.0	-89.0	
B. SECONDARY SOURCES OF ENERGY																								
PRODUCTION			14.8	8.8	14.8	3.5	1.4																	
NET BALANCE OF EXTERNAL TRADE			-0.2	-0.1	+29.3	+5.4	1.0	+2.7		7.3	1.9		4.3	2.4	4.0	4.0	0.2	6.5 ²	1.8				54.9	
BUNKERS					-2.6	-2.3	-0.7	-0.4		3.2	+11.3		+5.3	+0.4									29.0	
STOCK CHANGES			-1.2	-0.9	-2.3	-0.7				0.1			-2.5										-2.6	
TOTAL CONSUMPTION			13.4	7.8	39.2	8.2	1.0	3.7		0.2	-0.4		-0.6										-4.4	
QUANTITIES TRANSFORMED			-4.0		-0.8					4.2	12.8		6.5	2.8	4.0	4.0	0.2	6.5	1.8				76.9	
INTERNAL FINAL CONSUMPTION			9.4	7.8	38.4	8.2	1.0	3.7		0.8					-0.7	-0.1							-5.6	
TOTAL INTERNAL FINAL CONSUMPTION	49.0	100.2	9.4	7.8	38.4	8.2	1.0	3.7		3.4	12.8		6.5	2.8	3.3	3.9	0.2	6.5	1.8				71.3	
BREAKDOWN OF INTERNAL FINAL CONSUMPTION																								
A. CONSUMPTION BY THE ENERGY																								
SECTOR AND LOSSES	4.5	6.9			2.3																			
of which Coal Mines & Washeries	4.5	6.9												2.3	0.7	0.7		1.3	0.1				16.5	
Electric Power Plants*																		0.2	0.1				11.7	
Coke Ovens																		0.3					0.3	
Oil Refineries & Field Operation					2.3										0.5	0.1							0.6	
Losses														2.3									2.3	
B. CONSUMPTION BY OTHER SECTORS																								
TRANSPORTATION	32.3	43.5			12.4	8.2	1.0	2.6																
of which Road					10.6	8.2		2.4					0.6											88.7
Railroads	32.3	41.7			0.2			0.2																10.6
Tromways																								74.7
Waterways		1.8			0.6																			2.4
Air					1.0		1.0						0.6											1.0
INDUSTRY	12.2	44.1	9.4		8.8			0.8																85.0
of which Mining & Quarrying									2.0		0.1		5.9		2.6	3.2		3.2	1.5					
Fertilizer			1.2															0.1						
Heavy Chemical																			0.2					
Structural Clay Products		0.5																						
Cement		7.5																						
Iron and Steel	4.3		8.2																	0.1	0.3			
Non-ferrous		0.3													2.6	3.2		0.2	0.4					
Textiles																		0.1	0.1					
Other	7.9	35.8																1.4	0.3					
AGRICULTURE		1.4			2.2			0.3										1.3	0.2					
DOMESTIC				7.8	12.7					1.4								0.2					3.8	
COMMERCIAL		0.8									12.7						0.2	0.7		114.2	412.0	127.0	674.6	
GOVERNMENT		3.5																0.4					1.2	
OTHERS																		0.3					3.8	
TOTAL INTERNAL FINAL CONSUMPTION	49.0	100.2	9.4	7.8	38.4	8.2	1.0	3.7		3.4	12.8		6.5	2.8	3.3	3.9	0.2	6.5	1.8	114.2	412.0	127.0	873.7	

(1) Energy content of the falling water, assuming an average efficiency of 85%.
 (2) Of which, hydel production 2.8, thermal production 3.7
 (3) Sale to other agencies excluding utilities, break-up of which is not available.
 (4) Only quantities needed for energy purposes.
 (5) For our purposes we have assumed production of non-commercial fuels as equal to final consumption for energy uses only.
 * Covering only losses in auxiliaries of power plant. The actual transformation losses can be calculated by the difference between input and output on hydel and thermal plant.

NOTE: Quantity less than 5 x 10¹⁰ not shown.
 ↑ Value not yet isolated.

PRODUCTION AND USES OF ENERGY SOURCES - ALL INDIA - 1955-56
10¹² KILOCALORIES

	Coking Coal	Non-Coking Coal	Metal-lurgical Coke	Non-Metal-lurgical Coke	Crude Oil	Total Oil Products*	Motor Spirit	Aviation and Jet Fuel	HSDO	LDO	Kerosene	LPG	Fuel Oil	Vaporizing Oil & Ref. Fuel	Manufactured Gas			Electricity		Non-Comm. Energy			Grand Total	
	1	2	3	4	5	6	7	8							Utility	Non-Utility	Dung (Dry)	Fire-wood	Waste Products	18	19	20		21
PRODUCTION AND CONSUMPTION																								
A. PRIMARY SOURCES OF ENERGY																								
PRODUCTION	89.4	161.0			3.6																			
NET BALANCE OF EXTERNAL TRADE		-10.2			30.0														3.8 ¹		117.3 ⁵	417.0 ⁵	130.0 ⁵	922.1
BUNKERS		-1.5																						19.8
STOCK CHANGES	-4.9	-7.9			-0.2																			-1.5
TOTAL CONSUMPTION	84.5	141.4			33.4																			-13.0
QUANTITIES TRANSFORMED	-37.8	-38.4			-33.4																			927.4
INTERNAL FINAL CONSUMPTION	46.7	103.0																	-3.8		117.3	417.0	130.0	-113.4
B. SECONDARY SOURCES OF ENERGY																								
PRODUCTION			15.8	9.1		33.4	8.4		3.4															
NET BALANCE OF EXTERNAL TRADE			-0.1	-0.1		+15.2	+0.2	1.2	+1.4															75.4
BUNKERS						-2.9																		15.0
STOCK CHANGES			-1.0	-0.5		-2.1	-0.1		-0.2															-2.9
TOTAL CONSUMPTION			14.7	8.5		43.6	8.5	1.2	4.6															-3.6
QUANTITIES TRANSFORMED			-3.8			-0.8			4.3															83.9
INTERNAL FINAL CONSUMPTION			10.9	8.5		42.8	8.5	1.2	4.6															-5.3
TOTAL INTERNAL FINAL CONSUMPTION	46.7	103.0	10.9	8.5		42.8	8.5	1.2	4.6												117.3	417.0	130.0	814.0
BREAKDOWN OF INTERNAL FINAL CONSUMPTION																								
A. CONSUMPTION BY THE ENERGY																								
SECTOR AND LOSSES	4.8	7.3				3.2																		18.5
of which Coal Mines & Washeries	4.8	7.3																						12.4
Electric Power Plants*																								0.3
Coke Ovens																								0.7
Oil Refineries & Field Operation						3.2																		3.2
Losses																								1.9
B. CONSUMPTION BY OTHER SECTORS																								
TRANSPORTATION	34.8	46.0				13.6	8.5	1.2	3.3															95.0
of which Road						11.6	8.5		3.1															11.6
Railroads	34.8	44.0				0.2			0.2															79.5
Tramways																								0.1
Waterways		2.0				0.6																		2.6
Air						1.2		1.2					0.6											1.2
INDUSTRY	7.1	43.4	10.9			9.5																		81.6
of which Mining & Quarrying																								
Fertilizer				1.2																				
Heavy Chemical		0.1																						
Structural Clay Products		0.5																						
Cement		8.3																						
Iron and Steel	2.9		9.7																					
Non-ferrous		0.4																						
Textiles																								
Other	4.2	34.1																						
AGRICULTURE		2.1				2.3																		4.6
DOMESTIC				8.5		14.2																		687.9
COMMERCIAL		0.8																						1.2
GOVERNMENT		3.4																						3.7
OTHERS																								0.1
TOTAL INTERNAL FINAL CONSUMPTION	46.7	103.0	10.9	8.5		42.8	8.5	1.2	4.6												117.3	417.0	130.0	892.6

(1) Energy content of the falling water, assuming an average efficiency of 85%.
(2) Of which, hydel production 3.2, thermal production 4.1.
(3) Sale to other agencies excluding utilities, break-up of which is not available.
(4) Only quantities needed for energy purposes.
(5) For our purposes we have assumed production of non-commercial fuels as equal to final consumption for energy uses only.
* Covering only losses in auxiliaries of power plant. The actual transformation losses can be calculated by the difference between input and output on hydel and thermal plant.

Note: Quantity less than 5 x 10¹⁰ kcal not shown.

↑ Value not yet isolated.

PRODUCTION AND USES OF ENERGY SOURCES - ALL INDIA - 1956
10¹² KILOCALORIES

	Coking Coal	Non-Coking Coal	Metal-lurgical Coke	Non-Metal-lurgical Coke	Crude Oil ¹	Total Oil Products ⁴	Motor Spirit	Aviation and Jet Fuel	HSD ²	LDO	Kerosene	LPG	Fuel Oil	Vaporizing Oil & Ref. Fuel	Manufactured Gas			Electricity		Non-Comml. Energy			Grand Total
	1	2	3	4	5	6	7	8	9	10	11	12	13	14	Blast Furnace	Coke Oven	Gas Works	Utility	Non-Utility	Dung (Dry)	Fire-wood	Waste Products	23
PRODUCTION AND CONSUMPTION																							
A. PRIMARY SOURCES OF ENERGY																							
PRODUCTION	93.7	169.0			4.1																		
NET BALANCE OF EXTERNAL TRADE		-10.8			36.8													4.3 ¹		120.2 ⁵	423.0 ⁵	133.5 ⁵	947.8
BUNKERS		-1.5																					26.0
STOCK CHANGES	-4.1	-7.7			+0.2																		-1.5
TOTAL CONSUMPTION	89.6	149.0			41.1																		-11.6
QUANTITIES TRANSFORMED	-37.8	-40.0			-41.1																		960.7
INTERNAL FINAL CONSUMPTION	51.8	109.0																-4.3		120.2	423.0	133.5	-123.2
B. SECONDARY SOURCES OF ENERGY																							
PRODUCTION			15.5	9.1		41.1	9.8		4.8	2.9	5.6		14.6	3.4	3.8	3.6	0.2	8.3 ²	2.0				83.6
NET BALANCE OF EXTERNAL TRADE			-0.1	-0.1		+11.0	-1.1	+1.1	+1.1	+2.2	+9.9		-2.5	+0.4									10.8
BUNKERS						-3.8				-0.3			-3.5										-3.8
STOCK CHANGES			-1.2	+0.8		-0.7	-0.1	+0.3	+0.1	-0.3			-0.8	+0.1									-1.1
TOTAL CONSUMPTION			14.2	9.8		47.6	8.6	1.4	5.9	4.5	15.5		7.8	3.9	3.8	3.6	0.2	8.3	2.0				89.5
QUANTITIES TRANSFORMED			-3.8			-1.1				-0.8			-0.3		-0.7								-5.6
INTERNAL FINAL CONSUMPTION			10.4	9.8		46.5	8.6	1.4	5.1	3.7	15.5		7.5	3.9	3.1	3.6	0.2	8.3	2.0				83.9
TOTAL INTERNAL FINAL CONSUMPTION	51.8	109.0	10.4	9.8		46.5	8.6	1.4	5.1	3.7	15.5		7.5	3.9	3.1	3.6	0.2	8.3	2.0	120.2	423.0	133.5	921.4
BREAKDOWN OF INTERNAL FINAL CONSUMPTION																							
A. CONSUMPTION BY THE ENERGY																							
SECTOR AND LOSSES	4.8	7.7				3.4								3.4	0.8	0.7		1.6	0.1				19.1
of which Coal Mines & Washeries	4.8	7.7																0.2	0.1				12.8
Electric Power Plants*																		0.3					0.3
Coke Ovens															0.5	0.1							0.6
Oil Refineries & Field Operation						3.4								3.4									3.4
Losses															0.3	0.6		1.1					2.0
B. CONSUMPTION BY OTHER SECTORS																							
TRANSPORTATION	37.8	51.4				15.0	8.6	1.4	4.3				0.7					0.6	0.1				104.9
of which Road						12.6	8.6		4.0														12.6
Railroads	37.8	49.5				0.4			0.3				0.1					0.5	0.1				88.3
Tramways																		0.1					0.1
Waterways		1.9				0.6							0.6										2.5
Air						1.4		1.4															1.4
INDUSTRY	9.2	43.2	10.4			10.2				2.2	0.2		6.8		2.3	2.9		4.2	1.7				84.1
of which Mining & Quarrying																		0.1					
Fertilizer			1.2															0.1	0.3				
Heavy Chemical		2.0																0.1	0.1				
Structural Clay Products		9.8																					
Cement		9.3																					
Iron and Steel	4.1		9.2												2.3	2.9		0.1	0.3				
Non-ferrous		0.2																0.1	0.1				
Textiles		11.8																1.7	0.3				
Other	5.1	10.1																1.6	0.3				
AGRICULTURE		1.9				2.6			0.4	1.5					0.5			0.2					4.7
DOMESTIC				9.8		15.3					15.3							0.8		120.2	423.0	133.5	702.8
COMMERCIAL		0.7																0.5					1.2
GOVERNMENT		4.1																0.4					4.5
OTHERS																			0.1 ³				0.1
TOTAL INTERNAL FINAL CONSUMPTION	51.8	109.0	10.4	9.8		46.5	8.6	1.4	5.1	3.7	15.5		7.5	3.9	3.1	3.6	0.2	8.3	2.0	120.2	423.0	133.5	921.4

(1) Energy content of the falling water, assuming an average efficiency of 85%.
 (2) Of which, hydel production 3.7, thermal production 4.6.
 (3) Sale to other agencies excluding utilities, break-up of which is not available.
 (4) Only quantities needed for energy purposes.
 (5) For our purposes we have assumed production of non-commercial fuels as equal to final consumption for energy uses only.
 * Covering only losses in auxiliaries of power plant. The actual transformation losses can be calculated by the difference between input and output on hydel and thermal plant.

Note: Quantity less than 5 x 10¹⁰ kcal not shown.
 ↑ Value not yet isolated.

PRODUCTION AND USES OF ENERGY SOURCES - ALL INDIA - 1957/8

10¹² KILOCALORIES

	Coking Coal	Non-Coking Coal	Metal-lurgical Coke	Non-Metal-lurgical Coke	Crude Oil ⁵	Total Oil Products ⁵	Motor Spirit	Aviation and Jet Fuel	HSDO	LDO	Kerosene	LPG	Fuel Oil	Vaporizing Oil & Ref. Fuel	Manufactured Gas		Electricity		Non-Comml. Energy			Grand Total	
	1	2	3	4	5	6	7	8	9	10	11	12	13	14	15	16	17	18	19	20	21	22	23
PRODUCTION AND CONSUMPTION																							
A. PRIMARY SOURCES OF ENERGY																							
PRODUCTION	100.2	186.6			4.4	0.3 ⁴	0.3																
NET BALANCE OF EXTERNAL TRADE		-10.9			42.3																		
BUNKERS		-1.2																5.1 ¹		123.5 ⁶	429.9 ⁶	137.0 ⁶	987.0
STOCK CHANGES	-4.6	-2.6			-0.3																		31.4
TOTAL CONSUMPTION	95.6	171.9			46.4	0.3	0.3																-1.2
QUANTITIES TRANSFORMED	-41.2	-40.4			-46.4																		-7.5
INTERNAL FINAL CONSUMPTION	54.4	131.5				0.3	0.3											5.1		123.5	429.9	137.0	1009.7
B. SECONDARY SOURCES OF ENERGY																							
PRODUCTION			16.4	9.4		46.4	10.3	0.1	6.4	3.6													
NET BALANCE OF EXTERNAL TRADE			-0.2	-0.2		11.2	-2.1	+1.3	+1.2	+1.5	6.2												
BUNKERS						-4.3				+10.7			16.0	3.8		4.0	3.8	0.2	9.9 ²	2.0			
STOCK CHANGES			-1.9	+0.2		-1.4	-0.1	+0.3	+0.1	-0.4			-1.8	+0.4									92.1
TOTAL CONSUMPTION			14.3	9.4		51.9	8.1	1.7	7.7	4.7	-0.7		-3.9										10.8
QUANTITIES TRANSFORMED			-4.0			-2.0				16.2			9.3	4.2		4.0	3.8	0.2	9.9	2.0			-4.3
INTERNAL FINAL CONSUMPTION			10.3	9.4		49.9	8.1	1.7	7.7	0.8			-1.2	4.2	-0.6	3.8	0.2	9.9	2.0				-3.1
TOTAL INTERNAL FINAL CONSUMPTION	54.4	131.5	10.3	9.4		50.2	8.4	1.7	7.7	3.9	16.2		8.1	4.2	3.4	3.8	0.2	9.9	2.0	123.5	429.9	137.0	88.9
BREAKDOWN OF INTERNAL FINAL CONSUMPTION																							
A. CONSUMPTION BY THE ENERGY																							
SECTOR AND LOSSES	5.1	8.7				3.7																	
of which Coal Mines & Washeries	5.1	8.7																					
Electric Power Plants*														3.7	1.1	0.8		1.9	0.1				21.4
Coke Ovens																		0.2	0.1				14.1
Oil Refineries & Field Operation						3.7												0.4					0.4
Losses														3.7	0.7	0.1							0.8
B. CONSUMPTION BY OTHER SECTORS																							
TRANSPORTATION	37.8	57.9				16.6	8.4	1.7	5.7	0.1													
of which Road						13.7	8.4		5.3	0.1													
Railroads	37.8	55.8				0.5			0.4														113.0
Tramways																							13.7
Waterways		2.1				0.7			0.1														94.7
Air						1.7		1.7					0.6										0.1
INDUSTRY	11.5	59.6	10.3			11.1			11	2.3	0.2		7.4			2.3	3.0						2.8
of which Mining & Quarrying																							1.7
Fertilizer			1.2																				104.5
Heavy Chemical		2.4																					
Structural Clay Products		9.8																					
Cement		11.3																					
Iron and Steel	4.7		9.1																				
Non-ferrous		0.2														2.3	3.0						
Textiles		11.7																					
Other	6.8	24.2																					
AGRICULTURE		1.8				2.8			0.8	5													
DOMESTIC				9.4		16.0					16.0												
COMMERCIAL		0.6																					5.1
GOVERNMENT		2.9																					717.0
OTHERS																							1.1
TOTAL INTERNAL FINAL CONSUMPTION	54.4	131.5	10.3	9.4		50.2	8.4	1.7	7.7	3.9	16.2		8.1	4.2	3.4	3.8	0.2	9.9	2.0	123.5	429.9	137.0	965.5

Note: - Quantity less than 5 x 10¹⁰ kcal not shown

↑ Value not yet isolated.

- (1) Energy content of the falling water, assuming an average efficiency of 85%.
 - (2) Of which hydel production 4.4, Thermal production 5.5.
 - (3) Sale to other agencies excluding utilities, break-up of which is not available.
 - (4) This represents production of power alcohol which is a substitute fuel.
 - (5) Only quantities needed for energy purposes.
 - (6) For our purposes we have assumed production of non-commercial fuels as equal to fuel consumption for energy uses only.
- * Covering only losses in auxiliaries of power plant. The actual transformation losses can be calculated by the difference between input and output on hydel and thermal plant.

PRODUCTION AND USES OF ENERGY SOURCES - ALL INDIA - 1958/9
10¹² KILOCALORIES

	Coking Coal	Non-Coking Coal	Metal-lurgical Coke	Non-Metal-lurgical Coke	Crude Oil ⁵	Total Oil Products ⁵	Motor Spirit	Aviation and Jet Fuel	HSDC	LDO	Kerosene	LPG	Fuel Oil	Vaporizing Oil & Ref. Fuel	Manufactured Gas			Electricity		Non-Comml. Energy			Grand Total
	1	2	3	4	5	6	7	8	9	10	11	12	13	14	15	16	17	18	19	20	21	22	23
PRODUCTION AND CONSUMPTION																							
A. PRIMARY SOURCES OF ENERGY					4.5	0.3 ⁴	0.3											5.9 ¹		126.7 ⁶	436.0 ⁶	141.0 ⁶	1014.7
PRODUCTION	99.8	200.5			44.4																		33.6
NET BALANCE OF EXTERNAL TRADE		-10.8																					-0.9
BUNKERS		-0.9																					-8.6
STOCK CHANGES	-4.7	-3.9			48.9	0.3	0.3											5.9		126.7	436.0	141.0	1038.8
TOTAL CONSUMPTION	95.1	184.9			-48.9													-5.9					-148.2
QUANTITIES TRANSFORMED	-48.0	-45.4				0.3	0.3																890.6
INTERNAL FINAL CONSUMPTION	47.1	139.5																					
B. SECONDARY SOURCES OF ENERGY			20.3	10.2		48.9	9.7		8.1	4.4	6.7		16.5	3.5	5.0	4.9	0.3	11.2 ²	2.2				103.0
PRODUCTION			-0.2	-0.2		+12.4	-2.0	+1.2	+2.0	+1.0	+11.1		-1.3	+0.4									12.0
NET BALANCE OF EXTERNAL TRADE						-4.1				-0.2			-3.9										-4.1
BUNKERS			-0.6	+0.3		-1.8		+0.7	-0.6	-0.2	-1.1		-0.6										-2.1
STOCK CHANGES			19.5	10.3		55.4	7.7	1.9	9.5	5.0	16.7		10.7	3.9	5.0	4.9	0.3	11.2	2.2				108.8
TOTAL CONSUMPTION			-5.0			-2.5				-0.9			-1.6		-1.1	-0.1							-8.7
QUANTITIES TRANSFORMED			14.5	10.3		52.9	7.7	1.9	9.5	4.1	16.7		9.1	3.9	3.9	4.8	0.3	11.2	2.2				100.1
INTERNAL FINAL CONSUMPTION									8.5	4.1	16.7		9.1	3.9	3.9	4.8	0.3	11.2	2.2	126.7	436.0	141.0	990.7
TOTAL INTERNAL FINAL CONSUMPTION	47.1	139.5	14.5	10.3		53.2	8.0	1.9	8.5	4.1	16.7		9.1	3.9	3.9	4.8	0.3	11.2	2.2	126.7	436.0	141.0	990.7
BREAKDOWN OF INTERNAL FINAL CONSUMPTION																							
A. CONSUMPTION BY THE ENERGY SECTOR AND LOSSES	5.1	8.2				3.4												2.2	0.1				21.6
of which Coal Mines & Washeries	5.1	8.2																0.2	0.1				13.6
Electric Power Plants*																		0.5					0.5
Coke Ovens																							0.9
Oil Refineries & Field Operation						3.4								3.4	0.8	0.1							3.4
Losses															0.6	1.1		1.5					3.2
B. CONSUMPTION BY OTHER SECTORS						17.9	8.0	1.9	7.2	0.1			0.7					0.6	0.1				114.8
TRANSPORTATION	30.3	65.9				14.6	8.0		7.2	0.1								0.5	0.1				14.6
of which Road						0.6												0.1					95.1
Railroads	30.3	63.6							0.1	0.1			0.6										0.1
Tramways						0.8																	3.1
Waterways		2.3				1.9		1.9															1.9
Air						12.4			1.2	2.4	0.2		8.4		2.5	3.6		5.8	1.8				110.9
INDUSTRY	11.7	58.6	14.5															0.1	0.3				
of which Mining & Quarrying																		0.1	0.1				
Fertilizer				1.2																			
Heavy Chemical		2.3																0.2	0.4				
Structural Clay Products		12.6																0.5	0.3				
Cement		11.3													2.5	3.6		0.2	0.1				
Iron and Steel	5.9		13.3															1.8	0.3				
Non-ferrous		0.3																2.6	0.3				
Textiles		11.4																0.5					6.2
Other	5.8	20.7				3.0			0.1	1.6				0.5				1.0		126.7	436.0	141.0	731.8
AGRICULTURE		2.7				16.5												0.6					1.2
DOMESTIC				10.3														0.5					4.0
COMMERCIAL		0.6																	0.2 ³				0.2
GOVERNMENT		3.5																					
OTHERS								1.9	9	4.1	16.7		9.1	3.9	3.9	4.8	0.3	11.2	2.2	126.7	436.0	141.0	990.7
TOTAL INTERNAL FINAL CONSUMPTION	47.1	139.5	14.5	10.3		53.2	8.0	1.9	9	4.1	16.7		9.1	3.9	3.9	4.8	0.3	11.2	2.2	126.7	436.0	141.0	990.7

Note: Quantity less than 5 x 10¹⁰ kcal not shown.

↑ Value not yet isolated.

- (1) Energy content of the falling water, assuming an average efficiency of 85%.
- (2) Of which hydel production 5.0, Thermal production 6.2
- (3) Sale to other agencies excluding utilities, break-up of which is not available.
- (4) This represents production of power alcohol which is a substitute fuel.
- (5) Only quantities needed for energy purposes.
- (6) For our purposes we have assumed production of non-commercial fuels as equal to final consumption for energy uses only.

* Covering only losses in auxiliaries of power plant. The actual transformation losses can be calculated by the difference between input and output on hydel

PRODUCTION AND USES OF ENERGY SOURCES - ALL INDIA - 1959/6

10¹² KILOCALORIES

	Coking Coal	Non-Coking Coal	Metal-lurgical Coke	Non-Metal-lurgical Coke	Crude Oil ⁵	Total Oil Products ⁵	Motor Spirit	Aviation and Jet Fuel	HSDO	LDO	Kerosene	LPG	Fuel Oil	Vaporizing Oil & Ref. Fuel	Manufactured Gas			Electricity		Non-Comm. Energy			Grand Total		
	1	2	3	4	5	6	7	8	9	10	11	12	13	14	Blast Furnace	Coke Oven	Gas Works	Utility	Non-Utility	Dung (Dry)	Fire-wood	Waste Products	23		
PRODUCTION AND CONSUMPTION																									
A. PRIMARY SOURCES OF ENERGY																									
PRODUCTION	94.0	216.3			4.5	0.2	0.2 ⁴																		
NET BALANCE OF EXTERNAL TRADE		-8.8			47.7																				
BUNKERS		-0.9																	7.1 ¹		128.0 ⁶	452.0 ⁶	142.0 ⁶	1044.1	
STOCK CHANGES	-1.5	-17.1			-0.4																			38.9	
TOTAL CONSUMPTION	92.5	189.5			51.8	0.2	0.2																	-0.9	
QUANTITIES TRANSFORMED	-57.6	-46.2			-51.8																			-19.0	
INTERNAL FINAL CONSUMPTION	34.9	143.3				0.2	0.2												-7.1		128.0	452.0	142.0	1063.1	
B. SECONDARY SOURCES OF ENERGY																									
PRODUCTION			26.9	9.8		51.8	9.7		9.9	4.8	7.8	0.1	16.6	3.0	7.5	6.7	0.3	12.9 ²	2.5					118.4	
NET BALANCE OF EXTERNAL TRADE			-0.2	-0.2		+14.9	-1.8	+1.4	+1.8	1.2	+12.0			+0.3											14.5
BUNKERS						-3.7				0.2															-3.7
STOCK CHANGES			-1.3	+0.3		-1.9	-0.1	+0.9	-0.6	0.2	-1.0			-3.5											-2.9
TOTAL CONSUMPTION			25.4	9.9		61.1	7.8	2.3	11.0	5.6	18.8	0.1	12.2	3.3	7.5	6.7	0.3	12.9	2.5						-2.9
QUANTITIES TRANSFORMED			-7.5			-3.4				1.0															126.3
INTERNAL FINAL CONSUMPTION			17.9	9.9		57.7	7.8	2.3	11.0	4.6	18.8	0.1	9.8	3.3	-1.6	-0.5	0.3	12.9	2.5						-13.0
TOTAL INTERNAL FINAL CONSUMPTION	34.9	143.3	17.9	9.9		57.9	8.0	2.3	11.0	4.6	18.8	0.1	9.8	3.3	5.9	6.2	0.3	12.9	2.5	128.0	452.0	142.0		1013.7	
BREAKDOWN OF INTERNAL FINAL CONSUMPTION																									
A. CONSUMPTION BY THE ENERGY																									
SECTOR AND LOSSES	4.8	10.1				3.0																			
of which Coal Mines & Washeries	4.8	10.1												3.0	2.2	1.3		2.5	0.1					24.0	
Electric Power Plants*																		0.2	0.1					15.2	
Coke Ovens																		0.5							0.5
Oil Refineries & Field Operation						3.0									1.2	0.1									1.3
Losses															3.0			0.1							3.1
															1.0	1.2		1.7							3.9
B. CONSUMPTION BY OTHER SECTORS																									
TRANSPORTATION	25.9	73.9				19.6	8.0	2.3	8.4	0.1			0.8												
of which Road						15.7	8.0		7.7																120.1
Railroads	25.9	71.8				0.7			0.6																15.7
Tramways																			0.5	0.1					99.0
Waterways		2.1				0.9			0.1										0.1						0.1
Air						2.3		2.3					0.7												3.0
INDUSTRY	4.2	52.9	17.9			13.5			1.5	2.8	0.2		9.0		3.7	4.9		6.8	2.1						2.3
of which Mining & Quarrying																		0.1							106.0
Fertilizer				1.3														0.1	0.3						
Heavy Chemical		1.7																0.1	0.1						
Structural Clay Products		11.9																0.2	0.1						
Cement		11.9																							
Iron and Steel	2.9		16.6															0.3	0.4						
Non-ferrous		0.3													3.7	4.9		0.7	0.5						
Textiles		11.2																0.3	0.1						
Other	1.3	15.9																2.1	0.4						
AGRICULTURE		2.0				3.1			1.1	1.7				0.3				0.6							5.7
DOMESTIC				9.9		18.7												0.6							
COMMERCIAL		0.5									18.6	0.1						1.2		128.0	452.0	142.0		752.1	
GOVERNMENT		3.9																0.7							1.2
OTHERS																		0.5							4.4
TOTAL INTERNAL FINAL CONSUMPTION	34.9	143.3	17.9	9.9		57.9	8.0	2.3	11.0	4.6	18.8	0.1	9.8	3.3	5.9	6.2	0.3	12.9	2.5	128.0	452.0	142.0		1013.7	

(1) Energy content of the falling water, assuming an average efficiency of 85%,
 (2) of which hydel production 6.0, Thermal production 6.9
 (3) Sale to other agencies excluding utilities, break-up of which is not available.
 (4) This represents production of power alcohol which is a substitute fuel.
 (5) Only quantities needed for energy purposes.
 (6) For our purposes we have assumed production of non-commercial fuels as equal to final consumption for energy uses only.
 * Covering only losses in auxiliaries of power plant. The actual transformation losses can be calculated by the difference between input and output on hydel

Note: - Quantity less than 5 x 10¹⁰ kcal not shown.

↑ Value not yet isolated.

TABLE 6-8
PRODUCTION AND USES OF ENERGY SOURCES - ALL INDIA - 1960/1
10¹² KILOCALORIES

	Coking Coal	Non-Coking Coal	Metal-lurgical Coke	Non-Metal-lurgical Coke	Crude Oil ⁷	Total Oil Products ⁷	Motor Spirit	Aviation and Jet Fuel	HSD	LDO	Kerosene	LPG	Fuel Oil	Vaporizing Oil & Ref. Fuel	Manufactured Gas			Electricity		Non-Comml. Energy			Grand Total
	1	2	3	4	5	6	7	8	9	10	11	12	13	14	Blast Furnace	Coke Oven	Gas Works	Utility	Non-Utility	Dung (Dry)	Fire-wood	Waste Products	23
PRODUCTION AND CONSUMPTION																							
A. PRIMARY SOURCES OF ENERGY																							
PRODUCTION	103.2	253.2			4.6	0.2 ⁶	0.2											7.8 ¹		129.8 ⁸	470.0 ⁸	144.0 ⁸	1112.8
NET BALANCE OF EXTERNAL TRADE		-8.0			52.3																		44.3
BUNKERS		-0.7																					-0.7
STOCK CHANGES	-11.6	-15.6			-0.8																		-28.0
TOTAL CONSUMPTION	91.6	228.9			56.1	0.2	0.2											7.8 ¹		129.8	470.0	144.0	1128.4
QUANTITIES TRANSFORMED	-63.4	-57.0			-56.1													-7.8					-184.3
INTERNAL FINAL CONSUMPTION	28.2	171.9				0.2	0.2													129.8	470.0	144.0	944.1
B. SECONDARY SOURCES OF ENERGY																							
PRODUCTION			31.8	9.5		56.1	10.4		10.8	5.3	9.4	0.1	16.7	3.4	11.5	9.8	0.3	14.5 ²	2.8				136.3
NET BALANCE OF EXTERNAL TRADE			-0.1	-0.1		16.3	-2.0	2.1	2.1	1.2	11.5		1.2	0.2				0.2 ³	-0.2 ⁴				16.1
BUNKERS						-4.4				-0.3			-4.1										-4.4
STOCK CHANGES			+0.3	-0.2		-0.8	-0.1	0.7	-0.4	-0.1	-0.9												-0.7
TOTAL CONSUMPTION			32.0	9.2		67.2	8.3	2.8	12.5	6.1	20.0	0.1	13.8	3.6	11.5	9.8	0.3	14.7	2.6				147.3
QUANTITIES TRANSFORMED			-11.7			-3.9				-1.1			-2.8		-2.2	-0.7							-18.5
INTERNAL FINAL CONSUMPTION			20.3	9.2		63.3	8.3	2.8	12.5	5.0	20.0	0.1	11.0	3.6	9.3	9.1	0.3	14.7	2.6				128.8
TOTAL INTERNAL FINAL CONSUMPTION	28.2	171.9	20.3	9.2		63.5	8.5	2.8	12.5	5.0	20.0	0.1	11.0	3.6	9.3	9.1	0.3	14.7	2.6	129.8	470.0	144.0	1072.9
BREAKDOWN OF INTERNAL FINAL CONSUMPTION																							
A. CONSUMPTION BY THE ENERGY																							
SECTOR AND LOSSES	5.4	11.9				3.4								3.4	3.5	2.0		3.1	0.1				29.4
of which Coal Mines & Washeries	5.4	11.9																0.2	0.1				17.6
Electric Power Plants*																		0.6	Neg.				0.6
Coke Ovens															1.8	0.2							2.0
Oil Refineries & Field Operation						3.4								3.4				0.1					3.5
Losses															1.7	1.8		2.2					5.7
B. CONSUMPTION BY OTHER SECTORS																							
TRANSPORTATION	8.8	97.3				21.8	8.5	2.8	9.6	0.1			0.8					0.7	0.1				128.7
of which Road						17.4	8.5		8.9														17.4
Railroads	8.8	94.3				0.7			0.6				0.1					0.6	0.1				104.5
Tramways																		0.1					0.1
Waterways		3.0				0.9			0.7				0.7										3.9
Air						2.8		2.8															2.8
INDUSTRY	14.0	57.0	20.3			15.2			1.1	3.0	0.2		10.2		5.8	7.1		7.7	2.2				129.3
of which Mining & Quarrying		0.1				0.2			0.1	0.1								0.1	0.3				0.4
Fertilizer			1.3										0.7					0.1	0.1				1.7
Heavy Chemical		2.3				0.7							0.3					0.2	0.1				3.3
Structural Clay Products		6.9				0.5			0.1	0.1			0.1					0.4	0.4				7.4
Cement		15.0				0.3			0.1	0.1			0.6		5.8	7.1		0.9	0.6				42.7
Iron and Steel	8.7		19.0			0.6												0.3	0.1				0.7
Non-ferrous		0.3																0.3	0.1				0.7
Textiles		12.0				4.4			0.1	0.7			3.4					2.1	0.3				18.8
Other	5.3	20.4				8.5			1.1	2.0	0.2		5.1					3.6	0.4				38.2
AGRICULTURE		1.2				3.2			1.1	1.9				0.2				0.7					5.1
DOMESTIC		0.1		9.2		19.9					19.8	0.1					0.3	1.3		129.8	470.0	144.0	774.6
COMMERCIAL		0.4																0.7					1.1
GOVERNMENT		4.0																0.5					4.5
OTHERS																			0.2 ⁵				0.2
TOTAL INTERNAL FINAL CONSUMPTION	28.2	171.9	20.3	9.2		63.5	8.5	2.8	12.5	5.0	20.0	0.1	11.0	3.6	9.3	9.1	0.3	14.7	2.6	129.8	470.0	144.0	1072.9

(1) Energy content of the falling water assuming an average efficiency of 85%.

(2) Of which hydel production 6.7, thermal production 7.8.

(3) Purchase from Non-utilities. (4) Sale to Utilities.

(5) Sale to other agencies excluding utilities, break-up of which is not available.

(6) This represents production of power alcohol which is a substitute fuel.

(7) Only quantities needed for energy purposes.

(8) For our purposes we have assumed production of non-commercial fuels as equal to final consumption for energy uses only.

* Covering only losses in auxiliaries of power plant. The actual transformation

Note: - Quantity less than 5 x 10¹⁰ kcal not shown.

TABLE 6-9

PRODUCTION AND USES OF ENERGY SOURCES - ANDHRA PRADESH - 1960/1
10¹² KILOCALORIES

	Coking Coal	Non-Coking Coal	Metal-lurgical Coke	Non-Metal-lurgical Coke	Crude Oil	Total Oil Products (2)	Motor Spirit	Aviation and Jet Fuel	HSDO	LDO	Kerosene	LPG	Fuel Oil	Vaporizing Oil & Ref. Fuel	Manufactured Gas			Electricity		Non-Comml. Fuels			Grand Total
	1	2	3	4	5	6	7	8	9	10	11	12	13	14	15	16	17	18	19	20	21	22	23
PRODUCTION AND CONSUMPTION																							
A. PRIMARY SOURCES OF ENERGY																							
PRODUCTION		16.61																					
NET BALANCE OF EXTERNAL TRADE	+0.33	-1.29																0.76 ¹		9.60	42.30	12.20	81.47
BUNKERS		-0.26																					-0.96
STOCK CHANGES		-0.07																					-0.26
TOTAL CONSUMPTION	0.33	14.99																					-0.07
QUANTITIES TRANSFORMED		-1.64																0.76		9.60	42.30	12.20	80.18
INTERNAL FINAL CONSUMPTION	0.33	13.35																-0.76		9.60	42.30	12.20	-2.40
																				9.60	42.30	12.20	77.78
B. SECONDARY SOURCES OF ENERGY																							
PRODUCTION					9.00														0.77	0.13			9.90
NET BALANCE OF EXTERNAL TRADE			+0.06		-3.90													-0.10					-3.94
BUNKERS					-0.92																		-0.92
STOCK CHANGES					-0.20																		-0.20
TOTAL CONSUMPTION			0.06		3.98														0.67	0.13			4.84
QUANTITIES TRANSFORMED																							
INTERNAL FINAL CONSUMPTION			0.06		3.98														0.67	0.13			4.84
TOTAL INTERNAL FINAL CONSUMPTION	0.33	13.35	0.06		3.98		0.40	0.11	1.09	0.30	1.40		0.27	0.41				0.67	0.13	9.60	42.30	12.20	82.62
BREAKDOWN OF INTERNAL FINAL CONSUMPTION																							
A. CONSUMPTION BY THE ENERGY																							
SECTOR AND LOSSES		0.52			0.40									0.40				0.19	0.04				1.15
of which Coal Mines & Washeries		0.52																	0.04				0.56
Electric Power Plants																		0.02					0.02
Coke Ovens																							
Oil Refineries & Field Operation					0.40									0.40				0.01					0.41
Losses																		0.16					0.16
B. CONSUMPTION BY OTHER SECTORS																							
TRANSPORTATION	0.33	7.90			1.52	0.40	0.11	0.98					0.03					0.01					9.76
of which Road & Tramways					1.34	0.40		0.94															1.34
Railroads	0.33	7.90			0.04			0.04										0.01					8.28
Waterways					0.03								0.03										0.03
Air					0.11		0.11																0.11
INDUSTRY		4.80	0.06		0.45			0.04	0.17				0.24					0.31	0.06				5.68
of which Mining & Quarrying																							
Fertilizer		0.13																					
Heavy Chemical																							
Structural Clay Products		0.20																					
Cement		1.45																0.04					
Iron and Steel			0.06															0.02					
Non-ferrous																							
Textiles		0.79																0.04	0.01				
Other		2.23																0.21	0.05				
AGRICULTURE					0.20			0.07	0.13									0.05					0.25
DOMESTIC					1.41						1.40			0.01				0.06		9.60	42.30	12.20	65.57
COMMERCIAL																		0.03					0.03
GOVERNMENT		0.13																0.02					0.15
OTHER SECTORS																			0.03				0.03
TOTAL INTERNAL FINAL CONSUMPTION	0.33	13.35	0.06		3.98		0.40	0.11	1.09	0.30	1.40		0.27	0.41				0.67	0.13	9.60	42.30	12.20	82.62

(1) Energy content of falling water assuming an average efficiency of 85%.
(2) Only quantities needed for energy purposes.

Quantity less than 5 x 10⁹ kcal not shown.

↓ ↑ Values not possible to isolate and included in these figures.

TABLE 6-10
 PRODUCTION AND USES OF ENERGY SOURCES - ASSAM - 1960/1
 10¹² KILOCALORIES

	Coking Coal	Non-Coking Coal	Metal-lurgical Coke	Non-Metal-lurgical Coke	Crude Oil ²	Total Oil Products ²	Motor Spirit	Aviation and Jet Fuel	HSD	LDO	Kerosene	LPG	Fuel Oil	Vaporizing Oil & Ref. Fuel	Manufactured Gas			Electricity		Non-Comml. Fuel			Grand Total
	1	2	3	4	5	6	7	8	9	10	11	12	13	14	Blast Furnace	Coke Oven	Gas Works	Utility	Non-Utility	Dung (Dry)	Fire-wood	Waste Products	23
PRODUCTION AND CONSUMPTION																							
A. PRIMARY SOURCES OF ENERGY																							
PRODUCTION		4.61			4.60																		
NET BALANCE OF EXTERNAL TRADE		-0.26			52.30													0.02 ¹		1.20	20.70	4.20	35.33
BUNKERS																							52.04
STOCK CHANGES		+0.07			-0.80																		-0.73
TOTAL CONSUMPTION		4.42			56.10													0.02		1.20	20.70	4.20	86.64
QUANTITIES TRANSFORMED					-56.10													0.02					-56.12
INTERNAL FINAL CONSUMPTION		4.42																		1.20	20.70	4.20	30.52
B. SECONDARY SOURCES OF ENERGY																							
PRODUCTION					3.50													0.03	0.01				3.54
NET BALANCE OF EXTERNAL TRADE			+0.06		-0.60																		-0.54
BUNKERS																							
STOCK CHANGES																							
TOTAL CONSUMPTION			0.06		2.90													0.03	0.01				3.00
QUANTITIES TRANSFORMED																							
INTERNAL FINAL CONSUMPTION			0.06		2.90													0.03	0.01				3.00
TOTAL INTERNAL FINAL CONSUMPTION		4.42	0.06		2.90		0.60	0.07	0.21	0.22	0.80		0.61	0.32				0.03	0.01	1.20	20.70	4.20	33.52
BREAKDOWN OF INTERNAL FINAL CONSUMPTION																							
A. CONSUMPTION BY THE ENERGY																							
SECTOR AND LOSSES		0.20			0.30									0.30				0.01	0.01				0.52
of which Coal Mines & Washeries		0.20																					0.20
Electric Power Plants																							
Coke Ovens																							
Oil Refineries & Field Operation					0.30									0.30				0.01	0.01				0.31
Losses																		0.01					0.01
B. CONSUMPTION BY OTHER SECTORS																							
TRANSPORTATION		2.50			0.84	0.60	0.07	0.17															3.34
of which Road & Tramways					0.77	0.60		0.17															0.77
Railroads		1.52																					1.52
Waterways		0.98																					0.98
Air					0.07		0.07																0.07
INDUSTRY		1.52	0.06		0.78			0.07	0.10				0.61					0.01					2.37
of which Mining & Quarrying																							
Fertilizer																							
Heavy Chemical																							
Structural Clay Products		0.33																					
Cement																							
Iron and Steel			0.06																				
Non-ferrous																							
Textiles																							
Other		1.19																0.01					0.16
AGRICULTURE					0.16			0.04	0.12									0.01		1.20	20.70	4.20	27.00
DOMESTIC		0.07			0.82									0.02									
COMMERCIAL											0.80												
GOVERNMENT		0.13																					
OTHER SECTORS																							
TOTAL INTERNAL FINAL CONSUMPTION		4.42	0.06		2.90		0.60	0.07	0.21	0.22	0.80		0.61	0.32				0.03	0.01	1.20	20.70	4.20	33.52

(1) Energy content of falling water assuming an average efficiency of 85%.
 (2) Only quantities needed for energy purposes.

Quantity less than 5 x 10⁹ kcal not shown.

↓ ↑ Values not possible to isolate and included in these figures.

TABLE 6-11
 PRODUCTION AND USES OF ENERGY - BIHAR - 1960/1
 10¹² KILOCALORIES

	Coking Coal	Non-Coking Coal	Metal-lurgical Coke	Non-Metal-lurgical Coke	Crude Oil	Total Oil Products ⁽³⁾	Motor Spirit	Aviat and Jet Fuel	HSDO	LDO	Kerosene	LPG	Fuel Oil	Vaporizing Oil & Ref. Fuel	Manufactured Gas			Electricity		Non-Comml. Fuels			Grand Total		
	1	2	3	4	5	6	7	8	9	10	11	12	13	14	Blast Furnace	Coke Oven	Gas Works	17	18	19	Dung (Dry)	Fire-wood	Waste Products	23	
PRODUCTION AND CONSUMPTION																									
A. PRIMARY SOURCES OF ENERGY																									
PRODUCTION	98.70	73.34																	0.14 ¹		18.00	33.80	15.30	239.28	
NET BALANCE OF EXTERNAL TRADE	-40.90	-29.60																						-70.50	
BUNKERS																									
STOCK CHANGES	-11.18	-9.90																	0.14		18.00	33.80	15.30	147.70	
TOTAL CONSUMPTION	46.62	33.84																	-0.14						-47.54
QUANTITIES TRANSFORMED	-31.87	-15.53																			18.00	33.00	15.30	100.16	
INTERNAL FINAL CONSUMPTION	14.75	18.31																							
B. SECONDARY SOURCES OF ENERGY																									
PRODUCTION			13.55	8.20															1.39	0.91					31.31
NET BALANCE OF EXTERNAL TRADE			-2.44	-7.50		+4.20													(+0.15 ²)	-0.15					-6.13
BUNKERS																			(-0.39)						0.03
STOCK CHANGES			+0.18	-0.15																					25.21
TOTAL CONSUMPTION			11.29	0.55		4.20													1.15	0.76					-4.63
QUANTITIES TRANSFORMED			-4.09			-0.19													1.15	0.76					20.58
INTERNAL FINAL CONSUMPTION			7.20	0.55		4.01													1.15	0.76	18.00	33.80	15.30	120.74	
TOTAL INTERNAL FINAL CONSUMPTION	14.75	18.31	7.20	0.55	4.01	0.53	0.02	0.86		0.19	1.65		0.74	0.02	3.45	3.46									
BREAKDOWN OF INTERNAL FINAL CONSUMPTION																									
A. CONSUMPTION BY THE ENERGY																									
SECTOR AND LOSSES	5.20	3.30																	0.48	0.05					11.32
of which Coal Mines & Washeries	5.20	3.30																	0.10	0.05					8.65
Electric Power Plants																			0.09						1.22
Coke Ovens															1.13	0.09									1.36
Oil Refineries & Field Operation															0.06	1.01			0.29						1.36
Losses																									
B. CONSUMPTION BY OTHER SECTORS																									
TRANSPORTATION	1.55	9.81				1.07	0.53	0.02	0.49	0.01			0.02						0.02	0.01					12.46
of which Road & Tramways						0.61	0.53		0.08										0.02	0.01					0.61
Railroads	1.55	9.35				0.43			0.41																11.36
Waterways		0.46				0.01				0.01															0.47
Air						0.02		0.02																	0.02
INDUSTRY	8.00	4.74	7.20			1.16			0.30	0.12	0.02		0.72		2.26	2.36			0.55	0.70					26.97
of which Mining & Quarrying		0.13																							
Fertilizer			1.34																						
Heavy Chemical																									
Structural Clay Products		0.46																							
Cement		1.91													2.26	2.36			0.10	0.12					
Iron and Steel	2.70		5.86																0.32	0.21					
Non-ferrous		0.26																	0.03	0.02					
Textiles																			0.10	0.01					
Other	5.30	1.98																	0.02		18.00	33.80	15.30	69.34	
AGRICULTURE		0.13				0.13			0.07	0.06									0.04						0.03
DOMESTIC						1.65					1.63								0.03						0.34
COMMERCIAL				0.55															0.01						
GOVERNMENT		0.33																							
OTHER SECTORS																									
TOTAL INTERNAL FINAL CONSUMPTION	14.75	18.31	7.20	0.55	4.01	0.53	0.02	0.86		0.19	1.65		0.74	0.02	3.45	3.46			1.15	0.76	18.00	33.80	15.30	120.74	

(1) Energy content of falling water assuming an average efficiency of 85%.
 (2) 0.15 is purchase from non-utilities and 0.39 is inter-state sales.
 (3) Only quantities needed for energy purposes.

Quantity less than 5 x 10⁹ kcal not shown.

↑ Values not possible to isolate and included in these figures.

TABLE 6-12
 PRODUCTION AND USES OF ENERGY SOURCES - GUJARAT - 1960/1
 10¹² KILOCALORIES

	Coking Coal	Non-Coking Coal	Metal-lurgical Coke	Non-Metal-lurgical Coke	Crude Oil	Total Oil Products (1)	Motor Spirit	Aviation and Jet Fuel	HSDO	LDO	Kerosene	LPG	Fuel Oil	Vaporizing Oil & Ref. Fuel	Manufactured Gas			Electricity		Non-Comml. Fuels			Grand Total
	1	2	3	4	5	6	7	8	9	10	11	12	13	14	15	16	17	18	19	20	21	22	23
PRODUCTION AND CONSUMPTION																							
A. PRIMARY SOURCES OF ENERGY																							
PRODUCTION																				4.80	28.20	7.00	40.00
NET BALANCE OF EXTERNAL TRADE	+0.13	+23.11																					23.24
BUNKERS																							
STOCK CHANGES																							
TOTAL CONSUMPTION	0.13	23.11																		4.80	28.20	7.00	63.24
QUANTITIES TRANSFORMED		-6.73																					-6.73
INTERNAL FINAL CONSUMPTION	0.13	16.38																		4.80	28.20	7.00	56.51
B. SECONDARY SOURCES OF ENERGY																							
PRODUCTION																		1.10	0.08				1.18
NET BALANCE OF EXTERNAL TRADE			+0.18	+0.20		+4.80																	5.18
BUNKERS																							
STOCK CHANGES																							
TOTAL CONSUMPTION			0.18	0.20		4.80												1.10	0.08				6.36
QUANTITIES TRANSFORMED						-0.37																	-0.37
INTERNAL FINAL CONSUMPTION			0.18	0.20		4.43												1.10	0.08				5.99
TOTAL INTERNAL FINAL CONSUMPTION	0.13	16.38	0.18	0.20		4.43	0.53	0.10	0.65	0.95	1.52		0.66	0.02				1.10	0.08	4.80	28.20	7.00	62.50
BREAKDOWN OF INTERNAL FINAL CONSUMPTION																							
A. CONSUMPTION BY THE ENERGY																							
SECTOR AND LOSSES																		0.25					0.25
of which Coal Mines & Washeries																		0.07					0.07
Electric Power Plants																							
Coke Ovens																							
Oil Refineries & Field Operation																		0.18					0.18
Losses																							
B. CONSUMPTION BY OTHER SECTORS																							
TRANSPORTATION	0.13	7.26				1.13	0.53	0.10	0.50									0.01	0.01				8.54
of which Road & Tramways						1.01	0.53		0.48									0.01	0.01				1.01
Railroads	0.13	7.26				0.02			0.02														7.43
Waterways																							0.10
Air						0.10		0.10										0.68	0.07				11.34
INDUSTRY		9.05	0.18			1.36			0.05	0.64	0.01		0.66										
of which Mining & Quarrying																		0.01					
Fertilizer		0.95																					
Heavy Chemical																							
Structural Clay Products		0.26																0.04	0.04				
Cement		3.10																					
Iron and Steel			0.18																				
Non-ferrous																		0.39	0.03				
Textiles		4.67																0.24					0.43
Other		0.07																0.02					
AGRICULTURE						0.41			0.10	0.31	1.51							0.06		4.80	28.20	7.00	41.79
DOMESTIC						1.53												0.03					0.03
COMMERCIAL				0.20														0.05					0.12
GOVERNMENT		0.07																					
OTHER SECTORS																							
TOTAL INTERNAL FINAL CONSUMPTION	0.13	16.38	0.18	0.20		4.43	0.53	0.10	0.65	0.95	1.52		0.66	0.02				1.10	0.08	4.80	28.20	7.00	62.50

(1) Only quantities needed for energy purposes.

Quantity less than 5 x 10⁹ kcal not shown.

↑ ↓ Values not possible to isolate and included in these figures.

TABLE 6-13
 PRODUCTION AND USES OF ENERGY SOURCES - JAMMU & KASHMIR - 1960/1
 10¹² KILOCALORIES

	Coking Coal	Non-Coking Coal	Metal-lurgical Coke	Non-Metal-lurgical Coke	Crude Oil	Total Oil Products (2)	Motor Spirit	Aviation and Jet Fuel	HSDO	0	Kerosene	LPG	Fuel Oil	Vaporizing Oil & Ref. Fuel	Manufactured Gas			Electricity		Non-Comml. Fuels			Grand Total		
	1	2	3	4	5	6	7	8	9	10	11	12	13	14	Blast Furnace	Coke Oven	Gas Works	17	18. Utility	19. Non-Utility	Dung (Dry)	21. Fire-wood	22. Waste Products	23	
PRODUCTION AND CONSUMPTION																									
A. PRIMARY SOURCES OF ENERGY																			0.04 ¹		0.50	0.50	1.40	2.44	
PRODUCTION																									
NET BALANCE OF EXTERNAL TRADE																									
BUNKERS																									
STOCK CHANGES																									
TOTAL CONSUMPTION																			0.04		0.50	0.50	1.40	2.44	
QUANTITIES TRANSFORMED																			-0.04					-0.04	
INTERNAL FINAL CONSUMPTION																					0.50	0.50	1.40	2.40	
B. SECONDARY SOURCES OF ENERGY																			0.04					0.04	
PRODUCTION																									
NET BALANCE OF EXTERNAL TRADE						+0.22													+0.01					+0.23	
BUNKERS																									
STOCK CHANGES																								0.27	
TOTAL CONSUMPTION						0.22													0.05					0.27	
QUANTITIES TRANSFORMED																			0.05					0.27	
INTERNAL FINAL CONSUMPTION						0.22													0.05					0.27	
TOTAL INTERNAL FINAL CONSUMPTION						0.22	0.05	0.02	0.10				0.05						0.05			0.50	0.50	1.40	2.67
BREAKDOWN OF INTERNAL FINAL CONSUMPTION																									
A. CONSUMPTION BY THE ENERGY SECTOR AND LOSSES																			0.01					0.01	
of which Coal Mines & Washeries																									
Electric Power Plants																									
Coke Ovens																									
Oil Refineries & Field Operation																									
Losses																			0.01					0.01	
B. CONSUMPTION BY OTHER SECTORS																								0.16	
TRANSPORTATION																								0.14	
of which Road & Tramways																									
Railroads						0.16	0.05	0.02	0.09																
Waterways						0.14	0.05		0.09																
Air																								0.02	
INDUSTRY						0.02		0.02											0.02					0.02	
of which Mining & Quarrying																									
Fertilizer																									
Heavy Chemical																									
Structural Clay Products																									
Cement																									
Iron and Steel																									
Non-ferrous																									
Textiles																								0.02	
Other																								0.01	
AGRICULTURE																								0.02	
DOMESTIC						0.01			0.01			0.05							0.02			0.50	0.50	1.40	2.47
COMMERCIAL						0.05																			
GOVERNMENT																									
OTHER SECTORS																									
TOTAL INTERNAL FINAL CONSUMPTION						0.22	0.05	0.02	0.10			0.05							0.05			0.50	0.50	1.40	2.67

(1) Energy content of falling water assuming an average efficiency of 85%.

(2) Only quantities needed for energy purposes.

↓ Values not possible to isolate and included in these figures.

Quantity less than 5 x 10⁹ kcal not shown.

TABLE 6-14
 PRODUCTION AND USES OF ENERGY SOURCES - KERALA - 1960/1
 10¹² KILOCALORIES

	Coking Coal	Non-Coking Coal	Metal-lurgical Coke	Non-Metal-lurgical Coke	Crude Oil	Total Oil Products (3)	Motor Spirit	Aviation and Jet Fuel	HSD	LDO	Kerosene	LPG	Fuel Oil	Vaporizing Oil & Ref. Fuel	Manufactured Gas			Electricity		Non-Comml. Fuels			Grand Total
	1	2	3	4	5	6	7	8	9	10	11	12	13	14	15	16	17	18	19	20	21	22	23
PRODUCTION AND CONSUMPTION																							
A. PRIMARY SOURCES OF ENERGY																							
PRODUCTION																							
NET BALANCE OF EXTERNAL TRADE	+0.13	+0.92																0.59 ²		2.40	17.40	6.10	26.49
BUNKERS																							+1.05
STOCK CHANGES																							
TOTAL CONSUMPTION	0.13	0.92																					
QUANTITIES TRANSFORMED																		0.59		2.40	17.40	6.10	27.54
INTERNAL FINAL CONSUMPTION	0.13	0.92																-0.59		2.40	17.40	6.10	-0.59
																				2.40	17.40	6.10	26.95
B. SECONDARY SOURCES OF ENERGY																							
PRODUCTION																							
NET BALANCE OF EXTERNAL TRADE			+0.30			+3.30													0.50				0.50
BUNKERS						-0.81													+0.03 ²				+3.63
STOCK CHANGES																							-0.81
TOTAL CONSUMPTION			0.30			2.49																	2.49
QUANTITIES TRANSFORMED																							0.53
INTERNAL FINAL CONSUMPTION			0.30			2.49																	0.53
TOTAL INTERNAL FINAL CONSUMPTION	0.13	0.92	0.30			2.49	0.33		0.57	0.06	0.80		0.72	0.01				0.53		2.40	17.40	6.10	30.27
BREAKDOWN OF INTERNAL FINAL CONSUMPTIONS																							
A. CONSUMPTION BY THE ENERGY SECTOR AND LOSSES																							
of which Coal Mines & Washeries																							0.11
Electric Power Plants																							0.11
Coke Ovens																							0.02
Oil Refineries & Field Operation																							0.02
Losses																							0.09
B. CONSUMPTION BY OTHER SECTORS																							
TRANSPORTATION	0.13	0.79				0.95	0.33		0.07	0.01			0.14										1.87
of which Road & Tramways						0.78	0.33		0.05														0.78
Railroads	0.13	0.79				0.02			0.01														0.94
Waterways						0.15			0.01														0.15
Air									0.01	0.01			0.14										0.15
INDUSTRY		0.13	0.30			0.63			0.01	0.03			0.58										1.41
of which Mining & Quarrying																							
Fertilizer																							0.35
Heavy Chemical																							0.06
Structural Clay Products																							0.04
Cement		0.07																					0.01
Iron and Steel			0.30																				0.11
Non-ferrous																							0.01
Textiles																							0.11
Other		0.06																					0.01
AGRICULTURE						0.10			0.08	0.02													0.12
DOMESTIC						0.81					0.80												0.02
COMMERCIAL																				0.04	2.40	17.40	6.10
GOVERNMENT																							0.01
OTHER SECTORS																							0.01
TOTAL INTERNAL FINAL CONSUMPTION	0.13	0.92	0.30			2.49	0.33		0.57	0.06	0.80		0.72	0.01				0.53		2.40	17.40	6.10	30.27

(1) Energy content of the falling water assuming an efficiency of 85%.
 (2) Inter-State sale.
 (3) Only quantities needed for energy purposes.

Quantity less than 5 x 10⁹ kcal not shown.

Values not possible to isolate and included in these figures.

TABLE 6-15
 PRODUCTION AND USES OF ENERGY SOURCES - MADHYA PRADESH - 1960/1
 10¹² KILOCALORIES

	Coking Coal	Non-Coking Coal	Metal-lurgical Coke	Non-Metal-lurgical Coke	Crude Oil	Total Oil Products (3)	Motor Spirit	Aviation and Jet Fuel	HSDO	LDO	Kerosene	LPG	Fuel Oil	Vaporizing Oil & Ref. Fuel	Blast Furnace	Coke Oven	Gas Works	Electricity Utility	Non-Utility	Dung (Dry)	Fire-wood	Waste Products	Grand Total		
	1	2	3	4	5	6	7	8	9	10	11	12	13	14	15	16	17	18	19	20	21	22	23		
PRODUCTION AND CONSUMPTION																									
A. PRIMARY SOURCES OF ENERGY																									
PRODUCTION		43.37																							
NET BALANCE OF EXTERNAL TRADE	+8.57	-18.70																0.03 ¹		8.90	30.50	10.30	93.10		
BUNKERS																								-10.13	
STOCK CHANGES		-2.84																						-2.84	
TOTAL CONSUMPTION	8.57	21.83																0.03		8.90	30.50	10.30	80.13		
QUANTITIES TRANSFORMED	-6.78	-3.73																-0.03						-10.54	
INTERNAL FINAL CONSUMPTION	1.79	18.10																		8.90	30.50	10.30	69.59		
B. SECONDARY SOURCES OF ENERGY																									
PRODUCTION			4.09															1.95	1.30	0.41	0.21			7.96	
NET BALANCE OF EXTERNAL TRADE			+0.55	+0.10		+2.68														+0.02 ²				3.35	
BUNKERS																									
STOCK CHANGES																									
TOTAL CONSUMPTION			4.64	0.10		2.68												1.95	1.30	0.43	0.21			11.31	
QUANTITIES TRANSFORMED			-1.83			-0.10												-0.17	-0.08					-2.18	
INTERNAL FINAL CONSUMPTION			2.81	0.10		2.58												1.78	1.22	0.43	0.21			9.13	
TOTAL INTERNAL FINAL CONSUMPTION	1.79	18.10	2.81	0.10	2.58	0.41	0.08	0.76	0.25	1.05			0.02	0.01	1.78	1.22		0.43	0.21	8.90	30.50	10.30	78.72		
BREAKDOWN OF INTERNAL FINAL CONSUMPTION																									
A. CONSUMPTION BY THE ENERGY SECTOR AND LOSSES																									
of which Coal Mines & Washeries		2.10																							2.74
Electric Power Plants																				0.10	0.02			2.13	
Coke Ovens																				0.03				0.03	
Oil Refineries & Field Operation Losses																				0.22				0.22	
																				0.20	0.10			0.36	
B. CONSUMPTION BY OTHER SECTORS																									
TRANSPORTATION	0.79	11.20				1.05	0.41	0.08	0.5															13.04	
of which Road & Tramways						0.97	0.41	0.08	0.5															0.97	
Railroads	0.79	11.20																						11.99	
Waterways																									
Air																								0.08	
INDUSTRY	1.00	4.67	2.81			0.08		0.08	0.13	0.13	0.01		0.02		1.36	1.12		0.24	0.18					11.67	
of which Mining & Quarrying						0.29																			
Fertilizer																									
Heavy Chemical																									
Structural Clay Products																									
Cement		0.40																							
Iron and Steel	1.00	1.78																							
Non-ferrous			2.81												1.36	1.12		0.10	0.07						
Textiles		1.77																0.03	0.05						
Other		0.72																0.11	0.01						
AGRICULTURE						0.19			0.07	0.12														0.19	
DOMESTIC						1.05					1.04							0.04		8.90	30.50	10.30	50.89		
COMMERCIAL				0.10														0.02						0.02	
GOVERNMENT																		0.03						0.16	
OTHER SECTORS		0.13																							
TOTAL INTERNAL FINAL CONSUMPTION	1.79	18.10	2.81	0.10	2.58	0.41	0.08	0.76	0.25	1.05			0.02	0.01	1.78	1.22		0.43	0.21	8.90	30.50	10.30	78.72		

(1) Energy content of the falling water assuming an average efficiency of 85%.
 (2) Inter-State sale.

(3) Only quantities needed for energy purposes.

Quantity less than 5 x 10⁹ kcal not shown.

↑ ↓ Values not possible to isolate and included in these figures.

TABLE 6-16
 PRODUCTION AND USES OF ENERGY SOURCES - MADRAS - 1960/1
 10¹² KILOCALORIES

	Coking Coal	Non-Coking Coal	Metal-lurgical Coke	Non-Metal-lurgical Coke	Crude Oil	Total Oil Products ²	Motor Spirit	Aviation and Jet Fuel	HSDO	LDO	Kerosene	LPG	Fuel Oil	Vaporizing Oil & Ref. Fuel	Manufactured Gas			Electricity		Non-Comml. Fuels			Grand Total			
	1	2	3	4	5	6	7	8	9	10	11	12	13	14	15	16	17	18	19	20	21	22	23			
PRODUCTION AND CONSUMPTION																										
A. PRIMARY SOURCES OF ENERGY																										
PRODUCTION																		1.81 ¹		7.20	33.40	10.40	52.81			
NET BALANCE OF EXTERNAL TRADE	+0.46	+10.52																						10.98		
BUNKERS		-0.06																							-0.06	
STOCK CHANGES																										
TOTAL CONSUMPTION	0.46	10.46																1.81		7.20	33.40	10.40		63.73		
QUANTITIES TRANSFORMED		-2.09																-1.81							-3.90	
INTERNAL FINAL CONSUMPTION	0.46	8.37																		7.20	33.40	10.40		59.83		
B. SECONDARY SOURCES OF ENERGY																										
PRODUCTION																		1.90	0.03					1.93		
NET BALANCE OF EXTERNAL TRADE			+0.12	+0.05		+5.78												-0.02							5.93	
BUNKERS						-0.70																			-0.70	
STOCK CHANGES																										
TOTAL CONSUMPTION			0.12	0.05		5.08												1.88	0.03						7.16	
QUANTITIES TRANSFORMED						-0.10																			-0.10	
INTERNAL FINAL CONSUMPTION			0.12	0.05		4.98												1.88	0.03						7.06	
TOTAL INTERNAL FINAL CONSUMPTION	0.46	8.37	0.12	0.05	4.98	0.62	0.07	1.59	0.25	1.65			0.79	0.01				1.88	0.03	7.20	33.40	10.40		66.89		
BREAKDOWN OF INTERNAL FINAL CONSUMPTION																										
A. CONSUMPTION BY THE ENERGY																										
SECTOR AND LOSSES																		0.38							0.38	
of which Coal Mines & Washeries																		0.05							0.05	
Electric Power Plants																										
Coke Ovens																										
Oil Refineries & Field Operation																		0.33							0.33	
Losses																										
B. CONSUMPTION BY OTHER SECTORS																										
TRANSPORTATION	0.46	5.40			2.28	0.62	0.07	1.17					0.12					0.04							8.18	
of which Road & Tramways					2.09	0.62		1.07																		2.09
Railroads	0.46	5.40			0.03								0.03					0.04							5.93	
Waterways					0.09								0.09													0.09
Air					0.07		0.07																		0.07	
INDUSTRY		2.90	0.12		0.94			0.05	0.20	0.02			0.67					0.80	0.03						4.79	
of which Mining & Quarrying																										
Fertilizer		0.07																0.02								
Heavy Chemical																										
Structural Clay Products		0.40																0.10								
Cement		2.10																								
Iron and Steel			0.12																							
Non-ferrous																										
Textiles		0.07																0.20	0.02							
Other		0.26																0.48	0.01						0.46	
AGRICULTURE					0.12			0.07	0.05									0.34							52.83	
DOMESTIC				0.05	1.64					1.63								0.14		7.20	33.40	10.40			0.14	
COMMERCIAL																		0.14							0.11	
GOVERNMENT		0.07																0.04								
OTHER SECTORS																										
TOTAL INTERNAL FINAL CONSUMPTION	0.46	8.37	0.12	0.05	4.98	0.62	0.07	1.59	0.25	1.65			0.79	0.01				1.88	0.03	7.20	33.40	10.40		66.89		

(1) Energy content of falling water assuming an average efficiency of 85%.
 (2) Only quantities needed for energy purposes.

Quantity less than 5 x 10⁹ kcal not shown.

↑ Values not possible to isolate and included in these figures.

TABLE 6-17
PRODUCTION AND USES OF ENERGY SOURCES - MAHARASHTRA - 1960/1
10¹² KILOCALORIES

	Coking Coal	Non-Coking Coal	Metal-lurgical Coke	Non-Metal-lurgical Coke	Crude Oil	Total Oil Products (3)	Motor Spirit	Aviation and Jet Fuel	HSDO	LDO	Kerosene	LPG	Fuel Oil	Vaporizing Oil & Ref. Fuel	Manufactured Gas			Electricity		Non-Comm. Fuels			Grand Total
	1	2	3	4	5	6	7	8	9	10	11	12	13	14	Blast Furnace	Coke Oven	Gas Works	Utility	Non-Utility	Dung (Dry)	Fire-wood	Waste Products	
PRODUCTION AND CONSUMPTION																							
A. PRIMARY SOURCES OF ENERGY																							
PRODUCTION		5.13																1.38 ¹		9.20	49.50	12.70	77.91
NET BALANCE OF EXTERNAL TRADE	+1.60	+17.08																					18.68
BUNKERS		-0.06																					-0.06
STOCK CHANGES		-0.06																					-0.06
TOTAL CONSUMPTION	1.60	22.09																1.38		9.20	49.50	12.70	96.47
QUANTITIES TRANSFORMED	-0.67	-7.00																-1.38					-9.05
INTERNAL FINAL CONSUMPTION	0.93	15.09																		9.20	49.50	12.70	87.42
B. SECONDARY SOURCES OF ENERGY																							
PRODUCTION				0.35	43.78																		47.22
NET BALANCE OF EXTERNAL TRADE			+0.30	+0.40	-21.20																		-20.53
BUNKERS					-1.30																		-1.30
STOCK CHANGES					-0.60																		-0.60
TOTAL CONSUMPTION			0.30	0.75	20.68																		24.79
QUANTITIES TRANSFORMED					-2.60																		-2.60
INTERNAL FINAL CONSUMPTION			0.30	0.75	18.08																		22.19
TOTAL INTERNAL FINAL CONSUMPTION	0.93	15.09	0.30	0.75	18.08	1.69	0.82	1.70	1.21	4.14	0.06	5.74	2.72		0.13			2.79	0.14	9.20	49.50	12.70	109.61
BREAKDOWN OF INTERNAL FINAL CONSUMPTION																							
A. CONSUMPTION BY THE ENERGY SECTOR AND LOSSES																							
of which Coal Mines & Washeries		0.26			2.72																		3.47
Electric Power Plants		0.26																					0.26
Coke Ovens																							0.12
Oil Refineries & Field Operation					2.72									2.72									2.76
Losses																							0.33
B. CONSUMPTION BY OTHER SECTORS																							
TRANSPORTATION	0.93	9.30			4.11	1.69	0.82	1.68	0.02				0.50										14.66
of which Road & Tramways					2.74	1.69		1.65															2.75
Railroads	0.93	9.30			0.02			0.02															10.56
Waterways					0.53			0.01	0.02				0.50										0.53
Air					0.82		0.82																0.82
INDUSTRY		5.20	0.30		6.61			0.49	0.81	0.07			5.24							1.53	0.13		13.77
of which Mining & Quarrying																							
Fertilizer																				0.04	0.04		
Heavy Chemical																							
Structural Clay Products		0.26																					
Cement																							
Iron and Steel			0.30																				
Non-ferrous																							
Textiles		1.98																					
Other		2.96																					
AGRICULTURE					0.51			0.13	0.38														0.52
DOMESTIC				0.75	4.13					4.07	0.06										9.20	49.50	12.70
COMMERCIAL																							76.64
GOVERNMENT																							0.17
OTHER SECTORS		0.33																					0.38
TOTAL INTERNAL FINAL CONSUMPTION	0.93	15.09	0.30	0.75	18.08	1.69	0.82	1.70	1.21	4.14	0.06	5.74	2.72		0.13			2.79	0.14	9.20	49.50	12.70	109.61

(1) Energy content of falling water assuming an average efficiency of 85%.
(2) Inter-State sale.
(3) Only quantities needed for energy purposes.

Quantity less than 5 x 10⁹ kcal not shown.

Values not possible to isolate and included in these figures.

TABLE 6-18
 PRODUCTION AND USES OF ENERGY SOURCES - MYSORE - 1960/1
 10¹² KILOCALORIES

	Coking Coal	Non-Coking Coal	Metal-lurgical Coke	Non-Metal-lurgical Coke	Crude Oil	Total Oil Products (2)	Motor Spirit	Aviation and Jet Fuel	HSDO	LDO	Kerosene	LPG	Fuel Oil	Vaporizing Oil & Ref. Fuel	Manufactured Gas			Electricity		Non-Comml. Fuels			Grand Total
	1	2	3	4	5	6	7	8	9	10	11	12	13	14	15	16	17	18	19	20	21	22	23
PRODUCTION AND CONSUMPTION																							
A. PRIMARY SOURCES OF ENERGY																							
PRODUCTION																		1.01 ¹		6.00	32.50	8.00	47.51
NET BALANCE OF EXTERNAL TRADE	+0.27	+4.39																					4.66
BUNKERS																							
STOCK CHANGES																							
TOTAL CONSUMPTION	0.27	4.39																1.01		6.00	32.50	8.00	52.17
QUANTITIES TRANSFORMED		-0.57																-1.01					-1.58
INTERNAL FINAL CONSUMPTION	0.27	3.82																		6.00	32.50	8.00	50.59
B. SECONDARY SOURCES OF ENERGY																							
PRODUCTION																		0.88	0.09				0.97
NET BALANCE OF EXTERNAL TRADE			+0.55			+2.92												+0.04					3.51
BUNKERS																							
STOCK CHANGES																							
TOTAL CONSUMPTION			0.55			2.92												0.92	0.09				4.48
QUANTITIES TRANSFORMED			-0.18			-0.10												0.92	0.09				-0.28
INTERNAL FINAL CONSUMPTION			0.37			2.82												0.92	0.09				4.20
TOTAL INTERNAL FINAL CONSUMPTION	0.27	3.82	0.37			2.82	0.39	0.05	0.97	0.25	1.00		0.15	0.01				0.92	0.09	6.00	32.50	8.00	54.79
BREAKDOWN OF INTERNAL FINAL CONSUMPTION																							
A. CONSUMPTION BY THE ENERGY SECTOR AND LOSSES																							
of which Cool Mines & Washeries																		0.15					0.15
Electric Power Plants																		0.01					0.01
Coke Ovens																							
Oil Refineries & Field Operation																		0.14					0.14
Losses																							
B. CONSUMPTION BY OTHER SECTORS																							
TRANSPORTATION	0.27	2.70			1.30	0.39	0.05		0.86														4.27
of which Road & Tramways					1.24	0.39			0.85														1.24
Railroads	0.27	2.70																					2.97
Waterways					0.01				0.01														0.01
Air					0.05		0.05																0.05
INDUSTRY		1.12	0.37		0.33				0.03	0.14	0.01		0.15					0.59	0.09				2.50
of which Mining & Quarrying																		0.10					
Fertilizer																		0.02					
Heavy Chemical																							
Structural Clay Products																							
Cement		1.06																0.01	0.05				
Iron and Steel			0.37															0.24					
Non-ferrous																							
Textiles		0.06																0.04	0.02				
Other																		0.18	0.02				0.21
AGRICULTURE					0.19				0.08	0.11								0.02			6.00	32.50	8.00
DOMESTIC					1.00						0.99							0.07					47.57
COMMERCIAL																		0.02					0.02
GOVERNMENT																		0.07					0.07
OTHER SECTORS																							
TOTAL INTERNAL FINAL CONSUMPTION	0.27	3.82	0.37			2.82	0.39	0.05	0.97	0.25	1.00		0.15	0.01				0.92	0.09	6.00	32.50	8.00	54.79

(1) Energy content of falling water assuming an average efficiency of 85%.
 (2) Only quantities needed for energy purposes.

Quantity less than 5 x 10⁹ kcal not shown.

↑ ↓ Values not possible to isolate and included in these figures.

TABLE 6-19
 PRODUCTION AND USES OF ENERGY SOURCES - ORISSA - 1960/1
 10¹² KILOCALORIES

	Coking Coal	Non-Coking Coal	Metal-lurgical Coke	Non-Metal-lurgical Coke	Crude Oil	Total Oil Products (3)	Motor Spirit	Aviation and Jet Fuel	HSDO	LDO	Kerosene	LPG	Fuel Oil	Vaporizing Oil & Ref. Fuel	Manufactured Gas			Electricity		Non-Comml. Fuels			Grand Total		
	1	2	3	4	5	6	7	8	9	10	11	12	13	14	15	16	17	18	19	20	21	22	23		
PRODUCTION AND CONSUMPTION																									
A. PRIMARY SOURCES OF ENERGY																									
PRODUCTION		5.79																0.49 ¹		1.90	36.70	6.60	51.48		
NET BALANCE OF EXTERNAL TRADE	+5.80	-1.61																					+4.19		
BUNKERS																									
STOCK CHANGES		-0.32																						-0.32	
TOTAL CONSUMPTION	5.80	3.86																0.49		1.90	36.70	6.60	55.35		
QUANTITIES TRANSFORMED	-5.73	-0.57																-0.49						-6.79	
INTERNAL FINAL CONSUMPTION	0.07	3.29																		1.90	36.70	6.60	48.56		
B. SECONDARY SOURCES OF ENERGY																									
PRODUCTION			3.48															0.42	0.26					6.53	
NET BALANCE OF EXTERNAL TRADE			-0.43	+0.05		+0.84												(+0.04 ²)	-0.04					0.49	
BUNKERS																		(+0.03)							
STOCK CHANGES																									
TOTAL CONSUMPTION			3.05	0.05		0.84									1.30	1.07		0.49	0.22					7.02	
QUANTITIES TRANSFORMED			-1.10												-0.45	-0.29								-1.84	
INTERNAL FINAL CONSUMPTION			1.95	0.05		0.84									0.85	0.78		0.49	0.22					5.18	
TOTAL INTERNAL FINAL CONSUMPTION	0.07	3.29	1.95	0.05		0.84	0.18		0.19	0.04	0.40		0.03		0.85	0.78		0.49	0.22	1.90	36.70	6.60	53.74		
BREAKDOWN OF INTERNAL FINAL CONSUMPTION																									
A. CONSUMPTION BY THE ENERGY																									
SECTOR AND LOSSES		0.26																0.06						0.99	
of which Coal Mines & Washeries		0.26																							0.26
Electric Power Plants																									0.14
Coke Ovens															0.14										0.59
Oil Refineries & Field Operation															0.40	0.13		0.06							
Losses																									
B. CONSUMPTION BY OTHER SECTORS																									
TRANSPORTATION	0.07	1.98				0.32	0.18		0.14															2.37	
of which Road & Tramways						0.32	0.18		0.14															0.32	
Railroads	0.07	1.98																						2.05	
Waterways																									
Air																									
INDUSTRY		1.05	1.95			0.07			0.02	0.02			0.03		0.31	0.65		0.41	0.22					4.66	
of which Mining & Quarrying																									
Fertilizers		0.07																							
Heavy Chemical																									
Structural Clay Products		0.33																							
Cement		0.53																0.03							
Iron and Steel			1.95												0.31	0.65		0.10	0.15						
Non-ferrous																		0.19							
Textiles		0.06																		0.01					
Other		0.06																0.09	0.06						
AGRICULTURE						0.05																		0.05	
DOMESTIC				0.05		0.40			0.03	0.02								0.02			1.90	36.70	6.60	45.67	
COMMERCIAL											0.40														
GOVERNMENT																									
OTHER SECTORS																									
TOTAL INTERNAL FINAL CONSUMPTION	0.07	3.29	1.95	0.05		0.84	0.18		0.19	0.04	0.40		0.03		0.85	0.78		0.49	0.22	1.90	36.70	6.60	53.74		

(1) Energy content of falling water assuming an efficiency of 85%.
 (2) 0.04 is purchase from non-utilities and 0.03 is Inter-State sales.
 (3) Only quantities needed for energy purposes.

Quantity less than 5 x 10⁹ kcal not shown.

Values not possible to isolate and included in these figures.

TABLE 6-20
PRODUCTION AND USES OF ENERGY SOURCES - PUNJAB - 1960/1
10¹² KILOCALORIES

	Coking Coal		Non-Coking Coal		Metal-lurgical Coke	Non-Metal-lurgical Coke	Crude Oil	Total Oil Products ^a	Motor Spirit	Aviation and Jet Fuel	HSDO	LDO	Kerosene	LPG	Fuel Oil	Vaporizing Oil & Ref. Fuel	Manufactured Gas			Electricity		Non-Comm. Fuels			Grand Total	
	1	2	3	4													5	6	7	8	9	10	11	12		13
PRODUCTION AND CONSUMPTION																										
A. PRIMARY SOURCES OF ENERGY																										
PRODUCTION																					0.98 ¹	12.50	25.30	7.00	45.78	
NET BALANCE OF EXTERNAL TRADE	+0.53	+14.30																							14.83	
BUNKERS																										
STOCK CHANGES																										
TOTAL CONSUMPTION	0.53	14.30																			0.98	12.50	25.30	7.00	60.61	
QUANTITIES TRANSFORMED		-2.82																			-0.98				-3.80	
INTERNAL FINAL CONSUMPTION	0.53	11.48																				12.50	25.30	7.00	56.81	
B. SECONDARY SOURCES OF ENERGY																										
PRODUCTION																					1.10	0.15			1.25	
NET BALANCE OF EXTERNAL TRADE			+0.61	+1.55			+4.17														-0.03 ²				6.30	
BUNKERS																										
STOCK CHANGES																									7.55	
TOTAL CONSUMPTION			0.61	1.55			4.17														1.07	0.15			-0.10	
QUANTITIES TRANSFORMED							-0.10														1.07	0.15			7.45	
INTERNAL FINAL CONSUMPTION			0.61	1.55			4.07														1.07	0.15	12.50	25.30	7.00	64.26
TOTAL INTERNAL FINAL CONSUMPTION	0.53	11.48	0.61	1.55			4.07	0.77	0.42	1.23	0.34	1.13	0.03	0.12	0.03											
BREAKDOWN OF INTERNAL FINAL CONSUMPTION																										
A. CONSUMPTION BY THE ENERGY SECTOR AND LOSSES																										0.25
of which Coal Mines & Washeries																										0.02
Electric Power Plants																										0.23
Coke Ovens																										0.23
Oil Refineries & Field Operation ..																										0.23
Losses																										0.25
B. CONSUMPTION BY OTHER SECTORS																										7.59
TRANSPORTATION	0.53	4.90					2.14	0.77	0.42	0.95															1.69	
of which Road & Tramways							1.69	0.77		0.92																5.48
Railroads	0.53	4.90					0.03			0.03																0.42
Waterways																										6.66
Air							0.42		0.42												0.41	0.15				0.42
INDUSTRY		5.00	0.61				0.42			0.13	0.22	0.02			0.12											6.66
of which Mining & Quarrying							0.49																			0.42
Fertilizer		0.26																				0.04				0.26
Heavy Chemical																										0.26
Structural Clay Products		1.38																			0.03	0.03				1.38
Cement		0.99																								0.99
Iron and Steel			0.61																							0.61
Non-ferrous																										0.61
Textiles		0.40																			0.03	0.05				0.40
Other		1.97																			0.35	0.03				1.97
AGRICULTURE		0.53					0.27			0.15	0.12	1.11	0.03		0.03					0.07		12.50	25.30	7.00	47.66	
DOMESTIC							1.17														0.14					0.12
COMMERCIAL																					0.12					1.11
GOVERNMENT		1.05																			0.06					1.05
OTHER SECTORS																										1.05
TOTAL INTERNAL FINAL CONSUMPTION	0.53	11.48	0.61	1.55			4.07	0.77	0.42	1.23	0.34	1.13	0.03	0.12	0.03					1.07	0.15	12.50	25.30	7.00	64.26	

(1) Energy content of falling water assuming an efficiency of 85%.
(2) Includes Delhi & Himachal Pradesh
(3) 0.03 is Inter-State sale.
(4) Only quantities needed for energy purposes.

Quantity less than 5 x 10⁹ kcal is not shown.

↓ ↑ Values not possible to isolate and included in these figures.

TABLE 6-21
 PRODUCTION AND USES OF ENERGY SOURCES - RAJASTHAN - 1960/1
 10¹² KILOCALORIES

	Coking Coal	Non-Coking Coal	Metal-lurgical Coke	Non-Metal-lurgical Coke	Crude Oil	Total Oil Products (2)	Motor Spirit	Aviation and Jet Fuel	HSDO	LDO	Kerosene	LPG	Fuel Oil	Vaporizing Oil & Ref. Fuel	Manufactured Gas			Electricity		Non-Comm. Fuels			Grand Total		
	1	2	3	4	5	6	7	8	9	10	11	12	13	14	Blast Furnace	Coke Oven	Gas Works	17	18	19	Dung (Dry)	Fire-wood	Waste Products	23	
PRODUCTION AND CONSUMPTION																									
A. PRIMARY SOURCES OF ENERGY																									
PRODUCTION		0.34																			5.50	24.50	7.50	37.84	
NET BALANCE OF EXTERNAL TRADE	+0.53	+9.15																						9.68	
BUNKERS																									
STOCK CHANGES																									
TOTAL CONSUMPTION	0.53	9.49																			5.50	24.50	7.50	47.52	
QUANTITIES TRANSFORMED		-1.36																						-1.36	
INTERNAL FINAL CONSUMPTION	0.53	8.13																			5.50	24.50	7.50	46.16	
B. SECONDARY SOURCES OF ENERGY																									
PRODUCTION																			0.09	0.12				0.21	
NET BALANCE OF EXTERNAL TRADE			+0.06	+0.10		+1.49													+0.02 ¹					1.67	
BUNKERS																									
STOCK CHANGES																									
TOTAL CONSUMPTION			0.06	0.10		1.49													0.11	0.12				1.88	
QUANTITIES TRANSFORMED						-0.10													0.11	0.12				-0.10	
INTERNAL FINAL CONSUMPTION			0.06	0.10		1.39													0.11	0.12				1.78	
TOTAL INTERNAL FINAL CONSUMPTION	0.53	8.13	0.06	0.10		1.39	0.30	0.01	0.35	0.18	0.45		0.08	0.02				0.11	0.12		5.50	24.50	7.50	47.94	
BREAKDOWN OF INTERNAL FINAL CONSUMPTION																									
A. CONSUMPTION BY THE ENERGY SECTOR AND LOSSES																									
of which Coal Mines & Washeries																									
Electric Power Plants																									
Coke Ovens																									
Oil Refineries & Field Operation																									
Losses																			0.02						0.02
B. CONSUMPTION BY OTHER SECTORS																									
TRANSPORTATION	0.53	5.50			0.61	0.30	0.01	0.30											0.01	0.01					6.66
of which Road & Tramways					0.59	0.30		0.29																	0.59
Railroads	0.53	5.50			0.01			0.01											0.01	0.01					6.06
Waterways																									
Air					0.01		0.01																		0.01
INDUSTRY		2.24	0.06		0.20			0.05	0.07				0.08						0.03	0.11					2.64
of which Mining & Quarrying																									
Fertilizer		0.13																							
Heavy Chemical																									
Structural Clay Products		0.07																							
Cement		1.58																		0.10					
Iron and Steel			0.06																						
Non-ferrous																									
Textiles		0.26																	0.01	0.01					
Other		0.20																	0.02						0.24
AGRICULTURE		0.13																							
DOMESTIC				0.10		0.11			0.11		0.45			0.02					0.02		5.50	24.50	7.50	38.09	
COMMERCIAL						0.47													0.01					0.01	
GOVERNMENT		0.26																	0.02					0.28	
OTHER SECTORS																									
TOTAL INTERNAL FINAL CONSUMPTION	0.53	8.13	0.06	0.10		1.39	0.30	0.01	0.35	0.18	0.45		0.08	0.02				0.11	0.12		5.50	24.50	7.50	47.94	

(1) 0.02 is Inter-State sale.

(2) Only quantities needed for energy purposes.

Quantity less than 5 x 10⁹ not shown.

Values not possible to isolate and included in these figures.

PRODUCTION AND USES OF ENERGY SOURCES - UTTAR PRADESH - 1960/
10¹² KILOCALORIES

	Coking Coal	Non-Coking Coal	Metal-lurgical Coke	Non-Metal-lurgical Coke	Crude Oil	Total Oil Products (2)	Motor Spirit	Aviation and Jet Fuel	HSD	LDO	Kerosene	LPG	Fuel Oil	Vaporizing Oil & Ref. Fuel	Manufactured Gas			Electricity		Non-Comm. Fuels			Grand Total
	1	2	3	4	5	6	7	8	9	10	11	12	13	14	Blast Furnace	Coke Oven	Gas Works	Utility	Non-Utility	Dung (Dry)	Fire-wood	Waste Products	23
PRODUCTION AND CONSUMPTION																							
A. PRIMARY SOURCES OF ENERGY																							
PRODUCTION																							
NET BALANCE OF EXTERNAL TRADE	+1.45	+29.33																0.45 ¹		34.90	57.20	24.90	117.45
BUNKERS																							
STOCK CHANGES																							
TOTAL CONSUMPTION	1.45	29.33																					
QUANTITIES TRANSFORMED		-5.38																					
INTERNAL FINAL CONSUMPTION	1.45	23.95																0.45		34.90	57.20	24.90	148.23
																		-0.45		34.90	57.20	24.90	-5.83
																				34.90	57.20	24.90	142.40
B. SECONDARY SOURCES OF ENERGY																							
PRODUCTION																							
NET BALANCE OF EXTERNAL TRADE			+0.55	+0.80		+4.52																	
BUNKERS																		1.07	0.14				1.21
STOCK CHANGES																							5.87
TOTAL CONSUMPTION			0.55	0.80		4.52																	
QUANTITIES TRANSFORMED						-0.10																	
INTERNAL FINAL CONSUMPTION			0.55	0.80		4.42												1.07	0.14				7.08
																							-0.10
																							6.98
TOTAL INTERNAL FINAL CONSUMPTION	1.45	23.95	0.55	0.80		4.42	0.51	0.40	1.12	0.49	1.83		0.05	0.02				1.07	0.14	34.90	57.20	24.90	149.38
BREAKDOWN OF INTERNAL FINAL CONSUMPTION																							
A. CONSUMPTION BY THE ENERGY SECTOR AND LOSSES																							
of which Coal Mines & Washeries																							
Electric Power Plants																		0.24					0.24
Coke Ovens																		0.05					0.05
Oil Refineries & Field Operation																							
Losses																							0.19
B. CONSUMPTION BY OTHER SECTORS																							
TRANSPORTATION	1.45	16.40				1.83	0.51	0.40	0.90														
of which Road & Tramways						1.31	0.51		0.80														
Railroads	1.45	16.40				0.11			0.10	0.01								0.03	0.02				19.73
Waterways						0.01																	1.31
Air						0.01												0.03	0.02				18.01
INDUSTRY		6.57	0.55			0.40		0.40	0.10	0.01													0.01
of which Mining & Quarrying						0.42			0.10	0.01													0.40
Fertilizer		0.59								0.26	0.02		0.04					0.40	0.12				8.06
Heavy Chemical																							
Structural Clay Products		1.84																					
Cement		0.46																					
Iron and Steel																							
Non-ferrous			0.55																				
Textiles																							
Other		1.12																					
AGRICULTURE		2.56																					
DOMESTIC		0.46				0.34			0.11									0.13	0.01				0.97
COMMERCIAL						1.83												0.26	0.06				
GOVERNMENT																		0.17		34.90	57.20	24.90	119.74
OTHER SECTORS		0.52																0.11					0.06
																		0.06					0.58
TOTAL INTERNAL FINAL CONSUMPTION	1.45	23.95	0.55	0.80		4.42	0.51	0.40	1.12	0.49	1.83		0.05	0.02				1.07	0.14	34.90	57.20	24.90	149.38

(1) Energy content of falling water assuming an efficiency of 85%.

(2) Only quantities needed for energy purposes.

Quantity less than 5 x 10⁹ not shown.

Values not possible to isolate and included in these figures.

TABLE 6-ZZ
 PRODUCTION AND USES OF ENERGY SOURCES - UTTAR PRADESH - 1960/1
 10¹² KILOCALORIES

	Coking Coal	Non-Coking Coal	Metal-lurgical Coke	Non-Metal-lurgical Coke	Crude Oil	Total Oil Products (2)	Motor Spirit	Aviation and Jet Fuel	HSD	LDO	Kerosene	LPG	Fuel Oil	Vaporizing Oil & Ref. Fuel	Manufactured Gas			Electricity		Non-Comm. Fuels			Grand Total	
	1	2	3	4	5	6	7	8	9	10	11	12	13	14	Blast Furnace	Coke Oven	Gas Works	Utility	Non-Utility	Dung (Dry)	Fire-wood	Waste Products	23	
PRODUCTION AND CONSUMPTION																								
A. PRIMARY SOURCES OF ENERGY																								
PRODUCTION																								
NET BALANCE OF EXTERNAL TRADE	+1.45	+29.33																0.45 ¹		34.90	57.20	24.90	117.45	
BUNKERS																							30.78	
STOCK CHANGES																								
TOTAL CONSUMPTION	1.45	29.33																						
QUANTITIES TRANSFORMED		-5.38																						
INTERNAL FINAL CONSUMPTION	1.45	23.95																-0.45		34.90	57.20	24.90	148.23	
B. SECONDARY SOURCES OF ENERGY																								
PRODUCTION																								
NET BALANCE OF EXTERNAL TRADE			+0.55	+0.80		+4.52												1.07	0.14				1.21	
BUNKERS																							5.87	
STOCK CHANGES																								
TOTAL CONSUMPTION			0.55	0.80		4.52																		
QUANTITIES TRANSFORMED						-0.10																	7.08	
INTERNAL FINAL CONSUMPTION			0.55	0.80		4.42												1.07	0.14				-0.10	
TOTAL INTERNAL FINAL CONSUMPTION	1.45	23.95	0.55	0.80		4.42	0.51	0.40	1.12									1.07	0.14				6.98	
BREAKDOWN OF INTERNAL FINAL CONSUMPTION																								
A. CONSUMPTION BY THE ENERGY																								
SECTOR AND LOSSES																								
of which Coal Mines & Washeries																								
Electric Power Plants																		0.24					0.24	
Coke Ovens																		0.05					0.05	
Oil Refineries & Field Operation																								
Losses																							0.19	
B. CONSUMPTION BY OTHER SECTORS																								
TRANSPORTATION	1.45	16.40				1.83	0.51	0.40	0.90															
of which Road & Tramways						1.31	0.51		0.80														19.73	
Railroads	1.45	16.40				0.11			0.10	0.01								0.03	0.02				1.31	
Waterways						0.01																	18.01	
Air						0.40		0.40										0.03	0.02				0.01	
INDUSTRY		6.57	0.55			0.42			0.10	0.01													0.40	
of which Mining & Quarrying																							8.06	
Fertilizer		0.59								0.26	0.02							0.40	0.12					
Heavy Chemical																								
Structural Clay Products		1.84																						
Cement		0.46																						
Iron and Steel			0.55																					
Non-ferrous																								
Textiles		1.12																0.01						
Other		2.56																						
AGRICULTURE		0.46				0.34			0.12									0.13	0.01					
DOMESTIC				0.80		1.83												0.26	0.06				0.97	
COMMERCIAL										0.22								0.17					119.74	
GOVERNMENT		0.52									1.81							0.11		34.90	57.20	24.90	0.06	
OTHER SECTORS																		0.06					0.58	
TOTAL INTERNAL FINAL CONSUMPTION	1.45	23.95	0.55	0.80		4.42	0.51	0.40	1.12									1.07	0.14	34.90	57.20	24.90	149.38	

(1) Energy content of falling water assuming an efficiency of 85%.

(2) Only quantities needed for energy purposes.

Quantity less than 5 x 10⁹ not shown.

Values not possible to isolate and included in these figures.

TABLE 6-23
 PRODUCTION AND USES OF ENERGY SOURCES - WEST BENGAL - 1960/1
 10¹² KILOCALORIES

	Coking Coal	Non-Coking Coal	Metal-lurgical Coke	Non-Metal-lurgical Coke	Crude Oil	Total Oil Products (3)	Motor Spirit	Aviation and Jet Fuel	HSD	LDO	Kerosene	LPG	Fuel Oil	Vaporizing Oil & Ref. Fuel	Manufactured Gas			Electricity		Non-Comm. Fuels			Grand Total
															Blast Furnace	Coke Oven	Gas Works	Utility	Non-Utility	Dung (Dry)	Fire-wood	Waste Products	
	1	2	3	4	5	6	7	8	9	10	11	12	13	14	15	16	17	18	19	20	21	22	23
PRODUCTION AND CONSUMPTION																							
A. PRIMARY SOURCES OF ENERGY																		0.16 ¹		7.20	37.50	10.40	161.79
PRODUCTION	4.50	102.03																					-42.50
NET BALANCE OF EXTERNAL TRADE	+21.10	-63.60																					-0.38
BUNKERS		-0.38																					-2.67
STOCK CHANGES	-0.47	-2.20																0.16		7.20	37.50	10.40	116.24
TOTAL CONSUMPTION	25.13	35.85																-0.16					-28.41
QUANTITIES TRANSFORMED	-18.30	-9.95																		7.20	37.50	10.40	87.83
INTERNAL FINAL CONSUMPTION	6.83	25.90																					
B. SECONDARY SOURCES OF ENERGY																		1.99	0.53				22.67
PRODUCTION			10.68	0.90											4.45	4.12		+0.41 ²					11.43
NET BALANCE OF EXTERNAL TRADE			-0.30	+4.15		+7.17																	-0.70
BUNKERS						-0.70																	+0.12
STOCK CHANGES			+0.12																				33.52
TOTAL CONSUMPTION			10.50	5.05		6.47									4.45	4.12		2.40	0.53				-6.20
QUANTITIES TRANSFORMED			-4.46			-0.10									3.19	3.74		2.40	0.53				27.32
INTERNAL FINAL CONSUMPTION			6.04	5.05		6.37									3.19	3.74		2.40	0.53	7.20	37.50	10.40	115.15
TOTAL INTERNAL FINAL CONSUMPTION	6.83	25.90	6.04	5.05		6.37	1.20	0.59	1.06	0.27	2.15		1.08	0.02	3.19	3.74		2.40	0.53	7.20	37.50	10.40	115.15
BREAKDOWN OF INTERNAL FINAL CONSUMPTION																							
A. CONSUMPTION BY THE ENERGY																							7.83
SECTOR AND LOSSES	0.20	5.27													1.34	0.71		0.31					5.57
of which Coal Mines & Washeries	0.20	5.27																0.10					0.11
Electric Power Plants															0.33	0.09							0.42
Coke Ovens																							1.73
Oil Refineries & Field Operation															1.01	0.62		0.10					
Losses																							
B. CONSUMPTION BY OTHER SECTORS																		0.14	0.02				15.73
TRANSPORTATION	1.63	11.44				2.50	1.20	0.59	0.68	0.01								0.04					1.90
of which Road & Tramways						1.86	1.20		0.66									0.10	0.02				11.62
Railroads	1.63	9.86				0.01																	1.62
Waterways		1.58				0.04			0.02	0.01													0.59
Air						0.59		0.59															26.85
INDUSTRY	5.00	7.75	6.04			1.50			0.27	0.15	0.02				1.85	2.90		1.44	0.37				
of which Mining & Quarrying																							
Fertilizer		0.13																0.09	0.02				
Heavy Chemical																							
Structural Clay Products		0.92																					
Cement																		0.10	0.17				
Iron and Steel	5.00		6.04												1.85	2.90		0.02	0.06				
Non-ferrous																		0.51	0.04				
Textiles		0.40																0.72	0.08				0.22
Other		6.30																					62.74
AGRICULTURE						0.22			0.11	0.11	2.13							0.31		7.20	37.50	10.40	0.56
DOMESTIC				5.05		2.15												0.10					1.08
COMMERCIAL		0.46																0.10					0.14
GOVERNMENT		0.98																	0.14				
OTHER SECTORS																							
TOTAL INTERNAL FINAL CONSUMPTION	6.83	25.90	6.04	5.05		6.37	1.20	0.59	1.06	0.27	2.15		1.08	0.02	3.19	3.74		2.40	0.53	7.20	37.50	10.40	115.15

Quantity less than 5 x 10⁹ kcal not shown.

↑ ↓ Values not possible to isolate and included in these figures.

(1) Energy content of falling water assuming an efficiency of 85%.
 (2) 0.41 is Inter-State sale.
 (3) Only quantities needed for energy purposes.

TABLE 6-24
ENERGY CONSUMPTION IN INDIA BY PRIMARY SOURCE (1)
1953/4-1960/1
12
10¹² kilocalories

Year	Coal	Oil (3)	Hydro Power (2)	Total Commercial Sources	Non-Commercial Fuels			Grand Total
					Dung	Firewood	Waste Products	
1953/4	217.8	34.8	2.9	255.5	111.2	406.0	124.0	896.7
1954/5	217.7	39.2	3.3	260.2	114.2	412.0	127.0	913.4
1955/6	224.2	43.6	3.8	271.6	117.3	417.0	130.0	935.9
1956/7	238.0	47.6	4.3	289.9	120.2	423.0	133.5	966.6
1957/8	265.4	52.2	5.1	322.7	123.5	429.9	137.0	1013.1
1958/9	279.3	55.7	5.9	340.9	126.7	436.0	141.0	1044.6
1959/60	280.6	61.3	7.1	349.0	128.0	452.0	142.0	1071.0
1960/1	320.4	67.4	7.6	395.6	129.8	470.0	144.0	1139.4

- (1) Total internal consumption excluding international ocean going vessels (bunkers), taking account of the balance of foreign trade and stock changes in primary and secondary forms of energy and excluding non-energy petroleum products.
- (2) Energy content of the falling water assuming an average efficiency of 85%.
- (3) Includes power alcohol (a substitute fuel derived from molasses) equivalent to 0.3, 0.3, 0.2, & 0.2 10¹² kcal in 1957/58, 1958/59, 1959/60 & 1960/61 respectively

TABLE 6-25
CONTRIBUTION OF THE VARIOUS FORMS OF PRIMARY ENERGY TO THE TOTAL CONSUMPTION OF PRIMARY ENERGY IN INDIA
PERCENTAGES

Year	Coal	Oil	Hydro	Other Forms (Non-Commercial Sources)	
				Total	Total
1953/4	24.3	3.9	0.3	71.5	100
1954/5	23.8	4.3	0.4	71.5	100
1955/6	24.0	4.7	0.4	71.0	100
1956/7	24.8	4.9	0.4	70.0	100
1957/8	28.2	5.2	0.5	68.1	100
1958/9	28.7	5.3	0.6	67.4	100
1959/60	28.2	5.7	0.7	67.4	100
1960/1	28.1	5.9	0.7	65.3	100

TABLE 6-26
ENERGY CONSUMPTION IN INDIA BY INDIGENOUS PRIMARY SOURCE AND IMPORTS
1953/4 - 1960/1

Year	Indigenous Production				Total	10 ¹² kilocalories			Total Internal Consumption** (1)	Net Imports as % of Total Consum- ption.
	Coal	Oil Products (1)	Hydro Power (2)	Other Forms of Energy		Net Imports	Stock Changes *	Bunkers		
1953/4	236.1	2.0	2.9	841.2	882.2	22.0	-2.3	-5.2	896.7	2.45
1954/5	241.9	3.1	3.3	853.2	901.5	28.8	-12.0	-4.9	913.4	3.15
1955/6	250.4	3.6	3.8	864.3	922.1	34.8	-16.8	-4.4	935.9	3.72
1956/7	262.7	4.1	4.3	876.7	947.8	36.8	-12.7	-5.3	966.6	3.81
1957/8	286.8	4.7	5.1	890.4	987.0	42.2	-10.6	-5.5	1013.1	4.17
1958/9	300.3	4.8	5.9	703.7	1014.7	45.6	-10.7	-5.0	1044.6	4.37
1959/60	310.3	4.7	7.1	722.0	1044.1	53.4	-21.8	-4.6	1071.1	4.99
1960/1	356.4	4.8	7.8	743.8	1112.8	60.4	-28.7	-5.1	1139.4	5.30

*(-) put to stocks.

(+) taken from stocks.

** Excluding consumption by international ocean going vessels (bunkers).

(1) Includes power alcohol (a substitute fuel derived from molasses) equivalent to 0.3, 0.3, 0.2 & 0.2¹² kcal in 1957/8, 1958/9, 1959/60 & 1960/1 respectively.

(2) Energy content of the falling water assuming an average efficiency of 85%.

TABLE 8-27

FINAL CONSUMPTION OF THE VARIOUS FORMS OF PRIMARY & SECONDARY ENERGY IN INDIA.^{1/}

1953/4 - 1960/1

Year	10 ¹² KCALS									Grand Total
	Coking Coal	Non-Coking Coal	Metallurgical Coke	Non-Metallurgical Coke	Oil Products	Manufactured Gas	Electricity	Total Commercial Sources	Non-Commercial Sources ^{2/}	
1953/4	47.9	93.3	8.9	7.1	33.9	5.1	8.2	202.4	841.2	843.8
1954/5	44.5	93.3	9.4	7.8	38.1	8.0	8.8	204.0	853.2	857.2
1955/6	41.9	95.7	10.9	8.5	39.6	5.5	7.7	209.8	864.3	874.1
1956/7	47.0	101.3	10.4	9.8	43.1	5.4	8.8	225.8	878.7	902.3
1957/8	49.3	122.8	10.3	9.4	46.5	5.5	9.9	253.7	690.4	944.1
1958/9	42.0	131.3	14.5	10.3	49.8	8.4	11.1	285.4	703.7	989.1
1959/60	30.1	133.2	17.9	9.9	54.9	8.9	12.8	287.7	722.0	989.7
1960/1	22.8	160.0	20.3	9.2	60.1	13.2	14.1	299.7	743.8	1043.5

(1) Total internal final consumption excluding consumption by the energy sector and losses and consumption for transformation, i.e. the final coal consumption does not include the coal consumed in industrial auto producers' power and gas plants; the coke equivalent of the blast furnace gas produced has been deducted from the coke figures to arrive at final coke consumption in steel plants; the final gas consumption does not include the consumption and losses in blast furnaces and underfiring of coke ovens.

(2) Such as dung, firewood and waste products.

TABLE 6-28
PERCENTAGE OF FINAL CONSUMPTION OF THE VARIOUS FORMS OF PRIMARY AND SECONDARY ENERGY TO THE TOTAL
FINAL CONSUMPTION IN INDIA ¹⁾
1953/4 - 1960/1

Year	Coking Coal	Non-Coking Coal	Metallurgical Coke	Non- Metallurgical Coke	Oil Products	Manufactured Gas	Electricity	Non- Commercial Sources	Total
1953/4	5.7	11.1	1.1	0.8	4.0	0.6	0.7	76.0	100
1954/5	5.2	10.8	1.1	0.9	4.2	0.7	0.8	76.2	100
1955/6	4.8	11.0	1.2	1.0	4.5	0.6	0.9	76.0	100
1956/7	5.2	11.2	1.2	1.1	4.8	0.6	1.0	75.0	100
1957/8	5.2	13.0	1.1	1.0	4.9	0.6	1.0	73.1	100
1958/9	4.3	13.5	1.5	1.1	5.1	0.7	1.1	72.8	100
1959/60	3.0	13.5	1.8	1.0	5.5	0.9	1.3	73.0	100
1960/1	2.2	15.3	1.9	0.9	5.8	1.3	1.4	71.3	100

1) See notes to Table 6-27