

REPORT
OF THE
CALENDAR REFORM COMMITTEE

GOVERNMENT OF INDIA



सत्यमेव जयते

Council of Scientific and Industrial Research,
Old Mill Road,
New Delhi.
1955

REPORT
OF THE
CALENDAR REFORM COMMITTEE

GOVERNMENT OF INDIA

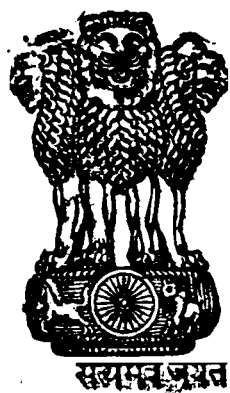

Council of Scientific and Industrial Research,
Old Mill Road,
New Delhi.
1955

Published by
The Council of Scientific and Industrial Research,
Old Mill Road,
New Delhi.



Printed by
Sri Hari Narayan Dey,
Sree Gopal Printing Works,
25/1A, Kalidas Singhee Lane,
Calcutta—9.



M E S S A G E .

I am glad that the Calendar Reform Committee has started its labours. The Government of India has entrusted to it the work of examining the different calendars followed in this country and to submit proposals to the Government for an accurate and uniform calendar based on a scientific study for the whole of India. I am told that we have at present thirty different calendars, differing from each other in various ways, including the methods of time reckoning. These calendars are the natural result of our past political and cultural history and partly represent past political divisions in the country. Now that we have attained independence, it is obviously desirable that there should be a certain uniformity in the calendar for our civic, social and other purposes and that this should be based on a scientific approach to this problem.

It is true that for governmental and many other public purposes we follow the Gregorian calendar, which is used in the greater part of the world. The mere fact that it is largely used, makes it important. It has many virtues, but even this has certain defects which make it unsatisfactory for universal use.

It is always difficult to change a calendar to which people are used, because it affects social practices. But the attempt has to be made even though it may not be as complete as desired. In any event, the present confusion in our own calendars in India ought to be removed.

I hope that our Scientists will give a lead in this matter.

Jawaharlal Nehru

New Delhi,
February 18, 1953.

MEMBERS OF THE CALENDAR REFORM COMMITTEE

CHAIRMAN

Prof. M. N. Saha, D. Sc., F. R. S., *M. P.*,
Director, Institute of Nuclear Physics,
92, Upper Circular Road, Calcutta-9.

MEMBERS

Prof. A. C. Banerji, M. A., M. Sc., F. N. I.,
Vice-Chancellor, Allahabad University,
Allahabad.

Dr. K. L. Daftari, B. A., B. L., D. Litt.,
Mahal, Nagpur.

Shri J. S. Karandikar, B. A., LL. B.,
Ex-Editor, The Kesari,
568 Narayan Peth,
Poona-2.

Dr. Gorakh Prasad, D. Sc.,
Reader in Mathematics, Allahabad University,
Beli Avenue, Allahabad.

Prof. R. V. Vaidya, M. A., B. T.,
Senior Lecturer in Mathematics, Madhav College, Ujjain,
78, Ganesh Bhuvan, Freegunj, Ujjain.

Shri N. C. Lahiri, M. A.,
55A, Raja Dinendra Street, Calcutta-6.

Shri N. C. Lahiri acted as the Secretary of the Committee.

TRANSLITERATION

The scheme of transliteration of Sanskrit alphabets into Roman script adopted in this publication is the same as generally followed. The corresponding scripts are given below :—

VOWELS			CONSONANTS		
अ	...	a	क	...	p
आ	...	ā	ख	...	ph
इ	...	i	ग	...	b
ई	...	ī	घ	...	bh
उ	...	u	ङ	...	m
ऊ	...	ū	च	...	y
ऋ	...	ṛ	छ	...	r
ॠ	...	ṝ	ज	...	l
ऌ	...	ḷ	झ	...	v
ॡ	...	ḹ	ञ	...	ñ
ए	...	e	ट	...	ś
ऐ	...	ai	थ	...	s
ओ	...	o	द	...	s
औ	...	au	ध	...	h
			ण	...	
			त	...	m̐
			थ	...	h̐
			द	...	,
			ध	...	
			न	...	

N. B. Diacritical marks have not generally been used in names of persons belonging to recent times as well as in well-known geographical names.

P R E F A C E

The Calendar Reform Committee was appointed in November, 1952, by the Council of Scientific and Industrial Research (of the Government of India) with the following terms of reference :

“To examine all the existing calendars which are being followed in the country at present and after a scientific study of the subject, submit proposals for an accurate and uniform calendar for the whole of India”.

In accordance with its terms of reference, the Committee (for personnel, see p. 4) has scientifically examined all the calendars prevalent in India (*vide* Part C, Chap. V), *viz.*,—

Gregorian Calendar...which is used for civil and administrative purposes (*vide* p. 170) all over the world.

Islamic Calendar.....used for fixing up the dates of Islamic festivals (*vide* p. 179).

Indian Calendars

or Pañcāngas.....used for fixing up dates and moments of Hindu, Bauddha and Jaina festivals in different States of India, and in many cases for civil purposes also. They are about 30 in number. (*vide* Chap. V, p. 258).

It has been pointed out (p. 171) that the Gregorian calendar, which is used all over the world for civil and administrative purposes, is a very unscientific and inconvenient one. The World Calendar (p. 173), proposed by the World Calendar Association of New York, has been examined and found suitable for modern life. The proposal for its adoption by all the countries of the world for civil and administrative purposes was sponsored by the Indian Government before the U. N. O. and debated before the ECOSOC (Economic and Social Council) at Geneva in June, 1954 (p. 173) and its recommendations have been transmitted to the Governments of the World for their opinion. It is hoped that the World Calendar will be ultimately adopted. It will lead to a great simplification of modern life.

The introduction of the World Calendar in place of the Gregorian is a matter for the whole world, which has now to look for decision by the U. N. O.

The Islamic (Hejira) calendar has been discussed on p. 179, along with some proposals for reform

suggested by Dr. Hashim Amir Ali of the Osmania University, and Janab Mohammed Ajmal Khan of the Ministry of Education. It is for the Islamic world to give its verdict on these suggestions. If these suggestions are accepted, the Islamic calendar would fall in line with other luni-solar calendars.

As these two important systems of calendars had to be left out, the Committee's labours were confined to an examination of the different systems of calendars used by Hindus, Bauddhas and Jainas in the different states of India, chiefly for the fixing up of the dates and moments of their religious festivals, and for certain civil purposes as well.

For the purpose of examining all the existing calendars of India, as per terms of reference, an appeal was issued to the Pañcānga (Almanac) makers for furnishing the Committee with three copies of their Pañcāngas. In reply to our request 60 Pañcāngas (Almanacs) were received from different parts of the country and were examined (p. 21). To facilitate examination of the calendars, a questionnaire was issued to which 51 replies were received (pp. 23-31). In addition to the above, 48 persons offered their suggestions (pp. 32-38) for reform of the Indian calendar. These views were very divergent in character. Some quoted ancient scriptures to prove that the earth is flat, with a golden mountain in the centre round which move the sun and the planets, others tried to refute the precession of equinoxes. All opinions were taken into consideration in arriving at the decisions of the Committee.

Principles followed in fixing up the Calendar :—The calendar has got two distinct uses—civil and religious. The Indian calendars are used not only for fixing up the dates and moments of religious observances but also for the purpose of dating of documents and for certain civil purposes not only by the rural, but also by a large section of the urban population. There is great divergence in practice in different parts of the country in this respect. Therefore a unified solar calendar has been proposed for all-India use for civil purposes. This has been based on the correct length of the year (*viz.* the tropical year) and the popular month-names, *viz.*, Caitra, Vaiśākha, etc. have been retained (see p. 6).

Calendars are based partly on SCIENCE which nobody is permitted to violate and partly on CONVENTIONS which are man-made and vary from

place to place. The Indian calendars put up by almanac-makers commit the violation of the following principles of science :—

They take the length of the year to be 365.258756 days (p. 240, Part C of Report) as given by the *Sūrya-Siddhānta* about 500 A. D. ; while the correct length of the tropical year, which alone can be used according to the *Sūrya-Siddhānta* and modern astronomy for calendarical use, is 365.242196 days. The difference of .01656 days is partly due to errors of observation, not infrequent in those days, and to their failure to recognize the precession of equinoxes. As the *Sūrya-Siddhānta* value of the year-length is still used in almanac-making, the year-beginning is advancing by .01656 days per year, so that in the course of nearly 1400 years, the year-beginning has advanced by 23.2 days, with the result that the Indian solar year, instead of starting on the day following the vernal equinox, i.e., on March 22, as prescribed in the *Sūrya-Siddhānta* (see Chap. V, p. 239), starts on April 13 or 14. The situation is the same as happened in Europe due to the acceptance of 365.25 days as the length of the year at the time of Julius Caesar ; the Christmas originally linked to the winter solstice preceded it by 10 days by 1582 A.D., when the error was rectified by the promulgation of a bull by Pope Gregory XIII. By this, Friday, October 5 was proclaimed as Friday, October 15, and new leap-year rules were introduced.

Unlike Europe, where the Pope in the medieval times possessed an authority which every one in Catholic Europe respected, India had a multiplicity of eras and year-beginnings due to her history during the years 500-1200 A. D. But for calendaric calculations, our astronomers all over India have been using only the Śaka era since Āryabhaṭa (500 A.D.) certainly and probably from much earlier times, and in local almanacs other eras are simply imposed on it. The Calendar Committee has therefore recommended :—

That for all official purposes, the Central as well as State Governments should use the Śaka era along with the civil calendar proposed by the Committee (p.6). It is suggested that the change-over may take place from the Śaka year 1878, Caitra 1 (1956, March 21). If this is accepted, the last month of the year, viz., 1877 Śaka, the solar Phālguna, which has a normal length of 30 days, will have an extra number of 6 or 7 days.

The pre-eminence of the Śaka era is due, as historical evidences cited on pp. 228-238 and 255-257 show, that it was the earliest era introduced in India, by Śaka ruling powers, and have been used exclusively by the Śakadvīpi Brahmins (forming the astrologer caste) for calendar-making on the basis of Siddhāntic

(scientific) astronomy evolved by Indian astronomers on the basis of old Indian calendaric conceptions, which were put on scientific basis by blending with them astronomical conceptions prevalent in the West, from the third century B.C.

The era is also used exclusively for horoscope making, a practice introduced into India since the first century A.D. by the Śakadvīpi Brāhmaṇas.

The Calendar Committee has devised a solar calendar with fixed lengths of months for all-India use, in which it has been proposed to give up the calculations of the *Sūrya-Siddhānta* in which the solar months vary from 29 to 32 days.

Religious Calendar—The Committee's task resolved itself into a critical examination of the different Indian local calendars, about 30 in number, which use different methods of calculation. This produces great confusion.

As already stated the *Sūrya-Siddhānta* year being longer than the tropical year by about 24 mins., the Hindu calendar months have gone out of the seasons to which they conformed when the Siddhāntic rules were framed ; as a result, the religious festivals are being observed not in the seasons for which they were intended but in wrong seasons. The Committee felt that the error should be corrected once for all and the months brought back to their original seasons. But with a view to avoiding any violent break in the present day practices, the desired shifting has not been effected, but any further increase of the error has been stopped by adopting the tropical year for our religious calendar also (see p. 7).

Before the rise of Siddhānta Jyotiṣa (400 A.D.), India used only the lunar calendar calculated according to the Vedāṅga Jyotiṣa rules and most religious festivals (e.g. the Janmāṣṭamī, the birthday of Śrī Kṛṣṇa) used to be fixed up by the lunar calendar which used only tithi and nakṣatra. The Calendar Committee could not find out any way of breaking off with the lunar affiliation short of a religious revolution and has, therefore, decided to keep them. For this purpose, the lunar year is to be pegged on to the solar year by a number of conventions. The Committee has adhered to the ancient conventions as far as possible. But the erroneous calculations of tithis and nakṣatras have been replaced by modern calculations given in the nautical almanacs and modern ephemerides, and the religious holidays have been fixed for a central station of India (vide page 40).

The present practice is to calculate the tithi for each locality and the result is that the same tithi may not occur on the same day at all places. The Calendar Committee has found that the continuance

of different lunar calendars for different places is a relic of medieval practice when communication was difficult, the printing press did not exist and astrologers of each locality used to calculate the calendar for that locality based on Siddhāntic rules and used to proclaim it on the first day of the year to their clients. In these days of improved communication, free press, and radio, there is not the slightest justification for continuance of this practice and the Committee has fixed up the holidays for the central station (82° 30' E, 23° 11' N, see Report p. 40); and recommended that these holidays may be used for the whole of India. The dates of festivals of the Hindus, Jains and Bauddhas have been determined on the above basis. This will put an end to the calendar confusion.

The confusion is symbolic of India's history. While all Christendom comprising people of Europe, Asia and America, follows the Gregorian calendar, and the whole of the Islamic world follows the Hejira calendar for civil and religious purposes, India uses 30 different systems for fixing up the same holidays in different parts of the country and frequently, two rival schools of pañcāṅga-makers in the same city fix up different dates for the same festival. This is a state of affairs which Independent India cannot tolerate. A revised national calendar, as proposed by us, should usher a new element of unity in India.

The Committee has therefore gone deeply into the history of calendar making in all countries from the earliest times particularly into the history of calendar-making in India (*vide* Chap. V) and has arrived at their conclusions. Its recommendations are entirely in agreement with the precepts laid down by the Siddhāntic astronomers, as given in the Sūrya-Siddhānta and other standard treatises (see p. 238 *et seq.*).

The Committee has also compiled a list of all religious festivals observed in different parts of India and listed them under the headings (i) Lunar, and (ii) Solar, with their criteria for fixing the dates of their observances (pp. 102-106).

Where does the Government come in : Though India is a secular state, the Central Government and the State Governments have to declare a number of holidays in advance, a list of which will be found on pages 117-154 for the Central Government as well as for the States. These holidays are of four different kinds, viz. :—

- (i) Holidays given according to the Gregorian calendar, e.g., Mahatma Gandhi's birthday, which falls on Oct. 2. These present no problem to any government.

- (ii) But there are other holidays, which are given according to the position of the Sun (*vide* pp. 117-118).
- (iii) Others which are given according to the luni-solar calendar (pp. 119-124).
- (iv) Holidays for Moslems and Christians (pp. 125 and 126).

It is a task for the Central as well as State Governments to calculate in advance dates for the holidays it gives. This is done on the advice of Pañcāṅga-makers attached to each Government. In addition, numerous indigenous pañcāṅgas are prepared on the Siddhāntic system of calculations, the elements of which are now found to be completely erroneous. There is a wide movement in the country first sponsored by the great savant, patriot and political leader, the late Lokamanya B. G. Tilak, for making the pañcāṅga calculations on the basis of the correct and up-to-date astronomical elements. As a result, there are almost in every State different schools of pañcāṅga calculations, differing in the durations of tithis, nakṣatras, etc., and consequently in the dates of religious festivals. The problem before the Government is : which one of the divergent systems is to be adopted. The Committee has suggested a system of calculations for the religious calendar also, based on most up-to-date elements of the motion of the sun and the moon. Calendars for five years from 1954-55 to 1958-59 have been prepared on this basis showing therein *inter alia* the dates of important festivals of different States (*vide* pp. 41-100). The lists of holidays for the Government of India and of each separate State for the five years have also been prepared from this calendar for the use of the Governments. The Committee hopes that the Government of India as well as the State Governments would adopt these lists in declaring their holidays in future. The Ephemerides Committee which has been formed by the Government of India, consisting of astronomers versed in the principles of calendar-making would act as advisers to the Central as well as State Governments. It may be assisted by an advisory committee to help it in its deliberations.

The responsibility of preparation of the five-yearly calendar and the list of holidays on the basis of recommendations adopted by the Committee has been shared by Sri N. C. Lahiri and Sri R. V. Vaidya, aided by some assistants and several pandits of note, amongst whom the following may be mentioned : Sri A. K. Lahiri, Sri N. R. Choudhury, Pandit Narendranath Jyotiratna, and Joytish Siddhanta Kesari Venkata Subba Sastry of Madras.

We have received great help from C. G. Rajan, B.A., Sowcarpet, Madras. He has kindly furnished

PREFACE

us with valuable suggestions regarding 'Rules for fixing the dates of festivals for South India'.

We are indebted to the Astronomer Royal of Great Britain, Sir Harold Spencer Jones, and to Mr. Sadler, head of the Ephemerides division of the Royal Observatory of U. K. for having very kindly supplied us with certain advance data relating to the sun and the moon which have facilitated our calculations. We have to thank the great oriental scholar, Otto Neugebauer for having helped us in clearing many obscure points in ancient calendaric astronomy. We wish to express our thanks to Prof. P. C. Sengupta for helping us in clearing many points of ancient and medieval Indian astronomy.

We have reproduced figures from certain books and our acknowledgement is due to the publishers. It was however not possible to obtain previous permission from them, but the sources have been mentioned at the relevant places.

It is a great pleasure and privilege to express our gratitude to our colleagues of the Calendar Committee for their active co-operation in the deliberations of the Committee, and ungrudging help whenever it was sought for.

Calcutta,
The 10th Nov., 1955.

M. N. Saha
Chairman
N. C. Lahiri
Secretary

CONTENTS

	PAGE		PAGE
Message from the Prime Minister ...	iii	Government of India Holidays ...	127
Members of the Calendar Reform Committee ...	v	List of Holidays for different States of India—	
Transliteration ...	vi	Assam Holidays ...	128
Preface ...	vii	Bihar „ ...	129
		Bombay „ ...	130
PART A		Madhya Pradesh Holidays ...	131
Introductory ...	1	Madras „ ...	132
Appointment of the Committee ...	4	Orissa „ ...	133
Final Recommendations of the Committee ...	6	East Punjab „ ...	134
		Uttar Pradesh „ ...	135
ANNEXURE :		West Bengal „ ...	136
I—Proceedings of the First Meeting of the Committee ...	9	Hyderabad „ ...	137
II—Proceedings of the Second Meeting of the Committee ...	15	Jammu & Kashmir „ ...	138
III—Proceedings of the Third Meeting of the Committee ...	17	Madhya Bharat „ ...	139
IV—A Summary of reasons for the dissenting note by Dr. K. L. Daftari ...	18	Mysore „ ...	140
V—List of Pañcāngas received ...	21	Patiala & East Punjab States Union Holidays ...	141
VI—Questionnaire ...	22	Rajasthan Holidays ...	142
Replies to questionnaire ...	23	Saurashtra „ ...	143
VII—Summary of suggestions for Indian Calendar Reform received from different persons and institutions ...	32	Travancore-Cochin „ ...	144
		Ajmer „ ...	145
PART B		Bhopal „ ...	146
Explanation ...	40	Bilaspur „ ...	147
REFORMED CALENDAR OF INDIA for each month of the five years 1876 to 1880 Śaka ...	41-100	Coorg „ ...	148
General rules for religious festivals ...	101	Delhi „ ...	149
Lunar festivals ...	102	Himachal Pradesh „ ...	150
Solar festivals ...	106	Kutch „ ...	151
Criteria of some festivals for South India ...	106	Manipur „ ...	152
Certain special tithis and combinations ...	107	Tripura „ ...	153
Certain special Yogas ...	108	Vindhya Pradesh „ ...	154
Tithis, Nakṣatras, Muhūrtas and their lords ...	109		
Yogas & Karaṇas ...	110	PART C	
Alphabetical list of festivals ...	111	History of the Calendar in different countries through the ages	
Sunrise and sunset for certain important places ...	116		
LIST OF HOLIDAYS ...	117	CHAPTER	
Consolidated list of holidays for all States of India--		I—General Principles of Calendar Making ...	157-163
A—Fixed holidays & Solar festivals ...	117	1.1 Introduction ...	157
B—Lunar festivals ...	119	1.2 The natural periods of time ...	157
Moslem festivals ...	125	1.3 The problems of the Calendar ...	158
Christian festivals ...	126	1.4 Subdivisions of the day ...	159
		1.5 Ahargaṇa or heap of days : Julian days ...	161
		II—The Solar Calendar ...	164-173
		2.1 Time reckonings in ancient Egypt ...	164
		2.2 Solar calendars of other ancient nations ...	165
		2.3 The Iranian Calendar ...	166

CHAPTER	PAGE	CHAPTER	PAGE
2.4	167	<i>Appendix :</i>	
2.5	168	4-A—Newton's explanation of the	
2.6	170	precession of the equinoxes	207
2.7	171	4-B—Stars of the lunar mansions	210
III—The Luni-Solar and Lunar Calendars	174-180		
3.1	174	V—Indian Calendar	212-270
3.2	175	5.1	212
Moon's synodic period or lunation :		5.2	214
Empirical relation between the year		5.3	218
and the month	175	literature	
3.3	176	5.4	221
The luni-solar calendars of the Babylonians,		5.5	226
the Macedonians, the Romans and the		records about calendar	
Jews	176	5.6	234
3.4	177	Solar Calendar in the Siddhānta Jyotiṣa	
3.5	179	period	234
3.6	179	5.7	245
IV—Calendaric Astronomy	181-211	Lunar Calendar in the Siddhānta Jyotiṣa	
4.1	181	period	245
4.2	184	5.8	251
Long period observations of the moon :		Indian Eras	
The Chaldean Saros	184	<i>Appendix :</i>	
4.3	188	5-A—The Seasons	259
4.4	190	5-B—The Zero-point of the Hindu Zodiac...	262
Night observations : the celestial		5-C—Gnomon measurements in the Aitareya	
pole and the equator	190	Brāhmaṇa	266
4.5	191	5-D—Precession of the Equinoxes amongst	
The apparent path of the sun in the sky :		Indian Astronomers	267
The Ecliptic	191	5-E—The Jovian years	270
4.6	192	Corrigenda and Addenda	271
4.7	194	Bibliography	272
Chaldean contributions to astronomy :		Index	274
Rise of planetary and horoscopic			
astrology	194		
4.8	201		
4.9	204		
Discovery of the precession of the			
equinoxes	204		

THE ZODIAC THROUGH THE AGES

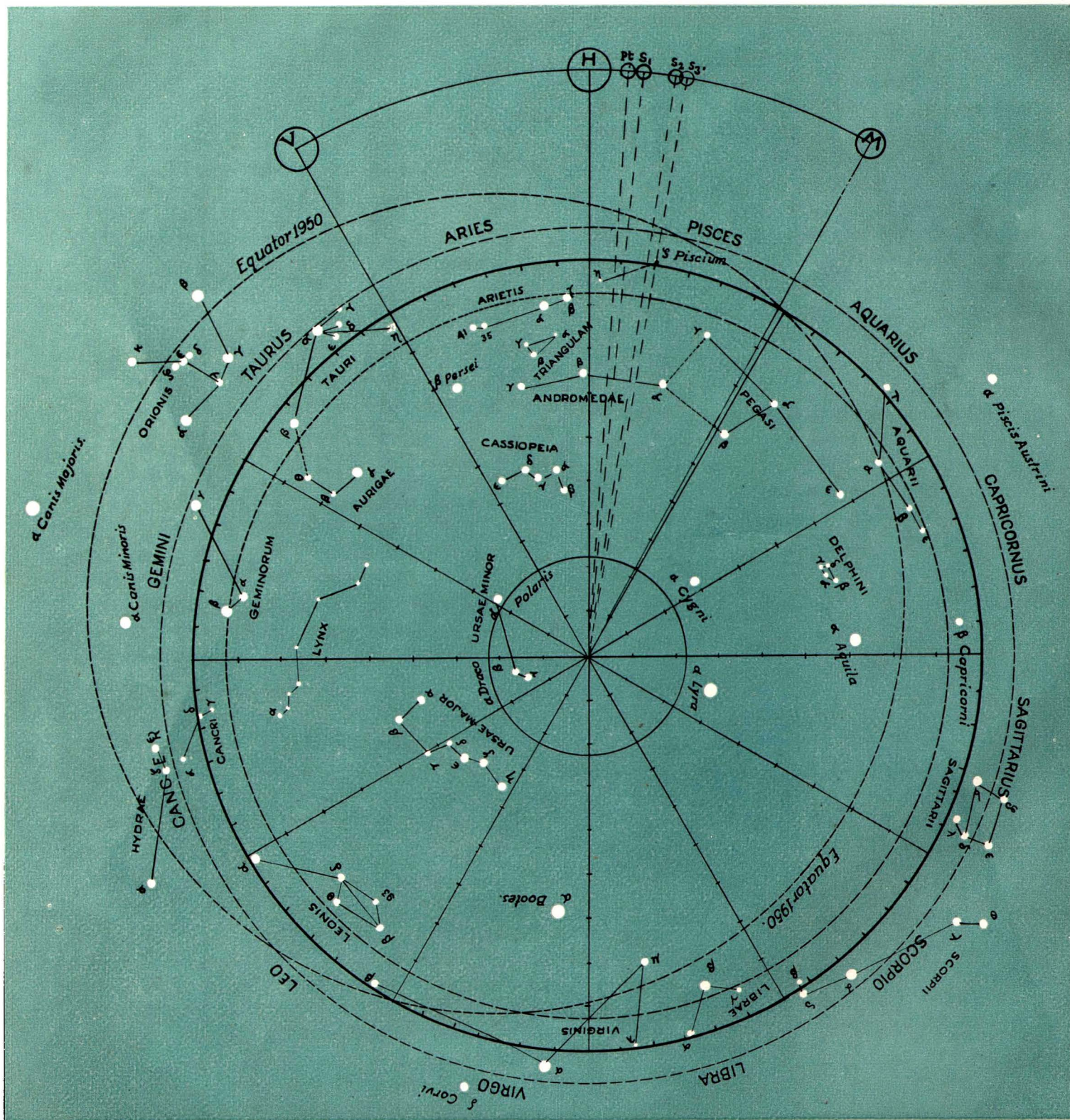

MAGNITUDES.

- FIRST ●
- SECOND ●
- THIRD ●
- FOURTH ●
- FIFTH ●

POSITIONS OF THE FIRST POINT OF ARIES (♈) IN DIFFERENT TIMES.

- V = Vedic Times about 2300 B.C.
- H = Hipparchos 140 B.C.
- Pt = Ptolemy 150 A.D.
- S₁ = Sūrya Siddhānta 285 A.D.
- S₂ = " 500 A.D.
- S₃ = " 570 A.D.
- M = Modern 1950 A.D.

REPORT OF THE CALENDAR REFORM COMMITTEE

PART-A

INTRODUCTORY

In India there is at present a terrible calendar confusion.

For official purposes, India has been using the Gregorian calendar since the imposition of the British rule in 1757. As the Gregorian calendar, on account of historic reasons, has attained the status of a World Calendar, it is still being used for official purposes after the attainment of Independence. There is a proposal sponsored by India before the UNO for the introduction of a new World Calendar for civil and administrative purposes in place of the Gregorian calendar, which is inconvenient and unscientific (*vide C § 2-7*).

During the period of Moslem supremacy (1200-1757), the lunar Hejira calendar had been used both for administrative as well as for Moslem religious purposes, except for a short period (1556-1630), when on the initiative of the Emperor Akbar, its use was prohibited and a form of the Iranian solar calendar (the Jelali calendar), under the name *Tārīkh Ilāhī*, was introduced. The Hejira calendar is now used only by the followers of Islam for fixing up the dates of their religious festivals.

Before the advent of Moslem domination, the different states of India used a bewildering variety of calendars for civil as well as religious purposes of which a detailed account is given in C §5. The inscriptions of Indian kings from the first century A.D. to medieval times are dated according to these calendars, and it is often a headache for the Indologist to find out the starting point of the eras used in these calendars.

Most of these calendars have gone out of use for civil purposes, but some are being still used for fixing up the dates and moments of religious festivals of communities following different schools of Hinduism and other religions having their origin in India (Buddhism, Jainism). They use different eras, different year-beginnings, and sometimes different methods of calculations based on the three *Siddhāntas* (scientific astronomical treatises), *viz.*, the *Sūrya*, the *Ārya*, and the *Brahma*, all dating from ancient and medieval times.

These practices often produce a bewildering confusion in fixing up dates and moments of observance of the religious festivals, of which some detailed examples are given later. The Calendar Reform

Committee was asked to make a study of the various Hindu religious calendars, and recommend to the Government a Unified National Calendar for Hindu religious purposes for the whole of India. The Committee has now finished its labours, and presents its report to the Government. The main points are summarized below :

The Hindu religious calendar is mainly luni-solar, *i.e.*, the seasons are fixed by the solar calendar, while the dates and moments are fixed according to the lunar calendar pegged on to it.

The calendar therefore depends on the science of astronomy which has evolved methods for correctly predicting the positions of the sun, the moon, and the planets (the Ephemerides). The astronomical part of the calculations should be the same for calendars used by all nations. But this is not the whole story ; for the calendar also depends on convention, which varies widely from country to country and from state to state.

Let us give some idea of the Science as well as of the Conventions in use for the solar and the lunar calendars respectively. For the solar calendar :

(1) The year should be properly defined, and the year-length taken should be astronomically correct.

(2) The seasons should be properly defined, and should start on proper dates.

(3) The day should start from midnight.

An examination of Chap. XIV of the *Sūrya-Siddhānta* (*vide C § 5-6*) shows that the author of this famous treatise accepted these principles and laid down the following rules for the compilation of a calendar :

(1) The year should start from the instant when the sun crosses the vernal equinoctial point and the length of the year should therefore be tropical (*sāyana*).

(2) The seasons should consist of two solar months, each defined by the time taken by the sun to traverse 30° of the sun's path (the ecliptic).

(3) The day should be from midnight (*ārdharātrika* system) for purposes of astronomical calculations.

These principles do not alone suffice to define the calendar, for the year does not consist of a whole number of days, but its length (length of the tropical year) is approximately 365·2422 mean solar days. The time taken by the sun to traverse 30° of the arc of the ecliptic varies from 29·44 days to 31·46 days.

For civil purposes, both the year and the month should consist of a whole number of days, and the civil day (*sāvāna*), according to Hindu religious practices, should start from sunrise. To achieve these purposes, different conventions have been used in different states which account partly for calendar confusion (*vide C § 5-6*).

But the most serious mistake has been in the length of the year taken by the *Sūrya Siddhānta*, a standard astronomical compilation having its beginning from the 4th century A.D. The year-length adopted is 365·25876 days, which is presumably sidereal, but even then the length is wrong by + 0.00240 days. But as is pointed out in C § 5-6, the *Sūrya Siddhānta* lays down definitely that the year-length should be tropical which, according to modern measurements, should have approximately 365·2422 days, but this rule has been misinterpreted.

The mistakes in astronomical constants (*e.g.*, in the fixing up of the length of the year or months) are common in all ancient astronomical treatises, whether Indian or occidental, but in the West, the correct values were obtained later by refined observations during medieval times and were then adopted for calendar calculations by edicts of dictators like Julius Caesar or Pope Gregory XIII on the advice of astronomers. In India, astronomical observations stopped from about 1200 A.D. after the advent of the Turkish invaders, when Indian observatories were either destroyed or abandoned by the astronomers and calendar making fell into the hands of astrologers, who had to depend on ancient treatises.

But a far more potent cause for the adherence to the wrong value was the failure, on the part of the Indian astronomers, to grasp the real nature of the phenomenon of Precession of Equinoxes (*vide C § 4-10*). In this, they were not alone, for the false notions about this phenomenon were not abandoned even in Europe till the advent of Newton (1687).

The Indian year is thus longer than the tropical year by 0.01656 days, and this error has been accumulating for nearly 1400 years with the result that the solar year, instead of starting on the day following the vernal equinox (21st March) as it did in the time of Varāhamihira starts nearly 23-24 days later. Thus the year-beginning as laid down by our almanac-makers has lost all connection with the actual year-beginning (the day following the vernal equinoctial day) as contemplated by the *Sūrya Siddhānta*, and the festivals as given by the Indian almanacs are being celebrated very frequently in wrong seasons. If *Śarat Purnimā* is celebrated in the *Hemanta* season, as would happen in the year 1955, it is obvious that our almanacs are following neither the Scriptures nor Science.

The Calendar Committee has tried to rectify this fundamental error, by recommending, as laid down by the *Sūrya Siddhānta*, that the year should begin on the day after the vernal equinox, and the year-length should be *sāvāna*.

LENGTHS OF THE SOLAR MONTHS :

The Hindu solar month-lengths vary from 29 to 32, as the time of passing 30° of the ecliptic varies, according to older data given in the *Sūrya Siddhānta* from 29·32 days to 31·64 days. These varying lengths, as is well-known, can be understood only from Kepler's first two laws, which were explained fully by Newton in 1687 on the basis of dynamics and law of universal gravitation, but these laws and their explanation were unknown to astronomers in 400 A.D. Further these month-lengths are different in the three *Siddhāntas* because they were calculated according to three different formulæ. On account of the ignorance of Kepler's laws and of the shift of the equinoctial lines in the Earth's orbit (*vide C § 5-6*) the ancient astronomers probably assumed that the times of passage through 30° as calculated according to formulæ given by them would be valid for all times. But we now know this assumption to be incorrect, and cannot stick to the lengths as given in the *Siddhāntas*, which also differ amongst themselves.

Further, all the numbers expressing month-lengths are fractional, and different states, *viz.*, Bengal, Orissa, Tamil Nad use different conventions for defining the day of the solar *saṁkrānti* (*vide C § 5-6*) *i.e.*, the civil day (sunrise to sunrise) which should be regarded as the day when the sun passes successive 30° of arc, beginning from the Hindu zero-point. The different conventions have their own merits, let the orthodox Bengalee, Oriya, or Tamil Pandit argue it out amongst themselves, but we feel that a convention which makes the solar month vary from 29 to 32 is very inconvenient for civil life, and we are quite sure that if the authors of the *Siddhāntas* were aware of Kepler's Laws and the shifting of equinoctial lines on the Earth's orbit, they would never have prescribed rules which would make the number of days in a solar month vary from 29 to 32. We have, therefore, assigned lengths of 30 and 31 days to the months. But the moment of the sun's traversing any multiple of the 30th degree from the vernal equinoctial point has been indicated.

We have recommended the ŚAKA era, as this is the era *par excellence* used by all Indian astronomers, and had been used and is still used for calendaric calculations all over India, since the days of the Ujjain astronomers (first century A.D.). This is the only era used in all Indian scientific treatises. For other eras see C § 5-8.

The new solar calendar is scientific, applicable to all parts of India, and follows the *Sūrya Siddhānta* in all essential points, and is absolutely sound as regards its astronomical basis. The conventions have been revised with the sole object of having a uniform system for the whole of India.

THE LUNAR CALENDAR :

The lunar calendar depends on the correct calculation of the moments of conjunction (*Amāvasyā*), opposition (*Paurṇamāsī*) and of the *tithis* (i.e., the moments when the moon gains 12° or its integral multiple on the sun). The Indian calendar-makers use for this purpose the formulæ on lunar motion given in the three *Siddhāntas*. But as these are known to be inaccurate, they use certain corrections called *bija* introduced by later Indian astronomers.

It is now well-known that the motion of the moon is very irregular and complex, and therefore the moon is very inconvenient as a time-marker. For this reason the moon was completely discarded by the Egyptians as a time-marker 3000 years before Christ. The ancient Egyptian solar calendar is the basis from which the present Gregorian calendar has sprung.

But other ancient and modern nations did not follow the Egyptians, and it became the chief duty on the part of their astronomers to observe the moon from day to day, and evolve mathematical formulæ from which the ephemerides of the moon could be calculated. As Neugebauer has shown (*Exact Sciences in Antiquity*), ancient Babylonian astronomy (700 B.C.-300 B.C.) was largely centred round devising, from actual observations of the moon's position, mathematical formulæ, which would enable them to calculate the longitude of the moon in advance. These attempts were continued by the Greeks, Indians, Arabs and medieval Europeans and are still being continued. For the calculation of the moon's position, formulæ are employed which require twenty pages of printed matter, containing about 1,500 terms in all. They have been evolved as measurements have become more refined and accurate, with the progress of astronomy; and were, of course, unknown to astronomers of ancient times.

Effect of Indian Lunar Calendars :

As the orthodox Indian calendar-maker still uses the old formulæ dating from 400 A.D., his calculations of the ending moments of *tithis* do not agree with those given by the Nautical Almanacs, which are based on modern formulæ and are verified by actual observations as shown in the following example :

ENDING MOMENTS OF TITHIS					
Date	Tithi	Modern (I.S.T.)	Old Method (I.S.T.)	Error in the old method.	
		h m	h m	h	m
1954.					
Sept. 27	30	6 20	5 4	-	1 16
" 30	3	12 50	10 24	-	2 26
Oct. 3	6	20 21	16 7	-	4 14
" 6	9	24 3	18 31	-	5 32
" 9	12	20 20	16 30	-	3 50
" 12	15	10 40	11 2	+	0 22
" 14	18	23 36	27 57	+	4 21
" 17	21	15 47	21 25	+	5 38
" 20	24	13 44	17 26	+	3 42
" 23	27	16 55	17 39	+	0 44
" 26	30	23 17	22 8	-	1 9

Some of the Indian calendar-makers are aware of these discrepancies, and give the ending moments of *tithis* according to the Nautical Almanac. But all of them give the moments of beginning and ending of lunar and solar eclipses according to the Nautical Almanac, as times calculated according to the *Siddhāntas* may be grossly inaccurate, and the mistakes would at once catch public attention and lower their prestige. In the words of one of our colleagues (Dr. Gorakh Prasad), these almanac-makers are like bicycle-riders riding without lamps, who get down from their cycles on street corners, just to avoid being caught by the Police.

The calculations of *tithis* given by the Calendar Committee follow the Nautical Almanac, and are based on correct positions of the moon and the sun.

The Committee has made another radical departure. According to conventions laid down in *Dharmaśāstras*, a religious festival is to be observed in a locality when the prescribed *tithi* is current at a particular hour of the civil day of that locality. But on the same day and hour, the *tithi* may vary from locality to locality and this, taken with the mistakes in calculating *tithi* according to ancient methods, may produce a day's difference in fixing up the dates of religious festivals.

If the different almanac-makers calculate the *tithi* not according to the Nautical Almanac, but according to different Indian astronomical treatises, the moment of the *tithi* may differ by as much as five hours, and the same festival, say the *Dusseva* (or *Durgā Pūjā*) may be fixed on two successive days in the same city, as happened in Calcutta in the case of *Durgā Pūjā* in 1952 and *Sarasvatī Pūjā* in 1953. Which set of Pandits is to be followed by the Government in fixing up the date of holidays in such cases ?

The Committee has taken the view that the ending moments of *tithis* should be given according to modern calculations (which would naturally agree with Nautical Almanacs) and the *tithi* current for the Central Station (82½° E. Long. and 23° 11' N. Lat.) should be the *tithi* for the whole of India. This is a very

sensible proposition, for if we have to follow the Siddhāntic convention to the letter, then even if the calculations are given correctly, every station would have its own *tithi*, just as according to Relativity, every moving particle has its own time. But the Pandits are not correct in their own claims that they are following the *Śāstras* correctly; for a Banaras almanac is according to Siddhāntic convention, true only for Banaras, but may on certain occasions, be incorrect for a place even a mile from Banaras. So the Siddhāntic convention was laid down in an age when there was no printing presses and no printed almanacs, but almanacs were to be fixed up and recited for every locality by local astrologers according to their own calculations. If it has still to be followed, every village should print its own almanac. In laying down the principle that the whole of India should follow the *tithi* calculated for a central locality, we are no more violating the Siddhāntic convention than the calculators of the Banaras or Calcutta almanacs which have currency over wide areas far away from their own city.

In course of fixing the festivals of different states in the Reformed Calendar, it has been found that different conventions are followed in different states in the matter of fixation of the same festival. For example it may be quoted that in 1954 *Janmāṣṭamī* was observed on the 21st August in North India and on the 20th, 21st and 22nd in other parts of India. *Rāmanavamī* was observed in Bengal on 24th March, 1953, while it was celebrated on the preceding day in upper India. The calculation of the ending moment of *tithi* is not the cause for such discrepancies in this case, but the difference in convention is solely responsible. We have followed all these differences of conventions in the state-wise fixation of the dates of festivals, as far as practicable. We are however of opinion that a uniform convention should be followed throughout India in this matter also. In order to explore the possibilities of such unification, it is desirable that necessary steps should be taken by the Government. The Ephemerides Committee which we have recommended may be entrusted with this work.

APPOINTMENT OF THE COMMITTEE

The Council of Scientific and Industrial Research appointed in November 1952, a Calendar Reform Committee with Prof. M. N. Saha, F.R.S., as Chairman and six other members (*vide* their letter No. 144 Bd. (G. P.)/52 dated the 11th November, 1952, intimating the decision of the Governing Body meeting held on 13. 8. 52) as follows :—

The Calendar Reform Committee

- | | | |
|---|-----|----------|
| 1. Prof. M. N. Saha, F.R.S. | ... | Chairman |
| 2. Prof. A. C. Banerji, Vice-Chancellor,
Allahabad University, Allahabad | ... | Member |
| 3. Dr. K. L. Daftari, Nagpur | ... | Member |
| 4. Shri J. S. Karandikar, Ex-Editor,
The Kesari, Poona | ... | Member |
| 5. Prof. R. V. Vaidya, Ujjain | ... | Member |
| 6. Dr. Gorakh Prasad, Allahabad | ... | Member |
| 7. Shri N. C. Lahiri, M.A., Calcutta | ... | Member |

[N. B. Numbers 6 and 7 were appointed in place of Prof. S. N. Bose and Dr. Akbar Ali, who were originally appointed by the Governing Body, but regretted their inability to serve, *vide* C.S.I.R. letter No. 144 Bd. (G. R.)/52, dated the 21st January, 1953].

The terms of reference are as follows :—

The Committee has been entrusted with the task of "examining all the existing calendars which are being followed in the country at present and after a scientific study of the subject, submit proposals for an accurate and uniform calendar for the whole of India."

COMMITTEE MEETINGS

The Committee had three meetings and have now finalized their recommendations to Government.

I. The first meeting was held at 10 A.M. on Saturday, the 21st February, 1953, in the C.S.I.R. Secretariat Buildings, Old Mill Road, New Delhi, and it continued also on the 23rd February. The Prime Minister sent a message and Shri K. D. Malaviya Deputy Minister, Natural Resources and Scientific Research, inaugurated the meeting. The proceedings of the meeting will be found in *Annexure I*.

After discussion on the several points mentioned by the Chairman, the Committee arrived at certain decisions and adopted the following resolutions :—

(1) The tropical year of 365.2422 days should be adopted for the purpose of calendar making.

(2) A scientific civil solar calendar to be henceforth called the National Calendar for purposes of dating should have its first day after the vernal equinox day, *i.e.*, on the 22nd March. But for religious purposes the calculations may start 23° 15' ahead of the V. E. point, for sometime to come (as a concession to the prevailing custom).

(3) The Śaka era should be adopted for the reformed Indian Calendar.

(4) All calculations should be made for a central station in India situated at 82½° East Longitude and 23° 11' North Latitude (latitude of Ujjain).

(5) The day should be reckoned from midnight to midnight of the central station for civil purposes, but for religious purposes the local sunrise system may be followed.

The Committee made the following recommendations to the Government of India :—

(i) A tentative national calendar for the whole of India should be prepared for five years in advance, showing dates, days, months, *tithis* (lunar days) and *nakṣatras* (lunar asterisms).

(ii) Steps should be taken to compile an Indian Ephemeris and Nautical Almanac by the Government of India showing in advance positions of the sun, the moon, planets and other important heavenly bodies.

(iii) There should be a National Observatory at a suitable place provided with modern equipments, apparatus and time-service.

The Council of Scientific and Industrial Research accepted the first recommendation and appointed Shri N. C. Lahiri and Prof. R. V. Vaidya, members of the Committee, as whole-time workers for the purpose of implementation of this recommendation, and also provided them with necessary assistants. The experimental National Calendar of India for the five years 1954-55 to 1958-59 A.D. (Śaka 1876 to 1880) has accordingly been prepared and will be found as Part B.

II. The second meeting of the Calendar Reform Committee was held on the 8th March, 1954, at 10 A.M. in the C.S.I.R. Building, New Delhi. In this meeting the detailed methods of preparation of the Reformed Calendar were discussed and certain resolutions were adopted which will be found in the proceedings of the meeting given in *Annexure II*. The question of adopting variable *ayanāṁśa* was discussed, but no final decision could be taken in the meeting. The Chairman decided the question later after taking opinion of members by correspondence. The following are the principal points decided :—

(1) *Caitra* (pronounced as Chaitra) should be the first solar month of the year starting on the day following vernal equinox, and the names of the solar months should be *Caitra*, *Vaiśākha*, etc.

(2) The lengths of the civil solar months be fixed as follows :

Caitra—30 & 31 days (31 days in a leap-year),
Vaiśākha—31, *Jyaiṣṭha*—31, *Āṣāḍha*—31
Śrāvṇa—31, *Bhādra*—31, *Āśvina*—30,
Kārtika—30, *Agrahāyana*—30, *Pauṣa*—30,
Māgha—30, and *Phālguna*—30 days. Leap-years should correspond with the leap-years of the Gregorian calendar.

(3) The *nakṣatras* should be calculated with a variable *ayanāṁśa*, so that they remain fixed with

respect to the stars ; otherwise the *nakṣatra* divisions would lose all connections with the stars or star-groups contained in those *nakṣatras*. For this purpose, the *ayanāṁśa* of 23° 15' should relate to 21st March, 1956, the middle of the five yearly period.

The calculations of the Reformed Calendar for five years, have been revised in the light of the above decisions.

III. The third and the final meeting of the Calendar Reform Committee was held on the 13th September, 1954, at 10-0 A.M. in the C.S.I.R. Building, New Delhi. In this meeting, the Reformed Calendar for five years, the resolutions so far adopted and the final report were approved for submission.* The proceedings will be found as *Annexure III*.

EXAMINATION OF THE EXISTING CALENDARS

With a view to examining the existing calendars, as per terms of reference, all the Pañcāṅga makers in different states of India were requested by a Press communique issued by the C.S.I.R. in March 1953, to send 3 copies of their Pañcāṅgas covering the year 1953-54. As a result of this request many calendars were received from different parts of India, a list of which is given as *Annexure V*. Some difficulty was experienced in studying the exact nature of these calendars due to language difficulty and want of the required data in these calendars. Accordingly a questionnaire was issued in November 1953, to all these and also to some other calendar makers whose addresses were known, requesting them to furnish certain data relating to their calendars. The questionnaire together with the replies so far received will be found as *Annexure VI*.

SUGGESTIONS RECEIVED FOR CALENDAR REFORM

We have received various suggestions for calendar reform from different persons. A summary of these suggestions will be found in *Annexure VII*. All the suggestions have been examined in the Committee meetings before finalization of the recommendations of the Committee. Some of the suggestions favour the continuance of the present inaccurate system of calendar making. But on the other hand there are many persons and organizations who have suggested that accurate and scientific calendar, as recommended by the Committee should be adopted.

HOLIDAYS

We have prepared tables (*vide B*) giving dates of various religious festivals and holidays observed in different states of India in four categories,

*The Chairman submitted the report to the President, Council of Scientific and Industrial Research, at the Board's meeting on the 14th September, 1954.

viz., solar, luni-solar, Christian and Moslem. Many festivals and holidays are common in all states, others are different. A festival which is considered very important in one state (*e.g.*, *Dussera* or *Durgā Pūjā* in Bengal) may be considered secondary in other regions (*e.g.*, in Western India). There are holidays confined only to certain states. It is hoped that the Central Government may make choice of such holidays which should be considered as Central, for obviously they cannot accept all holidays current in India, as there would then be few working days left.

On account of shortness of time, it has not been found possible to give planetary data except the heliacal rising and setting of Jupiter and Venus. These

are not necessary for calculation of the dates and moments of religious festivals, except in a few rare cases like the Kumbha Melā. The Ephemerides Committee, if it comes into existence, may be entrusted with this work.

In the compilation of the Reformed Indian Calendar, we have received invaluable help from Sir Harold Spencer Jones, Astronomer Royal of the United Kingdom, who provided us with certain advance data facilitating our calculations. The grateful thanks of the Committee are due to him. We also wish to thank our correspondents, many of whom helped us with valuable data and information.

FINAL RECOMMENDATIONS OF THE COMMITTEE

The calendar has got two distinct uses, *viz.*, civil and religious. The Indian calendars, in the particular form it has assumed in different parts of the country, are used for the purpose of dating not only by the rural, but also by a large section of the urban population. On account of the fact, as mentioned above, that the usage of one area differs from another, the Committee recommends that the unified National Calendar should be used uniformly in all states of India, for civil purposes wherever necessary, in place of local calendars.

RECOMMENDATIONS FOR CIVIL CALENDAR

(1) The Śaka era should be used in the unified national calendar. The year 1954-55 A.D. corresponds to 1876 Śaka or in other words the year 1954 A.D. corresponds to 1875-76 Śaka.

(2) The year should start from the day following the vernal equinox day.

(3) A normal year would consist of 365 days while a leap-year would have 366 days. After adding 78 to the Śaka era, if the sum is divisible by 4, then it is a leap-year. But when the sum becomes a multiple of 100, it would be a leap-year only when it is divisible by 400, otherwise it would be a common year.

The years Śaka 1878, 1882, 1886, 1890, 1894 etc., are leap-years consisting of 366 days each. But the years 2022, 2122, 2222 and again 2422, 2522, 2622 Śaka are not leap-years, while 1922, 2322, 2722 Śaka are leap-years.

(4) *Caitra* (pronounced as Chaitra) should be the first month of the year, and the lengths of the different months would be fixed as follows :—

Caitra	30 days (31 days in a leap-year)
Vaiśākha	31 days
Jyaiṣṭha	31 "
Āṣāḍha	31 "

Srāvaṇa	31 days
Bhādra	31 "
Āśvina	30 "
Kārtika	30 "
Agrahāyaṇa	
(Mārgaśīrṣa)	30 "
Pauṣa	30 "
Māgha	30 "
Phālguna	30 "

Corresponding dates :—The dates of the reformed Indian calendar would thus have a permanent correspondence with the dates of the present Gregorian calendar. The corresponding dates are as follows :—

Indian Calendar		Gregorian Calendar	
Caitra	1 ...	March 22 in a common year & March 21 in a leap-year.	
Vaiśākha	1 ...	April	21
Jyaiṣṭha	1 ...	May	22
Āṣāḍha	1 ...	June	22
Śrāvaṇa	1 ...	July	23
Bhādra	1 ...	August	23
Āśvina	1 ...	September	23
Kārtika	1 ...	October	23
Agrahāyaṇa	1 ...	November	22
Pauṣa	1 ...	December	22
Māgha	1 ...	January	21
Phālguna	1 ...	February	20

The Indian seasons would thus be permanently fixed with respect to the reformed calendar, as follows :—

Seasons	Calendar months
Griṣma (Summer)	Vaiśākha & Jyaiṣṭha
Varṣā (Rains)	Āṣāḍha & Śrāvaṇa
Śarat (Autumn)	Bhādra & Āśvina
Hemanta (Late Autumn)	Kārtika & Agrahāyaṇa
Śiśira (Winter)	Pauṣa & Māgha
Vasanta (Spring)	Phālguna & Caitra

In course of implementation of these recommendations, the states now having the solar calendar for civil and partly religious purposes which start the year from *Vaiśākha* 1 (April 14), will have to begin the year 23 days earlier, but the first month will be *Caitra*. The effect of this on the states are as follows :

Bengal, Orissa, & Assam :	Solar months start approximately seven days later than now,
Tamil Nad :	Solar months start approximately 23 days earlier than now,

for the month called *Vaiśākha* (14th April—14th May) in Bengal and Orissa is called *Chittirai* or *Caitra* in Tamil Nad.

Those who use the *Caitrādi* lunar calendar also for civil purposes, would however experience no great difficulty in adopting this unified calendar, as they have at present the beginning of their year varying from 15th March to 13th April, and the first month is *Caitra*.

RECOMMENDATIONS FOR RELIGIOUS CALENDAR

(5) The calculation of solar (*saura*) months necessary for determining the lunar months of the same name, will start $23^{\circ} 15'$ ahead of the vernal equinoctial point. This tallies with the present practice of most almanac-makers.

The months would thus commence at the moments when the tropical longitude of the sun attains the following values :—

Saura <i>Vaiśākha</i> commences when the		Sun has the longitude of	$23^{\circ} 15' 0''$
"	<i>Jyeṣṭha</i>	"	53 15 0
"	<i>Āṣāḍha</i>	"	83 15 0
"	<i>Śrāvaṇa</i>	"	113 15 0
"	<i>Bhādrapada</i>	"	143 15 0
"	<i>Āśvina</i>	"	173 15 0
"	<i>Kārtika</i>	"	203 15 0
"	<i>Mārgaśīrṣa</i>	"	233 15 0
"	<i>Pauṣa</i>	"	263 15 0
"	<i>Māgha</i>	"	293 15 0
"	<i>Phālguna</i>	"	323 15 0
"	<i>Caitra</i>	"	353 15 0

This recommendation is to be regarded only as a measure of compromise, so that we avoid a violent break with the established custom. But it does not make our present seasons in the various months as they were in the days of *Varāhamihira* or *Kālidāsa*. It is hoped that at not a distant date, further reforms for locating the lunar and solar festivals in the seasons in which they were originally observed will be adopted.

(6) As usual the lunar months for religious purposes would commence from the moment of new-moon and would be named after the *saura māsa* in which the new-moon falls. If there be two new-moons during the period of a *saura māsa*, the lunar month beginning from the first new-moon is the *adhika* or *mala* and the lunar month beginning from the moment of the second new-moon is the *śuddha* or *nija*, as usual.

(7) The moments of moon's exit from a *nakṣatra* division of $13^{\circ} 20'$ each or sun's entry into it, would be calculated with a variable *ayanāṁśa* i.e., on the supposition that they are fixed with respect to the stars. The value of this *ayanāṁśa* would amount to $23^{\circ} 15' 0''$ on 21st March, 1956. Thereafter it would gradually increase with the usual annual rate, the mean value of which is about $50^{\circ} 27'$.

These arrangements would ensure that the religious festivals, and observances determined by the sun (such as the *Mahāviṣuva saṁkrānti*, *Uttarāyana saṁkrānti*, *Dakṣiṇāyana saṁkrānti*) would follow astronomically correct seasons, but those determined by the lunar calendar would continue to be observed in times conforming to the present practice, and the correction we have introduced in the length of the year would prevent their further shift in relation to the seasons.

The dates of festivals have already shifted by 23 days from the seasons in which they were observed about 1400 years ago as a result of our almanac-makers having ignored the precession of the equinoxes. Although it may seem desirable that the entire amount of shifting should be wiped out at a time, we consider it expedient to maintain this as a constant difference and stop its further increase. As a result, there would at present be no deviation from the prevailing custom in the observance of the religious festivals.

In the calculation of *nakṣatras*, however, we have adopted a variable *ayanāṁśa*, so that at the time of a particular *nakṣatra* the moon may be seen in the sky near the star or star-group of that name. This practice is being followed in our country from the Vedic times and is perfectly scientific.

(8) The day should be reckoned from midnight to midnight of the central station ($82\frac{1}{2}^{\circ}$ E. Long. and $23^{\circ} 11'$ North Latitude) for civil purposes, but for religious purposes the local sunrise system may be followed.

(9) For the purpose of all calculations, the longitudes of the sun and the moon should be obtained by applying the most up to date and complete equations of their motions, so that they may tally with their observed values.

FURTHER RECOMMENDATIONS

(10) Steps should be taken to compile an "Indian Ephemeris and Nautical Almanac" by the Government of India, showing in advance, the positions of the sun, the moon, planets and other heavenly bodies. The Indian calendar—both civil and religious—prepared according to the above recommendations should be included in that publication every year.

A permanent Standing Committee to be called the Indian Ephemeris and Nautical Almanac Committee may be constituted for this purpose and attached to a scientific department of the Government of India.

(11) Steps should be taken to establish a National Astronomical Observatory at a suitable place, provided with modern equipment, apparatus and time-service.

We hope that the Government of India would make early arrangements for implementation of our recommendations. For this purpose the date 21st March, 1956 A.D., which is *Chaitra* 1, 1878 Saka seems

to be the most suitable time for introduction of the reformed calendar throughout India.

M. N. SAHA
J. S. KARANDIKAR
A. C. BANERJI
K. L. DAFTARI *
GORAKH PRASAD
R. V. VAIDYA
N. C. LAHIRI

NEW DELHI,

The 13th Sept. 1954.

Dissenting note to the report of the Committee by Dr. K. L. Daftari.

I agree with the final report of the Committee dissenting only on the following point. I hold that the fixed *nakṣatras*, though regarded as enjoined by the *dharmaśāstras* should not be taken into consideration in fixing days of the religious functions, or the *dharmaśāstras* be regarded as enjoining the moving *nakṣatras* starting from a point $23^{\circ} 15'$ ahead of the equinoctial point. I have given my reasons previously in my letters to the Chairman of the Committee, (a summary of which will be found as *Annexure IV*).

MAHAL, NAGPUR }
The 10th December, 1954 }

K. L. DAFTARI.

* Subject to the appended note

ANNEXURE I

PROCEEDINGS OF THE FIRST MEETING OF THE
CALENDAR REFORM COMMITTEE

The first meeting of the Indian Calendar Reform Committee, C.S.I.R., was held at 10 A.M. on Saturday, the 21st February, 1953, in the C.S.I.R. Secretariat Buildings, Old Mill Road, New Delhi. The meeting continued also on the 23rd February, 1953.

The following were present :—

Prof. M. N. Saha,	<i>Chairman</i>
Dr. K. L. Daftari,	<i>Member</i>
Dr. Gorakh Prasad,	"
Shri J. S. Karandikar,	"
Shri N. C. Lahiri,	"
Prof. R. V. Vaidya,	"
Shri A. Ghosh,	<i>By invitation</i>
Dr. P. K. Kichlu,	"
Dr. Lal C. Verman,	"
Shri S. Basu,	"
Shri K. G. Krishnamurthi,	<i>Asst. Secy., C.S.I.R.</i>

2. The Hon'ble Shri K. D. Malaviya, Deputy Minister, Natural Resources & Scientific Research, inaugurated the proceedings.

3. The Prime Minister, who could not be personally present, sent the following message :—

"I am glad that the Calendar Reform Committee has started its labours. The Government of India has entrusted to it the work of examining the different calendars followed in this country and to submit proposals to the Government for an accurate and uniform calendar based on a scientific study for the whole of India. I am told that we have at present thirty different calendars, differing from each other in various ways, including the methods of time reckoning. These calendars are the natural result of our past political and cultural history and partly represent past political divisions in the country. Now that we have attained independence, it is obviously desirable that there should be a certain uniformity in the calendar for our civic, social and other purposes and that this should be based on a scientific approach to this problem.

It is true that for Governmental and many other public purposes we follow the Gregorian calendar, which is used in the greater part of the world. The mere fact that it is largely used, makes it important. It has many virtues, but even this has certain defects which make it unsatisfactory for universal use.

It is always difficult to change a calendar to which people are used, because it affects social practices. But the attempt has to be made even though it may not be as complete as desired. In any event, the present confusion in our own calendars in India ought to be removed.

I hope that our scientists will give a lead in this matter."

4. Shri K. D. Malaviya, Deputy Minister, Natural Resources and Scientific Research, Government of India, inaugurated the first meeting of the Calendar Reform Committee. Shri Malaviya said :—

"It is my very pleasant duty to extend to the Members of the Calendar Reform Committee a hearty welcome on behalf of the Government of India.

You are meeting here this morning not for any academic discussion on a subject of scientific interest, but for giving a practical lead to the country on a very important task, that is, of bringing about a uniformity in the Indian Calendar. You know how fundamentally important is the concept of calendar for our civilized life, for without a calendar no country can get on with its day-to-day work.

The concept of month and year starts from accepting day as the unit. I learn that the Indian astronomers of the Siddhāntic period, 400 A.D. to 1200 A.D., were the first to invent the idea of *Ahargana* or heap of days for time reckonings. This device was introduced into European astronomy in 1582 A.D. by Joseph Scaliger. At the same time it is said by the modern astronomers that a critical review of the *Vedāṅga Jyotiṣa* calendar shows that purely Indian systems of time reckoning up to the early centuries of the Christian era were very crude compared to the contemporary Graeco-Chaldean time reckonings of the Near East.

It is rather strange to find that while most of Christendom, in spite of diversity of race and country, follows one single calendar which has become the world calendar, while all the Islamic countries follow also a single calendar, the different States and provinces of India have followed and are following not less than 30 different calendars differing in the era beginning, the initial date of the year, and to some extent in the methods of calculation. Though these calendars are used for social purposes, and for fixing up the religious holidays, their very diversity causes a great deal of inconvenience to the public and the State. The same holiday may be observed in different parts of the country and even in the same locality at intervals of one day according to the method of calculations. In some cases, as for example, in the case of the Car Festival of Puri, the days in the Bengal and Orissa calendars have sometimes differed by as much as a month. Why is it so? I understand that calendars were put on a scientific basis about 1,500 years ago; the rules laid down by our astronomers were based on scientific knowledge as then known and they always took the precaution of laying down the rule for the coming generations that they should always correct their calculations by means of

exact observations of the sun, the moon and other heavenly bodies, which serve as time-keepers.

Up to 1200 A.D., before India passed under foreign invaders, our astronomers at Ujjain and other centres, always took the trouble of correcting their calculations from direct observations of the heavenly bodies. But, after 1200 A.D., the indigenous centres of astronomical study were all broken up, and the new rulers did not take the trouble of setting up fresh centres till towards the end of the Moghul rule, when Maharja Jai Singh of Amber established five observatories at Ujjain, Jaipur and other centres for astronomical studies after the pattern of the famous observatory of Ulugh Begh at Samarkand. Our calendar-makers, being for long left to their own resources, and having no astronomical observatories had to fall back for calculations on rules which were insufficient and incorrect and which vitiated all the results. Therefore, confusion crept in the calendars, and they have become diversified according to local usage and customs. This condition is representative of 800 years of suppression, and is symbolic of the history of India.

Now that we are an independent nation and are making all efforts to bring about integration in our national life, it is obvious that an important item like the calendar cannot be left in the present confused state. We use for civil and administrative purposes the Gregorian Calendar which has been imposed by the British Rulers. This calendar is not their invention but like the Roman script, it was imposed on them by their Roman civilisers who got it partly from Egypt. On account of the dominance of the Christian powers during the last two centuries, it has become the World Calendar. But on principle it is a very inconvenient and unscientific calendar compared to ours, and needs reform.

There is a proposal before the U.N.O. by the World Calendar Association for the revision of the Gregorian calendar. One of the tasks of the present Committee would be to make suggestions to this world-body for the evolution of a world calendar which will be scientific and can command the consent of all nations. Our Mohammedan fellow citizens will continue to use the Hedjira calendar for fixing their religious holidays, and we leave them there. The labours of the present Calendar Committee is to make a scientific study of all the calendars of indigenous origin, and make suggestions for a unified calendar for the guidance of administration, for social purposes, and as far as practicable, for fixing up the religious holidays for India. I am assured by my astronomical friends assembled here that this is quite possible. We shall be looking forward to your evolving a formula which would be acceptable to the different people and States of India, and the Government of India will give serious considerations to the adoption of your proposals. I need hardly add that this should be based on science, should take due consideration of the customs and religious festivals in different parts of the country and at the same time would be a calendar which the different communities and States can adopt.

While making these suggestions before you I am aware of the difficulties. Calendar reform can be suggested by scientists, but it can be carried into practice only by those who have religious or political authority. The ancient Roman calendar could be reformed only by a dictator like Julius Caesar, and later on by the religious dictator of Christendom, Pope Gregory XIII, and the ancient luni-solar calendar only by the authority of the Prophet. But we are now under a democracy. Whatever proposals you may make would have to be submitted to the public for their opinion, and I am quite sure that our public would not resent any innovation simply because it is a new thing, just as they do not reject electricity or new machines. I hope the public response would be encouraging and the Government would find it possible to give serious consideration to your proposals."

5. Prof. M. N. Saha, the Chairman, on behalf of the members of the Committee, expressed grateful thanks to the Prime Minister for his kind message. The Committee regretted that the Prime Minister could not personally inaugurate the deliberations of the Committee. Prof. Saha, however, assured the Committee that the Prime Minister had his heart and soul in the matter, and that he wanted the Committee to get on with its work and evolve scientific proposals for preparation of a uniform calendar for the whole of India and for the benefit of the country.

6. The Chairman on behalf of the Committee, gratefully thanked the Deputy Minister for having graced the occasion by his presence and having inaugurated the work of the Committee. The Deputy Minister had laid down the lines on which the Committee may proceed. With the encouragement of the Government, the Committee hoped to be able to accomplish the desired objective, for without State support the discussions would be dead letter.

7. The Chairman pointed out that in India there were 30 or more different calendars. In Banaras alone they had four calendars and it was quite common that important Hindu festivals like *Ganeśa Caturchi* and *Sarasvati Pujā* were celebrated on different days in different parts of the country or even at the same city as happened this year at Calcutta. The Committee should aim at placing before the Government proposals for a uniform scientific calendar which would be acceptable to all. The task was not an easy matter.

8. Tracing out the history of the movement for calendar reform, the Chairman said that the idea was not a new one. The Indian luni-solar calendar up to 400 A.D. was very crude, but great astronomers of India after 400 A.D. in Pataliputra, Bhilmal in Rajasthan and in Ujjain particularly had made very great contributions to mathematical knowledge, to astronomy and to other branches of science. They

laid down the formulæ for the future generations and advised them to get their calculations verified by means of observations of the sun, the moon and the planets, which are our time-makers.

9. At the present moment, the *Ahargana* or the heap of days is in usage for accurate chronological calculations. The idea was first evolved by Hindu astronomers about 400 A.D. This was invented only in the 16th century in Europe by Joseph Scaliger. The Siddhāntic astronomers started the year from the day after the Vernal Equinox but the older tradition was, as many Indian savants had pointed out, to begin the calendar from Winter Solstice.

10. Solar months which were invented about these times had not proved very convenient for use. The month-lengths varied from 29 to 32. The greatest difficulty has been caused by the use of the sidereal year and not the year of seasons, as the Hindu savants of those times either were unaware of the existence of the phenomenon of precession of equinoxes, or thought it was not unidirectional. The mistake was found by Muñjala and Śrīpati in the 10th and 11th centuries, when the Vernal Equinox had receded by seven to eight days, and they tried to persuade the astronomers to take to *sāyana* reckoning but the attempt was unsuccessful. The situation now is that the Vernal Equinox falls on 21st March but our year beginning which ought to fall on the following day, falls actually on 13th or 14th April. Thus a mistake of 23 days had occurred in our calculation of seasons, or year-beginning.

11. The Chairman pointed out that it was for the Committee to discuss and decide whether the year was to be brought back by 23 days or to leave the mistake as it was and to retain a permanent constant error. He also pointed out that such a mistake had occurred in Europe and corrections had to be introduced. The Gregorian year in 1582 was found to have an error of 10 days. Pope Gregory XIII advised that the 5th October should be called the 15th October. This was adopted by the Catholics. Though the Protestant countries at first did not accept this move, simply because it came from the Pope, but 170 years later England had to accept the correction by legislation. Russia accepted the Gregorian calendar only after the Bolshevik revolution.

12. In India, the idea of Indian Calendar reform originated from Mahārāshtra. Lokamanya Shri Bal Gangadhar Tilak well-known as a great political figure of the last generation was, as is well-known, a great savant and antiquarian and initiated calendar reform in Mahārāshtra. He started a new reformed calendar which is still being published at Poona.

13. The great pioneer of calendar-studies was Sankara Balakrishna Dixit, whose history of *Bhāratiya Jyotiṣa-Śāstra* is a standard authoritative work, but his work is in Mārāthi and inaccessible to majority of India. The Chairman expressed the hope that it should be translated into English for the use of all.*

14. In Bengal, Madhab Chandra Chattopadhaya had been publishing the *Viśuddha Siddhānta Pañjikā* since 1890, in which all calculations were made according to modern accepted formulæ. Shri Nirmal Chandra Lahiri, a member of the Committee, has been continuing the work.

15. The problem of Indian Calendar Reform was also seriously examined at Banaras, the ancient seat of Indian culture and religion by the late Pandit Madan Mohan Malaviya, Shri Sampurnanand and others and the need for rectification of the present position was impressed upon.

16. Thus, the idea of calendar reform had been going on for a long time in this country *on a personal level*. But as it affected all classes of people, effective reform can be carried out only *on State level*. But all were agreed that there should be a uniform national calendar for the whole of India.

17. All our religious festivals are determined according to the lunar calendar which is pegged on to the present unsatisfactory solar calendar. Hence the task before the Committee is to devise a satisfactory solar calendar first and peg on to it a lunar calendar.

18. The Chairman pointed out that there was a good deal of dissatisfaction even with the Gregorian calendar, though it has attained the status of a world calendar. One of the main drawbacks of this calendar is that the ending of the year does not correspond with the winter solstice day. There are several proposals for reforming the Gregorian calendar. According to one proposal, every month was to be of 4 weeks, and therefore of 28 days and thirteen months would make a year of 364 days. One day, the year-end day, was to be without any name and named simply the year-end day. In leap years, there was to be an additional year-middle day, without any weekday name. Every month was to begin on a Sunday. According to the other proposal the year was to consist of 4 quarters, each of 91 days. Each quarter was to be divided into three months of 31, 30, 30 days. The year-end day, and the year-middle day in leap years were to be the same as before.

* The Council of Scientific and Industrial Research has since made arrangements for having the book translated into English and Prof. R. V. Vaidya, a member of the Committee has been entrusted with the work.

19. The World Calendar Association of New York, U.S.A., had a proposal before the United Nations Organization to evolve a uniform calendar for the whole world. Sir Harold Spencer Jones, the Astronomer-Royal of U.K. and other eminent astronomers had expressed their support of the proposals of W.C.A. They wanted to effect this change from 1956. This proposal, if accepted, would produce great convenience and simplicity but succession of day reckoning by the cycle of the seven day week will have to be given up. *

20. The Committee had to discuss all these matters, and its function was to submit proposals to the Government of India and devise ways and means of achieving the desired scientific calendar. The Chairman said that the Committee could count upon the sympathy of the Hon'ble the Prime Minister and the Deputy Minister and of the Government of India. The proposals to be discussed are :—

- (a) Whether a number of astronomical computers would have to be appointed for compiling an All-India Calendar for five years in advance on the lines which will be suggested by the Committee.
- (b) Whether steps should be taken to compile an Indian Ephemeris for the use of the calendar-makers, the Navy and the Air Force.
- (c) Establishment of a Central Astronomical Observatory by the Government equipped with modern instruments and apparatus.

21. The Chairman said that modern apparatus like the ammonia clock, the quartz clock should be installed in the observatory for the betterment of the time-service and for geophysical studies.

22. The Chairman said that geophysical studies with the aid of accurate clocks was of very great fundamental importance. All along scientists had studied only the surface of the earth. But now the study of the interior of the earth has attained great significance and with the aid of accurate clocks, it has been found that the period of rotation of the earth undergoes sudden variations which may be due to something going on inside the earth.

23. The Chairman emphasized that a reformed calendar and an Indian Ephemeris will be of advantage not only for civil, social and national life but will also be of great use for the army, the navy and the air force. He thanked the Hon'ble Deputy Minister on behalf of the Committee. (At this stage the Deputy Minister left the meeting.)

* The proposal of World Calendar Reform sponsored by the Government of India, is now under the active consideration of the ECOSOC of the United Nations.

24. The Chairman informed the Committee that he had received a number of good wishes for the deliberations of the Committee from not only India but also from several European countries as well as from Brazil, Canada, etc. The President of the W.C.A. Miss Achelis, had also sent her goodwill message.

25. The general question as to whether or not Government of India should undertake reform of the various Hindu calendars in India and have one uniform calendar for the whole of India was discussed.

Dr. Gorakh Prasad said that it will be in the fitness of things for the Government to initiate the reform and pointed out that only minimum necessary changes in the prevailing custom should be effected to avoid public resentment and opposition. He emphasized this point. He also pointed out that in the past there had been hero worship and *guru*-worship and due to personal animosity and financial considerations several anomalies have crept in. Even today *pañcāṅga* making was a financial proposition. Astrology flourished on the principle "Remember it if it fits and forget it if it misses."

Shri Lahiri said that proposals concerning religious festivals should be got ratified by eminent Pandits.

Prof. Vaidya said that as we have got a democracy, Government of the people and by the people, Government should undertake the reform.

Dr. Daftari pointed out, however, that the Committee had been definitely assigned the task of submitting proposals to the Government for a reform in the calendar and as such the general question whether the Government should undertake it or not did not arise. He laid emphasis on the fact that our present calendars were absurd in the sense that the seasons were moving backward and wanted that this should be stopped.

The Committee resolved that a National Solar Calendar for civil purposes should be prepared by the Committee under the auspices of the Central Government and that the lunar *pañcāṅga* should be pegged on to this calendar.

26. Whether India should support the proposals of the W.C.A. was discussed.

Dr. Gorakh Prasad was not in favour. Shri Karandikar opined that India should evolve a National Calendar and the whole world may follow it.

Discussion on this point was postponed; the Committee did not favour the Gregorian calendar.

27. *Sāyana* or *Nirayana* Reckoning.

The Chairman pointed out that the *sāyana* year was 365.2422 days and the Gregorian year was

365'2425 days. Thus the error in adopting the Gregorian leap year system would be only 1 day in 3300 years. He favoured the adoption of the *sāyana* reckoning.

The Committee agreed with the Chairman and resolved to adopt the *sāyana* reckoning for the reformed calendar.

28. Beginning of the Year.

The Chairman pointed out that there was an error of 23 days in the present calendars and desired to know whether the Committee would favour shifting of the year for the reformed calendar by 23 days to put an end to this mistake.

Dr. Gorakh Prasad pointed out that a suggestion to shift the year back by 23 days would meet with very great opposition from the public who will certainly resent such a move. He was not in favour of the shift.

Dr. Daftari opined that this error of 23 days can be left over as it was and allowed to remain as a permanent constant error. The increase of the error should be stopped.

Shri Karandikar said that the Government should have a solar year beginning from Vernal Equinox. He desired the length of the year to be tropical. He suggested that after shifting back by 23 days the V. E. day, *viz.*, 21st March may be the beginning of the solar year, but the *pañcāṅgas* may start the lunar year from *Caitra Śuklādi*.

29. Vernal Equinox & Winter Solstice.

The Chairman said that V.E. was on 21st March and that W.S. was on 22nd December. The problem was whether the Committee favoured V.E. or W.S. as the beginning of the solar year.

Dr. Daftari said that W.S. is good for the civil calendar. In any case, the seven-day week should not be touched which was agreed to by the Committee. Dr. Gorakh Prasad, Prof. Vaidya and Shri Lahiri favoured the V.E. as the commencement for the solar year.

The following resolution was adopted :—

The Committee recommends to the Government of India that a scientific Civil Solar Calendar to be henceforth called the National Calendar for purposes of dating should have its first day after the Vernal Equinox day, *viz.*, on the 22nd March, but for religious purposes in places where solar calendar is used, 13th or 14th April may be the first day of the year for some time to come (as a concession to the prevailing custom).

All the members of the Committee agreed to the resolution except Dr. Gorakh Prasad who recorded his disagreement with the resolution.

Dr. Gorakh Prasad was of the opinion that for civil purposes also the year should begin on the same day as for religious purposes. He thought that the existence of two Indian solar years would create confusion instead of producing any beneficial effects.

30. Length of the Months.

Shri Karandikar's view was that the time taken by the sun to go through 30° on the zodiac should be the length of the month. The Chairman pointed out that the lengths of months would vary from 29 to 32, and would cause much inconvenience.

The Committee agreed to have 5 solar months of 31 days and 7 months of 30 days in an ordinary year and in a leap year 6 solar months of 31 days and six months of 30 days.

31. Era.

The Chairman pointed out that the *Vikrama* era was never used by astronomers and in different States, there were different year beginnings for the *Vikrama Samvat* era. For all calculations the Indian astronomers have always used the Śaka era.

Dr. Daftari said that the *Siddhāntas* used the *Kaliyuga* era. Shri Karandikar was of the opinion that either *Kali* or *Kalpa* era should be used.

The Committee resolved that the current Śaka Era should be adopted for the reformed Indian calendar.

32. Reckoning of Day.

Two systems now prevalent are (a) reckoning the day from mid-night to mid-night and (b) from sun-rise to sun-rise. The Chairman favoured the mid-night system as the advantages in this system were :—

- (i) that the astronomers all over the world, including our ancient astronomers used it ;
- (ii) it was an international system ;
- (iii) complications due to latitude did not come in this system.

Dr. Daftari, Shri Karandikar, Prof. Vaidya and Dr. Gorakh Prasad, however, were in favour of reckoning the day from sun-rise to sun-rise ; even though latitude and longitude had to be considered in calculations. Shri Lahiri was in favour of reckoning the day from mid-night to mid-night.

The Committee resolved that in the Indian system of time reckoning, the day should be reckoned from mid-night to mid-night at an All-India Central Station for dating purposes only, but for religious and other purposes the day may begin from sun-rise of the Central Station; but tables showing local sun-rise for important stations should be given.

33. All-India Central Station.

The Chairman pointed out that it was necessary for international purposes that Indian time should be $5\frac{1}{2}$ hrs. ahead of the Universal Time (Greenwich Time). The Committee considered the question of location of the Central Astronomical Station.

Prof. Vaidya and Shri Karandikar put up maps and atlases. Prof. Vaidya proposed Ujjain on traditional grounds or Jubbulpore on geographical grounds. Dr. Gorakh Prasad and Shri Karandikar suggested Ujjain, while Shri Lahiri suggested $22\frac{1}{2}^{\circ}$ N. Latitude. It was decided that a place ($82\frac{1}{4}^{\circ}$ E. of Greenwich) and having the latitude of Ujjain (*viz.* $23^{\circ} 11'N$) be recognised as the Central Station for India.

34. Lunar Calendar.

The Committee agreed that the lunar months should be new-moon ending, and the lunar year should begin with *Caitra Śukla-pratipat*.

35. The year for Religious Calendar.

Dr. Daftari said that for the sake of convenience the first point of the zodiac should be $23^{\circ} 21'$ ahead of the real Vernal Equinox, and that all calculations should be made on this basis. Shri Lahiri pointed out that in Bengal they had $23^{\circ} 12'$.

It was decided that the first point of *Meṣa* is to be taken $23^{\circ} 15'$ ahead of the Vernal Equinoctial point, and all calculations should be made on that basis.

36. Names of Solar Months.

The names of the months should continue to be *Caitra*, *Vaiśākha*, etc., as at present; the appellation of solar or lunar should be attached to them as the case may be.

The point regarding naming of the months of the National Civil Calendar was postponed for the next meeting.

37. Tithi.

The Chairman said that *tithi* calculations according to Indian method were wrong at present by sometimes as much as 6 hours and said that the Committee

should favour a uniform *tithi* for the whole of India. Shri Karandikar however opposed the proposition and pointed out that the *tithi* depended on sunrise and so on local time and could never be uniform for the whole of India.

It was resolved that in the National Calendar, *tithi* should be given for the Central Station and the calculations of time should be given in hours and minutes.

38. Nakshatra.

The Chairman preferred an Indian calendar without *nakṣatras* being indicated. Dr. Daftari however said that the *nakṣatras* should be specified and that *Aśvini* should start with *Meṣa*. It was resolved that the *nakṣatras* should be given with *Aśvini* starting with *Meṣa*.

39. Recommendations to the

Government of India.

Resolutions proposed by the Chairman and un-animously passed by the Committee :—

1. A tentative National Calendar for the whole of India should be prepared, for five years in advance, showing dates, days, months, *tithis* and *nakṣatras*.

(Five years in advance was necessary to find out the practical implications and difficulties which may be caused by the occurrence of leap years and intercalary months.)

2. Steps should be taken to compile an Indian Ephemeris by the Government of India showing in advance positions of the Sun, the Moon, the planets, and other important heavenly bodies.
3. There should be a National Observatory at a suitable place provided with modern equipment, apparatus and time-service.

Monday, the 23rd February, 1953.

The following attended :

Prof. M. N. Saha	(Chairman)
Dr. K. L. Daftari	(Member)
Shri J. S. Karandikar	"
Shri N. C. Lahiri	"
Prof. R. V. Vaidya	"
Shri K. G. Krishnamurthi	

Assistant Secretary, C.S.I.R.

The Committee reviewed the items covered in the meeting held on Saturday.

2. Some members of the Committee suggested that additional members should be taken up on the Committee or co-opted. The Chairman said that, if necessary, additional members would be taken up or co-opted, but only at a later stage, after the proceedings are reported to the Council of Scientific and Industrial Research.

3. Discussing the procedure to be followed, the Chairman said that the Committee should request the Government of India to appoint two astronomers to prepare the National Calendar on the lines suggested by the Committee and give them the necessary assistance.

The Chairman is in correspondence with the Astronomer Royal of England regarding the compilation of the Indian Ephemeris.

4. The Chairman proposed to the Committee that Shri Lahiri and Prof. Vaidya may be recommended to the Government to be appointed for the work of compilation of the National Calendar.

The Committee recommended that the services of Shri Lahiri and Prof. Vaidya who were both Government servants be got on loan for a period of one year in the first instance. The Committee also recommended that two assistants be appointed to assist Shri Lahiri and Prof. Vaidya at Calcutta and Ujjain respectively.

The Committee recommended that suitable budget provision be made for one year for the work.*

* The Council of Scientific and Industrial Research had made budget grant for implementation of this recommendation and staff of calculators had been appointed.

ANNEXURE II

PROCEEDINGS OF THE SECOND MEETING

The second meeting of the Calendar Reform Committee was held on the 8th March, 1954 at 10 A.M. in the C.S.I.R. Building, New Delhi.

The following members were present :—

- | | |
|---------------------------|----------|
| 1. Prof. M. N. Saha, | Chairman |
| 2. Dr. Gorakh Prasad, | Member |
| 3. Shri J. S. Karandikar, | " |
| 4. Prof. R. V. Vaidya, | " |
| 5. Shri N. C. Lahiri, | " |

1. Prof. A. C. Banerji could not attend due to his other engagement which was appointed earlier. Dr. Daftari could not attend due to illness.

2. Dr. Daftari sent a letter which was read by the Chairman. According to his suggestion it was decided that *Yoga* should be given in the Experimental Calendar, but *Karana* need not be given. Instead of 27 *Yogas* only *Vyati-pāta* and *Vaidhṛti* calculated with tropical longitudes of the Sun and the Moon should be given.

3. The following further resolutions were adopted after discussion :—

(1) All festival days and days of religious observances in India should be shown and mention should be made of States in which they are observed, as has been done in the calendar.

(2) The system of starting the year on the day following Vernal Equinox is confirmed.

(3) *Caitra* should be the first month and the names of the months should be *Caitra*, *Vaiśākha*, etc. Alternatively the civil months may be called *Meṣa*, *Vṛṣabha* etc., *Meṣa* being the name for solar *Caitra*.

(4) The lengths of the months would be fixed as follows :

Caitra 30 days (31 days in leap years), *Vaiśākha*-31, *Jyaiṣṭha*-31, *Āṣāḍha*-31, *Śrāvaṇa*-31, *Bhādra*-31, *Āśvina*-30, *Kārtika*-30, *Agrahāyaṇa*-30, *Pauṣa*-30, *Māgha*-30, and *Phālguna*-30 days.

Leap-years should correspond with the leap-years of the Gregorian calendar.

(5) *Mahāviṣuva saṁkrānti* is to be stated in the calendar on the vernal equinox day and the *Uttarāyaṇa saṁkrānti* on the winter solstice day. *Makara saṁkrānti* should be on the day when the sidereal *Makara* is passed (i.e. on 14th Jan. as at present). *Vaiśākhi* is to be celebrated on the first of *Vaiśākha*.

(6) Dates of heliacal rising and setting of Jupiter and Venus should be given in the calendar.

(7) *Śukla* and *Kṛṣṇa Pakṣas* should be separately shown and *tithis* should be numbered from S 1 to 15 and K 1 to 14 and K 30.

(8) Moment of rising of the centre of the apparent Sun to be given after making correction for refraction. The moment of sunset similarly calculated should also be given.

(9) The moment of Sun's entry into the *nakṣatra* divisions should also be stated in the calendar.

4. Dr. Gorakh Prasad enquired as to the amount of the precession of the equinoxes adopted in calculating the *nakṣatras*. He was informed that the calculations have been made with a constant *ayanāṁśa* of 23° 15', as no definite directive was given in the

previous meeting for changing the *ayanāṁśa* year after year. He remarked that this is unscientific and opposed to the actual happenings in the sky.

5. At this time the meeting was postponed for lunch till 3-0 P.M. when all the members present again met.

6. Dr. Gorakh Prasad stressed upon the necessity of calculating the *nakṣatras* (and also the sidereal *Meṣādi* etc.) in such a manner that at the time of a particular *nakṣatra*, say *Kṛttikā*, the moon may be seen near the *Kṛttikā* group of stars in the sky. This practice is being followed since the Vedic times and is perfectly scientific and we cannot change this old system. Shri Karandikar did not support this and stressed upon the necessity of adopting a constant *ayanāṁśa*. The Chairman remarked that constant *ayanāṁśa* was opposed to science. Shri Lahiri and Prof. Vaidya pointed out that if any change is introduced in the *ayanāṁśa* at this stage, the calendar for four years so far calculated will require a thorough revision involving a great amount of labour and time. It was, however, agreed that if the difference be small such as one or two minutes of arc, the labour involved in the revision would not be much.

7. Dr. Gorakh Prasad pointed out that the *Nakṣatras* and the sidereal *Meṣādi* should be calculated from a fixed point which was $23^{\circ} 15'$ in advance of the vernal equinoctial point on a certain date (the middle of the period of 5 years for which the *Pañcāṅga* was to be calculated i.e. on 21st March, 1956) and the rate at which this *ayanāṁśa* is increasing on account of precession of the equinoxes should be taken into account.

8. For the purpose of examining the above position thoroughly, the Chairman asked Prof. Vaidya to prepare a note on the Zero-point of the Hindu celestial globe according to the *Sūrya Siddhānta* and other older Indian *Siddhāntas*. This will be circulated and after taking opinion the point in paragraph 7 above will be decided by the Chairman. Pending finalization of this question, the calculations so far made should be regarded as provisional.

9. The introduction to the report of the Calendar Reform Committee prepared by the Chairman was discussed and the general outline of the report approved.

10. The activities of the C.S.I.R. on the recommendation of the Calendar Reform Committee for publishing an Indian Ephemeris and Nautical Almanac on behalf of the Government of India was explained to the members by the Chairman.

11. It was resolved that an extension for six months should be given to the office of the Calendar

Reform Committee to complete the outstanding work, for which the C.S.I.R. may be moved by the Chairman.

12. The suggestions received from different persons and institutions were read and discussed.

Memorandum issued by the Chairman to the members
of the Calendar Reform Committee
on 22nd June, 1954.

In the second meeting of the Calendar Reform Committee held at the C.S.I.R. Building, New Delhi on the 8th March, 1954, Dr. Gorakh Prasad raised the question of adopting variable *ayanāṁśa* for the purpose of calculating *nakṣatras* as well as sidereal *Meṣādi*. After discussion it was, however, decided that Prof. Vaidya would prepare a note on the subject which would be circulated amongst the members, and after obtaining their opinion, the Chairman would decide the question.

Dr. Gorakh Prasad thereafter submitted a note containing his definite proposals in this respect, which was also circulated amongst the members. He proposed that $23^{\circ} 15'$ be taken as the *Ayanāṁśa* on the vernal equinox day (21st March) of 1956, because this will reconcile most of the *Pañcāṅgas* in India based on modern constants."

Prof. Vaidya prepared his note and it was circulated. Another note prepared in this office on the same subject was also circulated. It was explained in these notes that the *Meṣādi* of *Sūrya Siddhānta* was actually the V.E. point, and as the seasons and different solar and lunar months of the year are connected with *Meṣādi*, the year of the Indian religious calendar cannot but be the seasonal or tropical year. It has also been shown that it is not possible to arrive at any definite conclusion as to the actual amount of *ayanāṁśa* at any epoch, from an examination of the star positions given by the *Sūrya Siddhānta*.

Replies to the circular letters have been received from Dr. Daftari and Shri Karandikar, who desire that we should stick to the proposals adopted in the first meeting, viz., should adopt a constant *ayanāṁśa* of $23^{\circ} 15'$ for our religious calendar. I have consulted Shri Lahiri and Prof. Vaidya also on this question.

It appears to me that if we accept Dr. Gorakh Prasad's proposal of adopting a variable *ayanāṁśa* for the calculation of *nakṣatra* as well as *Meṣādi*, we shall lose the seasonal nature of the months which is against the *Dharmaśāstra*, as our *Meṣādi* being the V.E. point cannot be calculated with a variable *ayanāṁśa*. We cannot therefore accept Dr. Gorakh

Prasad's second part of the proposal that the sidereal *Meṣādi* should also be calculated with variable *ayanāṁśa*. It should therefore be calculated with a fixed *ayanāṁśa* of 23° 15' as already decided.

As regards the calculation of *nakṣatras*, I agree that it should be done with a variable *ayanāṁśa*, otherwise the *nakṣatra* divisions will lose all connections with the stars or star-groups contained in those *nakṣatras*. For this purpose I agree with Dr. Gorakh Prasad that the *ayanāṁśa* of 23° 15' should relate to 21st March, 1956, the middle of the five-yearly period.

This is acceptable without entering into any controversy about any particular value of *ayanāṁśa*.

The result would be that the *Meṣādi* would not coincide with any particular *nakṣatra* division for all time. This has got support of our *Śāstras* behind it, as there is mention of such receding back of the V.E. point (our *Meṣādi*) over the *nakṣatra* divisions.

The five yearly experimental calendar already prepared will be revised where necessary in the light of the above decision.

ANNEXURE III

PROCEEDINGS OF THE THIRD MEETING

The third meeting of the Calendar Reform Committee was held on the 13th Sept. 1954 at 10 A.M. in the C.S.I.R. Building, New Delhi.

The following members were present :—

- | | |
|---------------------------|-----------------|
| 1. Prof. M. N. Saha, | <i>Chairman</i> |
| 2. Shri J. S. Karandikar, | <i>Member</i> |
| 3. Prof. A. C. Banerji, | " |
| 4. Dr. Gorakh Prasad, | " |
| 5. Prof. R. V. Vaidya, | " |
| 6. Shri N. C. Lahiri, | " |

Dr. Daftari in letters to Dr. Gorakh Prasad and to Shri Karandikar expressed his inability to attend due to reasons of health.

1. The proceedings of the last meeting were read and confirmed.

2. The introductory portion of the report and the final recommendations and also the experimental National Calendar prepared for five years were read, and scrutinized by all the members and were approved after small corrections.

3. The members present signed the final report for submission.

4. It was resolved that the Government be requested to print Parts A and B immediately for circulation and eliciting public opinion. When Part C will be completed and approved by the members of the Committee, it will also have to be printed, and circulated.

5. A letter from the Chairman regarding his visit of the Nautical Almanac Office at Herstmonceux (England) was read. It was resolved that the travelling expenses from London to Herstmonceux and back incurred should be borne by the Calendar Reform Committee.

6. The members requested the Chairman to move the Government for making arrangement for publishing an 'Indian Ephemeris and Nautical Almanac' for India.

7. The Chairman then thanked the members for the trouble they had taken and the interest shown in the smooth working of the Committee.

ANNEXURE IV

A Summary of Reasons for the dissenting note by Dr. K. L. Daftari

The real problem before us is to stop the moving back of the seasons through the months *Caitra*, *Vaiśākha* etc., in such a manner that will fit in with the present *Dharmaśāstra*. We can only give a new interpretation or meaning to the words *Caitra*, *Vaiśākha* etc., and *Āśvini*, *Bharaṇī* etc., used in the *Dharmaśāstras*. From this stand point our resolutions in our first meeting still stand unimpeached. I shall now explain what I say.

To stop the moving back of the seasons through the months *Caitra* etc. we must make the months move back with equal motion. That means that the months must correspond to or be pegged on the seasonal year and not on the sidereal year as at present. Therefore our resolutions to adopt the seasonal year for the *pañcāṅga* is quite correct. All corollaries of this proposition must be correct and must be accepted. The corollary is that as at the time of *Caitri Pūrṇimā* the moon will not be near the fixed star *Citrā* and similarly in *Viśākhā* etc., the places where the moon will be under such circumstances must be given some other names and we should name them *Sāyana Citrā*, *Sāyana Viśākhā* etc. We adopt these names being convinced that when the *Dharmaśāstras* name *Caitra*, *Vaiśākha* etc., and *Āśvini*, *Bharaṇī* etc., they really mean *Sāyana Caitra*, *Sāyana Vaiśākha* etc. and *Sāyana Āśvini*, *Sāyana Bharaṇī* etc. The works on *Dharmaśāstras* came into existence before the precession of equinoxes was discovered. The astronomical works written before Muñjāla, had no idea of the precession of equinoxes. At that time the writers on *Dharmaśāstra* and astronomy thought that the seasonal year and the sidereal year were the same and as they had to regulate the religious functions according to the seasons they must have meant by *Caitra*, *Vaiśākha* etc., the *Sāyana Caitra*, *Sāyana Vaiśākha* and by *Āśvini*, *Bharaṇī* etc., the *Sāyana Āśvini*, the *Sāyana Bharaṇī* etc. That the *Dharmaśāstra* and the Vedas regard only the seasonal year as the year, is clear from the statement in the *Śatapatha Brāhmaṇa* “ऋतवः संवत्सरः ऋतुभिर्हि संवत्सरः शक्नोति स्थातुम्।” (The seasons is the year. The year can stand only by the help of the seasons). In view of this statement it is clear that we will do real justice to the *Dharmaśāstras* if we understand by *Caitra* etc. the *Sāyana Caitra* and by *Āśvini* etc. the *Sāyana Āśvini* etc. If we do not approve of the adjective *Sāyana* we may apply the adjective ‘*Calā*’ which is more expressive. We have to accept this interpretation of the *Dharmaśāstras* as the corollary of our proposition that we must accept the seasonal year for our calendar.

This manner of the calendar reform exactly fits in with the work on *Dharmaśāstra*. We have only to understand the words *Caitra* etc. and *Āśvini* etc. to be equivalent to *Sāyana Caitra* etc. and *Sāyana Āśvini* etc. These, the people will find given in our calendar. Thus the present works on *Dharmaśāstra* even without any change will continue to serve our purpose for all time to come. Any other way of reforming the calendar will require the changes in the works on *Dharmaśāstra* themselves and we have no power to do the same because the people do suppose that we have no qualifications sufficient to change the *Dharmaśāstras* but we can suggest the new and the rational interpretation of the *Dharmaśāstras* as given above.

Now I shall consider the objections raised by the Pañcāṅga Sodhana Pariṣad of Calcutta. The objections are stated in the following sentences. “Our religious festivals and observances were observed during all this period and no difficulty was experienced in any time. We are confident that in future also we shall experience no difficulty by this gradual shifting of the V. E. point. For this purpose if any attempt is made artificially to stop further receding back of the equinoxes, as appears to have been proposed by the Calendar Reform Committee, it will no doubt be completely opposed to our śāstric tradition as well as to science”.

This discloses complete ignorance of the history of our calendar system. In the beginning when our ancestors found that the V. E. had shifted back they changed the beginning of the year from one *nakṣatra* to another behind it, for example, they changed the beginning of the year from *Mṛga* to *Rohiṇī*, from *Rohiṇī* to *Kṛttikā*, from *Kṛttikā* to *Dhanīṣṭhā*, from *Dhanīṣṭhā* to *Śravaṇa* and from *Śravaṇa* again to *Āśvini*. These changes required corresponding changes in the *Dharmaśāstras* also. These were the times when the *Dharmaśāstra* had not become stationary as it has become at present. Our ancestors, therefore, could make necessary changes in *Dharmaśāstra* also. It was therefore that our ancestors, as the memorandum says, found no difficulty in observing the religious festivals. But now we actually find the difficulty because *Dharmaśāstra* has become stationary. Take the case of *Vaiśākha Śuddha Tṛtīyā* or *Akṣaya Tṛtīyā*. In this festival we have to offer to a Brāhman an earthen pot for cooling drinking water. At present we get very hot summer on *Akṣaya Tṛtīyā* and therefore the ceremony is the proper one at that time. In

future however, we shall have rainy season on *Vaiśākha Śuddha Tṛtīyā* after about 2000 years. Will this ceremony be proper at that time? We shall have to perform it at least on *Caitra Śuddha Tṛtīyā*. This shows that if we stick to the sidereal year we shall then have to change the *Dharmaśāstra* from time to time. Are the objectors willing to accept such a position? They do not appear to be, because they are staunch followers of the *Śāstras* and they want to follow them literally. The late S. B. Dixit has cited in his famous book some other examples like that of *Akṣaya Tṛtīyā* (see pages 420 to 423), and in fact we are very unwilling to perform our present functions in any season other than that in which we are at present performing them. The *Śāstras* also as shown above really regard the round of the seasons as the year. It is because our *Śāstras* regarded the seasons as equivalent to the year, and that our ancestors shifted several times, the beginning of the year from one *nakṣatra* to another, and they added intercalary months from time to time. Are we even now to follow this crude method of adjusting the year to the seasons or to adopt a more scientific method of gradually changing the beginning of the zodiac in conformity with the actual movements in the heaven?

It is objected that the *Śāstras* do not require all religious functions to be observed in the seasonal months. The objectors give example of *Janmāṣṭamī* and say that we need not bother whether it is in rainy season or not. This is not true. We all suppose that the Lord Kṛṣṇa was born in rainy season and that he was taken from Mathura to Gokul through the flooded Yamuna. We would not like his birth day to be celebrated in the cold seasons. Though the *Śāstras* require *Rohiṇī Nakṣatra* on the birth day of the Lord Kṛṣṇa, we would rather accept his birth day in the rainy season with *Sāyana* or *Cala Rohiṇī* on that day. Similarly about *Vaiśākhi Pūrṇimā*, *Śrāvaṇī Pūrṇimā*, *Māghī Pūrṇimā*, *Sarasvatī Pūjā*, mentioned in the memorandum, we do like to celebrate them in the seasons in which they are at present being celebrated and on days on which we shall have *Sāyana* or *Cala Vaiśākhi*, *Śrāvaṇa*, *Maghā*, etc. *nakṣatras*. By adopting *Sāyana* or *Cala nakṣatras*, we will avoid the necessity of two systems, one sidereal and other tropical suggested by the objectors and which will be too confusing to the public. The adoption of two systems will give rise to difficulties in *Dharmaśāstra*. It will give rise to questions about the system according to which particular ceremonies are to be performed, and different pandits will give different solutions to these questions. Thus there will be all confusion. On the contrary by adopting *Sāyana* or *Cala nakṣatra* for all ceremonies and *Sāyana* months, we avoid all confusion and create certainty.

The evidence in favour of seasonal months is so strong that the objectors make the following statement in favour of them. "In early Vedic times the sacrifices were performed in seasonal months. So all the Vedic festivals should no doubt be observed in the seasonal months." But the objectors say, "But we do not agree that all other festivals which developed after the Vedic period, are required to be observed in the seasonal months." This objection cannot stand because there is no ground to suppose that the *Dharmaśāstra* with the object of making a change accepted the sidereal year in place of the seasonal year.

It may be said that the names *Caitra*, *Vaiśākha* etc. prove that the *Dharmaśāstras* accepted the sidereal year in place of the seasonal year. But this reasoning is refuted by the fact that they changed the beginning of the year from one *nakṣatra* to another to keep agreement with the seasons. Therefore the conclusion is that even the names *Caitra*, *Vaiśākha* etc. in *Dharmaśāstra* implied particular seasons. Here I will cite the authority of the famous work *Dharmasindhu* which plans to give decisions without citing authority. The work says, चैवमारस्य मासत्रयद्वयान्तको । वसन्तादि षट् सत्रकचान्द्रः । मूलमासे तु किञ्चिदुन्नववतिसंख्यैर्दिनैश्चान्द्रश्चतुः । यौतस्मात्तौ चान्द्रतु अरणं प्रशस्तम् ।

Translation : Every two months from *Caitra* constitute lunar seasons beginning from *Vasanta*. However when there is intercalary month the lunar season consists of something less than 90 days. It is proper to mention the lunar season in all the ceremonies ordained by *ṛiti* and *smṛiti*.

This means that whenever there is the word *Caitra* it implies the season *Vasanta*. This was no doubt the condition when the name *Caitrādi* first came into existence. But now *Caitra* comes in hot season (गोष्म). The late S. B. Dixit also says :—

“चैत्रवैशाख हे वसंताचे मास ही परिभाषा सर्व ग्यात दिवस येते. ती स्थापित झाल्यावर पुष्कळ कालाने चत्वारंभ मासे आला, म्हणून कांहीं ग्यात मीन मेष हे मास म्हणजे फाल्गुन-चैत्र हे मास वसंताचे अशी परिभाषा आली. व तीप्रमाणे कांहीं पञ्चांगात हल्ली चतु लिहितात. सांप्रत माघ-फाल्गुनांत वसंत होतो. तरी देखील चैत्र-वैशाख वसंत चतु ह्या परिभाषेचे प्रावत्य आदेश.”

Translation : The technical language that *Caitra* and *Vaiśākha* are the months of *Vasanta* is found in all works. Long time after it was established, the beginning of the seasons receded back. Therefore in some works we find the technical language that the *Mina* and *Meṣa* i.e. *phālguna* and *Caitra* are the months of *Vasanta*, and in some *pañcāṅgas* seasons are written according to that. At present *Vasanta* comes in the months of *Māgha* and *Phālguna*. Even then the technical language that *Caitra* and *Vaiśākha* is *Vasanta* predominates.

All this shows that even when the names *Caitra*, *Vaiśākha* etc. were used they meant a particular season also and that the season implied has been changing. The resolutions of our Committee in our first meeting amount to this that *Caitra* and *Vaiśākha* hereafter shall always mean the *Griṣma* (hot season) etc. The memorandum of the objectors says that in the *Dharmaśāstra* seasons or seasonal months are not mentioned. To this my reply is as follows :

In the *Dharmaśāstra* that enjoins the particular ceremony there may be no mention of seasons or seasonal months. But the names of the months *Caitra*, *Vaiśākha* etc. are always there, and the names of the months implies particular season as shown above. Therefore the words *Phālguna* and *Caitra* in *Dharmaśāstra* always imply the *Vasanta* season and *Vaiśākha* always implies the hot seasons. This is the interpretation that we have to give to these names. By these names they always meant the particular seasons. We can give effect to the real meaning of these names only by supposing that *Caitra* means *Sāyana Caitra*, *Vaiśākha* means *Sāyana Vaiśākha* etc.

I have already suggested above that it is confusing to accept the seasonal year for some ceremony and sidereal year for other. It is better to hold that even the words *Caitra*, *Vaiśākha* etc. imply the particular seasons and to take the seasonal year and seasonal months for all ceremonies.

The memorandum raises objections on the grounds of the scientific terminology, Indian tradition and lexicography. This ground vanishes if we say that our names are really *Sāyana Caitra*, *Sāyana Vaiśākha* and *Sāyana* or *Cala Aśvinī*, *Sāyana* or *Cala Bharanī*,

etc., and if we say that these names express the real meaning of *Caitra*, etc. and *Aśvinī* etc. used in *Dharmaśāstras*.

India is the country of blind orthodoxy. Whenever any improvement is proposed the people suppose that they will be drowned in the torrent of improvements, and they oppose the improvement blindly. Any person who wants to introduce the improvement has to be firm and should not give way to such resistance. Signatories of the memorandum are persons who would resist any improvement. Now they would resist the improvement in the calendar and if they become successful they would then resist the necessary improvements in the *Dharmaśāstra* also. We should not take account of such people and we should take care that we make no abrupt change that would disturb the passions of the people. It is therefore that we have resolved that we should accept $23^{\circ} 15'$ *ayanāṁśa* instead of 0° *ayanāṁśa* as proposed by some enthusiastic reformers. By this I refer to the memorandum submitted by Yeshwant Pradhan, Krishnaram Valgi Bhat and Dattatraya K. Sule who have proposed that we should take 0° as *ayanāṁśa*.

In conclusion I submit that we have rightly chosen in our first meeting not to make any changes in the works of *Dharmaśāstra* but to give them correct interpretation and to make such changes in the calendar as will suit the calendar to that correct interpretation of the *Dharmaśāstras*. But unfortunately this decision has not been adhered to fully. *Nirayana nakṣatras* have been accepted for the calendar. This makes a change in the *Dharmaśāstra* necessary. Therefore now I suggest the alternative course suggested in my dissenting note.

K. L. Daftari.

ANNEXURE V

LIST OF PAÑCĀNGAS RECEIVED.

The following *pañcāngas* have been received from different parts of India in response to the request issued through the Press in March, 1953, for furnishing the office with three copies of the *pañcāngas* covering the year 1953-54.

1. Janmabhoomi (Gujrati)
Ghogha Street, Fort, Bombay.
2. Sandesh Pratyaksha Panchang (Gujrati)
22, Saraswati Society, Sarkhej Road,
Ahmedabad-7.
3. Jnanmandal Saura Panchang (Hindi)
Banaras-1.
4. Udiyavara Panchangam (Hindi)
Mangalore.
5. Chitrasala Panchang (Marathi)
1026, Sadasiv Peth, Poona 2.
6. Datey's Marathy Chaitri Astronomical
Ephemeris & Almanac (Marathi)
537, South Kasaba, Sholapur.
7. Maharashtra Panchang (Marathi)
Girgaon, Bombay-4.
8. Vidharva Panchang (Marathi)
Girgaon, Bombay-4.
9. Vijayanam Samvatsari Panchang (Marathi)
915/1, Shivajinagar, Poona-4.
10. Vijayanam Samvatsari Panchang (Marathi)
Girgaon, Bombay-4.
11. Nirnaya Sagar Panchang (Marathi)
26/28 Kolbhat St., Bombay-2.
12. Kutchi Ashadhi Panchang (Gujrati)
Kailash Bhavan, PENCHHATDI,
Bhuj (Kutch).
13. Kolhapuri Panchang (Marathi)
Hire Math, Shukrawar Peth, Kolhapur.
14. Latkar Panchang (Marathi)
152B, Mahadwar Road, Kolhapur.
15. Visapurkar Panchang (Marathi)
P.O. Sangli, Dist. Satara South.
16. Sri Mahendra Jain Panchang (Gujrati)
Ahmedabad-7.
17. Grahalaghaviya Sukshma Panchang (Marathi)
P.O. Deshing, Kolhapur,
Dt. S. Satara.
18. Brihan Maharashtra Panchang (Marathi)
364, Somwar Peth, Poona-2.
19. Prachin Grahalaghaviya Paddhati Panchang
(Marathi)
(Ganapati Sansthan Press), Sangli, Poona.
20. Sri Visvavijay Panchang (Hindi)
Goel Brothers Pustakalaya,
Daribakala, Delhi.
21. Shuddha Kartiki Panchang (Gujrati)
Ahmedabad.
22. Gharcha Jyotishi (Marathi)
471, Somwar Peth, P.O. Karad,
Dist. Satara.
23. Saptarshi Panchang (Hindi)
Bazar Sitaram, Delhi.
24. Nagpur Tilak Panchang (Marathi)
Panchang galli, Mahal, Nagpur-2.
25. Sri Kalikata Visvanatha Panchang (Hindi)
159A, Muktarām Babu Street, Calcutta.
26. Sri Krishna Panchang (Hindi)
20, Nariwal Gali, Lucknow.
27. Bisuddha Siddhanta Panjika (Bengali)
85, Grey Street, Calcutta-5.
28. Jagajiyoti Panjika (Bengali)
55A, Raja Dinendra Street, Calcutta-6.
29. Directory Susiddhanta Panjika (Bengali)
62A, Jay Mitra Street, Calcutta-5.
30. Nutan Purna Chandra Panjika & Directory
(Bengali)
40, Garanhata Street, Calcutta.
31. Nabagraha Panjika (Bengali)
16 Kashi Mitra Ghat Street,
Bagbazar, Calcutta.
32. B. K. Pal & Co.'s Panjika (Bengali)
1 & 3 Bonfield's Lane,
Pal's Building, Calcutta.
33. Varsa Vabhisya
P.O. Karad, Dist. Satara.
34. Kumbhakonam Maduthu Panchang (Tamil)
Melapavur, Dist. Tirunelveli.
35. Drigganitha Panchangam (Tamil)
Thillai Vasam, Madduvil North
Chavakachcheri, S. India.
36. Bharatiya Ephemeris of Planets' Positions
(Telegu)
P.O. Podagatlapalli, Dist. East Godavari.
37. Pathuri Vari Panchang (Telegu)
147, Mint Street, Madras 7.

- | | |
|---|--|
| <p>38. Purna Sastriya Andhra Patrika Panchang
(Telegu)
P.O. Podagatlapalli, Via Tanuku
Dist. East Godavari.</p> <p>39. Vijayanam Samvatsara Panchang (Telegu)
P.O. Podagatlapalli, Dist. East Godavari.</p> <p>40. Vijayanam Samvatsari Panchang (Telegu)
147 Mint Street, Madras-1.</p> <p>41. Vikritinam Samvatsara Panchang (Telegu)
Ankapalli, Dist. W. Godavari.</p> <p>42. Bhungalia Panchang (Gujrati)
Amareli, Saurashtra.</p> <p>43. Reformer Almanac (Malayalam)
Reformer Press, Calicut, S. Malabar.</p> <p>44. Jolsyamithra Almanac (Malayalam)
Congress Press, Palghat Post,
Malabar.</p> <p>45. Yogakshemam Panchangam (Malayalam)
Panchangam Press, Kunnamkulam,
Travancore-Cochin State.</p> <p>46. Suddha Nirayan Panchang (Marathi).
C/o. Keshari Mudranalaya,
568 Narayan Kelkar Road, Poona-2.</p> <p>47. Shuddha Panchang (Marathi)
140 Shukrawar Peth, Poona-2.</p> <p>48. Vijaya Samvatsara Siddhanta Panchangam
(Telegu)
Via Kollur, Dt. Guntur.</p> <p>49. Lingala Bangaraiah Siddhanti's Almanac
(Telegu)
Via Tanuku, Dist. East Godavari
Andhra State.</p> | <p>50. Namogal Drig-ganitha Saura Muhurtha
Panchangam (Tamil)
31 Ayalur Muthiah Mudali Street
P.O. Sowcarpet, Madras-1.</p> <p>51. Sri Sringagiri Sri Jagat Guru Srimath
Panchangam (Kanada)
Kollegal, Coimbatore, Madras.</p> <p>52. Kottur Guru Basaveswara Panchangam
(Kanada)
P.O. Kottur, Dist. Bellary.</p> <p>53. Panchang for 1953-54. (Kanada)
P.O. Haveri, Dt. Dharwar,
Kanada.</p> <p>54. Hooli Siddhanta Panchangam (Kanada)
Brihan Math, P.O. Hooli,
Dist. Bringham.</p> <p>55. Hubballi Panchangam (Kanada)
P.O. Hubli, Dt. Dharwar, Kanada.</p> <p>56. Bhagyodaya Panchangam (Kanada)
Taluk-Rone, Dist. Dharwar,
Kanada.</p> <p>57. Eadagoada Panchangam (Kanada)
P.O. Retihelli, Dt. Dharwar,
Kanada.</p> <p>58. Visva Panchang (Hindi)
Banaras Hindu University, Banaras.</p> <p>59. Uttara Malayala Panchangam (Malayalam)
P.O. Poyyannur, N. Malabar.</p> <p>60. The Indian Ephemeris, 1954. (English)
55A, Raja Dinendra Street,
Calcutta-6.</p> |
|---|--|

ANNEXURE VI

The calendar makers were requested to furnish certain data relating to their calendars, in the form of the following questionnaire issued to them. The replies received will be found in the following pages.

QUESTIONNAIRE

- | | |
|--|---|
| <p>1. Name of the Pañcāṅga.</p> <p>2. The year from which it is being published.</p> <p>3. Language in which it is published.</p> <p>4. Office address.</p> <p>5. Name of the chief compiler.</p> <p>6. Sāyana or Nirayaṇa ?</p> <p>7. Solar or luni-solar ? If luni-solar whether Pūrṇimānta or Amānta ?</p> <p>8. Beginning of the year.</p> | <p>9. Principal Era used, give the era of the current year with the English date of its beginning.</p> <p>10. Give the names of the months from the beginning of the year.</p> <p>11. Length of the solar year adopted.</p> <p>12. Amount of Ayanāṁśa on 21st March, 1954.</p> <p>13. Annual rate of ayanāṁśa (precession) adopted.</p> <p>14. Whether calculations are based on modern method or the old Siddhāntic method ? Give the name of the book, if any, on which the calculations are based.</p> |
|--|---|

REPLIES TO QUESTIONNAIRE

(1)

<i>Questionnaire</i>	<i>Ques. No.</i>	<i>Reply</i>
1. Name of the Pañcāṅga.	1.	Bisuddha Siddhanta Panjika.
2. The year from which it is being published.	2.	1297 B. S., 1890 A. D.
3. Language in which it is published.	3.	Bengali.
4. Office address.	4.	85, Grey Street, Calcutta-5.
5. Name of the chief compiler.	5.	Sasthi Charan Jyotirbhusan.
6. Sāyana or Nirayana ?	6.	Nirayana.
7. Solar or luni-solar ? If luni-solar whether Pūrṇimānta or Amānta ?	7.	Solar.
8. Beginning of the year.	8.	Mesha Sankranti.
9. Principal Era used, give the era of the current year with the English date of its beginning.	9.	Bengali San, 1360 begins on 14th April, 1953.
10. Give the names of the months from the beginning of the year.	10.	Vaisakha to Chaitra.
11. Length of the solar year adopted.	11.	365 ^d .25636.
12. Amount of Ayanāṁśa on 21st March, 1954.	12.	23° 12' 45"
13. Annual rate of ayanāṁśa (precession) adopted.	13.	50".3.
14. Whether calculations are based on modern method or the old Siddhāntic method ? Give the name of the book, if any, on which the calculations are based.	14.	Modern method. Karanvallabha by Badhavallabha Jyotistirtha & Nautical Almanacs of different countries.

(2)

<i>Ques. No.</i>	<i>Reply</i>
1.	Kumbakonam Madathu Panchangam.
2.	1876 A.D.
3.	Tamil.
4.	The Pioneer Publication, Teppakulam, Trichinopoly, Madras State.
5.	P. N. Krishna Ayengar.
6.	Nirayana.
7.	Solar.
8.	Mesha Sankranti.
9.	Pravabadi year, Vijayanam Samvatsaram and Kollam andu 1128 begins on 13th April, 1953.
10.	Chitrai, Vaikasi, Ani, Adi, Avani, Purattasi, Arpisi, Karthigai, Margali, Thai, Masi, Panguni.
11.	365 ^d 6 ^h 9 ^m
12.	23° 12' 9".88
13.	50".2677
14.	Modern method. Ketaki's Grahaganitam, Jyotirganitam, Grahakoshtha Ganitam, Ganita Nirnayam & Nautical Almanac.

(3)

<i>Questionnaire</i>	<i>Ques. No.</i>	<i>Reply</i>
1. Name of the Pañcāṅga.	1.	Paturi Vari Panchangam.
2. The year from which it is being published.	2.	1946 A.D.
3. Language in which it is published.	3.	Telegu.
4. Office address.	4.	147 Mint Street, Madras-1.
5. Name of the chief compiler.	5.	Paturi Subbaraya Sastry & Paturi Sri Rama Murthy.
6. Sāyana or Nirayana ?	6.	Nirayana.
7. Solar or luni-solar ? If luni-solar whether Pūrṇimānta or Amānta ?	7.	Luni-Solar.
8. Beginning of the year.	8.	Chaitra Suddha Pradhama.
9. Principal Era used, give the era of the current year with the English date of its beginning.	9.	Salivahana Saka (elapsed) begins on Chaitra Suddha Pradhama.
10. Give the names of the months from the beginning of the year.	10.	Chaitra, Vaishaka, Jyestha, Asadha, Sravana, Bhadrapada, Aswayuja, Kartika, Margasira, Pushya, Magha, Phalgun.
11. Length of the solar year adopted.	11.	365 ^d 15 ^s 31 ^{ss}
12. Amount of Ayanāṁśa on 21st March, 1954.	12.	23° 12' 4"
13. Annual rate of ayanāṁśa (precession) adopted.	13.	50".25
14. Whether calculations are based on modern method or the old Siddhāntic method ? Give the name of the book, if any, on which the calculations are based.	14.	Old Siddhāntic Method. Ganakananda.

(4)

<i>Ques. No.</i>	<i>Reply</i>
1.	Chitrasala Panchang.
2.	1924-25 A. D. (Saka 1846).
3.	Marathi.
4.	Chitrasala Press, 10/26 Sadasiv Peth, Poona-2.
5.	Dhundiraj Laxman Date of Sholapur and Gopal Balwant Joshi of Poona.
6.	Nirayana, Sun & Moon's entry into signs, nakshatras, yogas are also given on sayana basis.
7.	Luni-Solar, Amanta.
8.	1st tithi of Chaitra.
9.	Salivahana Saka 1875 begins on 16th March, 1953.
10.	Chaitra to Phalgun.
11.	365 ^d 6 ^h 9 ^m 11 ^s (365 ^d 15 ^s 22 ^{ss} 57 ^{tp}).
12.	23° 12' 7"
13.	50".2
14.	Modern method. Ketkar's Jyotirganitam, Grahaganita.

(5)		(6)		(7)	
<i>Ques. No.</i>	<i>Reply</i>	<i>Ques. No.</i>	<i>Reply</i>	<i>Ques. No.</i>	<i>Reply</i>
1.	Gupta Press Panjika.	1.	Gharcha Jyotishi.	1.	Ruikar Varsha Bhavishya.
2.	1277 B. S. (Sakabda 1792).	2.	1920 A.D.	2.	1933 A.D.
3.	Bengali.	3.	Marathi.	3.	Marathi.
4.	37/7 Beniatola Lane, Calcutta-9.	4.	471 Somwar Peth, P. O. Karad, Bombay State.	4.	471, Somwar Peth, P.O. Karad, Bombay State.
5.	Pt. Ramrup Vidyabagis.	5.	Uddhav Vishnu Ruikar.	5.	Uddhav Vishnu Ruikar.
6.	Nirayana.	6.	Nirayana.	6.	Nirayana.
7.	Solar (with all informations re- garding luni-solar, both purni- manta and amanta of the year).	7.	Luni-Solar, Amanta.	7.	Luni-Solar, Amanta.
8.	1st Vaisakha.	8.	Chaitra Sukla 1.	8.	Chaitra Sukla 1.
9.	Bangabda 1360 begins on 14th April, 1953.	9.	Salivahana Saka, 1875 begins on 16th March, 1953.	9.	Salivahana Saka 1875 begins on 16th March, 1953.
10.	Vaisakha to Chaitra.	10.	Chaitra to Phalgun.	10.	Chaitra to Phalgun.
11.	365 ^d .258756481 mean solar days.	11.	365 ^d 15 ^s 23 ^{vg}	11.	365 ^d 15 ^s 23 ^{vg} .
12.	21° 49' 26."55	12.	23° 12' 8"	12.	23° 12' 8"
13.	54"	13.	50"	13.	50"
14.	Siddhantic method. (Surya Siddhanta)	14.	Modern method. Ketaki Jyotirganita.	14.	Modern method. Ketaki Jyotirganita.

(8)		(9)		(10)	
<i>Ques. No.</i>	<i>Reply</i>	<i>Ques. No.</i>	<i>Reply</i>	<i>Ques. No.</i>	<i>Reply</i>
1.	Latkar Panchang.	1.	Kolhapuri Panchang.	1.	Sandesh Pratyaksha Panchang.
2.	1910 A.D. (Saka 1832).	2.	1910 A.D. (Saka 1832).	2.	1944 A.D.
3.	Marathi & Sanskrit mixed.	3.	Marathi & Sanskrit mixed.	3.	Gujrati.
4.	152B, Mahadwar Road, Kolhapur.	4.	Hire Math, Sukrawar Peth, Kolhapur.	4.	22. Saraswati Society, Sarkhej Road. Ahmedabad 7.
5.	Vasudeo Sankar Latkar.	5.	Pt. Channabasava Sastry Gurupad Swamy.	5.	Harihar P. Bhatt. B. A.
6.	Nirayana.	6.	Nirayana.	6.	Nirayana.
7.	Luni-Solar, Amanta.	7.	Luni-Solar, Amanta.	7.	Luni-solar, Amanta.
8.	1st day of Chaitra.	8.	1st day of Chaitra.	8.	October-November.
9.	Salivahana Saka 1875 begins on 16th March, 1953.	9.	Salivahana Saka 1875, begins on 16th March, 1953.	9.	Vikrama Samvat (Kartiki) 2010 begins on 7th Nov., 1953.
10.	Chaitra to Phalgun.	10.	Chaitra to Phalgun.	10.	Kartika to Asvina.
11.	365 ^d 6 ^h 9 ^m	11.	365 ^d 6 ^h 9 ^m	11.	365 ^d 6 ^h 9 ^m
12.	23° 12' 6"	12.	23° 12' 6"	12.	23° 12' 8"
13.	50". 22	13.	50". 22	13.	50". 2
14.	Modern method. Jyotirganita, Grahaganita, Karanakalpalata.	14.	Modern method. Jyotirganita, Karanakalpalata.	14.	Modern method.

(11)		(12)		(13)	
<i>Ques. No.</i>	<i>Reply</i>	<i>Ques. No.</i>	<i>Reply</i>	<i>Ques. No.</i>	<i>Reply</i>
1.	H. Kartigeya Iyer Drigganita Panchangam.	1.	Purna Sastriya Andhra Patrika Panchangam.	1.	Krishnamurthi Sastry Panchangam (Family panchangam)
2.	1887 A.D.	2.	1945 A.D.	2.	From about 350 years.
3.	Tamil.	3.	Sanskrit & Telegu.	3.	Sanskrit & Telegu
4.	Thillaiwasam, Madduvil, P.O. Chavakachcheri (Ceylon) S. India.	4.	P.O. Podagatlapally, Dt. East Godavari.	4.	P.O. Podagatlapally, Dt. E. Godavari.
5.	S. Subramania Ayer.	5.	Pidaparathi Krishnamurthi Sastry.	5.	Pidaparathi Krishnamurthi Sastry.
6.	Nirayana.	6.	Nirayana.	6.	Nirayana.
7.	Luni-Solar, Amanta.	7.	Luni-Solar, Amanta.	7.	Luni-Solar, Amanta.
8.	Sun entering 1st point of Asvini.	8.	Chaitra Sukla 1.	8.	Chaitra Sukla 1.
9.	Saka 1877 begins on 14th April, 1954 (Kali 5056).	9.	Salivahana Saka 1875 begins on 16th March, 1953.	9.	Salivahana Saka, 1875 begins on 16th March, 1953.
10.	Chitrai, Vaikasi, Ani, Adi, Avani Purottosi, Ipasi, Kartigai, Margali, Thai, Masi, Panguni.	10.	Chaitra to Phalguna.	10.	Chaitra to Phalguna.
11.	$365^d 15^s 23^{vs}$	11.	$365^d 15^s 23^{vs}$	11.	$365^d 15^s 23^{vs}$
12.	$23^\circ 12' 9''.87$	12.	$23^\circ 12' 7''$	12.	$23^\circ 12' 7''$
13.	$50''.26$	13.	$50''.268$	13.	$50''.268$
14.	Modern method. Chathray's Tables & Chandrasarani.	14.	Modern method. Grahasadhanakoshtaka by Kerolaxmana Chatraji, Ketkar's Jyotirganita.	14.	Modern method. Grahasadhanakoshtaka by Kerolaxmana Chatraji, Ketkar's Jyotirganita.

(14)		(15)		(16)	
<i>Ques. No.</i>	<i>Reply</i>	<i>Ques. No.</i>	<i>Reply</i>	<i>Ques. No.</i>	<i>Reply</i>
1.	Purnasashtriya Panchangam.	1.	Directory Susiddhanta Panjika.	1.	Bhungalia Panchang.
2.	From about 350 years.	2.	1356 B. S. (1949 A.D.)	2.	Since 100 years.
3.	Sanskrit & Telegu.	3.	Bengali.	3.	Gujrati.
4.	P.O. Podagatlapally, E. Godavari.	4.	62A, Jaymitra Street, Calcutta-5.	4.	Kameswar Pustakalaya, Amareli, Kathiawad.
5.	Pidaparathi Subramanya Sastry.	5.	Pt. Dwijapada Goswami Jyotisastry.	5.	Pt. N. G. Deshingkar.
6.	Nirayana.	6.	Nirayana.	6.	Nirayana.
7.	Luni-Solar, Amanta.	7.	Solar.	7.	Luni-Solar, Amanta.
8.	Chaitra Sukla 1.	8.	Mesha Sankranti.	8.	Chaitra S 1, 4th April, 1954,
9.	Salivahana Saka, 1875 begins on 16th March, 1953.	9.	Bengali San 1360 begins on 14th April, 1953.	9.	—
10.	Chaitra to Phalguna.	10.	Vaisakha to Chaitra	10.	Chaitra to Phalguna
11.	$365^d 15^s 23^{vs}$	11.	$365^d .256363$	11.	—
12.	$23^\circ 12' 7''$	12.	$23^\circ 13' 25''$	12.	$23^\circ 10' 0''$
13.	$50''.268$	13.	$50''.27$	13.	$58''.5$
14.	Modern method. Ketkar's Jyotirganita.	14.	Modern method. By the help of special tables.	14.	Old Grahalagaviya Siddhantic method.

(17)		(18)		(19)	
<i>Ques. No.</i>	<i>Reply</i>	<i>Ques. No.</i>	<i>Reply</i>	<i>Ques. No.</i>	<i>Reply</i>
1.	Jogakshemam Panchangam.	1.	Janmabhoomi Khagola Siddha Nirayana Kartiki Panchanga.	1.	Nagpur Tilak Panchang.
2.	1908-09 A.D. (Malayalam year 1085).	2.	(2002 Samvat) 1945 A.D.	2.	1925 A. D. (1848 Saka)
3.	Malayalam.	3.	Gujrati.	3.	Marathi.
4.	Panchangam Press, Kunnankulam, T. C. State.	4.	Janmabhoomi Bhavan, Ghoga Street, Fort-Bombay,	4.	Panchang gulli, Mahal, Nagpur-2
5.	Kanipayyoor Sankaran Nambudiripada.	5.	Devshi Virji Khona.	5.	Gangadhar Ramkrishna Deo of Nagpur & Dattatraya Krishna Rao Sule of Bombay.
6.	Nirayana.	6.	Nirayana.	6.	Nirayana.
7.	Solar.	7.	Luni-Solar, Amanta.	7.	Luni-Solar, Amanta.
8.	First day of Simha falling on middle of August.	8.	Kartika Sukla Pratipada.	8.	Chaitra.
9.	Malayalam Era or Kollam Era 1129 begins on 17th August 1953.	9.	Current Vikram Era 2010 begins on 7th November 1953.	9.	Saka era 1875 begins from 16th March, 1953.
10.	Simha, Kanya, Tula, Vriscika, Dhanus, Makara, Kumbha, Meena, Mesa, Vrisabha, Mithuna, Karkitaka.	10.	Kartika to Asvina.	10.	Chaitra to Phalgun.
11.	$365^d 6^h 12^m 5$ ($365^d 15^s 31^{vs}.25$)	11.	$365^d 256360$.	11.	$365^d 2564$
12.	$22^\circ 23' 27''$	12.	$23^\circ 12' 7''$	12.	$19^\circ 13' 51''$
13.	48"	13.	$50''.25$	13.	$50''.27$
14.	Old Brahma Siddhanta method. Kriyakramam & Panchabodham.	14.	Modern method. Tables of the Sun & the Moon by Dr. Gorakh Prasad, Ketkar's Jyotirganitam, Tables of Mercury by H. P. Bhatt, Karanakalpalata by Dr. K. L. Daftari, Raj Jyotish Ganitam by C. G. Rajan and Nautical Almanacs.	14.	Modern method. Karanakalpalata by Dr. K. L. Daftari.
(20)		(21)		(22)	
<i>Ques. No.</i>	<i>Reply</i>	<i>Ques. No.</i>	<i>Reply</i>	<i>Ques. No.</i>	<i>Reply</i>
1.	Prachin Grahalagaviya Paddhati Panchang.	1.	Jagajjyoti Panjika.	1.	Visapurkar Panchang.
2.	1852 Saka.	2.	1952 A. D. (1359 B. S.)	2.	1922 A. D.
3.	Marathi.	3.	Bengali.	3.	Marathi.
4.	Ganapati Sangsthan Press, Sangli, Poona.	4.	55A, Raja Dinendra Street, Calcutta-6.	4.	Old Sangli, P. O. Sangli, Dt. Satara South.
5.	Raghunath Sikdev Gulbani.	5.	N. C. Lahiri M.A.	5.	Bidesh Ganesh Joshi Visapurkar.
6.	Nirayana.	6.	Nirayana	6.	Nirayana.
7.	Luni-Solar, Amanta.	7.	Solar.	7.	Luni-solar, Amanta.
8.	Chaitra Sukla Pratipada.	8.	Meṣa Saṁkrānti	8.	Chaitra Sukla 1.
9.	Saka era begins on 16th March, 1953.	9.	Bengali San, 1360 B.S. begins on 14th April, 1953.	9.	Salivahana Saka 1875 begins on 16th March, 1953.
10.	Chaitra-Phalgun.	10.	Vaiśākha to Caitra.	10.	Chaitra-Phalgun.
11.	$365^d 15^s 31^{vs}.52$	11.	$365^d 25636$	11.	$365^d 6^h 9^m$
12.	$23^\circ 8' 3''$	12.	$23^\circ 13' 25''$	12.	$23^\circ 12' 6''$
13.	$58''.2$	13.	$50''.27$	13.	$50''.22$
14.	Old & modern method mixed. Surya Siddhanta, Grahalaghava, and works of R. N. Apte.	14.	Modern method. Tables of the Sun by N. C. Lahiri, Karanavallabha by Radhavallabha Jyotistirtha & Nautical Almanacs.	14.	Modern method. Jyotirganita & Karanakalpalata

(23)		(24)		(25)	
<i>Ques. No.</i>	<i>Reply</i>	<i>Ques. No.</i>	<i>Reply</i>	<i>Ques. No.</i>	<i>Reply.</i>
1.	Datey's Panchang (Big size & small size).	1.	Nirnaysagar Panchang.	1.	Grahalaghaviya Panchang.
2.	Shalivahana Saka 1833.	2.	Shalivahana Saka 1786.	2.	1917 A.D.
3.	Marathi.	3.	Marathi.	3.	Marathi.
4.	537, South Kasaba, Sholapur.	4.	Nirnaysagar Press, 26/23, Kolbhat Street, Kolbadevi Road, Bombay-2.	4.	Jyotirvijaya office, P.O. Deshing, Kolhapur (S. Satara).
5.	Laxman Gopal Date.	5.	Laxman Gopal Date of Sholapur.	5.	Pt. N. G. Deshingkar, Editor. Jyotirvijaya.
6.	Nirayana.	6.	Nirayana.	6.	Nirayana.
7.	Luni-Solar, Amanta.	7.	Luni-Solar, Amanta.	7.	Luni-Solar, Amanta.
8.	Chaitra Sukla 1.	8.	Chaitra Sukla 1.	8.	Chaitra Shudha 1.
9.	Current Salivahana Saka 1875 begins on 16th March, 1953.	9.	Current Shalivahana Saka era 1875 begins on 16th March, 1953.	9.	Sakarambha, April.
10.	Chaitra to Phalguna.	10.	Chaitra to Phalguna.	10.	Chaitra to Phalguna.
11.	365 ^d 25636	11.	365.25636 days	11.	365 ^d 15 ^s 3 ^{vs} 5
12.	23° 12' 7"	12.	23° 12' 7"	12.	23° 10' 1" *
13.	50".25	13.	50".25	13.	58".5
14.	Modern method. Tables of the Sun & the Moon by Dr. Gorakh Prasad, Jyotirganita by Ketkar, Karanakalpalata by Dr. K. L. Daftari, Tables of Mercury by Prof. Harihar Bhatt, Raja Jyotish Ganitam by C. G. Rajan and Nautical Almanac.	14.	Modern method. Tables of the Sun & the Moon by Dr. Gorakh Prasad, Jyotirganitam by V. B. Ketkar, Karanakalpalata by Dr. K. L. Daftari, Tables of Mercury By Prof. Harihar Bhatt, Raja Jyotish Ganitam by C. G. Rajan & help of Nautical Almanacs.	14.	Ancient Sidhantaka Grahalaghava System. * Zero ayanamasa year 450 from the starting point Nischar Revati yoga tara.
(26)		(27)		(28)	
<i>Ques. No.</i>	<i>Reply</i>	<i>Ques. No.</i>	<i>Reply</i>	<i>Ques. No.</i>	<i>Reply</i>
1.	Udiyavar Panchanga.	1.	Kutchi Ashadhi Panchang.	1.	Brihan Maharashtratriya Panchang.
2.	1887 A.D.	2.	Samvat 1960 (1903 A.D.)	2.	Shalivahan Saka 1871 (1949-50 A.D.)
3.	Kanada and Hindi since 1946.	3.	Gujrathi.	3.	Marathi.
4.	Dharmaprakash Press, Mangalore-1.	4.	Shree Ramkrishna Jyotish Karyalaya, Kailash Bhavan, Penchhatdi, Bhuj, Kutch.	4.	364, Somwar Peth, Poona-2.
5.	Udiyavar Vittalacharya.	5.	Raj-Jyotishi Pandit Gulab Shankar Lalji Sharma.	5.	Ganak Choodamani Pandit Krishna Chandra Shastri Sharma.
6.	Nirayana.	6.	Nirayana.	6.	Nirayana.
7.	Luni-Solar, Purnimanta.	7.	Luni-Solar, Amanta.	7.	Luni-Solar, Amanta.
8.	Chaitra Sukla 1.	8.	June or July.	8.	First day (Tithi) of the month of Chaitra.
9.	Shalivahana Saka 1876 begins on 4th April, 1954.	9.	Vikram Samvat 2010 begins on 12th July, 1953.	9.	Shalivahana Saka 1875 begins on 16th March, 1953.
10.	Chaitra to Phalguna.	10.	Ashadha to Jyestha.	10.	Chaitra to Phalguna.
11.	365 ^d 15 ^s 31 ^p 15 ^{vp}	11.	365 ^d 15 ^s 22 ^p 54 ^{vp} (365 ^d 6 ^h 9 ^m 9 ^s .55)	11.	365 ^d 15 ^s 22 ^p 57 ^{vp} (365 ^d 6 ^h 9 ^m 11 ^s)
12.	23° 12' 14".3994	12.	23° 12' 8"	12.	23° 12' 7"
13.	50".2671	13.	50".2	13.	50".26
14.	Arya Siddhanta, and modern method for planets with hand written tables.	14.	Modern method.	14.	Modern method. Jyotirganitam & Grahaganitha by V. B. Ketkar.

(29)

Ques. No.	Reply
1.	Sri Bapudev Shastri Panchang.
2.	Vikram Samvat 1933.
3.	Sanskrit & Hindi.
4.	Govt. Sanskrit College, Banaras.
5.	Ganapatidev Shastri.
6.	Nirayana.
7.	Luni-Solar, Purnimanta.
8.	Chaitra Sukla pratipad.
9.	Vikram Samvat 2010 begins on 16th March, 1953.
10.	Chaitra to Phalgun.
11.	$365^d 15^s 22^p 54^{vp}$ ($365^d 6^h 9^m 9^s.55$)
12.	$23^\circ 12' 8''$
13.	$50.^{\circ}2$
14.	Modern method.

(30)

Ques. No.	Reply
1.	Jyothir Deepika.
2.	1947 A. D.
3.	Malayalam.
4.	K. Rama Variar, Astrologer P.O. Thakazhi, T. C. State.
5.	K. Rama Variar.
6.	Nirayana.
7.	Solar.
8.	August.
9.	Kollam Era, 1129 begins on 17th August, 1953.
10.	Simha, Kania, Thula, Vrishchika, Danus, Makara, Kumbha, Meena, Mesha, Vrishabha, Mithuna Kataka.
11.	$365^d 6^h 9^m 9^s.55$
12.	$23^\circ 12' 8''$
13.	$50.^{\circ}2$
14.	Modern Method.

(31)

Ques No.	Reply
1.	Nava Bharatha Panchangam.
2.	1951 A. D.
3.	Malayalam.
4.	Ramchandra Astro-Research Institute, P. O. Ambalapuzha, T. C. State.
5.	K. P. Vasudevan Pillai.
6.	Nirayana.
7.	Solar.
8.	1st January.
9.	Kollam Era 1129 begins on August 17, 1953 (Principal era A.D.)
10.	January, February and so on.
11.	$365^d.25636042+0.00000011T$ (T=no. of centuries elapsed from 1900 A. D.)
12.	$23^\circ 12' 8''.6$ (mean)
13.	$50.^{\circ}25747+0^{\circ}000222 T$
14.	Modern method. Astronomical papers of the American Ephemeris.

(32)

Ques. No.	Reply
1.	Uthara Malayala Panchangam.
2.	1114 Malayalam Era.
3.	Malayalam.
4.	"Jyotissadan", P.O. Payyannur, N. Malabar.
5.	V. P. Kunhi Kanna Poduval.
6.	Nirayana.
7.	Souramanam.
8.	September, 1953.
9.	Malayalam Era 1129 begins on 17th September, 1953.
10.	Kanni, Thulam, Vrishchikam, Dhanu, Makaram, Kumbham, Meenam, Medam, Edavam, Midhunam, Karkitaka, Chingam.
11.	$365^d 25636$ ($365^d 15^s 22^p 54^{vp}$)
12.	$23^\circ 12' 9''$
13.	$50.^{\circ}25$
14.	Modern Method. Ketaki Grahaganitham.

(33)

Ques. No.	Reply
1.	Bhagyavati Panchanga.
2.	1930 A.D.
3.	Manipuri.
4.	Bhagyavati Karyalaya, Chudachand Printing Works, Imphal, Manipur.
5.	Devkishore Sharma.
6.	Nirayana.
7.	Luni-Solar, Amanta.
8.	1st tithi of Sajibhu (Chaitra).
9.	Manipurabda or Chandrabda 1165 begins on 16th March, 1953.
10.	Sajibhu, Kalen, Inga, Ingel, Thawan, Langban, Mera, Hiyangei, Poinou, Wakching, Phairen, Lamda.
11.	365.258757 days upto the current year, but from 4th April 1954, it will be 365.25636 days.
12.	$23^\circ 12' 44''$
13.	$50.^{\circ}3$
14.	Modern method. Works of Bapuji Venkatesh Ketkar.

(34)

Ques. No.	Reply
1.	Prabhakar Panchangam.
2.	Shalivahan Saka 1863.
3.	Kanada & Sanskrit.
4.	Prabhakar Panchang Karyalaya, Mudgal, Dt. Raichur (Hyderabad).
5.	Ramchandra Prabhakar Bhatt Joshi
6.	Nirayana.
7.	Luni-Solar, Amanta.
8.	About March.
9.	Shalivahan Saka 1875 begins on 16th March, 1953
10.	Chaitra to Phalgun.
11.	$365^d 15^s 22^p 54^{vp}$
12.	$23^\circ 12' 8''$
13.	$50.^{\circ}2$
14.	Modern Method. Ketkar's Sanskrit Jyotirganitam.

(35)		(36)		(37)	
<i>Ques. No.</i>	<i>Reply</i>	<i>Ques. No.</i>	<i>Reply</i>	<i>Ques. No.</i>	<i>Reply</i>
1.	Chintadalan Jantri.	1.	Khandesh Panchang.	1.	Jyolsyabharanam and Vidya-bhivardhini Kanakajobili Prasasti.
2.	1946 A.D.	2.	Shaka 1866, 1944 A. D.	2.	1085 M. E. (1910 A.D.)
3.	Hindi.	3.	Marathi.	3.	Malayalam.
4.	Jyotish Karyalaya, Khurja, Dt. Buland Sahar.	4.	P. K. Joshi, Rampeth, H.N. 15, Jalgaon, E.K.	4.	Shri P. S. Purushothaman Numboodiri, P. O. Puliyoor, (Via) Chengannur, T. C. State.
5.	Vishuddhananda Gaur Jyotish Pandit.	5.	Pralhad Keshav Joshi.	5.	P. S. Purushothaman Numboodiri.
6.	Sayana (?)	6.	Nirayana.	6.	Nirayana.
7.	Solar, Purnimanta.	7.	Luni-Solar, Amanta.	7.	Solar.
8.	January.	8.	About March every year.	8.	Simha Sankraman in August.
9.	Vikram Samvat 2011 (Eng. 1954)	9.	Saka 1875 begins on 16th March, 1953.	9.	Malayalam era begins on 16th, 17th or 18th August.
10.	Jan. to Dec.	10.	Chaitra to Phalguna.	10.	Simha, Kanya, Thula, Vrischika, Dhanu, Makara, Kumbha, Meena, Mesha, Vrishabha, Mithuna and Karkataka.
11.	$365^d 42^s 3^p 22^{vp}$?	11.	$365^d 6^h 9^m 9^s.55$	11.	365 or 366 days.
12.	$23^\circ 52'$	12.	$23^\circ 12' 8''$	12.	$23^\circ 12' 15''$
13.	—	13.	$50.^{\circ}2$	13.	$50.^{\circ}25645 + 0.^{\circ}000229 Y + 0.00000000027Y^2$
14.	Jyotirganitam ?	14.	Modern method. Mathematical system of Ketkar.	14.	Modern method since 1932. Ganitha Nirnayam by P. S. Numboodiri.

(38)		(39)		(40)	
<i>Ques. No.</i>	<i>Reply</i>	<i>Ques. No.</i>	<i>Reply</i>	<i>Ques. No.</i>	<i>Reply</i>
1.	Vaijyanthi Panchanga.	1.	Siddhanta Panchangam.	1.	Sri Saptarshi Panchang.
2.	Pingala Samvatsaram Chaitra Shalivahan 1839 (23.3. 1917).	2.	Vyaya.	2.	1933 A.D.
3.	Kanada.	3.	Telegu.	3.	Hindi.
4.	Vaijyanthi Panchang Office, Nerlakatte, P.O. Puttur Taluk, S. Kanada (Madras).	4.	Adijyotisalalayam, Anantavaram, Tenali Taluk, Dt Guntur.	4.	Bazar Sitarm, Delhi-6.
5.	Y. Shankar Joisa.	5.	Kuppa Sivarama Byragi Sastri.	5.	Pt. Brajalal Sharma.
6.	Nirayana.	6.	Sayana (?)	6.	Sayana (?)
7.	Luni-Solar, Amanta.	7.	Luni-Solar, Amanta.	7.	Luni-Solar, Amanta.
8.	Chaitradi.	8.	Sukla Pratipad of Solar Meena.	8.	Chaitra S 1 and Vaisakha Sankranti.
9.	Shalivahan Saka 1876 begins on 4th April, 1954.	9.	April, 1954.	9.	Vikram Samvat 2011.
10.	Chaitra to Phalguna.	10.	Chaitra to Phalguna.	10.	Chaitra to Phalguna.
11.	$365^d 15^s 22.^{vs} 9479$	11.	$365^d 15^s 22.^{vs} 9$ or 365. 257 days.	11.	365 days
12.	$23^\circ 12' 6''$	12.	$23^\circ 12' 7''$	12.	$23^\circ 52'$
13.	$50.^{\circ}2$	13.	$50.^{\circ}2$	13.	1 pal in a year.
14.	Modern method. Jyotirganitham by Ketkar.	14.	Tithi, Nakshatra, Yoga, Karana based on Siddhantic method. Grabasanchara on Modern Method. Marhati Grabaganitham by L. Chatri. & Jyotirganitam by Ketkar.	14.	Old method. Makaranda Sarani.

(41)		(42)		(43)	
Ques. No.	Reply	Ques. No.	Reply	Ques. No.	Reply
1.	Sri Viswa Martanda Panchang.	1.	Joshi Girijasankar Harisankar's Suddha Panchang.	1.	Hosaritti Panchanga.
2.	1934 A.D.	2.	1912 A.D.	2.	1907 A. D.
3.	Hindi.	3.	Gujrati.	3.	Sanskrit, Marathi & Kanada.
4.	53/66, Ramjas Road, Karol Bagh, New Delhi-5.	4.	Sankadi Sheri Hajirani Pole, Ahmedabad.	4.	Jyotirmartanda Pdt. Shankar Shastri. Hosaritti, Kesar i Hind, Haveri, Dt. Dharwar, Bombay.
5.	Ramnath Agarwal.	5.	Girijasankar H. Joshi.	5.	Pt. Shankar Shastri.
6.	Nirayana.	6.	Nirayana.	6.	Nirayana.
7.	Luni-Solar.	7.	Luni Solar Amanta.	7.	Luni Solar, Purnimanta.
8.	Chaitra S 1.	8.	1st day of bright half of Kartika.	8.	First day of Chaitra.
9.	Vikrama Samvat 2011 on 4th April, 1954.	9.	Vikram Samvat begins on 7th Nov., 1953.	9.	Shalivahana Saka begins in March or April.
10.	Chaitra Sukla to Chaitra Krishna.	10.	Kartika to Asvina	10.	Chaitra to Phalguna.
11.	365 ^d 15 ^s 22 ^p 57 ^{vp}	11.	365 ^d 6 ^h 9 ^m 9. ^s 55	11.	365 ^d 15 ^s 30 ^p
12.	23°12' 8" 4"	12.	23° 12' 8"	12.	23° 51'
13.	50" 13." 95	13.	50."2	13.	One ghatika every year.
14.	Modern method. Ketaki and Grahlaghavi.	14.	Modern method.	14.	Surya Siddhanta method. (a) Surya Siddhanta, (b) Siddhanta Shiromoni by Bhaskaracharya, (c) Grahlaghava by Ganesh Daivajnya, (d) Tithi Ratnavalli by Rama Daivajnya,
(44)		(45)		(46)	
Ques. No.	Reply	Ques. No.	Reply	Ques. No.	Reply
1.	Gouri Sankara Panchang.	1.	Namogal Drigganitha Saura Muhurtha Panchangam.	1.	Bhagyodaya Panchang.
2.	1930 A.D.	2.	1921 A.D.	2.	1936-37 A.D.
3.	Sanskrit & Telegu.	3.	Tamil.	3.	Kanada.
4.	Gouri Sankara Jyotisalayam, Lakshmi Polavaram, via. Tanuku, Dt. East Godavari.	4.	Sm. C. Kanakammal of Messrs. C. Subramanian & Bros., 31 Ayalur Muthiah Mudali St. P. O. Sowcarpet, Madras-1.	4.	Madihal, Dharwar, Bombay State.
5.	Lingala Bangarayya Siddhanti.	5.	C. Govinda Raja Mudaliar alias C. G. Rajan.	5.	Veerangonda D. S. Patil, Menasigi.
6.	Nirayana.	6.	Nirayana.	6.	Nirayana.
7.	Luni Solar, Amanta.	7.	Luni-Solar, Amanta.	7.	—
8.	Chaitra Sukla pratipad.	8.	13th or 14th April every year.	8.	Chaitra Sukla 1.
9.	Shalivahana Saka 1875 begins on 16th March, 1953.	9.	Kaliyuga era & Salivahana era, Salivahana 1876 begins on 13th April, 1953.	9.	Salivahana Saka, 1876 begins on 4th April, 1954.
10.	Chaitra to Phalguna.	10.	Luni-solar months Chaitra to Phalguna. Solar Months : Chittirai, Vaikashi, Ani, Adi, Avani, Purathosi, Arpisi, Karthigai, Margazhi, Thai, Masi, Panguni.	10.	Chaitra-Phalguna.
11.	365 ^d 15 ^s 23 ^{vs} or 365. 256 days	11.	365. 25636:days or 365 ^d 15 ^s 23 ^{vs}	11.	—
12.	23° 12' 7"	12.	23° 4' 54"	12.	23° 12' 9"
13.	50."268	13.	50."2684	13.	—
14.	Modern method. (a) Grahasadhana Kostaka of Kero Lakshmana Chatraji, (b) Jyotirganita by Ketkar, (c) Marathi Grahaganitam by Ketkar.	14.	Modern method. Nautical Almanacs of different countries.	14.	Old Siddhantic method. Arghyaprakashika.

(47)		(48)		(49)	
<i>Ques. No.</i>	<i>Reply.</i>	<i>Ques. No.</i>	<i>Reply</i>	<i>Ques. No.</i>	<i>Reply</i>
1.	Bhagyodaya Panchang <i>alias</i> Chintaharan Jantri.	1.	Sri Sringagiri Sri Jagat Guru Srimath Panchangam.	1.	Kottur Guru Basaveswara Panchangam.
2.	1941 A. D.	2.	Published since the last 12 yrs.	2.	1947 A. D.
3.	Hindi	3.	Kanada.	3.	Kanada.
4.	Chintaharan Jantri Karyalay, P.O. Kaswanda, Dt. Sitapur.	4.	C/o. Sri Venkata Subba Shastri, P. O. Kollegal, Dt. Coimbatore.	4.	Kottur Guru Basaveswara Jyotishalaya, Kottur, Dt. Bellary. Mysore State.
5.	Pt. Bachanprasad Tripathi.	5.	Venkata Subba Shastri, Asthana Vidyan.	5.	M. V. S. Kotrapaiah Sastry.
6.	Nirayana.	6.	Nirayana.	6.	Sayana (?)
7.	Luni Solar, Purnimanta.	7.	Luni Solar, Amanta.	7.	Luni-Solar
8.	Chaitra Sukla Pratipada.	8.	Chaitra Sukla Pratipada.	8.	March to April.
9.	Vikrama Samvat 2011 begins on 4th April, 1954.	9.	Kaliyuga era 5055 begins on 4th April, 1954.	9.	Shalivahana Saka Jaya Samvatsara begins on 4th April, 1954.
10.	Chaitra to Phalguna.	10.	Chaitra to Phalguna.	10.	Chaitra-Phalguna.
11.	365 ^d 15 ^s 30 ^p 31.4 ^{vp}	11.	365 ^d 15 ^s 31 ^p 31.4 ^{vp} .	11.	—
12.	23° 8' 23".4	12.	23° 24'	12.	23° 12' 7"
13.	54"	13.	54".9	13.	—
14.	Old Siddhantic method. Surya-Siddhanta.	14.	Old Surya Siddhanta method.	14.	Old Siddhantic method. (a) Driksiddhanta, (b) Grahalaghava, (c) Khacharadarpana, (d) Panchanga Manjusa, (e) Surya Siddhanta.

(50)		(51)	
<i>Ques. No.</i>	<i>Reply</i>	<i>Ques. No.</i>	<i>Reply</i>
1.	Shri Visva Vijaya Panchangam.	1.	Nutan Purna Chandra Directory Panjika.
2.	Vikrama Samvat 2003 (1946 A.D.)	2.	1325 B.S. (1918 A.D.)
3.	Hindi & Sanskrit.	3.	Bengali.
4.	Shri Swadhaya Sadan, Solan, (Simla Hills).	4.	40 Garanhatta Street, Calcutta.
5.	Pt. Hardev Sharma Trivedi, Jyotisacharya	5.	Narendra Krishna Jyotiratna.
6.	Nirayana.	6.	Nirayana.
7.	Luni Solar, Purnimanta.	7.	Solar.
8.	March or April.	8.	Nirayana Mesha Sankranti.
9.	Vikram Samvat 2011 begins on 4th April, 1954.	9.	Bengali San 1360 starts on 14th April, 1953.
10.	Chaitra to Phalguna	10.	Vaisakha to Chaitra.
11.	365 ^d 6 ^h 9 ^m 9.55	11.	365 ^d 6 ^h 12 ^m 36 ^s .57 (365 ^d 15 ^s 31 ^p 31 ^{vp} .4)
12.	23° 12' 8"	12.	21° 49' 27"
13.	50."2	13.	54".
14.	Modern method. Jyotirganitha, Grahalaghava.	14.	Old Siddhantic method. Dinachandrika for panchang calculation and Siddhanta Rahasya for longitudes of Planets, by Raghavananda Chakravarty.

ANNEXURE VII

Summary of suggestions for Indian Calendar Reform received from different persons and institutions.

1. Shri Sampurnanand,
Home and Labour Minister,
Govt. of U. P., Lucknow.

Letter dated 7. 3. 1953.

(i) The adoption of solar year. (ii) Adoption of "Sāyana" system. (iii) The difference of 23 days in our year beginning to be corrected. (iv) Beginning of the year to be on March 22, the day following Vāsanta Sampāt (vernal equinox). (v) Beginning of Aries (Meṣa) to be at a point 180° from Spica to mark the beginning of Aśvinī. (vi) Beginning of day from midnight. (vii) Beginning of lunar year from "Caitra." (viii) Uniform system of reckoning lunar months (preferably the pūrṇimānta one) to be adopted. (ix) A single era for India such as Śaka, Kali or (preferably) Vikrama to be adopted. (x) Calculations of pañcāṅgas should be drksiddha. (xi) Number of days per month may be fixed, and the leap-year rules should be the same as in the Gregorian calendar.

2. Brahma Shri G. V. Subba Rao, President,
Goshī, "Satyaprasad", Waltair.

Letter dated 14. 4. 53.

(i) Adoption of "Kali Śaka" era. (ii) Ujjain to be the standard meridian of India and a National Observatory at Ujjain. (iii) Approves other recommendations of the Committee.

3. Shri M. V. Kibe, Saraswati Niketan, Indore.

Letters dated 24. 2. 53 and 31. 5. 53.

(i) Tropical year not to be used for religious purposes. (ii) In favour of Vikrama Saṁvat. (iii) Ujjain or Banaras as standard Greenwich of India. (iv) One astronomical observatory with modern equipments at Ujjain. (v) The number of days of different months of a sidereal year to be fixed as follows :—Commencing from Vaiśākha—31, 31, 32, 31, 31, 30, 30, 30, 29, 30, 30, 30, or 31. (vi) Starting point of sidereal zodiac should be determined.

4. Shri Vallabhacharya Dixitji Maharaj, President
of the Conference of Calendar Experts, Bombay.

Letter dated 13. 6. 53, communicating the resolutions passed at a conference of Hindu calendar experts at Poona on 16th & 17th May, 1953, as follows :—

(i) This Conference congratulates the Govt. of India on its efforts to prepare a National Calendar according to Indian system for the purpose of reckoning time.

(ii) This Conference is of opinion that *Luni-Solar Nirayana Calendar* giving correct positions of heavenly bodies should be prepared taking the starting point at the beginning of Aśvinī and the ayanāṁśa should be the distance of the Vernal equinox from that fixed point.

5. Shri Radhagovinda Chandra, Sarkar Bazar,
P.O. Sukchar, 24 Parganas.

Letter dated 3. 4. 53.

(i) Advocates "Nirayana" system of calculation. (ii) Initial point to be 180° from the star Spica. (iii) Correct calculations to be adopted in the calendar. (iv) 21st March should be called as "Mahāviṣuva Dina" and not Mahāviṣuva Saṁkrānti.

6. Shri Radhāvallabh Smriti Vyakarana Jyotistirtha,
64, Kalinath Munshi Lane, Calcutta-36.

Letter dated 6. 4. 53.

(i) Advocates 'Nirayana' system of calculations. (ii) Starting point to be 180° apart from the star Spica.

Letter dated 2. 4. 54.

(i) Sāyana varṣa (tropical year) should not be adopted for our religious purposes. (ii) Sāyana system may be adopted for finding the lagna, sunrise, sunset etc. and nirayana calculations for determining the nakṣatras. (iii) Beginning of Aśvinī nakṣatra should be from a point 180° away from the star Citrā (Spica). (iv) Constant ayanāṁśa which is opposed to science, should not be adopted; if so, nakṣatras would lose their significance. (v) $23^\circ 15'$ ayanāṁśa should be taken at the end of 1956. (vi) The names of the months Vaiśākha, Jyaiṣṭha etc. should not be used in the tropical year, as these are associated with the nirayana year. Special names may be used.

Letter dated *nil*.

(vii) The number of days in the months should be standardised. (viii) There is no necessity of observing lunar festivals like Akṣaya tṛtīyā always in the fixed season, if it moves to other season it should be observed in the new season.

7. H. E. Shri Sriprakash, Governor of Madras,
Madras.

Letter dated 18. 5. 53.

(i) Beginning of the year with the month of Vaiśākha, on the morrow of the Sun's transit into Meṣa. (ii) Beginning of the month to be reckoned from Sun's passage from one sign to another. (iii) Christian era as well as Śalivāhana or Kaliyuga era to be adopted. (iv) Solar calendar of Jñāna Mandal of Banaras may be consulted in this connection.

8. Shri M. S. Bhatnagar, Head of the Dept. of
Geography, M.M.H. (Degree) College, Ghaziabad.

Letter dated 26. 2. 53.

(i) Proposed central Indian station for astronomical observatory should be at Sonhat in M. Pradesh in Korea Subdivision, Lat. $23^\circ 29'N$, Long. $82^\circ 30'E$, about 3000 ft. above sea-level.

9. Shri V. Thiruvengkatacharya, M.A.L.T., Madras Educational Service (Retd.), 13 Musa Sait Street, T-Nagar, Madras-17.

Letter dated 2. 3. 53.

(i) Starting of the luni-solar year to be at the moment when the sun enters the equinoctial point, viz., the sāyana first point of Aries. (ii) The problem of 23 days' error in the calendar to be solved by suppressing it in an adhimāsa. (iii) Against adoption of western calendar.

Letter dated 17. 2. 54, etc.

(i) The principal era should be either Kaliyuga (epoch 3102 B.C.) or Yudhiṣṭhira or Saptarṣi Śaka 3077 B.C. in place of Śalivāhana Śaka. (ii) Sāyana system should be observed for all religious purposes instead of nirayana system. The year should begin on or about 21st March when the Sun enters sāyana first point of Aries and not Āsvini. (iii) Definite lead should be given by the state on the observances of festivals like Ekādaśī, Śrī Jayantī, Gokulāṣṭamī, Śrī Rāmanavamī, etc.

10. Shri Ganga Prasad, M.A., M.R.A.S., Retired Judicial Minister, Tehri Garhwal State, Ex-President, International Aryan League, Delhi, Prithviraj Road, Jaipur.

Letters dated 25. 3. 53, and 21. 10. 53.

(i) National Solar Calendar on "sāyana" system of time reckoning to be adopted. (ii) 23 days to be omitted from the month of "Chait" in any year, the eighth day of Chait being followed by the first day of Vaiśākha. (iii) Supports the adoption of Vikrama Saṁvat as the era of the Indian National Calendar. (iv) Favours the names of months as Caitra, Vaiśākha, etc., and not Meṣa, Vṛṣa, etc.

11. Shri Harihar P. Bhatt, B.A., President, Editorial Board, The Sandesh Pratyaksha Panchang, 22, Saraswati Society, Sarkhej Road. Ahmedabad.

Letter dated 1. 5. 53.

(i) The initial point of the fixed zodiac to be decided, (ii) Favours acceptance of the modern elements of planetary motion in pañcāṅga calculations.

Letter dated 26. 2. 54.

(i) Suggests collection of opinion from the compilers of dr̥ggaṇita almanacs by votes on the following two items:— (a) whether the year should be tropical or sidereal, (b) ayanāṁśa on a given date; and the opinion of the majority members is to be accepted. (ii) Calculations of Nakṣatras and the daily Yogas (Viṣkumbha etc.) are to be postponed till the final decision on the adoption of the amount of ayanāṁśa. (iii) Nearly 60 almanacs in India are following Citrā-pakṣa whose ayanāṁśa is nearly 23° 12' on 21. 3. 54 and as such adoption of Citrā pakṣa in fixing the initial point of the nirayana zodiac is suggested.

12. Shri Ambhujprasad P. Shulet, Mersakasan's Chawk, Ghodhandur Road, Jogeswari, Bombay.

Letter dated 1. 3. 53.

(i) Favours adoption of Vikrama Saṁvat. (ii) Starting month as Kārtika Śuklapakṣa. (iii) Śuklapakṣa first, kṛṣṇapakṣa second in each month.

13. Shri Srinivas Rao R. Mangalvedhe, Journalist, Bagalkot, Bombay.

Letter dated 30. 3. 53.

(i) Solar year to be adopted. (ii) Beginning of the year to be the same throughout India. (iii) Kaliyuga era to be adopted for the whole of India as well as the world.

14. Shri Narendra Nath Bagal, Jyotisastrī, C/o. Prof. Manoranjan Dasgupta, 38 Karbala Tank Lane, Calcutta.

Letter dated 27. 4. 53.

(i) Correct method of calculations with nirayana system of reckoning to be taken in making pañcāṅgas. (ii) Starting point to be 180° apart from the star Spica. (iii) Central meridian of India to be situated at Ujjain. (iv) Dispute of ayanāṁśa to be settled. (v) Tropical year to be adopted and the beginning of the year to be 22nd March.

15. Shri Poluri Venkata Subbaiah Shastri, Siddhanti, Senior Telegu Pandit, Hindu College High School, Guntur.

Letter dated 20. 3. 53.

(i) Disapproves the adoption of one single pañcāṅga for the whole of India for the following reasons:—(a) the moment of sunrise differs from one place to another, hence aharpramāṇa also differs, resulting in the corresponding change in the date of śrāddha, (b) the following five mānas are in vogue:—1. Saura, 2. Sāvana, 3. Cāndra, 4. Bārhaspatya & 5. Nakṣatram, (c) no one can rely on one māna alone, such as saura or cāndra for all purposes, (d) the name of the year in the cycle of 60 years such as Prabhava, Vibhava and so forth also varies from place to place.

Letter dated 25. 5. 53.

(i) Tithi and nakṣatra to be calculated according to Sūrya Siddhānta and not according to modern correct method. (ii) Dṛksiddha calculations to be taken only for eclipse purposes. (iii) Single calendar for the whole of India may be adopted for dating purposes and not for religious purposes, and this calendar is also unnecessary if we take the present English calendar for dating purposes.

16. Shri R. M. Deshmukh, M.P., 171, Constitution House, New Delhi.

Letter dated 23. 2. 53.

(i) A uniform standard calendar for whole of India is not feasible so far as the festivals, social and religious ceremonies of different parts of India are concerned.

(ii) In Maharashtra, Tilak's Pañcāṅg which is correct and up-to-date is not accepted by the majority of people because of certain festivals, e.g. Dipālī, Holi etc., differing by one month from the other local pañcāṅgas and as such one uniform calendar for whole of India may not be accepted by the people. (iii) For conveniences' sake India should move for the adoption of "World Calendar" in U. N. O. for India and the world instead of the present Gregorian calendar. (iv) If one uniform calendar is made for all purposes, the Pandits from different localities would move in their own way by propagating their views against a solution for uniformity.

17. Shri K. Venkataraman, Visharad, 66 Nagappier Street, Triplicane, Madras-5.

Letter dated 23. 2. 53.

Bhāratīya new year to be calculated from "Uttarāyana."

18. Jyotissiddhanta Kesari K. Venkata Subba Sastri, Sringeri, Kollegal, Coimbatore, Madras.

Letters dated 13. 6. 53, 14. 7. 53, etc.

(i) One single calendar for whole of India is not desirable as the latitude and longitude of places vary. (ii) Disapproves modern calculations, as the duration of a *tithi* exceeds the limit of 65 to 54 ghatikās and it conflicts with dharmasāstras. (iii) Ancient method of calculation to be taken.

19. Shri Satish Chandra Das Roy, Baghbazar, Chandernagore, Hooghly.

Letter dated 6. 4. 53.

(i) Bengali year to be counted from Caitra to Phālguna (14th April to 13th April). (ii) The name *Agrahāyana* to be substituted by *Mārgaśīrṣa* in Bengal. (iii) Bhiṣmapañcamī (Śukla) during the Sun's stay in nirayana Meṣa to be introduced. (iv) Western method of *ayana* calculation to be discarded and position of Uranus and Neptune to be included. (v) Dispute of *ayanāmsa* to be settled and zero *ayanāmsa* year to be adopted as 499 A.D. (421 Śaka).

Letter dated 3. 7. 53.

States that the western theory of the precession of equinoxes is absurd. The trepidation theory of Sūrya Siddhānta is correct.

Letter dated 14. 7. 53.

Nirayana system of calculations to be adopted.

Letters dated 15. 7. 53 & 24. 7. 53, etc.

Advocates oscillation theory of the equinoxes, on which the calculations should be based.

20. Shri Linga Jois, Secretary, The All Karnataka Astronomical Association, Shimoga, Mysore.

Letter dated 6. 5. 53 intimating the resolutions adopted by the Association at its meeting held on 1. 5. 53.

(i) That the compilation of a secular calendar applicable to all India based on the indigenous methods of computation of time be immediately undertaken by the Govt. of India

and the Govt. be requested to immediately constitute a committee for that purpose. (ii) That the All Karnataka Astronomical Association, Shimoga, shall give all services to the Govt. of India in this behalf with its many learned pandits of astronomy on the roll of its members.

Letters dated 24. 5. 53, 10. 7. 53 & 23. 7. 53.

Resolutions adopted by the Association at its meeting held on 16. 7. 53 on the action taken by the Govt. of India regarding calendar reform, are as follows :—

Resolved that the Chairman of the All India Calendar Reform Committee, Calcutta, be requested to select two members of the All Karnataka Astronomical Association to co-operate with the members of the Calendar Reform Committee, New Delhi.

21. Bisuddha Siddhanta Panjika, 85, Grey Street, Calcutta.

Notes dated *nil*.

(i) Advocates correct nirayana (ḍṛk-gaṇitaikya) calculation.

(ii) Starting point to be 180° apart from the star Spica.

(iii) In taking correct calculation, though the thithimāna may exceed the limit of bānavṛddhi rasakṣaya, it does not conflict with dharmasāstras.

22. Hony. Secretary, Jyotirvidya Mandal, Astro-Research Institute, 3/25, Contractor's Building, Charni Road, Girgaon, Bombay-4.

Letters dated 16. 2. 53 & 30. 3. 53.

(i) Approves the interim recommendations of the Calendar Reform Committee made at its first meeting.

23. Devshi Virjee Khona, Chief Compiler, Janma-bhoomi Panchang, P.O. Box No. 62, Bombay-1.

Letter dated 16. 8. 53.

An ideal Indian calendar should have the following items :—

(a) Saṁvat era, (b) correct position of planets,

(c) fixed starting point opposite to the star Citrā, (d) the longitude should be nirayana not sāyana, (e) seasons to be shown according to the tropical year.

24. Shri G.R. Paranjpe, 128 Budhwar, Poona City.
Shri K. V. Phanse, 25, Budhwar, Poona City.
Shri S.R. Godbole, 146A Shaniwar, Poona City.
Shri R.D. Karmakar, Principal, Research Occult College, 51 Budhwar, Poona City.

Letter advocating,

(i) Reform of World Calendar.

(ii) Reform of Indian Calendar :—

(a) Length of the year to be 365^d 5^h 48^m 57^s.65

(b) Beginning of the year to be 22nd December or 21st March

(c) Number of days of the months as follows :—30, 30, 30,

30, 31, 31, 31, 31, 31, 30, 30, 30, (d) Standard meridian of

India as that of Banaras or Delhi, (e) Names of the months

should be the Vedic names, viz., Tapas, Tapasya etc.,

(f) Name of the calendar to be "Bhāratīya Saura Kālāyana."

25. Shri Rambhat Jyotishi,
C/o. Messrs. A. R. Sivanagappa & Sons,
Vag-vilas Book Depot, Hubli.

Letter dated 31. 3. 53.

Dr̥kka (correct) method of calculation conflicts with dharmasāstra, so a conference of all pañcāṅga makers may be called for final decision.

26. Shri R. L. Narasimaya, M.Sc., Lecturer in
Physics, Central College, Bangalore.

Letter dated 26. 5. 53 from Shri S. V. Krishna Moorthy Rao, forwarding two articles on Indo-Aryan Calendar.

(i) Correct duration of sidereal year should be adopted in place of Hindu siddhāntic sidereal year. (ii) Solar calendar should be sidereal. (iii) Lunar months should be coupled with tropical solar months, instead of sidereal solar months as at present. (iv) Lunar months commencing from new-moon preceding Meṣāyana should be named Caitra. (v) National astronomical observatories with latest equipments should be established at several places in India.

27. Shri R. N. Apte, M.A., LL.B., F.R.A.S.

C. S. I. R. letter dated 4. 5. 53 forwarding an article.

Tithis should be calculated from the data of the Nautical Almanac, because karaṇagranthas do not give correct results.

28. Shri P. Rama Kotaiah, Narasaraopet, (Andhra)

Letters dated 20. 4. 53 & 15. 8. 53.

Advocates adoption of Gandhian era :—

(a) Year commencing from 15th August, (b) Dates of this calendar to be fixed, (c) Names of the months and number of days of the months to be as follows :—

7th Year	
Svatantriyam	31 (First month) (15. 8. 53 to 14. 9. 53)
Bhāratīyam	30 (15. 9. 53 to 14. 10. 53)
Khādīprobodham	31 (15. 10. 53 to 14. 11. 53)
Harijanadharanam	30 (15. 11. 53 to 14. 12. 53)
Mārgadarsakam	31 (15. 12. 53 to 14. 1. 54)
Paramapadam	31 (15. 1. 54 to 14. 2. 54)
Uthejam	28 (15. 2. 54 to 14. 3. 54)
Caitanyam	31 (15. 3. 54 to 14. 4. 54)
Ahiṁsātmakam	30 (15. 4. 54 to 14. 5. 54)
Matasahanam	31 (15. 5. 54 to 14. 6. 54)
Satyāgraham	30 (15. 6. 54 to 14. 7. 54)
Śāntimayam	31 (15. 7. 54 to 14. 8. 54)

(d) 1st, 5th, 9th, 13th, 17th, 21st years etc. are leap-years.

29. Shri Hukum Singh Pansari, Khari Baoli, Delhi.

Letters dated 11. 5. 53, 26. 5. 53, etc.

(i) Gandhian era 6, 1953-54, starting from 30th January, should be adopted as the National Era of India.

(ii) Names of the months and number of days of each month to be as follows :—

Gandhi Martyrdom	30 days (Jan. 30 to Feb. 28)
Khadi Publicity	31 " (March)
Cottage Industries	30 " (April)
Hard Labour	31 " (May)
Service to Humanity	30 " (June)
Love of Universe	31 " (July)
National Independence	31 " (August)
Untouchable Uplift	30 " (September)
Charka Publicity	31 " (October)
Non-violence	30 " (November)
Co-operation	31 " (December)
Realization of Truth	29 " (January 1-29)

30. Shri Gopal Balwant Joshi, Compiler, Chitrasala Panchanga, Poona & Jotirvid Laxman Gopal Date, Compiler, Date Panchang, Sholapur.

Letter dated 28. 9. 53 (Memorandum).

(i) Suggesting to co-opt some suitable persons from Grahalāghava school in order to make the committee fully representative.

(ii) For civil purposes sāyana system may be adopted commencing the year from the vernal equinox day but for religious purposes nirayana reckoning should be adopted instead of sāyana system. (iii) The starting point of the nirayana zodiac should be the point directly in front of the star Citrā (Spica). (iv) The formula for leap-years with Śaka year should be worked out. (v) Criticises the adoption of constant ayanāṁśa for religious purposes.

31. Shri Chhedilal Jayeswal, P. O. Vindhachal, Dist. Mirzapur.

Favours adoption of Gandhian era.

32. Shri Arun Kumar Das, 22/3, Ray Street, Calcutta-20.

Letter dated 4. 12. 53.

(i) Length of the year should be 365.2422 days. (ii) The beginning of the year should be from 21st March i.e. V.E. day when the month of Vaiśākha should commence. (iii) The central observatory of India should be situated at Banaras and also some other observatories in some different parts of India. (iv) The beginning of the day should be from midnight. (v) Almanacs which give incorrect calculations should be banned by the Government. (vi) The era to be adopted for the Indian calendar should be counted from the birth time of Buddhadeva or from the time of Bhārata battle.

33. Shri Anand Prakash, T/8, Anand Parbat, New Delhi.

Letter dated 9. 12. 53.

(i) 'Śr̥ṅṅi Saṁvat' 1960853053 should be adopted as our national era ; for facility proposes the use of the last

two digits, e.g. 53 instead of the full number, as it is identical with the Christian era. (ii) Naming of months—Caitra, Vaiśākha etc. (iii) The starting of the year should be from the first day of Caitra. (iv) The month should start on the actual day of saṁkrānti i.e. when the sun enters into the next constellation.

34. Shri Pidaparty Krishnamurthy Sastry, (author of Andhra Patrika Panchangam), P.O. Podatlapalli, Via Tanuku, Dist. E. Godavari.

Letter dated 21. 11. 53.

(i) The first day of the lunar month in which Mīmāyana falls, be taken as the beginning of the year and the same is the first day of Madhumāsa. (ii) Names of the sāyana solar months to be as follows :—

Madhu,	Mādhava,	Śukra,	Śuci,
Nabha,	Nabhasya,	Iṣa,	Ūrja,
Saha,	Sahasya,	Tapā,	Tapasya.

35. Shri K. Sankaran Namboodiripad Avl., Chief Computer, Yogakshemam Panchangam, Panchangam Press, Kunnankulam (T.C. State).

Letter dated 30. 1. 54.

(i) Kali era be taken instead of Śaka era for the calendar. (ii) Stresses upon the fixation of the zero ayanāṁśa year. (iii) Cycle of nakṣatras will commence from the first point of Meṣa and not from the V.E. point. (iv) Favours standardization of months with 30 and 31 days alternately and introduction of leap-years. (v) Supports the recommendations of the Committee in general.

36. Jyotishratna Pandit Raghunath Sastri, Principal, Astrological Education Course, 140, Shukrawar Peth, Poona-2.

Letter dated 11. 2. 54.

(i) Suggests fixation of intercalary months according to the sāyana positions of the Sun, because various intercalary months cause differences in observance of festivals.

37. Shri V. P. K. Poduval, "Jyothissadan"
P.O. Payyanur, North Malabar.

Letter dated 22. 3. 54.

(i) Supports the recommendations of the Calendar Reform Committee made at its first meeting. (ii) The year should be brought back by 23 days as this error is causing mistakes in the calculation of seasons.

(iii) Suggests establishment of a central astronomical observatory with modern instruments and apparatus including ammonia and quartz clocks. (iv) Steps should be taken to publish an Indian Ephemeris for the use of the almanac makers, the Navy and the Air force.

38. Shri Jagadish Prasad Srivastava, B.Sc. LL.B.,
2062, Ladli Katra, Agra.

Letter dated 9. 3. 54.

(i) The beginning of the year should be 21st March, when the day and night are equal and this day corresponds accurately to the change of seasons. (ii) The names of the months should be as follows :—Prathama (prathama Varga), Dvitiya (Dvitiya Varga) and so on, being the Sanskrit equivalent of English months March, April etc. (iii) Suggests the name of the era as "Bhārata Era."

39. Shri Yeshawant K. Pradhan, Sayan Astronomical & Astrological Mandal, Jyotirmala Office, Shri Hari Building, near India Garage, Dadar, Bombay-14.

Letter dated nil.

I. For Civil Calendar :—

(i) The year should begin on the day when the Sun is in conjunction with the apparent first point of Aries. (ii) The length of the year should be 365.2422 days. For civil purposes the first 3 years would be of 365 days and the fourth year of 366 days. (iii) Śālivāhana Śaka may be used as the era. (iv) The solar month should begin on the day when the Sun enters the 31st degree and its multiples beginning from the vernal equinox. (v) Length of months :—the first 5 months should be of 31 days and the remaining 7 months of 30 days for the ordinary year while first 6 months should be of 31 days and the remaining 6 months of 30 days for the leap-year, i.e. the year of 366 days. (vi) The civil day should commence from midnight.

II. For Religious Calendar :—

(i) Religious calendar of India should be luni-solar. (ii) Names of the months should be Caitra, Vaiśākha etc., the first month being Caitra. (iii) Lunar month should be reckoned from true new-moon to true new-moon. (iv) During the period covered by two successive new-moons, the Sun may not transit over any multiple of 30° degrees of longitude in some cases, and in such cases the lunar month should be termed as intercalary month. (v) If during the period covered by two successive new-moons there would be two ingresses of the Sun, in such a case the name of the month shall be determined on the basis of the second ingress, the one on the basis of the first having been treated as kṣaya month. (vi) Any religious festival which is principally determined by nakṣatras should be based on the tropical nakṣatras without taking into account the position of fixed stars. (vii) Religious festivals may be determined in the following manner :—

- (a) In Northern India, with reference to the true sunrise of Delhi. (b) In Western India, with reference to the true sunrise of Bombay. (c) In Eastern India, with reference to the true sunrise of Calcutta. (d) In Southern India, with reference to the true sunrise of Madras. (e) In Central India, with reference to the true sunrise of Nagpur.

(viii) Indian standard time should be followed throughout.
(ix) Heliacal rising and setting of planets should be given for every parallel of latitude commencing from 6° North and for the meridian of 82½° East longitude of Greenwich.

40. Krishnaram Valji Bhatt, Yeshawant K. Pradhan, and Dattatraya K. Sule,
Dadar, Bombay-14.

Letter dated 3. 5. 54.

(i) The initial point of the zodiac cannot be anything else but the vernal equinox (even S.S. gives the initial point as vernal equinox). (ii) Length of the year should be 365.2422 days. (iii) Sāyana system should be accepted for our religious and other rites. (iv) If any attempt is made to fix the amount of ayanāṁśa from the fixed stars as given in the S. S., there will be 27 kinds of ayanāṁśas and no two of them will agree, so it is futile to determine the ayanāṁśa from the S. S.

41. Memorandum of the Sayana Astronomical and Astrological Mandal, Bombay, Received from :—

(1) Shri M.D. Sagona, M. A., LL.B., I.A.S., Retd. Deputy Commissioner, Raman Nivas, Bukmini Nagar, Amaravati, Madhya Pradesh, dated 28. 5. 53,

(2) Jyotishacharya D. N. Roy, 634 Shukrwar Peth, Poona-2, dated 28. 5. 53,

(3) Pdt. Krishnaram Bahaji, Bombay-2, dated nil,

(4) Shri V. G. Kulkarni, Vice-President, Astrological Bureau, Kolhapur, Siddheswar Jyotish Karyalaya, Kolhapur, dated nil,

(5) Capt. K. V. Mangaoker, Medical Officer, P. O. Kunta, Karwar,

(6) Shri H. D. Sagoma, Headmaster, Model High School, P. O. Arvi, Wardha (M. P.),

(7) Shri P. Y. Killekar, 6/12, Neruroji Road, Lower Colaba, Bombay-5,

(8) Shri Yeshawant K. Pradhan, Bombay-14,

(9) Shri Krishnaram Valji Bhatt, 95 Narayanji Sanji House, Canal Street, Bombay-2,

and 11 others.

In addition to the suggestions made in No. 39, above the following further suggestions have also been offered.

(i) Zero ayanāṁśa should be taken in each year, and the vernal equinoctial day be the beginning of the year.

(ii) Tropical and not the sidereal year should be the basis of reckoning.

(iii) The intercalary month should be determined by the Sun's entry into sāyana signs occurring during the lunar months.

(iv) Sāyana planetary positions and sāyana calculations alone must be taken for the religious pañcāṅgas.

(v) The celestial geocentric longitudinal conjunction of the sun, the moon and the planet with junction stars must be mentioned in the pañcāṅga.

(vi) Basis of the seasonal rites and ceremonies should be changed from Caitrādi lunar month to Madhu-Mādhavādi lunar month.

42. Shri Baldeva Misra, K. P. Jayaswal Research Institute, Patna.

Letter dated 3. 5. 54.

(i) For all religious purposes tithi, nakṣatra, yoga and longitudes of the Sun and Moon should be calculated according to the old system and not according to the (modern) Almanac system, for simple reason that our religion is based on the words of the ancient sages and ṛṣis. (ii) Nirayana calculation should be accepted. (iii) An observatory should be established. (iv) The advancement of science should be carried out giving due respect to śāstras.

43. Pandit Dwijapada Goswami, Secretary, Panchanga Sodhana Parisat, 102-3, Bakul Bagan Road, Calcutta-25.

Sending a Memorandum dated 16. 4. 54 prepared by a sub-committee consisting of Pt. Haricharan Smrititirtha Vidyaratna, Bhatpara, Pt. Sasthi Charan Bhattacharya of B.S. Panjika, Calcutta, Shri Jatindra Nath Bhattacharya, editor, Jyotirbijnan, Calcutta, Shri Sudhibhusan Bhattacharya M.A., Calcutta, Pt. Dwaresh Chandra Sarmacharya M.A., Calcutta and the Secretary.

(i) The latest astronomical elements should be adopted in the compilation of Indian pañcāṅgas. (ii) The calculation should be drk-siddha. (iii) The Nakṣatra cakra which is purely a sidereal system of astronomy and is being followed in India for at least the last 4000 years, should not be abandoned in the compilation of pañcāṅgas. (iv) The ayanāṁśa of the pre-siddhāntic period which was used in the Vedic period and in the glorious period of Hindu civilization should be accepted. (v) The Citrāpakṣa be adopted in the pañcāṅgas. (vi) According to Citrāpakṣa, 23° 15' ayanāṁśa should be accepted for the year 1956. (vii) Receding back of the equinoxes should not be stopped artificially as it will no doubt be completely opposed to our Śāstric traditions. (viii) Uttarāyana should start from the actual date i.e. Dec. 23 instead of Jan. 14 as it is now followed. (ix) The festivals which developed after the Vedic period are not necessary to be observed in the seasonal months. (x) The criterion of Aṣṭamī Rohiṇī in commemorating the birth day of Lord Kṛṣṇa should be followed, though it may go out of the rainy season. (xi) The tropical year which is being followed in certain religious festivals, should start from the V. E. point and not from 23° 15' ahead of the V. E. point. (xii) The sidereal names of the months cannot be used with the tropical year. For the tropical year, the names Madhu, Mādhava etc. or Prathama, Dvitiya etc. should be used. (xiii) The dates of the sidereal solar months should be standardized. (xiv) The sidereal year will have 12 months commencing from Vaiśākha, and general festivals should, however, be linked with the sidereal year.

44. Shri P. L. Bhagvat, 846 Sadashiv Peth, & Shri N. S. Gokhale, 346 Somwar Peth, Poona-2.

Letter dated 14. 5. 54.

(i) The vernal equinoctial point should be the starting point of the year. The year should be tropical, consisting of 365.2422 days. (ii) The calendar should contain Tithi, Nakṣatra, Yoga & Karāṇa (if necessary) and exact time of the conjunction of the Moon with the 1st and 2nd magnitude stars. (iii) Against the idea of taking $23^{\circ} 15'$ ayanāṁśa ahead of the V. E. point. (iv) Against the nirayaṇa system for the following reasons :—

- (a) The authors of the different Siddhāntas could not fix the initial point for nirayaṇa calculation.
- (b) Longitudes of some fixed stars as found in the Sūrya Siddhānta do not yield the location of the starting point.
- (c) At present the days and nights are not equal on the equinox days according to the present nirayaṇa pañcāṅgas.
- (d) There is no satisfactory proof in our śāstras that our religious festivals are based on nirayaṇa system.
- (e) The zero year of the Hindu zodiac is different in different pañcāṅgas.

45. Shri Kashiram Sharma, Secretary, Jyotisha Sammelana (4th), Upper India, Ambala Cantt.

Letter dated 7. 6. 54 intimating the recommendations of the conference.

(i) The new calendar to be prepared should be on Indian system and the important factors of the Pañcāṅga i.e. lunar days and asterisms etc. should be computed purely according to Sūrya Siddhānta, so that there should be uniformity in the pañcāṅgas all over India and there should be no confusion in the observances of national festivals etc. (ii) The long. $82^{\circ} 30'$ E. of Greenwich adopted as the standard meridian of India should be changed to 75° E. to be in conformity with ancient practices which will not in any way interfere with the universally accepted and prevalent zonal time convention. (iii) This conference demands from the Union Govt. that funds should be provided to start as many astronomical observatories as possible to promote the study of Jyotiṣa, during the next five years. In these observatories Indian astronomers well versed in Sanskrit and Hindu astronomy should be treated at par with modern astronomers. The central observatory should be situated at Ujjain or Kurukṣetra. (iv) To promote and encourage study of Jyotiṣa, it is desirable to start a Central College-cum Research Institute and a Central Library of Jyotiṣa. In this college arrangements should be made to teach Jyotiṣa with all its allied subjects on scientific lines.

46. Shri Manubhai P. Shukla, 180/1, Kocharab, P. O. Anandanagar, Ahmedabad.

Letters dated 12. 6. 54 & 19. 6. 54.

(i) Prefers fixed zodiac system for lunar calculations. (ii) Religious rites should be performed according to lunar month. (iii) A uniform calendar in India is desirable.

47. Shri Kshitish Chandra Chatterjee, M. A. D. Litt., 81, Shyambazar Street, Calcutta-4.

Letter dated 21. 8. 54 forwarding a pamphlet from Shri Bamacharan Tarkatirtha Nyayacharya, Professor, Hindu University, Banaras, Shri Narayan Chandra Smrititirtha, Shri Kalipada Jyotisastrī, M. Sc., Shri Ramrupa Vidyabagisa of Bhatpara, MM. Bireswar Tarkatirtha of Burdwan, MM. Rames Chandra Tarkatirtha, Shri Tripathanath Smrititirtha of Navadwip, MM. Kalipada Tarkacharya, etc. of Calcutta.

(i) For civil purposes 22nd March may be adopted as the beginning of the year but for religious purposes year beginning should be followed according to the different conventions of the States. (ii) The recommendation for starting the calculation for religious purposes $23^{\circ} 15'$ ahead of the V. E. point cannot be accepted, as the equinoxes are not fixed. (iii) Supports the recommendation for preparing a National Calendar for the whole of India and for establishing a National Observatory with modern equipments. (iv) Disapproves the inclusion of tithis and nakṣatras in the National Calendar. (v) For religious purposes the duration of a tithi must not exceed 65 dandas and must not fall short of 54 dandas. (vi) The calculation of tithis and nakṣatras should be done according to the Siddhāntas of India. (vii) To determine the months, dates and time for religious duties, calculation should be made from Sūrya Siddhānta on nirayaṇa basis commencing from the fixed "First point of Aries" in the zodiac with fixed length of the solar year viz., 365.2587 days.

48. Hon. Secretary, Jyotirvidya Mandal, 3/25 Contractor's Building, Girgaon, Bombay.

Letter dated 6. 9. 54.

Forwarding resolutions adopted at the Brihan Maharastra Jyotish Parishad conference, Jalgaon, held on 3rd, 4th & 5th July, 1954.

(1) Disapproval :—The decision of the Calendar Reform Committee of the Government of India, to fix $23^{\circ} 15'$ as the fixed ayanāṁśa is unscientific and would produce great confusion in future in religious matters, which are fixed in accordance with nakṣatras and would produce irreligiousness and harm to religious practice and religious culture. The precession of equinoxes should be taken into account every year while determining the ending moments of nakṣatras and the luni-solar calendar be compiled accordingly.

(2) Approval :—With respect to the other items proposed by the Committee e.g. Śālivāhana Śaka and the Caitrādi beginning of tropical solar year etc. are acceptable.

PART B.

REFORMED CALENDAR OF INDIA

for the five years

1876 to 1880 Śaka

(1954-55 to 1958-59 A.D.)

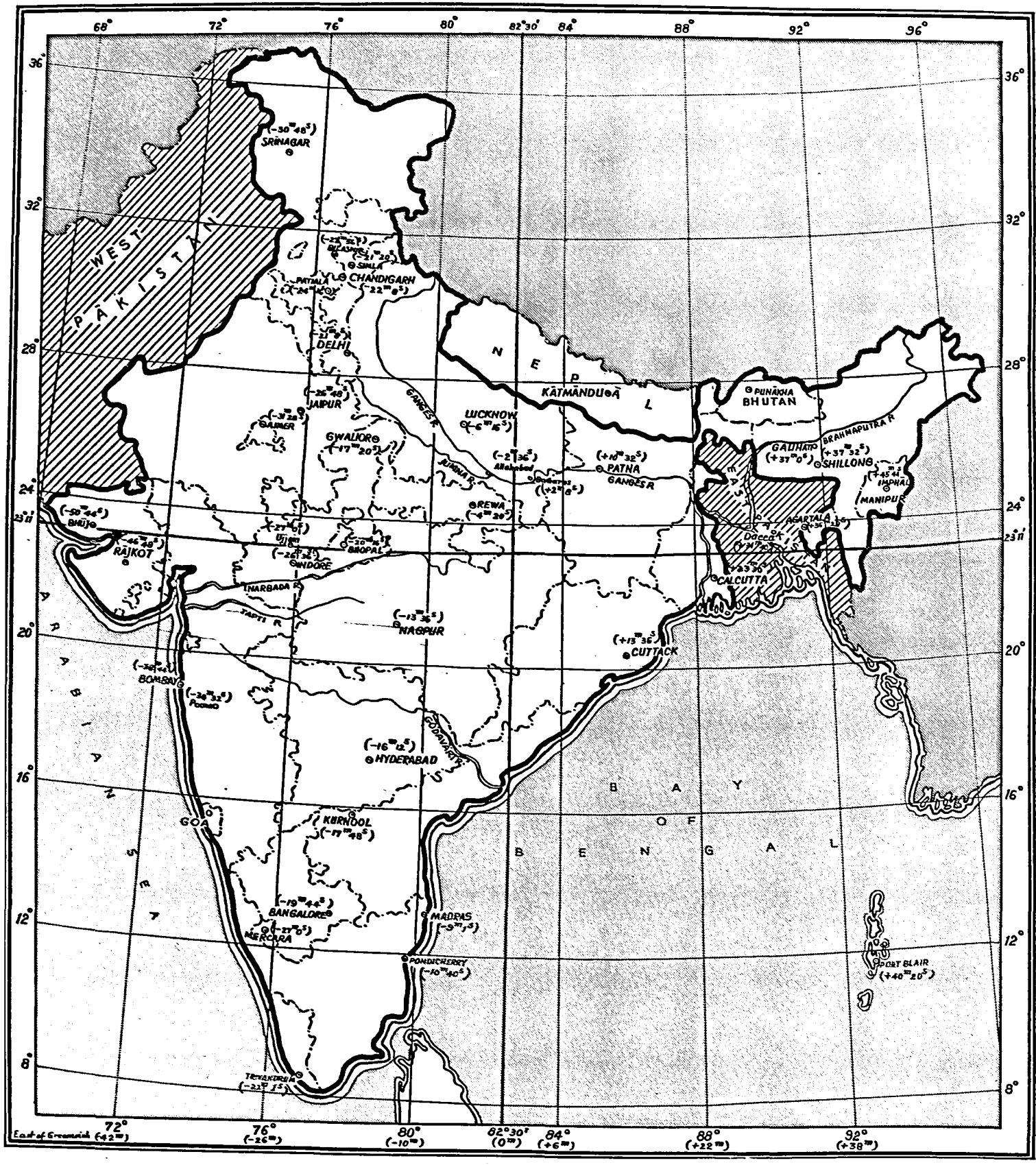

The Central Station for which the calculations of the Calendar have been made, lies on longitude 82° 30' East of Greenwich (Standard meridian of India) and latitude 23° 11' North (Lat. of Ujjain) indicated by the two thick lines in the map. The central station is at the intersection of these lines.

The local time-differences of principal cities from the standard meridian have been shown in brackets against cities.

EXPLANATION

I. Calendar for five years

The Reformed Calendar of India includes the following items, column by column :

- (1) Date of the Reformed Indian Calendar as recommended by the Committee with fixed number of days per month. The year begins with Caitra and ends in Phālguna.
- (2) The Week-day.
- (3) The corresponding Gregorian date with month and year.
- (4) The geocentric apparent longitude of the Sun measured from the true vernal equinoctial point. It is given for 5-30 A. M. I. S. T., which is the same as 0^h Greenwich mean mid-night or 0^h U. T.
- (5) Sunrise and sunset calculated for the central station i.e., 23° 11' North latitude and 82° 30' E. longitude, given in Indian Standard time. It relates to the appearance of the centre of the Sun on the horizon, as affected by refraction, the amount of which has been taken as 30' for the horizon of India.
- (6) Ordinal number of tithis and their ending moments. The numbers of tithis have been shown from Śukla 1 to Śukla 15 (full-moon), and again from Kṛṣṇa 1 to Kṛṣṇa 14, and Kṛṣṇa 30 (new-moon). The ending moments have been given in I.S.T. Tithi current at sunrise of the central station has been stated against the given date. When a second tithi ends before the next sunrise, it has been shown in brackets under the first tithi. The ending moment of a tithi is the time when the longitude of the Moon gains exactly 12° or its multiple on that of the Sun. For this purpose the longitudes

of the Sun and the Moon have been taken such as would agree with the figures of Nautical Almanacs.

- (7) Nakṣatras—number, name and ending moments. In giving the figures the same procedure has been followed as in the case of tithis. The nakṣatras have been calculated beginning from Aśvini as 1 and ending with Revati as 27. The period of a nakṣatra is the time taken by the Moon to travel over an arc of 13° 20' each, commencing from a point fixed amongst the stars about 23° 15' (on 21st March, 1956) ahead of the V. E. point. The actual distance between the V. E. point and the above mentioned fixed initial point of the nakṣatra system is called ayanāṁśa, the true value of which for the beginning of each month has been stated at the top of each page.
- (8) The solar months such as Saura Vaiśākha, Saura Jyaiṣṭha etc., have been reckoned from Meṣādi, Vṛṣādi, etc.
- (9) The lunar months are reckoned from new-moon to new-moon and are therefore new-moon ending (*mukhya māna*). These are named after the Saura month in which the initial new moon falls.
- (10) Transit of the Sun—Meṣādi, Vṛṣādi are the moments when the longitude of the Sun equals 23° 15', 53° 15' etc. Sun's entry into nakṣatras have been calculated in the same way as in the case of the moon, *viz.*, adopting variable ayanāṁśa. Sun's transits over every 30th degree of arc commencing from the vernal equinoctial point have been designated by Trop. Aries, Trop. Taurus, etc.

- (11) Phenomena include New-moon, Full-moon, Vyatipāta (when the sum of the sāyana longitudes of the Sun and the Moon equals 180°), Vaidhṛti (when the above sum amounts to 360°), Eclipses, and dates of heliacal rising and setting of Jupiter and Venus.

- (12) Festivals—As far as practicable all principal festivals of different states have been fixed in accordance with the calculations shown in this calendar. In this respect the convention followed in different states in the fixation of festivals has been observed as far as possible.

Note : The name of the month first given is that recommended by the Committee. The other names are alternative ones current at present in some parts of India or used in ancient times.

II. General rules for religious festivals

A statement has been appended showing the general rules for fixing the dates of religious festivals based on luni-solar and solar calendars. Attempts have been made to make it as comprehensive as possible by including the conventions of all the different States as far as practicable.

III. List of Holidays

The list of holidays for the Government of India as well as for all the States has been prepared for the five years 1954-55 to 1958-59 A.D., on the basis of the Reformed Calendar.

REFORMED CALENDAR OF INDIA

FOR ŚAKA ERA 1876 (1954-55 A.D.)

Month of CAITRA (30 Days)

Meṣa : Mādhava

Ayanārhśa on 1st = 23° 13' 19"

Spring 2nd Month

Date	Week Day	English Date	Long. of the Sun at 5-30 A.M.	Sun Rise	Sun Set	Tithi		Nakṣatra			Solar Month	Lunar Month	Transit of the Sun	Phenomena	Festivals
						No.	Ending Moment	No.	Name	Ending Moment					
1954 A.D.			° ' "	h m	h m		h m		h m						
1	Mon	Mar. 22	0 49 53	6 4	18 10	K 3	25 25	14	Citrā	9 42	SAURA CAITRA	CĀNDRA PHĀLGUNA	10-Enters Revati (9 ^h 7 ^m)	1-Indian New Year's Day. 3-Raṅga pañcamī, Vijay Govindaji Halenkar (Manipur). 4-Skanda ṣaṣṭhī (Bengal). 7-Śitalāṣṭamī (Bengal), Varṣṭapārambha (Jain). 10-Pāpamocanī ekādaśī, Trisprā mahādvaśāśī. 11-Vāruṇī (upto 18h 24m). 13-New Moon (17 ^h 55 ^m) 14-Navarātrārambha. 16-Gaurī tṛtīyā, Dolotsava, Āndolana tṛtīyā, Saubhāgya-śayana vrata, Sarhul (Bihar). 17-Śrī (Lakṣmī) pañcamī. 18-Aśoka ṣaṣṭhī (Bengal), Skanda ṣaṣṭhī (Orissa). 19-Vāsantī pūjā (Bengal). 20-Aśokaṣṭamī, Annapūrpā pūjā (Bengal), Bhavānī-utpattī, Oil beginning (Jain). 21-Rāma navamī, Śrī Rāma jayantī. 22-Dharmarāja daśamī. 23-Kāmadā ekādaśī, Dolotsava, Valākhī, Visu (T. C. State), Caṇḍaka pūjā (Bengal), Bahāg Bilu (Assam). 24-Viṣṇu damanotsava, Vāmana dvādaśī, Madana dvādaśī. 25-Anaṅga trayodaśī, Mahāvīra jayantī (Jain). 26-Madana bhāṅjī, Śiva damanaka (Orissa). 27-Viṣṇu damanaka (Orissa). 28-Iṅamat jayantī, Oil ends (Jain).	
2	Tue	23	1 49 23	3	10	4	27 51	15	Svātī	12 40					
3	Wed	24	2 48 52	2	11	5	— —	16	Viśākhā	15 32					
4	Thu	25	3 48 19	1	11	5	6 5	17	Anurādhā	18 8					
5	Fri	26	4 47 45	6 0	12	6	7 58	18	Jyeṣṭhā	20 19					
6	Sat	27	5 47 8	5 59	18 12	K 7	9 18	19	Mūla	21 55					
7	SUN	28	6 46 30	58	12	8	9 58	20	P. Āṣāḍhā	22 48					
8	Mon	29	7 45 50	57	13	9	9 49	21	U. Āṣāḍhā	22 52					
9	Tue	30	8 45 8	56	13	10	8 50	22	Śravaṇa	22 7					
10	Wed	31	9 44 25	56	13	11	7 3	23	Dhanīṣṭhā	20 35					
11	Thu	Apr. 1	10 43 40	5 55	18 14	K 13	25 22	24	Śatabhiṣajī	18 24					
12	Fri	2	11 42 53	54	14	14	21 47	25	P. Bhādrapadā	15 43					
13	Sat	3	12 42 4	53	14	K 30	17 55	26	U. Bhādrapadā	12 43					
14	SUN	4	13 41 12	52	15	S 1	13 59	27	Revatī	9 35					
15	Mon	5	14 40 19	51	15	2	10 11	1	Aśvinī	6 32					
16	Tue	6	15 39 24	5 50	18 16	S 3	6 41	3	Kṛttikā	25 27					
17	Wed	7	16 38 26	49	16	(4	27 40)	4	Rohiṇī	23 46					
18	Thu	8	17 37 27	48	16	5	25 17	4	Mṛgaśīras	22 47					
19	Fri	9	18 36 25	47	17	6	23 37	5	Ārdrā	22 34					
20	Sat	10	19 35 20	46	17	7	22 44	6	Punarvasu	23 8					
21	SUN	11	20 34 14	5 45	18 17	S 9	23 15	8	Puṣya	24 23					
22	Mon	12	21 33 5	44	18	10	24 28	9	Āśleṣā	26 13					
23	Tue	13	22 31 53	43	18	11	26 11	10	Maghā	28 31					
24	Wed	14	23 30 40	42	19	12	28 14	11	P. Phalgunī	— —					
25	Thu	15	24 29 24	41	19	13	— —	11	"	7 8					
26	Fri	16	25 28 7	5 41	18 19	S 13	6 30	12	U. Phalgunī	9 57					
27	Sat	17	26 26 47	40	20	14	8 53	13	IIasta	12 52					
28	SUN	18	27 25 25	39	20	S 15	11 18	14	Citrā	15 40					
29	Mon	19	28 24 2	38	21	K 1	18 42	15	Svātī	18 43					
30	Tue	Apr. 20	29 22 36	5 37	18 21	K 2	16 0	16	Viśākhā	21 31					

N.B.—All timings are given in I. S. T. or the local time of the meridian of 82½° E. Long.

REFORMED CALENDAR OF INDIA

FOR ŚAKA ERA 1876 (1954-55 A.D.)

Month of **V A I Ś Ā K H A** (31 Days)

Vṛṣa : Śukra

Ayanānśa on 1st = 23° 13' 22"

Summer 1st Month

Date	Week Day	English Date	Long. of the Sun at 5-30 A.M.	Sun Rise	Sun Set	Tithi		Nakṣatra			Solar Month	Lunar Month	Transit of the Sun	Phenomena	Festivals						
						No.	Ending Moment	No.	Name	Ending Moment											
1954 A.D.			° ' "	h m	h m		h m			h m											
1	Wed	Apr. 21	30 21 9	5 36	18 21	K 3	18 7	17	Anurādhā	24 8	SAURA VAIŚĀKHA	CĀNDRA CAITRA	7-Enters Bharāṇi (14 ^h 23 ^m)	7-Vaidhṛti (18 ^h 15 ^m)	9-Varūthini ekādaśī.						
2	Thu	22	31 19 39	36	22	4	19 58	18	Jyeṣṭhā	26 27											
3	Fri	23	32 18 8	35	22	5	21 24	19	Mūla	28 22											
4	Sat	24	33 16 36	34	23	6	22 19	20	P. Āṣādhā	- -											
5	SUN	25	34 15 2	33	23	7	22 35	20	"	5 44											
6	Mon	26	35 13 26	5 32	18 23	K 8	22 8	21	U. Āṣādhā	6 26	SAURA VAIŚĀKHA	CĀNDRA CAITRA	7-Enters Bharāṇi (14 ^h 23 ^m)	7-Vaidhṛti (18 ^h 15 ^m)	9-Varūthini ekādaśī.						
7	Tue	27	36 11 48	32	24	9	20 55	22	Śravaṇa	6 26											
8	Wed	28	37 10 10	31	24	10	18 57	23	Dhanīṣṭhā	5 40											
9	Thu	29	38 8 29	30	25	11	16 19	25	Śatabhiṣaj	28 11											
10	Fri	30	39 6 47	29	25	12	13 8	26	P. Bhādrapadā	26 4											
									U. Bhādrapadā	23 28											
11	Sat	May 1	40 5 4	5 29	18 26	K 13	9 33	27	Revati	20 33						SAURA VAIŚĀKHA	CĀNDRA CAITRA	12-New Moon (25 ^h 52 ^m)	13-Tithi of Deva Dāmodara (Assam).	14-Paraśurāma jayantī.	15-Akṣaya tṛtīyā, Candana yātrā (Bengal and Orissa), Varsītapa samāpana (Jain).
12	SUN	2	41 3 19	28	26	14	5 44	1	Āśvini	17 30											
13	Mon	3	42 1 32	27	26	(K 30) S 1	25 52	2	Bharāṇi	14 31											
14	Tue	4	42 59 44	27	27	2	18 45	3	Kṛttikā	11 47											
15	Wed	5	43 57 53	26	27	3	15 50	4	Rohiṇi	9 30											
16	Thu	6	44 56 1	5 25	18 28	S 4	13 34	5	Mṛgaśiras	7 49	SAURA VAIŚĀKHA	CĀNDRA CAITRA	19-Vyatipāta (11 ^h 11 ^m)	17-Śaṅkara's Birthday.	18-Candana ṣaṣṭhi (Bengal), Gaṅgotpatti.	19-Śarkarā saptamī, Jahnu saptamī (Bengal).					
17	Fri	7	45 54 7	25	28	5	12 3	6	Ārdra	6 51											
18	Sat	8	46 52 11	24	29	6	11 20	7	Punarvasu	6 41											
19	SUN	9	47 50 13	24	29	7	11 27	8	Puṣya	7 20											
20	Mon	10	48 48 14	23	30	8	12 18	9	Āśleṣā	8 43											
21	Tue	11	49 46 12	5 23	18 30	S 9	13 48	10	Maghā	10 45	SAURA VAIŚĀKHA	CĀNDRA CAITRA	21-Enters Kṛttikā (8 ^h 29 ^m)	21-Sitā navamī (Bengal & Orissa).	23-Mohini ekādaśī, Lakṣmīnārāyaṇa ekādaśī (Orissa).	24-Paraśurāma dvādaśī, Rukmiṇī and Pīpitaki dvādaśī (Bengal and Orissa).					
22	Wed	12	50 44 9	22	31	10	15 46	11	P. Phalgunī	13 15											
23	Thu	13	51 42 4	21	31	11	18 2	12	U. Phalgunī	16 3											
24	Fri	14	52 39 57	21	32	12	20 27	13	Hasta	19 1											
25	Sat	15	53 37 48	21	32	13	22 51	14	Citrā	21 58											
26	SUN	16	54 35 38	5 20	18 32	S 14	25 9	15	Svāti	24 50	SAURA VAIŚĀKHA	CĀNDRA CAITRA	24-Vṛṣādi (20 ^h 2 ^m)	26-Nṛsimha jayantī, Nṛsimha caturdaśī.	27-Buddha pūrṇimā, Vaiśākhī pūrṇimā, Sampat Gaurī vrata, Phuladola (Bengal), Gandheśvarī pūjā (Bengal).						
27	Mon	17	55 33 26	20	33	S 15	27 17	16	Viśākhā	27 32											
28	Tue	18	56 31 13	19	33	K 1	29 9	17	Anurādhā	- -											
29	Wed	19	57 28 59	19	34	2	- -	17	"	5 59											
30	Thu	20	58 26 43	18	34	2	6 43	18	Jyeṣṭhā	8 9											
31	Fri	May 21	59 24 25	5 18	18 35	K 3	7 56	19	Mūla	9 58	31-Trop. Gemini (20 ^h 18 ^m)										

N.B.—All timings are given in I. S. T. or the local time of the meridian of 82½° E. Long.

REFORMED CALENDAR OF INDIA

FOR ŚAKA ERA 1876 (1954-55 A.D.)

Month of **J Y A I Ś T H A** (JYĒṢṬHĀ) (31 Days)

Mithuna : Śuci Ayanāntīkā on 1st = 23° 13' 27"

Summer 2nd Month

Date	Week Day	English Date	Long. of the Sun at 5.30 A.M.	Sun Rise	Sun Set	Tithi		Nakṣatra		Solar Month	Lunar Month	Transit of the Sun	Phenomena	Festivals				
						No.	Ending Moment	No.	Name						Ending Moment			
			° ' "	h m	h m		h m		h m									
1	Sat	1954 A.D. May 22	60 22 7	5 18	18 35	K 4	8 44	20	P. Aṣādhā	11 22	CĀNDRA VAISĀKHA	3-Enters Rohiṇī (28 ^h 49 ^m)	1-Vaidhṛti (27 ^h 57 ^m)	4-Trilocanāṣṭami (Bengal).				
2	SUN	23	61 19 48	17	36	5	9 2	21	U. Aṣādhā	12 17								
3	Mon	24	62 17 27	17	36	6	8 47	22	Śravaṇa	12 39								
4	Tue	25	63 15 6	17	37	7	7 57	23	Dhanīṣṭhā	12 27								
5	Wed	26	64 12 43	17	37	8	6 31	24	Śatabhiṣaj	11 38								
						(9	28 31)											
6	Thu	27	65 10 20	5 16	18 38	K 10	25 58	25	P. Bhādrapadā	10 16	SAUBA JYAIŚṬHA			7-Aparā ekādaśī, Jalakṛīḍā ekādaśī (Orissa).				
7	Fri	28	66 7 56	16	38	11	23 0	26	U. Bhādrapadā	8 24								
8	Sat	29	67 5 31	16	38	12	19 43	27	Rovati	6 7								
						(1			Aśvini	27 35)								
9	SUN	30	68 3 5	16	39	13	16 17	2	Bharanī	24 57								
10	Mon	31	69 0 38	16	39	14	12 50	3	Kṛttikā	22 22								
11	Tue	June 1	69 58 10	5 15	18 40	K 30	9 33	4	Rohiṇī	20 2					CĀNDRA VAISĀKHA	11-New Moon (9 ^h 33 ^m)	11-Daśaharā snānārambha.	
12	Wed	2	70 55 41	15	40	5	6 34	5	Mṛgaśīras	18 5								
						(2	28 4)											
13	Thu	3	71 53 11	15	41	3	26 10	6	Ārdrā	16 41					SAUBA JYAIŚṬHA		13-Vyāntipāta (23 ^h 51 ^m)	13-Rambhā tṛtīyā, Pratāp Jayantī (Rajasthan). 14-Umā caturthī (Bengal & Orissa), Guru Arjun Dev's Martyrdom Day (Punjab). 15-Mahādeva vivāha (Orissa).
14	Fri	4	72 50 40	15	41	4	24 58	7	Punarvasu	15 57								
15	Sat	5	73 48 8	15	41	5	24 33	8	Puṣya	16 57								
16	SUN	6	74 45 35	5 15	18 42	S 6	24 54	9	Āśleṣā	16 44								
17	Mon	7	75 43 0	15	42	7	25 57	10	Maghā	18 14								
18	Tue	8	76 40 25	15	43	8	27 37	11	P. Phalgunī	20 21	CĀNDRA VAISĀKHA	17-Enters Mṛgaśīras (26 ^h 37 ^m)	16-Aranya gaurī vrata, Aranya ṣaṣṭhī (Bengal), Skanda ṣaṣṭhī (Orissa), Śītala ṣaṣṭhī (Orissa).					
19	Wed	9	77 37 48	15	43	9	—	12	U. Phalgunī	22 57								
20	Thu	10	78 35 10	15	43	9	5 43	13	Hasta	25 49								
21	Fri	11	79 32 32	5 15	18 44	S 10	8 3	14	Chitrā	28 46	SAUBA JYAIŚṬHA		21-Gaṅgā daśaharā. 22-Nirjalā ekādaśī, Devavivāha ekādaśī (Orissa). 23-Śrī Rāma dvādaśī, Campaka dvādaśī (Orissa). 25-Campaka caturdaśī (Bengal).					
22	Sat	12	80 29 52	15	44	11	10 26	15	Svātī	—								
23	SUN	13	81 27 11	15	44	12	12 41	15	"	7 39								
24	Mon	14	82 24 30	15	45	13	14 41	16	Viśākhā	10 17								
25	Tue	15	83 21 47	15	45	14	16 20	17	Anurādhā	12 37								
26	Wed	16	84 19 4	5 15	18 45	S 15	17 36	18	Jyotiṣhā	14 34	CĀNDRA VAISĀKHA	24-Mithunādi (26 ^h 40 ^m)	26-Full Moon (17 ^h 36 ^m) 27-Vaidhṛti (12 ^h 6 ^m) 27-Jupiter sets in the West.					
27	Thu	17	85 16 20	16	46	K 1	18 25	19	Mūla	16 5								
28	Fri	18	86 13 36	16	46	2	18 48	20	P. Aṣādhā	17 11								
29	Sat	19	87 10 52	16	46	3	18 45	21	U. Aṣādhā	17 52								
30	SUN	20	88 8 7	16	46	4	18 15	22	Śravaṇa	18 6								
31	Mon	June 21	89 5 21	5 16	18 47	K 5	17 20	23	Dhanīṣṭhā	17 55								

N.B.—All timings are given in I. S. T. or the local time of the meridian of 82½° E. Long

REFORMED CALENDAR OF INDIA

FOR ŚAKA ERA 1876 (1954-55 A.D.)

Karkatā : Nabhas

Ayanāntīkā on 1st = 23° 13' 32"

Month of Ā Ś Ā D H A (31 Days)

Ruina 1st Month

CR-7

Date	Week Day	English Date	Long. of the Sun at 5-30 A.M.	Sun Rise	Sun Set	Tithi		Nakṣatra			Solar Month	Lunar Month	Transit of the Sun	Phonomena	Festivals
						No.	Ending Moment	No.	Name	Ending Moment					
1954 A.D.			° ' "	h m	h m										
1	Tue	June 22	90 2 36	5 17	18 47	K 6	16 0	24	Śatabhiṣaj	17 20	CANDRA JYAIṢṬHA	14-Enters Punarvasu (25 ^h 11 ^m)	8-Vyatipāta (16 ^h 6 ^m) 9-New Moon (17 ^h 56 ^m) 9-Solar Eclipse (Total), visible in India.	1-Dakṣiṇāyana day.	
2	Wed	23	90 59 50	17	47	7	14 16	25	P. Bhādrapadā	16 21					
3	Thu	24	91 57 5	17	47	8	12 10	26	U. Bhādrapadā	15 0					
4	Fri	25	92 54 19	17	48	9	9 47	27	Revati	13 22					
5	Sat	26	93 51 33	17	48	10	7 9	1	Āśvini	11 31					
						(11	28 23)							5-Yogini (Gāndhārī) ekādaśī (Smārta).	
6	SUN	27	94 49 47	5 18	18 48	K 12	25 33	2	Bharanī	9 31	SAUBA Ā Ś Ā D H A	14-Enters Punarvasu (25 ^h 11 ^m)	8-Vyatipāta (16 ^h 6 ^m) 9-New Moon (17 ^h 56 ^m) 9-Solar Eclipse (Total), visible in India.	6-Yogini ekādaśī (Vaiṣṇava and in Bengal for all).	
7	Mon	28	95 46 2	18	48	13	23 47	3	Kṛttikā	7 31					
8	Tue	29	96 43 16	18	48	14	20 12	4	Rohiṇī	5 36					
9	Wed	30	97 40 30	19	48	K 30	17 56	6	Mṛgaśiras	27 54					
10	Thu	July 1	98 37 44	19	48	S 1	16 5	7	Ārdrā	26 34					
						S 1	16 5	7	Punarvasu	25 43			10-Manoratha dvitīyā vrata.		
11	Fri	2	99 34 58	5 19	18 48	S 2	14 47	8	Puṣya	25 26	CANDRA Ā Ś Ā D H A	14-Enters Punarvasu (25 ^h 11 ^m)	8-Vyatipāta (16 ^h 6 ^m) 9-New Moon (17 ^h 56 ^m) 9-Solar Eclipse (Total), visible in India.	11-Rathayātrā.	
12	Sat	3	100 32 12	20	48	3	14 7	9	Āślōṣā	25 47					
13	SUN	4	101 29 25	20	48	4	14 7	10	Maghā	26 50					
14	Mon	5	102 26 38	20	48	5	14 43	11	P. Phalgunī	28 31					
15	Tue	6	103 23 52	21	48	6	16 8	12	U. Phalgunī	- -					
16	Wed	7	104 21 4	5 21	18 48	S 7	17 59	12	U. Phalgunī	6 47	SAUBA Ā Ś Ā D H A	14-Enters Punarvasu (25 ^h 11 ^m)	8-Vyatipāta (16 ^h 6 ^m) 9-New Moon (17 ^h 56 ^m) 9-Solar Eclipse (Total), visible in India.	16-Vivasvat saptamī.	
17	Thu	8	105 18 17	22	48	8	20 11	13	Hasta	9 27					
18	Fri	9	106 15 29	22	48	9	22 32	14	Citrā	12 21					
19	Sat	10	107 12 42	23	48	10	24 48	15	Svātī	15 15					
20	SUN	11	108 9 54	23	48	11	26 49	16	Viśākhā	17 58					
21	Mon	12	109 7 7	5 23	18 48	S 12	28 25	17	Anurādhā	20 20	CANDRA Ā Ś Ā D H A	14-Enters Punarvasu (25 ^h 11 ^m)	8-Vyatipāta (16 ^h 6 ^m) 9-New Moon (17 ^h 56 ^m) 9-Solar Eclipse (Total), visible in India.	17-Parasūrama aṣṭamī (Orissa), Khārolī pūjā (Tripura).	
22	Tue	13	110 4 19	24	48	13	- -	18	Jyesthā	22 13					
23	Wed	14	111 1 31	24	47	13	5 30	19	Mūla	23 34					
24	Thu	15	111 58 44	24	47	14	6 1	20	P. Āṣādhā	24 22					
25	Fri	16	112 55 57	25	47	S 15	5 59	21	U. Āṣādhā	24 39					
26	Sat	17	113 53 10	5 25	18 47	K 1	5 26	22	Śravaṇa	24 27	SAUBA ŚRĀVĀṆA	14-Enters Punarvasu (25 ^h 11 ^m)	8-Vyatipāta (16 ^h 6 ^m) 9-New Moon (17 ^h 56 ^m) 9-Solar Eclipse (Total), visible in India.	20-Harīśayani ekādaśī, Ravinārayana ekādaśī (Orissa).	
27	SUN	18	114 50 24	26	47	(2	23 24)								
28	Mon	19	115 47 38	26	46	3	27 0	23	Dhanīṣṭhā	23 52					
29	Tue	20	116 44 53	27	46	4	25 16	24	Śatabhiṣaj	22 56					
30	Wed	21	117 42 9	27	46	5	23 17	25	P. Bhādrapadā	21 46					
31	Thu	July 22	118 39 25	5 27	18 45	K 7	18 53	27	U. Bhādrapadā	20 25	CANDRA Ā Ś Ā D H A	14-Enters Punarvasu (25 ^h 11 ^m)	8-Vyatipāta (16 ^h 6 ^m) 9-New Moon (17 ^h 56 ^m) 9-Solar Eclipse (Total), visible in India.	20-Nāga pañcamī (Bengal).	
						K 7	18 53	27	Revati	18 57					

N.B.—All timings are given in I. S. T. or the local time of the meridian of 82½° E. Long.

REFORMED CALENDAR OF INDIA

FOR ŚAKA ERA 1876 (1954-55 A.D.)

Month of Ś R Ā V A Ṇ A (31 Days)

Sīmha : Nabhasya Ayanāṁśa on 1st = 23° 13' 37"

Rains 2nd Month

Date	Week Day	English Date	Long. of the Sun at 5-30 A.M.	Sun Rise	Sun Set	Tithi		Nakṣatra			Solar Month	Lunar Month	Transit of the Sun	Phenomena	Festivals
						No	Ending Moment	No.	Name	Ending Moment					
			° ' "	h m	h m		h m			h m					
1	Fri	July 23	119 36 42	5 28	18 45	K 8	16 34	1	Āśvini	17 26	CĀNDRA ĀṢĀDHĀ	1-Trop. Leo (15 ^h 15 ^m)	3-Vyatipāta (6 ^h 22 ^m)	2-Ker puja (Tripura). 4-Kāmikā ekādaśī.	
2	Sat	24	120 34 0	28 45	9	14 16	2	Bharanī	15 55						
3	SUN	25	121 31 19	29 44	10	12 1	3	Kṛttikā	14 28						
4	Mon	26	122 28 39	29 44	11	9 53	4	Rohiṇī	13 9						
5	Tue	27	123 26 0	30 43	12	7 56	5	Mṛgaśiras	12 0						
6	Wed	28	124 23 22	5 30	18 43	K 13 (14 28 50)	6 13	6	Ārdrā	11 7	CĀNDRA Ś R Ā V A Ṇ A	7-New Moon (27 ^h 50 ^m)	7-Āḍi amāvasyā (S. India), Citāu amāvasyā (Orissa), Karkāṭaka vāvu (S. India). 10-Madhuśravā (Gujerat), Tilak Commemoration Day (Madhya Pradesh), Āḍi pūram (S. India—For some). 11-Āḍi pūram (S. India—For some). 12-Nāga pañcamī, Jāgratgaurī pañcamī (Orissa). 14-Luṅṭhana ṣaṣṭhī (Bengal). 15-Varalakṣmī vrata (S. India). 18-Jhulana yātrārambha. 19-Putradā (Pavitṛā) ekādaśī, Jhulana yātrārambha. 20-Buddha dvādaśī, Dāmodara dvādaśī, Viṣṇu pavitrāropanam. 21-Ākheṭaka trayodaśī (Orissa), Śiva pavitrāropanam (Orissa). 22-Varalakṣmī vrata (S. India). 23-Rakṣā bandhana, Rk-yaju Upākarma, Coconut day, Ṛṣi tarpaṇa, Solono (Pepsu), Jhulanayātrā samāpanam, Āvapi Avitṭam (S. India). 24-Independence Day, Āśūnya śayana vrata. 25-Manasā pūjā (Bengal). 26-Kajjali tṛtīyā, Aṅgabheṭa tṛtīyā (Orissa), Bahulā caturthī (Madhya Deśa). 27-Rakṣā pañcamī (Orissa), Tithi of Śrī Mādhava Deva (Assam). 28-Hala ṣaṣṭhī. 29-Śītalā saptamī, Janmāṣṭamī—Smārta (S. India), Śrī Jayantī. 30-Janmāṣṭamī, Gokulāṣṭamī. 31-Pañcarātra Śrī Kṛṣṇa Jayantī.		
7	Thu	29	125 20 45	30 42	K 30	27 50	7	Punarvasu	10 34						
8	Fri	30	126 18 8	31 42	S 1	27 18	8	Puṣya	10 25						
9	Sat	31	127 15 33	31 41	2	27 18	9	Āśleṣā	10 45						
10	SUN	Aug. 1	128 12 58	32 41	3	27 53	10	Maghā	11 38						
11	Mon	2	129 10 23	5 32	18 40	S 4	29 2	11	P. Phalgunī	13 5	SAURA Ś R Ā V A Ṇ A	11-Enters Āśleṣā (23 ^h 34 ^m)	15-Vaidhṛtī (29 ^h 0 ^m)		
12	Tue	3	130 7 50	32 40	5	—	12	U. Phalgunī	15 4						
13	Wed	4	131 5 17	33 39	5	6 43	13	Hasta	17 32						
14	Thu	5	132 2 45	33 39	6	8 49	14	Citrā	20 20						
15	Fri	6	133 0 14	34 38	7	11 9	15	Svāti	23 16						
16	Sat	7	133 57 43	5 34	18 37	S 8	13 31	16	Viśākhā	26 9	CĀNDRA Ś R Ā V A Ṇ A	23-Full Moon (16 ^h 33 ^m)			
17	SUN	8	134 55 13	35 37	9	15 41	17	Anurādhā	28 43						
18	Mon	9	135 52 44	35 36	10	17 26	18	Jyēṣṭhā	—						
19	Tue	10	136 50 16	35 35	11	18 37	18	"	6 49						
20	Wed	11	137 47 49	36 35	12	19 7	19	Mūla	8 17						
21	Thu	12	138 45 22	5 36	18 34	S 13	18 55	20	P. Āṣādhā	9 4	SAURA BHĀDRAPADA	25-Enters Maghā (21 ^h 16 ^m) 25-Simbhādi (21 ^h 49 ^m)			
22	Fri	13	139 42 57	37 33	14	18 2	21	U. Āṣādhā	9 11						
23	Sat	14	140 40 33	37 32	S 15	16 33	22	Śravaṇa	8 39						
24	SUN	15	141 38 10	37 32	K 1	14 34	23	Dhanīṣṭhā	7 36						
25	Mon	16	142 35 48	38 31	2	12 14	24	Śatabhiṣaj (25 P. Bhādrapadā)	6 8 28 25						
26	Tue	17	143 33 27	5 38	18 30	K 3	9 40	26	U. Bhādrapadā	26 32	CĀNDRA Ś R Ā V A Ṇ A	28-Vyatipāta (18 ^h 35 ^m)			
27	Wed	18	144 31 8	39 29	4	6 59	27	Revatī	24 40						
						(5 28 20)									
28	Thu	19	145 28 51	39 29	6	25 47	1	Āśvini	22 53						
29	Fri	20	146 26 35	39 28	7	23 26	2	Bharanī	21 17						
30	Sat	21	147 24 21	40 27	S 8	21 20	3	Kṛttikā	19 57						
31	SUN	Aug. 22	148 22 9	5 40	18 26	K 9	19 32	4	Rohiṇī	18 53					

N.B.—All timings are given in I. S. T. or the local time of the meridian of 82½° E. Long.

REFORMED CALENDAR OF INDIA

FOR ŚAKA ERA 1876 (1954-55 A.D.)

Kanyā : Iṣa

Ayanānīsa on 1st = 23° 13' 42"

Month of B H Ā D R A (BHĀDRAPADA) (31 Days)

Autumn 1st Month

Date	Week Day	English Date	Long. of the Sun at 5-30 A.M.	Sun Rise	Sun Set	Tithi		Nakṣatra			Solar Month	Lunar Month	Transit of the Sun	Phenomena	Festivals
						No.	Ending Moment	No.	Name	Ending Moment					
1954 A.D.			o ' "	h m	h m		h m			h m					
1	Mon	Aug. 23	149 19 58	5 40	18 25	K 10	18 3	5	Mṛgāśiras	18 9	CĀNDRA ŚRĀVAṆA	1-Trop. Virgo (22 ^h 6 ^m)		2-Ajā ekādaśī, Kālidāna ekādaśī (Orissa). 3-Paryuṣaṇa parvārambha (Jain-pañcamī pakṣa). 4-Aghora caturdaśī (Bengal & Orissa). 6-Āloka amāvasyā (Bengal), Kuśotpāṭinī (Pithorī) amāvasyā, Saptapuri amāvasyā (Orissa). 7-Rudravrata. 8-Tithi of Śrī Śaṅkara Deva (Assam). 9-Haritalikā tṛtīyā, Gaurī tṛtīyā (Mysore). 10-Gaṇeśa caturthī, Varadā caturthī, Saubhāgya caturthī (Bengal), Saṁvatsarī (Jain-caturthī pakṣa), Haritalī caturthī.	
2	Tue	24	150 17 49	41	24	11	16 53	6	Ārdrā	17 43					
3	Wed	25	151 15 42	41	23	12	16 4	7	Punarvasu	17 39					
4	Thu	26	152 13 36	41	23	13	15 36	8	Puṣya	17 55					
5	Fri	27	153 11 32	42	22	14	15 31	9	Āśleṣā	18 33					
6	Sat	28	154 9 30	5 42	18 21	K 30	15 51	10	Maghā	19 36	SAURA BHĀDRAPADA	8-Enters P. Phalgunī (17 ^h 10 ^m)	6-New Moon (15 ^h 51 ^m)	10-Vaidhṛtī (11 ^h 41 ^m)	
7	SUN	29	155 7 29	42	20	S 1	16 37	11	P. Phalgunī	21 5					
8	Mon	30	156 5 30	43	19	2	17 51	12	U. Phalgunī	23 1					
9	Tue	31	157 3 32	43	18	3	19 32	13	Hasta	25 22					
10	Wed	Sept. 1	158 1 36	43	17	4	21 37	14	Citrā	28 6	SAURA BHĀDRAPADA		11-Ṛṣi pañcamī & Rakṣā pañcamī (Bengal), Saṁvatsarī (Bombay, Surat & Ahmedabad), Paryuṣaṇa parva samāpana (Jain-pañcamī pakṣa), Guru pañcamī (Orissa). 12-Sūrya ṣaṣṭhī, Lolārka ṣaṣṭhī, Carpatā ṣaṣṭhī (Bengal), Somanātha vrata (Orissa), Manthāna ṣaṣṭhī (Bengal), Keil Muhurth (Coorg). 13-Muktābharāṇa vrata, Lalitā saptamī (Bengal). 14-Dūrvāṣṭamī Rādhaṣṭamī, Mahālakṣmī vrata, Durgā śayani (Orissa). 15-Aduḥkha navamī, Nandā navamī, Tāla navamī (Bengal), Āvaṇī mūlam (Madras). 18-Parivartana (Padmā) ekādaśī, Śravaṇa dvādaśī, Vāmana jayantī, First Onam Day (S. India). Dol Gyaras (Madhya Bharat), Heikra Hitamba (Manipur), Lakṣmīnārāyaṇa ekādaśī (Orissa). 19-Śakrotthāna, Kalkī dvādaśī, Viṣṇu parivartanotsava, Thiru Onam Day (S. India). 20-Ananta caturdaśī, Third Onam Day (S. India). 21-Indra-Govinda pūjā (Orissa), Fourth Onam Day (S. India), Śrī Nārāyaṇa Gūru Deva's Birthday (Madras). 22-Mahālayārambha. 23-Aśvīnya sayana vrata. 25-Viśvakarmā pūjā (Bengal). 26-Candra ṣaṣṭhī. 28-Mahālakṣmī vrata, Jitāṣṭamī (Bengal), Mūlāṣṭamī (Orissa). 29-Mātṛnavamī, Abidhavā navamī, Durgā navamī (Mahārāstra). 30-Samādhi Day of Nārāyaṇa Gūru (T. C. State). 31-Indirā ekādaśī.		
11	Thu	2	158 59 42	5 44	18 16	S 5	24 0	15	Svātī	- -					
12	Fri	3	159 57 48	44	15	6	26 29	15	Viśakhā	7 4					
13	Sat	4	160 55 56	44	14	7	28 53	16	Anurādhā	10 5					
14	SUN	5	161 54 6	45	13	8	- -	17	Jyēṣṭhā	12 57					
15	Mon	6	162 52 17	45	12	8	6 57	18		15 26					
16	Tue	7	163 50 30	5 45	18 11	S 9	8 28	19	Mūla	17 19	CĀNDRA BHĀDRAPADA	22-Enters U. Phalgunī (11 ^h 1 ^m)	23-Vyatipāta (9 ^h 42 ^m)		
17	Wed	8	164 48 44	46	10	10	9 16	20	P. Āṣādhā	18 29					
18	Thu	9	165 46 59	46	9	11	9 16	21	U. Āṣādhā	18 50					
19	Fri	10	166 45 17	46	8	12	8 26	22	Śravaṇa	18 24					
20	Sat	11	167 43 35	46	7	13	6 51	23	Dhaniṣṭhā	17 14					
21	SUN	12	168 41 56	5 47	18 6	S 15	25 49	24	Śatabhiṣaj	15 29	SAURA ĀŚVINA	25-Kanyādi (21 ^h 40 ^m)			
22	Mon	13	169 40 18	47	5	K 1	22 42	25	P. Bhādrapadā	13 17					
23	Tue	14	170 38 42	47	4	2	19 24	26	U. Bhādrapadā	10 50					
24	Wed	15	171 37 8	48	3	3	16 5	27	Revatī	8 18					
25	Thu	16	172 35 36	48	2	4	12 55	1	Aśvini	5 52					
26	Fri	17	173 34 6	5 48	18 1	K 5	10 1	3	Kṛttikā	25 49	SAURA BHĀDRAPADA				
27	Sat	18	174 32 38	49	18 0	6	7 31	4	Rohiṇī	24 25					
28	SUN	19	175 31 13	49	17 59	(7 29 30)	8	27 59	5	Mṛgāśiras			23 32		
29	Mon	20	176 29 50	49	58	9	27 0	6	Ārdrā	23 9					
30	Tue	21	177 28 29	50	57	10	26 30	7	Punarvasu	23 16					
31	Wed	Sept. 22	178 27 10	5 50	17 56	K 11	26 28	8	Puṣya	23 50					

N.B.—All timings are given in I. S. T. or the local time of the meridian of 82½° E. Long.

REFORMED CALENDAR OF INDIA

FOR ŚAKA ERA 1876 (1954-55 A.D.)

Month of Ā Ś V I N A (30 Days)

Tulā : Ūrja

Ayanāmsā on 1st = 23° 13' 45"

Autumn 2nd Month

Date	Week Day	English Date	Long. of the Sun at 5-30 A.M.	Sun Rise	Sun Set	Tithi		Nakṣatra			Solar Month	Lunar Month	Transit of the Sun	Phenomena	Festivals
						No.	Ending Moment	No.	Name	Ending Moment					
1954 A.D.			° ' "	h m	h m		h m			h m					
1	Thu	Sept. 23	179 25 53	5 50	17 55	K 12	26 53	9	Āśleṣā	24 50	CĀNDRA BHĀDRAPĀDA	1-Trop Libra (19 ^h 26 ^m) 4-Enters Hasta (26 ^h 30 ^m)	4-Vaidhṛti (18 ^h 2 ^m) 5-New Moon (6 ^h 20 ^m)	1-Pakṣavardhini mahādvādaśī, Jalaviṣuva day. 2-Magha trayodaśī. 4-Mahālayā amāvasyā, Sarvapitr amāvasyā. 6-Navarātrāmbha.	
2	Fri	24	180 24 39	50	54	13	27 39	10	Maghā	26 13					
3	Sat	25	181 20 27	51	53	14	28 49	11	P. Phalgunī	27 57					
4	SUN	26	182 22 17	51	52	30	— —	12	U. Phalgunī	— —					
5	Mon	27	183 21 8	52	51	K 30	6 20	12	"	6 2					
6	Tue	28	184 20 2	5 52	17 50	S 1	8 12	13	Hasta	8 26	SAUBRA Ā Ś V I N A	6-Navarātrāmbha.			
7	Wed	29	185 18 58	52	49	2	10 24	14	Citrā	11 9					
8	Thu	30	186 17 56	53	48	3	12 50	15	Svātī	14 7					
9	Fri	Oct. 1	187 16 56	53	47	4	15 25	16	Viśākhā	17 12					
10	Sat	2	188 15 57	53	46	5	18 0	17	Anurādhā	20 16					
11	SUN	3	189 15 0	5 53	17 45	S 6	20 21	18	Jyesthā	23 6	SAUBRA Ā Ś V I N A	9-Māna caturthī (Bengal). 10-Mahatma Gandhi's Birthday, Nata pañcamī (Orissa), Upānga lalitāvratā (Maharashtra). 11-Mahāśaṣṭhī, Durgāśaṣṭhī (Bengal), Tapahśaṣṭhī (Orissa). 12-Durgā pūjā, Sarasvatī sthāpana, Oli beginning (Jain). 13-Mahāṣṭamī, Viniṣṭamī, Sarasvatī pūjā. 14-Mahānavamī, Āyudha pūjā, Sarasvatī balidāna.			
12	Mon	4	190 14 5	54	44	7	22 17	19	Mūla	25 30					
13	Tue	5	191 13 12	54	43	8	23 34	20	P. Āṣāḍhā	27 15					
14	Wed	6	192 12 21	55	42	9	24 3	21	U. Āṣāḍhā	28 14					
15	Thu	7	193 11 31	55	41	10	23 40	22	Śravaṇa	28 20					
16	Fri	8	194 10 43	5 55	17 40	S 11	22 24	23	Dhanīṣṭhā	27 36	CĀNDRA Ā Ś V I N A	15-Vijyā daśamī, Daśaharā, Sarasvatī visarjana, Sudaśā vrata (Orissa). 16-Pāpānkuśā ekādaśī, Bharat Milap. 17-Padmanāva dvādaśī. 19-Kojāgarī Lakṣmī pūjā, Kumāra pūrṇimā (Orissa). 20-Oli ends (Jain), Mahārjī Vālmiki's birthday (Punjab). 21-Aśūnya śayana vrata.			
17	Sat	9	195 9 57	56	39	12	20 20	24	Śatabhiṣaj	26 5					
18	SUN	10	196 9 13	56	38	13	17 34	25	P. Bhādrapadā	23 55					
19	Mon	11	197 8 31	57	37	14	14 17	26	U. Bhādrapadā	21 17					
20	Tue	12	198 7 50	57	36	S 15	10 40	27	Revatī	18 22					
21	Wed	13	199 7 12	5 57	17 36	K 1	6 53	1	Āśvinī	15 22	SAUBRA KĀRTIKA	23-Karka caturthī, Daśaratha caturthī (Bengal). 25-Kāverī sarikramaṇa. 26-Ahoyī aṣṭamī (Gujerat), Karṣṭamī (Maharashtra). 29-Vaidhṛti (23 ^h 27 ^m) 30-Ramā ekādaśī, Govatsa dvādaśī.			
22	Thu	14	200 6 36	58	35	(2	27 8)	2	Bharanī	12 29					
23	Fri	15	201 6 1	58	34	3	23 36	3	Kṛttikā	9 53					
24	Sat	16	202 5 30	59	33	4	20 27	4	Rohiṇī	7 44					
25	SUN	17	203 5 0	59	32	5	17 49	5	Mrgāśiras	6 9					
26	Mon	18	204 4 33	5 59	17 31	(6	15 47)	6	Ārdrā	29 13)	SAUBRA KĀRTIKA	25-Tulādi (9 ^h 32 ^m)			
27	Tue	19	205 4 8	6 0	30	7	14 25	7	Punarvasu	28 57					
28	Wed	20	206 3 45	6 0	30	8	13 45	8	Puṣya	29 21					
29	Thu	21	207 3 25	1	29	9	13 44	9	Āśleṣā	— —					
30	Fri	Oct. 22	208 3 7	6 1	17 28	10	14 19	9	"	6 21					
						K 11	15 24	10	Maghā	7 51					

N.B.—All timings are given in I. S. T. or the local time of the meridian of 82½° E. Long.

REFORMED CALENDAR OF INDIA

FOR ŚAKA ERA 1876 (1954-55 A.D.)

Vṛścika : Sahas

Ayanānīśa on 1st = 23° 13' 48"

Month of K Ā R T I K A (30 Days)

Hemanta 1st Month

C.R.-8

Date	Week Day	English Date	Long. of the Sun at 5-30 A.M.	Sun Rise	Sun Set	Tithi		Nakṣatra			Solar Month	Lunar Month	Transit of the Sun	Phenomena	Festivals
						No.	Ending Moment	No.	Name	Ending Moment					
1954 A.D.			° ' "	h m	h m	h m	h m	h m	h m	h m					
1	Sat	Oct. 23	209 2 51	6 2	17 27	K 12	16 55	11	P. Phalgunī	9 48	CANDRA ASVINA	1-Enters Svāti (25 ^h 58 ^m) 1-Trop. Scorpio (28 ^h 27 ^m)	4-New Moon (23 ^h 17 ^m)	2-Dhana trayodaśī, Yamadīpadāna. 3-Śastrāhata caturdaśī, Naraka caturdaśī, Bhūta caturdaśī (Bengal), Kālī pūjā, Dipāvālī, Hanumat janmadina. 4-Dīpāvālī, Mahālakṣmī pūjā, Mahāvīra nirvāṇa (Jain), Kēthār Gaurī vrata (S. India). 5-Bali pūjā, Govardhana pūjā, Dyūta pratīpad, Annakūṭa. 6-Yama dvitīyā, Bhrātṛdvitīyā, Dwāt pūjā (Bihar). 7-Ālocanā Gaurī vrata. 8-Nāga caturthī. 10-Jñāna pañcamī (Jain), Skanda ṣaṣṭhī (Madras), Chhat (Bihar).	
2	SUN	24	210 2 37	2	26	13	18 47	12	U. Phalgunī	12 6					
3	Mon	25	211 2 25	3	26	14	20 55	13	Hasta	14 40					
4	Tue	26	212 2 16	3	25	K 30	23 17	14	Citrā	17 28					
5	Wed	27	213 2 8	4	24	S 1	25 48	15	Svāti	20 26					
6	Thu	28	214 2 3	6 4	17 23	S 2	28 25	16	Viśakhā	23 30	SAURA KĀRTIKA	15-Enters Viśakhā (10 ^h 2 ^m)	16-Venus sets in the West	11-Sūrya ṣaṣṭhī, Nāḍī ṣaṣṭhī (Bengal). 13-Gopāṣṭamī, Goṣṭhāṣṭamī. 14-Jagaddhātṛī pūjā (Bengal), Dūrgā navamī, Anlā navamī (Orissa), Akṣaya navamī, Gaurī vrata (Bengal), Viṣṇu trīrātra. 16-Bhīṣma pañcaka, Prabodhanī ekādaśī, Tulasī vivāha, Ravinārāyāna ekādaśī (Orissa), Narāyaṇa dvādaśī, Vṛndāvana dvādaśī, Pravodhanotsava. 18-Vaikunṭha caturdaśī, Cāturmāsya caturdaśī (Jain), Baḍa-Oṣā (Orissa). 19-Tripurotsava, Rāsayātrā, Rathayātrā (Jain), Kedāra vrata (Orissa), Guru Nanak's Birth Day. Kārtikī pūrṇimā, Annābhīṣekam (S. India), Puṣkar Fair (Ajmer).	
7	Fri	29	215 1 59	5	23	3	— —	17	Anurādhā	26 34					
8	Sat	30	216 1 57	5	22	3	7 1	18	Jyeṣṭhā	29 31					
9	SUN	31	217 1 56	6	22	4	9 28	19	Mūla	— —					
10	Mon	Nov. 1	218 1 58	6	21	5	11 36	19	"	8 11					
11	Tue	2	219 2 1	6 7	17 20	S 6	13 14	20	P. Āṣādhā	10 24					
12	Wed	3	220 2 6	8	20	7	14 13	21	U. Āṣādhā	12 0					
13	Thu	4	221 2 12	8	19	8	14 24	22	Śravaṇa	12 51					
14	Fri	5	222 2 20	9	19	9	13 45	23	Dhanīṣṭhā	12 53					
15	Sat	6	223 2 29	9	18	10	12 15	24	Śatabhiṣaj	12 6					
16	SUN	7	224 2 40	6 10	17 18	S 11	9 59	25	P. Bhādrapadā	10 32	SAURA KĀRTIKA	15-Enters Viśakhā (10 ^h 2 ^m)	16-Venus sets in the West	18-Vaikunṭha caturdaśī, Cāturmāsya caturdaśī (Jain), Baḍa-Oṣā (Orissa). 19-Tripurotsava, Rāsayātrā, Rathayātrā (Jain), Kedāra vrata (Orissa), Guru Nanak's Birth Day. Kārtikī pūrṇimā, Annābhīṣekam (S. India), Puṣkar Fair (Ajmer).	
17	Mon	8	225 2 53	10	17	12	7 3	26	U. Bhādrapadā	8 19					
						(13	27 39)	(27	Revatī	29 37)					
18	Tue	9	226 3 7	11	17	14	23 53	1	Āśvinī	26 37					
19	Wed	10	227 3 22	12	16	S 15	19 59	2	Bharaṇī	23 29					
20	Thu	11	228 3 40	12	16	K 1	16 8	3	Kṛttikā	20 26					
21	Fri	12	229 3 59	6 13	17 15	K 2	12 31	4	Rohiṇī	17 39	CANDRA ASVINA	25-Vṛścikādi (9 ^h 15 ^m)	25-Vaidhṛtī (6 ^h 45 ^m)	26-Kālāṣṭamī, Bhairavāṣṭamī, Prathamāṣṭamī (Orissa), Death Anniversary of Lala Lajpat Rai. 27-Kāñjī anlā navamī (Orissa). 30-Utpannā ekādaśī, Unmilanī mahādvādaśī.	
22	Sat	13	230 4 20	14	15	3	9 18	5	Mṛgaśīras	15 19					
	SUN	14	231 4 42	14	15	4	6 39	6	Ādrā	13 34					
23						(5	28 40)								
24	Mon	15	232 5 7	15	14	6	27 26	7	Punarvasu	12 31					
25	Tue	16	233 5 33	16	14	7	26 59	8	Puṣya	12 13					
26	Wed	17	234 6 2	6 16	17 14	K 8	27 17	9	Āśleṣā	12 40					
27	Thu	18	235 6 32	17	13	9	28 18	10	Maghā	13 51					
28	Fri	19	236 7 4	18	13	10	29 53	11	P. Phalgunī	15 39					
29	Sat	20	237 7 38	18	13	11	— —	12	U. Phalgunī	17 57					
30	SUN	Nov. 21	238 8 13	6 19	17 13	K 11	7 55	13	Hasta	20 36					

[48]

N. B.—All timings are given in I. S. T. or the local time of the meridian of 82½° E. Long.

REFORMED CALENDAR OF INDIA

FOR ŚAKA ERA 1876 (1954-55 A.D.)

Dhanuḥ : Sahasya Ayanāmsā on 1st = 23° 13' 52"

Month of AGRHĀYANA (MARGAŚIRṢA) (30 Days) Hemanta 2nd Month

Date	Week Day	English Date	Long. of the Sun at 5-30A.M.	Sun Rise	Sun Set	Tithi		Nakṣatra			Solar Month	Lunar Month	Transit of the Sun	Phenomena	Festivals
						No.	Ending Moment	No.	Name	Ending Moment					
1954 A.D.			o ' "	h m	h m		h m			h m					
1	Mon	Nov. 22	239 8 51	6 20	17 12	K 12	10 16	14	Citrā	23 30	CĀNDRA KĀRTIKA	1-Trop. Sagittarius (25 ^h 45 ^m)	4-New Moon (18 ^h 0 ^m)	4-Dīpāvalī amāvāsya (Orissa). 5-Rudropavāsa.	
2	Tue	23	240 9 29	20	12	13	12 48	15	Svāti	26 31					
3	Wed	24	241 10 10	21	12	14	15 25	16	Viśākhā	29 34					
4	Thu	25	242 10 52	22	12	K 30	18 0	17	Anurādhā	- -					
5	Fri	26	243 11 35	22	12	S 1	20 29	17	"	8 32					
6	Sat	27	244 12 20	6 23	17 12	S 2	22 46	18	Jyeṣṭhā	11 22	SAURA MĀRGASĪRṢA	8-Vyatipāta (22 ^h 22 ^m)	9-Nāga pañcamī (2nd), Sahid Day of Śrī Guru Teg Bahadur (Punjab). 10-Guha ṣaṣṭhī (Bengal), Mūlakarūpiṇī ṣaṣṭhī (Bengal), Prīvarāṇa ṣaṣṭhī (Orissa), Skanda ṣaṣṭhī, Campā ṣaṣṭhī (Maharashtra), Subrahmanya ṣaṣṭhī (Coorg). 11-Mitra saptamī.		
7	SUN	28	245 13 5	24	12	3	24 46	19	Mūla	13 57					
8	Mon	29	246 13 52	24	12	4	26 22	20	P. Āṣāḍhā	16 13					
9	Tue	30	247 14 40	25	12	5	27 28	21	U. Āṣāḍhā	18 2					
10	Wed	Dec. 1	248 15 30	26	12	6	27 57	22	Śravaṇa	19 18					
11	Thu	2	249 16 20	6 27	17 12	S 7	27 47	23	Dhaniṣṭhā	19 57	CĀNDRA MĀRGASĪRṢA	11-Enters Jyeṣṭhā (20 ^h 19 ^m)	15-Mokṣadā ekādaśī, Mauna ekādaśī (Jain).		
12	Fri	3	250 17 10	27	12	8	26 54	24	Śatabhiṣaj	19 55					
13	Sat	4	251 18 2	28	12	9	25 19	25	P. Bhādrapadā	19 12					
14	SUN	5	252 18 55	29	12	10	23 6	26	U. Bhādrapadā	17 49					
15	Mon	6	253 19 48	29	13	11	20 19	27	Revati	15 52					
16	Tue	7	254 20 42	6 30	17 13	S 12	17 6	1	Āsvini	13 28	SAURA MĀRGASĪRṢA	18-Full Moon (30 ^h 26 ^m)	16-Akhaṇḍa dvādaśī, Matsya dvādaśī, Vyañjana and Dāna dvādaśī (Orissa), Bharatī Dīpam (S. India). 17-Pāṣāṇa caturdaśī (Bengal & Orissa), Kṛttikā dīpam (S. India). 18-Dattātreyā jayantī, Vaikhānas dīpam (S. India).		
17	Wed	8	255 21 37	30	13	13	13 37	2	Bharatī	10 45					
18	Thu	9	256 22 33	31	13	14	10 0	3	Kṛttikā	7 53					
19	Fri	10	257 23 29	32	13	(S 15 30 26)	(4 30 26)	(4	Robhī	29 4)					
20	Sat	11	258 24 27	33	14	K 1	27 6	5	Mṛgaśiras	26 26					
21	SUN	12	259 25 25	6 33	17 14	K 3	21 42	7	Punarvasu	22 28	CĀNDRA MĀRGASĪRṢA	20-Vaidhṛti (20 ^h 26 ^m)	24-Enters Mūla (23 ^h 23 ^m) 24-Dhanurādi (23 ^h 49 ^m)		
22	Mon	13	260 26 24	34	14	4	19 55	8	Puṣya	21 24					
23	Tue	14	261 27 25	34	15	5	18 54	9	Āśleṣā	21 5					
24	Wed	15	262 28 26	35	15	6	18 41	10	Maghā	21 32					
25	Thu	16	263 29 28	35	15	7	19 17	11	P. Phalgunī	22 46					
26	Fri	17	264 30 32	6 36	17 16	K 8	20 36	12	U. Phalgunī	24 41	SAURA PAUṢA	26-Pūpāṣṭakā. 28-Pauṣa daśamī (Jain). 29-Saphalā ekādaśī.			
27	Sat	18	265 31 36	37	16	9	22 32	13	Hasta	27 10					
28	SUN	19	266 32 41	37	16	10	24 54	14	Citrā	30 1					
29	Mon	20	267 33 47	38	17	11	27 30	15	Svāti	- -					
30	Tue	Dec. 21	268 34 54	6 38	17 17	K 12	30 10	15	"	9 4					

N. B.—All timings are given in I. S. T. or the local time of the meridian of 82½° E. Long.

REFORMED CALENDAR OF INDIA

FOR ŚAKA ERA 1876 (1954-55 A.D.)

Makara : Tapas

Ayanāmsā on 1st = 23° 13' 58"

Month of P A U Ś A (30 Days)

Winter 1st Month

Date	Week Day	English Date	Long. of the Sun at 5-30 A.M.	Sun Rise	Sun Set	Tithi		Nakṣatra			Solar Month	Lunar Month	Transit of the Sun	Phenomena	Festivals
						No.	Ending Moment	No.	Name	Ending Moment					
			° ' "	h m	h m		h m			h m					
1954 A.D.															
1	Wed	Dec. 22	269 36 1	6 39	17 18	K 13	— —	16	Viśākhā	12 7	CĀNDRA MĀRGASĪRŚA	1-Trop. Capricornus (14 ^h 54 ^m)	3-Vyatipāta (26 ^h 11 ^m) 4-New Moon (13 ^h 3 ^m) 4-Solar Eclipse (Annular) invisible in India.	1-Uttarāyaṇa Day.	
2	Thu	23	270 37 9	39	18	13	8 44	17	Anurādhā	15 3				4-Vakula amāvasyā (Orissa).	
3	Fri	24	271 38 18	40	19	14	11 3	18	Jyeṣṭhā	17 45					
4	Sat	25	272 39 27	40	19	K 30	13 3	19	Mūla	20 6					
5	SUN	26	273 40 37	41	20	S 1	14 40	20	P. Āṣādhā	22 6					
6	Mon	27	274 41 47	6 41	17 21	S 2	15 51	21	U. Āṣādhā	23 40	SAURA PAUŚA	7-Enters P. Āṣādhā (25 ^h 32 ^m)	9-Guru pañcamī (Orissa). 10-Annarūpā ṣaṣṭhī (Bengal).		
7	Tue	28	275 42 56	42	21	3	16 35	22	Śravaṇa	24 47					
8	Wed	29	276 44 6	42	22	4	16 51	23	Dhaniṣṭhā	25 28					
9	Thu	30	277 45 16	42	22	5	16 38	24	Śatabhiṣaj	25 40					
10	Fri	31	278 46 26	43	23	6	15 56	25	P. Bhādrapadā	25 24					
1955 A.D.															
11	Sat	Jan. 1	279 47 36	6 43	17 24	S 7	14 45	26	U. Bhādrapadā	24 39	CĀNDRA PAUŚA	20-Enters U. Āṣādhā (27 ^h 33 ^m)	18-Full Moon (18 ^h 14 ^m)	11-English New Year's Day. Guru Govinda Singh's Birthday.	
12	SUN	2	280 48 46	43	24	8	13 5	27	Revatī	23 28					
13	Mon	3	281 49 55	44	25	9	11 1	1	Āśvini	21 54					
14	Tue	4	282 51 4	44	26	10	8 34	2	Bharanī	20 0					
15	Wed	5	283 52 13	44	26	(11 29 50)	12	26 54	3	Kṛttikā				17 51	14-Śamba daśamī (Orissa), Putradā (Gāndhārī) ekādaśī (Śmārta). 15-Vaikunṭha ekādaśī (Madras), Putradā ekādaśī (Vaiṣṇava and in Bengal for all), Kūrma dvādaśī.
16	Thu	6	284 53 22	6 44	17 27	S 13	23 55	4	Rohiṇī	15 36	SAURA MĀGHĀ	24-Makarādi (10 ^h 28 ^m)	23-Bhogī (S. India). 24-Makarādi snāna, Pongal (S. India), Tila saṅkrāntī, Māgha Bihu (Assam). 25- Mattu pongal (S. India).		
17	Fri	7	285 54 30	44	28	14	20 58	5	Mṛgaśīras	13 20					
18	Sat	8	286 55 38	45	28	S 15	18 14	6	Ārdra	11 14					
19	SUN	9	287 56 45	45	29	K 1	15 50	7	Punarvasu	9 24					
20	Mon	10	288 57 53	45	30	2	13 55	8	Puṣyā	8 1					
21	Tue	11	289 59 0	6 45	17 30	K 3	12 35	9	Āśleṣā	7 12	SAURA MĀGHĀ	30-Trop. Aquarius (25 ^h 32 ^m)	28-Vyatipāta (30 ^h 15 ^m)	26-Mānsāṣṭakā.	
22	Wed	12	291 0 8	45	31	4	11 59	10	Maghā	7 3					
23	Thu	13	292 1 15	45	32	5	12 8	11	P. Phalgunī	7 38					
24	Fri	14	293 2 22	45	33	6	13 4	12	U. Phalgunī	8 57					
25	Sat	15	294 3 29	45	33	7	14 41	13	Hasta	10 58					
26	SUN	16	295 4 35	6 45	17 34	K 8	16 53	14	Citrā	13 32	SAURA MĀGHĀ	29-Ṣaṭtilā ekādaśī.			
27	Mon	17	296 5 42	45	35	9	19 25	15	Svātī	16 29					
28	Tue	18	297 6 48	45	35	10	22 5	16	Viśākha	19 33					
29	Wed	19	298 7 54	45	36	11	24 39	17	Anurādhā	22 33					
30	Thu	Jan. 20	299 9 0	6 45	17 37	K 12	26 53	18	Jyeṣṭhā	25 15					

N.B.—All timings are given in I. S. T. or the local time of the meridian of 82½° E. Long.

REFORMED CALENDAR OF INDIA

FOR ŚAKA ERA 1876 (1954-55 A.D.)

Month of M Ā G H A (30 Days)

Kumbha : Tapasya

Ayanāmsā on 1st = 23° 14' 3"

Winter 2nd Month

Date	Week Day	English Date	Long. of the Sun at 5-30 A.M.	Sun Rise	Sun Set	Tithi		Nakṣatra			Solar Month	Lunar Month	Transit of the Sun	Phenomena	Festivals		
						No.	Ending Moment	No.	Name	Ending Moment							
			o ' "	h m	h m		h m			h m							
1955 A.D.																	
1	Fri	Jan. 21	300 10 5	6 45	17 37	K 13	28 40	19	Mūla	27 32	CĀNDRA PAUṢĀ	3-Enters Śravaṇa (29 ^h 48 ^m)	3-New Moon (30 ^h 36 ^m)	1-Meru trayodaśī (Jain).			
2	Sat	22	301 11 9	45	38	14	29 55	20	P. Āṣāḍhā	29 18				2-Yama tarpaṇa, Raṭantī Kālī pūjā (Bengal).			
3	SUN	23	302 12 13	45	39	K 30	30 36	21	U. Āṣāḍhā	30 33				3-Maunī amāvasyā (Uttar Pradesh),			
4	Mon	24	303 13 17	44	40	S 1	— —	22	Śravaṇa	— —				Thai amāvasyā (S. India), Makara vāyu (T. C. State),			
5	Tue	25	304 14 19	44	40	S 1	6 45	22	"	7 16				Triveṇī amāvasyā (Orissa), Netaji's Birthday.			
						(2	30 25)										
6	Wed	26	305 15 21	6 44	17 41	S 3	29 38	23	Dhanīṣṭhā	7 30	SAURA MĀGHA	17-Enters Dhanīṣṭhā (8 ^h 57 ^m)	18-Full Moon (7 ^h 13 ^m)	6-Republic day.			
7	Thu	27	306 16 22	44	42	4	28 31	24	Śatabhiṣaj	7 20				7-Varaḍā caturthī, Tila caturthī, Kunda caturthī,			
8	Fri	28	307 17 22	43	42	5	27 5	25	P. Bhādrapadā	6 49				Gaṇeśa pūjā (Bengal), Gaṇeśa jayantī.			
						(26	30 2)		U. Bhādrapadā	30 2				8-Śrī pañcamī, Vasanta pañcamī, Madana pañcamī.			
9	Sat	29	308 18 20	43	43	6	25 26	27	Revatī	29 1				9-Śitalā ṣaṣṭhī (Bengal).			
10	SUN	30	309 19 18	43	44	7	23 35	1	Āśvini	27 48				10-Ratha saptamī, Acalī saptamī, Ārogya and Vidhāna saptamī, (Bengal), Candrabhāgā saptamī (Orissa).			
11	Mon	31	310 20 14	6 42	17 45	S 8	21 34	2	Bharanī	26 27				CĀNDRA MĀGHA	23-Kumbhādi (23 ^h 24 ^m)	24-Vyatipāta (10 ^h 39 ^m)	11-Vaidhṛtī (24 ^h 41 ^m)
12	Tue	Feb. 1	311 21 9	42	45	9	19 26	3	Kṛttikā	25 0							11-Bhīṣmaṣṭamī.
13	Wed	2	312 22 2	42	46	10	17 14	4	Robhīṇī	23 23							12-Mahānandā navamī.
14	Thu	3	313 22 54	41	47	11	15 0	5	Mṛgāśīras	21 56							14-Jayā ekādaśī, Bhaimī ekādaśī, Lakṣmīnāryaṇa ekādaśī (Orissa).
15	Fri	4	314 23 45	41	47	12	12 47	6	Ārdrā	20 27	15-Bhīṣma dvādaśī, Varāha dvādaśī, Āmalaka dvādaśī (Orissa), Santāna dvādaśī (Orissa).						
16	Sat	5	315 24 34	6 40	17 48	S 13	10 41	7	Punarvasu	19 6	CĀNDRA MĀGHA	30-Enters Śatabhiṣaj (13 ^h 29 ^m)	30-Trop. Pisces (15 ^h 49 ^m)				
17	SUN	6	316 25 22	40	49	14	8 48	8	Puṣya	18 0				17-Māghī pūrṇimā, Agni utsava, Thai pūṣam (S. India),			
18	Mon	7	317 26 9	39	49	S 15	7 13	9	Āśleṣā	17 15				Guru Ravi Das's Birthday (Punjab).			
						(K 1	30 3)										
19	Tue	8	318 26 55	39	50	2	29 26	10	Maghā	16 58				SAURA PHĀLGUNA	30-Enters Śatabhiṣaj (13 ^h 29 ^m)	30-Trop. Pisces (15 ^h 49 ^m)	
20	Wed	9	319 27 39	38	50	3	29 26	11	P. Phalgunī	17 14							
21	Thu	10	320 28 22	6 38	17 51	K 4	30 7	12	U. Phalgunī	18 10							
22	Fri	11	321 29 4	37	52	5	— —	13	IIasta	19 45							
23	Sat	12	322 29 45	36	52	5	7 29	14	Citrā	21 57							
24	SUN	13	323 30 25	36	53	6	9 27	15	Svātī	24 38							
25	Mon	14	324 31 3	35	53	7	11 51	16	Viśākhā	27 39							
26	Tue	15	325 31 41	6 35	17 54	K 8	14 29	17	Anurādhā	— —							
27	Wed	16	326 32 17	34	54	9	17 4	17	"	6 43							
28	Thu	17	327 32 52	33	55	10	19 21	18	Jyeṣṭhā	9 35							
29	Fri	18	328 33 26	33	56	11	21 7	19	Mūla	12 2							
30	Sat	Feb. 19	329 33 58	6 32	17 56	K 12	22 14	20	P. Āṣāḍhā	13 54							

N.B.—All timings are given in I. S. T. or the local time of the meridian of 82½° E. Long.

REFORMED CALENDAR OF INDIA

FOR ŚAKA ERA 1876 (1954-55 A.D.)

Month of PHĀLGUNA (30 Days)

Mina : Madhu

Ayanaśā on 1st = 23° 14' 7"

Spring 1st Month

C. R.-9

Date	Week Day	English Date	Long. of the Sun at 5-30 A.M.	Sun Rise	Sun Set	Tithi		Nakṣatra		Solar Month	Lunar Month	Transit of the Sun	Phenomena	Festivals
						No.	Ending Moment	No.	Name					
1955 A.D.			° ' "	h m	h m		h m		h m					
1	SUN	Feb. 20	830 34 29	6 31	17 57	K 13	22 38	21	U. Aṣāḍhā	15 6	CĀNDRA MĀGHA		3-New Moon (21 ^h 24 ^m)	1-Mahāśivarātri.
2	Mon	21	831 34 59	30	57	14	22 20	22	Śravapā	15 36				
3	Tue	22	832 35 27	30	58	K 30	21 24	23	Dhanīṣṭhā	15 29				
4	Wed	23	833 35 54	29	58	8 1	19 57	24	Śatabhīṣaj	14 49				
5	Thu	24	834 36 19	28	59	2	18 7	25	P. Bhādrapadā	13 45				
6	Fri	25	835 36 42	6 27	17 59	8 3	16 2	26	U. Bhādrapadā	12 24	SAUBRA PHĀLGUNA		7-Vaidhṛti (10 ^h 40 ^m)	7-Śānta caturthī. 9-Gorāpīṭhī ṣaṣṭhī (Bengal).
7	Sat	26	836 37 3	26	18 0	4	13 48	27	Rovati	10 53				
8	SUN	27	837 37 22	26	0	5	11 31	1	Āśvini	9 20				
9	Mon	28	838 37 40	25	1	6	9 18	2	Bharāṇī	7 48				
10	Tue	Mar. 1	839 37 55	24	1	7 (8)	7 11 29 12)	4	Kṛttikā Rohiṇī	30 23 29 7				
11	Wed	2	840 38 8	6 23	18 2	8 9	27 23	5	Mṛgaśīras	27 59	SAUBRA PHĀLGUNA	13-Enters P. Bhādra- padā (19 ^h 45 ^m)	12-Phagu daśami and Sudāśā vrata (Orissa). 13-Āmalakī ekādaśī. 14-Nṛsiṅha dvādaśī.	
12	Thu	3	841 38 19	22	2	10	25 44	6	Ārdrā	27 3				
13	Fri	4	842 38 28	21	3	11	24 17	7	Punarvasu	26 17				
14	Sat	5	843 38 35	20	3	12	23 3	8	Puṣya	25 45				
15	SUN	6	844 38 40	20	4	13	22 5	9	Āśleṣā	25 29				
16	Mon	7	845 38 43	6 19	18 4	8 14	21 26	10	Maghā	25 32	CĀNDRA PHĀLGUNA	17-Full Moon (21 ^h 11 ^m) 10-Vyātipātā (17 ^h 25 ^m)	16-Cāturmāsyā caturdaśī (Jain), Māśī magham-nakṣatra canon (S. India). 17-Holkādahana, Dolayātrā, Māśī magham-pārgulmā canon (S. India), Birthday of Śrī Caitanya. 18-Holi, Vasantotsava.	
17	Tue	8	846 38 44	18	4	8 15	21 11	11	P. Phalgunī	26 0				
18	Wed	9	847 38 42	17	5	K 1	21 24	12	U. Phalgunī	26 55				
19	Thu	10	848 38 39	16	5	2	22 10	13	Īasta	28 23				
20	Fri	11	849 38 35	15	6	3	23 29	14	Citrā	- -				
21	Sat	12	850 38 28	6 14	18 6	K 4	25 20	14	Citrā	6 22	SAUBRA CAITRA	23-Minādi (20 ^h 17 ^m)	22-Rahga pañcamī, Vijaya Govindajī Hatenkar (Manipur). 23-Śkanda ṣaṣṭhī (Bengal). 25-Śitalaṣṭami, Varytāpārambha (Jain).	
22	SUN	13	851 38 20	13	6	5	27 38	15	Svātī	8 52				
23	Mon	14	852 38 10	12	7	6	- -	16	Viśākhā	11 45				
24	Tue	15	853 37 58	11	7	6	6 13	17	Anurādhā	14 51				
25	Wed	16	854 37 44	10	8	7	8 51	18	Jyotiṣhā	17 54				
26	Thu	17	855 37 29	6 9	18 8	K 8	11 13	19	Mūlu	20 39	CĀNDRA CAITRA	26-Enters U. Bhādra- padā (28 ^h 17 ^m) 30-Trop. Arion (15 ^h 6 ^m)	29-Pāpamocanī ekādaśī. 30-Mahāvīṣuva day, (Year-ending Day).	
27	Fri	18	856 37 12	8	8	9	13 11	20	P. Aṣāḍhā	22 52				
28	Sat	19	857 36 53	7	9	10	14 26	21	U. Aṣāḍhā	24 24				
29	SUN	20	858 36 33	6	9	11	14 54	22	Śravapā	25 8				
30	Mon	Mar. 21	859 36 10	6 6	18 10	K 12	14 32	23	Dhanīṣṭhā	25 4				

N. B.—All timings are given in I. S. T. or the local time of the meridian of 82½° E. Long.

REFORMED CALENDAR OF INDIA

FOR ŚAKA ERA 1877 (1955-56 A.D.)

Month of C A I T R A (30 Days)

Meṣa : Mādhava

Ayanānīśa on 1st = 23° 14' 10"

Spring 2nd Month

Date	Week Day	English Date	Long. of the Sun at 5-30 A.M.	Sun Rise	Sun Set	Tithi		Nakṣatra			Solar Month	Lunar Month	Transit of the Sun	Phenomena	Festivals	
						No.	Ending Moment	No.	Name	Ending Moment						
1955 A.D.			° ' "	h m	h m		h m			h m						
1	Tue	Mar. 22	0 35 46	6 5	18 10	K 13	13 23	24	Śatabhiṣaj	24 18	CANDRA PHALGUNA		2-Vaidhṛti (24 ^h 40 ^m) 3-New Moon (9 ^h 12 ^m)	1-Indian New Year's Day. Vāruṇī (upto 13h 23m). 3-Navarātrāmbha. 5-Gaurī tṛtīyā, Dolotsava, Āndolana tṛtīyā, Saubhāgya-śayana vrata, Sarhul (Bihar).		
2	Wed	23	1 35 20	4	10	14	11 34	25	P. Bhādrapadā	22 54						
3	Thu	24	2 34 52	3	11	K 30	9 12	26	U. Bhādrapadā	21 5						
4	Fri	25	3 34 23	2	11	S 1	6 29	27	Revatī	18 58						
5	Sat	26	4 33 50	6 1	11	(2 27 33)	3	24 33	1	Āśvini	16 45	SAURA CAITRA	10-Enters Revatī (15 ^h 3 ^m)	7-Śrī (Lakṣmī) pañcamī. 8-Āśoka ṣaṣṭhī (Bengal), Skanda ṣaṣṭhī (Orissa). 9-Vāsantī pūjā (Bengal), Oli beginning (Jain). 10-Annapūrṇā pūjā (Bengal), Bhavānī utpatti, Āśokāṣṭamī.		
6	SUN	27	5 33 16	6 0	18 12	S 4	21 40	2	Bharanī	14 34						
7	Mon	28	6 32 40	5 59	12	5	18 58	3	Kṛttikā	12 33						
8	Tue	29	7 32 1	58	13	6	16 35	4	Rohiṇī	10 49						
9	Wed	30	8 31 20	57	13	7	14 32	5	Mṛgaśiras	9 25						
10	Thu	31	9 30 36	56	13	8	12 53	6	Ārdrā	8 24						
11	Fri	Apr. 1	10 29 50	5 55	18 14	S 9	11 37	7	Punarvasu	7 46	SAURA CAITRA				14-Vyatīpāta (25 ^h 10 ^m)	11-Rāma navamī, Rāma jayantī. 12-Dharmarāja daśamī. 13-Kāmadā ekādaśī, Dolotsava, Ravinārāyaṇa ekādaśī (Orissa). 14-Vāmana dvādaśī, Viṣṇu damanotsava, Madana dvādaśī. 15-Anaṅga trayodaśī, Mahāvīra jayantī (Jain), Śiva damanaka (Orissa), Phalgunī uttiram-naks. canon (S. India). 16-Viṣṇu damanaka (Orissa), Madana bhañjī (Bengal & Orissa), Phalgunī uttiram—pūrpimā canon (S. India). 17-Hanumat jayantī, Oli ends (Jain).
12	Sat	2	11 29 2	54	14	10	10 45	8	Puṣya	7 31						
13	SUN	3	12 28 12	53	14	11	10 15	9	Āśleṣā	7 38						
14	Mon	4	13 27 19	52	15	12	10 7	10	Maghā	8 7						
15	Tue	5	14 26 24	51	15	13	10 22	11	P. Phalgunī	8 59						
16	Wed	6	15 25 27	5 50	18 16	S 14	11 1	12	U. Phalgunī	10 13						
17	Thu	7	16 24 28	49	16	S 15	12 5	13	Hasta	11 52						
18	Fri	8	17 23 26	48	16	K 1	13 35	14	Citrā	13 56						
19	Sat	9	18 22 23	47	17	2	15 30	15	Svātī	16 25						
20	SUN	10	19 21 18	46	17	3	17 48	16	Viśākhā	19 14						
21	Mon	11	20 20 11	5 45	18 17	K 4	20 21	17	Anurādhā	22 19	SAURA VAISAKHA	23-Enters Āśvini (23 ^h 30 ^m) 23-Meṣādi (23 ^h 50 ^m)	23-Vaiśākhī. 24-Bahāg bihu (Assam), Vishu (T. C. State), Cheiraoba (Manipur). Caḍaka pūjā (Bengal).			
22	Tue	12	21 19 2	44	18	5	23 0	18	Jyeṣṭhā	25 27						
23	Wed	13	22 17 51	43	18	6	25 30	19	Mūla	28 26						
24	Thu	14	23 16 39	43	19	7	27 39	20	P. Āṣādhā	—						
25	Fri	15	24 15 25	42	19	8	29 12	20	"	7 3						
26	Sat	16	25 14 9	5 41	18 19	K 9	—	21	U. Āṣādhā	9 5	SAURA VAISAKHA	28-Vaidhṛti (15 ^h 17 ^m) 30-Trop. Taurus (26 ^h 28 ^m)	28-Varūthinī (Gāndhārī) ekādaśī (Smārta). 29-Varūthinī ekādaśī (Vaiṣṇava and in Bengal for all).			
27	SUN	17	26 12 51	40	20	9	5 59	22	Śravaṇa	10 21						
28	Mon	18	27 11 32	39	20	10	5 56	23	Dhaniṣṭhā	10 48						
29	Tue	19	28 10 11	38	21	(11 29 0)	12	27 17	24	Śatabhiṣaj				10 24		
30	Wed	Apr. 20	29 8 48	5 37	18 21	K 13	24 52	25	P. Bhādrapadā	9 13						

N.B.—All timings are given in I. S. T. or the local time of the meridian of 82½° E. Long.

REFORMED CALENDAR OF INDIA

FOR ŚAKA ERA 1877 (1955-56 A.D.)

Month of **V A I Ś Ā K H A** (31 Days)

Vṛṣa : Śukra

Ayanāntiśa on 1st = 23° 14' 14"

Summer 1st Month

Date	Week Day	English Date	Long. of the Sun at 5-30 A.M.	Sun		Tithi		Nakṣatra			Solar Month	Lunar Month	Transit of the Sun	Phenomena	Festivals
				Rise	Set	No.	Ending Moment	No.	Name	Ending Moment					
1955 A.D.			° ' "	h m	h m		h m			h m					
1	Thu	Apr. 21	30 7 24	5 36	18 21	K 14	21 55	26	U. Bhādrapadā	7 25	CĀNDRA CĀITRA		2-New Moon (18 ^h 36 ^m)	3-Tithi of Deva Dāmodara (Assam). 4-Paraśurāma jayanti. 5-Akṣaya tṛtīyā, Candana yātrā (Bengal and Orissa), Varṣitapa samāpana (Jum).	
2	Fri	22	31 5 57	36	22	K 30	18 36	1	Revati	29 6					
3	Sat	23	32 4 29	35	22	S 1	15 6	2	Āsvini	26 30					
4	SUN	24	33 2 59	34	22	S 2	11 34	3	Bharanī	23 46					
5	Mon	25	34 1 27	33	23	S 3	8 11	4	Kṛttikā	21 5					
6	Tue	26	34 59 53	5 33	18 23	S 5	26 22	5	Rohiṇī	18 37	SAURA VAIŚĀKHA	7-Enters Bharanī (20 ^h 17 ^m)	6-Śaṅkara's Birthday. 7-Candana ṣaṣṭhī (Bengal). 8-Gaṅgotpatti, Jānu saptami (Bengal), Śarkarā saptami.		
7	Wed	27	35 59 17	32	24	S 6	24 10	6	Mṛgāśiras	16 29					
8	Thu	28	36 56 39	31	24	S 7	22 30	7	Ārdrā	14 49					
9	Fri	29	37 54 58	30	25	S 8	21 24	8	Punarvasu	13 40					
10	Sat	30	38 53 16	30	25	S 9	20 53	9	Puṣya	13 6					
11	SUN	May 1	39 51 31	5 29	18 25	S 10	20 55	10	Āśleṣā	13 5	CĀNDRA VAIŚĀKHA	10-Vyatipāta (8 ^h 58 ^m)	10-Sitā navami (Bengal & Orissa).		
12	Mon	2	40 49 45	28	26	S 11	21 26	11	Maghā	13 37					
13	Tue	3	41 47 56	28	26	S 12	22 26	12	P. Phalgunī	14 39					
14	Wed	4	42 46 6	27	27	S 13	23 50	13	U. Phalgunī	16 10					
15	Thu	5	43 44 13	26	27	S 14	25 37	14	Hasta	18 5					
16	Fri	6	44 42 19	5 26	18 28	S 15	27 44	15	Citrā	20 22	SAURA VAIŚĀKHA	16-Full Moon (27 ^h 44 ^m)	16-Vaiśākhī pūrṇimā, Buddha pūrṇimā, Phuladola (Bengal), Gandheśvarī pūjā (Bengal), Sampat Gaurī vrata.		
17	Sat	7	45 40 23	25	28	K 1	—	16	Svātī	22 59					
18	SUN	8	46 38 26	24	29	K 1	6 6	17	Viśākhā	25 52					
19	Mon	9	47 36 27	24	29	K 2	8 39	18	Anurādhā	28 56					
20	Tue	10	48 34 26	23	30	K 3	11 15	18	Jyeṣṭhā	—					
21	Wed	11	49 32 24	5 23	18 30	K 4	13 46	19	"	8 4	CĀNDRA VAIŚĀKHA	21-Enters Kṛttikā (14 ^h 33 ^m)	23-Vaidhṛti (25 ^h 7 ^m)		
22	Thu	12	50 30 21	22	30	K 5	16 0	20	Mūla	11 8					
23	Fri	13	51 28 16	22	31	K 6	17 46	21	P. Āṣādhā	13 57					
24	Sat	14	52 26 10	21	31	K 7	18 54	22	U. Āṣādhā	16 21					
25	SUN	15	53 24 2	21	32	K 8	19 18	23	Śravaṇa	18 8					
26	Mon	16	54 21 54	5 20	18 32	K 9	18 52	24	Dhanīṣṭhā	19 12	SAURA JYAIṢṬHA	24-Vṛṣādi (25 ^h 45 ^m)	25-Trilocanāṣṭami (Bengal).		
27	Tue	17	55 19 44	20	33	K 10	17 37	25	Śatabhiṣaj	19 28					
28	Wed	18	56 17 33	19	33	K 11	15 37	26	P. Bhādrapadā	18 57					
29	Thu	19	57 15 21	19	34	K 12	12 57	27	U. Bhādrapadā	17 38					
30	Fri	20	58 13 8	18	34	K 13	9 46	1	Revati	15 42					
31	Sat	May 21	59 10 53	5 18	18 35	K 14	6 13	2	Āsvini	13 16	CĀNDRA VAIŚĀKHA	31-Trop. Gemini (25 ^h 55 ^m)	31-New Moon (26 ^h 28 ^m)	30-Sāvitrī caturdaśī (Bengal). 31-Ṭaṣā sāvitrī vrata, Phalahāriṇī Kālikā pūjā (Bengal), Sāvitrī amāvasyā (Orissa).	
						(K. 30)	26 28)		Bharanī	19 29					

N.B.—All timings are given in I. S. T. or the local time of the meridian of 82½° E. Long.

REFORMED CALENDAR OF INDIA

FOR ŚAKA ERA 1877 (1955-56 A.D.)

Month of JYAIṢṬHA (JYEṢṬHA) (31 Days)

Mithuna : Śuci Ayanāmsā on 1st = 23° 14' 18"

Summer 2nd Month

Date	Week Day	English Date	Long. of the Sun at 5-30 A.M.	Sun Rise	Sun Set	Tithi		Nakṣatra			Solar Month	Lunar Month	Transit of the Sun	Phenomena	Festivals		
						No.	Ending Moment	No.	Name	Ending Moment							
1955 A.D.			° ' "	h m	h m		h m			h m							
1	SUN	May 22	60 8 38	5 18	18 35	S 1	22 42	3	Kṛttikā	7 33	SAURA JYAIṢṬHA	CĀNDRA JYAIṢṬHA	4-Enters Rohiṇī (10 ^h 44 ^m)	4-Vyatipāta (21 ^h 13 ^m)	1-Daśaharā śnānārambha. 3-Rambhā tṛtīyā, Pratāp Jayantī (Rajasthan). 4-Umā caturthī (Bengal & Orissa). Guru Arjun Dev's Martyrdom Day (Punjab). 5-Mahādeva vivāha (Orissa), Skanda ṣaṣṭhī and Śītala ṣaṣṭhī (Orissa), Guru pañcamī (Orissa). 6-Araṇya gaurī vrata, Araṇya ṣaṣṭhī (Bengal).		
2	Mon	23	61 6 21	18	36	2	19 4	5	Rohiṇī	28 38							
3	Tue	24	62 4 2	17	36	3	15 44	6	Mṛgaśīras	25 53							
4	Wed	25	63 1 43	17	37	4	12 50	7	Ārdrā	23 30							
5	Thu	26	63 59 21	17	37	5	10 29	8	Punarvasu	21 36							
6	Fri	27	64 56 58	5 16	18 37	S 6	8 46	9	Puṣya	20 17							
7	Sat	28	65 54 34	16	38	7	7 46	10	Āśleṣā	19 39							
8	SUN	29	66 52 8	16	38	8	7 27	11	Maghā	19 42							
9	Mon	30	67 49 41	16	39	9	7 50	12	P. Phalgunī	20 27							
10	Tue	31	68 47 13	16	39	10	8 51	13	U. Phalgunī	21 51							
									Hasta	23 48				10-Gaṅgā daśaharā.			
11	Wed	June 1	69 44 43	5 15	18 40	S 11	10 23	14	Citrā	26 12	SAURA JYAIṢṬHA	CĀNDRA JYAIṢṬHA	15-Full Moon (19 ^h 38 ^m)	15-Vaṭa sāvitṛī vrata (Deccan). Śnāna yātrā (Bengal and Orissa).			
12	Thu	2	70 42 12	15	40	12	12 21	15	Svātī	28 57							
13	Fri	3	71 39 40	15	41	13	14 37	16	Viśākhā	— —							
14	Sat	4	72 37 6	15	41	14	17 5	16	"	7 56							
15	SUN	5	73 34 32	15	41	S 15	19 38	17	Anurādhā	11 2							
16	Mon	6	74 31 57	5 15	18 42	K 1	22 10	18	Jyēṣṭhā	14 8							
17	Tue	7	75 29 20	15	42	2	24 33	19	Mūla	17 8							
18	Wed	8	76 26 43	15	43	3	26 41	20	P. Āṣāḍhā	19 56							
19	Thu	9	77 24 5	15	43	4	28 26	21	U. Āṣāḍhā	22 23							
20	Fri	10	78 21 27	15	43	5	— —	22	Śravaṇa	24 24							
21	Sat	11	79 18 48	5 15	18 44	K 5	5 42	23	Dhanīṣṭhā	25 51	SAURA JYAIṢṬHA	CĀNDRA JYAIṢṬHA	18-Enters Mṛgaśīras (8 ^h 42 ^m)	18-Vaidhṛti (7 ^h 4 ^m)			
22	SUN	12	80 16 8	15	44	6	6 22	24	Śatabhiṣaj	26 40							
23	Mon	13	81 13 28	15	44	7	6 22	25	P. Bhādrapadā	26 48							
24	Tue	14	82 10 48	15	45	8	5 41	26	U. Bhādrapadā	26 14							
						(9	28 17)										
25	Wed	15	83 8 7	15	45	10	26 14	27	Revatī	25 1							
26	Thu	16	84 5 26	5 15	18 45	K 11	23 35	1	Āśvini	23 12							
27	Fri	17	85 2 44	16	46	12	20 29	2	Bharanī	20 54							
28	Sat	18	86 0 2	16	46	13	17 2	3	Kṛttikā	18 16							
29	SUN	19	86 57 20	16	46	14	13 23	4	Rohiṇī	15 27							
30	Mon	20	87 54 38	16	46	K 30	9 42	5	Mṛgaśīras	12 36							
31	Tue	June 21	88 51 55	5 16	18 47	S 1	6 7	6	Ārdrā	9 53							
						(S 2	26 49)								25-Mithunādi (8 ^h 23 ^m)	30-New Moon (9 ^h 42 ^m) 30-Vyatipāta (15 ^h 26 ^m) 30-Solar Eclipse (Total) visible in India.	26-Yoginī ekādaśī. 31-Rathayātrī, Manorathā Dvītyā vrata (Bengal).

N.B.—All timings are given in I. S. T' or the local time of the meridian of 82½° E. Long

REFORMED CALENDAR OF INDIA

FOR ŚAKA ERA 1877 (1955-56 A.D.)

Simha : Nabhasya

Ayanānīśa on 1st = 23° 14' 28"

Month of Ś R Ā V A Ṇ A (31 Days)

Rains 2nd Month

Date	Week Day	English Date	Long. of the Sun at 5-30 A.M.	Sun Rise	Sun Set	Tithi		Nakṣatra			Solar Month	Lunar Month	Transit of the Sun	Phenomena	Festivals
						No.	Ending Moment	No.	Name	Ending Moment					
			o ' "	h m	h m		h m			h m					
1955 A.D.															
1	Sat	July 23	119 23 11	5 28	18 45	S 4	8 8	11	P. Phalgunī	12 27	SAURA Ś R Ā V A Ṇ A	C Ā N D R A Ś R Ā V A Ṇ A	1-Trop. Leo (20 ^h 55 ^m)	6-Vaidhṛti (18 ^h 25 ^m)	1-Āḍi pūram (S. India—For some). 2-Nāga pañcamī, Jāgratgaurī pañcamī (Orissa). 3-Luṅṭhana ṣaṣṭhī (Bengal).
2	SUN	24	120 20 29	28	45	5	7 32	12	U. Phalgunī	12 44					
3	Mon	25	121 17 48	28	44	6	7 45	13	Hasta	13 49					
4	Tue	26	122 15 7	29	44	7	8 44	14	Citrā	15 38					
5	Wed	27	123 12 27	29	44	8	10 24	15	Svātī	18 4					
6	Thu	28	124 9 47	5 30	18 43	S 9	12 35	16	Viśākhā	20 57	SAURA Ś R Ā V A Ṇ A	C Ā N D R A Ś R Ā V A Ṇ A	12-Enters Āśleṣā (5 ^h 43 ^m)	12-Full Moon (25 ^h 0 ^m)	7-Jhulanayātrārambha, Varalakṣmī vrata (S. India). 8-Putradā (Pavitṛā) ekādaśī, Jhulanayātrārambha. 9-Buddha dvādaśī, Viṣṇu pavitrōpaṇam, Dāmodara dvādaśī. 10-Ākṣheṭaka trayodaśī (Orissa). Tilak Commemoration Day.
7	Fri	29	125 7 7	30	42	10	15 5	17	Anurādhā	24 3					
8	Sat	30	126 4 29	31	42	11	17 38	18	Jyēṣṭhā	27 8					
9	SUN	31	127 1 50	31	42	12	20 3	19	Mūla	— —					
10	Mon	Aug. 1	127 59 12	32	41	13	22 9	19	"	6 2					
11	Tue	2	128 56 35	5 32	18 41	S 14	23 49	20	P. Āṣādhā	8 34	SAURA Ś R Ā V A Ṇ A	C Ā N D R A Ś R Ā V A Ṇ A	19-Vyatipāta (23 ^h 29 ^m)	19-Venus sets in the East.	11-Śiva pavitrōpaṇam (Orissa). 12-Rakṣā bandhana, Rṣitarpuṇa, Hayagrivotpatti, Jhulanayātrā samāpanam, Balabhadra pūjā (Orissa), Coconut day, Solono (Pepsu), Yaju Upākaram, Āvaṇi Avittam (S. India). 13-Upākarma (Rk). 14-Aśūnya śayana vrata. 15-Kajjali tṛtīyā, Aṅgabheṭ tṛtīyā (Orissa). 16-Bahulā caturthī (Madhya Deśa). 17-Rakṣā pañcamī (Orissa). 18-Hala ṣaṣṭhī. 19-Śitalā saptamī, Janmāṣṭamī (Smṛta). 20-Janmāṣṭamī (Vaiṣṇava), Gokulāṣṭamī.
12	Wed	3	129 53 59	32	40	S 15	25 0	21	U. Āṣādhā	10 39					
13	Thu	4	130 51 24	33	39	K 1	25 41	22	Śravaṇa	12 16					
14	Fri	5	131 48 49	33	39	2	25 53	23	Dhaniṣṭhā	13 24					
15	Sat	6	132 46 16	34	38	3	25 38	24	Satabhiṣaj	14 4					
16	SUN	7	133 43 44	5 34	18 38	K 4	24 59	25	P. Bhādrapadā	14 19	SAURA Ś R Ā V A Ṇ A	C Ā N D R A Ś R Ā V A Ṇ A	25-Enters Maghā (27 ^h 24 ^m)	26-New Moon (25 ^h 28 ^m)	23-Ajā ekādaśī, Kālidalana ekādaśī (Orissa). 24-Independence Day, Paryuṣaṇa pūrvārambha (Jain—pañcamī pakṣa). 25-Aghora caturdaśī (Bengal & Orissa). 26-Kuśōtpāṭini (Pithorī) amāvasyā, Āloka amāvasyā (Bengal), Saptapurī amāvasyā (Orissa), Manasā pūjā (Bengal). 28-Tithi of Śrī Śankara Deva (Assam). 30-Harītālī caturthī. 31-Sumvatsarī & Paryuṣaṇaparva samāpana (Jain—pañcamī pakṣa)
17	Mon	8	134 41 12	35	37	5	23 59	26	U. Bhādrapadā	14 12					
18	Tue	9	135 38 43	35	36	6	22 38	27	Revatī	13 44					
19	Wed	10	136 36 14	35	36	7	20 59	1	Āśvinī	12 57					
20	Thu	11	137 33 47	36	35	8	19 2	2	Bharāṇī	11 53					
21	Fri	12	138 31 22	5 36	18 34	K 9	16 50	3	Kṛttikā	10 32	SAURA Ś R Ā V A Ṇ A	C Ā N D R A Ś R Ā V A Ṇ A	25-Simhādi (27 ^h 36 ^m)	31-Vaidhṛti (26 ^h 7 ^m)	
22	Sat	13	139 29 57	37	33	10	14 25	4	Rohiṇī	8 57					
23	SUN	14	140 26 35	37	33	11	11 49	5	Mṛgaśīras	7 11					
								6	Ārdṛā	29 18					
24	Mon	15	141 24 13	37	32	12	9 7	7	Punarvasu	27 23					
25	Tue	16	142 21 54	38	31	13	6 25	8	Puṣya	25 34	SAURA Ś R Ā V A Ṇ A	C Ā N D R A Ś R Ā V A Ṇ A			
								14	(14 27 49)						
26	Wed	17	143 19 35	5 38	18 30	K 30	25 28	9	Āśleṣā	23 58					
27	Thu	18	144 17 18	38	30	S 1	23 29	10	Maghā	22 45					
28	Fri	19	145 15 2	39	29	2	22 2	11	P. Phalgunī	22 2					
29	Sat	20	146 12 48	39	28	3	21 13	12	U. Phalgunī	21 56	SAURA Ś R Ā V A Ṇ A	C Ā N D R A Ś R Ā V A Ṇ A			
30	SUN	21	147 10 35	40	27	4	21 7	13	Hasta	22 34					
31	Mon	Aug. 22	148 8 23	5 40	18 26	S 5	21 48	14	Citrā	23 57					

N. B.—All timings are given in I. S. T. or the local time of the meridian of 82½° E. Long.

REFORMED CALENDAR OF INDIA

FOR ŚAKA ERA 1877 (1955-56 A.D.)

Kanyā : Iṣa

Ayanāhā on 1st = 23° 14' 32"

Month of B H Ā D R A (BHĀDRAPADA) (31 Days)

Autumn 1st Month

Date	Week Day	English Date	Long. of the Sun at 5-30A.M.	Sun Rise	Sun Set	Tithi		Nakṣatra			Solar Month	Lunar Month	Transit of the Sun	Phenomena	Festivals		
						No.	Ending Moment	No.	Name	Ending Moment							
1955 A.D.			° ' "	h m	h m		h m		h m								
1	Tue	Aug. 23	149 6 12	5 40	18 25	S 6	23 11	15	Svāti	26 1	A D H I K A	1-Trop. Virgo (27 ^h 50 ^m)		3-Dārvāṣṭami.			
2	Wed	24	150 4 2	41	25	7	25 11	16	Viśakhā	28 39							
3	Thu	25	151 1 54	41	24	8	27 36	17	Anurādhā	— —							
4	Fri	26	151 59 47	41	23	9	— —	17	"	7 39							
5	Sat	27	152 57 41	42	22	9	6 10	18	Jyēṣṭhā	10 45							
6	SUN	28	153 55 36	5 42	18 21	S 10	8 37	19	Mūla	13 42		C Ā N D R A B H Ā D R A P A D A	8-Enters P. Phalguni (23 ^h 19 ^m)		7-Padmiṇī (Puruṣottami) ekādaśī. 8-First Onam Day (S. India). 9-Thiru Onam Day (S. India). 10-Āvaṇi aviṭṭam (Madras), Third Onam Day (S. India).		
7	Mon	29	154 53 32	42	20	11	10 44	20	P. Āṣāḍhā	16 18							
8	Tue	30	155 51 30	43	19	12	12 21	21	U. Āṣāḍhā	18 22							
9	Wed	31	156 49 30	43	18	13	13 20	22	Śravapā	19 51							
10	Thu	Sept. 1	157 47 31	43	17	14	13 42	23	Dhanīṣṭhā	20 43							
11	Fri	2	158 45 33	5 44	18 16	S 15	13 29	24	Śatabhiṣaj	21 1	S A U R A B H Ā D R A P A D A					11-Full Moon (13 ^h 29 ^m)	11-Fourth Onam Day (S. India). Śrī Nārāyaṇa (Guru Dev's Birthday (Madras). 12-Keil Muhurth (Coorg).
12	Sat	3	159 43 37	44	15	K 1	12 45	25	P. Bhādrapadā	20 50							
13	SUN	4	160 41 43	44	14	2	11 35	26	U. Bhādrapadā	20 17							
14	Mon	5	161 39 51	45	13	3	10 6	27	Revati	19 27							
15	Tue	6	162 38 0	45	12	4	8 24	1	Āśvini	18 25							
16	Wed	7	163 36 12	5 45	18 11	K 5	6 32	2	Bharāṇi	17 15	C Ā N D R A B H Ā D R A P A D A	14-Vyatipata (10 ^h 36 ^m)	15-Tithi of Śrī Mādhava Deva (Assam).				
17	Thu	8	164 34 25	45	10	(6 7	28 33)	26 31	3	Kṛttikā				16 0			
18	Fri	9	165 32 41	46	9	8	24 27	4	Rohiṇī	14 41							
19	Sat	10	166 30 58	46	8	9	22 21	5	Mṛgāśiras	13 21							
20	SUN	11	167 29 18	46	7	10	20 15	6	Ārdrā	12 1							
21	Mon	12	168 27 40	5 47	18 6	K 11	18 12	7	Punarvasu	10 42	S A U R A B H Ā D R A P A D A	22-Enters U. Phalguni (17 ^h 13 ^m)	18-Janmāṣṭami or Śrī Jayanti (Assam & S. India). 21-Kamālā ekādaśī (Puruṣottami). 22-Paryūṣaṇa parvārambha (Jain—caturthī puṣya). 23-Maghā trayodaśī (8 ^h 21 ^m to 14 ^h 27 ^m).				
22	Tue	13	169 26 4	47	5	12	16 14	8	Puṣya	9 27							
23	Wed	14	170 24 30	47	4	13	14 27	9	Āśleṣā	8 21							
24	Thu	15	171 22 58	48	3	14	12 57	10	Maghā	7 30							
25	Fri	16	172 21 28	48	2	K 30	11 49	11	P. Phalguni	7 0							
26	Sat	17	173 20 0	5 48	18 1	S 1	11 11	12	U. Phalguni	6 57	S A U R A B H Ā D R A P A D A	25-Kanyūdi (27 ^h 27 ^m)	25-New Moon (11 ^h 49 ^m) 26-Vaidhṛti (12 ^h 40 ^m)	26-Rudra vrata, Viśvakarmā pūjā (Bengal). 28-Haritalikā tṛtīyā, Gouri tṛtīyā, Gaṇeśa caturthī. 20-Varadā caturthī, Saubhāgya caturthī (Bengal), Saivatsari (Jain), Paryūṣaṇaparva samāpana (Jain—caturthī puṣya). 30-Guru pañcamī (Orissa), Rśī pañcamī, Rakṣā pañcamī (Bengal), Saivatsari (Bombay, Surat & Ahmedabad). Samādhi Day of Nārāyaṇa Guru (T. C. State). 31-Sūrya ṣaṣṭhī, Carpatā ṣaṣṭhī (Bengal), Manthāna ṣaṣṭhī (Bengal), Lolārka ṣaṣṭhī, Somanātha vrata (Orissa).			
27	SUN	18	174 18 33	49	0	2	11 9	13	Hasta	7 29							
28	Mon	19	175 17 9	49	17 59	3	11 45	14	Citrā	8 38							
29	Tue	20	176 15 46	49	58	4	13 2	15	Svāti	10 26							
30	Wed	21	177 14 25	49	57	5	14 55	16	Viśakhā	12 50							
31	Thu	Sept. 22	178 13 6	5 50	17 56	S 6	17 16	17	Anurādhā	15 40							

N.B.—All timings are given in I. S. T. or the local time of the meridian of 82½° E. Long.

REFORMED CALENDAR OF INDIA

FOR ŚAKA ERA 1877 (1955-56 A.D.)

Tula : Ūrja

Ayanantīśa on 1st = 23° 14' 36"

Month of A Ś V I N A (30 Days)

Autumn 2nd Month

Date	Week Day	English Date	Long. of the Sun at 5-30 A.M.		Sun Rise	Sun Set	Tithi		Nakṣatra			Solar Month	Lunar Month	Transit of the Sun	Phenomena	Festivals
			°	'			No.	Ending Moment	No.	Name	Ending Moment					
1955 A.D.			h	m	h	m	h	m	h	m	h	m				
1	Fri	Sept. 23	179	11 48	5 50	17 55	S 7	19 52	18	Jyesthā	18 45	SAURA Ā Ś V I N A	C Ā N D R A B H Ā D R A P A D A	1-Trop. Libra (25 ^h 11 ^m)	6-Venus rises in the West.	1-Muktābharaṇa vrata, Lalitā saptami (Bengal), Jalaviṣṇu Day. 2-Rādhāṣṭami, Mahālakṣmī vrata, Dūrvāṣṭami (Bengal), Durgā śayanī (Orissa). 3-Adulḥka navami, Nandā navami, Tāla navami (Bengal). 5-Parivartana (Pulmā) ekādaśī, Śravaṇa dvādaśī, Viṣṇu śrīkhalayoga, Dol gyanas (Madhya Bharat), Heikra hitomba (Manipur). 8-Vyatīpata (23 ^h 25 ^m) 9-Full Moon (24 ^h 47 ^m) 8-Ananta catuṛdaśī. 9-Indra Govinda pūjā (Orissa). 10-Mahālayārambha, Mahatma Gandhi's Birthday. 11-Aśūnya śayana vrata.
2	Sat	24	180 10 33	50	54	8	22 26	19	Mūla	21 51						
3	SUN	25	181 9 19	51	53	9	24 43	20	P. Aṣadhā	24 40						
4	Mon	26	182 8 6	51	52	10	26 28	21	U. Aṣadhā	26 58						
5	Tue	27	183 6 56	51	51	11	27 33	22	Śravaṇa	28 37						
6	Wed	28	184 5 47	5 52	17 50	S 12	27 53	23	Dhanīṣṭhā	29 32	SAURA Ā Ś V I N A	C Ā N D R A B H Ā D R A P A D A	18-Enters Citrā (21 ^h 41 ^m)	20-Vaidhṛti (23 ^h 0 ^m)	23-Mahālayā amāvasyā, Sarvapitr amāvasyā. 24-Navarātrārambha. 25-Kāveri saṅkramaṇa. 27-Māna catuṛthī. 28-Nata puṇenamī (Orissa), Upāṅga lalitā vrata (Maharashtra). 29-Sarasvatī sthāpana. 30-Durgā ṣaṣṭhī, Sarasvatī pūjā, Tapah ṣaṣṭhī (Orissa).	
7	Thu	29	185 4 40	52	49	13	27 29	24	Śatabhīṣaj	29 45						
8	Fri	30	186 3 34	52	48	14	26 24	25	P. Bhādrapadā	29 19						
9	Sat	Oct. 1	187 2 31	53	47	S 15	24 47	26	U. Bhādrapadā	28 21						
10	SUN	2	188 1 30	53	46	K 1	22 45	27	Rovati	26 59						
11	Mon	3	189 0 30	5 53	17 45	K 2	20 26	1	Aśvini	25 23						
12	Tue	4	189 59 33	54	44	3	17 58	2	Bharanī	23 39						
13	Wed	5	190 58 38	54	43	4	15 27	3	Kṛttikā	21 54						
14	Thu	6	191 57 45	55	42	5	13 1	4	Rohiṇī	20 14						
15	Fri	7	192 56 55	55	41	6	10 42	5	Mṛgaśiras	18 43						
16	Sat	8	193 56 7	5 55	17 40	K 7	8 33	6	Ārdra	17 24	SAURA Ā Ś V I N A	C Ā N D R A B H Ā D R A P A D A	18-Enters Citrā (21 ^h 41 ^m)	20-Vaidhṛti (23 ^h 0 ^m)	23-Mahālayā amāvasyā, Sarvapitr amāvasyā. 24-Navarātrārambha. 25-Kāveri saṅkramaṇa. 27-Māna catuṛthī. 28-Nata puṇenamī (Orissa), Upāṅga lalitā vrata (Maharashtra). 29-Sarasvatī sthāpana. 30-Durgā ṣaṣṭhī, Sarasvatī pūjā, Tapah ṣaṣṭhī (Orissa).	
17	SUN	9	194 55 21	56	39	8	6 37	7	Punarvasu	16 16						
18	Mon	10	195 54 38	56	39	(9	28 55)	8	Puṣya	15 23						
19	Tue	11	196 53 57	56	38	10	27 27	9	Āśleṣā	14 45						
20	Wed	12	197 53 18	57	37	11	26 15	10	Maghā	14 23						
21	Thu	13	198 52 42	5 57	17 36	K 13	24 49	11	P. Phalgunī	14 21						
22	Fri	14	199 52 7	58	35	14	24 41	12	U. Phalgunī	14 41						
23	Sat	15	200 51 35	58	34	K 30	25 2	13	Hasta	15 27						
24	SUN	16	201 51 5	58	33	S 1	25 54	14	Citrā	16 43						
25	Mon	17	202 50 37	59	32	2	27 19	15	Svātī	18 30						
26	Tue	18	203 50 11	5 59	17 31	3	29 16	16	Viśakha	20 48	SAURA K Ā R T I K A	C Ā N D R A Ā Ś V I N A	25-Tuladī (15 ^h 19 ^m)	23-New Moon (25 ^h 2 ^m)	23-Mahālayā amāvasyā, Sarvapitr amāvasyā. 24-Navarātrārambha. 25-Kāveri saṅkramaṇa. 27-Māna catuṛthī. 28-Nata puṇenamī (Orissa), Upāṅga lalitā vrata (Maharashtra). 29-Sarasvatī sthāpana. 30-Durgā ṣaṣṭhī, Sarasvatī pūjā, Tapah ṣaṣṭhī (Orissa).	
27	Wed	19	204 49 47	6 0	31	4	—	17	Anurādhā	23 32						
28	Thu	20	205 49 25	0	30	4	7 38	18	Jyesthā	26 35						
29	Fri	21	206 49 4	1	29	5	10 16	19	Mūla	29 46						
30	Sat	Oct. 22	207 48 46	6 1	17 28	S 6	12 58	20	P. Aṣadhā	—						

N.B.—All timings are given in I. S. T. or the local time of the meridian of 82½° E. Long.

REFORMED CALENDAR OF INDIA

FOR ŚAKA ERA 1877 (1955-56 A.D.)

Month of KĀRTIKA (30 Days)

Vṛścika : Sahas

Nyamānśa on Ist 23° 14' 39"

Hemanta 1st Month

C.R.-II

Date	Week Day	English Date	Long. of the Sun at 5-30 A.M.	Sun Rise		Sun Set		Tithi		Nakṣatra		Solar Month	Lunar Month	Transit of the Sun	Phenomena	Festivals
				h	m	h	m	No.	Ending Moment	No.	Name					
		1955 A.D.	o ' "													
1	SUN	Oct. 23	208 48 29	6 2	17 27	S 7	15 29	20	P. Āṣādhā	8 48						
2	Mon	24	209 48 13	2	27	8	17 32	21	U. Āṣādhā	11 29						
3	Tue	25	210 48 0	3	26	9	18 56	22	Śravaṇa	13 35						
4	Wed	26	211 47 48	3	25	10	19 34	23	Dhruvāṣṭhā	14 57						
5	Thu	27	212 47 38	4	24	11	19 21	24	Śatabhiṣaj	15 31						
6	Fri	28	213 47 30	6 4	17 24	S 12	18 21	25	P. Bhādrapadā	15 17						
7	Sat	29	214 47 23	5	23	13	16 37	26	U. Bhādrapadā	14 20						
8	SUN	30	215 47 18	5	22	14	14 19	27	Rovati	12 48						
9	Mon	31	216 47 15	6	22	S 15	11 34	1	Āśvini	10 48						
10	Tue	Nov. 1	217 47 14	6	21	K 1	8 32	2	Bharaṇi	8 32						
							(2 29 23)									
11	Wed	2	218 47 15	6 7	17 20	K 3	26 15	3	Kṛttikā	6 8						
								(4	Rohini	27 45)						
12	Thu	3	219 47 17	7	20	4	23 16	5	Mṛgaśiras	25 32						
13	Fri	4	220 47 22	8	19	5	20 33	6	Ārdrā	23 36						
14	Sat	5	221 47 29	9	19	6	18 11	7	Punarvasu	22 1						
15	SUN	6	222 47 38	9	18	7	16 14	8	Puṣya	20 50						
16	Mon	7	223 47 49	6 10	17 18	K 8	14 44	9	Āśleṣā	20 8						
17	Tue	8	224 48 3	10	17	9	13 43	10	Maghā	19 53						
18	Wed	9	225 48 18	11	17	10	13 11	11	P. Phalguni	20 7						
19	Thu	10	226 48 35	12	16	11	13 8	12	U. Phalguni	20 48						
20	Fri	11	227 48 54	12	16	12	13 33	13	Hasta	21 57						
21	Sat	12	228 49 15	6 13	17 15	K 13	14 26	14	Citrā	23 32						
22	SUN	13	229 49 38	13	15	14	15 46	15	Svāti	25 32						
23	Mon	14	230 50 3	14	15	K 30	17 31	16	Viśākhā	27 57						
24	Tue	15	231 50 30	15	14	S 1	19 41	17	Anurādhā	—						
25	Wed	16	232 50 58	15	14	2	22 9	17	"	6 42						
26	Thu	17	233 51 27	6 16	17 14	S 3	24 51	18	Jyēṣṭhā	9 43						
27	Fri	18	234 51 58	17	13	4	27 37	19	Mṛga	12 54						
28	Sat	19	235 52 31	17	13	5	30 15	20	P. Āṣādhā	16 3						
29	SUN	20	236 53 4	18	13	6	—	21	U. Āṣādhā	19 0						
30	Mon	Nov. 21	237 53 39	6 19	17 13	S 6	8 33	22	Śravaṇa	21 33						

SAURA KĀRTIKA
CĀNDRA ĀŚVINA
SAURA
MĀRGAŚIRSA
CĀNDRA
KĀRTIKA

N.B.—All timings are given in I. S. T. or the local time of the meridian of 82½° E. Long.

REFORMED CALENDAR OF INDIA

FOR ŚAKA ERA 1877 (1955-56 A.D.)

Dhanuḥ : Sahasra Ayanānta on 1st = 23° 14' 43"

Month of AGRHĀYANA (MĀRGAŚIRṢA) (30 Days) Hemanta 2nd Month

Date	Week Day	English Date	Long. of the Sun at 5-30 A.M.	Sun Rise	Sun Set	Tithi		Nakṣatra			Solar Month	Lunar Month	Transit of the Sun	Phenomena	Festivals
						No.	Ending Moment	No.	Name	Ending Moment					
1955 A.D.			° ' "	h m	h m		h m			h m					
1	Tue	Nov. 22	238 54 16	6 19	17 12	S 7	10 20	23	Dhanīṣṭhā	23 30	SAURA MĀRGAŚIRṢA	CĀNDRA KĀRTIKA	2-Trop. Sagittarius (7 ^h 32 ^m)	2-Gopāṣṭamī, Goṣṭhāṣṭamī. 3-Akṣaya navamī, Viṣṇu trīrātra, Jagaddhātri pūjā (Bengal), Durgā navamī, Gaurī vrata (Bengal), Anlā navamī (Orissa). 5-Pravodhanī ekādaśī, Bhīma pañcaka, Tulasī vivāha, Pravodhanotsava. 6-Nārāyaṇa dvādaśī, Vṛṇḍāvana dvādaśī. 7-Vaikuṇṭha caturdaśī, Baḍa oṣā (Orissa), Cāturmāsya caturdaśī (Jain), Pāṣāṇa caturdaśī (Bengal & Orissa). Bharṇī Dīpam (S. India), Kṛttikā Dīpam (S. India). 8-Tripurotsava Rāsayātrā, Rathayātrā (Jain), Kedāru vrata, Kārtikī pūrṇimā, Vaikhānaś Dīpam (S. India), Guru Nānak's Birthday.	
2	Wed	23	239 54 53	20	12	8	11 26	24	Śatabhiṣaj	24 44					
3	Thu	24	240 55 32	21	12	9	11 43	25	P. Bhādrapadā	25 9					
4	Fri	25	241 56 11	21	12	10	11 9	26	U. Bhādrapadā	24 46					
5	Sat	26	242 56 52	22	12	11	9 47	27	Revatī	23 37					
6	SUN	27	243 57 34	6 23	17 12	S 12 (13	7 42 28 59)	1	Aśvini	21 49					
7	Mon	28	244 58 17	24	12	14	25 49	2	Bharṇī	19 31					
8	Tue	29	245 59 1	24	12	S 15	22 20	3	Kṛttikā	16 51					
9	Wed	30	246 59 47	25	12	K 1	18 42	4	Rohiṇī	14 0					
10	Thu	Dec. 1	248 0 33	26	12	2	15 7	5	Mṛgaśiras	11 8					
11	Fri	2	249 1 21	6 26	17 12	K 3	11 42	6	Ārdrā	8 25					
12	Sat	3	250 2 11	27	12	4	8 37	8	Puṣya	28 3					
13	SUN	4	251 3 1	28	12	(5	29 59)	9	Āśleṣā	26 39					
14	Mon	5	252 3 53	28	12	6	27 56	10	Maghā	25 52					
15	Tue	6	253 4 47	29	12	7	26 32	11	P. Phalgunī	25 46					
16	Wed	7	254 5 41	6 30	17 13	8	25 49	12	U. Phalgunī	26 21					
17	Thu	8	255 6 38	30	13	K 9	25 48	12	Hasta	27 33					
18	Fri	9	256 7 35	31	13	10	26 26	13	Citrā	27 40					
19	Sat	10	257 8 33	32	13	11	27 40	14	Svātī	29 19					
20	SUN	11	258 9 33	32	14	12	29 24	15	"	- -					
21	Mon	12	259 10 34	6 33	17 14	13	- -	15	"	7 34					
22	Tue	13	260 11 35	34	14	K 13	7 32	16	Viśākhā	10 11					
23	Wed	14	261 12 38	34	14	14	9 59	17	Anurādhā	13 4					
24	Thu	15	262 13 41	35	15	K 30	12 37	18	Jyēṣṭhā	16 8					
25	Fri	16	263 14 45	35	15	S 1	15 21	19	Mūla	19 17					
26	Sat	17	264 15 50	6 36	17 16	2	18 4	20	P. Āṣādhā	22 24					
27	SUN	18	265 16 55	37	16	S 3	20 39	21	U. Āṣādhā	25 22					
28	Mon	19	266 18 0	37	16	4	22 58	22	Śravaṇa	28 4					
29	Tue	20	267 19 6	38	17	5	24 54	23	Dhanīṣṭhā	30 22					
30	Wed	Dec. 21	268 20 13	6 38	17 17	6	26 18	24	Śatabhiṣaj	- -					
						S 7	27 3	24	"	8 8					

N. B.—All timings are given in I. S. T. or the local time of the meridian of 82½° E. Long.

REFORMED CALENDAR OF INDIA

FOR ŚAKA ERA 1877 (1955-56 A.D.)

Month of P A U Ś A (30 Days)

Makara : Tapas

Ayanāntika on 1st = 23° 14' 49"

Winter 1st Month

Date	Week Day	English Date	Long. of the Sun at 5-30 A.M.		Sun Rise	Sun Set	Tithi		Nakṣatra		Solar Month	Lunar Month	Transit of the Sun	Phenomena	Festivals
			°	'			No.	Ending Moment	No.	Name					
1955 A.D.			h	m	h	m	h	m	h	m					
1	Thu	Dec. 22	269	21 19	6 39	17 18	S 8	27 5	25	P. Bhādrapadā	9 15	1-Trop. Capricornus (20 ^h 41 ^m)		1-Uttarāyana Day	
2	Fri	23	270	22 26	39	18	S 9	26 20	26	U. Bhādrapadā	9 40				
3	Sat	24	271	23 33	40	19	10	24 51	27	Revati	9 20				
4	SUN	25	272	24 40	40	19	11	22 40	1	Āśvini	8 17				
5	Mon	26	273	25 47	41	20	12	19 52	3	Bharanī (2 Kṛttikā	30 34) 28 18			4-Vaikuṭṭha ekādaśī (Madras), Moksudā ekādaśī, Mauna ekādaśī (Jain). 5-Matsya dvādaśī, Akṣaya dvādaśī, Vyāḍhama dvādaśī & Dāna dvādaśī (Orissa).	
6	Tue	27	274	26 54	6 41	17 20	S 13	16 36	4	Rohini	25 36	8-Enters P. Āṣādhā (7 ^h 44 ^m)	7-Vaidhṛti (13 ^h 38 ^m) 8-Full Moon (9 ^h 14 ^m)	7-Dattātreya Jayantī.	
7	Wed	28	275	28 1	41	21	14	13 0	5	Mṛgaśīras	22 39			8-Arudra darśana (S. India).	
8	Thu	29	276	29 9	42	22	S 15	9 14	6	Ārdra	19 37				
9	Fri	30	277	30 16	42	22	(K 1	29 28)	7	Punarvasu	16 40				
10	Sat	31	278	31 24	43	23	2	25 53	8	Puṣya	13 59				
1956 A.D.															
11	SUN	Jan. 1	279	32 33	6 43	17 23	K 4	19 55	9	Āśleṣā	11 46	SAURA PAUŚA	CANDRA MARGAŚIRṢA	11-English New Year's Day.	
12	Mon	2	280	33 41	43	24	5	17 51	10	Maghā	10 8				
13	Tue	3	281	34 50	43	25	6	16 33	11	P. Phalgunī	9 14				
14	Wed	4	282	35 59	44	25	7	16 6	12	U. Phalgunī	9 8				
15	Thu	5	283	37 9	44	26	8	16 28	13	Hastā	9 50			15-P'apāṣṭakā.	
16	Fri	6	284	38 18	6 44	17 27	K 9	17 37	14	Citrā	11 20	19-Vyātīpātā (22 ^h 31 ^m)	17-Pauṣa darśanī (Jain). 18-Sapthalā ekādaśī. 19-Pakṣavarīḥini mahādvādaśī, Surūpā dvādaśī (Orissa).		
17	Sat	7	285	39 28	44	27	10	19 27	15	Svātī	13 29				
18	SUN	8	286	40 38	45	28	11	21 46	16	Viśākhā	16 8				
19	Mon	9	287	41 48	45	29	12	24 24	17	Anurādhā	19 8				
20	Tue	10	288	42 58	45	30	13	27 10	18	Jyēṣṭhā	22 18				
21	Wed	11	289	44 8	6 45	17 30	K 14	29 55	19	Mūla	25 27	21-Enters U. Āṣādhā (9 ^h 42 ^m) 24-Makarārdī (16 ^h 15 ^m)	23-New Moon (8 ^h 31 ^m)	22-Vakula amāvasyā (Orissa).	
22	Thu	12	290	45 18	45	31	30	— —	20	P. Āṣādhā	28 30			23-Bhogī (S. India).	
23	Fri	13	291	46 27	45	32	K 30	8 31	21	U. Āṣādhā	— —			24-Tīla sanīkrāntī, Pongal (S. India).	
24	Sat	14	292	47 36	45	32	S 1	10 53	21	"	7 20			25-Māṭṭu pongal (S. India).	
25	SUN	15	293	48 45	45	33	2	12 57	22	Śravana	9 54			25-Māgha bihu (Assam), Makarārdī snāna.	
26	Mon	16	294	49 53	6 45	17 34	S 3	14 40	23	Dhanīṣṭhā	12 7	SAURA MĀGHĀ	CANDRA PAUŚA	28-Guru padamī (Orissa).	
27	Tue	17	295	51 1	45	35	4	15 58	24	Śatabhiṣaj	13 57			29-Annarūpā ṣaṣṭhī (Bengal).	
28	Wed	18	296	52 8	45	35	5	16 48	25	P. Bhādrapadā	15 21			30-Guru Govinda Singh's Birthday.	
29	Thu	19	297	53 14	45	36	6	17 6	26	U. Bhādrapadā	16 14				
30	Fri	Jan. 20	298	54 19	6 45	17 37	S 7	16 50	27	Revati	16 35				

N.B.—All timings are given in I. S. T. or the local time of the meridian of 82½° E. Long.

REFORMED CALENDAR OF INDIA

FOR ŚAKA ERA 1877 (1955-56 A.D.)

Month of M Ā G H A (30 Days)

Kumbha : Tapasya

Ayanāntīśa on 1st = 23° 14' 53"

Winter 2nd Month

Date	Week Day	English Date	Long. of the Sun at 5-30 A.M.	Sun Rise	Sun Set	Tithi		Nakṣatra			Solar Month	Lunar Month	Transit of the Sun	Phenomena	Festivals
						No.	Ending Moment	No.	Name	Ending Moment					
			° ' "	h m	h m		h m			h m					
1	Sat	1956 A.D. Jan. 21	299 55 23	6 45	17 37	S 8	15 57	1	Āśvini	16 20	SAURA MĀGHA	CĀNDRA PAUṢA	1-Trop. Aquarius (7 ^h 19 ^m) 4-Enters Śravaṇa (11 ^h 57 ^m)	2-Vaidhṛti (29 ^h 18 ^m)	3-Śāmba Daśami (Orissa), Netaji's Birthday. 4-Putradā ekādaśī, Trisprśā ekādaśī, Kūrma dvādaśī.
2	SUN	22	300 56 27	45	38	9	14 27	2	Bharanī	15 28					
3	Mon	23	301 57 29	45	39	10	12 22	3	Kṛttikā	14 2					
4	Tue	24	302 58 30	44	40	11	9 44	4	Rohiṇī	12 4					
5	Wed	25	303 59 31	44	40	13	27 17	5	Mṛgaśiras	9 41					
6	Thu	26	305 0 30	6 44	17 41	S 14	23 44	6	Ārdrā	7 0					
7	Fri	27	306 1 29	44	42	S 15	20 10	8	Punarvasu	28 11					
8	Sat	28	307 2 26	43	42	K 1	16 46	9	Puṣya	25 23					
9	SUN	29	308 3 23	43	43	2	13 44	10	Āśleṣā	22 48					
10	Mon	30	309 4 19	43	44	3	11 12	11	Maghā	20 37					
11	Tue	31	310 5 14	6 42	17 44	K 4	9 22	12	P. Phalgunī	19 1					
12	Wed	Feb. 1	311 6 8	42	45	5	8 21	13	U. Phalgunī	18 8					
13	Thu	2	312 7 1	42	46	6	8 12	14	Hasta	18 5					
14	Fri	3	313 7 54	41	46	7	8 57	15	Citrā	18 53					
15	Sat	4	314 8 46	41	47	8	10 30	16	Svātī	20 32					
16	SUN	5	315 9 37	6 40	17 48	K 9	12 41	17	Viśākḥā	22 52					
17	Mon	6	316 10 27	40	48	10	15 17	18	Anurādhā	25 43					
18	Tue	7	317 11 16	39	49	11	18 4	19	Jyesthā	28 52					
19	Wed	8	318 12 4	39	50	12	20 47	19	Mūla	— —					
20	Thu	9	319 12 51	38	50	13	23 16	20	"	8 3					
21	Fri	10	320 13 37	6 38	17 51	K 14	25 25	21	P. Āṣādhā	11 6					
22	Sat	11	321 14 22	37	51	K 30	27 8	22	U. Āṣādhā	13 51					
23	SUN	12	322 15 6	37	52	S 1	28 24	23	Śravaṇa	16 14					
24	Mon	13	323 15 48	36	53	2	29 16	24	Dhanīṣṭhā	18 12					
25	Tue	14	324 16 28	35	53	3	29 43	25	Śatabhiṣaj	19 45					
26	Wed	15	325 17 7	6 35	17 54	S 4	29 46	26	P. Bhūdrapadā	20 55					
27	Thu	16	326 17 45	34	54	5	29 26	27	U. Bhūdrapadā	21 41					
28	Fri	17	327 18 21	33	55	6	28 43	1	Revatī	22 6					
29	Sat	18	328 18 54	33	56	7	27 34	2	Āśvini	22 7					
30	SUN	Feb. 19	329 19 27	6 32	17 56	S 8	26 1	3	Bharanī	21 44					
									Kṛttikā	20 58					

N.B.—All timings are given in I. S. T. or the local time of the meridian of 82½° E. Long.

REFORMED CALENDAR OF INDIA

FOR ŚAKA ERA 1877 (1955-56 A.D.)

Mina : Madhu

Ayanānśa on 1st = 23° 14' 57"

Month of PHĀLGUNA (30 Days)

Spring 1st Month

C. R. - 12.

Date	Week Day	English Date	Long. of the Sun at 5-30 A.M.	Sun Rise	Sun Set	Tithi		Nakṣatra			Solar Month	Lunar Month	Transit of the Sun	Phenomena	Festivals
						No.	Ending Moment	No.	Name	Ending Moment					
1956 A.D.			° ' "	h m	h m		h m			h m					
1	Mon	Feb. 20	330 19 57	6 31	17 57	S 9	24 3	4	Rohiṇī	19 46	SAURA PHĀLGUNA CĀNDRA MĀGHA			1-Mahānandā navamī.	
2	Tue	21	331 20 25	31	57	10	21 41	5	Mṛgāśīras	18 11				3-Jayā ekādaśī, Bhaimī ekādaśī, Lakṣminārāyaṇa ekādaśī (Orissa).	
3	Wed	22	332 20 52	30	58	11	19 0	6	Ārdrā	16 16				4-Bhīṣma dvādaśī, Varāha dvādaśī, Āmalaka dvādaśī & Sautāna dvādaśī (Orissa).	
4	Thu	23	333 21 17	29	58	12	16 5	7	Punarvasu	14 6					
5	Fri	24	334 21 39	28	59	13	13 3	8	Puṣya	11 48					
6	Sat	25	335 22 0	6 27	17 59	S 14	10 2	9	Āśleṣā	9 31					
7	SUN	26	336 22 20	27	18 0	S 15	7 11	10	Maghā	7 25				7-Full Moon (7 ^h 11 ^m)	6-Agni utsava (Orissa), Māghī pūrṇimā, Guru Ravi Das's Birthday (Punjab), Māsī magham (S. India).
8	Mon	27	337 22 37	26	0	(K 1	28 42)	(11	P. Phalgunī	29 40)					
9	Tue	28	338 22 53	25	1	2	26 45	12	U. Phalgunī	28 27					
10	Wed	29	339 23 7	24	1	3	25 27	13	Hasta	27 53					
11	Thu	Mar. 1	340 23 20	6 23	18 2	4	24 56	14	Citrā	28 5					
12	Fri	2	341 23 31	22	2	K 5	25 15	15	Svātī	29 7					
13	Sat	3	342 23 40	22	2	6	26 23	16	Viśākḥā	- -					
14	SUN	4	343 23 48	21	3	7	28 15	16	"	6 56				13-Enters P.Bhādra-padā (25 ^h 58 ^m)	14-Sitāṣṭamī, Śākāṣṭakā.
15	Mon	5	344 23 55	20	3	8	- -	17	Anurādhā	9 23					
16	Tue	6	345 23 59	6 19	18 4	8	6 38	18	Jyēṣṭhā	12 19					
17	Wed	7	346 24 2	18	4	K 9	9 17	19	Mūla	15 26					
18	Thu	8	347 24 4	17	5	10	11 56	20	P. Āṣādhā	18 31					18-Vijayā ekādaśī.
19	Fri	9	348 24 4	16	5	11	14 21	21	U. Āṣādhā	21 19					
20	Sat	10	349 24 2	15	6	12	16 21	22	Śravaṇa	23 41					20-Mahāśivarātri.
						13	17 49	23	Dhanīṣṭhā	25 32					
21	SUN	11	350 23 58	6 14	18 6	K 14	18 44	24	Śatabhiṣaj	26 50					
22	Mon	12	351 23 53	13	6	K 30	19 6	25	P. Bhādrapadā	27 39					
23	Tue	13	352 23 45	12	7	S 1	19 0	26	U. Bhādrapadā	28 1				22-New Moon (19 ^h 6 ^m)	
24	Wed	14	353 23 36	11	7	2	18 29	27	Revatī	28 0				23-Vaidhṛtī (22 ^h 32 ^m)	
25	Thu	15	354 23 24	11	8	3	17 37	1	Āśvinī	27 41				23-Minādi (26 ^h 3 ^m)	
26	Fri	16	355 23 11	6 10	18 8	S 4	16 28	2	Bharanī	27 7					26-Śānta caturthī (Orissa).
27	Sat	17	356 22 55	9	8	5	15 6	3	Kṛttikā	26 20					28-Gorūpiṇī ṣaṣṭhī (Bengal).
28	SUN	18	357 22 37	8	9	6	13 30	4	Rohiṇī	25 20					
29	Mon	19	358 22 16	7	9	7	11 42	5	Mṛgāśīras	24 9					
30	Tue	Mar. 20	359 21 54	6 6	18 9	S 8	9 42	6	Ārdrā	22 47			27-Enters U.Bhādra-padā (10 ^h 21 ^m)	30-Mahāviṣuva Day. (Year-ending day)	
													30-Trop. Aries (20 ^h 51 ^m)		

N.B.—All timings are given in I. S. T. or the local time of the meridian of 82½° E. Long.

REFORMED CALENDAR OF INDIA

FOR ŚAKA ERA 1878 (1956-57 A.D.)

Meṣa : Mādhava

Ayanānīsa on 1st = 23° 15' 0"

Month of C A I T R A (31 Days : Leap-year)

Spring 2nd Month

Date	Week Day	English Date	Long. of the Sun at 5-30 A.M.	Sun Rise	Sun Set	Tithi		Nakṣatra			Solar Month	Lunar Month	Transit of the Sun	Phenomena	O I I O C I Festivals
						No.	Ending Moment	No.	Name	Ending Moment					
1956 A.D.			° ' "	h m	h m		h m			h m					
1	Wed	Mar. 21	0 21 29	6 5	18 10	S 9	7 33	7	Punarvasu	21 16					1-Indian New Year's Day. 1-Phagu daśamī & Sudaśa vrata (Orissa). 2-Āmalakī ekādaśī. 3-Āmalakī ekādaśī (Vaiṣṇava), Nṛsiṅha dvādaśī.
2	Thu	22	1 21 1	4	10	11	26 54	8	Puṣya	19 39					
3	Fri	23	2 20 32	3	11	12	24 33	9	Āśleṣā	18 2					
4	Sat	24	3 20 0	2	11	13	22 19	10	Maghā	16 29					
5	SUN	25	4 19 26	1	11	14	20 19	11	P. Phalgunī	15 8					
6	Mon	26	5 18 49	6 0	18 12	S 15	18 41	12	U. Phalgunī	14 8					
7	Tue	27	6 18 11	5 59	12	K 1	17 33	13	Hasta	13 36					
8	Wed	28	7 17 31	58	12	2	17 3	14	Citrā	13 39					
9	Thu	29	8 16 48	57	13	3	17 14	15	Svātī	14 23					
10	Fri	30	9 16 4	56	13	4	18 8	16	Viśakhā	15 48					
11	Sat	31	10 15 18	5 55	18 14	K 5	19 42	17	Anurādhā	17 53					
12	SUN	Apr. 1	11 14 30	54	14	6	21 50	18	Jyeṣṭhā	20 30					
13	Mon	2	12 13 40	53	14	7	24 19	19	Mūla	23 28					
14	Tue	3	13 12 49	52	15	8	26 53	20	P. Āṣādhā	26 32					
15	Wed	4	14 11 55	51	15	9	29 17	21	U. Āṣādhā	29 26					
16	Thu	5	15 11 0	5 50	18 15	K 10	— —	22	Śravaṇa	— —					
17	Fri	6	16 10 3	49	16	10	7 17	22	"	7 58					
18	Sat	7	17 9 5	48	16	11	8 44	23	Dhaniṣṭhā	9 57					
19	SUN	8	18 8 4	47	17	12	9 32	24	Śatabhiṣaj	11 19					
20	Mon	9	19 7 2	46	17	13	9 40	25	P. Bhādrapadā	12 2					
21	Tue	10	20 5 58	5 45	18 17	K 14	9 10	26	U. Bhādrapadā	12 10					
22	Wed	11	21 4 52	45	18	K 30	8 9	27	Revatī	11 46					
23	Thu	12	22 3 43	44	18	S 1	6 41	1	Āśvinī	10 57					
24	Fri	13	23 2 33	43	18	(2	28 53)								
25	Sat	14	24 1 21	42	19	3	26 52	2	Bharanī	9 50					
26	SUN	15	25 0 6	5 41	18 19	S 5	22 28	4	Rohiṇī	7 5					
27	Mon	16	25 58 49	40	20	(5	29 36)								
28	Tue	17	26 57 30	39	20	6	20 14	6	Ārdrā	28 8					
29	Wed	18	27 56 9	38	20	7	13 2	7	Punarvasu	23 42					
30	Thu	19	28 54 46	38	21	8	15 55	8	Puṣya	25 22					
31	Fri	Apr. 20	29 53 20	5 37	18 21	S 10	12 3	10	Āśleṣā Maghā	24 10 23 9					

N.B.—All timings are given in I. S. T. or the local time of the meridian of 82½° E. Long.

REFORMED CALENDAR OF INDIA

FOR ŚAKA ERA 1878 (1956-57 A.D.)

Month of **V A I Ś Ā K H A** (31 Days)

Vṛṣa : Śukra

Ayanāntā on 1st = 23° 15' 3"

Summer 1st Month

Date	Week Day	English Date	Long. of the Sun at 5-30 A.M.	Sun Rise	Sun Set	Tithi		Nakṣatra		Solar Month	Lunar Month	Transit of the Sun	Phenomena	Festivals
						No.	Ending Moment	No.	Name					
			° ' "	h m	h m		h m			h m				
1	Sat	1956 A.D. Apr. 21	30 51 52	5 36	18 22	S 11	10 24	11	P. Phalgunī	22 21	SAURA VAIŚĀKHA	CANDRA CAITRA	5-Full Moon (7 ^h 10 ^m)	1-Kāmadā ekādaśī, Dolotsava, Ravinārāyaṇa ekādaśī (Orissa). 2-Mulana dvādaśī, Viṣṇudamanotsava, Vāmana dvādaśī, Anāṅga rayodaśī. 3-Mahāvīra jayantī (Jain), Madana-bhanjī, Śiva damanaka (Orissa). 4-Viṣṇu damanaka (Orissa). 5-Hanumat jayantī, Oli-ending (Jain).
2	SUN	22	31 50 22	5 35	18 22	12	9 0	12	U. Phalgunī	21 52				
3	Mon	23	32 48 50	5 34	18 22	13	7 58	13	Ilustā	21 45				
4	Tue	24	33 47 15	5 33	18 23	14	7 19	14	Citrā	22 5				
5	Wed	25	34 45 39	5 33	18 23	S 15	7 10	15	Svātī	22 56				
6	Thu	26	35 44 1	5 32	18 24	K 1	7 34	16	Viśākhā	24 20				
7	Fri	27	36 42 22	5 31	18 24	2	8 31	17	Anurādhā	26 16				
8	Sat	28	37 40 40	5 30	18 25	3	10 2	18	Jyeṣṭhā	28 42				
9	SUN	29	38 38 57	5 30	18 25	4	12 2	19	Mūla	- -				
10	Mon	30	39 37 12	5 29	18 25	5	14 23	19	"	7 31				
11	Tue	May 1	40 35 26	5 28	18 26	K 6	16 53	20	P. Aṣādhā	10 31	SAURA VAIŚĀKHA	CANDRA CAITRA	13-Vaidhṛti (17 ^h 7 ^m)	
12	Wed	2	41 33 38	5 28	18 26	7	19 18	21	U. Aṣādhā	13 31				
13	Thu	3	42 31 49	5 27	18 27	8	21 26	22	Śravaṇa	16 17				
14	Fri	4	43 29 58	5 26	18 27	9	23 3	23	Dhanīṣṭhā	18 36				
15	Sat	5	44 28 6	5 26	18 28	10	24 2	24	Śatabhiṣaj	20 18				
16	SUN	6	45 26 12	5 25	18 28	K 11	24 16	25	P. Bhādrapadā	21 18	SAURA VAIŚĀKHA	CANDRA CAITRA	16-Varāthinī ekādaśī,	
17	Mon	7	46 24 17	5 24	18 29	12	23 47	26	U. Bhādrapadā	21 35				
18	Tue	8	47 22 21	5 24	18 29	13	22 36	27	Revatī	21 11				
19	Wed	9	48 20 23	5 23	18 29	14	20 50	1	Aśvinī	20 11				
20	Thu	10	49 18 24	5 23	18 30	K 30	18 34	2	Bharāṇī	18 43				
21	Fri	11	50 16 23	5 22	18 30	S 1	15 58	3	Kṛttikā	16 53	SAURA VAIŚĀKHA	CANDRA VAIŚĀKHA	20-Enters Kṛttikā (20 ^h 41 ^m)	20-New Moon (18 ^h 34 ^m)
22	Sat	12	51 14 20	5 22	18 31	2	13 8	4	Rohiṇī	14 50				
23	SUN	13	52 12 16	5 21	18 31	3	10 13	5	Mṛgaśīras	12 43				
24	Mon	14	53 10 10	5 21	18 32	4	7 19	6	Ārdrā	10 37				
25	Tue	15	54 8 2	5 20	18 32	(5 28 33) 6	26 0	7	Punarvasu	8 41				
26	Wed	16	55 5 53	5 20	18 33	S 7	23 45	8	Puṣya	6 58	SAURA VAIŚĀKHA	CANDRA VAIŚĀKHA	24-Vṛṣādi (7 ^h 30 ^m)	25-Vyatīpāta (22 ^h 59 ^m)
27	Thu	17	56 3 42	5 19	18 33	8	21 51	9	Āśleṣā	5 35				
						(10		10	Māghā	28 34				
28	Fri	18	57 1 29	5 19	18 34	9	20 22	11	P. Phalgunī	27 57				
29	Sat	19	57 59 14	5 19	18 34	10	19 18	12	U. Phalgunī	27 46				
30	Sun	20	58 56 58	5 18	18 35	11	18 42	13	Ilustā	28 3	SAURA VAIŚĀKHA	CANDRA VAIŚĀKHA	31-Trop. Gemini (7 ^h 43 ^m)	21-Tithi of Deva Dāmodara (Assam). 22-Parasūrama jayantī. 23-Aksaya tṛtīyā, Candana yātrā (Bengal and Orissa), Varṣitapa samāpana (Jain). 24-Śaṅkar's Birthday. 25-Candana ṣaṣṭhī (Bengal). 26-Gaṅgotpatti, Jānu saptamī (Bengal), Śarkarā saptamī. 28-Śitā navamī (Bengal & Orissa). 30-Mohinī ekādaśī, Lakṣmīnārāyaṇa ekādaśī (Orissa). 31-Parasūrama dvādaśī, Rukmiṇī & Pipitakī dvādaśī (Bengal & Orissa).
31	Mon	May 21	59 54 40	5 18	18 35	S 12	18 33	14	Citrā	28 47				

N.B.—All timings are given in I. S. T. or the local time of the meridian of 82½° E. Long.

REFORMED CALENDAR OF INDIA

FOR ŚAKA ERA 1878 (1956-57 A.D.)

Mithuna : Śuci Ayanāntīka on 1st = 23° 15' 7"

Month of J Y A I Ś T H A (JYEṢṬHA) (31 Days)

Summer 2nd Month

Date	Week Day	English Date	Long. of the Sun at 5-30 A.M.	Sun Rise	Sun Set	Tithi		Nakṣatra			Solar Month	Lunar Month	Transit of the Sun	Phenomena	Festivals
						No.	Ending Moment	No.	Name	Ending Moment					
			° ' "	h m	h m		h m			h m					
1	Tue	May 22	60 52 21	5 18	18 36	S 13	18 53	15	Svāti	— —	SAURA JYAIŚṬHA	CĀNDRA VAISĀKHA	3-Enters Rohiṇī (16 ^h 57 ^m)	3-Full Moon (20 ^h 56 ^m) 3-Lunar Eclipse (Partial) visible in India. 7-Vaidhṛti (23 ^h 27 ^m)	2-Nṛsiṃha jayanti, Nṛsiṃha caturdaśī. 3-Buddha pūrṇimā, Vaiśākhi pūrṇimā, Sūpat gaurīvrata, Phuladola (Bengal), Gandheśvarī pūjā (Bengal).
2	Wed	23	61 50 0	17 36	19 41	14	19 41	15	"	5 59					
3	Thu	24	62 47 38	17 36	20 56	S 15	20 56	16	Viśākhā	7 38					
4	Fri	25	63 45 15	17 37	22 36	K 1	22 36	17	Anurādhā	9 42					
5	Sat	26	64 42 50	16 37	24 38	2	24 38	18	Jyeṣṭhā	12 10					
6	SUN	27	65 40 24	5 16	18 38	K 3	26 57	19	Mūla	14 56					
7	Mon	28	66 37 57	16 38	— —	4	— —	20	P. Āṣādhā	17 55					
8	Tue	29	67 35 30	16 39	5 25	4	5 25	21	U. Āṣādhā	20 57					
9	Wed	30	68 33 1	16 39	7 52	5	7 52	22	Śravaṇa	23 52					
10	Thu	31	69 30 31	16 40	10 7	6	10 7	23	Dhaniṣṭhā	26 30					
11	Fri	June 1	70 28 1	5 15	18 40	K 7	11 59	24	Śatabhiṣaj	28 38	SAURA JYAIŚṬHA	CĀNDRA VAISĀKHA	17-Enters Mṛgaśīras (14 ^h 53 ^m)	18-New Moon (26 ^h 59 ^m) 18-Solar Eclipse (Total) invisible in India. 20-Vyatipāta (15 ^h 2 ^m)	12-Trilocanāṣṭamī (Bengal). 15-Aparā ekādaśī, Jalakṛīḍā ekādaśī (Orissa). 17-Sāvitrī caturdaśī (Bengal). 18-Vaṭasāvitrīvrata, Phalahāriṇī Kalikā pūjā (Bengal). Sāvitrī amāvasyā (Orissa). 19-Daśaharā snānārambha. 21-Rambhā tṛtīyā, Pratāp jayanti (Rajasthan). 22-Umā caturthī (Bengal & Orissa), Guru Arjun Dev's Martyrdom Day (Punjab). 23-Mahādeva vivāha (Orissa), Skanda ṣaṣṭhī & Śītala-ṣaṣṭhī (Orissa). 24-Araṇya gaurī vrata, Araṇya ṣaṣṭhī (Bengal). 27-Gaṅgā daśaharā. 28-Devavivāha ekādaśī (Orissa), Nirjalā ekādaśī. 29-Nirjalā ekādaśī (Vaiṣṇava), Śrī Rāma dvādaśī, Campaka dvādaśī (Orissa), Vañjulī mahādvādaśī. 31-Dakṣiṇāyana Day.
12	Sat	2	71 25 30	15 40	13 18	8	13 18	25	P. Bhādrapadā	— —					
13	SUN	3	72 22 58	15 41	13 55	9	13 55	25	"	6 9					
14	Mon	4	73 20 25	15 41	13 47	10	13 47	26	U. Bhādrapadā	6 57					
15	Tue	5	74 17 52	15 42	12 53	11	12 53	27	Revatī	6 59					
16	Wed	6	75 15 18	5 15	18 42	K 12	11 15	1	Āśvini	6 17					
17	Thu	7	76 12 44	15 42	8 59	13	8 59	3	Bharani	28 55					
18	Fri	8	77 10 8	15 43	6 11	14	6 11	4	Kṛttikā	27 0					
19	Sat	9	78 7 32	15 43	26 59	(K 30)	26 59	5	Rohiṇī	24 40					
20	SUN	10	79 4 55	15 44	23 33	S 1	23 33	5	Mṛgaśīras	22 4					
21	Mon	11	80 2 18	5 15	18 44	S 3	16 34	7	Ārdrā	19 22					
22	Tue	12	80 59 39	15 44	16 34	4	13 20	8	Punarvasu	16 45					
23	Wed	13	81 56 59	15 45	13 20	5	10 26	9	Puṣya	14 20					
24	Thu	14	82 54 19	15 45	10 26	6	8 0	10	Āśleṣā	12 16					
25	Fri	15	83 51 38	15 45	8 0	7	6 8	11	Maghā	10 42					
26	Sat	16	84 48 55	5 16	6 8	(8)	28 53	11	P. Phalgunī	9 41					
27	SUN	17	85 46 12	16 46	28 16	S 9	28 16	12	U. Phalgunī	9 17	SAURA JYAIŚṬHA	CĀNDRA VAISĀKHA	31-Enters Ārdrā (13 ^h 54 ^m)	27-Venus sets in the West	
28	Mon	18	86 43 28	16 46	28 17	10	28 17	13	Hasta	9 32					
29	Tue	19	87 40 43	16 46	28 54	11	28 54	14	Citrā	10 24					
30	Wed	20	88 37 58	16 47	— —	12	— —	15	Svāti	11 49					
31	Thu	June 21	89 35 11	5 16	18 47	S 13	7 36	17	Viśākhā	13 43					
									Anurādhā	16 2					

N.B.—All timings are given in I. S. T' or the local time of the meridian of 82½° E. Long.

REFORMED CALENDAR OF INDIA

FOR ŚAKA ERA 1878 (1956-57 A.D.)

Month of **Ā Ś Ā D H A** (31 Days)

Karkāṭa : Nabhas

Ayanāntiśa on 1st = 23° 15' 12"

Rains 1st Month

C.R.-13

Date	Week Day	English Date	Long. of the Sun at 5-30 A.M.	Sun Rise	Sun Set	Tithi		Nakṣatra			Solar Month	Lunar Month	Transit of the Sun	Phenomena	Festivals
						No.	Ending Moment	No.	Name	Ending Moment					
			° ' "	h m	h m		h m			h m					
1	Fri	1956 A.D. June 22	90 32 25	5 17	18 47	S 14	9 32	18	Jyesthā	18 39	SAURA ĀŚĀDHA CĀNDRA JYAIṢṬHA SAURA ĀŚĀDHA CĀNDRA ĀŚĀDHA SAURA ŚRĀVANA CĀNDRA ĀŚĀDHA	14-Enters Punarvasu (13 ^h 33 ^m) 24-Karkāṇḍi (25 ^h 3 ^m) 28-Enters Puṣya (13 ^h 2 ^m) 31-Trop. Leo. (26 ^h 51 ^m)	15-Vyātipāta (10 ^h 11 ^m) 17-New Moon (10 ^h 7 ^m)	13-Yoginī ekādaśī.	1-Campaka caturdaśī (Bengal), Vatasāvitrī vrata (Deccan). 2-Snāna yātrā (Bengal & Orissa). 6-Venus rises in the East 15-Rathayātrā, Manoratha dvitīyā vrata. 21-Skanda pañcamī. 22-Perā pañcamī (Orissa), Kumāra ṣaṣṭhī, Kardama ṣaṣṭhī (Bengal). 23-Vivusvat saptamī. 24-Parasūrāma aṣṭamī (Orissa), Khārcī pūjā (Tripura). 25-Manasā pūjā begins (Bengal). 26-Punaryātrā (Bengal & Orissa). 27-Hariśayana ekādaśī, Ravinātrīyaṇa ekādaśī (Orissa), Viṣṇu śayanotsava. 28-Gopadma vratārambha, Śrī Kṛṣṇa dvādaśī. 30-Śiva śayana caturdaśī (Orissa), Cāturmāsya caturdaśī (Jan). 31-Śiva śayanotsava, Guru pūrṇimā, Vyāsa pūjā, Kokilāvratā.
2	Sat	23	91 29 38	5 17	18 47	S 15	11 43	19	Mūla	21 30					
3	SUN	24	92 26 50	5 17	18 47	K 1	14 6	20	P. Āśādhā	24 29					
4	Mon	25	93 24 3	5 17	18 48	2	16 33	21	U. Āśādhā	27 31					
5	Tue	26	94 21 15	5 18	18 48	3	18 58	22	Śravaṇa	- -					
6	Wed	27	95 18 26	5 18	18 48	K 4	21 15	22	Śravaṇa	6 29					
7	Thu	28	96 15 38	5 18	18 48	5	23 16	23	Dhanīṣṭhā	9 15					
8	Fri	29	97 12 50	5 19	18 48	6	24 51	24	Śatabhiṣaj	11 41					
9	Sat	30	98 10 2	5 19	18 48	7	25 54	25	P. Bhādrapadā	13 39					
10	SUN	July 1	99 7 14	5 19	18 48	8	26 17	26	U. Bhādrapadā	15 2					
11	Mon	2	100 4 26	5 19	18 48	K 9	25 55	27	Revatī	15 43					
12	Tue	3	101 1 39	5 20	18 48	10	24 48	1	Āśvini	15 39					
13	Wed	4	101 58 51	5 20	18 48	11	22 57	2	Bharanī	14 51					
14	Thu	5	102 56 4	5 21	18 48	12	20 26	3	Kṛttikā	13 22					
15	Fri	6	103 53 17	5 21	18 48	13	17 22	4	Rohiṇī	11 16					
16	Sat	7	104 50 31	5 21	18 48	K 14	13 53	5	Mṛgaśiras	8 42					
17	SUN	8	105 47 45	5 22	18 48	K 30	10 7	6	Ārdrā	5 50					
18	Mon	9	106 44 58	5 22	18 48	S 1	6 17	7	Punarvasu	26 49					
19	Tue	10	107 42 12	5 23	18 48	(2	26 31)	8	Puṣya	23 52					
20	Wed	11	108 39 26	5 23	18 48	3	23 0	9	Āśleṣā	21 9					
21	Thu	12	109 36 40	5 23	18 48	4	19 55	10	Maghā	18 51					
22	Fri	13	110 33 54	5 24	18 48	S 5	17 24	11	P. Phalgunī	17 7					
23	Sat	14	111 31 8	5 24	18 47	6	15 34	12	U. Phalgunī	16 4					
24	SUN	15	112 28 22	5 24	18 47	7	14 30	13	Hasta	15 47					
25	Mon	16	113 25 36	5 25	18 47	8	14 14	14	Citrā	16 17					
26	Tue	17	114 22 50	5 25	18 47	9	14 44	15	Svatī	17 32					
27	Wed	18	115 20 4	5 26	18 46	S 10	15 54	16	Viśākhā	19 25					
28	Thu	19	116 17 18	5 26	18 46	11	17 37	17	Anurādhā	21 48					
29	Fri	20	117 14 33	5 27	18 46	12	19 43	18	Jyesthā	24 33					
30	Sat	21	118 11 48	5 27	18 45	13	22 4	19	Mūla	27 31					
31	SUN	July 22	119 9 4	5 28	18 45	14	24 32	20	P. Āśādhā	- -					
						S 15	26 59	20	"	6 33					

N.B.—All timings are given in I. S. T. or the local time of the meridian of 82½° E. Long.

REFORMED CALENDAR OF INDIA

FOR ŚAKA ERA 1878 (1956-57 A.D.)

Sīdhā : Nabhasya Āyanamīśā on 1st = 23° 15' 17"

Month of Ś R Ā V Ṃ Ā (31 Days)

Rains 2nd Month

Date	Week Day	English Date	Long. of the Sun at 5-30 A.M.	Sun Rise	Sun Set	Tithi		Nakṣatra		Solar Month	Lunar Month	Transit of the Sun	Phenomena	Festivals
						No.	Ending Moment	No.	Name					
1956 A.D.			° ' "	h m	n m		h m			h m				
1	Mon	July 23	120 6 20	5 28	18 45	K 1	29 20	21	U. Aśādhā	9 33	C Ā N D R A Ś R Ā Ḍ Ḍ Ā		2-Aśūnya śayana vrata.	
2	Tue	24	121 3 37	29	44	2	— —	22	Śravaṇa	12 27				
3	Wed	25	122 0 54	29	44	3	7 32	23	Dhanīṣṭhā	15 11				
4	Thu	26	122 58 13	29	44	4	9 29	24	Śatabhiṣaj	17 39				
5	Fri	27	123 55 32	30	43	5	11 7	25	P. Bhūdrapadā	19 46				
6	Sat	28	124 52 52	5 30	18 43	K 5	12 20	26	U. Bhūdrapadā	21 28	C Ā N D R A Ś R Ā Ḍ Ḍ Ā		6-Nāga puñcamī (Bengal).	
7	SUN	29	125 50 13	31	42	6	13 3	27	Revatī	22 39				
8	Mon	30	126 47 35	31	42	7	13 11	1	Aśvinī	23 14				
9	Tue	31	127 44 58	32	41	8	12 40	2	Bharanī	23 9				
10	Wed	Aug. 1	128 42 22	32	41	9	11 28	3	Kṛttikā	22 22				
11	Thu	2	129 39 48	5 32	18 40	K 10	9 34	4	Rohiṇī	20 56	C Ā N D R A Ś R Ā Ḍ Ḍ Ā		9-Vyatipāta (25 ^h 49 ^m)	
12	Fri	3	130 37 14	33	40	11	7 3	5	Mṛgaśiras	18 54				
						(12	27 59)	6	Ārdrā	16 24				
13	Sat	4	131 34 42	33	39	13	24 30	7	Punarvasu	13 34				
14	SUN	5	132 32 11	34	38	14	20 45	8	Puṣya	10 34				
15	Mon	6	133 29 41	34	38	K 30	16 55				S Ā U R Ā Ś R Ā Ḍ Ḍ Ā		15-New Moon (16 ^h 55 ^m)	
16	Tue	7	134 27 12	5 35	18 37	S 1	13 10	9	Āśleṣā	7 36				
17	Wed	8	135 24 44	35	36	2	9 42	11	P. Phalgunī	26 34				
18	Thu	9	136 22 17	35	36	3	6 41	12	U. Phalgunī	24 51				
						(4	28 17)	13	Hasta	23 51				
19	Fri	10	137 19 51	36	35	5	26 39	14	Citrā	23 42	C Ā N D R A Ś R Ā Ḍ Ḍ Ā		11-Enters Āśleṣā (11 ^h 59 ^m)	
20	Sat	11	138 17 26	36	34	6	25 51							
21	SUN	12	139 15 2	5 36	18 34	S 7	25 54	15	Svātī	24 23				
22	Mon	13	140 12 38	37	33	8	26 47	16	Viśākhā	25 52				
23	Tue	14	141 10 16	37	32	9	28 21	17	Anurādhā	28 1				
24	Wed	15	142 7 55	38	31	10	— —	18	Jyesthā	— —	S Ā U R Ā B H Ā Ḍ R Ā P Ā Ḍ Ā		15-Ādi amāvasyā (S. India), Karkāṭaka vānu (T. C. State), Citāu amāvasyā (Orissa).	
25	Thu	16	143 5 34	39	31	10	6 25	18	"	6 41				
26	Fri	17	144 3 15	5 38	18 30	S 11	8 49	19	Mūla	9 38				
27	Sat	18	145 0 57	39	29	12	11 20	20	P. Āśādhā	12 42				
28	SUN	19	145 58 40	39	28	13	13 48	21	U. Āśādhā	15 42				
29	Mon	20	146 56 24	39	27	14	16 5	22	Śravaṇa	18 33	C Ā N D R A Ś R Ā Ḍ Ḍ Ā		17-Ādi pūram (S. India). 18-Madhuśravā (Gujerat). 19-Nāga puñcamī, Jāgratgaurī puñcamī, Varalakṣmī-vrata (S. India). 20-Luṅṭhana ṣaṣṭhī (Bengal). 24-Independence Day. 25-Jhulana yātrārambha, Manasā pūjā (Bengal). 26-Jhulana yātrārambha, Putradā (Pavitrā) ekādaśī, Varalakṣmī vrata (S. India). 27-Buddha dvādaśī, Dāmodara dvādaśī, Viṣṇu pavitrāropanam. 28-Śiva pavitrāropanam (Orissa), Ākheṭaka trayodaśī (Orissa), First Onam Day (S. India). 29-Upākarma (Rt), Jhulana yātrā samāpana, Thiru Onam Day (S. India). 30-Rakṣā bandhana, Coconut Day, Rṣitarpana, Jhulanayātrāsamāpana, Hayagrivotpattī, Āvaṇī Avittam, Balabhadra pūjā (Orissa), Solono (Pepsu), Yaju Upākarma (S. India), Third Onam Day. 31-Fourth Onam Day (S. India). Śrī Nārāyaṇa Guru Deva's Birthday (S. India).	
30	Tue	21	147 54 9	40	26	S 15	18 8	23	Dhanīṣṭhā	21 8				
31	Wed	Aug. 22	148 51 56	5 40	18 26	K 1	19 52	24	Śatabhiṣaj	23 25				

N.B.—All timings are given in I. S. T. or the local time of the meridian of 82½° E. Long.

REFORMED CALENDAR OF INDIA

FOR ŚAKA ERA 1878 (1956-57 A.D.)

Month of **B H Ā D R A** (BHĀDRAPADA) (31 Days)

Kanya : Iṣa

Ayanāntika on 1st = 23° 15' 21"

Autumn 1st Month

Date	Week Day	English Date	Long. of the Sun at 5-30 A.M.	Sun Rise	Sun Set	Tithi		Nakṣatra			Solar Month	Lunar Month	Transit of the Sun	Phonomena	Festivals
						No.	Ending Moment	No.	Name	Ending Moment					
1956 A.D.			° ' "	h m	h m		h m		h m						
1	Thu	Aug. 23	149 49 45	5 41	18 25	K 2	21 17	25	P. Bhādrapadā	25 24	SAURA BHĀDRAPADA	CĀNDRA ŚRĀVANA	1-Trop. Virgo (9 ^h 45 ^m)	4-Vyātīpātā (11 ^h 22 ^m)	1-Aśūnya śayana vrata. 2-Kajjali tṛtīyā, Aṅgabheṭa tṛtīyā (Orissa). 3-Bahulā caturthī (Madhya Deśa). 4-Rakṣā pañcamī (Orissa), Tithi of Śrī Mādhava Deva (Assam). 5-Hula ṣaṣṭhī. 6-Śītalā saptaṃī, Janmāṣṭami or Śrī Jayantī (Smārta) (S. India). 7-Janmāṣṭami, Pañcarātra Śrī Kṛṣṇa jayantī (S. India), Gokulāṣṭami. 10-Ajā ekādaśī, Kālidāsa ekādaśī (Orissa).
2	Fri	24	150 47 34	41	24	K 3	22 20	26	U. Bhādrapadā	27 2					
3	Sat	25	151 45 26	41	23	4	23 1	27	Rovati	28 17					
4	SUN	26	152 43 19	42	22	5	23 16	1	Aśvini	29 6					
5	Mon	27	153 41 14	42	21	6	23 3	2	Bharanī	29 26					
6	Tue	28	154 39 11	5 42	18 20	K 7	22 18	3	Kṛttikā	29 15					
7	Wed	29	155 37 9	43	19	8	20 59	4	Rohiṇī	28 31	SAURA BHĀDRAPADA	CĀNDRA ŚRĀVANA	7-Enters P. Phalgunī (29 ^h 35 ^m)		
8	Thu	30	156 35 10	43	18	9	19 8	5	Mṛgaśīras	27 13					
9	Fri	31	157 33 12	43	18	10	16 44	6	Ārdrā	25 26					
10	Sat	Sept. 1	158 31 17	44	17	11	13 54	7	Punarvasu	23 13					
11	SUN	2	159 29 23	5 44	18 16	K 12	10 42	8	Puṣya	20 42					
12	Mon	3	160 27 31	44	15	13	7 17	9	Āśleṣā	18 2	SAURA BHĀDRAPADA	CĀNDRA ŚRĀVANA	13-New Moon (24 ^h 27 ^m)	11-Paryuṣaṇa parvārambha (Jain—pañcamī pakṣa). 12-Aghora caturdaśī (Bengal & Orissa), Keil Muhurth (Coorg). 13-Āloka amāvasyā (Bengal), Kusotpāṇī (Pithori) amāvasyā, Saptapurī amāvasyā (Orissa). 14-Rudravrata. 15-Tithi of Śrī Śankara Deva (Assam).	
13	Tue	4	161 25 41	45	14	(14 27 49)		10	Maghā	15 25					
14	Wed	5	162 23 53	45	13	S 1	21 23	11	P. Phalgunī	13 0					
15	Thu	6	163 22 6	45	12	2	18 47	12	U. Phalgunī	10 59	SAURA BHĀDRAPADA	CĀNDRA BHĀDRAPADA	16-Vaidhṛtī (7 ^h 47 ^m)	16-Haritalikā tṛtīyā, Gaurī tṛtīyā (Mysore). 17-Ganeśa caturthī, Varadī caturthī, Saubhāgya caturthī, Haritalī caturthī, Saivatsarī (Jain—caturthī pakṣa). 18-Ṛṣi pañcamī & Rakṣā pañcamī (Bengal), Saivatsarī (Bombay, Surat & Ahmedabad), Guru pañcamī (Orissa), Paryuṣaṇa parva samāpana (Jain—pañcamī pakṣa). 19-Sūrya ṣaṣṭhī, Lolārīka ṣaṣṭhī, Carpatā ṣaṣṭhī (Bengal), Somanātha vrata (Orissa), Manthāna ṣaṣṭhī (Bengal). 20-Muktābharapa vrata, Lalitā saptaṃī (Bengal). 21-Dārvāṣṭami (Bengal), Rādhāṣṭami, Durgāsayanī (Orissa), Mahālakṣmīvrata. Āvaṇī mūlam (S. India). 22-Aduhkha navamī, Tāla navamī (Bengal), Nandā navamī. 24-Parivartana (Padmā) ekādaśī, Lakṣmīnārāyaṇa ekādaśī (Orissa), Śravaṇa dvādaśī, Viṣṇu ūkhalayōga, Dol gyaras (Madhya Bharat), Heikta Hitomba (Manipur). 25-Sakrotthāna, Vāmana jayantī, Kalkī dvādaśī, Viṣṇu parivartanotsava, Viśvakarmā pūjā (Bengal). 27-Ananta caturdaśī. 28-Ananta caturdaśī (Bengal), Indra govinda pūjā (Orissa). 29-Mahālayārambha. 30-Aśūnya śayana vrata, Sumāhī day of Nārāyaṇa (Guru (T. C. State).	
16	Fri	7	164 20 21	5 45	18 11	S 3	16 48	13	Hasta	9 32					
17	Sat	8	165 18 38	46	10	4	15 34	14	Citrā	8 48					
18	SUN	9	166 16 56	46	9	5	15 10	15	Svātī	8 52					
19	Mon	10	167 15 16	46	8	6	15 37	16	Viśākhā	9 46					
20	Tue	11	168 13 38	47	7	7	16 51	17	Anurādhā	11 26	SAURA BHĀDRAPADA	CĀNDRA BHĀDRAPADA	21-Enters U. Phalgunī (23 ^h 19 ^m)	24-Jupiter rises in the East	
21	Wed	12	169 12 1	5 47	18 6	S 8	18 43	18	Jyēṣṭhā	13 46					
22	Thu	13	170 10 25	47	5	9	21 0	19	Mūla	16 32					
23	Fri	14	171 8 51	48	4	10	23 30	20	P. Āṣādhū	19 32					
24	Sat	15	172 7 19	48	3	11	25 59	21	U. Āṣādhū	22 33					
25	SUN	16	173 5 49	48	2	12	28 15	22	Śravaṇa	25 23	SAURA BHĀDRAPADA	CĀNDRA BHĀDRAPADA	25-Kanyādī (9 ^h 16 ^m)	29-Full Moon (8 ^h 49 ^m)	
26	Mon	17	174 4 20	5 49	18 1	S 13	--	23	Dhanīṣṭhā	27 54					
27	Tue	18	175 2 53	49	18 0	13	6 11	24	Śatabhiṣaj	--					
28	Wed	19	176 1 28	49	17 59	14	7 43	24	"	6 3					
29	Thu	20	177 0 4	49	57	S 15	8 49	25	P. Bhādrapadā	7 46					
30	Fri	21	177 58 43	50	57	K 1	9 31	26	U. Bhādrapadā	9 6					
31	Sat	Sept. 22	178 57 23	5 50	17 55	K 2	9 48	27	Rovati	10 2	SAURA BHĀDRAPADA	CĀNDRA BHĀDRAPADA	29-Vyatīpātā (18 ^h 57 ^m)		

N.B.—All timings are given in I. S. T. or the local time of the meridian of 82½° E. Long.

REFORMED CALENDAR OF INDIA

FOR ŚAKA ERA 1878 (1956-57 A.D.)

Tulā : Ūrjū

Ayamitiśā on 1st = 23° 15' 24"

Month of Ā Ś V I N A (30 Days)

Autumn 2nd Month

Date	Week Day	English Date	Long. of the Sun at 5-30 A.M.	Sun Rise	Sun Set	Tithi		Nakṣatra			Solar Month	Lunar Month	Transit of the Sun	Phenomena	Festivals
						No.	Ending Moment	No.	Name	Ending Moment					
			° ' "	h m	h m		h m			h m					
1	SUN	1956 A.D. Sept. 23	179 56 6	5 50	17 54	K 3	9 44	1	Āśvini	10 37	SAUBRA Ā Ś V I N A	CĀNDRA BHĀDRAPADA	1-Trop Libra (7 ^h 6 ^m)	1-Jalaviṣṭva Day.	
2	Mon	24	180 54 51	51	53	4	9 18	2	Bharanī	10 50			3-Enters	3-Candra ṣaṣṭhī.	
3	Tue	25	181 53 38	51	52	5	8 30	3	Kṛttikā	10 42			4-Enters		
4	Wed	26	182 52 27	51	51	6	7 21	4	Rohiṇī	10 13			IIasta		
5	Thu	27	183 51 18	52	50	(7 29 49)		5	Mṛgāśiras	9 22			(14 ^h 52 ^m)	5-Mahālakṣmī vrata, Jitāṣṭamī (Bengal), Malāṣṭamī (Orissa).	
6	Fri	28	184 50 12	5 52	17 49	K 9	25 42	6	Ārdrā	8 9				6-Mātṛnavamī, Abidhava navamī, Durgā navamī (Maharashtra).	
7	Sat	29	185 49 8	52	48	10	23 12	7	Punarvasu	6 37					
8	SUN	30	186 48 7	53	47	(8		8	Ṣṛṅṅā	28 48)					
9	Mon	Oct. 1	187 47 8	53	46	11	20 29	9	Āśleṣā	26 48				8-Indirā ekādaśī.	
10	Tue	2	188 46 11	53	45	12	17 40	10	Māghā	24 45				10-Vaidhyti (23 ^h 41 ^m)	10-Mahatma Gandhi's Birthday.
11	Wed	3	189 45 16	5 54	17 44	K 14	12 14	11	P. Phalgunī	22 45					11-Mahālayā amāvasyā, Sarvapatī amāvasyā.
12	Thu	4	190 44 23	54	43	K 30	9 54	12	U. Phalgunī	20 59					
13	Fri	5	191 43 32	54	42	S 1	8 3	13	IIasta	19 34		12-New Moon (9 ^h 54 ^m)	13-Navarātrambha.		
14	Sat	6	192 42 44	55	42	2	6 47	14	Citrā	18 41					
15	SUN	7	193 41 57	55	41	3	6 12	15	Svātī	18 26			15-Māna caturthī (Bengal).		
16	Mon	8	194 41 12	5 56	17 40	S 4	6 23	16	Viśākhā	18 53			16-Upāṅga kalitā vrata (Maharashtra), Nava puṅcamī (Orissa).		
17	Tue	9	195 40 29	56	39	5	7 19	17	Anurādhā	20 5					
18	Wed	10	196 39 48	56	38	6	8 55	18	Jyēṣṭhā	21 59		17-Enters	18-Durgā ṣaṣṭhī, Tapah ṣaṣṭhī (Orissa), Sarasvatī sthāpana.		
19	Thu	11	197 39 9	57	37	7	11 3	19	Mūla	24 26			19-Durgā pūjā, Sarasvatī pūjā, Oil begins (Jain).		
20	Fri	12	198 38 31	57	36	8	13 28	20	P. Āṣāḍhā	27 16			20-Mahāṣṭamī, Vīrāṣṭamī, Sarasvatī balidāna, Āyudha pūjā.		
21	Sat	13	199 37 55	5 58	17 35	S 9	15 58	21	U. Āṣāḍhā	6 15			21-Mahānavamī, Sarasvatī visarjana.		
22	SUN	14	200 37 21	58	34	10	18 17	22	Śravaṇa	9 9			22-Vijyā daśamī, Daśahanī.		
23	Mon	15	201 36 49	58	33	11	20 15	23	Dhanīṣṭhā	11 45			23-Papāhikuśā ekādaśī, Bharat Milap.		
24	Tue	16	202 36 19	59	33	12	21 44	24	Śatabhiṣaj	13 56			24-Padmanāva dvādaśī, Kāveri Śaṅkramana.		
25	Wed	17	203 35 50	5 59	32	13	22 40	25	P. Bhādrapadī	15 36					
26	Thu	18	204 35 23	6 0	17 31	S 14	23 3	26	U. Bhādrapadī	16 44					
27	Fri	19	205 34 58	0	30	S 15	22 54	27	Rovātī	17 21			27-Full Moon (22 ^h 54 ^m)	27-Kojāgarī Lakṣmī pūjā, Kumāra pūrgimā, Oil ends (Jain), Mahārṣi Vālmiki's Birthday (Punjab).	
28	Sat	20	206 34 35	1	29	K 1	22 18	1	Āśvini	17 30			27-Anubhiṣekam (S. India).		
29	SUN	21	207 34 15	1	28	2	21 19	2	Bharanī	17 15			29-Āśūnya śayama vrata.		
30	Mon	Oct. 22	208 33 56	6 2	17 28	K 3	20 0	3	Kṛttikā	16 40			30-Karaka caturthī.		

N.B.—All timings are given in I. S. T. or the local time of the meridian of 82½° E. Long.

REFORMED CALENDAR OF INDIA

FOR ŚAKA ERA 1878 (1956-57 A.D.)

Month of KĀRTIKA (30 Days)

Vṛścika : Sahas

Ayanāntika on 1st = 23° 15' 27"

Hemanta 1st Month

C.R.-14

Date	Week Day	English Date	Long. of the Sun at 5-30 A.M.	Sun		Tithi		Nakṣatra			Solar Month	Lunar Month	Transit of the Sun	Phenomena	Festivals								
				Rise	Set	No.	Ending Moment	No.	Name	Ending Moment													
			° ' "	h m	h m		h m																
1956 A.D.																							
1	Tue	Oct. 23	209 33 39	6 2	17 27	K 4	18 25	4	Rohiṇi	15 49	SAURA KĀRTIKA	CĀNDRA ĀŚVINA	1-Enters Svāti (14 ^h 15 ^m)	1-Daśaratha caturthī (Bengal).									
2	Wed	24	210 33 25	2	26	5	16 38	5	Mṛgaśīras	14 45						1-Trop. Scorpio (16 ^h 5 ^m)	4-Ahoyī aṣṭamī (Gujerat), Karīṣṭamī (Maharashtra).						
3	Thu	25	211 33 12	3	25	6	14 41	6	Ārdrā	13 32									6-Vaidhṛtī (12 ^h 29 ^m)	7-Ramā ekādaśī (Smārta).	8-Ramā ekādaśī. (Vaiṣṇava), Govatsa dvādaśī.		
4	Fri	26	212 33 2	4	25	7	12 36	7	Punarvasu	12 10												9-Dhana trayodaśī, Yama dipādāna.	10-Naraka caturdaśī, Kālī pūjā, Dīpāvalī, Bhūta caturdaśī (Bengal), Hanumat janmadina, Śaṣṭrābhata caturdaśī.
5	Sat	27	213 32 55	4	24	8	10 27	8	Puṣya	10 44													
6	SUN	28	214 32 49	6 5	17 23	K 9	8 15	9	Āśleṣā	9 16			14-Enters Viśakhā (22 ^h 18 ^m)	12-Govardhana pūjā, Bali pūjā, Dyūta pratipad, Annakūṭa.									
7	Mon	29	215 32 46	5	23	11	27 59	10	Maghā	7 48					15-Nāga caturthī.	13-Yama dvitīyā, Bhṛtṛdvitīyā, Dwāt pūjā (Bihar).							
8	Tue	30	216 32 45	6	22	12	26 4	11	P. Phalgunī	6 27							16-Jñāna pañcamī (Jain).	14-Ālocanā gaurī vrata.					
9	Wed	31	217 32 46	6	21	13	24 24	12	U. Phalgunī	29 15									17-Sūrya ṣaṣṭhī, Nāgī ṣaṣṭhī (Bengal), Skanda ṣaṣṭhī (Madras), Chhat (Bihar).	15-Nāga caturthī.			
10	Thu	Nov. 1	218 32 49	7	21	14	23 5	13	Hasta	28 20											19-Vyatīpāta (8 ^h 41 ^m)	16-Jñāna pañcamī (Jain).	
11	Fri	2	219 32 54	6 7	17 20	K 30	22 13	15	Svāti	27 40			20-Gopāṣṭamī, Goṣṭhāṣṭamī.	17-Sūrya ṣaṣṭhī, Nāgī ṣaṣṭhī (Bengal), Skanda ṣaṣṭhī (Madras), Chhat (Bihar).									
12	Sat	3	220 33 1	8	19	S 1	21 54	16	Viśakhā	28 6					21-Jagaddhātri pūjā (Bengal), Akṣaya navamī, Durgā navamī, Gaurī vrata (Bengal), Viṣṇu trīrātra, Anā navamī (Orissa).	23-Bhīṣma pañcaka, Tulasī vivāha, Prabodhanī ekādaśī.							
13	SUN	4	221 33 10	8	19	2	22 9	17	Anurādhā	29 7							24-Vṛścikādi (20 ^h 47 ^m)	24-Kārtika pūjā (Bengal), Vṛndāvana dvādaśī, Nārāyaṇa dvādaśī, Prabodhanotsava.					
14	Mon	5	222 33 21	9	18	3	23 3	18	Jyēṣṭhā	- -									25-Vaikunṭha caturdaśī, Baḍa oṣā (Orissa), Pāṣāṇa caturdaśī (Bengal & Orissa).	26-Cāturmāsya caturdaśī (Jain), Bharanī dīpam (S. India), Tripurotsava, Rāṣayātrā, Death Anniversary of Lala Lajpat Rai, Vaikhānasa dīpam (S. India).			
15	Tue	6	223 33 33	10	18	4	24 32	18	"	6 44											27-Enters Anurādhā (28 ^h 20 ^m)	27-Rathayātrā (Jain), Kṛttikā dīpam (S. India), Kedāra vrata (Orissa), Kārtikī pūrṇimā, Guru Nānak's Birthday, Puskar fair (Ajmer).	
16	Wed	7	224 33 47	6 10	17 17	S 5	26 31	19	Mūla	8 54													
17	Thu	8	225 34 2	11	17	6	28 53	20	P. Āṣādhā	11 31													
18	Fri	9	226 34 19	11	16	7	- -	21	U. Āṣādhā	14 25													
19	Sat	10	227 34 38	12	16	7	7 24	22	Śravaṇa	17 23													
20	SUN	11	228 34 58	13	15	8	9 51	23	Dhanīṣṭhā	20 12													
21	Mon	12	229 35 19	6 13	17 15	S 9	12 0	24	Śatabhiṣaj	22 39	SAURA MĀRGASĪRṢA	CĀNDRA KĀRTIKA	27-Full Moon (12 ^h 14 ^m)	27-Lunar Eclipse (total) invisible in India.									
22	Tue	13	230 35 42	14	15	10	13 39	25	P. Bhādrapadā	24 34													
23	Wed	14	231 36 6	15	14	11	14 41	26	U. Bhādrapadā	25 52													
24	Thu	15	232 36 31	15	14	12	15 2	27	Revatī	26 30													
25	Fri	16	233 36 58	16	14	13	14 42	1	Aśvinī	26 29													
26	Sat	17	234 37 27	6 17	17 13	S 14	13 45	2	Bharanī	25 53													
27	SUN	18	235 37 56	17	13	S 15	12 14	3	Kṛttikā	24 49													
28	Mon	19	236 38 28	18	13	K 1	10 18	4	Rohiṇi	23 22													
29	Tue	20	237 39 1	19	13	2	8 1	5	Mṛgaśīras	21 40													
30	Wed	Nov. 21	238 39 35	6 19	17 12	K 4	26 59	6	Ārdrā	19 50													

N.B.—All timings are given in I. S. T. or the local time of the meridian of 82½° E. Long.

72

REFORMED CALENDAR OF INDIA

FOR ŚAKA ERA 1878 (1956-57 A.D.)

Dhanuḥ : Sahasya Ayanāntika on 1st = 23° 15' 31"

Month of AGRĀHĀYANA (MĀRGASĪRṢA) (30 Days) Hemanta 2nd Month

Date	Week Day	English Date	Long. of the Sun at 5-30 A.M.	Sun Rise	Sun Set	Tithi		Nakṣatra			Solar Month	Lunar Month	Transit of the Sun	Phenomena	Festivals
						No.	Ending Moment	No.	Name	Ending Moment					
1956 A.D.			° ' "	h m	h m		h m	h m							
1	Thu	Nov. 22	239 40 11	6 20	17 12	K 5	24 26	7	Punarvasu	18 0	CĀNDRA KĀRTIKA	1-Trop. Sagittarius (13 ^h 21 ^m)	1-Vaidhṛti (22 ^h 59 ^m)	3-Kālāṣṭami, Bhairavāṣṭami. 4-Prathamāṣṭami (Orissa). 5-Kāñji Anā navami (Orissa).	
2	Fri	23	240 40 49	21	12	6	22 0	8	Puṣya	16 13					
3	Sat	24	241 41 29	21	12	7	19 45	9	Āśleṣā	14 37					
4	SUN	25	242 42 10	22	12	8	17 44	10	Maghā	13 15					
5	Mon	26	243 42 53	23	12	9	16 2	11	P. Phalguni	12 9					
6	Tue	27	244 43 37	6 23	17 12	K 10	14 39	12	U. Phalguni	11 23					
7	Wed	28	245 44 23	24	12	11	13 38	13	Hasta	10 58					
8	Thu	29	246 45 11	25	12	12	13 1	14	Citrā	10 56					
9	Fri	30	247 46 0	25	12	13	12 48	15	Svātī	11 18					
10	Sat	Dec. 1	248 46 50	26	12	14	13 2	16	Viśākhā	12 5					
11	SUN	2	249 47 42	6 27	17 12	K 30	13 42	17	Anurādhā	13 18	SAUBA MĀRGASĪRṢA	CĀNDRA	11-Enters Jyēṣṭhā (8 ^h 36 ^m)	11-New Moon (13 ^h 42 ^m) 11-Solar Eclipse (partial) visible in India. 14-Vyātīpātā (13 ^h 21 ^m)	11-Dipāvalī amāvasyā (Orissa), Cūḍāmaṇi yoga. 12-Rudropavāsa. 16-Nāga pañcamī (2nd), Śahid Day of Śrī Guru Teg Bahādur (Punjab). 17-Campā ṣaṣṭhī (Maharashtra), Guha ṣaṣṭhī (Bengal), Mūlakaṛṇṇī ṣaṣṭhī (Bengal), Prāvaraya ṣaṣṭhī (Orissa), Skanda ṣaṣṭhī, Subrahmanya ṣaṣṭhī (Coorg). 18-Mitra sapṭami.
12	Mon	3	250 48 35	27	12	S 1	14 51	18	Jyēṣṭhā	14 57					
13	Tue	4	251 49 29	28	12	2	16 27	19	Mūla	17 3					
14	Wed	5	252 50 23	29	12	3	18 28	20	P. Āṣāḍhā	19 33					
15	Thu	6	253 51 19	30	13	4	20 49	21	U. Āṣāḍhā	22 20					
16	Fri	7	254 52 16	6 30	17 13	S 5	23 21	22	Śravaṇa	25 19					
17	Sat	8	255 53 13	31	13	6	25 55	23	Dhaniṣṭhā	28 18					
18	SUN	9	256 54 11	32	13	7	28 18	24	Śatabhiṣaj	- -					
19	Mon	10	257 55 10	32	13	8	30 16	24	"	7 5					
20	Tue	11	258 56 9	33	14	9	- -	25	P. Bhādrapadā	9 27					
21	Wed	12	259 57 9	6 33	17 14	S 9	7 39	26	U. Bhādrapadā	11 16					
22	Thu	13	260 58 9	34	14	10	8 19	27	Revatī	12 21					
23	Fri	14	261 59 10	34	15	11	8 12	1	Āśvini	12 41					
24	Sat	15	263 0 12	35	15	12	7 17	2	Bharanī	12 15					
25	SUN	16	264 1 14	36	15	14	27 22	3	Kṛttikā	11 8					
26	Mon	17	265 2 16	6 36	17 16	S 15	24 36	4	Rohiṇī	9 25	CĀNDRA MĀRGASĪRṢA	SAUBA PAUṢA	24-Enters Mūla (11 ^h 33 ^m) 24-Dhanurādi (11 ^h 19 ^m)	26-Full Moon (24 ^h 36 ^m) 27-Vaidhṛti (13 ^h 14 ^m)	20-Dattātreya Jayantī. 27-Arudra darśanam (S. India).
27	Tue	18	266 3 19	37	16	K 1	21 30	5	Mṛgaśīras	7 15					
								6	Ārdrā	28 47					
28	Wed	19	267 4 23	37	17	2	18 12	7	Punarvasu	26 12					
29	Thu	20	268 5 27	38	17	3	14 54	8	Puṣya	23 41					
30	Fri	Dec. 21	269 6 32	6 39	17 17	K 4	11 45	9	Āśleṣā	21 21					

N. B.—All timings are given in I. S. T. or the local time of the meridian of 82½° E. Long.

REFORMED CALENDAR OF INDIA

FOR ŚAKA ERA 1878 (1956-57 A.D.)

Month of P A U Ṣ A (30 Days)

Makara : Tapas

Ayanāmsā on 1st = 23° 15' 36"

Winter 1st Month

Date	Week Day	English Date	Long. of the Sun at 5-30 A.M.	Sun Rise	Sun Set	Tithi		Nakṣatra			Solar Month	Lunar Month	Transit of the Sun	Phenomena	Festivals
						No.	Ending Moment	No.	Name	Ending Moment					
1956 A.D.			° ' "	h m	h m		h m			h m					
1	Sat	Dec. 22	270 7 38	6 39	17 18	K 5	8 52	10	Maghā	19 22	C Ā N D R A M Ā R G A Ś Ī R Ṣ A	7-Enters P. Āṣādhā (13 ^h 49 ^m)	9-Vyatīpāta (17 ^h 50 ^m)	1-Uttarāyaṇa Day	
2	SUN	23	271 8 44	40	18	(6 7	28 26	11	P. Phalgunī	17 50					
3	Mon	24	272 9 51	40	19	8	27 2	12	U. Phalgunī	16 49				3-Pūpāṣṭakā.	
4	Tue	25	273 10 59	40	20	9	26 12	13	Hasta	16 23				5-Pauṣa daśamī (Jain).	
5	Wed	26	274 12 7	41	20	10	25 58	14	Citrā	16 31				6-Saphalā ekādaśī.	
6	Thu	27	275 13 17	6 41	17 21	K 11	26 16	15	Svāti	17 11				7-Pakṣavardhini mahādvādaśī, Surūpā dvādaśī (Orissa).	
7	Fri	28	276 14 26	42	22	12	27 2	16	Viśākhā	18 20				10-Vakula amāvasyā (Orissa).	
8	Sat	29	277 15 36	42	22	13	28 15	17	Anurādhā	19 55				11-English New Year's Day.	
9	SUN	30	278 16 47	42	23	14	29 49	18	Jyeṣṭhā	21 52				11-New Moon (7 ^h 43 ^m)	
10	Mon	31	279 17 57	43	23	30	— —	19	Mūla	24 9					
1957 A.D.											S A U R A P A U Ṣ A	20-Enters U. Āṣādhā (15 ^h 43 ^m)	22-Vaidhṛti (29 ^h 6 ^m)		
11	Tue	Jan. 1	280 19 8	6 43	17 24	K 30	7 43	20	P. Āṣādhā	26 42					
12	Wed	2	281 20 19	43	25	S 1	9 54	21	U. Āṣādhā	29 28				16-Guru pañcamī (Orissa).	
13	Thu	3	282 21 30	44	25	2	12 18	22	Śravaṇa	— —				17-Annarūpā ṣaṣṭhī (Bengal).	
14	Fri	4	283 22 40	44	26	3	14 51	22	"	8 25				18-Guru Govinda Singh's Birthday.	
15	Sat	5	284 23 51	44	27	4	17 27	23	Dhanīṣṭhā	11 25				21-Śāmba daśamī (Orissa).	
16	SUN	6	285 25 1	6 44	17 27	S 5	19 57	24	Śatabhiṣaj	14 22				22-Putradā ekādaśī, Vaiṣṇava ekādaśī (S. India), Bhogi (S. India).	
17	Mon	7	286 26 11	45	28	6	22 11	25	P. Bhādrapadā	17 6				23-Kūrma dvādaśī, Tīla samkrānti, Makarādi snāna, Pongal (S. India), Māgh bihu (Assam).	
18	Tue	8	287 27 20	45	29	7	23 57	26	U. Bhādrapadā	19 26				24-Maṭṭu pongal (S. India).	
19	Wed	9	288 28 30	45	29	8	25 5	27	Revatī	21 11				26-Puṣyābhīṣekayātrā.	
20	Thu	10	289 29 39	45	30	9	25 27	1	Aśvinī	22 14	27-Thai pūṣam (S. India).				
21	Fri	11	290 30 46	6 45	17 31	S 10	24 59	2	Bharaṇī	22 28					
22	Sat	12	291 31 53	45	31	11	23 40	3	Kṛttikā	21 53					
23	SUN	13	292 33 0	45	32	12	21 35	4	Rohini	20 31					
24	Mon	14	293 34 6	45	33	13	18 48	5	Mṛgaśīras	18 28					
25	Tue	15	294 35 12	45	34	14	15 30	6	Ārdrā	15 54					
26	Wed	16	295 36 17	6 45	17 34	S 15	11 51	7	Punarvasu	12 59					
27	Thu	17	296 37 21	45	35	K 1	8 2	8	Puṣya	9 55					
28	Fri	18	297 38 25	45	36	(2 3	28 14)	9	Āśleṣū	6 53					
29	Sat	19	298 39 29	45	36	(10 4	21 28)	11	Maghā	28 5					
30	SUN	Jan. 20	299 40 32	6 45	17 37	K 5	18 49	12	P. Phalgunī	25 42					
									U. Phalgunī	23 54	30-Trop. Aquarius (13 ^h 9 ^m)				

N.B.—All timings are given in I. S. T. or the local time of the meridian of 82½° E. Long.

REFORMED CALENDAR OF INDIA

FOR ŚAKA ERA 1878 (1956-57 A.D.)

Kumbha : Tapasya Ayanānśa on 1st = 23° 15' 41"

Month of M Ā G H A (30 Days)

Winter 2nd Month

Date	Week Day	English Date	Long. of the Sun at 5-30 A.M.	Sun Rise	Sun Set	Tithi		Nakṣatra			Solar Month	Lunar Month	Transit of the Sun	Phenomena	Festivals					
						No.	Ending Moment	No.	Name	Ending Moment										
1957 A.D.			° ' "	h m	h m		h m			h m										
1	Mon	Jan. 21	300 41 35	6 45	17 38	K 6	16 51	13	Hasta	22 47	SAURA MĀGHA	CĀNDRA PAUṢA	3-Enters Śravaṇa (18 ^h 6 ^m)	4-Vyatipātā (21 ^h 53 ^m)	3-Māmsāṣṭakā, Nctaji's Birthday.					
2	Tue	22	301 42 37	45	39	7	15 37	14	Citrā	22 25										
3	Wed	23	302 43 39	44	39	8	15 10	15	Svātī	22 47										
4	Thu	24	303 44 41	44	40	9	15 28	16	Viśākhā	23 52										
5	Fri	25	304 45 42	44	41	10	16 25	17	Anurādhā	25 32										
6	Sat	26	305 46 42	6 44	17 41	K 11	17 55	18	Jyeṣṭhā	27 41										
7	SUN	27	306 47 42	43	42	12	19 49	19	Mūla	30 10										
8	Mon	28	307 48 41	43	43	13	22 1	20	P. Āṣādhā	— —										
9	Tue	29	308 49 39	43	43	14	24 25	20	"	8 54										
10	Wed	30	309 50 37	43	44	K 30	26 54	21	U. Āṣādhā	11 47										
11	Thu	31	310 51 33	6 42	17 45	S 1	29 27	22	Śravaṇa	14 44	SAURA MĀGHA	CĀNDRA MĀGHA	10-New Moon (26 ^h 54 ^m)	10-Maunī amāvasyā (Uttar Pradesh), Thai amāvasyā (S. India), Makara vavū (T. C. State), Trivenī amāvasyā (Orissa).	8-Meru trayodaśī (Jain). 9-Yama tarpaṇa, Raṭantī Kālikā pūjā (Bengal).					
12	Fri	Feb. 1	311 52 29	42	46	2	— —	23	Dhaniṣṭhā	17 42										
13	Sat	2	312 53 23	41	46	2	7 58	24	Śatabhiṣaj	20 37										
14	SUN	3	313 54 16	41	47	3	10 23	25	P. Bhādrapadā	23 24										
15	Mon	4	314 55 8	40	47	4	12 37	26	U. Bhādrapadā	25 56										
16	Tue	5	315 55 59	6 40	17 48	S 5	14 31	27	Revatī	28 5										
17	Wed	6	316 56 48	39	49	6	15 56	1	Aśvinī	29 43										
18	Thu	7	317 57 35	39	49	7	16 45	2	Bharaṇī	— —										
19	Fri	8	318 58 21	38	50	8	16 50	2	"	6 42										
20	Sat	9	319 59 6	38	51	9	16 6	3	Kṛttikā	6 56										
						(4			Rohiṇī	30 22)					14-Tila caturthī, Kunda caturthī, Gaṇeśa jayantī. 15-Varadā caturthī and Gaṇeśa pūjā (Bengal).					
21	SUN	10	320 59 49	6 37	17 51	S 10	14 34	5	Mṛgaśiras	29 1	SAURA MĀGHA	CĀNDRA MĀGHA	16-Enters Dhaniṣṭhā (21 ^h 11 ^m)	18-Vaidhṛtī (15 ^h 14 ^m)	16-Śrī pañcamī, Vasanta pañcamī, Madana pañcamī. 17-Śītalā ṣaṣṭhī (Bengal).					
22	Mon	11	322 0 30	37	52	11	12 17	6	Ārdrā	27 0										
23	Tue	12	323 1 10	36	53	12	9 20	7	Punarvasu	24 24										
						(13	29 53)													22-Jayā ekādaśī, Bhaimī ekādaśī.
24	Wed	13	324 1 48	36	53	14	26 5	8	Puṣya	21 26										
25	Thu	14	325 2 25	35	54	S 15	22 8	9	Āśleṣā	18 16										
																				23-Bhīṣma dvādaśī, Varāha dvādaśī, Āmalaka & Santāna dvādaśī (Orissa).
																				25-Māghī pūrṇimā, Agni utsava (Orissa), Guru Ravi Das's Birthday (Punjab), Māsi magham—pūrṇimā canon (S. India).
26	Fri	15	326 3 0	6 34	17 54	K 1	18 13	10	Maghā	15 6										
27	Sat	16	327 3 34	34	55	2	14 34	11	P. Phalgunī	12 9										
28	SUN	17	328 4 6	33	55	3	11 21	12	U. Phalgunī	9 38										
29	Mon	18	329 4 37	32	56	4	8 43	13	Hasta	7 41										
						(14			Citrā	30 28)					29-Enters Śatabhiṣaj (25 ^h 47 ^m)					
30	Tue	Feb. 19	330 5 6	6 31	17 56	K 5	6 50	15	Svātī	30 4										
						(6	29 47)								29-Vyatipātā (30 ^h 23 ^m) 29-Trop. Pisces (27 ^h 29 ^m)					

N.B.—All timings are given in I. S. T. or the local time of the meridian of 82½° E. Long.

REFORMED CALENDAR OF INDIA

FOR ŚAKA ERA 1878 (1956-57 A.D.)

Mina : Madhu

Ayanāmsā on 1st = 23° 15' 45"

Month of PHĀLGUNA (30 Days)

Spring 1st Month

C. R. - 15

Date	Week Day	English Date	Long. of the Sun at 5-30 A.M.		Sun Rise	Sun Set	Tithi		Nakṣatra			Solar Month	Lunar Month	Transit of the Sun	Phenomena	Festivals
			°	' "			No.	Ending Moment	No.	Name	Ending Moment					
1957 A.D.			h	m	h	m	h	m	h	m	h	m				
1	Wed	Feb. 20	331	5 35	6 31	17 57	K 7	29 36	16	Viśākhā	30 30	CĀNDRA MĀGHĀ			2-Śākāṣṭakā, Śrīkṛṣṇā.	
2	Thu	21	332	6 2	30	58	8	30 13	17	Anurādhā	- -					
3	Fri	22	333	6 27	29	58	9	- -	17	"	7 44					
4	Sat	23	334	6 52	29	59	9	7 33	18	Jyēsthā	9 39					
5	SUN	24	335	7 15	28	17 59	10	9 27	19	Mūla	12 4					
6	Mon	25	336	7 36	6 27	18 0	K 11	11 45	20	P. Āṣādhā	14 51	CĀNDRA MĀGHĀ	10-New Moon (21 ^h 42 ^m)	6-Vijayā ekādaśī.		
7	Tue	26	337	7 56	26	0	12	14 14	21	U. Āṣādhā	17 49					
8	Wed	27	338	8 14	25	1	13	16 48	22	Śravapā	20 49					
9	Thu	28	339	8 31	24	1	14	19 19	23	Dhanīṣṭhā	23 46					
10	Fri	Mar. 1	340	8 46	24	2	K 30	21 42	24	Śatabhiṣaj	26 36					
11	Sat	2	341	9 0	6 23	18 2	S 1	23 55	25	P. Bhādrapadā	29 14	SAURĀ PHĀLGUNA	13-Enters P. Bhādrapadā (8 ^h 4 ^m)	14-Śānta caturthī.		
12	SUN	3	342	9 11	22	2	2	25 53	26	U. Bhādrapadā	- -					
13	Mon	4	343	9 21	21	3	3	27 34	26	"	7 39					
14	Tue	5	344	9 29	20	3	4	28 53	27	Revatī	9 46					
15	Wed	6	345	9 34	19	4	5	29 44	1	Āśvinī	11 31					
16	Thu	7	346	9 38	6 18	18 4	S 6	30 3	2	Bharanī	12 49	CĀNDRA PHĀLGUNA	16-Gorūpiṇī ṣaṣṭhī (Bengal).			
17	Fri	8	347	9 40	17	5	7	29 44	3	Kṛttikā	13 33					
18	Sat	9	348	9 39	16	5	8	28 45	4	Rohiṇī	13 40					
19	SUN	10	349	9 36	15	5	9	27 6	5	Mṛgaśīras	13 7					
20	Mon	11	350	9 31	15	6	10	24 48	6	Ārdrā	11 55					
21	Tue	12	351	9 24	6 14	18 6	S 11	21 57	7	Punarvasu	10 7	CĀNDRA PHĀLGUNA	23-Minādi (7 ^h 54 ^m)	24-Cāturmāsya caturdaśī (Jain), Holikādhana.		
22	Wed	13	352	9 14	13	7	12	18 40	8	Puṣya	7 48					
									9	Āśleṣā	29 8					
23	Thu	14	353	9 2	12	7	13	15 7	10	Maghā	26 16					
24	Fri	15	354	8 49	11	7	14	11 27	11	P. Phalgunī	23 24					
25	Sat	16	355	8 33	10	8	S 15	7 52	12	U. Phalgunī	20 43	SAURĀ CAITRA	25-Full Moon (7 ^h 52 ^m)	25-Dolayātrī, Holi, Vasantotsava, Birthday of Śrī Caitanya.		
							(K 1	28 32)								
26	SUN	17	356	8 15	6 9	18 8	K 2	25 37	13	Hasta	18 24					
27	Mon	18	357	7 55	8	9	3	23 19	14	Citrā	16 37					
28	Tue	19	358	7 33	7	9	4	21 44	15	Svātī	15 32					
29	Wed	20	359	7 10	6	9	5	20 57	16	Viśākhā	15 13	29-Venus sets in the East.	29-Raṅga pañcamī, Vijay Govindajī Halenkar (Manipur).			
30	Thu	Mar. 21	0	6 45	6 5	18 10	K 6	21 1	17	Anurādhā	15 43					

[76]

N.B.—All timings are given in I. S. T. or the local time of the meridian of 82½° E. Long.

REFORMED CALENDAR OF INDIA

FOR ŚAKA ERA 1879 (1957-58 A.D.)

Meṣa : Mādhava

Ayanānśa on 1st = 23° 15' 45"

Month of C A I T R A (30 Days)

Spring 2nd Month

Date	Week Day	English Date	Long. of the Sun at 5-30 A.M.	Sun		Tithi		Nakṣatra			Solar Month	Lunar Month	Transit of the Sun	Phenomena	Festivals
				Rise	Set	No.	Ending Moment	No.	Name	Ending Moment					
			° ' "	h m	h m		h m			h m					
1957 A.D.															
1	Fri	Mar. 22	1 6 18	6 4	18 10	K 7	21 52	18	Jyēṣṭhā	17 1	SAURA CAITRA	CĀNDRA PHALGUNA	9-Enters Revati (27 ^h 26 ^m)	8-Vaidhṛti (24 ^h 54 ^m)	1-Indian New Year's Day.
2	Sat	23	2 5 49	3	10	8	23 25	19	Mūla	19 0					2-Śitalāṣṭami, Varṣitapārambha (Jain).
3	SUN	24	3 5 19	2	11	9	25 30	20	P. Āṣādhā	21 31					
4	Mon	25	4 4 46	1	11	10	27 54	21	U. Āṣādhā	24 23					
5	Tue	26	5 4 12	6 0	12	11	— —	22	Śravaṇa	27 23					
6	Wed	27	6 3 36	5 59	18 12	K 11	6 25	23	Dhanīṣṭhā	— —	SAURA CAITRA	CĀNDRA PHALGUNA	8-Vaidhṛti (24 ^h 54 ^m)	6-Pāpamocanī ekādaśī, Unmilanī mahāvādaśī.	
7	Thu	28	7 2 59	58	12	12	8 53	23	"	6 21				8-Vāruṇī (upto 9 ^h 9 ^m).	
8	Fri	29	8 2 19	57	13	13	11 10	24	Śatabhiṣaj	9 9					
9	Sat	30	9 1 37	56	13	14	13 10	25	P. Bhādrapadā	11 41					
10	SUN	31	10 0 54	55	14	K 30	14 49	26	U. Bhādrapadā	13 54				10-New Moon (14 ^h 49 ^m)	
11	Mon	Apr. 1	11 0 8	5 54	18 14	S 1	16 6	27	Revati	15 45	SAURA CAITRA	CĀNDRA CAITRA	21-Vyatipāta (15 ^h 2 ^m)	11-Navarātrārambha.	
12	Tue	2	11 59 21	53	14	2	16 59	1	Āśvini	17 14				13-Gaurī tṛtīyā, Dolotsava, Ādolana tṛtīyā, Saubhāgya-śayana vrata, Sarhul (Bihar).	
13	Wed	3	12 58 31	52	15	3	17 28	2	Bharanī	18 20				15-Śrī pañcamī (Lakṣmī).	
14	Thu	4	13 57 39	51	15	4	17 31	3	Kṛttikā	19 0					
15	Fri	5	14 56 45	50	15	5	17 7	4	Rohiṇī	19 14					
16	Sat	6	15 55 48	5 49	18 16	S 6	16 14	5	Mrgāśiras	19 0	SAURA CAITRA	CĀNDRA CAITRA	23-Meṣādi (16 ^h 28 ^m)	16-Āśoka ṣaṣṭhī (Bengal), Skanda ṣaṣṭhī (Orissa), Oli beginning (Jain).	
17	SUN	7	16 54 50	48	16	7	14 53	6	Ārdrā	18 18				17-Vāsantī pūjā (Bengal).	
18	Mon	8	17 53 49	48	16	8	13 5	7	Punarvasu	17 8				18-Annapūrnā pūjā (Bengal), Bhavānī utpatti, Āśokāṣṭamī, Rāma navamī (Smārta), Rāma jayantī.	
19	Tue	9	18 52 45	47	17	9	10 50	8	Puṣya	15 34				19-Rāma navamī (Vaiṣṇava and in Bengal for all).	
20	Wed	10	19 51 39	46	17	10	8 14	9	Āśleṣā	13 39				20-Dharmarāja daśamī, Kāmadā ekādaśī (Gāndhārī).	
						(11	29 21)								
21	Thu	11	20 50 31	5 45	18 18	S 12	26 19	10	Maghā	11 30	SAURA VAISAKHA	CĀNDRA CAITRA	24-Full Moon (17 ^h 39 ^m)	21-Kāmadā ekādaśī (Vaiṣṇava and in Bengal for all), Dolotsava, Vāmana dvādaśī, Madana dvādaśī, Viṣṇu damanotsava.	
22	Fri	12	21 49 21	44	18	13	23 16	11	P. Phalgunī	9 13				22-Pañgunī uttiram-Nak. Canon (S. India), Anaṅga trayodaśī, Mahāvira jayantī (Jain).	
23	Sat	13	22 48 9	43	18	14	20 20	12	U. Phalgunī	6 58				23-Madana bhañjī, Śiva damanaka (Orissa), Viṣṇu damanaka (Orissa), Bahag Bihu (Assam), Vaiśākḥī, Viṣu (T. C. State), Cheiraoba (Manipur), Caḍaka pūjā (Bengal).	
24	SUN	14	23 46 54	42	19	S 15	17 39	14	Hasta	28 53				24-Hanumat jayantī, Oli ends (Jain), Pañgunī uttiram-pūrṇimā canon (S. India).	
25	Mon	15	24 45 38	41	19	K 1	15 23	15	Citrā	27 8					
26	Tue	16	25 44 19	5 40	18 19	K 2	13 40	16	Viśākḥā	25 9	SAURA VAISAKHA	CĀNDRA CAITRA	30-Trop. Taurus (14 ^h 12 ^m)		
27	Wed	17	26 42 59	39	20	3	12 36	17	Anurādhā	25 9					
28	Thu	18	27 41 36	39	20	4	12 15	18	Jyēṣṭhā	25 52					
29	Fri	19	28 40 13	38	21	5	12 39	19	Mūla	27 18					
30	Sat	Apr. 20	29 38 47	5 37	18 21	K 6	13 46	20	P. Āṣādhā	29 22					

N.B.— All timings are given in I. S. T. or the local time of the meridian of 82¹/₄° E. Long.

REFORMED CALENDAR OF INDIA

FOR ŚAKA ERA 1879 (1957-58 A.D.)

Month of VAIŚĀKHA (31 Days)

Vṛṣa : Śukra

Ayanāmsā on 1st = 23° 15' 51"

Summer 1st Month

Date	Week Day	English Date	Long. of the Sun at 5-30 A.M.	Sun		Tithi		Nakṣatra			Solar Month	Lunar Month	Transit of the Sun	Phenomena	Festivals	
				Rise	Set	No.	Ending Moment	No.	Name	Ending Moment						
1957 A.D.			o ' "	h m	h m		h m			h m						
1	SUN	Apr. 21	30 37 20	5 36	18 21	K 7	15 28	21	U. Āṣāḍhā	— —	CĀNDRA CAITRA					
2	Mon	22	31 35 51	35	22	8	17 37	21	"	7 56						
3	Tue	23	32 34 20	34	22	9	20 1	22	Śravaṇa	10 47						
4	Wed	24	33 32 48	34	23	10	22 25	23	Dhaniṣṭhā	13 44						
5	Thu	25	34 31 14	33	23	11	24 39	24	Śatabhiṣaj	16 35				4-Vaidhṛti (6 ^h 37 ^m)	5-Varūthini ekādaśī.	
6	Fri	26	35 29 39	5 32	18 24	K 12	26 33	25	P. Bhādrapadā	19 8	CĀNDRA CAITRA					
7	Sat	27	36 28 2	31	24	13	28 0	26	U. Bhādrapadā	21 18						
8	SUN	28	37 26 23	31	24	14	28 57	27	Revati	23 0						
9	Mon	29	38 24 43	30	25	K 30	29 24	1	Āsvini	24 12				7-Enters Bharanī (8 ^h 43 ^m)		
10	Tue	30	39 23 0	29	25	S 1	29 21	2	Bharanī	24 55				9-New Moon (29 ^h 24 ^m)	10-Tithi of Deva Dāmodara (Assam).	
11	Wed	May 1	40 21 17	5 29	18 26	S 2	28 50	3	Kṛttikā	25 10	SAURA VAIŚĀKHA					
12	Thu	2	41 19 31	28	26	3	27 55	4	Rohiṇī	25 1						
13	Fri	3	42 17 43	27	27	4	26 38	5	Mṛgaśīras	24 31						
14	Sat	4	43 15 54	26	27	5	25 3	6	Ārdrā	23 41				10-Solar Eclipse (Annular) partly visible in India.	12-Akṣaya tṛtīyā, Candana yātrā (Bengal and Orissa), Paraśurāma jayantī, Varṣitapa samāpana (Jain).	
15	SUN	5	44 14 2	26	27	6	23 11	7	Punarvasu	22 35					14-Śaṅkara's Birthday.	
16	Mon	6	45 12 9	5 25	18 28	S 7	21 6	8	Puṣya	21 16	SAURA VAIŚĀKHA					
17	Tue	7	46 10 13	25	28	8	18 51	9	Āśleṣā	19 47				16-Vyātipāta (27 ^h 58 ^m)	16-Gaṅgotpatti, Jānuu saptamī (Bengal), Śarkarā saptamī.	
18	Wed	8	47 8 16	24	29	9	16 29	10	Maghā	18 11					18-Sitā navamī (Bengal & Orissa).	
19	Thu	9	48 6 17	23	29	10	14 4	11	P. Phalgunī	16 33					19-Sudaśā vrata (Orissa).	
20	Fri	10	49 4 16	23	30	11	11 40	12	U. Phalgunī	14 57				20-Enters Kṛttikā (26 ^h 53 ^m)	20-Mohinī ekādaśī.	
21	Sat	11	50 2 12	5 22	18 30	S 12	9 23	13	Hasta	13 27	CĀNDRA VAIŚĀKHA					
22	SUN	12	51 0 8	22	31	13	7 17	14	Citrā	12 11					21-Paraśurāma dvādaśī, Rukmiṇī & Pipitaki dvādaśī (Bengal & Orissa).	
23	Mon	13	51 58 1	21	31	14	5 29	15	Svāti	11 13					22-Nṛsimha jayantī, Nṛsimha caturdaśī.	
24	Tue	14	52 55 53	21	32	(S 15 28 4)	27 8	16	Viśākhā	10 40				23-Full Moon (28 ^h 4 ^m)	23-Buddha pūrṇimā, Vaiśākhī pūrṇimā, Sampatgaurī vrata, Phuladola (Bengal), Gandheśvarī pūjā (Bengal), Cūḍāmaṇi yoga.	
25	Wed	15	53 53 44	20	32	K 1 2	26 45	17	Anurādhā	10 36				24-Vṛṣādi (13 ^h 26 ^m)		
26	Thu	16	54 51 33	5 20	18 33	K 3	26 58	18	Jyēṣṭhā	11 7	SAURA JYAIṢṬHA					
27	Fri	17	55 49 20	20	33	4	27 49	19	Mūla	12 13						
28	Sat	18	56 47 7	19	34	5	29 14	20	P. Āṣāḍhā	13 56						
29	SUN	19	57 44 52	19	34	6	— —	21	U. Āṣāḍhā	16 10						
30	Mon	20	58 42 36	18	34	6	7 8	22	Śravaṇa	18 49						
31	Tue	May 21	59 40 19	5 18	18 35	K 7	9 22	23	Dhaniṣṭhā	21 42			29-Vaidhṛti (13 ^h 31 ^m)			
													31-Trop. Gemini (13 ^h 41 ^m)			

N.B.—All timings are given in I. S. T. or the local time of the meridian of 82½° E. Long.

REFORMED CALENDAR OF INDIA

FOR ŚAKA ERA 1870 (1957-58 A.D.)

Month of JYAIŚTHA (JYEŚTHIA) (31 Days)

Mithuna : Śuci Ayanāntika on 1st = 23° 15' 51"
Summer 2nd Month

Date	Week Day	English Date	Long. of the Sun at 5-30 A.M.		Sun Rise	Sun Set	Tithi		Nakṣatra			Solar Month	Lunar Month	Transit of the Sun	Phenomona	Festivals	
			°	'			"	h	m	No.	Ending Moment						No.
1957 A.D.			o	'	"	h	m	h	m	h	m						
1	Wed	May 22	60	38	1	5	18	18	35	K 8	11 44	24	Śatabhiṣaj	24 36			1-Trilocanāṣṭami (Bengal).
2	Thu	23	61	35	42	17	36	9	36	9	14 0	25	P. Bhādrapadā	27 18			
3	Fri	24	62	33	22	17	36	10	36	10	15 57	26	U. Bhādrapadā	—	3-Enters Rohini (23 ^h 13 ^m)		4-Aparā ekādaśī, Jalakrīḍā ekādaśī (Orissa).
4	Sat	25	63	31	1	17	37	11	37	11	17 25	26	"	5 37			
5	SUN	26	64	28	39	16	37	12	37	12	18 18	27	Rovati	7 25			
6	Mon	27	65	26	16	5	16	13	38	K 13	18 32	1	Aśvini	8 36			6-Sāvitrī caturdaśī (Bengal).
7	Tue	28	66	23	52	16	38	14	38	14	18 8	2	Bharanī	9 9			7-Phalahāriṇī Kālikā pūjā (Bengal).
8	Wed	29	67	21	27	16	39	K 30	39	15	17 9	3	Kṛttikā	9 5	8-New Moon (17 ^h 9 ^m)		8-Sāvitrī amāvasyā (Orissa), Vatasāvitrī vrata.
9	Thu	30	68	19	0	16	39	S 1	39	16	15 39	4	Rohini	8 30			9-Duśaharā snānāmbha.
10	Fri	31	69	16	33	15	39	2	39	17	13 44	5	Mṛgāśiras	7 28			
11	Sat	June 1	70	14	4	5	15	S 3	40	18	11 32	6	Ārdrā	6 7	11-Vyātipāta (16 ^h 21 ^m)		11-Rambhā tṛtīyā, Pratāp Jayanti (Rajasthan).
12	SUN	2	71	11	34	15	40	4	40	19	9 8	7	Punarvasu	28 33			
13	Mon	3	72	9	3	15	41	5	41	20	6 40	8	Puṣya	26 52			12-Umā caturthī (Bengal & Orissa), Mahādeva vivāha (Orissa), Guru Arjun Dev's Martyrdom Day (Punjab).
14	Tue	4	73	6	31	15	41	(6	41	21	28 11)	9	Āśleṣā	25 11			13-Aranya gaurī vrata, Aranya ṣaṣṭhī (Bengal).
15	Wed	5	74	3	58	15	41	7	41	22	25 48	10	Maghā	28 35			Skanda ṣaṣṭhī & Śītala ṣaṣṭhī (Orissa).
								8	41	23	23 34	11	P. Phalgunī	22 7			
16	Thu	6	75	1	23	5	15	S 9	42	24	21 31	12	U. Phalgunī	20 51			
17	Fri	7	75	58	47	15	42	10	42	25	19 43	13	Hasta	19 49	17-Enters Mṛgāśiras (21 ^h 3 ^m)		17-Gaṅgā daśaharā.
18	Sat	8	76	56	10	15	43	11	43	26	18 12	14	Citrā	19 3			18-Nirjalā ekādaśī, Devavivāha ekādaśī (Orissa).
19	SUN	9	77	53	32	15	43	12	43	27	16 59	15	Svāti	18 36			19-Śrī Rāma dvādaśī, Campaka dvādaśī (Orissa).
20	Mon	10	78	50	53	15	44	13	44	28	16 6	16	Viśākhā	18 30			
21	Tue	11	79	48	12	5	15	S 14	44	29	15 36	17	Anurādhā	18 46			21-Campaka caturdaśī (Bengal), Vatasāvitrī vrata (Deccan).
22	Wed	12	80	45	32	15	44	S 15	44	30	15 32	18	Jyēṣṭhā	19 28	22-Full Moon (15 ^h 32 ^m)		22-Snāna yātrā (Bengal & Orissa).
23	Thu	13	81	42	50	15	45	K 1	45	31	15 55	19	Mūla	20 37			
24	Fri	14	82	40	8	15	45	2	45	32	16 47	20	P. Āṣāḍhā	22 14	24-Mithunāndi (20 ^h 6 ^m)		23-Vaidhyti (22 ^h 32 ^m)
25	Sat	15	83	37	25	15	45	3	45	33	18 8	21	U. Āṣāḍhā	24 19			
26	SUN	16	84	34	41	5	15	K 4	45	34	19 55	22	Śravaṇa	26 49			
27	Mon	17	85	31	58	16	46	5	46	35	22 4	23	Dhāniṣṭhā	—	31-Enters Ārdrā (20 ^h 10 ^m)		
28	Tue	18	86	29	14	16	46	6	46	36	24 25	24	"	5 36			
29	Wed	19	87	26	29	16	46	7	46	37	26 46	25	Śatabhiṣaj	8 33			
30	Thu	20	88	23	45	16	47	8	47	38	28 54	26	P. Bhādrapadā	11 26	31-Trop. Cancer (21 ^h 51 ^m)		
31	Fri	June 21	89	21	0	5	16	K 9	47	39	—	26	U. Bhādrapadā	14 3			31-Dakṣiṇyana Day.

N.B.—All timings are given in I. S. T. or the local time of the meridian of 82½° E. Long

REFORMED CALENDAR OF INDIA

FOR ŚAKA ERA 1870 (1957-58 A.D.)

Month of **Ā Ś Ā Ḍ H A** (31 Days)

Karkaṭa : Nabhas

Ayananiśa on 1st = 23° 15' 59"

Rains 1st Month

C.R.-16

Date	Week Day	English Date	Long. of the Sun at 5-30 A.M.	Sun Rise	Sun Set	Tithi		Nakṣatra		Solar Month	Lunar Month	Transit of the Sun	Phenomena	Festivals
						No.	Ending Moment	No.	Ending Moment					
1957 A.D.			° ' "	h m	h m	No.	h m	No.	h m					
1	Sat	June 22	90 18 15	5 17	18 47	K 9	6 36	27	16 10	CĀNDRA JYAIṢṬHA			3-Yoginī ekādaśī.	
2	SUN	23	91 15 30	17 47		10	7 42	1	17 40					
3	Mon	24	92 12 44	17 47		11	8 5	2	18 25					
4	Tue	25	93 9 59	17 48		12	7 41	3	18 25					
5	Wed	26	94 7 14	18 48		13 (14)	6 33 (28 45)	4	17 43					
6	Thu	27	95 4 28	5 18	18 48	K 30	26 23	5	16 24	SAUBRA Ā Ś Ā Ḍ H A	14-Enters Punarvasu (19 ^h 41 ^m)	6-Vyatīpātā (7 ^h 47 ^m) 6-New Moon (26 ^h 23 ^m)	8-Rathayātrī, Manorathā dvitīyā vrata.	
7	Fri	28	96 1 42	18 48		S 1	23 37	6	14 36					
8	Sat	29	96 58 56	18 48		2	20 36	7	12 28					
9	SUN	30	97 56 10	19 48		3	17 28	8	10 11					
10	Mon	July 1	98 53 23	19 48		4	14 23	9	7 53					
11	Tue	2	99 50 36	5 19	18 48	S 5	11 28	10 (11)	5 44 (27 50)					
12	Wed	3	100 47 49	20 48		6	8 51	12	26 18					
13	Thu	4	101 45 2	20 48		7 (8)	6 37 (28 48)	13	25 12					
14	Fri	5	102 42 14	20 48		9	27 27	14	24 33					
15	Sat	6	103 39 25	21 48		10	26 33	15	24 21					
16	SUN	7	104 36 37	5 21	18 48	S 11	26 6	16	24 35	CĀNDRA Ā Ś Ā Ḍ H A	25-Karkāṭī (7 ^h 1 ^m)	16-Punaryātrī (Bengal and Orissa), Hariśayani ekādaśī, Ravinārāyaṇa ekādaśī (Orissa). 17-Viṣṇu śayanotsava, Śrī Kṛṣṇa dvādaśī, Gopadma vratārambha. 18-Vaidhṛtī (7 ^h 42 ^m) 20-Full Moon (28 ^h 20 ^m) 20-Guru pūrṇimā, Vyāsa pūjā, Kokilā vrata, Śiva śayanotsava. 22-Aśūnya śayana vrata.		
17	Mon	8	105 33 48	22 48		12	26 4	17	25 14					
18	Tue	9	106 31 0	22 48		13	26 27	18	26 17					
19	Wed	10	107 28 11	22 48		14	27 12	19	27 43					
20	Thu	11	108 25 22	23 48		S 15	28 20	20	29 30					
21	Fri	12	109 22 34	5 23	18 48	K 1	- -	21	- -					
22	Sat	13	110 19 46	24 48		1	5 50	21	7 39					
23	SUN	14	111 16 58	24 47		2	7 40	22	10 8					
24	Mon	15	112 14 10	24 47		3	9 50	23	12 54					
25	Tue	16	113 11 23	25 47		4	12 11	24	15 51					
26	Wed	17	114 8 37	5 25	18 47	K 5	14 38	25	18 52	SAUBRA ŚRĀVAṆA	28-Enters Puṣya (19 ^h 19 ^m)	31-Vyatīpātā (22 ^h 47 ^m)	25-Manasī pūjā begins (Bengal). 26-Nāga pañcamī (Bengal). 28-Śitalā saptamī (Orissa). 29-Ker pūjā (Tripura).	
27	Thu	18	115 5 51	26 46		6	16 57	26	21 44					
28	Fri	19	116 3 6	26 46		7	18 58	27	24 16					
29	Sat	20	117 0 22	27 46		8	20 27	1	26 15					
30	SUN	21	117 57 38	27 45		9	21 15	2	27 31					
31	Mon	July 22	118 54 55	5 28	18 45	K 10	21 14	3	27 59					

N.B.—All timings are given in I. S. T. or the local time of the meridian of 82½° E. Long.

REFORMED CALENDAR OF INDIA

FOR ŚAKA ERA 1870 (1957-58 A.D.)
Month of Ś R Ā V A Ṇ A (31 Days)

Sinhā : Nabhasya
Rains 2nd Month

Ayanāntika on 1st = 23° 16' 4"

Date	Week Day	English Date	Long. of the Sun at 5-30 A.M.	Sun Rise	Sun Set	Tithi		Nakṣatra			Solar Month	Lunar Month	Transit of the Sun	Phenomena	Festivals
						No.	Ending Moment	No.	Name	Ending Moment					
1957 A.D.			° ' "	h m	h m	h m	h m	h m	h m						
1	Tue	July 23	119 52 13	5 28	18 45	K 11	20 22	4	Rohiṇī	27 37	CĀNDRA ĀṢĀDHĀ	1-Trop. Leo (8 ^h 46 ^m)	5-New Moon (9 ^h 58 ^m)	1-Kāmkā ekādaśī.	
2	Wed	24	120 49 32	28	44	12	18 42	5	Mṛgaśīras	26 28				4-Āḍī amāvasyā (S. India).	
3	Thu	25	121 46 52	29	44	13	16 18	6	Ārdrā	24 39				5-Karkāṭaka vāsu (T. U. State), Citā amāvasyā (Orissa).	
4	Fri	26	122 44 12	29	44	14	13 21	7	Punarvasu	22 19					
5	Sat	27	123 41 34	30	43	K 30	9 58	8	Puṣya	19 38					
6	SUN	28	124 38 56	5 30	18 43	S 1	6 21	9	Āśleṣā	16 48	SAUBA ŚBĀVAṆA	11-Enters Āśleṣā (18 ^h 7 ^m)	12-Vaidhṛti (16 ^h 31 ^m)	7-Madhuśravā (Gujarat), Āḍī pūram (S. India - for some).	
7	Mon	29	125 36 18	30	42	3	23 8	10	Maghā	14 0				8-Āḍī pūram (South India - for some), Jāgratgnarī pañcamī (Orissa).	
8	Tue	30	126 33 42	31	42	4	19 52	11	P. Phalgunī	11 25				9-Nāga pañcamī.	
9	Wed	31	127 31 6	31	41	5	17 2	12	U. Phalgunī	9 13				10-Luṭṭhana ṣaṣṭhī (Bengal), Tilak Commemoration Day.	
10	Thu	Aug. 1	128 28 30	32	41	6	14 43	13	Īasta	7 31					
11	Fri	2	129 25 55	5 32	18 40	S 7	13 2	14	Citrā	6 24	SAUBA ŚBĀVAṆA	11-Enters Āśleṣā (18 ^h 7 ^m)	12-Vaidhṛti (16 ^h 31 ^m)	11-Varalakṣmī vrata (S. India).	
12	Sat	3	130 23 21	33	40	8	11 58	15	Svātī	5 54				14-Jhulanayātrārambha.	
13	SUN	4	131 20 47	33	39	9	11 31	16	Viśākhā	6 2				15-Putradā ekādaśī, Jhulanayātrārambha.	
14	Mon	5	132 18 14	33	38	10	11 40	17	Anurādhā	6 45				16-Buddha dvādaśī, Viṣṇupavitrāropāṇam, Dāmodara-dvādaśī.	
15	Tue	6	133 15 42	34	38	11	12 19	18	Jyēṣṭhā	7 59				17-Śivapavitrāropāṇam & Akhetaka trayodaśī (Orissa).	
16	Wed	7	134 13 11	5 34	18 37	S 12	13 24	19	Mūla	9 38	CĀNDRA ŚBĀVAṆA	19-Full Moon (18 ^h 35 ^m)	20-Pākarma (Rk & Yaju), Rakṣā bandhana, Rī-tarpāṇa, Coconut day, Hāyagrīvopatti, Balabhadra-pūjā (Orissa), Jhulanayātrā samāpana, Solono (PEPSU), Avāḍi avitṭam (S. India).		
17	Thu	8	135 10 40	35	37	13	14 51	20	P. Āṣādhā	11 40				21-Aśūnya śayana vrata.	
18	Fri	9	136 8 10	35	36	14	16 36	21	U. Āṣādhā	14 0				22-Kajjali tṛtīyā, Aṅgabheṭa tṛtīyā (Orissa).	
19	Sat	10	137 5 42	36	35	S 15	18 38	22	Śravāṇa	16 36				23-Bahulā caturthī (Madhyadeśa).	
20	SUN	11	138 3 14	36	34	K 1	20 53	23	Dhanīṣṭhā	19 24				24-Independence Day, Rakṣā pañcamī (Orissa).	
21	Mon	12	139 0 48	5 36	18 34	K 2	23 17	24	Śatabhiṣaj	22 21	SAUBA BHĀDRAPADA	25-Sinhādi (15 ^h 23 ^m)	26-Vyatīpātā (8 ^h 31 ^m)	25-Manasā pūjā (Bengal).	
22	Tue	13	139 58 23	37	33	3	25 45	25	P. Bhādrapadā	25 23				26-Hala ṣaṣṭhī, Śītalā sapṭamī.	
23	Wed	14	140 55 59	37	32	4	28 10	26	U. Bhādrapadā	28 21				27-Janmāṣṭamī (Smārta), Śrī Jayantī (S. India).	
24	Thu	15	141 53 36	37	31	5	- -	27	Revatī	- -				28-Janmāṣṭamī (Vaiṣṇava), Gokulāṣṭamī.	
25	Fri	16	142 51 15	38	31	5	6 22	27	"	7 7				29-Pañcavātra Śrī Kṛṣṇa Jayantī (S. India).	
26	Sat	17	143 48 56	5 38	18 30	K 6	8 10	1	Aśvinī	9 30	SAUBA BHĀDRAPADA	25-Enters Maghā (15 ^h 51 ^m)	26-Vyatīpātā (8 ^h 31 ^m)	31-Ajā ekādaśī, Tripprā mahādvādaśī, Kālidāna ekādaśī (Orissa), Paryuṣāṇa parvārambha (Jain-pañcamī pakṣa).	
27	SUN	18	144 46 38	39	29	7	9 25	2	Bharāṇī	11 20					
28	Mon	19	145 44 22	39	28	8	9 55	3	Kṛttikā	12 26					
29	Tue	20	146 42 7	39	28	9	9 37	4	Rohiṇī	12 44					
30	Wed	21	147 39 54	40	27	10	8 28	5	Mṛgaśīras	12 11					
31	Thu	Aug. 22	148 37 43	5 40	18 26	K 11 (K 12)	6 30 (27 49)	6	Ārdrā	10 52					

N. B.—All timings are given in I. S. T. or the local time of the meridian of 82½° E. Long.

REFORMED CALENDAR OF INDIA

FOR ŚAKA ERA 1879 (1957-58 A.D.)

Sinhā : Nabhasya

Ayanāmsā on 1st = 23° 16' 4"

Month of Ś R Ā V A N A (31 Days)

Rains 2nd Month

Date	Week Day	English Date	Long. of the Sun at 5-30 A.M.	Sun Rise	Sun Set	Tithi		Nakṣatra			Solar Month	Lunar Month	Transit of the Sun	Phenomena	Festivals
						No.	Ending Moment	No.	Name	Ending Moment					
1957 A.D.			° ' "	h m	h m		h m			h m					
1	Tue	July 23	119 52 13	5 28	18 45	K 11	20 22	4	Rohiṇī	27 37	CĀNDRA ĀṢĀDHĀ	1-Trop. Leo (8 ^h 46 ^m)	5-New Moon (9 ^h 58 ^m)	1-Kārikā ekādaśī.	
2	Wed	24	120 49 32	28	44	12	18 42	5	Mṛgaśīras	26 28					
3	Thu	25	121 46 52	29	44	13	16 18	6	Ārdrā	24 39					
4	Fri	26	122 44 12	29	44	14	13 21	7	Punarvasu	22 19					
5	Sat	27	123 41 34	30	43	K 30	9 58	8	Puṣya	19 38					
6	SUN	28	124 38 56	5 30	18 43	S 1	6 21	9	Āśleṣā	16 48	SĀUBA ŚRĀVAṆA	11-Enters Āśleṣā (18 ^h 7 ^m)	12-Vaidhṛti (16 ^h 31 ^m)	7-Madhurāvā (Gujerat), Āḍī pūram (S. India - for some).	
7	Mon	29	125 36 18	30	42	3	23 8	10	Maghā	14 0					
8	Tue	30	126 33 42	31	42	4	19 52	11	P. Phalgunī	11 25					
9	Wed	31	127 31 6	31	41	5	17 2	12	U. Phalgunī	9 13					
10	Thu	Aug. 1	128 28 30	32	41	6	14 43	13	Hastā	7 31					
11	Fri	2	129 25 55	5 32	18 40	S 7	13 2	14	Citrā	6 24					
12	Sat	3	130 23 21	33	40	8	11 58	15	Svātī	5 54					
13	SUN	4	131 20 47	33	39	9	11 31	16	Viśākhā	6 2					
14	Mon	5	132 18 14	33	38	10	11 40	17	Anurādhā	6 45					
15	Tue	6	133 15 42	34	38	11	12 19	18	Jyēṣṭhā	7 59					
16	Wed	7	134 13 11	5 34	18 37	S 12	13 24	19	Mūla	9 38	CĀNDRA ŚRĀVAṆA	19-Full Moon (18 ^h 38 ^m)	26-Vyatīpāta (8 ^h 31 ^m)	16-Buddha dvādaśī, Viṣṇupavitṛropāṇam, Dāmodara-dvādaśī.	
17	Thu	8	135 10 40	35	37	13	14 51	20	P. Āṣādhā	11 40					
18	Fri	9	136 8 10	35	36	14	16 36	21	U. Āṣādhā	14 0					
19	Sat	10	137 5 42	36	35	S 15	18 38	22	Śravaṇa	16 36					
20	SUN	11	138 3 14	36	34	K 1	20 53	23	Dhanīṣṭhā	19 24					
21	Mon	12	139 0 48	5 36	18 34	K 2	23 17	24	Śatabhiṣaj	22 21					
22	Tue	13	139 58 23	37	33	3	25 45	25	P. Bhādrapadā	25 23					
23	Wed	14	140 55 59	37	32	4	28 10	26	U. Bhādrapadā	28 21					
24	Thu	15	141 53 36	37	31	5	—	27	Revatī	—					
25	Fri	16	142 51 15	38	31	5	6 22	27	"	7 7					
26	Sat	17	143 48 56	5 38	18 30	K 6	8 10	1	Āśvinī	9 30	SĀUBA BHĀDRAPĀDA	25-Enters Maghā (15 ^h 51 ^m)	27-Janmāṣṭami (Smārta), Śrī jayantī (S. India).	21-Aśūnya śayana vrata.	
27	SUN	18	144 46 38	39	29	7	9 25	2	Bharāṇī	11 20					
28	Mon	19	145 44 22	39	28	8	9 55	3	Kṛttikā	12 26					
29	Tue	20	146 42 7	39	28	9	9 37	4	Rohiṇī	12 44					
30	Wed	21	147 39 54	40	27	10	8 28	5	Mṛgaśīras	12 11					
31	Thu	Aug. 22	148 37 43	5 40	18 26	K 11	6 30	6	Ārdrā	10 52					

N. B.—All timings are given in I. S. T. or the local time of the meridian of 82½° E. Long.

REFORMED CALENDAR OF INDIA

FOR ŚAKA ERĀ 1879 (1957-58 A.D.)

Kanyā : Iṣa

Ayanāmiśa on 1st = 23° 16' 8"

Month of BHĀDRĀ (BHĀDRAPADA) (31 Days)

Autumn 1st Month

Date	Week Day	English Date	Long. of the Sun at 5-30A.M.	Sun Rise	Sun Set	Tithi		Nakṣatra			Solar Month	Lunar Month	Transit of the Sun	Phenomena	Festivals		
						No.	Ending Moment	No.	Name	Ending Moment							
			° ' "	h m	h m		h m			h m							
1	Fri	1957 A.D. Aug. 23	149 35 33	5 40	18 25	K 13	24 34	7	Punarvasu	8 50	CĀNDRA ŚĒAVĀNA	1-Trop. Virgo (15 ^h 38 ^m)	2-Aghora caturdaśī (Bengal & Orissa). 3-Āloka amāvasyā (Bengal), Kuśotpāṇī (Pithori) amāvasyā, Saptapuri amāvasyā (Orissa). 4-Rudravrata. 5-Haritalikā tṛtīyā. Gaurī tṛtīyā, Tithi of Śrī Śaṅkara Deva (Assam). 6-Gaṇeśa caturthī, Varada caturthī, Saubhāgya caturthī, Haritalī caturthī, Saṁvatsarī (Jain-caturthī pakṣa). 7-Ṛṣipaṅcamī & Rakṣāpaṅcamī (Bengal), Saṁvatsarī (Bombay, Surat & Ahmedabad), Guru paṅcamī (Orissa), Paryuṣaṇa parva samāpana (Jain-paṅcamī-pakṣa). 8-Sūrya ṣaṣṭhī, Lolūkka ṣaṣṭhī, Carpatā ṣaṣṭhī (Bengal), Manthāna ṣaṣṭhī (Bengal), Somanātha vrata (Orissa). 9-Muktābharana vrata, Lalitā saptamī (Bengal). 10-Dūrvāṣṭamī, Rādhāṣṭamī, Mahālakṣmī vrata, Durgā śayanī (Orissa). 11-Aduhkha navamī, Tāla navamī (Bengal), Nandā navamī, Āvaṇī mūlam (S. India). 12-Keil Muhurth (Coorg). 13-Parivartana (Padmā) ekādaśī, Dol Gyaras (Madhya Bharat), Heikra Hitomba (Manipur). 14-Kalki dvādaśī, Viṣṇu parivartanotsava, Śakrothhāna, Vāmana jayantī, First Onam Day (S. India). 15-Thiru Onam Day (S. India). 16-Ananta caturdaśī, Third Onam Day (S. India), Āvaṇī avitṭam (Madras). 17-Indragovinda pūjā (Orissa), Fourth Onam Day (S. India), Śrī Nārāyaṇa Guru Dev's Birthday (S. India). 18-Mahālayārambha. 19-Aśūnya śayana vrata. 23-Tithi of Mādha Deva (Assam). 24-Candra ṣaṣṭhī. 25-Viśvakarmā pūjā (Bengal). 26-Mahālakṣmī vrata, Jitāṣṭamī (Bengal), Mūlāṣṭamī (Orissa). 27-Mātṛ navamī, Abidhava navamī, Durgā navamī (Maharashtra). 29-Indirā ekādaśī. 30-Maghā trayodaśī, Samādhi Day of Nārāyaṇa Guru.				
2	Sat	24	150 33 25	41	24	14	20 55	8	Puṣya	6 17							
3	SUN	25	151 31 19	41	23	K 30	17 2	9	Āśleṣā	27 22							
4	Mon	26	152 29 14	41	22	S 1	13 8	10	Maghā	24 16							
5	Tue	27	153 27 11	42	21	S 2	9 23	11	P. Phalgunī	21 14							
6	Wed	28	154 25 9	5 42	18 20	S 3	5 57	12	U. Phalgunī	18 25							
7	Thu	29	155 23 8	43	20	(4	27 1)	13	Hasta	16 0							
8	Fri	30	156 21 9	43	19	5	24 42	14	Citrā	14 9							
9	Sat	31	157 19 11	43	18	6	23 6	15	Svātī	12 57							
10	SUN	Sept. 1	158 17 15	43	17	7	22 14	16	Viśākhā	12 30							
						8	22 6	17	Anurādhā	12 46							
11	Mon	2	159 15 20	5 44	18 16	S 9	22 39	18	Jyesthā	13 45							
12	Tue	3	160 13 26	44	15	10	23 48	19	Mūla	15 19							
13	Wed	4	161 11 34	44	14	11	25 25	20	P. Āṣādhā	17 24							
14	Thu	5	162 9 43	45	13	12	27 23	21	U. Āṣādhā	19 50							
15	Fri	6	163 7 53	45	12	13	29 36	22	Śravana	22 33							
16	Sat	7	164 6 6	5 45	18 11	S 14	- -	23	Dhanīṣṭhā	25 26							
17	SUN	8	165 4 20	46	10	14	7 58	24	Satabhiṣaj	28 24							
18	Mon	9	166 2 35	46	9	S 15	10 25	25	P. Bhādrapadā	- -							
19	Tue	10	167 0 53	46	8	K 1	12 51	25	"	7 23							
20	Wed	11	167 59 12	47	7	2	15 12	26	U. Bhādrapadā	10.17							
21	Thu	12	168 57 33	5 47	18 6	K 3	17 22	27	Revatī	13 2							
22	Fri	13	169 55 56	47	5	4	19 14	1	Aśvinī	15 31							
23	Sat	14	170 54 22	48	4	5	20 40	2	Bharāṇī	17 36							
24	SUN	15	171 52 49	48	3	6	21 31	3	Kṛttikā	19 8							
25	Mon	16	172 51 18	48	2	7	21 43	4	Robhīṇī	20 2							
26	Tue	17	173 49 50	5 49	18 1	K 8	21 9	5	Mṛgaśiras	20 13							
27	Wed	18	174 48 24	49	18 0	9	19 50	6	Ārdṛā	19 38							
28	Thu	19	175 47 0	49	17 59	10	17 48	7	Punarvasu	18 20							
29	Fri	20	176 45 38	49	58	11	15 7	8	Puṣya	16 24							
30	Sat	21	177 44 18	50	57	12	11 55	9	Āśleṣā	13 57							
31	SUN	Sept. 22	178 43 1	5 50	17 56	K 13	8 21	10	Maghā	11 9							
						(K 14	28 35)										

N.B.—All timings are given in I. S. T. or the local time of the meridian of 82½° E. Long.

REFORMED CALENDAR OF INDIA

FOR ŚAKA ERA 1879 (1957-58 A.D.)

Tulā : Ūrja

Ayanārhā on 1st = 23° 16' 11"

Month of Ā Ś V I N A (30 Days)

Autumn 2nd Month

Date	Week Day	English Date	Long. of the Sun at 5-30 A.M.	Sun Rise	Sun Set	Tithi		Nakṣatra			Solar Month	Lunar Month	Transit of the Sun	Phenomena	Festivals
						No.	Ending Moment	No.	Name	Ending Moment					
			° ' "	h m	h m		h m			h m					
1	Mon	1957 A.D. Sept. 23	179 41 46	5 50	17 55	K 30	24 48	11	P. Phalgunī (12 U. Phalgunī)	8 10 29 13	SAUBA Ā Ś V I N A C Ā N D R A Ā Ś V I N A S Ā C R A K Ā R T I K A	1-Trop. Libra (12 ^h 57 ^m)	1-Vaidhṛti (23 ^h 22 ^m) 1-New Moon (24 ^h 48 ^m)	1-Mahālayā amāvasyā, Suryapitṛ amāvasyā, Jalaviṣuva day. 2-Navarātrārambha. 5-Māna caturthī (Bengal), Upāhga lalitā vrata (Maharashtra).	
2	Tue	24	180 40 33	5 51	17 54	S 1	21 11	13	IIasta	26 27					
3	Wed	25	181 39 21	5 51	17 53	2	17 54	14	Citrā	24 4					
4	Thu	26	182 38 12	5 51	17 52	3	15 6	15	Svātī	22 13					
5	Fri	27	183 37 5	5 52	17 51	4	12 56	16	Viśākhā	21 1					
6	Sat	28	184 35 59	5 52	17 50	S 5	11 29	17	Anurādhā	20 35		6-Nata pañcamī (Orissa). 7-Durgā sūctī, Tapas sūctī (Orissa). 8-Durgā pūjā, Sarasvatī sthāpana, Oil begins (Jain). 9-Mahāṣṭami, Sarasvatī pūjā, Virāṣṭami. 10-Mahānavamī, Sarasvatī balidāna, Āyudha pūjā, Mahatma Gandhi's birthday.			
7	SUN	29	185 34 55	5 52	17 49	6	10 50	18	Jyēṣṭhā	20 55					
8	Mon	30	186 33 53	5 53	17 48	7	10 58	19	Mūla	22 0					
9	Tue	Oct. 1	187 32 52	5 53	17 47	8	11 50	20	P. Āṣādhā	23 45					
10	Wed	2	188 31 53	5 53	17 46	9	13 20	21	U. Āṣādhā	26 3					
11	Thu	3	189 30 56	5 54	17 45	S 10	15 19	22	Śrāvṇa	28 45			11-Vijayā daśamī, Daśaharā, Sarasvatī visarjana, Sudāśā vrata (Orissa). 12-Pāpākuśā ekādśī, Bharat Milap. 13-Padmanāva dvādśī.		
12	Fri	4	190 30 1	5 54	17 44	11	17 38	23	Dhanuṣṭhā	— —					
13	Sat	5	191 29 8	5 54	17 43	12	20 6	23	"	7 39					
14	SUN	6	192 28 16	5 55	17 42	13	22 36	24	Śatabhiṣaj	10 39					
15	Mon	7	193 27 27	5 55	17 41	14	25 0	25	P. Bhādrapadā	13 36					
16	Tue	8	194 26 39	5 55	17 40	S 15	27 12	26	U. Bhādrapadā	16 24	16-Full Moon (27 ^h 12 ^m)	16-Koṣṭhagiri Lakṣmī pūjā, Kumāra pūjā (Orissa), Oil ends (Jain), Mahārṣi Vālmiki's Birthday (Punjab). 18-Āśūnya śayana vrata. 20-Karaka caturthī, Daśaratha caturthī (Bengal).			
17	Wed	9	195 25 54	5 56	17 39	K 1	29 9	27	Rovati	18 59					
18	Thu	10	196 25 10	5 56	17 38	2	— —	1	Āśvini	21 16					
19	Fri	11	197 24 29	5 57	17 37	2	6 46	2	Bharani	23 12					
20	Sat	12	198 23 49	5 57	17 36	3	7 59	3	Kṛttikā	24 44					
21	SUN	13	199 23 12	5 57	17 35	K 4	8 46	4	Rohiṇī	25 46	24-Tulādi (27 ^h 2 ^m)	24-Jupiter rises in the East. 25-Kāverī saṅkramaṇa. 27-Ramā ekādśī. 28-Govatsa dvādśī. 29-Dhana trayodaśī, Yamadīpa dāna. 30-Naraka caturdaśī, Kālī pūjā, Bhāta caturdaśī (Bengal), Hanumat Jannamāna, Śāstrīhata caturdaśī, Dipāvalī, Mahālakṣmī pūjā, Kothār Gaurl vrata (S. India).			
22	Mon	14	200 22 37	5 58	17 35	5	9 2	5	Mṛgaśiras	26 17					
23	Tue	15	201 22 5	5 58	17 34	6	8 45	6	Ārdṛā	26 14					
24	Wed	16	202 21 34	5 59	17 33	7	7 53	7	Punarvasu	25 37					
25	Thu	17	203 21 6	5 59	17 32	8	6 26	8	Puṣya	24 27					
26	Fri	18	204 20 41	6 0	17 31	K 10	25 58	9	Āślōṣā	22 47	27-Vaidhṛti (16 ^h 40 ^m)				
27	Sat	19	205 20 18	6 0	17 30	11	23 5	10	Mughā	20 42					
28	SUN	20	206 19 56	6 1	17 29	12	19 56	11	P. Phalgunī	18 20					
29	Mon	21	207 19 38	6 1	17 29	13	16 39	12	U. Phalgunī	15 49					
30	Tue	Oct. 22	208 19 21	6 1	17 28	K 14	13 21	13	IIasta	13 17					

N.B.—All timings are given in I. S. T. or the local time of the meridian of 82½° E. Long.

REFORMED CALENDAR OF INDIA

FOR ŚAKA ERA 1879 (1957-58 A.D.)

Month of KĀRTIKA (30 Days)

Vṛścika : Sahas

Ayanārhśa on 1st = 23° 16' 14"

Hemanta 1st Month

C.R.-17

Date	Week Day	English Date	Long. of the Sun at 5-30 A.M.	Sun		Tithi		Nakṣatra			Solar Month	Lunar Month	Transit of the Sun	Phenomena	Festivals
				Rise	Set	No.	Ending Moment	No.	Name	Ending Moment					
			° ' "	h m	h m		h m			h m					
		1957A.D.													
1	Wed	Oct. 23	209 19 7	6 2	17 27	K 30	10 13	14	Citrā	10 54	S A U R A K Ā R T I K A	Cāndra Āśvina	1-Enters Svāti (20 ^h 24 ^m)	1-New Moon (10 ^h 13 ^m)	1-Mahāvīra nirvāṇā (Jain), Govardhana pūjā, Balipūjā, Annakūṭa. 2-Dyūta pratipad, Bhrātṛdviṭiyā, Yama dviṭiyā, Dwāt pūjā (Bihar). 3-Ālocanā gaurī vrata. 4-Nāga caturthī. 5-Jñāna pañcamī (Jain).
2	Thu	24	210 18 54	2	26	S 1	7 24	15	Svāti	8 51					
3	Fri	25	211 18 43	3	26	(2 29 1)	27 15	16	Viśākhā	7 15					
4	Sat	26	212 18 35	3	25	3	26 9	17	Anurādhā	6 15					
5	SUN	27	213 18 28	4	24	4	26 9	18	Jyeṣṭhā	29 56					
6	Mon	28	214 18 22	6 4	17 23	5	25 50	19	Mūla	- -					
7	Tue	29	215 18 19	5	23	S 6	26 17	19	Mūla	6 23					
8	Wed	30	216 18 17	5	22	7	27 28	20	P. Āṣādhā	7 34					
9	Thu	31	217 18 16	6	21	8	29 16	21	U. Āṣādhā	9 26					
10	Fri	Nov. 1	218 18 18	7	21	9	- -	22	Śravaṇa	11 52					
						9	7 31	23	Dhanīṣṭhā	14 40	S A U R A K Ā R T I K A	Cāndra Āśvina	1-Trop. Scorpio (21 ^h 55 ^m)	1-Solar Eclipse (Total) invisible in India.	6-Sūrya ṣaṣṭhī, Nāḍī ṣaṣṭhī (Bengal), Chhat (Bihar), Skanda ṣaṣṭhī (Madras). 8-Gopāṣṭamī, Goṣṭhāṣṭamī. 9-Durgā navamī (Bengal), Viṣṇu trirātra, Gaurī vrata (Bengal), Jagaddhātṛī pūjā (Bengal), Akṣaya navamī, Anā navamī (Orissa).
11	Sat	2	219 18 21	6 7	17 20	S 10	10 1	24	Śatabhiṣaj	17 40					
12	SUN	3	220 18 25	8	20	11	12 34	25	P. Bhādrapadā	20 39					
13	Mon	4	221 18 31	8	19	12	14 58	26	U. Bhādrapadā	23 26					
14	Tue	5	222 18 39	9	18	13	17 4	27	Revatī	25 55					
15	Wed	6	223 18 49	9	18	14	18 46	1	Āśvini	27 59					
16	Thu	7	224 18 59	6 10	17 17	S 15	20 2	2	Bharanī	29 37					
17	Fri	8	225 19 13	11	17	K 1	20 49	3	Kṛttikā	- -					
18	Sat	9	226 19 27	11	16	2	21 7	3	"	6 47					
19	SUN	10	227 19 44	12	16	3	20 58	4	Rohiṇī	7 29					
20	Mon	11	228 20 2	13	16	4	20 24	5	Mṛgaśīras	7 47	S A U R A K Ā R T I K A	Cāndra Āśvina	14-Enters Viśākhā (28 ^h 29 ^m)	16-Full Moon (20 ^h 2 ^m)	12-Prabodhanī ekādaśī, Tulasi vivāha, Bhīṣma pañcaka, Raviṇārāyaṇa ekādaśī (Orissa). 13-Prabodhanotsava, Nārāyaṇa dvādaśī, Vṛndāvana dvādaśī. 14-Vaikunṭha caturdaśī. 15-Rāsyaṭrā, Cāturmāsya caturdaśī (Jain), Annābhīṣekam (S. India—for some), Bājā oṣā (Orissa). 16-Rāsyaṭrā, Tripurotsava, Rathayātrā (Jain), Kedāra vrata (Orissa), Kārtiki pūrṇimā, Annābhīṣekam (S. India—for some), Puṣkar fair (Ajmer), Guru Nanak's Birthday.
21	Tue	12	229 20 23	6 13	17 15	K 5	19 26	6	Ārdrā	7 40					
22	Wed	13	230 20 45	14	15	6	18 6	7	Punarvasu	7 10					
23	Thu	14	231 21 9	14	14	7	16 26	8	Puṣya	6 20					
24	Fri	15	232 21 35	15	14	(9	29 11)	9	Āśleṣā	29 11					
25	Sat	16	233 22 3	16	14	8	14 28	10	Maghā	27 46					
26	SUN	17	234 22 33	6 16	17 14	9	12 16	11	P. Phalgunī	26 8					
27	Mon	18	235 23 4	17	13	K 10	9 51	12	U. Phalgunī	24 22					
28	Tue	19	236 23 38	18	13	11	7 19	13	Hasta	22 30					
29	Wed	20	237 24 13	18	13	(12	28 45)	13	Citrā	20 41					
30	Thu	Nov. 21	238 24 50	6 19	17 13	13	26 14	14	Svāti	18 59	S A U R A M Ā R G A Ś Ī R S A	Cāndra Āśvina	24-Vṛścikādi (26 ^h 42 ^m)	28-Enters Anurādhā (10 ^h 31 ^m)	20-Death Anniversary of Lala Lajpat Rai. 27-Utpannā ekādaśī, Trisṛṣṭā mahādvdādaśī. 30-Dīpāvālī amāvasyā (Orissa).
						14	23 53	15	Viśākhā	17 33					
						16	21 49	16							

N.B.—All timings are given in I. S. T. or the local time of the meridian of 82½° E. Long.

REFORMED CALENDAR OF INDIA

FOR ŚAKA ERA 1879 (1957-58 A.D.)

Dhanuḥ : Sahasya Ayanānśa on 1st = 23° 16' 17"

Month of A G R A H Ā Y A N A (MARGAŚIRṢA) (30 Days) Hemanta 2nd Month

Date	Week Day	English Date	Long. of the Sun at 5-30 A.M.	Sun Rise	Sun Set	Titthi		Nakṣatra			Solar Month	Lunar Month	Transit of the Sun	Phenomena	Festivals
						No.	Ending Moment	No.	Name	Ending Moment					
1957 A.D.			° ' "	h m	h m		h m			h m					
1	Fri	Nov. 22	239 25 28	6 20	17 12	S 1	20 10	17	Anurādhā	16 30			1-Trop. Sagittarius (19 ^h 10 ^m)	1-Rudropavāsa.	
2	Sat	23	240 26 8	20	12	2	19 2	18	Jyeṣṭhā	15 56					
3	SUN	24	241 26 49	21	12	3	18 31	19	Mūla	15 58					
4	Mon	25	242 27 31	22	12	4	18 42	20	P. Aṣādhā	16 40				4-Vyatipāta (29 ^h 10 ^m)	
5	Tue	26	243 28 15	23	12	5	19 35	21	U. Aṣādhā	18 3				5-Nāga pañcami (2nd), Sahid Day of Śrī Guru Teg Bahadur (Punjab).	
6	Wed	27	244 28 59	6 23	17 12	S 6	21 9	22	Śravaṇa	20 5					
7	Thu	28	245 29 45	24	12	7	23 15	23	Dhaniṣṭhā	22 38					
8	Fri	29	246 30 32	25	12	8	25 43	24	Śatabhiṣaj	25 32					
9	Sat	30	247 31 19	25	12	9	28 19	25	P. Bhādrapadā	28 34					
10	SUN	Dec. 1	248 32 8	26	12	10	—	26	U. Bhādrapadā	—					
11	Mon	2	249 32 57	6 27	17 12	S 10	6 48	26	U. Bhādrapadā	7 29					
12	Tue	3	250 33 48	27	12	11	8 57	27	Revatī	10 3					
13	Wed	4	251 34 39	28	12	12	10 34	1	Aśvini	12 9					
14	Thu	5	252 35 31	29	12	13	11 36	2	Bharanī	13 39					
15	Fri	6	253 36 24	29	13	14	11 59	3	Kṛttikā	14 33					
16	Sat	7	254 37 18	6 30	17 13	S 15	11 46	4	Rohiṇī	14 52					
17	SUN	8	255 38 13	31	13	K 1	11 0	5	Mṛgaśiras	14 39				16-Full Moon (11 ^h 46 ^m)	
18	Mon	9	256 39 9	31	13	2	9 46	6	Ārdrā	14 1				18-Vaidhṛti (13 ^h 33 ^m)	
19	Tue	10	257 40 6	32	13	3	8 12	7	Punarvasu	13 3					
20	Wed	11	258 41 4	33	14	5	28 24	8	Puṣya	11 52					
21	Thu	12	259 42 3	6 33	17 14	K 6	26 21	9	Āśleṣā	10 33					
22	Fri	13	260 43 4	34	14	7	24 17	10	Maghā	9 10					
23	Sat	14	261 44 5	34	15	8	22 14	11	P. Phalgunī	7 47					
24	SUN	15	262 45 7	35	15	9	20 14	13	U. Phalgunī	30 26					
25	Mon	16	263 46 11	36	15	10	18 21	14	Hasta	29 10					
26	Tue	17	264 47 15	6 36	17 16	K 11	16 34	15	Citrā	27 59					
27	Wed	18	265 48 21	37	16	12	14 57	16	Svāti	26 56					
28	Thu	19	266 49 27	37	17	13	13 33	17	Viśākhā	26 5					
29	Fri	20	267 50 33	38	17	14	12 26	18	Anurādhā	25 28					
30	Sat	Dec. 21	268 51 41	6 39	17 17	K 30	11 42	19	Jyeṣṭhā	25 10					
									Mūla	25 17					

N. B.—All timings are given in I. S. T. or the local time of the meridian of 82½° E. Long.

REFORMED CALENDAR OF INDIA

FOR ŚAKA ERA 1870 (1957-58 A.D.)

Month of P A U Ṣ A (30 Days)

Makara : Tapas

Ayanāmsā on 1st = 23° 16' 22"

Winter 1st Month

Date	Week Day	English Date	Long. of the Sun at 5-30 A.M.	Sun Rise	Sun Set	Tithi		Nakṣatra			Solar Month	Lunar Month	Transit of the Sun	Phenomena	Festivals
						No.	Ending Moment	No.	Name	Ending Moment					
1957 A.D.			° ' "	h m	h m		h m		h m						
1	SUN	Dec. 22	269 52 49	6 39	17 18	S 1	11 25	20	P. Āṣādhā	25 53			1-Trop. Capricornus (8 ^h 19 ^m)	1-Uttarāyana Day	
2	Mon	23	270 53 57	40	18	2	11 40	21	U. Āṣādhā	27 2					
3	Tue	24	271 55 6	40	19	3	12 31	22	Śravaṇa	28 46					
4	Wed	25	272 56 15	40	20	4	13 58	23	Dhaniṣṭhā	— —				5-Guru pañcamī (Orissa).	
5	Thu	26	273 57 23	41	20	5	15 58	23	"	7 4					
6	Fri	27	274 58 33	6 41	17 21	S 6	18 23	24	Śatabhiṣaj	9 48				6-Annarūpā ṣaṣṭhī (Bengal).	
7	Sat	28	275 59 42	42	21	7	21 2	25	P. Bhādrapadā	12 49			7-Enters P. Āṣādhā (19 ^h 54 ^m)	7-Guru Govinda Singh's Birthday.	
8	SUN	29	277 0 51	42	22	8	23 39	26	U. Bhādrapadā	15 53					
9	Mon	30	278 2 0	42	23	9	25 58	27	Revatī	18 44					
10	Tue	31	279 3 9	43	23	10	27 45	1	Aśvini	21 7				10-Śāmba daśamī (Orissa).	
1958 A.D.															
11	Wed	Jan. 1	280 4 17	6 43	17 24	S 11	28 50	2	Bharaṇī	22 54				11-Putradā ekādaśī, Vaikuṅṭha ekādaśī (Madras), English New Year's Day.	
12	Thu	2	281 5 26	43	24	12	29 7	3	Kṛttikā	23 56			13-Vaidhṛti (25 ^h 0 ^m)	12-Kūrma dvādaśī.	
13	Fri	3	282 6 34	44	25	13	28 37	4	Rohiṇī	24 11			15-Full Moon (25 ^h 39 ^m)	15-Puṣyābhiṣekayātrā, Arudra darśana (S. India).	
14	Sat	4	283 7 43	44	26	14	27 26	5	Mṛgaśiras	23 45					
15	SUN	5	284 8 51	44	26	S 15	25 39	6	Ārdrā	22 42					
16	Mon	6	285 9 58	6 44	17 27	K 1	23 24	7	Punarvasu	21 11					
17	Tue	7	286 11 6	44	28	2	20 51	8	Puṣya	19 22					
18	Wed	8	287 12 14	45	28	3	18 10	9	Āśleṣā	17 23					
19	Thu	9	288 13 22	45	29	4	15 28	10	Maghā	15 24					
20	Fri	10	289 14 29	45	30	5	12 53	11	P. Phalgunī	13 32			20-Enters U. Āṣādhā (21 ^h 58 ^m)		
21	Sat	11	290 15 37	6 45	17 31	K 6	10 32	12	U. Phalgunī	11 53				22-Mānsāṣṭakā.	
22	SUN	12	291 16 45	45	31	7	8 26	13	Hasta	10 29				23-Bhogī (S. India).	
23	Mon	13	292 17 52	45	32	(8 30 41)	9	29 15	14	Citrā	9 26			24-Pongal (S. India), Mīgh bihu (Assam), Tila saṅkrāntī, Makarādi snāna.	
24	Tue	14	293 19 0	45	33	10	28 8	15	Svātī	8 42			23-Makarādi (27 ^h 56 ^m)	25-Vyatipāta (23 ^h 7 ^m)	
25	Wed	15	294 20 8	45	33	11	27 20	16	Viśākhā	8 16				25-Ṣuṭtilā ekādaśī, Maṭṭu pongal (S. India).	
26	Thu	16	295 21 15	6 45	17 34	K 12	26 53	17	Anurādhā	8 9				27-Meru trayodaśī (Jain).	
27	Fri	17	296 22 22	45	35	13	26 45	18	Jyeṣṭhā	8 22				28-Yama tarpaṇa, Raṭanti Kālikā pūjā (Bengal).	
28	Sat	18	297 23 29	45	36	14	26 58	19	Mūla	8 54				29-Maunī amāvasyā (Uttar Pradesh), Thai amāvasyā (S. India), Makara vāyu (T. C. State), Triveṇī amāvasyā (Orissa).	
29	SUN	19	298 24 35	45	36	K 30	27 38	20	P. Āṣādhā	9 48			29-New Moon (27 ^h 38 ^m)		
30	Mon	Jan. 20	299 25 40	6 45	17 37	S 1	28 43	21	U. Āṣādhā	11 7			30-Trop. Aquarius (18 ^h 59 ^m)		

SAURA PAUṢA
CĀNDRA PAUṢA
SAURA MĀGHA
Cāndra Magha

N.B.—All timings are given in I. S. T. or the local time of the meridian of 82½° E. Long.

REFORMED CALENDAR OF INDIA

FOR ŚAKA ERA 1870 (1957-58 A.D.)

Month of M Ā G H A (30 Days)

Kumbha : Tapasya

Ayanaśā on 1st = 23° 16' 27"

Winter 2nd Month

Date	Week Day	English Date	Long. of the Sun at 5-30 A.M.	Sun Rise	Sun Set	Tithi		Nakṣatra			Solar Month	Lunar Month	Transit of the Sun	Phenomena	Festivals
						No.	Ending Moment	No.	Name	Ending Moment					
1958 A.D.			° ' "	h m	h m		h m			h m					
1	Tue	Jun. 21	300 26 45	6 45	17 38	S 2	30 17	22	Śravaṇa	12 52	SAUBA MĀGHA	3-Enters Śravaṇa (24 ^h 12 ^m)	4-Venus sets in the West.	3-Tilā caturthī, Kunda caturthī, Gaṇeśa Jayantī, Gaṇeśa pūjā (Bengal), Netaji's Birthday, 4-Varadā caturthī (Bengal), Vasanta pañcamī, Madana pañcamī, 5-Śrī pañcamī.	
2	Wed	22	301 27 50	6 45	17 38	S 3	- -	23	Dhanisthā	15 4					
3	Thu	23	302 28 53	6 44	17 39	S 3	8 18	24	Śatabhishaj	17 41					
4	Fri	24	303 29 56	6 44	17 40	S 4	10 44	25	P. Bhādrapadā	20 39					
5	Sat	25	304 30 57	6 44	17 41	S 5	13 25	26	U. Bhādrapadā	23 47					
6	SUN	26	305 31 58	6 44	17 41	S 6	16 8	27	Revatī	26 51	CĀNDĀ MĀGHA	9-Vaidhṛtī (10 ^h 23 ^m)	6-Republic Day, Śītala gaṅgā (Bengal), 7-Ratha saptamī, Acalā saptamī, Ārogya and Vidhāna saptamī (Bengal), Candrabhāgā saptamī (Orissa), 8-Bhīṣmaṅgamī, 9-Mahānandā navamī, 10-Sudāśā vrata (Orissa),		
7	Mon	27	306 32 57	6 44	17 42	S 7	18 39	1	Āśvini	29 39					
8	Tue	28	307 33 56	6 43	17 43	S 8	20 42	2	Bharanī	- -					
9	Wed	29	308 34 53	6 43	17 43	S 9	22 6	2	"	7 55					
10	Thu	30	309 35 49	6 43	17 44	S 10	22 40	3	Kṛttikā	9 29					
11	Fri	31	310 36 43	6 42	17 45	S 11	22 20	4	Rohiṇī	10 12					
12	Sat	Feb. 1	311 37 37	6 42	17 45	S 12	21 9	5	Mṛgaśīras	10 4					
13	SUN	2	312 38 29	6 41	17 46	S 13	19 18	6	Ārdṛā	9 9					
14	Mon	3	313 39 20	6 41	17 47	S 14	16 37	7	Punarvasu	7 32					
15	Tue	4	314 40 9	6 41	17 47	S 15	13 35	8	Puṣya	29 23					
								9	Āśleṣh	26 54					
16	Wed	5	315 40 58	6 40	17 48	K 1	10 17	10	Maghā	24 15	SAUBA MĀGHA	16-Enters Dhanisthā (27 ^h 26 ^m)	11-Jayā ekādaśī, Bhūmī ekādaśī, 12-Bhīṣma dvādaśī, Varāha dvādaśī, Āmalakī & Santāna dvādaśī (Orissa), 14-Venus rises in the East, 15-Full Moon (13 ^h 35 ^m)		
17	Thu	6	316 41 45	6 40	17 49	K 2	6 54	11	P. Phalgunī	21 39					
						(3	27 35)								
18	Fri	7	317 42 32	6 39	17 49	K 4	24 30	12	U. Phalgunī	19 3					
19	Sat	8	318 43 17	6 39	17 50	K 5	21 46	13	Hasta	17 7					
20	SUN	9	319 44 1	6 38	17 51	K 6	19 30	14	Citrā	15 27					
21	Mon	10	320 44 44	6 38	17 51	K 7	17 44	15	Svatī	14 17					
22	Tue	11	321 45 27	6 37	17 52	K 8	16 32	16	Viśākhā	13 40					
23	Wed	12	322 46 8	6 36	17 52	K 9	15 51	17	Anurādhā	13 33					
24	Thu	13	323 46 48	6 36	17 53	K 10	15 41	18	Jyēṣṭhā	13 57					
25	Fri	14	324 47 27	6 35	17 54	K 11	15 58	19	Mūla	14 47					
26	Sat	15	325 48 5	6 34	17 54	K 12	16 40	20	P. Āṣāḍhā	16 3	CĀNDĀ MĀGHA	23-Kumbhādi (16 ^h 55 ^m)	21-Vyātipātā (7 ^h 13 ^m)		
27	SUN	16	326 48 41	6 34	17 55	K 13	17 46	21	U. Āṣāḍhā	17 40					
28	Mon	17	327 49 16	6 33	17 55	K 14	19 16	22	Śravaṇa	19 40					
29	Tue	18	328 49 50	6 32	17 56	K 30	21 8	23	Dhanisthā	22 1					
30	Wed	Feb. 19	329 50 22	6 32	17 56	S 1	23 18	24	Śatabhishaj	24 41					

N.B.—All timings are given in I. S. T. or the local time of the meridian of 82½° E. Long.

REFORMED CALENDAR OF INDIA

FOR ŚAKA ERA 1870 (1957-58 A.D.)

Mina : Madhu

Ayanānśa on 1st = 23° 16' 31"

Month of PHĀLGUNA (30 Days)

Spring 1st Month

C. R.—18

Date	Week Day	English Date	Long. of the Sun at 5-30 A.M.	Sun Rise	Sun Set	Tithi		Nakṣatra			Solar Month	Lunar Month	Transit of the Sun	Phenomona	Festivals	
						No.	Ending Moment	No.	Name	Ending Moment						
			° ' "	h m	h m		h m			h m						
1	Thu	Feb. 20	330 50 53	6 31	17 57	S 2	25 47	25	P. Bhādrapadā	27 37	SAURA PHĀLGUNA CĀNDRA PHĀLGUNA SAURA CAITRA Cāndra Caitra					
2	Fri	21	331 51 22	30	57	3	28 27	26	U. Bhādrapadā	— —						
3	Sat	22	332 51 49	29	58	4	— —	26	"	6 44						
4	SUN	23	333 52 15	29	58	4	7 13	27	Revatī	9 55						
5	Mon	24	334 52 38	28	59	5	9 48	1	Āśvinī	12 55						3-Śānta caturthī.
6	Tue	25	335 53 0	6 27	17 59	S 6	12 3	2	Bharanī	15 36						6-Gorūpīṅṅ ṣaṣṭhī (Bengal).
7	Wed	26	336 53 20	26	18 0	7	13 46	3	Kṛttikā	17 43						
8	Thu	27	337 53 38	25	0	8	14 45	4	Rohiṇī	19 8						
9	Fri	28	338 53 54	25	1	9	14 52	5	Mṛgaśīras	19 40						
10	Sat	Mar. 1	339 54 7	24	1	10	14 5	6	Ārdrā	19 22						10-Phagu daśami (Orissa).
11	SUN	2	340 54 19	6 23	18 2	S 11	12 28	7	Punarvasu	18 15						11-Āmalakī ekādaśī, Ravināṅṅyapa ekādaśī (Orissa).
12	Mon	3	341 54 29	22	2	12	10 5	8	Puṣya	16 24						12-Nṛsiṅha dvādaśī.
13	Tue	4	342 54 36	21	3	13	7 6	9	Āśleṣā	14 1						13-Cāturmāeya caturdaśī (Jain).
14	Wed	5	343 54 42	20	3	S 15	23 58	10	Maghā	11 14						14-Holikādhana, Dolayātrā, Māsi magham (South India), Birthday of Śrī Caitanya.
15	Thu	6	344 54 46	19	4	K 1	20 11	11	P. Phalgunī	8 14						15-Holi, Vasantotsava.
16	Fri	7	345 54 48	6 18	18 4	K 2	16 30	13	Πasta	26 27						
17	Sat	8	346 54 48	18	5	3	13 5	14	Oitrā	23 59						
18	SUN	9	347 54 47	17	5	4	10 5	15	Svātī	22 0						
19	Mon	10	348 54 44	16	5	5	7 37	16	Viśākhā	20 35						19-Raṅga pañcamī, Skanda ṣaṣṭhī (Bengal), Vijay Govindaji Halenkar (Manipur).
20	Tue	11	349 54 40	15	6	7	28 37	17	Anurādhā	19 51						
21	Wed	12	350 54 33	6 14	18 6	K 8	28 9	18	Jyesthā	19 47						21-Śitalāṣṭami, Varṣītapārambha (Jain).
22	Thu	13	351 54 25	13	7	9	28 21	19	Mūla	20 23						
23	Fri	14	352 54 15	12	7	10	29 9	20	P. Āṣādhā	21 35						
24	Sat	15	353 54 4	11	7	11	— —	21	U. Āṣādhā	23 20						
25	SUN	16	354 53 50	10	8	11	6 29	22	Śravaṇa	25 31						25-Pāpamocanī ekādaśī, Unmilanī mahādvādaśī.
26	Mon	17	355 53 35	6 9	18 8	K 12	8 16	23	Dhanīṣṭhā	28 3						
27	Tue	18	356 53 19	8	9	13	10 22	24	Śatabhiṣaj	— —						27-Vāruṅī (upto 10 ^h 22 ^m).
28	Wed	19	357 53 0	7	9	14	12 45	24	"	6 52						
29	Thu	20	358 52 40	6	9	K 30	15 20	25	P. Bhādrapadā	9 53						
30	Fri	Mar. 21	359 52 17	6 5	18 10	S 1	17 59	26	U. Bhādrapadā	13 1						30-Navarātrārambha, Mahāviṣuva day, (Year-ending Day).

N.B.—All timings are given in I. S. T. or the local time of the meridian of 82½° E. Long.

REFORMED CALENDAR OF INDIA

FOR ŚAKA ERA 1880 (1958-59 A.D.)

Month of CAITRA (30 Days)

Mesa : Mādhava

Ayanāṁśa on 1st = 23° 16' 34"

Spring 2nd Month

Date	Week Day	English Date	Long. of the Sun at 5-30 A.M.	Sun Rise	Sun Set	Tithi		Nakṣatra			Solar Month	Lunar Month	Transit of the Sun	Phenomena	Festivals
						No.	Ending Moment	No.	Name	Ending Moment					
1958 A.D.			° ' "	h m	h m		h m			h m					
1	Sat	Mar. 22	0 51 53	6 4	18 10	S 2	20 36	27	Revati	16 7					1-Indian New Year's Day.
2	SUN	23	1 51 26	3	10	3	23 6	1	Āśvini	19 6					2-Gaurī tṛtīyā, Āndolana tṛtīyā, Saubhāgya-śayana vrata, Dolotsava, Sarhul (Bihar).
3	Mon	24	2 50 57	2	11	4	25 20	2	Bharaṇi	21 53					4-Śrī (Lakṣmī) pañcamī.
4	Tue	25	3 50 26	1	11	5	27 6	3	Kṛttikā	24 15					5-Āśoka ṣaṣṭhī (Bengal), Skanda ṣaṣṭhī (Orissa).
5	Wed	26	4 49 53	6 0	12	6	28 18	4	Rohiṇi	26 5					
6	Thu	27	5 49 18	5 59	18 12	S 7	28 49	5	Mrgaśiras	27 15					
7	Fri	28	6 48 40	58	12	8	28 36	6	Ārdrā	27 43					6-Vāsantī pūjā (Bengal), Oli beginning (Jain).
8	Sat	29	7 48 0	57	13	9	27 32	7	Punarvasu	27 22					7-Annapūrṇā pūjā (Bengal), Āśokaṣṭamī, Bhavānī utpatti.
9	SUN	30	8 47 17	56	13	10	25 44	8	Puṣya	26 17					8-Rāma navamī, Śrī Rāma jayantī.
10	Mon	31	9 46 33	55	14	11	23 15	9	Āśleṣā	24 31					9-Dharmarāja daśamī. 10-Kāmadā ekādaśī, Dolotsava.
11	Tue	Apr. 1	10 45 45	5 55	18 14	S 12	20 12	10	Maghā	22 13					
12	Wed	2	11 44 56	54	14	13	16 45	11	P. Phalgunī	19 30					12-Vyatipāta (16 ^h 7 ^m)
13	Thu	3	12 44 5	53	14	14	13 2	12	U. Phalgunī	16 33					12-Anaṅga trayodaśī, Mahāvira jayantī (Jain), Śiva damanaka (Orissa).
14	Fri	4	13 43 11	52	15	S 15	9 15	13	Hasta	13 33					13-Madana bhañjī (Bengal & Orissa), Viṣṇu damanaka (Orissa), Paṅguni uttiram (S. India).
15	Sat	5	14 42 15	51	15	(K 1 2)	29 32 26 5	14	Citrā	10 41					14-Hanumat jayantī, Oli ends (Jain).
16	SUN	6	15 41 17	5 50	18 16	K 3	23 1	15	Svāti	8 6					
17	Mon	7	16 40 18	49	16	4	20 30	16	Viśākhā	5 58					
18	Tue	8	17 39 16	48	16	5	18 38	18	Anurādhā	28 24					
19	Wed	9	18 38 13	47	17	6	17 32	19	Jyeṣṭhā	27 33					
20	Thu	10	19 37 8	46	17	7	17 13	20	Mūla	27 27					
									P. Āṣāḍhā	28 7					
21	Fri	11	20 36 2	5 45	18 17	K 8	17 39	21	U. Āṣāḍhā	29 29					
22	Sat	12	21 34 53	44	18	9	18 46	22	Śravaṇa	- -					
23	SUN	13	22 33 43	43	18	10	20 30	22	"	7 29					23-Çaḍaka pūjā (Bengal), Bahag Bihu (Assam), Vaisākhi, Viṣṇu (T. C. State), Cheiraoba (Manipur).
24	Mon	14	23 32 31	42	19	11	22 42	23	Dhaniṣṭhā	10 2					24-Varūthini ekādaśī.
25	Tue	15	24 31 18	41	19	12	25 9	24	Śatabhiṣaj	12 54					
26	Wed	16	25 30 2	5 41	18 19	K 13	27 45	25	P. Bhādrapadā	15 57					
27	Thu	17	26 28 45	40	20	14	- -	26	U. Bhādrapadā	19 6					
28	Fri	18	27 27 26	39	20	14	6 24	27	Revati	22 11					
29	Sat	19	28 26 5	38	21	K 30	8 53	1	Āśvini	25 4					
30	SUN	Apr. 20	29 24 42	5 37	18 21	S 1	11 9	2	Bharaṇi	27 40					29-Solar Eclipse (annular) visible in India. 29-Tithi of Deva Dāmodara (Assam).

SAURA CAITRA
CĀNDRA CAITRA
SAURA VAIŚAKHA
Cāndra Vaisākha

N.B.—All timings are given in I. S. T. or the local time of the meridian of 82½° E. Long.

REFORMED CALENDAR OF INDIA

FOR ŚAKA ERA 1880 (1958-59 A.D.)

Month of VAIŚĀKHA (31 Days)

Vṛṣa : Śukra

Ayanāntiśa on 1st = 23° 16' 36"

Summer 1st Month

Date	Week Day	English Date	Long. of the Sun at 5-30 A.M.	Sun Rise	Sun Set	Tithi		Nakṣatra			Solar Month	Lunar Month	Transit of the Sun	Phenomena	Festivals
						No.	Ending Moment	No.	Name	Ending Moment					
			° ' "	h m	h m		h m	h m		h m					
1958 A.D.															
1	Mon	Apr. 21	30 23 18	5 36	18 21	S 2	13 5	3	Kṛttikā	- -					1-Paraśurāma jayanti (Pradoṣa).
2	Tue	22	31 21 51	5 35	18 22	S 3	14 38	3	"	5 57					2-Akṣaya tṛtīyā, Candana yātrā (Bengal and Orissa), Varyāpā samāpana (Jain).
3	Wed	23	32 20 22	5 35	18 22	S 4	15 45	4	Rohiṇī	7 48					4-Śaṅkara's Birthday, Guru pañcamī (Orissa).
4	Thu	24	33 18 51	5 34	18 23	S 5	16 18	5	Mṛgaśīras	9 10					5-Candana ṣaṣṭhī (Bengal).
5	Fri	25	34 17 18	5 33	18 23	S 6	16 16	6	Ārdrā	9 56					
6	Sat	26	35 15 43	5 32	18 23	S 7	15 39	7	Punarvasu	10 10					6-Gaṅgotpatti, Jahnu saptamī (Bengal), Śarkarā saptamī.
7	SUN	27	36 14 5	5 32	18 24	S 8	14 24	8	Puṣya	9 47					8-Sitā navamī (Bengal & Orissa).
8	Mon	28	37 12 26	5 31	18 24	S 9	12 33	9	Āśleṣā	8 47					
9	Tue	29	38 10 44	5 30	18 25	S 10	10 10	10	Maghā	7 14					
10	Wed	30	39 9 1	5 29	18 25	S 11	7 20	11	(11) P. Phalgunī	29 15					10-Mohini ekādaśī, Trisprā mahādvādaśī, Paraśurāma dvādaśī, Rukmiṇī & Pīpitaki dvādaśī (Bengal and Orissa).
						S 12	28 11	12	U. Phalgunī	26 55					
11	Thu	May 1	40 7 15	5 29	18 26	S 13	24 47	13	Haata	24 19					12-Nṛsiṅha caturdaśī, Nṛsiṅha jayanti.
12	Fri	2	41 5 28	5 28	18 26	S 14	21 18	14	Citrā	21 39					
13	Sat	3	42 3 38	5 27	18 27	S 15	17 53	15	Svātī	19 2					13-Full Moon (17 ^h 53 ^m)
14	SUN	4	43 1 47	5 27	18 27	K 1	14 42	16	Viśākhā	16 40					13-Lunar Eclipse (partial) partly visible in India.
15	Mon	5	43 59 54	5 26	18 27	K 2	11 52	17	Anurādhā	14 41					
16	Tue	6	44 58 0	5 25	18 28	K 3	9 33	18	Jyēṣṭhā	13 14					19-Vaidhṛti (28 ^h 15 ^m)
17	Wed	7	45 56 4	5 25	18 28	K 4	7 54	19	Mūla	12 27					20-Trilocanāṣṭamī (Bengal).
18	Thu	8	46 54 6	5 24	18 29	K 5	6 58	20	P. Āṣāḍhā	12 23					
19	Fri	9	47 52 8	5 24	18 29	K 6	6 49	21	U. Āṣāḍhā	13 8					
20	Sat	10	48 50 7	5 23	18 30	K 7	7 31	22	Śravaṇa	14 39					
21	SUN	11	49 48 6	5 23	18 30	K 8	8 54	23	Dhanīṣṭhā	16 49					21-Enters Kṛttikā (9 ^h 0 ^m)
22	Mon	12	50 46 3	5 22	18 31	K 9	10 53	24	Śatabhiṣaj	19 31					21-Trilocanāṣṭamī (for some).
23	Tue	13	51 43 59	5 21	18 31	K 10	13 16	25	P. Bhādrapadā	22 34					
24	Wed	14	52 41 54	5 21	18 32	K 11	15 53	26	U. Bhādrapadā	25 42					24-Aparā ekādaśī, Jalakṛīḍā ekādaśī (Orissa).
25	Thu	15	53 39 47	5 21	18 32	K 12	18 26	27	Rovati	28 45					
26	Fri	16	54 37 39	5 20	18 32	K 13	20 49	1	Āśvini	- -					27-Sāvitrī caturdaśī (Bengal), Phalahāriṇī Kālikā pūjā (Bengal).
27	Sat	17	55 35 30	5 20	18 33	K 14	22 53	1	"	7 35					28-Vaṣa Sāvitrī vrata, Sāvitrī amāvasyā (Orissa), Phalahāriṇī Kālikā pūjā (Bengal).
28	SUN	18	56 33 20	5 19	18 33	K 30	24 30	2	Bharaṇī	10 3					28-New Moon (24 ^h 30 ^m)
29	Mon	19	57 31 8	5 19	18 34	S 1	25 40	3	Kṛttikā	12 5					29-Daśaharā snānārambha.
30	Tue	20	58 28 54	5 18	18 34	S 2	26 20	4	Rohiṇī	13 39					31-Rambhā tṛtīyā, Pratap jayanti (Rajasthan).
31	Wed	May 21	59 26 40	5 18	18 35	S 3	26 33	5	Mṛgaśīras	14 46					

N.B.—All timings are given in I. S. T. or the local time of the meridian of 82½° E. Long.

REFORMED CALENDAR OF INDIA

FOR ŚAKA ERA 1880 (1958-59 A.D.)

Mithuna : Śuci Ayanāmsā on 1st = 23° 16' 40"

Month of JY A I Ś T H A (JYEṢṬHA) (31 Days)

Summer 2nd Month

Date	Week Day	English Date	Long. of the Sun at 5-30 A.M.	Sun Rise	Sun Set	Tithi		Nakṣatra			Solar Month	Lunar Month	Transit of the Sun	Phenomena	Festivals
						No.	Ending Moment	No.	Name	Ending Moment					
1958 A.D.			° ' "	h m	h m		h m			h m					
1	Thu	May 22	60 24 23	5 18	18 35	S 4	26 18	6	Ārdrā	15 25	SAURA JY A I Ś T H A C Ā N D R A J Y A I Ś T H A	3-Enters Rohiṇi (29 ^h 11 ^m)	2-Vyatīpāta (18 ^h 21 ^m)	1-Umā caturthī (Bengal & Orissa), Guru Arjun Dev's Martyrdom Day (Punjab). 2-Mahādeva vivāha (Orissa). 3-Aranya gaurī vrata, Aranya ṣaṣṭhī (Bengal), Skanda ṣaṣṭhī & Śītala ṣaṣṭhī (Orissa).	
2	Fri	23	61 22 6	17	36	5	25 37	7	Punarvasu	15 38					
3	Sat	24	62 19 46	17	36	6	24 31	8	Puṣya	15 26					
4	SUN	25	63 17 26	17	37	7	23 1	9	Āśleṣā	14 50					
5	Mon	26	64 15 3	17	37	8	21 9	10	Maghā	13 51					
6	Tue	27	65 12 40	5 16	18 38	S 9	18 56	11	P. Phalgunī	12 32					
7	Wed	28	66 10 14	16	38	10	16 26	12	U. Phalgunī	10 53					
8	Thu	29	67 7 48	16	38	11	13 43	13	Hasta	9 1					
9	Fri	30	68 5 19	16	39	12	10 51	14	Citrā	6 58					
10	Sat	31	69 2 50	16	39	13	7 56	16	Svātī	28 52					
						(14	29 4)		Viśākhā	26 48					
11	SUN	June 1	70 0 19	5 15	18 40	S 15	26 25	17	Anurādhā	24 55					
12	Mon	2	70 57 48	15	40	K 1	24 6	18	Jyeṣṭhā	23 23					
13	Tue	3	71 55 15	15	41	2	22 17	19	Mūla	22 19					
14	Wed	4	72 52 41	15	41	3	21 3	20	P. Āṣādhā	21 51					
15	Thu	5	73 50 7	15	41	4	20 31	21	U. Āṣādhā	22 5					
16	Fri	6	74 47 32	5 15	18 42	K 5	20 46	22	Śravaṇa	23 4					
17	Sat	7	75 44 56	15	42	6	21 46	23	Dhaniṣṭhā	24 47					
18	SUN	8	76 42 19	15	43	7	23 25	24	Śatabhiṣaj	27 8					
19	Mon	9	77 39 42	15	43	8	25 37	25	P. Bhādrapadā	—					
20	Tue	10	78 37 5	15	43	9	28 7	25	"	5 58					
21	Wed	11	79 34 26	5 15	18 44	K 10	—	26	U. Bhādrapadā	9 3					
22	Thu	12	80 31 48	15	44	10	6 38	27	Revati	12 7					
23	Fri	13	81 29 9	15	44	11	9 0	1	Āśvini	14 59					
24	Sat	14	82 26 29	15	45	12	10 57	2	Bharanī	17 25					
25	SUN	15	83 23 49	15	45	13	12 21	3	Kṛttikā	19 19					
26	Mon	16	84 21 8	5 15	18 45	K 14	13 12	4	Rohiṇi	20 40					
27	Tue	17	85 18 27	16	46	K 30	13 29	5	Mṛgaśiras	21 27					
28	Wed	18	86 15 45	16	46	S 1	13 13	6	Ārdrā	21 44					
29	Thu	19	87 13 3	16	46	2	12 28	7	Punarvasu	21 34					
30	Fri	20	88 10 20	16	46	3	11 19	8	Puṣya	21 3					
31	Sat	June 21	89 7 36	5 16	18 47	S 4	9 53	9	Āśleṣā	20 15					
											SAURA Ā Ś Ā D H A	24-Mithunādi (25 ^h 49 ^m)			
											C Ā N D R A Ā Ś Ā D H A	31-Enters Ārdrā (26 ^h 6 ^m) 27-Vyatīpāta (28 ^h 29 ^m) 31-Trop. Cancer (27 ^h 28 ^m)	27-New Moon (13 ^h 29 ^m) 29-Rathayātrā.		

N.B.—All timings are given in I. S. T' or the local time of the meridian of 82½° E. Long

REFORMED CALENDAR OF INDIA

FOR ŚAKA ERA 1880 (1958-59 A.D.)

Month of **Ā Ś Ā D H A** (31 Days)

Karkāṭa : Nabhas

Ayanāmsā on 1st = 23° 16' 45"

Rains 1st Month

C.R.—19

Date	Week Day	English Date	Long. of the Sun at 5-30 A.M.	Sun Rise	Sun Set	Tithi		Nakṣatra			Solar Month	Lunar Month	Transit of the Sun	Phenomena	Festivals
						No.	Ending Moment	No.	Name	Ending Moment					
1958 A.D.			° ' "	h m	h m		h m		h m						
1	SUN	June 22	90 4 52	5 16	18 47	S 5	8 11	10	Maghā	19 14	SAURA Ā Ś Ā D H A C Ā N D R A Ā Ś Ā D H A	14-Enters Punarvasu (25 ^h 45 ^m)	9-Vaidhṛti (6 ^h 38 ^m) 10-Full Moon (11 ^h 34 ^m)	25-Karkādi (12 ^h 39 ^m) 25-New Moon (24 ^h 3 ^m)	28-Enters Puṣya (25 ^h 14 ^m)
2	Mon	23	91 2 7	5 17	18 47	6	6 18	11	P. Phalgunī	18 4					
3	Tue	24	91 59 22	5 17	18 47	(7	28 18)	12	U. Phalgunī	16 46					
4	Wed	25	92 56 36	5 17	18 48	8	26 9	13	Hasta	15 22					
5	Thu	26	93 53 49	5 17	18 48	9	23 56	14	Citrā	13 55					
6	Fri	27	94 51 1	5 18	18 48	10	21 40	15	Svāti	12 25					
7	Sat	28	95 48 13	5 18	18 48	11	19 22	16	Viśākhā	10 56					
8	SUN	29	96 45 25	5 18	18 48	12	17 8	17	Anurādhā	9 35					
9	Mon	30	97 42 36	5 19	18 48	13	15 1	18	Jyesthā	8 25					
10	Tue	July 1	98 39 47	5 19	18 48	14	13 8	19	Mūla	7 34					
11	Wed	2	99 36 58	5 19	18 48	15	11 34	20	P. Āṣādhā	7 8					
12	Thu	3	100 34 9	5 20	18 48	K 1	10 28	21	U. Āṣādhā	7 14					
13	Fri	4	101 31 20	5 20	18 48	2	9 55	22	Śravāṇa	7 56					
14	Sat	5	102 28 31	5 20	18 48	3	9 59	23	Dhanīṣṭhā	9 21					
15	SUN	6	103 25 42	5 21	18 48	4	10 46	24	Śatabhiṣaj	11 22					
16	Mon	7	104 22 54	5 21	18 48	5	12 11	25	P. Bhādrapadā	13 57					
17	Tue	8	105 20 6	5 22	18 48	K 6	14 11	26	U. Bhādrapadā	16 55					
18	Wed	9	106 17 18	5 22	18 48	7	16 34	27	Revati	20 2					
19	Thu	10	107 14 31	5 22	18 48	8	19 7	1	Aśvinī	22 58					
20	Fri	11	108 11 44	5 23	18 48	9	21 30	2	Bharanī	25 35					
21	Sat	12	109 8 57	5 23	18 48	10	23 32	3	Kṛttikā	27 38					
22	SUN	13	110 6 11	5 24	18 48	11	25 1	4	Rohiṇī	29 0					
23	Mon	14	111 3 25	5 24	18 47	12	25 48	5	Mṛgaśīras	- -					
24	Tue	15	112 0 40	5 24	18 47	13	25 51	6	"	5 39					
25	Wed	16	112 57 56	5 25	18 47	14	25 14	7	Ārdrā	5 40					
26	Thu	17	113 55 11	5 25	18 47	15	24 3	8	Punarvasu	29 9					
27	Fri	18	114 52 27	5 26	18 46	S 1	22 24	9	Puṣya	28 9					
28	Sat	19	115 49 44	5 26	18 46	2	20 23	10	Āśleṣā	26 51					
29	SUN	20	116 47 1	5 26	18 46	3	18 8	11	Maghā	25 21					
30	Mon	21	117 44 17	5 27	18 46	4	15 47	12	P. Phalgunī	23 47					
31	Tue	July 22	118 41 35	5 27	18 45	5	13 25	13	U. Phalgunī	22 13					
						S 6	11 6	13	Hasta	20 44					

N.B.—All timings are given in I. S. T. or the local time of the meridian of 82½° E. Long.

REFORMED CALENDAR OF INDIA

FOR ŚAKA ERA 1880 (1958-59 A.D.)

Month of Ś R Ā V A Ṇ A (31 Days)

Sihha : Nabhasya

Ayanānīśa on 1st = 23° 16' 50"

Rains 2nd Month

Date	Week Day	English Date	Long. of the Sun at 5-30 A.M.	Sun Rise	Sun Set	Tithi		Nakṣatra			Solar Month	Lunar Month	Transit of the Sun	Phenomena	Festivals
						No	Ending Moment	No.	Name	Ending Moment					
			° ' "	h m	h m		h m			h m					
1	Wed	July 23	119 38 52	5 28	18 45	S 7	8 53	14	Citrā	19 22	SAUBA Ś R Ā V A Ṇ A C Ā N D R A Ś R Ā V A Ṇ A A D H I K A	1958 A.D.	1-Trop. Leo (14 ^h 21 ^m)	3-Vaidhṛti (19 ^h 17 ^m)	4-Padminī (Puruṣottamī) ekādśī.
2	Thu	24	120 36 10	28	45	8	6 47	15	Svātī	18 8					
3	Fri	25	121 33 28	29	44	(9)	28 52	16	Viśākhā	17 4					
4	Sat	26	122 30 46	29	44	10	27 6	17	Anurādhā	16 11					
5	SUN	27	123 28 5	30	43	11	25 33	18	Jyeṣṭhā	15 32					
6	Mon	28	124 25 25	5 30	18 43	S 13	23 11	19	Mūla	15 7					
7	Tue	29	125 22 45	30	42	14	22 31	20	P. Āṣāḍhā	15 4					
8	Wed	30	126 20 5	31	42	S 15	22 17	21	U. Āṣāḍhā	15 25					
9	Thu	31	127 17 26	31	41	K 1	22 33	22	Śravaṇa	16 14					
10	Fri	Aug. 1	128 14 49	32	41	2	23 23	23	Dhanīṣṭhā	17 35					
11	Sat	2	129 12 12	5 32	18 40	K 3	24 48	24	Śatabhiṣaj	19 30					
12	SUN	3	130 9 36	33	40	4	26 44	25	P. Bhādrapadā	21 57					
13	Mon	4	131 7 1	33	39	5	29 5	26	U. Bhādrapadā	24 48					
14	Tue	5	132 4 27	33	39	6	- -	27	Revatī	27 54					
15	Wed	6	133 1 55	34	38	6	7 38	1	Āśvini	- -					
16	Thu	7	133 59 24	5 34	18 37	K 7	10 9	1	Āśvini	6 59					
17	Fri	8	134 56 54	35	37	8	12 23	2	Bharāṇi	9 50					
18	Sat	9	135 54 25	35	36	9	14 5	3	Kṛttikā	12 12					
19	SUN	10	136 51 58	35	35	10	16 6	4	Rohiṇī	13 53					
20	Mon	11	137 49 32	36	35	11	18 19	5	Mṛgāśiras	14 49					
21	Tue	12	138 47 7	5 36	18 34	K 12	14 44	6	Ārdrā	14 58					
22	Wed	13	139 44 44	37	33	13	13 25	7	Punarvasu	14 23					
23	Thu	14	140 42 22	37	32	14	11 29	8	Puṣya	13 11					
24	Fri	15	141 40 2	37	32	K 30	9 3	9	Āśleṣā	11 29					
25	Sat	16	142 37 42	38	31	S 1	16 17	10	Maghā	9 30					
26	SUN	17	143 35 24	5 38	18 30	S 3	24 22	11	P. Phalgunī	7 21					
27	Mon	18	144 33 7	39	29	(12)	21 27	13	U. Phalgunī	29 10					
28	Tue	19	145 30 51	39	29	4	21 27	13	Hasta	27 6					
29	Wed	20	146 28 37	39	28	5	18 44	14	Citrā	25 14					
30	Thu	21	147 26 23	40	27	6	16 16	15	Svātī	23 40					
31	Fri	Aug. 22	148 24 11	5 40	18 26	S 8	14 9	16	Viśākhā	22 27					
							12 24	17	Anurādhā	21 36					

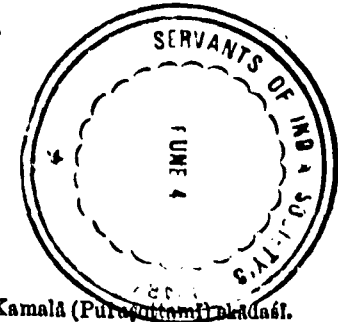

N.B.—All timings are given in I. S. T. or the local time of the meridian of 82½° E. Long.

REFORMED CALENDAR OF INDIA

FOR ŚAKA ERA 1880 (1958-59 A.D.)

Month of B H Ā D R A (BHĀDRAPADA) (31 Days)

Kanyā : Iṣa

Ayanāntiśa on 1st = 23° 16' 54"

Autumn 1st Month

Date	Week Day	English Date	Long. of the Sun at 5-30 A.M.	Sun Rise	Sun Set	Tithi		Nakṣatra			Solar Month	Lunar Month	Transit of the Sun	Phonomena	Festivals
						No.	Ending Moment	No.	Name	Ending Moment					
			° ' "	h m	h m	h m	h m								
1	Sat	1958 A.D. Aug. 23	149 21 59	5 40	18 25	S 9	11 2	18	Jyesthā	21 8	N I J A	1-Trop. Virgo (21 ^h 17 ^m)		2-Jhulana yātrārambha (Bengal & Orissa), Aṅgī mūlam (S. India). 3-Putradā ekādāśī, Jhulana yātrārambha. 4-Buddha dvādaśī, Viṣṇu pavitrāropanam, Dāmodara dvādaśī, 1st Onam Day. 5-Ākheṭaka trayodaśī (Orissa), Śiva pavitrāropanam (Orissa), Upākarma (Rk) (S. India), Thiru Onam Day.	
2	SUN	24	150 19 49	41	24	10	10 4	19	Mūla	21 2					
3	Mon	25	151 17 40	41	23	11	9 27	20	P. Āṣāḍhā	21 21					
4	Tue	26	152 15 32	41	23	12	9 17	21	U. Āṣāḍhā	22 5					
5	Wed	27	153 13 26	42	22	13	9 33	22	Śravaṇa	23 14					
6	Thu	28	154 11 21	5 42	18 21	S 14	10 15	23	Dhanīṣṭhā	24 49	S A U R A B H Ā D R A P A D A	8-Enters P. Phalgunī (17 ^h 46 ^m)	7-Full Moon (11 ^h 23 ^m)	6-Āvāpi aviṭṭam (S. India), Iṣi tarpaṇa, Jhulanayātrā samāpana, Third Onam Day.	
7	Fri	29	155 9 17	42	20	S 15	11 23	24	Śatabhiṣaj	26 50					
8	Sat	30	156 7 15	43	19	K 1	12 59	25	P. Bhādrapadā	29 18					
9	SUN	31	157 5 15	43	18	2	15 2	26	U. Bhādrapadā	— —					
10	Mon	Sept. 1	158 3 16	43	17	3	17 25	26	"	8 8					
11	Tue	2	159 1 19	5 44	18 16	K 4	20 0	27	Revati	11 12	S A U R A B H Ā D R A P A D A	11-Vyatipāta (6 ^h 26 ^m)	7-Rākhi pūrṇimā, Rakṣābandhana, Yaju Upākarma, Hayagrivotpatti, Jhulana yātrī samāpana, Balabhadra pūjā (Orissa), Nārolī pūrṇimā, Coconut Day, Varalakṣmī vrata (S. India), Solono (PEPSU), 4th Onam Day, Śrī Nārāyaṇa Guru deva's Birthday.		
12	Wed	3	159 59 24	44	15	5	22 38	1	Āśvini	14 21					
13	Thu	4	160 57 31	44	14	6	25 5	2	Bharanī	17 25					
14	Fri	5	161 55 40	45	13	7	27 6	3	Kṛttikā	20 8					
15	Sat	6	162 53 51	45	12	8	28 30	4	Rohiṇī	22 18					
16	SUN	7	163 52 4	5 45	18 11	K 9	29 10	5	Mṛgaśiras	23 47	S A U R A B H Ā D R A P A D A	22-Enters U. Phalgunī (11 ^h 37 ^m)	22-New Moon (17 ^h 32 ^m)	8-Āśūnya śayana vrata. 10-Kajjali tṛtīyā, Aṅgabheṭa tṛtīyā (Orissa), Bahulā caturthī (Madhyadeśa). 12-Rakṣā pañcamī (Orissa), Keil Muhurth (Coorg), Tithi of Śrī Mādha Deva (Assam). 13-Hala ṣaṣṭhī. 14-Śitalā saptamī. 15-Janmāṣṭamī, Gokulāṣṭamī, Śrī Jayantī (S. India). 18-Ajā ekādāśī, Kālidāsa ekādāśī (Orissa). 19-Ajā ekādāśī (Vaiṣṇava), Paryuṣaṇa parvārambha (Jain—pañcamī pakṣa). 21-Aghora caturdaśī (Bengal & Orissa). 22-Āloka amāvasyā (Bengal), Kuśōtpāṇī (Pithorī) amāvasyā, Suptapurī amāvasyā (Orissa). 23-Rudravrata. 24-Tithi of Śrī Śankara Deva (Assam). 25-Haritalikā tṛtīyā, Gaurī tṛtīyā, Varadā caturthī, Gaṇeśa caturthī, Saubhāgya caturthī (Bengal), Samvatsarī (Jain-caturthī pakṣa), Viśvakarmā pūjā (Bengal). 26-Iṣi pañcamī, Rakṣā pañcamī (Bengal), Samvatsarī (Bombay, Surat & Ahmedabad), Paryuṣaṇa parva samāpana (Jain-pañcamī pakṣa). 27-Sūrya ṣaṣṭhī, Manthāna ṣaṣṭhī, Lolūkā ṣaṣṭhī, Carpatā ṣaṣṭhī (Bengal), Somanātha vratārambha (Orissa). 28-Muktābharāṇa vrata, Lalitā saptamī (Bengal). 29-Rādhaṣṭamī & Dūrvāṣṭamī (Bengal), Mahālakṣmī vrata, Durgā śayantī (Orissa). 30-Aduhkha navamī, Nandā navamī, Tāla navamī (Bengal), Samādhī day of Nārāyaṇa Guru.	
17	Mon	8	164 50 18	46	10	10	29 0	6	Ārdrā	24 27					
18	Tue	9	165 48 35	46	9	11	27 58	7	Punarvasu	24 17					
19	Wed	10	166 46 54	46	8	12	26 10	8	Puṣya	23 20					
20	Thu	11	167 45 15	47	7	13	23 45	9	Āśleṣā	21 44					
21	Fri	12	168 43 38	5 47	18 6	K 14	20 48	10	Maghā	19 37	S A U R A B H Ā D R A P A D A	25-Kanyādi (20 ^h 53 ^m)			
22	Sat	13	169 42 3	47	5	K 30	17 32	11	P. Phalgunī	17 8					
23	SUN	14	170 40 30	47	4	S 1	14 4	12	U. Phalgunī	14 29					
24	Mon	15	171 38 58	48	3	2	10 35	13	Hasta	11 48					
25	Tue	16	172 37 29	48	2	3	7 13	14	Citrū	9 14					
26	Wed	17	173 36 1	5 48	18 1	S 5	25 23	15	Svāti	6 57	S A U R A Ā Ś V I N Ā	C Ā N D R A B H Ā D R A P A D A			
27	Thu	18	174 34 35	49	0	6	23 8	16	Viśākhā	29 5					
28	Fri	19	175 33 10	49	17 59	7	21 25	17	Anurādhā	27 40					
29	Sat	20	176 31 47	49	58	8	20 18	18	Jyesthā	26 50					
30	SUN	21	177 30 26	50	57	9	19 46	19	Mūla	26 33					
31	Mon	Sept. 22	178 29 6	5 50	17 56	S 10	19 47	21	P. Āṣāḍhā U. Āṣāḍhā	26 51 27 42					

N.B.—All timings are given in I. S. T. or the local time of the meridian of 82½° E. Long.

REFORMED CALENDAR OF INDIA

FOR ŚAKA ERA 1880 (1958-59 A.D.)

Month of **Ā Ś V I N A** (30 Days)

Tulā : Ūrja

Ayanāmsā on 1st = 23° 16' 56"

Autumn 2nd Month

Date	Week Day	English Date	Long. of the Sun at 5-30 A.M.	Sun Rise	Sun Set	Tithi		Nakṣatra			Solar Month	Lunar Month	Transit of the Sun	Phenomena	Festivals
						No.	Ending Moment	No.	Name	Ending Moment					
1958 A.D.			° ' "	h m	h m		h m			h m					
1.	Tue	Sept. 23	179 27 48	5 50	17 55	S 11	20 24	22	Śravaṇa	29 7	SAURA Ā Ś V I N A CĀNDRA BHĀDRAPĀDA	CĀNDRA BHĀDRAPĀDA	1-Trop Libra (18 ^h 39 ^m)	5-Vyatipāta (11 ^h 20 ^m) 5-Full Moon (27 ^h 13 ^m)	1-Parivartani (Padma) ekādaśī, Śravaṇa dvādaśī, Dol Gyaras (Madhya Bharat), Heikra Hitomba (Manipur), Viṣṇu śrūkhalayoga. 2-Viṣṇu parivartanotsava, Śakrotthāna, Kalki dvādaśī, Vāmana jayantī. 4-Ananta caturdaśī. 5-Indra govinda pūjā (Orissa).
2.	Wed	24	180 26 32	50	54	12	21 30	23	Dhanīṣṭhā	— —					
3.	Thu	25	181 25 17	51	53	13	23 2	23	"	6 58					
4.	Fri	26	182 24 4	51	52	14	24 57	24	Śatabhiṣaj	9 12					
5.	Sat	27	183 22 54	52	51	S 15	27 13	25	P. Bhādrapadā	11 49					
6.	SUN	28	184 21 45	5 52	17 50	K 1	29 43	26	U. Bhādrapadā	14 42					
7.	Mon	29	185 20 38	52	49	2	— —	27	Revatī	17 47					
8.	Tue	30	186 19 34	53	48	2	8 23	1	Āśvinī	20 57					
9.	Wed	Oct. 1	187 18 31	53	47	3	11 2	2	Bharaṇī	24 2					
10.	Thu	2	188 17 31	53	46	4	13 31	3	Kṛttikā	26 56					
11.	Fri	3	189 16 33	5 53	17 45	K 5	15 44	4	Rohiṇī	29 26					
12.	Sat	4	190 15 37	54	44	6	17 27	5	Mrgaśiras	— —					
13.	SUN	5	191 14 43	54	43	7	18 32	5	"	7 23					
14.	Mon	6	192 13 52	55	42	8	18 55	6	Ārdrā	8 41					
15.	Tue	7	193 13 3	55	41	9	18 30	7	Punarvasu	9 15					
16.	Wed	8	194 12 16	5 55	17 40	K 10	17 16	8	Puṣya	9 0					
17.	Thu	9	195 11 32	56	39	11	15 17	9	Āśleṣā	8 0					
18.	Fri	10	196 10 50	56	38	12	12 41	10	Maghā	6 19					
19.	Sat	11	197 10 10	57	37	13	9 34	12	P. Phalgunī	28 6					
20.	SUN	12	198 9 32	57	36	14	6 5	13	U. Phalgunī	25 28					
						(K 30)	26 22)		Hasta	22 35					
21.	Mon	13	199 8 57	5 57	17 36	S 1	22 38	14	Citrā	19 37					
22.	Tue	14	200 8 23	58	35	2	19 1	15	Svātī	16 45					
23.	Wed	15	201 7 52	58	34	3	15 41	16	Viśākhā	14 10					
24.	Thu	16	202 7 22	59	33	4	12 46	17	Anurādhā	11 59					
25.	Fri	17	203 6 55	59	32	5	10 26	18	Jyēṣṭhā	10 22					
26.	Sat	18	204 6 29	5 59	17 31	S 6	8 45	19	Mūla	9 25					
27.	SUN	19	205 6 4	6 0	30	7	7 48	20	P. Āṣādhā	9 10					
28.	Mon	20	206 5 42	0	30	8	7 36	21	U. Āṣādhā	9 39					
29.	Tue	21	207 5 21	1	29	9	8 10	22	Śravaṇa	10 53					
30.	Wed	Oct. 22	208 5 2	6 1	17 28	S 10	9 23	23	Dhanīṣṭhā	12 43					

N.B.—All timings are given in I. S. T. or the local time of the meridian of 82½° E. Long.

REFORMED CALENDAR OF INDIA

FOR ŚAKA ERA 1880 (1958-59 A.D.)

Vṛścika : Sahas

Ayanāmsa on 1st = 23° 16' 59"

Month of K Ā R T I K A (30 Days)

Hemanta 1st Month

C. R. - 20

Date	Week Day	English Date	Long. of the Sun at 5-30 A.M.	Sun Rise	Sun Set	Tithi		Nakṣatra			Solar Month	Lunar Month	Transit of the Sun	Phenomena	Festivals
						No.	Ending Moment	No.	Name	Ending Moment					
1958 A.D.			° ' "	h m	h m	h m	h m	h m	h m						
1	Thu	Oct. 23	209 4 44	6 2	17 27	S 11	11 9	24	Śatabhiṣaj	15 5			1-Enters Svāti (26 ^h 29 ^m)		1-Pāpāṅkuśā (Pāsāṅkuśā) ekādaśī, Lakṣmīnārāyaṇa ekādaśī (Orissa), Bharat Milap.
2	Fri	24	210 4 28	2	26	12	13 23	25	P. Bhādrapadā	17 51					2-Padmanāva dvādaśī.
3	Sat	25	211 4 14	3	26	13	15 52	26	U. Bhādrapadā	20 50					
4	SUN	26	212 4 3	3	25	14	18 30	27	Revati	23 56			1-Trop. Scorpio (27 ^h 42 ^m)	5-Full Moon (21 ^h 11 ^m)	5-Kojāgarī Lakṣmī pūjā, Kumāra pūrpimā (Orissa), Oli ends (Jain), Mahārṣi Vālmiki's Birthday (Punjab), Annābhṣekam (S. India).
5	Mon	27	213 3 52	4	24	S 15	21 11	1	Āśvini	27 4					
6	Tue	28	214 3 44	6 4	17 24	K 1	23 45	2	Bharani	30 4					7-Āśūnya śayana vrata.
7	Wed	29	215 3 38	5	23	2	26 10	3	Kṛttikā	- -					
8	Thu	30	216 3 34	5	22	3	23 16	3	"	8 54					
9	Fri	31	217 3 32	6	22	4	30 1	4	Rohiṇi	11 24					9-Karaka caturthī, Daśaratha caturthī (Bengal).
10	Sat	Nov. 1	218 3 32	6	21	5	- -	5	Mṛgaśiras	13 33					
11	SUN	2	219 3 33	6 7	17 20	K 5	7 15	6	Ārdrā	15 11					
12	Mon	3	220 3 37	8	20	6	7 58	7	Punarvasu	16 17					
13	Tue	4	221 3 44	8	19	7	8 2	8	Puṣya	16 43					13-Ahoyī aṣṭamī (Gujarat), Karāṣṭamī (Maharashtra).
14	Wed	5	222 3 52	9	19	8	7 25	9	Āśleṣā	16 31				14-Vaidhṛti (6 ^h 54 ^m)	
15	Thu	6	223 4 2	9	18	(9 30 9)	28 14	10	Maghā	15 40					
16	Fri	7	224 4 15	6 10	17 18	K 11	25 43	11	P. Phalgunī	14 11			15-Enters Viśākhā (10 ^h 40 ^m)		16-Ramā ekādaśī.
17	Sat	8	225 4 29	10	17	12	22 42	12	U. Phalgunī	12 9					17-Govatsa dvādaśī.
18	SUN	9	226 4 46	11	17	13	19 20	13	Hasta	9 40					18-Dhana trayodaśī, Yamadipadāna.
19	Mon	10	227 5 4	12	16	14	15 44	14	Citrā	6 56					19-Naraka caturdaśī, Bhūta caturdaśī (Bengal), Hanumat janmadina, Śastrāhata caturdaśī, Mahālakṣmī pūjā, Kālī pūjā, Dīpavali.
20	Tue	11	228 5 25	12	16	K 30	12 4	16	(15 Svāti) Viśākhā	28 1) 25 10				20-New Moon (12 ^h 4 ^m)	20-Mahāvīra nirvāṇa (Jain), Govardhana pūjā, Bali pūjā, Kethār Gaurī vrata (S. India), Annakūṭa.
21	Wed	12	229 5 47	6 13	17 15	S 1	8 31	17	Anurādhā	22 31					21-Bhrātṛ dvitīyā, Yama dvitīyā, Dyūta pratipad (Bengal), Dwāt pūjā (Bihar).
22	Thu	13	230 6 10	14	15	(2 29 13)	26 22	18	Jyēṣṭhā	20 15					22-Ālocanā Gaurī vrata.
23	Fri	14	231 6 36	14	15	3	26 22	18	Mūla	18 32					23-Nāga caturthī.
24	Sat	15	232 7 2	15	14	4	24 7	19	P. Āṣādhā	17 32					24-Jñāna pañcamī (Jain).
25	SUN	16	233 7 30	16	14	5	22 37	20	U. Āṣādhā	17 19					25-Nādi ṣaṣṭhī (Bengal), Sūrya ṣaṣṭhī, Chhat (Bihar), Skanda ṣaṣṭhī (Madras), Kārtika pūjā (Bengal).
26	Mon	17	234 8 0	6 16	17 14	S 7	22 4	22	Śravaṇa	17 54			25-Vṛścikādi (8 ^h 28 ^m)	25-Vyatīpātā (22 ^h 33 ^m)	26-Death Anniversary of Lala Lajpat Rai.
27	Tue	18	235 8 30	17	13	8	23 4	23	Dhanīṣṭhā	19 19				25-Jupiter rises in the East.	27-Goṣṭhāṣṭamī, Gopāṣṭamī.
28	Wed	19	236 9 2	18	13	9	24 47	24	Śatabhiṣaj	21 27					28-Akṣaya navamī, Jagaddhātṛī pūjā (Bengal), Viṣṇu trīrātra, Durgā navamī & Gaurī vrata (Bengal), Anlā navamī (Orissa).
29	Thu	20	237 9 35	18	13	10	27 2	25	P. Bhādrapadā	24 7					29-Sudāsā vrata (Orissa).
30	Fri	Nov. 21	238 10 10	6 19	17 13	S 11	29 41	26	U. Bhādrapadā	27 10					30-Prabodhanī ekādaśī, Bhīṣma pañcaka, Tulasī vivāha.

N. B.—All timings are given in I. S. T. or the local time of the meridian of 82½° E. Long.

[96]

REFORMED CALENDAR OF INDIA

FOR ŚAKA ERA 1880 (1958-59 A.D.)

Dhanuḥ : Sahasya Ayanantīka on 1st = 23° 17' 3"

Month of AGRAHĀYANA (MARGAŚIRṢA) (30 Days) Hemanta 2nd Month

Date	Week Day	English Date	Long. of the Sun at 6-30A.M.	Sun Rise	Sun Set	Tithi		Nakṣatra		Solar Month	Lunar Month	Transit of the Sun	Phenomena	Festivals	
						No.	Ending Moment	No.	Name						Ending Moment
			° ' "	h m	h m		h m			h m					
1	Sat	1058 A.D. Nov. 22	239 10 45	6 20	17 13	S 12	- -	27	Revati	30 19	SAUBA MARGAŚIRṢA	CĀNDRA KĀRTIKA	1-Trop. Sagittarius (25 ^h 0 ^m)	5-Full Moon (15 ^h 46 ^m)	1-Viṣṇu prabodhanotsava, Nārāyaṇa dvādaśī, Vṛndāvana dvādaśī, Vaiṣṇavi mahādvādaśī. 3-Vaikunṭha caturdaśī, Baḍa oṣā (Orissa), Bharuṣī Dīpam (Madras), Pāṣāṇa caturdaśī (Bengal & Orissa). 4-Tripurotsava, Rāsayātrā, Kṛttikā dīpam (S. India), Cāturmāsya caturdaśī (Jain). 5-Kedāra vrata (Orissa), Ratha yātra (Jain), Guru Nānaka's birthday, Kārtikī pūrṇimā, Rāsayātrā, Puṣkar fair (Ajmer).
2	SUN	23	240 11 22	20	12	12	8 25	1	Aśvini	- -					
3	Mon	24	241 12 0	21	12	13	11 7	1	"	9 27					
4	Tue	25	242 12 40	22	12	14	13 35	2	Bharuṣī	12 23					
5	Wed	26	243 13 21	22	12	S 15	15 46	3	Kṛttikā	15 1					
6	Thu	27	244 14 3	6 23	17 12	K 1	17 35	4	Rohiṇī	17 20	SAUBA MARGAŚIRṢA	CĀNDRA KĀRTIKA	9-Vaidhṛti (18 ^h 55 ^m)		
7	Fri	28	245 14 46	24	12	2	18 59	5	Mṛgaśiras	19 15					
8	Sat	29	246 15 31	24	12	3	19 58	6	Ārdrā	20 46					
9	SUN	30	247 16 17	25	12	4	20 32	7	Punarvasu	21 52					
10	Mon	Dec. 1	248 17 4	26	12	5	20 40	8	Puṣya	22 33					
11	Tue	2	249 17 53	6 27	17 12	K 6	20 20	9	Āśleṣā	22 46	SAUBA MARGAŚIRṢA	CĀNDRA KĀRTIKA	11-Enters Jyēṣṭhā (20 ^h 57 ^m)	12-Kālāṣṭami, Bhairava jayantī. 13-Prathamāṣṭami (Orissa). 14-Kāñḍī Anā navamī (Orissa).	
12	Wed	3	250 18 44	27	12	7	19 30	10	Maghā	22 32					
13	Thu	4	251 19 35	28	12	8	18 11	11	P. Phalgunī	21 47					
14	Fri	5	252 20 29	29	12	9	16 22	12	U. Phalgunī	20 34					
15	Sat	6	253 21 23	29	12	10	14 5	13	Hasta	18 55					
16	SUN	7	254 22 19	6 30	17 13	K 11	11 26	14	Citrā	16 53	SAUBA MARGAŚIRṢA	CĀNDRA KĀRTIKA	17-Venus rises in the West. 19-New Moon (22 ^h 53 ^m)	16-Utpannā ekādaśī. 18-Dīpāvalī amāvasyā (Orissa). 20-Rudropavāsa.	
17	Mon	8	255 23 16	30	13	12	8 28	15	Svātī	14 34					
18	Tue	9	256 24 14	31	13	(13 29 17)	26 3	16	Viśākhā	12 5					
19	Wed	10	257 25 14	32	13	K 30	22 53	17	Anurādhā	9 36					
20	Thu	11	258 26 14	33	14	S 1	20 1	18	Jyēṣṭhā	7 15					
21	Fri	12	259 27 15	6 33	17 14	S 2	17 34	20	P. Aṣāḍhā	27 44	SAUBA MARGAŚIRṢA	CĀNDRA MARGAŚIRṢA	21-Vyatīpātā (11 ^h 24 ^m)	24-Nāga pañcamī (2nd), Sahid Day of Śrī Guru Teg Bahadur. 25-Campā ṣaṣṭhī (Maharashtra), Skanda ṣaṣṭhī, Guha ṣaṣṭhī & Mūlakaṛṇipinī ṣaṣṭhī (Bengal), Prīvarapa ṣaṣṭhī (Orissa), Subrahmanya ṣaṣṭhī (Coorg). 26-Mitra sapta mī.	
22	Sat	13	260 28 17	34	14	3	15 44	21	U. Aṣāḍhā	26 54					
23	SUN	14	261 29 20	34	15	4	14 39	22	Śravaṇa	26 51					
24	Mon	15	262 30 23	35	15	5	14 23	23	Dhanīṣṭhā	27 37					
25	Tue	16	263 31 26	35	15	6	14 58	24	Śatabhiṣaj	29 11					
26	Wed	17	264 32 30	6 36	17 16	S 7	16 23	25	P. Bhādrapadā	- -	SAUBA MARGAŚIRṢA	CĀNDRA MARGAŚIRṢA	24-Enters Mūla (23 ^h 52 ^m)	30-Moṣṣadā ekādaśī, Vaiṣṇava ekādaśī (Madras), Mauna ekādaśī (Jain), Ravinaṛāyaṇa ekādaśī (Orissa).	
27	Thu	18	265 33 35	37	16	8	18 30	25	"	7 30					
28	Fri	19	266 34 39	37	16	9	21 2	26	U. Bhādrapadā	10 19					
29	Sat	20	267 35 44	38	17	10	23 48	27	Revati	13 25					
30	SUN	Dec. 21	268 36 50	6 38	17 17	S 11	26 30	1	Aśvini	16 36					

N. B.—All timings are given in I. S. T. or the local time of the meridian of 82½° E. Long.

REFORMED CALENDAR OF INDIA

FOR ŚAKA ERA 1880 (1958-59 A.D.)

Makara : Tapas

Ayanāntika on 1st = 23° 17' 8"

Month of P A U S A (30 Days)

Winter 1st Month

Date	Week Day	English Date	Long. of the Sun at 5-30 A.M.	Sun Rise	Sun Set	Tithi		Nakṣatra			Solar Month	Lunar Month	Transit of the Sun	Phenomena	Festivals
						No.	Ending Moment	No.	Name	Ending Moment					
			° ' "	h m	h m		h m			h m					
1958 A.D.															
1	Mon	Dec. 22	269 37 55	6 39	17 18	S 12	28 55	2	Bharani	19 33	SAURA PAUSA	CANDRA MARGASIRSA	1-Trop. Capricornus (14 ^h 10 ^m)		1-Matsya dvādāśī, Akṣaya dvādāśī (Bengal), Vyājana dvādāśī & Dāna dvādāśī (Orissa), Uttariyāna Day.
2	Tue	23	270 39 1	39	18	13	—	3	Kṛttikā	22 10					
3	Wed	24	271 40 7	40	19	13	6 56	4	Rohiṇī	24 18					
4	Thu	25	272 41 14	40	19	14	8 25	5	Mṛgaśīras	25 57					
5	Fri	26	273 42 20	41	20	S 15	9 24	6	Ārdrā	27 8					
6	Sat	27	274 43 27	6 41	17 21	K 1	9 54	7	Punarvasu	27 51			7-Enters P. Āṣādhā (26 ^h 8 ^m)		4-Vaidhṛti (19 ^h 45 ^m) 5-Full Moon (9 ^h 24 ^m)
7	SUN	28	275 44 35	41	21	2	9 56	8	Puṣya	28 11					
8	Mon	29	276 45 42	42	22	3	9 34	9	Āśleṣā	28 12					
9	Tue	30	277 46 50	42	22	4	8 55	10	Maghā	27 55					
10	Wed	31	278 47 59	43	23	5	7 57	11	P. Phalgunī	27 21					
1959 A.D.															
11	Thu	Jan. 1	279 49 8	6 43	17 24	K 7	29 12	12	U. Phalgunī	26 32	SAURA PAUSA	CANDRA MARGASIRSA	20-Enters U. Āṣādhā (28 ^h 4 ^m)		11-English New Year's Day. 12-Pūṇyākā. 14-Pauṣa daśami (Jain). 15-Saphalā ekādāśī. 16-Vyatipāta (26 ^h 2 ^m) 19-New Moon (11 ^h 5 ^m) 23-Bhogi (Madras). 24-Tila snikrānti, Pongal (Madras), Māgha Bihu (Assam), Makarādi snāna. 25-Annarūpā sūyāhi (Bengal), Mattu pongal (Madras). 28-Guru Govinda Singh's Birthday. 29-Vaidhṛti (25 ^h 42 ^m) 30-Śamba daśami (Orissa). 30-Putrādi ekādāśī.
12	Fri	2	280 50 18	43	24	8	27 26	13	Īasta	25 28					
13	Sat	3	281 51 27	44	25	9	25 24	14	Citrā	24 8					
14	SUN	4	282 52 37	44	26	10	23 8	15	Svātī	22 34					
15	Mon	5	283 53 47	44	26	11	20 41	16	Viśākhā	20 48					
16	Tue	6	284 54 58	6 44	17 27	K 12	18 8	17	Anurādhā	18 57					
17	Wed	7	285 56 8	44	28	13	15 35	18	Jyēṣṭhā	17 7					
18	Thu	8	286 57 18	45	28	14	13 11	19	Mūla	15 26					
19	Fri	9	287 59 28	45	29	K 30	11 5	20	P. Āṣādhā	14 3					
20	Sat	10	288 59 39	45	30	S 1	9 22	21	U. Āṣādhā	13 5					
21	SUN	11	290 0 49	6 45	17 30	S 2	8 16	22	Śravāṇa	12 44					
22	Mon	12	291 1 58	45	31	3	7 52	23	Dhanīṣṭhā	13 4					
23	Tue	13	292 3 7	45	32	4	8 13	24	Śatabhiṣaj	14 9					
24	Wed	14	293 4 15	45	33	5	9 22	25	P. Bhādrapādā	16 0					
25	Thu	15	294 5 23	45	33	6	11 14	26	U. Bhādrapādā	18 29					
26	Fri	16	295 6 30	6 45	17 34	S 7	13 37	27	Revatī	21 23					
27	Sat	17	296 7 36	45	35	8	16 18	1	Āśvinī	24 31					
28	SUN	18	297 8 42	45	35	9	19 0	2	Bharani	27 33					
29	Mon	19	298 9 47	45	36	10	21 25	3	Kṛttikā	30 18					
30	Tue	Jan. 20	299 10 51	6 45	17 37	S 11	23 25	4	Rohiṇī	—					

N.B.—All timings are given in I. S. T. or the local time of the meridian of 82½° E. Long.

REFORMED CALENDAR OF INDIA

FOR ŚAKA ERA 1880 (1958-59 A.D.)

Month of M Ā G H A (30 Days)

Kumbha : Tapasya Ayanāmsā on 1st = 23° 17' 12"

Winter 2nd Month

Date	Week Day	English Date	Long. of the Sun at 5-30 A.M.	Sun Rise	Sun Set	Tithi		Nakṣatra			Solar Month	Lunar Month	Transit of the Sun	Phenomena	Festivals
						No.	Ending Moment	No.	Name	Ending Moment					
1959 A.D.			° ' "	h m	h m		h m			h m					
1	Wed	Jan. 21	300 11 54	6 45	17 37	S 12	24 47	4	Rohiṇī	8 34	SAURA MĀGHA	CĀNDRA PAUṢA	3-Enters Śravaṇa (30 ^h 24 ^m)	4-Full Moon (25 ^h 3 ^m)	1-Kūrma dvādaśī.
2	Thu	22	301 12 56	45	38	13	25 29	5	Mṛgaśīras	10 12					3-Netaji's Birthday.
3	Fri	23	302 13 57	45	39	14	25 33	6	Ārdṛā	11 12					4-Puṣyābhīṣeka yātrā.
4	Sat	24	303 14 57	44	40	S 15	25 3	7	Punarvasu	11 37					
5	SUN	25	304 15 58	44	40	K 1	24 5	8	Puṣya	11 32					
6	Mon	26	305 15 57	6 44	17 41	K 2	22 45	9	Āśleṣā	11 2	SAURA MĀGHA	CĀNDRA PAUṢA	6-Republic day.		
7	Tue	27	306 17 55	44	42	3	21 9	10	Maghā	10 12					
8	Wed	28	307 18 52	43	42	4	19 22	11	P. Phalgunī	9 10					
9	Thu	29	308 19 49	43	43	5	17 30	12	U. Phalgunī	8 1					
10	Fri	30	309 20 45	43	44	6	15 34	13	Hasta (14 Citrā)	6 47 29 30)					
11	Sat	31	310 21 40	6 42	17 45	K 7	13 35	15	Svātī	28 12	SAURA MĀGHA	CĀNDRA PAUṢA	12-Vyatīpāta (12 ^h 46 ^m)	11-Māmasāṣṭakā.	
12	SUN	Feb. 1	311 22 35	42	45	8	11 36	16	Viśākḥā	26 55				14-Ṣaṭtilā ekādaśī (Gandhāri).	
13	Mon	2	312 23 29	42	46	9	9 39	17	Anurādhā	25 38				15-Ṣaṭtilā ekādaśī (Vaiṣṇava & in Beng. for all).	
14	Tue	3	313 24 22	41	47	10	7 41	18	Jyēṣṭhā	24 27					
15	Wed	4	314 25 14	41	47	(11 29 51) 12	28 10	19	Mūla	23 24					
16	Thu	5	315 26 5	6 40	17 48	K 13	26 42	20	P. Āṣādhā	22 32	SAURA MĀGHA	CĀNDRA PAUṢA	17-Enters Dhaniṣṭhā (9 ^h 34 ^m)	18-New Moon (24 ^h 52 ^m)	16-Meru trayodaśī (Jain).
17	Fri	6	316 26 56	40	49	14	25 33	21	U. Āṣādhā	21 59					17-Yama tarpaṇa (Aruṇodaya), Raṭanti Kālikā pūjā (Bengal).
18	Sat	7	317 27 45	39	49	K 30	24 52	22	Śravaṇa	21 51					18-Maunī amāvasyā (Uttar Pradesh), Thai amāvasyā (S. India), Triveṇī amāvasyā (Orissa), Makara vāvu (T. C. State).
19	SUN	8	318 28 33	39	50	S 1	24 42	23	Dhaniṣṭhā	22 14					
20	Mon	9	319 29 20	38	50	2	25 11	24	Śatabhīṣaj	23 14					
21	Tue	10	320 30 5	6 38	17 51	S 3	26 19	25	P. Bhādrapadā	24 50	SAURA PHĀLGUNA	CĀNDRA MĀGHA	23-Kumbhādi (22 ^h 41 ^m)	24-Vaidhṛti (30 ^h 17 ^m)	22-Tilā caturthī, Kunda caturthī, Gaṇeśa jayanti. Varadā caturthī, Gaṇeśa pūjā (Bengal).
22	Wed	11	321 30 50	37	52	4	28 2	26	U. Bhādrapadā	27 2					23-Śrī pañcamī, Madana pañcamī, Vasanta pañcamī, Guru pañcamī (Orissa).
23	Thu	12	322 31 32	36	52	5	30 17	27	Revatī	29 43					24-Śitalā ṣaṣṭhī (Bengal).
24	Fri	13	323 32 13	36	53	6	—	1	Aśvinī	—					25-Acalā saptamī, Vidhāna saptamī, Ārogya saptamī (Bengal), Candrabhāgā saptamī (Orissa).
25	Sat	14	324 32 52	35	53	6	8 52	1	"	8 44					26-Ratha saptamī (Aruṇodaya).
26	SUN	15	325 33 30	6 35	17 54	S 7	11 33	2	Bharaṇī	11 50	SAURA PHĀLGUNA	CĀNDRA MĀGHA	30-Trop. Pisces (15 ^h 8 ^m)	27-Bhīṣmaṣṭamī.	27-Bhīṣmaṣṭamī.
27	Mon	16	326 34 6	34	54	8	14 2	3	Kṛttikā	14 46					28-Mahānandā navamī.
28	Tue	17	327 34 40	33	55	9	16 7	4	Rohiṇī	17 17					30-Jayā ekādaśī, Bhaimī ekādaśī, Lakṣminārṇyaṇa ekādaśī (Orissa).
29	Wed	18	328 35 13	33	56	10	17 36	5	Mṛgaśīras	19 15					
30	Thu	Feb. 19	329 35 43	6 32	17 56	S 11	18 21	6	Ārdṛā	20 30					

N.B.—All timings are given in I. S. T. or the local time of the meridian of 82½° E. Long.

REFORMED CALENDAR OF INDIA

FOR ŚAKA ERA 1880 (1958-59 A.D.)

Month of PHĀLGUNA (30 Days)

Mina : Madhu

Ayanaiṣa on 1st = 23° 17' 16"

Spring 1st Month

C. R. - 21

Date	Week Day	English Date	Long. of the Sun at 5-30 A.M.	Sun Rise	Sun Set	Tithi		Nakṣatra			Solar Month	Lunar Month	Transit of the Sun	Phenomona	Festivals
						No.	Ending Moment	No.	Name	Ending Moment					
1959 A.D.			° ' "	h m	h m		h m		h m						
1	Fri	Feb. 20	330 36 12	6 31	17 57	S 12	18 21	7	Punarvasu	21 2	SAURA PHĀLGUNA	CĀNDRA MĀGHA	4-Full Moon (14 ^h 25 ^m)	1-Variha dvādaśī, Bhīṣma dvādaśī, Āmalakī dvādaśī and Santāna dvādaśī (Orissa). 3-Agni utsava (Orissa). 4-Māghī pūrṇimā, Guru Ravi Das's Birthday (Punjab), Māśī magham (S. India).	
2	Sat	21	331 36 40	30	57	13	17 37	8	Puṣya	20 51					
3	SUN	22	332 37 5	30	58	14	16 15	9	Āśleṣā	20 5					
4	Mon	23	333 37 29	29	58	S 15	14 25	10	Maghā	18 51					
5	Tue	24	334 37 51	28	59	K 1	12 10	11	P. Phalgunī	17 16					
6	Wed	25	335 38 11	6 27	17 59	K 2	9 40	12	U. Phalgunī	15 27					
7	Thu	26	336 38 30	26	18 0	3	7 3	13	Īasta	13 32					
						(4	28 25)								
8	Fri	27	337 38 47	26	0	5	25 54	14	Citrū	11 40					
9	Sat	28	338 39 3	25	1	6	23 32	15	Svātī	9 55					
10	SUN	Mar. 1	339 39 18	24	1	7	21 23	16	Viśākhā	8 19					
11	Mon	2	340 39 31	6 23	18 2	K 8	19 30	17	Anurādhā	6 59					
12	Tue	3	341 39 42	22	2	9	17 55	18	Jyesthā	29 57)					
13	Wed	4	342 39 51	21	3	10	16 39	19	Mūla	29 11					
14	Thu	5	343 40 0	20	3	11	15 44	20	P. Āṣādhā	28 46					
15	Fri	6	344 40 6	20	4	12	15 13	21	U. Āṣādhā	28 42					
								22	Śravaṇa	29 3					
16	Sat	7	345 40 11	6 19	18 4	K 13	15 7	23	Dhanīṣṭhā	29 49					
17	SUN	8	346 40 15	18	4	14	15 29	24	Śatabhiṣaj	- -					
18	Mon	9	347 40 16	17	5	K 30	16 20	24	"	7 4					
19	Tue	10	348 40 16	16	5	S 1	17 41	25	P. Bhādrapadā	8 47					
20	Wed	11	349 40 14	15	6	2	19 30	26	U. Bhādrapadā	10 59					
21	Thu	12	350 40 9	6 14	18 6	S 3	21 45	27	Revatī	13 34					
22	Fri	13	351 40 3	13	6	4	24 17	1	Āśvinī	16 31					
23	Sat	14	352 39 55	12	7	5	26 56	2	Bharanī	19 37					
24	SUN	15	353 39 44	11	7	6	29 29	3	Kṛttikā	22 41					
25	Mon	16	354 39 31	10	8	7	- -	4	Rohiṇī	25 29					
26	Tue	17	355 39 16	6 9	18 8	S 7	7 43	5	Mṛgaśiras	27 53					
27	Wed	18	356 38 59	8	8	8	9 28	6	Ārdrā	29 38					
28	Thu	19	357 38 39	7	9	9	10 30	7	Punarvasu	- -					
29	Fri	20	358 38 17	6	9	10	10 46	7	"	6 39					
30	Sat	Mar. 21	359 37 53	6 6	18 10	S 11	10 15	8	Puṣya	6 55					

[100]

N.B.—All timings are given in I. S. T. or the local time of the meridian of 82½° E. Long.

General Rules for Religious Festivals

The general rules that have been followed in the fixation of dates of different religious festivals in the Calendar, are given in the appended list. Attempts have been made to make it as comprehensive as possible by including the conventions of all the different States as far as practicable. The well known book 'An Indian Ephemeris' by Swamikannu Pillai has been of immense help in this respect. Other renowned works, such as 'Nirṇaya Sindhu, Dharma Sindhu, Vaidyanātha Dikṣitīyam, Tithitvatam, Utkalakalikā, Tantras and Purāṇas, etc., have been followed in fixing the dates of the festivals and in preparing the list. It may, however, be mentioned in this connection that the rules followed in the observance of religious rites in different parts of India and among different sects of the Hindu community are so divergent in nature that the formulation of any common rule for all India use is difficult. But with a view to securing uniformity, attempts have been made where possible, to lay down general rules for festivals based on the above mentioned religious books.

Most of the festivals are determined on the basis of the lunar (i.e. luni-solar) calendar, which are therefore shown first. There are certain festivals which are based purely on the solar calendar. The criteria for determining the dates of such festivals are given later.

The festivals are arranged according to the *amānta* (i.e. new-moon ending) lunar months commencing from *Caitra Śukla*. The numbers relate to the *tithi* with the *pakṣa* (S means *Śukla pakṣa*, and K *Kṛṣṇa pakṣa*).

As regards the hour of the day in which a religious festival is to be performed, the prescribed time is noon (*madhyāhna*) or fore-noon (*pūrvāhṇa*) except in case of some festivals for which the prescribed periods are different from the general rule. Here noon or *madhyāhna* relates to the period of time from 24 minutes (one *ghaṭikā*) before mid-day upto the same time after it. This is the most appropriate time. If this time is not covered by the *tithi* on any day, the festival is to be observed on the succeeding day of the *tithi*. Sometimes the *madhyāhna* is taken to represent a wider period than the above, viz., the 7th, 8th and 9th *muhūrtas* of the day commencing from sunrise, a *muhūrta* being $\frac{1}{3}$ th part of the day-time. In Bengal, where however a different rule is followed, the requisite *tithi* must cover at least one *muhūrta* of *pūrvāhṇa* of the day i.e., of the first $\frac{1}{3}$ rd part of the day-time. If the *tithi* does not cover such a period on any day, then *pūrvāhṇa* will have to be taken to represent the period from sunrise to mid-day. In cases where the prescribed hours of the day for the festivals are different from the general rule, the required periods to be covered by the *tithi* have been specially mentioned in the list in most cases.

When the requisite *tithi* covers the prescribed time on two successive days, the festival is to be observed in such a case on the first day where marked '*Pūrvavidhā*', and on the second day where marked '*Paravidhā*'. Further explanations of terms have been given later.

Lunar Festivals

CAITRA

- S 1 Navarātrāmbha (paravidhā).
 S 3 Dolotsava, Gaurī tṛtīyā, Āndolana tṛtīyā, Saubhāgya śayana vrata (paravidhā), Sārhu (Bihar).
 S 5 Śrī pañcamī or Lakṣmī pañcamī (pūrvavidhā).
 S 6 Aśoka ṣaṣṭhī (Beng.) (paravidhā), Skanda ṣaṣṭhī (Orissa).
 S 7 Vāsantī pūjā (Bengal) (paravidhā), Oli beginning (Jain—eight days before full-moon).
 S 8 Annapūrṇā pūjā (Beng.) (paravidhā), Bhavānī-utpatti (paravidhā), Aśokāṣṭamī (Special when combined with naks. Punarvasu and Wednesday, after mid-day).
 S 9 Rāmanavamī (madhyāhnavyāpinī, special with Punarvasu naks.), Rāma jayantī.
 S 10 Dharmarāja daśamī.
 S 11 Kāmadā ekādaśī, Dolotsava.
 S 12 Damanotsava, Vāmana dvādaśī, Madana dvādaśī.
 S 13 Anaṅga trayodaśī (pūrvavidhā), Mahāvīra jayantī (Jain).
 S 14 Madanabhañjī, (Bengal & Orissa) (paravidhā), Sivadamanakā caturdaśī, Viṣṇudamanakā caturdaśī (paravidhā).
 S 15 Caitrī pūrṇimā (paravidhā), Hanumat jayantī, Oli ending (Jain).
 K 11 Varūthini ekādaśī.

VAISĀKHA

- S 3 Akṣaya tṛtīyā (pūrvāhṇa vyāpinī, paravidhā) (Special when combined with Rohiṇī nakṣatra and Wednesday), Candanayātrā, Paraśurāma jayantī (pradoṣavyāpinī—if occurs on two successive days, the second day is to be observed).
 S 5 Śaṅkara jayantī.
 S 6 Candana ṣaṣṭhī (Bengal) (paravidhā).
 S 7 Gaṅgotpatti, (madhyāhna vyāpinī, if occurs on two successive days, the first day is to be observed), Jahnu saptamī, Sarkarā saptamī.
 S 9 Sītānavamī (Bengal & Orissa) (madhyāhna vyāpinī).
 S 11 Mohinī ekādaśī, Lakṣmīnārāyaṇa ekādaśī (Orissa).
 S 12 Paraśurāma dvādaśī (pūrvavidhā), Rukmiṇī dvādaśī (pūrvavidhā), Pipitakī dvādaśī (Bengal) (paravidhā).
 S 14 Nṛsimha caturdaśī (pradoṣa vyāpinī—if it occurs on two successive days, the second day is to be observed, special when combined with nakṣatra 'Svātī', yoga 'Siddhi' and 'Saturday').
 S 15 Sampat gaurī vrata (paravidhā), Phuladola (Bengal & Orissa) (paravidhā), Gandheśvarī pūjā (Bengal) (pūrvavidhā), Buddha pūrṇimā, Vaiśākhi pūrṇimā.
 K 8 Trilocanāṣṭamī (Bengal).
 K 11 Aparā ekādaśī, Jalakṛiḍā ekādaśī (Orissa).
 K 14 Sāvitrī caturdaśī (pradoṣa) (Bengal).
 K 30 Vaṭa-sāvitrī vrata, Sāvitrī amāvasyā (Orissa), Phalahāriṇī Kālikā pūjā (Bengal) (niśitha vyāpinī).

JYAIṢṬHA (Jyeṣṭha)

- S 1 Daśaharā snānāmbha (lasting for ten days).
 S 3 Rambhā tṛtīyā (pūrvavidhā).
 S 4 Umā caturthī (Bengal & Orissa) (paravidhā).
 S 5 Mahādeva vivāha (Orissa).
 S 6 Araṇya ṣaṣṭhī, Araṇya gaurī vrata, (paravidhā), Skanda ṣaṣṭhī, (pūrvavidhā), Śītala ṣaṣṭhī yātrā (Orissa).
 S 10 Gaṅgā daśaharā (special when combined with nakṣatra 'Hasta', yoga 'Vyatīpāta', karaṇa 'Gara' and Tuesday).
 S 11 Nirjalā ekādaśī, Devavivāha ekādaśī (Orissa). Rukmiṇī vivāha (Orissa).
 S 12 Śrī Rāma dvādaśī (pūrvavidhā), Campaka dvādaśī (Orissa) (pūrvavidhā).
 S 14 Campaka caturdaśī (Bengal) (paravidhā).
 S 15 Vaṭa-sāvitrī vrata (Deccan) (pradoṣavyāpinī, pūrvavidhā), Snānayātrā (Bengal & Orissa) (paravidhā).
 K 11 Yoginī ekādaśī.

ĀṢĀDHA

- S 2 Rathayātrā (paravidhā, special when combined with nakṣatra 'Puṣya'), Manoratha dvitīyā (it is to be observed only when the tithi touches both day and night on the date of observance when the moon becomes visible).
 S 5 Skanda pañcamī (paravidhā).
 S 6 Kumāra ṣaṣṭhī, Herapañcamī (Orissa), Kardama ṣaṣṭhī (Bengal) (paravidhā).
 S 7 Vivasvat saptamī (pūrvavidhā).
 S 8 Paraśurāmāṣṭamī (Orissa), Khārci pūjā (Tripura).
 S 10 Punaryātrā (on the ninth day from Rathayātrā).
 S 11 Hariśayanī ekādaśī, Ravinārāyaṇa ekādaśī (Orissa).
 S 12 Viṣṇu śayanotsava, Śrīkrṣṇa dvādaśī, Gopadma-vratāmbha.
 S 14 Caumāsī caudas (Cāturmāsya caturdaśī) (Jain), Śivaśayana caturdaśī (Orissa).
 S 15 Guru pūrṇimā (paravidhā), Vyāsa pūjā (paravidhā, 3 muhūrtas after sunrise), Kokilā vrata (sāyāhna vyāpinī), Śiva śayanotsava (pradoṣavyāpinī).
 K 2 Aśūnya śayana vrata (candrodaya vyāpinī; pūrvāhṇa vyāpinī and pūrvavidhā in Bengal).
 K 5 Nāga pañcamī (Bengal) (pūrvavidhā).
 K 7 Śītālā saptamī (Orissa).
 K 11 Kāmikā ekādaśī.
 K 30 Citāu amāvasyā (Orissa), Karkaṭaka vavu (T. C. State—in saura Śrāvaṇa).

ŚRĀVAṆA

- S 3 Madhuśravā (Gujerat) (paraviddhā).
 S 5 Nāga pañcamī (paraviddhā),
 Jāgratgaurī pañcamī (Orissa) (rātrivyāpinī).
 S 6 Luṅṭhana ṣaṣṭhī (Bengal) (paraviddhā).
 S 11 Putradā ekādaśī, Jhulanayātrā (pradoṣavyāpinī
 or pūrvāhṇavyāpinī).
 S 12 Buddha dvādaśī, Dāmodara dvādaśī (pūrva-
 viddhā), Viṣṇu-pavitrāropana.
 S 13 Ākhetaka trayodaśī (Orissa).
 S 14 Śiva pavitrāropana (Orissa) (rātrivyāpinī).
 S 15 Rākhi pūrṇimā, Nāroli pūrṇimā (Cocoanut
 day), Rakṣā Bandhana (in the second
 half of pūrṇimā), Rṣi tarpana (madhyāhna
 vyāpinī), Hayagrīva utpatti, Jhulanayātrā
 samāpana, Balabhadra pūjā (Orissa).
 Āvaṇi Avittam (South India)—But in some
 places, on the day of Dhaniṣṭhā nakṣatra
 falling on S 14 or 15; if Dhaniṣṭhā is not
 available before K 1, it is to be observed
 on the day of Dhaniṣṭhā nakṣatra of the
 next month.
 Upākarma (Saṃgavyāpinī i.e. S 15 covering
 4th, 5th and 6th muhūrtas)—(1) For R̥gvedis,
 it is to be observed on the day of Śravaṇa
 nakṣatra falling on S 14, S 15 or K 1.
 (2) For Yajurvedis—if saṃkramaṇa or eclipse
 occurs on the day, or Jupiter or Venus be
 heliacally set, then it is to be observed in
 Bhādrapada pūrṇimā and if that is also
 objectionable, it is to be observed in
 Āṣāḍha pūrṇimā.
 K 2 Aśūnyaśayana vrata (Dvitiyā current at moon-
 rise; if occurs on two successive days,
 it is to be observed on the second day).
 K 3 Kajjalī tr̥tīyā, (paraviddhā), Aṅgaveṭa tr̥tīyā
 (Orissa).
 K 4 Bahulā caturthī (Madhyadeśa) (Sāyāhna-
 vyāpinī: if occurs on two successive days,
 it is to be observed on the 1st day).
 K 5 Rakṣā pañcamī (Orissa) (pūrvaviddhā).
 K 6 Hala ṣaṣṭhī (paraviddhā).
 K 7 Śitalā saptamī (pūrvaviddhā).
 K 8 Janmāṣṭamī (madhyarātra-vyāpinī), if midnight
 is covered on two days, or not on any day,
 it is to be observed on the 2nd day; special
 when combined with nakṣatra 'Rohiṇī' at
 midnight, more so when on Monday or
 Wednesday. If the combination occurs
 before midnight and 'Rohiṇī' extends up to
 midnight, it is to be observed on that day.
 Gokulāṣṭmī.
 For Vaiṣṇavas: It is to be observed next to the
 day of saptamī.
 In Assam and S. India: It is to be observed in
 Śravaṇa K 8 or Bhādra K 8 falling in the
 month of saura Bhādrapada. In S. India
 some observe in Rohiṇī nakṣatra.
 K 11 Ajā ekādaśī.
 K 12 Paryuṣaṇa parvārambha (Jain-pañcamī pakṣa)
 —Eight days before Saṃvatsarī.
 K 14 Aghora caturdaśī (pradoṣa vyāpinī).
 K 30 Pithori amāvasyā, Āloka amāvasyā, Saptapurī
 amāvasyā (Orissa), Kuśagrahaṇa.

BHĀDRAPADA

- S 1 Rudra vrata (pūrvaviddhā).
 S 3 Haritālikā vrata (paraviddhā), Gaurī vrata
 (Orissa), Gaurī (Mysore).
 S 4 Varadā caturthī (pūrvaviddhā, madhyāhna-
 vyāpinī), Saṃvatsarī parva (Jain-caturthī
 pakṣa), Saubhāgya caturthī (Bengal), Gaṇeśa
 caturthī (madhyāhna vyāpinī and pūrva-
 viddhā), Haritālī caturthī (S 4 of saura
 Bhādra), Sarasvatī pūjā (Orissa).
 S 5 Rṣi pañcamī (madhyāhnavyāpinī)—If occurs
 on two successive days, it is to be observed
 according to Mādhava on the 1st day and
 according to Hemādri and Divodāsa on the
 2nd day; Rakṣā pañcamī (Bengal), Guru
 pañcamī (Orissa), Saṃvatsarī parva (Jain-
 pañcamī pakṣa).
 S 6 Sūrya ṣaṣṭhī (paraviddhā), Lolārka ṣaṣṭhī,
 Carpatā ṣaṣṭhī & Manthāna ṣaṣṭhī (Bengal),
 Campā ṣaṣṭhī (when combined with nakṣatra
 Viśākhā and yoga Vaidhrti and Tuesday),
 Somanātha vrata (Orissa).
 S 7 Muktabharāṇa vrata (pūrvaviddhā), Lalitā
 saptamī (Bengal & Orissa).
 S 8 Dūrvāṣṭamī (pūrvaviddhā—S 8 of saura
 Bhādra except Bengal), Mahālakṣmī vratā-
 rambha, Rādhāṣṭamī (madhyāhna vyāpinī),
 Durgā śayanāṣṭamī (Orissa).
 S 9 Adukhā navamī, Nandā navamī, Tāla navamī
 (Bengal & Orissa) (pūrvaviddhā).
 S 11 Parivartanī ekādaśī, Viṣṇu śrīkhalayoga—when
 combined with nakṣ. Śravaṇa and 12th tithi,
 Heikra Hitomba (Manipur), Dol gyaras (M. B.)
 S 12 Viṣṇuparivartanotsava, Śakrotthāna (in any of
 the nakṣatras U. Āṣāḍhā, Śravaṇa &
 Dhaniṣṭhā), Kalki dvādaśī, Śravaṇa dvādaśī
 (when combined with nakṣatra Śravaṇa),
 Vāmana jayantī (madhyāhna vyāpinī).
 S 14 Ananta caturdaśī (covering three muhūrtas
 from sunrise, but one muhūrta in Bengal).
 S 15 Indra-Govinda pūjā (Orissa) (pradoṣa).
 K 1 Mahālayārambha.
 K 2 Aśūnya śayana vrata (vide K 2 of Śravaṇa).
 K 6 Candra ṣaṣṭhī (Ṣaṣṭhī current at moon-rise, if
 occurs on two successive days, it is to be
 observed on the first day).
 Kapilā ṣaṣṭhī—when combined with nakṣatra
 Rohiṇī, yoga Vyatīpāta, Sun in Hasta and
 Tuesday.
 K 8 Mahālakṣmī vrata samāpana (current at moon-
 rise), Jitāṣṭamī (pradoṣa), Jīmūtavāhana pūjā,
 Mūlāṣṭamī (Orissa).
 K 9 Mātṛ navamī, Avidhavā navamī, Durgā navamī
 (Maharashtra).
 K 11 Indirā ekādaśī.
 K 13 Maghā trayodaśī (in Maghā nakṣatra even in
 malamāsa). Gajāclāyā when Sun in Hasta
 nakṣ.)
 K 30 Mahālayā amāvasyā (aparāhṇavyāpinī)

ĀŚVINA

- S 1 Navarātrārambha (paraviddhā).
 S 4 Māna caturthī (Bengal & Orissa).
 S 5 Upāṅga-lalitā vrata (Maharashtra) (pūrvaviddhā, in some opinion rātri vyāpinī), Nata pañcamī (Orissa).
 S 6 Durgā ṣaṣṭhī, Tapah ṣaṣṭhī (Orissa).
 S 7 Durgā saptamī (paraviddhā)—covering one muhūrta from sunrise, Sarasvatī sthāpana (to be observed in Mūla nakṣatra, not necessarily in S 7).
 Oli beginning (Jain)—Eight days before full-moon.
 S 8 Mahāṣṭamī (paraviddhā), Sarasvatī pūjana (to be observed in nakṣatra P. Āṣāḍhā)
 S 9 Mahānavamī (pūrvaviddhā) (In Bengal it is observed as paraviddhā covering one muhūrta from sunrise).
 Sarasvatī Balidāna (to be observed in nakṣatra U. Āṣāḍhā)
 S 10 Vijayā daśamī (In Bengal it is observed as paraviddhā, covering one muhūrta from sunrise. In other places, if it touches Śravaṇa nakṣatra in the day time it is observed on that day), Sarasvatī visarjana (to be observed in nakṣatra Śravaṇa), Daśaharā.
 S 11 Pāśāṅkuśā (Pāpāṅkuśā) ekādaśī, Bharat Milap.
 S 12 Padmanāva dvādaśī.
 S 15 Kojāgarī Lakṣmī pūrṇimā (pradoṣa vyāpinī)—(If occurs on two successive days, it is to be observed on the second day, otherwise on the first day), Kumāra pūrṇimā (Orissa), Oli ending (Jain).
 K 2 Aśūnya śayana vrata (*vide* K 2 of Śravaṇa).
 K 4 Karaka caturthī (current. at moon-rise, if occurs on two successive days, it is to be observed on the first day), Daśaratha caturthī (Bengal) (pradoṣa vyāpinī)—If occurs or does not occur on two days, then to be observed on the first day.
 K 8 Ahoyī aṣṭamī (Gujerat) (current at moonrise), Karāṣṭamī (Maharashtra). If occurs on two successive days, it is to be observed on the second day.
 K 11 Rāmā ekādaśī.
 K 12 Govatsa dvādaśī (pradoṣavyāpinī). If occurs on two days, it is to be observed on the first day.
 K 13 Yama dīpadāna (pradoṣa).
 K 14 Naraka caturdaśī (covering a period of 4 ghatikās before sunrise, if occurs on two successive days, it is to be observed on the first day), Bhūta caturdaśī, Dīpadāna, Śastrāhata caturdaśī, Hanumat Janmadina.
 K 30 Kālī pūjā (nīśithavyāpinī), Dīpāvalī or Diwali (pradoṣa), Mahālakṣmīpūjā (pradoṣa), Kethar Gaurī vrata (S. India), Mahāvīra nirvāṇa (Jain).

KĀRTIKA

- S 1 Govardhana pūjā, Annakūṭa [pūrvaviddhā], Balidaityarāja pūjā (pradoṣa), Dyūta pratipad (pūrvāhṇa).
 S 2 Bhrātrdvitīyā, Yamadvitīyā (madhyāhna, pūrvaviddhā), Masyādhāra (Dwat) pūjā (Bihar).
 S 3 Ālocanā Gaurī vrata (paraviddhā).
 S 4 Nāga caturthī (paraviddhā and madhyāhnavyāpinī).
 S 5 Jñāna pañcamī (Jain).
 S 6 Nāḍī ṣaṣṭhī, Skanda ṣaṣṭhī (Madras), Sūrya ṣaṣṭhī, Chhat (Bihar).
 S 8 Gopāṣṭamī, Goṣṭhāṣṭamī.
 S 9 Akṣaya navamī (pūrvāhṇavyāpinī), Jagaddhātrī pūjā (Bengal). (udayavyāpinī one muhūrta), Anlā navamī (Orissa), Durgā navamī (pūrvaviddhā), Gaurī vrata.
 S 11 Tulasi vivāha, Bhīṣma pañcaka, Prōbodhanī ekādaśī.
 S 12 Prōbodhanotsava, Nārāyaṇa dvādaśī, Vṛndāvana dvādaśī, Garuḍa dvādaśī (Orissa).
 S 14 Vaikuṅṭha caturdaśī (rātrivyāpinī), Caumāsī caudas (Jain), Baḍa oṣā (Orissa).
 S 15 Rāsayātrā, (nīśithavyāpinī, i.e. covering a period from 24 minutes before to 24 minutes after midnight. If occurs on two days or does not occur on any day, it is to be observed on the second day), Puṣkar Fair. Ratha yātra (Jain), Tripurotsava (evening), Kedāra vrata (Orissa), Kārtikī pūrṇimā.
 K 8 Kālāṣṭamī (rātrivyāpinī, paraviddhā), Kālabhairava jayantī, Prathamāṣṭamī (Orissa).
 K 9 Kāñjī Anlā navamī (Orissa).
 K 11 Utpannā (Utpatti) ekādaśī.
 K 30 Dīpāvalī amāvasyā (Orissa).

MĀRGASĪRṢA

- S 1 Rudropavāsa.
 S 5 Nāga pañcamī (2nd) (paraviddhā).
 S 6 Campā ṣaṣṭhī (Maharashtra) (paraviddhā). (Special when combined with nakṣatra Śatabhiṣaj, yoga Vyatīpāta and Sunday), Skanda ṣaṣṭhī (pūrvaviddhā), Guha ṣaṣṭhī, Mūlakarūpinī ṣaṣṭhī.
 S 7 Mitra saptamī (pūrvaviddhā).
 S 11 Mokṣadā (Mokṣā) ekādaśī, Mauna ekādaśī (Jain).
 S 12 Matsya dvādaśī, Akhaṇḍa dvādaśī (paraviddhā), Vyañjana dvādaśī & Dāna dvādaśī (Orissa).
 S 14 Pāṣāṇa caturdaśī (Bengal & Orissa) (In saura Mārgasīrṣa, night).
 S 15 Dattātreypatti (pradoṣa).
 K 8 Pūpāṣṭakā.
 K 10 Pauṣa daśamī (Jain).
 K 11 Saphalā ekādaśī.
 K 30 Vakula amāvasyā (Orissa).

PAUṢA

- S 6 Annarūpā ṣaṣṭhī (Bengal).
 S 10 Śāmba daśamī, Sūrya pūjā (Orissa).
 S 11 Putradā ekādaśī, Vaikuṅṭha ekādaśī (Madras),
 (In Saura Pauṣa).
 S 12 Kūrma dvādaśī.
 S 15 Puṣyābhiṣekayātrā (special when combined with
 Puṣya nakṣatra).
 K 8 Māmsāṣṭakā.
 K 11 Ṣaṭtilā ekādaśī.
 K 13 Meru trayodaśī (Jain).
 K 14 Yama tarpaṇa (covering a period of 4 ghaṭikās
 before sunrise), Raṭanti Kālikā pūjā (Bengal),
 (pradoṣavyāpinī or niśthavyāpinī).
 K 30 Mauna amāvasyā (Uttar Pradesh), Trivenī
 amāvasyā (Orissa), Makara vavū (T. C. State),
 Ardhodaya Yoga—When combined with
 nakṣatra Sravaṇa, yoga Vyatīpāta and Sunday
 at day-time.

MĀGHA

- S 4 Tila caturthī and Kunda caturthī (pradoṣa-
 vyāpinī), Varadā caturthī (Bengal & Orissa),
 Gaṇeśa caturthī, Gaṇeśa jayantī (madhyāhna-
 vyāpinī pūrvavidhā).
 S 5 Śrī Pañcamī (pūrvavidhā), Sarasvatī pūjā
 (Bengal), Vasanta pañcamī, Madana
 pañcamī.
 S 6 Śītalā ṣaṣṭhī (Bengal).
 S 7 Ratha saptamī (covering 4 ghaṭikās before
 sunrise), Acalā saptamī, Vidhāna saptamī,
 Ārogya saptamī [pūrvavidhā].
 S 8 Bhīṣmāṣṭamī.
 S 9 Mahānandā navamī.
 S 11 Jayā ekādaśī, Bhaimī ekādaśī (Bengal).
 S 12 Bhīṣma dvādaśī (pūrvavidhā), Āmalakī
 dvādaśī, Santāna dvādaśī, Varāha dvādaśī.
 S 15 Māghī pūrṇimā (paravidhā), Mahāmāghī—
 When Jupiter and Moon in nakṣatra Maghā,
 Sun in Śravaṇa and Saturn in Meṣa.
 Agnyutsava (night) (Orissa).

Observance of Ekādaśī—

As regards *Ekādaśī*, there are various rules for determining the date for fasting. The general rule prevalent in most part of India is that it is to be observed on the day when the *tithi* is current at sunrise. If it occurs on two successive days, it is to be observed on the second day. When does not occur on any day, it is to be observed on the day of the *tithi*, but widows and sannyāsins would observe on the next-day. But in Bengal in such cases, it is to be observed on the succeeding day by all i.e., the day of combination of *daśamī* with *ekādaśī* is avoided. The *Vaiṣṇavas* avoid such combination even at *aruṇodaya* (4 ghaṭikās before sunrise), *Nimbārka Vaiṣṇavas* avoid such combination even after the preceding midnight.

Māgha—contd.

- K 8 Sakāṣṭakā, Sītaṣṭamī (Birth day of Sīta).
 K 11 Vijayā ekādaśī.
 K 14 Mahāśivarātri (niśthavyāpinī)—In some
 opinion it is to be observed on niśitha and in
 some opinion on pradoṣa. If occurs on
 two successive niśithas then according to
 Hemādri it is to be observed on the first day
 and according to Mādhava, to be observed
 on the second day).

PHĀLGUNA

- S 4 Śānta caturthī (paravidhā) (Orissa).
 S 6 Gorūpiṇī ṣaṣṭhī (Bengal).
 S 10 Phagu daśamī (Orissa).
 S 11 Āmalakī ekādaśī.
 S 12 Nṛsimha dvādaśī (It is called Govinda dvādaśī
 when combined with Puṣya nakṣatra).
 S 14 Caumāsī caudas (Jain).
 S 15 Holikā-dahana (Sāyāhnavyāpinī—it should be
 observed on second half of pūrṇima
 at night), Dolayātrā (Bengal & Orissa)
 (covering 4 ghaṭikās before sunrise of
 the day of festival), Holi—on the day after
 Holikādahana.
 K 1 Vasantotsava (current at sunrise; if occurs
 on two successive days, it is to be observed
 on the first day).
 K 5 Raṅga pañcamī.
 K 6 Skanda ṣaṣṭhī (Bengal) (pūrvavidhā).
 K 8 Śītalāṣṭamī, (pūrvavidhā), Varṣītapārambha
 (Jain).
 K 11 Pāpamocanī ekādaśī.
 K 13 Madhukṛṣṇā trayodaśī,
 (Vāruṇī, when combined with nakṣatra
 Śatabhiṣaj; Mahāvāruṇī, when combined
 with nakṣatra Śatabhiṣaj and Saturday;
 Mahāmahā Vāruṇī when further combined
 with yoga Śubha).

Solar Festivals

The following festivals are observed according to the day of Sun's transit into *rāśis* (Ravi-saṁkramaṇa). For this purpose the day has been taken to begin from midnight, i.e., when the saṁkramaṇa takes place after midnight, the festival relating to the saṁkramaṇa is to be observed on the following day.

Meṣādi—Caḍaka pūjā (Bengal), Bahāg Bihu (Assam), Cheiraoba (Manipur), Viṣu (T. C. State), Vaiśākhī (on the saṁkramaṇa day commencing from sunrise).

Karkādi—Manasā pūjā begins (Bengal).

Siṁhādi—Manasā pūjā ends (Bengal). This is the principal day of the pūjā.

Kanyādi—Visvakarmā pūjā (Bengal).

Tulādi—Kāveri saṁkramaṇa snāna (Coorg).

Vṛścikādi—Kārtika pūjā (Bengal)

Makarādi—Makarādi snāna, Māgh Bihu (Assam), Tila saṁkrānti, Pongal (S. India), Bhogi (S. India—on the day before Pongal), Mattu Pongal (S. India—on the day after Pongal).

Criteria of some festivals for South India

Paṅguni Uttiram :—Observed in Uttara Phalguni nakṣatra of solar Caitra, nakṣatra covering 15th to 18th from sunrise. Also observed in pūrṇimā of solar Caitra covering tīrthakāla (viz., 15th to 18th from sunrise).

Āvaṇi Avittam or Yaju Upākarma :—

It is observed on Śrāvaṇa full-moon day. The pūrṇimā should be current for over twelve ghaṭikās. Āvaṇi month (Bhādrapada) or Avittam (Dhaniṣṭhā nakṣ.) are not generally necessary for this festival. Yaju Upākarma should not be observed (1) when Venus sets heliacally, (2) in an intercalary month, (3) if an eclipse or saṁkrānti occurs on that day.

Rk Upākarma :—It is observed in Śrāvaṇa nakṣatra in the month of lunar Śrāvaṇa. Nakṣatra should be current for three ghaṭis from sunrise. If it occurs on two successive days, the first day is selected.

Āḍi Pūram :—Pūrva Phalguni nakṣatra of saura Śrāvaṇa (pradoṣavyāpinī or tīrthakāla vyāpinī).

Āḍi Amāvasyā :—Amāvasyā (K 30) of saura Śrāvaṇa (aparāhṇavyāpinī).

Śrī Jayantī (or Smārta Śrī Kṛṣṇa jayantī) :—

Observed in K 8 of solar Bhādrapada—eighth tithi covering midnight. Doṣam or Vedai are not considered here.

Pañcarātra Śrī Kṛṣṇa jayantī :—Observed in Rohiṇī nakṣatra (Kṛṣṇa pakṣa) of solar Bhādrapada. Vedam or Doṣam is strictly considered here.

Āvaṇi Mūlam :—Mūla nakṣatra of saura Bhādrapada (pradoṣa), if it occurs on two successive days, the first day is selected.

Onam Day :—Śrāvaṇa nakṣatra of solar Bhādrapada (madhyāhna vyāpinī).

Kethār Gaurī Vrata :—Amāvasyā (K 30) of lunar Āśvina—if caturdaśī extends upto 18th it will be observed on the next day.

Ānnābhīsekam :—Pūrṇimā of saura Kārtika (pradoṣavyāpinī). The combination of Āśvini nakṣatra is favourable.

Bharaṇi Dipam :—Observed in Bharaṇi nakṣatra of saura Mārgaśīrṣa (pradoṣavyāpinī).

Kṛttikā Dipam :—Observed in Kṛttikā nakṣatra of saura Mārgaśīrṣa (pradoṣavyāpinī).

Vaiśākhāsa Dipam :—Pūrṇimā of saura Mārgaśīrṣa (pradoṣavyāpinī).

Arudra Darśanam :—Ārdra nakṣatra of saura Pauṣa.

Vaiṣṇava Ekādaśī (Vaiṣṇava) :—Śukla ekādaśī of saura Pauṣa.

Thai Pūṣam :—Observed in Puṣya nakṣatra of saura Māgha, nakṣatra covering the period 6 ghaṭikās from sunrise—If it occurs on two days the first day is to be selected.

Thai Amāvasyā :—Amāvasyā (K 30) of saura Māgha (aparāhṇavyāpinī).

Māśī Magham :—Observed in Maghā nakṣatra of saura Phalgunā, nakṣatra covering the period tīrthakālam. Also observed on the pūrṇimā day.

Notes :—If the determinants occur twice i.e., at the beginning and end of a solar month, the second occasion is generally adopted. If an eclipse occurs on the second occasion, the first occasion is selected. If both the occasions are vitiated, the second occasion is then selected.

In observing *Amāvasyā*, the following principles are generally followed :—

If Amāvasyā tithi covers the entire period of aparāhṇakāla on two successive days, it is observed on the first day in a decreasing tithimāna and on the second day in an increasing tithimāna.

Certain Special Tithis and Combinations.

YUGĀDI

1. Satya (Kṛta) Yugādi	Kārtika	S
2. Tretā Yugādi ...	Vaiśākha	S 3
3. Dvāpara Yugādi ...	Māgha	K 30
4. Kali Yugādi ...	Bhādra	K 13

In Bengal, however, the tithis of Yugādi are as follows :—

Satya Yugādi ...	Vaiśākha	S 3
Tretā Yugādi ...	Kārtika	S 9
Dvāpara Yugādi ...	Śrāvaṇa	K 13
Kali Yugādi ...	Māgha	S 15

MANVĀDI

1. Svāyambhūva ...	Āśvina	S 9
2. Svārociṣa ...	Kārtika	S 12
3. Uttama ...	Caitra	S 3
4. Tāmasa ...	Bhādra	S 3
5. Raivata ...	Pauṣa	S 11
6. Cakṣuṣa ...	Āṣāḍha	S 10
7. Vaivasvata ...	Māgha	S 7
8. Sūrya Sāvārṇi ...	Śrāvaṇa	K 8
9. Dakṣa Sāvārṇi ...	Śrāvaṇa	K 30
10. Brahma Sāvārṇi ...	Āṣāḍha	S 15
11. Dharma Sāvārṇi ...	Kārtika	S 15
12. Rudra Sāvārṇi ...	Phālguna	S 15
13. Raucya ...	Caitra	S 15
14. Bhautya ...	Jyeṣṭha	S 15

In Bengal there are some variations as noted below :—

No. 8. Sūrya Sāvārṇi—

Instead of Śrāvaṇa K 8, it is Āṣāḍha K 8.

No. 9. Dakṣa Sāvārṇi—

Instead of Śrāvaṇa K 30, it is Māgha K 30.

Note :—The tithis of Yugādi and Manvādi of śukla pakṣa should be pūrvāhṇavyāpinī, and of kṛṣṇa pakṣa aparāhṇavyāpinī. But in Bengal, all are udayagāminī covering the first muhūrta of the day.

KALPĀDI

1. Kūrma Kalpādi ...	Caitra	S 5 (& 2. Caitra K 30)
3. Pārthiva Kalpādi ...	Vaiśākha	S 3
4. Sāvitrī Kalpādi ...	Kārtika	S 7
5. Pralaya Kalpādi ...	Mārgaśīrṣa	S 9
6. Varāha Kalpādi ...	Māgha	S 13
7. Brahma Kalpādi ...	Phālguna	K 3

Note :—All are pūrvāhṇavyāpinī.

JAYANTĪ

(The three sets of tithis given below are according to three different versions).

Matsya—Caitra S 3	Caitra S 5	Āṣāḍha S 11
(Aparāhṇa)	(Madhyāhna)	(Prātaḥ)
Kūrma—Vaiśākha S 15	Jyeṣṭha S 12	Śrāvaṇa S 3
(Sāyāhna)	(Sāyāhna)	(Prātaḥ)
Varāha—Śrāvaṇa S 4	Caitra S 9	Bhādra S 5
(Aparāhṇa)	(Prātaḥ)	(Madhyāhna)
Nṛsimha—Vaiśākha S 14	Vaiśākha S 14	Vaiśākha S 14
(Sāyāhna)	(Pradoṣa)	(Sāyāhna)
Vāmana—Bhādra S 12	Bhādra S 12	Bhādra S 11
(Madhyāhna)	(Madhyāhna)	(Sāyāhna)

Parāśurāma—

Vaiśākha S 3	Vaiśākha S 3	Vaiśākha S 3
(Madhyāhna)	(Aruṇodaya)	(Pradoṣa)
Śrī Rāma—Caitra S 9	Caitra S 9	Caitra S 9
(Madhyāhna)	(Madhyāhna)	(Madhyāhna)
Śrī Kṛṣṇa—Śrāvaṇa K 8	Śrāvaṇa K 8	Śrāvaṇa K 8
(Madhyarātri)	(Madhyarātri)	(Madhyarātri)
Buddha—Āśvina S 10	Bhādra S 2	Pauṣa S 7
(Sāyāhna)	(Sāyāhna)	(Sāyāhna)
Kalki—Śrāvaṇa S 6	Jyeṣṭha S 2	Māgha S 3
(Sāyāhna)	(Prātaḥ)	(Prātaḥ)

MAHĀDVĀDAŚĪ.

The Dvādaśī tithi is called Mahādvādaśī in the following cases :—

(1) When the 11th tithi is current at sunrise on two successive days, the second day is called *Unmilanī Mahādvādaśī*.

(2) When the 12th tithi is current at sunrise on two successive days, then the first day is called *Vaṅjuli Mahādvādaśī*.

(3) When the 15th tithi or 30th tithi is current at sunrise on two successive days, the preceding Dvādaśī is called *Pakṣavardhinī Mahādvādaśī*.

(4) When the 11th, 12th and 13th tithis meet in an ahorātra (from one sunrise to next sunrise), the Dvādaśī is called *Trisprśā Mahādvādaśī*.

(5) When nakṣatra Śrāvaṇa, Rohiṇī, Punarvasu or Puṣya is current at sunrise on two successive days and combines with śukla dvādaśī tithi, which extends from sunrise to sunset on the first day of nakṣatra (except in case of Śrāvaṇa when the duration of tithi upto sunset is not essential), the Dvādaśī is called *Vijayā, Jayantī, Jayā* and *Pāpanāśinī* respectively.

GANĒŚA CATURTHI

The śukla caturthī in each month is called Gaṇeśa caturthī or Vināyaka caturthī. It is observed at madhyāhna. The chief among them are caturthīs of Bhādrapada and Māgha.

Similarly the kṛṣṇa caturthī in each month is called Saṅkaṣṭa caturthī, to be observed on the day when the tithi is current at moonrise. It is called Aṅgaraka caturthī if it falls on 'Tuesday'.

DURGĀṢṬAMI

The śuklāṣṭami in each month is called Durgāṣṭami. The chief among them are those of Āśvina and Caitra.

KĀLĀṢṬAMI

The kṛṣṇāṣṭami in each month is called 'Kālāṣṭami'. The chief among them is that of Kārtika.

ŚIVARĀTRI

The kṛṣṇa caturdaśī in each month is called 'Śivarātri'. The chief among them is that of Māgha. The tithi must cover niśitha (or pradoṣa in some opinion).

In Orissa, both śukla and kṛṣṇa caturdaśīs are observed as 'Sivacaturdaśī'. These are pradoṣavyāpini.

Certain other important Tithis

Pradoṣa-vrata—The śukla and kṛṣṇa trayodaśī tithis of each month when cover the period of 'pradoṣa', are observed as Pradoṣa-vratas.

Cāturmāsya-vrata—Cāturmāsya vrata commences on Āṣāḍha S 11 or (S 12), or S 15, or on Karkāṭa saṅkramaṇa, and ends on Kārtika S 12, S 15 and Vṛścika saṅkramaṇa respectively. If Vṛścika saṅkrānti occurs before Kārtika S 12, it will also then end on Kārtika S 12.

Certain special Yogas

Cūḍāmaṇi Yoga—Cūḍāmaṇiyoga occurs when a solar eclipse takes place in a locality on Sunday, or a lunar eclipse on Monday night.

Kumbha Yoga—The Kumbha yoga occurs at interval of three years, when Jupiter remains in Kumbha rāśi, Vṛṣa rāśi, Simha rāśi or Vṛścika-rāśi.

The Kumbha Yoga occurs at the following places :—

At Haridwar—Jupiter in Kumbha and Sun enters Meṣa.

At Prayāg (Allahabad)—Jupiter in Vṛṣava and Sun and Moon in Makara.

At Nasik—Jupiter in Simha and Sun and Moon in Karkāṭa.

At Ujjain—Jupiter in Vṛścika and Sun in Tula.

Note :—The Kumbha yoga at Ujjain originally used to be held during the year in which Jupiter remained in Vṛścika rāśi. But for more than the last hundred years, it is being observed during the year in which Jupiter remains in Simha at the time of full-moon of Vaiśākha. At this time *Ardha Kumbha* occurs at Haridwar.

Explanation of terms used in the above list.

Pūrvavidhā—When the required tithi combines with the next preceding tithi.

Paravidhā—When the required tithi combines with the next following tithi.

Note :—The above questions are to be considered only in case when the desired moment of festival is available on two successive days.

Yāmārdha—One-eighth part of the day-time i.e., about 1^h 30^m.

Muhūrta—One-fifteenth part of the day-time (approximately 2 ghaṭīs or 48 mins).

Aruṇodaya—Two muhūrtas (about 4 ghaṭikās or 1^h 36^m) before sunrise.

Prātaḥ—First three muhūrtas ($\frac{3}{8}$ th part of the day-time or about 2^h 24^m) after sunrise.

Saṅgava—4th, 5th, and 6th muhūrtas of the day.

Pūrvāhṇa—One-third of the day-time from sunrise i.e., the first five muhūrtas (about 4 hours from sunrise), or if this time is not available then pūrvāhṇa is first half of the day.

Madhyāhna—Second one-third of the day-time, i.e., 6th to 10th muhūrtas. Or 7th, 8th and 9th muhūrtas. Or two ghaṭikās covering mid-day.

Aparāhṇa—One-third of the day before sunset, or if this is not available then it is the last half of the day. Or 10th, 11th and 12th muhūrtas of the day-time.

Sāyāhna—One-fifth of the day (i.e. about 2^h 24^m) before sunset (13th, 14th and 15th muhūrtas).

Pradoṣa—Two muhūrtas (about 4 ghaṭikās or 1^h 36^m) after sunset. (In some opinion three muhūrtas after sunset).

Niśitha or Madhyarātri—Two ghaṭikās covering midnight.

Tithis, Nakṣatras, Muhūrtas and their Lords.

TITHIS			NAKṢATRAS			
No.	Tithi	Lord	No.	General Name	Tamil Name	Lord
1.	Pratipad	...	1.	Aśvinī	—	Aśvins
2.	Dvitiyā	...	2.	Bharaṇī	—	Yama
3.	Ṛtīyā	...	3.	Kṛttikā	Kiruttigai	Agni
4.	Caturthī	...	4.	Rohiṇī	—	Prajāpati
5.	Pañcamī	...	5.	Mṛgaśiras	Mirugaśiram	Soma
6.	Ṣaṣṭhī	...	6.	Ārdrā	Arudra or Tiruvādirai	Rudra
7.	Saptamī	...	7.	Punarvasu	—	Aditi
8.	Aṣṭamī	...	8.	Puṣya	Puṣam	Brhaspati
9.	Navamī	...	9.	Āśleṣā	Āyilyam	Sarpas
10.	Daśamī	...	10.	Maghā	Magham	Pitṛs
11.	Ekādaśī	...	11.	Pūrva Phalgunī	Pūram	Bhaga
12.	Dvādaśī	...	12.	Uttara Phalgunī	Uttiram	Aryamā
13.	Trayodaśī	...	13.	Hasta	Hastam	Savitā
14.	Caturdaśī	...	14.	Citrā	Cittirai	Tvaṣṭā
15.	Pūrṇimā (Paurṇamāsī)	...	15.	Svatī	—	Vāyu
30.	Amāvasyā	...	16.	Viśakhā	Viśakam	Indrāgnī
			17.	Anurādhā	Anuṣam	Mitra
			18.	Jyeṣṭhā	Keṭṭai	Indra
			19.	Mūla	Mūlam	Nirṛti
			20.	Pūrva Āṣāḍhā	Pūrāḍam	Āpah
			21.	Uttara Āṣāḍhā	Uttirāḍam	Viśvedevas
			22.	Śravaṇa	Tiruvonum	Viṣṇu
			23.	Dhaniṣṭhā (Śraviṣṭhā)	Aviṭṭam	Vasus
			24.	Śatabhiṣaj	Sadāyam	Varuṇa
			25.	Pūrva Bhādrapadā	Pūrattādi	Aja ekapād
			26.	Uttara Bhādrapadā	Uttirattādi	Ahirbudhnya
			27.	Revatī	—	Pūṣā

GENERAL RULES FOR PŪRVAVIDDHĀ AND PARAVIDDHĀ		
Tithi	Śuklapakṣa (Bright half)	Kṛṣṇapakṣa (Dark half)
1	Pūrva (but paraviddhā for Navarātri vrata)	Para
2	Para	Pūrva
3	Para (but pūrvaviddhā for Rambhā ṛtīyā)	Para
4	Para (but pūrvaviddhā for Gaṇeśa vrata)	Para
5	Pūrva (but paraviddhā for Nāga pūjā)	Pūrva
6	Para (but pūrvaviddhā for Skanda vrata)	Para
7	Pūrva	Pūrva
8	Para (but pūrvaviddhā for Dūrvāṣṭamī)	Pūrva (but paraviddhā for Śiva and Śakti pūjā)
9	Pūrva	Pūrva
10	Para	Pūrva
11	Para	Para
12	Pūrva (but paraviddhā for Pipitakī and Akhaṇḍa dvādaśī)	Pūrva
13	Pūrva	Para
14	Para	Pūrva
15 or 30	Para (but pūrvaviddhā for Śravaṇī, Sāvitrīvrata and in Bengal generally)	Para (but pūrvaviddhā for Sāvitrī- vrata)

MUHŪRTAS		
No. of	Lord	
Muhūrta	Day	Night
1	Ārdrā	Ārdrā
2	Āśleṣā	P. Bhādrapadā
3	Anurādhā	U. Bhādrapadā
4	Maghā	Revatī
5	Dhaniṣṭhā	Aśvinī
6	Pūrvāṣāḍhā	Bharaṇī
7	Uttarāṣāḍhā	Kṛttikā
8	Abhijit	Rohiṇī
9	Rohiṇī	Mṛgaśiras
10	Jyeṣṭhā (Viśakhā)	Punarvasu
11	Viśakhā (Jyeṣṭhā)	Puṣya (Śravaṇa)
12	Mūla	Śravaṇa (Puṣya)
13	Śatabhiṣaj	Hasta
14	U. Phalgunī	Citrā
15	P. Phalgunī	Svatī

N.B.—The Lords stated in brackets are according to the Bengal rule.

Yogas and Karanas.

YOGAS			Tithi		Karaṇa	
No.	Yoga	Lord		1st half of tithi	2nd half of tithi	
1.	Viṣkambha (Viṣkumbha)	Yama	S 1	Kimstughna	Bava	
2.	Prīti	Viṣṇu	2	Bālava	Kaulava	
3.	Āyusmān	Candra	3	Taitila	Gara	
4.	Saubhāgya	Brahmā	4	Vañij	Viṣṭi	
5.	Śobhana	Brhaspati	5	Bava	Bālava	
6.	Atigaṇḍa	Candra	6	Kaulava	Taitila	
7.	Sukarmā	Indra	7	Gara	Vañij	
8.	Dhṛti	Āpaḥ	8	Viṣṭi	Bava	
9.	Śūla	Sarpa	9	Bālava	Kaulava	
10.	Gaṇḍa	Agni	10	Taitila	Gara	
11.	Vṛddhi	Sūrya	11	Vañij	Viṣṭi	
12.	Dhruva	Prthivi	12	Bava	Bālava	
13.	Vyāghāta	Pavana	13	Kaulava	Taitila	
14.	Harṣaṇa	Rudra	14	Gara	Vañij	
15.	Vajra	Varuṇa	S 15	Viṣṭi	Bava	
16.	Siddhi (Asṛk in Beng.)	Gaṇeśa	K 1	Bālava	Kaulava	
17.	Vyatipāta	Śiva	2	Taitila	Gara	
18.	Variyān	Kuvera	3	Vañij	Viṣṭi	
19.	Parigha	Viśvakarmā	4	Bava	Bālava	
20.	Śiva	Mitra	5	Kaulava	Taitila	
21.	Siddha	Kārtika	6	Gara	Vañij	
22.	Sādhya	Savitri	7	Viṣṭi	Bava	
23.	Śubha	Kamalā	8	Bālava	Kaulava	
24.	Sukla (Sukra in Beng.)	Gauri	9	Taitila	Gara	
25.	Brahma	Aśvins	10	Vañij	Viṣṭi	
26.	Indra	Pitrs	11	Bava	Bālava	
27.	Vaidhṛti	Aditi	12	Kaulava	Taitila	
			13	Gara	Vañij	
			14	Viṣṭi	Sakuni	
			K 30	Nāga	Catuṣpada	

CALCULATION OF YOGA

Yoga is calculated from the sum of the longitudes of the sun and the moon. When this sum amounts to 13° 20' the first yoga Viṣkambha ends; similarly 26° 40' marks the ending moment of the second yoga Prīti, and so on. These yogas have not been given in the calendar.

	Karaṇa	Lord
1.	Bava	Indra
2.	Bālava	Brahmā
3.	Kaulava	Mitra
4.	Taitila	Aryamā
5.	Gara	Bh
6.	Vañij	Lakṣmi
7.	Viṣṭi	Yama
	Sakuni	Kali
	Nāga	Sarpa
	Catuṣpada	Vṛṣava
	Kimstughna	Vāyu

KARANAS

In each tithi there are two karaṇas covering the two halves of the tithimāna. A karaṇa is therefore completed when the moon gains every 6° on the sun.

N.B.—As regards the sthira karaṇas, viz., the last four, the above order is according to the Sūrya Siddhānta. But later authorities have adopted the order Śakuni, Catuṣpada, Nāga and Kimstughna (or Kintughna).

ALPHABETICAL LIST OF FESTIVALS

(Arranged according to the English alphabetical order)

A

- Acalā saptamī—Māgha S 7.
 Āḍi amāvasyā (South India)—K 30 of saura Śrāvaṇa.
 Āḍi pūram (South India)—P. Phalgunī nakṣatra of saura Śrāvaṇa (see p. 106).
 Aduḥkha navamī—Bhādra S 9.
 Aghora caturdaśī—Śrāvaṇa K 14.
 Agnyutsava—Māgha S 15.
 Ahoyī aṣṭamī (Gujerat)—Āśvina K 8.
 Ajā ekādaśī—Śrāvaṇa K 11.
 Akhaṇḍa dvādaśī—Mārgaśīrṣa S 12.
 Ākhetāka trayodaśī (Orissa)—Śrāvaṇa S 13.
 Akṣaya navamī—Kārtika S 9.
 Akṣaya tṛtīyā—Vaiśākha S 3 (Special when combined with Rohiṇī and Wednesday).
 Ālocanā Gaurī vrata—Kārtika S 3.
 Āloka amāvasyā—Śrāvaṇa K 30.
 Āmalakī dvādaśī—Māgha S 12.
 Āmalakī ekādaśī—Phālguna S 11.
 Anaṅga trayodaśī—Caitra S 13.
 Ananta caturdaśī—Bhādra S 14.
 Āndolana tṛtīyā—Caitra S 3.
 Aṅgabheṭa tṛtīyā (Orissa)—Śrāvaṇa K 3.
 Anlā navamī (Orissa)—Kārtika S 9.
 Annābhīṣekam (South India)—Pūrṇimā of saura Kārtika (see p. 106).
 Annakūṭa—Kārtika S 1.
 Annapūrṇā pūjā (Bengal)—Caitra S 8.
 Annarūpā ṣaṣṭhī (Bengal)—Pauṣa S 6.
 Aparā ekādaśī—Vaiśākha K 11.
 Araṇya-Gaurī vrata—Jyaiṣṭha S 6.
 Araṇya ṣaṣṭhī—Jyaiṣṭha S 6.
 Ardhodaya yoga—(Pauṣa K 30 combined with nakṣatra Śrāvaṇa, yoga Vyatipāta & Sunday at daytime).
 Ārogya saptamī—Māgha S 7.
 Arudra darśanam (South India)—Ārdra nakṣatra of saura Pauṣa.
 Aśokāṣṭamī—Caitra S 8 (Special when combined with nakṣatra Punarvasu and Wednesday).
 Aśoka ṣaṣṭhī (Bengal)—Caitra S 6.
 Aśūnya śayana vrata—Āṣāḍha K 2, Śrāvaṇa K 2, Bhādra K 2 & Āśvina K 2.
 Āvaṇi aviṭṭam (South India)—Śrāvaṇa S 15. (see pp. 103 & 106).
 Āvaṇi mūlam (South India)—Mūla nakṣatra of saura Bhādrapada (see p. 106).
 Avidhavā navamī—Bhādra K 9.

B

- Baḍa oṣā (Orissa)—Kārtika S 14.
 Bahāg Bihu (Assam)—The day of transit of the sun into Meṣa of the religious calendar.
 Bahulā caturthī (Madhyadeśa)—Śrāvaṇa K 4.
 Balabhadra pūjā (Orissa)—Śrāvaṇa S 15.
 Balidaityarāja pūjā—Kārtika S 1.
 Bhaimī ekādaśī—Māgha S 11.
 Bharāṇī dīpam (South India)—Bharāṇī nakṣatra of saura Mārgaśīrṣa.
 Bharat Milap—Āśvina S 11.
 Bhavānī utpatti—Caitra S 8.
 Bhīṣma dvādaśī—Māgha S 12.
 Bhīṣma pañcaka—Kārtika S 11.
 Bhīṣmāṣṭamī—Māgha S 8.
 Bhogi (South India)—The day before Pongal.
 Bhrātrdvitīyā—Kārtika S 2.
 Bhūta caturdaśī—Āśvina K 14.
 Buddha dvādaśī—Śrāvaṇa S 12.
 Buddha pūrṇimā—Vaiśākha S 15.

C

- Caḍaka pūjā (Bengal)—The day (midnight ending) of transit of the sun into Meṣa of the religious calendar.
 Caitrī pūrṇimā—Caitra S 15.
 Campaka caturdaśī (Bengal)—Jyaiṣṭha S 14.
 Campaka dvādaśī (Orissa)—Jyaiṣṭha S 12.
 Campā ṣaṣṭhī—Bhādra S 6—when combined with nakṣatra Viśākha, yoga Vaidhṛti and Tuesday.
 Campā ṣaṣṭhī (Maharashtra)—Mārga. S 6 (Special when combined with nakṣatra Śatabhiṣa, yoga Vaidhṛti and Sunday).
 Candana ṣaṣṭhī (Bengal)—Vaiśākha S 6.
 Candana yātrā—Vaiśākha S 3.
 Candrabhāgā saptamī (Orissa)—Māgha S 7.
 Candra ṣaṣṭhī—Bhādra K 6.
 Carpaṭā ṣaṣṭhī (Bengal)—Bhādra S 6.
 Cāturmāsya caturdaśī (Jain)—Āṣāḍha S 14, Kārtika S 14, Phālguna S 14.
 Cāturmāsya vrata—(see p. 108).
 Caumāsī caudas (Jain)—see Cāturmāsya caturdaśī.
 Cheiraoba (Manipur)—The day of transit of the sun into Meṣa of the religious calendar.
 Chhat (Bihar)—Kārtika S 6.
 Citāu (Citālāgi) amāvasyā (Orissa)—Āṣāḍha K 30.
 Cūḍāmaṇi yoga—Cūḍāmaṇi yoga occurs when a solar eclipse takes place in a locality on Sunday or lunar eclipse on Monday night.

D

- Damanotsava—Caitra S 12.
 Dāmodara dvādaśī—Śrāvaṇa S 12.
 Dāna dvādaśī (Orissa)—Mārgaśīrṣa S 12.
 Daśaharā—Āśvina S 10. (Special when combined
 with nakṣatra Śrāvaṇa).
 Daśaharā snānārambha—Jyaiṣṭha S 1 (lasting for
 10 days).
 Daśaratha caturthī (Bengal)—Āśvina K 4.
 Dattatreyotpatti—Mārgaśīrṣa S 15.
 Devavivāha ekādaśī (Orissa)—Jyaiṣṭha S 11.
 Dhana trayodaśī—Āśvina K 13.
 Dharmarāja daśamī—Caitra S 10.
 Dipadāna—Āśvina K 14.
 Dipāvalī (Dewali)—Āśvina K 30.
 Dipāvalī amāvasyā (Orissa)—Kārtika K 30.
 Dolayātrā—Phālguna S 15.
 Dol Gyaras (Madhya Bharat)—Bhādra S 11.
 Dolotsava—Caitra S 3, Caitra S 11.
 Durgā navamī—Kārtika S 9.
 Durgā navamī (Maharashtra)—Bhādra K 9.
 Durgā pūjā (Bengal)—Āśvina S 7 to S 10.
 Durgā saptamī—Āśvina S 7
 Durgā ṣaṣṭhī—Āśvina S 6.
 Durgā śayanāṣṭamī—(Orissa)—Bhādra S 8.
 Durgāṣṭamī—S 8 of each month is called Durgāṣṭamī
 (see also p. 108).
 Dūrvāṣṭamī—Bhādra S 8 (also observed in S 8 of
 saura Bhādra except Bengal).
 Dyūta pratipad—Kārtika S 1.

G

- Gandheśvari pūjā (Bengal)—Vaiśākha S 15.
 Gaṇeśa caturthī—Bhādra S 4, Māgha S 4.
 Gaṇeśa jayanti—Māgha S 4.
 Gaṅgā daśaharā—Jyaiṣṭha S 10 (Special when
 combined with nak. Hasta, yoga Vyatīpāta,
 karaṇa Gara and Tuesday).
 Gaṅgotpatti—Vaiśākha S 7.
 Gaurī (Mysore)—Bhādra S 3.
 Gaurī tṛtīyā—Caitra S 3.
 Gaurī vrata (Orissa)—Bhādra S 3.
 Gokulāṣṭamī—Śrāvaṇa K 8.
 Gopadma vratārambha—Āṣāḍha S 12.
 Gopāṣṭamī—Kārtika S 8.
 Gorūpiṇī ṣaṣṭhī (Bengal)—Phālguna S 6.
 Goṣṭhāṣṭamī—Kārtika S 8.
 Govardhana pūjā—Kārtika S 1.
 Govatsa dvādaśī—Āśvina K 12.
 Govinda dvādaśī—Phālguna S 12 when combined
 with Puṣya nakṣatra.
 Guha ṣaṣṭhī—Mārgaśīrṣa S 6.
 Guru pañcamī (Orissa)—S 5 of any month falling on
 Thursday.
 Guru pūrṇimā—Āṣāḍha S 15.

H

- Hala ṣaṣṭhī—Śrāvaṇa K 6.
 Hanumat janmadina—Āśvina K 14.
 Hanumat jayanti—Caitra S 15.
 Hariśayani ekādaśī—Āṣāḍha S 11.
 Haritalī caturthī—S 4 of saura Bhādra.
 Haritalikā vrata—Bhādra S 3.
 Hayagrivotpatti—Śrāvaṇa S 15.
 Heikra Hitomba (Manipur)—Bhādra S 11.
 Herā pañcamī (Orissa)—Āṣāḍha S 6.
 Holi—Day after Holikādahana.
 Holikādahana—Phālguna S 15.

I

- Indirā ekādaśī—Bhādra K 11.
 Indra-Govinda pūjā (Orissa)—Bhādra S 15.

J

- Jagaddhātṛī pūjā (Bengal)—Kārtika S 9.
 Jāgratgaurī pañcamī (Orissa)—Śrāvaṇa S 5.
 Jāhnu saptamī—Vaiśākha S 7
 Jalakṛīḍā ekādaśī (Orissa)—Vaiśākha K 11.
 Janmāṣṭamī—Śrāvaṇa K 8.
 Jayā ekādaśī—Māgha S 11.
 Jayanti—(see p. 107).
 Jhulanayātrā—Śrāvaṇa S 11.
 Jhulanayātrā samāpana—Śrāvaṇa S 15.
 Jīmūtavāhana pūjā—Bhādra K 8.
 Jitāṣṭamī—Bhādra K 8.
 Jñāna pañcamī (Jain)—Kārtika S 5.

K

- Kajjali tṛtīyā—Śrāvaṇa K 3.
 Kālabhairava jayanti—Kārtika K 8.
 Kālāṣṭamī—Kārtika K 8.
 Kālī pūjā—Āśvina K 30.
 Kāliyadalana ekādaśī (Orissa)—Śrāvaṇa K 11.
 Kalki dvādaśī—Bhādra S 12.
 Kalpādi—(see p. 107).
 Kāmādā ekādaśī—Caitra S 11.
 Kamalā ekādaśī—K 11 of a malamāsa.
 Kāmikā ekādaśī—Āṣāḍha K 11.
 Kañjī Anlā navamī (Orissa)—Kārtika K 9.
 Kapilā ṣaṣṭhī—Bhādra K 6 when combined with
 nakṣatra Rohiṇī, yoga Vyatīpāta, Sun in
 Hasta and Tuesday.
 Karaka caturthī—Āśvina K 4.
 Karāṣṭamī (Maharashtra)—Āśvina K 8.
 Kardama ṣaṣṭhī (Bengal)—Āṣāḍha S 6.
 Karkatāka vāyu (Travancore-Cochin)—K 30 of
 saura Śrāvaṇa.

K—contd.

- Kārtika pūjā (Bengal)—The day of transit of the sun into Vṛścika of the religious calendar.
 Kārtiki pūrṇimā—Kārtika S 15.
 Kāveri Saṁkramaṇa (Coorg)—The day of transit of the sun into Tulā of the religious calendar.
 Kedāra vrata—(Orissa)—Kārtika S 15.
 Ker pūjā (Tripura)—First Tuesday or Saturday after 14 days from Khārci pūjā.
 Kethār Gaurī vrata (South India)—Āśvina K 30.
 Khārci pūjā (Tripura)—Āṣāḍha S 8.
 Kojāgarī Lakṣmī pūrṇimā—Āśvina S 15.
 Kokilā vrata—Āṣāḍha S 15.
 Kṛttikā dipam (S. India)—Kṛttikā nakṣatra of saura Mārgaśīrṣa.
 Kumāra pūrṇimā (Orissa)—Āśvina S 15.
 Kumāra ṣaṣṭhī—Āṣāḍha S 6.
 Kumbha yoga—(see p. 108).
 Kunda caturthī—Māgha S 4.
 Kūrma dvādaśī—Pauṣa S 12.
 Kuśa grahaṇa—Śrāvaṇa K 30.

L

- Lakṣmīnārāyaṇa ekādaśī (Orissa)—S 11 of any month falling on Thursday.
 Lakṣmī pañcamī (Śrī pañcamī)—Caitra S 5.
 Lalitā saptamī (Bengal & Orissa)—Bhādra S 7.
 Lolārka ṣaṣṭhī—Bhādra S 6.
 Luṅṭhaṇa ṣaṣṭhī (Bengal)—Śrāvaṇa S 6.

M

- Madana bhañjī (Bengal & Orissa)—Caitra S 14.
 Madana dvādaśī—Caitra S 12.
 Madana pañcamī—Māgha S 5.
 Madhu-kr̥ṣṇā trayodaśī—Phālguna K 13.
 Madhuśravā (Gujerat)—Śrāvaṇa S 3.
 Maghā trayodaśī—Bhādra K 13 when combined with Maghā nakṣatra.
 Māgh Bihu (Assam)—The day of transit of the sun into Makara of the religious calendar.
 Māghī pūrṇimā—Māgha S 15.
 Mahādeva vivāha (Orissa)—Jyaiṣṭha S 5.
 Mahālakṣmī pūjā—Āśvina K 30.
 Mahālakṣmī vrata—Bhādra S 8 to Bhādra K 8.
 Mahālayā amāvasyā—Bhādra K 30.
 Mahālayārambha—Bhādra K 1.
 Mahā māghī—Māgha S 15, with Jupiter and Moon in nakṣatra Maghā, Sun in Śrāvaṇa and Saturn in Meṣa.
 Mahānandā navamī—Māgha S 9.
 Mahānavamī—Āśvina S 9.
 Mahāśivarātri—Māgha K 14.
 Mahāṣṭamī—Āśvina S 8.
 Mahāvīra jayantī (Jain)—Caitra S 13.
 Mahāvīra nirvāṇa—(Jain)—Āśvina K 30.
 Makara vavū (T. C. State)—K 30 of saura Māgha.

M—contd.

- Makarādi snāna—The day of transit of the sun into Makara of the religious calendar.
 Māmsaṣṭakā—Pauṣa K 8.
 Māna caturthī (Bengal & Orissa)—Āśvina S 4.
 Manasā pūjā (Bengal)—Saura Śrāvaṇa (see p. 106).
 Manoratha dvitīyā—Āṣāḍha S 2.
 Manthāna ṣaṣṭhī (Bengal)—Bhādra S 6.
 Manvādi—(see p. 107).
 Māśī magham (South India)—Maghā nakṣatra of saura Phālguna (also observed on the pūrṇimā day).
 Masyādhāra pūjā (Bihar)—Kārtika S 2.
 Mātṛ navamī—Bhādra K 9.
 Matsya dvādaśī—Mārgaśīrṣa S 12.
 Mattu Pongal (South India)—The day after Pongal.
 Mauna ekādaśī (Jain)—Mārgaśīrṣa S 11.
 Maunī amāvasyā (Uttar Pradesh)—Pauṣa K 30.
 Meru trayodaśī (Jain)—Pauṣa K 13.
 Mitra saptamī—Mārgaśīrṣa S 7.
 Mohinī ekādaśī—Vaiśākha S 11.
 Mokṣadā ekādaśī—Mārgaśīrṣa S 11.
 Muktabharaṇa vrata—Bhādra S 7.
 Mūlakarūpiṇī ṣaṣṭhī—Mārgaśīrṣa S 6.
 Mūlāṣṭamī (Orissa)—Bhādra K 8.

N

- Nāḍī ṣaṣṭhī (Bengal)—Kārtika S 6.
 Nāga caturthī—Kārtika S 4.
 Nāga pañcamī (1st)—Śrāvaṇa S 5.
 Nāga pañcamī (2nd)—Mārgaśīrṣa S 5.
 Nāga pañcamī (Bengal)—Āṣāḍha K 5.
 Nandā navamī—Bhādra S 9.
 Naraka caturdaśī—Āśvina K 14.
 Nārāyaṇa dvādaśī—Kārtika S 12.
 Nārolī pūrṇimā—Śrāvaṇa S 15.
 Nata pañcamī (Orissa)—Āśvina S 5.
 Navarātrārambha—Caitra S 1, Āśvina S 1.
 Nirjalā ekādaśī—Jyaiṣṭha S 11.
 Nṛsimha caturdaśī—Vaiśākha S 14 (Special when combined with nakṣatra Svātī, yoga Siddha and Saturday).
 Nṛsimha dvādaśī—Phālguna S 12.

O

- Oli beginning (Jain)—Caitra S 7, Āśvina S 7 (8 days before pūrṇimā).
 Oli ending (Jain)—Caitra S 15, Āśvina S 15.
 Onam day (South India)—Śrāvaṇa nakṣatra of solar Bhādrapada.

P

- Padmanābha dvādaśī—Āśvina S 12.
 Padminī ekādaśī—S 11 of a malamāsa.
 Pakṣavardhīṇī mahādvādaśī—When 15th tithi or 30th tithi is current at sunrise on two successive days, the dvādaśī first preceding is called Pakṣavardhīṇī mahādvādaśī.

P—contd.

- Pañcarātra Śrī Kṛṣṇa jayanti—Rohiṇī nakṣatra of saura Bhādrapada.
 Paṅguni uttiram (South India)—U. Phalguni nakṣatra of saura Caitra, also observed in Pūrṇimā of saura Caitra (see p. 106).
 Pāpamocanī ekādaśī—Phālguna K 11.
 Paraśurāma dvādaśī—Vaiśākha S 12.
 Paraśurāma jayanti—Vaiśākha S 3.
 Paraśurāmāṣṭamī (Orissa)—Āṣāḍha S 8.
 Pārśva or Parivartanī ekādaśī—Bhādra S 11.
 Paryuṣaṇa parvārambha (Jain-pañcamī pakṣa)—Śrāvaṇa K 12.
 Pāṣāṇa caturdaśī (Bengal & Orissa)—S 14 of saura Mārgaśīrṣa.
 Pāśāṅkuśā (pāpāṅkuśā) ekādaśī—Āśvina S 11.
 Pauṣa daśamī (Jain)—Mārgaśīrṣa K 10.
 Phagu daśamī (Orissa)—Phālguna S 10.
 Phalahāriṇī Kālikā pūjā (Bengal)—Vaiśākha K 30.
 Phuladola (Bengal & Orissa)—Vaiśākha S 15.
 Pipitaki dvādaśī (Bengal)—Vaiśākha S 12.
 Pithori amāvasyā—Śrāvaṇa K 30.
 Pongal (South India)—The day of transit of the sun into Makara of the religious calendar.
 Prabodhanī ekādaśī—Kārtika S 11.
 Prabodhanotsava—Kārtika S 12.
 Prathamāṣṭamī (Orissa)—Kārtika K 8.
 Prāvaraṇa ṣaṣṭhī (Orissa)—Mārgaśīrṣa S 6.
 Punaryātrā—Āṣāḍha S 10 (9th day from Rathayātrā).
 Pūpāṣṭakā—Mārgaśīrṣa K 8.
 Puskar Fair (Ajmer)—Kārtika S 15.
 Puṣyābhīṣekayātrā—Pauṣa S 15 (Special when combined with Puṣya nakṣatra).
 Putradā ekādaśī—Śrāvaṇa S 11, Pauṣa S 11.

R

- Rādhāṣṭamī—Bhādra S 8.
 Rākhī pūrṇimā—Śrāvaṇa S 15.
 Rakṣā bandhana—Śrāvaṇa S 15.
 Rakṣā pañcamī (Bengal)—Bhādra S 5.
 Rakṣā pañcamī (Orissa)—Śrāvaṇa K 5.
 Ramā ekādaśī—Āśvina K 11.
 Rāma jayanti—Caitra S 9.
 Rāmanavamī—Caitra S 9 (Special with Punarvasu nakṣatra).
 Rambhā trītiyā—Jyaiṣṭha S 3.
 Raṅga pañcamī—Phālguna K 5.
 Rāsayātrā—Kārtika S 15.
 Raṭanti Kālikā pūjā (Bengal)—Pauṣa K 14.
 Ratha saptamī—Māgha S 7.
 Ratha yātrā—Āṣāḍha S 2 (Special when combined with nakṣatra Puṣya).
 Rathayātrā (Jain)—Kārtika S 15.
 Ravinārāyaṇa ekādaśī (Orissa)—S 11 of any month falling on Sunday.
 Rk upākarma—Śrāvaṇa nakṣatra in the month of lunar Śrāvaṇa.

R—contd

- Rṣi pañcamī—Bhādra S 5.
 Rṣi tarpaṇa—Śrāvaṇa S 15.
 Rudra vrata—Bhādra S 1.
 Rudropavāsa—Mārgaśīrṣa S 1.
 Rukmiṇī dvādaśī—Vaiśākha S 12.

S

- Śakāṣṭakā—Māgha K 8.
 Śakrotthāna—Bhādra S 12.
 Sāmba daśamī (Orissa)—Pauṣa S 10.
 Sampat-Gaurī vrata—Vaiśākha S 15.
 Saṁvatsarī parva (Jain-caturthī pakṣa)—Bhādra S 4.
 Saṁvatsarī parva (Jain-pañcamī pakṣa)—Bhādra S 5.
 Śāṅkara jayanti—Vaiśākha S 5.
 Śānta caturthī—Phālguna S 4.
 Santāna dvādaśī—Māgha S 12.
 Saphalā ekādaśī—Mārgaśīrṣa K 11.
 Saptapuri amāvasyā (Orissa)—Śrāvaṇa K 30.
 Sarasvatī balidāna—in U. Āṣāḍhā nakṣatra of lunar Āśvina śuklapakṣa.
 Sarasvatī pūjā—in P. Āṣāḍhā nakṣatra of lunar Āśvina śuklapakṣa.
 Sarasvatī pūjā (Bengal & Orissa)—Māgha S 5.
 Sarasvatī sthāpana—in Mūla nakṣatra of lunar Āśvina śuklapakṣa.
 Sarasvatī visarjana—in Śrāvaṇa nakṣatra of lunar Āśvina śuklapakṣa.
 Sarhul (Bihar)—Caitra S 3.
 Śarkarā saptamī—Vaiśākha S 7.
 Śastrāhata caturdaśī—Āśvina K 14.
 Ṣaṭtilā ekādaśī—Pauṣa K 11.
 Saubhāgya caturthī (Bengal)—Bhādra S 4.
 Saubhāgya śayana vrata—Caitra S 3.
 Sāvitrī amāvasyā (Orissa)—Vaiśākha K 30.
 Sāvitrī caturdaśī (Bengal)—Vaiśākha K 14.
 Sayana ekādaśī—Āṣāḍha S 11.
 Sītālā saptamī—Śrāvaṇa K 7.
 Sītālā saptamī (Orissa)—Āṣāḍha K 7.
 Sītālā ṣaṣṭhī (Bengal)—Māgha S 6.
 Sītālā ṣaṣṭhī yātrā (Orissa)—Jyaiṣṭha S 6.
 Sītālāṣṭamī—Phālguna K 8.
 Sītā navamī (Bengal & Orissa)—Vaiśākha S 9.
 Sītāṣṭamī—Māgha K 8.
 Śiva damanaka caturdaśī (Orissa)—Caitra S 14.
 Śiva pavitrāropanam (Orissa)—Śrāvaṇa S 14.
 Śivarātri—K 14 of each month is called Śivarātri, Māgha K 14 (see also p. 108).
 Śiva śayana caturdaśī (Orissa)—Āṣāḍha S 14.
 Śayanotsava—Āṣāḍha S 15.
 Skanda pañcamī—Āṣāḍha S 5.
 Skanda ṣaṣṭhī (Orissa)—Caitra S 6.
 Skanda ṣaṣṭhī—Jyaiṣṭha S 6, Mārgaśīrṣa S 6.
 Skanda ṣaṣṭhī (Madras)—Kārtika S 6.
 Skanda ṣaṣṭhī (Bengal)—Phālguna K 6.

S—contd.

- Snāna yātrā (Bengal & Orissa)—Jyaiṣṭha S 15.
 Somanātha vrata (Orissa)—Bhādra S 6.
 Somanātha vrata samāpana (Orissa)—Āśvina S 10.
 Śravaṇa dvādaśī—Bhādra S 12, when combined
 with nakṣatra Śravaṇa.
 Śrī Jayantī (S. India)—K 8 of solar Bhādrapada
 (see also p. 106).
 Śrī Kṛṣṇa dvādaśī—Āśāḍha S 12.
 Śrī pañcamī—Māgha S 5, Caitra S 5 (Lakṣmī).
 Śrī Rāma dvādaśī—Jyaiṣṭha S 12.
 Sudaśā vrata (Orissa)—S 10 of any month falling
 on Thursday.
 Sūrya pūjā (Orissa)—Pauṣa S 10.
 Sūrya ṣaṣṭhī—Bhādra S 6, Kārtika S 6.

T

- Tāla navamī (Bengal & Orissa)—Bhādra S 9.
 Tapah ṣaṣṭhī (Orissa)—Āśvina S 6.
 Thai amāvasyā (S. India)—K 30 of saura Māgha
 (see p. 106).
 Thai pūṣam—Puṣya nakṣatra of saura Māgha
 (see p. 106).
 Tila caturthī—Māgha S 4.
 Tila saṁkrānti—The day of transit of the sun into
 Makara of the religious calendar.
 Trilocanāṣṭamī (Bengal)—Vaiśākha K 8.
 Tripurotsava—Kārtika S 15.
 Trispr̥ṣā mahādvādaśī—When 11th, 12th & 13th
 tithis meet in an ahorātra, the dvādaśī is
 called Trispr̥ṣā mahādvādaśī (see p. 107).
 Trivenī amāvasyā (Orissa)—Pauṣa K 30.
 Tulasī vivāha—Kārtika S 11.

U

- Umā caturthī (Bengal & Orissa)—Jyaiṣṭha S 4.
 Unmilānī mahādvādaśī—When 11th tithi is current
 at sunrise on two successive days, the
 second day is called Unmilānī mahādvādaśī.
 Upākarma (S. India)—Śrāvaṇa S 15 (see also
 pp. 103 & 106).
 Upāṅga lalitā vrata (Maharashtra)—Āśvina S 5.
 Utpannā (Utpatti) ekādaśī—Kārtika K 11.
 Utthāna ekādaśī—Kārtika S 11.

V

- Vaikhānasa dīpam (S. India)—S 15 of saura
 Mārgaśīrṣa.
 Vaikuṅṭha caturdaśī—Kārtika S 14.
 Vaikuṅṭha ekādaśī (Vaiṣṇava) (Madras)—S 11 of
 saura Pauṣa.

V—contd.

- Vaiśākhi—The day of transit of the sun into Meṣa
 of the religious calendar.
 Vaiśākhi pūrṇimā—Vaiśākha S 15.
 Vakula amāvasyā (Orissa)—Mārgaśīrṣa K 30
 Vāmana dvādaśī—Caitra S 12.
 Vāmana jayantī—Bhādra S 12.
 Vañjulī mahādvādaśī—when 12th tithi is current
 at sunrise on two successive days the
 first day is called Vañjulī mahādvādaśī.
 Varada caturthī—Bhādra S 4.
 Varadā caturthī (Bengal & Orissa)—Māgha S 4.
 Varāha dvādaśī—Māgha S 12.
 Varalakṣmī vrata (South India)—Friday in śukla-
 pakṣa in the month of lunar Śrāvaṇa.
 Varṣītapārambha (Jain)—Phālguna K 8.
 Varṣītapa samāpana (Jain)—Vaiśākha S 3.
 Vāruṇī—Phālguna K 13, combined with nakṣatra
 Śatabhiṣaj (see p. 105).
 Varūthini ekādaśī—Caitra K 11.
 Vasanta pañcamī—Māgha S 5.
 Vāsantī pūjā (Bengal)—Caitra S 7.
 Vasantotsava—Phālguna K 1.
 Vaṭa sāvitṛī vrata—Vaiśākha K 30.
 Vaṭa sāvitṛī vrata (Deccan)—Jyaiṣṭha S 15.
 Vidhāna saptamī—Māgha S 7.
 Vijayā daśamī—Āśvina S 10.
 Vijayā ekādaśī—Māgha K 11.
 Vishu (T. C. State)—The day of transit of the
 sun into Meṣa of the religious calendar.
 Viṣṇu damanaka caturdaśī—Caitra S 14.
 Viṣṇu parivartanotsava—Bhādra S 12.
 Viṣṇu pavitrāropanam—Śrāvaṇa S 12.
 Viṣṇu śayanotsava—Āśāḍha S 12.
 Viṣṇu trirātra—Kārtika S 9.
 Viṣṇu śṛṅkhala yoga—Bhādra S 11 when combined
 with nakṣatra Śravaṇa and 12th tithi.
 Viśvakarmā pūjā (Bengal)—The day of transit
 of the sun into Kanyā of the religious
 calendar.
 Vivasvat saptamī—Āśāḍha S 7.
 Vṛndāvana dvādaśī—Kārtika S 12.
 Vyañjana dvādaśī (Orissa)—Mārgaśīrṣa S 12.
 Vyāsa pūjā—Āśāḍha S 15.

Y

- Yaju upākarma—see p. 103.
 Yama dīpadāna—Āśvina K 13.
 Yama dvitīyā—Kārtika S 2.
 Yama tarpaṇa—Pauṣa K 14.
 Yoginī ekādaśī—Jyaiṣṭha K 11.
 Yugādi—see p. 107.

Sunrise and Sunset for certain important places

(Given in Indian Standard Time)

Date	Gauhati 26°N 11'		Calcutta 22°N 35'		Banaras 25°N 20'		Madras 13°N 4'		Nagpur 21°N 9'		Delhi 28°N 39'		Bombay 18°N 58'			
	Rise	Set	Rise	Set	Rise	Set	Rise	Set	Rise	Set	Rise	Set	Rise	Set		
	h m	h m	h m	h m	h m	h m	h m	h m	h m	h m	h m	h m	h m	h m	h m	
Caitra 1 6 11 16 21 26	Mar.	22(21)	5 27	17 33	5 41	17 47	6 2	18 8	6 14	18 19	6 18	18 24	6 25	18 31	6 43	18 49
		27(26)	22	36	36	48	5 57	10	10	19	13	25	19	34	39	50
	Apr.	1(0)	16	38	31	50	52	12	7	19	9	27	14	37	35	51
		6(5)	11	40	27	52	47	15	4	20	4	28	8	39	31	52
		11(10)	6	43	22	54	41	17	6	0	20	6 0	30	6 2	42	27
16(15)	5	45	18	55	37	19	5	57	20	5 56	31	5 57	45	23	55	
Vaisākha 1 6 11 16 21 26 31	May	21	4 56	17 47	5 13	17 57	5 32	18 21	5 55	18 21	5 52	18 33	5 52	18 48	6 19	18 56
		26	52	50	10	17 59	28	24	52	22	48	35	47	51	16	57
		1	48	52	6	18 1	24	26	50	23	45	37	43	54	13	18 59
	June	6	44	55	3	4	20	29	48	24	42	39	39	18 57	10	19 1
		11	41	17 58	5 0	6	17	31	46	25	39	41	35	19 0	8	2
		16	38	18 1	4 58	8	14	34	45	26	37	43	32	3	6	4
July	21	36	3	56	10	12	37	44	27	35	45	30	6	4	6	
	26	33	8	53	15	9	41	43	30	33	49	26	11	2	10	
	31	32	10	53	17	9	44	43	32	33	51	25	13	2	12	
Jyāishtha 5 10 15 20 25 30	June	5	32	10	53	17	9	44	43	32	33	51	25	13	2	12
		10	32	13	53	19	9	46	43	33	33	53	25	16	2	13
		15	32	14	53	20	9	48	44	35	33	55	25	18	3	15
		20	33	16	54	22	10	49	45	36	34	56	26	19	4	16
		25	33	16	54	22	10	49	45	36	34	56	26	19	4	16
Āṣāḍha 4 9 14 19 24 29	July	25	4 34	18 17	4 55	18 23	5 11	18 50	5 46	18 37	5 35	18 57	5 27	19 8	6 3	19 8
		30	36	17	56	23	12	51	47	38	37	58	29	21	6	18
		5	37	17	58	24	14	51	49	38	38	58	30	21	8	18
		10	39	17	5 0	23	16	50	50	38	40	58	33	20	9	18
		15	42	16	2	23	18	49	51	38	42	57	35	19	11	18
20	44	14	4	21	21	48	53	38	44	56	38	17	13	17		
Śrāvana 3 8 13 18 23 28	Aug.	25	4 47	18 12	5 6	18 20	5 23	18 46	5 54	18 37	5 46	18 54	5 40	19 15	6 15	19 16
		30	49	10	8	17	25	43	55	36	48	52	43	12	16	14
		4	51	7	10	15	28	40	56	34	50	50	46	8	18	12
		9	54	18 3	12	12	30	37	57	32	51	47	49	5	20	9
		14	56	17 59	14	8	32	33	58	30	53	44	51	19 0	21	6
19	4 59	55	16	4	34	29	58	27	55	40	54	18 56	22	19 3		
Bhādra 2 7 12 17 22 27	Sept.	24	5 1	17 50	5 18	18 0	5 37	18 24	5 59	18 24	5 56	18 36	5 57	18 51	6 24	18 59
		29	3	45	19	17	56	39	19	59	21	58	32	5 59	45	25
		3	5	40	21	51	41	14	59	17	5 59	27	6 2	40	25	51
		8	7	35	22	46	42	9	59	15	6 0	23	4	34	26	47
		13	9	29	24	42	44	18 4	59	11	1	18	6	28	27	43
18	11	24	25	36	46	17 58	59	7	3	13	9	22	28	38		
Āṣvina 1 6 11 16 21 26	Oct.	23	5 13	17 18	5 27	17 31	5 48	17 53	5 59	18 4	6 4	18 9	6 11	18 16	6 29	18 34
		28	15	13	28	27	50	48	6 0	18 0	5	18 4	14	10	30	29
		3	18	7	30	22	52	42	0	17 57	7	17 59	16	18 4	31	25
		8	20	17 2	32	17	54	37	0	54	8	55	19	17 59	32	21
		13	22	16 57	33	12	57	34	0	50	10	50	22	53	33	17
18	25	52	35	8	5 59	27	1	48	11	46	25	48	35	13		
Kārtika 1 6 11 16 21 26	Nov.	23	5 28	16 47	5 38	17 4	6 2	17 23	6 2	17 45	6 14	17 43	6 23	17 43	6 37	18 10
		28	31	43	40	17 1	5	19	3	43	16	39	31	39	38	7
		2	34	40	43	16 58	8	16	4	41	18	36	35	35	40	4
		7	37	36	46	55	11	12	6	40	21	34	39	31	43	2
		12	41	34	49	53	14	10	8	38	24	32	42	28	45	18 0
17	44	32	52	51	18	8	10	38	27	31	46	26	48	17 59		
Agrahā 1 6 11 16 21 26	Dec.	22	5 48	16 30	5 55	16 50	6 21	17 7	6 12	17 38	6 30	17 30	6 50	17 24	6 51	17 59
		27	52	30	5 59	50	25	6	15	38	33	29	54	23	54	59
		2	55	29	6 2	50	29	6	17	39	36	30	6 58	23	6 57	17 59
		7	5 59	30	5	50	32	6	20	40	39	30	7 2	23	7 0	18 0
		12	6 2	31	8	52	35	7	23	42	43	32	5	24	3	1
17	5	33	11	53	39	9	26	44	46	34	9	25	6	3		
Pauṣa 1 6 11 16 21 26	Jan.	22	6 8	16 34	6 14	16 56	6 41	17 11	6 28	17 46	6 48	17 36	7 11	17 27	7 9	18 5
		27	10	37	16	16 58	43	14	30	49	50	38	14	30	11	8
		1	12	41	18	17 1	45	17	33	52	52	41	15	34	13	11
		6	13	44	20	5	47	21	35	55	54	45	16	37	15	14
		11	14	48	20	8	47	24	36	17 58	55	48	17	41	16	17
16	14	51	21	12	47	28	37	18 0	55	51	17	45	16	20		
Māgha 1 6 11 16 21 26	Feb.	21	6 13	16 55	6 20	17 15	6 47	17 32	6 37	18 3	6 55	17 55	7 16	17 49	7 16	18 24
		26	12	16 59	19	18	45	35	37	5	54	17 57	14	53	16	26
		31	10	17 3	18	22	43	39	37	8	53	18 1	12	17 57	15	30
		5	7	7	16	25	41	43	36	10	51	4	9	18	1	32
		10	4	10	13	28	38	46	35	12	49	7	6	5	11	35
15	6 1	14	10	31	35	50	33	13	46	10	7 2	9	9	37		
Phālguna 1 6 11 16 21 26	Mar.	20	5 57	17 17	6 7	17 34	6 31	17 53	6 31	18 15	6 43	18 12	6 57	18 13	7 6	18 39
		25	53	20	6 3	36	27	56	29	16	39	15	53	16	7 3	41
		2(1)	48	23	5 59	39	22	17 58	26	16	36	17	48	20	6 59	43
		7(6)	43	26	55	41	18	18 1	23	17	31	18	42	23	56	45
		12(11)	38	28	50	43	13	3	20	18	27	20	37	26	52	46
17(16)	33	31	46	45	8	8	17	18	23	22	30	28	48	47		
22(21)	5 27	17 33	5 41	17 46	6 2	18 8	6 14	18 19	6 18	18 23	6 25	18 31	6 43	18 49		

Note.—The timings of sunrise and sunset relate to the appearance of the centre of the sun on the horizon as affected by refraction.

LIST OF HOLIDAYS

Lists of Holidays for the five years from 1954-55 (Śaka 1876) to 1958-1959 (Śaka 1880) have been prepared on the basis of the Reformed Calendar and are given below. The festivals have been arranged according to the Indian year which starts from March 22 (or 21) the day after the vernal equinox, and ends with March 21 (or 20) next year of the English calendar. The holidays have been shown by the dates of the English calendar which can easily be converted into the dates of our Indian calendar.

Two new holidays, viz., Indian New Year's day (March 22 or 21) and Mahāviṣuva day or Year-ending day (March 21 or 20), have been suggested for observance as all-India holidays, and the New-Year's days of different States so long observed on different dates have been omitted. All the holidays observed in different States have been included in the lists, as far as possible, except those of Jews and a few holidays of some States for which the criterion was not available. The festivals of Hindus (including Sikhs and Jains) have been given in the general tables and those of Moslems and Christians have been shown separately.

CONSOLIDATED LIST OF HOLIDAYS FOR ALL STATES OF INDIA

A.-Fixed Holidays and Solar Festivals

Festivals	States having holidays	Criterion	1954-55	1955-56	1956-57	1957-58	1958-59
			Śaka 1876	Śaka 1877	Śaka 1878	Śaka 1879	Śaka 1880
1. Indian New Year's Day*	Govt. of India and all States		Mar. 22	Mar. 22	Mar. 21	Mar. 22	Mar. 22
2. Vaiśākhi	Govt. of India, East Punjab, Jammu & Kashmir, Mysore, PEPSU, Ajmer, Bhopal, Bilaspur, Delhi and Himachal Pradesh	Day of transit of the Sun in Meṣa of the religious calendar	Apr. 13	Apr. 13	Apr. 13	Apr. 13	Apr. 13
3. Cheiraoba	Manipur	Day of transit of the Sun in Meṣa of the religious calendar	Apr. 13	Apr. 14	Apr. 13	Apr. 13	Apr. 13
Bahag Bihu	Assam		"	"	"	"	"
Vishu	Travancore-Cochin		"	"	"	"	"
Meṣa saṁkrānti	W. Bengal & Tripura		"	"	"	"	"
4. Tilak Commemoration day	Madhya Pradesh	Fixed	Aug. 1	Aug. 1	Aug. 1	Aug. 1	Aug. 1
5. Independence Day	Govt. of India and all States	Fixed	Aug. 15	Aug. 15	Aug. 15	Aug. 15	Aug. 15
6. Keil Muhurth	Coorg	Fixed	Sep. 3	Sep. 3	Sep. 3	Sep. 3	Sep. 3
7. H. H. Birthday	Bhopal	Fixed	Sep. 9	Sep. 9	Sep. 9	Sep. 9	Sep. 9
8. Samādhi day of Nārāyaṇa Guru	Travancore-Cochin	Fixed	Sep. 21	Sep. 21	Sep. 21	Sep. 21	Sep. 21
9. Mahatma Gandhi's Birthday.	Govt. of India and all States	Fixed	Oct. 2	Oct. 2	Oct. 2	Oct. 2	Oct. 2
10. Kāveri saṁkramaṇa	Coorg	Day of transit of the Sun in Tulā of the religious calendar	Oct. 17	Oct. 17	Oct. 16	Oct. 17	Oct. 17
11. Death Anniversary of Lala Lajpat Rai	East Punjab	Fixed	Nov. 17	Nov. 17	Nov. 17	Nov. 17	Nov. 17
12. H. H. Birthday	PEPSU	Fixed	Jan. 7	Jan. 7	Jan. 7	Jan. 7	Jan. 7

* Proposed all-India holiday.

REPORT OF THE CALENDAR REFORM COMMITTEE

CONSOLIDATED LIST OF HOLIDAYS

A.—Fixed Holidays and Solar Festivals—contd.

Festivals	States having holidays	Criterion	1954-55 Śaka 1876	1955-56 Śaka 1877	1956-57 Śaka 1878	1957-58 Śaka 1879	1958-59 Śaka 1880
13. Baba Ala Singhji's day	PEPSU	Fixed	Jan. 8	Jan. 8	Jan. 8	Jan. 8	Jan. 8
14. Bhogi	Madras	Day before Pongal	Jan. 13	Jan. 13	Jan. 12	Jan. 13	Jan. 13
15. Pongal	Madras	Day of transit of the Sun in Makara of the religious calendar	Jan. 14	Jan. 14	Jan. 13	Jan. 14	Jan. 14
Tai Pongal	Travancore-Cochin.	"	"	"	"	"	"
Māghī	PEPSU, Himachal Pradesh	"	"	"	"	"	"
Māgh Bihu	Assam	"	"	"	"	"	"
Makarādi	Rajasthan, Saurashtra, Coorg, Kutch, Manipur, and Vindhya Pradesh	"	"	"	"	"	"
Tila Saṅkr̥ti	Hyderabad, Madhya Bharat and Bhopal	"	"	"	"	"	"
16. Maṭṭu Pongal	Madras	Day after Pongal	Jan. 15	Jan. 15	Jan. 14	Jan. 15	Jan. 15
17. Netaji's Birthday	West Bengal	Fixed	Jan. 23	Jan. 23	Jan. 23	Jan. 23	Jan. 23
18. Republic Day	Govt. of India and all States	Fixed	Jan. 26	Jan. 26	Jan. 26	Jan. 26	Jan. 26
19. H. Swatantra Divas	Himachal Pradesh	Fixed	Feb. 18	Feb. 18	Feb. 18	Feb. 18	Feb. 18
20. Mahāviṣuva day* (Year-ending day) Nauroj.	Govt. of India and all States		Mar. 21	Mar. 20	Mar. 21	Mar. 21	Mar. 21

* Proposed all-India holiday.

N.B. The holidays of Madras include those of the newly formed Andhra State.

CONSOLIDATED LIST OF HOLIDAYS

B.-Lunar Festivals

Festivals	States having holidays	Criterion Lunar (Mukhya) Month & Tithi	Dates of Festivals				
			1954-55 Śaka 1876	1955-56 Śaka 1877	1956-57 Śaka 1878	1957-58 Śaka 1879	1958-59 Śaka 1880
1. Vijaya Govindaji Halenkar	Manipur	Phālguna K 5	Mar. 24, 1954 Mar. 13, 1955	—	Mar. 31, 1956 Mar. 20, 1957	Mar. 10, 1958	—
2. Vāruṇī	Manipur	Phālguna K 13 with Śatabhiṣaj nakṣatra	Apr. 1	Mar. 22, 1955	Apr. 8	Mar. 29, 1957 Mar. 18, 1958	—
3. Sthāpana Navarātra	Bombay, Jammu & Kashmir, Madhya Bharat and Rajasthan	Caitra S 1	Apr. 4	Mar. 24, 1955	Apr. 12	Apr. 1, 1957 Mar. 21, 1958	—
4. Sarhul	Bihar	Caitra S 3	Apr. 6	Mar. 26	Apr. 13	Apr. 3	Mar. 23
5. Rāmanavami	Govt. of India and all States <i>except</i> Assam, Madras, Orissa, West Bengal, Travancore- Cochin, Coorg, Manipur and Tripura	Caitra S 9	Apr. 11	Apr. 1	Apr. 19	Apr. 8	Mar. 29
6. Mahāvira Jayanti	All States <i>except</i> Assam, Madras, Orissa, West Bengal, Mysore, Travancore - Cochin, Bilaspur, Coorg, Hima- chal Pradesh, Manipur and Tripura	Caitra S 13	Apr. 15	Apr. 5	Apr. 23	Apr. 12	Apr. 2
7. Oli ends (Jain)	Bombay, Rajasthan and Saurashtra	Caitra S 15	Apr. 18	Apr. 7	Apr. 25	Apr. 14	Apr. 4
8. Tithi of Deva Dāmodara	Assam	S 1 of Saura Vaiśākha	May 3	Apr. 23	May 11	Apr. 30	Apr. 19
9. Akṣaya Tṛtīya	Manipur	Vaiśākha S 3	May 5	Apr. 25	May 13	May 2	Apr. 22
10. Buddha Pūrṇimā Buddha Jayanti	Govt. of India, Assam, Bihar, Uttar Pradesh, Jammu & Kashmir, Rajasthan, Ajmer, Bhopal and Bilaspur	Vaiśākha S 15	May 17	May 6	May 24	May 13	May 3
11. Pratap Jayanti	Rajasthan	Jyaiṣṭha S 3	June 3	May 24	June 11	June 1	May 21
12. Guru Arjun Dev's Martyrdom Day	East Punjab and PEPSU	Jyaiṣṭha S 4	June 4	May 25	June 12	June 2	May 22
13. Daśaharā	West Bengal	Jyaiṣṭha S 10	June 11	May 31	June 17	June 7	May 28
14. Nirjalā (Bhīm) Agiaras	Kutch	Jyaiṣṭha S 11	June 12	June 1	June 18	June 8	May 29
15. Rathayātrā	West Bengal, Orissa and Manipur	Āṣāḍha S 2	July 2	June 21	July 9	June 29	June 19
16. Khārci pūjā	Tripura	Āṣāḍha S 8	July 8	June 27	July 15	July 4	June 24
17. Punaryātrā	West Bengal, Orissa and Manipur	9th day from Rathayātrā	July 10	June 29	July 17	July 7	June 27
18. H. H. Maharaja's Birthday	Mysore	Āṣāḍha K 6	July 21	July 11	July 29	July 18	July 7

CONSOLIDATED LIST OF HOLIDAYS

B.-Lunar Festivals—contd.

Festivals	States having holidays	Criterion Lunar (Mukhya) Month & Tithi	Dates of Festivals				
			1954-55 Śaka 1876	1955-56 Śaka 1877	1956-57 Śaka 1878	1957-58 Śaka 1879	1958-59 Śaka 1880
19. Ker pūjā	Tripura	First Tuesday or Saturday after 14 days from Khārci pūjā.	July 24	July 12	July 31	July 20	July 8
20. Karkāṭaka Vavu	Travancore-Cochin	K 30 of Saura Śrāvāṇa	July 29	July 19	Aug. 6	July 27	Aug. 15
21. Nāga Pañcamī	Mādhya Pradesh	Śrāvāṇa S 5	Aug. 3	July 24	Aug. 10	July 31	Aug. 19
22. Jhulanayātrā	West Bengal & Manipur	Śrāvāṇa S 11	Aug. 10	July 30	Aug. 17	Aug. 6	Aug. 25
23. Rakṣā Bandhana	Mādhya Pradesh, Uttar Pradesh, Hyderabad, Jammu & Kashmir, Mādhya Bharat, Raja- sthān, Ajmer, Bhopal, Himachal Pradesh and Vindya Pradesh	Śrāvāṇa S 15	Aug. 14	Aug. 3	Aug. 21	Aug. 10	Aug. 29
Soleno	PEPSU and Delhi	"	"	"	"	"	"
Cocoanut Day	Bombay, Saurasthra and Kutch	"	"	"	"	"	"
Upākarma	Mysore and Coorg	"	"	"	"	"	"
Āvaṇi Avittam	Travancore-Cochin	"	Aug. 14	Aug. 3	Aug. 21	Aug. 10	Aug. 28
24. Āvaṇi Avittam	Madras	—	Aug. 14	Sep. 1	Aug. 21	Sep. 7	Aug. 28
25. Tithi of Śrī Mādhava Deva	Assam	K 5 of Saura Bhādra	Aug. 18	Sep. 6	Aug. 26	Sep. 14	Sep. 3
26. Śītalā Saptamī (Shili satam)	Saurashtra and Kutch	Śrāvāṇa K 7	Aug. 20	Aug. 10	Aug. 28	Aug. 17	Sep. 5
27. Janmāṣṭamī, Gokulā- ṣṭamī, Śrī Kṛṣṇa jayanti	Govt. of India and all States <i>except</i> Assam, Madras, Mysore, West Bengal, Orissa and Travancore-Cochin	Śrāvāṇa K 8	Aug. 21	Aug. 11	Aug. 29	Aug. 19	Sep. 6
Janmāṣṭamī	West Bengal and Orissa	"	"	Aug. 10	"	Aug. 18	"
Janmāṣṭamī	Assam	K 8 of Saura Bhādra	Aug. 21	Sep. 9	Aug. 29	Aug. 19	Sep. 6
Śrī Jayanti	Madras	"	"	"	"	"	"
Aṣṭamī Rohiṇī	Travancore-Cochin	K 8 of Saura Bhādra with Rohiṇī nak- ṣatra	"	"	"	"	"
28. Jain Festival	Bombay and Saurashtra	Śrāvāṇa K 13	Aug. 26	Aug. 15	Sep. 3	Aug. 23	Sep. 11
29. Jain Festival	Bombay and Saurashtra	Śrāvāṇa K 30	Aug. 28	Aug. 17	Sep. 4	Aug. 25	Sep. 13
30. Tithi of Śrī Śaṅkara Deva	Assam	S 2 of Saura Bhādra	Aug. 30	Aug. 19	Sep. 6	Aug. 27	Sep. 15
31. Gaurī Festival	Mysore	Bhādra S 3	Aug. 31	Sep. 19	Sep. 7	Aug. 27	Sep. 16

CONSOLIDATED LIST OF HOLIDAYS

B.-Lunar Festivals—contd.

Festivals	States having holidays	Criterion Lunar (Mukhya) Month & Tithi	Dates of Festivals				
			1954-55 Śaka 1876	1955-56 Śaka 1877	1956-57 Śaka 1878	1957-58 Śaka 1879	1958-59 Śaka 1880
32. Gaṇeśa Caturthī, Vināyaka Caturthī	Bombay, Madhya Pradesh, M a d r a s, Hyderabad, Madhya Bharat, Mysore, Rajasthan, Saurashtra, Travancore-Cochin Bhopal, Coorg and Kutch	Bhādra S 4	Sep. 1	Sep. 19	Sep. 8	Aug. 28	Sep. 16
Gaṇeśa Caturthī	Orissa	"	"	Sep. 20	"	"	"
33. Saṁvatsari and Paryuṣaṇa Parva (Jain)	Bombay, Saurashtra and Kutch	Bhādra S 5	Sep. 2	Sep. 21	Sep. 9	Aug. 29	Sep. 17
34. Rādhāṣṭamī	Manipur	Bhādra S 8	Sep. 5	Sep. 24	Sep. 12	Sep. 1	Sep. 20
35. First Onam Day	Travancore-Cochin	Day before Thiru Onam day	Sep. 9	Aug. 30	Aug. 19	Sep. 5	Aug. 26
36. Thiru Onam Day	Travancore-Cochin	Śravaṇa nakṣatra in Saura Bhādra Śukla pakṣa	Sep. 10	Aug. 31	Aug. 20	Sep. 6	Aug. 27
37. Third Onam Day	Travancore-Cochin	Day after Thiru Onam Day	Sep. 11	Sep. 1	Aug. 21	Sep. 7	Aug. 28
38. Fourth Onam Day	Travancore-Cochin	Two days after Thiru Onam Day	Sep. 12	Sep. 2	Aug. 22	Sep. 8	Aug. 29
39. Heikra Hitomba	Manipur	Bhādra S 11	Sep. 9	Sep. 27	Sep. 15	Sep. 4	Sep. 23
Dol Gyaras	Madhya Bharat	"	"	"	"	"	"
40. Ananta Caturdaśī	Hyderabad, Rajasthan, Ajmer and Delhi	Bhādra S 14	Sep. 11	Sep. 30	Sep. 18	Sep. 7	Sep. 26
41. Śrī Nārāyaṇa Guru Dev's Birthday	Madras	Śatabhiṣaj nakṣatra in saura Bhādra	Sep. 12	Sep. 2	Aug. 22	Sep. 8	Aug. 29
42. H. H. Birthday	Kutch	Bhādra K 13	Sep. 24	Oct. 13	Oct. 2	Sep. 22	Oct. 11
3. Mahālayā Amāvasyā, Pitṛ mokṣa Amāvasyā, Pitṛ Amāvasyā, Sarva Pitṛ Amāvasyā	Madhya Pradesh, Madras, Orissa, West Bengal, Jammu & Kashmir, Madhya Bharat, Mysore, Rajasthan, Coorg and Tripura	Bhādra K 30	Sep. 26	Oct. 15	Oct. 3	Sep. 23	Oct. 12
Tarpaṇa Layba (2nd day)	Manipur	"	"	"	Oct. 4	"	"
44. Commencement of Daśaharā, Sthāpana Navarātra	Mysore and Rajasthan	Āśvina S 1	Sep. 28	Oct. 16	Oct. 5	Sep. 24	Oct. 13

CONSOLIDATED LIST OF HOLIDAYS

Lunar Festivals—contd.

Festivals	States having holidays	Criterion Lunar (Mukhya) Month & Tithi	Dates of Festivals				
			1954-55 Śaka 1876	1955-56 Śaka 1877	1956-57 Śaka 1878	1957-58 Śaka 1879	1958-59 Śaka 1880
45. Durgā Pūjā	Assam, Bihar, Orissa, West Bengal, Manipur and Tripura	Āśvina S 7—10	Oct. 4-7	Oct. 23-26	Oct. 11-14	Sep. 30— Oct. 3	Oct. 19-22
Dussera	Govt. of India, East Punjab, Uttar Pradesh, PEPSU, Rajasthan, Ajmer, Bilaspur, Delhi, Himachal Pradesh and Vindhya Pradesh.	Āśvina S 7—10	Oct. 4-7	Oct. 23-26	Oct. 11-14	Sep. 30— Oct. 3	Oct. 19-21
Āyudha Pūjā	Madras	"	"	"	"	"	"
Āyudha Pūjā	Coorg	Āśvina S 7	Oct. 4	Oct. 23	Oct. 11	Sep. 30	Oct. 19
Durgāṣṭamī	Saurashtra & Travancore- Cochin	Āśvina S 8	Oct. 5	Oct. 24	Oct. 12	Oct. 1	Oct. 20
Dussera	Bhopal	"	"	"	"	"	"
Mahānavamī	Jammu and Kashmir, Mysore and Travancore- Cochin	Āśvina S 9	Oct. 6	Oct. 25	Oct. 13	Oct. 2	Oct. 20
Dussera	Hyderabad, Madhya Bharat and Bhopal	"	"	"	"	"	"
Vijayā Daśamī	Mysore, Saurashtra, and Travancore-Cochin	Āśvina S 10	Oct. 7	Oct. 26	Oct. 14	Oct. 3	Oct. 21
Dussera	Bombay, Madhya Pradesh Hyderabad, Jammu & Kashmir, Madhya Bharat, Bhopal and Kutch	"	"	"	"	"	"
46. Bharat Milap	Delhi	Āśvina S 11	Oct. 8	Oct. 27	Oct. 15	Oct. 4	Oct. 23
47. Lakṣmī Pūjā	Assam, Bihar, Orissa, West Bengal, Manipur and Tripura	Āśvina S 15	Oct. 11	Oct. 30	Oct. 19	Oct. 8	Oct. 27
Kumāra Utsava	Orissa	"	"	"	"	"	"
48. Maharṣi Vālmiki's Birthday	East Punjab, PEPSU and Himachal Pradesh	Āśvina S 15	Oct. 12	Oct. 31	Oct. 19	Oct. 8	Oct. 27
49. Dhan Teras	Saurashtra and Kutch	Āśvina K 13	Oct. 24	Nov. 11	Oct. 31	Oct. 21	Nov. 9
50. Naraka Caturdaśī, Kālī Caudas	Bombay, Mysore, Sau- rashtra and Kutch	Āśvina K 14	Oct. 25	Nov. 13	Nov. 1	Oct. 22	Nov. 10
Kālī Pūjā	Assam, West Bengal and Tripura	Āśvina K 30	Oct. 25	Nov. 13	Nov. 1	Oct. 22	Nov. 10

CONSOLIDATED LIST OF HOLIDAYS

B.-Lunar Festivals—contd.

Festivals	States having holidays	Criterion Lunar (Mukhya) Month & Tithi	Dates of Festivals				
			1954-55 Śaka 1876	1955-56 Śaka 1877	1956-57 Śaka 1878	1957-58 Śaka 1879	1958-59 Śaka 1880
51. Dipāvali, Diwali	Madhya Pradesh, Madras, East Punjab, Hyderabad and Travancore-Cochin	Āśvina K 14	Oct. 25	Nov. 13	Nov. 1	Oct. 21	Nov. 10
Dipāvali, Diwali, Dipamālikā	Govt. of India and all States <i>except</i> Assam, West Bengal, Travancore-Cochin, Bhopal and Tripura	Āśvina K 30	Oct. 26	Nov. 14	Nov. 2	Oct. 22	Nov. 10
Dipāvali, Diwali	Govt. of India, Bombay, Uttar Pradesh, Madhya Bharat, Rajasthan, Ajmer, Bhopal, Bilaspur, Himachal Pradesh and Vindhya Pradesh	Kārtika S 1	Oct. 27	Nov. 15	Nov. 3	Oct. 23	Nov. 11
Dipāvali, Diwali	Uttar Pradesh, Madhya Bharat, Rajasthan and Bhopal	Kārtika S 2	Oct. 28	Nov. 16	Nov. 4	Oct. 24	Nov. 12
52. Bali Pūjā Govardhana Pūjā	Mysore, PEPSU, Delhi and Manipur	Kārtika S 1	Oct. 27	Nov. 15	Nov. 3	Oct. 23	Nov. 11
53. Yama Dvitiyā Bhrātr Dvitiyā Dwāt Pūjā Tikka Ceremony	Ajmer and Vindhya Pradesh West Bengal and Manipur Bihar Himachal Pradesh	Kārtika S 2 " " "	Oct. 28 " " "	Nov. 16 " " "	Nov. 4 " " "	Oct. 24 " " "	Nov. 12 " " "
54. Chhat	Bihar	Kārtika S 6	Nov. 1	Nov. 20	Nov. 8	Oct. 28	Nov. 16
55. Goṣṭhāṣṭami	Manipur	Kārtika S 8	Nov. 4	Nov. 23	Nov. 11	Oct. 30	Nov. 18
56. Jagaddhātrī Pūjā	West Bengal and Tripura	Kārtika S 9	Nov. 5	Nov. 24	Nov. 12	Oct. 31	Nov. 19
57. Deo Prabodhanī Ekādaśī	Vindhya Pradesh	Kārtika S 11	Nov. 7	Nov. 26	Nov. 14	Nov. 3	Nov. 21
58. Guru Nanak's Birthday	Govt. of India, Bombay, East Punjab, Uttar Pradesh, Hyderabad, Jammu & Kashmir, Madhya Bharat, PEPSU, Rajasthan, Saurashtra, Bhopal, Bilaspur, Delhi, Himachal Pradesh and Vindhya Pradesh	Kārtika S 15	Nov. 10	Nov. 29	Nov. 18	Nov. 7	Nov. 26
Āśā Pūrṇimā	Orissa	"	"	"	"	"	"
Kārtiki Pūrṇimā	Uttar Pradesh	"	"	"	"	"	"
Jain Festival	Bombay and Saurashtra	"	"	"	"	"	"
Puṣkar Fair	Ajmer	"	"	"	"	"	"
59. Sahid Day of Guru Teg Bahadur	East Punjab, PEPSU and Delhi	Mārga. S 5	Nov. 30	Dec. 19	Dec. 7	Nov. 26	Dec. 15
60. Subrahmanya Ṣaṣṭhī	Coorg	Mārga. S 6	Dec. 1	Dec. 20	Dec. 8	Nov. 27	Dec. 16

CONSOLIDATED LIST OF HOLIDAYS

B.-Lunar Festivals—concl'd.

Festivals	States having holidays	Criterion Lunar (Mukhya) Month & Tithi	Dates of Festivals				
			1954-55 Śaka 1876	1955-56 Śaka 1877	1956-57 Śaka 1878	1957-58 Śaka 1879	1958-59 Śaka 1880
61. Guru Govinda Singh's Birthday	Bihar, East Punjab, Uttar Pradesh, Hyde- rabad, Jammu & Kashmir, Madhya Bharat, PEPSU, Rajasthan, Ajmer, Delhi, Himachal Pradesh and Vindhya Pradesh	Pauṣa S 7	Jan. 1	Jan. 20	Jan. 8	Dec. 28	Jan. 16
62. Vaikunṭha Ekādaśī	Madras	S 11 of Saura Pauṣa	Jan. 5	Dec. 25	Jan. 12	Jan. 1	Dec. 21
63. Mauni Amāvasyā Makara Vāvu	Uttar Pradesh Travancore-Cochin	Pauṣa K 30 K 30 of Saura Māgha	Jan. 23 "	Feb. 11 "	Jan. 30 "	Jan. 19 "	Feb. 7 "
64. Śrī Pañcamī Vasanta Pañcamī	Assam, West Bengal, Manipur and Tripura Bihar, Orissa, East Punjab, Uttar Pradesh, Jammu & Kashmir, PEPSU, Rajasthan, Ajmer, Bhopal, Delhi, Himachal Pradesh and Vindhya Pradesh	Māgha S 5 "	Jan. 28 Jan. 28	Feb. 16 Feb. 16	Feb. 5 Feb. 5	Jan. 25 Jan. 24	Feb. 12 Feb. 12
65. Guru Ravi Das's Birthday	East Punjab, PEPSU and Himachal Pradesh	Māgha S 15	Feb. 6	Feb. 25	Feb. 14	Feb. 4	Feb. 23
66. Mahāśivarātr	Govt. of India and all States <i>except</i> Tripura	Māgha K 14	Feb. 20	Mar. 10	Feb. 27	Feb. 16	Mar. 7
67. Dolayātrā Holi Feast	Assam, Orissa, West Bengal, Manipur and Tripura Mysore	Phālguna S 15 "	Mar. 8 "	— —	Mar. 26, 1956 Mar. 16, 1957 "	Mar. 5 "	— —
68. Holi, 1st day Holi, 2nd day	Govt. of India and all States <i>except</i> Assam, Bombay, Madhya Pradesh, Madras, Orissa, West Bengal, Mysore, Travancore- Cochin, Coorg and Tripura Govt. of India, and all States <i>except</i> Assam, Madras, West Bengal, Mysore, Travancore- Cochin, Coorg and Tripura	" Day after Holi 1st Day	Mar. 8 Mar. 9	— —	Mar. 26, 1956 Mar. 15, 1957 Mar. 27, 1956 Mar. 16, 1957	Mar. 5 Mar. 6	— —

N.B. The holidays of Madras include those of the newly formed Andhra State.

CONSOLIDATED LIST OF HOLIDAYS

MOSLEM FESTIVALS

Festivals	States having holidays	Criterion	Dates of Festivals				
			1954-55 Śaka 1876	1955-56 Śaka 1877	1956-57. Śaka 1878	1957-58 Śaka 1879	1958-59 Śaka 1880
1. Sab-e-Meraj	—	27 Rajab	Apr. 2	Mar. 22, 1955 Mar. 11, 1956	Feb. 28, 1957	Feb. 17, 1958	Feb. 6, 1959
2. Sab-e-Barat	Bombay, Madhya Pradesh, Hyderabad, Jammu & Kashmir, Saurashtra and Bhopal.	15 Shaban	Apr. 19	April 9	Mar. 28, 1956 Mar. 18, 1957	Mar. 7, 1958	Feb. 24, 1959
3. 1st. day of Ramadan	—	1 Ramadan	May 5	Apr. 24	Apr. 13	Apr. 2	Mar. 22, 1958 Mar. 11, 1959
4. Sub-e-Qdar	Jammu & Kashmir	27 Ramadan	May 31	May 20	May 9	Apr. 28	Apr. 17
5. Jamat-ul-Vida	Uttar Pradesh, Jammu & Kashmir and Bhopal	Last Friday of Ramadan	May 28	May 20	May 11	Apr. 26	Apr. 18
6. Id-ul-Fitr	Govt. of India and all States	1 Shawal	June 3	May 24	May 12	May 2	Apr. 21
7. Id-uz-Zuha (Bakrid)	Govt. of India and all States	10 Zilhijja	Aug. 10	July 30	July 19	July 9	June 28
8. Muharram	Govt. of India and all States	10 Muharram	Sep. 9	Aug. 29	Aug. 18	Aug. 7	July 28
9. Chelhum	Bihar and Uttar Pradesh	19 Safar	Oct. 18	Oct. 7	Sep. 25	Sep. 15	Sep. 4
10. Akheri Chahar Sumba	—	Last Wednes- day of Safar	Oct. 27	Oct. 12	Oct. 3	Sep. 25	Sep. 10
11. Fateha Dwaz Daham (Id-e-Milad or Bara Wafat)	Govt. of India and all States <i>except</i> Orissa, West Bengal and Tripura	12 Rabi-al-awal	Nov. 9	Oct. 29	Oct. 17	Oct. 7	Sep. 26
12. Fateha Yazdaham (Giarhween Sharif)	Bhopal	11 Rabi-us-sani	Dec. 8	Nov. 27	Nov. 15	Nov. 4	Oct. 25

N. B. The holidays of Madras include those of the newly formed Andhra State.

CONSOLIDATED LIST OF HOLIDAYS
CHRISTIAN FESTIVALS

Festivals	States having holidays	Criterion	Dates of Festivals				
			1954-55 Śaka 1876	1955-56 Śaka 1877	1956-57 Śaka 1878	1957-58 Śaka 1879	1958-59 Śaka 1880
1. Palm Sunday	—	7 days before Easter Sunday	Apr. 11	Apr. 3	Mar. 25	Apr. 14	Mar. 30
2. Good Friday	Govt. of India and all States <i>except</i> Madhya Bharat, PEPSU and Rajasthan	2 days before Easter Sunday	Apr. 16	Apr. 8	Mar. 30	Apr. 19	Apr. 4
3. Easter (Holy) Saturday	West Bengal, Travancore-Cochin and Tripura	Day before Easter Sunday	Apr. 17	Apr. 9	Mar. 31	Apr. 20	Apr. 5
4. Easter Sunday	—	The Sunday occurring on or immediate after the Full-moon following Mar. 21	Apr. 18	Apr. 10	Apr. 1	Apr. 21	Apr. 6
5. Low Sunday	—	7 days after Easter Sunday	Apr. 25	Apr. 17	Apr. 8	Apr. 28	Apr. 13
6. Rogation Sunday	—	35 days after Easter Sunday	May 23	May 15	May 6	May 26	May 11
7. Ascension Day—Holy Thursday	Travancore-Cochin	39 days after Easter Sunday	May 27	May. 19	May 10	May 30	May 15
8. Ascension Sunday	—	3 days after Ascension Day	May 30	May 22	May 13	June 2	May 18
9. Whit Sunday—Pentecost	Travancore-Cochin	49 days after Easter Sunday	June 6	May 29	May 20	June 9	May 25
10. Trinity Sunday	—	56 days after Easter Sunday	June 13	June 5	May 27	June 16	June 1
11. Corpus Christi (Thursday)	—	60 days after Easter Sunday	June 17	June 9	May 31	June 20	June 5
12. First Sunday in Advent	—	Fourth Sunday before Christmas or the nearest Sunday to Nov. 30	Nov. 28	Nov. 27	Dec. 2	Dec. 1	Nov. 30
13. Christmas Eve	Assam, Bihar and Travancore-Cochin	Day before Christmas	Dec. 24 (Fri)	Dec. 24 (Sat)	Dec. 24 (Mon)	Dec. 24 (Tue)	Dec. 24 (Wed)
14. Christmas Day	Govt. of India and all States	Fixed	Dec. 25 (Sat)	Dec. 25 (Sun)	Dec. 25 (Tue)	Dec. 25 (Wed)	Dec. 25 (Thur)
15. New Year Eve	—	Fixed	Dec. 31 (Fri)	Dec. 31 (Sat)	Dec. 31 (Mon)	Dec. 31 (Tues)	Dec. 31 (Wed)
16. Christian (English) New Year's Day	Govt. of India and all States	Fixed	Jan. 1 (Sat)	Jan. 1 (Sun)	Jan. 1 (Tues)	Jan. 1 (Wed)	Jan. 1 (Thur)
17. Epiphany	—	Fixed	Jan. 6 (Thur)	Jan. 6 (Fri)	Jan. 6 (Sun)	Jan. 6 (Mon)	Jan. 6 (Tue)
18. Septuagesima Sunday	—	63 days before Easter Sunday	Feb. 6	Jan. 29	Feb. 17	Feb. 2	Jan. 25
19. Quinquagesima (Shrove) Sunday	—	49 days before Easter Sunday	Feb. 20	Feb. 12	Mar. 3	Feb. 16	Feb. 8
20. Ash Wednesday	—	46 days before Easter Sunday	Feb. 23	Feb. 15	Mar. 6	Feb. 19	Feb. 11,

N.B The holidays of Madras include those of the newly formed Andhra State.

GOVERNMENT OF INDIA HOLIDAYS

Festivals	Dates of Festivals				
	1954-55 Śaka 1876	1955-56 Śaka 1877	1956-57 Śaka 1878	1957-58 Śaka 1879	1958-59 Śaka 1880
Indian New Year's Day*	Mar. 22	Mar. 22	Mar. 21	Mar. 22	Mar. 22
Vaiśākhi	Apr. 13	Apr. 13	Apr. 13	Apr. 13	Apr. 13
Independence Day	Aug. 15	Aug. 15	Aug. 15	Aug. 15	Aug. 15
Mahatma Gandhi's Birthday	Oct. 2	Oct. 2	Oct. 2	Oct. 2	Oct. 2
English New Year's Day	Jan. 1	Jan. 1	Jan. 1	Jan. 1	Jan. 1
Republic Day	Jan. 26	Jan. 26	Jan. 26	Jan. 26	Jan. 26
Mahāviṣuva Day*	Mar. 21, 1955	Mar. 20, 1956	Mar. 21, 1957	Mar. 21, 1958	Mar. 21, 1959
Rāmanavami	Apr. 11	Apr. 1	Apr. 19	Apr. 8	Mar. 29
Buddha Pūrṇimā	May 17	May 6	May 24	May 13	May 3
Janmāṣṭami	Aug. 21	Aug. 11	Aug. 29	Aug. 19	Sep. 6
Dussera	Oct. 4-7	Oct. 23-26	Oct. 11-14	Sep. 30-Oct. 3	Oct. 19-21
Diwali	Oct. 26-27	Nov. 14-15	Nov. 2-3	Oct. 22-23	Nov. 10-11
Guru Nanak's Birthday	Nov. 10	Nov. 29	Nov. 18	Nov. 7	Nov. 26
Mahāśivarātri	Feb. 20	Mar. 10, 1956	Feb. 27	Feb. 16	Mar. 7, 1959
Holi	Mar. 8-9, 1955	—	Mar. 26-27, 1956 Mar. 15-16, 1957	Mar. 5-6, 1958	—
Good Friday	Apr. 16	Apr. 8	Mar. 30	Apr. 19	Apr. 4
Christmas Day	Dec. 25	Dec. 25	Dec. 25	Dec. 25	Dec. 25
Id-ul-Fitr	June 3	May 24	May 12	May 2	Apr. 21
Id-uz-Zuha	Aug. 10	July 30	July 19	July 9	June 28
Muharram	Sep. 9	Aug. 29	Aug. 18	Aug. 7	July 28
Id-e-Milad	Nov. 9	Oct. 29	Oct. 17	Oct. 7	Sep. 26

* Proposed all-India holiday.

REPORT OF THE CALENDAR REFORM COMMITTEE

List of Holidays for different States—*contd.*

(1) ASSAM HOLIDAYS

Festivals	Dates of Festivals				
	1954-55 Śaka 1876	1955-56 Śaka 1877	1956-57 Śaka 1878	1957-58 Śaka 1879	1958-59 Śaka 1880
Indian New Year's Day*	Mar. 22	Mar. 22	Mar. 21	Mar. 22	Mar. 22
Bahag Bihu	Apr. 13	Apr. 14	Apr. 13	Apr. 13	Apr. 13
Independence Day	Aug. 15	Aug. 15	Aug. 15	Aug. 15	Aug. 15
Mahatma Gandhi's Birthday	Oct. 2	Oct. 2	Oct. 2	Oct. 2	Oct. 2
English New Year's Day	Jan. 1	Jan. 1	Jan. 1	Jan. 1	Jan. 1
Māgh Bihu	Jan. 14	Jan. 14	Jan. 13	Jan. 14	Jan. 14
Republic Day	Jan. 26	Jan. 26	Jan. 26	Jan. 26	Jan. 26
Mahāviṣuva Day*	Mar. 21, 1955	Mar. 20, 1956	Mar. 21, 1957	Mar. 21, 1958	Mar. 21, 1959
Tithi of Deva Dāmodara	May 3	Apr. 23	May 11	Apr. 30	Apr. 19
Buddha Pūrṇimā	May 17	May 6	May 24	May 13	May 3
Tithi of Śrī Mādhava Deva	Aug. 18	Sep. 6	Aug. 26	Sep. 14	Sep. 3
Janmāṣṭami	Aug. 21	Sep. 9	Aug. 29	Aug. 19	Sep. 6
Tithi of Śrī Śaṅkara Deva	Aug. 30	Aug. 19	Sep. 6	Aug. 27	Sept 15
Durgā Pūjā	Oct. 4-7	Oct. 23-26	Oct. 11-14	Sep. 30-Oct. 3	Oct. 19-22
Lakṣmī Pūjā	Oct. 11	Oct. 30	Oct. 19	Oct. 8	Oct. 27
Kālī Pūjā	Oct. 25	Nov. 13	Nov. 1	Oct. 22	Nov. 10
Śrī Pañcami	Jan. 28	Feb. 16	Feb. 5	Jan. 25	Feb. 12
Mahāśivarātri	Feb. 20	Mar. 10, 1956	Feb. 27	Feb. 16	Mar. 7, 1959
Dolayātrā	Mar. 8, 1955	—	Mar. 26, 1956 Mar. 16, 1957	Mar. 5, 1958	—
Good Friday	Apr. 16	Apr. 8	Mar. 30	Apr. 19	Apr. 4
Christmas Eve	Dec. 24	Dec. 24	Dec. 24	Dec. 24	Dec. 24
Christmas Day	Dec. 25	Dec. 25	Dec. 25	Dec. 25	Dec. 25
Id-ul Fitr	June 3	May 24	May 12	May 2	Apr. 21
Id-uz-Zuha	Aug. 10	July 30	July 19	July 9	June 28
Muharram	Sep. 9	Aug. 29	Aug. 18	Aug. 7	July 28
Fateha Dwazdaham	Nov. 9	Oct. 29	Oct. 17	Oct. 7	Sep. 26

* Proposed all-India holiday.

List of Holidays for different States—*contd.*

(2) BIHAR HOLIDAYS

Festivals	Dates of Festivals				
	1954-55 Śaka 1876	1955-56 Śaka 1877	1956-57 Śaka 1878	1957-58 Śaka 1879	1958-59 Śaka 1880
Indian New Year's Day*	Mar. 22	Mar. 22	Mar. 21	Mar. 22	Mar. 22
Independence Day	Aug. 15	Aug. 15	Aug. 15	Aug. 15	Aug. 15
Mahatma Gandhi's Birthday	Oct. 2	Oct. 2	Oct. 2	Oct. 2	Oct. 2
English New Year's Day	Jan. 1	Jan. 1	Jan. 1	Jan. 1	Jan. 1
Republic Day	Jan. 26	Jan. 26	Jan. 26	Jan. 26	Jan. 26
Mahāviṣuva Day*	Mar. 21, 1955	Mar. 20, 1956	Mar. 21, 1957	Mar. 21, 1958	Mar. 21, 1959
Sarhul	Apr. 6	Mar. 26, 1955	Apr. 13	Apr. 3	Mar. 23, 1958
Rāmanavami	Apr. 11	Apr. 1	Apr. 19	Apr. 8	Mar. 29
Mahāvīr's Birthday	Apr. 15	Apr. 5	Apr. 23	Apr. 12	Apr. 2
Buddha's Birthday	May 17	May 6	May 24	May 13	May 3
Janmāṣṭami	Aug. 21	Aug. 11	Aug. 29	Aug. 19	Sept. 6
Durgā Pūjā	Oct. 4-7	Oct. 23-26	Oct. 11-14	Sept. 30-Oct. 3	Oct. 19-22
Lakṣmī Pūjā	Oct. 11	Oct. 30	Oct. 19	Oct. 8	Oct. 27
Diwali	Oct. 26	Nov. 14	Nov. 2	Oct. 22	Nov. 10
Dwāt Pūjā	Oct. 28	Nov. 16	Nov. 4	Oct. 24	Nov. 12
Chhat	Nov. 1	Nov. 20	Nov. 8	Oct. 28	Nov. 16
Guru Govinda Singh's Birthday	Jan. 1	Jan. 20	Jan. 8	Dec. 28	Jan. 16
Vasanta Pañcamī	Jan. 28	Feb. 16	Feb. 5	Jan. 24	Feb. 12
Phālguna Śivarātri	Feb. 20	Mar. 10, 1956	Feb. 27	Feb. 16	Mar. 7, 1959
Holi, 1st day	Mar. 8, 1955	—	Mar. 26, 1956 Mar. 15, 1957	Mar. 5, 1958	—
Holi, 2nd day	Mar. 9, 1955	—	Mar. 27, 1956 Mar. 16, 1957	Mar. 6, 1958	—
Good Friday	Apr. 16	Apr. 8	Mar. 30	Apr. 19	Apr. 4
Christmas Eve	Dec. 24	Dec. 24	Dec. 24	Dec. 24	Dec. 24
Christmas Day	Dec. 25	Dec. 25	Dec. 25	Dec. 25	Dec. 25
Id-ul-Fitr	June 3	May 24	May 12	May 2	Apr. 21
Id-uz-Zuha	Aug. 10	July 30	July 19	July 9	June 28
Muharram	Sep. 9	Aug. 29	Aug. 18	Aug. 7	July 28
Chelhum	Oct. 18	Oct. 7	Sep. 25	Sep. 15	Sep. 4
Fateha Dwazdaham	Nov. 9	Oct. 29	Oct. 17	Oct. 7	Sep. 26

* Proposed all-India holiday.

List of Holidays for different States—*contd.*

(3) BOMBAY HOLIDAYS

Festivals	Dates of Festivals				
	1954-55 Śaka 1876	1955-56 Śaka 1877	1956-57 Śaka 1878	1957-58 Śaka 1879	1958-59 Śaka 1880
Indian New Year's Day*	Mar. 22	Mar. 22	Mar. 21	Mar. 22	Mar. 22
Independence Day	Aug. 15	Aug. 15	Aug. 15	Aug. 15	Aug. 15
Mahatma Gandhi's Birthday	Oct. 2	Oct. 2	Oct. 2	Oct. 2	Oct. 2
English New Year's Day	Jan. 1	Jan. 1	Jan. 1	Jan. 1	Jan. 1
Republic Day	Jan. 26	Jan. 26	Jan. 26	Jan. 26	Jan. 26
Mahāviṣṇva Day* (Jamshedi Nauroj)	Mar. 21, 1955	Mar. 20, 1956	Mar. 21, 1957	Mar. 21, 1958	Mar. 21, 1959
Gudi Padwa (Sthāpana Navarātra)	Apr. 4	Mar. 24 1955	Apr. 12	Apr. 1, 1957 Mar. 21, 1958	—
Rāmanavami	Apr. 11	Apr. 1	Apr. 19	Apr. 8	Mar. 29
Mahāvīr's Birthday	Apr. 15	Apr. 5	Apr. 23	Apr. 12	Apr. 2
Jain Festival (Oli ends)	Apr. 18	Apr. 7	Apr. 25	Apr. 14	Apr. 4
Coconut Day	Aug. 14	Aug. 3	Aug. 21	Aug. 10	Aug. 29
Gokulāṣṭami	Aug. 21	Aug. 11	Aug. 29	Aug. 19	Sep. 6
Jain Festival (Śrāvāṇa K 13)	Aug. 26	Aug. 15	Sep. 3	Aug. 23	Sep. 11
Jain Festival (Śrāvāṇa K 30)	Aug. 28	Aug. 17	Sep. 4	Aug. 25	Sep. 13
Gaṇeśa Caturthī	Sep. 1	Sep. 19	Sep. 8	Aug. 28	Sep. 16
Sainvatsari and Paryuṣaṇa Parva (Jain)	Sep. 2	Sep. 21	Sep. 9	Aug. 29	Sep. 17
Dussera	Oct. 7	Oct. 26	Oct. 14	Oct. 3	Oct. 21
Naraka Caturdaśī and Kālī Caudas	Oct. 25	Nov. 13	Nov. 1	Oct. 22	Nov. 10
Diwali	Oct. 26-27	Nov. 14-15	Nov. 2-3	Oct. 22-23	Nov. 10-11
Guru Nanak's Birthday	Nov. 10	Nov. 29	Nov. 18	Nov. 7	Nov. 26
Jain Festival (Kartika S 15)	"	"	"	"	"
Mahāśivarātri	Feb. 20	Mar. 10, 1956	Feb. 27	Feb. 16	Mar. 7, 1959
Holi	Mar. 9, 1955	—	Mar. 27, 1956 Mar. 16 1957	Mar. 6, 1958	—
Good Friday	Apr. 16	Apr. 8	Mar. 30	Apr. 19	Apr. 4
Christmas Day	Dec. 25	Dec. 25	Dec. 25	Dec. 25	Dec. 25
Sab-e-Barat	Apr. 19	Apr. 9	Mar. 28, 1956 Mar. 18, 1957	Mar. 7, 1958	Feb. 24, 1959
Id-ul-Fitr	June 3	May 24	May 12	May 2	Apr. 21
Id-uz-Zuha	Aug. 10	July 30	July 19	July 9	June 28
Muharram	Sep. 9	Aug. 29	Aug. 18	Aug. 7	July 28
Id-e-Milad	Nov. 9	Oct. 29	Oct. 17	Oct. 7	Sep. 26

* Proposed all-India holiday.

List of Holidays for different States—contd.

(4) MADHYA PRADESH HOLIDAYS

Festivals	Dates of Festivals				
	1954-55 Śaka 1876	1955-56 Śaka 1877	1956-57 Śaka 1878	1957-58 Śaka 1879	1958-59 Śaka 1880
Indian New Year's Day*	Mar. 22	Mar. 22	Mar. 21	Mar. 22	Mar. 22
Tilak Commemoration Day	Aug. 1	Aug. 1	Aug. 1	Aug. 1	Aug. 1
Independence Day	Aug. 15	Aug. 15	Aug. 15	Aug. 15	Aug. 15
Mahatma Gandhi's Birthday	Oct. 2	Oct. 2	Oct. 2	Oct. 2	Oct. 2
English New Year's Day	Jan. 1	Jan. 1	Jan. 1	Jan. 1	Jan. 1
Republic Day	Jan. 26	Jan. 26	Jan. 26	Jan. 26	Jan. 26
Mahāviṣuva Day*	Mar. 21, 1955	Mar. 20, 1956	Mar. 21, 1957	Mar. 21, 1958	Mar. 21, 1959
Rāmanavami	Apr. 11	Apr. 1	Apr. 19	Apr. 8	Mar. 29
Mahāvīr's Birthday	Apr. 15	Apr. 5	Apr. 23	Apr. 12	Apr. 2
Nāgapañcamī	Aug. 3	July 24	Aug. 10	July 31	Aug. 19
Rakṣā Bandhana	Aug. 14	Aug. 3	Aug. 21	Aug. 10	Aug. 29
Janmāṣṭamī	Aug. 21	Aug. 11	Aug. 29	Aug. 19	Sep. 6
Gaṇeśa Caturthī	Sep. 1	Sep. 19	Sep. 8	Aug. 28	Sep. 16
Pitṛmokṣa Amāvasyā	Sep. 26	Oct. 15	Oct. 3	Sep. 23	Oct. 12
Dussera	Oct. 7	Oct. 26	Oct. 14	Oct. 3	Oct. 21
Diwali	Oct. 25-26	Nov. 13-14	Nov. 1-2	Oct. 21-22	Nov. 10
Mahāśivarātri	Feb. 20	Mar. 10, 1956	Feb. 27	Feb. 16	Mar. 7, 1959
Holi	Mar. 9, 1955	—	Mar. 27, 1956 Mar. 16, 1957	Mar. 6, 1958	—
Good Friday	Apr. 16	Apr. 8	Mar. 30	Apr. 19	Apr. 4
Christmas Day	Dec. 25	Dec. 25	Dec. 25	Dec. 25	Dec. 25
Sab-e-Barat	Apr. 19	Apr. 9	Mar. 28, 1956 Mar. 18, 1957	Mar. 7, 1958	Feb. 24, 1959
Id-ul-Fitr	June 3	May 24	May 12	May 2	Apr. 21
Id-uz-Zuha	Aug. 10	July 30	July 19	July 9	June 28
Muharram	Sep. 9	Aug. 29	Aug. 18	Aug. 7	July 28
Id-e-Milad	Nov. 9	Oct. 29	Oct. 17	Oct. 7	Sep. 26

* Proposed all-India holiday.

List of Holidays for different States—*contd.*

(5) MADRAS HOLIDAYS

Festivals	Dates of Festivals				
	1954-55 Śaka 1876	1955-56 Śaka 1877	1956-57 Śaka 1878	1957-58 Śaka 1879	1958-59 Śaka 1880
Indian New Year's Day*	Mar. 22	Mar. 22	Mar. 21	Mar. 22	Mar. 22
Independence Day	Aug. 15	Aug. 15	Aug. 15	Aug. 15	Aug. 15
Mahatma Gandhi's Birthday	Oct. 2	Oct. 2	Oct. 2	Oct. 2	Oct. 2
English New Year's Day	Jan. 1	Jan. 1	Jan. 1	Jan. 1	Jan. 1
Bhogi	Jan. 13	Jan. 13	Jan. 12	Jan. 13	Jan. 13
Pongal	Jan. 14	Jan. 14	Jan. 13	Jan. 14	Jan. 14
Maṭṭu Pongal	Jan. 15	Jan. 15	Jan. 14	Jan. 15	Jan. 15
Republic Day	Jan. 26	Jan. 26	Jan. 26	Jan. 26	Jan. 26
Mahāviṣuva Day*	Mar. 21, 1955	Mar. 20, 1956	Mar. 21, 1957	Mar. 21, 1958	Mar. 21, 1959
Āvaṇi Aviṭṭam	Aug. 14	Sep. 1	Aug. 21	Sep. 7	Aug. 28
Śrī Jayanti	Aug. 21	Sep. 9	Aug. 29	Aug. 19	Sep. 6
Vināyaka Caturthī	Sep. 1	Sep. 19	Sep. 8	Aug. 28	Sep. 16
Śrī Nārāyaṇa Gurudev's Birthday	Sep. 12	Sep. 2	Aug. 22	Sep. 8	Aug. 29
Māhālayā Amāvasyā	Sep. 26	Oct. 15	Oct. 3	Sep. 23	Oct. 12
Āyudha Pūjā	Oct. 4-7	Oct. 23-26	Oct. 11-14	Sep. 30-Oct. 3	Oct. 19-21
Diwali	Oct. 25-26	Nov. 13-14	Nov. 1-2	Oct. 21-22	Nov. 10
Vaikunṭha Ekādaśī	Jan. 5	Dec. 25	Jan. 12	Jan. 1	Dec. 21
Mahāśivarātri	Feb. 20	Mar. 10, 1956	Feb. 27	Feb. 16	Mar. 7, 1959
Good Friday	Apr. 16	Apr. 8	Mar. 30	Apr. 19	Apr. 4
Christmas Day	Dec. 25	Dec. 25	Dec. 25	Dec. 25	Dec. 25
Id-ul-Fitr	June 3	May 24	May 12	May 2	Apr. 21
Id-uz-Zuha (Bakrid)	Aug. 10	July 30	July 19	July 9	June 28
Muharram	Sep. 9	Aug. 29	Aug. 18	Aug. 7	July 28
Id-e-Milad	Nov. 9	Oct. 29	Oct. 17	Oct. 7	Sep. 26

* Proposed all-India holiday.

N.B. The holidays of Madras include those of the newly formed Andhra State.

List of Holidays for different States—*contd.*

(6) ORISSA HOLIDAYS

Festivals	Dates of Festivals				
	1954-55 Śaka 1876	1955-56 Śaka 1877	1956-57 Śaka 1878	1957-58 Śaka 1879	1958-59 Śaka 1880
Indian New Year's Day*	Mar. 22	Mar. 22	Mar. 21	Mar. 22	Mar. 22
Independence Day	Aug. 15	Aug. 15	Aug. 15	Aug. 15	Aug. 15
Mahatma Gandhi's Birthday	Oct. 2	Oct. 2	Oct. 2	Oct. 2	Oct. 2
English New Year's Day	Jan. 1	Jan. 1	Jan. 1	Jan. 1	Jan. 1
Republic Day	Jan. 26	Jan. 26	Jan. 26	Jan. 26	Jan. 26
Mahāviṣuva Day*	Mar. 21, 1955	Mar. 20, 1956	Mar. 21, 1957	Mar. 21, 1958	Mar. 21, 1959
Rathayātrā	July 2	June 21	July 9	June 29	June 19
Punaryātrā	July 10	June 29	July 17	July 7	June 27
Janmāṣṭamī	Aug. 21	Aug. 10	Aug. 29	Aug. 18	Sep. 6
Gaṇeśa Caturthi	Sep. 1	Sep. 20	Sep. 8	Aug. 28	Sep. 16
Mahālayā Amāvasyā	Sep. 26	Oct. 15	Oct. 3	Sep. 23	Oct. 12
Durgā Pūjā	Oct. 4-7	Oct. 23-26	Oct. 11-14	Sep. 30-Oct. 3	Oct. 19-22
Lakṣmī Pūjā & Kumāra Utsava	Oct. 11	Oct. 30	Oct. 19	Oct. 8	Oct. 27
Dipāvalī	Oct. 26	Nov. 14	Nov. 2	Oct. 22	Nov. 10
Rāsa Pūrṇimā	Nov. 10	Nov. 29	Nov. 18	Nov. 7	Nov. 26
Vasanta Pañcamī	Jan. 28	Feb. 16	Feb. 5	Jan. 24	Feb. 12
Mahāśivarātri	Feb. 20	Mar. 10, 1956	Feb. 27	Feb. 16	Mar. 7, 1959
Dolayātrā	Mar. 8, 1955	—	Mar. 26, 1956 Mar. 16, 1957	Mar. 5, 1958	—
Holi	Mar. 9, 1955	—	Mar. 27, 1956 Mar. 16, 1957	Mar. 6, 1958	—
Good Friday	Apr. 16	Apr. 8	Mar. 30	Apr. 19	Apr. 4
Christmas Day	Dec. 25	Dec. 25	Dec. 25	Dec. 25	Dec. 25
Id-ul-Fitr	June 3	May 24	May 12	May 2	Apr. 21
Id-uz-Zuha	Aug. 10	July 30	July 19	July 9	June 28
Muharram	Sep. 9	Aug. 29	Aug. 18	Aug. 7	July 28

* Proposed all-India holiday.

List of Holidays for different States—*contd.*

(7) EAST PUNJAB HOLIDAYS

Festivals	Dates of Festivals				
	1954-55 Śaka 1876	1955-56 Śaka 1877	1956-57 Śaka 1878	1957-58 Śaka 1879	1958-59 Śaka 1880
Indian New Year's Day*	Mar. 22	Mar. 22	Mar. 21	Mar. 22	Mar. 22
Vaiśakhī	Apr. 13	Apr. 13	Apr. 13	Apr. 13	Apr. 13
Independence Day	Aug. 15	Aug. 15	Aug. 15	Aug. 15	Aug. 15
Mahatma Gandhi's Birthday	Oct. 2	Oct. 2	Oct. 2	Oct. 2	Oct. 2
Death Anniversary of Lala Lajpat Rai	Nov. 17	Nov. 17	Nov. 17	Nov. 17	Nov. 17
English New Year's Day	Jan. 1	Jan. 1	Jan. 1	Jan. 1	Jan. 1
Republic Day	Jan. 26	Jan. 26	Jan. 26	Jan. 26	Jan. 26
Mahāviṣuva Day*	Mar. 21, 1955	Mar. 20, 1956	Mar. 21, 1957	Mar. 21, 8	Mar. 21, 1959
Rāmanavamī	Apr. 11	Apr. 1	Apr. 19	Apr. 8	Mar. 29
Mahāvīr's Birthday	Apr. 15	Apr. 5	Apr. 23	Apr. 12	Apr. 2
Guru Arjun Dev's Martyrdom Day	June 4	May 25	June 12	June 2	May 22
Janmāṣṭamī	Aug. 21	Aug. 11	Aug. 29	Aug. 19	Sep. 6
Dussara	Oct. 4-7	Oct. 23-26	Oct. 11-14	Sep. 30-Oct. 3	Oct. 19-21
Maharṣi Vālmiki's Birthday	Oct. 12	Oct. 31	Oct. 19	Oct. 8	Oct. 27
Diwali	Oct. 25-26	Nov. 13-14	Nov. 1-2	Oct. 21-22	Nov. 10
Guru Nanak's Birthday	Nov. 10	Nov. 29	Nov. 18	Nov. 7	Nov. 26
Sahid-day of Śrī Guru Teg Bahadur	Nov. 30	Dec. 19	Dec. 7	Nov. 26	Dec. 15
Guru Govinda Singh's Birthday	Jan. 1	Jan. 20	Jan. 8	Dec. 28	Jan. 16
Vasanta Pañcamī	Jan. 23	Feb. 16	Feb. 5	Jan. 24	Feb. 12
Guru Ravi Das's Birthday	Feb. 6	Feb. 25	Feb. 14	Feb. 4	Feb. 23
Mahāśivarātri	Feb. 20	Mar. 10, 1956	Feb. 27	Feb. 16	Mar. 7, 1959
Holi	Mar. 8, 1955	—	Mar. 26, 1956 Mar. 15, 1957	Mar. 5, 1958	—
Hola	Mar. 9, 1955	—	Mar. 27, 1956 Mar. 16, 1957	Mar. 6, 1958	—
Good Friday	Apr. 16	Apr. 8	Mar. 30	Apr. 19	Apr. 4
Christmas Day	Dec. 25	Dec. 25	Dec. 25	Dec. 25	Dec. 25
Id-ul-Fitr	June 3	May 24	May 12	May 2	Apr. 21
Id-uz-Zuha	Aug. 10	July 30	July 19	July 9	June 28
Muharram	Sep. 9	Aug. 29	Aug. 18	Aug. 7	July 28
Id-e-Milad	Nov. 9	Oct. 29	Oct. 17	Oct. 7	Sep. 26

* Proposed all-India holiday.

List of Holidays for different States—*contd.*

(8) UTTAR PRADESH HOLIDAYS

Festivals	Dates of Festivals				
	1954-55 Śaka 1876	1955-56 Śaka 1877	1956-57 Śaka 1878	1957-58 Śaka 1879	1958-59 Śaka 1980
Indian New Year's Day*	Mar. 22	Mar. 22	Mar. 21	Mar. 22	Mar. 22
Independence Day	Aug. 15	Aug. 15	Aug. 15	Aug. 15	Aug. 15
Mahatma Gandhi's Birthday	Oct. 2	Oct. 2	Oct. 2	Oct. 2	Oct. 2
English New Year's Day	Jan. 1	Jan. 1	Jan. 1	Jan. 1	Jan. 1
Republic Day	Jan. 26	Jan. 26	Jan. 26	Jan. 26	Jan. 26
Mahāviṣuva Day*	Mar. 21, 1955	Mar. 20, 1956	Mar. 21, 1957	Mar. 21, 1958	Mar. 21, 1959
Rāmanavami	Apr. 11	Apr. 1	Apr. 19	Apr. 8	Mar. 29
Mahāvīr's Birthday	Apr. 15	Apr. 5	Apr. 23	Apr. 12	Apr. 2
Buddha Jayanti	May 17	May 6	May 24	May 13	May 3
Rakṣā Bandhana	Aug. 14	Aug. 3	Aug. 21	Aug. 10	Aug. 29
Jannāṣṭami	Aug. 21	Aug. 11	Aug. 29	Aug. 19	Sep. 6
Dusseera	Oct. 4-7	Oct. 23-26	Oct. 11-14	Sep. 30-Oct. 3	Oct. 19-21
Diwali	Oct. 26-28	Nov. 14-16	Nov. 2-4	Oct. 22-24	Nov. 10-12
Guru Nanak's Birthday & Kārtiki Pūrṇimā	Nov. 10	Nov. 29	Nov. 18	Nov. 7	Nov. 26
Guru Govinda Singh's Birthday	Jan. 1	Jan. 20	Jan. 8	Dec. 28	Jan. 16
Mauni Amāvasyā	Jan. 23	Feb. 11	Jan. 30	Jan. 19	Feb. 7
Vasanta Pañcamī	Jan. 23	Feb. 16	Feb. 5	Jan. 24	Feb. 12
Mahāśivarātri	Feb. 20	Mar. 10, 1956	Feb. 27	Feb. 16	Mar. 7, 1959
Holi, 1st day	Mar. 8, 1955	—	Mar. 26, 1956 Mar. 15, 1957	Mar. 5, 1958	—
Holi, 2nd day	Mar. 9, 1955	—	Mar. 27, 1956 Mar. 16, 1957	Mar. 6, 1958	—
Good Friday	Apr. 16	Apr. 8	Mar. 30	Apr. 19	Apr. 4
Christmas Day	Dec. 25	Dec. 25	Dec. 25	Dec. 25	Dec. 25
Jamat-ul-Vida (Last Friday of Ramadan)	May 28	May 20	May 11	Apr. 26	Apr. 18
Id-ul-Fitr	June 3	May 24	May 12	May 2	Apr. 21
Id-uz-Zuha	Aug. 10	July 30	July 19	July 9	June 28
Mubarram	Sep. 9	Aug. 29	Aug. 18	Aug. 7	July 28
Chelhum	Oct. 18	Oct. 7	Sep. 25	Sep. 15	Sep. 4
Bara Wafat	Nov. 9	Oct. 29	Oct. 17	Oct. 7	Sep. 26

* Proposed all-India holiday.

List of Holidays for different States—*contd.*

(9) WEST BENGAL HOLIDAYS

Festivals	Dates of Festivals				
	1954-55 Śaka 1876	1955-56 Śaka 1877	1956-57 Śaka 1878	1957-58 Śaka 1879	1958-59 Śaka 1880
Indian New Year's Day*	Mar. 22	Mar. 22	Mar. 21	Mar. 22	Mar. 22
Meṣa Sankranti	Apr. 13	Apr. 14	Apr. 13	Apr. 13	Apr. 13
Independence Day	Aug. 15	Aug. 15	Aug. 15	Aug. 15	Aug. 15
Mahatma Gandhi's Birthday	Oct. 2	Oct. 2	Oct. 2	Oct. 2	Oct. 2
English New Year's Day	Jan. 1	Jan. 1	Jan. 1	Jan. 1	Jan. 1
Netaji's Birthday	Jan. 23	Jan. 23	Jan. 23	Jan. 23	Jan. 23
Republic Day	Jan. 26	Jan. 26	Jan. 26	Jan. 26	Jan. 26
Mahaviṣuva Day*	Mar. 21, 1955	Mar. 20, 1956	Mar. 21, 1957	Mar. 21, 1958	Mar. 21, 1959
Dasaharā	June 11	May 31	June 17	June 7	May 28
Rathayātrā	July 2	June 21	July 9	June 29	June 19
Punaryātrā	July 10	June 29	July 17	July 7	June 27
Jhulanayātrā	Aug. 10	July 30	Aug. 17	Aug. 6	Aug. 25
Janmāṣṭamī	Aug. 21	Aug. 10	Aug. 29	Aug. 18	Sep. 6
Mahālayā Amāvasyā	Sep. 26	Oct. 15	Oct. 3	Sep. 23	Oct. 12
Durgā Pūjā	Oct. 4-7	Oct. 23-26	Oct. 11-14	Sep. 30-Oct. 3	Oct. 19-22
Lakṣmī Pūjā	Oct. 11	Oct. 30	Oct. 19	Oct. 8	Oct. 27
Kālī Pūjā	Oct. 25	Nov. 13	Nov. 1	Oct. 22	Nov. 10
Bhrātr̥ Dvitiyā	Oct. 28	Nov. 16	Nov. 4	Oct. 24	Nov. 12
Jagaddhātrī Pūjā	Nov. 5	Nov. 24	Nov. 12	Oct. 31	Nov. 19
Śrī Pañcamī	Jan. 23	Feb. 16	Feb. 5	Jan. 25	Feb. 12
Mahāśivarātrī	Feb. 20	Mar. 10, 1956	Feb. 27	Feb. 16	Mar. 7, 1959
Dolayātrā	Mar. 8, 1955	—	Mar. 26, 1956 Mar. 16, 1957	Mar. 5, 1958	—
Good Friday	Apr. 16	Apr. 8	Mar. 30	Apr. 19	Apr. 4
Easter Saturday	Apr. 17	Apr. 9	Mar. 31	Apr. 20	Apr. 5
Christmas Day	Dec. 25	Dec. 25	Dec. 25	Dec. 25	Dec. 25
Id-ul-Fitr	June 3	May 24	May 12	May 2	Apr. 21
Id-uz-Zuha	Aug. 10	July 30	July 19	July 9	June 28
Muharram	Sep. 9	Aug. 29	Aug. 18	Aug. 7	July 23

*— Proposed all-India holiday.

List of Holidays for different States—*contd.*

(10) HYDERABAD HOLIDAYS

Festivals	Dates of Festivals				
	1954-55 Śaka 1876	1955-56 Śaka 1877	1956-57 Śaka 1878	1957-58 Śaka 1879	1958-59 Śaka 1880
Indian New Year's Day*	Mar. 22	Mar. 22	Mar. 21	Mar. 22	Mar. 22
Independence Day	Aug. 15	Aug. 15	Aug. 15	Aug. 15	Aug. 15
Mahatma Gandhi's Birthday	Oct. 2	Oct. 2	Oct. 2	Oct. 2	Oct. 2
English New Year's Day	Jan. 1	Jan. 1	Jan. 1	Jan. 1	Jan. 1
Tila Sankranti	Jan. 14	Jan. 14	Jan. 13	Jan. 14	Jan. 14
Republic Day	Jan. 26	Jan. 26	Jan. 26	Jan. 26	Jan. 26
Mahaviṣuva Day* (Jamshedi Nauroj)	Mar. 21, 1955	Mar. 20, 1956	Mar. 21, 1957	Mar. 21, 1958	Mar. 21, 1959
Rāmanavami	Apr. 11	Apr. 1	Apr. 19	Apr. 8	Mar. 29
Mahāvir's Birthday	Apr. 15	Apr. 5	Apr. 23	Apr. 12	Apr. 2
Rakṣā Bandhana	Aug. 14	Aug. 3	Aug. 21	Aug. 10	Aug. 29
Gokulāṣṭami	Aug. 21	Aug. 11	Aug. 29	Aug. 19	Sep. 6
Ganeśa Caturthi	Sep. 1	Sep. 19	Sep. 8	Aug. 28	Sep. 16
Ananta Caturdaśi	Sep. 11	Sep. 30	Sep. 18	Sep. 7	Sep. 26
Dussera	Oct. 6-7	Oct. 25-26	Oct. 13-14	Oct. 2-3	Oct. 20-21
Diwali	Oct. 25-26	Nov. 13-14	Nov. 1-2	Oct. 21-22	Nov. 10
Guru Nanak's Birthday	Nov. 10	Nov. 29	Nov. 18	Nov. 7	Nov. 26
Guru Govinda Singh's Birthday	Jan. 1	Jan. 20	Jan. 8	Dec. 28	Jan. 16
Mahāśivarātri	Feb. 20	Mar. 10, 1956	Feb. 27	Feb. 16	Mar. 7, 1959
Holi, 1st day	Mar. 8, 1955	—	Mar. 26, 1956 Mar. 15, 1957	Mar. 5, 1958	—
Holi, 2nd day	Mar. 9, 1955	—	Mar. 27, 1956 Mar. 16, 1957	Mar. 6, 1958	—
Good Friday	Apr. 16	Apr. 8	Mar. 30	Apr. 19	Apr. 4
Christmas Day	Dec. 25	Dec. 25	Dec. 25	Dec. 25	Dec. 25
Sab-e-Barat	Apr. 19	Apr. 9	Mar. 28, 1956 Mar. 18, 1957	Mar. 7, 1958	Feb. 24, 1959
Id-ul Fitr	June 3	May 24	May 12	May 2	Apr. 21
Id-uz-Zuba	Aug. 10	July 30	July 19	July 9	June 23
Mubarram	Sep. 9	Aug. 29	Aug. 18	Aug. 7	July 23
Duazlaham Shariff (Id-e-Milad)	Nov. 9	Oct. 29	Oct. 17	Oct. 7	Sep. 26

* Proposed all-India holiday.

List of Holidays for different States—contd.

(11) JAMMU AND KASHMIR HOLIDAYS

Festivals	Dates of Festivals				
	1954-55 Śaka 1876	1955-56 Śaka 1877	1956-57 Śaka 1878	1957-58 Śaka 1879	1958-59 Śaka 1880
Indian New Year's Day*	Mar. 22	Mar. 22	Mar. 21	Mar. 22	Mar. 22
Vaiśākhī	Apr. 13	Apr. 13	Apr. 13	Apr. 13	Apr. 13
Independence Day	Aug. 15	Aug. 15	Aug. 15	Aug. 15	Aug. 15
Mahatma Gandhi's Birthday	Oct. 2	Oct. 2	Oct. 2	Oct. 2	Oct. 2
English New Year's Day	Jan. 1	Jan. 1	Jan. 1	Jan. 1	Jan. 1
Republic Day	Jan. 26	Jan. 26	Jan. 26	Jan. 26	Jan. 26
Mahāviṣuva Day* (Nauroj)	Mar. 21, 1955	Mar. 20, 1956	Mar. 21, 1957	Mar. 21, 1958	Mar. 21, 1959
Sthāpana Navarātra	Apr. 4	Mar. 24, 1955	Apr. 12	Apr. 1, 1957 Mar. 21, 1958	—
Rāmanavamī	Apr. 11	Apr. 1	Apr. 19	Apr. 8	Mar. 29
Mahāvīr's Birthday	Apr. 15	Apr. 5	Apr. 23	Apr. 12	Apr. 2
Buddha Jayantī	May 17	May 6	May 24	May 13	May 3
Rakṣā Bandhana	Aug. 14	Aug. 3	Aug. 21	Aug. 10	Aug. 29
Janmāṣṭamī	Aug. 21	Aug. 11	Aug. 29	Aug. 19	Sep. 6
Pitṛ Amāvasyā	Sep. 26	Oct. 15	Oct. 3	Sep. 23	Oct. 12
Mahānavamī	Oct. 6	Oct. 25	Oct. 13	Oct. 2	Oct. 20
Dussera	Oct. 7	Oct. 26	Oct. 14	Oct. 3	Oct. 21
Diwali	Oct. 26	Nov. 14	Nov. 2	Oct. 22	Nov. 10
Guru Nanak's Birthday	Nov. 10	Nov. 29	Nov. 18	Nov. 7	Nov. 26
Guru Govinda Singh's Birthday	Jan. 1	Jan. 20	Jan. 8	Dec. 28	Jan. 16
Vasanta Pañcamī	Jan. 28	Feb. 16	Feb. 5	Jan. 24	Feb. 12
Mahāśivarātri	Feb. 20	Mar. 10, 1956	Feb. 27	Feb. 16	Mar. 7, 1959
Holi, 1st day	Mar. 8, 1955	—	Mar. 26, 1956 Mar. 15, 1957	Mar. 5, 1958	—
Holi, 2nd day	Mar. 9, 1955	—	Mar. 27, 1956 Mar. 16, 1957	Mar. 6, 1958	—
Good Friday	Apr. 16	Apr. 8	Mar. 30	Apr. 19	Apr. 4
Christmas Day	Dec. 25	Dec. 25	Dec. 25	Dec. 25	Dec. 25
Sab-e-Barat	Apr. 19	Apr. 9	Mar. 28, 1956 Mar. 18, 1957	Mar. 7, 1958	Feb. 24, 1959
Sab-e-Qdar	May 31	May 20	May 9	Apr. 28	Apr. 17
Jamāt-ul-Vida	May 28	May 20	May 11	Apr. 26	Apr. 18
Id-ul-Fitr	June 3	May 24	May 12	May 2	Apr. 21
Id-uz-Zuha	Aug. 10	July 30	July 19	July 9	June 28
Muharram	Sep. 9	Aug. 29	Aug. 18	Aug. 7	July 28
Id-e-Milad	Nov. 9	Oct. 29	Oct. 17	Oct. 7	Sep. 26

* Proposed all-India holiday.

List of Holidays for different States—contd.

(12) MADHYA BHARAT HOLIDAYS

Festivals	Dates of Festivals				
	1954-55 Śaka 1876	1955-56 Śaka 1877	1956-57 Śaka 1878	1957-58 Śaka 1879	1958-59 Śaka 1880
Indian New Year's Day*	Mar. 22	Mar. 22	Mar. 21	Mar. 22	Mar. 22
Independence Day	Aug. 15	Aug. 15	Aug. 15	Aug. 15	Aug. 15
Mahatma Gandhi's Birthday	Oct. 2	Oct. 2	Oct. 2	Oct. 2	Oct. 2
English New Year's Day	Jan. 1	Jan. 1	Jan. 1	Jan. 1	Jan. 1
Tila Sankranti	Jan. 14	Jan. 14	Jan. 13	Jan. 14	Jan. 14
Republic Day	Jan. 26	Jan. 26	Jan. 26	Jan. 26	Jan. 26
Mahaviṣuva Day* (Nauroj)	Mar. 21, 1955	Mar. 20, 1956	Mar. 21, 1957	Mar. 21, 1958	Mar. 21, 1959
Gudi Padwa	Apr. 4	Mar. 24, 1955	Apr. 12	Apr. 1, 1957 Mar. 21, 1958	—
Rāmanavami	Apr. 11	Apr. 1	Apr. 19	Apr. 8	Mar. 29
Mahāvīr's Birthday	Apr. 15	Apr. 5	Apr. 23	Apr. 12	Apr. 2
Rakṣā Bandhana	Aug. 14	Aug. 3	Aug. 21	Aug. 10	Aug. 29
Janmāṣṭami	Aug. 21	Aug. 11	Aug. 29	Aug. 19	Sep. 6
Gaṇeśa Caturthi	Sep. 1	Sep. 19	Sep. 8	Aug. 28	Sep. 16
Dol Gyaras	Sep. 9	Sep. 27	Sep. 15	Sep. 4	Sep. 23
Sarvapitr Amāvasyā	Sep. 26	Oct. 15	Oct. 3	Sep. 23	Oct. 12
Dussera	Oct. 6-7	Oct. 25-26	Oct. 13-14	Oct. 2-3	Oct. 20-21
Diwali	Oct. 26-28	Nov. 14-16	Nov. 2-4	Oct. 22-24	Nov. 10-12
Guru Nanak's Birthday	Nov. 10	Nov. 29	Nov. 18	Nov. 7	Nov. 26
Guru Govinda Singh's Birthday	Jan. 1	Jan. 20	Jan. 8	Dec. 28	Jan. 16
Mahāśivarātri	Feb. 20	Mar. 10, 1956	Feb. 27	Feb. 16	Mar. 7, 1959
Holi, 1st day	Mar. 8, 1955	—	Mar. 26, 1956 Mar. 15, 1957	Mar. 5, 1958	—
Holi, 2nd day	Mar. 9, 1955	—	Mar. 27, 1956 Mar. 16, 1957	Mar. 6, 1958	—
Christmas Day	Dec. 25	Dec. 25	Dec. 25	Dec. 25	Dec. 25
Id-ul-Fitr	June 3	May 24	May 12	May 2	Apr. 21
Id-uz-Zuha	Aug. 10	July 30	July 19	July 9	June 23
Muharram	Sep. 9	Aug. 29	Aug. 18	Aug. 7	July 23
Bara Wafat	Nov. 9	Oct. 29	Oct. 17	Oct. 7	Sep. 26

* Proposed all-India holiday.

List of Holidays for different States—*contd.*

(13) MYSORE HOLIDAYS

Festivals	Dates of Festivals				
	1954-55 Śaka 1876	1955-56 Śaka 1877	1956-57 Śaka 1878	1957-58 Śaka 1879	1958-59 Śaka 1880
Indian New Year's Day*	Mar. 22	Mar. 22	Mar. 21	Mar. 22	Mar. 22
Vaiśākhi	Apr. 13	Apr. 13	Apr. 13	Apr. 13	Apr. 13
Independence Day	Aug. 15	Aug. 15	Aug. 15	Aug. 15	Aug. 15
Mahatma Gandhi's Birthday	Oct. 2	Oct. 2	Oct.	Oct. 2	Oct. 2
English New Year's Day	Jan. 1	Jan. 1	Jan. 1	Jan. 1	Jan. 1
Republic Day	Jan. 26	Jan. 26	Jan. 26	Jan. 26	Jan. 26
Mahāviṣuva Day*	Mar. 21, 1955	Mar. 20, 1956	Mar. 21, 1957	Mar. 21, 1958	Mar. 21, 1959
Rāmanavami	Apr. 11	Apr. 1	Apr. 19	Apr. 8	Mar. 29
H. H. Maharaja's Birthday	July 21	July 11	July 29	July 18	July 7
Upākarma	Aug. 14	Aug. 3	Aug. 21	Aug. 10	Aug. 29
Gauri Festival	Aug. 31	Sep. 19	Sep. 7	Aug. 27	Sep. 16
Gaṇeśa Caturthi	Sep. 1	Sep. 19	Sep. 8	Aug. 28	Sep. 16
Mahālayā Amāvasyā	Sep. 26	Oct. 15	Oct. 3	Sep. 23	Oct. 12
Commencement of Dussera	Sep. 28	Oct. 16	Oct. 5	Sep. 24	Oct. 13
Mahānavami	Oct. 6	Oct. 25	Oct. 13	Oct. 2	Oct. 20
Vijayā Daśami	Oct. 7	Oct. 26	Oct. 14	Oct. 3	Oct. 21
Naraka Caturdaśi	Oct. 25	Nov. 13	Nov. 1	Oct. 22	Nov. 10
Diwali	Oct. 26	Nov. 14	Nov. 2	Oct. 22	Nov. 10
Bali Pūjā	Oct. 27	Nov. 15	Nov. 3	Oct. 23	Nov. 11
Mahāśivarātri	Feb. 20	Mar. 10, 1956	Feb. 27	Feb. 16	Mar. 7, 1959
Holi Feast	Mar. 8, 1955	—	Mar. 26, 1956 Mar. 16, 1957	Mar. 5, 1958	—
Good Friday	Apr. 16	Apr. 8	Mar. 30	Apr. 19	Apr. 4
Christmas Day	Dec. 25	Dec. 25	Dec. 25	Dec. 25	Dec. 25
Id-ul-Fitr (Kutba Ramzan)	June 3	May 24	May 12	May 2	Apr. 21
Id-uz-Zuha (Bakrid)	Aug. 10	July 30	July 19	July 9	June 28
Muharram	Sep. 9	Aug. 29	Aug. 18	Aug. 7	July 28
Id-e-Milad	Nov. 9	Oct. 29	Oct. 17	Oct. 7	Sep. 26

* Proposed all-India holiday.

List of Holidays for different States—*contd.*

(14) PATIALA AND EAST PUNJAB STATES UNION HOLIDAYS

Festivals	Dates of Festivals				
	1954-55 Śaka 1876	1955-56 Śaka 1877	1956-57 Śaka 1878	1957-58 Śaka 1879	1958-59 Śaka 1880
Indian New Year's Day*	Mar. 22	Mar. 22	Mar. 21	Mar. 22	Mar. 22
Vaiśākhi	Apr. 13	Apr. 13	Apr. 13	Apr. 13	Apr. 13
Independence Day	Aug. 15	Aug. 15	Aug. 15	Aug. 15	Aug. 15
Mahatma Gandhi's Birthday	Oct. 2	Oct. 2	Oct. 2	Oct. 2	Oct. 2
English New Year's Day	Jan. 1	Jan. 1	Jan. 1	Jan. 1	Jan. 1
H. H. Birthday	Jan. 7	Jan. 7	Jan. 7	Jan. 7	Jan. 7
Baba Ala Singhji's Day	Jan. 8	Jan. 8	Jan. 8	Jan. 8	Jan. 8
Māghi	Jan. 14	Jan. 14	Jan. 13	Jan. 14	Jan. 14
Republic Day	Jan. 26	Jan. 26	Jan. 26	Jan. 26	Jan. 26
Mahāvīṣuva Day*	Mar. 21, 1955	Mar. 20, 1956	Mar. 21, 1957	Mar. 21, 1958	Mar. 21, 1959
Rāmanavamī	Apr. 11	Apr. 1	Apr. 19	Apr. 8	Mar. 29
Mahāvīr's Birthday	Apr. 15	Apr. 5	Apr. 23	Apr. 12	Apr. 2
Guru Arjun Dev's Martyrdom Day	June 4	May 25	June 12	June 2	May 22
Solono	Aug. 14	Aug. 3	Aug. 21	Aug. 10	Aug. 29
Janmāṣṭamī	Aug. 21	Aug. 11	Aug. 29	Aug. 19	Sep. 6
Dussera	Oct. 4-7	Oct. 23-26	Oct. 11-14	Sep. 30-Oct. 3	Oct. 19-21
Maharṣi Vālmiki's Birthday	Oct. 12	Oct. 31	Oct. 19	Oct. 8	Oct. 27
Diwali	Oct. 26	Nov. 14	Nov. 2	Oct. 22	Nov. 10
Govardhana Pūjā	Oct. 27	Nov. 15	Nov. 3	Oct. 23	Nov. 11
Guru Nānak's Birthday	Nov. 10	Nov. 29	Nov. 18	Nov. 7	Nov. 26
Sahid-day of Guru Teg Bahadur	Nov. 30	Dec. 19	Dec. 7	Nov. 26	Dec. 15
Guru Govinda Singh's Birthday	Jan. 1	Jan. 20	Jan. 8	Dec. 28	Jan. 16
Vasanta Pañcamī	Jan. 28	Feb. 16	Feb. 5	Jan. 24	Feb. 12
Guru Ravidas's Birthday	Feb. 6	Feb. 25	Feb. 14	Feb. 4	Feb. 23
Mahāśivarātri	Feb. 20	Mar. 10, 1956	Feb. 27	Feb. 16	Mar. 7, 1959
Holi	Mar. 8, 1955	—	Mar. 26, 1956 Mar. 15, 1957	Mar. 5, 1958	—
Hola	Mar. 9, 1955	—	Mar. 27, 1956 Mar. 16, 1957	Mar. 6, 1958	—
Christmas Day	Dec. 25	Dec. 25	Dec. 25	Dec. 25	Dec. 25
Id-ul-Fitr	June 3	May 24	May 12	May 2	Apr. 21
Id-uz-Zuha	Aug. * 10	July 30	July * 19	July * 9	June 28
Muharram	Sep. 9	Aug. 29	Aug. 18	Aug. 7	July 28
Id-e-Milad	Nov. 9	Oct. 29	Oct. 17	Oct. 7	Sep. 26

* Proposed all-India holiday.

List of Holidays for different States—*contd.*

(15) RAJASTHAN HOLIDAYS

Festivals	Dates of Festivals				
	1954-55 Śaka 1876	1955-56 Śaka 1877	1956-57 Śaka 1878	1957-58 Śaka 1879	1958-59 Śaka 1880
Indian New Year's Day*	Mar. 22	Mar. 22	Mar. 21	Mar. 22	Mar. 22
Independence Day	Aug. 15	Aug. 15	Aug. 15	Aug. 15	Aug. 15
Mahatma Gandhi's Birthday	Oct. 2	Oct. 2	Oct. 2	Oct. 2	Oct. 2
English New Year's Day	Jan. 1	Jan. 1	Jan. 1	Jan. 1	Jan. 1
Makarādi	Jan. 14	Jan. 14	Jan. 13	Jan. 14	Jan. 14
Republic Day	Jan. 26	Jan. 26	Jan. 26	Jan. 26	Jan. 26
Mahāviṣuva Day*	Mar. 21, 1955	Mar. 20, 1956	Mar. 21, 1957	Mar. 21, 1958	Mar. 21, 1959
Sthāpana Navarātra	Apr. 4	Mar. 24, 1955	Apr. 12	Apr. 1, 1957 Mar. 21, 1958	—
Rāmanavami	Apr. 11	Apr. 1	Apr. 19	Apr. 8	Mar. 29
Mahāvīr's Birthday	Apr. 15	Apr. 5	Apr. 23	Apr. 12	Apr. 2
Oli ends (Jain)	Apr. 18	Apr. 7	Apr. 25	Apr. 14	Apr. 4
Buddha Jayantī	May 17	May 6	May 24	May 13	May 3
Pratap Jayantī	June 3	May 24	June 11	June 1	May 21
Rakṣā Bandhana	Aug. 14	Aug. 3	Aug. 21	Aug. 10	Aug. 29
Janmāṣṭamī	Aug. 21	Aug. 11	Aug. 29	Aug. 19	Sep. 6
Gaṇeśa Caturthī	Sep. 1	Sep. 19	Sep. 8	Aug. 28	Sep. 16
Ananta Caturdaśī	Sep. 11	Sep. 30	Sep. 18	Sep. 7	Sep. 26
Sarvapitṛ Śrāddha	Sep. 26	Oct. 15	Oct. 3	Sep. 23	Oct. 12
Sthāpana Navarātra	Sep. 28	Oct. 16	Oct. 5	Sep. 24	Oct. 13
Dussera	Oct. 4-7	Oct. 23-26	Oct. 11-14	Sep. 30-Oct. 3	Oct. 19-21
Diwali	Oct. 26-28	Nov. 14-16	Nov. 2-4	Oct. 22-24	Nov. 10-12
Guru Nanak's Birthday	Nov. 10	Nov. 29	Nov. 18	Nov. 7	Nov. 26
Guru Govinda Singh's Birthday	Jan. 1	Jan. 20	Jan. 8	Dec. 28	Jan. 16
Vasanta Pañcamī	Jan. 28	Feb. 16	Feb. 5	Jan. 24	Feb. 12
Mahāśivarātri	Feb. 20	Mar. 10, 1956	Feb. 27	Feb. 16	Mar. 7, 1959
Holi, 1st day	Mar. 8, 1955	—	Mar. 26, 1956 Mar. 15, 1957	Mar. 5, 1958	—
Holi, 2nd day	Mar. 9, 1955	—	Mar. 27, 1956 Mar. 16, 1957	Mar. 6, 1958	—
Christmas Day	Dec. 25	Dec. 25	Dec. 25	Dec. 25	Dec. 25
Id-ul-Fitr	June 3	May 24	May 12	May 2	Apr. 21
Id-uz-Zuha	Aug. 10	July 30	July 19	July 9	June 28
Muharram	Sep. 9	Aug. 29	Aug. 18	Aug. 7	July 28
Bara Wafat	Nov. 9	Oct. 29	Oct. 17	Oct. 7	Sep. 26

* Proposed all-India holiday.

List of Holidays for different States—*contd.*

(16) SAURASHTRA HOLIDAYS

Festivals	Dates of Festivals				
	1954-55 Śaka 1876	1955-56 Śaka 1877	1956-57 Śaka 1878	1957-58 Śaka 1879	1958-59 Śaka 1880
Indian New Year's Day*	Mar. 22	Mar. 22	Mar. 21	Mar. 22	Mar. 22
Independence Day	Aug. 15	Aug. 15	Aug. 15	Aug. 15	Aug. 15
Mahatma Gandhi's Birthday	Oct. 2	Oct. 2	Oct. 2	Oct. 2	Oct. 2
English New Year's Day	Jan. 1	Jan. 1	Jan. 1	Jan. 1	Jan. 1
Makarādi	Jan. 14	Jan. 14	Jan. 13	Jan. 14	Jan. 14
Republic Day	Jan. 26	Jan. 26	Jan. 26	Jan. 26	Jan. 26
Mahāviṣuva Day* (Jamshedi Nauroj)	Mar. 21, 1955	Mar. 20, 1956	Mar. 21, 1957	Mar. 21, 1958	Mar. 21, 1959
Rāmanavamī	Apr. 11	Apr. 1	Apr. 19	Apr. 8	Mar. 29
Mahāvīr's Birthday	Apr. 15	Apr. 5	Apr. 23	Apr. 12	Apr. 2
Oli ends (Jain) (Caitra S 15)	Apr. 18	Apr. 7	Apr. 25	Apr. 14	Apr. 4
Cocoanut Day	Aug. 14	Aug. 3	Aug. 21	Aug. 10	Aug. 29
Shilīsatam (Śītalā Saptamī)	Aug. 20	Aug. 10	Aug. 28	Aug. 17	Sep. 5
Gokulāṣṭamī	Aug. 21	Aug. 11	Aug. 29	Aug. 19	Sep. 6
Jain Festival (Śrāvāṇa K 13)	Aug. 26	Aug. 15	Sep. 3	Aug. 23	Sep. 11
Jain Festival (Śrāvāṇa K 30)	Aug. 28	Aug. 17	Sep. 4	Aug. 25	Sep. 13
Gaṇeśa Caturthī	Sep. 1	Sep. 19	Sep. 8	Aug. 28	Sep. 16
Paryuṣaṇa Parva (Jain)	Sep. 2	Sep. 21	Sep. 9	Aug. 29	Sep. 17
Durgāṣṭamī	Oct. 5	Oct. 24	Oct. 12	Oct. 1	Oct. 20
Vijayā Daśamī	Oct. 7	Oct. 26	Oct. 14	Oct. 3	Oct. 21
Dhan-Teras	Oct. 24	Nov. 11	Oct. 31	Oct. 21	Nov. 9
Kālī Caudas	Oct. 25	Nov. 13	Nov. 1	Oct. 22	Nov. 10
Diwali	Oct. 26	Nov. 14	Nov. 2	Oct. 22	Nov. 10
Guru Nanak's Birthday	Nov. 10	Nov. 29	Nov. 18	Nov. 7	Nov. 26
Jain Festival (Kārtika S 15)	Nov. 10	Nov. 29	Nov. 18	Nov. 7	Nov. 26
Mahāśivarātri	Feb. 20	Mar. 10, 1956	Feb. 27	Feb. 16	Mar. 7, 1959
Holi, 1st day	Mar. 8, 1955	—	Mar. 26, 1956 Mar. 15, 1957	Mar. 5, 1958	—
Holi, 2nd day	Mar. 9, 1955	—	Mar. 27, 1956 Mar. 16, 1957	Mar. 6, 1958	—
Good Friday	Apr. 16	Apr. 8	Mar. 30	Apr. 19	Apr. 4
Christmas Day	Dec. 25	Dec. 25	Dec. 25	Dec. 25	Dec. 25
Sab-e-Barat	Apr. 19	Apr. 9	Mar. 28, 1956 Mar. 18, 1957	Mar. 7, 1958	Feb. 24, 1959
Id-ul-Fitr	June 3	May 24	May 12	May 2	Apr. 21
Id-uz-Zuha	Aug. 10	July 30	July 19	July 9	June 28
Muharram	Sep. 9	Aug. 29	Aug. 18	Aug. 7	July 28
Id-e-Milad	Nov. 9	Oct. 29	Oct. 17	Oct. 7	Sep. 26

* Proposed all-India holiday.

List of Holidays for different States—*contd.*

(17) TRAVANCORE-COCHIN HOLIDAYS

Festivals	Dates of Festivals				
	1954-55 Śaka 1876	1955-56 Śaka 1877	1956-57 Śaka 1878	1957-58 Śaka 1879	1958-59 Śaka 1880
Indian New Year's Day*	Mar. 22	Mar. 22	Mar. 21	Mar. 22	Mar. 22
Vishu	Apr. 13	Apr. 14	Apr. 13	Apr. 13	Apr. 13
Independence Day	Aug. 15	Aug. 15	Aug. 15	Aug. 15	Aug. 15
Samādhi day of Nārāyaṇa Guru	Sep. 21	Sep. 21	Sep. 21	Sep. 21	Sep. 21
Mahatma Gandhi's Birthday	Oct. 2	Oct. 2	Oct. 2	Oct. 2	Oct. 2
English New Year's Day	Jan. 1	Jan. 1	Jan. 1	Jan. 1	Jan. 1
Tai Pongal	Jan. 14	Jan. 14	Jan. 13	Jan. 14	Jan. 14
Republic Day	Jan. 26	Jan. 26	Jan. 26	Jan. 26	Jan. 26
Mahāvīṣuva Day*	Mar. 21, 1955	Mar. 20, 1956	Mar. 21, 1957	Mar. 21, 1958	Mar. 21, 1959
Karkāṭaka Vavu	July 29	July 19	Aug. 6	July 27	Aug. 15
Āvaṇi Avittam	Aug. 14	Aug. 3	Aug. 21	Aug. 10	Aug. 28
Śrī Jayantī (Aṣṭamī Rohiṇī)	Aug. 21	Sep. 9	Aug. 29	Aug. 19	Sep. 6
Vināyaka Caturthī	Sep. 1	Sep. 19	Sep. 8	Aug. 28	Sep. 16
First Onam Day	Sep. 9	Aug. 30	Aug. 19	Sep. 5	Aug. 26
Thiru Onam Day	Sep. 10	Aug. 31	Aug. 20	Sep. 6	Aug. 27
Third Onam Day	Sep. 11	Sep. 1	Aug. 21	Sep. 7	Aug. 28
Fourth Onam Day	Sep. 12	Sep. 2	Aug. 22	Sep. 8	Aug. 29
Durgāṣṭamī	Oct. 5	Oct. 24	Oct. 12	Oct. 1	Oct. 20
Mahānavamī	Oct. 6	Oct. 25	Oct. 13	Oct. 2	Oct. 20
Vijayā Daśamī	Oct. 7	Oct. 26	Oct. 14	Oct. 3	Oct. 21
Diwali	Oct. 25	Nov. 13	Nov. 1	Oct. 21	Nov. 10
Makara Vavu	Jan. 23	Feb. 11	Jan. 30	Jan. 19	Feb. 7
Mahāśivarātri	Feb. 20	Mar. 10, 1956	Feb. 27	Feb. 16	Mar. 7, 1959
Good Friday	Apr. 16	Apr. 8	Mar. 30	Apr. 19	Apr. 4
Easter Saturday	Apr. 17	Apr. 9	Mar. 31	Apr. 20	Apr. 5
Ascension Day (Holy Thursday)	May 27	May 19	May 10	May 30	May 15
Whit Sunday (Pentecost)	June 6	May 29	May 20	June 9	May 25
Christmas Eve	Dec. 24	Dec. 24	Dec. 24	Dec. 24	Dec. 24
Christmas Day	Dec. 25	Dec. 25	Dec. 25	Dec. 25	Dec. 25
Id-ul Fitr	June 3	May 24	May 12	May 2	Apr. 21
Id-uz-Zuha	Aug. 10	July 30	July 19	July 9	June 28
Muharram	Sep. 9	Aug. 29	Aug. 18	Aug. 7	July 28
Id-e-Milad	Nov. 9	Oct. 29	Oct. 17	Oct. 7	Sep. 26

* Proposed all-India holiday.

List of Holidays for different States—*contd.*

(18) AJMER HOLIDAYS

Festivals	Dates of Festivals				
	1954-55 Śaka 1876	1955-56 Śaka 1877	1956-57 Śaka 1878	1957-58 Śaka 1879	1958-59 Śaka 1880
Indian New Year's Day*	Mar. 22	Mar. 22	Mar. 21	Mar. 22	Mar. 22
Vaiśākhi	Apr. 13	Apr. 13	Apr. 13	Apr. 13	Apr. 13
Independence Day	Aug. 15	Aug. 15	Aug. 15	Aug. 15	Aug. 15
Mahatma Gandhi's Birthday	Oct. 2	Oct. 2	Oct. 2	Oct. 2	Oct. 2
English New Year's Day	Jan. 1	Jan. 1	Jan. 1	Jan. 1	Jan. 1
Republic Day	Jan. 26	Jan. 26	Jan. 26	Jan. 26	Jan. 26
Mahāvīṣuva Day*	Mar. 21, 1955	Mar. 20, 1956	Mar. 21, 1957	Mar. 21, 1958	Mar. 21, 1959
Rāmanavamī	Apr. 11	Apr. 1	Apr. 19	Apr. 8	Mar. 29
Mahāvīr's Birthday	Apr. 15	Apr. 5	Apr. 23	Apr. 12	Apr. 2
Buddha's Birthday	May 17	May 6	May 24	May 13	May 3
Rakṣā Bandhana	Aug. 14	Aug. 3	Aug. 21	Aug. 10	Aug. 29
Janmāṣṭamī	Aug. 21	Aug. 11	Aug. 29	Aug. 19	Sep. 6
Ananta Caturdaśī	Sep. 11	Sep. 30	Sep. 18	Sep. 7	Sep. 26
Dussera	Oct. 4-7	Oct. 23-26	Oct. 11-14	Sep. 30-Oct. 3	Oct. 19-21
Dipamālikā	Oct. 26-27	Nov. 14-15	Nov. 2-3	Oct. 22-23	Nov. 10-11
Yama Dvitiyā	Oct. 28	Nov. 16	Nov. 4	Oct. 24	Nov. 12
Puṣkar Fair	Nov. 10	Nov. 29	Nov. 18	Nov. 7	Nov. 26
Guru Govinda Singh's Birthday	Jan. 1	Jan. 20	Jan. 8	Dec. 28	Jan. 16
Vasanta Pañcamī	Jan. 28	Feb. 16	Feb. 5	Jan. 24	Feb. 12
Mahāśivarātri	Feb. 20	Mar. 10, 1956	Feb. 27	Feb. 16	Mar. 7, 1959
Holi, 1st day	Mar. 8, 1955	—	Mar. 26, 1956 Mar. 15, 1957	Mar. 5, 1958	—
Holi, 2nd day	Mar. 9, 1955	—	Mar. 27, 1956 Mar. 16, 1957	Mar. 6, 1958	—
Good Friday	Apr. 16	Apr. 8	Mar. 30	Apr. 19	Apr. 4
Christmas Day	Dec. 25	Dec. 25	Dec. 25	Dec. 25	Dec. 25
Id-ul-Fitr	June 3	May 24	May 12	May 2	Apr. 21
Id-uz-Zuha	Aug. 10	July 30	July 19	July 9	June 28
Muharram	Sep. 9	Aug. 29	Aug. 18	Aug. 7	July 28
Bara Wafat	Nov. 9	Oct. 29	Oct. 17	Oct. 7	Sep. 26

* Proposed all-India holiday.

List of Holidays for different States—contd.

(19) BHOPAL HOLIDAYS

Festivals	Dates of Festivals				
	1954-55 Śaka 1876	1955-56 Śaka 1877	1956-57 Śaka 1878	1957-58 Śaka 1879	1958-59 Śaka 1880
Indian New Year's Day*	Mar. 22	Mar. 22	Mar. 21	Mar. 22	Mar. 22
Vaiśākhi	Apr. 13	Apr. 13	Apr. 13	Apr. 13	Apr. 13
Independence Day	Aug. 15	Aug. 15	Aug. 15	Aug. 15	Aug. 15
H. H. Birthday	Sep. 9	Sept. 9	Sep. 9	Sep. 9	Sep. 9
Mahatma Gandhi's Birthday	Oct. 2	Oct. 2	Oct. 2	Oct. 2	Oct. 2
English New Year's Day	Jan. 1	Jan. 1	Jan. 1	Jan. 1	Jan. 1
Tila Saṁkrānti	Jan. 14	Jan. 14	Jan. 13	Jan. 14	Jan. 14
Republic Day	Jan. 26	Jan. 26	Jan. 26	Jan. 26	Jan. 26
Mahāviṣuva Day*	Mar. 21, 1955	Mar. 20, 1956	Mar. 21, 1957	Mar. 21, 1958	Mar. 21, 1959
Rāmanavami	Apr. 11	Apr. 1	Apr. 19	Apr. 8	Mar. 29
Mahāvira Jayanti	Apr. 15	Apr. 5	Apr. 23	Apr. 12	Apr. 2
Buddha Pūrṇimā	May 17	May 6	May 24	May 13	May 3
Rakṣā Bandhana	Aug. 14	Aug. 3	Aug. 21	Aug. 10	Aug. 29
Janmāṣṭami	Aug. 21	Aug. 11	Aug. 29	Aug. 19	Sep. 6
Gaṇeśa Caturthi	Sep. 1	Sep. 19	Sep. 8	Aug. 28	Sep. 16
Dussera	Oct. 5-7	Oct. 24-26	Oct. 12-14	Oct. 1-3	Oct. 20-21
Diwali	Oct. 27-28	Nov. 15-16	Nov. 3-4	Oct. 23-24	Nov. 11-12
Guru Nanak's Birthday	Nov. 10	Nov. 29	Nov. 18	Nov. 7	Nov. 26
Vasanta Pañcamī	Jan. 28	Feb. 16	Feb. 5	Jan. 24	Feb. 12
Mahāśivarātri	Feb. 20	Mar. 10, 1956	Feb. 27	Feb. 16	Mar. 7, 1959
Holi, 1st day	Mar. 8, 1955	—	Mar. 26, 1956 Mar. 15, 1957	Mar. 5, 1958	—
Holi, 2nd day	Mar. 9, 1955	—	Mar. 27, 1956 Mar. 16, 1957	Mar. 6, 1958	—
Good Friday	Apr. 16	Apr. 8	Mar. 30	Apr. 19	Apr. 4
Christmas Day	Dec. 25	Dec. 25	Dec. 25	Dec. 25	Dec. 25
Sab-e-Barat	Apr. 19	Apr. 9	Mar. 28, 1956 Mar. 18, 1957	Mar. 7, 1958	Feb. 24, 1959
Jamat-ul-Vida (Last Friday of Ramadan)	May 28	May 20	May 11	Apr. 26	Apr. 18
Id-ul-Fitr	June 3	May 24	May 12	May 2	Apr. 21
Id-uz-Zuha	Aug. 10	July 30	July 19	July 9	June 28
Muharram	Sep. 9	Aug. 29	Aug. 18	Aug. 7	July 28
Bara Wafat	Nov. 9	Oct. 29	Oct. 17	Oct. 7	Sep. 26
Giarhween Sharif	Dec. 8	Nov. 27	Nov. 15	Nov. 4	Oct. 25

* Proposed all-India holiday.

List of Holidays for different States—contd.

(20) BILASPUR HOLIDAYS

Festivals	Dates of Festivals				
	1954-55 Śaka 1876	1955-56 Śaka 1877	1956-57 Śaka 1878	1957-58 Śaka 1879	1958-59 Śaka 1880
Indian New Year's Day*	Mar. 22	Mar. 22	Mar. 21	Mar. 22	Mar. 22
Vaiśākhi	Apr. 13	Apr. 13	Apr. 13	Apr. 13	Apr. 13
Independence Day	Aug. 15	Aug. 15	Aug. 15	Aug. 15	Aug. 15
Mahatma Gandhi's Birthday	Oct. 2	Oct. 2	Oct. 2	Oct. 2	Oct. 2
English New Year's Day	Jan. 1	Jan. 1	Jan. 1	Jan. 1	Jan. 1
Republic Day	Jan. 26	Jan. 26	Jan. 26	Jan. 26	Jan. 26
Mahāvīṣuva Day*	Mar. 21, 1955	Mar. 20, 1956	Mar. 21, 1957	Mar. 21, 1958	Mar. 21, 1959
Rāmanavamī	Apr. 11	Apr. 1	Apr. 19	Apr. 8	Mar. 29
Buddha's Birthday	May 17	May 6	May 24	May 13	May 3
Janmāṣṭamī	Aug. 21	Aug. 11	Aug. 29	Aug. 19	Sep. 6
Dussera	Oct. 4-7	Oct. 23-26	Oct. 11-14	Sep. 30-Oct. 3	Oct. 19-21
Diwali	Oct. 26-27	Nov. 14-15	Nov. 2-3	Oct. 22-23	Nov. 10-11
Guru Nanak's Birthday	Nov. 10	Nov. 29	Nov. 18	Nov. 7	Nov. 26
Mahāśivarātri	Feb. 20	Mar. 10, 1956	Feb. 27	Feb. 16	Mar. 7, 1959
Holi, 1st day	Mar. 8, 1955	—	Mar. 26, 1956 Mar. 15, 1957	Mar. 5, 1958	—
Holi, 2nd day	Mar. 9, 1955	—	Mar. 27, 1956 Mar. 16, 1957	Mar. 6, 1958	—
Good Friday	Apr. 16	Apr. 8	Mar. 30	Apr. 19	Apr. 4
Christmas Day	Dec. 25	Dec. 25	Dec. 25	Dec. 25	Dec. 25
Id-ul-Fitr	June 3	May 24	May 12	May 2	Apr. 21
Id-uz-Zuba	Aug. 10	July 30	July 19	July 9	June 28
Muharram	Sep. 9	Aug. 29	Aug. 18	Aug. 7	July 28
Id-e-Milad	Nov. 9	Oct. 29	Oct. 17	Oct. 7	Sep. 26

* Proposed all-India holiday.

List of Holidays for different States—contd.

(21) COORG HOLIDAYS

Festivals	Dates of Festivals				
	1954-55 Śaka 1876	1955-56 Śaka 1877	1956-57 Śaka 1878	1957-58 Śaka 1879	1958-59 Śaka 1880
Indian New Year's Day*	Mar. 22	Mar. 22	Mar. 21	Mar. 22	Mar. 22
Independence Day	Aug. 15	Aug. 15	Aug. 15	Aug. 15	Aug. 15
Keil Muhurth	Sep. 3	Sep. 3	Sep. 3	Sep. 3	Sep. 3
Mahatma Gandhi's Birthday	Oct. 2	Oct. 2	Oct. 2	Oct. 2	Oct. 2
Kāveri Saṁkramaṇa	Oct. 17	Oct. 17	Oct. 16	Oct. 17	Oct. 17
English New Year's Day	Jan. 1	Jan. 1	Jan.	Jan. 1	Jan. 1
Makarādi	Jan. 14	Jan. 14	Jan. 13	Jan. 14	Jan. 14
Republic Day	Jan. 26	Jan. 26	Jan. 26	Jan. 26	Jan. 26
Mahāviṣuva Day*	Mar. 21, 1955	Mar. 20, 1956	Mar. 21, 1957	Mar. 21, 1958	Mar. 21, 1959
Upākarma	Aug. 14	Aug. 3	Aug. 21	Aug. 10	Aug. 29
Śrī Kṛṣṇa Jayanti	Aug. 21	Aug. 11	Aug. 29	Aug. 19	Sep. 6
Vināyaka Caturthī	Sep. 1	Sep. 19	Sep. 8	Aug. 28	Sep. 16
Mahālayā Amāvasyā	Sep. 26	Oct. 15	Oct. 3	Sep. 23	Oct. 12
Āyudha Pūjā	Oct. 4	Oct. 23	Oct. 11	Sep. 30	Oct. 19
Diwali	Oct. 26	Nov. 14	Nov. 2	Oct. 22	Nov. 10
Subrahmanya Ṣaṣṭhī	Dec. 1	Dec. 20	Dec. 8	Nov. 27	Dec. 16
Mahāśivarātri	Feb. 20	Mar. 10, 1956	Feb. 27	Feb. 16	Mar. 7, 1959
Good Friday	Apr. 16	Apr. 8	Mar. 30	Apr. 19	Apr. 4
Christmas Day	Dec. 25	Dec. 25	Dec. 25	Dec. 25	Dec. 25
Id-ul-Fitr (Ramzan-id)	June 3	May 24	May 12	May 2	Apr. 31
Id-uz-Zuha (Bakrid)	Aug. 10	July 30	July 19	July 9	June 28
Muharram	Sep. 9	Aug. 29	Aug. 18	Aug. 7	July 28
Id-e-Milad (Miladi Nobi)	Nov. 9	Oct. 29	Oct. 17	Oct. 7	Sep. 26

* Proposed all-India holiday.

List of Holidays for different States—*contd.*

(22) DELHI HOLIDAYS

Festivals	Dates of Festivals				
	1954-55 Śaka 1876	1955-56 Śaka 1877	1956-57 Śaka 1878	1957-58 Śaka 1879	1958-59 Śaka 1880
Indian New Year's Day*	Mar. 22	Mar. 22	Mar. 21	Mar. 22	Mar. 22
Vaiśākhi	Apr. 13	Apr. 13	Apr. 13	Apr. 13	Apr. 13
Independence Day	Aug. 15	Aug. 15	Aug. 15	Aug. 15	Aug. 15
Mahatma Gandhi's Birthday	Oct. 2	Oct. 2	Oct. 2	Oct. 2	Oct. 2
English New Year's Day	Jan. 1	Jan. 1	Jan. 1	Jan. 1	Jan. 1
Republic Day	Jan. 26	Jan. 26	Jan. 26	Jan. 26	Jan. 26
Mahāviṣuva Day*	Mar. 21, 1955	Mar. 20, 1956	Mar. 21, 1957	Mar. 21, 1958	Mar. 21, 1959
Rāmanavami	Apr. 11	Apr. 1	Apr. 19	Apr. 8	Mar. 29
Mahāvira Jayanti	Apr. 15	Apr. 5	Apr. 23	Apr. 12	Apr. 2
Solono	Aug. 14	Aug. 3	Aug. 21	Aug. 10	Aug. 29
Janmāṣṭami	Aug. 21	Aug. 11	Aug. 29	Aug. 19	Sep. 6
Ananta Caturdaśi	Sep. 11	Sep. 30	Sep. 18	Sep. 7	Sep. 26
Dussera	Oct. 4-7	Oct. 23-26	Oct. 11-14	Sep. 30-Oct. 3	Oct. 19-21
Bharat Milap	Oct. 8	Oct. 27	Oct. 15	Oct. 4	Oct. 23
Diwali	Oct. 26	Nov. 14	Nov. 2	Oct. 22	Nov. 10
Govardhana Pūjā	Oct. 27	Nov. 15	Nov. 3	Oct. 23	Nov. 11
Guru Nanak's Birthday	Nov. 10	Nov. 29	Nov. 18	Nov. 7	Nov. 26
Sahid Day of Guru Teg Bahadur	Nov. 30	Dec. 19	Dec. 7	Nov. 26	Dec. 15
Guru Govinda Singh's Birthday	Jan. 1	Jan. 20	Jan. 8	Dec. 28	Jan. 16
Vasanta Pañcamī	Jan. 28	Feb. 16	Feb. 5	Jan. 24	Feb. 12
Mahāśivarātri	Feb. 20	Mar. 10, 1956	Feb. 27	Feb. 16	Mar. 7, 1959
Holi	Mar. 8, 1955	—	Mar. 26, 1956 Mar. 15, 1957	Mar. 5, 1958	—
Dulhandi	Mar. 9, 1955	—	Mar. 27, 1956 Mar. 16, 1957	Mar. 6, 1958	—
Good Friday	Apr. 16	Apr. 8	Mar. 30	Apr. 19	Apr. 4
Christmas Day	Dec. 25	Dec. 25	Dec. 25	Dec. 25	Dec. 25
Id-ul-Fitr	June 3	May 24	May 12	May 2	Apr. 21
Id-uz Zuha	Aug. 10	July 30	July 19	July 9	June 28
Muharram	Sep. 9	Aug. 29	Aug. 18	Aug. 7	July 28
Id-e-Milad	Nov. 9	Oct. 29	Oct. 17	Oct. 7	Sep. 26

* Proposed all-India holiday.

List of Holidays for different States—*contd.*

(23) HIMACHAL PRADESH HOLIDAYS

Festivals	Dates of Festivals				
	1954-55 Śaka 1876	1955-56 Śaka 1877	1956-57 Śaka 1878	1957-58 Śaka 1879	1958-59 Śaka 1880
Indian New Year's Day*	Mar. 22	Mar. 22	Mar. 21	Mar. 22	Mar. 22
Vaiśākhi	Apr. 13	Apr. 13	Apr. 13	Apr. 13	Apr. 13
Independence Day	Aug. 15	Aug. 15	Aug. 15	Aug. 15	Aug. 15
Mahatma Gandhi's Birthday	Oct. 2	Oct. 2	Oct. 2	Oct. 2	Oct. 2
English New Year's Day	Jan. 1	Jan. 1	Jan. 1	Jan. 1	Jan. 1
Māghī	Jan. 14	Jan. 14	Jan. 13	Jan. 14	Jan. 14
Republic Day	Jan. 26	Jan. 26	Jan. 26	Jan. 26	Jan. 26
H. Swatantra Divas	Feb. 18	Feb. 18	Feb. 18	Feb. 18	Feb. 18
Mahāviṣuva Day*	Mar. 21, 1955	Mar. 20, 1956	Mar. 21, 1957	Mar. 21, 1958	Mar. 21, 1959
Rāmanavami	Apr. 11	Apr. 1	Apr. 19	Apr. 8	Mar. 29
Rakṣā Bandhana	Aug. 14	Aug. 3	Aug. 21	Aug. 10	Aug. 29
Janmāṣṭamī	Aug. 21	Aug. 11	Aug. 29	Aug. 19	Sep. 6
Dussera	Oct. 4-7	Oct. 23-26	Oct. 11-14	Sep. 30-Oct. 3	Oct. 19-21
Maharṣi Vālmiki's Birthday	Oct. 12	Oct. 31	Oct. 19	Oct. 8	Oct. 27
Diwali	Oct. 26-27	Nov. 14-15	Nov. 2-3	Oct. 22-23	Nov. 10-11
Tikka Ceremony	Oct. 28	Nov. 16	Nov. 4	Oct. 24	Nov. 12
Guru Nanak's Birthday	Nov. 10	Nov. 29	Nov. 18	Nov. 7	Nov. 26
Guru Govinda Singh's Birthday	Jan. 1	Jan. 20	Jan. 8	Dec. 28	Jan. 16
Vasanta Pañcamī	Jan. 28	Feb. 16	Feb. 5	Jan. 24	Feb. 12
Guru Ravi Das's Birthday	Feb. 6	Feb. 25	Feb. 14	Feb. 4	Feb. 23
Mahāśivarātri	Feb. 20	Mar. 10, 1956	Feb. 27	Feb. 16	Mar. 7, 1959
Holi, 1st day	Mar. 8, 1955	—	Mar. 26, 1956 Mar. 15, 1957	Mar. 5, 1958	—
Holi, 2nd day	Mar. 9, 1955	—	Mar. 27, 1956 Mar. 16, 1957	Mar. 6, 1958	—
Good Friday	Apr. 16	Apr. 8	Mar. 30	Apr. 19	Apr. 4
Christmas Day	Dec. 25	Dec. 25	Dec. 25	Dec. 25	Dec. 25
Id-ul-Fitr	June 3	May 24	May 12	May 2	Apr. 21
Id-uz-Zuha	Aug. 10	July 30	July 19	July 9	June 28
Muharram	Sep. 9	Aug. 29	Aug. 18	Aug. 7	July 28
Id-e-Milad	Nov. 9	Oct. 29	Oct. 17	Oct. 7	Sep. 26

Proposed all-India holiday.

List of Holidays for different States—*contd.*

(24) KUTCH HOLIDAYS

Festivals	Dates of Festivals				
	1954-55 Śaka 1876	1955-56 Śaka 1877	1956-57 Śaka 1878	1957-58 Śaka 1879	1958-59 Śaka 1880
Indian New Year's Day*	Mar. 22	Mar. 22	Mar. 21	Mar. 22	Mar. 22
Independence Day	Aug. 15	Aug. 15	Aug. 15	Aug. 15	Aug. 15
Mahatma Gandhi's Birthday	Oct. 2	Oct. 2	Oct. 2	Oct. 2	Oct. 2
English New Year's Day	Jan. 1	Jan. 1	Jan. 1	Jan. 1	Jan. 1
Makarādi	Jan. 14	Jan. 14	Jan. 13	Jan. 14	Jan. 14
Republic Day	Jan. 26	Jan. 26	Jan. 26	Jan. 26	Jan. 26
Mahāvīṣuva Day*	Mar. 21, 1955	Mar. 20, 1956	Mar. 21, 1957	Mar. 21, 1958	Mar. 21, 1959
Rāmanavami	Apr. 11	Apr. 1	Apr. 19	Apr. 8	Mar. 29
Mahāvīr's Birthday	Apr. 15	Apr. 5	Apr. 23	Apr. 12	Apr. 2
Nirjalā (Bhim) Agiaras	June 12	June 1	June 18	June 8	May 29
Cocconut Day	Aug. 14	Aug. 3	Aug. 21	Aug. 10	Aug. 29
Śitalā Saptamī	Aug. 20	Aug. 10	Aug. 28	Aug. 17	Sep. 5
Gokulāṣṭamī	Aug. 21	Aug. 11	Aug. 29	Aug. 19	Sep. 6
Gaṇeśa Caturthī	Sep. 1	Sep. 19	Sep. 8	Aug. 28	Sep. 16
Saivatsari & Paryuṣaṇa Parva (Jain)	Sep. 2	Sep. 21	Sep. 9	Aug. 29	Sep. 17
H. H. Birthday	Sep. 24	Oct. 13	Oct. 2	Sep. 22	Oct. 11
Dussera	Oct. 7	Oct. 26	Oct. 14	Oct. 3	Oct. 21
Dhan-Teras	Oct. 24	Nov. 11	Oct. 31	Oct. 21	Nov. 9
Kālī Caudas	Oct. 25	Nov. 13	Nov. 1	Oct. 22	Nov. 10
Diwali	Oct. 26	Nov. 14	Nov. 2	Oct. 22	Nov. 10
Mahāśivarātri	Feb. 20	Mar. 10, 1956	Feb. 27	Feb. 16	Mar. 7, 1959
Holi, 1st day	Mar. 8, 1955	—	Mar. 26, 1956 Mar. 15, 1957	Mar. 5, 1958	—
Holi, 2nd day	Mar. 9, 1955	—	Mar. 27, 1956 Mar. 16, 1957	Mar. 6, 1958	—
Good Friday	Apr. 16	Apr. 8	Mar. 30	Apr. 19	Apr. 4
Christmas Day	Dec. 25	Dec. 25	Dec. 25	Dec. 25	Dec. 25
Id-ul-Fitr	June 3	May 24	May 12	May 2	Apr. 21
Id-uz-Zuha	Aug. 10	July 30	July 19	July 9	June 28
Muharram	Sep. 9	Aug. 29	Aug. 18	Aug. 7	July 28
Id-e-Milad	Nov. 9	Oct. 29	Oct. 17	Oct. 7	Sep. 26

* Proposed all-India holiday.

List of Holidays for different States—*contd.*

(25) MANIPUR HOLIDAYS

Festivals	Dates of Festivals				
	1954-55 Śaka 1876	1955-56 Śaka 1877	1956-57 Śaka 1878	1957-58 Śaka 1879	1958-59 Śaka 1880
Indian New Year's Day*	Mar. 22	Mar. 22	Mar. 21	Mar. 22	Mar. 22
Cheiraoba	Apr. 13	Apr. 14	Apr. 13	Apr. 13	Apr. 13
Independence Day	Aug. 15	Aug. 15	Aug. 15	Aug. 15	Aug. 15
Mahatma Gandhi's Birthday	Oct. 2	Oct. 2	Oct. 2	Oct. 2	Oct. 2
English New Year's Day	Jan. 1	Jan. 1	Jan. 1	Jan. 1	Jan. 1
Makarādi	Jan. 14	Jan. 14	Jan. 13	Jan. 14	Jan. 14
Republic Day	Jan. 26	Jan. 26	Jan. 26	Jan. 26	Jan. 26
Mahāviṣuva Day*	Mar. 21, 1955	Mar. 20, 1956	Mar. 21, 1957	Mar. 21, 1958	Mar. 21, 1959
Vijay Govindaji Halenkar	Mar. 24, 1954 Mar. 13, 1955	—	Mar. 31, 1956 Mar. 20, 1957	Mar. 10, 1958	—
Vāruṇī	Apr. 1	Mar. 22, 1955	Apr. 8	Mar. 29, 1957 Mar. 18, 1958	—
Akṣaya Tṛtīyā	May 5	Apr. 25	May 13	May 2	Apr. 22
Rathayātrā	July 2	June 21	July 9	June 29	June 19
Punaryātrā	July 10	June 29	July 17	July 7	June 27
Jhulanayātrā	Aug. 10	July 30	Aug. 17	Aug. 6	Aug. 25
Janmāṣṭamī	Aug. 21	Aug. 11	Aug. 29	Aug. 19	Sep. 6
Rādhāṣṭamī	Sep. 5	Sep. 24	Sep. 12	Sep. 1	Sep. 20
Heikra Hitomba	Sep. 9	Sep. 27	Sep. 15	Sep. 4	Sep. 23
Tarpana Laybā	Sep. 26	Oct. 15	Oct. 4	Sep. 23	Oct. 12
Durgā Pūjā	Oct. 4-7	Oct. 23-26	Oct. 11-14	Sep. 30-Oct. 3	Oct. 19-22
Lakṣmī Pūrṇimā	Oct. 11	Oct. 30	Oct. 19	Oct. 8	Oct. 27
Diwali (Dīpanvitā)	Oct. 26	Nov. 14	Nov. 2	Oct. 22	Nov. 10
Govardhana Pūjā	Oct. 27	Nov. 15	Nov. 3	Oct. 23	Nov. 11
Bhrātr Dvitiyā	Oct. 28	Nov. 16	Nov. 4	Oct. 24	Nov. 12
Goṣṭhāṣṭamī	Nov. 4	Nov. 23	Nov. 11	Oct. 30	Nov. 18
Sri-Pāncamī	Jan. 28	Feb. 16	Feb. 5	Jan. 25	Feb. 12
Mahāśivarātri	Feb. 20	Mar. 10, 1956	Feb. 27	Feb. 16	Mar. 7, 1959
Dolayātrā	Mar. 8, 1955	—	Mar. 26, 1956 Mar. 16, 1957	Mar. 5, 1958	—
Good Friday	Apr. 16	Apr. 8	Mar. 30	Apr. 19	Apr. 4
Christmas Day	Dec. 25	Dec. 25	Dec. 25	Dec. 25	Dec. 25
Id-ul-Fitr	June 3	May 24	May 12	May 2	Apr. 21
Id-uz-Zuha	Aug. 10	July 30	July 19	July 9	June 28
Muharram	Sep. 9	Aug. 29	Aug. 18	Aug. 7	July 28
Id-e-Milad	Nov. 9	Oct. 29	Oct. 17	Oct. 7	Sep. 26

* Proposed all-India holiday.

List of Holidays for different States—*contd.*

(26) TRIPURA HOLIDAYS

Festivals	Dates of Festivals				
	1954-55 Śaka 1876	1955-56 Śaka 1877	1956-57 Śaka 1878	1957-58 Śaka 1879	1958-59 Śaka 1880
Indian New Year's Day*	Mar. 22	Mar. 22	Mar. 21	Mar. 22	Mar. 22
Meṣa Saṁkrānti	Apr. 13	Apr. 14	Apr. 13	Apr. 13	Apr. 13
Independence Day	Aug. 15	Aug. 15	Aug. 15	Aug. 15	Aug. 15
Mahatma Gandhi's Birthday	Oct. 2	Oct. 2	Oct. 2	Oct. 2	Oct. 2
English New Year's Day	Jan. 1	Jan. 1	Jan. 1	Jan. 1	Jan. 1
Republic Day	Jan. 26	Jan. 26	Jan. 26	Jan. 26	Jan. 26
Mahāviṣuva Day*	Mar. 21, 1955	Mar. 20, 1956	Mar. 21, 1957	Mar. 21, 1958	Mar. 21, 1959
Khārci Pūjā	July 8	June 27	July 15	July 4	June 24
Ker Pūjā	July 24	July 12	July 31	July 20	July 8
Janmāṣṭami	Aug. 21	Aug. 11	Aug. 29	Aug. 19	Sep. 6
Mahālayā Amāvasyā	Sep. 26	Oct. 15	Oct. 3	Sep. 23	Oct. 12
Durgā Pūjā	Oct. 4-7	Oct. 23-26	Oct. 11-14	Sep. 30-Oct. 3	Oct. 19-22
Lakṣmī Pūjā	Oct. 11	Oct. 30	Oct. 19	Oct. 8	Oct. 27
Kālī Pūjā	Oct. 25	Nov. 13	Nov. 1	Oct. 22	Nov. 10
Jagaddhātri Pūjā	Nov. 5	Nov. 24	Nov. 12	Oct. 31	Nov. 19
Śrī Pañcamī	Jan. 28	Feb. 16	Feb. 5	Jan. 25	Feb. 12
Dolayātrā	Mar. 8, 1955	—	Mar. 26, 1956 Mar. 16, 1957	Mar. 5, 1958	—
Good Friday	Apr. 16	Apr. 8	Mar. 30	Apr. 19	Apr. 4
Easter Saturday	Apr. 17	Apr. 9	Mar. 31	Apr. 20	Apr. 5
Christmas Day	Dec. 25	Dec. 25	Dec. 25	Dec. 25	Dec. 25
Id-ul-Fitr	June 3	May 24	May 12	May 2	Apr. 21
Id-uz-Zuha	Aug. 10	July 30	July 19	July 9	June 28
Muharram	Sep. 9	Aug. 29	Aug. 18	Aug. 7	July 28

* Proposed all-India holiday.

List of Holidays for different States—concluded.

(27) VINDHYA PRADESH HOLIDAYS

Festivals	Dates of Festivals				
	1954-55 Śaka 1876	1955-56 Śaka 1877	1956-57 Śaka 1878	1957-58 Śaka 1879	1958-59 Śaka 1880
Indian New Year's Day*	Mar. 22	Mar. 22	Mar. 21	Mar. 22	Mar. 22
Independence Day	Aug. 15	Aug. 15	Aug. 15	Aug. 15	Aug. 15
Mahātma Gandhi's Birthday	Oct. 2	Oct. 2	Oct. 2	Oct. 2	Oct. 2
English New Year's Day	Jan. 1	Jan. 1	Jan. 1	Jan. 1	Jan. 1
Makarādi	Jan. 14	Jan. 14	Jan. 13	Jan. 14	Jan. 14
Republic Day	Jan. 26	Jan. 26	Jan. 26	Jan. 26	Jan. 26
Mahāviṣuva Day*	Mar. 21, 1955	Mar. 20, 1956	Mar. 21, 1957	Mar. 21, 1958	Mar. 21, 1959
Rāmanavami	Apr. 11	Apr. 1	Apr. 19	Apr. 8	Mar. 29
Mahāvīr's Birthday	Apr. 15	Apr. 5	Apr. 23	Apr. 12	Apr. 2
Rakṣā Bandhana	Aug. 14	Aug. 3	Aug. 21	Aug. 10	Aug. 29
Janmāṣṭamī	Aug. 21	Aug. 11	Aug. 29	Aug. 19	Sep. 6
Dusseṛā	Oct. 4-7	Oct. 23-26	Oct. 11-14	Sep. 30-Oct. 3	Oct. 19-21
Diwali	Oct. 26-27	Nov. 14-15	Nov. 2-3	Oct. 22-23	Nov. 10-11
Yama Dvitiyā	Oct. 28	Nov. 16	Nov. 4	Oct. 24	Nov. 12
Deo Prābodhani Ekādaśī	Nov. 7	Nov. 26	Nov. 14	Nov. 3	Nov. 21
Guru Nanak's Birthday	Nov. 10	Nov. 29	Nov. 18	Nov. 7	Nov. 26
Guru Govinda Singh's Birthday	Jan. 1	Jan. 20	Jan. 8	Dec. 28	Jan. 16
Vasanta Pañcamī	Jan. 28	Feb. 16	Feb. 5	Jan. 24	Feb. 12
Mahāśivarātri	Feb. 20	Mar. 10, 1956	Feb. 27	Feb. 16	Mar. 7, 1959
Holi, 1st day	Mar. 8, 1955	—	Mar. 26, 1956 Mar. 15, 1957	Mar. 5, 1958	—
Holi, 2nd day	Mar. 9, 1955	—	Mar. 27, 1956 Mar. 16,	Mar. 6, 1958	—
Good Friday	Apr. 16	Apr. 8	Mar. 30	Apr. 19	Apr. 4
Christmas Day	Dec. 25	Dec. 25	Dec. 25	Dec. 25	Dec. 25
Id-ul-Fitr	June 3	May 24	May 12	May 2	Apr. 21
Id-uz-Zuha	Aug. 10	July 30	July 19	July 9	June 28
Muharram	Sep. 9	Aug. 29	Aug. 18	Aug. 7	July 28
Id-e-Milad	Nov. 9	Oct. 29	Oct. 17	Oct. 7	Sep. 26

* Proposed all-India holiday.

REPORT
OF THE
CALENDAR REFORM COMMITTEE

PART C

**History of the Calendar in different
Countries through the Ages**

BY

Prof. M. N. SAHA, D. Sc., F. R. S.
Professor Emeritus, University of Calcutta,
Chairman, Calendar Reform Committee,

AND

Sri N. C. LAHIRI, M. A.
Secretary, Calendar Reform Committee.

CHRONOLOGICAL TABLE

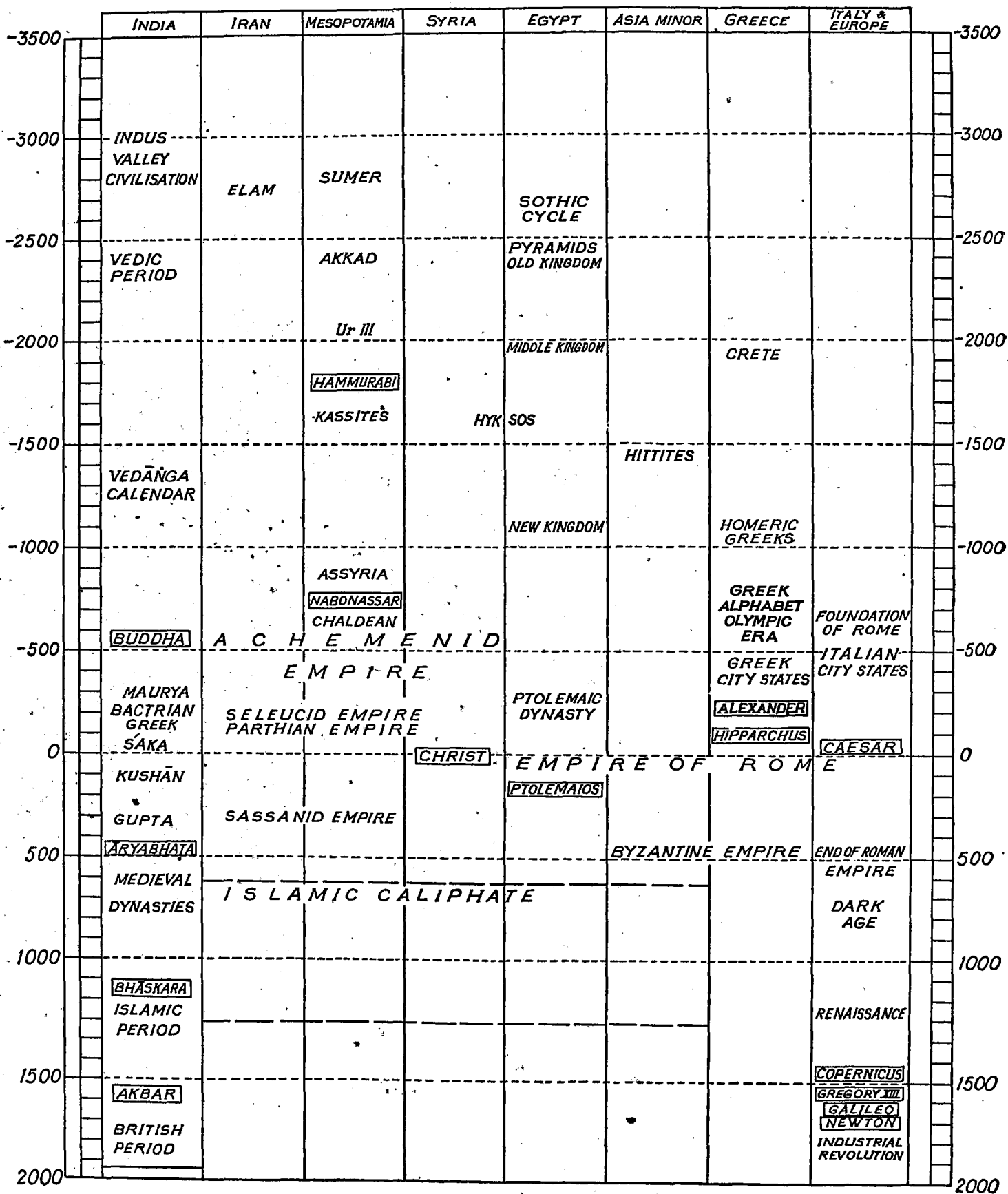

CHAPTER I

General Principles of Calendar Making

1.1 INTRODUCTION

The Flux of Time, of which we are all conscious, is apparently without beginning or end, but it is cut up periodically by several natural phenomena, *viz.* :—

- (1) by the ever-recurring alternation of daylight and night,
- (2) by the recurrence of the moon's phases,
- (3) by the recurrence of seasons.

It is these recurring phenomena which are used to measure time.

These phenomena have the greatest importance for man, for they determine all human and animal life. Even prehistoric men could not help noticing these time-periods, and their effect on life.

When human communities started organized social life in the valleys of the Indus and the Ganges (India), the Nile (Egypt), the Tigris and the Euphrates (Mesopotamia) and the Hoang Ho (China), several millenia before Christ (*vide* Chronological Table), these phenomena acquired new importance. For these early societies were founded on agriculture ; and agricultural practices depend on seasonal weather conditions. With these practices, therefore, grew national and religious festivals, necessary for the growth of social life, and of civilization. People wanted to know *in advance* when to expect the new moon or the full moon, when most of the ancient festivals were celebrated ; when to expect the onset of the winter or the monsoon ; when to prepare the ground for sowing ; the proper time for sowing and for harvesting. Calendars are nothing but predictions of these events, and were early framed on the basis of past experiences.

1.2 THE NATURAL PERIODS OF TIME

The three events mentioned in (1), (2) and (3) above define the natural divisions of time. They are :

The Day : defined by the alternation of daylight and night.

The Month : the complete cycle of moon's changes of phase, from end of new-moon to next end of new-moon (*amānta* months), or end of full-moon to end of next full-moon (*pūrṇimānta* months).

The Year : and its smaller subdivisions, *viz.*, the seasons.

The Day* :

The day, being the smallest unit, has been taken as *the fundamental unit of time* and the lengths of months, the year and the seasons are expressed in terms of the day as the unit.

But the day is to be defined. Many early nations defined the day as the time-period between sunrise to sunrise (*sāvāna* day in India) or sunset to sunset (Babylonians and Jews). But the length of the day, so defined, when measured with even the rough chronometers of early days, was found to be variable. This is due to the fact that except at the equator, the sun does not rise or set at the same time in different seasons of the year. So gradually the practice arose of defining the day as the period from midnight to midnight, *i. e.*, when the sun is at the nadir to its next passage through the nadir. Even then the length of the day is found to be variable when measured by an accurate chronometer. The reasons are set forth in all astronomical text books. Then came the idea of the mean solar day, and it is now taken as the fundamental unit of time. The mean solar day is the average interval between the two successive passages of the sun over the meridian of a place derived from a very large number of observations of such meridian passages. The time between two passages is measured by an accurate chronometer.

In addition to the solar day, the astronomers define also a sidereal day, which is the time period between two successive transits of a fixed star. It measures the time of rotation of the earth round its axis.†

The solar day is larger than the sidereal day, because by the time the earth completes a rotation about its axis, the sun slips nearly a degree to the east, due to the motion of the earth in its orbit, and it takes a little more time for the sun to come to the

* Day here means 'Day and Night'. In ancient times, the duration of day-light from sunrise to sunset, and of the night from sunset to sunrise, were measured separately with the aid of water-clocks. It was comparatively late that the length of the Day, meaning day-light and night, was measured. It was distinguished by the term *ahorātra* in Sanskrit, *ahna* meaning daylight time, and *rātri* meaning night time. In Greece, this was known as Nychthemeron.

† Actually speaking, the sidereal day is defined in astronomy as the period between two successive meridian passages of the First point of Aries. As this point has a slow westward motion among the fixed stars, the duration of the so called sidereal day is very slightly less than the actual sidereal day or the period of rotation of the earth.

have the relation :
 $365\frac{1}{4}$ mean solar days = $366\frac{1}{4}$ sidereal days.
 Rotation of the earth = $23^{\text{h}} 56^{\text{m}} 4^{\text{s}}.100$ mean solar time.
 Sidereal day = $23 56 4.091$ " " "
 Mean solar day = $24 3 56.555$ sidereal time

The actual sidereal day, which measures the period of rotation of the earth is generally taken to be constant. The variable part of the solar day comes from two factors :

- (1) Obliquity of the sun's path to the equator, and
- (2) Unequal motion of the sun in different parts of the year.

(See H. Spencer Jones, *General Astronomy* p. 45). It has however been recently found that even the period of rotation of the earth is not constant but fluctuates both regularly and irregularly by amounts of the order of 10^{-6} seconds.

The Month :

The month is essentially a lunar phenomenon, and is the time-period from completion of new moon (conjunction of moon with the sun) to the next new moon. But the length of the month so defined varies from 29.246 to 29.817 days, owing to the eccentricity of the moon's orbit and other causes. The month or lunation used in astronomy is the mean synodic period, which is the number of days comprised within a large number of lunations divided by the number of lunations. Its value is given by

1 lunation = $29.5305882 - 0.0000002 T$
 where T = no. of centuries after 1900 A.D.

The present duration of a lunation = 29.5305881 days or $29^{\text{d}} 12^{\text{h}} 44^{\text{m}} 2.8^{\text{s}}$. There are other kinds of months derived from the moon and the sun which will be discussed later.

The Year and the Seasons :

The year is the period taken by the seasonal characteristics to recur. The early people had but a vague notion of the length of the year in terms of the day. In the earliest mythology of most nations, the year was taken to have comprised 360 days, consisting of 12 months each of 30 days. They apparently thought that the moon's phases recur at intervals of 30 days.

But experience soon showed that these measures of the month and the year were wrong, but they have left their stamp on history. The sexagesimal measure used in astronomy and trigonometry, as well as fanciful cycles of life of the Universe, invented by ancient nations, appear to have been inspired by these numbers.

It appears that the Egyptians found very early (as related in the next section) from the recurrence of the Nile floods that the year had a length of 365 days. Later they found the true length to be nearer 365.25 days.

The ancient Babylonians, or Chaldeans as they were called from about 600 B.C., appear to have been the earliest people who tried to obtain correct measures of the time-periods : the month, the year, and the seasons in terms of the day, and its subdivisions. Their determinations were transmitted to the Greeks who refined both the notions and measurements very greatly. This story will be told in Chapter II.

At present it is known that the length of the seasonal year (tropical year) is given by :—

Tropical year = $365.24219879 - 0.614(t - 1900)$ days, where t = Gregorian year.

The present duration of a tropical year is 365.2421955 days or $365^{\text{d}} 5^{\text{h}} 48^{\text{m}} 45.7^{\text{s}}$.

The Sidereal Year :

In some countries, the ancients took the year to be the period when the sun returned to the same point in its path (the ecliptic). This is the time of revolution of the earth in its orbit round the sun. The tropical year, or the year of seasons, is the time of passage of the sun from one vernal equinox to the next vernal equinox. The two years would have been the same, if the vernal equinoctial point (hereafter called the vernal point) were fixed. But as narrated in Chapter IV, it recedes to the west at the rate of $50''$ per year. The tropical year is therefore less than the sidereal year by the time taken by the sun to traverse $50''$, i.e., by $.014167$ days or $20^{\text{m}} 24^{\text{s}}$.

For calendarical purpose, it is unmeaning to use the sidereal year ($365^{\text{d}}.256362$), as then the dates would not correspond to seasons. The use of the tropical year is enjoined by the Hindu astronomical treatises like the *Sūrya Siddhānta* and the *Pañca Siddhāntikā*. But these passages have been misunderstood, and Indian calendar makers have been using the sidereal year with a somewhat wrong length since the fifth century A.D.

1.3 THE PROBLEMS OF THE CALENDAR

Whatever may be the correct lengths of the astronomical month and the year, for application to human life, the following points have to be observed in framing a civil calendar.

- (a) The civil year and the month must have an integral number of days.

(b) The starting day of the year, and of the month should be suitably defined. The dates must correspond strictly to seasons.

(c) For purposes of continuous dating, an era should be used, and it should be properly defined.

(d) The civil day, as distinguished from the astronomical day, should be defined for use in the calendar.

(e) If the lunar months have to be kept, there should be convenient devices for luni-solar adjustment.

A correct and satisfactory solution of these problems has not yet been obtained, though in the form of hundreds of calendars which have been used by different people of the world during historical times, we have so many attempted solutions. The early calendars were based on insufficient knowledge of the duration of the natural time cycles—day, month and year—and led to gross deviations from actual facts, which had to be rectified from time to time by the intervention of dictators like Julius Caesar, Pope Gregory XIII, or a founder of religion like Mohammed, or by great monarchs like Melik Shah the Seljuk, or Akber, the great Indian emperor.

Owing to the historical order of development, calendars have been used for the double purpose :

(i) of the adjustment of the civic and administrative life of the nation,

(ii) of the regulation of socio-religious life of the people.

In ancient and medieval times, society, state and church were intermingled, and the same calendar served all purposes. The modern tendency is to dissociate civic life and administration from socio-religious life. Also due to the enormous growth of intercourse amongst all nations of the world, the need has been felt for a World Calendar dissociated from all religious and social bias. Owing to historical reasons, the Gregorian calendar is now used internationally for civic and administrative purposes, but it is very inconvenient, and proposals have been made to the U. N. O. for the adoption of a simple World Calendar (*vide* § 2.7).

1.4 SUBDIVISIONS OF THE DAY

For practical purposes, the day is divided into 24 hours, an hour into sixty minutes and a minute into sixty seconds.

∴ 1 mean solar day = $24 \times 60 \times 60 = 86,400$ seconds.

The subdivisions of time are measured by highly developed mechanical contrivances (clocks, watches and chronometers), but they have come into use only

during comparatively recent times. The ancient people used very primitive devices.

The time-keeping apparatus of the ancients were the gnomon, the sundial, and the water-clock or the clepsydra. The first two depend on the motion of the sun, and require correction. The water-clock which probably was first invented in Egypt, appears to have been used down to the time of Galileo, when the discovery of pendulum motion led to the invention of clocks based on pendulum motion or use of the balance wheel.

Subdivisions of time can be measured by the motion of any substance, which repeats itself regularly ; at the present time in addition to pendulum clocks, quartz-clocks, and ammonia clocks have been used. The latter depend upon harmonic motions within the ammonium molecule, giving rise to spectral lines whose frequency can be accurately measured.

The present divisions of the solar day have interesting history.

It is stated by Sarton that the ancient Sumerians (original dwellers of Babylon) divided the day-time and night-time into three watches each. The watches were naturally of unequal lengths and varied throughout the year. It was only during equinoxes that the watches were of equal length, each of our 4 hours.

These unequal watches continued down to medieval times. The life of a medieval monk was watch-wise as follows.

- (1) Matins—last watch of the night. The monk got up nearly two hours before sunrise and started his work,
- (2) Prima—at sunrise,
- (3) Tertia—half-way between sunrise and noon—time of saying Mass,
- (4) Sexta—at noon (hence the word, Siesta—midday rest),
- (5) Nona—mid-afternoon, whence our word Noon,
- (6) Vespers—an hour before sunset,
- (7) Compline—at sunset.

The watches were variable in duration and in their starting moments. Sarton remarks :

A clock regularly running and dividing the day into periods of equal duration would have been, at first, more disturbing than useful. For monastic purposes, a human variable clock (*e. g.* a bell rung by a monk or lay brother at the needed irregular intervals) was more practical than an automatic one.*

But even in ancient times, the need for measurement of equal intervals of time was felt. The ancient Babylonians used the Nychthemeron (Day and Night

*Sarton, *Introduction to the History of Science*, Vol. III, Part I, p. 716.

combined = *Ahorātra*) into 12 hours of 30 *Gesh* each, *Gesh* being = 4 minutes. The Egyptians divided the day-light time into 12 hours, and the night into 12 hours. Later in medieval times, the 24-hour division for the whole day (day and night) has been adopted. The division into A.M. and P.M. were for the sake of convenience, so that the maximum number of times a bell has to be rung, on the completion of an hour, would not exceed 12, for apparently ringing a bell 24 times would be a torture of the flesh.

The broad divisions of the day were secured by the Hindus in two ways. They divided the day-time (from sunrise to sunset) into 4 equal parts each called a *prahara* or *yāma*. The night time was also similarly divided into 4 equal *praharas*. The *prahara* is so popular a unit in Indian time measurement that even the lay man expresses time in terms of *praharas* and half *praharas*. An alternative system of division of the time is the '*muhūrta*' obtained by dividing the daytime into 15 *muhūrtas* determined by gnomon shadow lengths. The day *muhūrtas* were measured from lengths of shadows of the gnomon. The night *muhūrtas* are similarly the fifteenth part of the night time.

As the durations of day and night are not equal except on the vernal and autumnal equinox days, the *prahara* and *muhūrta* of the day-time have not the same durations as those of their nocturnal counterparts. On equinox days, they are however equal, when

$$\begin{aligned} 1 \text{ Prahara} &= 3^h \ 0^m = 7^h \ 30^v \\ 1 \text{ Muhūrta} &= 0 \ 48 = 2 \ 0 \end{aligned}$$

The Hindu astronomers appear to have switched on to the *ahorātra* during *Vedānga Jyotiṣa* times. As it is rather complicated, we do not give an account of it. The reader may consult Dixit's *Bhāratiya Jyotiṣāstra*. But in *Siddhānta Jyotiṣa*, they had a full fledged scientific system.

The scientific divisions of time followed by the Siddhāntas are the *ghaṭikā* (*daṇḍa* or *nāḍī*), *prahara* or *yāma*, and *muhūrta* etc. The day is measured from sunrise and the period from sunrise to next sunrise is divided into 60 equal '*ghaṭikās*' or *daṇḍas*; each *ghaṭī* is subdivided into 60 *vighaṭīs* or *palas*, and each *vighaṭī* or *pala* into 60 *vīpalas*. So a day consists of 60 '*ghaṭīs* or 3600 *palas* or 216000 *vīpalas*. Thus

$$\begin{aligned} 1 \text{ ghaṭikā} &= 24^m \ 0^s \ 0 \\ 1 \text{ pala} &= 0 \ 24 \cdot 0 \\ 1 \text{ vīpala} &= 0 \ 0 \cdot 4 \end{aligned}$$

The *pala* or *vighaṭī* is sometimes subdivided into 6 divisions called a '*prāṇa*'. A *prāṇa* is therefore equivalent to 4 secs. of time. There are 360 *prāṇas* in a *ghaṭikā* and the day contains 360×60 or 21600 *prāṇas*,

the same as the number of minutes (*kalā* or *līptikā*) in a circle. In *Siddhāntas* (astronomical treatises of the Hindus) there are conceptions with nomenclatures of still smaller divisions of time, but they had no practical utility.

None of the time-periods of the sun, and the moon, *viz.*, the year and the season, and the lunations and half-lunations are integral multiples of the day; on the other hand, the figures run to several places of decimals. How did the ancients, who quickly discovered that the time-periods were not integral multiples of the day, express their findings?

It will take us a long dive into the history of mathematical notation to elucidate this story. The curious reader may consult Neugebauer's *Exact Sciences in Antiquity* or van der Waerden's *Science Awakening* (pp.51-61). In fact, the symbolism was very cumbersome before the discovery of the decimal notation about 600 A.D. in India, where it quickly replaced the old cumbersome notation. The discovery was quickly adopted by the Arabs for certain purposes, but was first made known to Europe by Leonardo of Pisa in a treatise on Arithmetic published in 1202 A.D., but a few more centuries passed before it was universally adopted.

The practice of expressing fractions by means of decimals came later, both in India and Europe. In India, an astronomer who wrote an astronomical treatise called '*Bhāsvatī*' in 1099 A. D. was called Śātānanda, (*i.e.*, revelling in hundreds) because he used to write fractions in hundredths *i.e.* $\frac{1}{2}$ as 25 hundredths, $\frac{2}{3}$ as 75 hundredths. In Europe, the expression of fractions by decimals came into vogue about the seventeenth century.

The Hindu astronomer of the Siddhāntic age expressed the periods of the sun, the moon and the planets by the number of their periods in a *Mahāyuga* (4.32×10^6 years). The number is usually integral.

But how did this cumbersome system originate?

Probably many of these values were obtained by counting the number of days between a large number of periods and dividing them by the number of periods. For example, take the case of the length of the mean lunation (lunar month). All ancient nations give this length correct to a large number of decimals. This must have been obtained by counting the number of days between two new moons, separated by a large number of years, and dividing it by the number of lunations contained in the interval. Of course, the utmost they could have done was to keep records for at most a hundred years, but the rule of three was always available.

In the following sections, the different ways of tackling the calendar problem in different centres of

civilization have been described. We have described in Chap. II, the purely solar calendars, in which the moon is altogether discarded as a time-marker. This practice originated in Egypt about 3000 B.C. These calendars require only a correct knowledge of the length of year, and are therefore comparatively simpler. They required very little or almost no knowledge of astronomy.

We have described in Chap. III, the luni-solar calendars, prevalent in ancient Mesopotamia, India, China and most other countries. In these calendars, both the sun and the moon are used as time-markers, and therefore precise knowledge of their motion in the heavens was essential for the formulation of a correct calendar. We mark two stages: first the formulation of a calendar from a knowledge of only the length of the year, and of the mean lunar month. This was an older phase. It did not work satisfactorily, because it depended on the mean motion of the two luminaries. Actually, the time-predictions have to be verified by actual comparison of the predicted happenings (say of the vernal equinox day in the case of the sun, or the first appearance of the crescent of the moon after new moon on the western horizon) with the time of actual happenings. This gave rise to the need for watching the daily motion of the two luminaries, and invention of methods for recording and storing these observations; in other words, this led to the science of astronomy. Early astronomy is almost completely calendarical. At a later stage, the five planets attracted attention, on account of their association with astrology.

We have therefore devoted Chap. IV to calendaric astronomy, which was evolved by the Chaldeans and taken over from them by the Greeks, and in time diffused to other countries.

In Chap. V, we have described the various stages of the development of the Indian calendar:—the empirical stage (R̥g-Vedic), the mean motion stage (*Vedāṅga Jyotiṣa*), and the scientific stage (*Siddhānta Jyotiṣa*). From 1200 A.D., astronomical studies became decadent in India, and we have analysed the cause of decadence. We have given a full account of precession, as most Indian calendar makers still believe in the false theory of Trepidation which disappeared from Europe after 1687 A. D.

1.5 AHARGANA OR HEAP OF DAYS : JULIAN DAYS

Though the Flux of Time is a continuous process, it is divided for the sake of convenience and for natural reasons too, into years, months and days. The years are mostly counted from the beginning of an era, so that if we wish to date a memorable event,

say the birth-day of George Washington, it can be seen from an inspection of his birth register that it took place on Feb. 11, of the year 1732. But this practice by itself does not enable a scientific chronologist to fix up the event unambiguously on the absolute Scale of Time, unless the whole history of the particular method of date-recording is completely and accurately known. One must know the lengths of the individual months, the leap-year rules, and the history of calendar reform. In the particular case mentioned, though George Washington according to his birth register is stated to have been born on Feb. 11, 1732, his birth-day is celebrated on Feb. 22. Why? Because Feb. 11 was the date according to the Julian calendar. But in 1752, England (America was then a colony of England) adopted the reformed Gregorian calendar, and by an Act of Parliament, declared Sept. 3 to be Sept. 14, a difference of 11 days. Following the Gregorian calendar, Washington's birth-day had to be shifted to Feb. 22. A scientific chronologist, say of China, would find it difficult to locate Washington's birth-day unless he knew the whole history of the Gregorian calendar.

This difficulty is more pronounced when we have to deal a luni-solar calendar, say that of Babylon. Many records of lunar eclipses occurring in Babylon were known to the Alexandrian astronomer, Claudius Ptolemy, but they were dated in Seleucid era, and Babylonian months, say year 179, 10th of Nisan. Now the Babylonian months were lunar, had lengths of 29 or 30 days, but the year could have lengths of 353, 354, 383, 384 (*vide* § 3.3). Therefore when two eclipse datings were compared, it was impossible to calculate the number of days between them, unless the investigator had before him a record showing the lengths of years and months between the two events. Ptolemy expressed his datings according to the Egyptian calendar, which enables one to calculate the interval far more easily. He must have taken lot of pains to carry out the conversion from the Babylonian to Egyptian dates.

How much better it would have been if a great genius at the beginning of civilization, say near about 3000 B.C., started with a zero day, and started the practice of dating events by the number of days elapsed since this zero date, to the date when this particular event took place. Such a great genius did not appear and a confusing number of calendars came into existence. The scientific chronologist is now faced with the reverse problem: Suppose two ancient or medieval events are found dated according to two different calendars. How to reduce these dates to an absolute chronological scale?

For this purpose, a medieval French scholar, Joseph Scaliger introduced in 1582 A.D., a system known as

'Julian Days' after his father, Julius Scaliger. The Julian period in years is

$$7980 \text{ years} = 19 \times 28 \times 15$$

19 being the length in years of the Metonic Cycle,
15 " " " " " of the Cycle of Indiction,
and 28 " " " " " of the Solar Cycle.

It was found by calculation that these three cycles started together on Jan. 1, 4713 B.C. So the Julian period as well as the Julian day numbers started from that date. The Julian period is intended to include all dates both in the past and in the future to which reference is likely to be made and to that extent it has an advantage over an era whose epoch lies within the limits of historical time. The years of the Julian period are seldom employed now, but the day of the Julian period is frequently used in astronomy and calendaric tables. Unlike the civil day, the Julian day number is completed at noon.

Let us give the Julian days for a number of world-events, as given by Ginzel, in his *Handbuch der Mathematischen und Technischen Chronologie*.

Table 1.—Julian day numbers.

	Date	Julian day
Kaliyuga	... 17 February, 3102 B.C.	588,465
Nabonassar	... 26 February, 747 B.C.	1,448,638
Philippi	... 12 November, 324 B.C.	1,603,398
Śaka era	... 15 March, 78 A.D.	1,749,621
Diocletian	... 29 August, 284 A.D.	1,825,030
Hejira	... 16 July, 622 A.D.	1,948,440
Jezdegerd (Persian)	... 16 June, 632 A.D.	1,952,063
Burmese era	... 21 March, 638 A.D.	1,954,167
Newar era	... 20 October, 879 A.D.	2,042,405
Jelali era (Iran)	... 15 March, 1079 A.D.	2,115,236

It may be mentioned here that the ideas underlying continuous reckoning of days occurred much earlier to the celebrated Indian astronomer, Āryabhaṭa I (476–525 A.D.), who introduced it under the designation "*Ahargana*" or heap of days in his celebrated *Āryabhaṭīya*. The idea of counting *ahargana* or heaps of days elapsed from a specified epoch upto the given date dawned upon the Hindu astronomers as a necessity for calculating the position of planets for that date. They followed the cumbrous luni-solar calendar for dating purposes, which was not based upon any simple rules. It contains months of 29 or 30 days, and occasionally a thirteenth month, the recurrence of which was determined by elaborate methods. The dates of the months are not numbered serially, but designated by the *tithi* current at sunrise. It was accordingly found almost impossible to work out the mean positions of planets on the basis of the luni-solar calendar alone.

For this purpose a continuous and uniform time scale was necessary, and this was served by the *ahargana*.

Āryabhaṭa had somehow the idea that the planets, and the two nodes (which were treated as planets in Hindu astronomy) return to the first point of Aries after every 4.32×10^6 years, and there was a unique assemblage of planets at the first point of the Hindu sphere at some past date which he called the beginning of *Kali Yuga*. The date assigned to the *Kali* beginning is now known to be 3102 B.C., February 17-18. The common period of revolution of planets of 4.32×10^6 years constitute a *Mahāyuga* consisting of

Satya yuga of	1.728×10^6 years
Tretā yuga of	1.296×10^6 "
Dvāpara yuga of	0.864×10^6 "
Kali yuga of	0.432×10^6 "
Total	4.32×10^6 years

It may be noticed that

$$4.32 \times 10^6 = 12000 \times 360$$

Āryabhaṭa gave tables showing the number of sidereal revolutions of planets in the period of 4.32×10^6 years. The total number of days in a *Mahāyuga* = 1,577,917,800 which gives the length of a year = 365.25875 days.

Brahmagupta was evidently not satisfied that Āryabhaṭa's figures for the periods of planets were correct. He introduced a *Kalpa* = 1000 *Mahāyugas* = 4.32×10^9 years. The '*Kalpa*' was supposed to constitute a 'Day' of the Creator, Grand-father Brahmā. He gave the number of sidereal revolutions of the planets in a *Kalpa*, and thought he had improved Āryabhaṭa's figure for the year.

Brahmagupta's year = 365.25844 days.

Āryabhaṭa calculated '*Ahargana*' or heap of days, from the beginning of the *Mahāyuga* as the zero-day.

But evidently this practice involves very large numbers, and is inconvenient to use. Therefore the later astronomers used modifications of the system by counting *Ahargana* from other convenient epochs, within historical reach. The different epochs which have been used are:—

- (1) The beginning of the Kali era or 3102 B.C.
- (2) 427 Śaka era or 505 A.D. as is found in *Puñcasiddhāntikā* of Varāhamihira.
- (3) 587 Śaka era or 665 A.D. as is found in the *Khaṇḍakhādya* of Brahmagupta.
- (4) 854 Śaka era or 932 A.D. as is found in the *Laghumānasa* of Muñjala.
- (5) 961 Śaka era or 1039 A.D. in the *Siddhānta Śekhara* of Śrīpati.

The astronomical treatises of the Hindus have been divided into three categories according to the initial

epoch employed for calculation. In which the calculations of *ahargana* as well as the planetary mean places are made from the *Kalpa*, is called a *Siddhanta*; when the calculations start from a *Mahayuga* or *Kali*-beginning it is called a *Tantra*, and when it is done from a recent epoch it is called a *Karana*. In any case, the mean places of the planets with their nodes and apsides are given for the epoch of the treatise from which calculations are to be started, with rules for finding the *ahargana* for any later date. This *ahargana* is then made use of in finding for that later date the positions of planets from their given initial positions and their daily motions, for,

The mean position at any epoch
 = the mean position at the initial epoch
 + daily motion \times *ahargana*.

Due to the complexity of the Hindu luni-solar calendar, one has to go through complicated rules in determining the *ahargana* for any particular day. Dr. Olaf Schmidt of the Brown University and the Institute of Advanced Study, in discussing the method of computation of the *Ahargana* at length, has pointed out that the present Hindu method suffers from a

disturbing discontinuity. The curious reader may go through his article published in the *Centaurus*.

We, however, give below the corresponding Julian day numbers and *Kali ahargana* for certain modern dates.

	<i>Julian days</i> (elapsed at mean noon)	<i>Kali ahargana</i> (elapsed at following midnight)
1900, Jan. 1	2,415,021	1,826,556
1947, Aug. 15	2,432,413	1,843,948
1956, Mar. 21	2,435,554	1,847,089

The difference between the two numbers 588,465 represents the Julian day number on the *Kali* epoch, as already stated.

The use of *ahargana* plays a very important part in modern epigraphical researches when the date recorded in an inscription is required to be converted into the corresponding date of the Julian calendar. If the *Kali ahargana* for the recorded date can be determined, then the problem of ascertaining the corresponding Julian or Gregorian date becomes a very easy task.

CHAPTER II

The Solar Calendar

2.1 TIME-RECKONINGS IN ANCIENT EGYPT

Like other nations of antiquity the early Egyptians had a year of 360 days divided into 12 months, each of 30 days; but they found very early from the recurrence of the Nile flood, that the seasonal year consisted approximately of 365 days, and that a month or lunation (period from one new-moon to another) was nearly $29\frac{1}{2}$ days (real length 29.531 days). But they had already framed a calendar on the 30-day month, and 360-day year, which had received religious sanction. Hence arose the first necessity for calendar-reform recorded in ancient history. To persuade the people to agree to this reform their priests invented the following myth:

"The Earth god *Seb* and the sky goddess *Nut* had once illicit union. The supreme god *Ra*, the Sun, thereupon cursed the sky goddess *Nut* that the children of the union would be born neither in any year nor in any month. *Nut* turned to the god of wisdom, *Thoth*, for counsel. *Thoth* played a game of dice with the Moon-goddess, and won from her $\frac{1}{2}$ th part of her light out of which he made five extra days. To appease *Ra* the Sun-god, these five days were given to him, and his year gained by five days while the Moon-goddess's year lost five days. The extra five days in the solar year were not attached to any month, which continued to have 30 days as before; but these days came at the end of the year, and were celebrated as the birthdays of the gods born of the union of *Seb* and *Nut*, viz., Osiris, Isis, Nephthys, Set and Anubis, five chief gods of the Egyptian pantheon." *

Let us scrutinize the implications of this myth. This is tantamount to discarding the moon altogether as a time-maker, and basing the calendar entirely on the sun. This was a very wise step, for as has been found from ancient times, the moon is a very inconvenient time-marker. The Egyptians maintained the old custom of keeping months of 30 days' duration, and 12 months made a year. But five days (*Epagomenai* in Greek) were added to the year at the end, which were not attached to any month. They were celebrated as national holidays. Each month of the Egyptian calendar was divided into 3 weeks, each of 10 days (Decads).

The names of the Egyptian months together with the dates of beginning of each month as they stood in 22 B.C., are as follows:

<i>Egyptian Calendar</i>	...	<i>Julian Calendar</i>
1 Thoth (30)	...	29 August
1 Phaophi (30)	...	28 September
1 Athyr (30)	...	28 October
1 Choiak (30)	...	27 November
1 Tybi (30)	...	27 December
1 Mechir (30)	...	26 January
1 Phamenoth (30)	...	25 February
1 Pharmuthi (30)	...	27 March
1 Pachon (30)	...	26 April
1 Payni (30)	...	26 May
1 Epiphi (30)	...	25 June
1 Messori (30)	...	25 July
(1 Epagomenai 5)	...	24 August

The year was divided into three seasons, each of four months: Flood time, Seed time and Harvest time.

But the Egyptians soon found that even a year of 365 days did not represent the correct length of the year, which, as we now know, is nearly $365\frac{1}{4}$ days. This fact they appear to have discovered in two different ways:

- (1) from their measurement of the length of the year from heliacal risings of Sirius, and
- (2) from their long record of floods extending over centuries.

The fixed star Sirius, which is the most brilliant star in the heavens, was early associated with the chief goddess of the Egyptian pantheon, Isis, and was the subject of observation by her priests. The day of its first appearance on the eastern horizon at day-break (heliacal rising) appeared to have been carefully observed, and then on every subsequent day, its position in the sky at sunrise used to be noted. It was found that gradually it got ahead of the sun, so its appearance on the horizon would be observed sometime before sunrise, and on every successive sunrise, it would be found higher up in the heaven. After about a year it would be seen in the western horizon at sunset for a few days till it could no longer be traced. The Egyptians found as a result of long periods of observation, that it came again to the horizon at day break at the end of $365\frac{1}{4}$ days, not 365 days. If on one year, the heliacal rising of Sirius took place on Thoth 1, (Thoth was the name of the first month of the year) four years later it would take place on Thoth 2, and forty years later on Thoth 11. As the mean interval

* Zinner—*Geschichte der Sternkunde*, p. 3.

of heliacal rising of Sirius at the latitude of Memphis was 365.25 days, the Egyptians concluded that the heliacal rising of Sirius would continue to move round the year in a complete cycle of *ca.* 1460 years ; called the Sothic cycle, after Sothis (Isis). They also appear to have found from observations over long periods of years that the Nile flood occurred not at intervals of 365 days, but of $365\frac{1}{4}$ days.

On account of the deficiency of $\frac{1}{4}$ day in the year, the year-beginning lost touch with the arrival of the Nile flood, though the temple priests had devised a method of finding out the interval between Thoth 1, and arrival of the Nile flood by observations of the heliacal rising of the bright star Sirius, identified with their chief goddess Isis. But they kept the knowledge to themselves.

If the Egyptians carried out a reform of their calendar incorporating this fact, that the tropical year had a length of $365\frac{1}{4}$ days, their calendar could have been almost perfect. *All that they had to do was to take 6 extra days instead of 5 every fourth year.* But the 365-day year had so much soaked into the Egyptian mind, that this move for calendar reform was never adopted in spite of serious attempts by earlier Pharaohs, and later, a more serious one by the Graeco-Egyptian ruler Ptolemy Euergetes (238 B.C.). But it became generally known that the correct length of the year was $365\frac{1}{4}$ days. Fotheringham in his article on "The Calendar" observes :

An additional day was inserted at the close of the Egyptian year 23-22 B.C. on August 29 of what we call the Julian calendar, and at the close of every fourth year afterwards, so that the reformed or Alexandrian year began on August 30 of the Julian calendar in the year preceding a Julian leap year and on August 29 in all other years. The effect of this reform was to keep each Egyptian month fixed to the place in the natural year which it happened to occupy under the old calendar in the years 26-22 B.C. But the old calendar was not easily suppressed, and we find the two used side by side till A.D. 238 at least. The old calendar was probably the more popular, and was preferred by astronomers and astrologers. Ptolemy (150 A.D.) always used it, except in his treatise on annual phenomena, for which the new calendar was obviously more convenient. Theon in the fourth century A.D., though mentioning the old calendar, habitually used the new.

Though not quite perfect, the Egyptian calendar was greatly admired in antiquity on account of its simplicity, for the length of the year and the months were fixed by definite rules and not by officials or *pandits*. The religious observances fell on fixed days of the month and at stated hours, which were fixed about 1200 B.C.

On account of its simplicity, the Egyptian calendar was adopted by many nations of antiquity, and even sometimes by the learned Chaldeans and Greeks, Fotheringham observes :

"The Egyptian calendar was, upto the time of Julius Caesar's reform of the Roman calendar in 46 B.C., the only civil calendar in which the length of each month and of each year was fixed by rule instead of being determined by the discretion of officials or by direct observation. If the number of years between two astronomical observations, dated by the Egyptian calendar, was known, the exact number of days could be determined by a simple calculation. No such comparison could be made between dates referred to any other civil calendar unless the computer had access to a record showing the number of days that had actually been assigned to each month and the number of months that had actually been assigned to each year. It is true that the Egyptians did not use a continuous era, but were content to number the years of each reign separately, so that there was a difficulty in identifying a particular year, but the astronomers of the Ptolemaic age rectified this by the introduction of eras.* The simplicity and regularity of the Egyptian calendar commended it to astronomers, who found it excellently adapted to the construction of tables that could be readily applied and used even for a remote past or for a distant future without any fear that the system by which time was reckoned in the tables might not coincide with the system in actual use. In the second century B.C. we find Chaldean observations, sometimes nearly six centuries old, reduced to the Egyptian calendar in the works of Hipparchus (126 B.C.), who observed not in Egypt but at Rhodes, and cited from him by the Egyptian Ptolemy in the second century of our era ; we also find in the second century B.C., an Athenian observation of 432 B.C. reduced to the Egyptian calendar on an inscription found at Miletus, which appears to represent the work of the astronomer Epigenes". †

This calendar survives in a slightly modified form in the Armenian calendar, the three first months of the old Egyptian year corresponding exactly with the three last months of the Armenian year. The Alexandrian calendar is still the calendar of Abyssinia and of the Coptic Church, and is used for agricultural purposes in Egypt and other parts of northern Africa.

2.2. SOLAR CALENDARS OF OTHER ANCIENT NATIONS

The story of the calendar in Egypt has been given in full, because the ancient Egyptians evolved a very simple and convenient calendar which, as mentioned before, would have been almost perfect (provided the year was taken to consist of $365\frac{1}{4}$ days instead of 365 days). This was rendered possible by their bold initia-

* The Nabonassar Era—*vide* § 3.4.

† Article on "The Calendar", *Nautical Almanac*, 1935.

tive of discarding the moon as a time-marker. But people in the remaining parts of the civilized world (e.g., in Babylon, Greece, India and China) in ancient and modern times, retained the moon and preferred the more complex luni-solar calendars described in Chap. III. This was rather fortunate, for if their rulers had adopted the Egyptian calendar, the priest-astronomers of ancient nations, particularly of Babylon, would never have taken to observation of the sun, the moon, and the planets, and tried to evolve mathematical formulae for predicting their positions amongst stars in advance (the Ephemerides), which form the basis on which our astronomical knowledge has been built up; for the Egyptian calendar was evolved simply from results of experiences extending over centuries, and required almost no astronomical sense, or observations either of the sun, the moon and stars, except the heliacal rising of Sirius. *It was simple and convenient, but like many perfect things, it killed intellectual curiosity.*

But as will be described in Chap. III, the luni-solar calendar is a very complex thing, and has taken infinite variations in different regions. Hence the simple Egyptian calendar appealed to many nations of antiquity as well as of modern times. We have related the case of the Greek astronomers Hipparchos and Ptolemy who preferred the Egyptian method of date-recording to the Greek methods. This was, however, not the solitary instance.

2.3 THE IRANIAN CALENDAR

The great Iranian conqueror Darius (520 B. C.), whose empire comprised Egypt, Mesopotamia, Syria and Asia Minor, besides his native country of Iran, certainly came into contact with the diverse calendars of older civilizations, but he appears to have preferred the Egyptian calendar to the more complex Babylonian calendar, and introduced it in his vast empire.

But the astronomers of Darius made correction of the deficit of $\frac{1}{4}$ day of the year in another way. They had all years of 365 days, but used an intercalary month of 30 days in a cycle of 120 years.

All the names of the old Iranian months and details of their calendar are not available now. The month-names as far as could be traced are stated below :—

1. Thuravāhara
2. Thagrāci
3. Adukāni
4.
5. Garmapada
6.

7. Bāgayādi
8.
9. Atriyādija
10. Anāmaka
11. Margazana
12. Viyachna

The Persians did not have weeks or decads, but named the successive days of the month serially according to their gods or religious principles, as below :—

<i>Zend</i>	<i>Pehlewi</i>	<i>Nearest Vedic</i>
1. Ahurahē mazdāo	Aūharmazd	
2. Vanheus mananhō	Vohūman	
3. Ashahē vahistahē	Ardavahisht	
4. Kshathrahē vairjēhē	Shatvairō	
5. Spentajāo āmatōis	Spendarmad	
6. Haurvatātō	Horvada	
7. Ameretātō	Amerōdad	Amṛtatva
8. Dathushō	Dīn-i-pavan	Ātarō
9. Āthrō	Ātarō	Atharvan
10. Apām	Āvān	Apām
11. Hvarekshaētahe	Khūrshēd	
12. Māonhō	Māh	
13. Tistrjēhē	Tir	
14. Geus	Gōsh	
15. Dathushō	Dīn-i-pavan	Mitrō
16. Mithrahē	Mitrō	Mitrāha
17. Sraoshahē	Srōsh	
18. Rashnaos	Rashnū	
19. Fravashinām	Fravardīn	
20. Verethraghnahē	Vāhrām	Vṛtragnāha
21. Rāmanō	Rām	
22. Vātahē	Vād	
23. Dathushō	Dīn-i-pavan	Dīnō
24. Daēnajāo	Dīnō	
25. Ashōis	Ard	
26. Arstātō	Āshtād	
27. Asmanō	Āsmān	
28. Zemō	Zamjād	
29. Mathrahēspentahē	Mārspend	
30. Anaghranām	Anīrān	

After the Islamic conquest of Persia in 648 A.D., the purely lunar calendar of Islam (Hejira) was imposed on Persia, but it does not appear to have been liked by the native Iranians.

In 1074-75 the Seljuq Sultan Jelal Uddin Melik Shah called upon the celebrated Omar Khayyam and seven others to reform the old Persian calendar. The calendar as reformed by them was called Tarikh-i-Jelali, its era was the 10th Ramadan of Hejira

471=16th March, 1079 A.D. There are many interpretations of the Jelali reform, the modern interpretation being 8 intercalary days in 33 years, giving the length of the year as 365.24242 days. The year started from the day of or next to vernal equinox.

The Parsees in India, the followers of the Prophet Zarathustra are the descendants of Iranians who took shelter in India on the conquest of Persia by the Arabs. The following details about their calendar is reproduced from *Encyclopaedia Britannica* (14th edition), Parsees :—

The Parsees of India are divided into two sects, the Shahanshahis and the Kadmis. They differ as to the correct chronological date for the computation of the era of Yazdegerd, the last king of Sassanian dynasty, who was dethroned by the caliph Omar about A.D. 640. This led to the variation of a month in the celebration of the festivals. The Parsees compute time from the fall of Yazdegerd. Their calendar is divided into twelve months of thirty days each ; the other five days, being added for holy days, are not counted. Each day is named after some particular angel of bliss, under whose special protection it is passed. On feast days a division of five watches is made under the protection of five different divinities. In midwinter a feast of six days is held in commemoration of the six periods of creation. About March 21, the vernal equinox, a festival is held in honour of agriculture, when planting begins. In the middle of April a feast is held to celebrate the creation of trees, shrubs and flowers. On the fourth day of the sixth month a feast is held in honour of Sahrevar, the deity presiding over mountains and mines. On the sixteenth day of the seventh month a feast is held in honour of Mithra, the deity presiding over and directing the course of the sun, and also a festival to celebrate truth and friendship. On the tenth day of the eighth month a festival is held in honour of Farvardin, the deity who presides over the departed souls of men. This day is especially set apart for the performance of ceremonies for the dead. The people attend on the hills where the "towers of silence" are situated, and in the *sagris* pray for the departed souls. The Parsee scriptures require the last ten days of the year to be spent in doing deeds of charity.

In modern Iran when Riza Shah Pahlavi came to power in 1920, he instituted a reform of the existing Muslim calendar abandoning the strictly lunar reckoning and introducing purely solar year restoring the early Persian names which had never fallen entirely out of use.

The names of the months, and their lengths are as follows :

Farvardin-mah (31)	begins 21 or 22 March
Ardibahisht-mah (31)	.. 21 or 22 April
Khordad-mah (31)	.. 22 or 23 May
Tir-mah (31)	.. 22 or 23 June

Mordan-mah (31)	begins 23 or 24 July
Shartvar-mah (31)	.. 23 or 24 August
Mehr-mah (30)	.. 23 or 24 September
Aban-mah (30)	.. 23 or 24 October
Azar-mah (30)	.. 22 or 23 November
Dai-mah (30)	.. 22 or 23 December
Bahman-mah (30)	.. 21 or 22 January
Esfand-mah (29, 30)	.. 20 or 21 February

2.4 THE FRENCH REVOLUTION CALENDAR

The Egyptian calendar attracted the notice of the calendar committee of the French Revolutionary Government (1789-1795) who wanted to replace *Religion by Reason*. The committee consisted, amongst others, the great mathematicians Laplace and Lagrange and the poet d'Eglantine. Laplace proposed that the year 1250 A.D., when according to his calculations the equinoctial line was perpendicular to the apse line of the Earth's orbit should be taken the starting point of the French Revolution Era in place of a hypothetical year of Christ's birth. But the calendar committee did not agree with him but started the era of the glorious French revolution, with the autumnal equinox day of 1792 A.D., as this was nearest in date to the outbreak of the revolution. Sentiment proved stronger than cold scientific reasoning.

French Revolution Calendar

(1792 Sept. 22 to 1806)

(The Months consist of 30 days each)

Month	Season	Month beginning
AUTUMN		
1. Vendemiaire :	Grape gathering	Sept. 22
2. Brumaire :	Fog	Oct. 22
3. Frimaire :	Frost	Nov. 21
WINTER		
4. Nivose :	Snow	Dec. 21
5. Pluviose :	Rain	Jan. 20
6. Ventose :	Wind	Feb. 19
SPRING		
7. Germinal :	Seed	March 21
8. Floreal :	Blossom	April 20
9. Prairial :	Pasture	May 20
SUMMER		
10. Messidor :	Harvest	June 19
11. Thermidor :	Heat	July 19
12. Fructidor :	Fruit	Aug. 18
	Day of Virtue	Sept. 17
	" Genius	" 18
	" Labour	" 19
	" Opinion	" 20
	" Rewards	" 21

The seven-day week was abandoned for a week of 10 days. The month names were invented by the poet member of the committee. The last five days were dedicated to the service of the poor (*Sans-Culottides*) and did not form part of any month.

After 13 years of service, the French Revolution calendar was abolished by Napoleon Bonaparte, then emperor of France, as part of his bargain with the Roman Catholic Church for his coronation by the Pope.

2.5 THE ROMAN CALENDAR

(The Christian Calendar)

What is now known as the Christian calendar, and used all over the world for civil purposes, had originally nothing to do with Christianity. It was, according to one view, originally the calendar of semi-savage tribes of Northern Europe, who started their year sometime before the beginning of Spring (March 1 to 25) and had only ten months of 304 days ending about the time of winter solstice (December 25), the remaining 61 days forming a period of hibernation when no work could be done due to the onset of winter, and were not counted at all. The city state of Rome also had originally this calendar, but several corrections were made by the Roman Governments at different epochs and the final shape was given to it by Julius Caesar in 46 B.C.; the calendar so revised is known as the Julian calendar.

As already stated, this calendar originally had contained ten months from March to December comprising 304 days. It may be regarded as certain that the months were lunar. The second Roman king of the legendary period, Numa Pompilius, is supposed to have added two months (51 days) to the year in about 673 B.C., making a total of 355 days; January (named from the god Janus, who faced both ways) now began the year, and February preceded March, which became the third month. The number of days of the months were 29, 28, 31, 29, 31, 29, 31, 29, 29, 31, 29, 29. Adjustment of the year to the proper seasons was obtained by intercalation of a thirteenth month of actually 22 or 23 days' length (called Mercedonius) after two years or three years as was considered necessary, and was inserted between February and March.* Had the intercalation been applied regularly at alternate years the additional days in four years would have been 45 (22+23) or $11\frac{1}{2}$ days per year on average,

* In fact, the intercalary month consisted sometimes of 27 days and sometimes of 28 days and was inserted after February 23. The last five days of February, which were due to be repeated after the close of the intercalary month, were not actually repeated, resulting in the intercalation of 22 or 23 days only.

and so the year-length would have been $366\frac{1}{2}$ days, only one day in excess of the correct length. But as the intercalation was applied rather arbitrarily sometimes after two years and sometimes after three years, the year-beginning gradually shifted and the year started before the arrival of the proper seasons.

The days of the month in the Roman calendar were enumerated backwards from the next following Kalends (1st of month), Nones (5th of month, except in the 31-day months, when the 7th of month), or Ides (13th of month, except in the 31-day months, when the 15th of month). The day after the Ides of March, for instance, would be expressed as 17 days before the Kalends of April.

The Romans upto 45 B.C. apparently had rather a vague idea of the correct length of the year. Julius Caesar after his conquest of Egypt in 44 B.C. introduced the leap-year system on the advice of Egyptian astronomer Sosigenes, who suggested that the mean length of the year should be fixed at $365\frac{1}{4}$ days, by making the normal length of the year 365 days and inserting an additional day every fourth year. At the same time the lengths of the months were fixed at their present durations. The extra day in leap years was obtained by repeating the sixth day before the Kalends of March. The name Quintilis, the 5th month from March, was changed to July (Julius) in 44 B.C. in honour of Julius Caesar, and the name Sextilis was changed to August in 8 B.C. during the reign of his successor, Augustus, and in honour of him. There is a very widespread idea that the durations of July and August were fixed at 31 days each in order to please the two Roman dictators Julius Caesar, and Octavius Caesar, also called Augustus, and for this purpose the two extra days were cut off from February, thus reducing its duration to 28 days. It is a nice story, but does not appear to have been critically probed.

Owing to the drifting of the year-beginning, the year 46 B.C. started about 90 days before the proper seasons. The months were first brought back to their correct seasons by giving the year corresponding to 46 B.C., a normal intercalation of 23 days after February and then inserting 67 additional days between November and December. This year therefore contained 445 days in all and is known as the '*year of confusion*'.

But the perfect calendar was still a long way off. Caesar wanted to start the new year on the 25th December, the winter solstice day. But people resisted that choice because a new-moon was due on January 1, 45 B.C. and some people considered that the new-moon was lucky. Caesar had to go along with them in their desire to start the new reckoning on a traditional lunar landmark.

The Julian calendar spread throughout the Roman empire and survived the introduction of Christianity. But the Christians introduced their own holidays which were partly Jewish in origin and for this, luni-solar and week-day reckonings had to be adopted.

Origin of the Seven-day Week

Historical scholarship has shown that unlike the year and the month, the seven-day week is an artificial man-made cycle. The need for having this short cycle arose out of the psychological need of mankind for having a day of rest and religious service after protracted labour extending over days. The seven-day week with a sabbatical day at the end, or something similar to it, is needed not only by God Almighty, but also by humbler toiling men. But there has been no unanimity of practice.

As already stated, the ancient Egyptians had a ten-day week. The Vedic Indians had a six-day week. The ancient Babylonians who started the month on the day after new-moon, had the first, eighth, fifteenth, and the twenty-second day marked out for religious services. This was a kind of seven-day week with sabbaths, but the last week might be of eight or nine days' duration, according as the month which was lunar had a length of 29 or 30 days. The ancient Iranians had a separate name for each day of the month, but some days, at intervals of approximately seven, were marked out as *Din-i-Parvan*, for religious practices. The pattern followed appears to have been similar to the Babylonian practice. The continuous seven-day week came into general use sometime after the first century A.D. It was unknown to the writers of the New Testament who do not mention anything about the week day on which Christ was crucified or the week day on which he is alleged to have ascended to Heaven. The fixing of Friday and Sunday for these incidents is a later concoction, dating from the fifth century after Christ. All that the New Testament books say is that He was crucified on the day before the Hebrew festival of Passover which used to be celebrated and is still celebrated on the full-moon day of the month of Nisan.

The continuous seven-day week was evolved on astrological grounds by unnamed astronomers who may have been Chaldean or Greek at an unknown epoch, but before the first century A.D. The Jews adopted it as a cardinal part of their faith during days of their contact with the Chaldeans. It is not their invention. We give a short story of this invention, as it is generally believed. But it may not be quite accurate in all details.

Invention of the Seven-day Week

Much of ancient astronomical knowledge is due to Chaldean astronomers who flourished between the seventh century B.C. and the third century A.D., as related in §4.7. They gave particular attention to the study of the movement of the sun, the moon and the planets, which they identified with their gods, because they thought that destiny of kings and states were controlled by the gods, i.e., by the planets, and attached the greatest importance to the observation of the position and movement of planets. They attached magical value to the number 'Seven' which was the number of planets or gods controlling human destiny.

In 'Planetary Astrology', the sun, the moon and the five planets, were identified with the chief gods of the Babylonian pantheon as given below :

<i>Planets</i>	<i>Babylonian God-names</i>	<i>Their function</i>
(1) Saturn	...Ninib ...	God of Pestilence and Misery.
(2) Jupiter	...Marduk ...	King of Gods.
(3) Mars	...Nergal ...	God of War.
(4) Sun	...Shamash...	God of Law & Order or Justice.
(5) Venus	...Ishtar.....	Goddess of Fertility.
(6) Mercury	...Nabu.....	God of Writing.
(7) Moon	...Sin.....	God of Agriculture.

These seven gods, sitting in solemn conclave, were supposed to control the destinies of kings and countries, and it was believed that their will and judgement with respect to a particular country or its ruler could be obtained from an interpretation of the position of the seven planets in the heavens, and the nature of motion of the planets (direct or retrograde).

The Chaldean god-names are given in the second column, and the functions they control in the third column. Their identification with the Roman gods is given in the first column. The planets* were put in the order of their supposed distances from the earth.

Further, the day was divided into 24 hours, and each of the seven gods was supposed to keep watch on the world over each hour of the day in rotation. The particular day was named after the god who kept watch at the first hour. Thus on Saturday, the watching god on the first hour was Saturn, and the day was named after him. The succeeding

*Planets used not in modern sense but in the old sense of a *wandering* heavenly body.

hours of Saturday were watched by the seven gods in rotation as follows :

Saturday	
Hours	1 2 3 4 5 6 7 8...14 15 22 23 24 25
God Watching	1 2 3 4 5 6 7 1... 7 1 1 2 3 4 (Sun)

The table shows the picture for Saturday. On this day, Saturn keeps watch at the first hour, so the day is named after him. The second hour is watched over by (2) Jupiter, third by (3) Mars and so on. Saturn is thus seen to preside at the 8th, 15th and 22nd hours of Saturday. Then for the 23rd, 24th and 25th hours come in succession (2) Jupiter, (3) Mars and (4) Sun. The 25th hour is the first hour of the next day, which was accordingly named after the presiding planet of the hour, *viz.*, No. 4 which is Sun. We thus get Sunday following Saturday. If we now repeat the process, we get the names of the week days following each other, as follows :

Saturday, Sunday, Monday, Tuesday,
Wednesday, Thursday, and Friday.

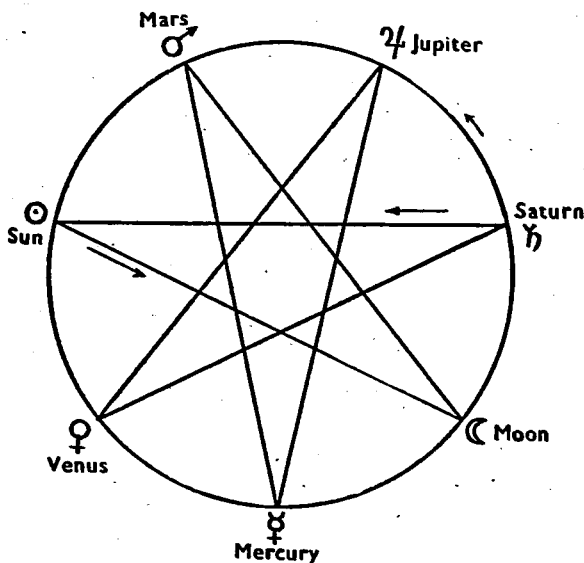

Fig. 1—The order of week-days derived from the order of planets. Saturday followed by Sunday, then Monday and so on.

The Jews, it may be mentioned, reckon the days by ordinal numbers—the first, second.....seventh day. The first day is Saturday.

The seven-day week, from the account of its origin is clearly based on astrological ideology. The continuous seven-day week was unknown to the classical Greeks, the Romans, the Hindus, and early Christians. It was introduced into the Christian world by an edict of the Roman emperor Constantine, about 323 A.D., who changed the Sabbath to the Lord's Day (Sunday), the week-day next to the Jewish Sabbath. Its introduction into India is about the same time and from the same sources. The week-days are not found in earlier Hindu scriptures like the Vedas or

the classics like the great epic *Mahābhārata*. They occur in inscriptions only from 484 A.D., but not in inscriptions of 300 A.D. Even now, they form but an unimportant part in the religious observances of the Hindus which are determined by the moon's phases.

It can therefore be said that the unbroken seven-day week was not a part of the religious life of any ancient nation, and it is not, even now, part of the religious life of many modern nations. It is a man-made institution introduced on psychological grounds, and therefore can be or should be modified if that leads to improvement and simplification of human life.

The Christian Era

The present Christian era came into vogue much later. About 530 A.D., the era-beginning was fixed from the birth year of Christ which was fixed after a certain amount of research by the Scythian Bishop Dionysius Exiguus and Christ's birth day (Christmas) was fixed on December 25 which was the Julian date for the winter solstice day and the ceremonial birth day of the Persian god Mithra in the first century B.C. The discovery of a Roman inscription at Ankara shows that King Herod of the Bible who is said to have ordered the massacre of innocents was dead for four years at 1 A.D., and therefore Christ must have been born on 4 B.C., or somewhat earlier.

2.6 THE GREGORIAN CALENDAR

The Julian year of 365.25 days was longer than the true year of 365.2422 by .0078 days, so the winter solstice day which fell on December 21 in 323 A.D., fell back by 10 days in 1582 A.D. and the Christmas day appeared to be losing all connections with the winter solstice. Similar discrepancy was also noticed in connection with the observance of the Easter.* Various proposals were made for correcting the error and the Council of Trent which assembled in 1545 authorised the Pope to deal with the matter. When in 1572, Gregory XIII became Pope, these schemes were considered and the plan that was most

* Easter, the most joyous of the Christian festivals, is observed annually throughout Christendom in commemoration of the resurrection of Jesus Christ, on the first Sunday after the full-moon following the vernal equinox day. The last days of Christ coincided with the Passover fast of the Jews and his death fell upon the day of the feast of the Passover, on the 14th day of the month of Nisan. As the date of Easter is associated with the moon's phases, as well as the vernal equinox day, it is a movable festival, falling anywhere between March 22 and April 25. A movement is going on for narrowing down the range of variation of the Easter day; in 1928 the British Parliament passed the Easter Act, which contingent upon its acceptance internationally; fixed Easter day as the first Sunday after the second Saturday in April, falling between April 9 and 15. (*Vide Encyclopaedia Britannica, Easter.*)

favoured was the one that had been proposed by Aloysius Lilius, a Neapolitan physician. In 1582, Pope Gregory XIII published a bull instituting the revised calendar and ordained that Friday, October 5 of that year was to be counted as Friday, October 15. For the future, centurial years that were not divisible by 400 were not to count as leap-years; in consequence the number of leap-years in 400 years was reduced from 100 to 97 and the year-length of the calendar thus became 365.2425 days, the error being only one day in 3300 years.

The Gregorian reformation of the calendar was at once adopted by the Catholic states of Europe, but other Christian states took longer time to accept it. In Great Britain it was officially introduced in 1752. As the error had by that time amounted to 11 days, the September of 1752 was deprived of these days and 3rd September was designated as the 14th September. In some countries the Gregorian calendar was not adopted until the present century. China and Albania adopted it in 1912, Bulgaria in 1916, Soviet Russia in 1918, Roumania and Greece in 1924, and Turkey in 1927. The rules for Easter which were revised on the basis of the Gregorian calendar have not been adopted by the Greek orthodox Church.

In spite of its wide use, the Christian or Gregorian calendar is a clumsy and inconvenient system of time-reckoning on account of the arbitrary length of its months ranging from 28 to 31. With a view to reforming it many schemes have been proposed, but the one deserving of serious consideration is the new World Calendar advocated originally by the Italian astronomer Armellini in 1887 and adopted by the World Calendar Association, Inc., which has its headquarters in New York (630, Fifth Avenue, New York 20, N. Y), under the able presidentship of Miss Elisabeth Achelis.*

In the ecclesiastical calendar some holy days are observed on fixed days of the year, others known as movable festivals are observed on fixed days of the week. Most of these are at fixed intervals before or after Easter day. When the Easter day of any year is fixed, the dates of other movable festivals can accordingly be ascertained. The Council of Nice convened in 325 A.D. adopted the rule for fixing the date of Easter—it was to fall on the first Sunday after the 14th day of the moon (nearly full moon) which occurs on or immediately after March 21. In fact there are certain special tables for determining the

Easter day, based on the mean length of the lunar month, and the determination does not require any advance calculation of moon's position. The following are the principal holidays dependent on the date of Easter.

<i>Days before Easter</i>		<i>Days after Easter</i>	
Septuagesima Sunday	63	Low Sunday	7
Quinquagesima ..	49	Rogation Sunday	35
Ash Wednesday	46	Ascension Day	39
Quadragesima Sunday	42	Whit Sunday	49
Palm Sunday	7	Trinity Sunday	56
Good Friday	2	Corpus Christi	60

2.7 THE WORLD CALENDAR

As already stated the Gregorian calendar is a most inconvenient system of time-reckoning. The days of the months vary from 28 to 31; quarters consist of 90 to 92 days; and the two half-years contain 181 and 184 days. The week-days wander about the month from year to year, so the year and month beginnings may fall on any week-day, and this causes serious inconvenience to civic and economic activities. The number of working days per month varies from 24 to 27, which creates considerable confusion and uncertainty in economic dealings and in the preparation and analysis of statistics and accounts. The present Gregorian calendar is therefore in dire need of reform.

The question of resolving these difficulties had been under consideration for more than the last 100 years. In 1834, the Italian Padre Abbe' Mastrofini proposed the Thirteen-Month Calendar, which was strongly advocated by the positivist philosopher August Comte. But this calendar could not attract much attention and consequently it was abandoned. The plan of reform which has received the most favourable comments is, as mentioned earlier, that of the World Calendar Association.

Let us explain the ideas behind this movement :

Calendars are used for regulating two essentially distinct types of human activities, viz.,

- (a) Civic and administrative,
- (b) Social and religious.

In ancient and medieval times, different countries and religions had developed their characteristic calendars to serve both purposes, but in the modern age, due to historic reasons, almost all countries use :

- (a) the Gregorian calendar for regulation of civic and administrative life,
- (b) their own characteristic calendars for regulation of social and religious observances.

* She had been devoting her services ungrudgingly for the cause of calendar reform for the last twenty-five years, and also been publishing a 'Journal of Calendar Reform' since then.

For example, India uses the Gregorian calendar for civic and administrative purposes, but various luni-solar calendars for fixing up dates for religious festivals of Hindus in different states. The Islamic countries also follow the same practice—Gregorian calendar for civic and administrative purposes, but the lunar calendar for religious purposes.

Even in Christian countries, which apparently use the Gregorian calendar for both purposes, in actual practice, some additional time-reckonings have to be done for fixing the date of Easter and other holidays which move with it. These reckonings constitute the ecclesiastic calendar, and are survival of earlier luni-solar calendars.

The disadvantages of the Gregorian calendar as used for civic and administrative purposes are :

- (a) that the years and months begin on different week days,
- (b) that months are of unequal length—from 28 to 31 days—and they start on week-days which are most changeable.

This happens because a normal year of 365 days consists of 52 weeks *plus* one day ; and a leap-year coming every fourth year, has 366 days, and consists of 52 weeks *plus* 2 days. If a normal year begins on a Sunday, the next year will start on Monday, and the year after a leap-year will jump two week-days.

This causes a most undesirable wandering of the week-day on which the year begins, as is seen for the next few years. This year 1954, has started on a Friday. We shall have

1955	starting on Saturday
1956 Sunday
1957 Tuesday
1958 Wednesday
1959 Thursday
1960 Friday
1961 Sunday

How much better it would be for civic and administrative life if a system could be devised that every year should start on a Sunday ?

The World Calendar Plan

This is how the World Calendar Plan proposes to prevent this wandering of the starting-day of the year. It is a very simple device.

If from 1961, which starts on a Sunday, the last day of the year (*i.e.* Dec. 31) which would be under the present system a Sunday, is called the *Worldsday*, that is, no week-day denomination is attached to it, then 1962 also will start on a Sunday, and so will every year till the next leap-year 1964. On that year another

additional day, the *Leap-Year Day*, is inserted at the end of June, and have the usual *Worldsday* at the end of the year ; then 1965 will also start on a Sunday.

So, by this simple device of having a *Worldsday* at the end of every year and a *Leap-Year Day* at the end of June every fourth year, both without any week-day denomination, every year can be made to start on a Sunday. This will prove to be an inestimable advantage for the civic life of mankind.

It is needless to add illustrations of the chaotic way in which the starting week-days of months vary. They are chaotic, because lengths of months vary from 28 to 31. There is not the slightest scientific justification for these varying lengths. They are said to have been due to the caprice of two Roman dictators, or some other historical cause not yet clear. How much better it would be for civic purposes, if each month could start on a fixed day of the week ?

The World Calendar plan proposes to put this right by dividing the year into four quarters, each of three months of 31, 30, 30 days' duration. According to this plan,

January, April, July, October would have each 31 days, and start on Sunday,

February, May, August, November would have each 30 days, and start on Wednesday,

March, June, September, December would have each 30 days, and start on Friday.

If this plan be adopted, the calendar will be perpetual and fool-proof. What a welcome change it would prove when compared to the present chaotic and wandering calendar ?

The year has to conform to the period of the sun, and this is covered by the leap-year rules, amended by Pope Gregory XIII in 1582. The leap-year rules introduced by the Iranian poet-astronomer Omar Khayyam in 1079, were more accurate, but less convenient. The Gregorian leap-year rules will cause a mistake of only one day in 3,300 years, which is trivial.

As regards the duration of months, the World Calendar plan is a marked improvement on the chaotic lengths and starting days of months, inherited from the Julian calendar, which has been tolerated too long. The months of all the quarters are identical and have got 31, 30 & 30 days, commencing on Sundays, Wednesdays and Fridays respectively. Each month has thus got exactly 26 working days. It has retained the present 12 months, thus the four quarters are always equal, each quarter has 3 months or 13 weeks or 91 days beginning on Sunday and ending with Saturday.

The objections to the World Calendar plan come from several Jewish organizations, on the ground that the World Calendar plan interferes with the unbroken seven-day week, by introducing World-day and Leap-year Day without any week-day denomination. This, they say, will interfere with their religious life.

As already shown, the religious sanction for the seven-day cycle is either non-existent, or slight, amongst communities other than the Jews, and even amongst them, it dates only from the first century A. D. The claims of certain Jewish Rabbis to prove that the seven-day week cycle has been ordained by God Almighty from the moment of creation which event, according to these Jewish Rabbis, took place on the day of the autumnal equinox, also a new moon day, is a fantastic conception of medieval scholars, which no sane man can entertain in these days of Darwin and Einstein.

The World Calendar plan has no intention of interfering with the characteristic calendars of communities or nations. They can exist side by side with the World Calendar. For such communities as intend to maintain the continuous seven-day week, their religious week-days, including Sundays, would no doubt wander through the World Calendar week-days, and cause some inconvenience to the very small

fraction of people who would want to observe their religious rites according to established usage.

But these inconveniences can be adjusted by agreement, and it would be egoistical on the part of a particular community or communities to try to impede the passage of a measure of such great usefulness to the whole of mankind on the plea that the World Calendar plan interferes with the continuous seven-day week. Calendars are based on Science, which everybody must bow to; and on Convention, which may be altered by mutual consent. The unbroken seven-day week is a *Convention*, but the World Calendar plan has proposed a far better *Convention*, which should be examined on its own merits.*

As a result of a request from the Government of India, the proposal of the World Calendar Reform had become the subject of discussion at the eighteenth session of the Economic and Social Council of the United Nations held at Geneva during June-July, 1954. Professor M. N. Saha, F. R. S., Chairman, Calendar Reform Committee, attended the ECOSOC meeting at Geneva to explain the desirability of the proposed reform.

* Being the full text of the address in support of the Indian proposal for World Calendar reform, by Prof. M. N. Saha, F.R.S. at the 18th Session of the Economic and Social Council of the United Nations, held at Geneva in June-July, 1954.

THE WORLD CALENDAR

1ST QUARTER	JANUARY							FEBRUARY							MARCH						
	S	M	T	W	T	F	S	S	M	T	W	T	F	S	S	M	T	W	T	F	S
	1	2	3	4	5	6	7	1	2	3	4				1	2					
	8	9	10	11	12	13	14	5	6	7	8	9	10	11	3	4	5	6	7	8	9
	15	16	17	18	19	20	21	12	13	14	15	16	17	18	10	11	12	13	14	15	16
22	23	24	25	26	27	28	19	20	21	22	23	24	25	17	18	19	20	21	22	23	
29	30	31					26	27	28	29	30			24	25	26	27	28	29	30	
2ND QUARTER	APRIL							MAY							JUNE						
	S	M	T	W	T	F	S	S	M	T	W	T	F	S	S	M	T	W	T	F	S
	1	2	3	4	5	6	7	1	2	3	4				1	2					
	8	9	10	11	12	13	14	5	6	7	8	9	10	11	3	4	5	6	7	8	9
	15	16	17	18	19	20	21	12	13	14	15	16	17	18	10	11	12	13	14	15	16
22	23	24	25	26	27	28	19	20	21	22	23	24	25	17	18	19	20	21	22	23	
29	30	31					26	27	28	29	30			24	25	26	27	28	29	30 W	
3RD QUARTER	JULY							AUGUST							SEPTEMBER						
	S	M	T	W	T	F	S	S	M	T	W	T	F	S	S	M	T	W	T	F	S
	1	2	3	4	5	6	7	1	2	3	4				1	2					
	8	9	10	11	12	13	14	5	6	7	8	9	10	11	3	4	5	6	7	8	9
	15	16	17	18	19	20	21	12	13	14	15	16	17	18	10	11	12	13	14	15	16
22	23	24	25	26	27	28	19	20	21	22	23	24	25	17	18	19	20	21	22	23	
29	30	31					26	27	28	29	30			24	25	26	27	28	29	30	
4TH QUARTER	OCTOBER							NOVEMBER							DECEMBER						
	S	M	T	W	T	F	S	S	M	T	W	T	F	S	S	M	T	W	T	F	S
	1	2	3	4	5	6	7	1	2	3	4				1	2					
	8	9	10	11	12	13	14	5	6	7	8	9	10	11	3	4	5	6	7	8	9
	15	16	17	18	19	20	21	12	13	14	15	16	17	18	10	11	12	13	14	15	16
22	23	24	25	26	27	28	19	20	21	22	23	24	25	17	18	19	20	21	22	23	
29	30	31					26	27	28	29	30			24	25	26	27	28	29	30 W	
W (Worldday, a World Holiday) equals 31 December (365th day) and follows 30 December every year. W (Leapyear Day, another World Holiday) equals 31 June and follows 30 June in leap years.																					

In this Improved Calendar :

- * Every year is the same.
- * The quarters are equal: each quarter has exactly 91 days, 13 weeks or 3 months; the four quarters are identical in form.
- * Each month has 26 weekdays, plus Sundays.
- * Each year begins on Sunday, 1 January; each working year begins on Monday, 2 January.
- * Each quarter begins on Sunday, ends on Saturday.
- * The calendar is stabilized and perpetual, by ending the year with a 365th day that follows 30 December each year, called Worldday dated "W" or 31 December, a year-end world holiday. Leap-year day is similarly added at the end of the second quarter, called Leapyear Day dated "W" or 31 June, another world holiday in leap years.

CHAPTER III

The Luni-Solar and Lunar Calendars

3.1 PRINCIPLES OF LUNI-SOLAR CALENDARS

The Egyptians appear to have been the only cultural nation of antiquity who discarded the moon entirely as a time-marker. Other contemporaneous cultural nations, e.g., the Sumero-Akkadians of Babylon, and the Vedic Indians retained both the sun and the moon as time-markers, the sun for the year, the moon for the month.

The Indian astronomers called the moon *māsakṛt*, (month-maker) and before the *Siddhānta Jyotiṣa* time, the moon was considered more important as a time-marker than the sun (*vide* §5). It was the same with other nations too, for as Pannekoek remarks, we find the opinion written in the sacred books of many nations "For regulating time, the moon has been created".

The retention of both the sun and the moon, however, gives rise to a multitude of problems, of which a fair summary is given by Pannekoek as follows.*

"With all peoples of antiquity, the Indians, Babylonians, Jews, Greeks, we find the moon-calendar used; the period of the moon, the regular sequence of the first appearance of the fine crescent moon in the evening sky, its growth to first quarter, to full moon, at the same time coming up later and filling the whole night, then the decrease to last quarter till its disappearance after the last thin crescent before sunrise was seen,—this regular cycle of the moon's phases in the period of $29\frac{1}{2}$ days was everywhere the first basis of chronology".

"But the calendar could not be satisfactorily fixed with the establishment of the moon-cycle. In these ancient times, the people, the tribe, and the state was a political, spiritual and religious unity. Important events of society, the great agricultural performances, the beginning of the ploughing, the sowing or the harvesting were great popular festivals and at the same time chief religious ceremonies, when offerings were presented to the gods. The moon calendar had to adapt itself to the economic life of the people, which was governed by the cycle of seasons. Thus arose the practical problem of adapting the moon-period of $29\frac{1}{2}$ days to the solar year of 365 days. *This chief problem of ancient chronology has been a mighty impulse to the study of astronomy, because it necessitated continuous observation of the sky.*"

* Article on 'Astrology and its influence upon the development of Astronomy' by Anton Pannekoek, published in the *Journal of the Royal Astronomical Society of Canada*, April, 1930.

Twelve lunar months of $29\frac{1}{2}$ days each, making a total of 354 days, fall nearly 11 days short of the solar year. In the next year, the beginning of each month occurs 11 days earlier, in three years 33 days will be lost.* To fix the same month to the same season always, there are no other means than after two or three years to intercalate a Thirteenth Month, number 13, by repeating the last month of the year.

The luni-solar adjustment which is next taken up is the first step to the solution of problems stated by Pannekoek, but it is not however the whole solution, for it leaves untouched the problem of correct prediction of the day when the crescent of the moon first appears after new moon in the western horizon. This will be taken up later (*vide* §4).

Luni-solar adjustment can be satisfactorily made if we have accurate knowledge of the length of the tropical year, and of the mean length of the lunation. Let us see how these fundamental periods were determined in ancient times.

Length of Seasons and the Year

The length of the year was obtained in Egypt, as we have already seen, from the recurrence of the Nile flood. In Babylonia, no such striking natural phenomena were available. It is very probable that the Babylonians early learnt the use of the gnomon, with the aid of which they could determine the cardinal days of the year: *viz.*, the summer and winter solstices, and the two equinoxes coming in between.

The lengths of the seasons were found by counting the number of days from one cardinal day to the next. The number may vary by one day from year to year, and astronomers must have realized that the correct length of a season was not a whole number but was fractional. Probably the correct length was found by taking a large number of observations, and taking the mean. The following table shows the length of the seasons and of the year as found by ancient astronomers.

* The mean duration of a lunar month consists of 29.530588 days and twelve such lunations amount to 354.36706 days, while the length of a tropical solar year is 365.24220 days. The length of a lunar year thus falls short of the solar year by 10.87514 days, and instead of there being exactly twelve lunar months in a year, there are 12.36827 months.

Table 2.—Showing the length of seasons.

	Euctemon (432 B.C.)	Calippos (370 B.C.)	Chaldean (200 B.C.)	Correct values for 1384 B.C.
	days	days	days	days
Spring	93	94	94.50	94.09
Summer	90	92	92.73	91.29
Autumn	90	89	88.59	88.58
Winter	92	90	89.44	91.29
Total ...	365	365	365.26	365.25

The length of the year was also found by the same method. The solar year is the period between successive transitions of the sun through the same cardinal point. Neugebauer thinks that summer solstice was first used for this purpose in ancient times. But subsequently evidences are found of the use of other cardinal points.

Thus we find that during the classical period in Babylon, the solar year started with the vernal equinox. But the Macedonian Greeks and the Jews started with the autumnal equinox. The west European countries appear to have started the solar year with the winter solstice.

The number of days in a solar year would vary between 365 and 366. Probably the exact length was determined by counting the number of days between the year-beginnings separated by a large number of years and taking the mean. The Indian practice, followed in the *Siddhāntas*, is to give the number of days in a *Kalpa* (a period of 4.32×10^9 years) from which one can find out the number of days in a year by simple division. This appears in modern times to be a rather cumbersome practice, but is probably reminiscent of taking the mean for a large number of years.

In ancient times, people had not learnt to follow the motion of the sun in the starry heavens, so they were unaware of the difference between the sidereal year and the tropical year. But from their method of measurement, they unconsciously chose the correct, or the tropical year.

Modern measurements show that the length of the tropical year is not constant, but is slowly varying. It is becoming shorter at the rate of .0001 days or 8.6 secs. in 1600 years.

So that in Sumerian times, the tropical year had a length of 365.2425 days. The present length is 365.2422 days.

3.2 MOON'S SYNODIC PERIOD OR LUNATION : EMPIRICAL RELATION BETWEEN THE YEAR AND THE MONTH

The solar year has thus a pretty nearly constant value, but even the earliest astronomers appear to have observed, that the lunation, or the synodic period of the moon is not a constant, but is variable. As a matter of fact, the period varies from 29.246 to 29.817 days—nearly fourteen hours. The observation of the actual motion of the moon formed the most formidable problem in ancient astronomy (*vide* §4).

But all ancient nations show knowledge of an astonishingly correct value of the *mean synodic period*, which is known to be 29.530588 days. This is probably because they could count the number of days with fractions comprising a very large number of lunations, and therefore the mean value came out to be very correct.

With the aid of the knowledge of correct values of the length of the tropical year, and of the *mean synodic period* of the moon, it is possible to find out correct rules for luni-solar adjustment, as narrated below. But this could happen only at a later stage. The first stage was certainly empirical as is clearly indicated from a record of the great Babylonian king and law-giver Hammurabi (1800 B. C.), which says that the thirteenth month was proclaimed by royal order throughout the empire on the advice of priests. All religious observances were forbidden during this period.*

It is not known however, what principles, if any, guided the king or rather his advisers in their selection of the thirteenth month, but most probably the adjustment was empirical, *i.e.*, the month was discarded when the priests found 'from actual experience that the festival was going out of season. Many ancient nations who used the luni-solar calendar, do not appear to have gone beyond the empirical stage.

Empirical Relations between the Solar and Lunar Periods : The Intercalary Months.

The Chaldean astronomers (as the Babylonians were called after 600 B.C.) appear to have striven incessantly to obtain very accurate values for the mean lunation and the length of the solar year, and

* It is said that in ancient Palestine, the custom was that the Rabbis went to the fields and watched the time by their calendar for the ripening of wheat. If the lunar month of Addaru (last month of the year) fell back too much towards winter, they would proclaim a second Addaru in that year, so that the first of Nisan would coincide roughly with the ripening of wheat.

work out at the discovery of mathematical relationships between these two periods having the form—

$$m \text{ lunar months} = n \text{ solar years}$$

where both m and n are integers.

Let us describe some of these relations.

The *Octaeteris* : This depends on the relation :

$$8 \text{ tropical years} = 2921.94 \text{ days}$$

$$99 \text{ lunar months} = 2923.53 \text{ days.}$$

The difference is only 1.59 days in 8 years. We have used here the correct lengths of the two periods. The Babylonian values were slightly different.

According to this relation, there were to be three extra or intercalary months in a period of 8 years, and festivals would fall approximately in the right seasons, if these three months were suitably excluded for religious observances. But the rule was only approximate. In a few cycles, the discrepancy would be too large to be disregarded.

According to the celebrated exponent of Babylonian astronomy, Father Kugler, this system was in vogue from 528 B.C. to 505 B.C., then there was an interval when they used to have 10 intercalary months in a period of 27 years. From 383 B.C., the Chaldeans used the 19-year cycle, based on the relation :

$$19 \text{ solar years} = 6939.60 \text{ days}$$

$$235 \text{ lunar months} = 6939.69 \text{ days.}$$

There is a discrepancy of .09 days in 19 years, or a mistake of 1 day in 210 years.

The 19-year cycle, with 7 intercalary months was used throughout the whole Seleucid times (313 B.C.—75 B.C.), as shown by Pannekoek. This system has not been superseded in spite of various attempts.

These rules came into vogue at a time (383 B.C.), when Babylon had lost her independence and became a vassal state of the Persian empire of the Acheminids. We do not know what was the original calendar of pre-Acheminid Persia, but the great Acheminid emperor Darius preferred the simpler Egyptian solar calendar to the complex luni-solar calendar of Babylon. The population of Babylon could no longer depend upon the king to adjust the dates of their religious observances by royal decree, as happened in the time of Hammurabi (1800 B.C.). Probably therefore the priest-astronomers felt the need of mathematical rules which should take the place of royal decrees.

Table 3.—The 19-year cycle.

Cycle of 19 years showing Intercalary Months

(Compiled from Pannekoek's calculation of dates in Babylonian Tables of planets)

Year in the 19-year cycle	Total no. of days	Years of the Seleucid Era
1*	384	134 153 172 191 210 229
2	354	135 154 173 192 211 230
3	355	136 155 174 193 212 231
4*	384	137 156 175 194 213 232
5	355	138 157 176 195 214 233
6	354	139 158 177 196 215 234
7*	384	140 159 178 197 216 235
8	354	141 160 179 198 217 236
9*	384	142 161 180 199 218 237
10	355	143 162 181 200 219 238
11	354	144 163 182 201 220 239
12*	384	145 164 183 202 221 240
13	355	146 165 184 203 222 241
14	354	147 166 185 204 223 242
15*	384	148 167 186 205 224 243
16	354	149 168 187 206 225 244
17	355	150 169 188 207 226 245
18†	383	151 170 189 208 227 246
19	354	152 171 190 209 228 247
Total	6940	

N. B. Years marked * have a second Addaru, and years marked † have a second Ululu.

312—Seleucid era = Christian era B.C.

(Jan. to Sept.)

Seleucid era—311 = Christian era A.D.

(Jan. to Sept.)

The 'Nineteen-year cycle' is generally known as the 'Metonic Cycle' after Meton, an Athenian astronomer who unsuccessfully tried to introduce it at Athens in 432 B.C. But there is no proof that it was used at Athens before 343 B.C. The question of 'priority' of this discovery is therefore a disputed one.

3.3 THE LUNI-SOLAR CALENDARS OF THE BABYLONIANS, THE MACEDONIANS, THE ROMANS, AND THE JEWS

In addition to the Chaldeans, many other nations of antiquity, *viz.*, the Vedic Indians, the Greeks, the Romans and the Jews and others used the luni-solar calendar, and had to make luni-solar adjustments. It will be tedious to relate how they did it, except in the case of the Vedic Indians (*vide* § 5). But the knowledge of the nineteen-year rule appears to have diffused to all countries by the first century of the Christian era. From this time onwards, the lunar months of different nations appear to be interchangeable. This is shown in the following Table No. 4.

We have almost complete knowledge of the luni-solar calendars of the Babylonians during Seleucid times. The names of months with their normal lengths are shown in column (2) of the table.

Table 4.—Corresponding Lunar months.

Lunar Month-Names			
(1)	(2)	(3)	(4)
<i>Indian</i>	<i>Chaldean</i>	<i>Macedonian</i>	<i>Jewish</i>
CAITRA	Addaru	Xanthicos	
Vaiśākha	NISANNU (30)	Artemesios	Nissan
Jyaiṣṭha	Airu	(29) Daisios	Iyyar
Āṣāḍha	Sivannu	(30) Panemos	Sivan
Śrāvaṇa	Duzu	(29) Loios	Tammuz
Bhādra	Abu	(30) Gorpaios	Ab
Āśvina	Ululu	(29) Hyperberetrios	Ellul
Kārtika	Tasritu	(30) DIOS	TISHRI
Mārgaśīrṣa	Arah		
	Samnah	(29) Appelaos	Marheshvan
Pauṣa	Kisilibu	(30) Audynaios	Kislev
Māgha	Dhabitu	(29) Peritios	Tebeth
Phālguna	Shabat	(30) Dystros	Shebat
Caitra	Addaru	(29) Xanthicos	Adar and Veadar

The first Babylonian month Nisannu, started with 30 days, and other months were alternately 29 and 30 days. A normal year thus consisted of 354 days, but occasionally an extra day was added to the last month, and it became a year of 355 days.

The effect of these intercalations was that the first month, *viz.*, the month of Nisannu, never strayed for more than 30 days beyond the day of vernal equinox.

As the table shows, the Babylonian year might be of 354, 355, 383, or 384 days' duration, and occasionally it is said that they extended to 385 days. It was therefore impossible to calculate the number of days between two incidents, dated according to the Chaldean calendar, unless the investigator had a table of past years showing the lengths of each individual year. Herein comes the superiority of the Egyptian system, where the number of days between two incidents, dated according to the Egyptian system, could be easily calculated. The two greatest astronomers of ancient times, Hipparchos and Ptolemy, therefore, preferred the Egyptian system of dating to the Chaldean or the Macedonian.

The Macedonian Greeks used the months given in column (3) in their home land. When they settled in Babylon as rulers (313 B.C.), they continued to use the same months, but got them linked to Chaldean months. Their first month was Dios, which was the seventh month of Chaldeans. This was probably linked to the autumnal equinox in the same way as Nisannu was to the vernal equinox. The Macedonian year started six months earlier than the Chaldean year.

The Macedonian months were used by the Parthians, the early Śakas, and the Kushans in India without change of name (*vide* § 5.5), and probably the

month-lengths were also the same as in the Chaldean 19-year system. When the Śakas and Kushans began to rule in India, from first century B.C., they used the Macedonian months alternatively with the Indian months which are shown in the first column. The first Indian season, Spring, however according to immemorial Indian custom, has been on both sides of the vernal equinox (-30° to 30°), while in the Graeco-Chaldean system, the Spring started with vernal equinox (0°). The first Indian month is *Caitra*, the first of the spring months, and according to rules prevalent in Siddhāntic times (300 A.D.), the month was to be always on the lower side of the vernal equinox, *i.e.*, the beginning of lunar *Caitra* was to be on a date before the vernal equinox. It may be added that the Indian lunar months mentioned here are *amānta* or new moon ending.

3.4 THE INTRODUCTION OF THE ERA

For accurate date-recording, we require besides the month and the day, also a continuously running era. But the era came rather late in human history. We find dated records of kings in Babylon from about 1700 B.C. (Kassite kings). They used regnal years, lunar months, and the day of the lunar month. The ancient Egyptian records do not use any era, but sometimes the regnal years. But the use of regnal years is very inconvenient for purposes of exact chronology, because one has to locate the beginning of the reign of the king on the time-scale which often proves to be an extremely difficult problem, *e.g.*, in India, Emperor Asoke used regnal years, but it is a problem of nearly hundred years for archaeologists to find out the exact date of the commencement of his reign. This varies from 273 B.C. to 264 B.C.

In the writings of the Greek astronomers Hipparchos (140 B.C.) and Ptolemy (150 A.D.), we come across an era purporting to date from the time of one king Nabu Nazir of Babylon (747 B.C.), who is known to history, though this era is not used in records of the Babylonian kings themselves.

The inference has been made, though without clear proof, that the Babylonian or rather Chaldean astronomers who were the earliest systematic observers of the heavenly bodies, got tired of the use of the regnal years, and felt the need of a continuously running era for precision in time-reckoning. They took advantage of a unique gathering of planets about Feb. 26, 747 B.C. when Nabu Nazir was reigning in Babylon to proclaim that the gods have ordained the 'introduction of a continuously running era' (*Sky and Telescope*, Vol. I, p. 9, April, 1942).

But the use of the Nabonassar era appears to have been confined to astronomers. The kings continued

to record events in their regnal years as this had a great propaganda value for the royal family which they were unwilling to forego.

It is now known that the other ancient eras, like that of the *Greek Olympiads* (776 B.C.) or the era of *Foundation of Rome* (753 B.C.) are extrapolated eras. The ancient Greek method of dating by Olympiads is of uncertain origin, but the system was critically examined by the Alexandrian chronologists, particularly Eratosthenes (3rd century B.C.), the founder of scientific chronology. According to the *Encyclopaedia Britannica*, 14th edition, Greek chronology is not reliable till the 50th Olympiad (*i.e.* 576 B.C.). The era was therefore invented a long time after its alleged year of starting. The era of the Foundation of Rome had a similar history (see *Encyclopaedia Britannica*, 14th edition, Chronology). The starting years of these eras are suspiciously close to that of the Nabonassar era (747 B.C.). Probably both these eras were plagiarized from the era of Nabonassar after the savants of ancient Greece and Rome acquired the time-sense.

It is noteworthy that Hipparchos and Ptolemy used neither the era of Olympiads nor the era of Foundation of Rome, nor Greek or Chaldean months which were lunar, but the Nabonassar era and the more convenient Egyptian solar months. They preferred science to nationalistic chauvinism.

The Seleucid and other derived Eras

The Seleucid Era (the S. E. era): The first continuously running era which ran into general circulation is that introduced to commemorate the foundation of Seleucus's dynasty and dates from the year when Seleucus occupied the city of Babylon after defeating his rivals. There were two methods of counting, differing in the initial year and the first day of the year.

According to the official (Macedonian) reckoning, the era started from the lunar month of Dios (near autumnal equinox) in the year (—311) A.D. or 312 B.C. The months had Macedonian names.

According to the native Babylonian reckoning, the era started from the lunar month of Nisan (near vernal equinox) six months later than the starting of the Macedonian year. The months had Chaldean names, as given in Table No. 4.

The Seleucid monarchs ruled over a vast empire from Syria to the borders of Afghanistan from 311 B.C. to 65 B.C. *i.e.*, nearly for 250 years and under their rule, the knowledge of Graeco-Chaldean astronomy and time-calculations spread far and wide, ultimately reaching India, and profoundly modifying the indigenous system in India. The use of Macedonian months

spread over all these countries, as is apparent from contemporary inscriptions and coin-datings mentioned in § 5.5. The months were *amānta*, *i.e.*, started after the new-moon was completed and were pegged on to the solar year which started on the day of the vernal equinox. The Nisan was the first lunar month after the vernal equinox. There were 7 intercalary months in a period of 19 years. The correspondence between Chaldean and Greek months and the position of the intercalary months have been worked out by Prof. Pannekoek between the years 134-247 of the Seleucid era, as already given (*vide* § 3.2 and 3.3) along with their Indian equivalent lunar months.

The Parthian Era

Since the introduction of the Seleucid era, the practice arose for a nation or a dynasty to start eras commemorating some great event in their national or dynastic life. The first in record is the Parthian era, and the story of its starting is well-known. The Seleucid emperors ruled the Near East from 312 B.C. imposing on the countries under their domination Greek culture, the Seleucid era, and the Graeco-Chaldean system of time-reckoning. About 250 B.C., there were wide-spread revolts against Seleucid rule in Bactria, in Parthia (Eastern Persia), and other parts of the Near East. The revolt in Parthia was led by one Arsaces and his brother Tiridates who belonged to an Iranian tribe, which had adopted Greek culture. To commemorate their liberation from Seleucid rule, the Parthians introduced an era, beginning 64 years after the Seleucid era (*i.e.* 248 B.C.). But at first this era (Arsacid era) was only rarely used. The early Parthian emperors preferred to use on their coins the Seleucid era, the Macedonian months, and the Graeco-Chaldean system of time-reckoning inscribed in Greek letters. In the first century A.D., there was a Zoroastrian revival, the S.E. was dropped in favour of the Parthian era and Pehlevi began to be used in place of Greek, though Macedonian month-names were still kept.

Though kings bearing Parthian names ruled at Taxila about the first century B.C. to first century A.D., *e.g.*, king Gondophernes, no clear evidence of the use of the Parthian era on Indian soil has yet been found.

It is very likely that the Śaka era, with its methods of calendar-reckoning, which came into vogue in India during the *Siddhānta Jyotiṣa* times, was started by the Śaka tribes when they attained prominence, and started an era of their own, in imitation of the Parthians. They, however, retained the Graeco-Chaldean method of lunar month-reckoning and probably the same system of intercalary months.

3.5 THE JEWISH CALENDAR

The ancient Jewish calendar was lunar, the beginning of the month being determined by the first visibility of the lunar crescent. As the month-names show (col. 4 of the table No. 4), they were evidently derived from the Babylonian month-names excepting one or two, *viz.*, Marheshvan and Tammuz. The day began in the evening and probably at sunset. The year used to begin with the spring month Abib or Nisan, the latter being the Babylonian name of the month which was adopted by the Jews in the post-exilic times. Intercalation was performed, when necessary, repeating the twelfth month 'Adar' which was then known as 'Veadar' followed by Adar. The year-beginning was subsequently changed and in the last century before Christ, it became the month of Tishri, corresponding to the Macedonian month of *Dios*. This must have been due to the desire or need to follow the practice of the ruling race.

Originally there were no definite rules for intercalation and for fixing up the beginning of the months. Because various religious festivals and sacrifices were fixed with reference to the beginning of the month, information about it was spread throughout the country by messengers and by signal fires on hilltops.

About the 4th century A.D., fixed rules were introduced in the calendar and nothing was left to observation or discretion. Intercalation is governed by a 19-year cycle in which the 3rd, 6th, 8th, 11th, 14th, 17th and 19th years have got an extra month. The actual beginning of the initial month of the year, *viz.*, Tishri is obtained from the mean new-moon by complicated rules which are designed to prevent certain solemn days from falling on inconvenient days of the week. As a result, a common year may consist of 353, 354 or 355 days and an embolismic or leap-year of 383, 384 or 385 days. Ten of the months have got fixed durations of 29 or 30 days, as well as the intercalary month which contains 30 days, the other two varying according to the requisite length of the year.

The Jewish Era of Creation

The Jews use an Era (*Anno Mundi, libriath olum*) or 'Era of Creation' which is supposed to have been started from the day of creation of the world. We quote the following passages from *Encyclopaedia Britannica*, 14th edition, 'Chronology, Jewish'.

(1) The era is supposed to begin, according to the mnemonic *Beharad*, at the beginning of the lunar cycle on the night between Sunday and Monday, Oct. 7, 3761 B.C., at 11 hours 11½ minutes P.M. This is indicated by *be* (*beth*,

two, *i.e.*, 2nd day of week), *ha* (*he*, five, *i.e.*, fifth hour after sunset) and *Rad* (*Resh, dalet*, 204 minims after the hour).

(2) In the Bible various eras occur, *e.g.*, the Flood, the Exodus, the Earthquake in the days of King Uzziah, the regnal years of monarchs and the Babylonian exile. During the exile and after, Jews reckoned by the years of the Persian kings. Such reckonings occur not only in the Bible (*e.g.*, Daniel viii, I) but also in the Assouan papyri. After Alexander, the Jews employed the Seleucid era (called *Minyan Shetaroth*, or era of deeds, since legal deeds were dated by this era). So great was the influence exerted by Alexander, that this era persisted in the East till the 16th century, and is still not extinct in south Arabia. This is the only era of antiquity that has survived. Others, which fell into disuse, were the Maccabaeen eras, dating from the accession of each prince, and the national era (143-142 B.C.), when Judæa became free under Simon. That the era described in Jubilees was other than hypothetical, is probable. Dates have also been reckoned from the fall of the second Temple (*Le-Horban hab-bayyith*). The equation of the eras is as follows :

$$\begin{aligned} \text{Year 1 after destruction} &= \text{A.M. 3831} \\ &= 383 \text{ Seleucid} \\ &= \text{A.D. 71} \end{aligned}$$

The 'Era of Creation' is supposed to have started from the day of autumnal equinox of the year 3761 B.C. So the sun and the moon must have existed before the day of creation !!

3.6 THE ISLAMIC CALENDAR

The Mohammedan calendar is purely lunar and has no connection with the solar year. The year consists of 12 lunar months, the beginning of each month being determined by the first observation of the crescent moon in the evening sky. The months have accordingly got 29 or 30 days and the year 354 or 355 days. The new-year day of the Mohammedan calendar thus retrogrades through the seasons and completes the cycle in a period of about 32½ solar years.

The era of the Mohammedan calendar, *viz.*, the Hejira (A.H.), which was probably introduced by the Caliph Umar about 638-639 A.D., started from the evening of 622 A.D., July 15, Thursday*, when the crescent moon of the first month Muharram of the Mohammedan calendar was first visible. This was the new-year day preceding the emigration of Muhammad from Mecca which took place about Sept. 20 (8 Rabi I), 622 A.D.

*As the day of the Islamic calendar commences from sunset, Friday started from the evening of that day.

For astronomical and chronological purposes the lengths of the months are however fixed by rule and not by observation. The lengths of the months in days for this purpose are as follows :

Muharram30
Safar29
Rabi-ul awwal30
Rabi-us sani29
Jamada'l awwal30
Jamada-s sani29
Rajab30
Shaban29
Ramadan30
Shawal29
Zilkada30
Zilhijja29 (or 30)

The leap-year, in which Zilhijja has one day more, contains 355 days and is known as *Kabishah*. In a cycle of 30 years, there are 19 common years of 354 days and 11 leap-years of 355 days. Thus 360 lunations are made equivalent to 10,631 days or only 0'12 days less than its actual duration. The rule for determining the leap-year of this fixed calendar is that, if after dividing the Hejira year by 30, the remainder is 2, 5, 7, 10, 13, 16, 18, 21, 24, 26 or 29, then it is a leap-year.

The only purely lunar calendar is the 'Islamic calendar', which has been in vogue amongst the followers of Islam since the death of the Prophet Muhammad (632 A.D.). But it is well-known that before this period Mecca observed some kind of luni-solar calendar in common with all countries of the Near East. The common story is that when pilgrims from distant countries and other parts of Arabia came to perform Hajj at Mecca (Hajj is a pre-Islamic practice), they often found that it was an *intercalary month* according to Meccan calculation, when no religious festival could be performed, and had to wait for a month before they were allowed to perform the rites. This meant great hardships for distant visitors and to prevent recurrence of such incidents the Prophet forbade the use of intercalary or 13th month and decreed that the calendar should henceforth be purely lunar.

It has now been shown by Dr. Hashim Amir Ali of the Osmania University, Hyderabad, that the Mohammedan calendar was originally luni-solar in which intercalation was made when necessary, and not purely lunar. This view-point has now been strongly supported by Mohammed Ajmal Khan of the Ministry of Education, Govt. of India. They emphasize that upto the last year of the life of Mohammed, *i.e.*, upto A.H. 10 or A.D. 632, a thirteenth month was intercalated when necessary. The Arabs, among whom there were relatively few men conversant with astronomical calculations, had a system in which a family of astronomers, known as Qalammas was responsible for proclaiming at the Hajj (falling in the last month of the year : Zilhijja) that a thirteenth month would or would not be added. Astronomically such intercalation should be made 3 times in 8 years or 7 times in 19 years. The elder of the Qalammas had a certain amount of discretion in determining when this intercalation was to be practised, and this very practice afterwards caused great confusion.

According to this view, proper intercalation was applied in all the years where necessary upto A.H. 10 and consequently the year A.H. 11 (coming next to the Hajj of A.H. 10) which started on March 29, 632 A.D. (*i.e.*, after the vernal equinox day) seems to have been a rather normal year, and as such all the previous new-year days appear to have been celebrated on the visibility of the crescent moon after the vernal equinox day. The Muslim months should accordingly occupy permanent places in the seasons as follows* :—

Muharram...	Mar.—April	Rajab	...Sept.—Oct.
Safar...	... April—May	Shaban	...Oct.—Nov.
Rabi I	... May —June	Ramadan	...Nov.—Dec.
Rabi II	... June —July	Shawal	...Dec.—Jan.
Jamadi I	... July —Aug.	Zilkada	...Jan. —Feb.
Jamadi II	... Aug. —Sept.	Zilhijja	...Feb. —Mar.

* If this view is accepted, it would then be necessary to shift the starting epoch of the Hejira era, which is commonly accepted as July 16, 622 A.D., to an earlier date, as 4 intercalary months or 118 days will then have to be inserted between the new-year days of A.H. 1 and of A.H. 11, which is March 29, 632 A.D. The initial epoch of the Hejira era thus arrived at is the evening of March 19, 622 A.D., Friday, the day following the vernal equinox.

CHAPTER IV

Calendric Astronomy

4.1 THE MOON'S MOVEMENT IN THE SKY

The scheme of lunar months given in Table No. 4 in a nineteen-year period, which came into vogue in Babylon about 383 B.C. did not, however, completely satisfy the needs of the Babylonian calendar, because for religious purposes, the month was to start on the day the crescent moon was first visible in the western horizon after conjunction with the sun (the new-

and the moon move uniformly in the same great circle in the heavens. But even the most primitive observers could not fail to notice that neither do the two luminaries move in the same path, nor do they move uniformly, each in its own path.

The motion of the moon amongst the stars is the easiest to observe. This is illustrated in the two figures reproduced from the *Sky and Telescope*, giving

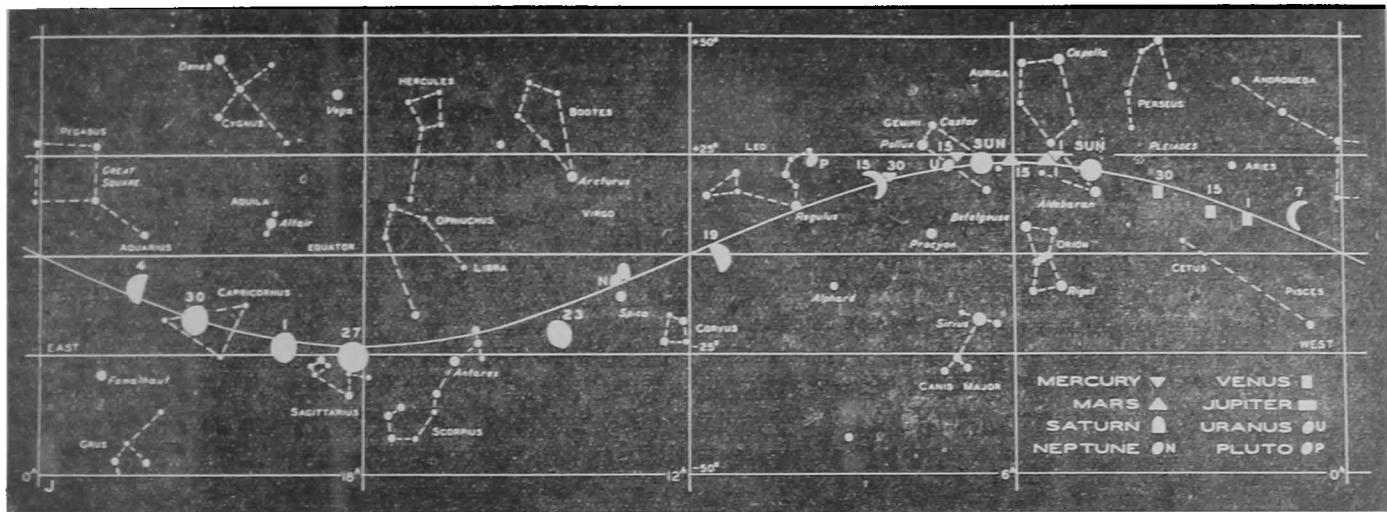

Fig. 2—Showing the positions of the sun, moon and planets among the stars in June, 1953.

moon, a custom which is still followed in the Islamic countries. But the first visibility may not occur on the predicted day for manifold reasons.

positions of the moon, the sun, and the planets in the field of fixed stars in the months of June and July, 1953.

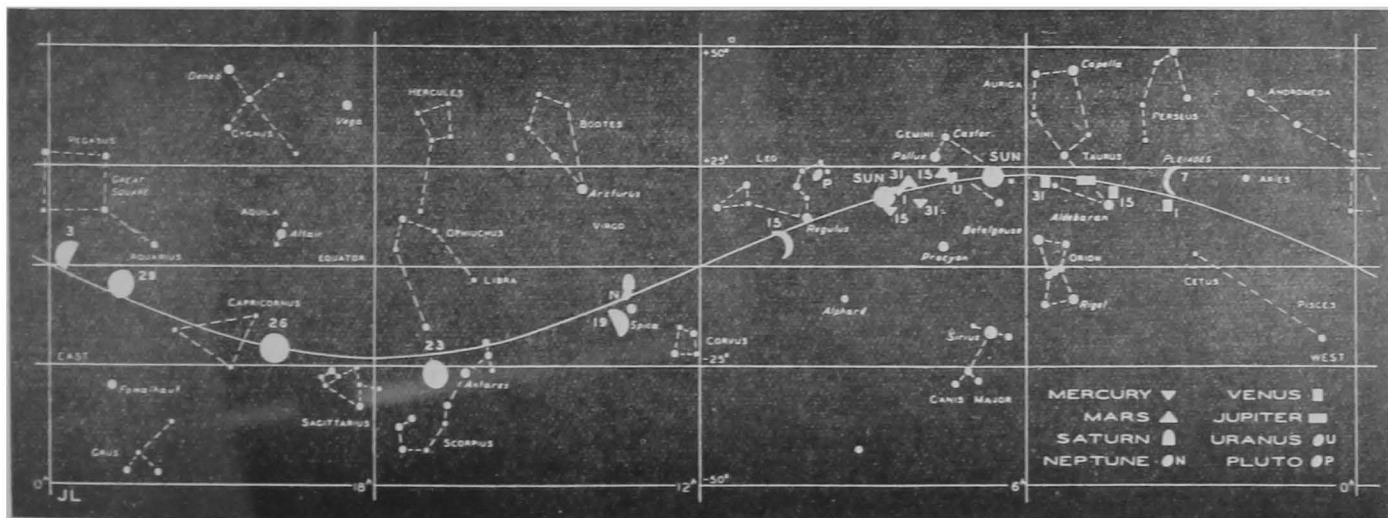

Fig. 3—Showing the positions of the sun, moon and planets among the stars in July, 1953.

The table given on p. 176 is based on mean values of the lengths of the year and the synodic month, which is equivalent to the assumption that the sun

The central horizontal line is the line of the celestial equator (§ 4.4), and the sinuous line represents the ecliptic or the sun's path (§ 4.5), but we may

ignore these now, and simply concentrate on the moon and the stars or star-clusters near which it passes.

The moon begins as a thin crescent on the western horizon on the evening of June 12, the day of the first visibility after the new-moon, at an angle of 11° , from the sun which has just set, below the bright stars Castor and Pollux (*Punarvasu*). Then we notice the position of the moon on successive evenings at *sunset*. We find she is moving eastward at the rate of about 13° and becoming fuller (increasing in phase). She passes the bright star Regulus (*Maghā*) on the 17th, on the 19th, she is half and passes β *Leonis* (*Uttara Phalguni*) leaving it a good deal to the north. Then she passes the bright star Spica (α *Virginis* or *Citrā*) on the 21st, and is then gibbous on the 23rd near the star α -*Libra* (*Viśākhā*). Then she passes the well known Scorpion-cluster and becomes full on the 27th, near a star-cluster which cannot be seen on the night of full-moon, but can be detected later as the star cluster Sagittarius. On the full moon day, she rises nearly at sunset, at 180° from the sun (opposition). On each successive night after full moon she rises later and later, and passes the phases in the reverse order, i.e., becomes gibbous on June 30, when she has the bright star Altair (*Śravaṇa*) far to the north and is half on July 4, and becomes a crescent on July 7 on the eastern sky, and then fails to appear for three days, and must have passed the sun on the 11th July which is the new moon day, when she is with the sun (*Amāvasyā* or conjunction, *lit.* the sun and the moon living together). On the 12th July, she reappears on the western horizon as a thin crescent, near the star δ -*Canceri* (*Puṣya*), and the cycle again starts.

The crescent of the moon, either in the western or the eastern sky, is always turned away from the sun.

The ancients must have observed the motion of the moon day after day, from new-moon to new-moon (a full lunation or lunar month) and become familiar with the stars or star-clusters which she passes. It is always easy to observe them when the moon is a crescent; when the moon becomes fuller, the stars are lost in the moon's glare particularly if they are faint. But if observations be carried on for a number of years, the observers would become familiar with all the stars or star-clusters which the moon passes.

By observations like this, the ancients must have found that both the moon and the sun are moving to the east, the moon very fast, the sun more slowly. By the time the moon, after making a whole round, comes back to the sun, the latter has moved further to the east by about 30° . For example in the above figures Nos. 2 and 3, the sun was somewhat to the west of the

bright star-group *Orionis* (*Mrgāśiras*) to the west of Castor and Pollux on June 11th, the day of the new-moon. But on the next new-moon day, July 11th, she has moved near Castor and Pollux (*Punarvasu*) about 30° to the east.

The ancients must have found that the moon takes a little over 27.3 days (sidereal period of the moon), to return to the same star, but to overtake the sun, it takes a little longer, a little over 29.5 days (the synodic period of the moon). Exactly,

$$\begin{aligned} \text{the mean sidereal period} &= 27.321661 \text{ days} \\ &= 27^{\text{d}} 7^{\text{h}} 43^{\text{m}} 11^{\text{s}}.5 \end{aligned}$$

with a variation of $\pm 3\frac{1}{2}$ hours

$$\begin{aligned} \text{and the mean synodic period} &= 29.530588 \text{ days} \\ &= 29^{\text{d}} 12^{\text{h}} 44^{\text{m}} 2^{\text{s}}. \end{aligned}$$

with a variation of ± 7 hours.

The Lunar Mansions :

Many ancient nations developed the habit of designating the day-to-day (or night-to-night) position of the moon by the stars or star-clusters it passed on successive nights. The number of such stars or star-clusters was either 27 or 28; the ambiguity was due to the fact that the mean sidereal period of the moon is about $27\frac{1}{2}$ days, the actual period having a variation of seven hours, and the ancients who did not know how to deal with fractions, oscillated between 27 and 28. In India, originally there were 28 *nakṣatras*, but ultimately 27 was accepted as the number of lunar *nakṣatras* (or asterisms).

The lunar zodiac is also found amongst the Chinese who designate them by the term *Hsiu*; and amongst the Arabs, who call them *Manzil*, both terms denoting mansions. Both the Chinese and the Arabs had 28 mansions. The Indian term '*nakṣatra*' is of uncertain etymological origin. Some hold that the term *nakṣatra* carried the sense that 'it does not move' and meant a star.

Names of certain '*nakṣatras*' are found in the oldest scriptures of India, *viz.*, the R̥g-Vedas, but a full list is first found in the Yajurveda (*vide* § 5.3). In the older classics of India (the Yajurveda, the *Mahābhārata*), the *nakṣatras* invariably start with *Kṛttikā*, the Pleiades; the supposition has been made that the *Kṛttikās* were near the vernal point, when this enumeration was started. This is apparent from the couplet found in the *Taittirīya Brāhmaṇa* which runs thus :

Taittirīya Brāhmaṇa, i, 1, 2, 1.

Kṛttikā svagnimādadhita...

Mukham vā etannakṣatrānām, Yatkṛttikā.

Translation : One should consecrate the (sacred) fire in the *Kṛttikās*;...the *Kṛttikās* are the mouth of the *nakṣatras*.

Later during *Siddhānta Jyotiṣa* times the enumeration started with *Aśvini* (α, β *Arietis*), and this is still reckoned to be the first of the *nakṣatras*, although the vernal point has now receded to the *Uttarabhādrapadā* group which should accordingly be taken as the first *nakṣatra*. But the change has not been done because the Indian astrologers have failed to correct the calendar for the precession of equinoxes.

The Chinese start their *Hsius* with *Citrā* or α *Virginis*. This refers probably to the time when α *Virginis* was near the autumnal equinoctial point (285 A.D.). The Arabs start their *Mansils* with β *Arietis* (Ash-Sharaṭāni).

There has been a good deal of controversy regarding the place of origin of the lunar zodiac. Many savants were inclined to ascribe the origin of the 27 *nakṣatra* system to ancient Babylon, like all other early astronomical discoveries. But as far as the authors of this book are aware, there is no positive evidence in favour of this view. Thousands of clay tablets containing astronomical data going back to 2000 B.C., and extending up to the first century A.D. have been obtained, but none of them are known to have any reference to 27 or 28 lunar mansions.

On the other hand (as mentioned before) some of the *nakṣatra* names are found in the oldest strata of the *R̥g-Vedas* (vide § 5.2), which must be dated before 1200 B.C., and a full list with some difference in names is found in the *Yajur-Veda*, which must be dated before 600 B.C. Nobody has yet been able, to refute yet Max Muller's arguments in favour of the indigenous origin of the Indian *nakṣatra* system given in his preface to the *R̥g-Veda Saṁhitā*, page xxxv.

It should be admitted that the lunar zodiac was pre-scientific, i.e., it originated before astronomers became conscious of the celestial equator and the ecliptic, and began to give positions of stellar bodies with these as reference planes. The *nakṣatras* give very roughly the night-to-night position of the moon, by indicating its proximity to stars and star-groups. Many of the Indian stars identified as *nakṣatras* are not at all near the ecliptic or the moon's path which, on account of its obliquity, is contained in a belt within $\pm 5^\circ$ of the ecliptic. Such are for example :

(15) *Srāṭī*, which is identified with Arcturus (α *Boötis*), which has a latitude of 31° N.

(22) *Śravaṇa*, identified with α, β, γ *Aquiliae*, having the latitude of 29° N.

(23) *Śraviṣṭhā*, identified with $\alpha, \beta, \gamma, \delta$ *Delphini*, α having the latitude of 33° N.

(25) *Pūrva Bhādrapadā* identified with α *Pegasi* and some other adjacent stars, α *Pegasi* having latitude of 19° N.

At one time, the brilliant star Vega (α *Lyræ*) was also included making 28 *nakṣatras*. But this has a latitude of 62° N and was later discarded.

No satisfactory argument has been given for the inclusion of such distant stars in the lunar zodiac. The Arabs and the Chinese do not include these distant stars in their lunar zodiac, but fainter ones near the ecliptic. Prof. P. C. Sengupta is of the opinion that Indians generally preferred bright stars, but when such were not available near the ecliptic, they chose brighter ones away from the ecliptic, which could be obtained on the line joining the moon's cusps.

The *nakṣatras* were used to name the 'days' in the earliest strata of Indian literature. Thus when the moon is expected to be found in the *Maghā nakṣatra* (α *Leonis*), the day would be called the *Maghā* day. This is the oldest method of designating the day, for it is found in the *R̥g-Vedas*. Other methods of designating the day by *tithis* or lunar days, or by the seven week-days, came later. The system has continued to the present times. In old times, astrology was based almost entirely on the *nakṣatras*, e.g., in Asoke's records, the *Puṣya nakṣatra* day was regarded as auspicious when *Brāhmaṇas* and *Śramaṇas* were fed, in order to enhance the king's *puṇya* (religious merits). In the *Mahābhārata* also we find that the days are designated by *nakṣatras* which apparently mean the star or star-cluster near which the moon is expected to be seen during the night.

As is apparent from Table No. 5, the *nakṣatras* are at rather unequal distances, i.e., they rarely follow the ideal distance of $13\frac{1}{3}^\circ$. This is rather inconvenient for precision time-reckoning. We find in the *Vedāṅga Jyotiṣa* times an attempt at a precise definition of the two limits of a *nakṣatra*, which was defined as $800'$ ($=13^\circ 20'$) of the ecliptic. The *nakṣatra* was named according to the most prominent star (*Yogatārā*) contained within these limits. These are given in column (2) of Table 5.

We do not, however, have any idea as to how the beginnings and endings of the *nakṣatra* divisions were fixed in India. The prominent ecliptic stars which were used as *Yogatārās* (junction-stars) in pre-Siddhāntic period, are not distributed at regular intervals along the ecliptic; and so it was found very difficult to include the stars in their respective equal divisions. This will be clear from table (No. 5) where the junction stars of the *nakṣatras* according to the *Sūrya-Siddhānta* are given in col. (2). The celestial longitudes of the stars for 1956 A.D. are given in col. (4) and the beginnings of each division for the same year are given in col. (5), taking the star α *Virginis* to occupy the middle position of the *nakṣatra Citrā*, which marked

Table 5.—Stars of the Nakṣatra divisions.

Positions of the Junction Stars of Nakṣatra Divisions of the Siddhantas					
Name of nakṣatras	Junction star (Yogatārā) of nakṣatras	Latitude	Longitude Sāyana (1956)	Beginning point of the nakṣatra division (1956)	Position of the star in the nakṣatra division.
(1)	(2)	(3)	(4)	(5)	(6)
1. Aśvini	β Arietis	+ 8° 29'	33° 22'	23° 15'	10° 7'
2. Bharanī	41 Arietis	+10 27	47 36	36 35	11 1
3. Kṛttikā	η Tauri	+ 4 3	59 23	49 55	9 28
4. Rohiṇī	α Tauri	- 5 28	69 11	63 15	5 56
5. Mṛgaśīras	λ Orionis	-13 23	83 6	76 35	6 31
6. Ārdrā	α Orionis	-16 2	88 9	89 55	(-)1 46
7. Punarvasu	β Geminorum	+ 6 41	112 37	103 15	9 22
8. Puṣya	δ Cancri	+ 0 5	128 7	116 35	11 32
9. Āśleṣā	α Cancri	- 5 5	133 2	129 55	3 7
10. Maghā	α Leonis	+ 0 28	149 13	143 15	5 58
11. Pūrva Phalgunī	δ Leonis	+14 20	160 42	156 35	4 7
12. Uttara Phalgunī	β Leonis	+12 16	171 1	169 55	1 6
13. Hasta	δ Corvi	-12 12	192 51	183 15	9 36
14. Citrā	α Virginis	- 2 3	203 14	196 35	6 39
15. Svātī	α Bootis	+30 46	203 38	209 55	(-)6 17
16. Viśākhā	α Libra	+ 0 20	224 28	223 15	1 13
17. Anurādhā	δ Scorpii	- 1 59	241 58	236 35	5 23
18. Jyēṣṭhā	α Scorpii	- 4 34	249 9	249 55	(-)0 46
19. Mūla	λ Scorpii	-13 47	263 59	263 15	0 44
20. Pūrvāṣāḍhā	δ Sagittarii	- 6 28	273 58	276 35	(-)2 37
21. Uttarāṣāḍhā	σ Sagittarii	- 3 27	281 47	289 55	(-)8 8
22. Śravaṇa	α Aquilae	+29 18	301 10	303 15	(-)2 5
23. Dhaniṣṭhā	β Delphini	+31 55	315 44	316 35	(-)0 51
24. Śatabhiṣaj	λ Aquarii	- 0 23	340 58	329 55	11 3
25. Pūrva Bhādrapadā	α Pegasi	+19 24	352 53	343 15	9 38
26. Uttara Bhādrapadā	γ Pegasi	+12 36	8 33	356 35	11 58
27. Revatī	ζ Piscium	- 0 13	19 16	9 55	9 21

the position of the autumnal equinox at the time when the table was compiled. The figures in the last column represent the position of the star in the *nakṣatra* division of that name. It seems that a few of the *Yogatārās*, viz., No. 6 *Ārdrā*, No. 15 *Svātī*, No. 18 *Jyēṣṭhā*, No. 20 *Pūrvāṣāḍhā*, No. 21 *Uttarāṣāḍhā*, No. 22 *Śravaṇa*, and No. 23 *Dhaniṣṭhā* fall outside the *nakṣatra* division of which they are supposed to form the *Yogatārā*. Matters do not improve much, if we shift the beginning of each division so as to place ζ *Piscium* (*Revatī*) at the end of the *Revatī* division or in other words at the beginning of the *Aśvini* division. This will mean that the figures in col. (6) will then have to be increased by 3° 59', which will push up the *Yogatārās* of 1 *Aśvini*, 2 *Bharanī*, 3 *Kṛttikā*, 8 *Puṣya*, 13 *Hasta*, 25 *P. Bhādrapadā*, and 26 *U. Bhādrapadā*, so as to go outside the *nakṣatra* division of which they form the *Yogatārā*. In fact no arrangement at any time appears to have been satisfactory enough for all the *Yogatārās* to fall within their respective *nakṣatra* divisions.

The divisions of *nakṣatras* shown in the table, as already stated, has been based on the assumption that the star Spica occupies the 180th degree of the lunar zodiac. This arrangement agrees with the statement of the *Vedāṅga Jyotiṣa* that the *Dhaniṣṭhā* star (α or β *Delphini*) marked the beginning of the *Dhaniṣṭhā* division, and also of the *Varāha's Sūrya Siddhānta* that Regulus (α *Leonis*) is situated at the 6th degree of the *Maghā* division.

4.2 LONG PERIOD OBSERVATIONS OF THE MOON : THE CHALDEAN SAROS

The moon gains on the sun at the average rate of 12 $\frac{1}{2}$ ° per day, but it did not take the ancients long to discover that the daily gain of the moon on the sun is far from uniform ; in fact as we know now, it varies from approximately 10 $\frac{3}{4}$ ° to 14 $\frac{1}{2}$ ° per day. It was therefore not possible to say beforehand whether the crescent moon would appear on the 29th or on the 30th day after the beginning of the previous month.

But the exact prediction of the day was a necessity from the socio-religious point of view. In India, the month was measured from full-moon to full-moon, and in the *Mahābhārata*, the great epic which was compiled from older materials about 400 B. C., it is recorded that sometimes the full moon occurred on the thirteenth day after the new-moon. This was taken to forebode great calamities for mankind. There were similar ideas in Babylon of which Pannekoek says :

"When the Moon is full on the night of the 14th, the normal time, it was a lucky omen ; when full-moon happened on the night of the 13th, 15th or 16th, it was abnormal, hence a bad omen. Here astrology and calendar were merged ; deviation in the calendar was considered an unlucky sign and had to be restored at the end of the month."*

Neugebauer says :

"The months of the Babylonian calendar are always real lunar months, the first day of which begins with the first visibility of the new crescent. The exact prediction of this phenomenon is the main problem of the lunar theory as known to us from about 250 B. C. onwards."†

This is rather comparatively late date. The reason is that the accomplishment of this objective depends on the evolution of methods of exact astronomical observations, and of a method of recording them in precise mathematical language. Some ancient people never reached this stage. As far as we are aware, the ancient Babylonians were the first to evolve methods of observational astronomy. They also arrived at the principles of angular measurements, found the apparent paths of the moon, the sun, and the planets in the heavens, and discovered that it was only the sun's path (the ecliptic) which was fixed, and the paths of the moon, and the planets deviated somewhat from it. How this was done will be related later.

But even before these accurate methods had been discovered, the Babylonian astronomers had learnt a lot more about the moon from long period observations. The most remarkable of these discoveries is that of the Chaldean Saros, or a period of 18 years $10\frac{1}{2}$ days, in which the eclipses of the sun and the moon recur.

The occurrence of solar or lunar eclipses, when the two great luminaries disappear suddenly, either partially or wholly, were very striking phenomena for the ancient and medieval people, and gave rise to gloomy forebodings. There were all kinds of speculations about the cause of the eclipses, *e.g.*, that the sun and the moon were periodically devoured by demons or dragons. The ancient astronomers, however, found that a solar eclipse takes place only near conjunction

(new-moon), but every conjunction of the sun and the moon is not the occasion for a solar eclipse. A lunar eclipse takes place only near opposition (full-moon), but every opposition of the sun and the moon is not the occasion for a lunar eclipse.

In many ancient countries, China and Babylon for example, records of occurrence of eclipses had been kept. The celebrated Greek astronomer, Ptolemy of Alexandria (*ca.* 150 A. D.) had before him a record of eclipses kept at the Babylonian archives dating from 747 B. C. They gave date of occurrence, time, and features of the eclipse, whether they were partial or total. From an analysis of these records, the Chaldean astronomers tried to discover the laws of periodicity of eclipses, which ultimately resulted in the discovery of the Saros cycle of 18 years and 10 or 11 days. The basis of the Saros cycle is as follows :

We do not exactly know when the ancient astronomers outgrew the myth of demons periodically devouring the sun and the moon during eclipse times, and arrived at the physical explanations now known to every student of astronomy, and reproduced in the diagrams given below.

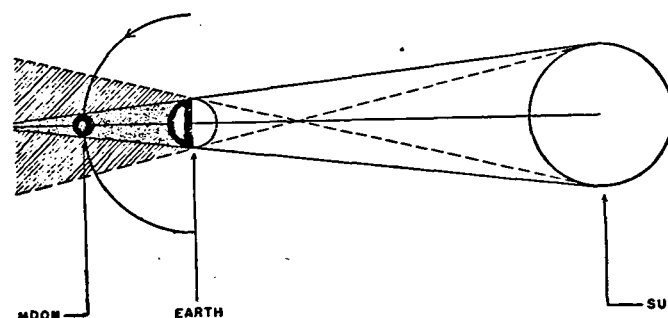

Fig. 4—Showing an eclipse of the moon.

But when they arrived at physical explanation of eclipses, they had an understanding as to why there are no eclipses during every full moon and new moon. The paths of the two luminaries must be in different planes. This we take up in a subsequent section more fully, when we describe how the sun's path or ecliptic was discovered.

Suffice it to say that at some ancient epoch, some Chaldean astronomer discovered that the moon's path was different from the sun's, and therefore cuts the sun's path at two points, now called *Nodes*. The condition for an eclipse to happen is that the full-moon and new-moon must take place sufficiently close to the Nodes, otherwise the luminaries would be too far apart, for an eclipse to take place.

The 'Nodes' now take the place of the mythical dragons which were supposed to waylay the sun and the moon, periodically, and swallow and disgorge them. In Hindu astronomy, the ascending node is called

* A. Pannekoek : *The Origin of Astronomy*.

† O. Neugebauer : *Babylonian Planetary Theory*.

Rahu with the symbol ☊, and the descending node is called Ketu with the symbol ☋, the names of the two

month, because the nodes regress to the west. Its value is 27.21222 days.

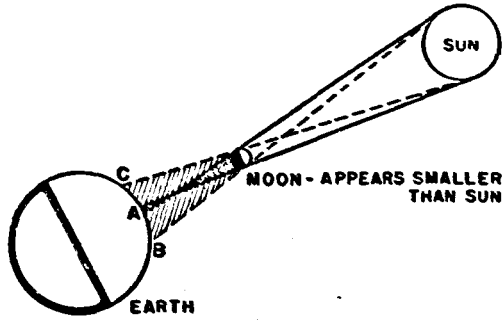

Fig. 5—Showing an annular eclipse of the sun.

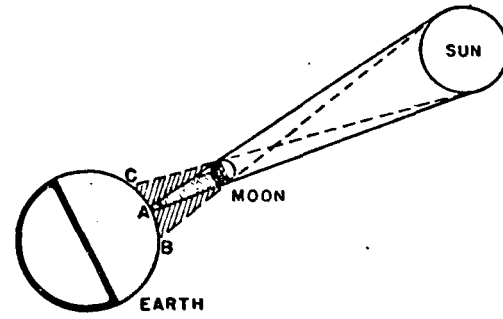

Fig. 6—Showing a total eclipse of the sun.

halves of the demon, who was cut in two by gods, so that the sun and the moon could get out.

In very ancient times, it was found that the two 'Nodes' were not fixed, but moved steadily to the west, so that the sun took less than a year to return to the same node. This time is known as the 'Draconitic year' or year of the Dragons, and its length is 346.62005 days. The time in which the moon returns to the same node is known as the draconitic month or the month of dragons. It is slightly less than the sidereal

The Chaldeans appear to have found, about 400 B. C., that 223 synodic months=242 draconitic months.

The reader can verify

$$\begin{aligned} 223 \text{ synodic month} &= 6585.321 \text{ days} \\ 242 \text{ draconitic months} &= 6585.357 \text{ days} \end{aligned}$$

From their long observations of eclipses, the Chaldean astronomers must have found that eclipses recur after an interval of 6585½ days or 18 years 11½ days (or 18 years 10½ days if 5 leap-years intervene). This cycle has been known as the *Chaldean Saros*. The extent to which a knowledge of the cycle is useful is given in the following modern table.

Table 6.—List of Lunar Eclipses of the Saros cycle.

Lunar Eclipses				
1914, Mar. 12	1932, Mar. 22	1950, Apr. 2	Asc.	Part.-Total
Sept. 4	Sept. 14	Sept. 26	Des.	Part.-Total
1916, Jan. 20	1934, Jan. 30	1952, Feb. 11	Asc.	Partial
July 15	July 26	Aug. 5	Des.	Partial
1917, Jan. 8	1935, Jan. 19	1953, Jan. 29	Asc.	Total
July 4	July 16	July 26	Des.	Total
Dec. 28	1936, Jan. 8	1954, Jan. 19	Asc.	Total
1918, June 24	July 4	July 16	Des.	Partial
1919, Nov. 7	1937, Nov. 18	1955, Nov. 29	Asc.	Partial
1920, May 3	1938, May 14	1956, May 24	Des.	Total-Part.
Oct. 27	Nov. 7	Nov. 18	Asc.	Total
1921, Apr. 23	1939, May 3	1957, May 13	Des.	Total
Oct. 16	Oct. 28	Nov. 7	Asc.	Part.-Total
1923, Mar. 3	1941, Mar. 13	1959, Mar. 24	Des.	Partial
Aug. 26	Sept. 5	—	Asc.	Partial
1924, Feb. 20	1942, Mar. 3	1960, Mar. 13	Des.	Total
Aug. 14	Aug. 26	Sept. 5	Asc.	Total
1925, Feb. 8	1943, Feb. 20	1961, Mar. 2	Des.	Partial
Aug. 4	Aug. 15	Aug. 26	Asc.	Part.-Total
1927, June 15	1945, June 25	1963, July 6	Asc.	Total-Part.
Dec. 8	Dec. 19	Dec. 30	Des.	Total
1928, June 3	1946, June 14	1964, June 25	Asc.	Total
Nov. 27	Dec. 8	Dec. 19	Des.	Total
—	1947, June 3	1965, June 14	Asc.	Partial
1930, Apr. 13	1948, Apr. 23	—	Asc.	Partial
Oct. 7	—	—	Des.	Partial
1931, Apr. 2	1949, Apr. 13	1967, Apr. 24	Asc.	Total
Sept. 26	Oct. 7	Oct. 18	Des.	Total

Table 7.—List of Solar Eclipses.

Eclipses of the Saros cycle

Solar Eclipses

The dates of recurrence of the corresponding eclipses in three cycles from 1914 to 1967, the node at which the eclipse occurs, and the nature of the eclipse are shown below.

1914, Feb. 25	1932, Mar. 7	1950, Mar. 18	Asc.	Annular
Aug. 21	Aug. 31	Sept. 12	Des.	Total
1915, Feb. 14	1933, Feb. 24	1951, Mar. 7	Asc.	Annular
Aug. 10	Aug. 21	Sept. 1	Des.	Annular
1916, Feb. 3	1934, Feb. 14	1952, Feb. 25	Asc.	Total
July 30	Aug. 10	Aug. 20	Des.	Annular
Dec. 24	1935, Jan. 5	1953, —	Asc.	Partial
1917, Jan. 23	Feb. 3	Feb. 14	Asc.	Partial
June 19	June 30	July 11	Des.	Partial
July 19	July 30	Aug. 9	Des.	Partial
Dec. 14	Dec. 25	1954, Jan. 5	Asc.	Annular
1918, June 8	1936, June 19	June 30	Des.	Total
Dec. 3	Dec. 13	Dec. 25	Asc.	Annular
1919, May 29	1937, June 8	1955, June 20	Des.	Total
Nov. 22	Dec. 2	Dec. 14	Asc.	Annular
1920, May 18	1938, May 29	1956, June 8	Des.	Part.-Total
Nov. 10	Nov. 22	Dec. 2	Asc.	Partial
1921, Apr. 8	1939, Apr. 19	1957, Apr. 29	Des.	Annular
Oct. 1	Oct. 12	Oct. 23	Asc.	Total-Part.
1922, Mar. 28	1940, Apr. 7	1958, Apr. 19	Des.	Annular
Sept. 21	Oct. 1	Oct. 12	Asc.	Total
1923, Mar. 17	1941, Mar. 27	1959, Apr. 8	Des.	Annular
Sept. 10	Sept. 21	Oct. 2	Asc.	Total
1924, Mar. 5	1942, Mar. 16	1960, Mar. 27	Des.	Partial
July 31	Aug. 12	—	Asc.	Partial
Aug. 30	Sept. 10	Sept. 20	Asc.	Partial
1925, Jan. 24	1943, Feb. 4	1961, Feb. 15	Des.	Total
July 20	Aug. 1	Aug. 11	Asc.	Annular
1926, Jan. 14	1944, Jan. 25	1962, Feb. 5	Des.	Total
July 9	July 20	July 31	Asc.	Annular
1927, Jan. 3	1945, Jan. 14	1963, Jan. 25	Des.	Ann.-Total
June 29	July 9	July 20	Asc.	Total
Dec. 24	1946, Jan. 3	1964, Jan. 14	Des.	Partial
1928, May 19	May 30	June 10	Asc.	Total-Part.
June 17	June 29	July 9	Asc.	Partial
Nov. 12	Nov. 23	Dec. 4	Des.	Partial
1929, May 9	1947, May 20	1965, May 30	Asc.	Total
Nov. 1	Nov. 12	Nov. 23	Des.	Annular
1930, Apr. 28	1948, May 9	1966, May 20	Asc.	Ann.-Total
Oct. 21	Nov. 1	Nov. 12	Des.	Total
1931, Apr. 18	1949, Apr. 23	1967, May 9	Asc.	Partial
Sept. 12	—	—	Des.	Partial
Oct. 11	Oct. 21	Nov. 2	Des.	Part.-Total

The problem of first visibility of the moon¹ with which we started cannot therefore be taken up unless we describe how the path of the sun and the moon in

the sky were discovered in ancient times. This is taken up in the succeeding sections.

4.3 THE GNOMON

Observations of the positions of the sun, the moon, planets and stars are now made very accurately with elaborate instruments installed in observatories. But these instruments have been evolved after thousands of years of experience and application of human ingenuity, and have undergone radical changes in design and set-up with every great technological discovery. But let us see how the early astronomers who had no instruments or very primitive ones made observations, collected the fundamental data, and evolved the basic astronomical ideas.

The earliest instrument used by primitive astronomers appears to have been the gnomon, which we now describe.

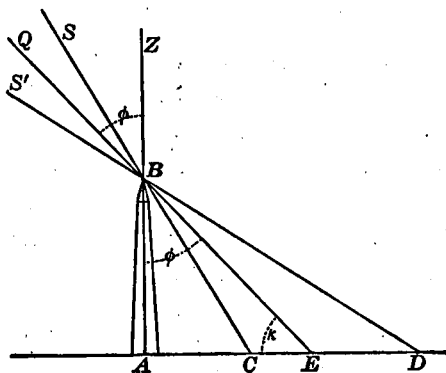

Fig. 7—The gnomon

The ancients determined the latitude of the place, obliquity of the ecliptic, the length of the year and the time of day by measuring the length and direction of shadow of the gnomon. The figure shows the noon-shadow of the gnomon AB, AE being the equinoctial shadow and AC and AD the shadow on two solstice-days, at a place on latitude = ϕ .

Nobody can fail to see the change in direction and length of shadows of vertical objects throughout the day-time, and throughout the year. When these observations are carefully made, by means of the gnomon (*Śanku* in Sanskrit), which is simply a vertical stick planted into the ground, and standing on fairly level ground of large area, without obstructions from any direction, a good deal of astronomical knowledge can be easily deduced. These observations appear to have been made in all ancient countries.

We have the following description, by George Sarton, of observations made in ancient times in Greece with the aid of the gnomon.*

"It (the gnomon) is simply a stick or a pole planted vertically in the ground, or one might use a column built for that purpose or for any other; the Egyptian obelisks would have been perfect gnomons if sufficiently isolated from other buildings. Any intelligent person, having driven his spear

* Sarton mentions Anaximander (c. 610-545 B.C.) of Miletus as the earliest Ionian philosopher who used the gnomon in Greater Greece.

into the sand, might have noticed that its shadow turned around during the day and that it varied in length as it turned. The gnomon in its simplest form was the systematization of that casual experiment. Instead of a spear, a measured stick was established solidly in a vertical position in the middle of a horizontal plane, well smoothed out and unobstructed all around in order that the shadow could be seen clearly from sunup to sundown. The astronomer (the systematic user of the gnomon deserves that name) observing the shadow throughout the year would see that it reached a minimum every day (real noon), and that minimum varied from day to day, being shortest at one time of the year (*summer solstice*) and longest six months later (*winter solstice*). Moreover, the direction of the shadow turned around from West to East during each day, describing a fan the amplitude of which varied throughout the year".*

From the observation of the shadows cast by the gnomon, many useful deductions could be made. These are :—

(1) Mark the points in the morning and in the evening when the shadows are equal in length and draw the lines showing the shadows. Then bisect the angle between the two shadow lines. This gives us the *meridian* or the north-south direction of the place.

The process of bisection was done by taking a rope attaching extreme points to the end points of the equal shadows; then take the mid-point of the rope, and stretch the rope, and mark the position of the mid-point. This connected to the pole gives us the meridian line. If we draw a circle, with the pole as centre, and draw the meridian, the point where it strikes the northern semi-circle is the North point, opposite is the South point. The East and West points are found by drawing a line at right angles to the north-south direction.

So the cardinal directions are found.

(2) Observe the position of the sunrise from day to day. If observations are carried on throughout the year, there will be found two days in the year when the sun will arise exactly on the east point. Then it is found that the day and night are equal in length. These days are called the *Equinoctial days*. Let us start from the equinoctial day in Spring (vernal equinox). This happens on March 21st. Then we observe that the sun at sunrise is steadily moving to the north, at first rapidly, then more slowly. Near the extreme north, the sun's movement is very slow, so this point is called the '*Solstice*' which means the sun standing still. Actually the sun reaches its northern-most point on June 22 (summer solstice).

* George Sarton : *A History of Science*, p. 174.

The day is longest on this date. Then the sun begins to move south till it crosses the east point on September 23, when day and night again become equal (the autumnal equinox day). It continues to move south, till the extreme south is reached on December 22, (the winter solstice day), when daylight is shortest for places on the northern hemisphere. Then the sun turns back towards the east point reaching it on March 21, and the year-cycle is complete.

The gnomon thus enabled the ancient astronomers (in Babylon, India, Greece, and China) to determine :

(a) *The Cardinal points* : East, North, West, and South ; the north-south line is the meridian line (the *Yāmyottara-rekhā* in Indian astronomy).

(b) *The Cardinal days of the Year* : viz.,

The Vernal Equinox (V.E.) day, when day and night are equal.

The Summer Solstice (S.S.) day, when the day is the longest for observers on the northern hemisphere.

The Autumnal Equinox (A.E.) day, when day and night are again equal.

The Winter Solstice (W.S.) day, when the day is the shortest for observers on the northern hemisphere.

All early astronomical work was done in the northern hemisphere.

These methods are fully described in the *Sūrya-Siddhānta*, Chap. III, but they appear to have been practised from far more ancient times. In the appendix (5-C), we have quoted passages from the *Aitareya Brāhmaṇa* which shows that the gnomon was used to determine the cardinal days of the year at the time when this ritualistic book was compiled. The date is at least 600 B.C., i.e., before India had the Greek contact. It may be considerably older even.

(c) *To mark out the Seasons* : We have mentioned earlier that in countries other than Egypt, there were no impressive physical phenomenon like the arrival of the annual flood of the Nile to mark the beginning of the solar year, or of the seasons. The seasons pass imperceptibly from the one to the other.

The gnomon observations probably enabled the early astronomers of Babylon and Greece to define the onset of the seasons, and the length of the year with greater precision.

In Graeco-Chaldean astronomy, we have four seasons :

Springfrom V.E. to S.S.

Summer... .. „ S.S. to A.E.

Autumn..... „ A.E. to W.S.

Winter... .. „ W.S. to V.E.

Thus every season starts immediately after a cardinal day of the year and ends on the next cardinal day.

According to Neugebauer :

"Babylonian astronomy (during Seleucid periods, 300 B.C.-75 A.D.) was satisfied with an exact four-division of the seasons as far as solstices and equinoxes are concerned, with the summer solstice (and *not* the vernal point) as the fixed point."*

At a later stage, they however found that the four seasons had unequal lengths (*vide* § 3-1).

The above definition of 'seasons' has come down to modern astronomy. The Hindu definition of seasons was different (*vide* § 5-6 and 5-A)

The observation of the *Cardinal days* of the year appear to have been carried out all over the ancient world by other methods, and often in a far more elaborate manner. People would observe the day-to-day rise of the sun on the eastern horizon, and mark out the days when the sun was farthest north (summer solstice day), or farthest south (winter solstice day). The time period taken by the sun to pass from the southern solstitial point to the northern solstitial point was known in the Vedas as the *Uttarāyana* (northern passage), and that taken by the sun to pass from the northern solstitial point to the southern solstitial point was known as the *Dakṣiṇāyana* (southern passage). Exactly midway between these points the sun rises on the vernal and autumnal equinoctial days. From the passage in the *Śatapatha Brāhmaṇa*, quoted later (*vide* § 5-3), we see clearly that the point on the eastern horizon, where the sun rose on these days, was recognized to be the true east.

Doubt has been expressed about the ability of Vedic Aryans to make these observations, but to these objections, B. G. Tilak replied in his *Orion*, pp. 16-17.

"Prof. Weber and Dr. Schrader appear to doubt the conclusion on the sole ground that we cannot suppose the primitive Aryans to have so far advanced in civilization as to correctly comprehend such problems. This means that we must refuse to draw legitimate inferences from plain facts when such inferences conflict with our preconceived notions about the primitive Aryan civilization. I am not disposed to follow this method, nor do I think that people, who knew and worked in metals, made clothing of wool, constructed boats, built houses and chariots, performed sacrifices, and had made some advance in agriculture, were incapable of ascertaining the solar and the lunar years. They could not have determined it correct to a fraction of a second as modern astronomers have done ; but a rough practical estimate was, certainly, not beyond their powers of comprehension."

The best example of the ability of the ancient people to observe the cardinal points of the sun's motion is afforded by the Stonehenge in the Salisbury plains of England, of which detailed accounts

* Neugebauer : *Babylonian Planetary Theory*, Proc. Amer. Philos. Soc. Vol. 98 : 1, 1954, p. 64.

have recently appeared in *Scientific American* (188, 6-25, 1953) and *Discovery* (1953, Vol. XIV, p.276).

It is related in these two publications, that not a long time subsequent to 1800 B.C., say about 1500-1200 B.C., the then inhabitants of Britain, who had not even learnt the use of any metal, but used only stone implements, could construct a huge circular area enclosed by large upright monoliths forming lintels and with a horse-shoe shaped central area having its axis in the direction of sunrise on the summer solstice day. It has been proved, almost beyond any doubt, that the Stonehenge was used for the ceremonial observation of sunrise on this day. Sir Norman Lockyer in 1900 found that the direction of the axis of the horse-shoe actually makes an angle of about $1\frac{1}{2}^\circ$ with the present direction of sunrise on the summer solstice day. He did not think that it was a mistake on the part of the original builders; but that on account of the change in obliquity (angle between equator and ecliptic), the present direction of sunrise had changed to the extent of $1\frac{1}{2}^\circ$ and using the rate of change of obliquity, he could fix up the time of construction at 1800 ± 200 B.C. This estimate has been brilliantly confirmed by C^{14} -analysis of some wood charcoal found in the local burial pits which are presumed to be contemporary with the erection of the Stonehenge.

After this brilliant confirmation of Lockyer's hypothesis, it is hoped that there will be less hesitation on the part of scholars to admit that it was possible for the Vedic Aryans who knew the use of metal and were far more advanced than the stone-age people of Britain, to devise methods for the observation of the cardinal points of the year.

How did they observe these points? Probably in the same way as the Britishers of 1500 B.C., by observing from a central place, the directions of sunrise on the eastern horizon throughout the year. The directions of the solstitial rises could be easily marked. Probably the equinoctial points were found by bisecting the angle between these two directions by means of ropes as described in the *Sulva-Sūtras*.

4.4 NIGHT OBSERVATIONS: THE CELESTIAL POLE AND THE EQUATOR

Almost all ancient nations were familiar with the night-sky either as shepherds, travellers or navigators, and were acquainted with more detailed knowledge of the revolving blue firmament studded with stars than the modern city dweller. The striking constellations like the Great Bear, the Pleiades, the Orion could not but catch their fancy and references to these star-groups are found in ancient literature, in the Vedas, in

the book of Job (the Bible) and in Homer. In the last, the star-groups are used by sailors to find out their orientation. Representations of star-groups are found in ancient Babylonian boundary stones of about 1300 B.C. (see Fig. 15).

Let us now see how these observations were made.

Suppose, on a clear moonless evening in early Spring (say March) and at about 8-30 P.M., we take our stand in a wide field undisturbed by city lights,

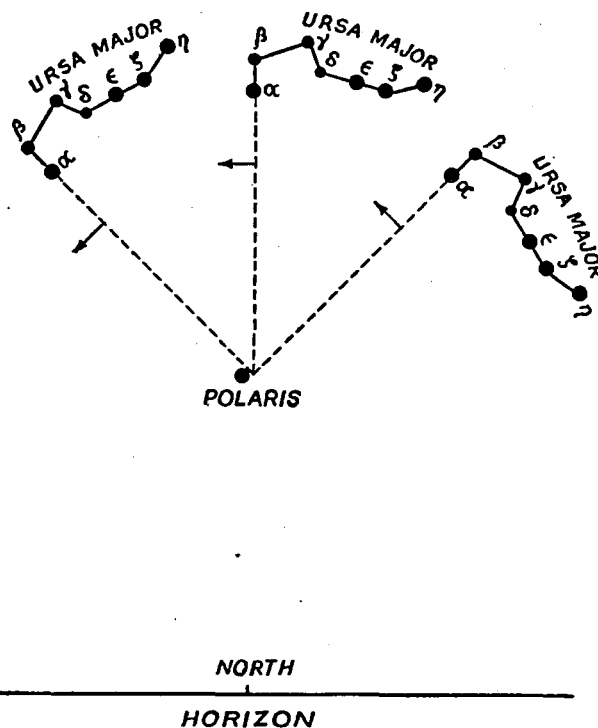

Fig. 8—Showing the positions of Ursa Major (*Saptarṣi*) at interval of 3 hours.

and our vision is unobstructed in all directions. We now face the north. We shall find the appearance of the heavens as shown in Fig. (8):

In the north, a little high up to our right hand side we cannot fail to observe the conspicuous constellation of seven stars, called in Europe the Great Bear, but in India, the *Saptarṣi* or seven seers. If we observe the heavens 3 hours later, we shall observe that the group has changed its position as shown in Fig. (8). Let us fix our attention on the two front stars (the pointers) of the Great Bear and join a line through them. The line joining these two stars appear to behave like the hands of a watch, for if produced they pass through a star half as bright at some distance, and appear to have revolved about it as centre. This star is called the Pole Star or *Polaris*, or *Dhruva* in Sanskrit which means fixed. If we observe throughout the night, we shall find that the *Polaris* remains approximately fixed, and the line of pointers continues to go round it. The next day, at

8-26 P.M., nearly 24 hours later they are again almost exactly at the same position.

We naturally come to the conclusion that the whole starry heavens have been rotating round an axis passing through the observer and the Pole Star from *east to west*, and the rotation is completed in nearly 24 hours (exactly $23^{\text{h}} 56^{\text{m}} 4^{\text{s}}$ of mean solar time).

Definition of the Poles

The celestial poles, or the poles round which the rotation of the celestial sphere takes place may therefore be defined as those two points in the sky where a star would have no diurnal motion. The exact position of either pole may be determined with proper instruments by finding the centre of the small diurnal circle described by some star near it, as for instance, the stars belonging to the Ursa Minor group. Actually the so-called pole star is at present 57 minutes away from the correct position of the pole which is not actually occupied by any star.

Since the two poles are diametrically opposite in the sky, only one of them is usually visible from a given place: observers north of the equator see only the north pole, and *vice versa* in the southern hemisphere. The south pole is not marked by any prominent star.

Knowing as we now do, that the apparent revolution of the celestial sphere is due to the rotation of the earth on its axis, we may also define the poles as the two points where the earth's axis of rotation (or any set of lines parallel to it), produced indefinitely, would pierce the celestial sphere.

The Celestial Equator and Hour Circles

The celestial equator is the great circle of the celestial sphere, drawn halfway between the poles

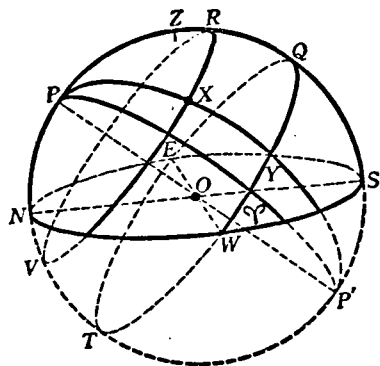

Fig. 9—The celestial sphere.

(and therefore everywhere 90° from each of them), and is the great circle in which the plane of the earth's equator cuts the celestial sphere, as illustrated in Fig. (9). Small circles drawn parallel to the celestial

equator, like the parallels of latitude on the earth, are called parallels of declination. A star's parallel of declination is identical with its diurnal circle.

The great circles of the celestial sphere, which pass through the poles in the same way as the meridians on the earth, and which are therefore perpendicular to the celestial equator, are called hour-circles. Each star has its own hour-circle, which at the moment when the star passes the north-south line through the zenith of the observer, coincides with the celestial meridian of the place.

4.5 THE APPARENT PATH OF THE SUN IN THE SKY : THE ECLIPTIC

The apparent path of the sun in the sky is known in astronomical language as the ecliptic. It is a great circle cutting the celestial equator at an angle of *ca* $23\frac{1}{2}^\circ$ (exactly $23^\circ 26' 43''$ in 1955, but the angle varies from $21^\circ 59'$ to $24^\circ 36'$). This is known as the *obliquity* of the ecliptic.

The ecliptic is the most important reference circle in the heavens, and let us see how a knowledge of it was obtained in ancient times.

It is obvious that a knowledge of the stars marking the sun's path could not be obtained directly as in the case of the moon; for when the sun is up, not even the brightest stars are visible. The knowledge must have been obtained indirectly. Early observers were accustomed to observe the heliacal rising of stars, i.e., observe the brilliant stars lying close to the sun which are on the horizon just before sunrise. This must have given them a rough idea of the stars lying close to the sun's path. From these observations, as well as from successive appearances of the moon on the first days of the month as narrated in § 4.1, they must have also deduced that the sun was slipping from the west to the east with reference to the fixed stars, and completing a revolution in one year. *But how was this path rigorously fixed?*

It appears that a knowledge of the stars lying on, or close to the moon's path was obtained from observations made during lunar, rarely of solar eclipses.

They must have realized, as narrated in § 4.2, that during a total lunar eclipse, the moon occupies a position in the heavens opposite the sun, and the stars close to the moon, which become visible during totality, approximately mark out points on the sun's path. So the word '*Ecliptic*' which means the locus of eclipses, came to denote the sun's path.

The two points of intersection of the ecliptic with the celestial equator are called respectively the

First point of Aries, and the First point of Libra. The first point of Aries is the ascending node, when the sun passes from the south to the north; the first point of Libra is the descending node, when the sun passes from the north to the south. We have vernal equinox when the sun is at the first point of Aries, summer solstice when the sun is at the first point of Cancer, autumnal equinox when the sun is at the first point of Libra, and winter solstice when the sun is at the first point of Capricorn. To the origin of nomenclature, we return later.

The celestial equator and the ecliptic are the most important reference planes in astronomy. The positions of all heavenly bodies are given in terms of these planes, taking the first point of Aries as the initial point. We explain below the scientific definitions of spherical co-ordinates used to denote the position of a body on the celestial globe.

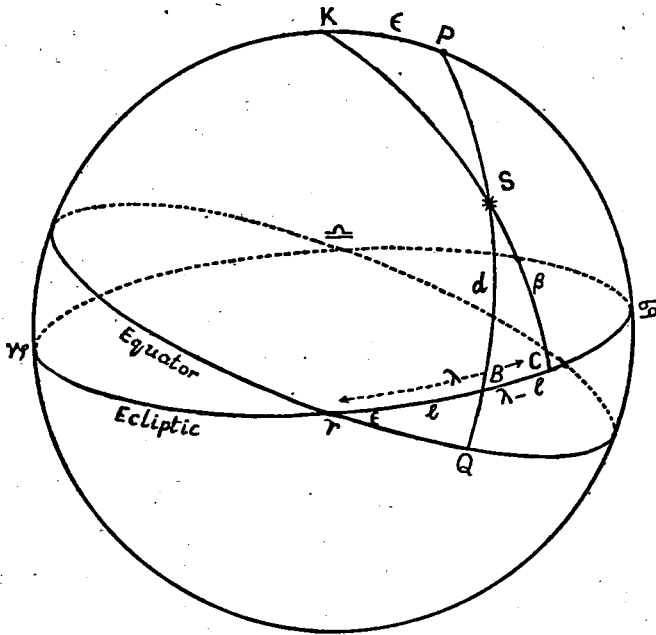

Fig. 10.—Showing the spherical co-ordinates of a star.

In this figure :

- P = Celestial pole (*dhruva*).
- $rQ\cap$ = Celestial equator.
- K = Pole of the ecliptic (*kadamba*).
- $r\cap$ = Plane of the ecliptic.
- r = First point of Aries (vernal equinox).
- \cap = First point of Cancer (summer solstice).
- \cap = First point of Libra (autumnal equinox).
- \cap = First point of Capricorn (winter solstice).
- S = A heavenly body.
- PS = Great circle thro' P, S cutting equator at Q.
- rQ = Right ascension = a .
- QS = Declination = δ .
- KS = Great circle through K, S cutting ecliptic at C.

rC = Celestial longitude = λ

CS = Celestial latitude = β

Let PS cut the ecliptic at B. Then

rB = Polar longitude or *dhruvaka* = l

BS = Polar latitude or *viksepa* = d

These last two peculiar co-ordinates, now no longer used, were used by the *Sūrya Siddhānta* to denote star positions. They have been traced by Neugebauer to Hipparchos five centuries earlier.

The position of a stellar body may be defined by either its right ascension (a) and declination (δ), or its celestial longitude (λ) and latitude (β).

The positions of stars in these co-ordinates began to be given from the time of Claudius Ptolemy (150 A.D.) who used them in his *Syntaxis*.

4.6 THE ZODIAC AND THE SIGNS

The early astronomers must have found that the sun's path in the heavens was almost fixed, while that of the moon, and of the planets, which acquired for astrological reasons great importance from about 1200 B.C., strayed some degrees to the north and south of the ecliptic.

In case of the moon the deviation from the ecliptic was found to be not much greater than 5° , but some of the planets strayed much more; in the case of Venus, her perpendicular distance from the ecliptic rises sometimes as high as 8° degrees. So a belt was imagined straying about 9° north and 9° south of the ecliptic, in which the planets would always remain in course of their movement. This belt came to be known as the 'Zodiac.'

The complete cycle of this belt was divided into 12 equal sectors each of 30° , and each sector called a 'Sign'. The signs started with one of the points of intersection of the ecliptic and the equator, and the first sign was called 'Aries' after the constellation of stars within it. The names of the succeeding signs are given in Table No. 8 on the next page, in which :

The first column gives the beginning and ending of the signs, the vernal equinoctial point being taken as the origin.

The second column gives the international names which are in Latin with the symbols used to denote the signs.

The third column gives their English equivalent.

The fourth column gives the Greek names. They are synonymous with the international names.

The fifth column gives a set of alternative names for the signs given by Varāhamihira.

Table 8.—Zodiacal Signs.
Different Names of Zodiacal Signs

Beginning and ending of the Signs (1)	Name of the Signs & Symbol (2)	English equivalent (3)	Greek names (4)	Varāha Mihira (5)	Indian names (6)	Babylonian names (7)
0° - 30°	♈ Aries	Ram	Krios	Kriya	Meṣa	Ku or Iku (Ram)
30 - 60	♉ Taurus	Bull	Tauros	Tāburi	Vṛṣabha	Te-te (Bull)
60 - 90	♊ Gemini	Twins	Didumoi	Jituma	Mithuna	Masmasu (Twins)
90 -120	♋ Cancer	Crab	Karxinos	Kulira	Karka or Karkaṭa	Nangaru (Crab)
120 -150	♌ Leo	Lion	Leon	Leya	Siṃha	Aru (Lion)
150 -180	♍ Virgo	Virgin	Parthenos	Pāthona	Kanyā	Ki (Virgin)
180 -210	♎ Libra	Balance	Zugos	Jūka	Tulā	Nuru (Scales)
210 -240	♏ Scorpio	Scorpion	Scorpios	Kaurpa	Vṛścika	Akrabu (Scorpion)
240 -270	♐ Sagittarius	Archer	Tozeutes	Tauksika	Dhanuḥ	Pa (Archer)
270 -300	♑ Capricornus	Goat	Ligoxeros	Ākokera	Makara	Sahu (Goat)
300 -330	♒ Aquarius	Water Bearer	Gdroxoos	Hṛdroga	Kumbha	Gu (Water carrier)
330 -360	♓ Pisces	Fish	Ichthues	Antyabha	Mina	Zib (Fish)

The sixth column gives the Indian names.

The seventh column gives the Babylonian names.

It can be easily inferred from the table that the names are of Babylonian origin, but their exact significance is not always known. It has been assumed that the symbols used to denote the signs have been devised from a representation of the figure of the animal or object after which the sign has been named, for example, the mouth and horns of the Ram, the same of the Bull, and so on.

It is seen that Varāhamihira's alternative names given in column (5) are simply the Greek names corrupted in course of transmission and as adopted for Sanskrit; with the exception of the name for Scorpion, which is given as 'Kaurpa'. This has phonetic analogy with the corresponding Babylonian sign name Akrabu for Scorpion. The purely Sanskrit names given in column (6) are all translations of Greek names with the exceptions of :

(3) Twins, which become *Mithuna* or 'Amorous couple',

(9) the Archer, which becomes the 'Bow',

(10) the Goat, which becomes the 'Crocodile',

(11) Water bearer, which becomes the 'Waterpot'.

Some of them appear to have been translations of Babylonian names.

The Babylonian names, as interpreted by Ginzl* are given in the seventh column, with their meanings.

It is thus seen that the names of the zodiacal signs are originally of Babylonian origin. They were taken over almost without change by the Greeks, and subsequently by the Romans, and the Hindus, from Graeco-Chaldean astrology.

* Ginzl, *Handbuch der Mathematischen und Technischen Chronologie*, Vol. I, p. 84.

• But why was such an odd assortment of animal names chosen for the 'Signs'? There have been interesting speculations. The reader may consult Brown's *Researches into the Origin of the Primitive Constellations of the Greeks, Phoenicians and Babylonians*, London, 1900.

These signs were taken up by almost all nations in the centuries before the Christian era on account of the significance attached to them by astrologers. In Greece, they were first supposed to have been introduced by the early Greek astronomer Cleostratos, an astronomer who observed about 532 B.C. in the island of Tenedos off the Hellespont who introduced the designation 'Zodiac' to describe the belt of stars about the ecliptic. The twelve 'Zodiacal Signs' are not known in older ritualistic Indian literature like the *Brāhmaṇas*. They appear to have come to India in the wake of the Macedonian Greeks or of nations like the Śakas who were intermediaries for transmission of Greek culture to India.

Confusion in the starting point of the Zodiac

The 'Initial Point' of the zodiac should be the *Vernal Point* or the point of intersection of the ecliptic and the equator, but as will be shown in the next section, this point is not fixed, but moves west-ward along the ecliptic at the rate of approximately 50" per year (precession of the equinoxes). This motion is unidirectional, but before Newton proved it to be so in 1687 from dynamics and the law of gravitation, there was no unanimity even amongst genuine astronomers about the uni-directional nature of precessional motion, in spite of overwhelming observational evidences.

The hesitation of the medieval astronomers in accepting precession can be easily understood. Most of them earned their livelihood by practising the 'Astrological Cult' which was reared on the basis that the signs of the zodiac are fixed, and coincident with certain star-groups; but this assumption crumbles to the ground if precession is accepted. But as historical records now show, though astronomers had clearly recognized that the initial point should be the point of intersection of the equator and the ecliptic, there was no unanimity even amongst ancient astronomers of different ages regarding the location of this point in the heavens, because it was not occupied by any prominent star at any epoch and the ancients were unaware of the importance of its motion (*vide* § 4-9).

4.7 CHALDEAN CONTRIBUTIONS TO ASTRONOMY : RISE OF PLANETARY AND HOROSCOPIC ASTROLOGY

We have seen that it was the needs of the calendar which gave rise to scientific astronomy— which in the earliest times covered :

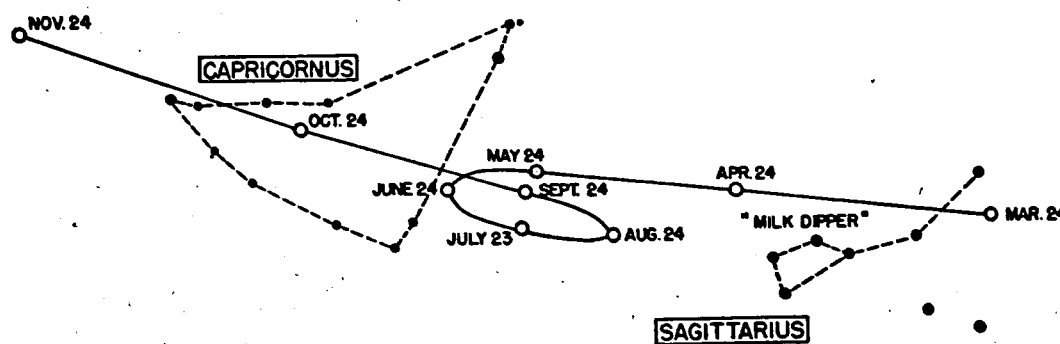

The Path of Mars Among the Stars in 1939.

Fig. 11—Showing the retrograde motion of Mars.

Although the planets always move in the same direction round the sun, their apparent motion among the fixed stars as seen from the earth, is not always in the same forward direction. They sometimes appear to move also in the backward direction among the stars, and this is known as the retrograde motion of a planet. The above figure reproduced from *Pictorial Astronomy* by Alter and Clemenshaw illustrates how Mars was seen to retrograde during June 24 to August 24.

- (a) Systematic observation of the movements of the moon, and the sun,
- (b) Recording of the observations in some convenient form on permanent materials,
- (c) Invention of mathematical methods to deal with the observations, with a view to predict astronomical events.

It is not, however, correct to say that it was the calendar based on the sun and the moon which provided the sole stimulus for astronomical studies. At one time, "the planets strongly captured the attention of man".*

* A. Pannekoek : *The Origin of Astronomy*, p. 351.

The attention of mankind was drawn in remote antiquity to the five star-like bodies :

Venus, Jupiter, Mars, Saturn and Mercury.

Venus and Jupiter and occasionally Mars are more brilliant than ordinary stars. Sooner or later it was found that while the ordinary stars remain fixed on the revolving heavens these five stars creep along them, as a modern author puts it, 'like glow-worms on a whirling globe', each in its own way. Venus appears as a morning and evening star, the maximum elongation being 47°. It early drew the attention of sea-faring people, its appearance on the eastern horizon indicating early sunrise to persons on lonely seas. But it took mankind some time to discover that it was the same luminary which appeared for some period as a morning star, then as an evening star. Its brilliance could not but strike the imagination of mankind. Mercury also appears regularly as morning and evening star, and it must have been discovered later than Venus, but still at such a remote age in antiquity that all traces of its discovery are lost.

The motion of the brilliant luminary, Jupiter across the sky attracted early attention; Mars

occasionally bursts into brilliance with fierce, red light, which could not but attract notice. The three planets, Mars, Jupiter, and Saturn though generally moving to the east, from time to time reverse their direction of motion (retrograde motion), as shown in Fig. 11.

From very early times and amongst widely separated communities, mystical importance was ascribed to the wandering of the planets.

These mystical ideas took a very definite form in the shape of 'Planetary Astrology' which grew in Mesopotamia during the period 1300 B.C. to 800 B.C. This Planetary Astrology is to be distinguished from

an older form of Astrology widely found in Vedic India, which centred mainly round the moon, and the lunar mansions, and to a lesser extent on the sun. The conjunction of the moon with certain *nakṣatras* was considered lucky, others unlucky (*vide* § 4.1).

Planetary Astrology took the world by the storm after 300 B.C. and its influence was strongest during middle ages in Europe, till the rise of rationalism and modern science almost completely undermined this influence. But it still survives amongst the credulous in the West, but to a far greater extent than amongst the eastern nations.

emerged in Babylonian history from the time of Assyrian supremacy (*ca.* 1300 B.C.), for these appeared to be linked up with the mysteries of Heaven itself, and the astrologer enjoyed very great prestige amongst the public, for did he not possess the mysterious power of foretelling correctly the dates of eclipses !

Here are some of the samples of astronomical omnia during the last centuries of Assyrian power (900 B.C.-600 B.C.).

“Mercury went back as far as the Pleiades” ; “Jupiter enters Cancer” ; “Venus appears in the East” ; “Mars is very bright” ; “Jupiter appears in the region of Orion” ;

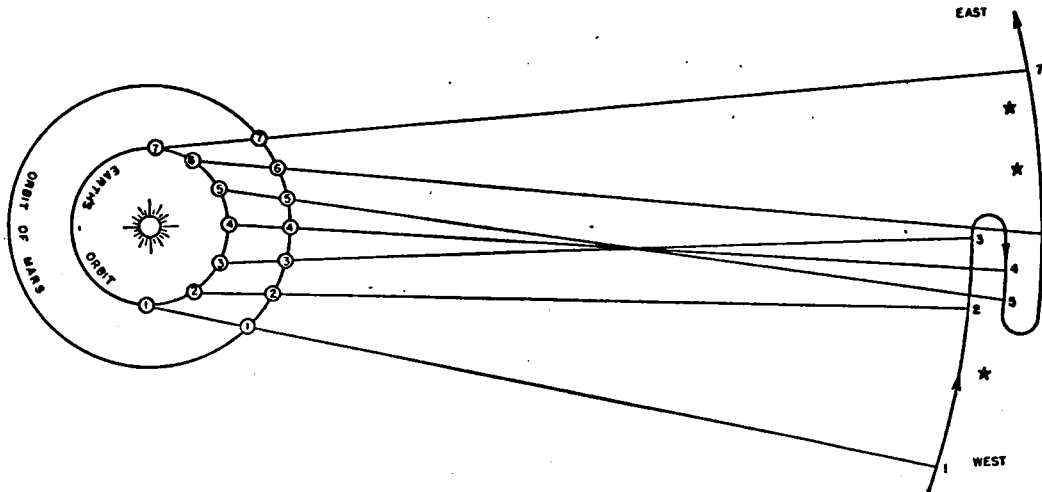

Fig. 12—Showing the motion of Mars relative to the earth.

By placing the sun at the centre and having the earth and the other planets revolve in circles around it, Copernicus (1473-1543) was able to explain the backward motion of the planets among the stars much more simply than in the Ptolemaic system. This is illustrated in the above figure, taken from *Pictorial Astronomy*, in the case of Mars as seen from the earth. The earth's speed is 18½ miles a second while that of Mars is only 15 miles a second. As the earth overtakes Mars, the latter seems to move backward. The direct motion of Mars to the east is shown at positions 1, 2 and 3, backward or retrograde motion to the west at 4 and 5, and direct motion to the east again at 6 and 7.

What was the reason for the strong fascination which man has for astrology ?

Mankind has always a psychological weakness for omnia, *i.e.*, some signs which can predict future events, good or bad. The older form of omnia were rather crude, *viz.*, flight of certain birds like the crow, or movements of animals like the jackal or the snake, howlings of certain birds and animals. In many countries, sheep and goats were sacrificed to gods on the eve of great enterprises, and Augurs claimed to be able to interpret the intentions of the gods from an examination of lines and convolutions on the liver of the sacrificial animal (Hepatoscopy). Meteorological phenomena such as a lightning discharge, haloes round the moon, aurora were also regarded as 'omens'.

The older forms of omnia were all apparently very crude compared to planetary omnia which gradually

“Mars stands in Scorpio, turns and goes forth with diminished brilliancy” ; “Saturn has appeared in the Lion” ; “Mars approached Jupiter” ; and so on.

There is not a trace of scientific interest in these texts ; the mind of the reporters is entirely occupied by the omens : When such or such happens,

- “it is lucky for the king, my lord” ;
- or, “copious floods will come” ;
- “there will be devastation” ;
- “the crops will be diminished” ;
- “the king will be besieged” ;
- “the enemy will be slain” ;
- “there will be raging of lions and wolves” ;
- “the gods intend Akkad for happiness” ;
- and so on.

Yet, with all those observations, these reports represent a considerable astronomical activity. For the first time in history a large number of data on the planets had been

collected ; it implies a detailed knowledge of facts about their motion.”*

The huge temples, called Ziggurats, ruins of which have been found in Mesopotamia, are supposed to have been dedicated to the planetary gods, each storey being assigned to a particular god. It was the duty of temple priests to keep the planets under observation, and record their positions on the only writing material available then *viz.*, clay-tablets. Hundreds of thousands such clay tablets have been discovered in the ruins of Ziggurats, royal palaces and libraries, and patiently interpreted by western scholars like Kugler.

the moon, and the planets, and compilation of tables of positions, which afforded the basis on which modern astronomy has been built up. In the large number of ancient horoscopes which have been studied by scholars, and in the astronomical tables compiled by ancient and medieval scholars, we have a huge amount of data on planets.

Pannekoek observes :

“The circumstance that made this possible for astronomy was the occurrence of extremely simple and striking periodicities in the celestial phenomena. What looked irregular on occasional and superficial observing revealed

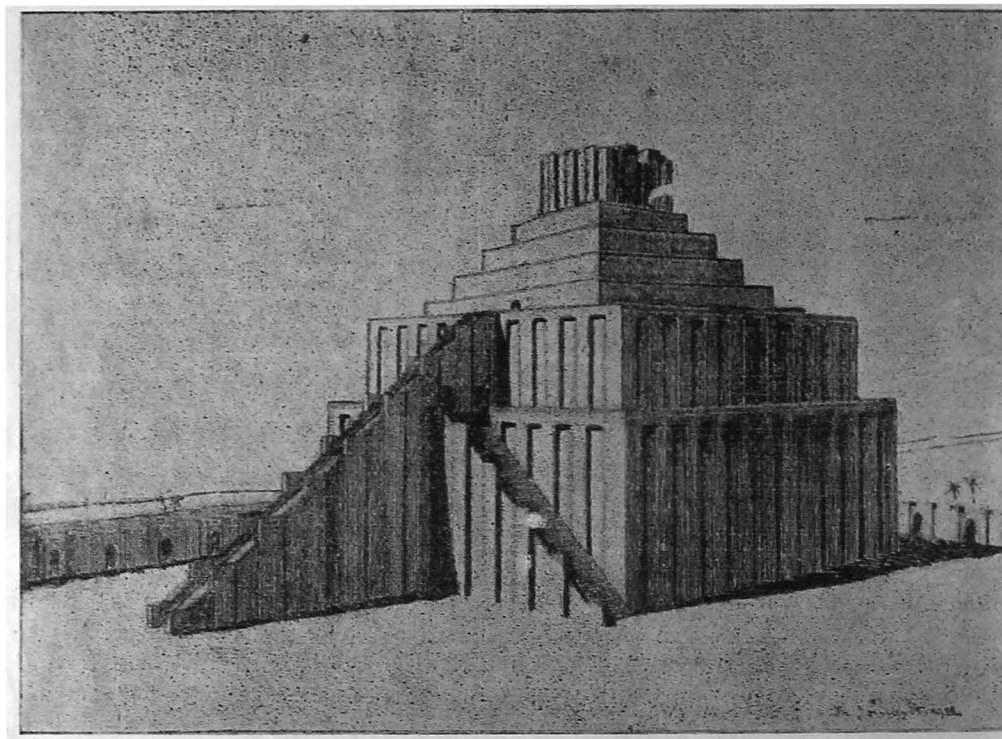

Fig. 13—Ziggurat.

(Reproduced from Zinner's *Geschichte der Sternkunde*)

At first, planetary astrology appear to have been confined to states, and kings or powerful officials representing the state. But after the conquest of Babylon by the Persian conqueror Cyrus (538 B.C.), they appear to have been extended to private individuals. Thus came into existence 'Horoscopic Astrology', in which a chart is made of the 12 signs of the zodiac with the position of the planets shown therein, for the time of his birth, from which are foretold the events of his life and career. We are not interested in 'Horoscopic Astrology' at all, but wish only to remark that but for the stimulus provided by astrology, there would not have been that intense activity during ancient and (from about 500 B.C.) medieval times, for large scale observations of the sun,

its regularity in a continuous abundance of data.

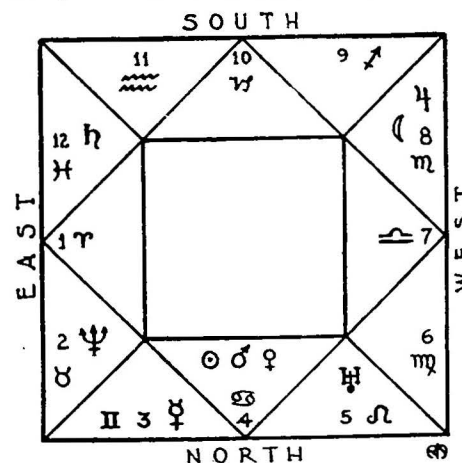

Fig. 14—Showing a horoscope cast in the European method. The sign Aries, the first house or ascendant, is in the east. The sign Capricornus, the 10th house, is on the meridian at the time of birth and so is in the south. The planets occupying the different signs are shown by the respective symbols.

* Pannekoek: *The Origin of Astronomy*—reprinted from the Monthly Notices of the Royal Astronomical Society, Vol III, No. 4, 1951, pp. 351-52.

Regularities were not sought for ; but regularities imposed themselves, without giving surprise. They aroused certain expectations. Expectation is the first unconscious form of generalized knowledge, like all technical knowledge in daily life growing out of practical experience. Then gradually the expectation develops into prediction, an indication that the rule, the regularity, has entered consciousness. In the celestial phenomena the regularities appear as fixed periods, after which the same aspects return. Knowledge of the periods was the first form of astronomical theory*.

The astronomical knowledge which the Chaldean astronomers bequeathed to the world are :—

(1) Conception of the celestial equator and recognition of the ecliptic as the sun's path.

(2) A number of relations between the synodic and other periods of the moon and planets, viz.,

1 year = 12.36914 lunar months ;
modern value = 12.36827 lunar months.

Mean daily motion of the sun = 59' 9" ;
modern value = 59' 8".3.

Mean daily motion of the moon = 13° 10' 35" ;
modern value = 13° 10' 35".0

Extreme values of the true motion of the moon :
15° 14' 35" to 11° 6' 35" .

According to modern determination these limits
are about 15° 23' to 11° 46' .

Length of the anomalistic month = 27.55555 days ;
modern value = 27.55455 days.

Or 9 anomalistic months = 248 days ;
modern value = 247.991 days.

Length of the synodic month = 29.530594 days ;
modern value = 29.530588 days.

223 synodic months = 242 draconitic months.
This gave rise to the Chaldean Saros cycle
of eclipses.

269 anomalistic months = 251 synodic months.
The length of the anomalistic month
deduced from this relation = 27.554569 days,
the modern value being 27.554550 days.

The Greek papyri gives longitudes of the moon for dates 248 days apart. This period is based on the Babylonian relation : 9 anomalistic months = 248 days. After eleven such steps of 248 days, there is a big step of 303 days in the ephemeris. The length of the anomalistic month derived from these steps are as follows.

	No. of anomalistic months	No. of days	Length of the anomalistic month derived	
D	9	248	27.555,556	days
Δ	11	303	27.545,455	"
C=11D+Δ ...	110	3031	27.554,545	"
			Actual value = 27.554,550.	"

It is not sure whether these figures were arrived at by the Babylonians or by astronomers of other places. But these and the more accurate approximation of the moon's motion is found in the *Pañca Siddhāntikā* of Varāhamihira and is found used by Tamil astronomers.

In the *Pañca Siddhāntikā* the synodic revolutions of planets are given, but they apparently differ much from the actual figures. The figures are quoted in col. (2) of the table No. 9 below. The actual periods of the synodic revolutions in days are given in col. (3).

Table 9.—Synodic revolutions of planets from Pañca-Siddhāntikā.

Planet	As given in P.S.	Actual (days)	Converted from Col. (2) (days)
(1)	(2)	(3)	(4)
Mars	768 $\frac{2}{3}$	779.936	779.944
Mercury	114 $\frac{6}{9}$	115.878	115.870
Jupiter	393 $\frac{1}{7}$	398.884	398.868
Venus	575 $\frac{1}{2}$	583.921	583.880
Saturn	372 $\frac{2}{3}$	378.092	378.093

Dr. Thibaut in his *Pañca Siddhāntikā* could not explain the figures in col. (2). It can be verified that we can obtain the figures in col. (3) if we multiply the corresponding figures in col. (2) by

$$\frac{365.2422}{360} \text{ or by } (1 + \frac{5.2422}{360})$$

The figures obtained by such multiplication are shown in col. (4), which are found to be very close to the figures in col. (3). The figures in col. (2) can be explained in another way, viz., they are in degrees representing the arc through which the sun moves between two conjunctions. In other words, the figures in col. (2), not being ordinary mean solar days, are 'saura days' of Indian astronomy, a saura day being the time taken by the sun to move through one degree by mean motion, or 360 saura days = 365.2422 mean solar days. This explanation has been found by O. Neugebauer (vide his *Exact Sciences in Antiquity*). Most of these data were known to Hipparchos and also to Geminus, a Greek astronomer, who flourished about 70 B.C.

The "astronomical science" as evolved by the Chaldean astronomers, is seen to be in reality the by-

*Pannekoek: *The Origin of Astronomy*, p. 352.

product of the huge amount of astrological nonsense, a few pearls in a huge mass of dung, as Alberuni observed nearly ten centuries ago. Let us see when these "pearls" gradually crystallized out of the dung-heap.

Two texts called '*Mul Apin*' dated round about 700 B.C. have been discovered which contain summary of the astronomical knowledge of the time. Here is one of the pertinent passages from Neugebauer's *Exact Sciences in Antiquity* (p. 96).

"They are undoubtedly based on older material. They contain a summary of the astronomical knowledge of their time. The first tablet is mostly concerned with the fixed stars which are arranged in three "roads", the middle one being an equatorial belt of about 30° width. The second tablet concerns the planets, the moon, the seasons, lengths of shadow, and related problems. These texts are incompletely published and even the published parts are full of difficulties in detail. So much, however, is clear: we find here a discussion of elementary astronomical concepts, still quite descriptive in character but on a purely rational basis. The data on risings and settings, though still in a rather schematic form, are our main basis for the identification of the Babylonian constellations."

The passage indicates that the Chaldean astronomers of this period could locate the north pole, and had come to an idea of the celestial equator, and could

cuts the horizon at the east and west points as determined by the gnomon.

The Ecliptic:—From archæological records, it is generally held that a knowledge of the star-groups lying



Fig. 15—Two sculptured stones of ancient Babylon displaying the Sun, the Moon, Venus and Scorpion—symbols of a primitive astrological science which fathered the modern conception of astronomy.

close to the ecliptic was obtained in Babylon as early as



Fig. 16—Babylonian Boundary Stone showing Pythagorean numbers (Plimpton 322).

(Reproduced from Neugebauer's *Exact Sciences in Antiquity*)

trace it in the heavens. We do not know when they came to the knowledge that the celestial equator

1300 B.C., for some of the ecliptic star-groups like the Cancer, or Scorpion are found portrayed on boundary

stones which can be dated 1300 B.C. Neugebauer and Sachs maintain that the ecliptic is first found mentioned in a Babylonian text of 419 B.C., but its use as a reference plane must have started *much* earlier, probably before 550 B.C. But the steps by which the knowledge of stars marking the ecliptic

Probably the first stage was to determine the angular distance of heavenly bodies from some 'Normal Stars' as indicated by Sachs.* These normal stars were stars either on the ecliptic, like Regulus, Spica, or α *Librae* or some other stars close to it. Sachs gives a list of 34 such normal stars. Probably the

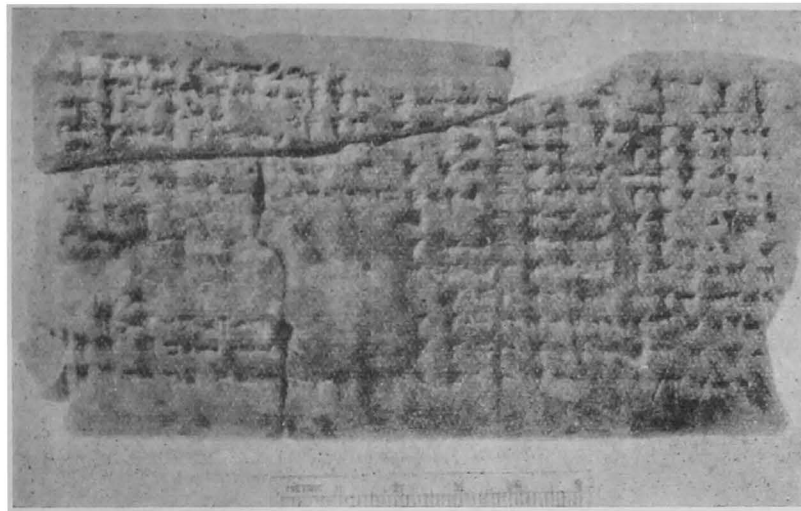

Fig. 17—Babylonian Boundary stone showing lunar ephemeris engraved on it (A. 3412 Rev.) (*Exact Sciences in Antiquity*)

was obtained, are not yet known with precision. Only some guesses can be made.

The early astronomers probably observed that the bright stars Regulus (α *Leonis*), Spica (α *Virginis*), the conspicuous group Pleiades, and certain fainter stars α *Librae*, α *Scorpii* were almost on the sun's path. The ecliptic could be roughly constructed by joining these stars.

'Regulus' or α *Leonis* was the 'Royal Star' in Babylonian mythology. In Indian classics, it is known as *Maghā* (or the Great) and the presiding deity is *Indra*, the most powerful Vedic god. It is almost exactly on the ecliptic. *Citrā* (or α *Virginis*) is 2° to the south.

The First Point of Aries :—The first point of Aries is the fiducial point from which all astronomical measurements are made. But how was this point, or any other cardinal point, say the first point of Cancer (summer solstice), the first point of Capricornus (winter solstice) and the first point of Libra, were located on the circle of the ecliptic in early times?

For rarely have the first point of Aries nor any other of the cardinal points been occupied by prominent stars during historical times. Even if for measurement, the ancient astronomers used some kind of astronomical instrument, say the armillary sphere, it would be difficult for them to locate the first point of Aries correct within a degree.

ecliptic positions of these normal stars were determined after some effort by some method not yet known, and then the positions of other heavenly

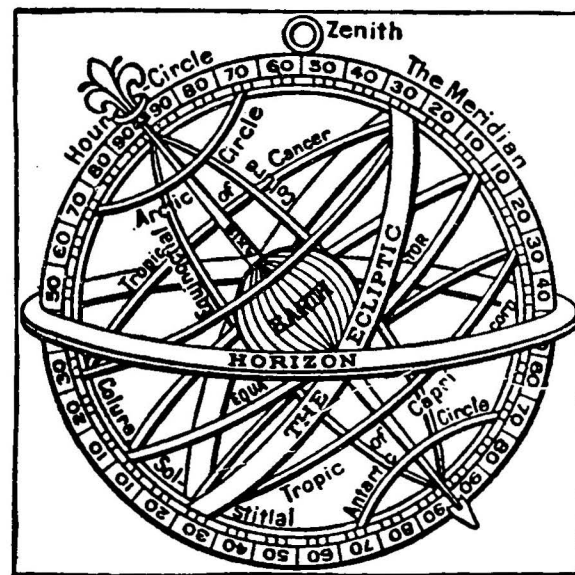

Fig. 18—Armillary sphere. (Reproduced from *Encyclopaedia Britannica*).

bodies referred to the first point of Aries or the beginning of a sign could be found. The early observations are rough and no accuracy of less than a degree is claimed by any classical scholar for them.

* A. Sachs, Babylonian Horoscopes, p. 53, *Journal of Cuneiform Studies*, Vol. VI. No. 2.

Precession of Equinoxes:—But the first point of Aries is not a fixed point on the ecliptic, though all ancient astronomers believed it to be *fixed* once for all. It moves steadily to the west at the rate of 50'' per

Ptolemy's first point of Aries γ is 4° to the west of Hipparchos's.

Clay tablet records have been obtained in Mesopotamia which have been interpreted as represen-

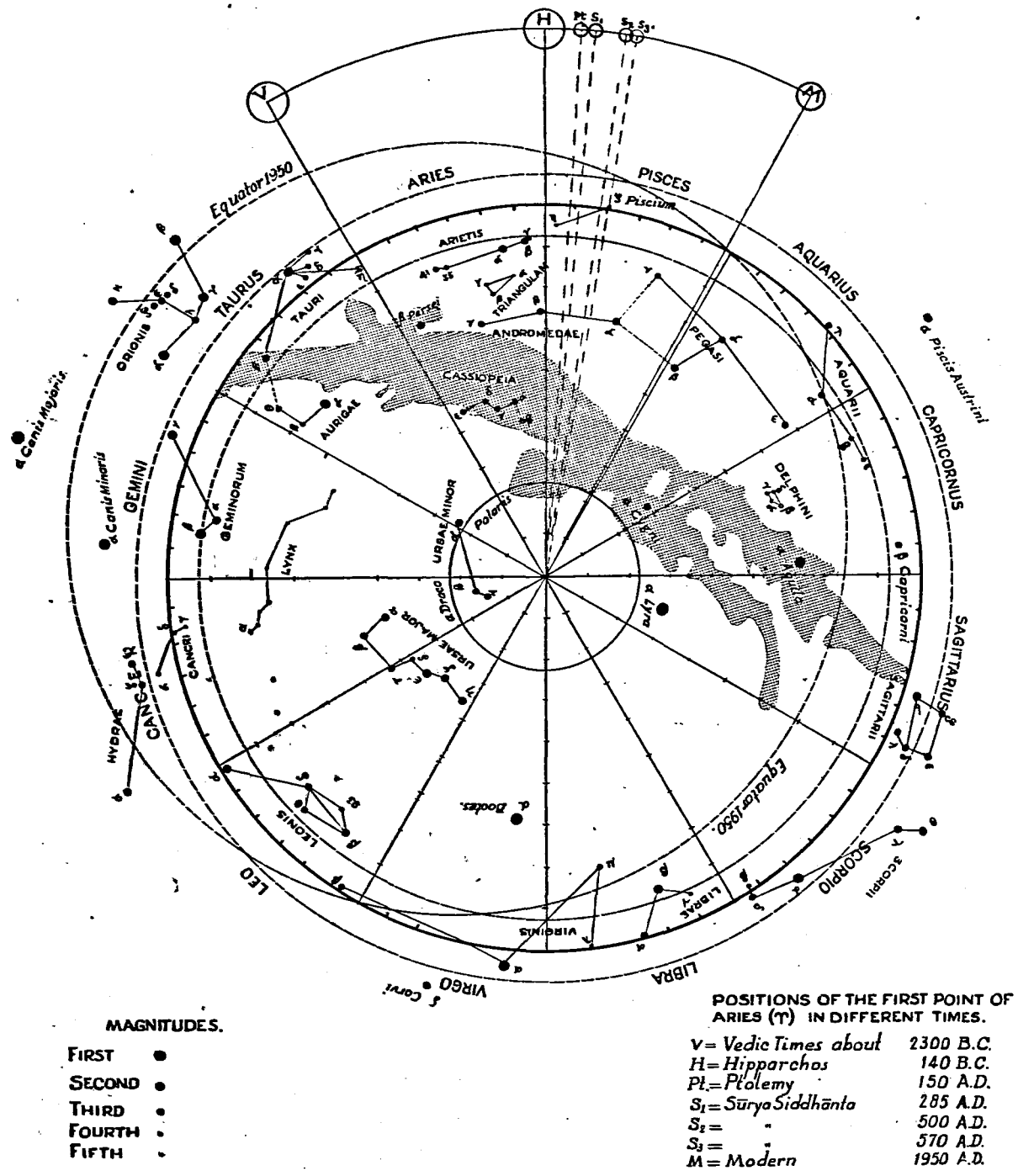

Fig. 19—The Zodiac through ages.

year. Astronomers of different ages must have given measurements of stellar positions from observations made either during their own times, or from observations made by their predecessors, quite unconscious of the fact that the reference point had shifted. The result is that the positions of stars given by different astronomers of antiquity do not tally, and the positions given by the same astronomer are not always consistent. This is illustrated in Fig. 19 of the Zodiac.

Let us take Hipparchos's First point of Aries γ as our standard point.

ting two systems of Ephemeris known as Systems A and B. System B indicates that the vernal point is Aries 8°. This indicates that the observations were taken about 550 years before Ptolemy. This coincides approximately with the time of the Chaldean astronomer Kidinnu, who observed at Borsippa near Babylon, and is taken to be the author of the nineteen-year cycle. System A uses Aries 10° as the vernal point; the author of this system might have flourished 120-150 years before Kidinnu, and may be identified with Naburiannu, son of Balatu, who flourished about 490

B.C. Older still is the use of Aries 15° by Eudoxus of Cnidus, the first Greek astronomer to start a geometrical theory of planetary motion. This refers to observations dating from about 810 B.C. These dates, before they are accepted, should receive independent verification.

The Use of Spherical Co-ordinates

The ancient astronomers were interested primarily in the moon and the planets but later about 150 B.C., Hipparchos gives lists of fixed stars as well with their positions.

It was clearly observed that though these planets keep near the ecliptic, they deviate by small amounts sometimes to the north, sometimes to the south. In the case of the moon, the maximum deviation amounts to nearly 5° (inclination of the moon's orbit to the ecliptic). In the case of planets, excepting in the case of Mercury and Venus, the deviation was not large.

In the case of the moon, a knowledge of the moon's celestial latitude was necessary for prediction of eclipses and therefore both the celestial longitude and latitude used to be recorded by the Chaldean astronomers of the Seleucid era. In the case of planets, only the celestial longitude appear to have been used.

The Chaldean astronomers were the first to frame lunar and planetary ephemerides (*i.e.* calculation in advance of lunar and planetary positions—the precursor of modern Nautical Almanacs and Ephemerides) from about 500 B.C. But during these times, neither the knowledge of the sphere nor of spherical or plane trigonometry had developed. The Chaldeans had only developed the ideas of angular measurement which they expressed in degrees, minutes and seconds, the whole circle being divided into 360° degrees. Their methods, which have been elucidated by Neugebauer, Sachs and others were arithmetical. They took maximum and minimum values of astronomical quantities, and interpolated for an intermediate period, assuming the change to be linear (zigzag function; *vide* Neugebauer, *Exact Sciences in Antiquity*, Chap. V, Babylonian Astronomy).

It was the Greeks who introduced geometrical methods to deal with positions of heavenly bodies, and made the next great advance in astronomy. But they developed trigonometry only to a rudimentary stage (*vide* § 4.8). But they also used Babylonian arithmetical methods alternately. Thus while Ptolemy uses the trigonometric chord functions in his *Syntaxis*, in the astrological text, called *Tetrabiblos*, he uses the Babylonian arithmetical methods.

Though the calendar, as we have seen, gave the first stimulus for the cultivation of the astronomical

science, the use of astronomy for perfecting the calendar appears in the West to have come to a stop after the Seleucid era. For Rome conquered the whole western Asia up to the Euphrates by about 80 A. D., and the Julian calendar replaced the Babylonian luni-solar calendar, which have, however, continued to currency probably in limited regions like Syria, Arabia and Iraq amongst certain communities. The Sassanid Persians also followed their own solar calendars inherited from Acheminid times. But the elements of the Chaldean luni-solar calendar have been used in a limited way, for the Christian ecclesiastic calendar for Christianity arose in Palestine and Syria, and the most important event in Christ's life, His crucifixion, is recorded in terms of the luni-solar calendar prevalent in Palestine about the first century A.D.

4.8 GREEK CONTRIBUTION TO ASTRONOMY

It has been considered necessary to give a short account of Greek contributions to astronomy, because there is a widespread view that it was Greek astronomy which formed the basis of calendar reform in India which took place about 400 A.D. (*Siddhānta Jyotiṣa* calendar). Let us see how far this view is correct. The Greeks themselves appear to have made no use of astronomy for the reform of their own calendars, as was done later in India. They cultivated astronomy partly as pure science, partly as an indispensable adjunct to astrology.

It is now well-known that Greek civilization had a long past going back to at least 1500 B.C. The remains of this civilization have been found in Crete (Minoan), and on the Greek mainland itself (Mycenean). Inscriptions have been found in strange scripts (Linear A, and B) which defied decipherment till 1952. We have therefore as yet no knowledge of the calendar in the Mycenean age of Greece (1400 B.C.—1000 B.C.), but probably they will now be forthcoming.

The Homeric poems '*Iliad*' and '*Odyssey*' written about 900 B.C., as well as Hesiod writing about 700 B.C. show considerable acquaintance of stars and constellations needed for sea-faring people, to find out their orientation when out at sea.

From about 750 B.C., the Greek city-states began to emerge; they were engaged in maritime trade over the whole Mediterranean basin. These activities brought them into contact with many older nations who had attained a high standard of civilization, *e.g.*, the Egyptians, the nations of the Near East, *viz.*, the Lydians, the Phoenicians, and the Assyrians and imbibed many elements of their civilization. The older Greek scholars themselves admit that the Greeks

borrowed their script* from the Phoenicians, their coinage from the Lydians, their preliminary ideas of geometry from the Egyptians and of astronomy from the Chaldeans. But they enriched all these sciences beyond measure by their own original thoughts and contributions. As Plato (428-348 B.C.) proudly remarks: "...whatever the Greeks acquire from foreigners, is turned by them into something nobler."

Greek science goes no further back than Thales of Miletus (624-548 B.C.), who is reckoned to be the first of the seven sages of Greece. Considerable knowledge of astronomy and physics was ascribed to him by later writers. He is supposed to have predicted the occurrence of an almost total solar eclipse, which occurred on May 28, 585 B.C., on the basis of his knowledge of the Chaldean Saros. These stories are now disbelieved by scholars well versed in Assyriology, for according to their finding, the Chaldeans themselves before 400 B.C., had no knowledge of the Saros of 18 years-10 $\frac{1}{2}$ days used later to predict the eclipses, but they used other methods with only partial success. Thales might have used one of these methods, but not certainly the Chaldean Saros. Considering the crude state of Greek civilization in Thales' times, these scholars think that it is a fairytale of modern times that Thales knew anything about the Saros. Thales lived in a coastal city of Asia Minor which had active contact with the great civilizations of the Near East, and probably much of the knowledge ascribed to him were picked up from Babylon and Egypt.

The next figure in Greek astronomy is Anaximander, (610-545 B.C.), likewise of Miletus a junior contemporary of Thales, who is said to have introduced the use of the gnomon (*vide* § 4'3). This may be conceded, but this practice was derived most probably from the Chaldeans, who used the gnomon from much earlier times. Cleostratos (530 B.C.) of Tenedos was cited by later authors to have introduced the knowledge of the zodiac, of the eight-year cycle of intercalations in Greece, but probably he merely transmitted the Babylonian knowledge and practice. Meton of Athens is said to have introduced the nineteen-year cycle of 7 intercalary months in Athens in 432 B.C., but as remarked earlier, its use in Greek calendars cannot be dated before 342 B.C., though it was known in Babylon from at least 383 B.C. The question of priority of this discovery is still to be decided, probably by fresh finds and interpretation of ancient astronomical records.

* It appears that the Greeks of Homeric poems used linear A and B, but about 900 B.C., they borrowed the simpler Phoenician script and adopted it to their use by the addition of vowels. Thereby they forgot their old script and history, which became myth and legend. The decipherment of Minoan Linear B has been achieved in 1952 by Ventris and Chadwick.

We have besides philosophers of the Pythagorean school (500-300 B. C.), a religious brotherhood which cultivated geometry, astronomy, physics and mathematics. They are cited by later writers to have propagated the view that the earth was a sphere, and the planets were also spherical bodies like the earth, but it is difficult to state when, and on what grounds these theories were first propounded.

These were the periods of tutelage. Greek genius in astronomy began to flower only after 400 B.C., and was aided by a number of causes.

The first was the development of geometry as a science by philosophers of the Pythagorean school (500-300 B. C.), and other scholars, notably Hippocrates of Chios (450-430 B.C.), and Democritus of Abdera (460-370 B.C.). A great impetus to both plane and solid geometry was given by Plato (428-348 B.C.), famous philosopher and founder of a school of studies and research known to the world as the '*Academy*'. Plato counted amongst his contemporaries and juniors several geometers of distinction, *viz.*, Archytas of Tarentum (first half of fourth century B.C.), Theaitetus of Athens (c. 380 B.C.), Eudoxus of Cnidos (d. 355 B.C.), and several others. All the geometrical knowledge developed by these and other scholars was compiled, and rewritten into a logical system with rich contributions of his own by Euclid, who lived in the Museum of Alexandria (280 B.C.), and was bequeathed to the world in thirteen (or fifteen) books known as the '*Elements of Euclid*', which have remained to this day the basis of the teaching of elementary geometry. There is no other book of science which have remained current and authoritative for such a long stretch of time, now extending over two thousand years.

The second factor was political. During the sixth and fifth centuries before Christ, the Greek savants and scholars had indeed undertaken educational journeys to the Near East in search of knowledge—journeys which were made possible and safe under the orderly regime of the Acheminid empire (Persian). But it was the conquest of the Persian empire by Alexander of Macedon in 330 B.C., which rendered these contacts easier and more fruitful. The Greek successor dynasties, *viz.*, the Ptolemaic dynasty in Egypt, and the Seleucid dynasty in Babylon and other dynasties in Asia Minor were all great patrons of learning and encouraged and maintained scholars; the former set up the famous Museum at Alexandria, which was a research institution with a great library, an observatory and other necessary equipment. It attracted scholars from all parts of Greater Greece and provided them with free board, lodge and a salary. This place nurtured a number of great Greek geniuses:

Euclid, already mentioned; Eratosthenes who first measured correctly the diameter of the earth and was the founder of scientific chronology; and others whom we shall meet presently.

On the Asiatic side, under the centralized rule of the Seleucids, the later Chaldean and Greek astronomical efforts became very much intermingled. A Chaldean priest, Berossus, who lived during the reign of the second Seleucid king Antiochos Soter (282-261 B.C.), translated into Greek the standard Chaldean works on astronomy and astrology. The period from 340 B.C. to 150 A.D. may be called the most flourishing period of astronomical studies in antiquity. The Chaldeans figured prominently during the earlier part of this period but their methods were based on a primitive form of algebra and arithmetic. According to Neugebauer, their contributions in mathematics and astronomy were as good as those of the contemporary Greeks who used geometry, but they gradually faded into obscurity on account of their infatuation with astrology; and the Greeks, though they were great believers in astrology, freed themselves at least from astrology, and cultivated astronomy as part of astrology, and emerged as leaders in astronomical science.

The earliest Greek astronomer to use geometrical ideas in astronomy is, if we leave aside the Pythagoreans, probably Eudoxus of Cnidos (d. 355 B.C.), a junior contemporary, friend and pupil of Plato. He made great original discoveries in geometry, and Books V and VI of Euclid are ascribed to him. It was probably his knowledge of geometry which led him to make the first scientific attempt to give a geometrical explanation for the irregular motions of the sun, the moon, and the planets. Twenty-seven spheres, all concentric to the earth were needed to account for these motions. This theory had but a short life, but it is remarkable as the first instance, when heavenly bodies, connected with great gods, were treated on a human level.

Eudoxus is supposed to be the inventor of geometrical methods for determining the sizes and distances of the sun and the moon, usually ascribed to Aristarchus of Samos (*fl.* 280 B.C.), who is known to have taught that the daily revolution of the celestial sphere was due to the rotation of the earth round its axis. He is also said to have first put forward the heliocentric theory of the universe. Neither of these theories was accepted by contemporary astronomers. The world had to wait for the appearance of a Copernicus (1473-1543), for the acceptance of these views.

Apollonius of Perga (born about 262 B.C.) known more for his treatise on Conics, originated the theory

of epicycles, and eccentrics to account for planetary motion. He was a junior contemporary of two great figures: Eratosthenes already mentioned and Archimedes of Syracuse (287-212 B.C.), a great figure in mechanics, hydrostatics and other sciences, but to astronomy, he is remembered as originator of the idea of Planetarium—a revolving open sphere with internal mechanisms with which he could imitate the motions of the sun, the moon, and the five planets.

Archimedes is also credited with attempts for finding out the actual distances of the planets from the earth. We do not know whether this is correct or not, but about this time, we find the planets arranged according to the order of their distances from the earth:

Moon, Mercury, Venus, Sun, Mars, Jupiter, Saturn
or if we take the reverse order:

Saturn, Jupiter, Mars, Sun, Venus, Mercury, Moon.

This last order was taken up by astrology and formed the basis of the seven-day week, which came into vogue about the first century A.D.

The greatest name in Greek astronomy is Hipparchos of Nicaea, in Bithynia who settled in the island of Rhodes and had an observatory there (*fl.* 161-127 B.C.). He probably corresponded with the savants at the Museum of Alexandria. Not much of his writings have come down to us, except through quotations and remarks by Claudius Ptolemy, the famous Alexandrian astronomer who flourished three centuries later. Sarton writes about Hipparchos:

"It is possible that all the Ptolemaic instruments, except the mural quadrant, had already been invented by him (e.g. dioptra, parallactic and meridian instruments). He was the first Greek observer who divided the circles of his instruments into 360 degrees. He constructed the first celestial globe on record.

He used and probably invented the stereographic projection. He made an immense number of astronomical observations with amazing accuracy".

The principle of measurement of angles was certainly derived from the Chaldeans. Hipparchos gave a catalogue of 850 stars with their positions which is reproduced in Ptolemy's *Syntaxis*. Vogt found that of the 471 preserved numbers giving position, 64 are declinations, 67 are right ascensions, 340 are in polar longitudes and latitudes, which reappear in the *Sūrya Siddhānta*, six hundred years later.

It is suggested that after his discovery of precession (*vide* § 4.9), Hipparchos probably used celestial longitudes and latitudes. But these co-ordinates had been already used by the Chaldeans at least a century earlier.

Hipparchos had probably some knowledge of plane and spherical trigonometry necessary for the solution

of astronomical problems, *e. g.*, finding out the time of rise of zodiacal signs during the year, a problem of great importance to horoscopic astrology. It is the current opinion that he used the double chord, illustrated below :

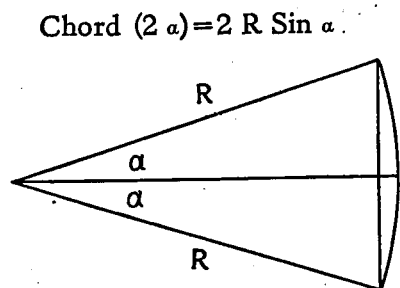

Fig. 20

and gave a table of double-chords from 0° to 90° , which was later improved by Ptolemy in his *Syntaxis*. It is suggested by Neugebauer, that the 'Sine function' (*Jyā* in Hindu astronomy) was introduced 600 years later by Āryabhaṭa, and replaced the double chord. The Hindu astronomers used *Utkramajyā* which is the versine function, $1 - \cos \alpha$, but do not appear to have used the cosine function as such. Neither the Greeks nor the Hindus used the tangent, and the cotangent, which were introduced by Arab astronomers about the ninth century (al-Battānī, 858-929 A.D.), and were known in Latin in early days as *Umbra Versa*, and *Umbra Extensa* (extent of shadow) respectively. These are reminiscent of the practice of designating the zenith distance Z of the sun by the length l of the shadow of the gnomon, $l = p \tan Z$, p being the height of the gnomon.

Between Hipparchos and Claudius Ptolemy (150 A.D.), who lived at the Alexandrian Museum from 128 A.D. to 151 A.D., there is a gap of 300 years, which saw the phenomenal rise of horoscopic astrology. There are, however, very few great names in astronomy. Menelaos, a Greek astronomer who lived in Rome about 98 A.D., laid the foundation of spherical trigonometry, but it was confined to a transversal proposition from which Ptolemy deduced solutions for only right angled spherical triangles, of which either two sides or an angle and one side are given. The Hindu astronomers likewise used only solutions of right angled spherical triangles. The discovery of general relations in spherical trigonometry was the work of Arabic astronomers (al-Battānī).

Claudius Ptolemy who worked at Alexandria between 128-151 A.D., was, as Sarton says, a man of the Euclidean type. Great equally as an astronomer, mathematician, geographer, physicist, and chronologist, his main work is the great mathematical and astronomical treatise known in Greek as '*Syntaxis*', and in

Arabic translation as the *Almagest*. It has been long supposed that it rendered all previous treatises in astronomy obsolete, and remained a standard text, which fertilized the brains of all ancient and medieval astronomers, Greek, Jew, Arab, and European, till the rise of the heliocentric theory of the universe rendered it obsolete. This opinion appears to have been rather exaggerated. Strangely enough, the *Syntaxis* appears to have been quite unknown to Hindu astronomers of the 5th century A.D.

Ptolemy's chief contribution to astronomy was his elaborate theory of planetary motion and discovery of a second inequality in the motion of the moon, now called *Evection*. He gave a catalogue of 1028 stars with their positions, most of which have been shown to have been taken from Hipparchos by adding 3° to the longitudes given by him. This represents the shift of the first point of Aries since Hipparchos's time according to Ptolemy's calculation. The actual value is 4° .

Ptolemy wrote a treatise on astrology known as the "*Tetrabiblos*" which long remained the Bible of the astrologers.

After Ptolemy, there were no great figure in astronomy except few commentators and workers of mediocre ability like Theon of Alexandria (about 370 A.D.), who initiated the false theory of trepidation of the equinoxes, and Paulus of Alexandria (fl. 378 A.D.) who wrote an astrological introduction. He is supposed to have been the inspirer of the Indian Siddhānta known as '*Paulīśa*' *Siddhānta*' (*vide* § 5'6), but this hypothesis started by Alberuni has never been proved. With the advent of Christianity, and after murder of the learned Hypatia (415 A.D.), the 'light' goes out of Greece.

The Greek contributions to astronomy are :

A geocentric theory of the universe, with the planets in the order given on page 203.

The treatment of planets as spherical bodies similar to the earth.

Geometrization of astronomy, development of the concepts of the equator, the ecliptic and of spherical co-ordinates (right ascension and declination, celestial latitude and longitude), some elementary knowledge of plane and spherical trigonometry to deal with astronomical problems.

Knowledge of planetary orbits, and attempts to explain them with the aid of epicyclic theories.

4.9 DISCOVERY OF THE PRECESSION OF THE EQUINOXES

In the previous sections, we have stated how the Chaldean and Greek astronomers started giving

positions of planets, and stars, with the point of intersection of the ecliptic and the equator—the first point of Aries—as the fiducial point. We shall now relate how the discovery was made that this point is not fixed in the heavens, but has a slow motion along the ecliptic to the west at the rate of *ca.* 50" per year. The rate is very small, but as it is unidirectional and cumulative, it is of immense importance to astronomy, and incidentally is very damaging to astrology.

When the sun, in course of its yearly journey arrives at the first point of Aries, we have the vernal equinox. The first point of Aries is therefore also called the *vernal point*.

The position of the vernal point has rarely in the course of history, been occupied by a prominent star, but in India, as narrated in § 5.4, its nearness to star-groups as well as the nearness of other cardinal points to star-groups have been noted from very early times. Traditions of different epochs record different stars as being near to the cardinal points. But nobody appears to have drawn any conclusion from these records (*vide* for details § 5.4).

In Babylon also, different sets of positions of stars and planets record Aries 15°, Aries 10°, and Aries 8° (the zero is of Ptolemy's) as being the vernal point. But no Chaldean astronomer to our knowledge appears to have drawn any conclusion from these data.

The first astronomer known to have drawn attention to the precession of the equinoxes was Hipparchos. He particularly mentions that the distance of the bright star Spica (*a Virginis* or *Citrā*) has shifted by 2° from the autumnal equinoctial point since the time of his predecessor Timocharis who observed at Alexandria about 280 B.C. He concluded that the autumnal point, and therefore also the vernal point, was moving westward at the rate of 51½ seconds per year.

It is not known whether Hipparchos considered the motion as unidirectional. It was impossible for him to say anything definite on this point, as observations extending over centuries are required to enable one to make a definite statement on this point.

Though Hipparchos made, as time showed, one of the greatest astronomical discoveries of all times, which is all-important for the calendar, as well as for astronomy, its great importance does not appear to have been realized by either his contemporaries or followers for thousands of years.

Let us, therefore, dwell a little on the consequences of this discovery. Later and more accurate observations have shown that the rate is nearly 50" per year,

but is subject to variations which we may disregard at this stage. The shift is accumulative and in 100 years would amount to 1° 24', and in about 26000 years the first point will go completely round the ecliptic. The period depends upon certain factors and is not constant.

The tropical year, or the year which decides the recurrence of seasons, is the time-interval for the return of the sun in its orbit, starting from the year's vernal equinoctial point to the next vernal equinoctial point. If these points were fixed on the ecliptic, the tropical year would be the same as the sidereal year, which is the same as the time of revolution of the earth in its orbit. But since the vernal equinoctial point slips to the west, the sun has to travel 360° 0' 0" – 50" = 359° 59' 10" to arrive at the new vernal equinoctial point, hence the duration of the tropical year is less than that of the sidereal year by about 20 minutes. In exact terms :

duration of the sidereal year = 365.25636 mean solar days
 " " " tropical " = 365.24220 " "
 at the present time.

Further Consequences of the Precession of the Equinoxes

We may now consider some consequences of the precession of the equinoxes.

Hipparchos appears first to have marked out the beginning of the astronomical first point of Aries. It started 8° west of the star *a Arietis*. Ptolemy had found that it had shifted by his time by about 3°, and gave the rate of precession as 36" per year. In this, he was wrong, the true shift being about 4°. Ptolemy in his '*Uranometry*' gives the starting point of the sign of Aries as 6° to the west of *β Arietis*, and the other constellations marked at intervals of 30° may be marked out on the zodiac. The picture (Fig. 19) gives the boundaries of the different signs according to Hipparchos. The boundaries of the signs of Ptolemy would be 4° to the west of those of Hipparchos.

By the time of Ptolemy, (and probably much earlier), a complex system of *astrology* had developed which connected men's destiny in life with the position of planets in the different signs at the time of his birth (horoscopy). It was claimed that even the fortunes of nations and countries could be calculated in advance from planetary positions in the signs. Though a few rational men like Seneca and Cicero were as much sceptical about the claims of astrology as the modern man, the general mass became converted to its claims, even astronomers not excepted. Even the great Ptolemy wrote a treatise '*The Tetrabiblos*' exposing the principles of Astrology.

In fact, belief in astrology was one of the main incentives for the observation of the positions of heavenly bodies in ancient and medieval times which were carried out by medieval astronomers with so much zeal under the willing patronage of influential persons.

The discovery of precession is very disconcerting to astrologers, for in the astrological lore, the signs are identified with certain fixed star-clusters; whereas precession tends to take them entirely out of these star-clusters. Thus since Hipparchos's time, the shift has been nearly 30 degrees, and what was the sign of Pisces in Hipparchos's time has now become the sign of Aries, and the astronomical sign of Aries has now nothing to do with the Aries constellation.

This consequence must have been foreseen by the followers of Ptolemy, and they probably started, more on psychological than on scientific grounds, to find out theories to mitigate the devastating influence of precession on astrology. Astronomers immediately following Ptolemy barely mentioned precession. It was first referred to by Theon of Alexandria (ca. 370 A.D.) who invented the theory of *Trepidation*, i.e., he said that the precessional motion was not unidirectional, but oscillatory. He gave the amplitude of oscillation as 8° . Probably this figure was suggested by the fact that at Theon's time the first point of Aries had shifted by a little less than 8° from Hipparchos's position, and Theon thought that it would go back and save astrology.

Proclus the successor (410-485 A.D.), head of the Platonic Academy at Athens, a very learned man and one of the founders of Neoplatonism, denied the existence of precession!

After the sixth century A.D., the dark age set in Europe and the mantle of scientific investigation fell on the Hindus and the Arabs. Let us see how the Arab astronomers regarded the precession.

Thabit ibn Qurra (826-901 A.D.), who flourished at Baghdad under the early Abbasides, translated

Ptolemy's *Almagest* into Arabic; he noted precession, but upheld the theory of trepidation. But the other great Arabic astronomers like al-Farghānī (861-Baghdad), al-Battānī (858-Syria), Abd al-Rahamān al-Šūfī (903-986-Teheran) and Ibn Yūnus (d. 1009—Cairo), all noted precession and rejected the theory of trepidation. In fact al-Battānī gave the rate of precession as $54''$ per year, which is far more correct than the rate given by Ptolemy, viz., $36''$ per year.

But unfortunately, Europe recovering from the slumbers of dark ages were more influenced by the Spanish-Muslim astronomers al-Zarquali (1029-1087 of Cordova) and al-Bitruji (ca. 1150, living at Seville), who upheld the theory of trepidation. As their influence was considerable, they were largely responsible for its diffusion among the Muslim, Jewish and Christian astronomers, so much so that Johann Werner (1522) and Copernicus himself (1543) were still accepting it; Tycho Brahe and Kepler had doubts concerning the continuity and regularity of the precession, but they finally rejected the trepidation. The theory of trepidation was completely given up in Europe after 1687, when Newton gave a physical explanation of it from dynamics and the law of gravitation. This is given in appendix (4-A), for the benefit of Indian astrologers and almanac-makers who still believe in the theory of trepidation and oppose reform of the wrong calendar they are using for centuries.

Sarton from whose writings much of this account has been compiled, writes* :

"The persistence of the false theory of trepidation is difficult to understand. At the very beginning of our era, the time span of the observations was still too small to measure the precession with precision and without ambiguity, but as the centuries passed there could not remain any ambiguity. Between the stellar observations registered in the *Almagest* and those that could be made by Copernicus, almost fifteen centuries had elapsed, and the difference of longitudes would amount to $21''$ "

* Sarton, *A History of Science*, p. 446.

APPENDIX 4-A

Newton's Explanation of the Precession of the Equinoxes

In view of the prevailing confusion in the minds of Indian almanac makers regarding precession of the equinoxes, a short sketch of the physical explanation of the phenomenon originally given first by Newton is given here in the hope that those amongst Indian calendar makers who believe in science, may be persuaded to give up their belief in the theory of trepidation and be converted to the *sāyana* reckoning advocated in these pages. This explanation will be found in any standard book on Dynamics or Dynamical Astronomy, *e.g.*, in Webster's *Dynamics*.

We have now to regard the earth as a material sphere, spinning rapidly round its axes, which is inclined at an angle of $\frac{\pi}{2} - \omega$ to the plane of the ecliptic, where ω = obliquity of the ecliptic to the equator.

The earth is kept in its orbit by the gravitational pull of the sun, which is situated at one of the foci of the earth's orbit which is an ellipse. Dynamics shows that the plane of the ecliptic is almost invariant, *i.e.*, does not change with time, except a very small oscillation due to attraction of other planets on the earth. What is then precession due to?

This is explained by means of the following figure.

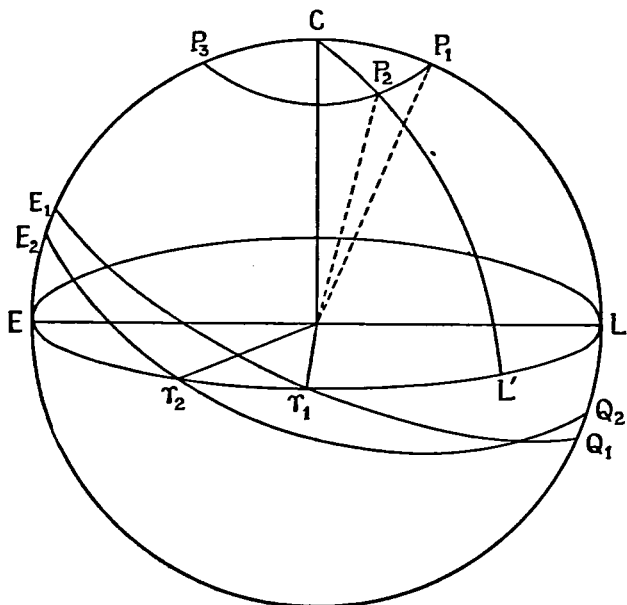

Fig. 21—Showing the precession of the equinoxes.

In the above figure (No. 21), *C* is the pole of the ecliptic *EL'L*. Let τ_1 midway between *E* and *L* be the first point of Aries for year 1. Then the celestial pole is *P*₁, and the celestial equator is *E*₁ τ_1 *Q*₁. Due to precession of the equinoxes, the first point of Aries is slowly moving in the backward direction *L* τ_1 *E* along the ecliptic. If τ_1 shifts to τ_2 in year 2, the celestial pole shifts to *P*₂ along the small circle *P*₁ *P*₂ *P*₃... where *CP* = obliquity of

the ecliptic. The celestial equator assumes a new position *E*₂ τ_2 *Q*₂ in year 2.

The celestial pole *P* therefore goes round the pole of the ecliptic *C*, and it makes a complete cycle in a period of about 26000 years as shown in fig. 22.

At present (1950 A. D.), the celestial pole is 58' from Polaris (α *Ursa Minoris*) which is a star of the second magnitude. *CP*, *i.e.*, the line joining the pole of the ecliptic *C* to the celestial pole *P* continues to approach the Polaris up to 2105 A. D., when the pole would be only 30' away from the star and will then begin to recede from it.

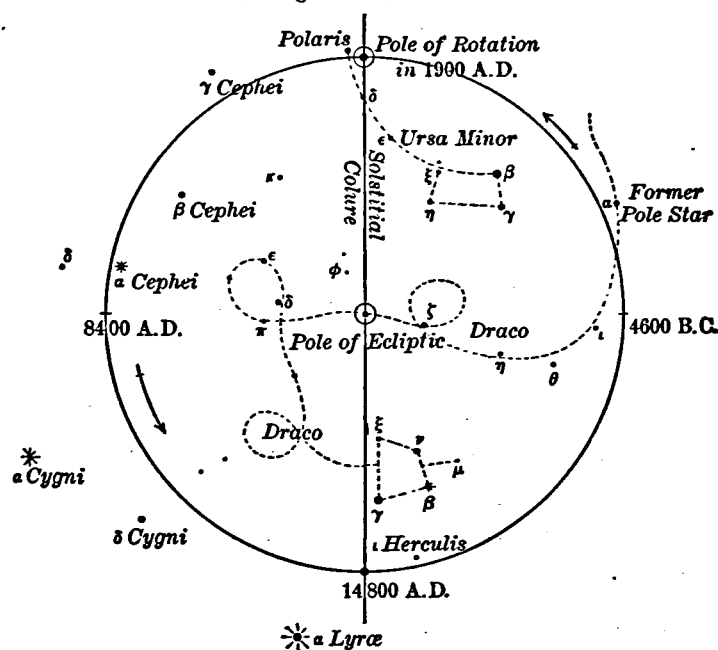

Fig. 22—Showing the precessional path of the celestial pole among the stars.

(Taken from *Astronomy* by Russell & others)

It will be seen that the celestial pole has not been marked with a prominent star for most part of this period of 26000 years. About 2700 B. C., the second magnitude star α *Draconis* was the pole-star, as was probably known to the ancient Egyptians, the Chinese and the Rg-Vedic Hindus. Conscious human history hardly goes beyond this period. The prominent stars which will become pole stars in future are :

γ Cephei.....	4500 A.D.
α Cephei.....	7500 A.D.
δ Cygni	11200 A.D.
α Lyræ (Vega)...	13600 A.D.

The last is a first magnitude star, the brightest in the northern heavens and can be easily picked up with the naked eye.

The phenomenon of precession of the equinoxes tells us that in addition to rotation, the earth has another motion, *viz.*, a slow conical motion of its axis round the pole of the ecliptic which causes the equinoxes to move backward. The phenomenon can be visualized by reference to the motion of tops played by boys (Fig. 23).

It is a matter of common experience with those who have played with tops that when the top is thrown spinning on the earth, the axis round which the top is spinning very often is not vertical, but is oblique; and it is also having a slow motion in a circle round the vertical as shown in fig. 23. This last motion is *precessional motion*. The top may be likened to the earth, and the vertical direction of gravity, corresponds to the pole of the ecliptic. The

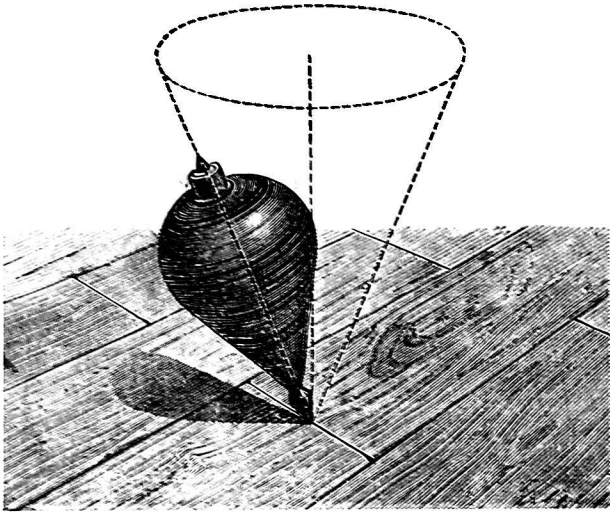

Fig. 23—Motion of a top.

The spinning top, which is likened to the earth, causes precessional motion of its axis.

top would have fallen but for its spin. When it slows down, the top falls down; the precessional motion of the top is due to the pull exerted by the gravity.

Now turning to the earth, we see that as a first approximation, we may take it as a point of mass concentrated at the centre, and then deduce its orbit as is done in classical planetary theory. This would have been all right, if the earth were a *homogeneous sphere*. But the earth is not a sphere, but a spheroid, having its polar axis shorter than the equatorial axis by 43 kms. (=27 miles). There is an equatorial bulge of matter. The pull due to the sun, is now equivalent to a force in the ecliptic passing through the centre of the earth defining the orbital motion, plus a couple, which tends to turn the equator of the earth into the plane of the ecliptic. It is this couple which produces *precessional motion*.

For details of calculation the reader may refer to a book on Rigid Dynamics, say A.G. Webster, *Dynamics*, pp. 298-302.

We mention only the results here :

If ψ be the angle of precession, *i.e.*, the angle P_1CP_2 in fig. 21, we have due to the sun's attraction

$$\psi = \frac{3\gamma m}{2\Omega r^3} \times \frac{C-A}{C} \cos \omega \left(t - \frac{\sin 2l}{2n} \right)$$

where :

- γ = gravitational constant = 6.67×10^{-8} c. g. s. units ;
- C = moment of inertia of the earth round the polar axis ;
- A = moment of inertia of the earth round an equatorial axis ;
- ω = obliquity of the ecliptic = $23^\circ 26' 45''$;
- m = mass of the sun = 1.99×10^{33} gms ;
- r = distance of the earth from the sun = 1.497×10^{13} cms ;
- $\frac{\gamma m}{r^3}$ = tide-raising term ;
- l = longitude of the sun ;
- n = angular velocity of the earth ;
- Ω = angular rotational speed of the earth in radians.

If the earth were a homogeneous sphere, C would be A , and $\psi = 0$. But taking the polar radius $c = a(1 - \epsilon)$, where ϵ = ellipticity of the earth, it can be shown that for the earth, in which concentric layers are taken to be homogeneous

$$\frac{(C-A)}{C} = \epsilon = \frac{1}{297} \text{ (nearly).}$$

But actually $\frac{C-A}{C}$ is the mechanical ellipticity of the earth, the value of which has been found by observation as $\frac{1}{304}$.

Substituting the values as given above in the expression

$$\frac{d\psi_s}{dt} = \frac{3\gamma m}{2\Omega r^3} \cdot \frac{C-A}{C} \cos \omega (1 - \cos 2l)$$

we get the progressive part of the solar precession = 2.46×10^{-12} .

This is in radians per second of time. To convert it to seconds of arc per year, we have to multiply the expression by $2.063 \times 10^5 \times 3.156 \times 10^7$.

2.063×10^5 being the number of seconds of angle in a radian, and 3.156×10^7 the number of seconds of time in the year.

We have therefore the rate of solar precession = $16''.0$ per year.

We have now to calculate the action of the moon which, in spite of its much smaller mass, exerts a far larger perturbing force as the lunar distance is much smaller. In fact the tide raising force $\left(\frac{\gamma m}{r^3}\right)$ for the moon is more than double that of the sun. This makes the rate of lunar precession = $34''.4$ per year.

But there is another complication. The moon's orbit is not coincident with the sun's path (ecliptic) but is inclined at an average angle of $5^\circ 9'$, the extreme values being $5^\circ 19'$ and $4^\circ 59'$. Further the points of intersection of the moon's orbit with the ecliptic travel round the ecliptic in a period of 18.6 years. The pole of the moon's orbit M therefore moves round the pole of the ecliptic C as shown in fig. 24 in a period of 18.6 years. The lunar precessional angle ψ_m has therefore to be defined from the instantaneous position of M .

Combination of the two precessional motions.

The two precessions can be combined as in fig. 24. Here C, M are the poles of the ecliptic and of the moon's orbit. P is the celestial pole. The solar precession can be

represented by the vector ψ , along the line PS perpendicular to CP , but the lunar precession is represented by the vector PR , which goes up and down as M goes round C in a

the ecliptic, which would otherwise have been uniform. These periodic (period=18'6 years) variations are known as *Nutation*.

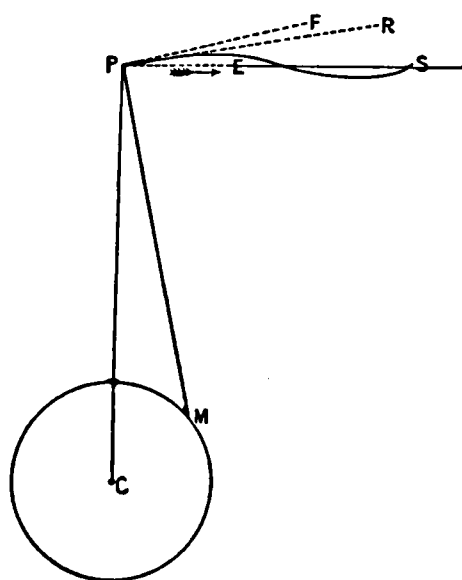

Fig. 24—Combination of two precessional motions.

complete cycle of 18.6 years (period of moon's node). Therefore the motion is equivalent to

$$\psi_{m_s} = \psi_s + \psi_m \cos MPC \dots \text{parallel to } PS.$$

$$\psi_n = \psi_m \sin MPC \dots \text{perpendicular to } PS.$$

This causes certain irregularities in the precessional motion and also in the annual variation of the obliquity of

Annual Rate of Precessional Motion

The solar and lunar precessions amount to 50."37 per tropical year, with a very small centurial variation. After making necessary corrections for the slight motion of the plane of the ecliptic due to attraction of planets, the annual rate of general precession in longitude is obtained as follows :—

Rate of precession = 50."2564 + 0."0222 T per trop. year, where T = Tropical centuries after 1900 A.D.

The nutation in longitude may amount to $\pm 17."$ 2 according to different positions of the lunar node, but its effect on the annual rate of precession does not exceed $\pm 5."$ 8, so that the actual precession rate per year may vary between 44."5 to 56."0.

The average rate of annual precession is not constant, it is very slowly increasing. The annual rate for certain epochs along with the period taken by the equinoxes to move through 1°, are however stated below :—

	Rate of precession	No. of years per degree
2000 B.C.	49."391	72.89
0	49.835	72.24
1900 A.D.	50.256	71.63
2000 A.D.	50.279	71.60

APPENDIX 4-B

Stars of the Lunar Mansions

Comparative statement showing the Indian *Nakṣatras*, Chinese *Hsiu*, and Arabic *Manzil*, together with the names of stars comprising the mansions.

Indian <i>Nakṣatra</i>		Chinese <i>Hsiu</i>		Arabic <i>Manzil</i>		Junction star (<i>Yogatārā</i>) of the <i>Nakṣatra</i>	Magni- tude	Celestial Latitude	Celestial Longitude (1956)		
No. (1)	No. (2)	Name	Meaning	No.	Name					No.	Name
1	27	Aśvinī (β, γ Arietis)	Equestrian	16	Lou (α, β, γ Arietis)	1	ash-Sharaṭāni (β, γ Arietis)	β Arietis	2.72	+ 8° 29'	33° 22'
2	28	Bharaṇī (35, 39, 41 Arietis)	Bearer	17	Wei (35, 39, 41 Arietis)	2	al-Buṭain (35, 39, 41 Arietis)	41 Arietis	3.68	+ 10 27	47 36
3	1	Kṛttikā (Pleiades) η Tauri	Interlaced	18	Mao (Pleiades)	3	at-Turajjā (Pleiades)	η Tauri	2.96	+ 4 3	59 23
4	2	Rohiṇī α Tauri (α, θ, γ, δ, ε Tauri)	Ruddy	19	Pi (α, θ, γ, δ, ε Tauri)	4	al-Dabarān (α, θ, γ, δ, ε Tauri)	α Tauri	1.06	- 5 28	69 11
5	3	Mṛgaśiras (λ, θ ₁ , θ ₂ Orionis)	Stag's head	20	Tzu (λ, θ ₁ , θ ₂ Orionis)	5	al-Haq'ah (λ, θ ₁ , θ ₂ Orionis)	λ Orionis	3.7	- 13 23	83 6
6	4	Ārdrā (α Orionis)	Moist	21	Ts'an (α, β, γ, δ, ε, ξ, η, κ Orionis)	6	al-Han'ah (η, μ, ν, γ, ξ Geminorum)	α Orionis	0.6 v	- 16 2	88 9
7	5	Punarvasu (α, β Geminorum)	The good again	22	Ching (μ, ν, γ, ξ, λ, ζ, ε Gemin.)	7	adh-Dhirā'u (α, β Geminorum)	β Geminorum	1.21	+ 6 41	112 37
8	6	Puṣya (γ, δ, θ Cancri)	Flower	23	Kuei (γ, δ, θ, η Cancri)	8	an-Naṭrah (γ, δ, ε Cancri)	δ Cancri	4.17	+ 0 5	128 7
9	7	Āśleṣā (η σ, δ, ε, ρ, ζ Hydrae)	Embracer	24	Liu (η, σ, δ, ε, ρ, ζ, ω, θ Hydrae)	9	at-Tarf (ξ Cancri, λ Leonis)	ε Hydrae (α Cancri)	3.48 (4.27)	- 11 6 (- 5 5)	131 44 (133 2)
10	8	Maghā (α, η, γ, ζ, μ, ε Leonis)	Generous	25	Hsing (α, γ Hydrae)	10	al-Jabhah (α Leonis and 3 more)	α Leonis	1.34	+ 0 28	149 13
11	9	Pūrva Phalgunī (δ, θ Leonis)	The first Phalgunī	26	Chang (κ, λ, μ, θ, ν, υ, Hydrae)	11	az-Zubrah (δ, θ Leonis)	δ Leonis	2.58	+ 14 20	160 42
12	10	Uttara Phalgunī (β, 93 Leonis)	The second Phalgunī	27	I (α Crateris)	12	as-Sarfah (β Leonis)	β Leonis	2.23	+ 12 16	171 1
13	11	Hasta (δ, γ, ε, α, β Corvi)	Hand	28	Chen (γ, ε, δ, β, η Corvi)	13	al-'awwā (β, η, γ, δ, ε Virginis)	δ Corvi	3.11	- 12 12	192 51
14	12	Citrā (α Virginis)	Bright	1	Ohio (α Virginis)	14	aḡ-Ṣimāk (α Virginis)	α Virginis	1.21	- 2 3	203 14

[210]

Stars of the Lunar Mansions—contd.

C. R.—35

Indian <i>Nakṣatra</i>				Chinese <i>Hsiu</i>		Arabic <i>Manzil</i>		Junction Star (<i>Yogalārā</i>) of the <i>Nakṣatra</i>	Magni- tude	Celestial Latitude	Celestial Longitude (1956)
No. (1)	No. (2)	Name	Meaning	No.	Name	No.	Name				
15	13	Svāti (<i>α</i> Bootis)	Sword	2	Kang (<i>ι, κ, λ, μ</i> Virginis)	15	al-Ghafr (<i>ι, κ, λ</i> Virginis)	<i>α</i> Bootis	0.24	+ 30° 46'	203° 38'
16	14	Viśākhā (<i>α, β, ι, γ</i> Librae)	Branched	3	Ti (<i>α, β, ι, γ</i> Librae)	16	az-Zubānay (<i>α, β</i> Librae)	<i>α</i> Librae (<i>ι</i> Librae)	2.90 (4.66)	+ 0 20 (- 1 51)	224 28 (230 23)
17	15	Anurādhā (<i>β, δ, π</i> Scorpii)	Propitious	4	Fang (<i>β, δ, π, ρ</i> Scorpii)	17	al-Iklīl (<i>β, δ, π</i> Scorpii)	<i>δ</i> Scorpii	2.54	- 1 59	241 58
18	16	Jyēṣṭhā (<i>α, σ, τ</i> Scorpii)	First born	5	Hsin (<i>α, σ, τ</i> Scorpii)	18	al-Qalb (<i>α</i> Scorpii)	<i>α</i> Scorpii	1.22	- 4 34	249 9
19	17	Mūla (<i>λ, υ</i> Scorpii)	Root	6	Wei (All the stars in the tail of Scorpion)	19	ash-Shaulah (<i>λ, υ</i> Scorpii)	<i>λ</i> Scorpii	1.71	- 13 47	263 59
20	18	Pūrvāṣāḍhā (<i>δ, ε</i> Sagittarii)	Former Unconquered	7	Chi (<i>γ, δ, ε</i> Sagittarii and <i>β</i> Telescopii)	20	an-Na'ajim (<i>γ, δ, ε, η, θ, σ, τ, ζ</i> Sagittarii)	<i>δ</i> Sagittarii	2.84	- 6 28	273 58
21	19	Uttarāṣāḍhā (<i>θ, τ, σ, γ</i> Sagittarii)	Latter Unconquered	8	Tou (<i>θ, τ, σ, γ, λ, μ</i> Sagittarii)	21	al-Baldah (Space vacant of stars above the head of Sagittarius)	<i>σ</i> Sagittarii	2.14	- 3 27	281 47
—	20	Abhijit (<i>α, ε, ξ</i> Lyrae)	Victorious	9	Niu (<i>α, β</i> Capricorni)	22	Sa'd adh-dhābiḥ (<i>α, β</i> Capricorni)	<i>α</i> Lyrae	0.14	+ 61 44	284 42
22	21	Śravaṇa (Śroṇā) (<i>α, β, γ</i> Aquilae)	Ear (lame)	10	Nu (<i>ε, μ, υ</i> Aquarii)	23	S'ad-bula' (<i>ε, μ, υ</i> Aquarii)	<i>α</i> Aquilae	0.89	+ 29 18	301 10
23	22	Dhanīṣṭhā (Śraviṣṭhā) (<i>α, β, δ, γ</i> Delphini)	Wealthy (most famous)	11	Hsi (<i>β, ξ</i> Aquarii)	24	Sa'd-as-Su'ūd (<i>β, ξ</i> Aquarii)	<i>β</i> Delphini	3.72	+ 31 55	315 44
24	23	Śatabhiṣaj (Śatatārakā) (<i>λ</i> Aquarii and 100 adja- cent stars)	Hundred physicians (hundred stars)	12	Wei (<i>α</i> Aquarii ; <i>θ, ε</i> Pegasi)	25	Sa'd al-abbija (<i>α, γ, ζ, η</i> Aquarii)	<i>λ</i> Aquarii	3.84	- 0 23	340 58
25	24	Pūrva Bhādrapadā (<i>α, β</i> Pegasi)	Former auspi- cious feet	13	Shih (<i>α, β</i> Pegasi)	26	al-Fargh al-awwal (<i>α, β</i> Pegasi)	<i>α</i> Pegasi	2.57	+ 19 24	352 53
26	25	Uttara Bhādrapadā (<i>γ</i> Pegasi, <i>α</i> Andromedae)	Latter auspi- cious feet	14	Pi (<i>γ</i> Pegasi, <i>α</i> Andromedae)	27	al-Fargh al-tāni (<i>γ</i> Pegasi, <i>α</i> Andromedae)	<i>γ</i> Pegasi	2.87	+ 12 36	8 33
27	26	Revati (32 Stars of which sou- thernmost is <i>ζ</i> Piscium)	Wealthy	15	K'uei (16 Stars from <i>ψ</i> Piscium to <i>γ</i> Andromedae)	28	baṭn-al-Iḥūt (<i>β</i> Andromedae & other stars)	<i>ζ</i> Piscium	5.57	- 0 13	19 16

Note :—The first series of numbers under the column 'Indian *Nakṣatra*' starts from Aśvini as 1 following the Siddhāntic system, and the second series starts from Kṛttikā according to the older system which includes Abhijit.

CHAPTER V

Indian Calendar

5.1 THE PERIODS IN INDIAN HISTORY

The time-periods in Indian history necessary for our purpose are shown in the Chronological Table.

The earliest civilization so far discovered in India is the Harappā-Mohenjo-Daro civilization (sometimes also called the Indus-Valley civilization) named after the two ancient buried cities of Harappā in the Punjab and Mohenjo-Daro in Sind. They were first brought to light by the late R.D. Banerjee, Superintendent of the Western Circle of Archaeology of India in 1924. It has now been ascertained that this civilization extended right upto Ruar on the Sutlej in the east and to the Narmadā valley in the south. This civilization was certainly contemporaneous with the Mesopotamian civilizations of about 2500 B.C., nearly 500 years before the city of Babylon had risen to supremacy amongst the cities of Sumer and Akkad; and with the first dynastic civilization of Egypt. How far back it projected into the time-scale is not yet known, but certainly many thousand years back.

From the material records of the Indus-valley civilization, it is obvious that the Harappā-Mohenjo-Daro people had attained to as high a standard of civilization, if not higher, as the contemporary people of Iraq and Egypt. But the script has not yet been deciphered; it is therefore difficult to give a chronological history, but it is not so difficult to make a study of the attainments of this civilization in arts and sciences; they could build well planned cities, used a drainage system superior to that of contemporary Egypt or Iraq, used copper and bronze, and had evidently evolved a highly complex social organization.

All civilized communities have been found to have evolved accurate systems of weights and measures and some kind of calendar for the regulation of social life. We have some evidences of the use of standard weights and measures in the Indus valley.

But had they evolved a calendar? The presumption is that they must have, but nothing has yet been discovered amongst the artefacts left by these people so far recovered by the Archaeological Survey which throws light on the calendar, or the system of time-measurement they used.

It is held on quite sound grounds that the Harappā-Mohenjodāro people were succeeded in the Punjab and in the valley of the now lost Sarasvatī river by the Aryan people who were either autochthonous or more probably came through Afghanistan in single or

successive streams between 2500 B.C. and 1500 B.C. Others would go further back in time-scale from certain astronomical evidences.

Few, almost none of the material records or artefacts of the early Aryans except some potteries tentatively ascribed to them, have so far been discovered. Almost the whole of our knowledge about them are derived from the hymns of the R̥g-Vedas which were composed by priestly families amongst them in an archaic form of Sanskrit (Vedic Sanskrit), in honour of the gods they worshipped; in these hymns are found occasional references to the sun, the moon, certain stars, and to months and seasons. Some think that there are also references to planets, *i.e.*, the Vedic Aryans could distinguish between fixed stars and planets, but this is doubtful. From certain references which we discuss in § 5.2, we may conclude that they used an empirical luni-solar calendar. Probably this was used till 1300 B.C. We do not come across sufficient material records until we come to the time of Aśoka about 270 B.C.

What was the calendar during the period 1300 B.C.—250 B.C.? The *Yajur-Veda*, the *Brāhmaṇas*, the *Upaniṣads* and other post R̥g-Vedic literature, and the early Buddhistic literature contain occasional astronomical references, from which the nature of the calendar used for ceremonial and other purposes can be inferred. The interpretation of the texts is neither easy, nor unambiguous. The latter part of this period has been called by S. B. Dīkṣit, our pioneer in calendar research, as the *Vedāṅga Jyotiṣa period*. This is discussed in § 5.4.

The Vedāṅga Jyotiṣa calendar appears to have been almost completely free from foreign influence, though this point of view has been contested. The Persian conqueror Darius conquered Afghanistan, and Gāndhār, about 518 B.C.; this region appears to have continued under the Achemenids for nearly two centuries. The Achemenids used a solar calendar probably adopted from Egypt in contrast to the luni-solar calendar of India, but this does not appear to have disturbed the indigenous luni-solar calendarical system.

The Vedāṅga Jyotiṣa period, which as we shall show, was continued by Indian dynasts up to the time of the Sāta-yāhanas (200 A.D.), was succeeded by the *Siddhānta Jyotiṣa* period, but the first record of this period is available only about 400 A.D. The transi-

tional period from 100 A.D. to 400 A.D. is one of the darkest periods in Indian chronology. Due to successive invasions by Macedonian and Bactrian Greeks (*Yavanas*), Parthians (*Pallavas*), Śakas and Kuṣāṇas, the period from 300 B.C. to 200 A.D. is one of large foreign contacts which profoundly modified Indian life in arts, sciences, sculpture and state-craft. But the history of this period was entirely forgotten and is being recovered bit by bit from inscriptions, foreign references, and from artefacts recovered in excavations of the sites occupied by invaders of this period. Let us give a bird's eye view of the history of this period, imperfect as it is, so that the reader may follow without strain our account of the transition of the *Vedāṅga Jyotiṣa* calendar to *Siddhāntic* calendar.

In 323 B.C., Alexander of Macedon raided the Punjab, but this incident by itself had no such profound influence on Indian life as is generally made out. Its influence was rather indirect. In India, it gave rise to a great national movement of unification under Candragupta and Cānakya. In the former empire of Darius, it gave rise to a number of Greek states which became the focus of radiation of Greek culture throughout the East. The most important were Egypt under the rule of the Ptolemies, with capital at Alexandria, and the Near East under the Seleucids with capital at Babylon, which was succeeded a few years later by Seleucia a few miles distant from later Baghdad. In 306 B.C., Candragupta and Seleucus faced each other, but the Greek army was rolled back to the borders of modern Iran, and almost the whole of modern Afghanistan except Bactria (modern Balkh) constituting the four satrapies of the old Persian empire were ceded to India. They continued to be politically and culturally parts of India till the tenth century A.D.

The Mauryas kept out the Greeks till 186 B.C., when on the break-up of their empire, the Greek settlers in Bactria who had revolted from their overlords, the Seleucids, began to make inroads into India. There were two rival Greek houses, the earlier, the Euthydemids who under Demetrius and Menander (175 B.C.) took possession of the Punjab and Sind between 180 B.C. to 150 B.C. and threatened even Pātaliputra but were rolled back beyond the Jamunā by the Śuṅgas; the line of Eukratidas who ousted Demetrius and his line from Bactria and Afghanistan proper about 160 B.C., reigned in Afghanistan up to 50 B.C. But there rose about 226 B.C., a great barrier between the Eastern Greeks (Bactrians and Indian Greeks) and the Western Greeks in the shape of the Parthian empire (248 B.C.), which became very powerful under Mithradates I

(175—150 B.C.), who controlled the whole of Iran and wrested Bactria from the line of Eukratidas in 138 B.C.

But inspite of these political happenings, Greek remained the language of culture throughout the whole Near East, from Asia Minor to North-Western India. The Parthians since 128 B.C. called themselves 'Philhellens' or lover of Greek culture and used Greek on their coins, and the Graeco-Chaldean method of date-recording on their inscriptions. But about 140 B.C., a new power was on the move, *viz.*, the Śakas from Central Asia; they began to emerge as a ruling race from about 138 B.C. In 129 B.C. they attacked Bactria, and by 123 B.C. they wrested it completely out of the Parthian empire, after defeating and killing on the battlefield two successive Parthian emperors, *viz.*, Phraates II (128 B.C.) and Artabanus I (123 B.C.).

The early Śakas appear from their coins to have been under the spell of Greek civilization, and used Greek as a language of culture and put motifs taken from Greek mythology on their coins. Pressed by the next Parthian emperor, Mithradates II (123—90 B.C.), they poured by 80 B.C., into the whole of what is modern Afghanistan, except the Kabul valley, which the Greeks held for sometime. Their new territory became known as 'Śakasthān' comprising modern Afghanistan and parts of N.W. India. From Afghanistan, they poured in successive streams to Mālwa, Guzrāt, Taxilā about 70 B.C., and to Mathurā, somewhat later and had put an end to the numerous Greek principalities in the Punjab. Their further progress was barred by the Sātavāhanas in the South, and numerous small kingdoms which arose in the Gangetic valley on the break-up of the Śuṅga and Kāṇva empires (45 A.D.). After 50 A.D., the Śakas of the North were supplanted by the Kuṣāṇas belonging to a kindred race, and speaking the Śaka language; they ruled Northern India from their capitals at Peshawar and Mathurā up to at least 170 A.D. Contemporaneously with them, were the Śaka Satrap houses of Ujjain, who started ruling from about first century of the Christian era.

A chart of these historical incidents is attached for the sake of elucidation as they are necessary for the comprehension of the extent and amount of Greek culture, which was propagated into India, *not so much through the Greeks directly*, but as it appears now, indirectly through the early Śakas and their successors, the Kuṣāṇas.

It now appears very probable that it was during the regime of the Śaka and Kuṣāṇa rulers (100 B.C.-200 A.D.) that a knowledge of the Graeco-Chaldean astronomy, which had developed in the Grecian world after 300 B.C., and ended with the astronomer

Ptolemy (150 A.D.), and in the Near East under the Seleucids (300 B.C. to 100 A.D.), penetrated into India, being brought by astronomers belonging to the Śaka countries, who later were absorbed into Indian society as Śākadvīpī or Scythian Brahmins. The borrowings appear to be more from Seleucid Babylon than from the west. The knowledge of Graeco-Chaldean astronomy was the basis on which the calendar prescribed by the *Sūrya Siddhānta* and other *Siddhāntas* were built up. It completely replaced the former *Vedāṅga Jyotiṣa* calendar and by about 400 A.D. when the *Vedāṅga Jyotiṣa* calendar had completely disappeared from all parts of India.

From 400 A.D. to 1200 A.D., almost the whole of India used calendars based on *Siddhānta Jyotiṣa* for date-recording. All Indian astronomers used the Śaka era for purposes of accurate calculations, but its use for date-recording by kings and writers was generally confined to parts of the South. In general, the Indian dynasties used eras of their own, or regnal years, though the annual calendar was compiled according to rules laid down either in the *Sūrya Siddhānta*, the *Ārya Siddhānta* or the *Brahma Siddhānta*. These did not much differ in essentials.

When India since 1200 A.D. fell under Islamic domination, the rulers introduced the lunar Hejira calendar for civil and administrative purposes as well. Indian calendars were retained only in isolated localities where Hindus happened to maintain their independence, or used only for religious purposes. The emperor Akber in 1584 tried to suppress the Hejira calendar for administrative purposes by the *Tārīkh-Ilāhī*, a modified version of the solar calendar of Iran, but this fell in disuse from about 1630. Since the advent of British rule in 1757, the Gregorian calendar has been used for civil and administrative purposes, which is still being continued.

We have attempted to give below short accounts of calendars in use in different epochs of history.

5.2 CALENDAR IN THE RIG-VEDIC AGE

(—1200 B.C.)

The Vedic Literature : The knowledge of the calendar in this age can be obtained only from the Vedic literature which consists however of different strata, greatly differing in age. According to the great orientalist Max Müller four periods each presupposing the preceding can be distinguished. They are :—

(a) *The Chandas and Mantras* composing the *Samhitās* or collections of hymns, prayers, incantations, benedictions, sacrificial formulas, and litanies

comprising the four Vedas : The Ṛk, Sāma, Yajus, and Atharva.

(b) *The Brāhmaṇas* which are prose texts containing theological matter, particularly observations on sacrifices and their mystical significances ; attached to the *Brāhmaṇas*, but reckoned also as independent works are the *Āraṇyakas* or *Upaniṣads* containing meditations of forest hermits and ascetics on God, the world, and mankind. These treatises are attached to each of the individual Vedas.

(c) *The Sūtras* or Aphorisms, or *Vedāṅgas*.

'*Vedāṅgas*', *lit.* limbs of Vedas, are post-Vedic *Sūtra* or aphorism literature which grew as results of attempts to understand the Vedas in their various aspects, and sometimes to develop the ideas contained in the Vedas. According to the orthodox view, there are six *Vedāṅgas* as follows :

(1) *Śikṣā* : or phonetics ; texts explaining how the Vedic literature proper is to be pronounced, and memorized.

(2) *Kalpa* : or ritualistic literature, of which four types are known : *Śrauta Sūtras* dealing with sacrifices ; *Gṛhya Sūtras* dealing with domestic duties of a householder ; *Dharma Sūtras* dealing with religious and social laws ; *Sūlva Sūtras* dealing with the construction of sacrificial altars.

(3) *Vyākaraṇa* : or Grammar, *e. g.*, Pāṇini's famous *Aṣṭādhyāyī*, which once for all fixed up the Sanskrit language. The *Aṣṭādhyāyī* is however the culmination of attempts by large number of older authors, whose works were rendered obsolete by Pāṇini's masterpiece.

(4) *Nirukta* or Etymology: explanation of the Vedic words ascribed to one Yāska, who lived before Pāṇini.

(5) *Chandas*—Metrics ascribed to Piṅgala.

(6) *Jyotiṣa*—Astronomy: the Ṛg-Jyotiṣa is ascribed to one Lagadha, of whom nothing is known.

Only the sixth *Vedāṅga* or *Jyotiṣa* interests us, though there are occasional references to the calendar in all *Sūtra* literatures.

Age of the Vedic Literature *

The above gives the 'Philologists' stratification of the age of the Vedic literature. About the actual age of each strata, there is great divergence of opinion, though it is admitted that the oldest in point of age are the *Samhitās*, then come the *Brāhmaṇas* and

* Much of the substance-matter of this section is taken from Winternitz's *A History of Indian Literature* Vol. I, published by the University of Calcutta. Chap. I, on Vedic Literature.

Upaniṣads, next the *Sūtras* or the *Vedāṅgas*. Of the four Vedas, the Ṛg-Vedas are by common consent taken to be the earliest in age and as Winternitz remarks, though all subsequent Indian literature refers to the Ṛg-Vedas, they presuppose nothing extant.

Max Müller made a rough assignment of age to the different strata as follows on the assumption that the Brāhmaṇic and Upaniṣadic literature predated the rise of Buddhism, and that the *Sūtra* literature which may be synchronous with the Buddhistic literature may be dated 600 B.C. to 200 B.C. Working backwards he assigned the Brāhmaṇic literature to 600 B.C. to 800 B.C., the interval 800 B.C. to 1000 B.C. as the period in which the collections of hymns were arranged, and 1000 B.C. to 1200 B.C. as the period of the beginning of Vedic poetry. He always regarded these periods as *terminus ad quem*, and in his Gifford Lectures on Physical Religion in 1889, he expressly states "that we cannot hope to fix a *terminus a quo*. Whether the Vedic hymns were composed 1000, 1200, 2000 or 3000 years B.C., no power on earth will ever determine. *

It is not correct therefore to say, as some people say, that Max Müller had proved that 1200-1000 B.C. is the date of the Ṛg-Vedas. †

Other authorities, Schrader, Tilak, Jacobi, and P. C. Sengupta have found much older age for Ṛg-Vedic Indians: in fact, even as early as 4000 B.C., for some incidents described in the Ṛg-Vedas.* But their arguments, being based on interpretations of vague passages assumed to refer to astronomical phenomena have not commanded general recognition.

Let us first look at the strata within the Ṛg-Veda itself. The Ṛg-Vedas are divided into 10 *Maṇḍalas* (lit. circles) or books. Of these, the 2nd to the 8th books are ascribed to certain priestly families, e.g. the 2nd book is ascribed to *Grītsamadas*, the 3rd to the *Viśvāmitras*, etc. These are agreed to be the oldest parts of the Vedas.

The ninth book is devoted to *Soma* which is an intoxicating drink pressed out of a plant. The drink was dear to the Aryans and is also mystically identified with the Moon.

* For details about Vedic antiquity, see *Ancient Indian Chronology* by P. C. Sengupta.

† It appears that Max Müller has been a bit dogmatic in his opinion. Shortly after his death the names of the Vedic gods, *Indra*, *Varuṇa*, *Mitra* and the *Nāsatyas* in their Ṛg-Vedic forms were discovered in the Hittite clay tablets discovered at Boghaz Kuei in Asia Minor. They have been assigned to about 1450 B.C. More evidences about the Vedic Aryans were discovered in the excavations in the Sarasvati valley now being undertaken by the Archaeological Dept. of the Govt. of India. Further, fresh evidences are expected also in the archaeological work undertaken in Afghanistan, Iran and Central Asia.

The first and the tenth books are miscellaneous collections ascribed to different authors. They are taken to be the latest in age.

The Ṛg-Vedas consist of 1028 hymns, containing over 40,000 lines of verses.

The Vedas are regarded as '*Śrutis*' or "revealed knowledge preserved by hearing." According to savants, they were the *outpourings of the heart and mind*, of ancient priestly leaders, to their gods which were mostly forces of nature, intermingled very often with secular matter. Priestly families were trained to memorize the texts and pass them on to succeeding generations in ways which guaranteed their transmission without error or alteration of the text. Savants are almost unanimous in their opinion that the Ṛg-Vedic texts which were composed in an archaic form of Sanskrit, which was not completely understood even in 500 B.C., have come to us without change. The orthodox Indian view that they are revealed knowledge is of course not shared by scholars, both eastern and western, who point out that very often in the text of the Vedas themselves and in *Anukramaṇis* or introductions to texts, the authors of each hymn are mentioned by name and family.

To which locality are the Vedas to be ascribed?

As regards locality, they are certainly to be ascribed to parts of Afghanistan, east of the Hindukush and the Punjab. The rivers of the Punjab, the Indus and its tributaries on both sides and the now lost Sarasvatī are frequently mentioned, the Ganges only once in a later text. The authors call themselves *Āryas* or Aryans, in contrast to the *Dāsas* or *Dasyus* who were alien to them, and with whom they came in frequent clash. The Dasyus are now taken to be partly Indus valley people, partly aboriginals.

The Ṛg-Vedas describe a highly complex society of priests, warriors, merchants and artisans, and slaves but the rigid caste system had not yet developed. There are also references to cities, but no artefacts except some pottery, have yet been discovered which can be referred to the Ṛg-Vedic Aryans.

The Ṛg-Vedic Aryans, it appears, were contemporaneous (if not older) with the great civilizations of Mesopotamia, both Sumerian, and later Accadian, and according to one view, some of the royal families of Asia Minor, were probably '*Vedic Aryans*'. It is therefore quite probable that they had attained as high a stage of civilization as that of Egypt of the Pyramid builders (2700 B.C.), or of Sumer and Accad under Sargon I.

Let us see what information we can gather about the calendar which they must have used; for no civilized community can be without a calendar.

Further, the whole life of Vedic Aryans was centred round sacrifices to their great gods ; and sacrifices had to be carefully timed with respect to seasons, and moon's phases. In fact, some sacrifices were year-long, as Dr. Martin Haug, the great Vedic scholar remarks in his introduction (p. 46) to *Aitareya Brāhmaṇa* (affiliated to the Rg-Veda).

"The Sattras [or sacrifices] which lasted for one year, were nothing but an imitation of the sun's yearly course. They were divided into two distinct parts, each of six months of thirty days each ; in the midst of both was the *Viṣuvān*, i.e., equator, or central day, cutting the whole Sattra into two halves".

This refers to somewhat later times than the Rg-Veda, but even during these early times, the sacrificial cult was fully developed. Let us see what references we get about the calendar from the Rg-Vedic times.

Calendaric and Astronomical References in the Rig-Vedas

These are few, and interspersed along with other matter. This is not to be wondered at, for the hymns are addressed chiefly to the gods, *Agni* (sacrificial fire), *Indra* (the national warrior god), etc., and other references are only incidental. The direct references are found only in Books 1 and 10 which are later in age than the family books.

Let us give the texts of a few hymns and their translations in English.

Rg-Veda, 1.164.11

Dvādaśāraṃ nahi tajjarāya varvarti cakraṃ
paridyāmṛtasya
Ā putrā agne mithunāso atra sapta śatāni
viṃśatisca tasthuḥ.

Translation : The wheel (or time) having twelve spokes revolve round the heavens, but it does not wear out. Oh Agni ! 720 pairs of sons ride this (wheel).

Here the year is likened to a wheel, having 12 spokes (or months) ; the 720 pairs of sons are 360 days and nights.

The interpretation commonly accepted is that the year was taken to consist of 360 days divided into 12 months, and the night and the day (following or preceding) constituted a couple.

Rg-Veda, 1.164.48.

Dvādaśa pradhayaścakramekaṃ trīṇi nabhyāni
ka u tacciketa
Tasmin tsākaṃ trisatā na śaṅkavo'rpitāḥ
śaṣṭirna calācalāsaḥ.

Translation : Twelve spoke-boards : One wheel : three navels. Who understands these ? In these there are 360 śaṅkus (rods) put in like pegs which do not get loosened".

The year is compared to a revolving wheel, whose circumference is divided into 12 parts (twelve months). They are grouped into three navels (seasons).

Here also we have a year of 360 days, divided into 12 months, four months constituting a season, as we find in the oldest inscriptions.

If the interpretation of the last passage is correct, we have the earliest reference to the later *cāturmāsya* system, or division of the year into three seasons each of four months.

It appears from these passages that Vedic Aryans had once a year of 360 days as ancient Egyptians also had, but they discovered later that this was not the correct value either for 12 lunar months, or for a seasonal year. For the following reference shows that they used also a *thirteenth month*.

Rg-Veda, 1. 25. 8

Veda māso dhṛtavrato dvādaśa prajāvataḥ
vedāya upajāyate.

Translation : *Dhṛtavrata* (*Varuṇa*) knows the twelve months : (and) the animals created during that period ; (and) he knows (the intercalary month) which is created (near the twelve months).

This passage makes it clear that the calendar was luni-solar. But how was the adjustment made ?

A hymn in the *Rg-Veda* first noted by Tilak comes to our help.

Rg-Veda, 4. 33. 7

Dvādaśa dyūn yadagohyasyā tithye raṇannṛbbabaḥ
sasantaḥ.
Sukṣetrākṛnvannanayaṃ ta sindhūn dhanvātiṣṭha
nnoṣadhīr nimnamāpaḥ.

Translation : When the *Rbhus* sleeping for twelve days have made themselves comfortable as guests of the unconcealable (sun), they bring the fields in good order and direct the rivers. The plants grow in wildernesses, and lowland is spread with water".

According to Tilak, the *Rbhus* are the genii of seasons. They are said to enjoy the hospitality of the sun for twelve days in the above verse. This passage, according to Tilak means the adjustment of the solar year with the lunar (i.e., 366—354=12 days).*

* cf. *Ancient Indian Chronology*, Chapter VI.

Another hymn from Atharva Veda (4.11.11) states that: 'Prajapati, the lord of yearly sacrifices after finishing one year's sacrifice, prepared himself for the next year's sacrifice'.

The sacrificial literature of India still preserves the memory of these days by ordaining that a person wishing to perform a yearly sacrifice should devote 12 days (*dvādaśāha*) before its commencement to the preparatory rites.

Did the Ṛg-Vedic Aryans have any knowledge of the lunar zodiac, or designate the days by the lunar mansions, as we find widely prevalent during later times?

There is no explicit reference to this point, but words which are now used to denote the lunar mansions are found in several verses of the Ṛg-Vedas, e.g.,

Citrā (a *Virginis*) is mentioned in RV. 4-51-2

Maghā (a *Leonis*) is mentioned in RV. 10-85-13 but in these passages the meaning of these words is not very clear.

The following references are more explicit.

Ṛg-Veda, 5. 54. 13

Yuṣmā datrasya Maruto vicetaso rāyaḥ syāma
rathyo vayasvataḥ na yo yucchati tiṣyo yathā
divo'sme rāranta Marutaḥ sahasriṇām.

Translation: You wise *Maruts*, we would like to be disposer of the wealth conferred by you on us; it should not deviate (from us) as *Tiṣya* does not deviate from the heavens.

Here one is tempted to identify the word '*Tiṣya*' with the lunar asterism of that name, *viz.*, *Puṣya* (δ *Cancer*).

The following reference is more explicit.

Ṛg-Veda, 10. 85. 13

Sūryāyā vahatuḥ prāgāt savitā yamavāsṛjat.
Aghāsu hanyante gāvo'rjunyoḥ paryuhyate.

Translation: The (dowry) of cows which was given by *Savitā* (Sun) had already gone ahead of *Suryā*. On the *Aghā*-day, the cattle were slain (acc. to *Sāyaṇa* had departed), on the two *Arjunī*-days, she was led to the bridegroom's house.

This passage occurs in the famous bridal hymn, where the Sun god (*Savitṛ*) gives away his daughter *Suryā* to *Soma* (Moon) in marriage. It says that on the *Aghā*-day the cows, given as bridal dowry are, driven away; on the two *Arjunī*-days, the bride goes to the bridegroom's house.

This hymn is repeated in the *Atharva Samhitā* as follows:

Atharva Samhitā, 14.1.13

Sūryāyā vahatuḥ prāgāt savitā yam avāsṛjat
Maghāsu hanyante gāvaḥ phalguniṣu vyuhyate.

Translation: The first line is identical. In the second line, the only change is *Maghā* for *Aghā*, and *Phalgunī* for *Arjunī*. In the lunar zodiac, *Maghā* stands for lunar asterism No. 10, of which the chief star is a *Leonis*. The two *Phalgunī* stars, *Uttara Phalgunī* (No.12) and *Purva Phalgunī* (No. 11) stand for β *Leonis* and δ *Leonis*.

This verse shows that the custom of designating the day (it means day and night) by the lunar asterism in which the moon is found in the night, which is found widely in vogue in later times, and is used even to-day for religious purposes, was in use at the time when this hymn was written. The practice therefore dates earlier than 1200 B.C. at least.

Longer periods of Time : The Yuga

'Yuga' is a very common word used in Indian literature of all times to denote an integral number of years when certain astronomical events recur. It exactly corresponds to the Chaldean word 'Saros' which has gone into international vocabulary. In later Indian literature we have Yugas of all kinds: the five yearly yuga, sixty yearly yuga, and Mahāyugas of $4 \cdot 32 \times 10^6$ years. Was any Yuga, known in Ṛg-Vedic times?

There is evidence that some kind of a short period yuga, probably the five yearly yuga of later times, in which the moon's phases roughly recur, and which was the chief theme of the *Vedāṅga Jyotiṣa* was known in Ṛg-Vedic times as the following quotation shows:

Ṛg-Samhitā, 1.158.6

Dirghatamā māmateyo jujurvān daśame yuge
apāmarthaṁ yatinām Brahmā bhavati sārathiḥ.

Translation: *Dirghatamā* the son of *Mamatā* having grown old in the tenth yuga became the charioteer of the *karma* which leads to semi-result.

The most rational explanation of the word yuga here is probably the five yearly yuga of *Vedāṅga Jyotiṣa* for it is rational to expect that a man becomes old after he attains the 50th year. But there have been other explanations.

The Seasons and the Year

The most commonly used word for year in the Indian literature is *Varṣa* or *Vatsara*. The word '*Versa*' is very similar to *Varṣā*, the rainy season, and is probably derived from it. But curiously enough, this word is not found in Ṛg-Vedas. But the words *Śarad* (Autumn), *Hemanta* (early Winter) etc., are very often found to denote 'seasons' and sometimes years.

just as in English we very often say 'A young lady of eighteen summers'.

Summary : The above passages show that the R̥g-Vedic Aryans, who must be placed at least before 1200 B.C., had a luni-solar calendar, and used intercalary months. We do not have, however, their names for the 12 months, and there is no clue to find out how the intercalary month which is mentioned at one place was introduced. It appears that they denoted individual days by the *nakṣatra* i.e., by the lunar asterism in which the moon is found at the night, and hence it is permissible to deduce that they used the lunar zodiac for describing the motion of the moon. There is no mention of the *tithi* (or the lunar day) widely used in Indian calendars, in the R̥g-Vedas. The solar year was probably taken to consist of 366 days, of which 12 were dropped for luni-solar adjustment.

5.3 CALENDARIC REFERENCES IN THE YAJUR VEDIC LITERATURE

The Atharva Veda consisting mostly of magic incantations also contain calendaric references, but we shall make only occasional use of them, as the text of this Veda has not probably come to us in unadulterated form, for the Atharva Veda was not regarded as holy as the R̥g-Veda.

Of the two other Vedas, the Sāma-Vedas contain no new matter than what is contained in the R̥g-Veda. But there are copious calendaric reference in the Yajurveda for obvious reasons, which are clearly brought out in the following extracts from Winternitz's introductory remarks to Yajurvedic studies (p. 152-159) :

"The two Saṁhitās [R̥k and Atharva] which have so far been discussed have in common the fact that they were not compiled for special liturgical purposes. Although most of the hymns of the R̥g-Veda could be, and actually were used for sacrificial purposes, and although the songs and spells of the Atharvaveda were almost throughout employed for ritualistic and magic purposes, yet the collection and arrangement of the hymns in these Saṁhitās have nothing to do with the various liturgical and ritualistic purposes. The hymns were collected for their own sake and arranged and placed, in both these collections, with regard to their supposed authors or the singer-schools to which they belonged, partly also according to their contents and still more their external form-number of verses and such like. They are as we may say, collections of songs which pursue a *literary* object.

It is quite different with the Saṁhitās of the two other Vedas, the Sāmaveda and the Yajurveda. In these collections we find the songs, verses, and benedictions arranged

according to their practical purposes, in exactly the order in which they were used at the sacrifice. These are, in fact, nothing more than *prayer-books and song-books* for the practical use of certain sacrificial priests—not indeed written books, but texts, which existed only in the heads of teachers and priests and were preserved by means of oral teaching and learning in the priests' schools.*

The Yajurvedas were compiled for the use of the Adhvaryu priest "*Executor of the Sacrifice*" who performs all the sacrificial acts, and at the same time uttering prose prayers and sacrificial formulæ (Yajus). They are the liturgical Saṁhitās, and prayer books of the priests.

Winternitz gives reasons to believe that the Saṁhitās of the Black Yajurveda school are older than those of the White school.

Even such a conservative thinker as Berriedale Keith gives 600 B.C. as the *terminus ad quem* for the verses of the Yajurveda Saṁhitā. As we shall see, there are references which point to a much earlier origin.

The Yajur-Veda gives the names of twelve months, and the names of the lunar mansions with their presiding deities, and talks of the sun's northernly and southernly motion. We do not give the texts here, but only Dr. Berriedale Keith's translation.

Taittirīyā Saṁhitā, 4.4.11

- (a) (Ye are) Madhu and Mādhava, the months
of Spring.
- (b) (Ye are) Śukra and Śuci, the months of Summer.
- (c) (Ye are) Nabha and Nabhasya, the months
of Rain.
- (d) (Ye are) Iṣa and Ūrja, the months of Autumn.
- (e) (Ye are) Sahas and Sahasya, the months
of (Early) Winter (*Hemanta*).
- (f) (Ye are) Tapas and Tapasya, the months of
cool season.

* There are two schools of the Yajurveda Saṁhitā each with a number of recensions as shown below :

1. The Black Yajurveda School, with the following recensions :
 - (a) The Kaṭhaka
 - (b) The Kapiṣṭhala-Kaṭha-Saṁhitā, which is preserved only in a few fragments of manuscript.
 - (c) The Maitrāyaṇī-Saṁhitā—shortly called M. S.
 - (d) The Taittirīya-Saṁhitā, also called "Āpastamba-Saṁhitā" after the Āpastamba-School, one of the chief schools in which this text was taught—shortly called T. S.

These four recensions are closely inter-related, and are designated as belonging to the "Black Yajurveda". Differing from them is the White Yajurveda which is known as Śukla Yajurveda.

2. The Vājasaneyī-Saṁhitā shortly called V. S. which takes its name from Yājñavalkya Vājasaneyā, the chief teacher of this Veda. Of this Vājasaneyī-Saṁhitā there are two recensions, that of the Kāṇva and that of the Mādhyandina-school, which however differ very little from each other.

The month-names which are given here and repeated in many other verses of the Yajur-Veda have been interpreted by all authorities to be tropical. Further this is probably the earliest mention of month-names in Indian literature ; these names are no longer in use, and have been replaced by lunar month-names (*Caitra*, *Vaiśākha*, etc.) which are, however, found at a later stage.

Madhu and *Mādhava* have been taken in later literature to correspond to the time-period when the sun moves from -30° to 30° along the ecliptic, and so on for the other months. But we have no reason to believe that the Yajurvedic priests had developed such a fine mathematical sense of seasonal definition. But it is almost certain that they must have developed some method of observing the cardinal points of the sun's yearly course, *viz.*, the two solstices and the equinoxes. From these observations, they must have counted that the number of days in a year was 366 in round numbers.

The Yajur-Veda speaks in many places of the *Uttarāyana*, the northernly course of the sun from winter solstice to summer solstice and the *Dakṣiṇāyana* or the southernly course from summer solstice to winter solstice and the *Viśuvān*, or the equinoctial point. The *ayanas* or courses must have received their designation from daily notings of sunrise on the eastern horizon. The year-long observation of shadows cast by a gnomon, of which we have evidences, may have formed an alternative method for fixing up the solstitial days, and the cardinal points on the horizon, (*vide* Appendix 5-C), where some passages from the *Aitareya Brāhmaṇa* attached to the Rg-Veda are stated in favour of the view that the cardinal points were observed by means of the gnomon.

Once they learnt to anticipate the cardinal days, determination of the month-beginnings marking seasons would not be difficult. The *Madhu*-month (the first month of spring) would begin 30 or 31 days before the vernal equinox day or 61 days after the winter solstice day, and the *Mādhava* month on the day after the equinoctial day and so on. Average length of $30\frac{1}{2}$ days ($=\frac{366}{12}$) would be given to each month, or 30 and 31 days to the two months forming a season.

The Nakshatras

One of the peculiar features of the Indian calendars is the use of the *Nakshatras* as explained in § 4'1. Evidences have been given that the custom started from Rg-Vedic times. But we come across a full list of *Nakshatras* only in the Yajurveda with names of presiding deities as given in Table No. 10 (p. 220), taken from Dikṣit's *Bhāratīya Jyotiśāstra*.

There are several points to be noticed in this list, which may be compared with the list given on p. 210.

First, the *nakṣatras* start with *Kṛttikās* which all authorities identify with the conspicuous group Pleiades. What is the significance of this ?

At the present times, the *nakṣatras* start with *Aśvini*, of which the junction star is α or β *Arietis*. This custom, *Aśvinyādi*, was introduced in Siddhānta Jyotiṣa time (500 A.D.), when the astronomical first point of Aries was near the end of the *Revati nakṣatra* (ζ *Piscium*), or the beginning of *Aśvini*. We do not enter into the controversy about the exact location of this point by the Siddhānta astronomers, which is fully discussed in Appendix 5-B. At present, the astronomical first point had shifted by as much as 19° from ζ *Piscium*, but the orthodox Indian calendar makers do not admit in the continued precession of the equinoxes, and still count the *nakṣatras* from *Aśvini*.

In all older literatures, on the other hand, including the great epic *Mahābhārata*, whose composition or compilation may be dated about 400 B.C., the first *nakṣatra* is *Kṛttikā*. It therefore stands to reason to assume that at one time, when the *nakṣatra* enumeration started, the Pleiades were close to the astronomical first point of Aries, or rose near the true east. This is implied in the following verse which S. B. Dikṣit picked out of the *Śatapatha Brāhmaṇa* :

Śatapatha Brāhmaṇa, 2.1.2.

Ekam dve triṇi catvāriti vā anyāni
nakṣatrānyathaitā eva bhūyīṣṭhā yat kṛttikā....
Etā ha vai prācyai diśo na cyavante
sarvāni ha vā anyāni nakṣatrāṇi
prācyai diśaścyavante.

Translation :—Other *nakṣatras* have one, two, three or four (stars) only ; these *Kṛttikās* have many (stars)...They do not deviate from the east ; all other *nakṣatras* deviate from the east.

The names as given in this list are somewhat different from those now adopted, which have come into vogue since 500 A.D.; for example, we have :

- No. 6 Tiṣya for Puṣya
- No. 16 Rohiṇi for Jyeṣṭhā
- (There are thus two Rohiṇis, No. 2, and No. 16).
- No. 17 Vicṛtau for Mūla
- No. 20 Śroṇā for Śravaṇa
- No. 21 Śraviṣṭhā for Dhaniṣṭhā
- No. 23 Proṣṭhapada for Bhādrapada
- No. 26 Aśvajuya for Aśvini
- No. 27 Apabharaṇī for Bharāṇī

The more important question is whether the lunar mansions denote definite clusters of stars, or the *nakṣatra*-divisions of later times, amounting to $13^\circ 20'$ or $800'$ minutes ? This point has been discussed in § 4'1.

Table 10.

Names of Nakshatras in the Yajurveda with their Presiding Deities

No.	Name of Nakshatra	Presiding Deity	Number* (Grammatical)	Principal Star	Longitude (1950'0)	Latitude
1.	Kṛttikā	Agni	P	η Tauri	59° 17' 39"	+ 4° 2' 46"
2.	Rohiṇī	Prajāpati	S	α Tauri	69 5 25	- 5 28 14
3.	Mṛgaśīrṣa	Soma	S	λ Orionis	83 0 31	- 13 22 32
	Invakā	"	P			
4.	Ārdrā	Rudra	S	α Orionis	88 3 22	- 16 1 59
	Bāhū	"	D			
5.	Punarvasu	Aditi	D	β Geminorum	112 31 29	+ 6 40 51
6.	Tiṣya	Bṛhaspati	S	δ Cancri	128 1 23	+ 0 4 32
7.	Āśreṣā	Sarpa	P	ε Hydrae	131 38 59	- 11 6 25
8.	Maghā	Pitṛ	P	α Leonis	149 8 1	+ 0 27 48
9.	Phalgunī	Aryamā	D	δ Leonis	160 36 52	+ 14 19 58
	Pūrva Phalgunī					
10.	Phalgunī	Bhaga	D	β Leonis	170 55 23	+ 12 16 13
	Uttara Phalgunī					
11.	Hasta	Savitā	S	δ Corvi	192 45 23	- 12 11 31
12.	Citrā	Indra, Tvaṣṭā	S	α Virginis	203 8 37	- 2 3 4
13.	Svāti	Vayu	S	α Bootis	203 32 8	+ 30 46 3
	Niṣṭyā					
14.	Viśakhā	Indrāgni	D	α Libræ	224 23 7	+ 0 20 19
15.	Anurādhā	Mitra	P	δ Scorpī	241 52 23	- 1 53 49
16.	Rohiṇī	Indra	S	α Scorpī	249 3 51	- 4 33 50
	Jyeṣṭhā					
17.	Viṣṭau	Pitṛ	D	λ Scorpī	263 53 14	- 13 46 56
	Mūlabarhaṇī, Mūla	Nirṛti, Prajāpati	S			
18.	Aṣādhā	Āpah	P	δ Sagittarii	273 52 55	- 6 27 58
	Pūrvāṣādhā					
19.	Aṣādhā	Viśvedeva	P	σ Sagittarii	281 41 11	- 3 26 36
	Uttarāṣādhā					
—	Abhijit	Brahma	S	α Lyrae	284 36 54	+ 61 44 7
20.	Śroṇā	Viṣṇu	S	α Aquilae	301 4 16	+ 29 18 18
21.	Śraviṣṭhā	Vasu	P	β Delphini	315 38 38	+ 31 55 21
22.	Śatabhisak	Indra, Varuṇa	S	λ Aquarii	340 52 38	- 0 23 8
23.	Proṣṭhapada	Ajaekapād	P	α Pegasi	352 47 19	+ 19 24 25
	Pūrva Proṣṭhapada					
24.	Proṣṭhapada	Ahirbudhniya	P	γ Pegasi	8 27 32	+ 12 35 55
	Uttara Proṣṭhapada					
25.	Revati	Pūṣā	S	ζ Piscium	19 10 40	- 0 12 52
26.	Aśvayuja	Aśvin	D	β Arietis	33 16 18	+ 8 29 7
27.	Apabharani	Yama	P	41 Arietis	47 30 19	+ 10 26 48

* S=Singular ; D= Dual ; P=Plural.

Taittirīya Samhitā, 7.4.8.

The Lunar Month-Names

The solar month-names given earlier have not gone into general currency. The month-names generally used are of lunar origin as given in § 5-7. These names are first found in the *Taittirīya Samhitā* 7.4.8, and in many other places of the Yajur-Veda literature, but in a somewhat different form. We quote parts of the passage.

Saṁvatsarasya yat phalgunī pūrṇamāso mukhata
eva saṁvatsaramārabhya dikṣante tasyai kaiva
niryā-yat sāmmedhye viṣuvānt saṁpadyate
Citrā pūrṇamāse dikṣeran mukhaṁ vā etat saṁvatsarasya
yat citrā pūrṇamāso mukhata eva...

Translation :—One should get consecrated on the
Phalgunī full-moon day because *Phālguna* full moon
is the "mouth" of the year. Hence, (such people) are

taken as consecrated from the very beginning of the year. But such people have to accept one 'niryā' (draw back), viz., that the 'Viṣuvān' occurs in the cloudy season (*sammedhya*). Hence, one should consecrate on the *Citrā* full-moon day. The *Citrā* full moon month is the 'mouth' of the year.

From these passages, we learn that the lunar month came gradually. The ancient Indians reckoned by the *pakṣa* or the fortnight, and distinguished the closing full moon day of the *pakṣa* by the *nakṣatra* where the moon was full. Thus *Phālgunī Paurṇamāsī* is that full moon when the moon gets full near the *Uttara Phalgunī* star (β *Leonis*), one of the lunar mansions. *Caitrī Paurṇamāsī* is that full moon, when the moon gets full near the *Citrā* star (α *Virginis*), which is the 14th lunar mansion. Later, as the months were always full-moon ending, the word *paurṇamāsī* was dropped, and, e.g., the first part of *Caitra-Paurṇamāsī*, i.e., *Caitra* became the lunar month-name. The above passage says that the *Phālguna Paurṇamāsī* was regarded as the last day of the year and less frequently the *Caitra Paurṇamāsī*. This system still continues, and the first lunar month *Caitra* of the lunar year begins on the day after *Phālgunī Paurṇamāsī*.

There are twenty-seven *nakṣatras* and so only 12 can be selected for lunar month-names.

The twelve names which we have got are :

Caitra	from	Citrā	(No. 14)
Vaiśākha	"	Viśākḥā	(,, 16)
Jyaiṣṭha	"	Jyeṣṭhā	(,, 18)
Āṣāḍha	"	Āṣāḍhā	(,, 20 & 21)
Śrāvaṇa	"	Śrāvaṇa	(,, 22)
Bhādra	"	Bhādrapadā	(,, 25 & 26)
Āśvina	"	Āśvinī	(,, 1)
Kārtika	"	Kṛttikā	(,, 3)
Mārgaśīrṣa	"	Mṛgaśīras	(,, 5)
Pauṣa	"	Puṣya	(,, 8)
Māgha	"	Maghā	(,, 10)
Phālguna	"	Phalgunī	(,, 11 & 12)

Of course, full moon takes place by turn in all the *nakṣatras*. But only 12 at approximately equal intervals could be selected. But we have too *Rauhiṇya paurṇamāsī* etc. the *pakṣa* when the moon becomes full near *Rohiṇī*, or Aldebaran (lunar mansion No. 4). But *Rauhiṇya* was not selected for the name of a lunar month, because it was too near *Kṛttikā-Paurṇamāsī*.

Tithi

'Tithi' or 'Lunar Day' is a very important conception in Hindu astronomy, for holidays are always dated by the *tithi*. According to Siddhāntic definition, a *tithi*

is completed when the moon is ahead of the sun by 12°, or integral multiples of 12° (*vide* § 5.7).

Thus the first *tithi* (*Pratipada*, *lit.* when the moon is regenerated) in the waxing half starts when the moon is in conjunction with the sun, and ends when she has gone ahead of the sun by 12°, when the second *tithi* of the waxing moon begins. The *tithis* are numbered ordinally from 1 to 15, the end of the fifteenth *tithi* being full-moon. Then begins the *tithis* of the waning moon, numbered from 1 to 15, the end of the 15th *tithi* being the new-moon. There are thirty *tithis* in a lunar month, and though the average duration is less than a solar day, being 23.62 hours, the length of individual *tithis* may vary from 26.8 to 20.0 hours., on account of irregularity in the moon's motion.

This is the definition of the *tithi* given in *Siddhāntas* or scientific astronomy which started about 400 A.D. But this presupposes knowledge of measurement of angles, and precise scientific observation, of which we find no trace in the Vedic literature. What was then the origin of this system ?

We have no reference to *tithi* in the Ṛg-Veda. The first reference is found in Yajurvedic literature, and the *Brāhmaṇas*. The *Taittirīya Saṁhitā* talks of the *pañcadaśī tithi*, which shows that the lunar *pakṣa* was divided into 15 *tithis*, counted by ordinal numbers from 1 to 15 for each *pakṣa*. But what was the time-period meant by a *tithi*? The *Aitareya Brāhmaṇa* attached to the Ṛg-Veda gives the following definition of the *tithi*.

Aitareya Brāhmaṇa, 32.10

Yān paryastamiyād abhyudiyāditi sā tithih.

The *tithi* is that time-period about which the moon sets or rises.

This has been interpreted by Prof. P. C. Sengupta as follows :

During the waxing moon (*śukla pakṣa*), the *tithi* was reckoned from moon-set to moon-set ; and during the waning moon (*kṛṣṇa pakṣa*), the *tithi* was reckoned from moon-rise to moon-rise. The *tithis* were thus of unequal length, as shown by Prof. P. C. Sengupta in Table No. 11 on page 222.

5.4 THE VEDANGA JYOTISHA CALENDAR

The history of the Indian calendar from the end of the Yajurveda period to the beginning of the *Siddhānta Jyotiṣa* period is very imperfectly known though there are plenty of calendaric references in the *Brāhmaṇas*, *Sūtras*, and the epic *Mahābhārata* and various literature. On time-scale, it extends from

Table 11.

Duration of Vedic Tithi

English Date	Modern Tithi	Ending of Vedic Tithi		Duration of Vedic Tithi	Vedic Elapsed Tithi No.
		Event	Time of Event (L. M. T.-Cal.)		
(1936 A.D.)					
			h m	h m	
Oct. 15	Amāvasyā	Moonset or Sunset	17 34	—	—
16	Pratipad	"	17 33	—	—
17	Dvitiyā	Moonset	18 36	25 3	1
18	Tṛtiyā	"	19 16	24 40	2
19	Caturthī	"	20 3	24 45	3
20	Pañcamī	"	20 53	24 50	4
21	Ṣaṣṭhī	"	21 46	24 53	5
22	Saptamī	"	22 41	24 55	6
23	Aṣṭamī	"	23 38	24 57	7
24	Navamī	"	24 36	24 58	8
25	Daśamī	"	25 35	24 59	9
26	Ekādaśī	"	26 35	25 0	10
27	Dvādaśī	"	27 37	25 2	11
28	Trayodaśī	"	28 42	25 5	12
29	Caturdaśī	Moonset	29 49	25 7	13
30	Pūrṇimā	Moonrise or Sunset	17 22	11 33	14
31	Pratipad & Dvitiyā	Moonrise	18 18	24 56	15
Nov. 1	Tṛtiyā	"	19 18	25 0	16
2	Caturthī	"	20 20	25 2	17
3	Pañcamī	"	21 23	25 3	18
4	Ṣaṣṭhī	"	22 23	25 0	19
5	Saptamī	"	23 21	24 58	20
6	Aṣṭamī	"	24 14	24 53	21
7	Navamī	"	25 7	24 53	22
8	Daśamī	"	25 58	24 51	23
9	Ekādaśī	"	26 47	24 49	24
10	Dvādaśī	"	27 37	24 50	25
11	Trayodaśī	"	28 27	24 50	26
12	Caturdaśī	Moonrise	29 17	24 50	27
13	"	Sunrise	30 14	24 57	28
14	Amāvasyā	Sunset	17 15	11 1	29
Nov. 15	Pratipad	Moonset	18 0	24 45	1

Note :—The Vedic tithi ends at moonset in the light half and at moonrise in the dark half. Near *amāvasyā* when the moon remains invisible, the ending is at sunset. There are 29 or 30 such tithis in a lunar month, and all tithis are of more than 24 hours' duration except *amāvasyā* and *pūrṇimā* which are of about 12 hours' duration.

an unknown antiquity, which is set by some at 1300 B.C. to 300 A.D.

The *Vedāṅga Jyotiṣa* is generally assigned to this period. It may be said to be a sort of collection of short aphorisms giving mathematical rules for fixing the calendar in advance, and is known in three versions: the Rg-Jyotiṣa consisting of 36 verses, attached to the Rg-Veda and ascribed to one Lagadha

as mentioned earlier, the Yājñ Jyotiṣa attached to the Yajurveda and consisting of 43 verses, and there is a text ascribed to one Somākara, a commentator of unknown age of the Vedas. The different texts contain about the same matter, but the verses are haphazardly arranged showing that the original texts have not come down to us in an unadulterated form. The number of independent verses in all the versions

is not more than 49, and some of the verses have not been interpreted.

There are several other calendarical treatises which can be assigned to this period. The *Sūrya Prajñapti*, a Jaina astronomical work, the *Jyotiṣakaraṇḍa*, and the *Kālālokaprakāśa*.

A short account of the calendaric rules followed in these treatises is given in Varāhamihira's *Pañca Siddhāntikā*, Chap. XII, where the rules are collected as "*Paitāmaha Siddhānta*" or Astronomical Calendar according to Grandfather Brahmā, the Creator, in Hindu mythology. That shows the high antiquity of the rules. Varāhamihira, as well as Brahmagupta describe the rules as very "inaccurate" (*Dūravibhraṣṭau*, furthest from truth in Varāhamihira's language) though they pay a formal courtesy to the supposed authors. But such has been the case with calendars of all ancient nations, including the Babylonians at this period and a critical account of the *Vedāṅga Jyotiṣa* is important from the historical point of view.

It may be remarked here that there are minor differences between *Vedāṅga Jyotiṣa*, the Jain systems, and the *Paitāmaha Siddhānta*, which appear to be the latest of this group. The older treatises have a year of 366 days, while the *Paitāmaha Siddhānta* has a year of 365.3569 days (Dikṣit).

There is an extensive literature on *Vedāṅga Jyotiṣa* which has been studied by Dr. G. Thibaut, S. B. Dikṣit, S. K. Pillai, and Dr. R. Shama Sastry, amongst others. We here give an account of the calendar according to the *Paitāmaha Siddhānta*.

Summary of the Contents

"Five years constitute a *Yuga* or Saros of the sun and the moon.

The *yuga* comprises 1830 *sāvāna* days (civil days) and 1860 *tithis* (lunar days).

In the *yuga*, there are 62 lunar months and 60 solar months. So two months are omitted as intercalary months, in a period of 5 years.

The number of omitted *tithis* in the period is 30.

There are 67 *nakṣatra*-months (sidereal months) in the *yuga*. The moon passes through $67 \times 27 = 1809$ *nakṣatras* within this period.

The *yuga* begins at winter solstice with the sun, and the moon together at the *Dhanīṣṭhā* asterism (α or β Delphinus)."

These are the main points from which the five yearly calendar can be constructed.

The *Vedāṅga Jyotiṣa* further describes measurements of the subdivisions of the day by means of the clepsydra, as well as by gnomon-shadows.

One particular feature is the assumption that the ratio of the length of the day to that of the night on the summer solstice day is as 3 : 2.

Let us now examine these points critically.

We observe that all the mathematical rules point out only to mean motions of the sun and the moon, i.e., the periods of the sun and the moon were obtained by counting the number of *sāvāna* days in a large number of years and months, and dividing the number by the number of periods (year or month). No evidence is found of the systematic day to day observations of the sun and the moon. Only the lunar zodiac was used for describing the positions of the sun and the moon, which appears to have been divided into 27 equal parts or *nakṣatras*; in other words the *nakṣatras* no longer denoted star-clusters but equal divisions of the lunar belt.

There is no mention of the zodiac or twelve signs of the zodiac, or of week days, or of planetary motion.

Let us now look critically into the rules.

5 solar years = $365.2422 \times 5 = 1826.2110$ days ;
62 synodic months = $29.53059 \times 62 = 1830.8965$ days ;
67 sidereal months = $27.32166 \times 67 = 1830.5512$ days.

Therefore, regarded as a measure for luni-solar adjustment, the error is 4.685 days in a period of 5 years, i.e., if we started a *yuga* with the sun and the moon together on the winter solstice day, the beginning of the next *yuga* (6th year) would occur 4.685 days later than the winter solstice and in 5 to 6 *yugas* the discrepancy would amount to a month or half season. This cannot escape notice, and therefore there must have been some way of bringing back the *yuga* to the winter solstice day. Otherwise the calendar becomes useless. But how could it have been done ?

This is a matter for conjecture and several hypotheses have been proposed. According to S. B. Dikṣit, we should have in 95 years :

according to the *V. J.*, $\frac{2}{3} \times 95 = 38$ intercalary months, while actually we have, $\frac{7}{8} \times 95 = 35$ intercalary months.

So the *Vedāṅga Jyotiṣa* rules introduce 3 more intercalary months than necessary in 95 years, and if these are dropped, we can have good adjustment. This could have been done as follows :

In the first period of 30 years = 6 *yugas*, suppose they had 11 intercalary months instead of 12.

The beginning of the *yuga* would go ahead of the winter solstice in 30 years by $4.685 \times 6 = 28.110$ days.

But if we do not have the intercalary month on the 30th year, the *yuga*-beginning is brought back to $29.53 - 28.110 = 1.421$ days before the W.S. day. The same process is repeated for the next period of 30 years. The *yuga*-beginning is thus brought back to 2.842 days before the W.S. day.

The next period may be taken to consist of 35 years, i.e., 7 *yugas* each of five years, in which the *yuga*-beginning goes ahead by 3.264 days. The combined result of the three periods of 30, 30, and 35 years is to put the *yuga* beginning ahead of the W.S. day by 0.422 days only. Other conjectural cycles are described by Dr. Shama Sastry.

But was any such practice really followed? We have no evidence from the verses; but S. B. Dikṣit mentions that intercalary months were inserted only when needed, and hence probably they were 'dropped when not needed.'

Tithis

The main object of the *Vedāṅga Jyotiṣa* calendar appears to have been the correct prediction of the *tithi* and *nakṣatra* on any *sāvāna* (civil) day within the *yuga*. In this respect, the rules were more accurate. A *tithi* is defined as $\frac{1}{30}$ th of the lunar month. The correct measure is

$$1 \text{ tithi} = \frac{29.530588}{30} = .984353 \text{ days,}$$

while the measure taken = $\frac{8}{8\frac{1}{2}} = .983871$ days. The mistake is .000482 days on the lower side or one *tithi* in 2075 days or in $5\frac{2}{3}$ years.

The five yearly period consists of 1830 civil days in which there are 62 synodical months.

We know $62 \times 29.53059 = 1830.8965$ days. Hence in order to make the *tithi* calculations correct, one day (exactly 0.8965 days) had to be added to the total number of civil days in the period.

Nakshatras

The days were named according to the *nakṣatras* or lunar asterisms in which the moon was found, and a lot of crude astrology* had grown up round this system. So it was necessary to predict the *nakṣatra* in advance. The *Vedāṅga Jyotiṣa* calendar prescribed some methods for such predictions.

In a five yearly period of 1830 days, the sidereal revolutions of the moon amounted to 67 in which there are 1809 *nakṣatras*.

$$\text{Actually 1 } \textit{nakṣatra} \text{ day} = \frac{27.32166}{27} = 1.011913 \text{ days,}$$

$$\text{while the measure taken} = \frac{1\frac{8}{8\frac{1}{2}}}{1\frac{8}{8\frac{1}{2}}} = 1.011608 \text{ days.}$$

*Astrology based only on the sun and the moon. Later post-Siddhāntic astrology in India is largely Graeco-Chaldean, and makes use of the signs of the zodiac, and of planetary position and motion.

The mistake was .000305 days on the lower side or 1 *nakṣatra* in 3279 days or about 9 years.

The Time of the Vedāṅga Jyotiṣa

All recensions of the *Vedāṅga Jyotiṣa* contain the following verses :

Svarākramete somārkaṁ yadā sākaṁ savāsavaṁ
 Syāttadādiyugaṁ māghastapaḥ śuklo'yanam hyudak. (6)
 Prapadyete śraviṣṭhādaṁ sūryācandramasāvudak
 Sārpārdhe dakṣiṇārkastu māghaśrāvāṇayoḥ sadā. (7)

These two verses taken together yield the following :

The winter solstice took place at the lunar asterism *Śraviṣṭhā*, which is later called *Dhaniṣṭhā*.

This is the 21st *nakṣatra* in the *Kṛttikādi* system and 23rd in the *Āśvinyādi* system and its component stars are α , β , γ and δ *Delphini*.* These stars are far away from the ecliptic. We have for 1950 :

α Delphini,	Long. = 316° 41'	Lat. = +33° 2'
β " "	= 315 39	" = +31 55
γ " "	= 318 40	" = +32 41
δ " "	= 318 35	" = +31 57

The Arabs have β and ξ *Aquarii* which also represent the Chinese *Hsiu*.

It has been stated in the *Vedāṅga Jyotiṣa* that the junction star of the asterism was placed at the beginning of the division and it marked the beginning of *Uttarāyana* or the W.S. day. Thus the star representing the *Dhaniṣṭhā* division had 270° as the longitude at the time when the tradition of the *Vedāṅga Jyotiṣa* calendar was formulated. If α *Delphini* is taken as the principal star of the asterism, then its longitude was 270° at the time of the *Vedāṅga Jyotiṣa* and in 1950, its longitude is 316° 41'. As the solstices take about 72 years to retrograde through one degree, the time of *Vedāṅga Jyotiṣa* is found to be $(316° 41' - 270°) \times 72 = 46.07 \times 72 = 3362$ years before 1950 A.D. or 1413 B.C. The star β *Delphini*, however, yields a somewhat lower period, i.e., about 1338 B.C.

The Plan of the Calendar

In a period of 5 years, there are :—

1830 civil days,

62 lunar months, and so 1860 *tithis*,

67 sidereal months and so 1809 *nakṣatras*.

As the period contains 60 solar months, there are 2 intercalary months which are placed after every

* On a *Dhaniṣṭhā* day the moon got conjoined with both the β and α *Delphinis* at interval of 2 hours.

30 lunar months. Thus in the third year, the month *Śrāvaṇa* is *adhika* which is followed by *śuddha Śrāvaṇa*; and in the fifth year the last month is also *adhika* which is *adhika Māgha*.

There are 1860 *tithis* while the number of civil days is 1830; so there are 30 omitted *tithis* (*tithi kṣaya*). Each period of 61 days contains 62 *tithis*, so one *tithi* is omitted after 61 civil days. From this consideration the number of civil days per month can be obtained and will be shown in the table below. The *Vedāṅga Jyotiṣa* people regularly counted a *tithi* to a day, but after 61 days one *tithi* was omitted.

As regards *nakṣatras*, their number is 1809 in 1830 civil days, the difference being 21. So 87 $\frac{1}{7}$ days were equivalent to 86 $\frac{1}{7}$ *nakṣatras*. They counted a *nakṣatra* to a day successively, but after every 87 days (actually 87 $\frac{1}{7}$ days), one *nakṣatra* was repeated for two days.

The five different years of the period had distinctive names, viz., (1) *Saṁvatsara*, (2) *Parivatsara*, (3) *Idāvatsara*, (4) *Anuvatsara*, and (5) *Idvatsara*.

The plan of the five yearly calendar is shown below:

Table 12.

	Number of days in each month of the Vedāṅga Jyotiṣa Calendar				
	<i>Saṁvat-sara</i>	<i>Parivat-sara</i>	<i>Idāvat-sara</i>	<i>Anuvat-sara</i>	<i>Idvat-sara</i>
<i>Māgha</i>	30	29	29	29	29
<i>Phālguna</i>	30	30	30	30	30
<i>Caitra</i>	29	29	29	29	29
<i>Vaiśākha</i>	30	30	30	30	30
<i>Jyaiṣṭha</i>	29	29	29	29	29
<i>Āṣāḍha</i>	30	30	30	30	30
<i>Śrāvaṇa (adhika)</i>	—	—	29	—	—
<i>Śrāvaṇa</i>	29	29	30	29	29
<i>Bhādrapada</i>	30	30	30	30	30
<i>Āśvina</i>	29	29	29	29	29
<i>Kārtika</i>	30	30	30	30	30
<i>Mārgaśīrṣa</i>	29	29	29	29	29
<i>Pauṣa</i>	30	30	30	30	30
<i>Māgha (adhika)</i>	—	—	—	—	29 or 30
Total No. of days in the year	355	354	384	354	383 or 384

As already shown, the actual length of 62 lunar months is 1830.8965 days, while there are 1830 civil days in the five yearly period. It is therefore very likely that one civil day was added to the period when necessary to make it conform to the phases of the moon which were regularly observed. This additional day was no doubt placed at the end of the

period, and when it was added the last month *adhika Māgha* contained 30 days instead of 29 days which was otherwise its due.

The ratio $\frac{2}{3}$ for the duration of the longest day to that of the shortest night given in the *Vedāṅga Jyotiṣa* was first noted by Dr. Thibaut. Later the same ratio was found by Father Kugler from Babylonian cuneiform records of the Seleucid period. The ratio is characteristic of a latitude of 35° N, which is nearly that of Babylon (for Babylon $\phi = 32^{\circ} 40' N$). Hence it has been inferred that the *Vedāṅga Jyotiṣa*-astronomers got this ratio from Seleucid Babylon. But it may be pointed out that the Vedic life centred round North-Western India, from the Sarasvatī valley (Kurukṣetra $\phi = 29^{\circ} 55'$) to Gāndhār ($\phi = 31^{\circ} 32' N$). The ratios of the duration of daylight to night on the summer-solstice day for different latitudes are as follows:

Table 13.

Longest day and shortest night

(Calculated with obliquity of ecliptic as 23° 51' which is for 1300 B. C. The results for 500 B. C. are also almost the same.)

Latitude	Longest day	Shortest night	Ratio
30° N	13 ^h 58 ^m	10 ^h 2 ^m	1.39
31° N	14 3	9 57	1.41
31° 32' N	14 6	9 54	1.42
32° N	14 8	9 52	1.43
32° 40' N	14 12	9 48	1.45
33° N	14 14	9 46	1.46
34° N	14 19	9 41	1.48
35° N	14 24	9 36	1.50

It is seen from the above table, that even at the latitude of Babylon, the ratio is not 1.50 but 1.45. At Gāndhār, it is 1.42. The difference is not very large. But there is another factor to which attention must be drawn.

Both Babylonians and Indians measured subdivisions of the day by means of some kind of Clepsydra. A description of the Clepsydra used by Indians during the *Vedāṅga Jyotiṣa*-period will be found in S.B. Dīkṣit's *Bhāratiya Jyotiṣāstra* (Sec. II, Chap. I). But the day-length must have been measured from the observed time of sunrise to the observed time of sunset. This is somewhat larger than the astronomical time of sunrise on account of refraction. Assuming that the effect of refraction is to elevate a celestial body near the horizon by about 35', and the sun's semi-diameter is about 16', the sun's upper limb appears on the horizon at a place on 32° latitude, about 4 $\frac{1}{2}$ minutes before the centre of the sun is due on the horizon. For the same reason, the sunset takes place 4 $\frac{1}{2}$ minutes after the astronomical

calculated sunset. So the apparent length of the day is increased by $2 \times 4\frac{1}{2}$ min. or by 9 minutes. Therefore for the latitude of Babylon we have the length of maximum day-light $14^h 12^m + 9^m = 14^h 21^m$, and the night is $9^h 39^m$. The ratio is now 1.49. Taking the effect of refraction into consideration the ratio for Gāndhār also becomes 1.46, which is not much different from 1.50 as for Babylon. So it is not necessary to assume that the ratio was obtained from Babylonian sources.

Effect of Precession

The *Vedānga Jyotiṣa* was prevalent for a long time over India, for over 1300 years (1000 B.C. to 300 A.D.). Hence it is likely that the subsequent astronomers noticed the gradual shift of the solstitial colour in the lunar zodiac. In fact, several references are found to this effect. Garga, an astronomer whose name is found in the *Mahābhārata*, where he is described as having an astronomical school at a place called Gargasrota in the Sarasvatī basin, is the reputed author of a pre-Siddhāntic calendaric treatise called *Garga Saṁhitā*. He notes :

Yadā nivartate'prāptaḥ śraviṣṭhāmuttarāyaṇe
Āśleṣām dakṣiṇe'prāptaḥ tadā vindyānmaḥād bhayam.

Translation : When at the time of *Uttarāyaṇa* the sun is found turning (north) without reaching the *Śraviṣṭhās*, and (at the time of *Dakṣiṇāyaṇa*) turning (south) without reaching the *Āśleṣā*, it should be taken to indicate a period of calamity.

It shows that at the time of Garga the W.S. did no longer occur in *Śraviṣṭhā*, neither the S.S. occurred in the *Āśleṣā* division. At the time of *Vedānga Jyotiṣa* the two solstices were marked by the starting point of *Śraviṣṭhā* and the middle point of *Āśleṣā* respectively. Garga therefore observed that the solstices were receding back over the lunar calendar, and had shifted at least by half a *nakṣatra*-division from the middle of *Āśleṣā*. His observations are therefore at least 480 years later than those of the *Vedānga Jyotiṣa*.

In the *Mahābhārata* we get the following verse :

Aśvamedha, Chap. 44,2

Ahaḥ pūrvaṁ tatorātrirmāsāḥ śuklādayaḥ smṛtāḥ
Śravaṇādini ṛkṣāni ṛtavaḥ śiśirādayaḥ

Translation : Day comes first and then the night ; months are known to commence with the bright half, the *nakṣatras* with *Śravaṇa*, and the seasons with *Śiśira*.

Here the asterism *Śravaṇa* is described as the one where the winter solstice takes place. *Śravaṇa* is just preceding *Śraviṣṭhā* and the solstices take about 960 years to retrograde through one *nakṣatra* division.

We get from this the time of composition of the *Mahābhārata* as about 450 B.C. or sometime earlier.

Varāhamihira also notes that the winter solstice no longer took place at *Dhaniṣṭhā*.

Pañca Siddhāntikā, III, 21

Āśleṣārdhādāsīt yadā nivṛtṭiḥ kiloṣṇakiraṇasya
Yuktamayanaṁ tadāsīt sāmpratamayanaṁ
punarvasutaḥ.

Translation : When the return of the sun towards the south (i.e., the summer solstice) took place from the middle of *Āśleṣā*, the *ayana* was right : at the present time *ayana* begins from *Punarvasu*.

In his *Bṛhat Saṁhitā*, an astrological treatise, he records :

Bṛhat Saṁhitā, III, 1

Āśleṣārdhātdakṣiṇaṁ uttaramayanaṁ raverdhanisṭhādyam
Nūnaṁ kadācidāsīt yenoktaṁ pūrvaśāstreṣu.

Translation : The beginning of the southern motion when the sun has passed half of *Āśleṣā* and the beginning of the northern motion when the sun has passed the beginning of *Dhaniṣṭhā*, must have taken place at some epoch ; for these are recorded in old treatises.

From the time of *Vedānga Jyotiṣa* to Varāhamihira's time the summer solstice moved through more than $1\frac{1}{2}$ *nakṣatras* ($\frac{1}{2}$ of *Āśleṣā* + *Puṣya*) which indicated a lapse of more than 1500 years from the time of *Vedānga Jyotiṣa*.

It is thus seen that the Hindu astronomers observed the shifting of the cardinal points due to precession of the equinoxes ; but as they had not developed the sense of era, they were unable to find out the time-interval between different records, and obtain a rate for precession, as was done by Hipparchos. Their observations were also crude, as they used only the lunar zodiac. The shifting of the solstitial colours remained to them an unsolved mystery.

5.5 CRITICAL REVIEW OF THE INSCRIPTIONAL RECORDS ABOUT CALENDAR

In this chapter, we are undertaking a critical review of the references to the calendar in ancient inscriptions, because, from the point of view of accurate history, inscriptional records are far more valuable than any references in ancient scriptures or classics, as they are contemporary documents, which have remained unaltered since the framers left them*.

* Sometimes inscriptions and copper plate records have been found to have been forged at a latter date but such instances are rare and can not escape detection by an experienced archaeologist.

References in ancient scriptures, poems, epics and other literatures are, on the other hand, very often liable to alterations, interpolations and errors in the hands of *latter-day copyists* and are, therefore, less trust-worthy.

The oldest inscriptional records bearing a date (barring those belonging to the Indus-valley period which have not been deciphered) belong to the reign of the Emperor Aśoka (273-236 B.C.). From these, we can make fairly accurate deductions regarding the calendar then in use.

We take the Fifth Pillar Edict, Rāmpurvā version found at the Champāraṅ district, Bihar. The language is Aśokan Prākṛt, the script is the oldest form of Brāhmī. (Sircar pp. 62-63)

Fifth Pillar Edict—Rāmpurvā Version

- (1) *Saḍvīsati[va]sābhīsitenā (Saḍvīsati-varṣābhīsktēna)*—'After twenty-six years had elapsed since coronation'.
- (2) *Tisu cāturmā[si]su tiṣyaṁ puṇnamāsiyaṁ tinidivasāni cāvudasaṁ paṇṇadaśaṁ paṭipadaṁ.....*
(*Tiṣṣu cāturmāsiṣu tiṣyāyāṁ puṇnamāsiyāṁ, triṣu divaseṣu-caturdaśe paṇṇadaśe pratipadī.....*)
'On the three *cāturmāsi* days, on the *tiṣya* full moon day, on the 14th, 15th and the first day.....'
(On these and some other days, sale of fish is forbidden).

Again, in the same :

- (3) *Aṭhami-pakhāye cāvudasaṁ paṇṇadaśaṁ tiṣāye puṇnavasune.....(Aṣṭamī-pakṣe, catur-daśyāṁ, paṇṇadaśyāṁ, tiṣyāyāṁ, puṇnavasau.....)* ;
'On the eighth *pakṣa*, on the 14th, and the 15th (new moon) on the *Tiṣya* and *Puṇnavasu Nakṣatra* days.....,
(On these days, he forbids the castration of bulls).

From these passages, we conclude that :

1. No era was used, but regnal years (number of years elapsed since the king's coronation) were used for dating.
2. The time-reckoning was by seasons, each of 8 *pakṣas*. The seasons are :
Griṣma (Summer) : Comprising *Caitra, Vaiśākha, Jyaiṣṭha, Āṣāḍha*.
Varṣā (Rains) : Comprising *Śrāvaṇa, Bhādra, Āśvina, Kārtika*.
Hemanta (Winter) : Comprising *Agrahāyana, Pauṣa, Māgha, Phālguna*.

3. The months are not mentioned by name, except in one case where the month of *Māgha* is mentioned. They are *puṇṇimānta*, i.e., they started after full moon and ended in full moon. This is not expressly mentioned but can be inferred from the fact that the 14th, the 15th (*Paṇṇadaśī*) and the *Pratipada*, i.e., the first *tithi* are enjoined to be the days on which certain actions are forbidden. These must be the three days of invisibility of the moon, the 14th being before new moon, the 15th the new moon, and the first, the day after new moon, which were observed as unsuitable for many particular performances.

4. The day reckoning was by the *tithi* (lunar day), but the word *tithi* is probably not to be taken in the sense of the present Siddhāntic *tithi*, but in the sense of the Vedāṅga Jyotiṣa *tithi* or the old Brāhmaṇic *tithi*. In the latter system, a *tithi* was counted from moon-set to moon-set during the bright half, and from moon-rise to moon-rise during the dark-half. There was the same *tithi* for the whole day. Prof. P. C. Sen Gupta has discussed this method of *tithi* reckoning (see p. 222).

5. Two days are mentioned by the lunar asterisms *Tiṣya* (δ *Canceri*), and *Puṇnavasu* (β *Geminorum*). As suggested one was probably his birth *nakṣatra*, the other his coronation *nakṣatra*. The days were therefore also named after the *nakṣatra*. This system is found in vogue in the epic *Mahābhārata*, e.g., in the following passage :

Balarāma, the elder brother of Kṛṣṇa, after returning from pilgrimage on the eighteenth day of the battle states :

M. Bh., Śalya Parva, Ch. 34, 6

Catvāriṃśadahānyadya dve ca me niḥṣṛtasya vai Puṣyena saṁprayāto'smi Śrāvaṇe puṇarāgataḥ.

Translation : It is forty-two days since I left the house. I started on the *Puṣya* (day) and have returned on the *Śrāvaṇa*.

6. There is no mention of the year-beginning. The *Tiṣya Puṇnamāsi*, i.e., the full-moon day ending the lunar month of *Pauṣa* is marked out particularly.

It appears from the records that in Aśoka's time, the principles followed in framing the calendar were those given in the *Vedāṅga Jyotiṣa*. No era was used. From the inscriptions, we can make no inference about the luni-solar adjustment, but there is no doubt that the year was seasonal as given in the inscription of the *Sātavāhanas* (see next page).

No records bearing a date of the imperial dynasties following the Mauryas, *viz.*, the Śuṅgas, and Kāṇvas (186 B.C.-45 A.D.) are known. But the next imperial dynasty, the Sātavāhanas have left plenty of dated records. In these, the same system of date-recording by regnal years, the seasons, the *pakṣas*, and *tithis* are found. There are 8 *pakṣas* in a season of four months, and they were serially numbered from 1 to 8. The odd ones were *Kṛṣṇa pakṣas*, the even ones *Śukla pakṣas*.

Some examples are given below :

(1) Nāsik Inscription of the Sātavāhana Emperor, Gautamīputra Śrī Sātakarṇi (Sircar, pp. 192-93).

Datā patīkā Savachare 10+8 vāsapakhe 2 divase 1 (dattā patīkā Samvatsare aṣṭādaśe 18 Varṣāpakṣe divītye 2 divase prathame 1).

i.e. the inscription was recorded in the eighteenth year elapsed since the coronation on the first day of the second *Pakṣa* of the *Varṣā* season, i.e., in the lunar month of *Śrāvāṇa*, on the first day after new moon (*Śukla pakṣa*).

There are other Sātavāhana inscriptions similarly dated as summarized in the table below :

Table 14.

Table of Inscriptions of Sātavāhana Kings, showing date-recording.

Lüders			
1024	Raño Gotamīputasa Sāmi-Siriyaṇa-Sātakarṇi	16-G	1-5
1100	Raño Vāsiṭhiputasa Sāmi-Siri-Pulumāvisa	7-G	5-1
1106	R. V. Siri-Pulumāvisa	24-H	3-2
1122	R. V. Siri-Pulumāyisa	6-G	5-6
1123	R. V. Siri-Pulumāyisa	19-G	2-13
1124	R. V. Siri-Pulumāyisa	19-G	2-13
		22-G	1-7
1126	R. G. Sātakarṇi	24-V	4-5
1146	R. G. Sāmi Siriyaṇa Sātakarṇi	7-H	1
1147	R. V. Sāmi Siri-Pulumāyisa	2-H	8
90	(Sircar)-Siri-Pulumāyisa	8-H	2-1

R means raño, V-Vāsiṭhiputasa, G-Gotamīputasa.

The number in the first column indicates the serial number of the inscription in Lüders' list. The last column contains dates, in an abridged form ; e.g., in 1123, we have 19, G 2-13. Here '19' is the regnal year, G denotes *Griṣma* or summer season, '2' following G denotes the second *pakṣa*, i.e., the second half of the month of Caitra, constituting the *Śukla pakṣa*, and the last numeral '13' denotes the day. But it is not clear whether the day is the lunar day, i.e., the *tithi* or the solar day. Even if it be the *tithi*, it is probably not the Siddhāntic *tithi*, but the old Brāhmaṇic or Vedāṅga *tithi*.

According to our calculations, the date of Gautamīputra Sātakarṇi would be about the first century A.D. We take some still later records.

(2) Rājā Vīrapuruṣadatta of Nāgarjunikoṇḍa (Sircar, pp. 220-221)

Raṁṇo Śrī Vīrapuruṣadattasa Sava 6 vā pa 6 di 10 (Rājñah Śrī Vīrapuruṣadattasya samvatsare ṣaṣṭhe 6 varṣāpakṣe ṣaṣṭhe 6 divase daśame 10).

On the sixth year of King Śrī Vīrapuruṣadatta on the 6th *pakṣa* of the *varṣā* season, on the tenth day. The sixth of *varṣā pakṣa* is month of *Āśvina*, second or light half (*Śukla pakṣa*).

It is obvious from the above inscriptional evidences, that continuous era-recording was not used by Indian dynasts up to the time of the Sātavāhanas, and no ancient books, not even the *Mahābhārata* mentions an era.

As no era is mentioned, it has been difficult to work out a chronology of the early Indian dynasts including the Sātavāhanas.

The Coming of the Era to India

As we have seen in § 3.5, the era reckoning had been in use in Bābylon since 747 B.C., and the Seleucid era which marked the accession to power of Seleucus at Bābylon in 312 B.C., was widely current in the whole of the Middle East, both by the royalty and the public.

But though as Aśoka's Girnar inscription says that he was in diplomatic correspondence with five Greek kings of the West, including Antiochus I and II of Bābylon, and the Ptolemy of Egypt, and sent Buddhist missionaries to these countries, it is clear from his records that he continued to use the purely Indian methods of date-recording based on the *Vedāṅga-Jyotiṣa*. There is not the slightest indication that any of the Indian imperial dynasties which followed the Mauryas, *viz.*, the Śuṅgas and Kāṇvas (186 B.C.-45 A.D.), the Sātavāhanas (100 A.D.) allowed themselves to be influenced by the Graeco-Chaldean luni-solar calendar which was then in vogue in the Near East.

From about 180 B.C., North-Western India having Taxila as capital passed under the Bactrian Greeks.

It is rather strange that though we have plenty of coins of the Bactrian Greeks who ruled in Afghanistan and N.W. India between 160 B.C., and 50 B.C., from which their names have been recovered, and some kind of chronology has been worked out, not a single record has *yet* been discovered which bears a date, except two doubtful ones. One is the coin of a certain Plato, found in the Kabul valley, which bears certain symbols which have been interpreted as 147 of the Seleucid era, i.e., 165 B.C., Plato has been

identified by Tarn to be a brother of Eucratidas, founder of the second Greek ruling house (175 B.C.-139 B.C.) in Bactria. But the interpretation is doubtful.

The second one is an inscription of the time of king Menander, the great king of the Euthydemid house who ruled over the Punjab, Sind and Rajputana about 150 B.C., on the Shinkot Steatite Casket, the only one of the Greek kings who has found a permanent place in Indian literature in the celebrated *Milinda Pañho*, a philosophical treatise meaning questions of king Menander. The inscription referred to mentions regnal year 5, the Indian month of *Vaiśākha*, and the twenty-fifth day. Thus the date-recording is Indian, but slightly different from the system used in Aśokan or Śātavāhana inscriptions because the *pakṣa* is omitted.

Our studies given in § 3·3, shows that a mathematically accurate luni-solar calendar, based on astronomical knowledge, was first evolved in Seleucid Babylon between 300 B.C. to 200 B.C. by Chaldean astronomers. The features of this calendar were :

(a) The use of the Seleucid era for numbering years in place of the regnal years.

(b) The beginning of the year with the lunar month of Nisan which was to start on a date not later than a month of the vernal equinox.

(This corresponds to the Indian month of *Vaiśākha* later defined in Siddhāntic calendars).

(c) There was an alternative method of starting with the Greek month of *Dios* which was to begin on a date not later than a month of the autumnal equinox.

(This corresponds to the Indian month of *Kārtika*, as later defined in Siddhāntic calendars).

(d) Luni-solar adjustment was done by the nineteen-year cycle (*vide* § 3·2-3·4).

This system of date-recording spread far and wide in the Near East and was adopted by other ruling dynasties, viz., the Parthians, who however used an era starting from 248 B.C. They used Macedonian months without alteration.

It can now be shown that this system penetrated gradually into India.

Era or eras of unknown origin began to be mentioned in certain inscriptions found in the North-Western Punjab and the Kabul valley about the first century B.C. Some of them mention kings belonging to the Śāka tribes who ruled Ariana (west and southern Afghanistan comprising the Herat regions-Area), the Kāndāhār regions (Arachosia), and Gāndhāra (N.W. Punjab) between the second century B.C. and the first

century A.D. The inscriptions are mostly in Kharoṣṭhī and later ones found on Indian soil are in Brāhmī. The Kharoṣṭhī inscriptions are collected by Dr. Sten Konow in his monumental work *Corpus Inscriptionum Indicarum*, Vol. II., Part I., and are reproduced below in Groups A and B.

Group A is identical with Konow's A (with the omission of Nos. 20-23) and contains dates from year 58 to 200. Group B, identical with Konow's B-Group, contains the inscriptions of Kuṣāṇa period bearing dates of years between 300 and 400.

GROUP A

1. Maira : [sām 58].
2. Śahdaur A : ra [ja] no Damijadasa saka-sa... [ṣaṣṭi...60].
(Reading uncertain.)
3. Śahdaur B : [maharayasa ?] Ayasa sām....
4. Mānsehrā : ...aḍhaṣaṭhi....
5. Fatehjang : sām 68 Proṭharatasa masasa divase ṣoḍaśe 16.
6. Taxila copper-plate : sāmvaṭṣaraye aṭhasatātimae 78 maharayasa mahāntasa Mogasa Panemasa masasa divase pañcame 5 etaye purvaye.
7. Mucai : vaṣe ekaśitīmaye 81.
8. Kala Sang : [sām 100]. Reading uncertain.
9. Mount Banj : sāmvaṭṣaraye 102.
10. Takht-i-Bāhī : maharayasa Guduharasa vaṣa 26 sāmvaṭṣarave tiśatimae 103 Veśakhasa masasa divase [praṭha] me [di 1 atra puñā] pakṣe.
11. Pājā : sāmvaṭṣaraye ekadaśa [śa*] timaye 111 Śravaṇasa masasa di [va*] se pañ[cada]śe 15.
12. Kāldarra : vaṣa 113 Śravaṇasa 20.
13. Mārguz : [vaṣe 1*]17.
14. Panjtār : sām 122 Śravaṇasa masasa di pradhamae 1 maharayasa Guṣaṇasa rajami.
15. Taxila silver scroll : sa 136 ayasa Aṣaḍasa masasa divase 15 iśa divase...maharajasa rajatirajasa devaputrasa Khuṣaṇasa aroga-dakṣiṇae.
16. Peṣāwar Museum, No. 20 : sām 168 Jeṭhamase divase pañcadaśe.
17. Khalatse : sām 187 maharajasa Uvimaka [vthi] sasa.
18. Taxila silver vase : ka 191 maharaja [bhrata Maṇigulasa putrasa*]Jihonikasa Cukhsasa kṣatrapasa.
19. Dewai : sām 200 Veśakhasa masasa divase aṭhame 8 itra khaṇasa.

The Method of Date Recording

A record fully dated in Group A gives :

The year of the era in figures and words ; though it does not give any particular designation to the era.

The month, mostly in Sanskrit ; the day, by its ordinal number, e.g., No. 11, which means in the year 111 on the 15th day of the month of *Śrāvāṇa*.

The months are all in Sanskrit, except in No. 6, in which the month is in Greek (*Panemos* = *Āṣāḍha*). No. 6 alone of this group contains the rather mysterious phrase '*Etaye purvaye*' which means, 'before these'. This phrase, the meaning of which is not clear, occurs in Kuṣāṇa (Group B) and even in Gupta inscriptions.

This method of dating is quite different from that of the contemporary Indian dynasts, viz., the Sātavāhanas, which mentioned regnal years, the season, the *pakṣa*, and then probably the old *tithi* or the lunar day. But it agrees with the method followed in contemporary Parthia, which mentions the year usually in the Seleucid era, rarely in the Arsacid era, the name of the month in Greek, and the ordinal number of the day, which ranges from 1 to 30 (see Debevoise, 1938). From No. 10, it appears that whenever Indian months were used they were *Purimānta*, following the classical Indian custom.

Date of records of Group A

None of the inscriptions of Group A appear to be 'Royal Records' but some contain names of kings, e.g., No. 6, which mentions a *Mahārājā Mahānta* Moga, who is taken to be identical with a king whose coins have been found in large numbers in Gāndhāra. He calls himself '*Maues*' in the Greek inscription on the obverse, and *Moasa* (i.e. of Moa) in Kharoṣṭhī on the reverse. The title given there usually is *Maharajasa Rajatirajasa Mahāntasa*. It is held that King Moga was Saka leader who starting from a base in Seistan or Arachosia, invaded Gāndhāra through the southern route, sailed up the Indus, and ousted the Greek rulers Archebius from Taxila, Artemidorus from Puṣkalāvati and Telephos from Kapśā (Bachhofer, 1936) and founded a large empire comprising parts of Afghanistan, Gāndhāra and the Punjab.

He is generally held to have been a Śaka, but some hold without sufficient reason that he was a Parthian. He is the first of Indo-Scythian kings known to numismatics. He was followed by other Indo-Scythian kings in Gāndhāra, who are known from wide variety of coins issued, viz., Azes I, Azilises and Azes II. But there is no clear reference to them in these inscriptions except the word '*Ayasa*' in Nos. 10 and 15,

which is supposed to stand for Azes. But this has been disputed.

This series starts with the year 58, if Cunningham's reading of (1) with the additional reading of the king's name 'Moasa' is accepted. But even if we reject it, the series certainly starts with the year 68 in No. 5, and goes up to 136 at fairly small intervals, then to 168, 187, 191, 200 containing names of rulers known from coins, viz., besides Maues above mentioned, Gondophernes (103=20 B.C.), some Kuṣāṇa king (122=1 B.C.), Devaputra Kuṣāṇa (136=14 A.D.), Mahārāj-bhrātā Jehonika (191=69 A.D.). They are held to be dated in the same era, which is usually called the Old Śaka Era, shortly called O.S.E. But up to this time, there has been no unanimity amongst scholars about the starting date of the era used in inscriptions grouped under A.

We now take the second group of inscriptions which are those of the Kuṣāṇas, who ruled in North India in the second century A.D.

GROUP B

The Kuṣāṇa Inscriptions after Kaniṣka :

24. Kaniṣka casket : *saṁ 1 ma[harajasa] Kaniṣkasa.*
25. Sui Vihār : *maharajasya rajatirajasya devaputrasya Kaniṣkasya saṁvatṣare ekadaśe saṁ 11 Daisi(m)kasya masas[ya] divase(m) aṭhaviśe 28 [aya] tra divase.*
26. Zeda : *saṁ 11 Aṣāḍasa masasa di 20 Utaraphagure iśa kṣuṇami.....muroḍasa marjhakasa Kaniṣkasa rajami.*
27. Mānikīāla : *saṁ 18 Kartiyasa majh[e] divase 20 etra purvae maharajasa Kaniṣkasa.*
28. Box lid : *saṁ 18 masye Arthamisiya sastehi 10 iś[e] kṣuṇammi.*
29. Kurram : *saṁ 20 masasa Avadunakasa di 20 iś[e] kṣuṇammi.*
30. Peṣāwar Museum, No. 21 : *maharajasa [Vajus] kasa saṁ [24 Jeṭhasa?] masasadi.....iśe kṣuṇammi.*
31. Hidda : *saṁvatṣarae aṭhaviśatihi 28 masye Apelae sastehi daśahi 10 iś[e] kṣuṇammi.*
32. Śakardarra : *saṁ 40 P[r]oṭhavadasa masasa divas[ami] viśami di 20 atra divasakāle.*
33. Ārā : *maharajasa rajatirajasa devaputrasya kaisarasa Vajheṣkaputrasya Kaniṣkasa saṁvatṣarae ekacapar[i]śa[i] saṁ 41 Jeṭhasa masasa di 25 iś[e] divasakṣuṇami.*
34. Wardak : *saṁ 51 masy[e] Arthamisiya sastehi 15 imena gaḍrigreṇa.....maharaja rajatiraja Hoveṣkasa agrabhagrae.*

35. Uṇḍ : *saṁ 61 Cetrasa mahasa divase aṭhami di 8 iśa kṣunamī*.....*Purvaṣaḍe.*

36. Mamāne Dherī : *saṁ 89 Margasirasra masi 5 iśe kṣunamī.*

An incomplete date, *masasa di 25*, is further found in the Kāniza Dherī inscription.

The second group Nos. 24-36 contains Kharoṣṭhī inscriptions of the Kuṣāṇa kings after the first Kaniṣka. These and Kuṣāṇa Brāhmī inscriptions mention :

Years from 1 to 98, the kings Kaniṣka I from 1 to 24,

Vajheska from 24-28, Kaniṣka II of the year 41,

Huviṣka from 33-60,

Vāsudeva from 62-98.

The King's name and the titles are given in full, and in the genitive. The era is generally ascribed to the famous Kaniṣka as we have a record of his first year.

Their method of date-recording is the same as in Group A, viz., (see No. 25) the year of the era, the month name in Greek or Sanskrit, the ordinal number of the day, then the phrase equivalent to *asyām pūrvāyām* (before these), but in these inscriptions, it is expressed in the form *iśe kṣunamī* or its variant, which has been interpreted by Konow as equivalent of *asyām* or *etasyām pūrvāyām* in the Khotanī Śaka language which Konow thinks was the mother tongue of kings of the Kaniṣka group and which they use in their inscriptions. In fact kings of this group use a number of Khotanī Śaka words, and from their wide range of coins are known to have put in a medley of Greek, Iranian, and Indian gods including Buddha on their coins, but the names of the gods are not in their original Indian, Iranian or Greek form but invariably in the form used in the Khotanī Śaka language.

The method of date-recording followed by the Kuṣāṇas, in spite of its identity with that of Group A shows some interesting variations. In the Kharoṣṭhī inscriptions of the Kuṣāṇas, the months are mostly Greek, less so in Sanskrit (*Caitra*, *Vaiśākha*, etc.). The days run from 1 to 30 and clearly they are not *tithis* but solar days. When we turn to Brāhmī inscriptions, we find that the month names are mostly seasonal : *Griṣma*, *Varṣā*, or *Hemanta* as in the Sātavāhana records. But since 4 is the maximum number attached to these, and the day numbers run from 1 to 30, the number after the season denotes a month, not a *pakṣa* and the days are solar. Thus G 4 denotes the fourth month of the *Griṣma* season, viz, *Āṣāḍha*, and not the fourth *pakṣa* as was the case with the Sātavāhanas which would be the second half of *Vaiśākha*. The *pakṣa* is given up.

This is a deviation from Sātavāhana method of date-recording and follows closely the Graeco-Chaldean method. Some inscriptions mention Greek months (e. g. *Gorpiaios* which is *Āṣvina* or *Bhādra* in Sircar's No. 49, p. 146) others Indian lunar months (e. g. *Śrāvaṇa* in No. 51), but their number is small compared with the seasonal mode of recording months. These inscriptions give no indication as to whether the month is *Pūrṇimānta* or *Amānta*. The Indian months are *Pūrṇimānta*.

But the Zeda inscription of year 11 (No. 26 of Group B) mentions that the *nakṣatra* was *Uttaraphalgunā* on the 20th of *Āṣāḍha*, and (35) mentions that in the year 61, the *nakṣatra* on the 8th day of *Caitra* was *Pūrvāṣāḍhā*. A comparison with tables of *nakṣatras* shows that the months ended in full moon (*Pūrṇimānta*). As *pūrṇimānta* months were unknown outside India, the Kuṣāṇas must have yielded to Indian influence and adapted their original time-reckonings to the Indian custom; at least in their use of Indian months.

Historians and chronologists now almost unanimously hold that all these inscriptions of Group B are dated in the same era which is sometimes called the Kuṣāṇa era, which was founded by King Kaniṣka. This is said to be proved by the fact that the inscriptions range from year 1, and we have phrases as in No. 25 'of the *Mahārāja Rājādhirāja Devaputra Kaniṣka*, in the year 11. But a little more scrutiny shows that it is only a conventional phraseology, used in almost all Kuṣāṇa inscriptions, for even in as late as an inscription of year 98 of this group, we read 'of the *Mahārājā Vāsudeva* in the year 98'. It is therefore by no means clear that such phrases can be interpreted to mean that Kaniṣka started an entirely new era. In fact, from Kaniṣka's profuse use of Greek months and Greek gods, in his inscriptions and coins, Cunningham was led to the belief that Kaniṣka dated his inscriptions in the Seleucid era, with hundreds omitted, so that year 1 of Kaniṣka, is the year 401 of S. E. and year 90 of the Christian era.

But it has been known for some time that the Kuṣāṇa empire did not stop with that Vāsudeva who comes after Huviṣka. Dr. L. Bachhofer (1936) has proved from numismatics the existence of :

Kaniṣka III, reigning apparently after Vāsudeva I, Vāsudeva II, reigning after Kaniṣka III.

The kings appear to have retained full control of the whole of modern Afghanistan including Bactria which appears to have been the home land of the Kuṣāṇas and some parts of the Punjab, right up to Mathurā.

There is yet no proof for or against the point that they retained the eastern parts, after year 98 of Kuṣāṇa

era. Herzfeld had established that Vāsudeva II, who appears to have come after Kaniṣka III about 210 A.D., was deprived of Bactria by Ardeshir I, the founder of the Sasanid dynasty of Persia. The Sasanids converted Bactria into a royal province under the charge of the crown prince, who struck coins closely imitating those of the Kuṣāṇas. Vāsudeva II is also mentioned in the Armenian records of Moise of Khorene, a Jewish scholar, under the name Vehsadjan, as an Indian king who tried to form a league with Armenia and other older powers against the rising imperialism of Ardeshir. Vasudeva II is also thought to have sent an embassy to China about 230 A.D. *

The second Sassanian king Shapur I, claims to have conquered sometime after 240 A.D. 'PSKVR', which has been identified with Puruṣapura or Peshawar, the capital of the Kuṣāṇas. This has also been confirmed by the French excavations at Begram (Kāpiśi) in Afghanistan, which was destroyed by Shapur between 242 and 250 A.D. But this probably was not a permanent occupation but a raid, as a Kuṣāṇa king or Shah is mentioned in the Paikuli inscription of the Sasanid king Narseh (293-302 A.D.).

Kushana Method of Date-recording In India :

It appears rather strange that the Kuṣāṇa way of date-recording should suddenly come to a dead stop on Indian soil with the year 98 of Vāsudeva I, and no records containing a year number exceeding 100 should be found on Indian soil.

The mystery appears now to have been successfully solved by Mrs. Van Lohuizen de Leeuw in her book *The Scythian Period* (pub. 1949). She has proved that several Brāhmī inscriptions in the Mathurā region bear dates from years 5 to 57 in which, following an old Indian practice, the figure for hundred has been omitted. Thus '5' stands for 105, '14' stands for 114 of the Kuṣāṇa era. The following example will suffice (*vide* pp. 242-43 of *The Scythian Period*).

One and the same person Āryā Vasulā, female pupil of Āryā Saṅgamikā, holding the important position of a religious preacher in the Jaina community, is mentioned in two Brāhmī inscriptions (No. 24 and No. 70 of Lüders) bearing the year designations of 15 and 86 respectively, the date-recording being in the typical Kuṣāṇa style. The palaeographical evidence also shows that the inscriptions were recorded in the Kuṣāṇa age, though the name of the reigning monarch

* Ghirshman thought that the Vāsudeva Kuṣāṇa of these references is Vāsudeva I, whose last reference is year 98. He equated year 98 of Kaniṣka's era to year 242-250 A.D., and arrived at the date 144 to 152 A.D. for the initial year of the Kaniṣka era. But the equation of this Vāsudeva with Vāsudeva I is certainly wrong. This must be Vāsudeva II, or may be a still later Vāsudeva.

is not mentioned. Now it is clearly impossible that the same person would occupy such an important position from the year 15 to 86, a period of 71 years. L. de Leeuw therefore suggests that while 86 is the usual Kuṣāṇa year (reckoning from year 1 of Kaniṣka), '15' is really with hundred omitted and represents actually the year 115 of Kaniṣka, i.e., dates of the two inscriptions differ by $115 - 86 = 29$ years, which is much more plausible. In other words, after the year 100 of the Kaniṣka era was passed, hundreds were dropped in inscriptions found near about Mathurā.

The author has sustained her ground by numerous other illustrations, and there seems to be no doubt that this is a brilliant suggestion and it can be taken as proved that in numbering years of an era, hundreds were omitted in certain parts of the Kuṣāṇa dominion in the second century of the Kaniṣka era. L. de Leeuw has found such dates in no less than 7 instances bearing years 5, 12, 15, 22, 35, 50, 57 in which apparently 100 has been omitted, so that 57 really stands for 157, and if we take the Kaniṣka era to have started from 78 A.D., the date of the last one is A.D. $235 = (157 + 78)$. Probably the name of the reigning king was not mentioned, as he had either lost control over these regions, or as the inscriptions were religious, it was not considered necessary. The second alternative appears to be more correct.

This is supported by the inscription on an image discovered by Dayaram Sahni in Mathurā in 1927. It mentions *Māhārāja Devaputra* Kaniṣka. But on palaeographic grounds, he can neither be Kaniṣka I (1-24) nor Kaniṣka II (41), but a later Kaniṣka, coming after Vāsudeva I, and 14 is really year 114 of the Kaniṣka era. We may identify him with Kaniṣka III of Bachhofer.

So we come to this conclusion :

The records of Kuṣāṇa kings, after Kaniṣka I range from year 1 to 98. In the second century of the Kaniṣka era, hundreds are omitted and such records have been found up to year 157, i.e., year 235 of the Christian era.

This raises a strong presumption that Kaniṣka was not the founder of the era, but he used one already in vogue, but omitted the hundreds. Thus year 1 of Kaniṣka is really year 1 plus some hundred, may be 1, 2, or 3. L. de Leeuw does not expressly suggest this, though it is apparent from her reasoning that year 1 of King Kaniṣka is year 201 of the Old Śaka era*. If this suggestion be correct, since the old Śaka era is taken to have started in 123 B.C. (-122 A.D.) instead of in 129 B.C., as postulated by L. de Leeuw, Kaniṣka started reigning in $(201 - 123) = 78$ A.D.

* The suggestion is of Prof. M. N. Saha.

From the above review of inscriptional records and contemporary history, the following story has been reconstructed.

(1) The Śaka era was first started in 123 B.C. when the Sakas coming from Central Asia due to the pressure of Hūnas wrested Bactria from the Parthian emperors after a seven years' war. The leader was probably one 'Azes', and therefore the era was also alternately called the 'Azes' era. This Azes is not to be confounded with the two later Azes who succeeded Maues and reigned between 45 B.C. to 20 B.C. Earlier Sakas used Macedonian months and Graeco-Chaldean method of date recording, prevalent throughout the whole of Near East. In Indian dominions, Indian months which were equated to Greek months were used. As their coins show, the ruling class had adopted Greek culture.

(2) When the Sakas spread from 'Śakasthān', i.e., modern Afghanistan into contiguous parts of India, they began to be influenced by Indian culture. During the first stage, they exclusively used Greek in their coins, but later they began to use Kharoṣṭhī and Brāhmī as well. The coins of Maues (80 B.C.—45 B.C.), Azes I, Azilises, Azes II show increasing influence of Indian culture. The southern Sakas who penetrated into Saurashtra and Malwa show Indian influence to a greater degree.

(3) In the first three centuries, they (Maues group, Nahapāna group and Kuṣāṇas) used the old Śaka era omitting hundreds, and using a method of date-recording which was an exact copy of the contemporary Graeco-Chaldean system prevalent throughout the Parthian empire (Macedonian months, and ordinal number of days). But they also began to use Indian months. Whenever they did it, the month was *Pūrṇimānta*, as was the custom with old Hindu dynasts (Mauryas and Sātavāhanas).

(4) The classical Śaka era starting from 78 A.D. is nothing but the old Śaka era, starting from 123 B.C. with 200 omitted, so that the year 1 of Kaniṣka is year 201 of the Old Śaka era.

Śaka Era in the South-West.

Besides the earlier Śakas belonging to the Maues group, and the Kuṣāṇas, there was another group of Śaka kings, who penetrated into the south-western part of India. The earliest representative of this group was Nahapāna and his son-in-law Uṣavadāta. Their records are dated in years 41 to 46 of an unknown era. They use Indian lunar months and days (probably *tithis*). These Śakas ruled in Rajputana, Malwa, and northern Maharashtra and were engaged in continuous warfare with the Sātavāhana ruler Gautamīputra Śātakarṇi who claim to have destroyed them root and branch.

The senior author has shown that Nahapāna used the old Śaka era with one hundred omitted, so that the year 46 of Nahapāna was the year 146 of the old Śaka era or about 24 A.D.

The Sātavāhana kings Gautamīputra Śātakarṇi and his son Vāsiṣṭhīputra Pulumavi, whose records are found dated in the typical Indian fashion, reigned according to his hypothesis from about 40 A.D. to 80 A.D. From epigraphical record, Nahapāna is at least separated by about 100 years from the next group of Śaka rulers, *viz.*, the Śakas of Ujjain belonging to the house of Caṣṭana.

The Śaka satraps of Ujjain.

We come across the records of another Śaka ruling family, reigning in Ujjain.

[Andau (Cutch) stone inscriptions of the time of Caṣṭana and Rudradāman, Sircar, p. 167].

Rājñāḥ Caṣṭanasya Jāmotika-putrasya rājñāḥ Rudradāmnāḥ Jayadāma-putrasya [ca] varṣe dvīpañcāśe 52 Phālguna-bahulasya (=kṛṣṇa-pakṣasya) dvītiya vāre (=divase) 2 madanena Śinhīla-putreṇa bhaginyāḥ Jyeṣṭhavrāyāḥ Śinhīla-duhituḥ aupaśati sagotrāyāḥ yaṣṭiḥ utthāpita...

Translation : Of king Caṣṭana, son of Jāmotika and of king Rudradāman son of Jayadāman, in the year 52, on the dark half of the month of Phālguna and on the 2nd day...

This inscription mentions the year 52, the second day of the *Kṛṣṇa pakṣa* of the month of *Phālguna*.

There is no doubt that the year mentioned is that of the *Śaka era as now known*. For this satrapal house reigned continuously for nearly 300 years and has left a wealth of dated records. But the name of the era is not mentioned in the earlier records. They are mentioned merely as years so and so.

The earliest authentic instance of the use of Śaka era by name is supplied by the Bādāmi inscription of Calikya Vallabhesvara (Pulakesin I of the Cālukya dynasty), dated 465 of the Śaka era (*Śaka-Varṣeṣu Catuś-śateṣu pañca-śaṣṭhi-yuteṣu* : *Epigraphia Indica* XXVII, p. 8). In literature the use of the era by name appears still earlier. The *Lokavibhāga* of Simhasūrī, a Digambara Jaina work in Sanskrit is stated in a manuscript to have been completed in 80 beyond 300 (i.e. 380) of the Śaka years (*Ep. Ind.*, XXVII, p. 5). There is no doubt that the era used in the records of the western satrapal house beginning with Caṣṭana and Rudradāman have come down to the present times as the Śaka Era, which is the 'Era' par excellence used by Indian astronomers for purposes of calculation. There are 30 or more 'Eras' which have been in use in India (*vide* § 5'8), but none of them have been

used for calendrical calculation by the Indian astronomers.

Yet it is difficult to assign the origin of the Śaka era to the western satraps. An era can be founded only by an imperial dynasty like the Seleucids, the Parthians or the Guptas. The western satraps never claim, in their numerous records, any imperial position. They are always satisfied with the subordinate titles like *Kṣatrapa* (*Satrap*) or *Mahā Kṣatrapa* (*Great Satrap*) while the imperial position is claimed by their northern contemporaries, the Kuṣāṇas.

The conclusion is that the western Kṣatrapas used the old Śaka era, with 200 omitted; so that year 1 of the present Śaka era is year 201 of the old Śaka era, i.e., $(201 - 122) = 79$ A.D.

The gradual adoption of characteristic Indian ideas by the Śakas is shown in a record of Satrap Rudrasimha dated 103 S.E. or 181 A.D.

[Gundā Stone Inscription of the time of Rudrasimha I, Sircar, p. 176]

Siddham. Rājñah mahākṣatrapasya svāmi-Caṣṭana-prapautrasya rājñah kṣatrapasya svāmi Jayadāmapautrasya rājñah mahākṣatrapasya svāmi-Rudradāma-putrasya rājñah kṣatrapasya svāmi-Rudrasimhasya varṣe tryuttarasata (tame) (=adhika) 103 Vaiśākha śuddhe (=śuklapakṣe) pañcama-dhanya tithau Rohiṇi nakṣatramuhūrte ābhireṇa senāpati Bappakasya putreṇa senāpati Rudrabhūtina grāme rasāpadrake vāpī (=kūpaḥ) khānita, bāndhitā [śilādibhiḥ] ca sarva sattvānām hila-sukhārtham iti.

Translation: Of king Mahākṣatrapa.....of Svāmī Rudrasimha in the year 103 in the light half of the month of Vaiśākha on the 5th tithi and in the Rohiṇi nakṣatra muhūrta,.....

The Śaka satrap Rudrasimha, reigning in 181 A.D. thus dates his inscriptions using an era (the Śaka era), purely Indian months, *tithis* and *nakṣatras*. This is in full Siddhāntic style, because the characteristic features of Siddhāntic method of date recording which mention *tithi* and *nakṣatra* are first found in this inscription. The 'week day' is however not mentioned.

This is first mentioned in an inscription of the emperor Budhagupta (484 A. D.).

Śate pañcaṣaṣṭyādhike varṣānām bhūpatau ca Budhagupte Āṣāḍha māsa [śukla]—[dvā] dasyām suragurordivase.....

(Iran Stone Pillar Inscription of Budha Gupta—Gupta year 165=484 A.D.).

Translation: In the year 165 of the Gupta era during the reign of emperor Budhagupta in the month of Āṣāḍha and on the 12th tithi of the light half which was a Thursday (i.e. day dedicated to the preceptor of Gods).

5.6 SOLAR CALENDAR IN THE SIDDHANTA JYOTISHA PERIOD

Rise of Siddhantas or Scientific Astronomy

The *Vedāṅga Jyotiṣa* calendrical rules appear, from inscriptional records, to have been used right up to the end of the reign of the Sātavāhanas (200 A.D.). The analysis of inscriptional data on methods of date-recording given in § 5.5 shows that it was the Śaka and Kuṣāṇa rulers (50 B.C. – 100 A.D.), who introduced the Graeco-Chaldean methods of date-recording, prevalent in the Near East into India. These methods require a knowledge of the fundamentals of astronomy, which must have been available to the Śaka and Kuṣāṇa rulers. In India, as the inscriptional records show, some purely Indian dynasts probably accepted the system in full from about 248 A.D. (date of foundation of the Kalachuri era, the earliest era founded by Indian kings, leaving aside the Saka era which is admittedly of foreign origin and the Vikrama era whose origin is still shrouded in mystery). During the time of the Guptas who founded an era commemorating their accession to power in 319 A.D. the integration of the western system with the Indian appears to have been complete.

Indian astronomical treatises, explaining the rules of calendaric astronomy, are known as *Siddhāntas*, but it is difficult to find out their dates. The earliest Indian astronomer who gave a date for himself was the celebrated Āryabhaṭa who flourished in the ancient city of Pataliputra and was born in 476 A.D.

It is necessary to reply to a question which has very often been asked, but never satisfactorily answered, *viz.*,

Why did the Indian savants who were in touch with the Greeks, and probably with Greek science since the time of Alexander's raid (323 B.C.), take about 500-600 years to assimilate Greek astronomy, and use it for their own calendar-framing?

The Indians of 300 B.C. to 400 A.D., were quite vigorous in body as well as in intellect as is shown by their capacity to resist successive hordes of foreign invaders, and their remarkable contributions to religion, art, literature and certain sciences. Why did they not accept the fundamentals of Greek astronomy for calendrical calculations earlier?

The reply to this query appears to be as follows:

The Greeks of Alexander's time had almost nothing to give to the Indians in calendaric astronomy, for their own knowledge of astronomy at this period was extremely crude and far inferior to that of the contemporary Chaldeans. The remarkable achievements of the Greeks in astronomy, and geometry,

though they started from the time of Alexander (Plato's Academy), really flowered in full bloom in the century following Alexander (330 B.C.—200 B.C.). The culmination is found in Hipparchos of Rhodes who flourished from 160—120 B.C. ; he wrote treatises on astronomy. Simultaneously in Seleucid Babylon, Chaldean and Greek astronomers made scientific contributions of the highest order to astronomy (*vide* § 4.7 & 4.8), but none of their works have survived, but are now being found by archaeological explorations.

It is therefore obvious that the Indians of the age of Aśoka (273 B.C.—200 B.C.), who were in touch with the Greek kingdoms of Babylon and Egypt, had not much to learn from the Greeks in astronomy.

The Mauryas were succeeded by the Suṅgas (186 B.C.—75 B.C.), but Indians during this age were in touch only with the Bactrian Greeks. But by this time, the Parthian empire had arisen (250 B.C.), producing a wedge between western and eastern Greeks. The only dated record of the Indo-Bactrian king, Menander (150 B.C.), is purely Indian in style.

By about 150 B.C., direct contact between India and Greater Greece which included Babylon had almost ceased, due to the growth of the Parthian empire. Whatever ideas came, was through the Śaka-Kuṣāṇa kingdoms which came into existence after 90 B. C. By that time, astronomy was regarded as only secondary to planetary and horoscopic astrology, which had grown to mighty proportions in the West. This may have been probably one of the main reasons for late acceptance of Graeco-Chaldean astronomy in India, for Indian thought during these years was definitely hostile to astrology.

It will surprise many of our readers to be told that astrology was not liked by Indian leaders of thought, which dominated Indian life during the period 500 B.C.—1 A.D. Nevertheless, it is a very correct view.

The Great Buddha, Whose thoughts and ideas dominated India from 500 B.C. to the early centuries of the Christian era, was a determined foe of astrology. In Buddha's time, and for hundreds of years after Buddha, there was in India no elaborate planetary or horoscopic astrology, but a crude kind of astrology based on conjunctions of the moon with stars and on various kinds of omina such as appearance of comets, eclipses, etc. But Buddha appears to have held even such astrological forecasts in great contempt, as is evident from the following passage ascribed to him :

Yathā vā paṇ'ēke bhonto. Samaṇa-brāhmaṇā
saddhā-deyyāni bhojanāni bhujjītvā te evarūpāya
tiracchāna-vijjāya micchājīvena-jīvikāṃ kappenti-

seyyathidam *canda-ggāho bhavissati,
suriyaggāho bhavissati, nakkhatta-ggāho bhavissati.
Candima suriyānaṃ pathagamaṇaṃ bhavissati,
candima suriyānaṃ uppathagamaṇaṃ, bhavissati,
nakkhattānaṃ pathagamaṇaṃ bhavissati,
nakkhattānaṃ uppathagamaṇaṃ bhavissati.
Ukkāpāto bhavissati. Disā-ḍāho bhavissati.
Bhūmicālo bhavissati. Devadundubhi bhavissati.
Candima suriya nakkhattanaṃ uggamaṇaṃ
ogamaṇaṃ saṃkilesaṃ vodānaṃ bhavissati.**

(*Dīgha Nikāya*, Vol. 1, p. 68, Pali Text Book Society)

Translation : Some brāhmaṇas and śramaṇas earn their livelihood by taking to beastly professions and eating food brought to them out of fear ; they say : "there will be a solar eclipse, a lunar eclipse, occultation of the stars, the sun and the moon will move in the correct direction, in the incorrect direction, the nakṣatras will move in the correct path, in the incorrect path, there will be precipitation of meteors, burning of the cardinal directions (?), earthquakes, roar of heavenly war drums, the sun, the moon, and the stars will rise and set wrongly producing wide distress amongst all beings, etc."

This attitude to astrology and astrolatry on the part of Indian leaders of thought during the period of 500 B.C. to 100 A.D., was undoubtedly a correct one, and would be welcomed by rationalists of all ages and countries. But such ideas had apparently a very deterrent effect on the study of astronomy in India. Pursuit of astronomical knowledge was confused with astrology, and its cultivation was definitely forbidden in the thousands of monasteries which sprang all over the country within few hundred years of the Nirvāṇa (544 B.C./ 483 B.C). Yet monasteries were exactly the places where astronomical studies could be quietly pursued and monks were, on account of their leisure and temperament, eminently fitted for taking up such studies, as had happened later in Europe, where some of the most eminent astronomers came from the monkist ranks, e.g., Copernicus and Fabricius.

Neither did Hindu leaders, opposed to Buddhism, encourage astrology and astrolatry. The practical politician thought that the practice of astrology was not conducive to the exercise of personal initiative and condemned it in no uncertain terms. In the *Arthaśāstra* of Kauṭilya, a treatise on statecraft, which took shape between 300 B.C. and 100 A.D., and is ascribed to Cānakya, the following passage is found :

* Acknowledgement is due to Prof. Mm. Bidhusekhar Sastri, who supplied these passages.

Kauṭīliya Arthaśāstra

Nakṣatraṃ atiprocchantāṃ bālaṃ artho'tivartate
Artho hyarthasya nakṣatraṃ kiṃ kariṣyanti tārakāḥ.

Translation: The objective (*artha*) eludes the foolish man (*bālam*) who enquires too much from the stars. The objective should be the *nakṣatra* of the objective, of what avail are the stars?

This may be taken to represent the views of the practical politician about astrology and astrolatry, during the period 500 B.C. to 100 B.C.

Cānakya was the great minister of Candragupta, and history says that these two great leaders rolled back the hordes of the Macedonians, who had conquered the Acheminid Empire of Iran comprising the whole of the Near East to the borders of Iran, and thereafter laid the foundation of the greatest empire India has ever seen. They clearly *not only did, not believe in astrology, but openly, and without reserve, ridiculed its pretensions.*

But the influence of original Buddhism waned after the rise of Mahāyānist Buddhism, which received great encouragement during the reign of Kaniṣka (78 A.D. to 102 A.D.) and other Kuṣāṇa and Saka kings. Then came Buddhist iconography, coins, and knowledge of the methods of western date-recording which the Śakas and Kuṣāṇas used. They blended with the indigenous Indian system slowly.

The focus of diffusion of western astronomical knowledge appears to have been the city of Ujjayinī, capital of the western Satraps who were apparently the first to use a continuous era (the Śaka era), and a method of date-recording which was at first purely Graeco-Chaldean as prevalent in Seleucid Babylon, but gradually Indian elements like the *tithi* and the *nakṣatra* were blended, as we find for the first time in the inscription of Satrap Rudrasimha, dated 181 A.D. (*vide* § 5.5).

This city of Ujjayinī was later adopted as the Indian Greenwich, for the measurement of longitudes of places. The borrowal of astronomical knowledge was not therefore from Greece direct, but as now becomes increasingly clearer, from the West, which included Seleucid Babylon, and probably through Arsacid Persia. The language of culture in these regions was Greek, and we therefore find Greek words like *kendra* (centre), *liptikā* (lepton), *horā* (hour) in use by Indian astronomers.

This view is supported by the Indian myth that astrolatry and astrology were brought to India by a party of *Śakadvīpi Brāhmaṇas* (Scythian Brahmins), who were invited to come to India for curing Śamba, the son of Kṛṣṇa, of leprosy by means of incantations

to the Sungod. Professional astrologers, in many parts of India, admit to being descendants of these *Śakadvīpi - Brāhmaṇas* and probably many of the eminent astronomers like Āryabhaṭa and Varāhamihira who made great scientific contributions to astronomy belonged to this race. The planetary Sungod is always shown with high boots on, as in the case of Central Asian kings (e.g., Kaniṣka).

It is a task for the historian to trace how the steps in which the importation of western astronomical knowledge took place for the *Siddhāntas*, which incorporate this knowledge and are all a few centuries later, and many of them bear no date.

A good *point d'appui* for discussion is Varāhamihira's *Pañca Siddhāntikā*; for Varāhamihira's date is known. He died in 587 A.D., in ripe old age so he must have written his book about 550 A.D. This is a compendium reviewing the knowledge contained in the five *Siddhāntas* which were current at his time. These were regarded as '*Apauruṣeya*' or "knowledge revealed by gods or mythical persons".

The five *Siddhāntas* are :

- Paitāmaha* ... Ascribed to Grandfather Brahmā.
- Vāsiṣṭha* ... Ascribed to the mythical sage Vasiṣṭha, a Vedic patriarch, and revealed by him to one Māṇḍavya.
- Romaka* ... Revealed by god Viṣṇu to Ṛṣi Romaśa or Romaka.
- Pauliśa* ... Ascribed sometimes to the sage Pulastya, one of the seven seers or patriarchs forming the Great Bear constellation of stars (but see later).
- Sūrya* ... Revealed by the Sungod to Asura Maya, architect of gods, who propounds them to the Ṛṣis.

The five *Siddhāntas* are given in the increasing order of their accuracy according to Varāhamihira. Thus Varāhamihira considers the *Sūrya Siddhānta* as the most accurate, and next in order are the *Pauliśa*, and the *Romaka*. The *Vāsiṣṭha* and *Paitāmaha* are, according to Varāhamihira, not accurate.

Why were those *Siddhāntas* regarded as "*Apauruṣeya*" (i.e. not due to any mortal man)? Dikṣit says (*Bhāratīya Jyotiṣāstra*, Part II, Chap. 1) :

"The knowledge of astronomy as seen developed during the Vedic and Vedāṅga Jyotiṣa periods and described in Part I, was *wide* as compared with the length of the period; but *it is very meagre, when compared with the present position****. The oldest of astronomical knowledge (given in the oldest *Siddhāntas*) reveal a sudden rise in the *standard* of astronomical knowledge. Those who raised the standard as given

in these works, were naturally regarded as superhuman and hence the available ancient works on astronomy are regarded as 'apauruṣeya' (i.e. not compiled by mortal men) and it is clear that the belief has been formed later".

This statement, made by Dikṣit nearly sixty years ago, really singles out only one phase of the issue, viz., the wide gulf in the level of astronomical knowledge of the Siddhāntas and that in the *Vedāṅga Jyotiṣa*; but leaves the question of actual authorship open. In our opinion the *Siddhāntas* were regarded as *Apauruṣeya* because they appear to have been compilations by different schools of the knowledge of calendaric astronomy, as they diffused from the West during the period 100 B.C.—400 A.D. But let us look into them a little more closely.

The Paitamaha Siddhanta: described in five stanzas in Chap. XII. of the *Pañca Siddhāntikā*.

As already discussed it is a revised edition of the *Vedāṅga Jyotiṣa*, but later authors say that it contained rules for the calculation of motions of the sun, the moon and also the planets which were not given by the *Vedāṅga Jyotiṣa*. As the full text of the original Siddhānta has not been recovered, it is difficult to say how the borrowal took place.

The Vasistha Siddhanta: as known to Varāhamihira is described in 13 couplets in Chap. II of the *Pañca Siddhāntikā*. It describes methods of calculating *tithi* and *nakṣatra*, which are inaccurate. Besides it mentions *Rāṣi* (zodiacal signs), angular measurements, discusses length of the day, and the *lagna* (ascendant part of the zodiac). Apparently this represents one attempt by a school to propagate western astronomical knowledge. The school persisted and we have *Vāsiṣṭha Siddhāntas* later than Varāhamihira. One of the most famous was Viṣṇucandra (who was somewhat later than Āryabhaṭa) who was conscious of the phenomenon of precession of the equinoxes. No text of the Siddhānta is available, except some quotations.

Varāhamihira pays a formal courtesy to *Paitāmaha* and *Vāsiṣṭha*; this does not prevent him from describing these two as 'dūravibhraṣṭau', i.e., furthest from truth.

The Romaka Siddhanta :

The *Romaka Siddhānta* as reviewed by Varāhamihira uses :

A Yuga of 2850 years = $19 \times 5 \times 30$ years ;
150 years = 54787 days ;
1 year = 365.2467 days.

The number of intercalary months in the *yuga* is given as 1050, i.e., there are 7 intercalary months in 19 years.

We need not go any further into the contents of this Siddhānta. As the name indicates, the knowledge was borrowed from the West, which was vaguely known as 'Romaka' after the first century A.D. The *yuga* taken is quite un-Indian, but appears to be a blending of the nineteen-year cycle of Babylon, the five-yearly *yuga* of *Vedāṅga Jyotiṣa*, and the number 30 which is the number of *tithis* in a month. The length of the year is identical with Hipparchos's (365.2467), and this alone of the Siddhāntas gives a length of the year which is unmistakably tropical.

The *Romaka Siddhānta* appears to represent a distinct school who tried to propagate western astronomical knowledge on the lines of Hipparchos. One of the later propounders was Śrīṣeṇa, who flourished between Āryabhaṭa and Brahmagupta; the latter ridicules him roundly for having made a "kānthā", i.e. a wrapper made out of discarded rags of all types—meaning probably Śrīṣeṇa's attempt to blend two incongruous systems of knowledge, western and eastern.

The Paulisa Siddhanta :

This Siddhānta was at one time regarded as the rival of the *Sūrya Siddhānta*, but no text is available now. But it continued to be current up to the time of Bhaṭṭotpala (966 A.D.), who quotes from it.

Alberuni (1030-44 A.D.) who was acquainted with it, said that it was an adaptation from an astronomical treatise of Paulus of Sainthra, i.e., of Alexandria. But it is not clear whether he had actually seen Paulus's treatise, and compared it with the *Pauliṣa Siddhānta* or simply made a guess on the analogy of names merely. The name of one Paulus is found in the Alexandrian list of savants (378 A.D.) but his only known work is one on astrology, and it has nothing in common with *Pauliṣa Siddhāntā*, which appears to have been purely an astronomical treatise as we can reconstruct it from the *Pañca Siddhāntikā* (*vide infra*). The ascription to Paulus of Alexandria is not therefore proved. There is, however, reference in the *Pauliṣa Siddhānta* to Alexandria, or Yavanapura, as it was known to Hindu savants. The longitudes of Ujjainī and Banaras are given with reference to Alexandria (P. S., Chap. III).

The *Pañca Siddhāntikā* devotes a few stanzas of Chaps. I, III, VI, VII, and VIII to this exposition of the *Pauliṣa Siddhānta*. Nobody seems to have gone critically into the contents of these chapters after Dr. Thibaut who tried to explain these in his introduction to the *Pañca Siddhāntikā*, but left most of them unexplained owing to their obscurity.

In Chap. I, (verses 24—25), 30 Lords of the days of the month are mentioned. This is quite un-Indian

and reminds one of the Iranian calendar in which each one of thirty days of the month is named after a god or principle (see § 2.3). The names of the lords of the days as given in the *Paulīṣa Siddhānta* are of course all Indian.

The Surya Siddhanta

Of all the Siddhāntas mentioned by Varāhamihira this alone has survived and is still regarded with veneration by Indian astrologers. This Siddhānta was published with annotations by Rev. E. Burgess, in 1860, and has been republished by the Calcutta University under the editorship of P. L. Gangooly, with an introduction by Prof. P. C. Sengupta.

This is supposed to have been described by the Sungod to *Asura Maya*, the architect of the gods, who revealed it to the Indian Ṛṣis. These legends certainly represent some sort of borrowing from the West, but it would be fruitless to define its exact nature unless the text is more critically examined. Varāhamihira describes in Chapters IX, X, XI, XVI, XVII of the *Pañca Siddhāntikā* the contents of the *Sūrya Siddhānta* as known to him; they are somewhat different from those as found in the modern text. It appears that this Siddhānta was constantly revised with respect to the astronomical constants contained in it as all astronomical treatises should be. The text as we have now was fixed up by Raṅganātha in 1603 after which there have been no changes. Burgess, from a study of the astronomical constants, thought that the final text referred to the year 1091 A.D. Prof. P. C. Sengupta shows that the S.S. as reported by Varāhamihira borrowed elements of astronomical data from Āryabhaṭa, and the S.S. as current now has borrowed elements from Brahmagupta (628 A.D.).

The modern *Sūrya Siddhānta* is a book of 500 verses divided into 14 chapters, contents of which are described briefly below :

- | | |
|-------|--|
| Chap. | I—Mean motions of the Planets. |
| .. | II—True places of the Planets. |
| .. | III—Direction, Place, and Time. |
| .. | IV—Eclipses, and especially Lunar Eclipses. |
| .. | V—Parallax in a Solar Eclipse. |
| .. | VI—Projection of Eclipses. |
| .. | VII—Planetary Conjunctions. |
| .. | VIII—The Asterisms. |
| .. | IX—Heliacal Risings and Settings. |
| .. | X—Moon's Risings and Settings, and the Elevation of her Cusps. |
| .. | XI—Certain malignant Aspects of the Sun and the Moon. |

Chap. XII—Cosmogony, Geography, Dimension of the Creation.

.. XIII—Armillary Sphere, and other Instruments.

.. XIV—Different modes of reckoning Time.

A scrutiny of the text shows that it is, with the exception of a few elements, almost completely astronomical. A few verses in Chap. III, *viz.*, Nos. 9-12 deal with the trepidation theory of the precession of equinoxes. These are regarded by all critics of the *Sūrya Siddhānta* to be interpolations made after the 12th century.

It will take us too much away from our main theme to give a critical account of this treatise, but every critic has admitted that the text does not show any influence of Ptolemy's *Almagest*. Prof. P. C. Sengupta's introduction is particularly valuable. This Siddhānta indicates that longitudes should be calculated from Ujjain and makes no mention of Alexandria. Prof. Sengupta thinks that it dated from about 400 A.D., but a scrutiny of the co-ordinates of certain stars marking the ecliptic, which we have discussed in Appendix 5-B, shows that it might have utilized data collected about 280 A.D., when the star *Citrā* (a *Virginis*), was close to the autumnal equinoctial point, and is therefore subsequent to 280 A.D.

The rules of framing the calendar are found in Chapter XII of which we give an account in the next section.

After about 500 A.D., the Indian astronomers gave up the pretext of ascribing astronomical treatises to gods or mythical sages and began to claim authorship of the treatises they had written; the earliest that has survived is that of Āryabhaṭa (476—523 A.D.). The objects of their treatises were to frame rules for calendaric calculations, knowledge of astronomy forming the basis on which these rules were framed.

In addition to the *Sūrya Siddhānta* only two other systems have survived, *viz.*,

The Ārya Siddhānta—due to Āryabhaṭa II, an astronomer of the 10th century, and supposed to be related to the *Āryabhaṭīya* of Āryabhaṭa, who claims to have derived it from *Brahmā*, the Creator.

The Brahma Siddhānta—vaguely related to the *Paitāmaha Siddhānta*, but the human authorship is ascribed to the celebrated astronomer Brahmagupta (628 A.D.).

But a number of astronomical treatises like that of *Siddhānta Śiromaṇi* by Bhāskarācārya and many others, have survived either on account of their own merit or their connection with astrology.

**The Solar Calendar according to the
Surya Siddhanta**

The first few verses of Chap. XII deal with the creation of the world according to Hindu conception, and the creation of the elements ; of the sun, the moon, and the planets. The universe is taken to be geocentric, and the planets in order of their decreasing distances from the earth are given as (*vide* verse 31) :

Saturn, Jupiter, Mars, the Sun, Venus, Mercury
and the Moon.

The fixed stars are placed beyond the orbit of Saturn.

Sūrya Siddhānta, XII, Verse 32

Madhye samantāt daṇḍasya bhūgolo byomni tiṣṭhati
Bibhrāṇaḥ paramām śaktim brahmaṇo dhāraṇātmikān.

Translation : Quite in the middle of the celestial egg (*Brahmāṇḍa*), the earth sphere (*Bhūgola*) stands in the ether, bearing the supreme might of *Brahmā* which has the nature of a self supporting force.

The astronomers are thus conscious that the earth is a spherical body suspended in ether (*byomni*)

Verse 34 : Describes the earth's polar axis, which passing through the earth's centre emerges as mountains of gold on either side.

Verse 35 : Gods and Ṛṣis are supposed to dwell on the upper (northern) pole, and the demons are supposed to dwell on the nether (south) pole.

Verse 43 : Describes two pole-stars (*Dhruva-tārās*) which are fixed in the sky.

The author could have been aware only of the Polaris. By analogy he inferred the existence of a southern pole-star which, as is well-known, does not exist. He had apparently no knowledge of the sky far south of the equator.

The remaining verses describe the equator : As in modern astronomy, it says that the polar star is on the horizon of a person on the equator and the co-latitude (*Lambaka*) of the equator is 90°.

The Siddhāntic astronomers thus completely accepted the geocentric theory of the solar system. It was a great improvement on the ideas of the world prevalent in India at the time of the great epic *Mahābhārata* (date about 300 B.C.), in which the earth is described to be a flat disc, with the *Sumeru* mountain as a protruding peg in the centre, round which the diurnal motion of the celestial globe carrying the stars, planets, the sun and the moon takes place. This idea of the world is also found in the *Jātakas* and other Buddhist scriptures.

In the subsequent verses four cardinal points on the equator are recognized, these are :

Laṅkā, which is technically the name of a locality on the equator lying in the meridian of Ujjayinī, which was the Greenwich of ancient India. This *Laṅkā* had nothing to do with Ceylon, but is a fictitious name ;

90° west of *Laṅkā* the city called *Romaka*, and 90° east of *Laṅkā* the city known as *Yamakoṭi*.

The name *Romaka* vaguely refers to the capital of the Roman Empire. 'Yamakoṭi' is quite fanciful.

The *Sūrya Siddhānta* takes it for granted that the sun's yearly motion through the ecliptic is known to the reader and now proceeds to explain the Signs of the Zodiac.

Sūrya Siddhānta XII, 45

Meṣādau devabhāgasthe devānām yāti darśanaṁ
Asurāṇām tulādau tu sūryastadbhāga sañcaraḥ.

Translation : In the half revolution beginning with *Meṣādi* (*lit.* the initial point of Aries), the sun being in the hemisphere of gods, is visible to the gods ; but while in that beginning with *Tulādi* (*lit.* the initial point of Libra) he is visible to the demons moving in their hemisphere.

This means that when the sun reaches *Meṣādi*, the initial point of the sign of Aries, the gods who are supposed to be in the north pole just witness the rising of the sun and has the sun over the horizon for six months. All these six months, the demons who are supposed to be at the south pole are in the dark. It is *vice versa* for their enemies the *Asuras* for whom, dwelling in the south pole, the sun rises for them when it is at *Tulādi* (beginning of the *Tulā* sign i.e., first point of Libra) and remains above the horizon for six months.

According to the S.S., therefore, *the first point of Aries is coincident with the vernal equinoctial point, and the first point of Libra with the autumnal equinoctial point.*

Sūrya Siddhāntā, XIV, 9 and 10

Bhānormakarasaṁkrānteh ṣaṇmāsā uttarāyaṇaṁ
Karkādestu tathaiva syāt ṣaṇmāsā dakṣiṇāyaṇaṁ. 9
Dvirāśināthā ṛtava stato'pi śiśirādayaḥ
Meṣādayo dvādaśaite māsāstaireva vatsaraḥ. 10.

Translation: From the moment of the sun's entrance (*saṁkrānti*) into *Makara*, the sign of Capricorn, six months make up his northward progress (*uttarāyaṇa*) ; so likewise from the moment of entrance into *Karkāṭa*, the sign of Cancer, six months are his southward progress (*dakṣiṇāyaṇa*). (9)

Thence also are reckoned the seasons (*ṛtū*), the cool season (*śiśira*) and the rest, each prevailing through two signs. These twelve, commencing with

Aries, are the months; of them is made up the year (10).

These quotations leave not the slightest doubt that according to the compilers of the S.S., the first point of the zodiac is the point of intersection of the ecliptic and the equator, and the signs of the zodiac cover 30° each of the ecliptic.

It is supposed on good grounds that much of the astronomical knowledge found in the *Sūrya Siddhānta* is derived from Graeco-Chaldean sources. But it is clear from the text that the compilers of the S.S. had no knowledge of the precession of equinoxes, but they took the first point of Aries to be fixed. This is not to be wondered at, for as shown in § 4.9, in spite of the works of Hipparchos and Ptolemy, precession was either not accepted or no importance was attached to it by the astronomers of the Roman empire. It may be added that the compilers of the S.S. were not aware of the theory of trepidation of equinoxes which appears to have been first formulated in the West by Theon of Alexandria (ca. 370 A.D.). It is also important to note that the Indian astronomers did not take the first point of Aries to be identical with that given either by Hipparchos, Ptolemy or any other western authority as would have been the case if there was blind-folded borrowing. They assimilated the astronomical knowledge intelligently and took the first point of Aries as the point of intersection of the equator and the ecliptic, and made successive attempts to determine it by some kind of actual observations, as shown in appendix 5-B. These observations appear first to have been made about 280 A.D.

Length of the Year

The length of the year, according to the different authorities are as follows.

<i>Sūrya Siddhānta</i> of	days
Varāhamihira ... 365 ^d 6 ^h 12 ^m 36 ^s	=365.25875
Current S.S. ... 365 6 12 36.56	=365.258756
Ptolemy (sidereal) 365 6 9 48.6	=365.256813
Correct length of the sidereal year.... 365 6 9 9.7	=365.256362
Correct length of the tropical year... 365 5 48 45.7	=365.242196

N. B. Varāhamihira's length of the year is also found in Āryabhaṭa's *ārdharātrika*, or midnight system, and in Brahmagupta's *Khaṭṭa Khādyaka*.

How did the Indian savants manage to have such a wrong value for the length of the year?

The year, according to the *Sūrya Siddhānta*, is meant to be clearly tropical, but as the Indian savants compiling the S.S. were ignorant of the phenomenon of

precession of the equinoxes, they were unaware of the distinction between the sidereal year and the tropical year. They had to obtain the year-length either from observation or from outside sources. If they obtained it from observations, they must have counted the number of days passed between the return of the sun to the same point in the sky over a number of years. Such observations would show that the year had not the traditional value of 366 days given in *Vedāṅga Jyotiṣa*, but somewhat less. In fact, the *Paitāmaha* length is 365.3569 days and there is no reason to believe that it was derived from foreign sources. Successive observations must have enabled the Indian savants to push the accuracy still higher.

Or alternatively they might have borrowed the value from Graeco-Chaldean astronomy, but we cannot then explain why their value is larger than Ptolemy's. We have seen that the *Romaka Siddhānta* gives a value which is Hipparchos's, and tropical, but the three more correct Siddhāntas reject it, as being too small. This however indicates that they probably tried to derive the length from observations as stated in the previous paragraph and found the *Romaka Siddhānta*-length too small. If they had taken it from some other source, we have still to discover that source. It is certainly not Ptolemy's *Almagest*.

The ex-cathedra style of writing adopted by the Siddhāntic astronomers, e.g., the number of days in a *Kalpa* (a period of 4.32×10^9 years) is 1,577,917,828,000 according to Grandfather *Brahmā*, or the Sungod, does not enable one to trace the steps by which these conclusions were reached.

The two problems of (i) distinguishing between the tropical year, and the sidereal year and of (ii) determining the correct length of the year in terms of the mean solar days are very exacting ones.

We have seen how it took the West the whole time-period between 3000 B.C. to 1582 A.D. to arrive at the idea that the true length of the tropical year was close to 365.2425 days. Probably Iranian astronomers of Omar Khayam's time (1072 A.D.), who had the advantage of the great Arabian observations by al-Battānī and others had a more correct knowledge of this length. The final acceptance of the distinction between the tropical and the sidereal year dates only from 1687 A.D., when Newton proved the theory of trepidation to be wrong.

The Siddhāntic astronomers of 500-900 A.D. cannot therefore be blamed for their failure to grasp the two problems. But what to say of their blind followers who, in the twentieth century, would continue to proclaim their belief in the theory of trepidation?

Effect of continuance of the mistake

The *Sūrya Siddhānta* value, viz., 365.258756 days is larger than the correct sidereal value by .002394 days and larger than the tropical length by .016560 days.

As the S.S. value is still used in almanac-framing, the effect has been that the year-beginning is advancing by .01656 days per year, so that in course of nearly 1400 years, the year-beginning has advanced by 23.2 days, so that the Indian solar year, instead of starting on the day after the vernal equinox (March 22) now starts on April 13th or 14th. The situation is the same as happened in Europe, where owing to the use of a year-length of 365.25 days, since the time of Julius Cæsar, the Christmas preceded the winter solstice by 10 days, when the error was rectified by a Bull of Gregory XIII, and the calendar was stabilized by introducing revised leap-year rules.

The Calendar Reform Committee has proposed that the Indian New Year should start on the day after the vernal equinox day. Most of the Indian calendar makers belong to the no-changer school, or the *nirayana* school (i.e., school not believing in the precession of the equinoxes). But this school does not realize that even if the sidereal length of the year be accepted, the Indian year-length used by them is larger by nearly .0024 days, which cannot be tolerated. So if a change has to be made, it is better to do it whole-hog, i.e., take the year-length to be tropical, and start the year on the day after the vernal equinox.

This is the proposal of the Indian Calendar Reform Committee, and it is in full agreement with the canons laid down in the *Sūrya Siddhānta*.

Historical Note on the Year-beginning

The Indian year, throughout ages, has been of two kinds, the solar and the lunar, each having its own starting day. The year-beginning for the two kinds of years, for different eras, is shown in Table No. 27.

The Starting Day of the Solar Year

In the Vedic age, the year-beginning was related probably to one of the cardinal days of the year, but we do not know which cardinal day it was. The *Vedānga Jyotiṣa* started the year from the winter solstice day, *Brāhmaṇas* started the year from the Indian Spring (*Vasanta*) when the tropical (*Sāyana*) longitude of the sun amounted to 330°.

The Siddhāntic astronomers must have found a confusion, and so fixed up a rule for fixing the year-beginning, which we have just now discussed. These rules amount to :

(a) Starting the astronomical year from the moment the sun crosses the vernal equinoctial point.

(b) Starting the civil year on the day following.

The Siddhāntic astronomers thus brought the Indian calendar on a line with the Graeco-Chaldean calendar prevalent in the Near East during the Seleucid times.

In a few cases, e.g., in the case of the Vikrama era reckoning as followed in parts of Guzrat, the year-beginning is in *Kārtika*. This seems to be reminiscent of the custom amongst the Macedonian Greek rulers of Babylon to start the year on the autumnal equinox day.

The First Month of the Year :

This has to be defined with respect to the definition of the seasons.

According to modern convention, which is derived from Graeco-Chaldean sources, the first season of the year is spring ; it begins on the day of vernal equinox, as shown in fig. 25 which shows also the other seasons. The Indian classification of seasons is, however, different as the following table shows.

Table 15—Indian Seasons.

—30° to 30°	...Spring (<i>Vasanta</i>)	<i>Caitra</i> & <i>Vaiśākha</i>
30 to 90	...Summer (<i>Grīṣma</i>)	<i>Jyaiṣṭha</i> & <i>Āṣāḍha</i>
90 to 150	...Rains (<i>Varṣā</i>)	<i>Śrāvaṇa</i> & <i>Bhādra</i>
150 to 210	...Early Autumn (<i>Śarat</i>)	<i>Āśvina</i> & <i>Kārtika</i>
210 to 270	...Late Autumn (<i>Hemanta</i>)	<i>Agrahāyana</i> & <i>Pausa</i>
270 to 330	...Winter (<i>Śiśira</i>)	<i>Māgha</i> & <i>Phālguna</i>

The Siddhāntic astronomers, therefore, found themselves in a difficulty. If they were to follow the Indian convention, *Caitra* would be the first month of the solar year. If they were to follow the Graeco-Chaldean convention, they had to take *Vaiśākha* as the first month of the solar year.

They struck a compromise. For defining the solar year, they took *Vaiśākha* as the first month and for defining the lunar year they took *Caitra* as the first month (see § 57).

But this rule has been followed only in North India. In South India, they had different practices, as shown in the list of solar month-names (Table No. 16).

In North India the first month is *Vaiśākha* as laid down in the S.S. which starts just after sun's passage through the V.E. point.

It is interesting to see that in Tamil Nad, some of the names are of Sanskritic origin, others are of Tamil origin. *But the most striking fact is that the first month, starting after vernal equinox is not Vaiśākha as in the*

Table 16.

Corresponding Names of Solar Months.

Indian Names of Signs	Bengal Orissa	Assam	Tamil	Tinnevelly or S. Malayalam (Orissa)	N. Malayalam
MEṢA	VAIŚĀKHA	BAHĀG	CITTIRAI	MEṢA	MEDAM
Vṛṣava	Jyaiṣṭha	Jeṭh	Vaikāsi	Vṛṣava	Edavam
Mithuna	Āṣāḍha	Āhār	Āṇi	Mithuna	Midhunam
Karkatā	Śrāvana	Śāon	Āḍi	Karkitaka	Karkitaka
Siṃha	Bhādra	Bhād	Āvaṇi	SIMHA	Ciṅgam
Kanyā	Āśvina	Āhin	Puraṭṭāsi	Kanyā	KANNI
Tulā	Kārtika	Kāti	Arppiṣi (Aippaṣi)	Thulā	Thulam
Vṛṣciḥka	Agrahāyana	Aghoṇ	Kārthigai	Vṛṣciḥka	Vṛṣciḥkam
Dhanuḥ	Pauṣa	Puha	Mārgali	Dhanus	Dhanu
Makara	Māgha	Māgh	Thai	Makara	Makaram
Kumbha	Phālguna	Phāgun	Māsi	Kumbha	Kumbham
Mina	Caitra	Ca't	Paṅguni	Mina	Minam

(The first month of the year has been distinguished by capitals).

N.B. The Bengali or Oriya names of solar months are taken without change from Sanskrit. The Assamese names are the same, but have local pronunciations.

rest of India but Chittirai or Caitra, and so on. We do not know why Tamil astronomers adopted a different convention. We can only guess: probably they wanted to continue the old Indian usage that *Caitra* is to remain the first month of the year.

In Tinnevelly and Malayalam districts the solar months are named after the signs of the zodiac.

There is, therefore, no uniformity of practice in the nomenclature of the solar months, and in fixing up the name of the first month of the solar year.

Solar Months : Definition

After having defined the solar year, and the year beginning, the *Sūrya Siddhānta* proceeds to define the "Solar Month."

Sūrya Siddhānta, Chap. 1, 13

Aindavastithibhi-stadvat saṁkrāntiā saura ucyaṭe
Māsairdvādaśabhirvarṣaṁ divyaṁ tadaharucyate.

Translation: A lunar month, of as many lunar days (*tilhi*); a solar (*saura*) month is determined by the entrance of the sun into a sign of the zodiac, *i.e.* the length of the month is the time taken by the sun in passing 30° of its orbit, beginning from the initial point of a sign; twelve months make a year, this is called a day of the gods.

This definition is accepted by the *Ārya*, and *Brahma Siddhāntas* as well.

The working of this rule gives rise to plenty of difficulties, which are described below:

The mean length of a solar month

=30.43823 according to S.S.

=30.43685 according to modern data.

The actual lengths of the different solar months, however, differ widely from the above mean values. This is due to the fact that the earth does not move with uniform motion in a circular orbit round the sun, but moves in an elliptic orbit, one focus of which is occupied by the sun, and according to Kepler's second law, it sweeps over equal areas round the sun in equal intervals of time. When the earth is farthest from the sun, *i.e.* at aphelion (sun at apogee) of the elliptic orbit, the actual velocity of the earth becomes slowest, and the apparent angular velocity of the sun becomes minimum, and consequently the length of the solar month is greatest. This happens about 3rd or 4th July, *i.e.*, about the middle of the solar month of *Āṣāḍha* (*Mithuna*), and consequently this month has got the greatest length. The circumstances become reversed six months later on about 2nd or 3rd January, when the earth is nearest to the sun, *i.e.*, at perihelion (sun at perigee), the angular velocity of the sun at that time becomes maximum, and consequently the solar month of *Pauṣa* (*Dhanuḥ*) which is opposite to *Āṣāḍha*, has got the minimum length. The following two figures (Nos. 25 & 26) will explain the position.

The durations of the different months, which are different from each other due to the above reason, are also not fixed for all time. The durations of the solar

months undergo gradual variations on account of two reasons ; viz.,

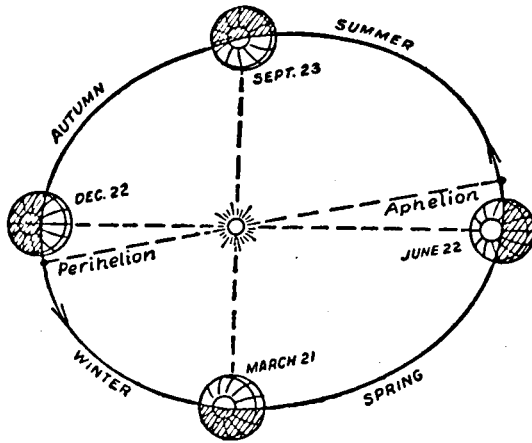

Fig. 25

(i) the line of apsides of the earth's elliptic orbit (i.e., the aphelion and perihelion points) is not fixed

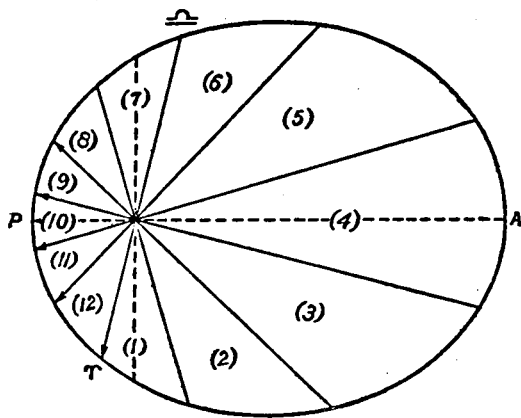

Fig. 26

in space but is advancing along the ecliptic at the rate of 61".89 per year or 1.72 per century. This is

made up of the precessional velocity of 50".27 per year in the retrograde direction and the perihelion velocity of 11".62 per year in the direct direction due to planetary attraction. This movement of the apse line with respect to the V.E. point causes variation in the lengths of the different months.

(ii) The second reason is that the ellipticity of the earth's orbit is not constant ; it is gradually changing. At present the eccentricity of the orbit is diminishing and the elliptic orbit is tending to become circular. As a result, the greatest duration of the month is diminishing in length and the least one increasing. Similarly the lengths of other months are also undergoing variation.

The modern elliptic theory of planetary orbits was not known to the makers of Indian Siddhāntas, but they knew that the sun's true motion was far from uniform. They conceived that the sun has uniform motion in a circle, with the earth not exactly at the centre of that circle, but at a small distance from it. The orbit therefore becomes an eccentric circle or an epicycle. Here also the angular motion of the sun becomes minimum when at apogee or farthest from the earth, and maximum when nearest to the earth or at perigee. In this case the size and eccentricity of the circle are invariable quantities, and consequently the maximum and minimum limits of the months are constant. The apse line advances in this case also, but with a very slow motion, which according to the *Sūrya Siddhānta* amounts to a degree of arc in 31,008 years, or 11" in a century. The variations of the durations of months due to this slow motion of the apse line is quite negligible and the lengths of the months according to the *Sūrya Siddhānta* are practically constant over ages.

Table 17—Lengths of different solar months reckoned from the vernal equinox.

		Lengths of Solar months.						
(1)	(2)	According to <i>Sūrya Siddhānta</i>			Modern value (1950 A.D.)			Names of Months (as proposed)
		(3)	(4)	(5)	(3)	(4)	(5)	
		a	h	m	a	h	m	
Vaiśākha (Meṣa)	(0° - 30°)	30	22	26.8	30	11	25.2	Caitra
Jyaiṣṭha (Vṛṣa)	(30 - 60)	31	10	5.2	30	23	29.6	Vaiśākha
Āṣāḍha (Mithuna)	(60 - 90)	31	15	28.4	31	8	10.1	Jyaiṣṭha
Śrāvaṇa (Karkaṭa)	(90 - 120)	31	11	24.4	31	10	54.6	Āṣāḍha
Bhādra (Siṃha)	(120 - 150)	31	0	26.8	31	6	53.1	Śrāvaṇa
Āśvina (Kanyā)	(150 - 180)	30	10	35.6	30	21	18.7	Bhādra
Kārtika (Tulā)	(180 - 210)	29	21	26.4	30	8	58.2	Āśvina
Agrahāyaṇa (Vṛścika)	(210 - 240)	29	11	46.0	29	21	14.6	Kārtika
Pauṣa (Dhanuḥ)	(240 - 270)	29	7	37.6	29	13	8.7	Agrahāyaṇa
Māgha (Makara)	(270 - 300)	29	10	45.2	29	10	38.6	Pauṣa
Phālguna (Kumbha)	(300 - 330)	29	19	41.2	29	14	18.5	Māgha
Caitra (Mina)	(330 - 360)	30	8	29.0	29	23	18.9	Phālguna
		365	6	12'6	365	5	48'8	

In the *Sūrya Siddhānta*, a formula is given for finding the true longitude of the sun from its mean longitude. As the length of a month is the time taken by the sun to traverse arcs of 30° each along the ecliptic by its true motion, the lengths of the different months can be worked out when its true longitudes on different dates of the year are known. The true longitude is obtained by the *Sūrya Siddhānta* with the help of the following formula :

$$\text{True Long.} = \text{Mean Long.} - 133.68 \sin K + 3.18 \sin^2 K$$

where K = Mandakendra of the sun,
i.e., = mean sun - sun's apogee.

At the approximate time of each *samkrānti*, the true longitude of the sun is calculated by the above formula for two successive days, one before the attainment of the desired multiple of 30° of longitude and the other after it, and then the actual time of crossing the exact multiple of 30th degree is obtained by the rule of simple proportion. This is called the time of *samkrānti* or solar transit. The time interval between the two successive *samkrāntis* is the actual length of the month. The lengths of the months thus derived from the *Sūrya Siddhānta* compared with the modern values, i.e., the values which we get after taking the elliptic motion of the sun, and the shift of the first point of Aries are shown in Table No. 17, on p. 243, in which :—

- Column (1) gives the names of months.
 .. (2) gives the arc measured from the first point of Aries (the V.E. point) covered by the true longitude of the sun.
 .. (3) gives the lengths of the months derived from the *Sūrya-Siddhānta* rules.
 .. (4) gives the correct lengths of the months as in 1950 A.D.
 .. (5) gives the corresponding names of the months as proposed by the Committee.

It would appear from table No. 17 that the lengths of the months of the *Sūrya Siddhānta* are no longer correct ; they greatly differ from their corresponding modern values, sometimes by as much as $11\frac{1}{2}$ hours. The *Sūrya Siddhānta* values, which the almanac makers still use, are therefore grossly incorrect. Moreover, the lengths of the months are undergoing gradual variation with times due to reasons already explained.

Different conventions for fixing up the beginning of the solar month

The *samkrānti* or ingress of the sun into the different signs may take place at any hour of the day. Astronomically speaking the month starts from that moment. But for civil purposes, the month should start from a sunrise ; it should therefore start either on the day of the *samkrānti* or the next following day according to the convention adopted for the locality. There are four different conventions in different States of India for determining the beginning of the civil month.

Rules of Samkranti

The Bengal rule : In Bengal, when a *samkrānti* takes place between sunrise and midnight of a civil day, the solar month begins on the following day ; and when it occurs after midnight, the month begins on the next following day, i.e., on the third day. This is the general rule ; but if the *samkrānti* occurs in the period between 24 minutes before midnight to 24 minutes after midnight, then the duration of *tithi* current at sunrise will have to be examined. If the *tithi* at sunrise extends up to the moment of *samkrānti*, the month begins on the next day : if the *tithi* ends before *samkrānti*, the month begins on the next following or the third day. But in case of *Karkāṭa* and *Makara samkrāntis*, the criterion of *tithi* is not to be considered. If the *Karkāṭa samkrānti* falls in the above period of 48 minutes about the midnight, the month begins on the next day, and if the *Makara samkrānti* falls in that period, the month begins on the third day.

The Orissa rule : In Orissa the solar months of the Āmli and Vilāyati eras begin civilly on the same day (sunrise to next sunrise) as the *samkrānti*, irrespective of whether this takes place before or after midnight.

The Tamil rule : In the Tamil districts the rule is that when a *samkrānti* takes place before sunset, the month begins on the same day, while if it takes place after sunset the month begins on the following day.

The Malabar rule : The rule observed in the North and South-Malayalam country is that, if the *samkrānti* takes place between sunrise and 18 *ghatikās* ($7^h 12^m$) or more correctly $\frac{3}{8}$ th of the duration of day from sunrise (about 1-12 P.M.) the month begins on the same day, otherwise it begins on the following day.

It will be observed that as a result of the different conventions combined with the incorrect month-lengths of the *Sūrya Siddhānta* we are faced with the following problems

(1) the civil day of the solar month-beginning may differ by 1 to 2 days in different parts of India.

(2) The integral number of days of the different solar months also vary from 29 to 32.

The months of *Kārtika*, *Agrahāyana*, *Pauṣa*, *Māgha* and *Phālguna* contain 29 or 30 days each, of which two months must be of 29 days, and others of 30 days. The months *Caitra*, *Vaiśākha* and *Āśvina* contain 30 or 31 days.

The rest, *viz.*, *Jyaiṣṭha*, *Āṣāḍha*, *Śrāvaṇa* and *Dhādra* have got 31 to 32 days each, of which one or two months will contain 32 days every year.

(3) The length of the month by integral number of civil days is not fixed, it varies from year to year.

Justification of the Solar Calendar as proposed by the Committee

It has been shown that the intention of the maker of *Sūrya Siddhānta* and of other *Siddhāntas* was to start the year from the moment of sun's crossing the vernal equinoctial point and to start the civil year from the day following. The Committee has also adopted this view and proposed that the civil year for all-India use should start from the day following the V. E. day, *i.e.*, from March 22. In the Vedic literature also it is found that the starting of the year was related with one or other of the cardinal days of the year. The *Vedāṅga Jyotiṣa* started the year from the winter solstice day, the *Brāhmaṇas* started the year from the Indian spring (*Vasanta*) when the tropical (*Sāyana*) longitude of the sun amounted to 330°, but in the Siddhāntic period the year-beginning coincided with the V. E. day. So in adopting the *Sāyana* system in our calendar calculations, the Indian tradition, from the Vedic times up to the Siddhāntic times, has been very faithfully observed. This has ensured that the Indian seasons would occupy permanent places in the calendar.

As regards the number of days per month, although the *Sūrya Siddhānta* defines only the astronomical solar month as the time taken by the sun to traverse 30° of arc of the ecliptic, four different conventions have been evolved in different States of India for determining the first day of the civil month from the actual time of transit as narrated earlier. None of the conventions is perfect. Such rules do not yield fixed number of days for a month, as a result of which it becomes extremely difficult for a chronologist to locate any given date of this calendar, unambiguously, in the Gregorian calendar, without going through lengthy and laborious calculations. Moreover, the number of days of months obtained

from such rules vary from 29 to 32, which is very inconvenient from various aspects of civil life.

The Committee has therefore felt that there is no need for keeping the solar months as astronomically defined. The length of 30 and 31 days are quite enough for civil purposes. Moreover, fixed durations of months by integral number of days is the most convenient system in calendar making. The five months from the second to the sixth have the lengths of over 30½ days, and so their lengths have been rounded to 31 days each; and to the remaining months 30 days have been allotted.

5.7 THE LUNAR CALENDAR IN THE SIDDHANTA JYOTISHA PERIOD

The broad divisions of the year into seasons or months are obtained by the solar calendar, but since for religious and social purposes the lunar calendar had been used in India from the Vedic times, it becomes incumbent to devise methods for pegging on the lunar calendar to the solar.

The extent to which the lunar calendar affects Indian socio-religious life will be apparent from the tables of holidays we have given on pp. 117-154. There the religious and social ceremonies and observances and holidays of all states and communities are classified under the headings :

- (1) Regulated by the solar calendar of the Siddhāntas ;
- (2) Regulated by Gregorian dates ;
- (3) Regulated by the lunar calendar.

The tables show that by far the largest number of religious holidays and other important social ceremonies are regulated by the lunar calendar. It is difficult to see how the lunar affiliation, inconvenient as it is, can be replaced altogether, short of a revolution in which we break entirely with our past. The lunar calendar will therefore continue to play a very important part as we continue to keep our connection with the past, and with our cherished traditions.

Let us now restate the problems which arise when, with reference to India, we want to peg the lunar calendar to the solar, how it was tackled in the past, and how the Calendar Reform Committee wants to tackle it.

The lunar month consists of 29.5306 days and 12 such lunar months fall short of the solar year by 10.88 days. After about 2 or 3 years one additional or intercalary lunar month is therefore necessary to make up the year ; and in 19 years there are 7 such intercalary months. In Babylon and Greece there were fixed rules

for intercalation ; the intercalary months appeared at stated intervals and were placed at fixed positions in the calendar (*vide* § 3.2). It appears that some kind of rough rules of intercalation of lunar months were followed in India up to the first or second century A.D. when the calendar was framed according to the rules of *Vedāṅga Jyotiṣa* (*vide* § 5.4). Thereafter the Siddhāntic system of calendar-making began to develop, replacing the old *Vedāṅga* calendar.

The *Vedāṅga* calendar as we have seen was crude and was based on approximate values of the lunar and solar periods, the calendar was framed on the mean motions of the luminaries, and as such an intercalary month was inserted regularly after every period of 30 months.

The *Siddhānta Jyotiṣa* introduced the idea of true positions of the luminaries as distinct from their mean positions, and devised rules for framing the calendar on the basis of the true positions, and adopted more correct values for the periods of the moon and the sun. But some time elapsed before new rules were adopted, and intercalary months continued to be calculated on the basis of the mean motions of the sun and the moon, employing however more correct values of their periods as given by the *Siddhāntas*. In this connection the following remarks by Sewell and Dikṣit, in the *Indian Calendar* (p. 27) are worth noting.

"It must be noted with regard to the intercalation and suppression of months, that whereas at present these are regulated by the sun's and moon's apparent motion,—in other words, by the apparent length of the solar and lunar months—and though this practice has been in use at least from 1100 A.D. and was followed by Bhāskarācārya, there is evidence to show that in earlier times they were regulated by the mean length of months. It was at the time of the celebrated astronomer Śrīpati (1039 A.D.) that the change of practice took place".

Intercalary months or Malamasas.

The length of the *Sūrya Siddhānta* year is 365.258756 days and of a lunar month according to the S. S. is 29.5305879 days. Twelve such lunar months fall short of the S. S. year by 10.891701 days. The lunar year therefore slides back on the solar scale each year by about 11 days. If the months were allowed to slide back continuously it would have completed the cycle in 33.5355 years, and the festivals attached to the lunar calendar would have moved through all the seasons of the year within this period, as now happens with the Islamic calendar.

To prevent the occurrence of this undesirable feature, the system of intercalary months or *mala māsas*

have been introduced. Taking the mean values of the lunation-period and of the length of the solar year, the time when one extra month (*i.e.*, intercalary month) will have to be introduced can easily be determined. But the luminaries do not move with uniform angular motions throughout their period of revolution and so the determination of the intercalary month on the basis of the actual movement of the sun and the moon is a very difficult problem. The calculations according to the mean motions are however shown below.

Table 18—Calculation of intercalary months in a 19-year cycle.

	<i>Sūrya Siddhānta</i> days	<i>Modern- Sidereal</i> days	<i>Modern- Tropical</i> days
Length of year	365.258756	365.256361	365.242195
Solar month	30.438230	30.438030	30.436850
Lunation	29.530588	29.530588	29.530588
No. of solar months after which a lunar month is added	32.5355	32.5427	32.5850
19 years = 235 lunations (= 19 × 12 + 7) =	6939.91636	6939.86896	6939.60171
Error in the 19-year cycle	-0.22818	-0.18078	+0.08647

It would appear from the above figures that the 19-year cycle with 7 *mala māsas* is a better approximation if we adopt the tropical year, and the error gradually increases with the sidereal year and the *Sūrya Siddhānta* year. In 11½ cycles, *i.e.*, in 220 years, the discrepancy would amount to only a day in the case of the tropical year.

It is also seen that one intercalary month is to be added at intervals of 32½ solar months, or in other words an intercalary month recurs alternately after 32 and 33 solar months. According to this scheme the intercalary months in a period of 19 years would be as follows :—

Year	Intercalary month	Year	Intercalary month
1	—	11	10 Pauṣa
2	—	12	—
3	9 Mārgaśīrṣa	13	—
4	—	14	7 Āśvina
5	—	15	—
6	5 Śrāvaṇa	16	—
7	—	17	3 Jyeṣṭha
8	—	18	—
9	2 Vaiśākha	19	12 Phālguna
10	—		

But the makers of Indian calendars have not followed any scheme for intercalation based on mean motions. They evolved a plan for distinguishing an intercalary month from a normal month based on the true motions of the sun and the moon. This plan is also followed in giving the name to a lunar month, as explained below :

Siddhantic rules for the Lunar Calendar

There are two kinds of lunar months used in India, the new-moon ending and the full-moon ending. In calendarical calculations only the new-moon ending months are used.

(i) The new-moon ending lunar month covers the period from one new-moon to the next. This is known as *amānta* or *mukhya cāndra māsa*. It gets the same name as the solar month in which the moment of initial new-moon of the month falls. For this purpose the solar month is to be reckoned from the exact moment of one *sainkrānti* of the sun to the moment of the next *sainkrānti*. When a solar month completely covers a lunar month, i.e., when there are two moments of new-moon (*amānta*), one at the beginning and the other at the end of a solar month, then the lunar month beginning from the first new-moon is the intercalary month, which is then called an *adhika* or *mala māsa*, and the lunar month beginning from the second new-moon is the normal month which is termed as *śuddha* or *nija* in the Siddhāntic system. Both the months bear the name of the same solar month but are prefixed by *adhika* or *śuddha* as the case may be. In an *adhika* month religious observances are not generally allowed.

If on the other hand, a lunar month completely covers a solar month, no new-moon having occurred in that solar month, the particular lunar month is then called a *kṣaya* or decayed month.

As the *mukhya* or new-moon ending lunar month begins from the *Amāvasyā* or the new-moon occurring in the solar month bearing the same name, the lunar month may begin on any day during that solar month—it may begin on the first or even on the last day of that solar month.

(ii) The full-moon ending lunar month known as *pūrṇimānta* or *gauna cāndra māsa*, covers the period from one full-moon to the next, and is determined on the basis of the corresponding new-moon ending month as defined above. It begins from the moment of full-moon just a fortnight before the initial new-moon of an *amānta* month, and it also takes the name of that month.

But in the *gaunamāna* (i.e., full-moon ending lunar month), as the month starts 15 days earlier than the

new-moon ending month, it may begin on any day during the last half of the preceding solar month and the first half of the solar month in question. It will therefore be seen that while the new-moon ending or *mukhya* month sometimes falls almost entirely outside (i.e., after) the relative solar month, the full-moon ending or a *gauna* month always covers at least half of the solar month of that name.

The months used for civil purposes in the Hindi calendar are the full-moon ending lunar months, and are sub-divided into two halves—*kṛṣṇa pakṣa* covering the period from full-moon to new-moon and termed as *radī*, and *śukla pakṣa* covering the period from new-moon to full-moon and termed as *śudī*. As these months are on the *gauna māna*, the *radī* half of a month comes first followed by the *śudī* half. The last day of the year is therefore a full-moon day, the *Phālgunī* (or *Holi*) *Pūrṇimā*, in keeping with the ancient Indian custom.

The *Saṁvat* and *Śaka* years in the Hindi calendar begins with *Caitra Śukla Pratipad*. For astronomical purposes, however, the year begins a few days later with the entrance of the sun into *Meṣa*.

The calendars of *Āṣādhī Saṁvat* and *Kārtikī Saṁvat* are, on the other hand, based on the new-moon ending months, and consequently the months begin 15 days later than the months of the *Caitrādi* full-moon ending calendar. The *Āṣādhī* calendar begins with *Āṣāḍha Śukla 1*, and the *Kārtikī* calendar with *Kārtika Śukla 1*.

The table (No. 20 on p. 249) shows the scheme of the different calendars for the year *Śaka 1875* (1953-54). The year contains a *mala* or *adhika* month.

It may be seen from the above mentioned table that in case of the light half of the month (*śudī* half) the month has the same name for the two systems of month-reckonings, but in the dark half of the month (*radī* half) the names of the months in the two systems are different.

The year-beginnings of the *Saṁvat* era in the three systems of luni-solar calendar are also different, as may be seen from the following table.

Table 19—Showing the year-beginnings of the different systems of *Saṁvat* era.

Calendar	Caitrādi system	Āṣāḍhādi system	Kārtikādi system
<i>Saṁvat</i> era	2010	2010	2010
Beginning of year	Caitra S 1 (16 Mar., 1953)	Āṣāḍha S 1 (12 July, 1953)	Kārtika S 1 (7 Nov., 1953)

Counting of the Succession of Days

In all the calendars used in India, days are counted according to the solar reckoning, as well as according to the lunar reckoning (i.e., by *tithi* or lunar day). But there is a difference in emphasis.

In the eastern regions (Bengal, Orissa and Assam), and in Tamil Nād and Malabar, the solar reckoning is given more prominence. The almanacs give solar months and count the days serially from 1 to 29, 30, 31 or 32 as the case may be. The *tithi* endings are given for every day, and the *tithi* may start at any moment of the day.

In other parts of India (except Bengal, Orissa, Assam and Tamil Nād), the counting of days is based on the lunar reckoning, and the number of the *tithi* current at sunrise is used as the ordinal number of the date necessary in civil affairs. So there are 29 or 30 days in a month, but the days are not always counted serially from 1 to 29 or 30.

The month in the lunar calendar is divided into two half-months, the *sudi* and *vadi* halves in the new-moon ending system, and the *vadi* and *sudi* halves in the full-moon ending system. In fact the year is divided into 24 half-months instead of 12 months. So there are 14 to 15 days in a half-month (*vide* Table 20).

The *tithi* or lunar day is measured by the positions of the moon and the sun. When they are in conjunction, i.e., at new-moon the 30th *tithi* or *amāvasyā* ends and the first *tithi* starts which continues upto the moment when the moon gains on the sun by 12° in longitude. Similarly when the difference between the moon and the sun is 24° the second *tithi* ends, and so on. The average duration of a *tithi* is 23^h 37.^m5, but the actual duration of a particular *tithi* undergoes wide variations from the above average according to the different positions of the sun, the moon and the lines of their apsides. It may become as great as 26^h 47^m and as small as 19^h 59^m. So generally to every day there is a *tithi*. But sometimes a *tithi* begins and ends on the same civil day, and such a *tithi* is dropped; and some religious ceremonies of auspicious character are not allowed to take place on such a *tithi*, and the following day begins with the next following *tithi*. For example, if the third *tithi* is dropped, the sequence of days of the half-month is 1, 2, 4, 5 etc., thus the seriality is broken here.

As opposed to the above-mentioned case, the *tithi* sometimes extends over two days, there being no *tithi* ending in a day (from sunrise to next sunrise). As the same *tithi* remains current on two successive sunrises, the same *tithi*-number is allotted to both the days; in the second day, however, it is suffixed by the term

'*adhika*'. For example if the third *tithi* is repeated, then the sequence of days of the half-month would be 1, 2, 3, 3 *adhika*, 4, etc.

Some improvement in the use of *tithi* for dating purposes is, however, observed in the Fusli calendar in vogue in some parts of Northern India. In this calendar the month begins from the day following the full-moon and dates are counted consecutively from 1 to 29 or 30 without any break at new-moon, or any gapping or over-lapping of dates with *kṣaya tithi* or *adhika tithi*. In fact the dates of this calendar have no connection with *tithis* after the starting of the month has been determined. The year of Fusli begins after the full-moon day of lunar *Bhādra*

Mala Masa and Kshaya Masa

It has been stated before that even at the beginning of the Siddhānta Jyotiṣa period, the intercalary months (*mala* or *adhika*) were determined on the basis of the mean motions of the sun and the moon, and as such there was no possibility of the occurrence of any so called *kṣaya* or decayed month. But as already mentioned, from about 1100 A.D., the intercalary months are being determined on the basis of the true motions of the luminaries, i.e., on the actual lengths of the new-moon-ending lunar month and of the different solar months as obtained from Siddhāntic rules. This gave rise to the occurrence of *kṣaya* months, and the intercalary months were also placed at very irregular intervals.

The period from new-moon to new-moon (the lunar month) is not a period of fixed duration; it varies within certain limits according to the different positions of the apse line of the lunar and solar orbits, as follows:—

LENGTH OF THE LUNATION

By mean motion		According to S.S.		Modern	
a	h	a	h	a	h
		29	6.3	29	5.9
29	12.73	to		to	
		29	19.1	29	19.6

Comparing these values with the actual lengths of solar months given in Table 24, it is observed that the *minimum* length of the lunar month falls short of all the solar months, even of the shortest month of *Pauṣa*. But as a *mala māsa* is not possible in that month, the maximum and minimum limits of the lunar months are recalculated for each of the solar months from *Kārtika* to *Phālguna* separately.

Table 20.

Scheme of the Luni-Solar Calendar

(Śaka 1875=1953-54 A.D.)

Religious Calendar		Civil Luni-Solar Calendar		Initial date reckoned on the Solar Calendar as is now in use.	
<i>Mukhya or new-moon ending</i>	<i>Gauṇa or full-moon ending</i>	<i>Full-moon ending</i>	<i>New-moon ending</i>	<i>Indian Solar Calendar date</i>	<i>Gregorian date</i>
Caitra S	Caitra S	Caitra S	Caitra S	2 Caitra	16 Mar.
Caitra K	Vaiśākha K	Vaiśākha V	Caitra V	17 Caitra	31 Mar.
Vaiśākha S (mala)	Vaiśākha S (mala)	Vaiśākha S (adhika)	Vaiśākha S (adhika)	1 Vaiśākha	14 Apr.
Vaiśākha K (mala)	Vaiśākha K (mala)	Vaiśākha V (adhika)	Vaiśākha V (adhika)	17 Vaiśākha	30 Apr.
Vaiśākha S (śuddha)	Vaiśākha S (śuddha)	Vaiśākha S	Vaiśākha S	31 Vaiśākha	14 May
Vaiśākha K (śuddha)	Jyeṣṭha K	Jyeṣṭha V	Vaiśākha V	15 Jyeṣṭha	29 May
Jyeṣṭha S	Jyeṣṭha S	Jyeṣṭha S	Jyeṣṭha S	29 Jyeṣṭha	12 June
Jyeṣṭha K	Āṣāḍha K	Āṣāḍha V	Jyeṣṭha V	14 Āṣāḍha	28 June
Āṣāḍha S	Āṣāḍha S	Āṣāḍha S	Āṣāḍha S	28 Āṣāḍha	12 July
Āṣāḍha K	Śrāvaṇa K	Śrāvaṇa V	Āṣāḍha V	11 Śrāvaṇa	27 July
Śrāvaṇa S	Śrāvaṇa S	Śrāvaṇa S	Śrāvaṇa S	25 Śrāvaṇa	10 Aug.
Śrāvaṇa K	Bhādra K	Bhādra V	Śrāvaṇa V	9 Bhādra	25 Aug.
Bhādra S	Bhādra S	Bhādra S	Bhādra S	24 Bhādra	9 Sep.
Bhādra K	Āśvina K	Āśvina V	Bhādra V	8 Āśvina	24 Sep.
Āśvina S	Āśvina S	Āśvina S	Āśvina S	23 Āśvina	9 Oct.
Āśvina K	Kārtika K	Kārtika V	Āśvina V	6 Kārtika	23 Oct.
Kārtika S	Kārtika S	Kārtika S	Kārtika S	21 Kārtika	7 Nov.
Kārtika K	Mārga. K	Mārga. V	Kārtika V	5 Agrah.	21 Nov.
Mārga. S	Mārga. S	Mārga. S	Mārga. S	21 Agrah.	7 Dec.
Mārga. K	Pauṣa K	Pauṣa V	Mārga. V	6 Pauṣa	21 Dec.
Pauṣa S	Pauṣa S	Pauṣa S	Pauṣa S	22 Pauṣa	6 Jan, 1954
Pauṣa K	Māgha K	Māgha V	Pauṣa V	6 Māgha	20 Jan.
Māgha S	Māgha S	Māgha S	Māgha S	21 Māgha	4 Feb.
Māgha K	Phālguna K	Phālguna V	Māgha V	6 Phālguna	18 Feb.
Phālguna S	Phālguna S	Phālguna S	Phālguna S	22 Phālguna	6 Mar.
Phālguna K	Caitra K	Caitra V	Phālguna V	6 Caitra	20 Mar.

S = Śukla pakṣa or Sudi.

K = Kṛṣṇa pakṣa.

V = " " or Vadi.

When the lunar month nearly covers the Solar month of	Length of the lunar month.	
	Minimum a h	Maximum a h
Kārtika or Phālguna	29 9.7	29 18.0
Agrahāyana or Māgha	29 10.5	29 18.8
Pauṣa	29 10.8	29 19.1

Comparing the above limits with the actual lengths of months stated before, it is found that the minimum length of the lunar month falls short of all the solar months except *Pauṣa*. So a *malamāsa* or intercalary month is possible in all the months except the month of *Pauṣa* only.

The maximum duration of a lunar month, on the other hand, exceeds the lengths of the solar months only in case of solar *Agrahāyana*, *Pauṣa* and *Māgha*. So a *kṣaya* month is possible only in these three months.

A list is given below showing the actual intercalary months occurring during the period Śaka 1823 (1901-2 A. D.) to Śaka 1918 (1996-97 A. D.) on the basis of *Sūrya Siddhānta* calculations.

Table 21.

Intercalary months in the present century	
Śaka	Śaka
1823	Śrāvaṇa
1826	Jyaiṣṭha
1828	Caitra
1831	Śrāvaṇa
1834	Āṣāḍha
1837	Vaiśākha
1839	Bhādra
1842	Śrāvaṇa
1845	Jyaiṣṭha
1847	Caitra
1850	Śrāvaṇa
1853	Āṣāḍha
1856	Vaiśākha
1858	Bhādra
1861	Śrāvaṇa
1864	Jyaiṣṭha
1866	Caitra
1869	Śrāvaṇa
1872	Āṣāḍha
1875	Vaiśākha
1877	Bhādra
1880	Śrāvaṇa
1883	Jyaiṣṭha
1885*	Āśvina, Caitra
1888	Śrāvaṇa
1891	Āṣāḍha
1894	Vaiśākha
1896	Bhādra
1899	Āṣāḍha
1902	Jyaiṣṭha
1904**	Āśvina-Phāl.
1907	Śrāvaṇa
1910	Jyaiṣṭha
1913	Vaiśākha
1915	Bhādra
1918	Āṣāḍha

* Pauṣa is *Kṣaya*, ** Māgha is *Kṣaya*.

As regards the *kṣaya* months that occurred and will be occurring during the period from 421 Śaka (499-500 A.D.) to 1885 Śaka (1963-64 A.D.) a statement is given below showing all such years mentioning the month which is *kṣaya* and also the months which are *adhika* in these years. The calculations are based on *Sūrya Siddhānta* without *bija* corrections upto 1500 A. D. and with these corrections after that year.

Table 22—*Kṣaya* or decayed months

Śaka	A.D.	<i>Kṣaya</i> month	<i>Adhika</i> months before and after the <i>Kṣaya</i> month
448	526-27	Pauṣa	Kārtika, Phālguna
467	545-46	Pauṣa	Kārtika, Phālguna
496	564-65	Pauṣa	Āśvina, Phālguna
532	610-11	Mārgaśirṣa	Kārtika, Vaiśākha
551	629-30	Pauṣa	Āśvina, Caitra
692	770-71	Pauṣa	Āśvina, Caitra
814	892-93	Mārgaśirṣa	Kārtika, Caitra
833	911-12	Pauṣa	Āśvina, Caitra
974	1052-53	Pauṣa	Āśvina, Caitra

Śaka	A.D.	<i>Kṣaya</i> month	<i>Adhika</i> month
1115	1193-94	Pauṣa	Āśvina, Caitra
1180	1258-59	Pauṣa	Kārtika, Caitra
1199	1277-78	Pauṣa	Kārtika, Phālguna
1218	1296-97	Pauṣa	Mārga., Phālguna
1237	1315-16	Mārgaśirṣa	Kārtika, Phālguna
1256	1334-35	Pauṣa	Āśvina, Phālguna
1302	1380-81	Mārgaśirṣa	Kārtika, Vaiśākha
1321	1399-1400	Pauṣa	Kārtika, Caitra
1397	1475-76	Māgha	Āśvina, Phālguna
1443	1521-22	Mārgaśirṣa	Kārtika, Vaiśākha
1462	1540-41	Pauṣa	Āśvina, Caitra
1603	1681-82	Pauṣa	Āśvina, Caitra
1744	1822-23	Pauṣa	Āśvina, Caitra
1885	1963-64	Pauṣa	Āśvina, Caitra

It will be observed from the above table that according to *Sūrya Siddhānta* calculations one *kṣaya* month occurs on average after 63 years. But one may repeat as soon as after 19 years and as late as after 141 years. In rare cases they recur after 46, 65, 76 and 122 years.

Intercalary months according to modern calculations

The lunar calendar proposed by the Committee for religious purposes is based on the most up-to-date value of the tropical year and the correct timings of new-moon. As such the intercalary months according to these calculations would not always be the same as determined from *Sūrya Siddhānta*-calculations and shown above. The intercalary (*mala* or *adhika*) and decayed (*kṣaya*) months according to these calculations are shown below for Śaka years 1877 to 1902.

Table 23—Intercalary month according to modern calculations.

Śaka	A.D.	Intercalary Month	Śaka	A.D.	Intercalary Month
1877	1955-56	Bhādra	1896	1974-75	Bhādra
1880	1958-59	Śrāvaṇa	1899	1977-78	Śrāvaṇa
1883	1961-62	Jyaiṣṭha	1902	1980-81	Jyaiṣṭha
1885	1963-64	Kārtika & Caitra (<i>Agrahāyana kṣaya</i>)			
1888	1966-67	Śrāvaṇa			
1891	1969-70	Āṣāḍha			
1894	1972-73	Vaiśākha			

Proposal of the Committee about the Lunar Calendar

According to the Siddhāntic rules, the lunar calendar is pegged on to the solar calendar, and so it is the luni-solar calendar with which we are at present concerned. It has already been shown that the length of the *Sūrya Siddhānta* year is greater than the year of the seasons (*i.e.*, the tropical year) by about 24 minutes. As a result of this the seasons have

fallen back by about 23 days in our solar calendar. The lunar calendar, being pegged on to the Siddhāntic solar calendar, has also gone out of seasons by about the same period, and consequently religious festivals are not being observed in the seasons originally intended.

The solar (saura) month for the religious calendar

Although the Committee considers that the solar year to which the religious lunar calendar is to be pegged on should also start from the V. E. day, it felt that the change would be too violent; with a view to avoiding any such great changes in the present day religious observances, it has been considered expedient not to introduce for sometime to come any discontinuity in this system, but only to stop further increase of the present error. The solar year for the religious calendar with *Vaiśākha* as its first saura month should now commence when the tropical longitude of the sun amounts to 23° 15'. This saura month will determine the corresponding lunar months required for fixing the dates of religious festivals. The lengths of such months, which are also fractional, are stated below, giving the lengths according to the *Sūrya Siddhānta* calculations compared with the corresponding modern values.

Table 24—Lengths of Solar months of the Religious Calendar.

Saura Māsa	Long. of Sun	Lengths of Months	
		According to <i>Sūrya Siddhānta</i>	Modern Value (1950 A.D.)
Vaiśākha	23° 15'—	30 ^d 22 ^h 27 ^m	30 ^d 20 ^h 55 ^m
Jyaiṣṭha	53 15—	31 10 5	31 6 39
Āṣāḍha	83 15—	31 15 28	31 10 53
Śrāvaṇa	113 15—	31 11 24	31 8 22
Bhādrapada	143 15—	31 0 27	30 23 51
Āśvina	173 15—	30 10 36	30 11 51
Kārtika	203 15—	29 21 27	29 23 41
Mārgaśīrṣa	233 15—	29 11 46	29 14 33
Pauṣa	263 15—	29 7 38	29 10 40
Māgha	293 15—	29 10 45	29 12 57
Phālguna	323 15—	29 19 41	29 20 54
Caitra	353 15—	30 8 29	30 8 33
		365 6 13	365 5 49

The lengths of the months according to the *Sūrya Siddhānta* are the same as shown earlier, as the same month was used by the S. S. for both the purposes. But the modern value is different from that shown before, due to the fact that a different point is taken here for the beginning of months. The modern value is, however, not fixed for all times, but it undergoes slight variation as explained previously.

The luni-solar calendar by which the religious festivals are determined has been pegged on to the religious solar calendar starting from a point 23° 15' ahead of the V. E. point. As this religious solar calendar is based on the tropical year, the luni-solar calendar pegged on to it would not go out of the seasons to which they at present conform, and so the religious festivals would continue to be observed in the present seasons and there would be no further shifting.

The Committee has proposed that the luni-solar calendar should no longer be used for civil purposes in any part of India. In its place the unified solar calendar proposed by the Committee should be used uniformly in all parts of India irrespective of whether the luni-solar or solar calendar is in vogue in any particular part of the country.

5.8 INDIAN ERAS

Whenever we wish to define a date precisely we have to mention the year, generally current of an era, besides the month and the particular day of the month, and the week-day. This enables an astronomer, well-versed in technical chronology, to place the event correctly on the time-scale. In international practice the Christian era is used, which is supposed to have started from the birth-year of Jesus Christ. But as mentioned in Chapter II, it is an *extrapolated era* which came in use five hundred years after the birth of the Founder of Christianity, and its day of starting may be widely different from the actual birthday of Christ, about which there exists no precise knowledge.

In India, nearly 30 different eras were or are used which can be classified as follows:—

- (1) Eras of foreign origin, e.g., the Christian era, the Hejira era, and the Tārikh Ilāhi of Akber.
- (2) Eras of purely Indian origin, list given.
- (3) Hybrid eras which came into existence in the wake of Akber's introduction of Tārikh Ilāhi.

Table 27 shows purely Indian eras, with their starting years in terms of the Christian era, the elapsed year of the era*, the year-beginning, solar, lunar or both solar and the lunar as the case may be, the particular regions of India where it is current. In spite of the apparent diversity in the ages of the eras, the methods of calendarical calculations associated with each era are almost identical; to be more accurate only slightly different and follow the rules given in either of the three Siddhāntas, *Sūrya*, *Ārya* and *Brahma*. The three methods differ but slightly.

* Generally, but not always the Indian eras have "elapsed years". Thus year 1876 of Śaka era would be, if we followed the western convention, year 1877 Śaka (current).

The apparent antiquity of certain eras, e.g., the *Kaliyuga* or the *Saptarṣi*, are however rather deceptive, for these eras are not mentioned either in the Vedic literature or even in the *Mahābhārata* (a work of the 4th to 2nd century B.C.). The best proof, however, that no eras were used in date-recording in ancient India is obtained from "Inscriptions" which give 'contemporary evidence' of the method of date-recording in use at the time when the inscription was composed.

In India, the oldest inscriptions so far discovered and deciphered satisfactorily are those of the Emperor Aśoka (273 to 227 B.C.); for the earlier Indus valley seal recordings have not yet been deciphered and no inscriptions or seals which can be referred to the time-period between 2500 B.C. (time of Indus valley civilization) and 250 B.C. (time of Aśoka) have yet been brought to light. Aśoka mentions in his inscriptions only the number of years elapsed since his coronation. No month, week-day or the serial number of the day in the month is mentioned. A typical Aśokan inscription giving time references is given in § 5. 5.

Continuous eras first began to be used in the records of the Indo-Scythian kings who reigned in modern Afghanistan and North-Western India between 100 B.C. to 100 A.D.

What is then the origin of the *Kaliyuga* or *Saptarṣi* era given in Table 27 which go back to thousands of years before Christ? We are going to show presently that they are extrapolated eras invented much later than the alleged starting year.

It is clear from historical records that date-recording by an era in India started from the time of the Kuṣāṇa emperors and Śaka satraps of Ujjain. But India cannot be singled out in this respect, for none of the great nations of antiquity, viz., Egypt, Babylon, Assyria or later Greece and Rome, used a continuously running era till rather late in their history. The introduction of the era is connected with the development of the sense of 'History' which came rather late to all civilized nations.

Critical Examination of Indian Eras

Here we are examining critically the claims of a few eras, which are supposed to date much earlier, e.g., the *Kaliyuga* era which is commonly believed to have been introduced in 3102 B.C., the *Saptarṣi* era, and the *Pāṇḍava-Kāla* mentioned by Kalhaṇa, the historian of Kashmir, who wrote in 1150 A.D., and supposed to be dating from 2449 B.C., and others.

The *Saptarṣi* era commonly known as *Lokakāla* or *Laukika Kāla* is measured by centuries and has 27 such

centuries in the total period of the cycle. Each century is named after a *nakṣatra*, viz., *Aśvini*, *Bharāṇi*, etc.; and the number of years within the century is generally mentioned, so that the number of year of the era never exceeds 100. This era was in use in Kashmir and neighbouring places. In fact this era has no relation with the seven *R̥sis* (the Great Bear) in the sky or with any actual *nakṣatra* division. There is difference of opinion as to the beginning of the era. According to Vṛddha Garga and the Purāṇas the starting year of the tenth century named after Maghā are 3177 B.C., 477 B.C. and 2224 A.D. of the different cycles, when according to Varāhamihira the third century named Kṛttikā begins. The beginning years of Varāhamihira's Maghā century of the different cycles are however 2477 B.C., 224 A.D. and 2924 A.D.

The Pāṇḍava Kāla or the Yudhiṣṭhira era started from 2449 B.C. according to Varāhamihira.

The so-called Yudhiṣṭhira era (2449 B.C.) is given by Kalhaṇa, chronicler of Kashmir (1150 A.D.), who quotes the date from Vṛddha Garga, an astronomer whose time is unknown. This era also does not occur in any inscription or any ancient treatise prior to Kalhaṇa (1150 A.D.). Prof. M. N. Saha has shown that in the *Mahābhārata* the Kṛttikās are in many places taken as the first of the *nakṣatras* and are very nearly coincident with the vernal equinox. If we calculate the date of the M.Bh. incidents on this basis, the date comes out to be very nearly 2449 B.C.

It, however, neither proves that the incidents mentioned in the M.Bh., if they were actual occurrences, took place in 2449 B.C., for the epic was not certainly put to writing before 400 B.C. as we know from a verse already mentioned on p. 226. It is inconceivable to think that the dates could be remembered correctly for over 2000 years, when writing was in a very primitive state. The astronomical references in the battle scenes, from which certain writers very laboriously deduce the date of these occurrences, are most probably later interpolations, on the supposition that the incidents occurred about 2449 B.C. There is no inscriptional record regarding the use of Yudhiṣṭhira era or Pāṇḍavakāla.

(a) The Kaliyuga Era

It is easy to show that the *Kaliyuga* era which purports to date from 3102 B.C. is really an extrapolated era just like the Christian era, introduced long long after the supposed year of its beginning.

It is first mentioned by Āryabhaṭa, the great astronomer of ancient Pāṭaliputra, who says that 3600

years of the Kaliyuga had passed when he was 23 years old which is Śaka year 421 (499 A. D.). It is not mentioned earlier either in books or in inscriptions. The first mention of this era in an inscription is found in the year 634-35 A.D., the inscription being that of king Pulakeśin II of the Cālukya dynasty of Bādāmi, or somewhat earlier in a Jain treatise. It was most probably an era invented on astrological grounds just like the era of Nabonassar, by Āryabhaṭa or some other astronomer, who felt that the great antiquity of Indian civilization could not be described by the eras then in use (Śaka, Chedi or Gupta era), as they were too recent.

What were these astrological grounds ?

The astrological grounds were that at the beginning of the Kaliyuga, the sun, the moon and the planets were in one zodiacal sign near the fixed Siddhāntic Meṣādi which according to some authorities is ζ *Pisium*, but according to others is 180° from *Citrā* or a *Virginis*. This was probably a back calculation based on the then prevailing knowledge of planetary motion, but has now been found to be totally wrong, when recalculated with the aid of more accurate modern data on planetary motion. We quote from *Ancient Indian Chronology*, pp. 35-39 by Prof. P. C. Sengupta, who has given a full exposition of Burgess's views on this point, with recalculations of his own.

should also be a total eclipse of the Sun ; but no such things happened at that time. The beginning of the *Kaliyuga* was the midnight at Ujjayinī terminating the 17th February of 3102 B.C., according to *Sūrya Siddhānta* and the *ārdharātrika* system of Āryabhaṭa's astronomy as described in the *Khaṇḍakhādya* of Brahmagupta. Again this *Kaliyuga* is said to have begun, according to the *Āryabhaṭīya* from the sunrise at Lāṅkā (supposed to be on the equator and on the same meridian with Ujjain)—from the mean sunrise on the 18th Feb., 3102 B.C.

Now astronomical events of the type described above and more specially the conjunction of the sun and the moon cannot happen both at midnight and at the next mean sunrise. This shows that this *Kaliyuga* had an unreal beginning.

The researches of Bailey, Bentley and Burgess have shown that a conjunction of all the 'planets' did not happen at the beginning of this *Kaliyuga*. Burgess rightly observes : *'It seems hardly to admit of a doubt that the epoch (the beginning of the astronomical Kaliyuga) was arrived at by astronomical calculation carried backward.'*

We also can corroborate the findings of above researchers in the following way and by using the most up-to-date equations for the planetary mean elements.

Now the precession of the equinoxes from 3102 B. C. to 499 A.D. or Āryabhaṭa's time works out to have been = 49° 32' 39". The mean planetary elements at the beginning of the *Kaliyuga*, i.e., 17th Feb., 3102 B.C., Ujjayinī mean time 24 hours, are worked out and shown below. We have

Table 25—Longitudes of Planets at Kali-beginning.

Planet	Mean Tropical longitudes on Feb. 17, U.M.T. 24 hrs., 3102 B.C. (Moderns.)	Longitude at the same time measured from the Vernal Equinox of 499 A.D., i.e., Āryabhaṭa's time.	The same as assumed in the <i>Ārdharātrika</i> system at the same time as before and also at next mean sunrise.	Error in the assumption of Āryabhaṭa and also of the modern <i>Sūrya-Siddhānta</i> and the <i>Khaṇḍakhādya</i> .
Sun	301° 40' 9.22"	351° 12' 48"	0° 0' 0"	+ 8° 47' 12"
Moon	305 33 13.81	355 10 53	0 0 0	+ 4 49 7
Moon's Apogee	44 25 27.66	93 58 7	90 0 0	- 3 58 7
Moon's Node	147 20 15.05	196 52 54	180 0 0	-16 52 54
Mercury	268 24 1.65	317 56 41	0 0 0	+42 3 19
Venus	334 44 50.25	24 17 29	0 0 0	-24 17 29
Mars	290 2 54.67	339 35 34	0 0 0	+20 24 26
Jupiter	318 39 45.74	8 12 25	0 0 0	- 8 12 25
Saturn	282 24 15.07	331 56 54	0 0 0	+23 3 6

"Astronomical Kaliyuga an Astronomical Fiction"

At the beginning of the astronomical *Kaliyuga*, all the mean places of the planets, viz., the Sun, Moon, Mercury, Venus, Mars, Jupiter and Saturn, are taken to have been in conjunction at the beginning of the Hindu sphere, the moon's apogee and her ascending node at respectively a quarter circle and a half circle ahead of the same initial point. Under such a conjunction of all the planets, there

added 49° 32' 39" to these mean tropical longitudes arrived at from the rules used, so as to get the longitudes measured from the vernal equinox of Āryabhaṭa's time.

Hence we see that the assumed positions of the mean planets at the beginning of the astronomical *Kaliyuga* were really incorrect and the assumption was not a reality. But of what use this assumption was in Āryabhaṭa's time, i.e., 499 A.D., is now set forth below.

Āryabhaṭa says that when he was 23 years old, 3600 years of Kali had elapsed. According to his *Ārdharātrika* system :

3600 years = 1/1200 of a Mahāyuga = 1314931.5 days.

Again according to his *Audayika* system :

3600 years = 1/1200 of a Mahāyuga = 1314931.25 days.

Hence according to both these systems of astronomy of Āryabhaṭa, by counting 3600 years from the beginning of the astronomical *Kali* epoch, we arrive at the date March 21, 499 A.D., Ujjayinī mean time, 12 noon. The unreality of the *Kali* epoch is also evident from this finding. However, the position of mean planets at this time work out as given in table 26 below.

about 57 B. C. Moreover a critical examination of inscriptions show the following details about this era.

The earliest mention of this era, where it is definitely connected with the name of king Vikramāditya is found in an inscription of one king Jaikadeva who ruled near Okhamandal in the Kathiawar State. The year mentioned is 794 of Vikrama era, i.e., 737 A.D. In a subsequent inscription, dated 795 V.E. it is also called the era of the lords of Mālava. So the Vikrama era and the era of Mālava lords are one and the same. Tracing back, we find the Mālavagaṇa era in use by a family of kings reigning at Mandasor, Rajputana between the years 461-589 V.E., as feuda-

Table 26—Longitudes of Planets at 3600 Kaliyuga era.

Date : March 21, 499 A.D.—Ujjayinī Mean Midday.

Planet	Mean Long. <i>Ārdharātrika</i> system.	Mean Long. <i>Audayika</i> system.	Mean Long. Moderns.	Error in the <i>Audayika</i> system.
Sun	0° 0' 0"	0° 0' 0"	359° 42' 5"	+17' 55"
Moon	280 48 0	280 48 0	280 24 52	+23 8
Moon's Apogee	35 42 0	35 42 0	35 24 38	+17 22
Moon's Node	352 12 0	352 12 0	352 2 26	+ 9 34
Mercury	180 0 0	186 0 0	183 9 51	+2° 50' 9"
Venus	356 24 0	356 24 0	356 7 51	+16 9
Mars	7 12 0	7 12 0	6 52 45	+19 15
Jupiter	186 0 0	187 12 0	187 10 47	+ 1 13
Saturn	49 12 0	49 12 0	48 21 13	+50 47

It is thus clear that the beginning of the Hindu astronomical *Kaliyuga* was the result of a back calculation wrong in its data, and was thus started wrongly.

It is also established that the astronomical Kaliyuga-reckoning is a pure astronomical fiction created for facilitating the Hindu astronomical calculations and was designed to be correct only for 499 A.D. This Kali-reckoning cannot be earlier than the date when the Hindu scientific *Siddhāntas* really came into being. As this conclusion cannot but be true, no Sanskrit work or epigraphic evidences would be forthcoming as to the use of this astronomical Kali-reckoning prior to the date 499 A.D."

(b) The Vikrama Era

The Vikrama Era is widely prevalent in Northern India, excepting Bengal, and used in inscriptions from the ninth century A.D. Let us probe into its origin.

In popular belief, the Vikrama era was started by king Vikramāditya of Ujjain who is claimed to have repelled an attack on this famous city by Śaka or Scythian hordes about 57 B. C. and founded an era to commemorate his great victory.

Unfortunately no historical documents or inscriptions have yet been discovered showing clearly the existence of a king Vikramāditya reigning at Ujjain

to the Imperial Guptas (319-550 A.D.). They call it not only the era of the Mālava tribe, but also alternatively as the Kṛta era. A number of inscriptions bearing dates in the Kṛta era have been found in Rajasthan, and the earliest of them goes back to the year 282 of the Kṛta era (The Nandsa Yupa inscription described by Prof. Altekar, *Epigraphia Indica*, Vol. XXVII, p. 225).

From these evidences, it has been concluded by historians that the earliest name so far found of this era was Kṛta. What this means is not clear. Then between 405-542 A.D., it came to be known as the era of the Mālava tribe and was used by the Verma kings of Mandasor, Rajputana, though they were feudatories of the Gupta emperors (319-550 A.D.). Its association with king Vikrama is first found in the year 737 A.D., nearly 800 years after the supposed date of king Vikrama. Its use appears to have been at first confined to Kathiawar and Rajasthan, for the whole of Northern India used between 320 A.D. to 600 A.D., the Gupta era, which fell into disuse with the disappearance of the Gupta rule in 550 A.D. For a time, Northern India used the Harṣa era introduced by the emperor Harṣa Vardhana (606 A.D.), but when the Gurjāra-Pratihārs, who came from

Rajasthan, conquered the city of Kanauj about 824 A.D., they brought the Vikrama era from their original home, and it became the current era all over northern India except the eastern region, and was used by all Rajput dynasties of medieval times.

The months of the Vikrama era are all lunar, and the first month is *Caitra*. The months begin after the full-moon but the year begins 15 days after the full-moon of Phālguna, i.e. after the new-moon of Caitra. But for astronomical calculations, it is pegged on to a solar year, which starts on the first of solar Vaiśākha, theoretically the day after the vernal equinox. The Vikrama era is current also in parts of Gujrat, but there the year begins in *Kārtika* and the months are *amānta*, which corresponds to the Macedonian month of Dios, and the epoch is just six months later. Thus the western and northern varieties of the Vikrama era follow respectively the Macedonian and Babylonian reckonings (see § 3.3), the year of starting is 255 years later than that of the Seleucidian era.

The conclusion is that the champions of the Vikrama era have still to prove the existence of king Vikrama of Ujjain. Early inscriptions show that the method of date-recording is not typically Indian as in the Sātavāhana inscriptions but follow the Śaka-Kuṣāṇa method, which follows the contemporary Graeco-Chaldean method. It was therefore a foreign reckoning introduced either by the Greeks or Śakas, or an Indian prince or tribe who had imbibed some Graeco-Chaldean culture, but was adopted by the Mālava tribes who migrated from the Punjab to Rajasthan about the first century B.C. The association with a king Vikrama occurred 800 years later, and is probably due to lapse of historical memory, for the only historical king Vikramāditya who is known to have crushed the Śaka power in Ujjain, was king Candragupta II of the Gupta dynasty (about 395 A.D.). Before this, the Śaka dynasty in Ujjain had reigned almost in unbroken sequence from about 100 A.D. to 395 A.D., and had used an era of their own, later known as the 'Śaka' era. All the Gupta emperors from Samudragupta, had an "Āditya" title, and many of them had the title "Vikramāditya" so that the Gupta age was par excellence the age of Vikramādityas. But all the Gupta emperors use in their inscriptions the family era called the Guptakāla which commemorated the foundation of Gupta empire (319 A.D.). The association of the Mālava era with king Vikramāditya, and assignment of king Vikramāditya to Ujjain, was due to confusion of historical memory not infrequent in Indian history. It may be mentioned that the Vikrama era is never used by Indian astronomers for their calendaric calculations, for which purpose the Saka era is exclusively used.

(c) The Saka Era

The Śaka Era is the era par excellence which has been used by Indian astronomers all over India in their calculations since the time of the astronomer Varāhamihira (died 587 A.D.) and probably earlier. The Indian almanac-makers, even now, use the Saka era for calculations, and then convert the calculations to their own systems.

This era is extensively used over the whole of India except in Tinnevely and part of Malabar, and is more widely used than any other era. It is also called Śaka Kāla, Śaka Bhūpa Kāla, Śakendra Kāla, and Sālivāhana Śaka and also Śaka Saṁvat. Its years are *Caitrādi* for luni-solar reckoning and *Meṣādi* for solar reckoning. In the luni-solar reckoning the months are *pūrṇimāntā* in the North and *amāntā* in Southern India. The reckoning of the Śaka era begins with the vernal equinox of 78 A.D., and is measured by expired years, so the year between the vernal equinox of 78 A.D. to that of 79 A.D. is zero of Śaka era. In some pañcāṅgas of Southern India the current year is however seen to be used instead of the elapsed year, where the number of year of the era is one more than the era in general use.

But we are not yet sure about the origin of this era. It has been traced back to the Śaka satraps of Ujjain, from the year 52 (130 A.D.) to the end of the dynasty about 395 A.D. But in their own records, they merely record it as year so and so, but there is not the slightest doubt that the era used by them subsequently became known as the Śaka era (*vide* § 5.5).

The Old and the New Śaka era.

The dates given by different authorities about the starting year of the old Śaka era mentioned in § 5.5 vary from 155 B.C. to 88 B.C. as given below :

Konow : 88 B.C. (date of death of Mithradates II, the powerful Parthian emperor who is said to have subjugated the Sakas).

Konow has proposed a number of other dates.

Jayaswal : 120 B.C. :

Herzfeld : 110 B.C. : Settlement of the Śakas in Seistan by Mithradates II.

Rapson : 150 B.C. : Establishment of the Śaka kingdom of Seistan.

Tarn : 155 B.C. : Date of settlement of the Śaka immigrants in Seistan by Mithradates I.

Recently Dr. Van Lohuizen de Leeuw has discussed the starting point of this era in her thought-provoking book '*The Scythian Period of Indian History*'. She has rejected all the above dates, and fixed up 129 B.C. as the starting date of the old Śaka era. She identifies this year as the one in which the Śakas, descending from the Trans-Oxus region, attacked the Parthian empire

in which the Parthian emperor Phraates II was defeated and killed, and the rich province of Bactria was occupied by the Śakas. They founded an era to commemorate their victory over the Parthians which their successors took to India, as they expanded and put an end to the Bactrian Greek principalities in Afghanistan and north-west Punjab. She suggests that the old Śaka era was also used by the Kuṣāṇas, who were after all a Sakish ruling tribe, but from the time of Kaniṣka with hundreds omitted.

Dr. M. N. Saha has supported this theory in its main features, but he thinks that the era was founded in 123 B.C., for he shows from historical records that the Śakas assailed Bactria first in 129 B.C. and entered into a seven year conflict with the Parthians, and finally conquered Bactria in 123 B.C., when the Parthian emperor Artabanus II, was defeated and killed. Probably the Śakas then founded their era. This was also called the era of Azes. Dr. Van Lohuizen de Leeuw has accepted Saha's suggestion.

This hypothesis, though not finally settled appears to have a good deal of probability, for the following reasons :

Dr. Saha points to the fact that Indian classics, which can be dated from the third century B.C. to the second century A.D., mentions three races in what is modern Afghanistan and N. W. India, *viz.*, the Śakas, the Yavanas, and the Pallavas, who attained to the status of ruling races. The order in which they are mentioned denotes correct chronological sequence, for they are arranged in the order of their chronological appearance in history, the Śakas being mentioned as a subject race in Darius's inscription (518 B.C.). But the Yavanas (Greeks) were the first to attain the status of a ruling race, from 312 B.C., the date of foundation of the Seleucid empire, whose power in the west was overthrown by the Parthians, or Pehlevis (Pallavas of Indian classics) in 248 B.C.

Both these ruling races of Yavanas and Pallavas used eras of their own, *viz.*, the Seleucid era from 312 B.C., and the Parthian era from 248 B.C. Did the third race, *viz.*, the Śakas who were the last to attain status of a ruling race *ever use an era of their own?* It would be surprising if they did not, for it became the fashion for all races, who attained the status of ruling people, to have eras of their own. The early Śakas, as their records show, were deeply influenced by their neighbours to the west, *viz.*, the Parthians who adopted Greek culture, and their coin-records show that they also adopted Greek culture, and therefore most probably, the Graeco-Chaldean method of date recording.

The points given in § 5.5 and above may be summarized as follows :—

(a) The Śakas starting from Central Asia attacked the Parthian empire in 129 B.C., and overcame Parthian resistance by 123 B.C. It is very probable that they started an era to commemorate their accession to power in Bactria from 123 B.C. They used Macedonian months and Graeco-Chaldean methods of calendaric calculations as prevalent in the Seleucid and Parthian dominions. Probably the era was sometimes named after Azes, who was probably their leader. But this Azes is not to be confounded with later Azes I or Azes II, who reigned in Taxila between 40 B.C. and 20 B.C. Within the first 200 years of its starting, the era was alternatively called the Azes era.

(b) This Śaka era (known to archaeologists as the old Śaka era) was used by the Śaka emperors and Śaka satraps in their Indian territories, but the time-reckoning began to be gradually influenced by Indian customs. They began to use Indian months alternatively with Macedonian months and *Pūrṇimānta* months in place of *Amānta* months. During the first 200 years, the hundreds were sometimes omitted, in the use of the era.

(c) The so-called Kaniṣka era is nothing but the old Śaka era with 200 omitted.

(d) The Śaka era was used by the house of Caṣṭana of Ujjain with 200 omitted, but gradually they forgot the origin of the era and continued their own reckoning without further omission of hundreds upto the end of the Śaka satrapal rule over Ujjainī about 395 A.D. As the early Indian astronomers were mostly of foreign origin (*viz.* Śākadvīpi Brāhmaṇa) the astronomical reckonings necessary for compiling the calendar were carried out using the Śaka era and Graeco-Chaldean astronomy. The blending of Graeco-Chaldean astronomy as known about the early years of the Christian era with older Indian calendarical features formed the basis of Siddhānta Jyotiṣa. The Śākadvīpi Brahmins also brought to India horoscopic astrology using the Śaka era exclusively in horoscopes, a custom which has persisted to this day. These facts explain the pre-eminence of the Śaka era.

(d) Other Eras

Buddha Nirvāṇa Era :—The Buddhists of Ceylon have been using since the first century B.C. the Buddhist Nirvāṇa era, having its era-beginning in 544 B.C. This era has not however been found in use on the Indian soil, except for a solitary instance in an inscription of Aśokachalla Dev found at Gaya dated in the year 1813 of the Buddhist Nirvāṇa

era=1270 A.D. Most of the antiquarians however put the date of Nirvāṇa in 483 B.C. The origin of the Buddha Nirvāṇa era used in Ceylon has not yet been satisfactorily explained.

The Gupta Era :—This era was clearly established by the founder of the Gupta dynasty (Candragupta I) to commemorate the accession to imperial power of his family, about 319 A.D., and was in vogue over the whole of Northern India from Saurashtra to Bengal during the days of their hegemony (319 A.D.-550 A.D.). After the decay of their empire, the era was continued by their former vassals, the Maitrakas of Vallabhi and was in use in parts of Guzrat and Rajputana up to the thirteenth century. Its use in Bengal was discontinued from about 510 A.D. with the disappearance of Gupta rule first in South Bengal, then over the whole of Eastern India. In the Uttar Pradesh (ancient Madhyadeśa), it was driven out by the Harṣa era, which had a short period of existence, 606-824 A.D., when the city of Kanauj was occupied by king Nāgabhata of the Pratihār dynasty, who hailed from Rajasthan. The Pratihārs brought with them the Vikrama era, which had been current in Rajasthan, and this became the great era of the north, used by all medieval Rajput dynasties, except those belonging to the eastern region.

Eras in Eastern India

Most parts of Bengal were under the Gupta emperors, and used the Gupta era during their hegemony (319-510 A.D.). But Gupta rule disappeared as mentioned above from major parts of Bengal from ca. 510 A.D., and the subsequent dynasties including the Pāla emperors (750 A.D.—1150 A.D.) used regnal years in their inscriptions for four hundred years of their rule. The Śaka era in Bengal appear to have been introduced by the Sena dynasty which replaced the Palas; the Senas were migrants from the south (Kaṛṇāṭa-Kṣatriyas), where they were familiar with the Śaka era, but it was not used in royal records which continued to use regnal years. The Vikrama Saṁvat never became popular in Bengal, or Eastern India. After Mohamedan conquest, Bengal was left without an era. For official purposes, Hejira was used, but the learned men used the Śaka era, and the common people in certain parts used a rough reckoning,

called *Parganati-Abda*, reckoned from the time of disappearance of Hindu rule.

After the introduction of *Tārīkh Ilāhi*, the people of Bengal began to use the Sūrya Siddhānta reckoning, and the solar year. The Bengali San had thus a hybrid origin; to find the current year of the Bengali San, we take Hejira year elapsed in 1556, i.e., 963 and add to it the number of solar years. Thus 1954 A. D. is $963 \text{ A.D.} + (1954 - 1556) = 1361$ of Bengali San.

Other hybrid eras

A number of other hybrid eras formed in a similar way to Bengali San is mentioned in the table (No. 27): Āmli and Vilāyati in Bengal and Orissa, the various Fasli or harvest years in Bengal, Deccan, and Bombay.

All the other eras mentioned as hybrid in the chart were formed in a similar way, and the slight differences are due to mistakes in calculation, or differences in the time of introduction. While the Bengali San has Meṣādi as year-beginning, others have taken the year-beginning to be coincident with some important mythical event of local provenance, e.g., the year-beginning of the Āmli era used in Orissa, *viz.*, the 12th lunar day of the light half of the month of *Bhādra* is said to represent the birth date of king Indradyumna, the mythical king who is said to have discovered the site of modern Puri. The great temple of Puri was actually built by king Anyanka Bhīm Dev of the Gaṅgā dynasty about 1119 A.D., and kings of this dynasty who held sway in Orissa from 1035-1400 A. D. used the Gaṅgā era.

The Kollam era prevalent in the Malayalam countries is of obscure origin. The year of this era is known as the Kollam Āṇḍu. The era is also called the Era of Paraśurāma, and is said to have omitted thousands from their previous reckonings. In South Malabar it begins with the solar month Simha and in North Malabar with the solar month Kanyā. The era started from 825 A.D.

The Jovian cycle : In Southern India the years are named after the name of the Jovian year and so it also serves the purpose of an era of a short period, *viz.*, 60 years, after which the years recur. Details about Jovian years will be found in Appendix 5-E.

Table 27.
Indian Eras

ERA	Zero-year of Era	Year of era current in 1954 A. D. (latter part)	Date of commencement in 1954 A. D.	Year-beginning		Pūrṇimānta or Amānta (Lunar months)	Provenance	Remarks
				Solar	Luni-Solar			
Kali Yuga	A. D. -3101	5055	April	Meṣādi (Ver. equi.)	Caitra S 1	—	—	Extrapolated
<i>Saptarṣi</i> ¹	-3176	—	—	—	Caitra S 1	Pūrṇimānta	Kashmir	—
<i>Yudhiṣṭhira</i>	-2448	—	—	—	—	—	—	—
<i>Laukika</i>	724 (?)	—	—	—	—	—	Multan & Kashmir	Adopted by Kalhaṇa
Buddha Nirvāṇa	-544	2498	May 17	—	Vaiśākha S 15	—	Ceylon	—
Mahāvira Nirvāṇa	-527	2481	—	—	Kārtika S 1	—	—	—
Vikrama (I)	-57	2011	April 4	Vernal equinox	Caitra S 1	Pūrṇimānta	N. India except Bengal } Gujarat Kathiawar	Earlier known as Kṛta or Mālavagaṇa.
" (II)	-57	2011	Oct. 27	—	Kārtika S 1	Amānta		
" (III)	-57	2011	July 1	—	Āṣāḍha S 1	Amānta		
Christian	0	1954	Jan. 1	Jan. 1	—	—	World	—
Saka	78	1876	April	Meṣādi (Vernal equinox)	Caitra S 1	P (N. India) A (S. India)	All India	Astronomer's era
<i>Chedi</i> (Kālācūri)	248	—	—	—	Āśvina S 1	Pūrṇimānta	Western & Central India	—
<i>Vallabhi</i>	318	—	—	—	Kārtika S 1	Both P. & A.	Kathiawar & Saurashtra	From Gupta era
<i>Gupta</i>	319	—	—	—	Caitra S 1	Pūrṇimānta	Gupta empire (Cen. I. & Nep.)	—
<i>Harṣa</i>	606	—	—	—	—	—	Mathura & Kanauj	—
Hejirā	622	1374	Aug. 31	—	Muharram (Lun.)	—	—	Lunar reckoning
Bengali San	—	1361	April 14	Meṣādi	—	—	Bengal	963+ Solar years since 1556
Vilāyati	—	1362	Sept. 16	Kanyādi	—	—	Bengal & Orissa	—
Āmli	—	1362	Sept. 10	—	Bhādra S 12	—	Orissa	—
Fasli (I)	—	1362	Sept. 13	—	Bhādra K 1	Pūrṇimānta	Bengal	992+ Solar years since 1584
" (II)	—	1364	July 1	July 1	—	—	Deccan	—
" (III)	—	1364	June 8	Sun enters Mṛga. nakṣ.	—	—	Bombay	—
<i>Maḡi</i>	638	—	—	Meṣādi	—	—	Arakan, Chittagong	Similar to Bengali San
<i>Gaṅgā</i>	—	—	—	—	—	—	Eastern Deccan	—
Kollam (I)	824	1130	Sept. 17	Kanyādi	—	—	North Malabar	—
" (II)	824	1130	Aug. 17	Siṃhādi	—	—	South Malabar	—
<i>Newar</i>	879	—	—	—	Kārtika S 1	Amānta	Nepal	In vogue till 1768 A. D., suppressed by Gurkhas.
<i>Cālukya Vikrama</i>	1075	—	—	—	—	—	Western Deccan	Current only for 100 years.
<i>Lakṣmaṇa Sena</i>	1104-1118	—	—	—	Kārtika S 1	—	Mithilā	—
<i>Siṃha</i>	1113	—	—	—	Āṣāḍha S 1	Amānta	Gujarat	Started by Siddharāja Jayasimha
<i>Tārīkh Ilāhi</i>	1555	—	—	Vernal equinox	—	—	Akber's empire	Introduced by Akber (963 Hejirā)
<i>Rāja Śaka</i>	1673	—	—	—	Jyeṣṭha S 13	Amānta	Maharashtra	From the coronation of Śivāji

APPENDIX 5-A

The Seasons

We have seasons because the celestial equator is oblique to the sun's path (or the ecliptic), or in modern parlance, the axis of rotation of the earth is not perpendicular to its orbit, but inclined at an angle of $66\frac{1}{2}^\circ$. This causes varying amounts of sunlight to fall on a particular locality throughout the year. If the earth's axis were perpendicular to the ecliptic, in other words the obliquity were zero, every portion of the earth from the equator to the pole would have had 12 hours of sunlight, and 12 hours of shade. There would have been no seasons on any part of the earth, just as we have now for places on the earth's equator, where we have no variation of season throughout the year, because the day and night are equal for all days of the year.

It can be proved from spherical trigonometry that the duration of sunlight for a place having the latitude ϕ is given by

$$12 + \frac{2}{15} \sin^{-1} (\tan \phi \tan \delta) \text{ hours,}$$

where δ = declination of the sun on that day; δ being counted positive when it is north of the equator, and negative when south.

If δ is negative, i.e., when the sun is south of the equator, the second term of the above equation is negative, and daylight will be of less than 12 hours' duration.

This holds up to the latitude of $\frac{\pi}{2} - \epsilon = 66\frac{1}{2}^\circ$, i.e., the beginning of the arctic zone. Between the arctic circle and the north pole, the sun will remain constantly above the horizon more than twenty-four hours for several days together during the year. Thus at a place on 70° north latitude, the continuous day is observed for 64 days from 21st May to 24th July, at 80° north latitude it is for 133 days from 17th April to 28th August, at the north pole it is for six months from 21st March to 23rd September.

For a person on the north pole, the sun will appear on the horizon on the vernal equinox day, and will go on circling round the sky parallel to the horizon and rising every day a little up, till on the solstitial day, he attains the maximum altitude, viz., $23^\circ 27'$. After that the sun will begin to move down and on the day of autumnal equinox, will pass below the horizon. Thus for six months, from 21st March (V.E.) there will be continuous day for a person on the north pole, and from the 23rd Sept. (A.E.) to the next 21st March (V.E.), there will be a continuous night for six months.

The position described above is for the northern hemisphere, viz., for those dwelling north of the equator. In the southern hemisphere the position is just reversed; when the day is longer in the northern hemisphere, it is shorter in the southern hemisphere.

The amount of daylight received at any place determines the season. When we have maximum sunlight, we have the hot season. When we have minimum sunlight, we shall have winter. The other seasons come in-between. Rain, frost, etc., are secondary effects produced by varying amounts of sunlight, and of the atmospheric conditions stimulated by the sunlight received. The sun is the sole arbiter of the seasons.

Hence the definitions of seasons as given by the ancient astronomers, whether Western and Indian, which base them on the cardinal days of the year, are the only *correct definitions*. A system which deviates from this practice is wrong.

The majority of the Indian calendar makers have not, however, followed this definition. The reason is more psychological than scientific. For along with astronomy, there has been also a growth of astrology which has fixed up its canons on the basis of a fixed zodiac commonly known as the *Nirayana* system. The effect of this will be clear from the following example.

The winter season (*śiśira*) begins on the winter solstice day which date is also marked in *all the Siddhāntas* by sun's entry (*saṁkrānti*) into *Makara*. This event occurs on the 22nd December. But the Indian calendar makers, following the *nirayana* system, state that the *Makara Saṁkrānti* happens not on the 22nd December but on the 14th January and the winter season also begins on that date. Similar is the case with other seasons also. The result is that there is a clear difference of 23 days in the reckoning of seasons. The later Hindu savants tried to reconcile the two points of view by adopting a theory of trepidation, which after Newton's explanation of precession, has been definitely shown to be false. It is therefore absolutely wrong to stick to the *nirayana* system.

It is however refreshing to find that a few Indian savants have definitely stood against the false *nirayana* system. The earliest were Muñjala Bhaṭṭa (932 A.D.), a South Indian astronomer and Pṛthūdaka Svāmī (950 A.D.), who observed at Kurukṣetra. One of the latest was Mm. Bapudev Sastri, C. I. E., Professor in the Sanskrit College, Banaras, who wrote in 1862, as follows :

"Since the *nirayana saṁkrāntis* cannot be determined with precision and without doubt and since the *nirayana rāśis* have no bearing on the ecliptic and its northern and southern halves, we must not hanker after *nirayana* system for the purposes of our religious and other rites. We must accept *sāyana* and our religious and other rites should be performed in accordance with the *sāyana* system".

It is not generally known that another great man who probably felt that the *nirayana* system gave us wrong seasons, was Pandit Ishwar Chandra Vidyasagar. We learn from his biography that he had a course in Indian astronomy while he was a student of the Sanskrit College, Calcutta about 1840. Before him, the *Vasanta* or Spring consisted of the months *Madhu* and *Mādhava*, i.e., *Caitra* and *Vaiśākha*, as in other parts of India. But from 1850, Vidyasagar began to bring out text books in Bengali in which he retarded the seasons by a month, e.g., he said that the spring consists of *Phālguna* and *Caitra*, and no one questioned it. So in Bengal, as far as popular notion goes, *Vasanta* season starts on Feb. 12, while in other parts it starts on March 14, a month later, while the correct astronomical date according to Hindu Siddhāntas is Feb. 19. Bengal thus commits a negative mistake of 7 days while other parts of India has a positive mistake of 23 days.

The position in respect of all the seasons is stated below :

Sun's longitude	Correct date	Present date
Vasanta (-) 30° to 30° (Spring)	Feb. 19 to Apr. 19	Mar. 14 to May 13
Grīṣma 30° to 90° (Summer)	Apr. 20 to June 20	May 14 to July 15
Varṣā 90° to 150° (Rains)	June 21 to Aug. 22	July 16 to Sep. 15
Śarat 150° to 210° (Autumn)	Aug. 23 to Oct. 22	Sep. 16 to Nov. 15
Hemanta 210° to 270° (Late Autumn)	Oct. 23 to Dec. 21	Nov. 16 to Jan. 12
Śiśira 270° to 330° (Winter)	Dec. 22 to Feb. 18	Jan. 13 to Mar. 14

In continuing to follow the *nirayana* system, the Hindu calendar makers are under delusion that they are following the path of *Dharma*. They are actually committing the whole Hindu society to *Adharma*.

The period covering the north-ward journey of the sun was known in Indian astronomy as the *Uttarāyana* i.e., north-ward passage and it consisted of the Winter, Spring and Summer. It is the period from winter solstice to summer solstice, and *vice-versa*, the period from summer solstice to winter solstice was known as the *Dakṣiṇāyana*, i.e., southward passage and it consisted of Rains, Autumn and *Hemanta*.

The names of months given in the second column of Table No. 23 are found first in *Taittirīya Saṁhitā*, and they are *tropical*, because they attempt to define the physical characteristics of the months.

Madhu.....means 'Honey' and the name indicates that the month was pleasant like honey.
Mādhava...means 'Honeylike' or 'Sweet one'.

The names are thus expressive of the pleasantness of the spring season.

The figures in the third column of the table below denote the angular distance of the sun from the astronomical first point of Aries (the V.E. point) indicating the beginning of the month.

The two months constituting the 'Spring Season' would thus include the day from Feb. 19 or 20 to April 19 or 20. The Vernal Equinox day (March 21) would be just in the middle. The same is the case with other seasons each of two months.

Table 28.

Spring	Madhu	} -30°	Honey or sweet spring
	Mādhava		0
Summer	Śukra	} 30	Illuminating
	Śuci		60
Rains	Nabhas	} 90	Cloud
	Nabhasya		120
Autumn	Īsa	} 150	Moisture
	Ūrja		180
Late Autumn	Sahas	} 210	Power
	Sahasya		240
Winter	Tapas	} 270	Penance, mortification, fire
	Tapasya		300

These names were seldom used by the common people, but they were very popular with poets.

The figures in the second column of table No. 29 denote the angular distance of the sun on the ecliptic, the origin being the first point of Aries. We have described in § 4.5 how an idea of the ecliptic was derived from night observations of the sky and observation of eclipses, and how it came to be used as a reference plane from very ancient times.

The Indian definition of the seasons, though was based on the cardinal days, was different from the definition of the westerners who divided the year into four seasons each of three months Winter, Spring, Summer and Autumn, starting from the four cardinal days. The ancient Indians divided the year into six seasons each of two months as given in the table below. The spring season did not start with the vernal equinox, as already stated but a month earlier and it was extended a month later, and so for every season.

Table 29.

Indian Seasons	Tropical Month-names	Lunar Month-names
Spring (-30° to 30°)	Madhu & Mādhava	Caitra-Vaiśākha
Summer (30° to 90°)	Śukra & Śuci	Jyaiṣṭha-Āṣāḍha
Rains (90° to 150°)	Nabhas & Nabhasya	Śrāvaṇa-Bhādra
Autumn (150° to 210°)	Īsa & Ūrja	Aśvina-Kārtika
Late Autumn (210° to 270°)	Sahas & Sahasya	Agrahāyana-Pauṣa
Winter (270° to 330°)	Tapas & Tapasya	Māgha-Phālguna

The early Greek astronomers have left records about their successive attempts to measure the length of the year

correctly. It is now known that they all used the gnomon. Measures of the length of the different seasons and of the year by some of their eminent astronomers are given in the table (No. 30) below.

The Chaldeans must have also measured the length of the year by the same method, either somewhat earlier or simultaneously with the early Greeks, but their names, excepting those of a few have not survived. But if in reality, the nineteen-year cycle was of as early as 747 B.C., they must have arrived at a correct length of the year much earlier than any other nation.

The Length of the Seasons : The lengths of seasons were found exactly in the same way as in the case of the year, e.g., in the case of Spring, by counting the number of days from the day next to the vernal equinox day to the summer solstice day. The number would be variable from year to year, but a correct value was found by taking the observations for a number of years and taking the mean. The lengths obtained by early astronomers are :

Table 30.

	Spring days	Summer days	Autumn days	Winter days	Total days
Chaldean ...	94.50	92.73	88.59	89.44	365.26
Euctemon (432 B.C.)	93	90	90	92	365
Calippos (370 B.C.)	94	92	89	90	365
Correct values for 1384 B.C. ...	94.09	91.29	88.58	91.29	365.25

The ancients early discovered that the seasons were of unequal length, but they were ignorant of the physical reasons. These exact definitions of seasons, both in India and in the West, were arrived at very early, and are very important for accurate calendar-making ; but the true meaning of these definitions were forgotten in the succeeding periods in India.

In European astronomy, which is derived from Graeco-Chaldean astronomy, we have :

Spring	0°— 90°	from V.E. to S.S.
Summer	90°—180°	" S.S. to A.E.
Autumn	180°—270°	" A.E. to W.S.
Winter	270°—360°	" W.S. to V.E.

According to this scheme, the Rainy season consisting of months of *Nabhas* and *Nabhasya* formally set in when

the sun crossed the summer solstice (June 22), as is evident from the lines in Kālidāsa's *Meghadūta* or Cloud-Messenger.

Pratyāsanne *Nabhasi* dayitājivitā lambanārthi
Jimūtena svakuśalamayim hārayiṣyan pravṛttim.

Translation : When the month of *Nabhas* was imminent, (just marking the onset of monsoon), etc."

Or in the *Rāmāyaṇa*, *Ayodhyākāṇḍa*

Udagatvā-abhyupābrtte paretācaritām diśam
Ābrnvānā diśaḥ sarvāḥ snigdḥā dadṛśire ghanāḥ.

Translation : When the sun just reversed its motion after going (continuously) to the north, and began to proceed in the direction inhabited by departed souls (dakṣiṇāyana), the whole sky was overcast with clouds (i.e., the monsoon set in) ;.....

Winter solstice set in with the month of *Tapas*, which means penance. The winter solstice as mentioned above was the time from which the yearly sacrifices started.

The month names in the last column of table (No. 29) are 'lunar', but they were linked to the solar months. They are now in universal use all over India to denote solar as well as lunar months ; but the two varieties are distinguished by the adjectives 'Solar' or 'Lunar'.

Both the European and Indian definitions of seasons are scientific as they are based on the cardinal days. The difference in nomenclature is trivial.

The Length of the Year : The length of the year, as mentioned earlier, must have been found by counting the number of days from one equinox to another, or one solstice to another.

In actual practice, the number of days of the year, counted in this way would vary between 365 and 366. In the early stages, the length of the year was whole-numbered, but Indians of Vedāṅga Jyotiṣa period had a year of 366 days. Later when they came to a rigorous definition of the year, they realized that the number of days was not whole, but involved fractions. Probably the attempt at determining the exact length of the year involving fractional numbers was obtained by adding up the lengths for a number of years, and taking the mean.

APPENDIX 5-B

The Zero-point of the Hindu Zodiac

The Zero-point of the Hindu Zodiac : By this is meant the Vernal Equinoctial Point (first point of Aries) at the time when the Hindu savants switched on from the old *Vedāṅga-Jyotiṣa* calendar to the Siddhāntic calendar (let us call this the epoch of the Siddhānta-Jyotiṣa or S. J.). There is a wide spread belief that a definite location can be found for this point from the data given in the *Sūrya-Siddhānta* and other standard treatises. This impression is however wrong.

Its location has to be inferred from the co-ordinates given for known stars in Chap. VIII of the *Sūrya Siddhānta*. From these data Dikṣit thought that he had proved that it was very close to *Revatī* (ζ *Piscium*); but another school thinks that the autumnal equinoctial point (first point of Libra) at this epoch was very close to the star *Citrā* (Spica, α *Virginis*), and therefore the first point of Aries at the epoch of S.J was 180° behind this point. The celestial longitude in 1950 of ζ *Piscium* was $19^\circ 10' 39''$ and of α *Virginis* was $203^\circ 8' 36''$. The longitudes of the first point of Aries, according to the two schools therefore differ by $23^\circ 9' (-) 19^\circ 11' = 3^\circ 58'$ and they cannot be identical. *Revatī* or ζ *Piscium* was closest to τ_0 (the V.E. point) about 575 A.D., and *Citrā* or α *Virginis* was closest to ω (the A.E. point) about 235 A.D., a clear difference of 290 years.

Thus even those who uphold the *nirayana* school are not agreed amongst themselves regarding the exact location of the vernal point in the age of the *Sūrya-Siddhānta* and though they talk of the Hindu zero-point, they do not know where it is. Still such is the intoxication for partisanship that for 50 years, a wordy warfare regarding the adoption of either of these two points as the zero-point of the Hindu zodiac has gone on between the two rival factions known respectively as the *Revatī-Pakṣa* and *Citrā-Pakṣa*, but as we shall show the different parties are simply beating about the bush for nothing.

Chapter VIII of the S.S gives a table of the celestial co-ordinates (*Dhruvaka* and *Vikṣepa*) of the junction-stars (identifying stars) of 27 asterisms forming the Hindu lunar zodiac. It is agreed by all that these co-ordinates must

have been given taking the position of the V.E. point at the observer's time as the fiducial point. It is possible to locate it, as Burgess had shown in his edition of the S.S., if with the aid of the data given, λ , i.e., celestial longitude of the junction-stars in the epoch of S.J. is calculated, and compare it with the λ of the same stars for 1950. Let the two values of λ be denoted by λ_1 and λ_2 , λ_1 being the value at the epoch of S. J., λ_2 for the year 1950. Then $\lambda_2 - \lambda_1$ should have a constant value, which is the celestial longitude of the V.E. point at the epoch of the S.J. on the assumption that they refer to observations at a definite point of time. The following is a short exposition of Burgess's calculations.

The S.S. gives the position of the junction-stars in terms of *Dhruvaka* and *Vikṣepa*, two co-ordinates peculiar to *Sūrya-Siddhānta*. Their meaning and relation to the usually adopted co-ordinates is illustrated by means of fig. 27 and for convenience of the reader, the standard

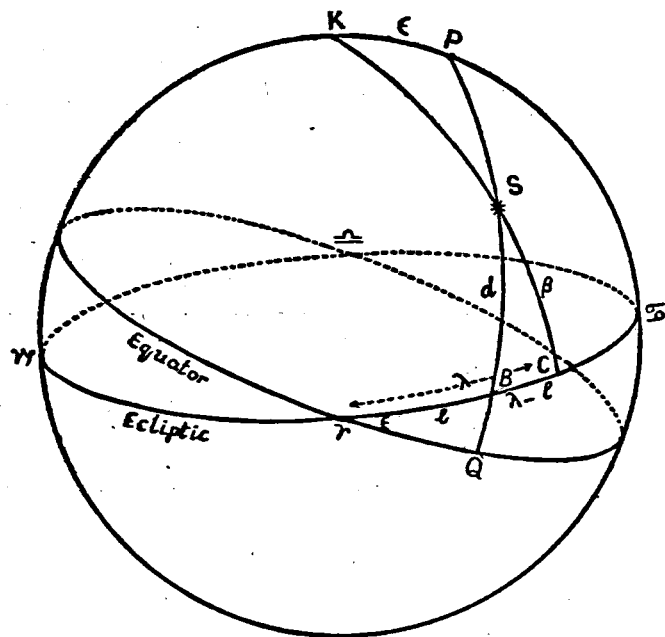

Fig. 27

designations, symbolisms used for the different systems of celestial co-ordinates along with their Hindu equivalents are shown in the table below :

Table 31—Siddhāntic designation of celestial co-ordinates.

<i>Co-ordinate</i>	<i>Hindu Designation</i>	<i>Symbol</i>	<i>Figure</i>	<i>Remarks</i>
Celestial longitude	Bhoga	λ	τC	As in <i>Sūrya Siddhānta</i>
Celestial latitude	Śara	β	CS	Used by Bhāskara
✓ Right Ascension	Viṣuvāṁśa	α	τQ	Modern
✓ Declination	Krānti	δ	QS	As in <i>Sūrya Siddhānta</i>
Polar longitude	Dhruvaka	l	τB	"
Polar latitude	Vikṣepa	d	BS	"

With the aid of spherical trigonometry, the following relations may be deduced :—

$$\begin{aligned} \sin \beta &= \sin d \sin B \dots\dots\dots(1) \\ \sin (\lambda-l) &= \tan \beta \cot B \} \dots\dots\dots(2) \\ \text{or } \tan (\lambda-l) &= \tan d \cos B \} \\ \text{where, } \cot B &= \cos l \tan \epsilon \dots\dots\dots(3) \end{aligned}$$

The objective is to deduce the values of λ and β of a star whose l, d are to be found from Chap. VIII of S.S. As the formulae show, the key angle is B , which is determined with the aid of relation (3). Then (1) gives us β and (2) gives us $\lambda-l$. So λ and β for the star are found.

Proceeding in this way, Burgess calculated the values of λ and β of the junction-stars given in the S.S. We have checked these calculations. These are reproduced in table No. 32 on pp. 264-65 in which :

Column 1	gives us the serial no. of the nakṣatra.
" 2	" " their names.
" 3	" " the name of the junction star as accepted (see however later remarks).
" 4	" " the magnitude of the star.
" 5	" " the celestial longitude of the star in 1950 from data given in a modern Ephemeris.
" 6	" " the celestial latitude of the star.
" 7	" " the dhruvaka or polar longitude as given in S.S.
" 8	" " vikṣepa or polar latitude as given in S.S.
" 9	" " the celestial longitude of junction star from the data given in the S.S. converted with the aid of the formula mentioned above.
" 10	" " celestial latitude similarly converted from data given in S.S.
" 11	" " the difference in celestial longitude of the star for 1950 over that for the time of SS.
" 12	" " the difference between the latitudes.

It is evident that $\beta-\beta'$ ought to be zero for all stars, which is however not the fact as may be seen from the table. In the time of the S.S., the observations cannot be expected to have been very precise. But yet we cannot probably hold that an identification is correct when the difference is too large. We are therefore rejecting all identifications where $\beta-\beta'$ exceeds 2° . Probably these stars have not been correctly identified from the description given for them, or the co-ordinates given in the *Sūrya-Siddhānta* were erroneously determined or wrongly handed down to us. In the case of other stars, we find that $\lambda_2-\lambda_1$ is $16^\circ 47'$ (or $10^\circ 52'$), $16^\circ 58'$ and $26^\circ 18'$ for three stars. We are also rejecting these three identifications. This leaves us with the identification of 16 stars as somewhat

certain. The values of $\lambda_2-\lambda_1$ are in three groups as follows :

	No	$\lambda_2-\lambda_1$	Average
Group 1.....	2	22° 53'	} 22° 33'
	8	22 1	
	9	22 57	
	14	22 21	
Group 2.....	1	21 16	} 20° 48'
	3	20 10	
	4	20 57	
	10	20 8	
	12	20 47	
	21	21 18	
Group 3.....	7	19 40	} 19° 9'
	18	18 58	
	20	19 14	
	22	18 34	
	27	19 21	

(N.B. In giving the *Dhruvaka* and *Vikṣepa*, the S.S. uses a unit called *Liptikā*, which means a minute of arc. This is traced to Greek "Lepton". Prof. R. V. Vaidya thinks that some of the figures for asterisms, as they are given by cryptic Sanskrit words, have not been properly interpreted).

We are not aware how the Hindu savants determined the *dhruvakas* and *vikṣepas*. It appears that they had a kind of armillary sphere with an ecliptic circle which they used to set to the ecliptic with the aid of standard stars like Puṣya (δ *Cancer*), Maghā (α *Leonis*) Citrā (α *Virginis*), Viśākhā (α *Librae*) and Śatabhiṣaj (λ *Aquarii*) and Revatī (ζ *Piscium*). They could also calculate the *dhruvaka* and *vikṣepa* of a star during the moment of its transit over the meridian of the place of observation. They calculated the *daśama lagna* (known as the tenth house in astrological parlour) for the moment of transit from tables already constructed for the latitude of the observer, and this *daśama lagna* was the required *dhruvaka* of the star. By using two big vertical poles (i.e., gnomons) situated in the north-south line, the zenith distance of the star at transit could be determined from which the declination of the star was deduced, from the relation :

$$\text{Declination} = \text{latitude of place minus zenith distance.}$$

Since $\text{Vikṣepa } (BS) = QS - QB$ i.e., declination of the star minus declination of a point B on the ecliptic [which is $\sin^{-1}(\sin l \sin \epsilon)$], the polar longitude (dhruvaka) and the declination give the *vikṣepa* which is thus :

$$\delta - \sin^{-1}(\sin l \sin \epsilon)$$

Anyhow the above analysis seems to show that the co-ordinates of stars were determined at different epochs. Firstly when Υ was respectively $22^\circ 21'$ ahead of the present Υ , secondly when it was $20^\circ 8'$ ahead, and thirdly when it was $19^\circ 21'$ ahead. The epochs come out to be 340 A.D., 500 A.D., and 560 A.D., respectively. The first epoch is nearly 200 years from the time of Ptolemy, and if it is assumed that Hindu astronomers assumed Citrā (Spica or α *Virginis*) to occupy the first point

Table 32.

Star-Positions of the Surya-Siddhanta

No.	Name of Nakṣatra	Junction-Star	Magni- tude	Celestial Longitude in 1950 λ_2	Celestial Latitude in 1950 β	Dhruvaka as in S.S. l	Vikṣepa as in S.S. d	Celestial Longitude calculated from (l, d) λ_1	Celestial Latitude calculated from (l, d) β'	$\lambda_2 - \lambda_1$	$\beta - \beta'$	Remarks
(1)	(2)	(3)	(4)	(5)	(6)	(7)	(8)	(9)	(10)	(11)	(12)	
1	Āsvini	β Arietis	2.72	33° 16'	+ 8° 29'	8° 0'	+ 10° 0'	12° 0'	+ 9° 10'	+ 21° 16'	- 0° 41'	
2	Bharanī	41 Arietis	3.68	47 30	+ 10 27	20 0	+ 12 0	24 37	+ 11 5	22 53	- 0 38	
	"	35 Arietis	4.58	46 14	+ 11 19	20 0	+ 12 0	24 37	+ 11 5	21 37	+ 0 14	
3	Kṛttikā	γ Tauri	2.96	59 18	+ 4 3	37 30	+ 5 0	39 8	+ 4 43	20 10	- 0 40	
4	Rohiṇī	α Tauri	1.06	69 5	- 5 23	49 30	- 5 0	48 8	- 4 49	20 57	- 0 39	
5	Mṛgaśiras	λ Orionis	3.70	83 1	- 13 23	63 0	- 10 0	61 2	- 9 49	21 59	- 3 34	Latitudes differ much
6	Ādrā	α Orionis	0.6 v	88 3	- 16 2	67 20	- 9 0	65 49	- 8 52	22 14	- 7 10	"
7	Punarvasu	β Geminorum	1.21	112 32	+ 6 41	93 0	+ 6 0	92 52	+ 6 0	19 40	+ 0 41	
8	Puṣya	δ Cancri	4.17	128 1	+ 0 5	106 0	0 0	106 0	0 0	22 1	+ 0 5	
9	Āśleṣā	α Cancri	4.27	132 57	- 5 5	109 0	- 7 0	110 0	- 6 56	22 57	+ 1 51	
	"	ϵ Hydræ	3.48	131 39	- 11 6	109 0	- 7 0	110 0	- 6 56	21 39	- 4 10	Latitudes differ much
10	Maghā	α Leonis	1.34	149 8	+ 0 28	129 0	0 0	129 0	0 0	20 8	+ 0 28	
11	Pūrva Phalgunī	δ Leonis	2.58	160 37	+ 14 20	144 0	+ 12 0	139 56	+ 11 18	20 41	+ 3 2	Latitudes differ much
12	Uttara Phalgunī	β Leonis	2.23	170 55	+ 12 16	155 0	+ 13 0	150 8	+ 12 4	+ 20 47	+ 0 12	

Star-Positions of the Surya-Siddhanta—contd.

No.	Name of Nakṣatra	Junction-Star	Magni- tude	Celestial Longitude in 1950 λ_2	Celestial Latitude in 1950 β	Dhruvaka as in S.S. l	Vikṣepa as in S.S. d	Celestial Longitude calculated from (l,d) λ_1	Celestial Latitude calculated from (l,d) β'	$\lambda_2 - \lambda_1$	$\beta - \beta'$	Remarks
(1)	(2)	(3)	(4)	(5)	(6)	(7)	(8)	(9)	(10)	(11)	(12)	
13	Hasta	δ Corvi	3.11	192° 45'	- 12° 11'	170° 0'	- 11° 0'	174° 24'	- 10° 6'	+18° 21'	- 2° 5'	Latitudes differ much
14	Citrā	α Virginis	1.21	203 9	- 2 3	180 0	- 2 0	180 48	- 1 50	22 21	- 0 13	
15	Svāti	α Bootis	0.24	203 32	+ 30 46	199 0	+ 37 0	182 56	+ 33 47	20 36	- 3 1	Latitudes differ much
16	Viśākhā	α Libræ	2.90	224 23	+ 0 20	213 0	- 1 30	213 31	- 1 24	10 52	+ 1 44	Identification doubtful
	"	ϵ Libræ	4.66	230 18	- 1 51	213 0	- 1 30	213 31	- 1 24	16 47	- 0 27	"
17	Anurādhā	δ Scorpii	2.54	241 52	- 1 59	224 0	- 3 0	224 54	- 2 52	16 58	+ 0 53	"
18	Jyeṣṭhā	α Scorpii	1.22	249 4	- 4 34	229 0	- 4 0	230 6	- 3 51	18 58	- 0 43	
19	Mūla	λ Scorpii	1.71	263 53	- 13 47	241 0	- 9 0	242 53	- 8 48	21 0	- 4 59	Latitudes differ much
20	Pūrvāṣādhā	δ Sagittarii	2.84	273 53	- 6 28	254 0	- 5 30	254 39	- 5 28	19 14	- 1 0	
21	Uttarāṣādhā	σ Sagittarii	2.14	281 41	- 3 27	260 0	- 5 0	260 23	- 4 59	21 18	+ 1 32	
22	Śravaṇa	α Aquariæ	0.89	301 4	+ 29 18	280 0	+ 30 0	282 30	+ 29 54	18 34	- 0 36	
23	Dhaniṣṭhā	β Delphini	3.72	315 39	+ 31 55	290 0	+ 36 0	296 8	+ 35 33	19 31	- 3 38	Latitudes differ much
24	Śatabhiṣaj	λ Aquarii	3.84	340 53	- 0 23	320 0	- 0 30	319 51	- 0 28	21 2	+ 0 5	
25	Pūrva Bhādrapadā	α Pegasi	2.57	352 47	+ 19 24	326 0	+ 24 0	334 38	+ 22 29	18 9	- 3 5	Latitudes differ much
26	Uttara Bhādrapadā	γ Pegasi	2.87	8 28	+ 12 36	337 0	+ 26 0	347 19	+ 24 0	21 9	- 11 24	"
	"	α Andromedæ	2.15	13 37	+ 25 41	337 0	+ 26 0	347 19	+ 24 0	26 18	+ 1 41	Identification doubtful
27	Revati	ζ Piscium	5.57	19 11	- 0 13	359 50	0 0	359 50	0 0	+19 21	- 0 13	

of Libra, the epoch comes out to be 285 A.D., and the corresponding Vernal point 2° to the west of Ptolemy's.

This analysis shows that the Indian astronomers had arrived at the idea that the equinoctial point should be properly located with reference to some standard stars and there were probably three attempts, one about 285 A.D., the next about 500 A.D., and the last one about 570 A.D. They had not accepted the first point given by Ptolemy or any western astronomer.

The compiler (or compilers) of the S.S. was clearly unconscious of the precession of equinoxes, and while in his report, he made a selection of these data, he did not perceive that they were inconsistent with the idea of a fixed V.E. point.

But he did not err on the fundamental point. He had clearly laid down that Meṣādi, i.e., the first point of Aries from which the year was to be started was to be identified with the vernal equinoctial point.

It is to be noticed that though the maker of the S.S. has absorbed many of the ideas from Greek astronomy including the use of technical terms like *horā*, *liptikā*, *kendra*, etc., he did not either blindly copy the Graeco-Chaldean data. From whichever source he might have got the ideas, he absorbed it correctly and made an attempt to fix up the actual V.E. point, as required in Chaldean astronomy, otherwise his zero-point would have been coincident with Ptolemy's. We have shown that whatever the Hindu zero-point of the zodiac might be, it is not coincident with that of Ptolemy.

APPENDIX 5-C

Gnomon Measurements in the Aitareya Brahmana

References to the observation of the solstice are found in very early literature as the following passage from the *Aitareya Brāhmaṇa* shows :

'They perform the *Ekaviṃśa* day, the *Viṣuvān*, in the middle of the year : by this *Ekaviṃśa* day the gods raised up the sun towards the world of heaven (the highest region of the heavens, viz., the zenith). For this reason this sun (as raised up) is (called) *Ekaviṃśa*, of this *Ekaviṃśa* sun (or the day), the ten days before are ordained for the hymns to be chanted during the day ; the ten days after are also ordained in the same way ; in the middle lies the *Ekaviṃśa* established on both sides in the *Virāj* (a period of ten days). It is certainly established in the *Virāj*. Therefore he going between (the two periods of 10 days) over these worlds, does not waver.'

'The gods were afraid of this *Āditya* (the sun) falling from this world of heaven (the highest place in the heavens) ; him with three worlds (diurnal circles) of heaven (in the heavens) from below they propped up ; the *Stomas* are the three worlds of heaven (diurnal circles in the heavens). They were also afraid of his falling away upward ; him with three worlds of heaven (diurnal circles in the heavens) from above they propped up ; the *Stomas* are the three worlds of heaven (diurnal circles in the heavens) indeed. Thus three below are the *Saptadaśas* (seventeen), three above ; in the middle is the *Ekaviṃśa* on both sides supported by *Svarasamans*. Therefore he going between these *Svarasamans* over these worlds does not waver'.

This obscure passage has been interpreted as follows by Prof. P.C. Sengupta in his *Ancient Indian Chronology*.

The Vedic year-long sacrifices were begun in the earliest times on the day following the winter solstice. Hence the *Viṣuvān* which means the middle day of the year was the summer solstice day. The above passage shows that the sun was observed by the Vedic Hindus to remain stationary i. e., without any change in the meridian zenith distance for 21 days near the summer solstice. The argument was this that if the sun remained stationary for 21 days, he must have had 10 days of northerly motion, 10 days of southerly motion, and the middle (eleventh) day was certainly the day of the summer solstice ; hence the sun going over these worlds, in the interval between the two periods of 10 days on either side, did not 'waver'. Thus from a rough observation, the Vedic Hindus could find the real day of the summer or winter solstice.

The next passage from the *Aitareya Brāhmaṇa* (not quoted) divides the *Virāj* of 10 days thus : $10=6+1+3$; the first 6 days were set apart for a *Ṣaḍaha* (six day-) period, followed by an *atirātra* or extra day and then came the three days of the three *Stomas* or *Svarasamans*. The *atirātra* days before and after the solstice day were respectively styled *Abhijit* and *Viśvajit* days. It may thus be inferred that the Vedic Hindus by more accurate observation found later on that the sun remained stationary at the summer solstice for 7 and not 21 days.

Question may now be asked how could they observe that the sun remained stationary for 21 days and not for 23, 27, 29, or 31 days. This depended on the degree of accuracy of observation possible for the Vedic Hindus by their methods of measurement. They probably observed the noon-shadow of a vertical pole.

APPENDIX 5-D

Precession of the Equinoxes amongst Indian Astronomers

On p. 226, we have given references to pre-Siddhāntic notices of the location of the vernal point in the sky. We saw that ancient Indian savants noticed its gradual shift (due to precession), but were only puzzled by the phenomenon. Let us see what was the experience of the Siddhāntic astronomers in this respect.

Dikṣit, in his *Bhāratīya Jyotiṣāstra*, has summarized the adventures of the idea of Precession of the Equinoxes amongst Indian astronomers of the Siddhānta period. The following account draws heavily on his Chap. 3 (p. 326) on *Ayana-Calana*, which literally means 'the movement of the solstitial points'. *

The 'Solstitial points' were known amongst Indians as 'Ayanas' and Siddhāntic astronomers regarded them as 'imaginary planets' as they used to do in the case of the nodes of the lunar orbit. Though the nomenclature is cumbersome, the chapter actually deals with the precession of the equinoxes, as this point is 90° behind the summer solstitial point.

Before the Siddhāntic period, the lunar calendar was of primary importance, hence the exact fixation of the vernal equinoctial point (Υ_0) was not very important. It became important from the time the Indian astronomers of the Siddhānta period first realized that Υ_0 should form the zero-point of the zodiac; and made attempts at different epochs (285 A.D.-600 A.D.) to give co-ordinates of stars (*Dhruvaka* and *Vikṣepa*) with respect to this as the initial point. Chapter VIII of modern *Sūrya-Siddhānta* gives a resume of these co-ordinates for the junction-stars of the lunar asterisms. Our analysis of these data as given in Appendix 5-B shows that these co-ordinates must have been obtained by actual observations at different epochs, and as the compiler of the *Sūrya-Siddhānta* was ignorant of the phenomenon of precession of the equinoxes, he made an uncritical selection of these data compiled at different times and included them in his Chap. VIII.

From these data, it is impossible to determine the exact location of Υ_0 at the time when the *Sūrya-Siddhānta* was compiled. So the wordy warfare between the upholders of the *Citrā-pakṣa* and the *Revatī-pakṣa* becomes meaningless as pointed out on p. 262.

* The word '*Ayana Calana*' strictly means the movement of the "Solstitial Points". Bhāskarācārya uses the word '*Sampāt-Calana*' for movement of the equinoctial points (Υ and \cap). Mathematically the two denominations are equivalent, but it has become the practice in Hindu astronomy to render the term 'Precession of the Equinoxes' by the words '*Ayana Calana*'. We shall follow this practice throughout.

The surmise that the early Siddhāntic astronomers were ignorant of the movement of the equinoxes is supported by the fact that neither of the early eminent astronomers Āryabhaṭa I (476—523 A.D.) nor Lalla (748 A.D.) whose dates are known, mention anything about precession of the equinoxes in their writings which have come down to us. If they derived their knowledge of astronomy from the West, they followed the current western practice of ignoring the precession. The astronomer Varāhamihira, who wrote about 550 A.D., and has left us a compendium of the five Siddhāntas, makes no mention of the phenomenon. This proves that the original *Sūrya Siddhānta* as known to Varāhamihira contained no reference to the movement of the equinoctial points. In his *Bṛhat Saṁhitā* as mentioned on p. 226, Varāhamihira, however, noted that the solstices were receding back, but he could not say anything about the actual nature of the precession or assign any rate to it.

But it is obvious that once the Indian astronomers recognized Υ_0 as the starting point of the zodiac, and started giving co-ordinates of stars in terms of Υ_0 as the starting point, they could not avoid noticing the movement of the equinoxes, just as it happened with Hipparchos in Greece. According to Brahmagupta (628 A.D.), the first astronomer who made a pointed reference to it was one Viṣṇu Candra, author of the *Vāsiṣṭha Siddhānta* whose date is given as ca. 578 A.D. He was supported by one Śriṣeṇa of whom only the name survives. For holding these views these astronomers were roundly abused by Brahmagupta whose views on these points appear to have been confused. But undeterred by the great prestige of Brahmagupta, later astronomers continued to make references to the movement of the equinoctial points.

We cite some examples.

Muñjāla Bhaṭa, a south Indian astronomer, wrote a treatise called *Laghumānasa* in 854 Śaka or 932 A.D. A later commentator, Muniśvara, ascribes the following verses to him.

Uttarato yāmyadiśāṁ yāmyāntāttadanu
saumyadigbhāgaṁ
parisaratāṁ gaganasadāṁ calanāṁ kiñcid bhaved
dapame. 1.

Viṣṇuvadapakramamaṇḍala-saṁpāte prāci meṣādiḥ
paścāttulādiranayo-rapakramāsaṁbhavaḥ proktaḥ. 2.

Rāsitrayāntaresmāt karkādiranukramānṛgādiśca
tatra ca paramā krāntirjinabhāgamitātha tatraiva. 3.

Nirdiṣṭo-yanasandhiścalanāṁ tatraiva saṁbhavati
tadbhagaṇāḥ kalpe syu-go-rasa-rasago-ṅka-candra
mitāḥ. 4.

Translation

1. While the celestial bodies move in the sky from north to south and again from south to north, a very small variation takes place in their declination.

2. The (ascending) node in which the celestial equator and the ecliptic intersect is the first point of Aries (*Meṣṛīdi*), and it gives the 'East'. The second node is the first point of Libra (*Tulāṅgi*), and these two points never change their declination value (which is zero).

3. The first point of Cancer (*Karkādi*) is at a distance of three signs (i.e. 90°) from it, and at a distance of three signs in the reverse order is the position of the first point of Capricorn (*Makarāṅgi*). These give the positions of maximum declination which is 24 degrees.

4. The solstitial points (which mark the *ayanas*) show a movement, and the number of their revolutions in a *Kalpa* is counted as 199669.

The last passage recognizes precessional motion, says that it is continuous, and gives the rate as 59".9 per year. Muñjāla Bhaṭṭa makes no mention of trepidation. He noticed that the *Ayanas* had precessed by about 6° from the position given in the *Sūrya-Siddhānta*.

Pr̥thūdaka Svāmī (born 928 A.D.), an astronomer who observed at Peihowa, near Kurukṣetra, commenting on a passage of Brahmagupta says :

"The revolution of *Ayana* in one *Kalpa* is 189411.
This is called the *Ayana Yuga*".

This passage recognizes the continuous nature of precessional motion, and gives the rate of precessional motion as 56".82 seconds per year.

So far we have no mention of the 'Theory of Trepidation.' This is first mentioned in the *Ārya Siddhānta*, ascribed to Āryabhaṭṭa II, whose date is 1028 A.D. It says :

*Ayanagrahadolḥ krāntijyācāpaṁ kendravat dhanarṇaṁ syāt
Ayanalavāstat saṁskṛta khetādayana carāpamalagnāni. 12.*

Translation :—Find the sine declination (*krāntijyā*) of the *ayanagraha* (in a way similar to that of the sun's declination) ; from it deduce the amount of declination, plus (north) or minus (south), which is the amount of *ayanāṁśa*.* After applying this *ayanāṁśa*-correction to the planet, the values of *cara* (half the difference between the lengths of day and night), declination of planets, *lagna* (the orient ecliptic point), etc., are to be calculated.

This has been interpreted as follows (Dikṣit, p.330).

The equinox oscillates between $\pm 24^\circ$, and the number of revolutions of the *Ayana*-planet in a *Kalpa* is 578159, which gives the period of revolution as 7472 years and the annual rate of motion as 173".4. During a quarter period *viz.*, 1868 years, the *ayanāṁśa* increases from 0° to 24°, at first, rapidly, then gradually more slowly like the increase of

* This is a technical term used by Indian astronomers to denote the distance of the vernal point from the fixed Hindu Zodiac.

declination of the sun. Thereafter it diminishes in like manner and after the lapse of 3736 years, i.e. the half period, it again becomes zero and goes on the other side. The annual rate of motion, which on the average amounts to 46".3 seconds, varies from $\pm 70''5$ to 0"

We now come to a very controversial passage in the modern *Sūrya Siddhānta*, Chap. III, verses 9 to 12. These are :

Triṁśat kṛtyo yuge bhānāṁ cakraṁ prāk parilamvate
tadgunād bhūdinairbhaktāt dyugaṇāt yadabāpyate. 9
Taddostrighnā daśāptāṁśā vijñeyā ayanābhidhāḥ
tatsaṁskṛtādgrahāt krānticchāyā caradalādikāṁ
sphutaṁ dṛktulyatāṁ gacchedayane viṣuvadvaye. 10
Prāk cakraṁ calitāṁ hīne chāyārkāt karaṇāgate
antarāṁśai rathāvṛtya paścāccheṣaistathādihike. 11
Evaṁ viṣuvaticchāyā svadeśe yā dinārdhajā
dakṣinottara rekhāyāṁ sā tatra viṣuvat prabhā. 12

Translation

9. In an Age (*yuga*), the circle of the asterisms (*bha*) falls back eastward thirty score of revolutions. Of the result obtained after multiplying the sum of days (*dyugaṇa*) by this number, and dividing by the number of natural days in an Age,

10. Take the part which determines the sine, multiply it by three, and divide by ten ; thus are found the degrees called those of the precession (*ayana*). From the longitude of a planet as corrected by these are to be calculated the declination, shadow, ascensional difference (*caradala*) etc.

11. The circle, as thus corrected, accords with its observed place at the solstice (*ayana*) and at either equinox ; it has moved eastward, when the longitude of the sun, as obtained by calculation, is less than that derived from the shadow.

12. By the number of degrees of the difference ; then, turning back, it has moved westward by the amount of difference, when calculated longitude is greater.

These verses occur in the chapter on astronomical measurements by the gnomon, and are misfits there ; according to all authorities, these verses did not exist in the original *Sūrya-Siddhānta*, but have been extrapolated there, and have no reference to the context of the chapter. The extrapolation must, however, have taken place before the time of Bhāskara-cārya II (1114-1178 A.D.), because he comments on this passage.

The passage supports the theory of trepidation and says that the amplitude of precessional oscillation is 27° and the period of one complete oscillation is stated to be 7200 years. The rate of precession is given as 54" per year, which is uniform and the same throughout the oscillation. These stanzas are quoted by Indian astrologers who are advocates of the *nirayana* system, in support of their arguments for sticking to the sidereal year. They say that the present *ayanāṁśa* is about 22°, and Υ will go on precessing for another 350 years till *ayanāṁśa* becomes 27° and will then turn back on its return journey.

This is sufficient argument to them to turn down all proposals for *Sāyana* reckoning taking the length of the year to be tropical.

We now take the opinion of the last great Indian astronomer Bhāskarācārya II (1150 A.D.).

He uses the term '*Sampāt-Calana*' i.e., movement of the intersection of the ecliptic and the equator, instead of the classical term *Ayana*. He says :

*Siddhānta Śiromani, Goladhāyāya,
Golabandhādihikāra*

Tasya [viṣuvatkrāntivalayapātasya] apī calanamasti.
Ye'ayanacalana bhāgāḥ prasiddhāsta eva vilomagasya
krāntipātasya bhāgāḥ

Translation :—It (the equinox) has also movement. What is commonly known as the amount of precession (*ayanāṁśa*) is the same as the longitude of the equinoctial point measured backwards.

This evidently shows that he regarded the change as due to the retrograde motion of the *node* (i.e. equinoctial point) like modern European astronomers.

He criticises Brahmagupta for his views on *Ayana Calana* and says : "One can observe that at the time of Brahmagupta, the *ayanāṁśa* value was very small and hence it is likely that it could not have come to his notice ; yet how is it that he did not take the rate of revolution of equinoxes as given by the *Sūrya-Siddhānta*, just as he has taken figures for rates in some other cases on the basis (or authority) of already proved and accepted rates".

He further says :

Ayanacalanam yaduktam Muñjalādyaḥ sa evāyam
(krāntipātāḥ)
tatpakṣe tadbhaganāḥ kalpe go'ngartu-nanda-go-candrāḥ
(199669).

Atha ca ye vā te vā bhaganāḥ bhavantu yadā ye'ṁśā
nipuṇairupa labhyante tadā sa eva krāntipātāḥ.

Translation :—"What Muñjāla and others have mentioned as '*Ayana Calana*', is nothing but the motion of this equinoctial point. According to their view the number of revolution in a *Kalpa* is 199669 (yielding annual rate of 59".9). Let whatsoever be the number of revolutions, whatever amount is obtained by expert observers is the angle of precession for that time."

From this it is clear that he recommends one to accept the *ayanāṁśa* which one would actually get by observation of sun's place at any particular time. Dikṣit says :

I have not come across single statement in which Bhāskarācārya has clearly said that equinoctial point makes a complete "circular revolution", nor does he say that "it does not make it".

He has taken 1 minute per year as the *ayana*-motion and has supposed 11° as the *ayanāṁśa* in Śaka 1105. He thus means to take Śaka 445 as the zero-precession year.

We thus perceive that Indian astronomers up to the time of Bhāskarācārya were as much divided in their ideas about precession of the equinoxes as the contemporary Arab astronomers of the West (Hispano-Muslim), and the East. It is only after 1024 A.D. that they adopted a theory of trepidation. The earlier-astronomers like Muñjāla and Pṛthūdaka merely *noticed precession* and gave their own rates for it. Bhāskarācārya is non-committal about trepidation. The Indian astronomers do not appear to have been influenced by the views of the western astronomers, the earlier Greeks or later Arabs.

It will be *sheer stupidity* to hold to the theory of trepidation of equinoxes 270 years after it has been definitely proved to be wrong. The law of universal gravitation will not be changed by God Almighty to oblige astrologers.

APPENDIX 5-E

The Jovian Years

(*Bārhaspatya Varṣa*)

The sidereal period of Jupiter, according to the *Sūrya Siddhānta* is 4332.32 days which is nearly 11.86 sidereal years. Therefore Jupiter roughly stays for one year in one zodiacal sign, if we calculate by mean motion.

This was taken advantage of to devise a cycle of 12 Jovian years. If we divide the *Sūrya-Siddhānta* period by 12, we get 361.026721 days which is taken as the length of a Jovian year. This is 4.232 days less than the *Sūrya Siddhānta* solar year. So if a Jovian year and an ordinary solar year begin on the same day, the Jovian year will begin to fall back, completing a complete retrogression in $85\frac{65}{211}$ solar years, according to the *Sūrya-Siddhānta*.

So $85\frac{65}{211}$ solar years = $86\frac{65}{211}$ Jovian years, and one Jovian year is expunged in every $85\frac{65}{211}$ years. The expunged year

is called the *Kṣaya* year. In actual practice, the interval between two expunctions is sometimes 85 and sometimes 86 years.

There was indeed at one time a period of 12 Jovian years, but at some past epoch, a fivefold multiple, a cycle of 60 Jovian years, each with a special name suffixed by the word 'Saṁvatsara', came into use.

The beginning of the Jovian years is determined by the entry of Jupiter into an Indian sign by mean motion, the 1st, 13th, 25th, 37th and 49th years being marked by the entry of Jupiter into the sign *Kumbha*, and not *Meṣa* which is otherwise the first of the signs of the *Siddhāntas*. It thus appears that the system of counting Jovian years is a pre-Siddhāntic practice.

The sixty-year cycle is at present in daily use in Southern India (south of Narmada) where each year (the solar year or the luni-solar year) is named after that of the corresponding Jovian year. The years are counted there in regular succession and no *saṁvatsara* is expunged. This practice is being followed since about 905-06 A.D. (827 Śaka), as a result of which the number of North-Indian *Saṁvatsara* has been gradually gaining over that of the South from that time. The Śaka year 1876 (1954-55 A.D.) is named 41 *Plavaṅga* in the North while in the South it is 28 *Jaya*.

The following are the names of the different years :

(1) Prabhava	(21) Sarvajit	(41) Plavaṅga
(2) Vibhava	(22) Sarvadhārin	(42) Kilaka
(3) Śukla	(23) Virodhin	(43) Saumya
(4) Pramoda	(24) Vikṛta	(44) Sādhāraṇa
(5) Prajāpati	(25) Khara	(45) Virodhakṛt
(6) Aṅgiras	(26) Nandana	(46) Paridhāvin
(7) Śrimukha	(27) Vijaya	(47) Pramādin
(8) Bhāva	(28) Jaya	(48) Ānanda
(9) Yuvan	(29) Manmatha	(49) Rākṣasa
(10) Dhātri	(30) Durmukha	(50) Anala (Nala)
(11) Īśvara	(31) Hemalamba	(51) Piṅgala
(12) Bahudhānya	(32) Vilamba	(52) Kālayukta
(13) Pramāthin	(33) Vikārin	(53) Siddhārthin
(14) Vikrama	(34) Śarvarī	(54) Raudra
(15) Vṛṣa	(35) Plava	(55) Durmati
(16) Chitrabhānu	(36) Subhakṛt	(56) Dundubhi
(17) Subhānu	(37) Śobhana	(57) Rudhīrodgārin
(18) Tāraṇa	(38) Krodhin	(58) Raktākṣa
(19) Pārthiva	(39) Viśvāvasu	(59) Krodhana
(20) Vyaya	(40) Parābhava	(60) Kṣaya (Akṣaya)

CORRIGENDA AND ADDENDA

Part A

- Page 2, 1st col. line 36, *For C § 4'10, read C § 4'9*
 Page 3, 2nd col. line 46, *For happend, read happened*
 Page 4, 1st col. line 12, *For was, read were*
 Page 21, 2nd col. No. 35, *Insert Ceylon after Chavakachcheri*

Part B

Śaka 1877

- Page 56, Āṣāḍha 9—*For Ravinārāyaṇa ekādaśī, read Lakṣminārāyaṇa ekādaśī*
 Page 57, Śrāvaṇa 1—*Insert Jāgratgaurī pañcamī.*
 " 2—*Delete Jāgratgaurī pañcamī.*
 Page 58, Bhādra 25—*Insert Rudravrata.*
 " 26—*Delete Rudravrata.*
 " 29—*Insert Ṛṣi pañcamī (Orissa)*
 " 30—*Delete Guru pañcamī (Orissa)*
 Page 60, Kārtika 5—*Insert Lakṣminārāyaṇa ekādaśī (Orissa)*
 " 8—*Insert Kumāra pūrṇimā (Orissa)*
 " 9—*Delete Kumāra pūrṇimā (Orissa)*
 " 23—*Insert Balipūjā*
 Page 61, Agrah. 2—*Insert Anlā navamī (Orissa)*
 " 3—*Delete Anlā navamī (Orissa)*
 " 7—*Delete "& Orissa" from Pāṣāna caturdaśī (Bengal & Orissa)*
 " 22—*Insert Dipāvalī amāvasyā (Orissa)*
 " 23—*Delete Dipāvalī amāvasyā (Orissa)*
 Page 62, Pauṣa 4—*Insert Ravinārāyaṇa ekādaśī (Orissa)*
 " 6—*Insert Pāṣāna caturdaśī (Orissa)*
 " 19—*Delete Surūpā dvādaśī (Orissa)*
 " 23—*Delete Guru pañcamī (Orissa)*
 Page 63, Māgha 27—*Insert Guru pañcamī (Orissa)*
 Page 64, Phālguna 3—*Delete Lakṣminārāyaṇa ekādaśī (Orissa)*
 " 26—*Delete (Orissa) from Śānta caturthī (Orissa)*

Śaka 1878

- Page 65, Caitra 1—*Delete "& Sudaśa vrata"*
 " 2—*Insert Lakṣminārāyaṇa ekādaśī (Orissa)*
 Page 66, Vaiśākha 1—*Delete Ravinārāyaṇa ekādaśī (Orissa)*
 " 10—*ending moment of nakṣatra : 19 Mula —For 7^u 1^m read 7^h 31^m (in some books).*
 " 30—*For Lakṣminārāyaṇa ekādaśī (Orissa) read Ravinārāyaṇa ekādaśī (Orissa)*
 Page 68, Āṣāḍha 21—*Insert Guru pañcamī (Orissa)*
 " 27—*Delete Ravinārāyaṇa ekādaśī (Orissa)*
 Page 69, Śrāvaṇa 17—*Insert Madhuśravā (Gujerat)*
 " 18—*Delete Madhuśravā (Gujerat)*

Śaka 1878—cont.

- Page 70, Bhādra 18—*Delete Guru pañcamī (Orissa)*
 " 20—*Insert Durgāsayanī (Orissa)*
 " 21—*Delete Durgāsayanī (Orissa)*
 " 24—*Delete Lakṣminārāyaṇa ekādaśī (Orissa)*
 Page 72, Kārtika 20—*Insert Anlā navamī (Orissa)*
 " 21—*Delete Anlā navamī (Orissa)*
 " 25—*Delete "& Orissa" from "Pāṣāna caturdaśī (Bengal & Orissa)"*
 Page 73, Agrah. 10—*Insert Dipāvalī amāvasyā (Orissa)*
 " 11—*Delete Dipāvalī amāvasyā (Orissa) and Insert Rudropavāsa*
 " 12—*Delete Rudropavāsa*
 " 25—*Insert Pāṣāna caturdaśī (Orissa)*
 Page 74, Pauṣa 7—*Delete Surūpā dvādaśī (Orissa)*
 " 16—*Delete Guru pañcamī (Orissa)*

Śaka 1879

- Page 77, Caitra 21—*Delete Viṣṇu damanotsava*
 " 22—*Insert Viṣṇu damanotsava*
 " 24—*Delete Paṅguni uttiram—pūrṇima canon (S. India)*
 Page 88, Phālguna 18—*Insert Raṅgapañcamī*
 " 19—*Delete Raṅgapañcamī*

Śaka 1880

- Page 94, Bhādra 6—*Insert Balabhadra pūjā (Orissa)*
 " 7—*Delete Balabhadra pūjā (Orissa)*
 " 25—*Insert Haritālī caturthī*
 Page 97, Agrah. 3—*Delete "& Orissa" from Pāṣāna caturdaśī (Bengal & Orissa)"*
 Page 98, Pauṣa 3—*Insert Pāṣāna caturdaśī (Orissa)*
 Page 100, Phālguna 22—*Delete "(Orissa)" from "Śānta caturthī (Orissa)"*
 " 29—*Delete "& Sudaśa vrata"*
 Page 101, line 5, *Insert "Gādhara-Paddhati" after Tithitvatam.*

Lunar Festivals

- Page 102, Caitra S 14—*For Madanabhañjī (Bengal & Orissa) (Paraviddhā), read Madanabhañjī (Bengal—paraviddhā & Orissa—pūrvaviddhā)*
 " Vaiśākha S 11—*Delete Lakṣminārāyaṇa ekādaśī (Orissa)*
 " Jyaiṣṭha S 11—*Delete Rukmiṇī vivāha (Orissa)*
 " Āṣāḍha S 11—*Delete Ravinārāyaṇa ekādaśī (Orissa)*
 Page 103, Śrāvaṇa K 5—*Insert 'and rātrivyāpini' after pūrvaviddhā*
 " Bhādra S 5—*Delete Guru pañcamī (Orissa)*

Part C

- Page 157, 1st col. line 39, *For mew-moon read new-moon*
 Page 191, 2nd col. line 17-18, *For "the angle varies from 21°59' to 24°36'," read "the angle varies from 22°35' to 24°13'."*
 Page 201, 2nd col. line 19, *For necessary, read necessary*

BIBLIOGRAPHY

- Achelis, Elisabeth (1955)—Of Time and the Calendar, New York.
- Alter, D. & Cleminshaw, C. H. (1952)—Pictorial Astronomy, New York.
- Āryabhaṭīya* of Āryabhata—translated with notes by W. E. Clark, Chicago, 1930.
- American Ephemeris & Nautical Almanac* for the years 1954 and 1955.
- Bachhofer, Dr. L. (1936)—Herrscher and Munzen in spatien Kushanas, *Journal of American Oriental Society*, Vol. 56.
- (1941) On Greeks and Śakas in India, *Journal of American Oriental Society*, Vol. 61, p. 223.
- Basak, Dr. Radhagovinda (1950)—Kauṭīliya Arthaśāstra, Bengali translation, Calcutta.
- Bhandarkar (1927-34)—Inscriptions of Northern India, Appendix to *Epigraphia Indica*, Vols. XIX-XXII.
- Brennand, W. (1896)—Hindu Astronomy.
- Burgess, Rev. E. (1935)—The Sūrya-Siddhānta, English translation, with an introduction by P. C. Sengupta (Republished by the Calcutta University).
- Clark, Walter Eugene (1930)—The Āryabhaṭīya of Āryabhata, English translation with notes, Chicago.
- Couderc, Paul (1948)—Le Calendrier, France.
- Cunningham, Alexander (1883)—Book of Indian Eras with tables for calculating Indian dates, Calcutta.
- Debevoise (1938)—Political History of Parthia.
- Deydier (1951)—Le date de Kaniska etc. *Journal Asiatique*, Vol. 239.
- Dīgha Nikāya* (1890), Vol. I, Pali Text Book Society.
- Dikṣit, S. B. (1896)—Bhāratīya Jyotiśāstra (in Mārāthi).
- Discovery* (1953), Vol. XIV, p. 276, Norwich (Eng.).
- Dreyer, J.L.E. (1953)—A History of Astronomy from Thales to Kepler, Dover Publications, Inc.
- Dvivedi, Sudhākara (1925)—The Sūrya Siddhānta, translation under his editorship, Asiatic Society of Bengal, Cal.
- Encyclopaedia Britannica* (14th edition)—Articles on Chronology, Calendar and Easter.
- Encyclopaedia of Religion & Ethics*—Vols. I, II & III, New York (1911),—Articles on Calendar and Festivals.
- Epigraphia Indica*, Vol. XXVII.
- Flammarion, C. & Gore, J. E. (1907)—Popular Astronomy, London.
- Fotheringham, Dr. J. K. (1935)—The Calendar, article published in the *Nautical Almanac*, London 1935.
- Ginzler, F. K. (1906)—Handbuch der Mathematischen und Technischen Chronologie, Bd. I, Leipzig.
- Haug, Dr. Martin—Aitareya Brāhmaṇa of the Rig-Veda.
- Herzfeld (1932)—Śakasthan, *Archaeologische Mitteilungen aus Iran*.
- Jacobi, Prof. Hermann (1892)—The computation of Hindu dates in inscriptions, *Eph. Ind.* Vol. I, p. 403.
- Jones, Sir H. Spencer (1934, 1955)—General Astronomy, London.
- (1952)—Calendar, Past, Present & Future—a lecture delivered at the Royal Society of Arts, London, 1952.
- (1937)—The measurement of time, published in the Reports on Progress in Physics, Vol. IV, London.
- Journal of Calendar Reform*, New York.
- Keith, Dr. Berriedale—The Veda of the Black Yajur School entitled Taittirīya Saṁhitā, Part. 2.
- Khaṇḍakhādya* of Brahmagupta—Edited with an introduction by Babua Misra—translated by P. C. Sengupta (1934), Calcutta University, 1934.
- Konow, Dr. Sten (1929)—Corpus Inscriptionum Indicarum, Vol. II, Karoṣṭhī Inscriptions.
- Krogdhal, Wasleg. S.—The Astronomical Universe, U. S. A.
- Lahiri, N. C. (1952)—Tables of the Sun, Calcutta.
- Lüders (1909-10)—A list of Brāhmī Inscriptions from the earliest times to 400 A.D. Appendix to *Epigraphia Indica*, Vol. X. (The references are given, e.g., Lüders 942, which means inscription No. 942 of Lüders).
- Majumder, N. G. (1929)—Inscriptions of Bengal, Rajshahi, Bengal.
- Majumder, R. C. (1943)—The History of Bengal, Vol. I. Dacca University.
- Nautical Almanac* (British) for the years 1935 & 1954 to 1956.
- Neugebauer, O. (1952)—The Exact Sciences in Antiquity, Princeton, New Jersey.
- (1954) Babylonian Planetary Theory, *Proceedings of the American Philosophical Society*, Vol. 98. No. 1, 1954
- Newcomb, Simon (1906)—A Compendium of Spherical Astronomy, New York.
- Norton, Arthur P. (1950)—A Star Atlas, London.
- Pannekoek, Antone (1916)—Calculation of Dates in Babylonian Tables of Planets, *Proc. Roy. Soc. Amst.* I, 1916, 684.
- (1951)—The Origin of Astronomy, *M. N. R. A. S.* Vol. III, No. 4, 1951.
- (1930)—Astrology and its influence upon the development of Astronomy—*Jr.R. A. S. of Canada*, April, 1930.

- Panth, B. D. (1944)—Consider the Calendar, New York.
- Pillai, L. D. Swamikannu (1922)—An Indian Ephemeris, Vol. I, Suptd. Govt. Press, Madras.
- Rapson (1922)—The Cambridge History of India, Vol. I, Ancient India.
- Ray Chowdhury, H. C. (1933)—Political History of Ancient India, 5th edition, Calcutta University.
- Roy, J. C. (1903)—Āmāder Jyotiṣa O Jyotiṣī (Bengali). Calcutta.
- Rufus, W. Carl (1942)—How to meet the fifth column in Astronomy, *Sky & Telescope*, Jan, 1942, Vol. I, No. 3.
- Russell, H. N., Dugan, R. S., & Stewart, J. Q. (1945)—Astronomy, 2 Vols, U. S. A.
- Sachau, Edward C. (1910)—Alberuni's India, English translation in 2 Vols., London.
- Sachs, A. (1952)—Babylonian Horoscopes,—Reprinted from the *Journal of Cuneiform Studies*, Vol. VI, No. 2.
- Saha, M. N. (1952)—Reform of the Indian Calendar, *Science & Culture*, Vol. 18, 1952.
- (1952)—Calendar through Ages and Countries, Lecture delivered at the Andhra University, 1952.
- (1953)—Different methods of Date recording in Ancient and Medieval India and the origin of the Śaka era—*Journal of the Asiatic Society*, Letters, Vol. XIX, No. 1, 1953.
- Sarton, George (1953)—A History of Science, Oxford University Press, London.
- Introduction to the History of Science, Vol. III.
- Schmidt, Olaf (1951)—On the Computation of the Ahargaṇa, *Centaurus*, September, 1952, 2. Copenhagen.
- Scientific American*, 188, 6-25, 1953, New York.
- Sen, Sukumar (1941)—Old Persian Inscriptions of the Achemenian Emperors, Calcutta University.
- Sengupta, P. C. (1947)—Ancient Indian Chronology, Calcutta University.
- Articles published in the *Śrī Bhāratī* (Bengali)
- (1925)—Khaṇḍakhādyaka of Brahmagupta edited with an introduction, Calcutta University.
- Sewell, R. S. (1924)—The Siddhāntas and the Indian Calendar.
- (1912)—The Indian Chronography
- Sewell, R. S. & Dikṣit, S. B. (1896)—The Indian Calendar, London.
- Shamasastry, R. (1936)—Vedāṅga Jyautiṣha—edited with English translation & Sanskrit commentary, Mysore.
- Sirkar, D. C. (1942)—Select inscriptions bearing on Indian history and civilization, Calcutta University.
- Sky & Telescope*, Vol. I, 1942 & Vol. XII, 1953, Cambridge, Mass., U. S. A.
- Smṛtitīrtha, Pt. Radhavallabha—Siddhānta Śiromaṇi of Bhāskarācārya—Bengali translation in 2 Vols. Calcutta.
- Svāmī, Vījñānānanda (1909)—Sūrya Siddhānta, Bengali translation with notes, Calcutta.
- Thibaut, G. (1889)—The Pañca Siddhāntikā—the Astronomical works of Varāhamihira, edited by G. Thibaut & Mm. Sudhakara Dvivedi, Banaras.
- Tilak, B. G. (1893)—Orion or Researches into the Antiquity of the Vedas, Poona.
- Universal History of the World, Vols. I & II, edited by J. H. Hammerton, London.
- Van der Waerden—Science Awakening.
- Van Lohuizen de Leeuw (1949)—The Scythian Period, Leiden, (shortly called L. de. Leeuw or Leeuw with page following).
- Varāhamihira—Bṛhat Saṁhitā, Bengali translation by Pt. Pañcānana Tarkaratna (1910), Calcutta.
- Pañca Siddhāntikā—edited by G. Thibaut & Mm. Sudhakara Dvivedi, Banaras, 1889.
- Watkins, Harold (1954)—Time Counts, London.
- Webster, A. G.—Dynamics of Particles and of Rigid Elastic & Fluid bodies.
- Winternitz—History of Indian Literature, Vol. I, Calcutta University.
- Woolard, Edgar W. (1942)—The Era of Nabonassar, article published in the *Sky & Telescope*, Vol. I, No. 6, April, 1942.
- Yampolsky, Philip (1950)—The Origin of the Twenty-eight Lunar mansions, published in *Osiris*, Vol. IX, 1950.
- Zinner, Dr. Ernest (1931)—Die Geschichte der Sternkunde, Berlin.

INDEX

- Abbe Mastrofini, 171
 Abd al-Rahamān al-Šūfi, 206
 Achelis, Miss Elisabeth, 12, 171
 Adar, 179
 Addaru, 175, 176
 Adhika (= mala) month, 7, 247, 250
 Agni, 216
 Ahargana, 9, 11, 161, 162, 163
 Ahorātra, 157, 160
Aitareya Brāhmaṇa, 189, 216, 219, 221, 266
 Akber, 1, 159, 214, 251
 Akṣaya tṛtīyā, 18, 19
 Al-Battānī, 204, 206, 240 ;
 rate of precession, 206
 Alberuni, 198, 204, 237 ;
 Al-Bitruji, 206
 Alexander of Macedon, 202, 213, 234, 235
 Āl-Farghānī, 206
Almagest, 204, 206, 238, 240
 Aloysius Lilius, 171
 Altekar, Prof., 254.
 Al-Zarquali, 206
 Amānta month, 101, 157, 177, 247
 Ammonia clock, 12, 159
 Anaximander of Miletus, 188, 202 ;
 gnomon, 202
Ancient Indian Chronology, 215, 253, 266
 Andau (inscription), 233
 Antiochus Sorter, 203
 Antiochus I, II of Babylon, 228
 Anubis, Egyptian god, 164
 Anuvatsara, 225
 Anyanka Bhīma Deva of Gaṅgā dynasty, 257
 Aparāhna, 108
Āpastamba Saṃhitā, 218
 Aphelion, 242 ; movement of, 243
 Apollonius of Perga, 203
 Ārā (inscription), 230
 Arachosia, 229, 230
 Āraṇyaka, 214
 Archebius of Taxila, 230
 Archimedes of Syracuse, 203
 Archytas of Tarentum, 202
 Ardeshir I of Persia, 232
 Ārdharātriḱa system, 1, 253, 254
 Ariana, Herat regions, 229
 Aries (zodiacal sign), 192, 193
 Aries, first point of, 157, 192, 199, 207, 239, 240, 262, 268 ;
 Hipparcho's, 200, 205, 206 ;
 movement of 200, 205, 206 ;
 position in different times, 200 (fig).
 Ptolemy's, 200
 Aristarchos of Samos, 203
 Armellini, 171
 Armillary sphere, 199 (fig.), 263
 Arsaces of Parthia, 178
 Artabanus I of Parthia, 213
 Artabanus II of Parthia, 256
 Artemidorus of Puṣkalāvati, 230
Arthasāstra of Kautilya, 235, 236
 Aruṇodaya, 108
 Āryabhaṭa I, 204, 234, 236, 237, 238, 240, 252, 253, 254, 267
 Āryabhaṭa II, 238, 268
Āryabhaṭīya of Āryabhaṭa, 162, 238, 253
 Āryā Saṅgamikā, 232
Ārya Siddhānta, 1, 214, 251, 268
 Āryā Vasulā, 232
 Aśokachalla Deva, 256
 Aśoke, 177, 212, 227, 228, 252
 Assouan papyri, 179
Āstādhyāyī, 214
 Astrolatry, 235, 236
 Astrology, 12, 194, 196, 205, 206, 235, 236, 256
Atharva Saṃhitā, 217, 218
Atharva Veda, 214, 217, 218
 Audaṃyika system, 254
 August Comte, French positivist philosopher, 171
 Augustus, 168
 Ayanāṃśa, 5, 7, 16, 17, 20, 268, 269 ;
 amount of acc. to Āryabhaṭa II, 268
 amount of fixed, 16, 17
 (see also calendar for five years)
 definition, 268
 rate of, 7
 rate of Bhāskarācārya, 269
 value of, 7, 17
 Ayanas, 267, 268, 269
 Azes, 256
 Azes I, 230, 233, 256
 Azes II, 230, 233, 256
 Azilises, 230, 233
 Babylon, 225, 226, 228 ; latitude of, 225
 Bachhofer, Dr. L., 230, 231, 232
 Bādāmi (inscription), 233, 253
 Bailey, 253
 Balarāma, 227
 Banerjee, late R. D., 212
 Bentley, 253
 Berossus, Chaldean priest, 203
Bhāratiya Jyotiṣāstra, 11, 160, 219, 225, 236, 267
 Bhāskarācārya, 238, 246, 262, 267, 268, 269 ;
 ayana calana, 269
Bhāskari, 160
 Bhaṭṭotpala, 237
 Bhoga (celestial longitude), 262
 Bija (correction), 3
 Box lid (inscription), 230
 Brahmā, Creator in Hindu mythology, 223, 236, 238, 239, 240
 Brahmagupta, 223, 237, 238, 240, 253, 267, 268, 269
Brahma Siddhānta, 1, 214
Brāhmaṇas, 193, 214, 221, 241, 245
 Brāhmī, 227, 229, 231, 232, 233
Bṛhat Saṃhitā, 226, 267
 Brown, 193
 Buddha, 231, 235 ;
 nirvāṇa of, 256, 257
 views on astrology, 235
 Budhagupta, Gupta emperor, 234
 Burgess, Rev. E., 238, 253, 262, 263
 Calendar, defined, 1, 157 ;
 civil, 6 ;
 compilation according to S. S., 1 ;
 confusion in Indian, 10 ;
 Egyptian, 164 ;
 French revolution, 167 ;
 Fusli, 248 ;
 Gregorian, 1, 3, 11, 170-172 ;
 Hejira, 1, 166, 179, 180, 214 ;
 history of reform movement, 10, 11 ;
 Iranian (Jelali) 1, 166, 167 ;
 Islamic, 179, 180 ;
 Jewish 179 ;
 lunar, 3, 179, 245, 247 ;
 luni solar, 1, 3, 174, 249, 251 ;
 calendar in Siddhāntas 245-251 ;
 of Babylonians, Macedonians, Roman
 and the Jews, 176, 177 ;
 principles of 174 ;
 Siddhāntic rules for 247 ;
 National, 12-14 ;
 Paitāmaha Siddhānta, 223 ;
 problems of the, 158, 159 ;
 Reformed, 4 ;
 Religious 7 ;
 Roman, 168 ;
 Seleucid Babylonian, 229 ;
 Siddhānta Jyotiṣa period, 245, 246
 Solar, 1, 2, 164-173, 245 ;
 Siddhānta Jyotiṣa period, 234-245
 Tārikh-i-Jelali, 166, 167 ;
 Tārikh-Ilāhi, 1, 214, 251, 257, 258 ;
 Vedāṅga Jyotiṣa, 9, 221, 222, 223 ;
 World, 1, 171-173
 Calendar of India, Reformed (as recommended by the Committee), 41-100 ;
 explanation of terms used, 40
 Calendar Reform,
 suggestion received, 5 ;
 summary of suggestions, 32-38
 Cālikya Vallabhesvara, 233
 Caliph Omar, 167, 179
 Calippos, length of season, 175, 261
 Cānakya, 213, 235, 236
 Cancer, first point of, 192, 199
 Candragupta, Maurya, 213, 236, 257
 Candragupta II, Vikramāditya, 254, 255
 Capricorn, first point of, 192

- Cara, correction, 268
 Cardinal days, 189
 Cardinal points, 189, 190, 219 ;
 determination of, 190
 Caṣṭana, Śaka Satrap, 233, 256
Centaurus, 163
 Central Station, 3, 4, 7, 14, 40
 Chadwick, 202
 Chaldean Saros, 184, 185, 186, 202
 Christ, Jesus, 157, 201
 Chronometer, 157
 Cicero, 205
 Cleostratos of Tenedos, 193, 202 ;
 zodiac, 193, 202 ;
 8-year cycle of intercalation, 202
 Clepsydra, 159, 223, 225
 Committee, Indian Calendar Reform—
 appointment of, 4 ;
 dissenting note, 8, 18 ;
 final recommendations of civil, 6, 7 ;
 final recommendations of religious, 7, 8 ;
 members of, 4 ;
 proceedings of the first meeting, 9 ;
 proceedings of the second meeting, 15 ;
 proceedings of the third meeting, 17 ;
 terms of reference, 4
 Committee, Indian Ephemeris and Nautical
 Almanac, 8
 Committee meetings, 4, 5 ; resolutions of 4, 5
 Compline (division of day), 159
 Constantine, Roman emperor, 170
 Co-ordinate, celestial. Siddhāntic designation
 of, 262
 Copernicus, 195, 203, 206, 235
Corpus-Inscriptionum Indicarum, 229
 Cūḍāmaṇi yoga, 108
 Cunningham, 230, 231
 Cycle of Indiction, 162
- Dakṣiṇāyana, 189, 219, 226, 239, 260
 Daṇḍa (= nāḍi or ghaṭikā), 160
 Darius I, Acheinenid emperor, 166, 176, 212,
 256
 Day,
 apparent length of, 226 ;
 astronomical, 159 ;
 civil, 159 ;
 counting of the
 succession of, 248 ;
 definition of, 157, 217 ;
 designation in ancient
 time, 183 ;
 division among Egyptians, 160 ;
 division among Hindus, 160 ;
 Julian, 161, 162 ;
 length of, 157, 159, 259 ;
 length at Babylon, 226 ;
 length of longest and shortest, 225 ;
 mean solar, 157, 158, 159, 197 ;
 reckoning of, 13, 14 ;
 saura, 197 ;
 sidereal, 157, 158 ;
 solar, 157 ;
 starting of, 1, 5, 7 ;
 sub-divisions of, 159 ;
 Debevoise, 230
- Decad, 164
 D' Eglantine, 167
 Declination, 192, 204, 263
 Demetrius, 213
 Democritus of Abdera, 202
 Dewai (inscription), 229
Dharma Sindhu, 19, 101
 Dhruva (celestial pole), 190, 192
 Dhruvaka (polar long.), 192, 262, 263, 267
 of junction stars, 264, 265
Digha Nikāya, 235
 Dikṣit, S. B., 11, 19, 160, 212, 219, 223, 224, 225,
 236, 237, 246, 262, 267, 268, 269
 Diopter, 203
 Dios, Macedonian month, 179, 229, 255
 Direct motion, 169, 195
Discovery, 190
 Durgāṣṭami, 108
 Dvādaśāha, 217
- Earth—
 equatorial axis of, 208 ;
 period of rotation, 12 ;
 polar axis of, 208 ;
 speed in a second, 195 ;
 spinning of, 208
 Easter, 170, 171
 Eclipses—
 condition of, 185 ;
 list of lunar, 186 ;
 list of solar, 187 ;
 periodicity of, 185 ;
 recurrence of, 186 ;
 saros cycle, 184-187 ;
 Ecliptic, 158, 181, 191, 192, 197, 198, 207, 259 ;
 definition of, 191 ;
 earliest mention of, 199 ;
 fixing of, 191 ;
 plane of, 192, 207 ;
 pole of, 192, 208 ;
 obliquity of, 191, 207, 208, 225
 Ekādaśī, observance of, 105
Elements of Euclid, 202
 Elliptic theory, 243
Encyclopaedia Britannica, 170, 179, 199
Epagomenai, 164
 Ephemerides, 201
 Ephemerides Committee, 4, 6
 Epicycle, 203
 Epigenis, 165
Epigraphia Indica, 233, 254
 Equator, celestial, 191, 192, 197, 207, 239, 259
 Equinoctial days, 188
 Equinoxes, 188 ;
 autumnal, 189, 192 ;
 oscillation of, 268 ;
 vernal, 2, 11, 13, 188, 189, 192, 205, 253,
 260
- Era, 13, 177, 228-231, 236, 251, 252, 258 ;
 Amli, 244, 257, 258 ;
 Arsacid, 178, 230 ;
 Azes, 232, 256 ;
 Bengali San, 257, 258 ;
 Buddha Nirvāṇa, 256-258 ;
 Burmese, 162 ;
 Calukya Vikrama, 258 ;
 Chedi (Kālācuri), 258 ;
 Era—*contd.*
 Christian, 170, 251, 258 ;
 current, 251 ;
 Diocletian, 162 ;
 elapsed, 251 ;
 Fasli, 257, 258 ;
 French Revolution, 167 ;
 Gaṅgā, 257, 258 ;
 Gupta, 255, 257, 258 ;
 Harṣa, 254, 258 ;
 Hejirā, 162, 180, 258 ;
 introduction of, 177 ;
 Jelali (Iranian), 162 ;
 Jewish era of Creation, 179 ;
 Jezdegerd (Persian), 162 ;
 Kālāchuri (Chedi), 234 ;
 Kaliyuga, 13, 162, 252, 254, 258 ;
 Kaniṣka, 232, 256 ;
 Kollam, 257, 258 ;
 Kollam Andu, 257 ;
 Kṛta, 254 ;
 Kuṣāṇa, 231, 232 ;
 inscription of, 230 ;
 method of date-recording, 232 ;
 Lakṣmaṇa Sena, 258 ;
 Laukika kāla, 258 ;
 Maccabaeon, 179 ;
 Magi, 258 ;
 Mahāvira Nirvāṇa, 258 ;
 Mālavagaṇa, 254 ;
 Nabonassar, 162, 177, 178, 253 ;
 Newar, 162, 258 ;
 Old Śaka, 230, 232-234, 236, 255, 256 ;
 Olympiads, 178 ;
 Pāṇḍava kāla, 252 ;
 Paraśurāma, 257 ;
 Parganati Abda, 257 ;
 Parthian, 178, 256 ;
 Philippi, 162 ;
 Rāja Śaka, 258 ;
 Śaka, 2, 4, 6, 13, 162, 178, 214, 233, 234,
 236, 255-258 ; earliest records of, 233 ;
 Saptarṣi, 190, 252, 258 ;
 Seleucidian, 161, 176, 178, 179, 229, 230,
 231, 255, 256 ;
 Vallabhi, 258 ;
 Vikrama, 13, 234, 247, 254, 255, 257, 258 ;
 Vilāyati, 244, 257, 258 ;
 Yudhiṣṭhira, 252, 258
 Eratosthenes, 178 ; on diameter of the earth,
 203
 Euclid, 202, 203
 Eucratidas, 229
 Euctemon, length of season, 175, 261
 Eudoxus of Cnidus, 201, 202 ; on geometry, 203
 Euphrates, river, 157
 Euthydemids, 213
 Evection, 204
Exact Sciences in Antiquity, 3, 197, 198, 201
- Fabricious, 235
 Fatehjang (inscription), 229
 Festivals, Religious—
 Alphabetical list of, 111-115
 Christian, 126 ;
 general rules for, 101 ;

- Festivals, Religious—contd.**
 Lunar—general rules for, 102-105 ;
 dates of, 119-124
 Moslem, 125 ;
 Solar—general rules for, 106 ;
 dates of, 117-118 ;
 South Indian—general rules for 106 ;
 Fotheringham, Dr. J. K., 165
- Galileo, 159
 Gāndhāra, 225, 226, 229, 230 ; latitude of 225
 Gaṇeśa caturthī, 108
 Ganges, river, 157
 Gangooly, P. L., 238
 Garga, 226 ; receding of solstices, 226
Garga Saṁhitā, 226
 Gargasrota, river, 226
 Gauṇa (māna), 247, 248
 Geminus, 197
General Astronomy, 158
 Geocentric theory, 204, 239
 George Washington, birthday of, 161
 Gesh (division of time), 160
 Ghaṭikā, 160
 Ghirshman, 232
 Ginzel, F. K. 162, 193
 Gnomon, 159, 174, 188, 189, 202, 219, 223, 268 ;
 measurement in Aitareya Brāhmaṇa, 266
 Gondophernes, 178, 230
 Gorpaios, Greek month, 231
 Great Bear (Saptarṣi), 190
 Greek Olympiads, 178
 Greenwich time (U. T.), 14
 Gregory XIII, Pope, 2, 10, 11, 170, 171
 Gunda (inscription), 234
 Guptas, 254, 255, 257
- Hajj, 180
 Hammurabi, Babylonian king, 175
 Harappā, 212
 Harṣa Vardhana, 254
 Hashim, Amir Ali, 180
 Haug, Dr. Martin, 216
 Heliacal rising, 164, 191
 Heliocentric theory, 203
 Herzfeld, 232, 235
 Hesiod, 201
 Hidda (inscription), 230
 Hipparchos of Nicaea, 165, 166, 177, 178, 192,
 197, 200, 201, 203, 205, 206, 226, 235,
 237, 240 ;
 catalogue of stars, 203 ;
 discovery of precession, 205, 267 ;
 first point of Aries, 200, 205, 206 ;
 geometry & spherical trigonometry, 203,
 204
 Hippocrates of Chios, 202
History of Science, 206
 Hoang Ho, river, 157
 Holidays, 5, 6 ; list of, 117-154 ;
 Ajmer, 145 ;
 Assam, 128 ;
 Bhopal, 146 ;
 Bihar, 129 ;
 Bilaspur, 147 ;
- Holidays, list of—contd.
 Bombay, 130 ;
 Christian festivals, 126 ;
 Coorg, 148 ;
 Delhi, 149 ;
 East Punjab, 134 ;
 Fixed holidays & solar festivals, 117, 118 ;
 Govt. of India, 127 ;
 Himachal Pradesh, 150 ;
 Hyderabad, 137 ;
 Jammu & Kashmir, 138 ;
 Kutch, 151 ;
 Lunar festivals, 119-124 ;
 Madhya Bharat, 139 ;
 Madhya Pradesh, 131 ;
 Madras, 132 ;
 Manipur, 152 ;
 Moslem festivals, 125 ;
 Mysore, 140 ;
 Orissa, 133 ;
 Patiala & East Panjab States Union, 141 ;
 Rajasthan, 142 ;
 Saurashtra, 143 ;
 Travancore-Cochin, 144 ;
 Tripura, 153 ;
 Uttar Pradesh, 135 ;
 Vindhya Pradesh, 154 ;
 West Bengal, 136
- Horā, 236, 266
 Horoscope, 196, 205, 256
 Horoscopic astrology, 194, 196, 204, 256
 Hour circle, 191
 Hsiu, Chinese lunar mansion, 182, 183, 210,
 211, 224 ;
 names with component stars, 210, 211 ;
 starting of, 183
 Huviska, 231
 Hypatia, 204
- Ibn Yunus, 206
 Idavatsara, 225
 Ides, 168
 Idvatsara, 225
Iliad, 201
Indian Calendar, 246
Indian Ephemeris, An, 101
 Indian Ephemeris and Nautical Almanac,
 5, 8, 12, 14, 17
 Indra, Indian god, 199, 215, 216
 Indus, river, 157
 Intercalary month (= malamasa), 175, 176,
 245, 246 ;
 Babylonian calendar, 176 ;
 calculation of, 246, 249 ;
 definition of 247 ;
 eight-year cycle, 202 ;
 Islamic calendar, 180 ;
 Jewish calendar, 179 ;
 list of acc. to modern calculations, 250 ;
 list of according to S. S., 250 ;
 19-year cycle, 176, 200, 202, 229, 245, 246 ;
 Paitāmaha Siddhānta, 223 ;
 Ṛg-Veda, 216, 218 ;
 Romaka Siddhānta, 237 ;
 Siddhānta Jyotiṣa, 246, 248 ;
 Vedāṅga Jyotiṣa, 223, 224, 225, 246
- Introduction to the History of Science*, 159
 Isis, Egyptian god, 164, 165
- Jacobi, 215
 Jaikadeva, 254
 Jai Singh of Amber, 10
 Jāmōtika, Śaka king, 233
 Janmāṣṭamī, 19
 Jātakas, 239
 Jayantī, names of, 107
 Jayaswall, 255
 Jehonika, 230
 Jelaluddin, Melik Shah, 166
 Johann Werner, 206
 Jones, Sir Harold Spencer, 6, 12, 158
 Jovian cycle, 257
 Jovian (Bārhaspatya) years, 270 ;
 names of, 270
 Julian days, 161, 162
 Julian days of important events, 162, 163
 Julian period, 162
 Julius Caesar, 2, 10, 159, 165, 168, 241
 Junction stars, of nakṣatra, 184, 210, 211, 220 ;
 262-265 ;
 dhruvaka of, 264, 265 ;
 latitude of (1950), 220, 264, 265 ;
 " (1956), 184, 210, 211 ;
 long. of (1950), 220, 264, 265 ;
 " (1956), 184, 210, 211 ;
 magnitude of, 210, 211, 264, 265
 Jupiter, planet, 194, 195, 203, 239 ;
 sidereal period of, 270
 Jyā (chord), 204
Jyotiṣa Karaṇḍa, 223
- Kabishah*, 180
 Kadamba, pole of the ecliptic, 192
 Kalā or liptikā, 160
Kātaloka Prakāsa, 223
 Kalasang (inscription), 229
 Kālāṣṭamī, 108
 Kāldarra (inscription), 229
 Kalends, 168
 Kalhaṇa, Historian of Kashmir, 252
 Kali, 162 ; long. of planets at Kali beginning
 253
 Kālidāsa, 7, 261
 Kalpa, 162, 175, 214, 240, 268, 269
 Kalpādi, names of, 107
 Kāndāhār, 229
 Kaniṣka, 230, 231, 236, 256
 Kaniṣka I, 231
 Kaniṣka II, 232
 Kaniṣka III, 231, 232
 Kaniṣka Casket (inscription), 230
 Kāniza Dheri (inscription), 231
 Kāṇva, 213, 228
 Kapiṣṭhala Kāṭha Saṁhitā, 218
 Kapsa, 230
 Karaṇa, 163
 Karaṇas, definition, names and calculation of,
 110 ; lords of, 110
 Kāṭhaka, 218
 Kaurpa (name of a sign), 193

- Kauṭīlya, views on astrology, 236
 Keith, Dr. Berriedale, 218
 Kendra, 236, 266
 Kepler, 2, 206, 242
 Ketu (node), 186
 Khalatse (inscription), 229
Khaṇḍakhādya of Brahmagupta, 162, 240, 253
 Kharoṣṭhī (inscription), 229, 230, 231, 233
 Khotanī Śāka (language), 231
 Kidinnu, 200
 Konow, Dr. Sten, 229, 231, 235
 Krānti (declination), 262
 Kṛttikās, 182, 219, 232
 Kṛaya month, 247, 248, 250
 Kugler, 176, 196, 225
 Kumbha melā, 6
 Kumbha yoga, 108
 Kurram (inscription), 230
 Kurukṣetra, latitude of, 225
 Kuṣāṇas, 213, 230-234, 236, 252, 256
- Lagadha, 214, 222
Laghumānasa of Muñjāla, 162, 267
 Lagna (orient ecliptic point), 237, 268
 Lagrange, 167
 Lalla, on precession, 267
 Lambaka (co-latitude), 239
 Lañkā, Greenwich of ancient India, 239, 253
 Laplace, 167
 Latitude, celestial, 192, 203, 204, 210, 211, 264, 265;
 polar, 192, 263, 264, 265
 Leap year, 6, 13, 15; of Islamic calendar, 180;
 of Reformed Calendar of India, 186
 Leonardo of Pisa, 160
 Leeuw, Mrs. Van Lohuizen, 232, 255, 256
 Libra, first point of, 192, 199, 239, 262, 268
 Liptikā, 160, 236, 263, 266
 Lockyer, Sir Norman, 190
Lokavibhāga of Śimhasuri, 233
 Longitude, celestial, 7, 192, 203, 204, 210, 211, 253, 264, 265;
 polar, 192, 263, 264, 265
 Longitudes of planets at Kali-beginning, 253
 Lüders, 228, 232
 Lunar eclipse, 185
 Lunar mansions, 182;
 of Ṛg Veda, 217;
 stars of, 210, 211
 Lunar year, beginning of, 220, 221
 Lunation, duration of, 158, 174, 175, 246;
 length of, 164, 248
- Madhyāhna, 101, 108
Mahābhārata, 170, 183, 185, 219, 221, 227, 228, 239, 252;
 month reckoning in, 185;
 time of compilation, 226, 252
 Mahāvadaśī, defined, 107
 Mahāyuga, 160, 162, 217, 254
 Maira (inscription), 229
Maitrāyaṇī Saṁhitā, 218
 Malamāsa, 246, (see also intercalary month),
 Mamāne Dherī (inscription), 231
- Māpikīala (inscription), 230
 Māpsehrā (inscription), 229
 Manvādī, names of, 107
 Manzil, Arabian lunar mansion, 182, 183, 210, 211;
 names with component stars, 210, 211;
 starting of, 183
 Mārguz (inscription), 229
 Mars, planet, 194, 195, 203, 239;
 retrograde motion of, 194
 Māsakṛt, 174
 Matins, 159
 Maues, 230, 233
 Mauryas, 228
 Max Müller, 183, 214, 215
 Maya, 236, 238
 Mean solar day, 157, 158
 Mean solar time, 158
Meghadūta of Kālidāsa, 261
 Melik Shah the Seljuk, 159
 Menander, 213, 229, 235
 Menelaos (Greek astronomer), 204;
 Spherical trigonometry, 204
 Mercedonius, 168
 Mercury, planet, 194, 195, 203, 239
 Meridian passage, 57
 Meṣādi, 239
 Meṣādi, sidereal, 16, 17, 40
 Meton of Athens, 176, 202;
 nineteen-year cycle, 202
 Metonic cycle, 162, 176
Milinda Pañho (philosophical treatise), 229
 Mithra (Persian god), 167, 170
 Mithradates I, 213, 255
 Mithradates II, 213, 255
 Mitra, Indian god, 215
 Moga, Śāka king, 230
 Mohammed Ajmal Khan, 180
 Mohammed, Prophet, 159, 179, 180
 Mohenjodāro, 212
 Moise of Khorene, 232
 Month, anomalistic, 197;
 beginning in Babylonian calendar, 185;
 definition of, 157, 158, 185;
 draconitic, 186, 197;
 intercalary (see intercalary month);
 Lunar, 220, 221, 225, 245, 246;
 commencement of as recommended
 by the Committee, 7;
 names of Indian, Chaldean and
 Jewish, 177; Macedonian, 177, 229;
 length of Islamic, 180;
 interpretation of month names, 221;
 length acc. to S. S., 246
 reckoning in Mahābhārata, 185;
 relation between draconitic and synodic,
 186;
 sidereal, 223;
 Solar, causes of variation in length, 243;
 commencement of, 7;
 definition of, 242;
 different conventions in beginning
 of, 244;
 duration of, 243;
 Egyptian, 164;
 first month of the year, 5, 6;
- Month, Solar—*contd.*
 Iranian names, 166;
 length of, 211, 242-246, 251;
 length recommended by the
 Committee, 2, 5, 6, 13, 15;
 names in French Revolution
 calendar, 167;
 names in Yajur-Veda, 218;
 names of, Indian, 5, 6, 7, 14, 15;
 names, Persian, 166, 167;
 number of days in Vedāṅga Jyotiṣa,
 225;
 variation in length, 1
 Synodic period, 197, 223
 Moon, crescent of, 182;
 deviation of path from the ecliptic, 192,
 208;
 inclination of path to the ecliptic, 201;
 limiting values of true motion, 197;
 mean daily motion, 197;
 motion of, 182;
 movement of, 31, 181, 182;
 rate of motion over the sun, 184;
 sidereal period of, 182;
 synodic period of, 182
 Mount Banj (inscription), 229
 Mucai (inscription), 229
 Muhūrta, 100, 108, 160; lords of, 109
 Mukhya māna, 247, 249
Mul Apin, Babylonian astrological text, 198
 Muniśvara, commentator, 267
 Muñjāla Bhaṭa, 11, 259
 on precession, 267-269
 Mural quadrant, 203
- Nabu Nazir, 177
 Naburiannu, 200
 Nadir, 157
 Nāgabhaṭa, 257
 Nahapāna, 233
 Nakṣatra, average length of, 224;
 beginning of, 14, 229;
 calculation of (acc. to the recommenda-
 tions of the Committee), 5, 7, 16, 17;
 component stars of, 210, 211;
 def. of in earliest times, 183, 218, 227;
 def. of in Vedāṅga Jyotiṣa, 183, 223-225;
 designation of, 182, 183;
 division of, 183, 184, 219;
 junction-stars of, 184, 210, 211, 220,
 264, 265;
 lords of, 109;
 meaning of Indian, 182, 210, 211,
 names of—general, 210, 211, 263;
 " " Tamil, 109;
 " " -Yajur Vedic with presiding
 deities, 220;
 number of, 182;
 Ṛg-Vedic, 183;
 shifting of the beginning of, 18, 19;
 starting of, 182, 183
 Nandsa Yupa inscription, 254
 Napoleon Bonaparte, 168
 Narseh, Sassanid king, 232
 Nāsatya, 215
 Nasik, 228

- National Observatory, 5, 8, 12, 14
Nautical Almanac, 3, 165
 Nephys, 164
 Neugebauer, O., 3, 160, 175, 185, 189, 192, 197, 198, 199, 201, 203, 204
New Testament, 169
 Newton, Isaac, 2, 193, 206, 240, 259 ;
 precession of the equinoxes, 207
 Night, definition of, 157
 Nile flood, 158, 164, 165, 174, 189
 Nineteen-year cycle, 176, 200
 Nirayana, 259, 260, 262, 268
Nirayana Sindhu, 101
 Nirukta, 214
 Nirvāna, Buddha, 235, 257
 Nisan, 161, 170, 175, 178, 179, 229
 Niśītha, 108
 Nodes, 185, 186, 187, 269
 Nona, 159
 Nones, 168
 Numa Pompilius, 168
 Nut, 164
 Nutation, 209
Nychthemeron, 157, 159
- Obliquity, of the ecliptic, 158, 191, 207, 208, 225
 amount of, 191 ;
 definition of, 191 ;
- Oclæteris*, 176
 Octavius Caesar, 168 ;
Odyssey, 201
 Olympiads, 178
 Omar Khayyam, 166, 172, 240
 Omina, 195, 235
 Orbit, of the earth, 207
Orion, 189
 Orion, 190, 195
 Osiris, Egyptian god, 164
- Paikuli (inscription), 232
Pañcama Siddhānta, 223
 Pājā (inscription), 229
 Pakṣa, 227-231 ;
 kṛṣṇa or vahula, 15, 221, 228, 233, 247 ;
 śukla, 15, 221, 228, 247 ;
- Pala, 160
 Palas, 257
 Pallavas, 256
 Pañcāṅgas, list of, 21, 22
Pañca Siddhāntikā of Varāhamihira, 158, 162, 197, 223, 226, 236, 237, 238
 Panemos, Greek month, 230
 Pāṇini, 214
 Panjar (inscription), 229
 Pannekoek, Dr. Anton, 174, 176, 178, 185, 194, 196, 197
 Paravidhā, 101, 108 ; rules for, 109
 Parivatsara, 225
 Passover fast, 170
 Pātaliputra, 10, 213, 234, 252
Paulīsa Siddhānta, 204
 Paulus of Alexandria, 204, 237
 Perihelion, 242 ; movement of, 243
 Peshāwar Museum (inscription), 229, 230
 Philhellens, 213
- Phraates I, 213
Pictorial Astronomy, 194, 195
 Pillai, S. K., 101, 223
 Piṅgala, 214
 Planet, 169 ; order of distance, 203 ;
 references in Ṛg-Veda, 212 ;
 Planetarium, 203
 Planetary Astrology, 169, 194-196
 Plato, 202, 203, 228, 229 ; geometry, 202
 Pleiades, 182, 190, 195, 199, 219
 Polar axis, 208
 Polaris (α *Ursae Minoris*), 190, 207, 239
 Pole, celestial, 191, 192, 207 ;
 definition of, 191 ;
 motion of, 207 ;
 observation of, 190, 191 ;
 precessional path of, 207
 Pope, Gregory XIII, 159, 172
 Pradoṣavrata, 108
 Prahara, 160
 Prajāpati, 217
 Prāṇa (division of time), 160
 Prātaḥ, 108
 Precession of the equinoxes, 2, 7, 8, 193, 200, 204-206, 237, 238, 240, 253, 259, 267 ;
 Al-Batṭāni's rate of, 206 ;
 among Hindus, 226 ;
 among Indian astronomers, 267 ;
 amplitude of precessional oscillation according to S. S., 268 ;
 Bhāskarācārya's rate of, 269 ;
 consequences of, 205, 206 ;
 discovery of, 204, 205 ;
 effect in Indian calendar, 7, 11, 18 ;
 effect in Indian Siddhāntas, 226 ;
 explanation by Newton, 207, 208 ;
 Hipparchos's rate of, 205 ;
 motion of (precessional), 208, 268 ;
 Munājāla Bhaṭṭa's rate of, 268 ;
 numerical value of, 209 ;
 physical explanation of, 207, 208 ;
 Pṛthūdaka Svāmī's rate of, 268 ;
 Ptolemy's rate of, 205, 206 ;
 rate of annual, 209 ;
 rate of lunar, 208, 209 ;
 rate of solar, 208, 209 ;
 Sūrya Siddhānta's rate of, 268
 Pṛthūdaka Svāmī, 259, 268, 269
 Proclus, on precession, 206
 Ptolemy, Claudius, 161, 165, 166, 177, 178, 185, 192, 200, 201, 203-206, 214, 228, 238, 240, 263, 266 ;
 on astrology, 205 ;
 " evection, 204 ;
 " rate of precession, 205 ;
 " theory of planetary motion, 204 ;
 Ptolemies, 213
 Ptolemy, Euergetes, 165
 Pulakesin I, 233
 Pulakesin II, 253
 Pulastya, 236
 Purānas, 101, 252
 Pūrṇimānta, month, 157, 227, 230, 231, 233, 247, 256
 Puruṣpur, 232
 Pūrvāhna, 101, 108
 Pūrvavidhā, 101, 108 ; rules for, 109
- Puskalāvati, 230
 Pythagorean number, 198 (fig.)
- Quartz clock, 12, 159
 Questionnaire, regarding calendar, 22 ;
 replies to, 23-31
- Rā, Egyptian sun-god, 164
 Rahu, ascending node, 186
Rāmāyana, 261
 Rāmpūrva (inscription), 227
 Raṅganātha, 233
 Rapson, 255
 Refraction, 225, 226 ; effect of, 225
 Retrograde motion, 169, 194, 195
 Ṛg-Saṁhitā, 217, 218
Rig-Vedas, 163, 212, 214, 216, 217, 218, 221, 222 ;
 calendaric references in, 216-218 ;
 description of, 215 ;
 Ribhus, 216
 Right ascension, 192, 204
 Riza Shah Pahlavi ; 167
 Romaka, 236, 239
 Rome, Era of foundation of, 178
 Rotation of the earth, 157, 158
 Rudradāman, 233
 Rudra Sinha, Śaka satrap, 231, 236
- Sachs, A., 199, 201
 Saha, Prof. M. N., 173, 232, 252, 256
 Sahdaur A (inscription), 229
 Sahdaur B (inscription), 229
 Sahni, Dayaram, 232
 Śakas, 213, 230, 233, 236
 Śakadvīpī Brāhmaṇas, 214, 236, 256
 Śaka saṁvat, 255
 Śakasthān, 213, 233
 Śakendra kāla, 255
 Śalivāhana Śaka, 255
 Samarkand, 10
Sama Veda, 214, 218
 Saṁhitās, 214, 218
 Saṁkrānti, 2, 7, 239, 244 ;
 Mahāviṣuva, 215 ;
 Makara, 215
 rules of, 244, 247, 259 ;
 Uttarāyana, 215 ;
 Sampāt calana, 269
 Samudragupta, 255
 Samvatsara, 255, 270
 Saṅgava, 108
 Śanku (gnomon), 188
 Śara (celestial latitude), 262
 Sargon I, 215
 Saros, 184, 185, 202, 217
 Sarton, George, 159, 188, 203, 204, 206
 Śāstry, Mm. Bapudev, 259
 Śāstry, Prof. Mm. Bidhusekhar, 235
 Śātakarṇi, 228, 233
 Śātānanda, 160
Satapatha Brāhmaṇa, 18, 189, 219
 Śātavāhanas, 212, 213, 227-231, 233, 234, 255
 Saturn, planet, 194, 195, 203, 239

- Saura day, 197
 Sāvana, 2, 157, 223, 224
 Sāvāhna, 108
 Sāvāna, 1, 11, 12, 13, 217, 239
 Scaliger, Joseph, 9, 11, 161
 Scaliger, Julius, 162
 Schmidt, Dr. Olaf, 163
 Schrader, 215
Scientific American, 190
 Scorpion, 193, 195, 198
Scythian Period of Indian History, 232, 255
 Seasons, 157, 158, 174, 189, 216, 217, 227, 230, 239
 causes of, 259 ;
 determination by gnomon, 189
 error in counting, 260 ;
 length of, 174, 175, 261 ;
 moving back of, 18 ;
 names of Indian, 217, 241, 260 ;
 position of, 1, 6, 260 ;
 relation of months with seasons in Vedic
 age, 216, 218 ;
 in R̥g-Veda, 216, 217
 Seb, Egyptian god 164
 Seleucus, 178, 213, 228
 Senas, Hindu ruling dynasty, 237
 Seneca, 225
 Sengupta, P. C., 183, 215, 221, 227, 238, 253,
 266
 Set, Egyptian god, 164
 Sewell, R. S., 246
 Sexta, 159
 Shahpur I (Sassanid king), 232
 Shama Sastry, Dr. R., 223, 224
 Shin Kot (inscription), 229
 Siddhānta Jyotiṣa, 161, 221
 Siddhāntas, 1, 2, 3, 163, 234, 236, 237, 238,
 245 ;
 Ārya, 238, 242, 251 ;
 Brahma, 238, 242, 251 ;
 definition of, 234 ;
 Paitāmaha, 236-238 ;
 Paulīśa, 236-238 ;
 Romaka, 236, 237, 240 ;
 Sūrya, 236, 238-244 ;
 Vāsiṣṭha, 236, 237
Siddhānta Sekhara of Śrīpati, 162
Siddhānta Śīromaṇi of Bhāskarācārya, 238,
 269
 Sidereal time, 158
 Signs, of the zodiac, 192, 193, 194, 196, 206,
 223, 224, 237, 239, 240
 Śikṣā, 214
 Sircar, D. C., 228, 231, 233, 234
 Sirius, 164
 Śivarātri, 108
Sky and Telescope, 177
 Solar day, mean, 157, 158 ;
 division of, 159 ;
 Solar cycle, 162 ;
 Solar time, mean, 158 ;
 Solstices, 188, 189, 226 ;
 determination by Vedic Hindus, 266 ;
 observation in Aitareya Brāhmaṇa, 266
 summer, 188, 189, 192, 226, 266 ;
 winter, 13, 189, 192, 223, 224, 226, 241,
 259 ;
 Solstitial colure, 226
 Somākara, 222
 Sosigenes, 168
 Sothic cycle, 165
 Śrīpati, 11, 246
 Śrīṣeṇa, 237 ; on precession, 267
 Stone-henge, 189, 190
 Śudi, 247, 248
 Śuddha, 7, 247
 Sui Vihar (inscription), 230
 Sūlva-Sūtras, 190, 214
 Sun, distance from the earth, 208 ;
 entry into nakṣatras, 15, 40 ;
 mass of, 208 ;
 mean daily motion, 197 ;
 semi-diameter of, 225
 Sun-dial, 159
 Sun-rise, 15 ;
 timings of certain important places, 116
 Sun-set, 15
 timings of certain important places, 116 ;
 Suṅga, 213, 228, 235
Sūrya Prayāpti, 223
Sūrya Siddhānta, 1, 2, 158, 189, 192, 203, 214,
 236-240, 242-46, 250, 251, 253, 262-264,
 267, 268, 270 ;
 calendar in, 239, 240 ;
 description of, 238, 244 ;
 error in length of year, 2, 241 ;
 length of the year, 2, 240, 241 ;
 star positions of, 264, 265 ;
 theory of trepidation, 268
 Sūtras, 214, 215, 221 ;
 Śrauta, Gṛhya, Dharma, Sūlva, 214
 Synodic period, 158, 175, 182 ;
 revolution of planets acc. to P. S., 197
Syntaxis or *Almagest*, 192, 201, 203, 204

Taittirīya Brāhmaṇa, 182 ;
Taittirīya Saṁhitā, 218, 220, 221, 260
 Takht-i-Bahi (inscription), 229
 Tantra, 163
 Tarn, 229, 255
 Taxila, 213, 228, 230, 256
 Taxila copper plate (inscription), 229
 Taxila silver scroll (inscription), 229
 Taxila silver vase (inscription), 229
 Telephos of Kapśā, 230
 Tertia, 159
Tetrabiblos, 201, 204, 205
 Thabit-ibn-Qurra, 206
 Thales of Miletus, 202
 prediction of solar eclipse, 202 ;
 Theaitetus of Athens, 202 ;
 Theon of Alexandria, 204, 206, 240 ;
 on trepidation, 206, 240
 Thibaut, Dr. G., 197, 223, 225, 237
 Thirteen-month calendar, 171
 Thoṭh, Egyptian god, 164
 Tigris, river, 157
 Tilak, B. G., 11, 189, 215, 216
 Time, natural divisions of, 157-160
 Timocharis, 205
 Tiridates, 178
 Tiṣya, 217, 227
 Tithi, 183, 218, 227, 228, 230, 234, 236, 248 ;
 average duration of, 221, 222, 224, 248 ;
 comparison of Siddhāntic and modern, 3
 defined, 3, 221 ;
 definition in Aitareya Brāhmaṇa, 221 ;
 " " Siddhāntas, 221 ;
 " " Vedāṅga Jyotiṣa, 224, 225 ;
 duration of Vedic tithi, 221 ;
 error in the old method, 3, 14 ;
 lords of, 109 ;
 measurement of, 248 ;
 names of, 222 ;
 numbers of, 15, 221, 222
Tithitvatam, 101
 Trepidation, theory of, 204, 206, 207, 238, 240,
 259, 268, 269
 Tulādi, 239
 Tycho Brahe, 206

 Ullulu, 176
 Ulugh Begh, 10
 Umbra Extensa, 204
 Umbra Versa, 204
 Und (inscription), 231
 Upaniṣads, 214, 215
Uranometry, 205
 Usavadata, Śaka prince, 233
Utkalalikā, 101
 Utkramajyā, 204
 Uttarāyana, 189, 219, 224, 226, 239, 260

 Vadi, 247, 248
 Vaidya, Prof. R.V., 263
Vaidyanātha Dikṣitīyam, 101
Vājasaneyi Saṁhitā, 218
 Vajheska, 231
 Van der Waerden, 160
 Varāhamihira, 2, 7, 192, 193, 197, 223, 226, 236,
 237, 238, 240, 252, 255, 267
 Varuṇa, Indian god, 215, 216
 Vasiṣṭha, Indian sage, 236
Vāsiṣṭha Siddhānta, 236, 237, 267
 Vāsudeva I, 231, 232
 Vāsudeva II, 231, 232
 Vedas, description and literature, 214 ;
 age of its literature, 214, 215
 Vedāṅgas, 214, 215
 Vedāṅga Jyotiṣa, 161, 217, 224, 226, 237, 240,
 241, 245, 246 ;
 description of, 221-225
 Vehsadjan, 232
 Ventris, 202
 Venus, planet, 194, 195, 198, 203, 239 ;
 heliacal rising and setting of, 6, 15
 (see also Calendar for five years).
 Vernal equinox, 2, 158, 226, 239, 241, 267
 Vernal point, 1, 158, 205 ;
 movement of, 193, 194, 205, 267
 Vespers, 159
 Vidyasagar, Pandit Ishwar Chandra, 260
 Vighaṭi, 160
 Vikramāditya, 254, 255
 Vikṣepa, 192, 262-265, 267
 Virapurūṣadatta, 228

Viṣṇu Candra, 237 ; on precession, 267
 Viṣuvān, 216, 219, 221, 266
 Viṣuvānsa, 262
 Vogt, 203
 Vṛddha Garga, 252
 Vyākaraṇa, 214

 Wardak (inscription), 230
 Water-clock, 157, 159
 Webster, A. G., 207, 208
 Week, 169, 170, 203, 223, 234, 251, 252 ;
 origin and invention of, 169, 170
 Winternitz, 214, 215, 218
 World Calendar Association, 10, 12, 171
 Worlds' day, 172, 173

 Yājñavalkya Vājasaneyā, 218
 Yajur Veda, 182, 183, 214, 218-222 ;
 Black, 218 ;
 Śukla, 218
 Yājurveda Samhitā, 218
 Yajus Jyotiṣa, 222
 Yāma, division of day, 160
 Yamakoṭi, 239
 Yāmārdha, 103
 Yaska, 214
 Yavanapuri, 237
 Yavanas, 213, 256

Year, 216 ; beginning of, 1, 4, 6, 13, 175 ;
 beginning of in Brāhmaṇas, 241, 245 ;
 beginning of lunar, 221 ;
 " " in Paitāmaha, 223 ;
 " " in S. S., 239
 " " religious calendar, 251 ;
 " " Siddhāntic, 11, 241, 245 ;
 " " Solar, 2, 241 ;
 " " Vedāṅga Jyotiṣa, 241, 245 ;
 " " Vedic Aryan, 216, 218 ;
 definition of, 157, 158 ;
 draconitic (eclipse), 186 ;
 error in beginning of, 1, 13, 15, 241 ;
 error in beginning of Indian solar, 2 ;
 first month of, 4, 6, 241, 242, 251 ;
 Jovian (Bārhaspatya), 270 ;
 length (average) of Babylonian, 161, 177 ;
 length of as found by ancient astronomers,
 174, 261 ;
 " " Brahmagupta, 162 ;
 " " Gregorian, 12, 13 ;
 " " Paitāmaha, 223, 240 ;
 " " Ptolemy, 240 ;
 " " sidereal, 158, 205, 240, 246 ;
 " " solar, 223 ;
 " " Sūrya Siddhānta, 2, 240, 241, 246 ;
 " " tropical, 1, 2, 4, 12, 158, 174, 175,
 205, 240, 246 ;
 " " Varāhamihira, 240 ;
 " " Vedic Aryan, 216 ;

Year—*contd.*

 starting day of the solar, 241
 Yoga, names and lords of, 110 ;
 calculation of, 110
 Yogatārā (junction star), 183, 184, 210, 211
 Yuga, 217 ;
 of Romaka Siddhānta 237
 of Vedāṅga Jyotiṣa, 223, 224 ;
 Yugādi, 107

 Zarathustra, 167
 Zeda (inscription), 230, 231
 Ziggurat, 196
 Zinner, Dr. Ernest, 164, 196
 Zodiac, definition of, 192, 193, 202 ;
 first point of, 14 ;
 lunar, 182, 183, 223, 226 ;
 Arabian, 182, 183 ;
 Chinese, 182, 183 ;
 Indian (*see* nakṣatra)
 place of origin, 183 ;
 Ṛg Vedic, 217 ;
 position through ages, 200 ;
 signs of the, 193 ;
 starting point of, 193 ;
 zero point of the Hindu, 262, 266, 267,
 269 ;
 Zodiacal signs, different names of, 193 (*see also*
 signs of the zodiac).

