

CONTENTS

Introduction	5
Factory Site	5
Water Supply	5
Plan of Building	5
Construction of Building	6
Cannery Lighting	7
The Steam Boiler	7
Type of Boiler	7
Water Treatment	7
Location of Boiler	8
The Canning Process	8
Preparation of the Products, Grading and Packing in Cans	9
Types and Sizes of Cans	9
Preparation of Syrup or Brine	10
Exhausting	13
Capping	14
Coding	17
Cooking	17
Cooling	19
Fruits	28
Varieties	28
Maturity and Storage	28
Yield	29
General Equipment	29
Floor Plan No. 1	29
Floor Plan No. 2	41
Floor Plan No. 3	46
Special Equipment	50
Canning Procedure	54
Vegetables	58
Varieties	58
Maturity and Storage	58
General Equipment	59
Special Equipment	67
Canning Procedure	68
Equipment Cost	75
Length of Canning Season	75
Warehousing	75
Sanitation	77
Waste Disposal	78
Floors	78
Drums	78
Overhead Pipes, Shafts and Ventilation	78
Washrooms	78
Clean-up	79
Keeping Records	79
Marketing	81
The Meat and Canned Foods Act	82
Acknowledgments	83

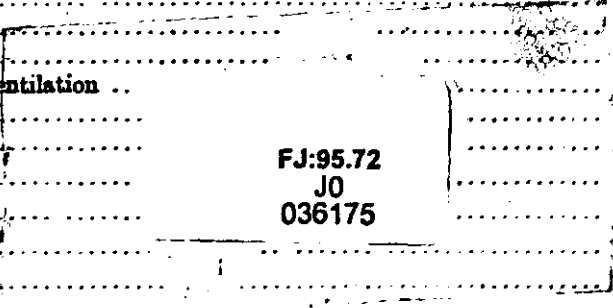

SMALL CANNERIES

F. E. ATKINSON and C. C. STRACHAN

**Fruit and Vegetable Products Laboratory
Dominion Experimental Station
Summerland, B.C.**

Introduction

Canada has a large number of small canneries. These small plants can, and often do, pack a quality product. Because there is a variation in quality, however, this bulletin has been prepared to assist the small operators. Regardless of whether a plant is large or small, good quality raw products should be used, the plant should be kept in a sanitary condition, and processes should be standardized.

This bulletin deals with the smallest scale of commercial operation up to a single mechanical line. When a single, fully mechanized line is in efficient operation the factory has reached the top of the small cannery grouping.

Factory Site

Considerations

1. Proximity to raw material.
2. Possible future development of the plant. Although only a small site of probably half an acre is needed for a start, availability of adjoining property to expand to seven or eight acres should be considered.
3. Location on flat land where there is ample provision for drainage facilities. Proper drainage to carry away waste products is of primary importance.
4. Availability of rail connection. Although rail connection is not necessary for small operations, provision for a railroad siding in case of expansion is desirable.
5. Availability of labour.
6. Availability and dependability of supply of good water and electricity. These should be at reasonable rates.

Water Supply

Satisfactory water is a very important consideration. To be good, water should be free from bacterial contamination and have a low mineral content, particularly in regards to calcium, magnesium and iron. In submitting samples of water for testing, it should be specified that one wishes to use this water for canning purposes and that both a bacteriological and chemical test are required. In several of the provinces, bacteriological tests are made free by the Public Health Laboratories. Samples for tests of hardness are best submitted to a laboratory dealing with processing of fruits and vegetables.

Plan of Building

In the smallest operations, a building 16 feet wide and of varying length may be employed. Eventually as the plant expands the 16-foot building is extended in length so as to accommodate one single mechanical line. The length of this line will depend on the type of product being processed. A single line may be considered as the bar of an H and as the plant develops the legs of the H are put on at each end, one leg being the receiving room and one being the warehouse. Railroad tracks are most advantageous if they run parallel to the side

of the leg which is the warehouse. As the plant continues to expand, other lines may be placed beside the first one, either above or below the bar of the H, without changing the rest of the building. The length of the room for a single line cannot be definitely specified as it will vary with different products.

Construction of Building

The buildings suggested in these plans are of timber construction. For the 16-foot lines, the height of studding is 10 feet and 14 feet with a shed roof. Two by four inch studding is used. A row of windows is placed below the ceiling on the high side. If possible, it is preferable to lay out the building so that these windows face north. When additional lines are built, the shed roof of one line becomes one unit of a saw tooth roof. If a flat roof is being used the ceiling height should be not less than 12 feet. The interior of the building should be lined and painted white or pastel shades. Mould inhibiting paint is desirable.

The warehouse also may be of timber construction in which case 20-foot studs of 2 by 8 inch material are used. This height makes possible the eventual use of lift trucks and pallets. Moisture-proof paper may be used on one side and ordinary paper on the other. This paper in turn is covered with shiplap or tongue and groove, and the outside of the building may be finished with aluminum siding. Every precaution must be taken to prevent any moisture vapour from the canning lines entering the warehouse. Waterproof paper and extra sheathing lumber between the lines and the warehouse are good safeguards. Extra care should be taken to ensure good ventilation above the canning lines adjacent to the warehouse.

The floor in the processing area is of concrete while the floors in the other areas are of wood. The concrete floor should slope to a centre drain in each bay, having a slope of 1 inch in 8 feet. The top inch of concrete may be treated with one of the water-proofing compounds which make it hard and resistant to acid attack. It also may be treated with sodium silicate to reduce the refractory characteristics of ordinary concrete. Some factories are finding that a concrete floor surfaced with a hardening compound and with iron filings included in the concrete gives a good surface. Good floors are a necessity for sanitary operation.

Drains are designed according to the cross-section in Figure 1.

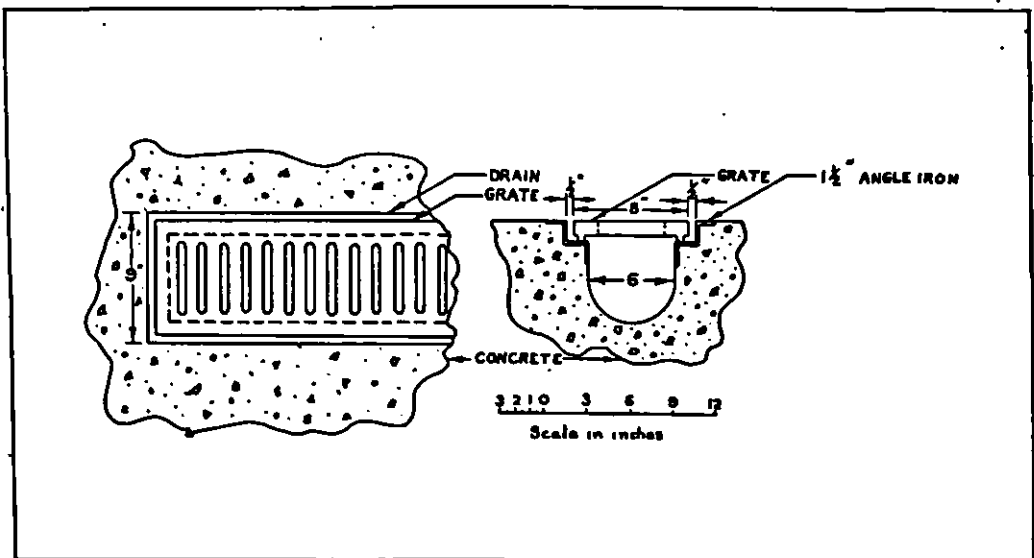

FIG. 1—Detail of Floor Drain

Cannery Lighting

Adequate lighting assists materially in efficient cannery operation. The intensity of light required varies in the different parts of the cannery; for instance, 100 foot-candles is recommended for sorting belts, while the general lighting in the preparation room may be between 30 and 35 foot-candles. In the processing room, the recommended amount is decreased to 20-foot candles while in the storage and warehouse as low as 10 foot-candles is satisfactory. Lighting is an item that does not remain constant but is influenced by dirty floors, lamps and reflectors, walls that need repainting and lamps in which the light has depreciated. Consequently it is good policy to design the lighting requirements for 50 per cent more than recommended and to check frequently with a light meter. Cleaning and painting maintenance should be kept up to its original standard. Free lighting plans will often be made by electrical supply houses.

The Steam Boiler

Type of Boiler

Steam under pressure is not necessary for all small canneries as will be discussed later. However, for small canneries of Floor Plan No. 3 discussed here, the steam boiler should be at least 40 h.p. and should be passed by the provincial boiler inspector for a working pressure of 125 pounds. When the permissible pressure on a boiler drops below 100 pounds it is approaching the worn out stage. A boiler passed for 125 pounds is still in relatively good condition. The type of boiler for the small cannery should be one that does not require too much overhauling and is simple to install and operate. To get these advantages one must sacrifice some efficiency and consequently the locomotive type is suggested. The Scotch return tubular marine boiler also is good. Although initially more expensive than the locomotive type, it is more economical to operate. The vertical boiler has the disadvantage of the top end of the flues being out of the water and under some conditions severe pitting takes place at the water line. The portable return tubular boiler with insulation made up in sections that come apart is good but expensive to purchase.

These small boilers are very useful in a factory even after larger units have been installed. Thus their value continues after the period when they carried the full load. Installation of a standardized size and type of boiler is recommended when the plant expands past the No. 3 plan. The boiler usually selected is a horizontal return tubular boiler, 6 feet in diameter and 18 feet long, known as a "72 by 18" boiler. These boilers are suspended above the combustion chamber and are completely "bricked in". The flames and combustion gases follow along the bottom half of the outside shell and return through the flues to the stack. These boilers are economical for large operations. Several can be placed side by side.

Water Treatment

Regardless of the type of boiler, it can be ruined quickly if care is not exercised in properly treating the boiler feed water. Alkaline water will deposit scale, usually of calcium and magnesium while acid water reacts directly with the steel. Scale decreases boiler efficiency by acting as an insulating layer on the tube. At the same time, by preventing the heat from radiating into the water, it allows the steel of the tube to become overheated with resulting injury to the tube. An operator should consult a company which is an accepted authority on boiler feed water treatment. Sodium carbonate and trisodium phosphate are two compounds commonly used in treating alkaline boiler feed water. With these, the pH of the water is maintained between pH 10.00 and 11.00. On the other hand, if the water is acid it may be necessary to add slaked lime to the

boiler feed water to neutralize it. Slaked lime is only slightly soluble in water and an operator would have to experiment until he obtained a very light white powdery deposit on the tubes. The foregoing two suggestions may serve as a stop-gap until a proper water analysis and recommendation can be made by a reputable company.

Location of Boiler

Where feasible, the boiler house should be situated with a 25-foot space between it and the cannery building. If the boiler is within the cannery building, then fire walls should be built to isolate the boiler room. The fire insurance company with whom the cannery operator will deal should be consulted regarding specifications for boiler house installations.

The Canning Process

Steps in the process of canning involve: (1) washing, (2) preparation including blanching, grading and packing in cans, (3) addition of sugar, salt, syrup, brine or sweetened brine, (4) exhausting, (5) capping, (6) cooking (processing), and (7) cooling. The canning process depends entirely on the action of heat to kill micro-organisms or spores of micro-organisms in the product. Salt or sugar, used in concentrations giving the greatest palatability, have no sterilizing effect.

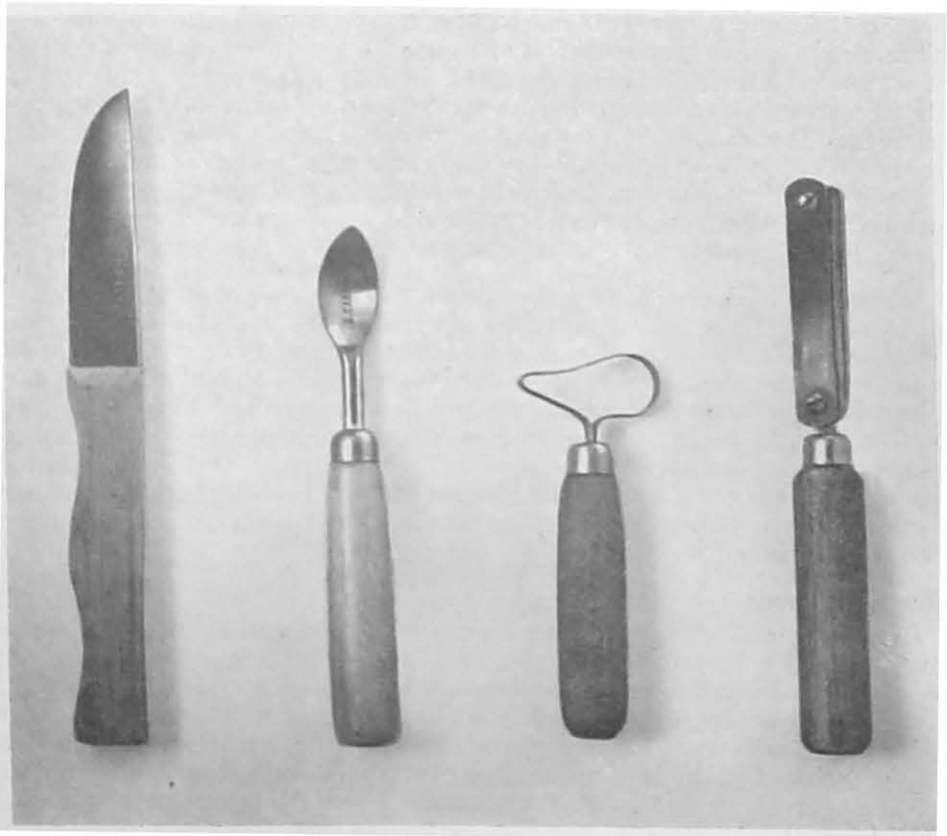

FIG. 2—Preparation Utensils
 (Left to right) Cannery knife, peach pitting spoon, pear coring loop, and pear paring knife.

Preparation of the Products, Grading and Packing in Cans

Preparation refers to the washing, cutting, pitting, scalding, peeling, trimming, sorting and grading of the product for canning. Preparation utensils are shown in Figure 2. The raw product going into the cans should be graded for quality and size so that the finished product will comply with the grades of the Meat and Canned Foods Act.

Types and Sizes of Cans

Cans for fruit are either plain or enamel. Enamel cans are used for coloured fruits or vegetables such as berries, prunes, beets, etc. A special enamel may be used for a corrosive product such as apple juice. Corn is an example of another product requiring a special enamel. When contemplating a pack, it is a good policy to consult the company from whom containers will be purchased to ascertain the type of can recommended. The classification for some of the more important fruits and vegetables is given in Table 1.

TABLE 1—CLASS OF ENAMEL FOR VARIOUS PRODUCTS

Product	Enamel
<i>Fruits</i>	
Apricots	Plain
Blackberries	Enamel
Blueberries	Plain or Enamel
Cherries:	
Black, and Red Sour	Enamel
Royal Anne	Plain
Loganberries	Enamel
Peaches	Plain
Pears	Plain
Plums:	
Green and Yellow varieties	Plain
Red varieties	Enamel
Prunes	Enamel
Raspberries	Enamel
Strawberries	Enamel
Tomatoes	Plain
<i>Vegetables</i>	
Asparagus	Plain
Beans, Green	Plain
Beets	Enamel or C Enamel
Carrots	Plain or C Enamel
Corn	C Enamel
Peas	Plain
Spinach	Plain

At one time, cans for fruit were commonly described by numbers that were assigned to them, such as No. 1, No. 2, No. 2½ and No. 10. Latterly, they have been described by their equivalent weights, such as 16 fluid ounce, 20 fluid ounce, 28 fluid ounce, or 105 fluid ounce, or the more accurate description which gives the measurement of diameter and height. For instance, a No. 2 is a 20 fluid ounce or 307 x 409. The first figure, "3" means inches and the last figure "7" means sixteenths. Thus a No. 2 can is 3-7/16 by 4-9/16 inches. This definitely identifies a can and overcomes possible confusion that may result from previous nomenclatures. A table entitled "Metal Containers" in the Meat and Canned Foods Act describes the can sizes that may be used for each product in Canada. For fruits the following sizes are legal at the time of writing:

<i>Size Designation</i>	<i>Diameter and Height</i>
Canada size—	
10 fluid ounce	211 x 400
15 " "	300 x 407
	301 x 406
	307 x 309
20 " "	307 x 409
28 " "	401 x 411
105 " "	603 x 700

For most vegetables the foregoing sizes also apply. However, there are variations for asparagus and mushrooms. Because of variations and possibility of amendments to the Act, it is wise to consult the Chief Canning Inspector in regards to containers that are standard for each product.

Preparation of Syrup or Brine

The strength of syrup added to canned fruits is regulated by the Meat and Canned Foods Act while the strength of brine is left to the discretion of the processor. The required strength of syrup is expressed as a percentage such as 35, 40, 45, etc. This means, in the case of a 35 percent syrup, that 35 pounds of sugar is used with 65 pounds of water to make 100 pounds of syrup. To test this syrup, a Balling or Brix hydrometer is used. Both these instruments read directly in percentage. Hydrometers may be purchased in ranges such as 0-11, 9-21, 19-31, 29-41, etc. Less accurate hydrometers can be purchased which

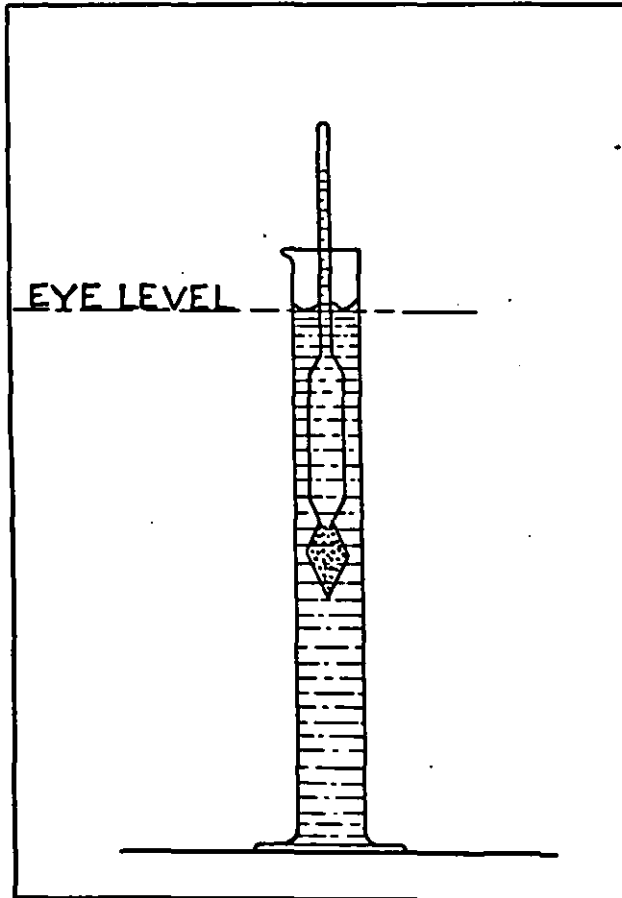

FIG. 3—Proper Level for Reading Hydrometer

TABLE 2—TEMPERATURE CORRECTIONS FOR BALLING (BRIX) HYDROMETERS*
(Hydrometers calibrated at 68° F. (20° C.))

Showing actual Balling reading of syrup at observed temperature

Temp- era- ture	Degree of syrup (percent of sugar) desired														Temp- era- ture	
	5	10	15	20	25	30	35	40	45	50	55	60	65	70		
	Actual hydrometer reading at temperature observed															
° F.																° C.
32	5.5	10.6	15.8	20.9	26.0	31.1	36.2	41.2	46.3	51.4	56.4	61.4	66.5	71.5	0	
35	5.5	10.6	15.7	20.8	25.9	31.0	36.1	41.1	46.2	51.3	56.3	61.3	66.3	71.4	1.7	
40	5.5	10.6	15.7	20.7	25.8	30.9	35.9	41.0	46.0	51.1	56.1	61.1	66.2	71.2	4.4	
45	5.4	10.5	15.6	20.6	25.7	30.7	35.8	40.8	45.9	50.9	55.9	60.9	66.0	71.0	7.2	
50	5.4	10.4	15.5	20.5	25.6	30.6	35.6	40.7	45.7	50.7	55.7	60.7	65.8	70.8	10.0	
55	5.3	10.3	15.4	20.4	25.4	30.4	35.5	40.5	45.5	50.5	55.5	60.5	65.6	70.6	12.8	
60	5.2	10.2	15.2	20.2	25.3	30.3	35.3	40.3	45.3	50.3	55.3	60.3	65.3	70.3	15.5	
65	5.1	10.1	15.1	20.1	25.1	30.1	35.1	40.1	45.1	50.1	55.1	60.1	65.1	70.1	18.3	
68	5.0	10.0	15.0	20.0	25.0	30.0	35.0	40.0	45.0	50.0	55.0	60.0	65.0	70.0	20.0	
70	4.9	9.9	14.9	19.9	24.9	29.9	34.9	39.9	44.9	49.9	54.9	59.9	64.9	69.9	21.1	
75	4.8	9.8	14.8	19.7	24.7	29.7	34.7	39.7	44.7	49.7	54.7	59.7	64.7	69.7	23.9	
80	4.6	9.6	14.6	19.6	24.5	29.5	34.5	39.5	44.5	49.5	54.5	59.5	64.5	69.5	26.7	
85	4.4	9.4	14.4	19.4	24.3	29.3	34.3	39.3	44.3	49.3	54.2	59.2	64.2	69.2	29.4	
90	4.2	9.2	14.2	19.1	24.1	29.1	34.0	39.0	44.0	49.0	54.0	59.0	64.0	69.0	32.2	
95	4.0	9.0	13.9	18.9	23.9	28.8	33.8	38.8	43.8	48.8	53.8	58.8	63.8	68.8	35.0	
100	3.7	8.7	13.7	18.7	23.6	28.6	33.6	38.6	43.5	48.5	53.5	58.5	63.5	68.5	37.8	
105	3.5	8.5	13.4	18.4	23.4	28.3	33.3	38.3	43.3	48.3	53.3	58.3	63.3	68.3	40.5	
110	3.2	8.2	13.2	18.1	23.1	28.1	33.1	38.0	43.0	48.0	53.0	58.0	63.1	68.1	43.3	
115	2.9	7.9	12.9	17.8	22.8	27.8	32.8	37.8	42.8	47.8	52.8	57.8	62.8	67.8	46.1	
120	2.6	7.6	12.6	17.6	22.5	27.5	32.5	37.5	42.5	47.5	52.5	57.5	62.6	67.6	48.9	
125	2.3	7.3	12.3	17.2	22.2	27.2	32.2	37.2	42.2	47.3	52.3	57.3	62.3	67.3	51.7	
130	2.0	7.0	11.9	16.9	21.9	26.9	31.9	37.0	42.0	47.0	52.0	57.0	62.0	67.1	54.4	
135	1.6	6.6	11.6	16.6	21.6	26.6	31.6	36.7	41.7	46.7	51.7	56.8	61.8	66.8	57.2	
140	1.3	6.3	11.3	16.3	21.3	26.3	31.3	36.4	41.4	46.4	51.5	56.5	61.5	66.6	60.0	
145	0.9	5.9	10.9	15.9	20.9	26.0	31.0	36.0	41.1	46.1	51.2	56.2	61.2	66.3	62.8	
150	0.5	5.5	10.5	15.6	20.6	25.6	30.7	35.7	40.8	45.8	50.9	55.9	61.0	66.1	65.5	
155	0.1	5.2	10.2	15.2	20.3	25.3	30.3	35.4	40.4	45.5	50.6	55.6	60.7	65.8	68.3	
160		4.8	9.8	14.9	19.9	24.9	30.0	35.0	40.1	45.2	50.2	55.3	60.4	65.5	71.1	
165		4.5	9.4	14.5	19.5	24.6	29.6	34.7	39.8	44.9	49.9	55.0	60.1	65.3	73.9	
170		4.1	9.0	14.1	19.2	24.2	29.3	34.4	39.5	44.5	49.6	54.7	59.8	65.0	76.7	
175		3.6	8.6	13.7	18.8	23.9	28.9	34.0	39.1	44.2	49.3	54.4	59.5	64.7	79.4	
180		3.2	8.1	13.3	18.4	23.5	28.6	33.7	38.8	43.8	48.8	53.9	59.1	64.4	82.2	
185		2.7	7.6	12.8	18.0	23.1	28.2	33.3	38.4	43.5	48.6	53.7	58.8	64.1	85.0	
190		2.2	7.1	12.4	17.5	22.7	27.8	32.9	38.0	43.1	48.2	53.4	58.5	63.8	87.8	
195		1.8	6.7	12.0	17.1	22.3	27.4	32.5	37.7	42.8	47.9	53.1	58.2	63.5	90.5	
200		1.3	6.2	11.5	16.7	21.8	27.0	32.1	37.3	42.4	47.5	52.7	57.8	63.1	93.3	
205		0.8	5.7	11.1	16.2	21.4	26.5	31.7	36.9	42.0	47.2	52.4	57.5	62.8	96.1	
210		0.2	5.3	10.6	15.8	21.0	26.1	31.3	36.5	41.6	46.8	52.0	57.2	62.5	98.9	
212		0.1	5.2	10.4	15.6	20.8	26.0	31.2	36.1	41.5	46.7	51.9	57.0	62.4	100.0	

* This table is calculated from data in the U.S. Bureau of Standards Circular No. 440; Table 44.4 in Methods of Analysis, A.O.A.C., 1945; and tests made in the Summerland Laboratory. Figures are to the nearest tenth.

cover a range of 0-30 and 30-70. With these hydrometers, one should buy a hydrometer jar of either Pyrex glass or metal. The proper method of reading a hydrometer in a glass cylinder or jar is illustrated in Figure 3. The correct method of reading the hydrometer in a metal cylinder is to have the cylinder full and take the reading at the top of the surface of the liquid. Since the density of a syrup decreases as the temperature increases, it is necessary to use a temperature correction table for hot syrups. Table 2 gives the necessary corrections for a hydrometer standardized at 68° F. For example, a 45 percent syrup reads 39.5 percent at 170° F. With this table, it is necessary to use a thermometer and it is suggested that one with a scale of 30-300° F. in 2° divisions be purchased.

Strengths of syrup required by the Act at the present time are given in Table 3. The gallons of syrup of the usual strengths that can be made from 100 pounds of sugar are given in Table 4.

A salt hydrometer, sometimes called a salometer, with a scale of 0-100° is used for testing the strength of brine. Each 4° equals 1 percent salt. Most vegetables are canned in 10° or 2½ percent brine. The hydrometer is accurate at the temperature marked on the stem.

TABLE 3—MINIMUM SUGAR SYRUP STRENGTHS FOR CANNED FRUITS

Fruit	Percentage of sugar
Loganberries	50
Apricots	45
Cherries, sour	
Peaches	
Rhubarb	
Strawberries	
Blackberries	40
Boysenberries	
Crabapples	
Currants	
Fruit Cocktail	
Fruits for Salad	
Gooseberries	
Lawtonberries	
Maraschino Cherries	
Nectarberries	
Raspberries, all varieties	
Thimbleberries	
Pears, Bartlett, Flemish Beauty and other similar varieties	35
Apples	30
Blueberries	
Cherries, sweet	
Grapefruit	
Plums or Prunes	
Cantaloupe	25
Grapes	
Pears, Kieffer, Clapp and other similar varieties	

TABLE 4—SUGAR-SYRUP TABLE

(Based on figures accepted by International Commission,
Table 44.3, p. 815, A.O.A.C., 1945)

Relationship of syrup-Balling saccharimeter percentages, (actual percentage sugar), syrup specific gravity, and sugar calculated at 60° F. for use in preparation of syrups. Distilled water weighs 10 lb. per Imperial gal. at 60° F. For weight of syrup per gal. multiply specific gravity of syrup by 10. To calculate pounds of water per gal. of syrup, subtract weight of sugar from 10 times specific gravity of syrup of desired per cent sugar.

Balling reading and % sugar syrup	Specific gravity	Lb. sugar per gal. syrup	100 lb. sugar makes gallons syrup	Balling reading and % sugar syrup	Specific gravity	Lb. sugar per gal. syrup	100 lb. sugar makes gallons syrup
%		lb.	gal.	%		lb.	gal.
5	1.020	0.51	196.1	40	1.179	4.72	21.2
6	1.024	0.61	163.9	41	1.184	4.85	20.6
7	1.028	0.72	132.9	42	1.189	5.00	20.0
8	1.032	0.82	122.0	43	1.195	5.14	19.5
9	1.036	0.93	107.5	44	1.200	5.28	18.9
10	1.040	1.04	96.2	45	1.205	5.42	18.5
11	1.044	1.15	87.0	46	1.211	5.57	18.0
12	1.048	1.26	79.4	47	1.216	5.72	17.5
13	1.052	1.37	73.0	48	1.221	5.86	17.1
14	1.057	1.48	67.6	49	1.227	6.01	16.7
15	1.061	1.59	62.9	50	1.232	6.16	16.2
16	1.065	1.70	58.8	51	1.238	6.31	15.8
17	1.070	1.82	54.9	52	1.243	6.46	15.5
18	1.074	1.93	51.8	53	1.249	6.62	15.1
19	1.078	2.05	48.8	54	1.255	6.78	14.7
20	1.083	2.17	46.1	55	1.260	6.93	14.4
21	1.087	2.28	43.9	56	1.266	7.09	14.1
22	1.092	2.40	41.7	57	1.272	7.25	13.8
23	1.097	2.52	39.7	58	1.278	7.41	13.5
24	1.101	2.64	37.9	59	1.284	7.58	13.2
25	1.106	2.77	36.1	60	1.289	7.73	12.9
26	1.110	2.89	34.6	61	1.295	7.90	12.7
27	1.115	3.01	33.3	62	1.301	8.07	12.4
28	1.120	3.14	31.8	63	1.307	8.23	12.2
29	1.125	3.26	30.7	64	1.313	8.41	11.8
30	1.129	3.39	29.5	65	1.319	8.57	11.6
31	1.134	3.52	28.4	66	1.325	8.74	11.4
32	1.139	3.64	27.5	67	1.331	8.92	11.2
33	1.144	3.78	26.5	68	1.337	9.09	11.0
34	1.149	3.91	25.6	69	1.343	9.27	10.8
35	1.154	4.04	24.8	70	1.350	9.45	10.6
36	1.159	4.17	24.0	71	1.356	9.63	10.4
37	1.164	4.31	23.2	72	1.362	9.81	10.2
38	1.169	4.44	22.5	73	1.369	9.99	10.0
39	1.174	4.58	21.8	74	1.375	10.17	9.8
				75	1.381	10.36	9.6

Exhausting

Exhausting means the heating of filled cans before capping, in either hot water or steam, so that the contents will be expanded and the air contained in the product will be driven off or "exhausted". Removal of the air reduces corrosion of the tin plate and assists in preserving the flavour and colour of the product. Heating the contents of the can before capping overcomes undue strain on the can during the final cook. Exhausting also makes possible a greater vacuum on the finished product and thus delays the appearance of hydrogen swells or "springers". Consequently, shelf life is increased. For many products, a satisfactory exhaust should give at least a can centre temperature of 160° F.

at the end of the process (130° F. is sufficient for tomatoes). Some canneries, however, prefer to work to a definite vacuum. If the vacuum is to be used as a guide, it is taken after the cooked can has been cooled to room temperature. In this case the following vacuums can be recommended.

20 oz. (No. 2) & 28 oz. (No. 2½)	—	10-15 inches
105 oz. (No. 10)	—	8-10 inches

Capping

For the small canners, machines for putting the lids on cans are somewhat of a problem. The smallest canners are often trying to use a small machine for a job that is too big for it. Consequently, the machine parts become worn and a sloppy seam results with subsequent spoilage. The commercial power-driven machines include one with hand-operated rolls and foot treadle, Figure 4; one with mechanically-operated rolls and foot treadle, Figure 5; and a completely

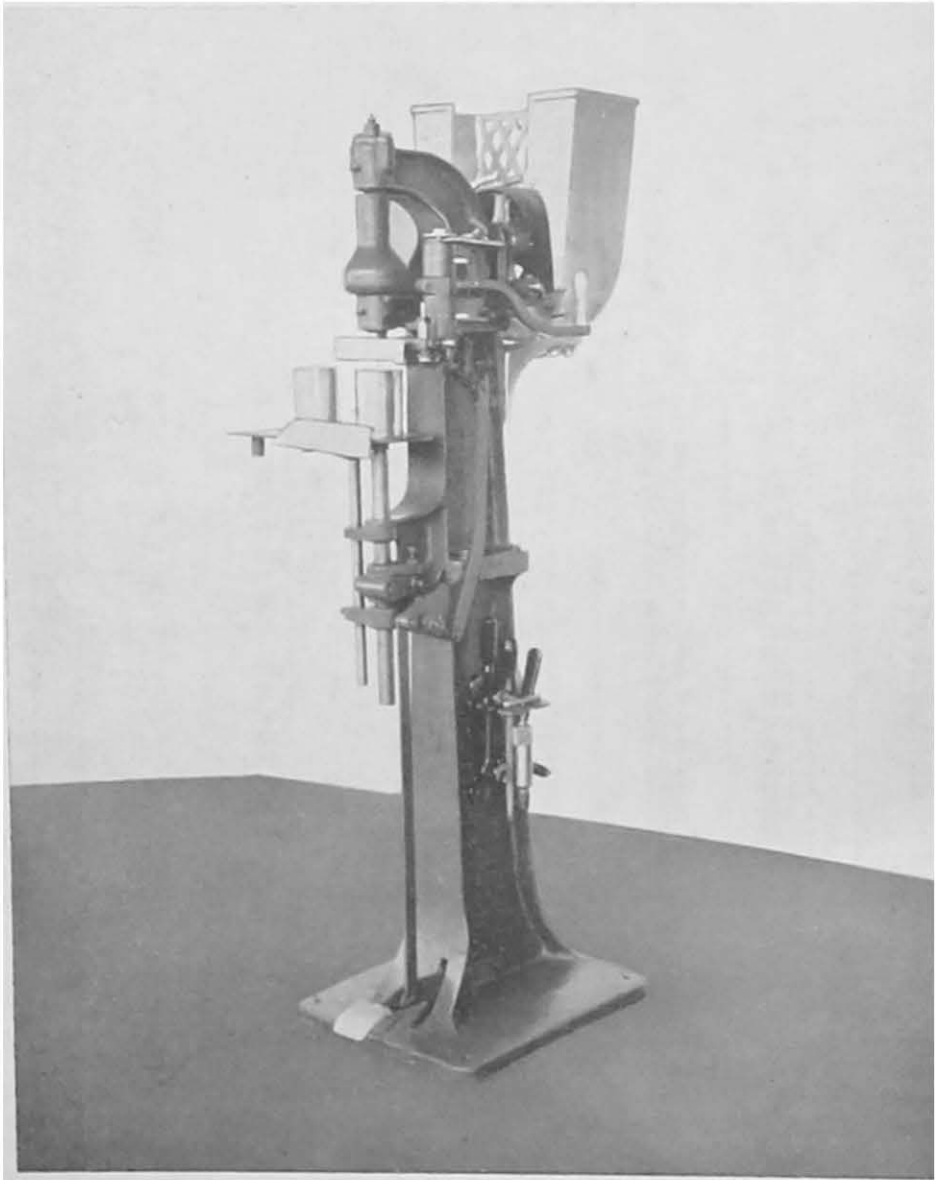

FIG. 4—Hand-operated Capper for No. 1 Size Cannery

automatic machine, Figure 6. These machines are obtainable on a rental basis from the can companies. It is suggested that a prospective canner become familiar with the machine he is using as quickly as possible and know how to adjust it so as to obtain a good seam. Poor seams are a frequent cause of trouble if a constant watch is not kept on the machine. A seam should be filed and taken apart during both the morning and afternoon shifts to determine if a properly formed seam is being obtained. Charts usually are available from the can manufacturing companies giving desirable measurements for the seam during its formation and when completed. Figure 7 shows the measurements that may be made and the names of the various parts*.

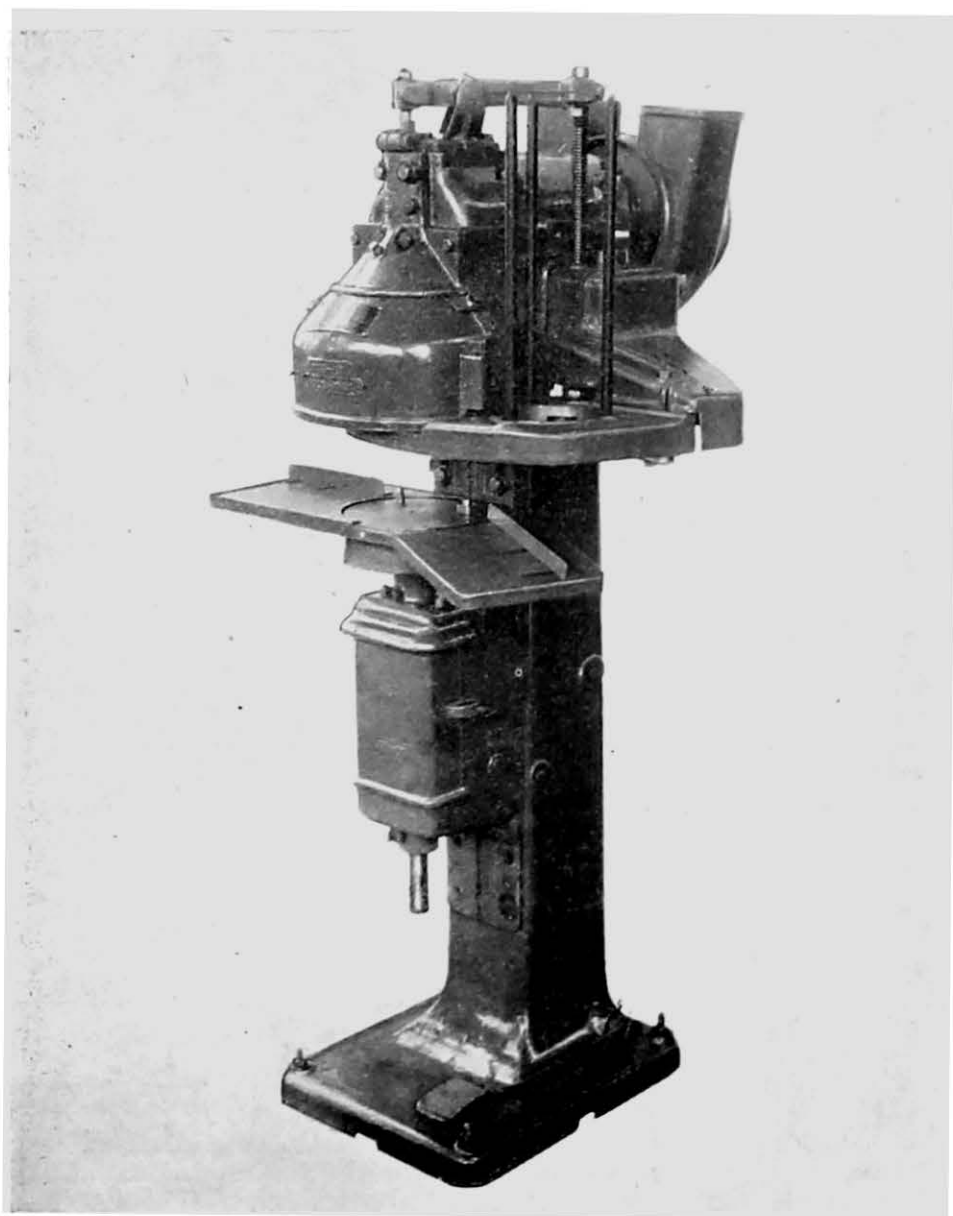

FIG. 5—Copper with Mechanically-operated Lid Feed and Rolls for Size No. 2 Cannery.

* Complete details on seams are given in an American Can Company Leaflet No. 4800, "The Top End Double Seam for Round Sanitary Type Process Cans", Revised 1948.

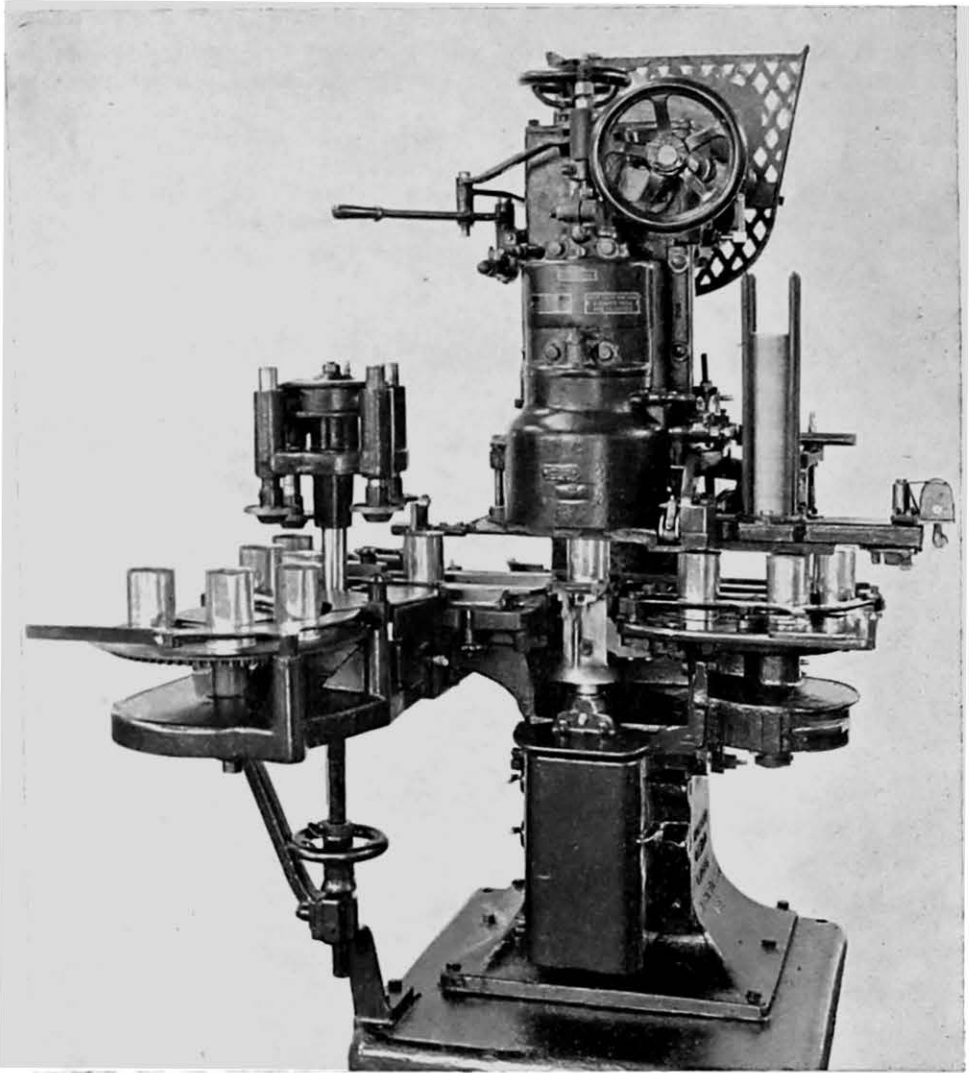

FIG. 6—Capper with Mechanical Lid Feed, Rolls and Can Conveyor for Size No. 3 and Larger Canners

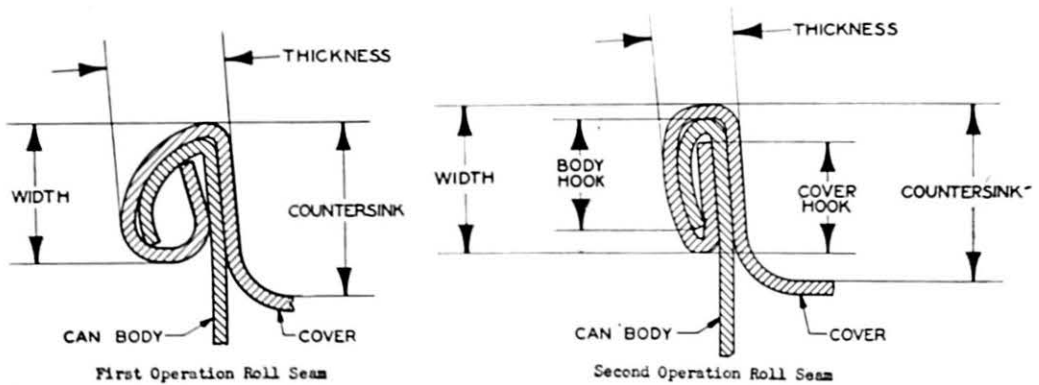

FIG. 7—Description of Double Seam

Coding

The establishment of a system of coding is very important. Many factors contribute to differences in quality between runs so that it is highly desirable that such runs can be identified later in the warehouse. It cannot be too strongly recommended that a system of coding be instituted which will at least identify each day's run and preferably each half-day's run. If the plant is being run on a 24-hour basis, coding could identify the product packed on each shift. A simple five-letter code is as follows:

A, B, or C—shift

a —day

1 —month ("1" would be the first month of operation in a year)

X —cannery mark (location in code indicates year)

As this is a five-letter code there are five possible locations for the cannery mark. The code can be repeated every five years.

A —product and grade

If cherries are the start of the season, "A" can mean Royal Ann Choice; "B", Lambert Choice; "C", Lambert Standard. If apricots are the next pack, "D" could mean Blenheim Fancy, "E", Moorpark Choice, etc.

If cherries were the first product packed in a year and July the start of the pack, the code, applied to the first shift on July 4, 1947, would be as follows: "Ad1XA".

This code is suitable for a small plant but would have to be expanded into a two-line code for large operations.

It is a good practice to use a notebook of a size that will fit comfortably into a pocket, for each year's coding system.

Cooking

The product is capped as soon after the exhaust treatment as possible and then cooked.

Factors influencing the cook are as follows:

1. Types of organisms to be destroyed, that is, the one with the highest heat resistance.

2. Number of organisms. The amount of heat required is partly dependent on numbers. (To overcome this factor, increase the cook or decrease the infestation.)

3. Rate of heat penetration at slowest heating point.

4. Initial temperature of food. Where cans wait for a cook to be made up such as in retort basket cooking, initial temperature should be considered as that of the first can placed in the basket.

5. Cooling rate of cans. Cans cooled with water need more cook than those that are air cooled.

6. Can centre temperature at the end of the process is more important than cook time and temperature. In taking the can centre temperature, an arrangement of equipment as illustrated in Figure 8 is suitable under factory conditions. This apparatus maintains the pressure on the can and thus turbulence is prevented which may cause the centre of the can to receive hot liquid from outside surfaces. Can centre temperature at the completion of the cook should be 190° F. or more for acid products. Tomatoes and Flemish Beauty pears should

reach 200° F. Non-acid products should attain a temperature of at least 240° F. but as this is not determinable with ordinary equipment one must rely on strict adherence to a definite retort operating schedule involving all the factors given later under "Retort Operation".

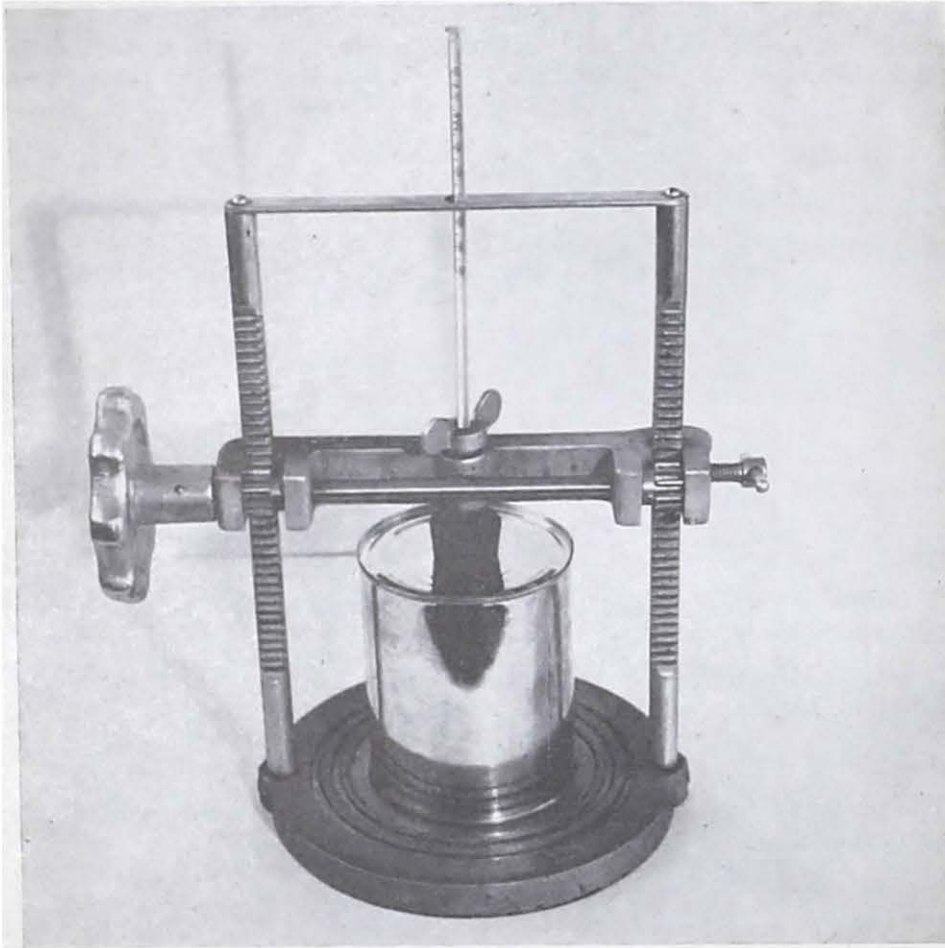

FIG. 8—Equipment for Determining Can Centre Temperature Under Factory Conditions

In cooking canned foods, the object is to obtain sufficient heat penetration so that any organisms that may cause spoilage, under the conditions in the can, are destroyed or rendered inactive. How heat will penetrate depends on the nature of the product. In the case of large fruits in syrup, such as halved peaches or pears, convection currents are set up. The syrup rises as it is heated around the outside of the can and flows down through the centre of the can which is thus quickly heated. In the case of a product such as solid pack spinach no convection currents are possible and the heat has to penetrate by the process of conduction by which one molecule heats another from the outside towards the centre of the can. This is a much slower process.

Another factor of extreme importance in sterilizing a can of produce is the presence or absence of acid. Products containing a substantial amount of acid are called "acid products", those containing little acid are called "low-acid products". If acid is present as in fruits, the combination of heat and acid will kill the organisms present if the can is heated in boiling water. Thus, acid

products are cooked in either boiling water or steam. Accordingly, fruit is processed in the following types of cookers: agitating, draper belt, open bath and retorts at low pressure. Where retorts are used for acid products, it is recommended that the temperature be at least 220° F. in order to obtain adequate steam circulation in the retort. The first two methods provide for a continuous line operation and give a more uniform cook. The time for the cook with an agitating cooker or draper belt is taken from the moment the can enters the cooker. The time for the start of the cook if an open bath is used is taken from the commencement of the boil. The cook time when a retort is used is taken from the time the retort is vented of air and the desired temperature and pressure shows on the instruments. When retorts are used at low pressures for cooking fruit the process lacks standardization as the air is difficult to vent from the loads of cans.

Low acid products such as vegetables, meat or fish, require cooking under pressure in a retort in order to obtain temperatures sufficiently high to effect the killing of the bacteria. Attempted sterilization of low acid products at the boiling point is never safe or practical. In processing low acid products, it is sometimes impractical to kill all the organisms as the heavy process would change the product so that it would be unacceptable. Consequently, the aim is to kill all organisms that grow at ordinary temperatures. Thermophiles or bacteria that only grow under high storage temperatures such as 130-140° F. are often present after the process is complete. They do not cause spoilage under normal storage conditions. Because these organisms are often present in canned low acid foods, the products are said to be "commercially sterile". When these organisms become active they may produce the so-called "flat sour" effect, or they may produce gas. All these faults will spoil the product for food. In order to obtain the necessary killing effect with as little change to the product as possible, asparagus, beans, beets, carrots, corn, peas, spinach, pumpkin, etc. always should be sterilized in a pressure cooker. With steam under 10 or 15 pounds pressure, temperatures of 240° and 252° F. are obtained. These temperatures are 28 to 40° hotter than boiling water and materially assist heat penetration and subsequent sterilization.

Table 5 gives suggested cooks and exhausts for acid products and Table 6, cooks for low acid products.

Cooling

After processing, vegetables usually are cooled with water by flooding the retort, by towing baskets through a cooling canal, by spraying, or by combinations of these methods. Similar cooling methods are employed with fruits. Cooling is continued until there is just enough heat left in the cans to dry the surface by evaporating the adhering water. This temperature is around 100 to 110° F. It is a good practice to use a cold potable water for cooling. Chlorination of cooling water is proving advantageous with many canned products where the bacterial contamination of the water is high.

TABLE 5—COOKS AND EXHAUSTS FOR ACID PRODUCTS

The cooks and exhausts given in this table should be used only as a guide. The can centre temperature at the end of the exhaust and at the end of the cook should be used as the final criterion.

Product	Size of can	Exhaust*		Cook at 212° F.		Remarks		
		Time	Temp.	Agitating or draper belt	Open bath or retort**			
Apples:— Solid pack	2	min.	° F. Filled hot @ 155-180° F.	min.	min.			
	2½							
	10						30-35	35-40
Sauce	2			8	8-12			
	2½			8	8-12			
	10			17	20-25			
Crabapples	2							
	2½							
	10	3	210	20	30			
Apricots:— Whole, halved	2	4-6	200	12	17	Better colour by not cool- ing too much.		
	2½	5-7	200	14				
		or 10	175					
	10			23				
Blackberries	2	7	190	11	10			
	2½							
	10	10	190	25	28			
Blueberries	2	8	200	6-10		Sometimes cooked in a kettle, filled hot, with no sterilization. A cook is considered advisable.		
	2½							
	10	10	200	18				

* These exhausts are suggested with an ingoing syrup temperature of 150-200° F.

** Retort preferably at 220° F.

TABLE 5—COOKS AND EXHAUSTS FOR ACID PRODUCTS (Continued)

Product	Size of can	Exhaust		Cook at 212° F.		Remarks
		Time	Temp.	Agitating or draper belt	Open bath or retort	
Cherries:— Black		min.	° F.	min.	min.	
	2	4-6	200	13-15		
	2½	7	200	16		
	10	12	200	25-30		
Red Sour pitted	2	8	200	17		
	2½					
	10	10	200	22	25-30	
Royal Anne	2	4-6	195-200	13-15		
	2½	6-7	195-200	16		
	10	12	200	25-30		
Fruit Salad	2					
	2½	8	200	10-12		
	10					
Gooseberries	2	8	185	8		
	2½					
	10	10	185	12-15		
Loganberries	2	8	200	8	10	
	2½					
	10	10	200	22	25	
Peaches	2	4-6	200	15	19	
	2½	5-7	200	20	23	
	10	12-14	200	30		

TABLE 5—COOKS AND EXHAUSTS FOR ACID PRODUCTS (Continued)

Product	Size of can	Exhaust		Cook at 212° F.		Remarks
		Time	Temp.	Agitating or draper belt	Open bath or retort	
		min.	° F.	min.	min.	
Pears:— Bartlett	2	7	200	17		
	2½	8	200	16-18	20	
	10	12	200	25	30	
Plums	2					
	2½	8	195	16	20	
	10	10	200	25		
Prunes:— Italian, fresh	2	4-6	200	13		
	2½	6-7	200	13-15		
	10	10-12	200	20		
Raspberries:— Black	2	7-8	190	10	10-12	
	2½					
	10	10	190	22	25	
Red	2	6-7	190	8	10	
	2½	7			14	
	10	10-12	200	22	25	
Rhubarb	2	9	200	11		
	2½					
	10	10-12	190	20		
Strawberries	2	7	190	10		
	2½					
	10	10	195	20		

TABLE 5—COOKS AND EXHAUSTS FOR ACID PRODUCTS (Continued)

Product	Size of can	Exhaust		Cook at 212° F.		Remarks
		Time	Temp.	Agitating or draper belt	Open bath or retort	
Tomatoes	2½	min. 8-10	° F. 205	min. 25-30	min. 30-35	
	10					
Juice	20 oz.	Preheated to 190° F. before filling, or preheated to 250° F. and cooled to 190° F. before filling, capped, cooled.		10		
	48 oz.			15		
	105 oz.					
Puree and Pulp	10 4 gal.	Filled at 190° F. or more, air cooled. No. 10 cans filled at 180° F. or less should be cooked 1 hour in open bath.				
Apple Juice	20 oz. 48 oz. 105 oz.	Flash heated to 190° F. Filled immediately and cooled. A time interval of 2 min. after capping may be allowed before cooling.				

TABLE 6—COOKS FOR LOW-ACID PRODUCTS*

Asparagus, all green

Can name	Dimensions	Retort temperature	Time (a)	
			Tips up	Tips down
		° F.	min.	min.
12 fl. oz.	211 x 409	240	26	25
		248	16	15
20 fl. oz. (b)	307 x 409	240	26	25
		248	16	15

Asparagus cuts, white or green, including soup cuts

Can name	Dimensions	Retort temperature	Time
			min.
		° F.	
12 fl. oz.	211 x 409	240	25
		248	15
20 fl. oz. (b)	307 x 409	240	25
		248	15
105 fl. oz.	603 x 700	240	30
		248	18

- (a) Two series of processing times are shown in the last two columns, headed tips up and tips down, respectively. These headings refer to the position of the spears in the retort during processing. Processing the cans in a vertical position is very important.
- (b) Cans of 307 diameter but of other lengths than 409 should be given the same processes as the standard 20 fl. oz. can.
- * The figures in these tables have been taken from the 6th Edition of the National Canners Association Bulletin 26-L "Processes for Low-Acid Canned Foods in Metal Containers", March, 1946. Acquisition of this bulletin is strongly recommended for details on retort operation in connection with canning low-acid products.

Beans, green or wax, asparagus style (a) (b)

Can name	Dimensions	Retort temperature	Time
			min.
		° F.	
10 fl. oz.	211 x 400	240	25
20 fl. oz.	307 x 409	240	25
105 fl. oz.	603 x 700	240	45

- (a) These processes apply only to beans that are properly blanched.
- (b) All cans of asparagus style beans should be processed in a position such that the beans are upright in the retort.

Beans with pork, or baked beans (a)

Can name	Dimensions	Initial temperature	Process time at		
			240° F.	245° F.	250° F.
		° F.	min.	min.	min.
10 fl. oz.	211 x 400	140	70	60	50
		180	60	50	45
15 fl. oz.	300 x 407	140	80	70	60
		180	70	60	50
20 fl. oz.	307 x 409	140	95	85	75
		180	80	70	65
105 fl. oz.	603 x 700	(b) 160	210	190	175

(a) These processes are for beans with sauce, baked in pots or not baked in pots, with or without pork.

(b) Initial temperature of 160° F. specified for 105 oz. can.

Beets, whole, cut, diced, sliced or shoestring (a)

Can name	Dimensions	Retort temperature	Time
		° F.	min.
10 fl. oz.	211 x 400	240	30
20 fl. oz.	307 x 409	240	30
105 fl. oz. except sliced	603 x 700	240	40
105 fl. oz., sliced	603 x 700	240	45

(a) If beets are lye-peeled, the cooks apply only provided the lye has been completely removed by washing.

Carrots, whole, sliced, diced or shoestring, packed in brine (a)

Can name	Dimensions	Retort temperature	Time
		° F.	min.
10 fl. oz.	211 x 400	240	30
		250	20
20 fl. oz.	307 x 409	240	30
		250	20
105 fl. oz. except sliced	603 x 700	240	40
		250	27

(a) These cooks apply only to a brine pack. Other styles of carrots, including carrot chips, should not be packed without directions from a research laboratory connected with the canning industry. If carrots are lye-peeled, the cooks apply only provided the lye has been completely removed by washing. If carrots are packed "asparagus style", the cans should be processed on end.

Corn, cream style, or succotash

Can name	Dimensions	Initial temperature	Retort temp.	Time
		° F.	° F.	min.
10 fl. oz.	211 x 400	180	240	85
			245	65
			250	55
20 fl. oz.	307 x 409	180	240	90
			245	80
			250	70

Corn, whole kernel in brine (a)

Can name	Dimensions	Retort temperature	Time
		° F.	min.
10 fl. oz.	211 x 400	240	50
		245	35
		250	25
20 fl. oz.	307 x 409	240	50
		245	35
		250	25

(a) These processes apply only if the corn is well cleaned.

Peas

Can name	Dimensions	Retort temperature	Time
		° F.	min.
10 fl. oz.	211 x 400	240	35
		245	25
		250	15
20 fl. oz.	307 x 409	240	35
		245	25
		250	15
105 fl. oz.	603 x 700	240	50
		245	35
		250	23

Peas and Carrots

Can name	Dimensions	Retort temperature	Time
		° F.	min.
10 fl. oz.	211 x 400	240	40
		245	30
		250	20
20 fl. oz.	307 x 409	240	40
		245	30
		250	20
105 fl. oz.	603 x 700	240	60
		245	45
		250	30

Pumpkin or Squash

Can name	Dimensions	Initial temperature		Retort temp.		Time
		° F.		° F.		min.
15 fl. oz.	300 x 407	160	240	65		
		180	240	60		
		160	250	55		
		180	250	45		
20 fl. oz.	307 x 409	160	240	80		
		180	240	70		
		160	250	65		
		180	250	60		
28 fl. oz.	401 x 411	160	240	105		
		180	240	95		
		160	250	85		
		180	250	75		
105 fl. oz.	603 x 700	160	240	210		
		180	240	190		
		160	250	185		
		180	250	165		

Spinach or other greens

Draiped weight and net weight are of determining importance with spinach and other greens and must be controlled to ensure that the retort process will carry the intended sterilizing efficiency. The maximum drained weight given cannot be safely exceeded, and the net weight of contents should be at least that given for the respective sizes of can. Since blanched spinach tends to become stratified horizontally in 105 fl. oz. cans, it is found that heat penetration is more rapid when these cans are processed on their sides rather than in a vertical position. Therefore the process is shorter for cans processed in a horizontal position.

Can name	Dimensions	Retort temperature		Time	Maximum drained wt.	Minimum drained wt.	Minimum net wt.
		° F.					
10 fl. oz.	211 x 400	252	35	8	7	10	
20 fl. oz.	307 x 409	252	45	14.5	13	18	
105 fl. oz. (Horizontal position)	603 x 700	252	60	66	60	100	
		240	100	66	60	100	
105 fl. oz. (Vertical position)	603 x 700	252	75	66	60	100	
		240	130	66	60	100	

Fruits

Varieties

The following varieties of fruits are canned successfully:

<i>Fruit</i>	<i>British Columbia</i>	<i>Eastern Canada</i>
Apricots	Royal, Blenheim, Tilton	
Cherries	Royal Anne, Bing, Lambert	Royal Anne, Montmorency
Peaches	Veteran, Vedette, Valiant, Elberta, J. H. Hale	Jubilee, Veteran, Vedette, Valiant, Elberta
Pears	Bartlett, winter varieties	Bartlett, Kieffer, Clapp
Prunes	Italian	Italian and (Lombard and Green Gage Plums)
Raspberries	Washington, Willamette	Cuthbert, Columbia
Strawberries	British Sovereign	Premier, Senator Dunlap
Tomatoes	Clark's Special Early, Sugawara, John Baer, Stokesdale No. 4, Pritchard, strains of Earliana, Sioux.	John Baer, Bonny Best group

Maturity and Storage

Two factors—(1) the selection of fruit at its proper maturity for canning, and (2) careful handling in either common or cold storage—have a major influence on the quality of the final pack. If a canner is confronted with a large supply of fruit, cold storage is indispensable for keeping this fruit in good condition until it can be canned. Details are given under the following sub-headings.

Apricots

Apricots should be a golden colour and sufficiently firm for the majority of the fruits to be handled without bruising. A slight tinge of green in the suture is not objectionable. Canners prefer apricots that tend to be too ripe rather than green fruit that requires considerable sorting. The ripe fruit will produce a good quality canned pack and pie pack, or jam stock. The green fruit will produce a canned pack of poor quality and considerable fruit that will eventually be discarded.

If the fruit is in good condition it can be stored up to 2 weeks at 31° F. Storage for apricots should be free from any objectionable odours as these are easily absorbed by the fruit.

Peaches

Peaches (Veteran, Vedette and Valiant) are harvested when 4 to 6 days from canning maturity. The fruit should be transported to the factory while still firm. Ripening should be at a temperature of 70 to 75° F. Low temperatures in the neighbourhood of 35 to 45° F. will result in thin skins that are difficult to peel. High temperatures (85 to 90° F.) often result in a tendency towards being more clingstone. If the fruit is to be cold stored, it should be allowed to ripen until almost ready to can, and then stored at 31° F. Regardless of the kind of storage for peaches, the boxes should be "open-stacked", that is, there should be a 4- to 6-inch space between the rows of stacks, and each stack should be kept 2 to 3 inches away from other stacks in the row. In this way there can be ample movement of air, with subsequent lower humidity. This is very important in the control of rot and fruit flies. These varieties can be successfully stored 2 to 3 weeks at 31° F.

Hale and Elberta peaches may be treated similarly to the V varieties but there are seasons in northern areas when these varieties are not adaptable to cold storage.

Bartlett Pears

Bartlett pears are harvested when their pressure test with a Ballauf pressure tester is between 19 and 17 pounds. They then should be stored within 24 hours of harvest in cold storage at a temperature between 30 and 31° F. Forty-five days is a safe storage period. The fruit is ripened at a temperature between 65 and 70° F. Pears that have only been cold stored 10 days to 2 weeks will require about 11 days to ripen. Pears that are approaching the end of their storage life require only 3 to 4 days to ripen.

Italian Prunes

Prunes are harvested when the fruit is sweet, free from the pit, and the colour of the flesh is amber. If a refractometer is available, the juice of the fruit should show a soluble solids content of not less than 17 per cent. Fruit that has been harvested under dry conditions and is free from skin injury can be stored up to 3 weeks at 31° F. A fill of the container to not more than two-thirds is advisable.

All other commonly canned Canadian fruits should be harvested for canning when they are considered to be at their maximum eating ripe maturity. The practice of picking partially coloured fruit and allowing it to colour on the cannery platform should be discouraged.

Yield

The yield in cases per ton of tree fruits can vary tremendously depending on the size, quality, maturity and variety of the fruits being canned. The following figures in cases of 24-20 ounce cans per ton are considered very good yields. With the usual quality of fruit, some reduction should be expected and under abnormal conditions may be reduced as much as one-third to one-half.

<i>Fruit</i>	<i>Yield in cases per ton (24-20 oz. cans)</i>
Apricots	100
Cherries	100
Peaches	83
Pears	77
Prunes	100

General Equipment

The equipment described in the following is specifically for fruit, especially apricots, sweet cherries, peaches, pears, plums and prunes. Modifications for vegetables such as peas, corn and string beans will be given later.

Small canneries may be divided into three groups:

(1) those with only boiling water as in Plan No. 1; (2) those using boiling water and steam under no pressure as in Plan No. 2; and (3) those using a mechanical line and steam under pressure as in Plan No. 3. Plant capacity may be set at 5,000 cases of 24/20 ounce cans for plants with only boiling water, up to 10,000 to 12,000 cases for plants with steam under no pressure, and 25,000 cases or more for Plan No. 3. From Plan No. 3 a plant may expand into a large cannery.

Floor Plan No. 1:

Cannery With Only Boiling Water

This plan, Figure 9, is suggested for individuals in remote areas who wish to can their fruits, and as a pilot plant for groups who might wish to engage in the canning business but who are not familiar with the process. For this latter group, a great deal of information can be gained by having simple equipment and operating it for one season. This equipment would be set up in a building 16 feet wide and 40 feet long. The general operation of this cannery is described in the following paragraphs.

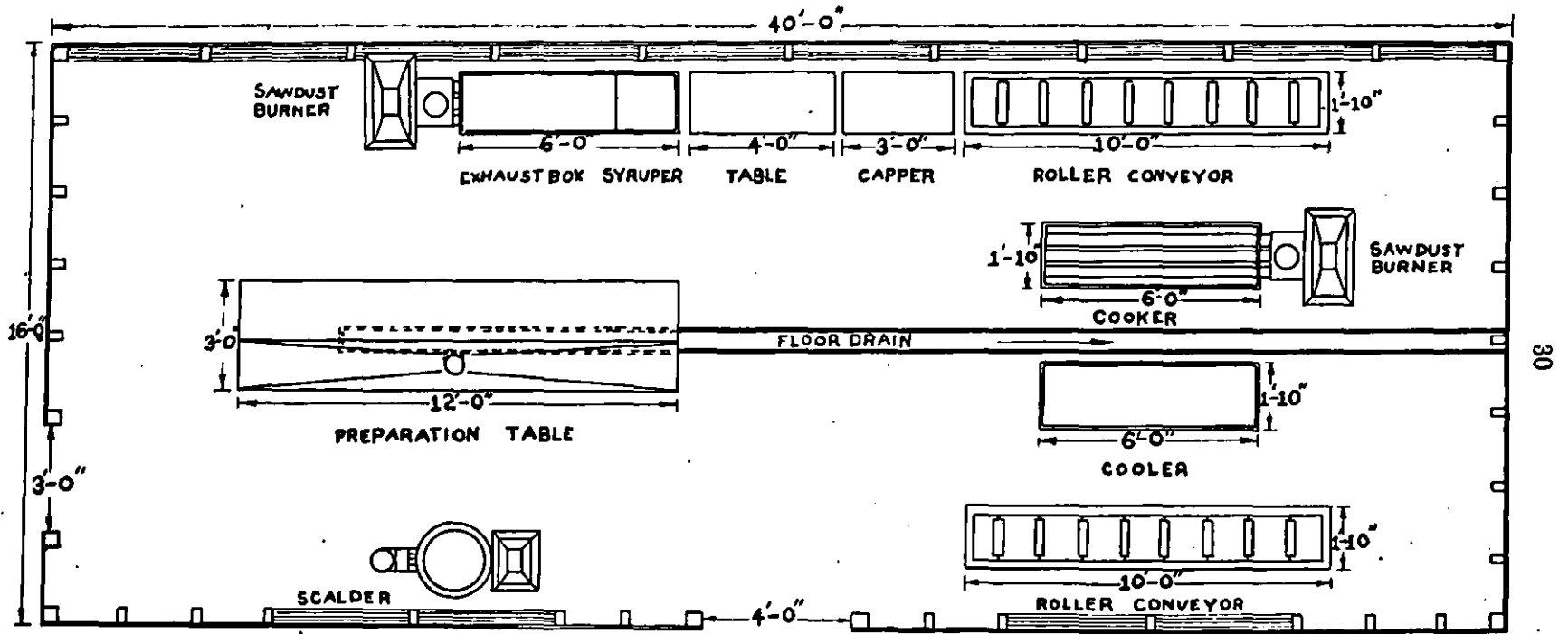

FIG. 9—Floor Plan of No. 1 Cannery

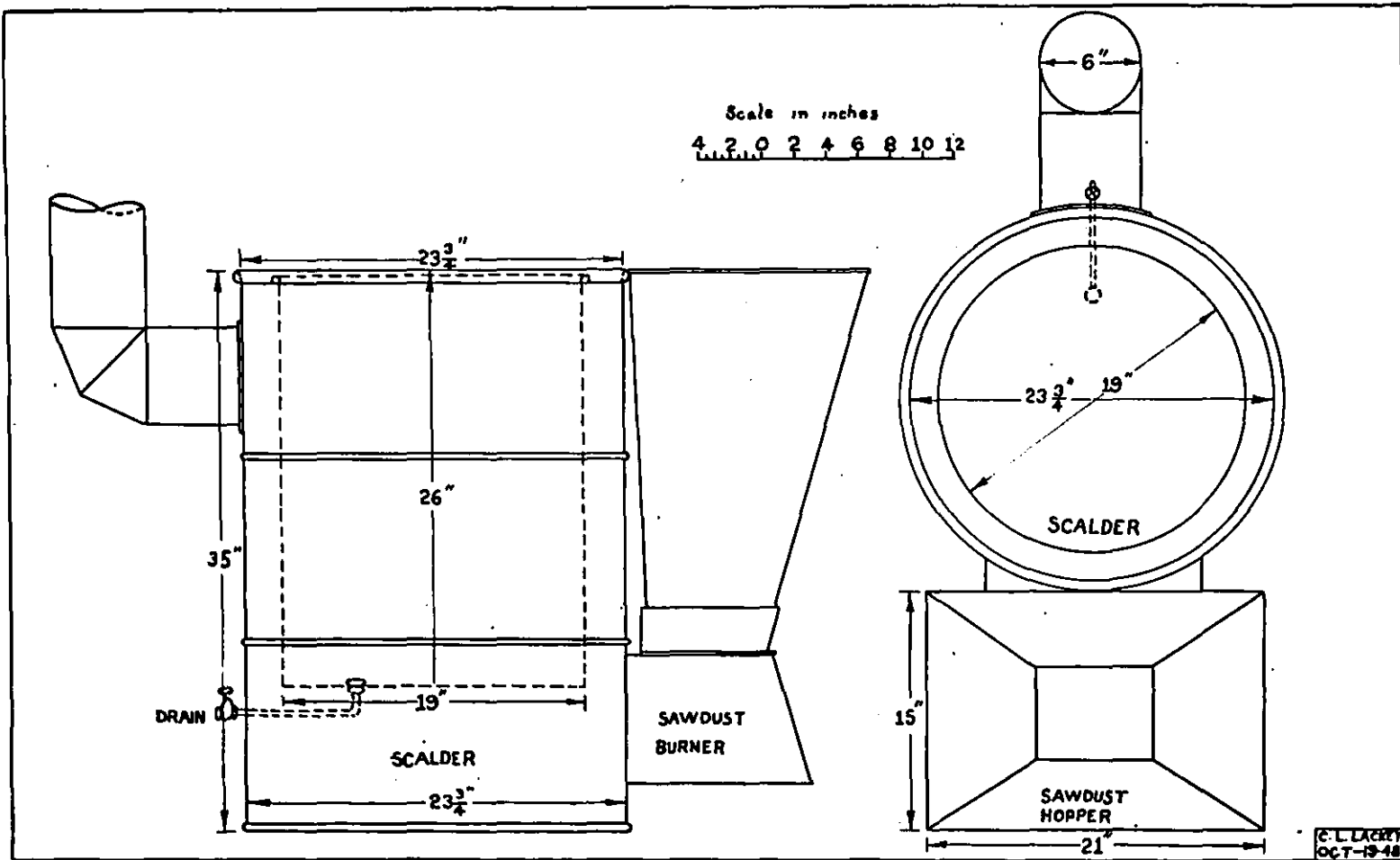

FIG. 10—Scalding for No. 1 Cannery

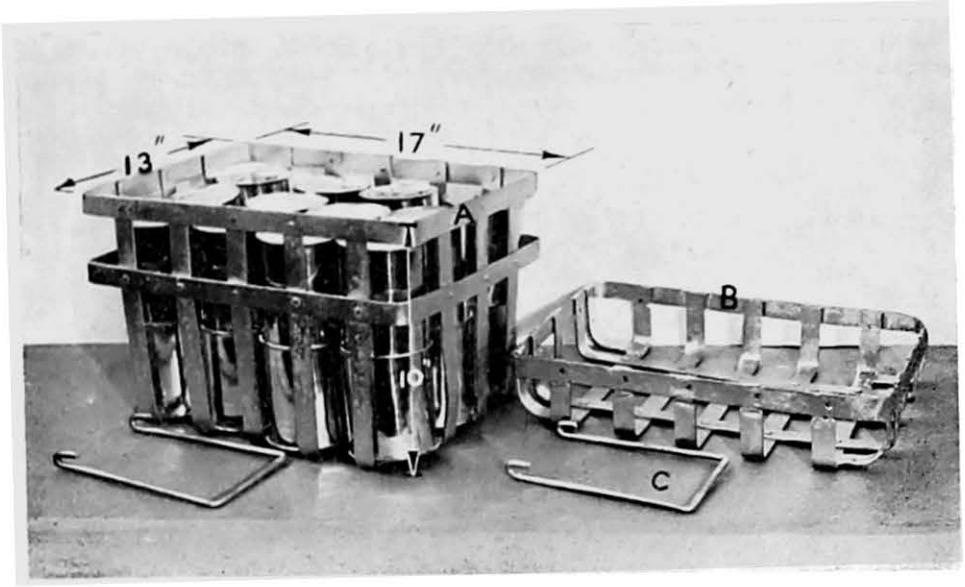

Fig. 11—Iron Baskets for No. 1 Cannery

A—cooking basket; B—exhausting basket; C—removable handles.

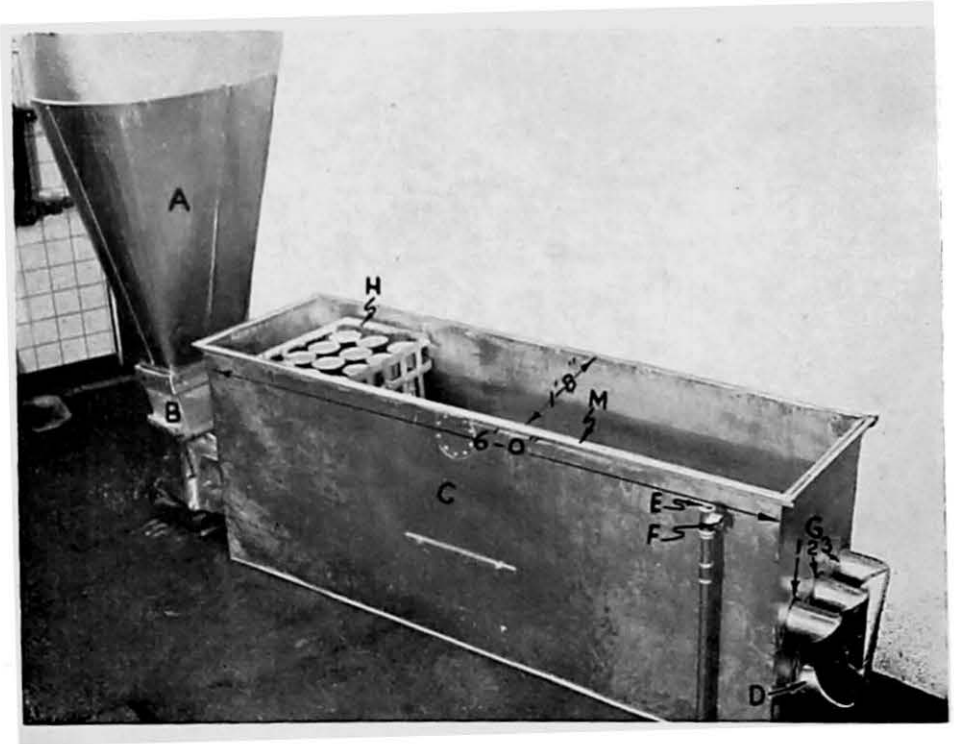

FIG. 12—No. 1 Cannery Cooker

A—hopper of sawdust burner; B—12" sawdust burner; C—main tank of cooker made of 20 ga. galvanized iron; D—end of 12" pipe carrying fire from sawdust burner; E—inlet of water supply; F—overflow to maintain even level; G 1, 2 and 3—4" pipes carrying flue gas back to end with sawdust burner; H—basket of cans ready for cook; M—angle iron reinforcing top of tank.

Products such as tomatoes are scalded in the scalding, Figure 10, and then placed in the sink of the preparation table for peeling and trimming. The product is filled into the cans and placed in trays illustrated in Figure 11, which each hold twelve 28-ounce cans. Trays of filled cans of tomatoes are placed in the exhaust box with the water of the box about half-way up the cans. Cans of fruit are syruped before being placed in the exhaust box. The exhaust box is similar to the cooker illustrated in Figure 12, but contains a galvanized tank that fits in one end in which syrup can be made for canning fruit. From the exhaust box the product is taken to a table near the capper and capped. The capped cans are placed in baskets, Figure 11, which are made to hold either 2 dozen No. 2½ or 39 No. 2 cans. As these baskets are filled, they are placed on the roller conveyor and when five are ready they are placed in the cooker. If the operation is progressing slowly so that there would be a long wait between capping and cooking, then each basket should be placed in the cooker as it is ready. In this case, individual times should be taken from the start of the cook for each basket. The cooking times are given in Tables 5 and 6. When the cook is complete the baskets are lifted into the cooler and cooled until the cans are a little warmer than blood heat (100 to 105° F.). The baskets of cans are then removed from the cooler and placed on the roller conveyor in such a position that the majority of cans will lie on their sides. This position allows for drainage and drying of the cans. They are then cased and warehoused.

PREPARATION TABLE.—The preparation table, 3 by 12 feet, has a 17-inch sink on the front side and shelves above the back portion, or sinks on both sides with central shelves as in Figure 13. The sink is provided with fresh water and a drain.

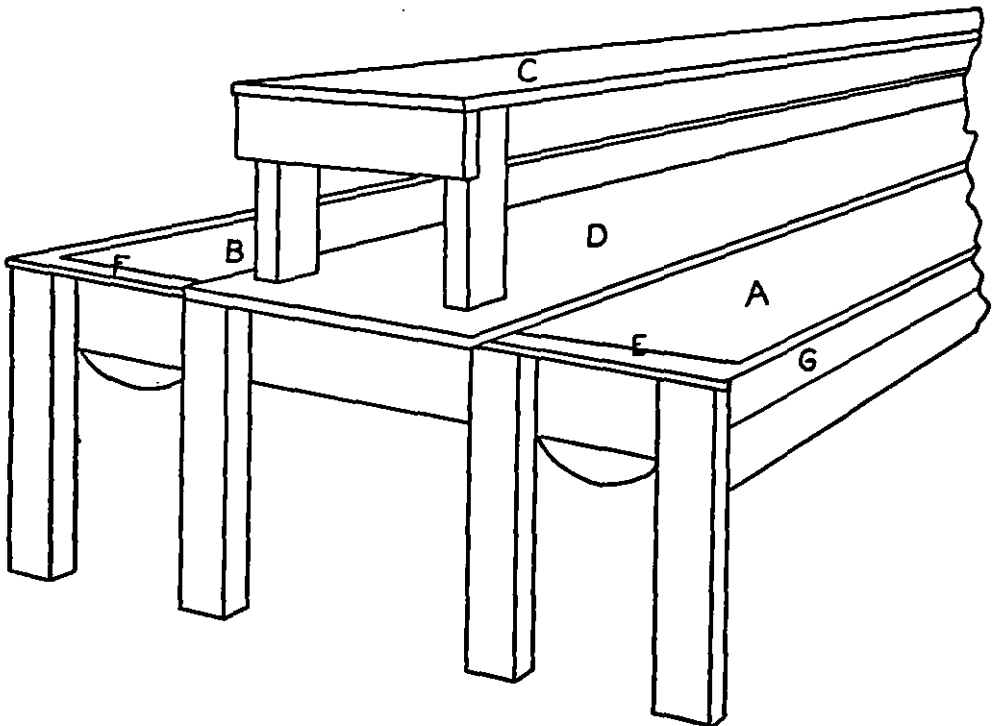

FIG. 13—Preparation Table for No. 1 Cannery

A and B—15' metal sinks; C—shelf for storage of empty cans; D—space for filled cans and cans being filled; E and F—location for taps to provide potable clean water; G—metal overlap from sink. Suggested table height for most workers is 36 inches.

EXHAUST BOX.—(similar design to cooker). The exhaust box is built of 20-gauge galvanized iron and may be heated with an 8-inch sawdust burner. Sawdust where available is a very convenient and economical source of heat for this purpose. However, the box could be heated with oil. If wood is to be used, additional depth to the box is needed with a bottom pipe about 14 inches in diameter. The syrup tank is 18 by 18 by 12 inches deep. This tank has a separate lid from the rest of the box. The syrup from this tank can be placed in any suitable container with a spout, for syruling fruit on the adjoining table.

CAPPER.—The capper for this cannery is power-driven of the type illustrated in Figure 4.

ROLLER CONVEYOR.—The roller conveyor is standard equipment available from any conveyor company. If it is not available, then rolls of 2- to 4-inch diameter may be placed between two 2 by 4's for this purpose.

COOKER.—The cooker is shown in Figure 12 with a 12-inch sawdust burner. A 24-foot stack of at least 7-inch diameter is required for proper operation of the sawdust burner. If one is operating in cool weather a brick chimney is preferred as it keeps the flue gas warm and thus maintains the necessary draught.

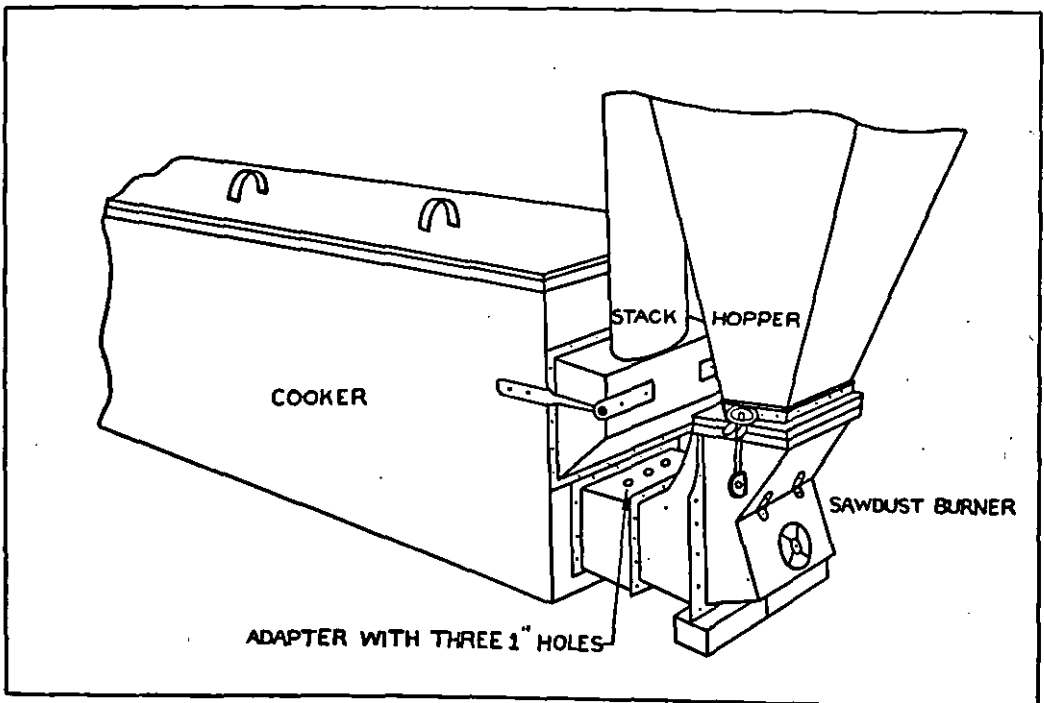

FIG. 14—Adapter for Sawdust Burner on No. 1 Cannery Cooker or Exhaust Tank.

An adapter as illustrated in Figure 14 is required for attaching the sawdust burner to the cooker. This adapter is made of light metal and has 3 one-inch holes on its top surface. These are necessary to provide additional air ahead of the burner. A flat piece of metal may be laid over these holes to act as a damper when the burner is being stopped. There should be no black colouring to the smoke. If there is any dark smoke more air through the adapter is indicated.

COOLER.—The cooler is a tank made of metal or wood and is approximately the same size as the cooker.

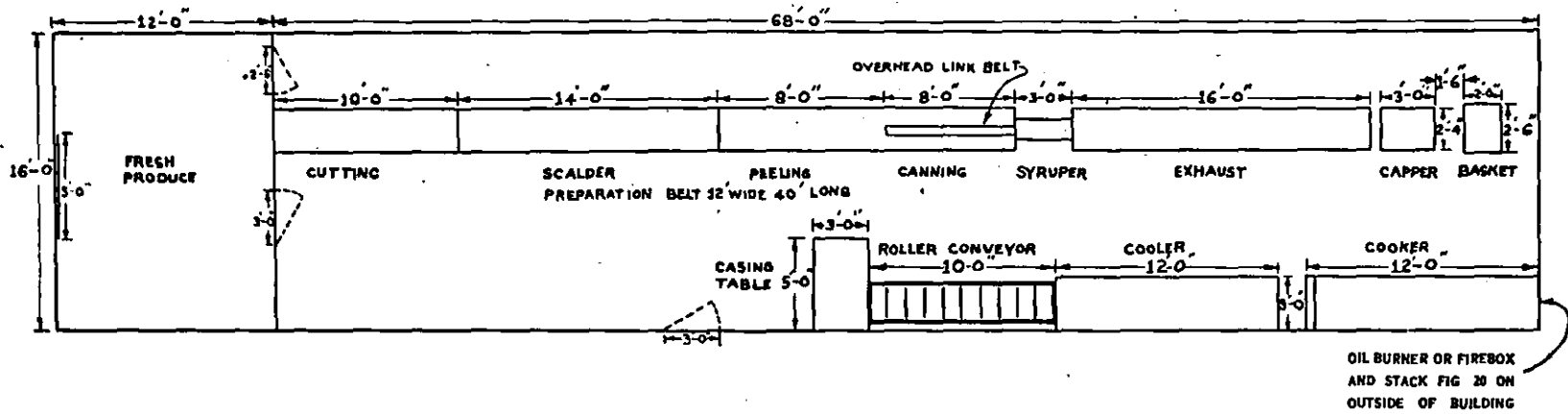

Fig. 15—Floor Plan of No. 2 Cannery

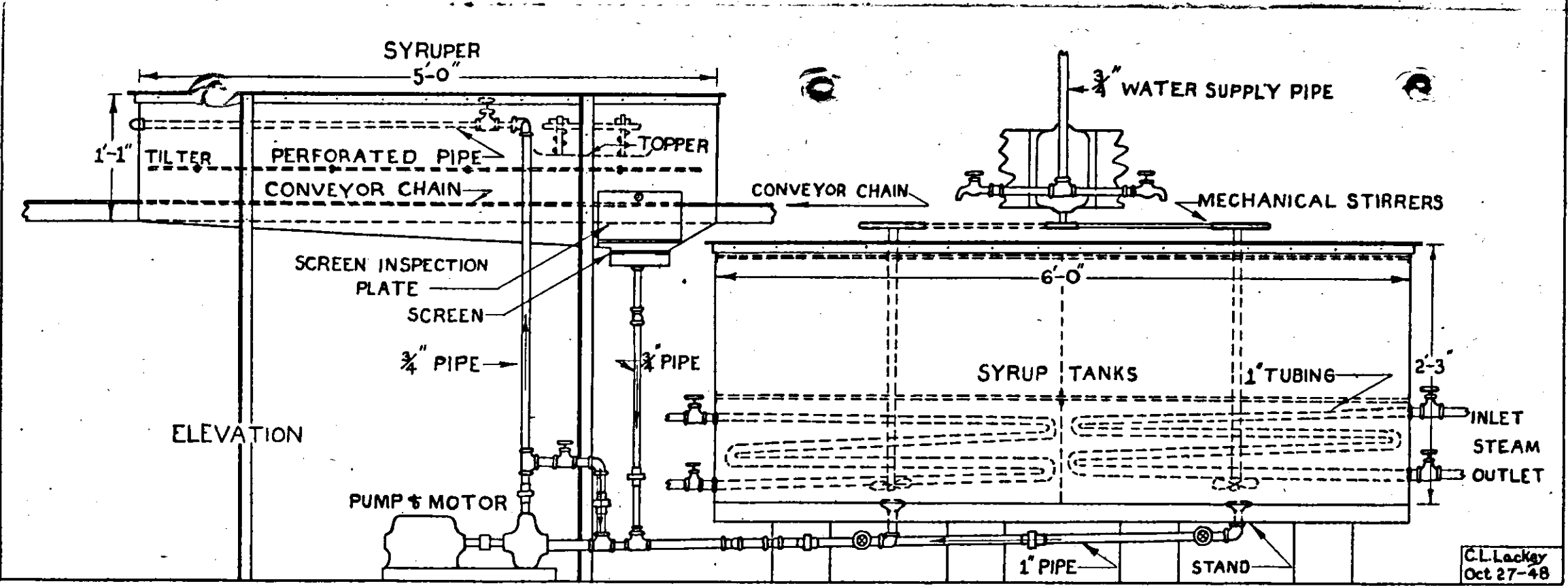
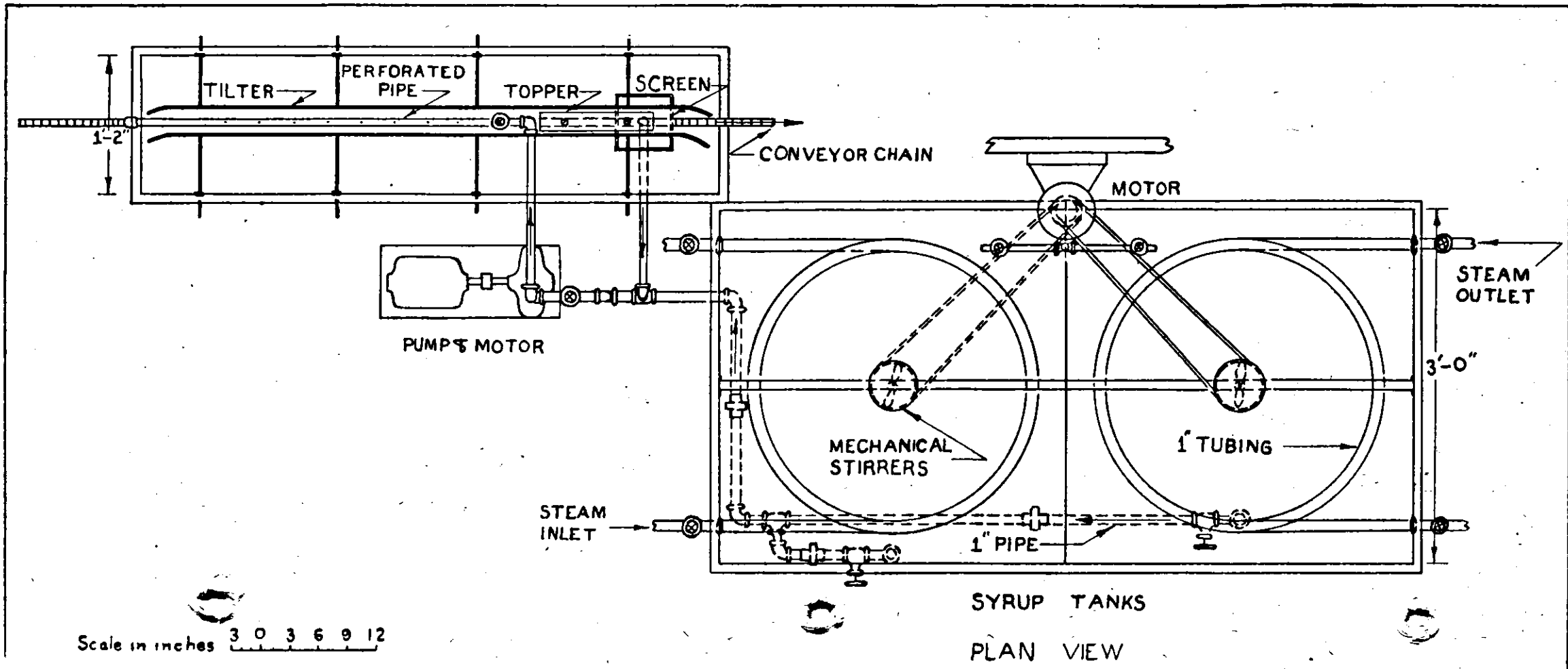

FIG. 16—Plan View and Elevation of Syruper for No. 2 and No. 3 Cannery

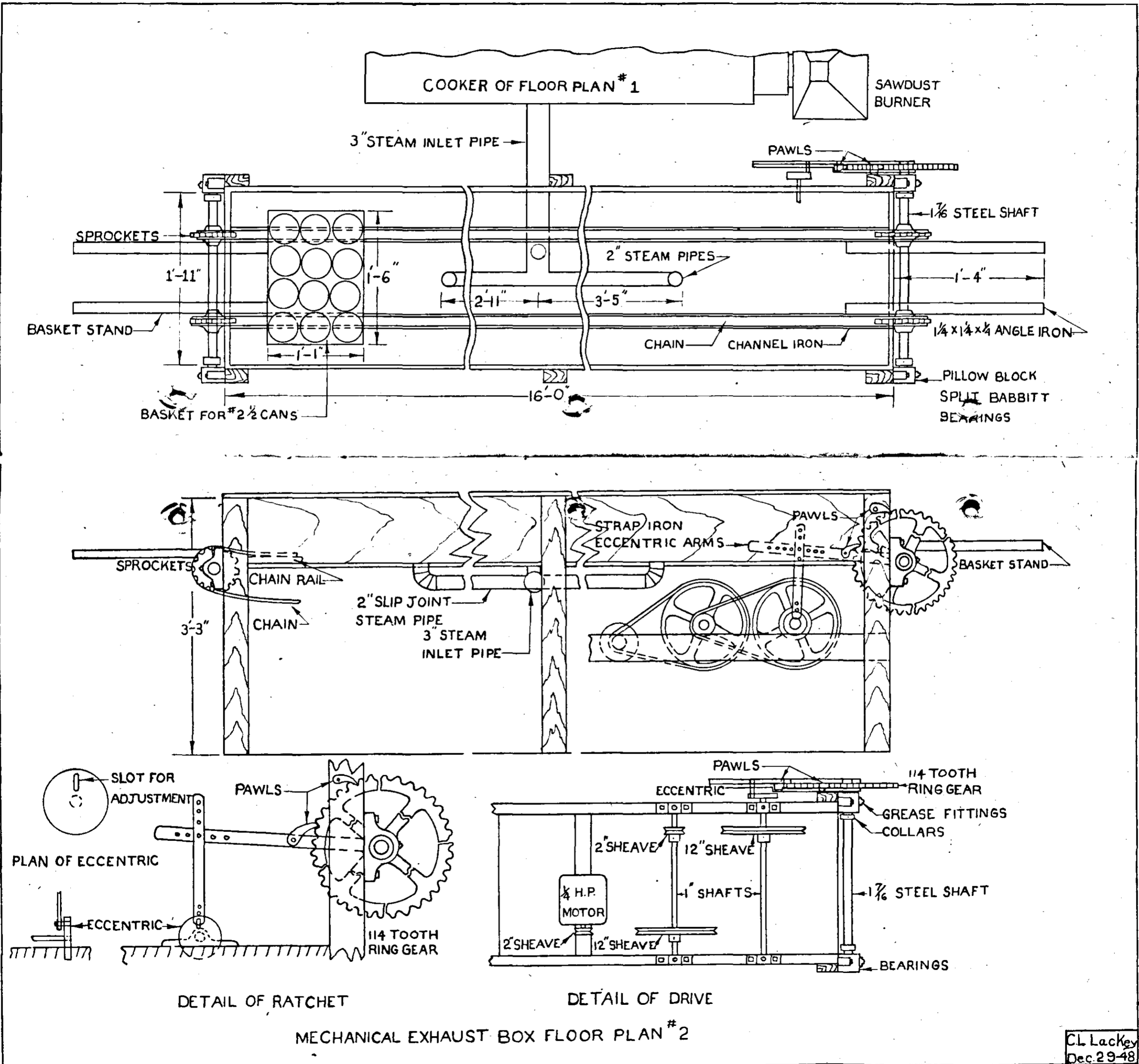

FIG. 17—Mechanical Exhaust Box for No. 2 Cannery

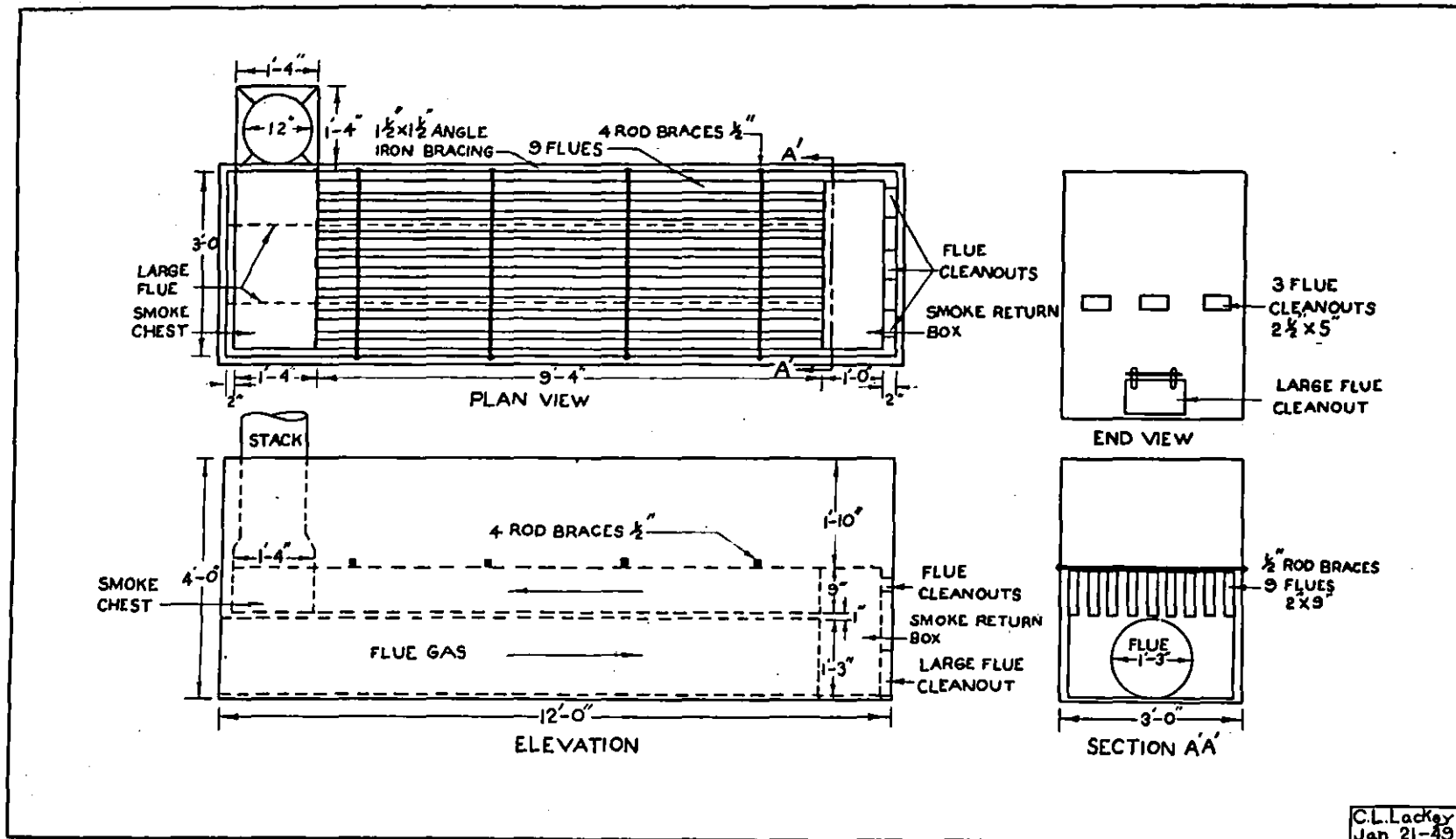

FIG. 18—Cooker for No. 2 Cannery

NOTES—(1) Plugs for flue cleanouts may be made from galvanized iron. (2) Supports may be welded to bottom of smoke boxes. (3) Separate lids over each basket of cans (baskets 23" x 34" x 18"). Lids wood or insulated metal, hinged on one side, raised with cord and pulley.

Floor Plan No. 2:

Cannery With Boiling Water And Steam Under No Pressure

PREPARATION BELT.—In this cannery, Figure 15, the preparation table and sink of Plan No. 1 have been replaced with a preparation belt 24 inches wide and 40 feet long. Cutting, scalding, peeling, and canning are done along the sides of this belt. Small removable sinks, 8 inches square and of varying length, are placed on the sides wherever necessary. Over the delivery end of this belt at the canning section, there is a link belt (S42 or similar link). This belt carries the filled cans through the syruper and to the exhaust box.

SYRUPER.—The syruper is a straight line machine as illustrated in Figure 16.

EXHAUST BOX.—The exhaust box is 16 feet long with either a 12-inch mat belt or two link belts. Details of a box with link belts are given in Figure 17. If the mat belt is used the cans may be transferred from the link belt in the syruper to the mat belt, but if the link belt is used, additional labour is needed to place the cans in trays. An alternative is to syrup by hand, and tray at the same time.

CAPPER.—The most practical capper for this operation is a power-driven machine with automatic rolls and foot treadle, Figure 5. The cans from this machine are placed in large slatted baskets (23 by 34 by 18 inches deep), which are lifted with an electric hoist and placed in the cooker, Figure 18.

COOKER.—The cooker indicated in the floor plan is 12 feet long, 4 feet high, and 3 feet wide, made of 16-gauge black iron and can be fired with either oil or by attaching a locomotive type boiler firebox. This firebox has the added advantage of supplying steam under no pressure for scalding and for the exhaust box. If an operator wishes to mechanize the cooker and cooler this can be equipped with mat draper belts similar to those used in the cooker and cooler in Plan No. 3. Otherwise it will be necessary to use baskets and an electric hoist. These baskets would be built similarly to those for the smaller cooker but would be 28 inches square and 18 inches high.

Locomotive boiler fireboxes that have been used for the purpose described here are the ones that have been left when boilers of about 40 h.p. have been scrapped. When this is done the tubes are used for some other purpose such as irrigation pipe and the body of the boiler is sold as steel plate. The remaining firebox has no scrap value and accordingly can be purchased at a low figure. A sheet of steel is welded over the original crown sheet to close the tube holes and a second is welded over the opening caused by cutting off the body of the boiler. The space between these sheets is usually 3 to 4 inches and becomes part of the water jacket. Holes for a 15-inch pipe are cut in these sheets to accommodate a connection for the flue gas and smoke flowing from the firebox to the flues of the cooker.

Where fireboxes are used, a complete variety of fuels may be burned including 4-foot slab wood, hog fuel, oil, sawdust, shavings, or stoker coal. A large-size sawdust burner is shown in Figure 19*, while a dutch oven with feed for shavings is shown in Figure 20. In the apparatus for feeding shavings a screw is used to convey this material and is driven by a ratchet similar to that shown in Figure 17 of the mechanical exhaust box for No. 2 canneries.

All this heating apparatus should be insulated.

* This burner was developed by Louis Deighton of Oliver, B.C.

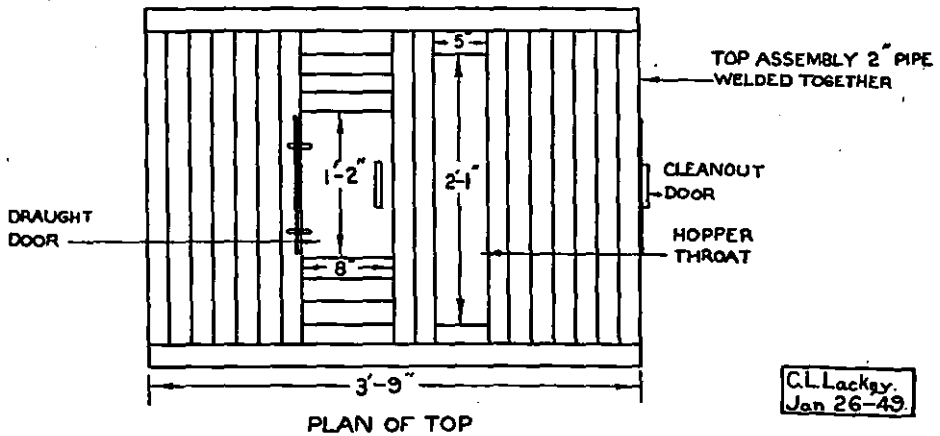
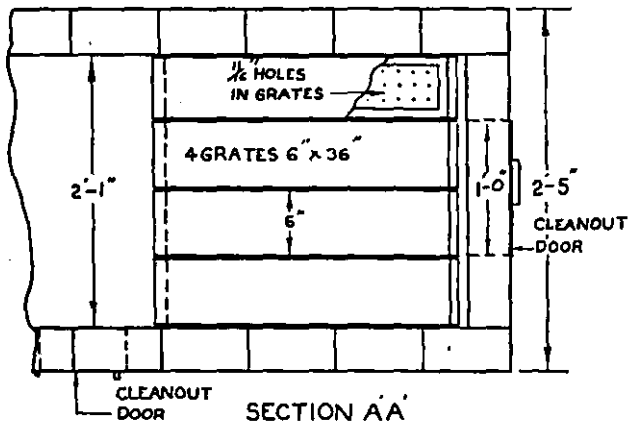
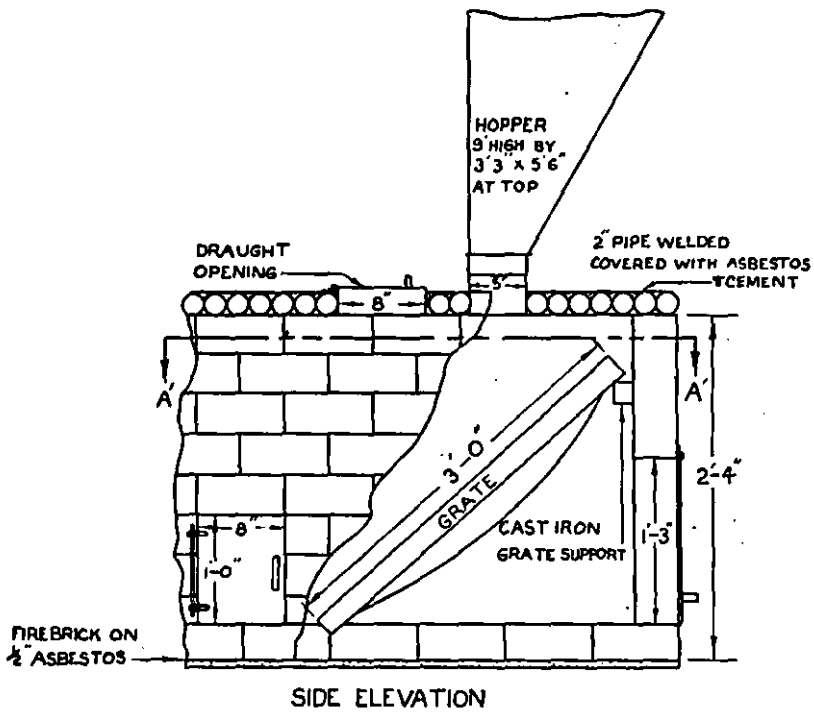

C.L. Lackey
Jan 26-49

FIG. 19—Large Sawdust Burner for No. 2 Cannery, showing Side Elevation, Section and Plan of Top

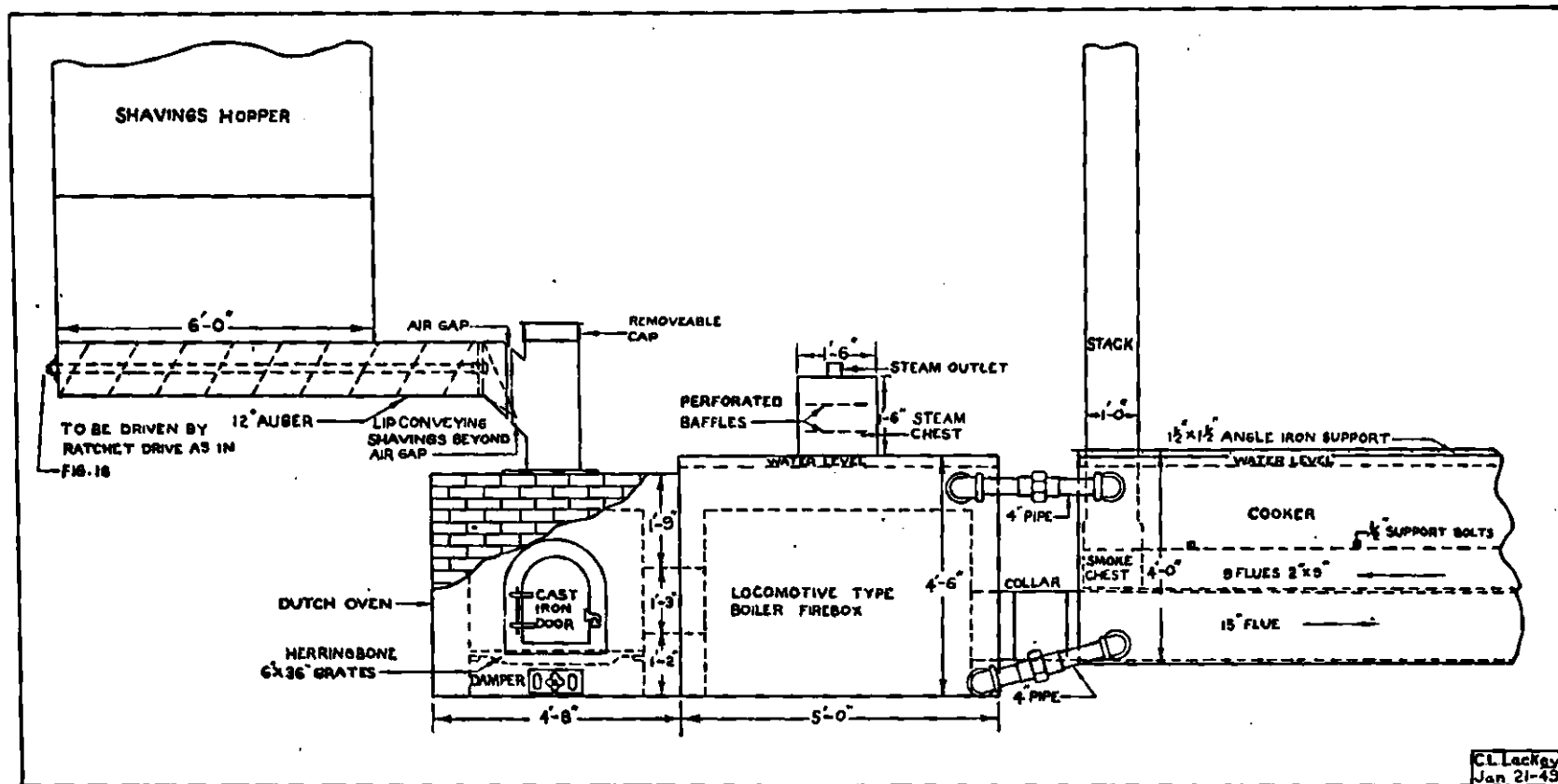

FIG. 20—Boiler Firebox Equipped with Dutch Oven and Shavings Hopper for No. 2 Cannery Cooker.

NOTES—(1) Thermostatic control for stoker, oil or shavings, to regulate temperature to 208° F. (2) 12" stack, 36' high, is shown. Stack 15 to 18" diameter preferred.

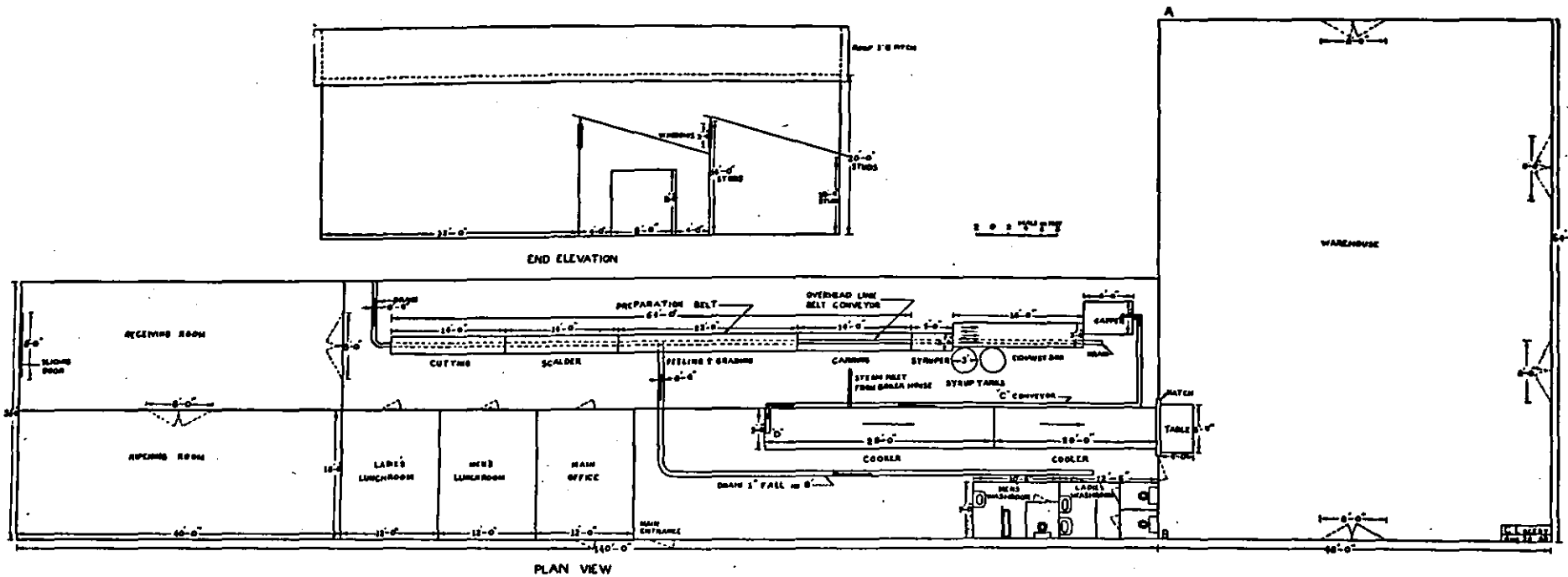

FIG. 21—Floor Plan and Elevation of No. 3 Cannery

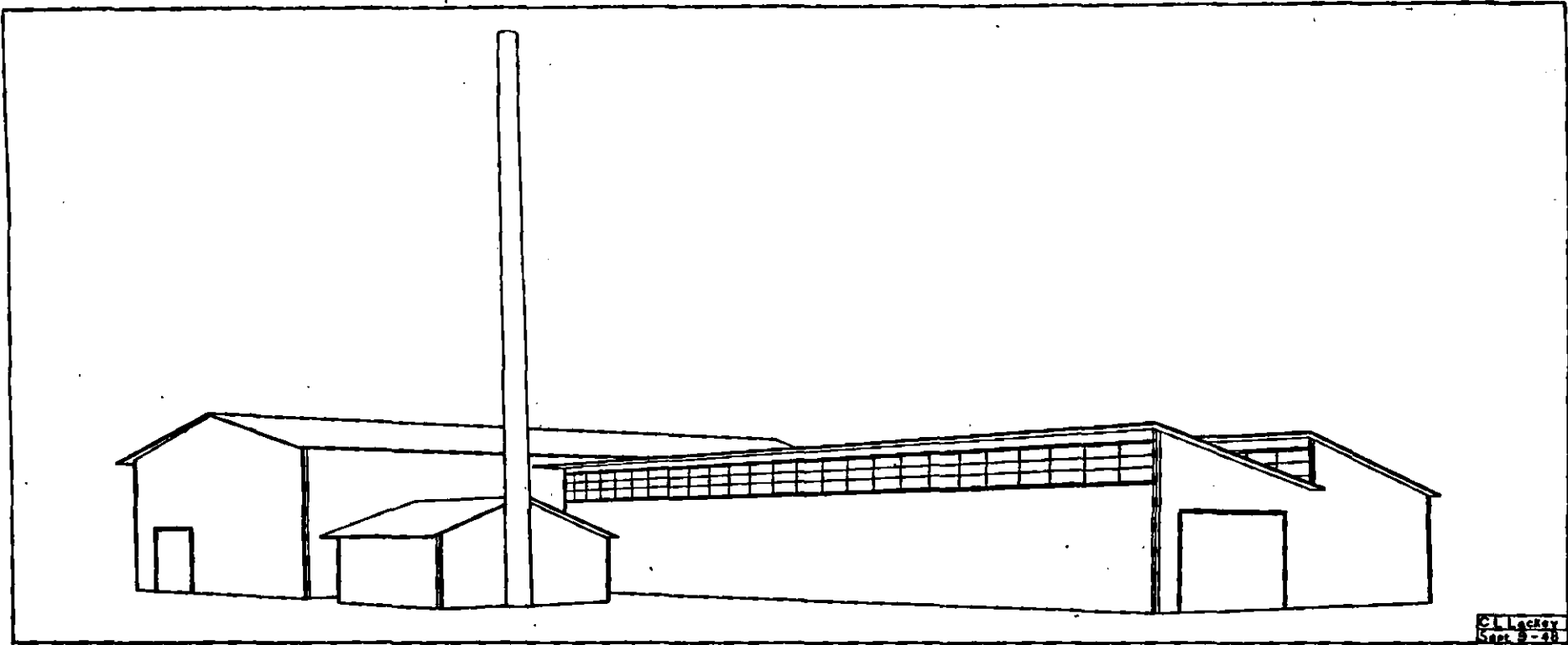

FIG. 21(A)—Perspective of No. 3 Cannery Showing Sawtooth Roof Over Cannery Lines, Warehouse and Boiler House

C. L. Lacey
Gen. 3-48

An alternative to using one large cooker is to use several of the small cookers described in Floor Plan No. 1. For a similar capacity about four of the smaller cookers would be required. These may be set up with a 3-foot space between each cooker. One large basket for each cooker can be made instead of the five smaller baskets. One large basket holds in the neighbourhood of 200 cans of 20-ounce size. An electric hoist may be used for placing these baskets in the cookers and removing them. Similar cookers may be covered with tight-fitting lids and equipped with 3-inch pipes going to each of the exhaust boxes and scalders to provide steam for these pieces of equipment. The advantage of using four smaller cookers instead of one is in flexibility. The disadvantages are: (1) there are six fires to tend instead of one, (2) there is very little saving in installation cost.

After cooking and cooling the cans are dried and cased.

Floor Plan No. 3:

Cannery with Mechanical Line and Steam Under Pressure

When one reaches this stage, it is possible he will develop his plant into a large cannery. Consequently, in this plan, Figure 21, an effort has been made to design a building that will require the least amount of change as the cannery expands. Space which eventually may be used for two lines is shown. This space is 32 feet wide by 140 feet long and directly adjoins the warehouse. The first unit of the warehouse is 48 by 64 feet. This would have a hip roof running lengthwise to the building and additions would be joined to the ends at either A or B, giving a continuous hip roof for the enlarged building. Only temporary partitions are put in for the pear storage, women's lunchroom, men's lunchroom, and office, so that these accommodations can be located in another place, and eventually each of the 16-foot bays could be used entirely for canning lines. Eventually, also, a receiving room will be built parallel to the warehouse at the other end of the canning lines. As it is impossible to know how long the canning lines will be, it is better to house the receiving room in the 16-foot bays until experience has indicated the length of bays required.

PREPARATION BELT.—The length of belt shown is 64 feet and includes the same facilities as in Floor Plan No. 2.

SYRUPER.—This is similar to Floor Plan No. 2.

EXHAUST BOX, CAPPER, COOKER, COOLER.—A five-line exhaust box using a link belt of S42 or similar link is shown in Figure 22 (B). A power turn as used in this box is illustrated in Figure 22 (D). This box delivers the cans to a completely automatic capper, Figure 6, which can be set for different speeds up to 65 cans per minute. About 40 cans per minute will suffice for most products being handled on this line. The cans fall from the capper to a can conveyor, "C", in Figure 21. This conveyor is on a grade so that the cans are elevated sufficiently to roll into the cooker at "D". The cooker, Figures 23, 23 (A) and 23 (B), is of the draper belt type made of either laminated 2 by 4 or steel sheets.

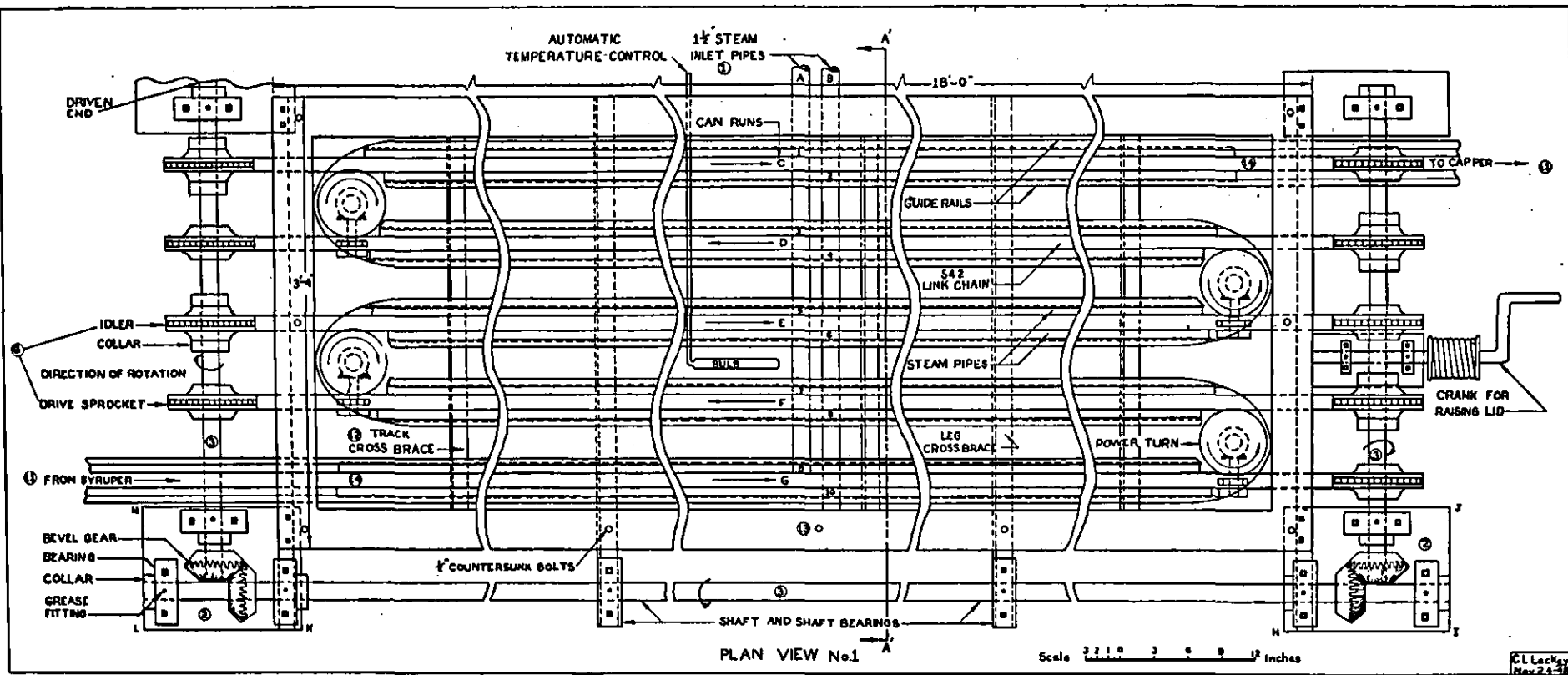
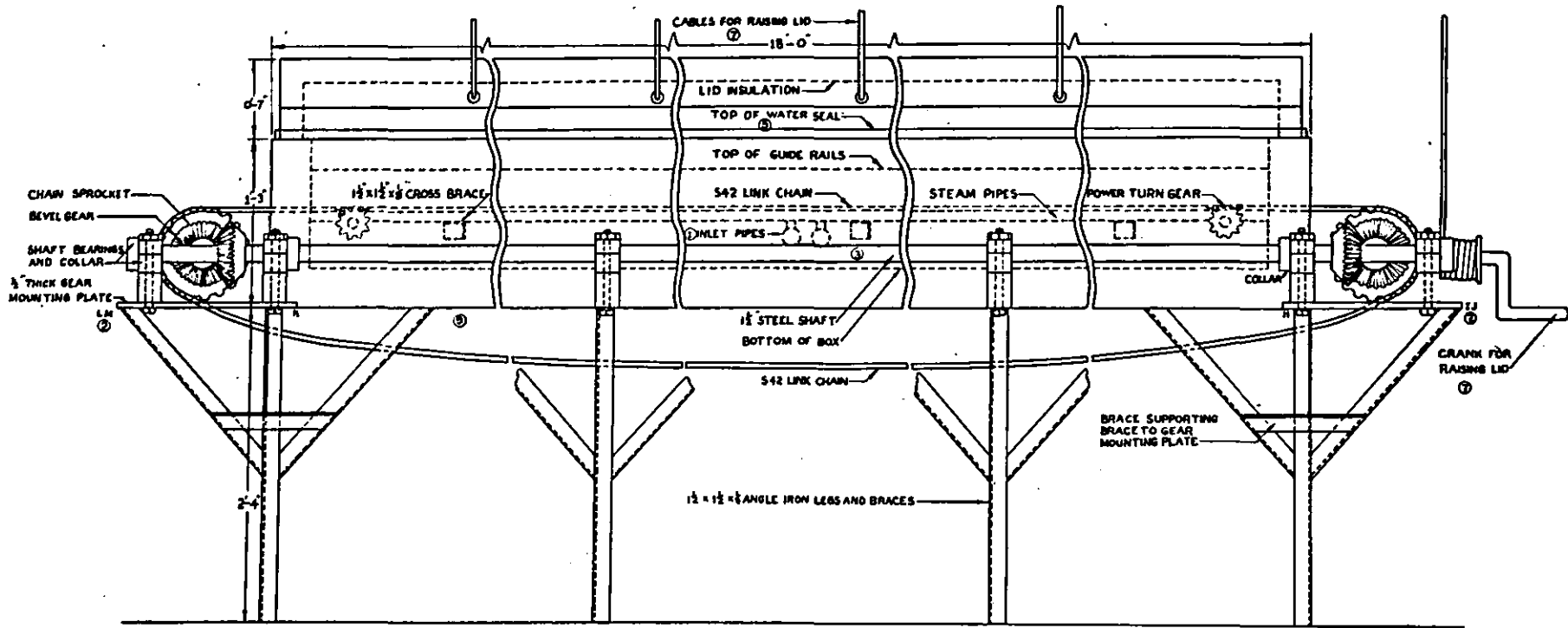

FIG. 22—Exhaust Box for No. 3 Cannery—Plan View

NOTES—(1) Steam inlet pipes connected to alternate pipes. (2) Plate mounting for gears supported at points H, I, J, K, L, M, to leg; other corners fastened to box with lag screws. (3) Shafts $1\frac{1}{4}$ ". (4) Lid insulated or not as desired. (5) Lid sealed by $1 \times 1 \times \frac{1}{8}$ " angle iron forming water seal. (6) Sprockets on shafts alternately drivers and idlers. (7) Lid hinged on one side and lifted as a unit by means of a drum and crank. Cable fastened to lid at four different points. (8) Door at each end of box to provide access for cleaning with hose. (9) Box sloped slightly towards one end. (10) Holes in steam pipes $\frac{1}{8}$ " in diameter and 3" apart. (11) Can run C extends back to syruper, and G towards capper. (12) Cross braces supporting can runs are 2 feet apart. (13) $\frac{1}{2}$ " countersunk bolts spaced 2 feet apart hold box together. (14) Steam tunnels extend 12" into box at inlet and outlet ends of can runs C and G to check excessive loss of steam.



SIDE ELEVATION No 2

Scale 1/4" = 1' inches

FIG. 22(A)—Side Elevation

E.L. Leary
Nov. 28-29

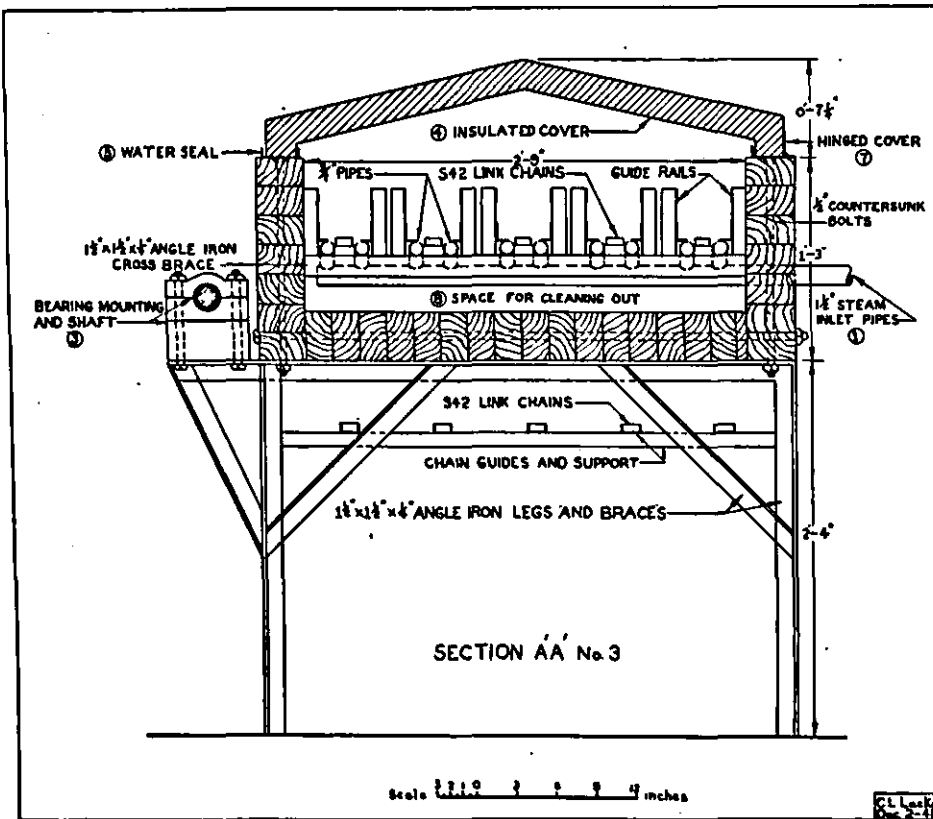

Fig. 22(B)—Section

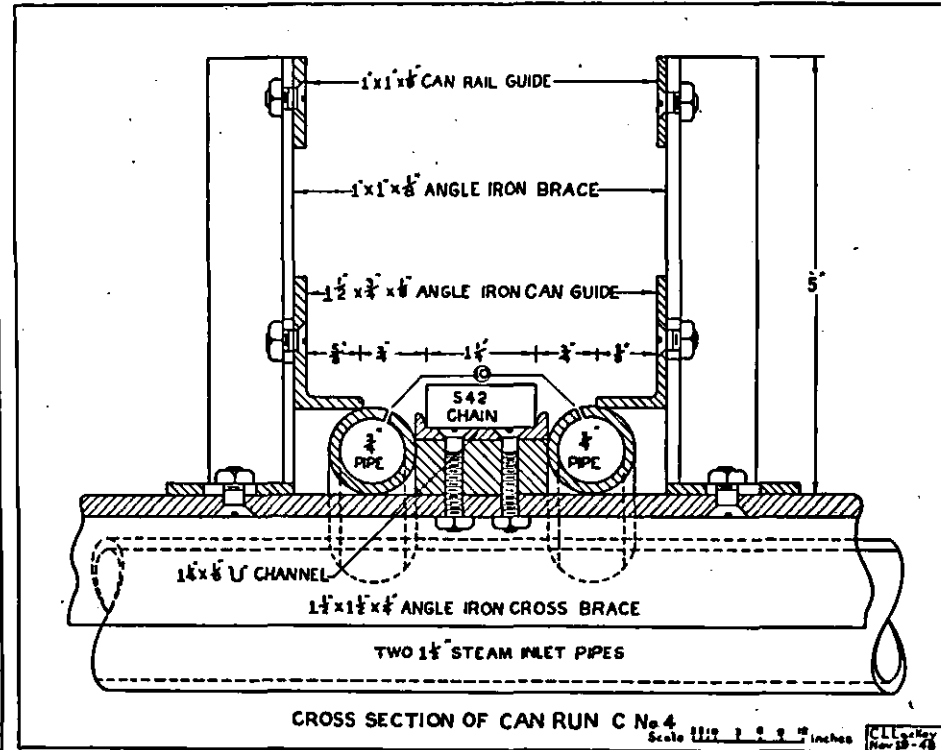

Fig. 22(C)—Detail of a Single Run

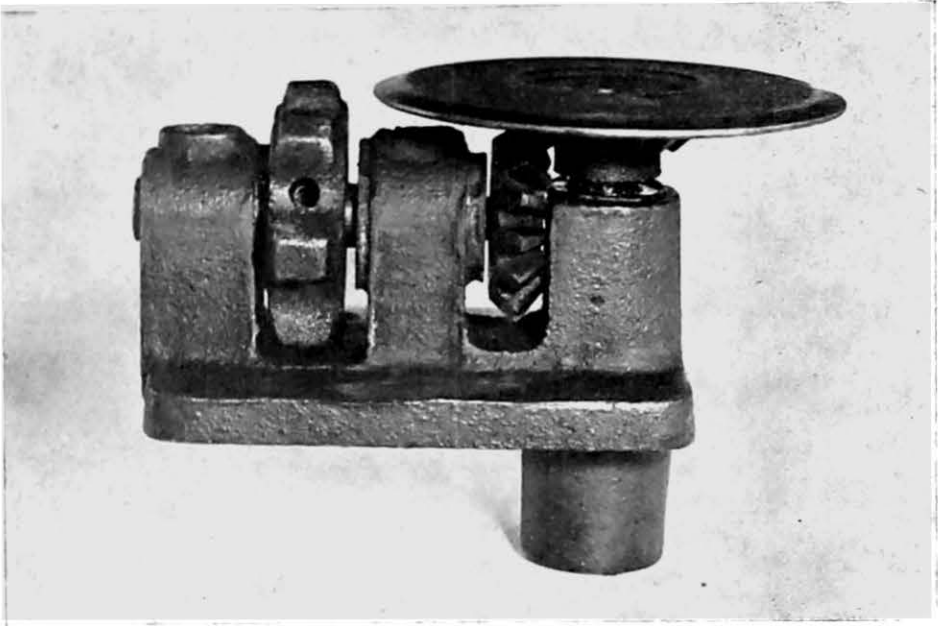

FIG. 22(D)—Power Turn for Exhaust Box

If steel is used it should be insulated. The cooker is 5 by 28 feet and the cooler, 5 by 20. The cooler has no heating pipes and no lids. The cans emerge from the cooler to a table where they are allowed to dry before being cased and warehoused.

This is a mechanical line which can be expanded as the operator sees fit. A large line of this type will handle 120 cans per minute. In this latter case, all the equipment would be placed in a straight line in the 16-foot bay. When this stage is reached, an unscrambler may be used to straighten out the cans after they come from the cooler. Also, with this latter scale of operation, a can track to convey the cans for several hundred feet to dry them before labelling and casing will be necessary. Labelling, Figure 42, may or may not be part of the operation at the time of canning, depending on market conditions and connections.

Special Equipment

Apricots

Fishmouth cutter as shown in Figures 24 and 25.

Sweet Cherries

One stemming machine for No. 3 cannery.

Peaches

Fishmouth cutter, Figure 24, 25; experimental peach cutter, Figure 26; and perforated dish pans or pails for cannery of size No. 1.

Pears

Perforated pan or pail for cannery of size No. 1; cannery knife, Figure 2, and pear loop, Figure 2. One peeling machine for No. 3 cannery.

Tomatoes

Tomato peeling and trimming knife is similar to the peach pitting spoon in Figure 2 but flatter.

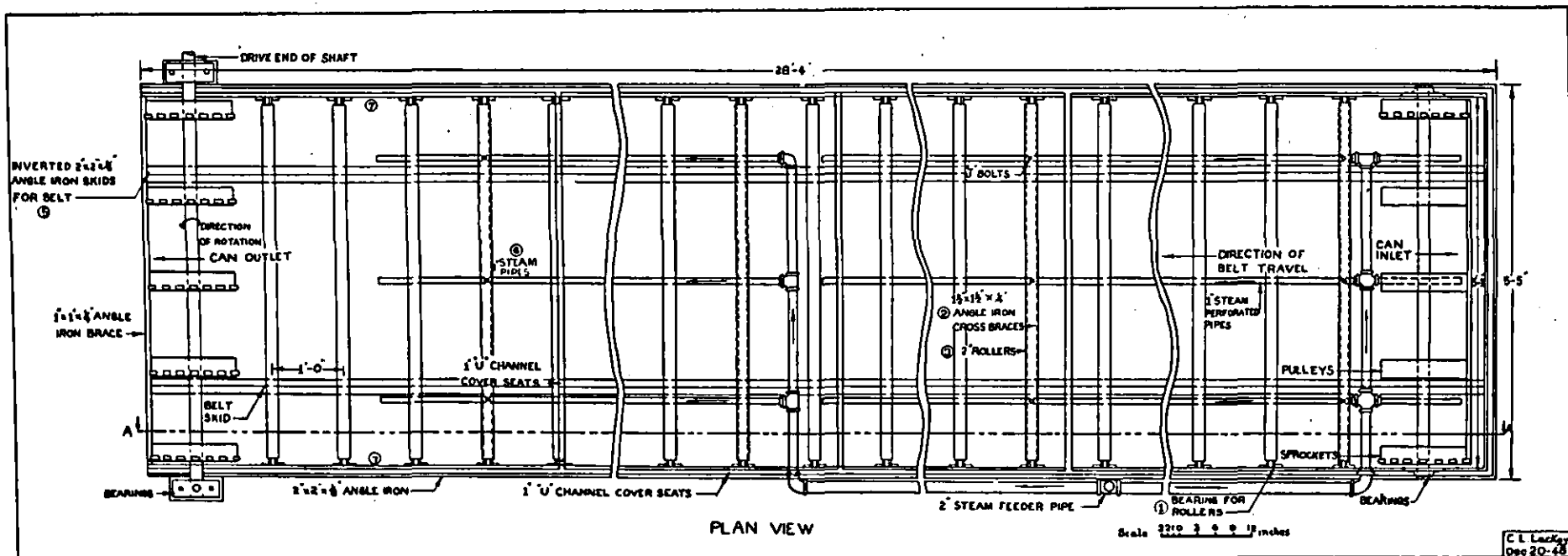

FIG. 23—Plan View of Cooker for No. 3 Cannery

NOTES re Figs. 23 and 23(A)—(1) Bearing patches are riveted to side of tank. (2) The $1\frac{1}{2} \times 1\frac{1}{2} \times \frac{1}{4}$ " angle iron shown for bracing spaced 4' apart on inside of tank can be replaced with $\frac{1}{2}$ " rods. (3) Rollers are made of 2" pipe with spindles welded into ends. (4) One end of curved cover extends down far enough into cooler to be below the surface of the water and thus forms a steam seal. (5) Two $2 \times 2 \times \frac{1}{8}$ " angle irons are placed on bottom of tank in an inverted position to act as skids for the belt. (6) Steam pipes perforated. (7) There should be $\frac{1}{2}$ " clearance on each side of the belt.

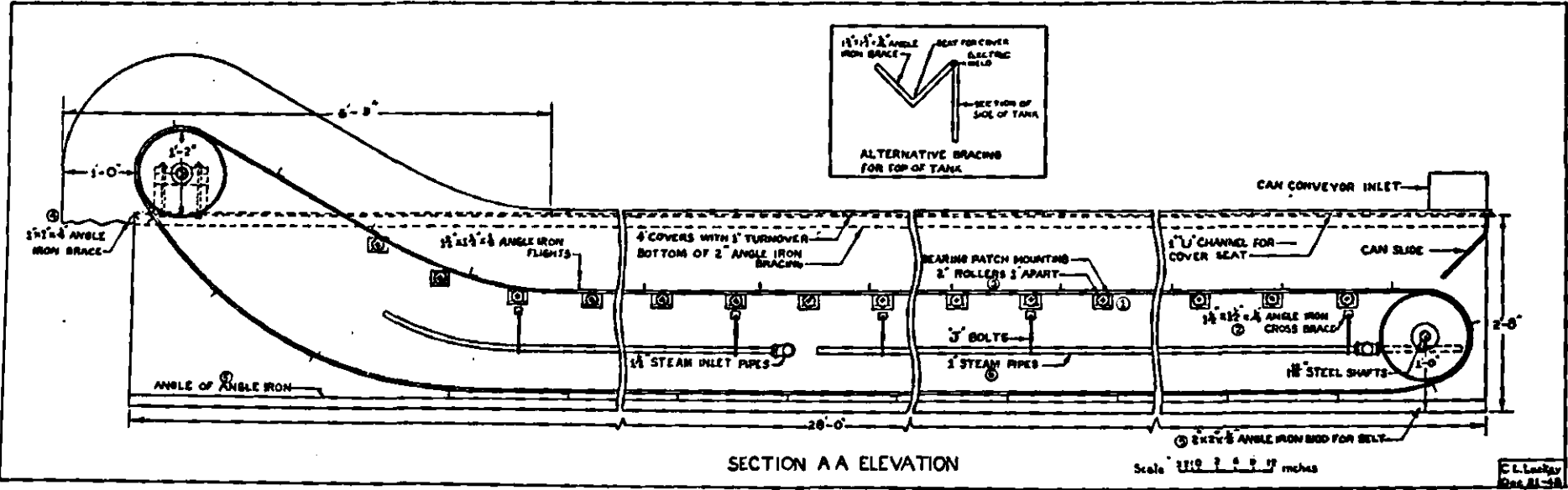

FIG. 23(A)—Elevation of Cooker for No. 3 Cannery

C. L. Leckey
 Dec. 21-18

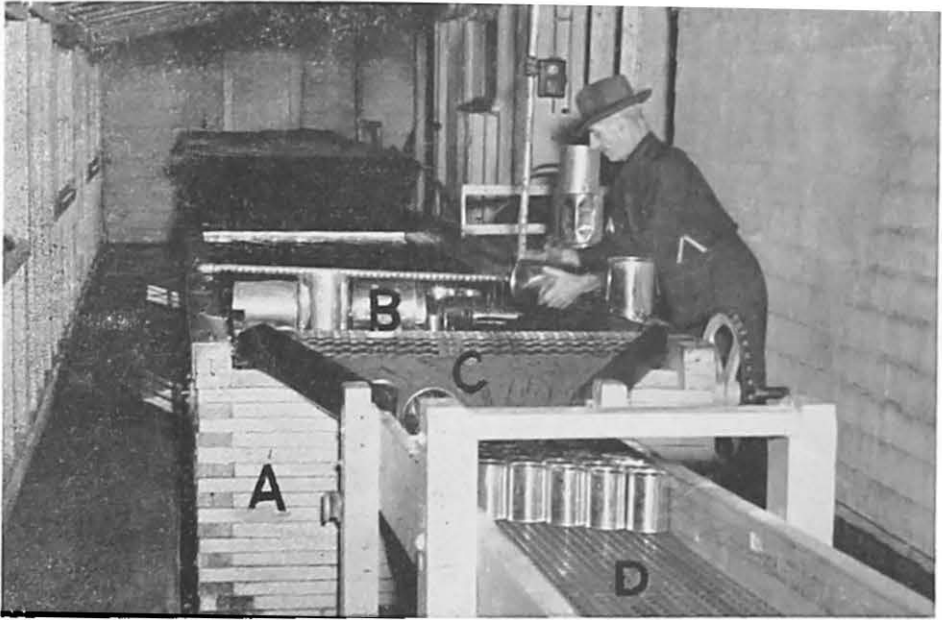

FIG. 23(B)—End View of Cooker and Cooler in No. 3 Cannery

A—laminated 2 x 4 construction of cooler; B—cans emerging from cooler; C—mat belt of cooler; D—conveyor belt to warehouse.

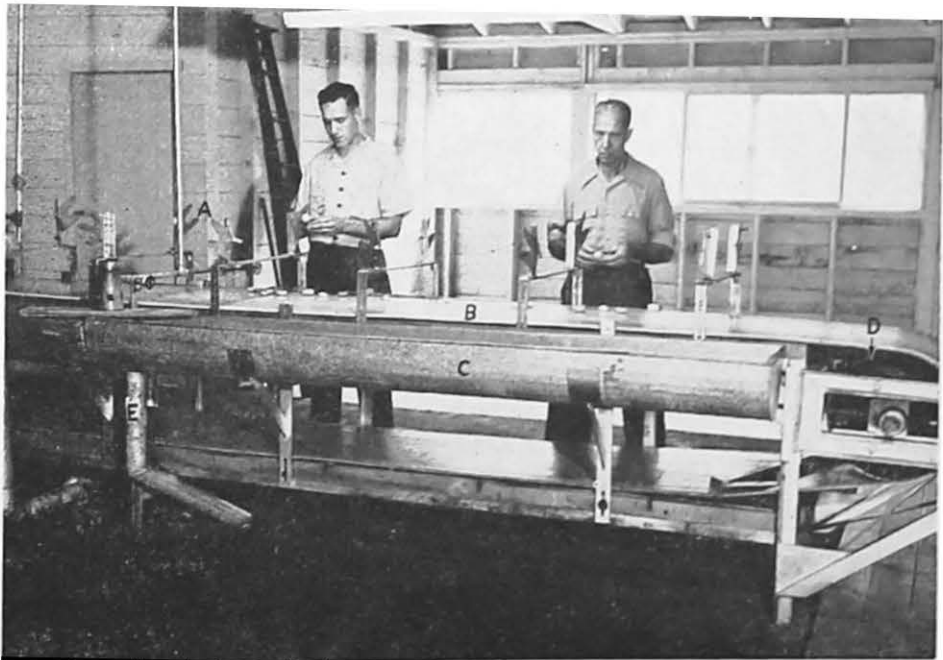

FIG. 24—Starting End of Preparation Belt in No. 3 Cannery .

A—Fishmouth apricot or peach cutters; B—24-inch preparation belt; C—removable sinks; D—idler pulley; E—drain into floor drain.

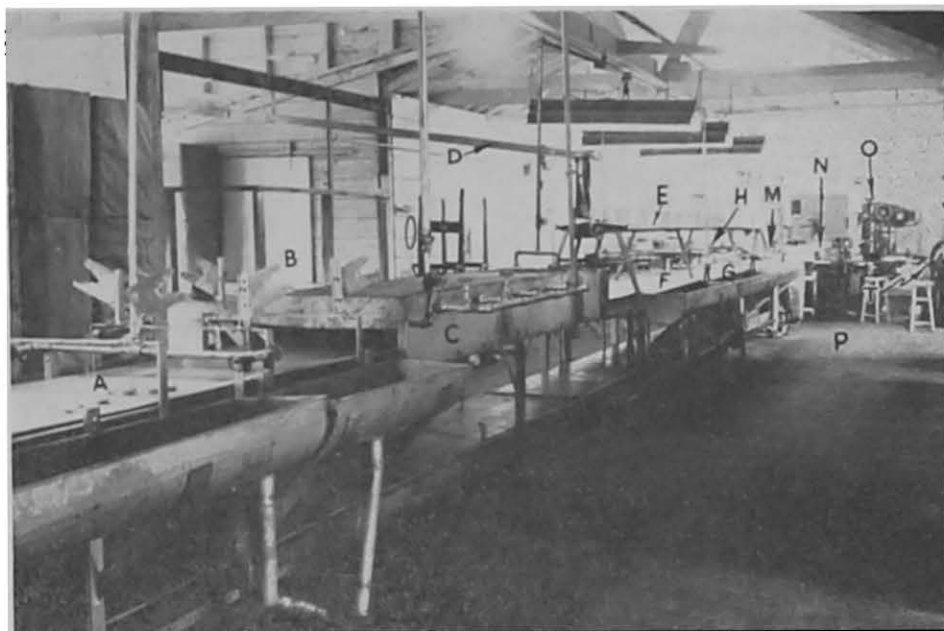

FIG. 25—Preparation Belt for No. 3 Cannery, continuing from FIG. 24

A—preparation belt; B—fishmouth cutters; C—scalding tank for peaches and pears; D—empty can conveyor; E—table for empty cans fitted with belt down centre; F—skinning section of belt; G—canning section; H—link belt conveying filled cans to syruper; M—location of syruper; N—exhaust box; O—capper; P—bituminous floor over wooden floor; T—conveyor of capped cans to cooker.

Canning Procedure

Plan No. 1

The following outline of procedure is given for canning fruits using the set-up of Plan No. 1. All fruit is sorted, trimmed and graded before the canning operation so that the fruit in the can complies with the regulations for one of the grades in the Meat and Canned Foods Act.

APRICOTS.—Apricots are placed in the sink for washing and are halved with knives or small fishmouth cutters. The halves are sorted into about three size grades and filled into cans.

BERRIES.—Berries are gently washed and filled into cans.

SWEET CHERRIES.—Sweet cherries are placed in the sink of the preparation table, stemmed, washed, sorted, size graded by hand, and placed in cans at the back of the table.

PEACHES.—Peaches are delivered to a person at one end of the preparation table, who halves them on a cutter, Figures 24, 25, which is attached to the sink. The halves free of pits are placed in either a perforated dishpan or a pail for scalding, while the pits in the remaining halves are removed by the operator using a pitting spoon. Pans of these halved peaches are suspended with detachable handles (as used with the baskets in the cooker) in the scalding tank and delivered to another section of the sink where they are sprayed with cold water, skinned, graded, trimmed and placed in cans.

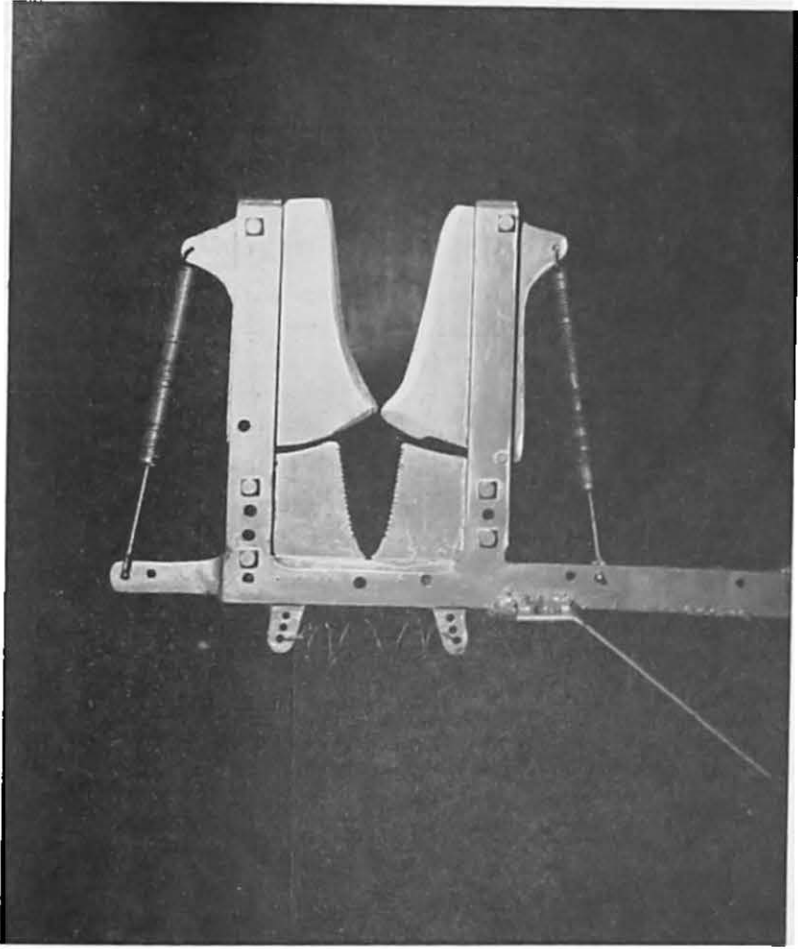

FIG. 26—Peach Cutter. (Sharpened blades which follow contour of pit, followed by saw-teeth on blades to grasp pit.)

PEARS.—After having been stored at 30-31° F. and ripened at 65°, pears are placed in perforated pans, scalded as with peaches, cooled with cold water, and the pan placed in the sink. One operator there slips the skins from the pears, a second operator halves them and a third operator removes the stems and cores, using a coring loop, Figure 2. The halves then are graded, sorted and placed in pans.

PRUNES.—Prunes are rolled down a slatted cradle to eliminate leaves and small branches. Then they are placed in the sink, washed, sorted, graded and canned.

In each case the fruit is filled into cans from the preparation table and the cans checked for the required net weight as given in Table 7. Then they are taken to the table near the capper for syruing. With small fruit the can should be full even if this exceeds the minimum net weight. The proper fill of fruit and syrup in a 20-ounce can should give a headspace not exceeding $\frac{5}{16}$ of an inch. The strength of syrup should be as given in Table 3. The tray containing a single layer of 12 properly filled cans then is placed in the exhaust box with water about half-way up the sides of the cans and kept there until the can centre temperature is around 160° F. with the exhaust tank at a gentle boil. The cans then are capped, placed in baskets, Figure 11, and the filled basket placed in the cooker. The length of the cook in boiling water would be as given in Table 5.

TOMATOES.—Tomatoes are sorted into perforated pails and scalded in boiling water in a scalding illustrated in Figure 10. This scald is sufficient to thoroughly check the skin. Then they are placed in the sinks for peeling and trimming. In this operation all peel is removed, the core completely removed, and any green shoulders or other defects are cut off. In packing the prepared tomatoes into cans, an effort is made to keep them as whole as possible. The spaces between the whole tomatoes are filled with broken tomatoes and juice. About 3/4 teaspoon of salt is added to each No. 2½ can. The cans are exhausted to a can centre temperature of around 130° F. and cooked as per Table 5.

TABLE 7—REQUIRED INGOING WEIGHTS OF FRUIT FOR 20-OZ. CANS (307 x 409)

Fruit	Required ingoing weights oz.
<i>Apricots</i>	
Blenheim and Royal.....	12.00
Tilton.....	11.50
Wenatchee Moorpark.....	12.00
<i>Cherries</i>	
Bing.....	11.75
Lambert.....	11.75
Royal Anne.....	11.75
<i>Peaches</i>	
Elberta.....	13.00
Hale.....	13.50
"V" varieties.....	12.75
<i>Pears</i>	
Bartlett.....	12.25
<i>Prunes</i>	
Italian.....	12.50

Plan No. 2 or 3

With Plans 2 and 3, the filled cans are placed on a link belt above the canning section that conveys the cans through the syruper. In Plan No. 2 this belt may deposit the cans on a mat belt in the exhaust or the cans may be syrupered by hand and placed in baskets in which they are exhausted. In Plan No. 3 link belt continues into the exhaust box. In either case the cans arrive at the capper. After capping the cans are placed in cooking crates or else proceed mechanically through the cooker and cooler.

The following outline of procedure is given for canning fruits using the set-up of Plan No. 2 or 3.

APRICOTS.—Apricots are trucked up to the starting end of the preparation belt and halved on a cutter, Figure 24, attached to the framework for the belt. The halved fruit is placed on the belt and proceeds to the canning section, Figure 25. Pipes arranged in the scalding can be used for washing the fruit. The fruit proceeds to the canning section where it is sorted into three sizes and filled into cans.

BERRIES (STRAWBERRIES AND RASPBERRIES).—If these are quite clean they may be placed directly on the preparation belt and washed with the sprays of water after the scalding. If they need considerable washing then a washer can be set at the starting end of the belt. After washing, the berries are directed over the sides of the belt by means of light metal scoops set at a sharp angle to the

side. Use of a trough filler, Figure 27, will reduce danger of mashing or bruising the berries. The filled cans are syruped, exhausted, capped, cooked and cooled. An alternative is to use a high exhaust which raises the can centre temperature to at least 190° F., cap, invert the can, hold for the period given in Table 5 and cool. Gentle care while hot is imperative.

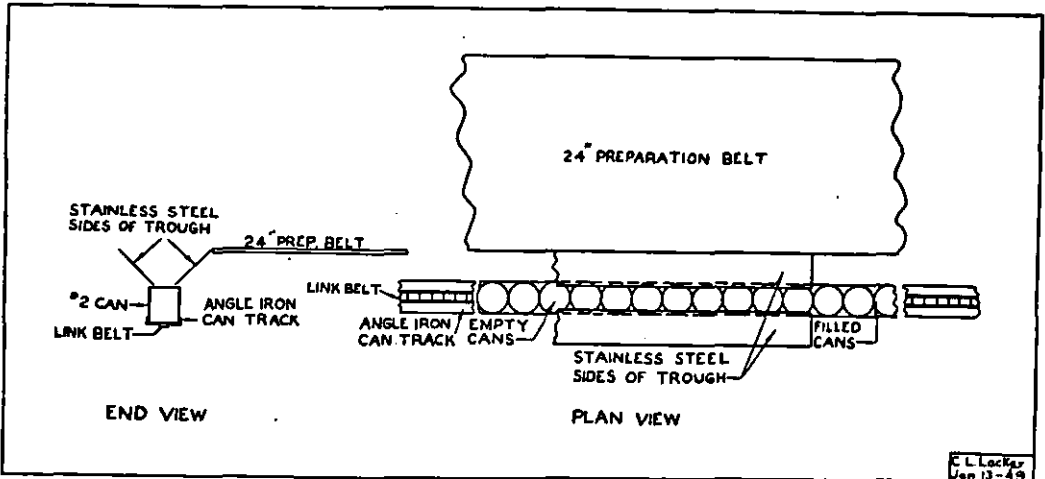

FIG. 27—Trough Filler

SWEET CHERRIES.—Sweet cherries are placed in 8 by 8 inch sinks in the peeling and canning section where they are stemmed, washed, sorted for size and defects, and filled into cans. A trough filler as illustrated in Figure 27 is useful for this product. A mechanical stemmer is essential for a very extensive tonnage and if used would be fed with cherries direct from the lug boxes.

PEACHES.—Peaches are trucked in boxes up to the cutting section of the belt where the operator selects the fruit of canning maturity and halves it on a cutter, Figures 24 and 25. Other operators remove any remaining pits. After this operation, the peaches are placed on the belt with the cut side down. They then pass through the scalding which should take a period not exceeding 40 seconds. The scalding is followed by cold water spray to chill the surface of the peach. The skins then are removed and the peeled peaches proceed to the canning section. Here they are sorted for size and quality. Similar sized halves are placed in each can and if Choice quality is the main run, all Standard peaches and Fancy cans are coded with different coloured marking inks. Waterproof marking inks must be obtained from a reputable company that will guarantee they do not contain any phenols that will flavour the product. Black is the most dependable colour in this respect. It is a good policy to use only this colour but in different patterns. The filled cans then proceed through the remainder of the equipment.

PEARS.—The ripened pears are placed on the belt in the cutting section and proceed through the scalding. Rods of the size of welding rod placed just above the belt will tend to roll the pear so that all surfaces are scalded evenly. Some experience is required in regulating the adjustment of the scalding so that the pears receive sufficient steam to loosen the skin but yet not sufficient to cook the flesh of the pear making removal of the skin difficult and producing a poor appearing fruit. A scald of 15 to 30 seconds is usually satisfactory. After being peeled the pears are halved, cored and canned in successive operations.

TOMATOES.—This product is placed on the belt, washed, scalded, peeled, trimmed and canned. The peeling, trimming and filling of the cans is the same as described in Plan No. 1.

PRUNES.—When handling prunes on a preparation belt a small piece of wood along the edges of the belt is necessary to keep the fruit from rolling off. The prunes are fed onto the belt by rolling them down a slatted cradle as in Plan No. 1. The fruit is washed, sorted for size and maturity, and filled into cans at the canning section using a trough filler.

Vegetables

Varieties

The following varieties of vegetables are canned successfully:

<i>Vegetable</i>	<i>British Columbia</i>	<i>Eastern Canada</i>
Asparagus	Mary Washington	Mary Washington
Beans	Blue Lake, Stringless strains of Blue Lake, Kentucky Wonder, Refugee, Stringless Green Pod, Pencil Pod, Golden Wax	Round Pod Kidney Wax, Pencil Pod Black Wax, Stringless Green Pod, Masterpiece
Beets	Detroit Dark Red	Detroit Dark Red
Carrots	Scarlet Nantes, Chantenay	Chantenay, Imperator
Corn	Golden Bantam, Golden Sunshine, Golden Cross, Country Gentleman	Golden Cross Bantam, Carmel Cross, Vincross, Golden Hybrid
Peas	Laxton, Alaska, Lincoln, Perfection, Pioneer, Surprise	Alaska, Prince of Wales, Little Marvel, Surprise, Wisconsin Early Sweet, Thomas Laxton, Perfection, Pride
Spinach	Savoy Bloomsdale, King of Denmark, Giant Leaved Nobel	Bloomsdale, King of Denmark, Nobel

Maturity and Storage

The selection of vegetables for canning at the best maturity means the choice of these products when they are at their maximum desirability as fresh vegetables. Generally for maximum quality, vegetables must be canned within a few hours of harvesting as with few exceptions they deteriorate rapidly after harvesting.

Asparagus

Asparagus should be sufficiently tender to snap.

Beans

Beans should be of a good green colour, fleshy, snap readily, and be as free as possible from fibre or strings.

Beets

Beets should be harvested before they are tough and woody.

Corn

Corn should be between the milk and the dough stage so that there will be some body to it and yet not be tough and dry.

Peas

Peas are best harvested while tender and before they become starchy.

Spinach

Spinach is harvested when the blossom stalks have just begun to form. As the cut spinach deteriorates rapidly, it should be canned immediately. Excessive bruising or crushing is to be avoided.

General Equipment

Most of the equipment described in the foregoing Plans 1, 2 and 3 is for use in canning fruits. However, a preparation belt can be of considerable value in various kinds of vegetable canneries. In general, these latter plants require a great deal of specialized equipment and steam under pressure for sterilizing the canned products in retorts. When steam under pressure is considered, one must bear in mind the requirements of the province in which the prospective operator is situated. For instance, in British Columbia a pressure vessel which develops more than 2.9 h.p. comes under the requirements of the Boiler Inspection Act which specifies that an operator with fourth class engineer's papers is needed for operating boilers between 2.9 and 100 h.p. Various small retorts have been designed which could be used in conjunction with small canneries but rather than provide designs of this equipment it is suggested that a prospective operator contact the chief boiler inspector in his province for suggestions. A very small retort fired with gasoline is available from the Dominion Evaporator, 1630 Delorimier St., Montreal, 24.

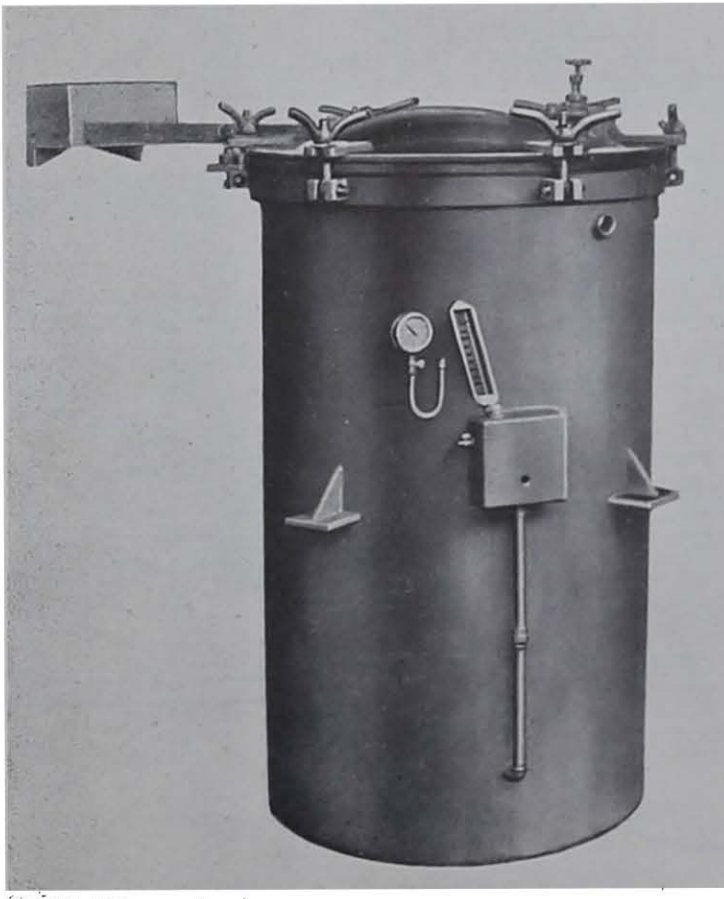

FIG. 28—Vertical Retort

A small vertical retort used commercially in vegetable canning is illustrated in Figures 28, 29, 30 together with the arrangement of steam and water pipes. When increased capacity is required, horizontal retorts as illustrated in Figure 31 are recommended. It is necessary for satisfactory operation of a retort to have it equipped with both a pressure gauge and a thermometer. These should be in

an area where the steam is constantly circulating. If the altitude is not known, it is better for the operator to work to temperature until a correction for the pressure gauge can be obtained.

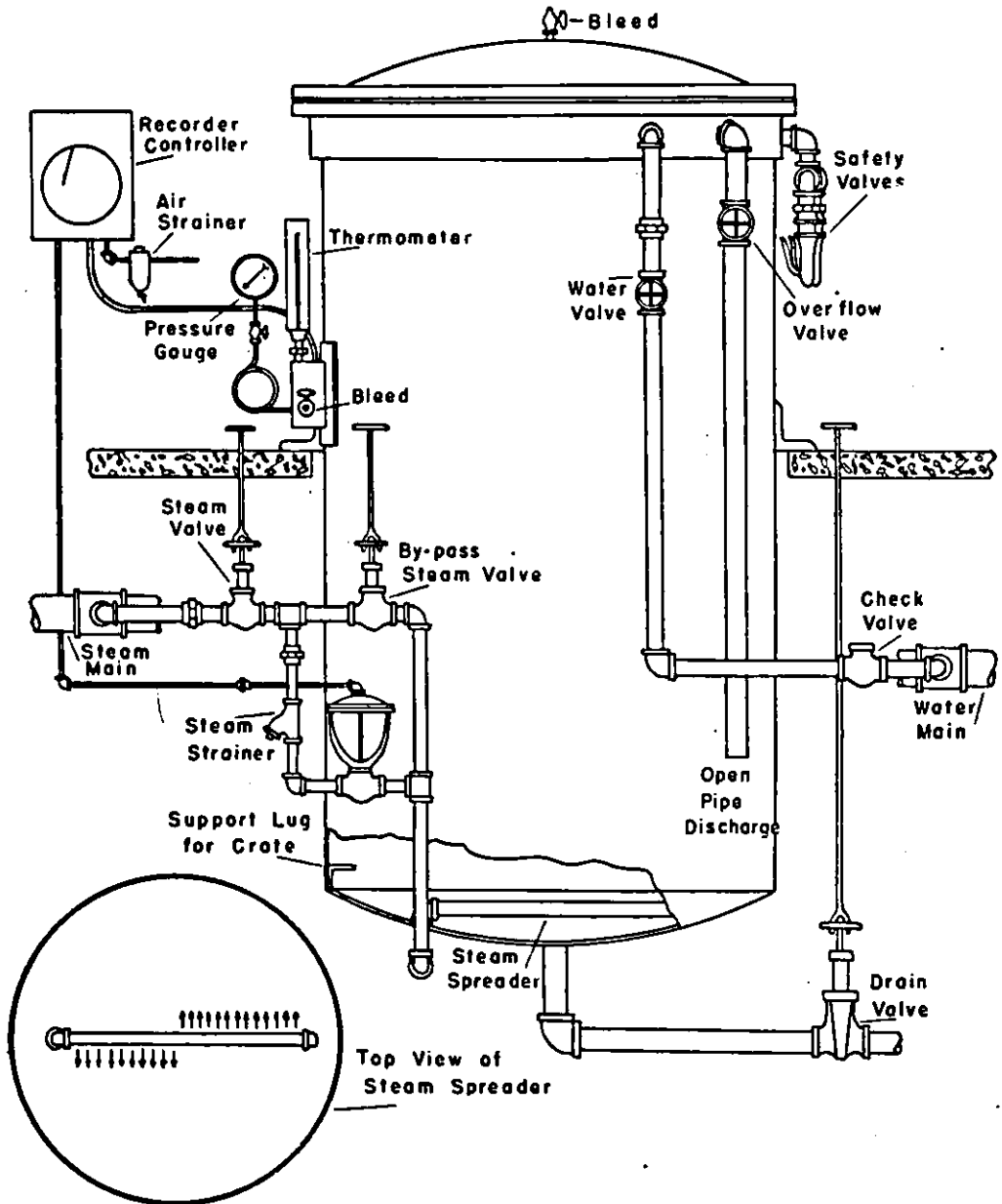

FIG. 29—Vertical Retort Equipped with Bottom Steam Inlet

Retort Operation

Although only a few types of batch retorts are in general commercial use, many systems of piping and operation are possible. For the small canner, a vertical retort has been suggested and two satisfactory methods of attaching the piping to this type of retort will be discussed. The size of this retort is 42 inches by 72 inches and accommodates three baskets. If the capacity of the plant is such, it may be necessary to reduce these retorts in height so as to use only one

or two baskets. The general principles of operation apply equally to other sizes of non-continuous retorts, but the amount and type of accessory equipment may vary with size.

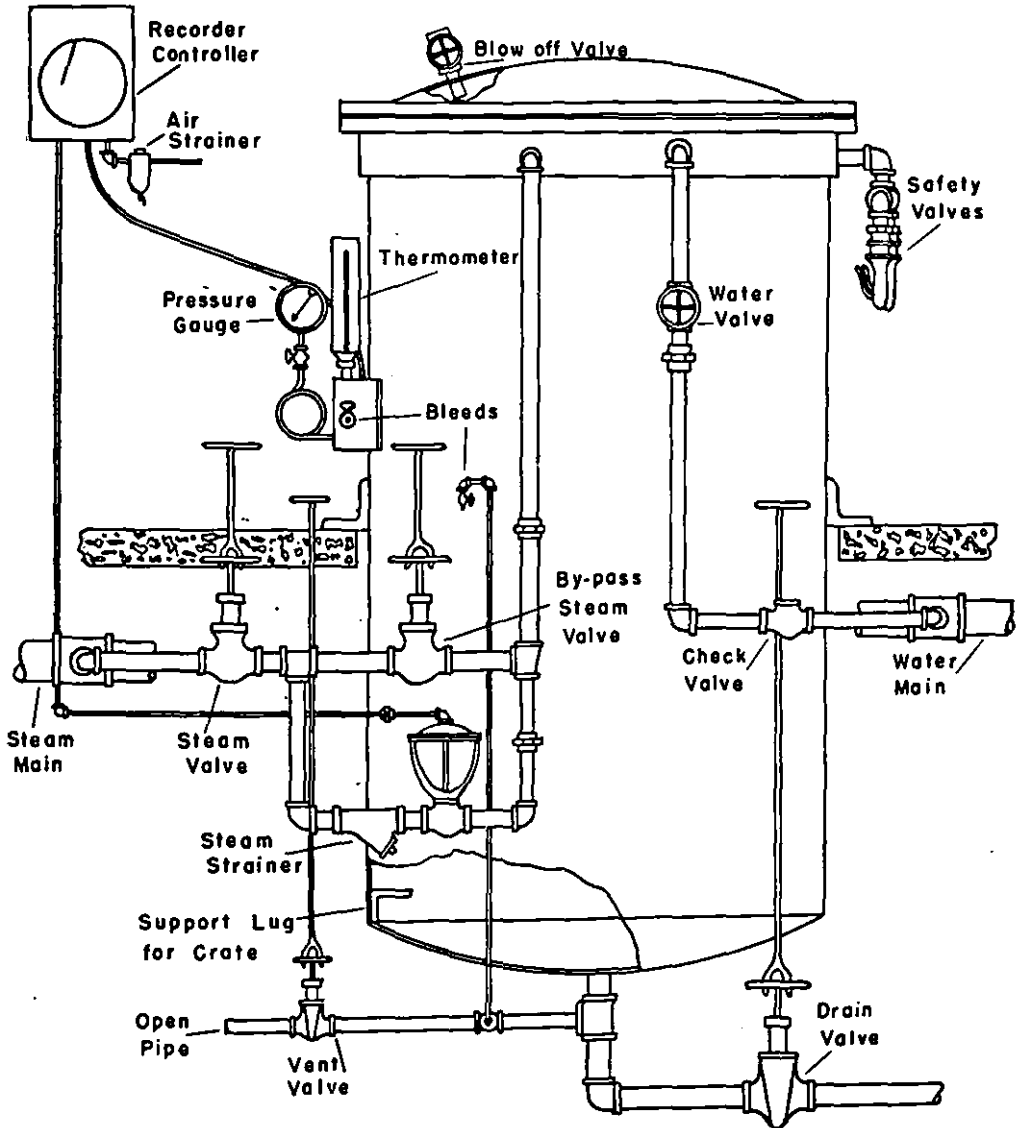

FIG. 30—Vertical Retort Equipped with Top Steam Inlet

In a general way, the steps involved in retort processing are as follows:

1. After the retort is loaded and the cover secured, steam is admitted to bring the retort rapidly to processing temperature, the air being vented from the retort during this "coming-up" period.
2. The retort temperature is accurately maintained at processing temperature throughout the processing or holding period.
3. The cans are cooked as rapidly as possible.

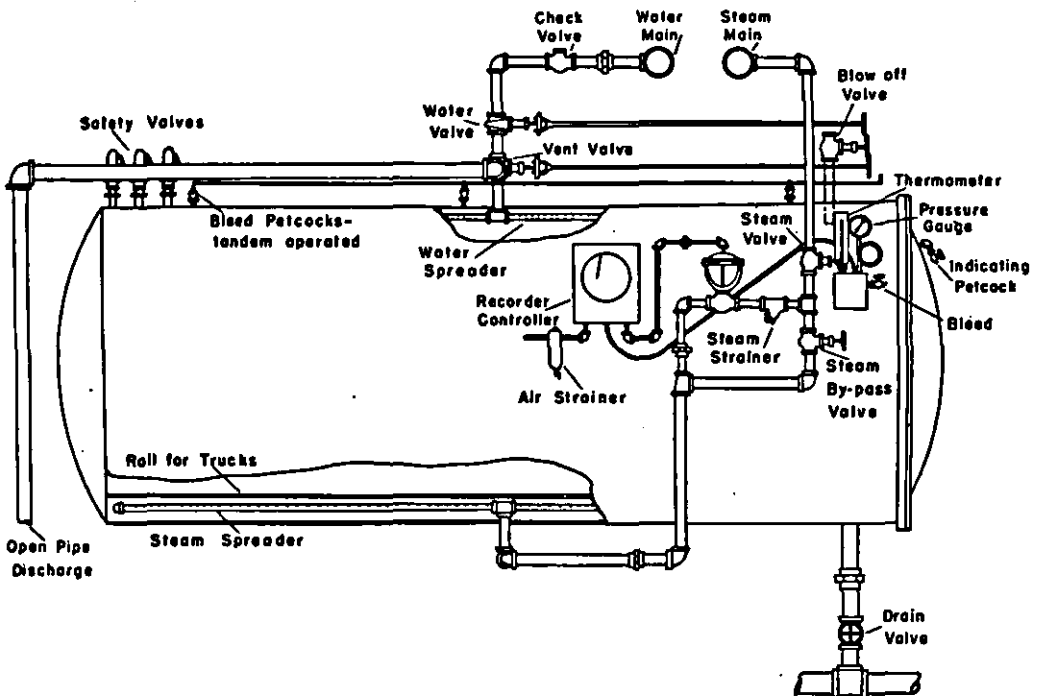

FIG. 31—Horizontal Retort

TABLE 8—SUGGESTED EQUIPMENT AND SPECIFICATIONS FOR A 3-CRATE VERTICAL RETORT

Equipment	Specifications
<i>Steam Supply</i>	
Steam pipe to retort.....	1"
Steam valve.....	1" globe valve
Steam by-pass valve.....	1" globe valve
Control valve.....	Refer to manufacturer
Steam strainer.....	Same size as control valve
Steam spreader (Note 1).....	1" perforated pipe
<i>Drain, Vent, Overflow</i>	
Bleeds.....	Two 1/8" petcocks
Vent valve (Note 2).....	Figure 30, 1" gate valve
Steam trap (Note 3).....	Refer to manufacturer
Overflow valve.....	Figure 29, 1 1/2" gate valve
Drain valve.....	2" gate valve
Blow-off valve.....	1" globe valve
<i>Water Supply (if retort cooling is used)</i>	
Water valve.....	1 1/2" gate
Check valve.....	1 1/2"
Water spreader (Note 4).....	
<i>Instruments and Controls</i>	
Controller (Note 5).....	Refer to manufacturer
Thermometer.....	Industrial type 170° to 270° F. range
Pressure gauge, compound type.....	30" vacuum to 30 p.s.i. pressure
<i>Safety Valves (Note 6).....</i>	2—2 1/2"
<i>Retort Baskets or Trucks</i>	Slat type or perforated steel having 1" perforation on 2" centres or equivalent.

RETORT EQUIPMENT.—Figures 29 and 30 illustrate two suitable hook-ups for vertical retorts. Figure 29 is designed for admitting steam at the bottom and venting from the top. Figure 30 is designed for admitting steam at the top and venting from the bottom. The choice of the hook-ups is optional with the canner, although the hook-up shown in Figure 30 is preferred from steam consumption, and possibly temperature distribution considerations. However, with a top steam inlet, it is very important to prevent the accumulation of condensate in the bottom of the retort. Both the venting and elimination of condensate may be accomplished automatically by means of a specially adjusted thermostatic steam trap. With manual operation, part of the condensate is eliminated through the vent valve during the come-up and the remainder through the bottom petcock bleed.

The steam main supplying the retorts should carry steam at not less than 90 pounds per square inch and should have capacity to provide all retorts in a battery with sufficient steam so that no pressure will be lost in one retort when an adjacent one is turned on.

Sufficient water capacity should be available to supply each vertical retort being simultaneously cooled with 60 gallons per minute. A water main pressure of at least 50 pounds per square inch is recommended.

Suggested equipment and specifications for an ordinary 3-crate vertical retort are given in Table 8.

NOTE 1.—The steam spreader used in Figure 29 is the swirling type with the holes drilled as shown in the illustration. It is suggested that the spreader be constructed of 1-inch pipe and contain a total of about fifty $\frac{1}{4}$ -inch holes. No steam spreader is required when a top steam inlet is used, as illustrated in Figure 30.

NOTE 2.—In Figure 29 it is intended that the $1\frac{1}{2}$ -inch gate type overflow valve be used as a vent during the coming-up time. If desired, a 1-inch gate valve vent may be installed in the retort cover and used in place of the overflow valve.

NOTE 3.—If the steam inlet is in the retort bottom, a steam trap is of no utility. However, if the steam inlet is in the top of the retort, a steam trap is a valuable adjunct to retort operation as it ensures against the accumulation of condensate which, being colder than the steam above it, might be a cause of understerilization if any of the bottom cans are covered with the condensate. It is important that the trap be equipped with an air relief feature that will prevent air binding. Thermostatic type traps are well adapted to this application as they will function as automatic vents during the come-up period and will close when temperature pressure agreement is reached. For best results, it is recommended that the thermostatic type traps open with a 6 to 8° F. temperature differential and close with a 2 to 3° F. temperature differential between condensate and saturated steam. The thermostatic traps should have a capacity of about 3000 pounds per hour of condensate at a 2 pound per square inch pressure differential. Traps of these specifications can be supplied by most manufacturers of this equipment.

NOTE 4.—Water spreader pipes are not necessary in vertical retorts, although when the water enters at the top of the retort, a spray ring or multiple water inlets distributed around the circumference of the retort will result in a faster and more uniform cool.

NOTE 5.—The controller should be capable of controlling the retort temperature to within $\pm\frac{1}{2}$ ° F. Experience has shown that air-operated controllers of reliable manufacture are capable of accomplishing this. Either temperature or

pressure controllers may be used. Self- or steam-actuated controllers are used to a considerable extent in the industry although, generally speaking, they do not have the sensitivity of the air-operated instruments. If the purchase of self-actuated instruments is contemplated, it is recommended that some assurance be obtained from the manufacturer as to the ability of the instrument to control within the limits specified above.

NOTE 6.—The safety valve specifications should meet the A.S.M.E. code for unfired pressure vessels or the requirements of the Provincial Government Boiler Inspection Act.

The various steps of retort operation are discussed in some detail in the following and are summarized later.

THE COME-UP.—The time consumed in bringing the retort to processing temperature at the start of a process is known as the “coming-up period” or the “come-up”. As a general rule, the come-up time should be just long enough to ensure proper elimination of air from the retort by the time the processing temperature is attained.

The procedure for bringing the retort up to processing temperature is listed below. Assuming that all valves on the retort are closed the following steps apply:

1. Open the valve which functions as a vent (overflow valve, Figure 29; vent valve, Figure 30), and all bleed valves.
2. Open the steam valve and the steam by-pass valve.
3. As the temperature and pressure rise in the retort, the entrapped air will be discharged through the retort vent. When the air has been expelled, the vent should be closed. If a thermostatic steam trap is used, Figure 30, this will be done automatically. For manual operation, the minimum times and temperatures suggested for closing the vents are given in Table 9.

TABLE 9—MINIMUM TIMES AND TEMPERATURES FOR CLOSING VENTS

Figure	Type of vent used	Time	Temperature shown on thermometer
		min.	° F.
29* Alternative:	1½" gate type overflow-vent	3	215
	1" gate valve vent on cover	3	220
30	1" gate valve vent	3	220

*This venting condition applies only if the swirling type steam spreader is used. If a steam spreader is used which directs the steam upward or if no steam spreader is used, a longer venting time and a higher venting temperature will be required.

4. Close steam by-pass valve when holding temperature is reached.
5. The timing of the process should be started if the thermometer and pressure gauge indicate corresponding temperature and pressure. If this condition is not obtained, either the thermometer or the pressure gauge is inaccurate, or the retort has not been sufficiently vented. The remedy in the latter case is to open the vent until all air has been expelled.

The importance of venting the retort properly during the come-up cannot be over-emphasized. Inadequate elimination of air may be the direct cause of such difficulties as paneled cans, rusted cans, spoilage due to under-sterilization

or non-uniformity of cook between different cans in the retort. The importance of thorough elimination of air is of extreme importance in the case of short, high temperature cooks.

THE HOLD.—Throughout the holding time, the bleeds on the thermometer pocket and on top or bottom of the retort should be left open to prevent any accumulation of air which might gain access to the retort along with the steam. The petcock (not shown) on the bottom of the retort, Figure 30, will indicate whether condensate is accumulating in the bottom of the retort. If a steady stream of condensate discharges from this petcock, the drain valve should be opened for a few seconds.

It is extremely important that a constant temperature be maintained during the holding period. Temperature fluctuations downward may result in under-sterilization; fluctuations upward in an overcooked product. Manual control of temperature is possible, but requires a careful conscientious operator unhampered by other duties if it is to be successfully accomplished. Automatic control is much to be preferred and this may be either temperature or pressure control as discussed under "Equipment".

At the end of the prescribed process time, the steam is shut off and the blowdown commenced.

THE BLOWDOWN.—As soon as the steam is shut off, the overflow valve or blow-off valve in the top of the retort should be opened. Ordinarily, for 401 (4-1/16") diameter and smaller cans, the retort may be blown-down as rapidly as possible without harm to the containers, although this is somewhat dependent on the type of container and potential can vacuum as well as the size of the container.

As soon as the retort has reached zero pressure, the cans are ready to be cooled. Cooling of the cans should be started immediately to prevent loss of quality due to overcooking.

COOLING IN THE RETORT.—If the cans are to be cooled in the retort, the water valve should be turned on when the retort pressure has reached zero gauge pressure. If a thermostatic valve or steam trap is used, the hand-controlled valve ahead of it should be closed.

Care should be taken not to create a high vacuum in the retort by the too rapid condensation of the steam at the start of the cooling procedure. Air will be drawn in through the overflow valve or blow-off valve and prevent the formation of a high vacuum, but it is well to turn the cooling water on slowly at first until enough air is drawn in to replace most of the condensed steam.

When the retort has filled with water the drain valve should be opened, the blow-off valve or overflow closed, and water permitted to drain at the same rate at which it enters. This can be easily accomplished by regulating the water inlet and drain valves so that a constant slight pressure is shown on the gauge. A saving in water can be accomplished by reducing the flow of water as the cool progresses, at all times keeping the retort full of water.

The time of water cooling is dependent upon the rate of cooling of the product and it must be prescribed for each specific product. A good cool is one which reduces the average temperature of the can contents to 100 to 105° F. Cooling to a lower temperature than this will not leave enough heat in the cans to dry them properly and exterior rusting of the cans may occur. Undercooling is to be avoided as continued high temperature in the product may result in loss of quality as well as spoilage due to development of thermophilic forms of bacteria. These bacteria may survive ordinary processes but will not grow unless the storage temperature is in the neighbourhood of 110 to 140° F.

For cans larger than 4-1/16 inch diameter, pressure cooling is necessary. Information on this procedure should be obtained from the writers of this bulletin.

SUMMARY.—The various steps of proper retort operation in chronological order follow:

1. Load retort, close and secure cover.
2. Close drain valve and open all bleed valves.
3. Open vent valve, Figure 30, or overflow valve, Figure 29.
4. Open steam valve and by-pass valve.
5. If a thermostatic steam trap is not used, close vent valve or overflow valve according to the schedule given under "The come-up" above.
6. When the prescribed holding temperature is reached, close the by-pass steam valve and start timing of process if temperature pressure agreement is indicated on the thermometer and gauge.
7. At the end of the process, shut off steam valve.
8. Open blow-off valve or overflow valve.
9. If cooling is to be in the retort and a steam trap is used, the valve ahead of it should be closed.
10. Open water valve slowly at first so as not to create a high vacuum in the retort.
11. When retort is filled with water, open drain and permit water to flow through the retort, keeping it filled with water at all times. Close blow-off valve or overflow valve.
12. Continue cool for prescribed time after which water may be shut off, the retort drained and cans removed.

MISCELLANEOUS NOTES.—A few additional facts may be given to emphasize the importance of venting and certain other factors affecting the elimination of air and even distribution of steam.

CONTAINED AIR.—A vertical retort, when fully loaded, may still have over 60 per cent of its space occupied by air and a fully loaded horizontal retort may have 70 to 80 per cent of its space occupied by air. Tests have shown that a retort must be exceptionally well equipped and vented to have a coming-up time of less than 5 minutes.

TRAYS AND BASKETS.—There are various types of trays, pans, baskets, and gondolas used for holding cans in retorts. Strap iron or wire equipment is desirable because it permits good steam circulation. Perforated sheet metal equipment as generally used offers more of a baffling effect to the flow of steam than properly constructed strap iron containers. If perforated sheet metal is to be used, then 1-inch holes on 1½-inch centres are desirable. An alternative is to place a wire screen of ½- or 1-inch mesh and made of 13 to 16 gauge wire on the bottom of the basket.

ARRANGEMENT OF CANS.—In the large baskets used in vertical retorts or in the gondolas or deep pans sometimes used in horizontal retorts, cans are stacked many layers deep. Under these conditions it is very important that cans be staggered so that they do not rest directly over one another so as to give a tubular effect. In all deep baskets, a jumbled method of filling is the most desirable, except in the case of certain products such as asparagus which must be

processed in a vertical position, or No. 10 cans of spinach which should be processed in a horizontal position. Where baskets are stacked several deep as in the vertical retort, the top layer of cans in each basket should not project above the rim of the basket. If a space is not left between each pair of baskets and one basket rests directly on the layer of cans below it, steam circulation may be hindered considerably. Also, cans carrying the load above are apt to suffer a mechanical damage.

Horizontal stacking is frequently used in gondolas. In perforated equipment this method allows for better heat distribution than vertical stacking because the holes in the bottom of the gondolas are not blocked off and steam travels readily up through the cans.

SEPARATORS.—Some canners use separators of various kinds such as sacks, boards, perforated plates or wire mesh between cans having different code marks in the same retort load or on top of cans in baskets to prevent them from floating during cooling. Sacks, boards or perforated plates should not be permitted. Wire mesh is most suitable for this purpose.

PARTIALLY FILLED RETORTS.—A retort only partially filled with cans contains considerably more air than one with a full load. This must be kept in mind during the coming-up period and the vents must be left open for a sufficient period of time to remove all the air. This usually requires more venting than when the retort is fully loaded. If partially filled retorts are a frequent condition, acquisition of smaller retorts may be advisable.

TEMPERATURE-PRESSURE AGREEMENT.—It has been common practice to vent retorts until temperature-pressure agreement is indicated. This practice is unreliable if the retort is loaded in a manner which traps air. Thus, as soon as the space around the retort load is filled with pure steam, agreement may be indicated even though there may still be a considerable amount of air trapped within the load itself. The presence of such air is not revealed by the readings of the retort pressure gauge and thermometer.

However, although exceptions may occur, it is important that such agreements always be attained. The only way to ensure adequate venting is to adopt a tested operating procedure which must be followed every time a batch is processed.

Vents should be located in the opposite side of the retort from the steam inlet and for the best operation they should be equipped with gate or plug cock type valves of at least the same size as the vent pipe specified. If globe valves are used they should be of larger pipe size than is necessary when gate valves are installed. If the vents do not discharge directly into the atmosphere and the extension of the pipes are more than a few feet in length, a larger size of pipe should be used.

The importance of venting the retort properly during the coming-up time cannot be over-emphasized. Inadequate elimination of air may be the direct cause of such difficulties as paneled cans, rusted cans, spoilage due to under-sterilization, or non-uniformity of cook between different cans in the retort.

Special Equipment

For the small canneries considered in this bulletin, an effort has been made to simplify the equipment for vegetables as much as possible. However, in view of the standards that have been reached with equipment in large factories, it does not seem sensible to suggest equipment that will give a quality too far below that packed by larger plants. Three of the products considered here, beans, peas and corn, all require specialized equipment and the following suggests what may be considered the minimum equipment for these products.

Canning Procedure

Asparagus

Green asparagus is allowed to grow until it is of sufficient height to fill the cans in which it is to be packed and with about an inch of butt that will be cut off in trimming. It should be harvested before the buds start to open. If there is to be very much delay before canning, the asparagus should be washed so as to remove possibilities of earthy flavours. When it is received at the cannery, it is sorted into size grades according to the thickness of the stalks. The number of grades will depend upon the asparagus being handled. All the stalks in a can should be of similar size. If a cannery of No. 1 plan is operating on asparagus, then the stalks, after having been graded for length, are placed in boxes of the depth required for the various cans. These lengths are usually about one-half inch shorter than the can. For instance, for a 20-ounce can (4-9/16" high) the inside depth of the box should be 4 inches. The stalks are then cut to a similar length by cutting off the protruding butts. The stalks, after being cut to length, are placed in wire baskets and blanched about 2 minutes in boiling water in the scalding, Figure 10. Then they are cooled by dipping in cold water and placed in the sink for filling into cans. In the No. 2 or 3 cannery, the stalks after being graded for size are placed along the preparation belt with the part of the butt which is to be cut off protruding from the side of the belt. The stalks then pass under a circular knife revolving at high speed which trims them to the proper length. Blanching in the steam blancher on the belt takes from 2 to 4 minutes, depending on the size of the stalk. The stalks are spray-cooled and filled into cans at the canning section of the belt. Then the cans are filled with brine, exhausted, capped and retorted. It is important in processing asparagus that the cans be kept in a vertical position with the spears upright.

Beans

It is anticipated that a small canner would pack beans "ungraded as to size". String beans likely would be delivered to the factory in sacks or slatted crates. From these sacks they are poured into snippers. From the snipper, the beans can be fed into a cutter, Figure 33, which would cut them into the required lengths. Following this, the manufacturer could make a screen shaker which would remove the small nubbins. From the shaker, the cut beans fall into an 8-foot rotary blancher, Figure 34, or are blanched in boiling water in wire baskets. In the rotary blancher, the time is 3 minutes at 190° F. From the blancher, the beans drop into a flume of cold water and flow into a draining reel. From the draining reel, they fall onto an inspection belt. Then they are filled on a trough filler, Figure 27. Hot brine is added and the cans exhausted, capped, retorted, cooled, etc. An alternative method is to perform the inspection before the blanch and to fill the hot beans from the blancher directly into cans, cover with hot brine and cap. This obviates the use of an exhaust box. However, if a plant is being run in conjunction with a fruit cannery the exhaust box would be available. If only one snipper is being used, as has been suggested, then two retorts, 42 by 72 inches, vertical, Figure 29 or 30, would be needed. These hold 1056 cans per charge and one could be used every half-hour. Following the retort, the cans are cooled, allowed to dry, cased and warehoused.

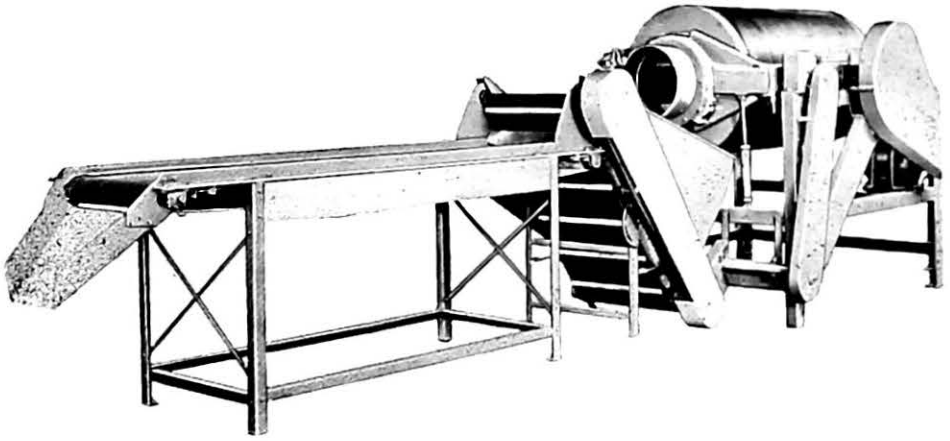

FIG. 32—Bean Snipper



FIG. 33—String Bean Cutter

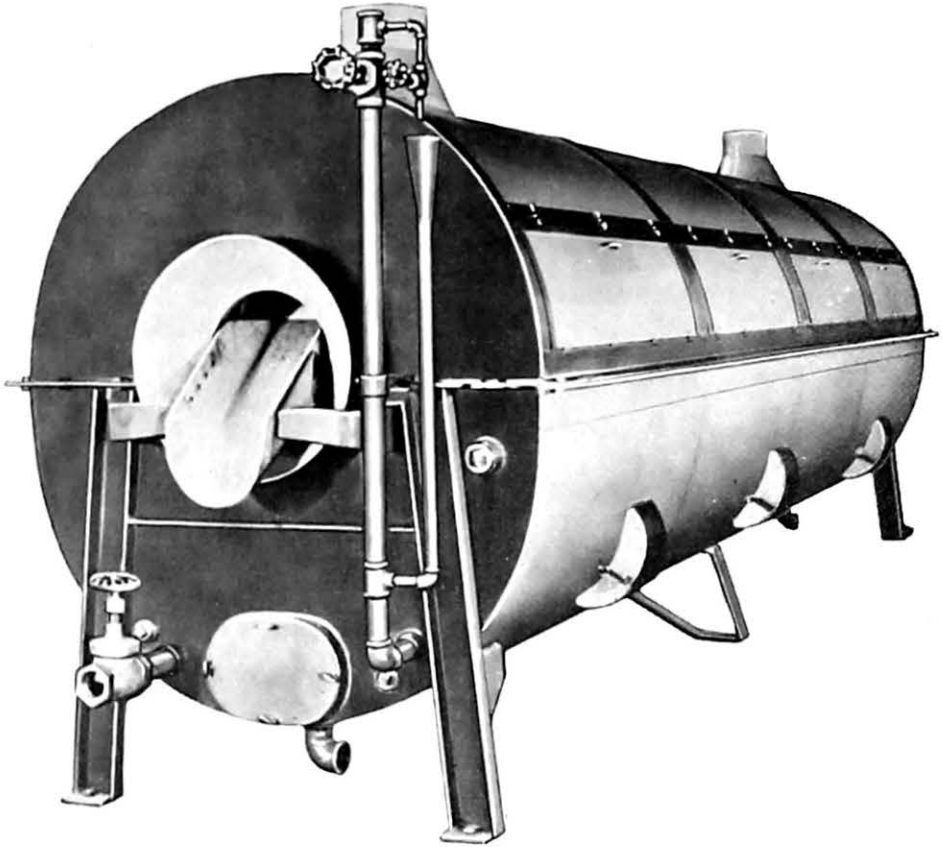

FIG. 34—Vegetable Blancher

Beets

If beets are to be canned, the canner should endeavour to obtain the very best seed for canning beets from which to grow the crop. The best beets for canning are small in size, of uniform deep red colour, tender and of good flavour. They are graded for size, the smaller or baby beets being canned whole while larger sizes are diced. In the canning operation, the beets are soaked in water and thoroughly washed under sprays to remove adhering soil. To facilitate peeling, the beets are steamed in a retort at 220° F. for 20 to 25 minutes, chilled and peeled. For small plants, some type of abrasive peeler is most practical. The prepared beets are filled into lacquered cans, covered with a 2½ per cent hot brine, exhausted, capped, retorted and cooled.

Corn

Corn on a small scale also presents problems. About three-quarters of the corn packed is cream style while one-quarter is whole kernel. The maturity preferred is between the milk and dough stage. The corn is picked in the field and delivered to the factory where it is placed in a double husker, Figure 35. At this machine, one woman stands on each side feeding cobs into spaces on the husker. These huskers handle 1½ tons per hour if all spaces are filled. About 32 per cent of this corn is recovered as the cut product. From the husker, the cobs fall on to a short inspection belt where wormy cobs, excess silk and pieces of husk, etc. are removed, and then pass into the cutter, Figure 36. The cut corn from the cutter should fall onto a shaker screen to act as a desilker. If cream style corn is to be packed a second head containing scrapers should be used in the cutter. It is suggested that the desilker could be made by the manufacturer

using $\frac{1}{2}$ -inch mesh. The kernels of corn would fall through the $\frac{1}{2}$ -inch opening while the wire would catch the cob and silk. The screens used for this should be quickly removable so the ones that become clogged can be cleaned.

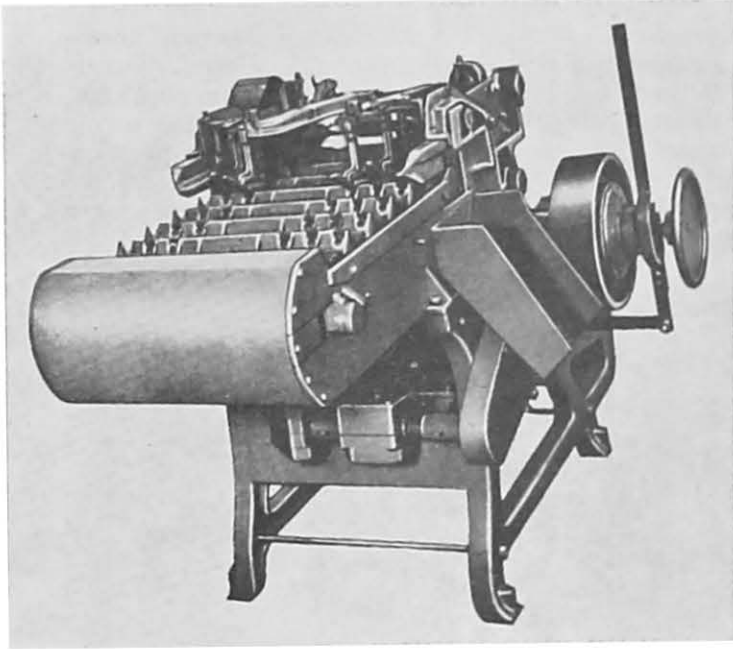

FIG. 35—Double Corn Husker

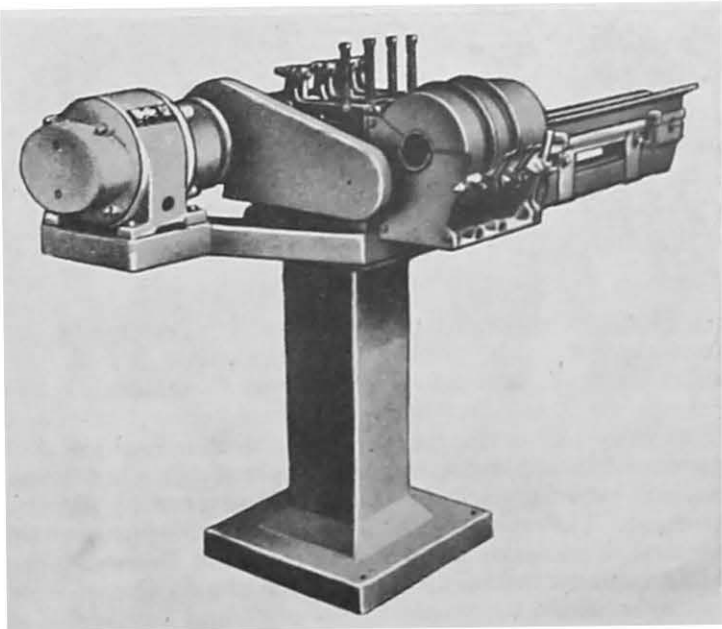

FIG. 36—Corn Cutter

CREAM STYLE.—After being desilked the cut corn and scrapings are conveyed to a mixing tank (which may be a steam-jacketed milk pasteurizer) where the sugar and salt are added. A sweet brine of 200 to 300 pounds of sugar and 95 to 100 pounds of salt per 400 gallons of water is added to the mixing tank to give the desired consistency. The amount of this brine required will vary with the maturity of the corn at the rate of one to four when the corn is less mature and one to three for mature corn. Two pasteurizers are needed for continuous operation or a conventional mixing tank might be used. This is a duplex mixer, Figure 37, with two compartments; one in which the corn can be receiving the sweetened brine and be heated, while from the other the corn can be filled into cans. In the small plant, a filler presents a problem as these machines are built for a much larger capacity. If a plant can afford a filler, a 6-pocket filler, Figure 38, with a capacity of 90 to 100 cans per minute is suitable but expensive for the scale of operation. This filler can be used for other products such as pumpkin.

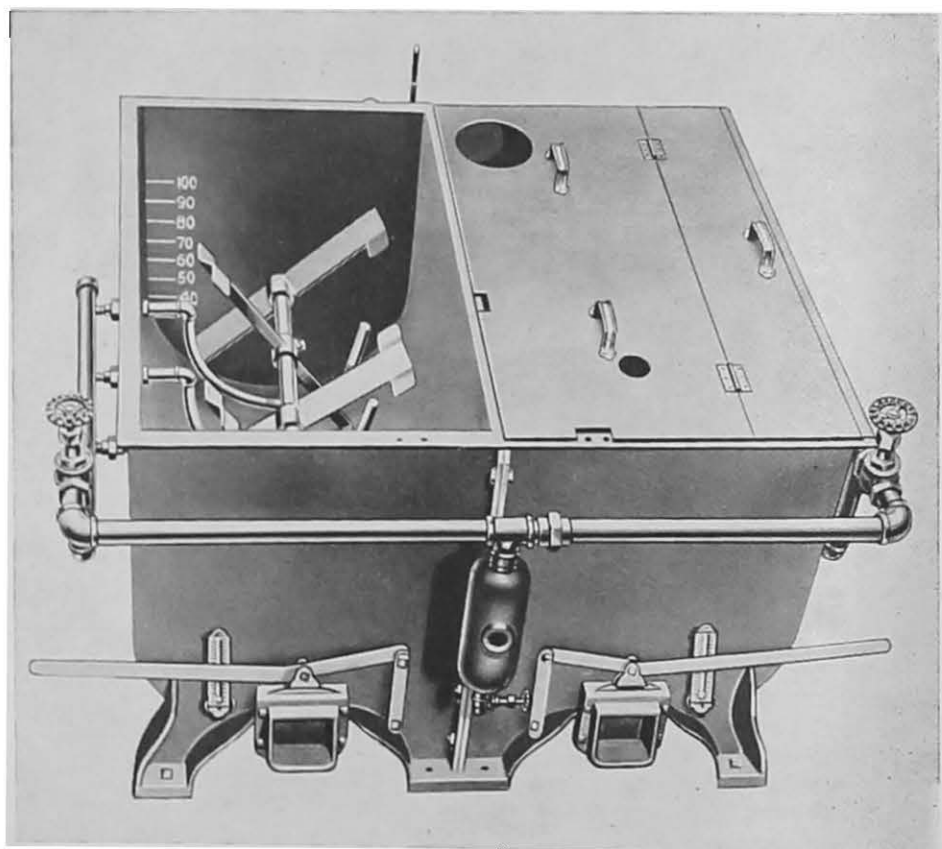

FIG. 37—Duplex Batch Cream Style Corn Mixer

WHOLE KERNEL.—After the corn has been desilked and shaker-screened in the previous process, it is filled into cans, covered with hot brine, exhausted, capped, cooked and cooled. The brine usually consists of $1\frac{1}{2}$ -2 per cent salt and $2-2\frac{1}{2}$ per cent sugar. The whole kernel is a much simpler process than preparing the cream style and, if a market is available, it should be used as it will be much easier to obtain a uniform product. There is the one handicap, however, in that mature corn is not suitable for whole kernel pack and because of this feature it is possibly wise to pack some cream style even in a small cannery. If this is done then the cobs would be sorted for maturity.

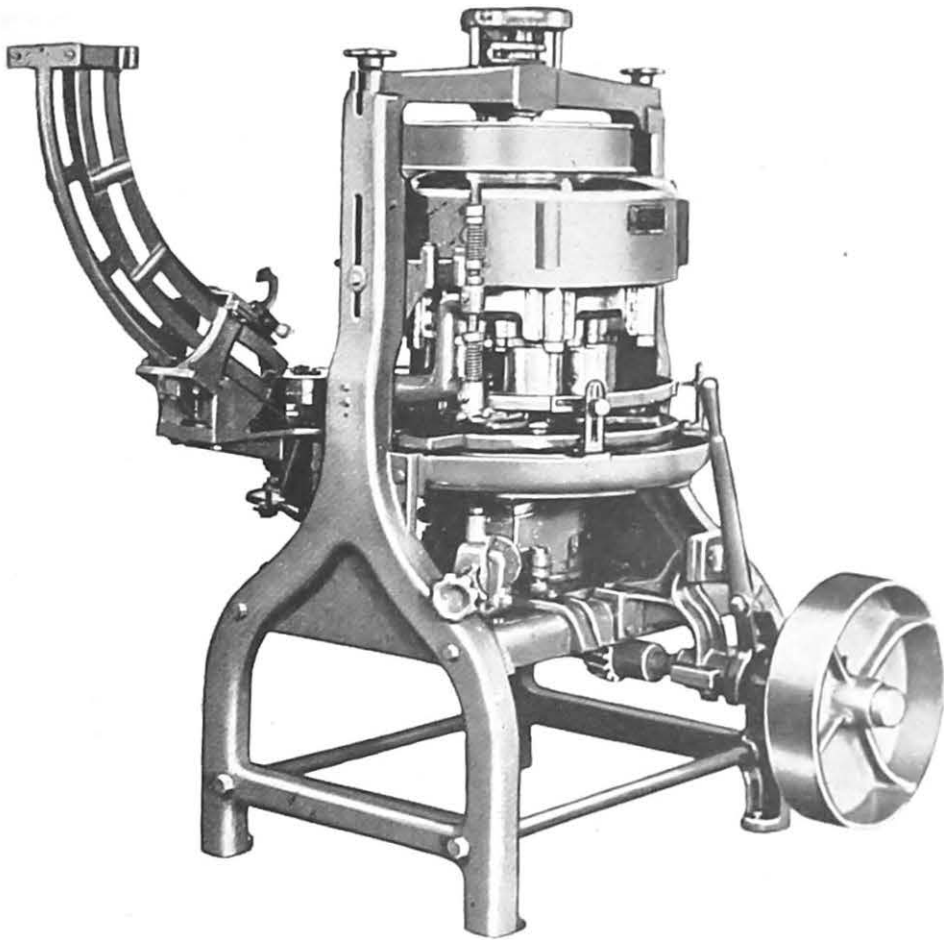

FIG. 38—Six-Pocket Plunger Filler

Peas

With small scale canning of peas, there is the alternative of picking by hand and shelling at the cannery, or using a viner in the field. If the peas are picked by hand, labour is high but the cost of the sheller is relatively low, being about \$500.00. On the other hand if a viner is used this equipment costs about \$2,000.00 but will handle about 1,000 to 1,500 pounds of peas per hour. Where the viner is used, the vines are mowed, and pitch-forked into a truck and then pitch-forked from the truck into the viner. A considerable amount of labour is saved by this method. From the viner, the peas fall into lug boxes in which they are delivered to the cannery. At the cannery, the first step is to pass them through a No. 7 Clipper cleaner, Figure 39. This removes a great deal of the waste. The peas then fall into a flume which partially washes them. This flume should have some riffles about $\frac{1}{2}$ -inch high in the bottom so any stones will be caught by the riffles. Also, a scoop should be placed below the surface of the water at the outlet of the flume so as to divert the surface inch into a separate trough and pour this inch over a screen so as to remove any floating debris. The remaining water and peas then flow into a rod rotary washer, 5 feet long with rods lengthwise, the rod spacing being $\frac{5}{32}$ of an inch. Additional sprays are provided from a pipe along the top of the washer. From the washer, the peas are elevated by a goose-neck elevator to the blancher. The blancher is the same one as used for beans, Figure 34. For peas of desirable maturity and medium size, a blanch of

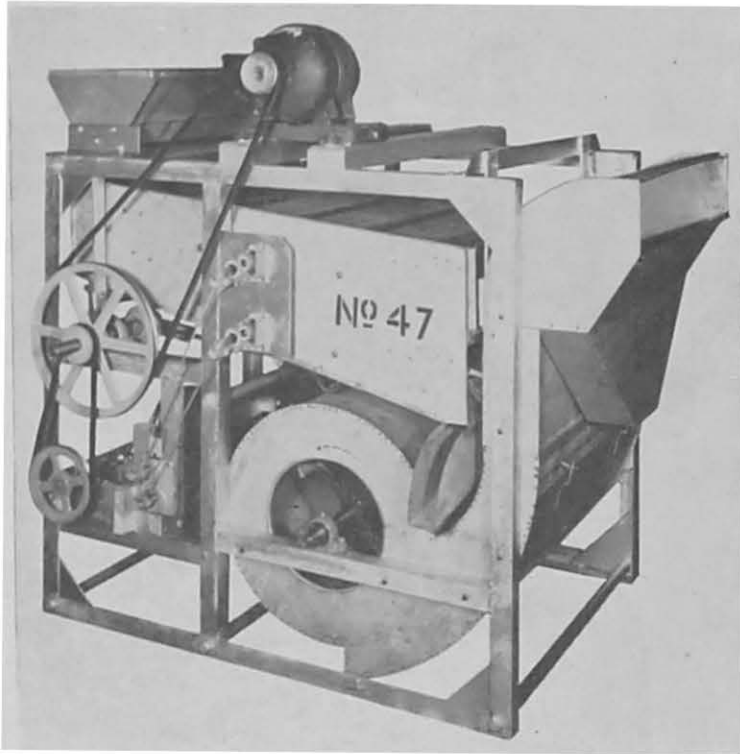

FIG. 39—Pea Cleaner

2 to 3 minutes at 205° F. is satisfactory. From the blancher, the peas fall into a flume and draining reel, the same as suggested for beans. They then pass onto an inspection belt from which a metal scoop or plough diverts them to a trough filler, Figure 27. A boiling hot brine is added consisting of 2 per cent salt and 2-5 per cent sugar.

Spinach

Spinach should not be canned by the smallest canners such as those described in cannery sizes No. 1 and 2. Actually, to make a thorough job of washing and sterilizing, it should not be canned in canneries of size No. 3.

Spinach requires a great deal of thorough washing due to the fact that it grows near the ground and has a type of leaf to which dust particles and sand will adhere. Also, there is the possibility of aphid infestation. Large plants have the spinach harvested with a mower which cuts the leaves loose above the crown. This is placed on an inspection belt where as many defects are removed as possible. The leaves then fall into the first of two tandem tanks of water. These tanks have header pipes about every two feet and sufficient taps for throwing water into the tank at a 45° angle. The taps are sufficiently close together on each header so that the sprays from the taps overlap. This forceful stream from the taps causes a flow of water which carries the spinach leaves forward and makes possible a thorough washing. Two tanks equipped in this manner are used, the first containing cold water and the second containing hot water. Following this wash, the leaves are elevated to the blancher, Figure 34, and blanched at 170° for about 6 minutes. The hot blanched spinach is again sorted on a moving rubber belt before being conveyed to the canning tables. The filling is to a definite weight and is done by women wearing rubber gloves. The minimum net drained weight for 20-ounce cans is 13 ounces. This should not be exceeded to

any great extent as heat penetration in a tightly packed can is greatly reduced. After filling, a hot 2 per cent brine is added and any method that will distribute it throughout the can is an advantage. The cans are then exhausted to give a can centre temperature for gallons of 150° F. and a temperature in excess of 160° F. for smaller cans. In larger factories where agitating rotary cookers heated with boiling water are available, the capped cans of spinach are passed through this apparatus in order to raise the can centre temperature to at least 180° F. before the cans enter the retort. If this apparatus is not available, then the processes given in Table 6 should be closely adhered to.

Equipment Cost

Costs of the foregoing equipment for beans, peas and corn f.o.b. U.S.A. points, summer of 1948, were as follows:

<i>Beans</i>	Snipper.....	\$2,000.00
	Cutter.....	514.00
	Blancher.....	1,125.00
	Retorts (2).....	650.00
		\$4,289.00
<i>Corn</i>	Husker.....	\$1,225.00
	Cutter.....	900.00
	Mixer.....	1,000.00
	Filler.....	2,200.00
		\$5,325.00
<i>Peas</i>	Viner.....	\$2,000.00
	Clipper Cleaner.....	140.00
	Rotary Washer.....	500.00
	Gooseneck Elevator.....	350.00
		\$2,990.00

Length of Canning Season

The length of the canning season for beans, peas and corn varies from year to year and between districts. A prospective canner should be careful not to anticipate a length of season that can seldom be attained in his district. A rather conservative estimate of the canning season in British Columbia is as follows: beans, 30 to 40 days; peas, 15 to 30 days; and corn, 30 days.

Warehousing

Starting with a pack in the neighbourhood of 25,000 or 30,000 cases, a lift truck using 2-way pallets, Figure 40, is an economical investment. For this reason, the warehouse has been planned with 20-foot studs which allow for 15 feet of actual case and the remainder for pallets, leaving a headspace for ventilation, and possible installation of a sprinkler system. About 3 feet should be free over the cases for ventilation. These figures are based on the use of pallets stacked three high and each pallet carrying six layers of cases of 20-ounce cans. This height is considered most economical for small canneries. The warehouse in cannery plan No. 3 is 48 feet wide. This allows for an 8-foot aisle and sections 20 feet deep for stacking. These stacks may be of a size that gives multiples of 1,000 cases to simplify taking of inventory. Only similar codes are stacked together.



FIG. 40—Lift Truck and Palletized Storage

The storage described in this bulletin would have stacks of 3 pallets high with the cases 6 high rather than 8 as shown. The 2-way entry pallet may be compared with the 4-way pallet shown in Fig. 41.

The warehouse should be insulated so that a temperature of around 50° F. is maintained even in winter. If the temperature gets too close to freezing and the goods are shipped in this cold condition to a milder climate, excessive condensation may result. The space between the studs should be filled with an insulating material and in cold climates the 8-inch width of stud should be increased. In stacking, a 6-inch space should be left between the wall and the first stack of cases. The 2-way entry pallet seen in Figure 40 may be compared with the 4-way entry pallet shown in Figure 41. The machine labelling operation, as carried out in the warehouse, is illustrated in Figure 42.

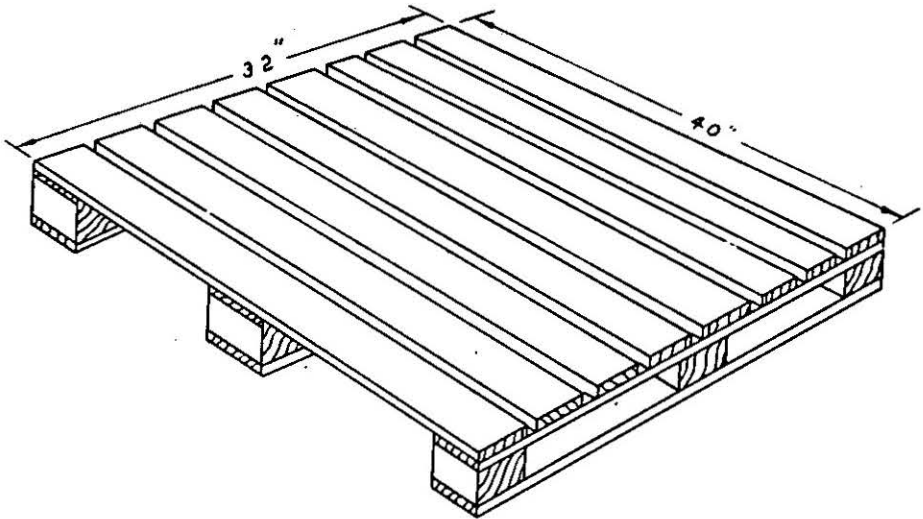

FIG. 41—4-Way Entry Pallet. Material for top and bottom 1" x 6"; corner blocks are 6" x 6" x 4".

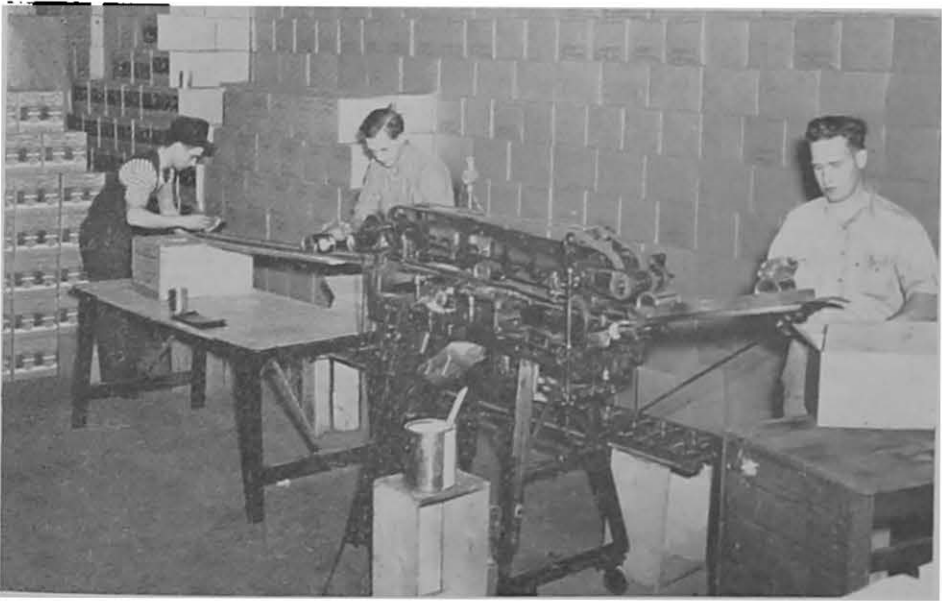

FIG. 42—Labelling Machine for No. 3 Cannery

Sanitation

Plant sanitation could be called "good housekeeping". Only a brief resume is intended here of such pertinent items as waste disposal, floors, drains, overhead pipes, shafts, ventilation and clean-up. The latest amendments to the Meat and Canned Foods Act cover many items of sanitation. These should be studied carefully.

A plant, if properly cleansed, should be open for public inspection at any time. Clean sanitary plants do much to improve the quality of the product and the efficiency of the employees.

Waste Disposal

Waste from a cannery may be removed continuously by washing it away in a drain or it may be allowed to accumulate in truck loads and be hauled away. Regardless of the system, it should be removed at least daily. In many areas, the waste can be put through a revolving or shaker screen to separate the water from the solids and the solids hauled to farm land and distributed. Where screens, elevators, and hoppers are used, as much of the equipment as possible should be made of metal so that it will be easy to clean. In very small canneries, septic tanks can be used. The system chosen will depend on local conditions but it is imperative that the waste be definitely removed from the cannery.

Floors

To be sanitary, cannery floors must be smooth, tight, sloping at least 1/8 inch per foot to a drain, and be of a material that does not absorb liquids.

Wherever possible, a concrete floor laid on gravel at ground level and surfaced with a hardening and sealing agent is preferred. The extending use of fork trucks has greatly reduced the need of raising floors 4 feet above ground level to be at the same level as box car floors.

Wooden floors that are being used for processing operations definitely should receive a mastic surface to make them tight and sanitary. If they are not tight, waste material can drain to an unaccessible place under the building and putrify. This presents a serious problem in sanitation which is difficult to adequately control.

Drains

A successful plan has been to locate drains in the centre of each 16-foot bay of the processing section of the building. Thus, these drains would be 16 feet apart with a 1-inch elevation in the floor midway between them. A drain with a round bottom is preferred. This bottom should slope 1/8-inch per foot. The walls should be smooth and the recessed cover should be made in short sections that can be easily raised for cleaning or in the case of blockage. The drain covers should be 1/2-inch narrower than the recess for the cover and may be kept centered with 1/4-inch blocks or lugs on each side of the cover. The cover also should be 1/2-inch shallower than the recess with 1/2-inch blocks or lugs under the cover to provide support. By having the cover so spaced, continual drainage can take place. See Figure 1 for detail of floor drain. No drain should be less than 4 inches in width.

Overhead Pipes, Shafts and Ventilation

These subjects are more or less related. If there is not sufficient ventilation there will be excessive condensate dripping from the pipes and shafts into the open cans and onto the workers. Bearings without drip cans will add the odd drop of lubricating oil to products being processed. Wherever possible it is suggested that overhead shafting be replaced with individual drives on the machines.

Ventilation should be sufficient so that condensate does not form on walls and other parts of the buildings as this will encourage growth of organisms and also devalue the building abnormally fast.

Washrooms

The size of washrooms will depend on the size of the plant and the provincial health regulations governing such factors. Each washroom should have a water toilet, hand basin, liquid or powder soap and paper towels. It should be located on an outside wall with ventilation to the outside. Toilet rooms should be fitted with self-closing doors and these should not open directly into the workroom.

The floors should be of an impervious material, preferably of a type that can be washed with a hose or steam gun and treated with a disinfectant. The washroom should be presentable at all times.

Clean-up

Select a person to be in charge of clean-up who comes from a clean home and who is clean and tidy in his habits. Pay him a wage comparable to foremen's wages. Provide him with the necessary tools and written instructions on the cleaning he is to do. If he is to dismantle machinery, be sure he knows how this should be done. In general, it is desirable, while the factory is running, to have employees on the job who are constantly doing as much tidying as possible. In this way, the plant always looks businesslike. Then as soon as the processing is completed, the remainder of the clean-up crew start to wash down floors and equipment, and treat them with disinfectants that will prevent growth of slime and other organisms. All equipment such as moving belts, conveyors, piping, blanchers, cookers, brine tanks, fillers, tables, pans, buckets and any other equipment used in packing operations must be thoroughly scoured and scalded with hot water followed by a cold water wash. This is one of the most important operations of general clean-up and it is an insurance against possible spoilage of the canned product.

Before the factory starts the next shift, the superintendent should look under conveyor belts, into drains and preparation machines and so forth, to see how well the clean-up crew have done their job. In general, all possible contaminants should be eliminated. Machinery, belts, and floors should be free from slime, mould growth, scale deposit and spilled food particles. The factory should smell sweet with all objectionable odours eliminated. Elimination means their removal and not substitution with some other odour from a disinfectant such as creosote or a supposedly attractive perfume in the washroom.

All outside premises should be clean and tidy. Yards adjacent to the plant should be covered with gravel, cinders or some similar surfacing material.

Keeping Records

Canning is an exacting and highly competitive industry. If one is to succeed he should know his position in regards to production and costs at all times. Consequently, it is imperative that a record be kept of all transactions. The books should be organized so that at the end of the season one can determine the various costs given under Annual Overhead. In addition, the variable charges under Operating Costs should be quickly determinable from day to day. If, for instance, the cost of fruit, female or male labour, or sugar, has been excessively high on a Wednesday, the manager should know of this by 10:00 o'clock Thursday morning so that steps can be taken to correct the situation. In other words, a simple record of variable costs should be made up each morning as soon as the individual in charge of accounting reports for work. For comparison between days, the operating costs can be calculated on a basis of 1000 cans or per case, whichever is preferred. If the records already mentioned are properly kept, then various calculations can be made at the end of the season. The form, Summary of Fruit Account, is an example of what is intended.

SUMMARY OF FRUIT ACCOUNT

Total of season's pack		
Cherries, 20 oz.	_____	cases
Apricots	_____	
Peaches	_____	
Pears	_____	
Prunes	_____	
Total 20 oz.	_____	cases

	Tons of fruit purchased tons	Cost per ton \$	Cases per ton (as 20 oz.) cases	Net fruit cost per case \$
Cherries.....	_____	_____	_____	_____
Apricots.....	_____	_____	_____	_____
Peaches.....	_____	_____	_____	_____
Pears.....	_____	_____	_____	_____
Prunes.....	_____	_____	_____	_____

Marketing

Quite as important as operating an efficient plant and producing a quality product, is the problem of marketing the output of the cannery. The small canner has the following courses open to him.

1. Selling direct to the retail trade.
2. Selling exclusively to a wholesaler.
3. Selling to the wholesale trade generally through a broker.
4. Selling through a canner-owned and directed sales office.

There are few, if any, reasons justifying direct sales to a retail store. The temptation to by-pass the wholesale trade should be resisted. No matter how small production may be at the start, it is highly improbable that any retail outlet would be in a position to absorb the canner's entire output. Certain it is that no canner can expect to sell the cream of his pack to a retail outlet, and then expect some wholesaler to dispose of the balance. As pack volume increases, the necessity for wider distribution becomes more pressing. Eventually a reliable wholesale outlet becomes a necessity.

Once the decision is made to sell to the wholsale trade only, the canner has to decide whether to make an exclusive deal with some wholesaler or to sell to the trade generally. There are arguments both for and against in either case.

If an exclusive deal is made, the wholesaler is likely to put forth greater sales effort. On the other hand, he will probably insist on marketing under his own brand name, and having his cost reduced by the usual brokerage fee. Further, an exclusive deal with one wholesaler automatically closes the door to selling to other wholesalers. There is no such thing as exclusive deals with more than one wholesaler.

If the canner decides to sell on the open market, he must decide whether to act as his own salesman, to hire a broker to represent him, or set up a canner-owned sales organization.

The first of these choices offers little possibility of success. Very few operators of small canneries have either the experience or connections to undertake sales.

Selling through a broker is a time-proved method. The problem, if this method is to be employed, is to find the right broker. The agent chosen must be well accepted by the trade and well connected with it. It is not satisfactory to choose a broker who already represents a competing line. Since usual brokerage on canned goods is low, there must be sufficient sales volume to make it worth the broker's while to handle the line. Success with sales depends entirely on choosing the right man and seeing that he is adequately recompensed for his efforts.

If several small canners can arrange to work together, it may be possible to set up a canner-owned and directed sales office. The following outlines how one group effected this step.

They formed an association registered under the laws of the province.

They marketed under a single brand name.

They packed to a uniform standard.

They chose as their sales manager a man familiar with their crop production problems. He also had experience in plant operation and was thus able to act as an organization inspector to maintain uniformity of pack. He had business experience and was able to assist members with problems incidental to banking, credits, etc. He had connections with the wholesale trade and was acceptable to them. Men with such qualifications are not easy to find but, if any of these qualifications must be sacrificed, it is most important that the man chosen has the right connections with the trade.

This association paid their sales manager on a commission basis. He received 5 per cent of all sales, took care of his own office, and travelling expenses. When sales volume increased, commissions were reduced to 2½ per cent, the usual brokerage fee.

The sales office received all orders, issued all shipping instructions to canner members, did all invoicing, all collecting, and banking of returns. Disbursements then were made to canner members twice a month. An important feature of the set-up was that sales were pooled. Thus, if goods were sold on markets with varying returns, all canner members received the same price for their products. Pack insurance was carried as an association charge, canner members paying that portion of the entire cost that their pack bore to the combined pack of the group.

This method of selling has several commendable features but it is possible only where a group of small canners are prepared to work together, and where combined sales are sufficient to attract a properly qualified man.

The Meat and Canned Foods Act

The processed fruit and vegetable regulations of the Meat and Canned Foods Act are very important to any canner or prospective canner. In this Act, enactments are given which cover inspection of the factory and of the finished product; the quality of the products being used for various grades and definition of the grades; the net and minimum drained weights; the amount of sugar in syrups; the size of cans permitted; and the size and kind of markings on labels. Because these items are of prime importance to anyone considering engaging in the canning industry, it is suggested that a copy of this Act be obtained as soon as possible.