

Symposium

on

Integrated Development of Surface and Sub-surface Water Resources

Volume I

**44TH ANNUAL BOARD SESSION
CENTRAL BOARD OF IRRIGATION AND POWER**

**PROCEEDINGS OF THE SYMPOSIUM
ON
INTEGRATED DEVELOPMENT OF SURFACE
AND SUB-SURFACE WATER RESOURCES**

Volume I

Publication No. 113

CENTRAL BOARD OF IRRIGATION AND POWER

New Delhi

November 1971

NOTE : The Statements and opinions expressed in this Publication are not necessarily those of the Central Board of Irrigation and Power.

FOREWORD

Recent years have witnessed a remarkable acceleration in the utilisation of ground water resources of the country. At the end of the Third Five-Year Plan there were about 80,000 private tube-wells in operation; another 1,75,000 private tube-wells were added during the three-year period 1966-69. During the same period as many as 4 lakh percolation wells were deepened and renovated as compared to 2.2 lakh wells during the whole Third Five-Year Plan. At the end of 1968-69 over a million irrigation pump sets and tube-wells had been energised, which is more than 5 times the number of such wells energised in 1960-61. The Fourth Plan provides for more than doubling this number.

This remarkable development in the utilization of ground water resources was perhaps stimulated by the droughts of the year 1965-66 and 1966-67 which also coincided with the development of the high yielding varieties in the agricultural sector which perform best under conditions of controlled and timely irrigation. The increased availability of equipment for drilling and blasting and of pump sets coupled with the expansion of the rural electrification programme has made this development possible.

This expansion in the utilisation of the ground water resources has taken place not only in the areas which were without other alternate sources of irrigation but also in alluvial tracts already commanded by existing canal systems. Ground water exists in comparatively copious quantities at shallow depths in such areas and this enables the farmer to grow more than one crop on an assured basis. It is well-known that such utilisation of ground water from canal commanded areas has in certain places acted as the appropriate remedy to combat the evils of water-logging and development of salinity. In various tracts of Punjab and Haryana this system of ground water exploitation in canal commanded areas has helped in arresting the spread of water-logging and its attendant evils.

With such a massive programme for utilisation of ground water resources it becomes necessary to ensure that the development takes place along controlled lines. It is also necessary to safeguard against

(ii)

over-utilization. There is thus a need to undertake a correct assessment of the ground water potential of various regions of the country and to plan the integrated utilisation of both surface and ground water resources. To focus attention on this subject and to pool the knowledge and experience gained in tackling this problem, the Central Board of Irrigation and Power decided at its 43rd Annual Session held in 1970 that a Symposium may be arranged on this subject at the time of the next Board Meeting.

Twelve papers have been received for the Symposium scheduled to be held along with the 44th Annual Board Session. These cover the aspects, "Assessment of Resources" and "Planning for Integrated Development of Surface and Sub-surface Water Resources". The initial announcement of the Symposium indicated that the scope of the Symposium would also cover the aspect "Implementation of Plans for Integrated Development". However, no papers have been received on this topic.

These papers are presented in this pre-session volume of the proceedings to enable all the participants to study the papers in advance and take part actively in the discussions. It is hoped that the information contained herein would be useful to the profession in the economic and efficient utilisation of the water resources of the country.

NEW DELHI
November 1971

I. P. KAPILA
Secretary
Central Board of Irrigation and Power

CONTENTS

	PAGE
FOREWORD	(i)
ASSESSMENT OF RESOURCES	
(1) Technique and Methodology for Assessing Surface Water Resources of a River Basin	<i>K. V. Sreenivasa Rao, M. Ganesan and D. P. Ghose</i> 1
(2) Ground Water Potential of the Part of Ong Basin, Balangir, Orissa	<i>M. N. Satpathy and C. P. Sengupta</i> 11
(3) A Plea for Ground Water Reservoirs to Store Excess Rain Water	<i>R. D. Verma, M. M. Dandekar and R. M. Advani</i> 17
(4) Dipole Pumping Test and Concept of Aquifer Matrix to be Utilised for Computer Simulation of Aquifers	<i>P. Kumaraswamy</i> 21
(5) Techniques and Methods for Development and Assessment of Ground Water Resources	<i>R. P. Sharma, S. R. Sehgal and A. D. Gulati</i> 31
PLANNING FOR INTEGRATED DEVELOPMENT OF SURFACE AND SUB-SURFACE WATER RESOURCES	
(6) Integrated Development and Conjunctive Use of Surface and Ground Waters	<i>O. P. Gupta</i> 41
(7) Need for a National Water Policy	<i>G. N. Kathpalia and N. S. Varadan</i> 49
(8) Use of Statistical Techniques in Planned Development of Sub-surface Water Resources	<i>A. P. Bhattacharya</i> 67
(9) Conjunctive Development of Surface and Ground Water Resources	<i>M. C. Chaturvedi</i> 75
(10) Development of Water Resources—An Integrated Approach and their Environmental Effects	<i>D. R. Sikka</i> 85
(11) Sprinkler Irrigation as a Measure for the Integrated Development of Surface and Sub-surface Water Resources	<i>B. C. Shah and M. V. Bapat</i> 89
(12) Conjunctive Utilisation of Surface and Sub-surface Water Resources for Future Water Supply in Chandigarh	<i>N. Narayana Pillai and Baljeet Singh</i> 99

SESSION I

ASSESSMENT OF RESOURCES

Technique and Methodology for Assessing Surface Water Resources of a River Basin

K. V. SREENIVASA RAO

Member (W.R.)

M. GANESAN

Director

D. P. GHOSE

Deputy Director

Central Water and Power Commission, New Delhi.

SYNOPSIS

A reliable assessment of the surface water resources in different regions of the country is a basic requirement in the planning of water resources development projects. The assessment of surface water resources of a river basin depends upon the nature and extent of hydrological and meteorological data which may be of three types, viz. : (1) when adequate records are available for a long period, (2) when the records are for a limited period, and (3) when there are no records of hydrological data but meteorological data are available. This paper describes briefly the methods of assessment of surface water resources for the three types of data. A statement showing the results of studies carried out in C.W.P.C. in respect of water resources of Sabarmati, Tapi, Mahanadi and Damodar River basins is appended. Additional measures to ensure dependable assessment of water resources in future have been briefly indicated.

1. Introduction

1.1 The water resources of a country are the most important of all the natural resources for its economic development and the welfare of its people. This naturally calls for the optimum exploitation of the water resources. A reliable assessment of the water resources in different regions is a basic requirement for the proper planning of water resources development projects. In March 1962, the then Technical Committee on Water of the Planning Commission while reviewing the existing status of the availability and utilisation of the country's water resources felt the necessity of a more reliable knowledge of the water resources and the balance of water that would be available in each river basin and sub-basin after meeting the current utilisation and additional future requirements for existing and committed projects. Accordingly, the Committee recommended an outline of studies for making a comprehensive and dependable assessment of the water resources based on observations and data currently available.

1.2 The Central Water and Power Commission has been entrusted with the studies of surface water resources of all the river basins of the country other than the Ganga, the Brahmaputra and the Indus River basins. The

Commission has evolved the necessary techniques and methodology for assessing the surface water resources of a river basin which are briefly presented in this paper.

2. Methods of Assessment of Surface Water Resources

2.1 A dependable assessment of surface water resources of a river basin can only be made by analysis of observed hydrological and hydrometeorological data and existing quanta of consumptive utilisations of river waters. However, the requisite observed data are generally lacking for the river basins of this country and as such the method of assessment will depend upon the nature and extent of data which may be of the following categories :—

- (i) When adequate records of gauge and discharge and withdrawals data, etc, to cover the entire basin and sub-basins are available for a sufficient length of time, say 30 to 40 years.
- (ii) When a limited record of gauge and discharge data for a period of say 10 to 15 years are available, but other meteorological data such as rainfall, temperature, humidity, etc., are available for a period of 30 to 40 years.

(iii) When there are no records of gauge and discharge but other meteorological data like rainfall, temperature, humidity, etc., are available.

3. Assessment of Water Resources from Adequate Record of Data

3.1 Study of River System

3.1.1 As a first step for the assessment of water resources, a study of the basin as regards river system including the tributaries, topography of the basin and its characteristics, geology, etc., is made with the help of topographical maps. An index map showing the river and its tributaries, gauge-discharge sites both existing and proposed, project sites, State boundaries and catchment limits is prepared to serve as a reference map.

3.2 Collection and Compilation of Gauge and Discharge Data

3.2.1 An inventory of gauge-discharge data giving information of the location of the gauge-discharge sites and the period for which the gauge-discharge data are available for each site on the main river and its tributaries is prepared. From a study of the index map showing the location of gauge-discharge sites and of the extent of availability of gauge-discharge data, the important gauging sites are selected. After having selected the gauge-discharge sites, the relevant gauge-discharge data are collected from the various sources with whom these data may be available.

3.3 Unit Period of Study

3.3.1 The unit period of study may be a 10-day period or a month depending on the nature of data available. It is obvious if the water resources are worked out on a 10-day basis, the planning of a project can more accurately conform with the various seasonal water requirements. This advantage is, however, lost if the water resources are worked out on a monthly basis.

3.4 Scrutiny of Gauge-Discharge Data

3.4.1 Before the gauge-discharge data can be used for studies these have to be scrutinised for consistency and reliability to ensure that these are reasonably accurate. Consistency as well as reliability has to be checked as extremely misleading results can arise from the use of non-homogeneous data. Consistency of river flow data can be judged from a comparison of gauge and discharge hydrographs at a particular discharge site which will reveal whether there are wide variations in the discharge for more or less the same gauge readings and whether higher gauge readings give lower discharges and *vice versa*. The consistency of the data can also be judged by a comparison of the discharges at a site with those at gauge-discharge sites above and below. The reliability of the river flow data can be ascertained from the methods and equipment used for the discharge observation. The velocity

observed by current meter will be more reliable as compared to the velocity measured by floats. As regards method of computation it needs to be checked whether the cross-section of the river was divided into a number of smaller segments and the total discharge for the whole section was worked out by summation of discharges calculated for each of the segment.

3.5 Supplementing Missing Data

3.5.1 After carrying out the scrutiny of the observed discharge data and adjustment, if any, for removing inconsistencies, the next step is to fill up the gaps or the missing links in the observed discharge data. The gaps may be for a few days or for a longer period. The missing data may be either the gauges or the discharges or both. If the discharge data are only missing but gauges are available, the discharges may be estimated with the help of properly drawn 'gauge-discharge' curves, by extrapolation. Where gauge-discharge data are missing for longer periods say, for a month, the runoff is estimated after establishing monthly rainfall-runoff relationships. The estimated discharges are further checked up by comparing them with the corresponding observed runoff figures at upstream or downstream gauging sites, if available.

3.6 Collection and Compilation of Data of Consumptive Utilisation of Surface Water

3.6.1 The observed discharges at a site are the actual flows after upstream withdrawals from the river have been made in respect of irrigation projects, industrial undertakings, urban and rural water supply schemes, hydel and steam power plants and other uses such as anti-salinity measures, flushing river channels, navigation needs, etc. To obtain the historical flow at a site the quanta of actual upstream consumptive utilisation (or withdrawal) must be added to the observed discharges at a site.

3.6.2 An inventory of project sites together with the details of withdrawals is prepared and the data collected for the period these are available. Besides the information regarding existing withdrawals, the details of planned withdrawals for projects under construction and committed for future construction are also required in order to work out balance of water that would be available after meeting the requirement of planned withdrawals.

3.6.3. The evaporation losses from a reservoir, if existing, are also considered as withdrawal from the river. The evaporation losses may be estimated on the basis of evaporation data recorded by the Indian Meteorological Department at a nearby observatory.

3.6.4 In cases where the actual withdrawal data for irrigation schemes are not available these may be estimated from the agricultural statistics of the areas actually irrigated, crop pattern, duty/delta, etc.

3.7 Determination of Time-lag

3.7.1 The time-lag between any two sites is defined as the average time taken by a particle of water to travel

from one station to another. It is generally measured to the nearest day and is given by the time interval between the prominent flood peaks or troughs of the corresponding discharge hydrographs between the two stations. This time-lag decreases as the discharge increases, but the exact relations are indefinite and at confluences where the discharge of one river affects or is affected by the discharge of the other, relations are further complicated. In view of these difficulties, the time-lag can, at best, be determined only approximately. Thus, for example, if the average time interval between the corresponding peaks in the discharge hydrographs of two stations *A* and *B* is 3 days and that between the corresponding troughs is 5 days, then the time-lag for the reach between *A* and *B* may be taken at its median value, say 4 days. Time-lag is important in dealing with water resources studies based on a 10-day period as the total discharge in the period 1st-10th at a station is related to the period 5th-14th at a downstream station, if the time-lag is 4 days. The time-lag is, however, not of any consequence for a monthly analysis.

3.8 Determination of Historical Discharges

3.8.1 The historical flows at any point in the river basin are determined by adding to the adjusted discharges, after screening and scrutiny, the quanta of the actual upstream consumptive withdrawals including evaporation losses from reservoirs. Similarly, if need be, additions for measured spills upstream and deductions for the known inlets from outside sources have to be made. The diversions for storage or to adjacent basins are to be treated as withdrawals, while releases from storages upstream are to be accounted for as inlets.

3.8.2 A typical case is assumed to illustrate the procedure for the determination of historical flows. Let *A* and *B* be the two gauging sites on a river. In the reach *A-B*, there exists a tributary *T*, a storage reservoir *SR* and an inlet *I*. There are withdrawals taking place from the river. The hypothetical reach of the river basin considered is shown in Figure 1.

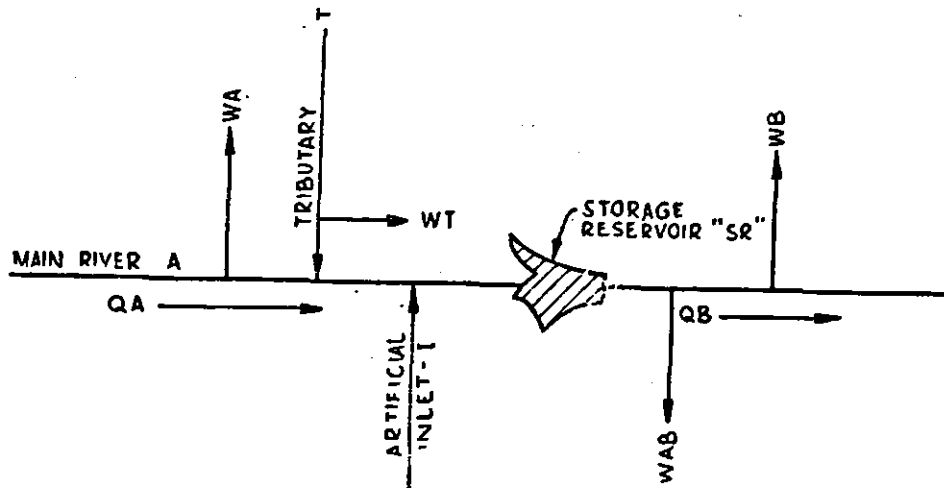

FIGURE 1 : A hypothetical reach of a basin.

- (i) Particulars of Gauge-Discharge Site at *A*
 - (a) Observed/adjusted discharges = QA
 - (b) Withdrawals upstream (cumulative consumptive) = WA
 - (c) Historical flow at *A* = QHA
- (ii) Particulars of Gauge-Discharge Site at *B*
 - (a) Observed/adjusted discharge = QB
 - (b) Withdrawals upstream (cumulative consumptive) = WB
 - (c) Historical flow at *B* = QHB
- (iii) Particulars in the Reach *A-B*
 - (a) Consumptive withdrawals in the tributary '*T*' = WT
 - (b) Consumptive withdrawals in the reach *A-B* = WAB
(including spills within the reach)
 - (c) Storage into or releases from the reservoir '*SR*' (Storage into the reservoir + WSR = $\pm WSR$
Releases from reservoir - WSR)
 - (d) Evaporation losses from the reservoir '*SR*' = ESR
 - (e) Inlet into the river from outside = I

As stated in para 3.8.1 the historical flow at *A* is,

$$QHA = QA + WA \quad \dots(3.1)$$

The historical flow at *B* would be given by the following expression :-

$$QHB = QB + WB \pm WSR + ESR - I \quad \dots(3.2)$$

Where, $WB = WA + WT + WAB$

It may be seen that the moderating effect of reservoir $\pm WSR$ may be either storage into the reservoir + WSR in which case it may be treated as +ve

consumptive withdrawal or the releases from the reservoir—*WSR* in which case it may be treated as —ve consumptive withdrawal. The physical concept involved is that had there been no reservoir inbetween the sites *A* & *B*, the element of storage occurring in it would have contributed to the observed discharge at *B*. Similarly, the element of release from the reservoir would not have resulted in increasing the observed discharge at *B*.

3.9 Absorption and Transit Losses and Contributions by way of Return Flow from Regeneration and Valley Storage

3.9.1 There is a loss of water due to absorption and transit of water from one station to another station. Similarly, there will be contributions to the river discharges at a site due to return flow from regeneration including regeneration from the irrigated areas upstream and valley storage. If the runoff at a lower site is less than that at an upper site, there is a loss in the reach. On the other hand, if the runoff at the lower site is more, then there is a contribution from the intermediate catchment. The absorption and transit losses and the contributions from the regeneration and valley storage under the existing conditions of withdrawal are worked on the basis of historical run-offs. For the purpose of assessing what would be the unutilised or residual water resources in the river after all the existing and committed projects have reached the full development, it is necessary to re-assess the future changes that are likely to occur in the absorption and transit losses or contributions by return flows from regeneration and valley storage.

3.10 Assessment of Absorption and Transit Losses and Contributions from Regeneration and Valley Storage

3.10.1 The absorption and transit losses are expressed as a percentage of the discharge at the head of the reach. Thus, the percentage historical loss is given by,

$$\frac{\text{Historical loss}}{\text{Historical flow at the head of the reach}} \times 100.$$

These losses are assumed to vary in direct proportion to the discharges in the river. If there is an additional upstream withdrawal, there will be reduction in the river flows and consequently, the losses will be less.

3.10.2 The contributions due to regeneration would increase on account of reduction in flow in the river consequent upon withdrawal upstream. No definite method of estimating regeneration flow has yet been found. It will be safer to assume that the contribution from the regeneration and valley storage will remain unchanged as a result of the additional withdrawal.

3.11 Assessment of Residual River Flows

3.11.1 The unutilised or residual water resources are determined on the assumption of the continuity equation which expresses the fact that the volume of water arriving at any point on a river is the volume

of water leaving an upstream point less the withdrawals plus the contributions from the reach between these points but less the absorption and transit losses. Based on this assumption, water accounts are prepared for working out the residual water resources, reach by reach, starting from the uppermost to the lowermost discharge site in a river basin. The operations involved in these water accounts are explained in the illustrative example given in Appendices I and II. The line diagram of the river basin considered is shown in Figure 2. Appendix-I shows the 10-day water account to calculate historical discharges. Appendix II is the 10-day water account for computation of residual discharges after taking into consideration additional future withdrawals. As will be seen from the water accounts, effects of time-lag have been duly considered with reference to the lowermost discharge site *C*. In the example, the time-lag between *A* and *B* is 1 day, between *B* and *C* 2 days and between *T* and *B* it is nil. In case where long-term data are available these water accounts should be prepared for a period of 30 to 40 years so that percentage dependabilities of the available runoff can be worked out.

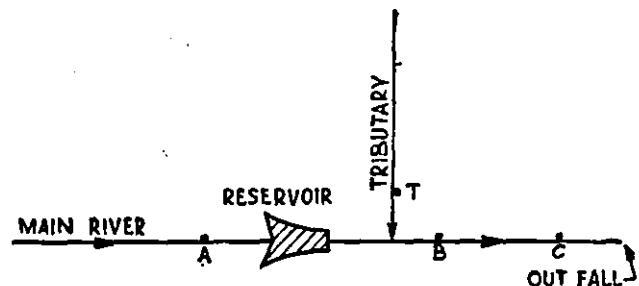

FIGURE 2: Line diagram of a river basin.

3.12 Determination of River Flows at various Percentage of Dependabilities

3.12.1 The total annual runoff in a river varies from year to year and a knowledge of the variability of runoff is essential for planning any water resources project. The design criteria for such a project is normally fixed for a specified dependability of the annual yield. For example, an irrigation project is normally designed based on a 75 percent dependable annual yield which would mean that for a successful irrigation the annual runoff must be available for 3 out of 4 years on the average.

3.12.2 The percentage dependabilities of historical runoff are worked out by statistical analyses of a runoff series for a period of 35 years. The runoff series are tested to see whether it follows a normal distribution or a skew frequency distribution. The determination of percentage dependabilities, therefore, depends on the nature of distribution of the runoff series. When the annual runoff series follow a normal distribution, the stream-flow for various percentages of time or

percentage dependabilities are worked out from the equation,

$$R_p\% = \bar{m} - Z\sigma \quad \dots(3.3)$$

where, \bar{m} is the mean flow, Z is the value of frequency factor of normal distribution (given in published normal tables) corresponding to the various percentage dependabilities and σ is the standard deviation of a long-term runoff series.

When the annual runoff series do not follow a normal distribution but follow some type of skew frequency distribution, the percentage dependability of runoff $R_p\%$ is calculated by the following equation given by Goodrich⁽²⁾

$$\log R_p\% = A + B \log \operatorname{colog} \left(1 - \frac{p}{100} \right) \quad \dots(3.4)$$

where, p is the percentage dependability, A and B are constants which are evaluated by solving the following equation by the method of 'Least Squares'

$$\log R = A + B \log \log \left(\frac{n}{m - \frac{1}{2}} \right) \quad \dots(3.5)$$

where, R is the runoff, m is the rank order of the runoff R , after arranging the runoff series in ascending order of magnitude and n is the number of years in the runoff series.

4. Assessment of Water Resources from a Limited Record of Data

4.1 When the records of gauge-discharge data are available for a limited period of say 10 to 15 years, then the runoff data are extrapolated for the balance period of 25 to 20 years to obtain a 35 years' runoff series. Such extrapolation is done by establishing suitable rainfall-runoff correlation by statistical methods. In this way only the annual runoff and to some extent monthly runoff are estimated by the methods explained in paras 4.2 and 4.3. The estimation of 10-day runoff is, however, not made as the factors like soil characteristics, absorption, regeneration, evapo-transpiration which significantly affect such short period runoff are difficult to evaluate.

4.2 Annual and Monsoon Rainfall-Runoff Relationships

4.2.1 In developing annual rainfall-runoff relationship the yearly observed runoff of 10 to 15 years is correlated with the corresponding annual rainfall by statistical analyses. Similarly, monsoon rainfall is correlated with observed monsoon runoff or annual runoff to develop monsoon rainfall-runoff relationship. The relationship which estimates runoff values closer to the observed ones is adopted for extrapolation of runoff series.

4.2.2 The nature of relationship is approximately judged from a scattered diagram or plot of points of one variable against the other. The relationship can be either a straight line or a parabolic curve. In the latter case, the points when plotted on logarithmic scale (both axes) will align along a straight line. The func-

tion relating to the variables is termed as 'Regression Equation' and if all the plotted points of the observed data lie exactly on the Regression line, the correlation coefficient is unity and the relationship is perfect. If the points are very much scattered the relationship is then said to be very poor and the correlation coefficient may be zero. When the correlation coefficient is found to be sufficiently high (after performing reliability test) then a good regression equation connecting the two variables, viz., runoff and rainfall may be obtained by the method of 'Least Squares'. Using this equation, the values of runoff can be extrapolated from rainfall data. The effective length of extended record will depend upon the period of recorded data and the coefficient of correlation⁽³⁾.

4.3 Monthly Rainfall-Runoff Relationship

4.3.1 The runoff during a month includes runoff from the previous months' rain in addition to the runoff from the rainfall during the concurrent month. Throughout this period ground water is also available to the runoff. Thus, the runoff in a month may be considered as functions of the concurrent and preceding months' rainfall. This may be expressed by a 'Linear Multiple Regression Equation' of the form,

$$Y = a + b_1X_1 + b_2X_2 + b_3X_3 \quad \dots(4.1)$$

Where, Y is the current month's runoff

X_1 is the current month's rainfall

X_2 is the rainfall of the first antecedent month.

X_3 is the rainfall of the second antecedent month, and so on

a is the station constant

b_1, b_2 and b_3 are the regression coefficients which represent the relative contribution of a previous month's rainfall to current month's runoff.

4.3.2 Equation (4.1) holds good for the monsoon months. In the case of non-monsoon months the 'Linear Multiple Regression Equation' is given by,

$$Y = a + b_1X_1 + k.P_a \quad \dots(4.2)$$

Where, Y, X_1, a and b_1 have the same meaning as in Equation (4.1).

k is the regression coefficient.

P_a is antecedent precipitation index (A. P. I.) which is computed by the following formula given by Langbein⁽³⁾,

$$P_a = \frac{1}{2}P_{n-1} + \frac{1}{4}P_{n-2} + \frac{1}{8}P_{n-3} \\ + \frac{1}{16}P_{n-4} + \frac{1}{32}P_{n-5} + \dots$$

The antecedent precipitation index, P_a is the sum of $\frac{1}{2}$ of the precipitation in the month immediately antecedent (P_{n-1}), $\frac{1}{4}$ th of the second antecedent month (P_{n-2}) and so on. For example, A. P. I. for November 1961 is the sum of one-half the rainfall for October 1961, plus one-fourth the rainfall during September 1961, plus one-

eighth the rainfall during August 1961, plus one-sixteenth the rainfall during July 1961, plus one-thirty-two the rainfall during June 1961, where coefficients $\frac{1}{2} + \frac{1}{4} + \frac{1}{8} + \frac{1}{16} + \frac{1}{32}$ add to unity.

4.4 Assessment of Water Resources

4.4.1 The studies mentioned in para 3 for the assessment of water resources from adequate records of data are carried out for the period for which data are available (i.e., 10 to 15 years). From the water accounts prepared on the lines suggested in Appendix I, the historical runoffs at various gauge-discharge sites are calculated. The historical runoffs are used to develop suitable rainfall-runoff relationship for extending the runoff series for 35 years to work out the various percentage dependabilities of annual and monthly runoffs. The residual water resources are worked out by preparing the water accounts as explained in Appendix II.

5. Assessment of Water Resources of a Ungauged River Basin

5.1 When no discharge records whatever are available for a river basin, the water resources of the basin may be assessed either from the runoff records of an adjacent river basin or by empirical formulae.

5.1.1 When the discharges have been observed at a station in an adjoining river basin having similar basin and hydrometeorological characteristics the rainfall-runoff relationship of that station may be assumed to hold good for the ungauged basin also. The long-term runoff series for 35 years may then be obtained using the rainfall-runoff curve after working out the rainfall for the past years. The percentage dependabilities of the runoff values are determined, based on the estimated runoff series.

5.1.2 The empirical formulae for estimating runoff that are commonly in vogue are : (1) Strange's tables, (2) Khosla's formula, and (3) Inglis formula. But these formulae have serious limitations. From a comparison of the observed flows for a few catchments, it is found that the errors in estimating the flow from these empirical formulae are very great. These formulae are therefore, not recommended for any reliable estimate of flows. They can at best be taken for purely preliminary studies and not for any project planning.

5.1.2.1 Strange's Table

Mr. W. L. Strange has prepared a table in which the percentage of monsoon runoff to monsoon rainfall are separately tabulated for three classes of catchment namely, good, average and bad catchments. While using the Strange's table, great caution is warranted in assigning the type of catchment. Also, Strange's tables do not give runoff values for rainfall values of over 152 cm (60 in.). Strange himself has cautioned that his tables should not be used where observed data are available.

5.1.2.2 Khosla's Formula

The forecast of runoff by this formula is based on the concept that runoff is the residual of rainfall after the evapotranspiration losses have been accounted for. The mean temperature is assumed as a complete measure of all the factors affecting such losses. The formula based on month as a unit is,

$$R_m = P_m - \frac{T_m - 32}{9.5} \quad \dots(5.1)$$

Where, R_m = Monthly runoff in inches

P_m = Monthly rainfall in inches

T_m = Mean monthly temperature in degrees Fahrenheit (Temperature greater than 40° F).

In this formula monthly runoffs are worked out and are aggregated to give the annual runoff. This formula is, however, not meant for working out individual month's runoff.

5.1.2.3 Inglis Formula

Messrs Inglis and D'souza had evolved two empirical formulae for the Bombay State (now Maharashtra). One is for the Ghat catchments and the other for non-Ghat catchments. The formula for the Ghat catchment is,

$$R = 0.85P - 12 \quad \dots(5.2)$$

for non-Ghat catchment the formula is,

$$R = \frac{P - 7}{100} \times P \quad \dots(5.3)$$

Where, R = Annual runoff in inches

P = Annual rainfall in inches.

The limitations of the above formulae are indicated here. The formula for Ghat catchments is applicable to large catchments in which rainfall over a part of the area is very great. In the case of non-Ghat formula, it is only applicable for low figures of rainfall.

6. Results of Some Studies

6.1 The detailed studies for the assessment of surface water resources and the residual water resources have been worked out in respect of Sabarmati, Tapi, Mahanadi and Damodar River basins. The result of the studies is enclosed in Appendix III wherein 75 percent dependable yield and the residual water resources of these river basins and their major sub-basins have been given. From Appendix III it will be seen that adequate balance water resources in these river basins are available for future exploitation. The exploitation of the water resources is, however, subject to favourable topographical and geological features of the river basins.

7. Additional Measures to ensure Dependable Assessment of Water Resources

7.1 A comprehensive and dependable assessment of surface water resources is largely dependent upon the

adequacy and reliability of the observed hydrological and meteorological data. The inadequacies and limitations of the current available data as revealed from the water resources studies need to be critically reviewed and suggestions for additional measures required for the improvement are to be made with particular reference to the following items :—

- (i) Adequacy of hydrological network.
- (ii) Adequacy of hydrometeorological stations.
- (iii) Methodology and equipments used for observation of hydrological data.
- (iv) Organisation control.

7.2 If the network of gauge and discharge sites and the hydrometeorological stations are found to be inadequate in the basin, the recommendations are to be made as regards additional number of stations required and their distribution.

7.3 Similarly, if the methods adopted and equipments used for the measurement of river discharges are not

dependable, then suggestions for improvement in the methodology, equipments and organisations for collection and compilation of data are required.

7.4 There should be adequate arrangements and organisations in the States for maintaining detailed and systematic records for various water utilisation data and for standardisation and publication of hydrological data.

8. References

- (1) Framji, K.K. : "An Outline of the Studies for the Programme of Assessment of Surface Water Resources and their Utilisation". Unpublished.
- (2) Goodrich, R. D. : "Straight Line Plotting of Skew Frequency Data". Paper No. 1622 of Transactions of Am. Soc. of Civil Engrs., Vol. 91, December 1927.
- (3) Langbein, W. B. : "Hydrologic Data Networks and Methods of Extrapolating or Extending available Hydrologic Data." Flood Control Series No. 15, ECAFE and WHO.

APPENDIX I

Computation of 10-day Historical Flows in the Reach A to B.

(Refer Figure 2, para 3.11)

Units : Cumecs-days

G-D stands for gauge-discharge

AT G-D SITE, A ON MAIN STEM				AT G-D SITE, T ON TRIBUTARY				AT G-D SITE, B ON MAIN STEM				
Period at G-D site A	Observed (Screened or adjusted) flow	Withdrawal up to G-D site A	Historical flow Col. 2+3	Corresponding period at G-D site T	Observed (Screened or adjusted) flow	Withdrawal up to G-D site T	Historical flow Col. 6+7	Corresponding period at G-D site B	Observed (Screened or adjusted) flow	Withdrawal up to G-D site B	Storage (+) or Release (-) from reservoir 'R'	Historical flow Col. 10+11+12
1	2	3	4	5	6	7	8	9	10	11	12	13
March-April				March-April				March-April				
29-7	351.12	45.93	397.05	30-8	25.27	Nil	25.27	30-8	2738.59	1374.96	(-)2284.94	1828.61
8-17	299.87	43.13	343.00	9-18	20.04	Nil	20.04	9-18	2912.07	1404.75	(-)2284.94	2031.88
18-27	236.16	77.15	313.31	19-28	16.92	Nil	16.92	19-28	3478.07	1438.77	(-)2284.94	2631.90
April-May				April-May				April-May				
28-7	213.95	64.01	277.96	29-8	33.51	Nil	33.51	29-8	2754.15	1501.23	(-)2006.24	2249.14
8-17	185.00	56.06	241.06	9-18	33.14	Nil	33.14	9-18	1041.44	1480.37	(-)2006.24	515.57
18-28	153.05	60.93	213.98	19-29	35.43	Nil	35.43	19-29	452.23	1589.13	(-)2006.24	35.12
May-June				May-June				May-June				
29-7	177.28	62.57	179.85	30-8	22.33	Nil	22.33	30-8	10.18	1500.44	(-) 929.99	580.63
8-17	104.29	63.70	167.99	9-18	8.66	Nil	8.66	9-18	236.87	1527.09	(-) 929.99	833.97
18-27	358.93	61.98	420.91	19-28	1542.55	Nil	1542.55	19-28	Nil	1533.83	(-) 929.99	603.84

APPENDIX II

10-Day Water Account for Computation of Residual Discharge after Additional Future Withdrawals.
(Refer para 3.11 and Appendix I)

Units : Cumecs-days
(Cusecs-days)
G-D stands for gauge-discharge

AT G-D SITE, A ON MAIN STEM				AT G-D SITE, T ON TRIBUTARY				AT G-D SITE, B ON MAIN STEM							
Period at G-D site A	Historical discharge prior to new withdrawal	New withdrawal	Residual discharge at A Col. 2 - 3	Period at G-D site T	Historical discharge prior to new withdrawal	New withdrawal	Residual discharge at T Col. 6-7	Period at G-D site B	Historical discharge at B	Contribution from (+) or losses (-) in reach AB Col. 10- Col. (2+6)	% age Historical Loss (-) Col. 11 / 2+6 × 100	Reduced % Loss after new withdrawal Col. 4+8 / 2+6 × Col. 12	Future Losses (-) contribution (+) after new withdrawal Loss = Col. 13 × Col. 4+8 / 100 Contribution = Col. 11	New withdrawal at B	Residual river discharge at B after new withdrawal Col. 4+8 ± Col. 14 - Col. 15
1	2	3	4	5	6	7	8	9	10	11	12	13	14	15	16
March-April				March-April				March-April							
29-7	397.05	100	297.05	30-8	25.27	10	15.27	30-8	1828.61	(+)1406.29	-	-	(+)1406.29	800	918.61 (32445.31)
8-17	343.00	150	193.00	9-18	20.04	10	10.04	9-18	2031.88	(+)1668.84	-	-	(+)1668.84	800	1071.88 (37858.80)
18-27	313.31	150	163.31	19-28	16.92	10	6.92	19-28	2631.90	(+)2301.67	-	-	(+)2301.67	500	1971.90 (69647.51)
April-May				April-May				April-May							
28-7	277.96	150	127.96	29-8	33.51	10	23.51	29-8	2249.14	(+)1937.67	-	-	(+)1937.67	500	1589.14 (56128.42)
8-17	241.06	100	141.06	9-18	33.14	15	18.14	9-18	515.57	(+) 241.37	-	-	(+) 241.37	200	200.57 (7084.13)
18-28	213.98	100	113.98	19-29	35.43	15	20.43	19-29	35.12	(-) 214.29	(-)85.92	(-)46.30	(-) 62.23	50	22.18 (783.40)
May-June				May-June				May-June							
29-7	179.85	100	79.85	30-8	22.33	15	7.33	30-8	580.63	(+) 378.45	-	-	(+) 378.45	50	415.63 (14680.05)
8-17	167.99	100	67.99	9-18	8.66	5	3.66	9-18	833.97	(+) 657.32	-	-	(+) 657.32	400	328.97 (11619.22)
18-27	420.91	200	220.91	19-28	1542.55	500	1042.45	19-28	603.84	(-)1359.62	(-)69.25	(-)44.56	(-) 563.00	100	600.46 (21200.25)

TECHNIQUE AND METHODOLOGY FOR ASSESSING SURFACE WATER RESOURCES

APPENDIX III

Statement showing the Surface Water Resources of Mahanadi, Sabarmati, Tapi and Damodar River Basins.

Sl. No.	Name of Basin	Catchment area sq km	75% dependable yield M. cu m	Residual water resources M. cu m
1	2	3	4	5
I	(i) Mahanadi Basin (up to Kaimundi)	1,31,717	53,786	43,072
	(ii) Major Sub-Basins			
	1. Sheo-Nath	30,760	12,132	9,194
	2. Hasdeo	9,803	4,966	4,602
	3. IB	12,447	8,375	8,181
	4. Jonk	3,483	1,767	1,744
	5. Ong	5,128	2,058	1,958
	6. Mand	5,237	3,660	3,653
	7. TEL	22,817	10,898	10,729
II	(i) Sabarmati Basin (up to Cambay)	21,674	2,602	1,305
	(ii) Major Sub-Basins			
	1. Harnav	972	87	61
	2. Hathmati	1,523	151	Nil
	3. Meshwa	2,808	273	Nil
	4. Watrak	3,108	357	357
	5. Shedi	2,722	324	324
III	(i) Tapi Basin (up to Kathore)	62,701	13,235	6,418
	(ii) Major Sub-Basins			
	1. Purna	18,259	1,118	701
	2. Girna	10,075	2,149	891
	3. Bori	2,447	322	283
	4. Vaghur	2,422	150	150
	5. Aner	1,260	143	143
IV	(i) Damodar River Basin (up to Durgapur Barrage)	19,554	6,160	1,276
	(ii) Major Sub-Basins			
	1. Barakar	6,294	2,250	1,309
	2. Konar	2,240	784	485
	3. Jamunia	1,141	327	316
	4. Gowai	1,412	434	432

Ground Water Potential of the Part of Ong Basin, Balangir, Orissa

M. N. SATPATHY

C. P. SENGUPTA

Directorate of Lift Irrigation, Bhubaneswar

SYNOPSIS

The paper reports an investigation conducted to estimate the ground water resources of a part of Ong basin. The area considered includes southern catchment from its confluence with Mahanadi to about 40 km upstream. The northern catchment being partly covered under Hirakud Canal System is not considered in the present investigation. The paper discusses the geomorphology, geology, ground water geology and ground water hydrology of the basin. The investigations have shown that ground water tract comprising unconsolidated sandstones as available are suitable for ground water development by deep tube-wells. Shallow aquifers confined to weathered and fractured zones of the archaean tract can be tapped by dug wells and brought under use in minor irrigation.

1. Introduction

1.1 River Mahanadi has an important catchment through Ong River which has a gross catchment area of 4,303 sq km mostly in Orissa. This river joins Mahanadi near Pondtal village ($83^{\circ} 99' 30''$ long $20^{\circ} 54' N$ Lat.). The basin including the southern catchment from its confluence with Mahanadi to about 40 km upstream has been taken into consideration under the present discourse. The northern basin is partly covered by the Hirakud Canal System. Hence ground water development is essential particularly in the southern basin.

1.2 The area is approachable from Balangir through Salebhata ($20^{\circ} 57' : 83^{\circ} 32'$) in the Balangir-Sambalpur State Highway. There are metalled roads to approach Upper Bahal ($20^{\circ} 59' 30'' : 83^{\circ} 28'$) Lachipur ($20^{\circ} 55' : 83^{\circ} 40'$) and confluence ($20^{\circ} 54' : 83^{\circ} 50'$) of Ong with Mahanadi from Salebhata and Sonepur.

2. Geomorphology

2.1 The part of the Ong sub-basin under discussion is bounded by low hills (stretching roughly east-west) on the south and the River Ong itself on the north running from WNW to ESE. The hill range which forms the water divide between the Suktel sub-basin on the south and Ong sub-basin on the north ranges in height from 150 to 470 m and the hilly terrain has a steep slope whereas the submountainous region lies between the

elevations 135 m and 150 m. The ground slope is of the order of 5 to 6 m/km. The valley portion lies between contours 110 m and 135 m and slope is gently being of the order of 4 to 5 m/km. The River Ong has an average fall of 6 m/km for its stretch of length under consideration.

2.2 The main drainage is WNW-ESE which is highly influenced by the east-west stretching trough fault, within gondwanas. Its tributaries are mostly oriented in SW-NE trend and are perennial in character. The runoff is exceedingly high due to steep hill slopes. As such, the flood plains are limited.

2.3 This geomorphological condition partly contributes to the hydrological condition of the area under consideration.

3. General Geology (Figure 1)

3.1 This is a narrow valley bounded in the south by medium to high hill ranges composed of archaean formations, (khondalites) generally dipping at steep angles to the south. There are number of charnockite intrusives of acidic type mostly on the northern slope of these hill ranges. There appears to be a boundary fault running east-west from Lachipur to Uperbahal and the fault plane is marked by later quartz and pegmatitic intrusion at few places. Talcher shales are seen in

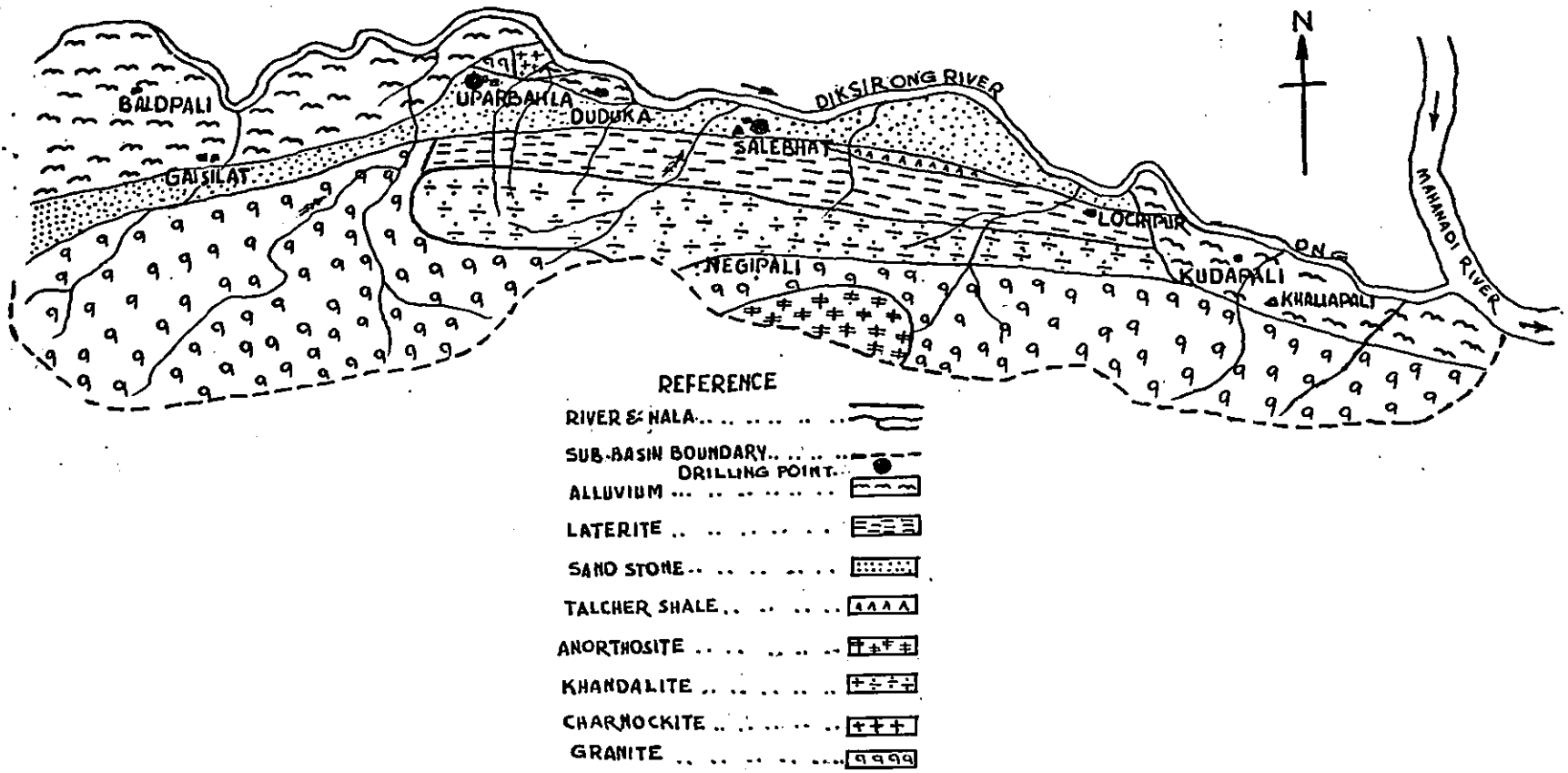

FIGURE 1 : Geological map in parts of Ong River.

faulted contact with khondalites, where the shales have been highly disturbed and steep dipping to the north. The khondalite rocks north of the fault zone, wherever exposed, show northerly steep dip. The entire fault zone area is occupied by lateritic and gondwana rocks. The northern down faulted block preserves an outlier of Mahanadi gondwana master basin which is only about 1.5 km at the broadest. The gondwana beds started with typical needle shales of Talcher stage overlain by sandy shales and fine grained compact buff sandstones. The intercalated shales or these sandstones contain fragmentary fossils of glossopteris assemblages and proves beyond doubt the lower gondwana age of the beds (these beds were mistaken to be cuddapahs by earlier workers). These sandstones and shales deep at 10° to the north. The thickness of Talcher shales and sandstone as evidenced in the well section and computed from the exposed thickness may be of the order of 122 m (400 ft) at the fullest development. These are of Barakar age. The total thickness is of the order of 90 m. They have a faulted contact of Talcher formations as is evident from the nature of outcrop in Kutasingha area. The lowest bed is of the gritty to pebbly sandstone which is exposed in Lachipur area. The gondwana boundaries are obscured in south by laterite and in north by alluvia. The River Ong more or less forms the boundary of gondwana outlier in the north although sandstone exposers are seen in the northern bank of Lachipur. It appears that the northern boundary is also faulted by which is occupied by the river. A faulted block near Duduka (20° 59' : 83° 24') exposes charnockite, dipping south south-east. To the north of Ong River towards Kutasingha bridge archaean rock of granitic suite area exposed showing the gondwana to be confined to the faulted trough along the Ong valley.

3.2 The general geological sequence of the area is :

Recent to sub-verent	—River alluvia	3 to 12 m (10 to 40 ft)
Tertiary	—Laterite	9 m (30 ft)
Gondwana Barkar	—Sandstone, grey-shale, carbonaceous shale, pebbles sandstone	30 to 91 m (100 to 300 ft)
+ Talcher	—Ferruginous sandstone, sandy shales, needle shales	61 to 122 m (200 to 400 ft)
Archaean	—Granite unconformity gneisses, charnockites and khondalites.	Weathered zone —25', Fissured zone— 20-45' continues to depth.

4. Ground Water Geology

4.1 The ground water geology is essentially different in two distinct lithofacies: (1) the archaean and (2) the gondwanas.

4.2 In the archaean group of rocks namely the granite gneisses and khondalites ground water exists essentially in the shallow/perched aquifer, composed mainly of weathered and fissured zones. Weathered zone of course is covered either by laterite or residual soils. The top unconsolidated and shallow formation serve as passage for ground water percolation.

4.3 The weathering of the granites and gneisses produces kaolin extensively which renders bad permeability condition in such formations. The weathering khondalite produces mostly materials which exhibit better permeability than the weathered felspathic granite and gneisses. Although the laterites have good porosity and permeability they do not serve as aquifer as the local water-table is below the laterite thickness. In the parts of the valley reaches covered by archaean the geolithological sequence is as shown below :—

Thickness range	Depth zone	Lithology
0-3 m	Top layer	Residual soil, clay, sandy clay, laterite and lateritic soil.
0-8 m	Weathered zone	Weathered granite khondalites.
6-14 m	Fissured zone	Fissured granite gneisses and khondalites.
below 14 m	Compact rock	Massive granite gneisses and khondalites.

4.4 In the gondwana sandstones, ground water exists in the water-table aquifer as well as in the deeper unconfined and confined aquifers composed of medium to coarse grained sandstone, lying between beds of fine cemented sandstone. It is evident from drilling at Salebhata that the zone composed of medium to coarse grained sandstones are likely to be moderately productive. The overlying and underlying fine grained sandstone, also the shale horizons are unsuitable for ground water exploitation. The conglomerate sandstone with a width of 150 m is seen near the village Bhirpali. It is unproductive as the pebbles are finally cemented in fine grained sandstone matrix. In the gondwana stretch of the terrain two drill holes have been given at Uperbahal and Salebhata, Figures 2 and 3.

5. Ground Water Hydrology

5.1 The first aquifer exists in the weathered archaean and deep aquifers under both confined and unconfined condition are restricted to the gondwana sandstone. The valley portion occupied by archaean is 110 sq km whereas the gondwana covers about 55 sq km. The remaining part of the sub-basin covered by high relief comprises 155 sq km of recharge area.

5.2 The average rainfall is 119 mm annually and the total hills recharge area is 155 sq km. The rate of infiltration as calculated from the pump test conducted in Salebhata areas comes to 10 percent. As such, the

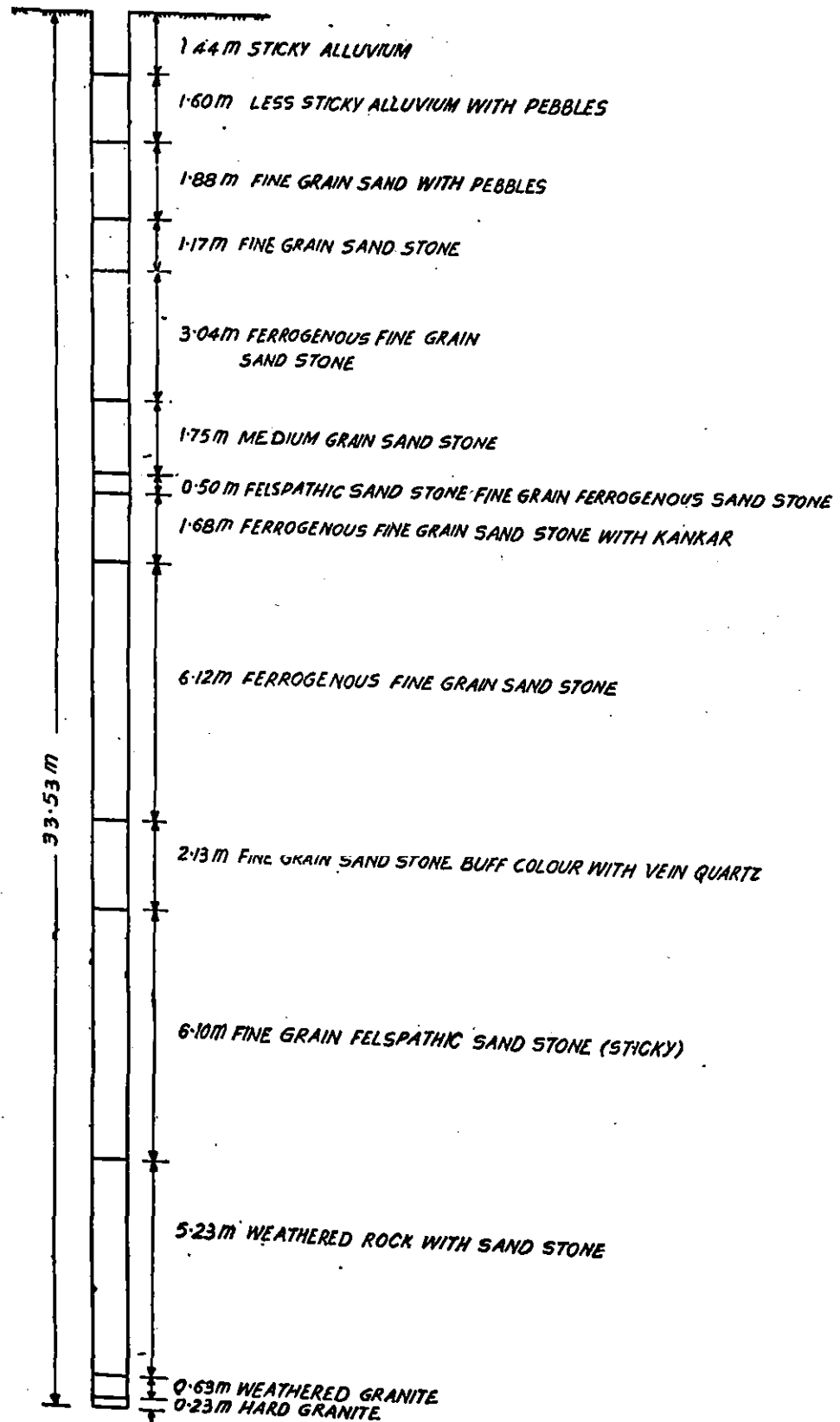

FIGURE 2 : Bore-hole log—Uperbahal.

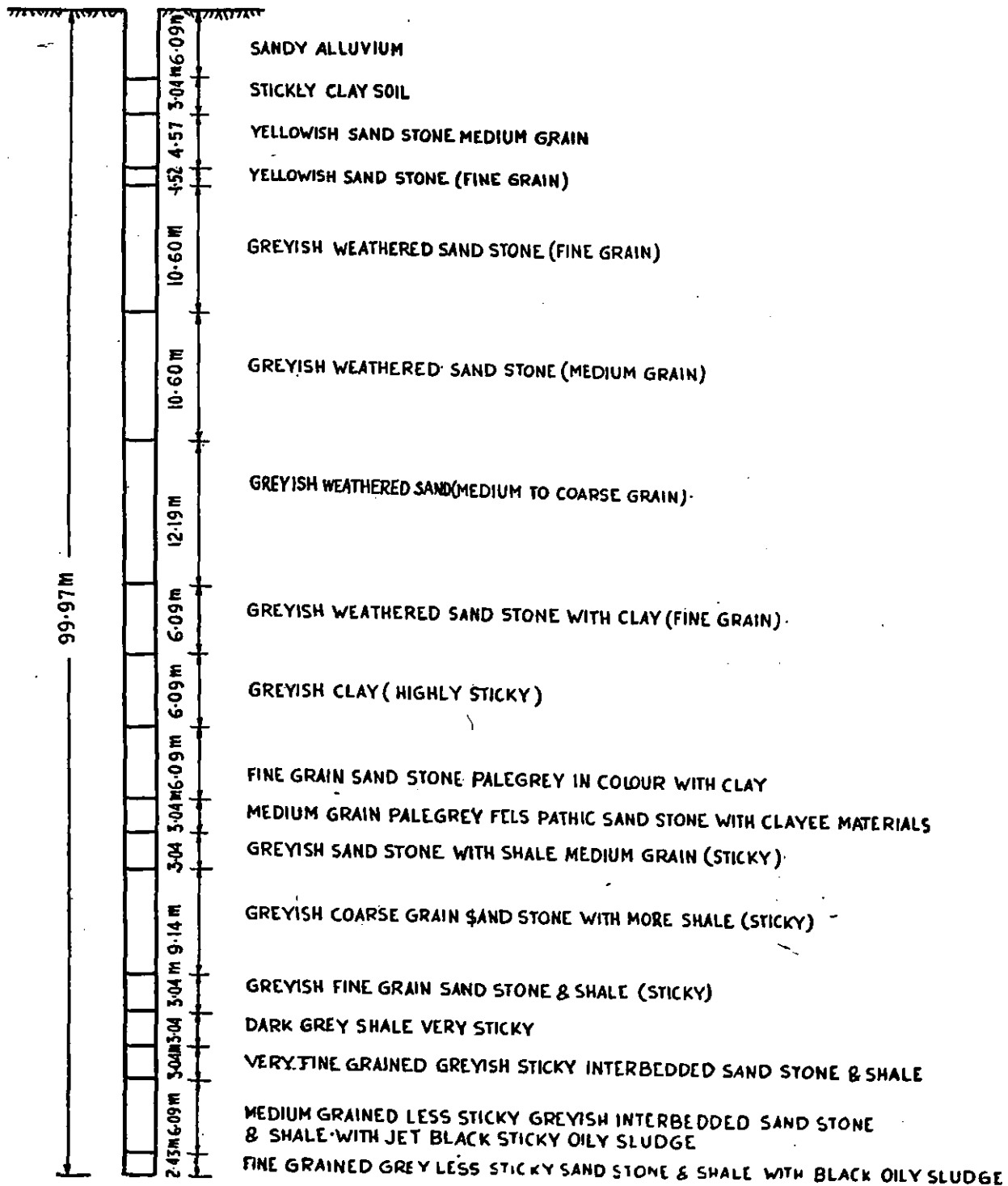

FIGURE 3 : Bore hole log—Salebhata.

total infiltration comes to 56,740 T cu m (46,000 acre-ft), which is likely to recharge the valley area in ideal condition.

5.3 In the valley tracts the area occupied by archaean and gondwana is 165 sq km. The annual average rainfall is approximately 1140 mm. Assuming infiltration at 15 percent for both the regions, the gondwana sandstone at the top layers is fine grained and their porosity

and permeability will not deviate much from that of the area occupied by weathered archaean. With these assumptions the direct recharge to the water-table aquifer comes at 70.3 million cu m (57,000 acre-ft) per annum. Hence the total ground water recharge to the unit of the sub-basin 1270.48 lakh cu m (1.03 lakh acre-ft) assuming the leakage to be nil. The difference of postmonsoon and premonsoon water-table is taken as 3 m in average. With calculated 5 percent of effective porosity

the ground water reserve in the valley area is estimated at 25.9 million cu m (21,000 acre-ft) of available water.

5.4 On the basis of hydrological investigation, the following compact areas are selected for ground water development :

<i>Location</i>	<i>Area in sq km</i>	<i>Terrain type</i>
(1) Lachipur, Salebhata, Phasar.	33	C ₁ A
(2) Daduka, Gaisilet, Bariya Pukhapani.	23	C ₁ B
(3) Along Ong River near Kurtipur.	2.5	C ₂ B

5.5 An area of 155 sq km of the part of the Ong basin under discussion falls under 'D' category of terrain classification where no ground water development is possible due to poor storage conditions.

5.6 115 sq km area falls under 'C' category of which 58 sq km. area can be brought under intensive agricultural development by tapping both shallow and deep aquifer and the later area is classified under C₁A, C₁B and C₂B.

6. Conclusion

6.1 It is evident from the above discourse that the gondwana tract comprising unconsolidated sandstones at deeper horizons are suitable for ground water development by deep tube-wells. The shallow aquifer confined to weathered and fractured zones of the archaean tract can be tapped by dug wells and be brought under use in intensive minor irrigation.

6.2 As electricity is readily available at Salebhata, the roadside village within the basin, ground water development by both deep tube-wells and shallow open wells be taken up from the village in both easterly and westerly direction gradually.

A Plea for Ground Water Reservoirs to Store Excess Rain Water

R. D. VERMA

Reader in Civil Engg.

M. M. DANDEKAR

Professor of Civil Engg.

R. M. ADVANI

Principal

Malaviya Regional Engineering College, Jaipur

SYNOPSIS

India is facing problems of flood damage in some areas and severe droughts in other areas. For many irrigation projects in the past, surface water reservoirs with expensive distribution systems were provided to store excess rain water and for supplying it during low flows and/or to areas with little precipitation. However, it is expected that the use of surface water will grow more expensive as good reservoir sites are exhausted and as treatment costs increase. Also in arid and semi-arid regions where the water is usually scarce, a significant percentage of the total surface water is lost in evaporation. Under these circumstances aquifers should be looked as possible storage media for surplus flood water, in place of dams and reservoirs. In U.S.A. and Israel many projects of artificial recharge to ground water are in progress.

Planning of aquifers for storage reservoirs involves management of surface and ground water. Availability of good hydrogeologic maps, giving the position of aquifer system and its boundaries and a description of water bearing properties are very important for the planning of recharge sites. The paper presents some aspects for the planning of ground water reservoirs for arid and semi-arid regions.

1. Introduction

1.1 The distribution of rainfall with respect to time and space in India is highly unequal. The bulk of precipitation occurs during the monsoon season which lasts for about three months. Substantial variations in the quantity, incidence and duration of rainfall in individual tracts of India from year to year cause flood havoc at some places while other places are left completely dry. This extreme variation of rainfall together with increased use of water on account of rapid industrialization, agriculture and population growth has been posing serious problems of water conservation and management in the country.

1.2 The average annual surface water resources of India from its 110 rivers have been placed at a total of 168 million ha m, of which only about 1/3rd can be used for irrigation on account of physio-graphical conditions. It is further estimated that about 22 million ha m of ground water can be utilized for

irrigation. The planning and execution of the best possible programmes for the conservation and control of water is the nation's most important natural resource problems especially in arid regions.

1.3 Since independence, India has developed a large number of irrigation projects in which many dams have been constructed to store excess rain water in surface water reservoirs. Enormous amounts of public money have been spent in the construction of these surface reservoirs and on providing necessary distribution systems. In the past, surface reservoirs have been used with almost complete disregard of the interaction between surface and ground water. Although we have made some progress, the water problems in the country are still acute. It is possible that for many areas in the country ground water reservoirs may be better and more economical than surface water reservoirs for storing excess precipitation. This paper presents some aspects of ground water reservoirs and their usefulness in arid and semi-arid regions.

2. Advantages of Ground Water Reservoirs

2.1 In most cases ground water reservoirs have tremendous storage capacity and small losses from evaporation and sub-surface outflow. For example, it is estimated that the Sacramento Valley in California has ground water storage capacity equal to about three times the reservoir capacity of Grand Coulee Dam in Washington⁽¹⁾. The rate of evaporation for arid and semi-arid regions is very high; it is estimated that in some areas about 50 to 60 percent or even more, of the total quantity of surface water is lost through evaporation. Surface storage is, therefore, less efficient. If it is assumed that 50 percent of the water is lost through evaporation, it would mean that the efficiency of storage can never exceed 50 percent. The evaporation losses can be eliminated almost completely with ground water storage.

2.2 Another advantage of underground storage over that of surface storage is that it requires no man-made reservoirs and few distribution works. A river, for example, carries water to a diversion-point from which man must then construct numerous lengthy canals to carry the water to his thirsty fields. An underground storage basin, on the other hand, carries water not to a point but to a wide area throughout which man may sink wells directly to serve those same fields. Underground water conveyance has a long history and has been tried by Middle East countries through what is known as systems of "Quanats", i.e., tunnels in the rock for transporting water.

2.3 During infiltration of water into the ground, the quality of water improves. It is known⁽²⁾ that the upper few centimetres of the soil mantle of the earth is an effective barrier to the travel of pathogens. It also arrests suspended particles. An excellent example for this is the Whittier Narrows Water Reclamation Plant at Whittier, California⁽¹⁾ where about 2,000 ha m per year of reclaimed waste water is artificially recharged to the ground water basin.

2.4 As compared to surface water reservoirs, ground water reservoirs have uniform temperatures of water. Underground storage is almost invulnerable to earthquakes.

2.5 The defence requirements necessitate a sparing use of surface reservoirs (particularly in border areas) as the enemy can destroy such reservoirs very easily. Underground storage has a definite advantage under such a situation.

3. Methods of Artificial Recharge

3.1 Various methods of ground water recharge have been discussed by several investigators^{(3) (4)}. The common methods of artificial recharge are: (i) recharge from basins, (ii) recharge from pits, and (iii) recharge through wells.

(i) *Recharge from Basins*: If the basins are designed and operated properly, it is possible to have a high

rate of infiltration and large quantities of water can be made to infiltrate. In Los Angeles County, the sustained rate of infiltration is around 55 to 60 cu m/sec, through the use of 20 spreading grounds.

(ii) *Recharge from Pits*: Recharge from gravel pits or auger bored holes filled with gravel has been practised in some cases. It has been found successful, especially where natural recharge water is desilted through detention reservoirs, by chemical precipitants, or by a combination of both.

(iii) *Recharge through Wells*: Recharge through wells or seepage pits has been found especially useful for confined aquifers. Basin recharge through wells may simultaneously give rise to a fresh water barrier to stem intrusion of the aquifer by the saline water of the sea.

4. Physical Considerations of Artificial Recharge

4.1 The design of a ground water reservoir for infiltration of excess water into the soil will depend upon the hydraulic properties of the aquifer. The ground water recharge can also be achieved with the help of ditches and furrows. The soil has to be permeable whatever be the method of recharge. The design of a system of recharge areas with wells or other collection facilities should be such that high water-table mounds beneath the recharge areas can be avoided, otherwise this will reduce the rate of infiltration. Bouwer⁽⁵⁾ has developed a procedure to predict water-table positions for a system of parallel, rectangular recharge areas, with wells located midway between the areas. This enables the evaluation of the most favourable layout of recharge areas and wells with the desired water-table response and travel times. Procedures for obtaining the necessary information on the hydraulic conductivity conditions of the aquifer for recharge systems have been developed. Using an analogue technique, Bouwer has also determined the horizontal and vertical hydraulic conductivity of an aquifer from the recharge rate and the water-level response in two observation wells of different depths. From the hydraulic conductivity data, an effective transmissibility coefficient of the aquifer for recharge can be computed.

4.2 Any other design of a ground water recharge can be analysed based on the physics of flow through porous media. Extensive literature⁽⁶⁾⁽⁷⁾ is available in this area. Electrical analogue computers have been extensively used in problems involving ground water movement. The use of electrical analogues has been a standard design procedure, used for many years by the Bureau of Reclamation, U.S.A., in studying complex ground water problems. The basis for these model studies is the analogy between Ohm's law for the flow of electricity through a conductor and Darcy's law for the flow through porous media. Voltage, current capacitance and conductance can be related to head, quantity of flow, storage coefficient and transmissibility respectively. The validity of the analogue depends upon the accuracy with which the field conditions can be portrayed in the

electrical simulation. Field tests must be made to establish values of transmissibility and storage coefficient for the aquifer. Phillips and Mc Donald⁽⁸⁾ have developed an analogue model which adequately simulates the hydrologic conditions for a historical period of about 50 years. The model was used to evaluate the adequacy of existing water supplies for the period 1962 to 2010. Imported water was used to recharge the aquifer in the project area which also served as a distribution system to supply irrigation wells in the project area. With the help of the analogue model, Phillips and Mc Donald, were able to determine that for the year 2010 the aquifer was not as effective a distribution system as was desired; the analogue indicated that sufficient water would be available physically to meet the project requirements.

4.3 Artificial recharge implies the existence of surface flows at or reasonably near the areas of possible recharge. In arid regions surface flows can be temporarily controlled by dams, dikes, pits or a combination of them. In order to estimate the quantity of recharge that may be expected and to design the necessary structures, the surface flows must be described. The physical processes governing recharge have been further described by Marshall⁽⁹⁾ and Liakopoulos⁽¹⁰⁾.

5. Practical Examples of Ground Water Recharge

5.1 Artificial ground water recharge has been practised since 1890 in California and its southern arid parts. It has now found use at a number of places in U.S.A. and Israel. An excellent example of ground water recharge is the Flushing Meadows Project in Phoenix, Arizona. In this project treated sewage has been put to beneficial use by providing artificial recharge to the ground water basin. The Flushing Meadows Project consists basically of six parallel recharge basins 6×210 m each and 6 m apart. Constant water depths of about 20 cm are maintained during inundation and the infiltration rate for each basin is evaluated from records of the inflow at one end and the outflow at the other end of the basin. Because maintaining high infiltration rates is crucially important in the successful operation of a recharge system, different surface conditions have been included to determine how these affect infiltration rates. Preliminary results⁽¹¹⁾ show that with an inundation schedule of about 4 days wet, 3 days dry, infiltration rates of about 0.6 m/day can be maintained for an inundation depth of about 0.3 m. Including the time for dry ups and maintenance, recharge rates of about 90 ha m/ha/year could be maintained. The basins with gross cover gave the highest infiltration rates. For the Flushing Meadows Project area, the water-table rose only about 1.2 m in the centre of the 66×120 m basin area for an average intake rate of 1 m/day in the basins.

5.2 Some projects of ground water recharge are underway in Israel. Accordingly, some of the rain-water runoff is intercepted by damming the streams that carry the water of winter storms and inducing the

arrested flows to percolate underground instead of running out to sea. Attention has been paid to the development of regional systems. The largest of these is the Yarkon-Negev Project⁽¹²⁾, for diverting the water of the Yarkon from its sources, at the Rosh Ha'avin springs near Tel Aviv, to the northern Negev. The first part of it was completed in 1955 to supply from the Yarkon, and from numerous bore-hole wells incorporated in the system 270 million cu m per annum through 106 km of prestressed concrete pipe. Another important project where ground water reservoirs have been utilized in Israel is that of Lake Kinneret⁽¹³⁾. During the rainy season, surface water from Lake Kinneret is transferred through the National System to the South and injected underground through special wells, for subsequent recovery by pumping during the dry season. Similar measures of artificial recharge are being taken to conserve storm-water and keep it from running out to the sea. Accordingly, some of the rain-water runoff is intercepted by damming the streams that carry the water of winter storms and inducing the arrested flows to percolate underground instead of running out to sea.

5.3 Pilot experiments in artificial recharge conducted at Bay Park, Long Island, New York, using tertiary treated sewage plant effluents for recharge water has shown little deterioration in well capacity⁽¹⁴⁾. Injection of recharge water was made through a well cased with fiberglass and finished with a gravel packed, 40 cm diameter, stainless steel screen. An entirely different technique of artificial recharge, viz., surface spreading was utilized in Walnut Creek Watershed, in Central Kansas, to replenish ground water at a rate of about 0.15 ha m/per day/ha. The water was pumped into a pond formed by a semi-circular dam enclosing about 0.33 ha on an alluvial slope covered with native grass. The pond could hold about 0.24 ha m of water with an average depth of 0.66 m. The water was successfully recharged through approximately 13 m of clayey to sandy silt to the underlying sand and gravel heads⁽¹⁴⁾.

5.4 An impressive plan of deep tunnel storage is being developed for pollution abatement and flood control for the city of Chicago⁽¹⁵⁾. The Chicago Land Deep Tunnel Project, as the plan is called, would capture the flow from the 750 sq km section of the city, now served by combined storm-sanitary sewers, in mammoth storage caverns carved from bedrock 250 m or more below the city. From such storage caverns, the water would be pumped subsequently to surface reservoirs during low flow periods. The most impressive aspect of the plan is its magnitude. The cost of the 10 year project would be a staggering \$ 1.02 billion. The two proposed mined storage cavities would each have a capacity of up to 2,160 ha m of water.

6. Problems Associated with Ground Water Storage

6.1 The biggest problem for the development and planning of ground water reservoirs in India is lack of adequate hydrological and geological data. Extensive and reliable data must be available for proper investi-

gations to the feasibility of the project. If the ground water is saline, the charging of good water into this aquifer, may render the good water also useless.

6.2 Banks⁽¹⁶⁾ has enumerated some financial and legal problems. The following are some of them :

- (1) How can control be retained over the sale and distribution of water that has been salvaged by operations of underground reservoirs ?
- (2) Who will receive the benefit of such a conservation programme and to what extent ?
- (3) Who is to pay the costs for conservation ? How are such costs to be allocated and in what amounts ?
- (4) How can a legal right be attained to operate an underground reservoir, particularly if exportation is to be increased ?

The solution of these problems lies in the : (i) Establishment of an authority to collect all necessary hydrological and geological data, and (ii) Planning of a National Water Career System where surface and ground water resources of the country are integrated for proper rationing and distribution of water for various uses. Such a system should be managed by one central authority.

7. Need for Research

7.1 Although ground water reservoirs are being used at many places (mainly in U.S.A. and Israel) there is need of further research to critically look into the feasibility of such projects. Some specific problems for research are given below :

- (1) Is it possible to create a small underground reservoir by artificial means in sandy soils, for example—sides and bottom being sealed by bentonite clay or similar material ?
- (2) Can recharge operations be taken up to feed rock aquifers ? For example, in Rajasthan, Lathi series of the Jurassic age in Jaisalmer area yield potable water through rock aquifers, how can this supply be augmented through artificial recharge ?
- (3) Under what geological, climatical and hydrological conditions, would the ground water reservoirs be technically and economically feasible ?

8. Conclusions

Ground water aquifers can be looked on as possible storage media for surplus flood water, in place of dams and reservoirs. This can be done by artificial recharge of the aquifers. The key to artificial recharge is economics. The water resources engineers should conduct the needed research and experimentation to determine when, where, and how ground water reservoirs can be charged artificially at a reasonable cost. This is just one aspect of the problem only. Since the

rate of water consumption is rising at an alarming rate and resources of fresh water are restricted, other techniques for augmenting fresh water resources have also to be adopted like reclamation of waste waters, artificial rain through cloud seeding and sea water and brackish water desalination.

9. References

- (1) Hall, W.A. and Dracup, J.A. : "Water Resources System Engineering". Mc Graw Hill Book Company, 1970.
- (2) Mc Gauhey, P.H. et al : "Quality Aspects of Ground Water Use and Management in Leonard Schiff". Proceedings 1965 Biennial Conference. Ground Water Recharge, Development and Management, Fresno Field Station, Agricultural Research Service, U.S. Department of Agriculture, January 1966, pp. K-1 to K-22.
- (3) Baumann, P. : "Technical Development in Ground Water Recharge". Advances in Hydroscience, Vol. 2, Edited by V.T. Chow, Academic Press New York and London, 1965.
- (4) Muckel, D.C. : "Research in Water Spreading". Transactions of the American Society of Civil Engineers, Vol. 118, 1953, pp. 209-219.
- (5) Bouwer, H. : "Ground Water Recharge Design for Renovating Waste Water". Journal of the Sanitary Engineering Division, American Society of Civil Engineers, February 1970, pp. 59-74.
- (6) Polubarinova—Kochina, P. Ya. : "Theory of Ground Water Movement". Moscow Gosizdat, Tekh-teor. Liter (In Russian) 1952. English Translation, Princeton University Press, 1962.
- (7) Scheidegger, A.E. : "The Physics of Flow through Porous Media". Toronto University, Toronto Press, 2nd edition, 1960.
- (8) Phillips, H.B. and Mc Donald, H.R. : "Analog of Ground Water in East Central New Mexico". Journal of the Irrigation and Drainage Division, American Society of Civil Engineers, March 1966, pp. 27-42.
- (9) Marshall, T.J. : "Relations between Water and Soil". Commonwealth Bureau of Soils, Harpenden, England, Technical Communication 50, 1959.
- (10) Liakopoulos, A.C. : "Theoretical Approach to the Solution of the Infiltration Problem". International Association of Scientific Hydrology, 1966, Bulletin 11(1), pp. 69-110.
- (11) Bouwer, H. : "Putting Waste Water to Beneficial Use—The Flushing Meadows Project". Proceedings of the 12th Annual Arizona Watershed Symposium, Phoenix, Arizona, 1968.
- (12) "Water in the Land of Sand Dunes". A Pragma Prakashan Publication, Jaipur, 1970, pp. 101-106.
- (13) Prushansky, Y. : "Water Development". Israel Today, No. 11, Publication by Israel Digest, P.O.B. 92, Jerusalem, December 1967.
- (14) U.S. Department of the Interior. Geological Survey Research 1969. Chapter A. Geological Survey Professional Paper 650-A. U.S. Government Printing Office, Washington, D.C. 1969.
- (15) "Deep Tunnel Storage may solve City Storm Water Problem". Environmental Science and Technology, Vol. 3, No. 3, March 1969, pp. 209-211.
- (16) Banks, Harvey O. : "Utilization of Underground Storage Reservoirs". Transactions of the American Society of Civil Engineers, Vol. 118, 1953, pp. 220-234.

Dipole Pumping Test and Concept of Aquifer Matrix to be Utilised for Computer Simulation of Aquifers

P. KUMARASWAMY

Director

Irrigation Research Station, Poondi

SYNOPSIS

The author had developed in the year 1966 a new approach for simulating aquifers by a Direct Simulation Electronic Analogue Computer. In order to transmit data from the aquifer to the Computer Tank through telemetry and to operate the servomechanisms of the penetrometers of the computer, a new type of sensor, both hydraulic and electrical, called Dipole has also been evolved. An interesting concept of Aquifer Matrix has also been developed for utilisation in electronic simulation of aquifers with a large number of pumps. This paper describes the philosophy of dipole pumping and elucidates the concept of Aquifer Matrix.

1. Introduction

1.1 In the usual pumping test to enumerate the factors, transmissibility T and storage coefficient S of an aquifer, the aquifer is excited with a pumping pulse of constant discharge and the response of the aquifer through its water-level change pattern is observed in selected observation wells. Since there is continuous extraction of water from the aquifer, the transients take a pretty long time to die down and during the test period, a lot of background noise and external perturbations are injected into the observations. It is very difficult to isolate the pumping features of the test pump alone, filtering out the background noise.

1.2 In order to devise some means by which the integrated characteristics of the aquifer collected all over its extent up to its boundary, can be condensed into a single parameter, a new type of pumping test called Dipole Pumping Test has been conceived by the author.

1.3 Referring to Figure 1, it may be seen that the dipole has two limbs. One of the limbs (which is a tube-well penetrating the aquifer) is used to pump water out of the aquifer. The same flow is pumped in a closed circuit through the second limb back into the aquifer. The differential head between the limbs gradually increases with time and attains a steady state quite quickly, and the fraction

$\frac{\text{Flow}}{\text{Differential head}}$ is called the 'Conductance' of the dipole.

2. Hydraulic Characteristics of the Dipole

2.1 Shape Factor

2.1.1 Let us now derive the conductance of a dipole assuming an aquifer with vertical leakage (Figure 2).

The radii of the two wells are each r_w and the distance between the centres of wells is d . The flow through the circuit is Q . The recharging limb will be considered to be positive and the discharging limb negative. The limbs are numbered as 1 and 2 as shown in Figure 2.

2.1.2 The various drawdowns in the wells are defined as follows:—

Drawdown in Well 1 due to its own pumping $\dots y_{11}$

Drawdown in Well 2 due to its own pumping $\dots y_{22}$

Drawdown in Well 1 due to pumping in Well 2 $\dots y_{21}$

Drawdown in Well 2 due to pumping in Well 1 $\dots y_{12}$

If K = Coefficient of permeability of the aquifer,

K' = Coefficient of permeability of the aquiclude,

b = Depth of the aquifer,

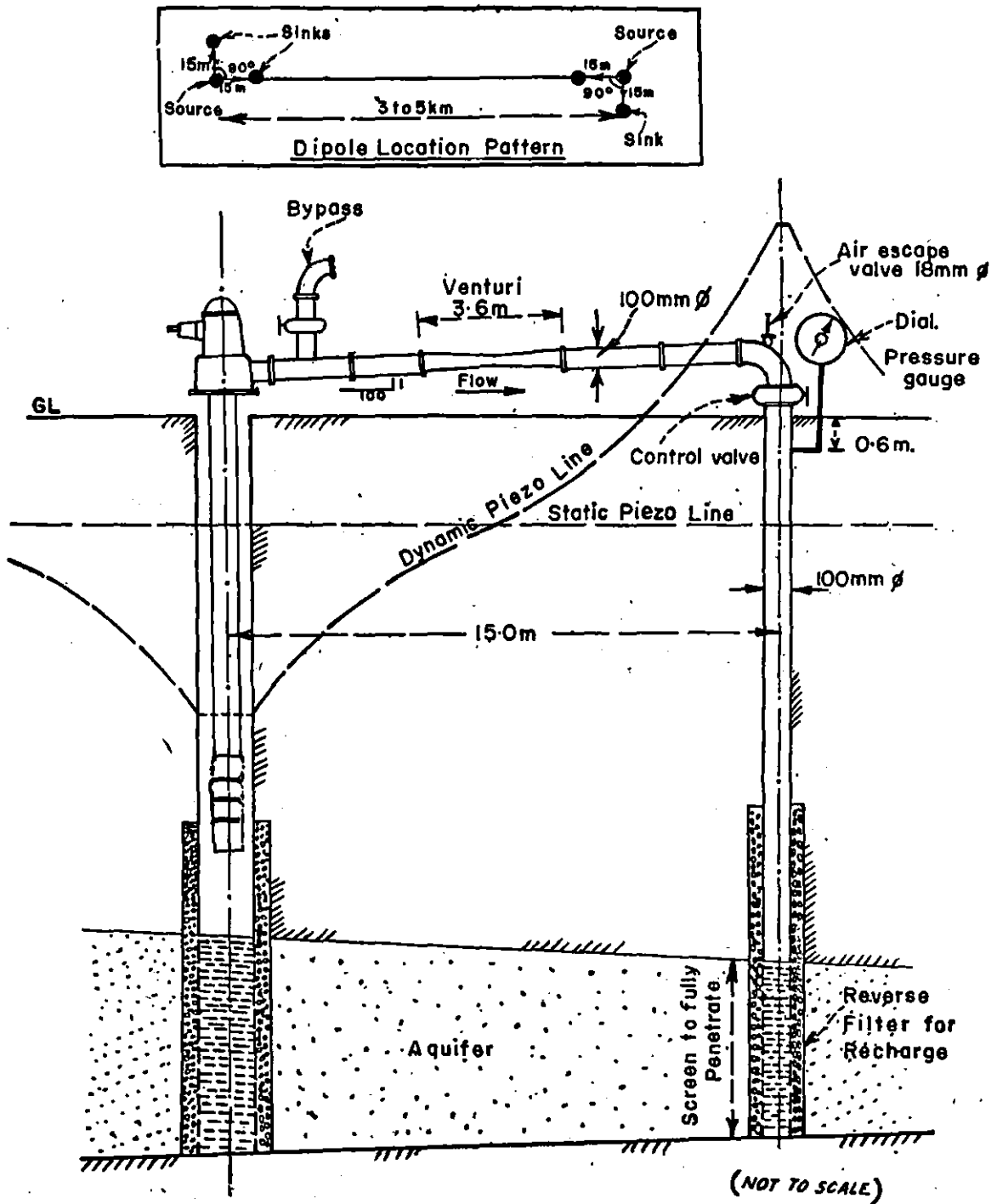

FIGURE 1: Dipole Pumping—Test Definition Sketch for Dipole Assembly.

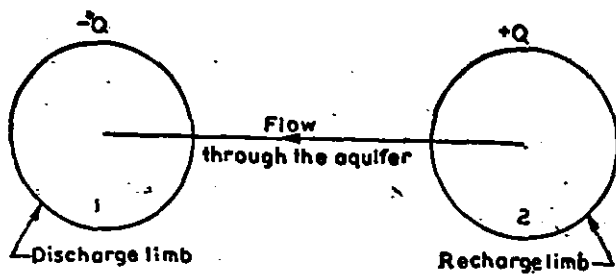

FIGURE 2

b' = depth of the aquiclude,
 $B = (Kbb'/K')^{\frac{1}{2}}$,
 t = time elapsed after pumping started,
 and $u = \frac{r^2 S}{4Tt}$.

From existing theory⁽¹⁾, we know that

$$y_{12} = \frac{-Q}{4\pi T} \cdot W \left(u_{12}, \frac{r_w}{B} \right)$$

and $y_{21} = \frac{+Q}{4\pi T} \cdot W\left(u_{21}, \frac{d}{B}\right)$, and

as $u \rightarrow 0$, we have $W\left(0, \frac{x}{B}\right) = 2 K_0\left(\frac{x}{B}\right)$.

Where W is the Well function, and

K_0 is the modified Bessel function of the second kind and of Zero order.

As $u \rightarrow 0$

$$y_{11} = \frac{-Q}{4\pi T} \cdot 2 \cdot K_0\left(\frac{r_w}{B}\right)$$

$$\text{and } y_{21} = \frac{+Q}{4\pi T} \cdot 2 \cdot K_0\left(\frac{d}{B}\right)$$

The drawdown in well 1 = y_1

$$= y_{11} + y_{21}$$

$$= \frac{Q}{2\pi T} \left[K_0\left(\frac{d}{B}\right) - K_0\left(\frac{r_w}{B}\right) \right]$$

2.1.3 We know that for small values of x ,

$$K_0(x) = -\ln\left(\frac{x}{2}\right) = \ln\left(\frac{2}{x}\right)$$

If $\frac{d}{B}$ is a small value,

$$\begin{aligned} K_0\left(\frac{d}{B}\right) - K_0\left(\frac{r_w}{B}\right) &= \ln\frac{2B}{d} - \ln\frac{2B}{r_w} \\ &= \ln\left(\frac{r_w}{d}\right) = -\ln\left(\frac{d}{r_w}\right) \end{aligned}$$

As $u \rightarrow 0$, or $t \rightarrow \infty$

$$y_1 = \frac{-Q}{2\pi T} \ln\left(\frac{d}{r_w}\right)$$

$$\text{Similarly, } y_2 = \frac{+Q}{2\pi T} \ln\left(\frac{d}{r_w}\right)$$

Therefore the differential head of the dipole

$$= h_{12} = y_2 - y_1 = \frac{Q}{\pi T} \cdot \ln\left(\frac{d}{r_w}\right)$$

2.1.4 It may be noticed that S does not find a place in the formula for differential head which is a great advantage in field tests.

2.1.5 Therefore Conductance of

$$\begin{aligned} \text{dipole} &= \frac{\text{Flow}}{\text{Differential Head}} \\ &= Q \times \frac{\pi T}{Q \cdot \ln\left(\frac{d}{r_w}\right)} \end{aligned}$$

$$= \frac{\pi T}{\ln\left(\frac{d}{r_w}\right)}$$

$$= \frac{\pi}{\ln\left(\frac{d}{r_w}\right)} \cdot T = \frac{\pi}{\ln\left(\frac{d}{r_w}\right)} K.d.$$

Hence the shape factor of a dipole

$$= \frac{\pi}{\ln\left(\frac{d}{r_w}\right)}$$

2.2 Shape Factor derived More Accurately

2.2.1 The above shape factor can be derived more accurately by the formula developed by the author for computing shape factor between two external wells (Appendix I). Since the two limbs have equal radius r_w each,

$$m = \frac{r_w}{r_w} = 1; \epsilon = \frac{d}{r_w}$$

$$\beta = \frac{\epsilon^2 - (1+m^2)}{2m} = \frac{\epsilon^2 - 2}{2} = \frac{\epsilon^2}{2} - 1$$

$$\phi = \frac{2\pi}{\text{Cosh}^{-1} \beta} = \frac{2\pi}{\text{Cosh}^{-1}\left(\frac{\epsilon^2}{2} - 1\right)}$$

Now, $\text{Cosh}^{-1} \beta = \ln[\beta + \sqrt{\beta^2 - 1}]$

If $\frac{d}{r_w} > 5$, which is generally the case,

$$\beta + \sqrt{\beta^2 - 1} \approx 2\beta$$

as $\frac{d}{r_w} > 5$, $\text{Cosh}^{-1} \beta = \ln 2\beta$

$$= \ln 2 \left(\frac{\epsilon^2}{2} - 1 \right) \approx \ln \epsilon^2$$

$$\phi = \frac{2\pi}{\ln \epsilon^2} = \frac{2\pi}{2 \ln \epsilon} = \frac{\pi}{\ln\left(\frac{d}{r_w}\right)} \text{ as before}$$

2.2.2 Therefore it is possible to calculate the shape factor of the dipole most accurately without any limiting assumptions using the formula developed by the author and shown in Appendix I, if $\frac{d}{r_w}$ is < 5 also.

We have therefore,

$$\begin{aligned} \text{Conductance of the dipole} &= \frac{\text{Flow}}{\text{Differential Head}} \\ &= (\text{Shape factor of dipole}) \times (T) \end{aligned}$$

$$\text{Hence } T = \frac{\text{Conductance of dipole}}{\text{Shape Factor of dipole}}$$

T can thus be derived from a number of field tests very accurately and quickly.

2.3 Time to attain Steady State

2.3.1 We know that $W(u) \rightarrow \ln \left(\frac{0.562}{u} \right)$

When $u \leq 0.01$

Therefore when u_{21} (the larger of u_{11} or u_{21}) is < 0.01 , h_{12} would have stabilised and steady state would have been reached.

$$\text{i.e., } \frac{d^2 S}{4T t_{st}} = 0.01$$

$$\text{i.e., } t_{st} = 25 \frac{d^2 S}{T}$$

$$\text{Therefore, } S = \frac{t_{st} \times T}{25 d^2}$$

2.3.2 By measuring the conductance of the dipole and the time taken to attain steady state, S and T can be computed much more quickly and more accurately than by the traditional pumping tests.

3. Dipole as an Aquifer Sensor

3.1 The conductance of a dipole may not be strictly constant, but will vary minutely dependent upon the activities of other pumps and dipoles in the neighbourhood and also on the variation of T from time to time consequent to changes in aquifer water levels in the case of unconfined aquifers. Therefore these dipoles permanently fixed at strategic locations in an aquifer can be used as Sensors of the prevalent status of the aquifer from instant to instant. If the flow and the differential head are suitably transduced to current and voltage, these data can be transmitted through telemetry to the computer tank when the Direct Simulation Electronic Analog Computer developed by Kumaraswamy is the type of computer used for simulating the aquifer ⁽³⁾, ⁽⁵⁾, ⁽⁴⁾. It is also possible to evolve electrical aquifer dipoles on this principle after establishing a physical correlation between the hydraulic conductance, and storage characteristics of the aquifer and their electrical counterparts ⁽⁵⁾ to ⁽¹⁰⁾. Further work in this direction is in progress at the Irrigation Research Station, Poondi.

4. The Concept of Aquifer Matrix in Problems of Multiple Well Pumping from Leaky Aquifers

4.1 Suppose there are n pumps working in n wells, and let the parameters of the i^{th} well be defined as follows :—

- Location coordinates (X_i, Y_i)
- Radius of well r_i

- Representative thickness of aquifer at pump location b_i
- Permeability coefficient of aquifer material k_i
- Representative thickness of clay (aquiclude) Layer at pump location b'_i
- Permeability coefficient of clay k'_i
- Penetration coefficient to account for the effects of partial penetration P_i
- Storage coefficient of aquifer at pump location S_i

4.2 Let the following field experiment be conducted:—

Start all the n pumps simultaneously with constant discharges (not necessarily equal to each other) out of the aquifer, Q_{i1} at the i^{th} pump. After time t has elapsed, note the drawdowns Z_{i1} in each well. This triplet is defined as (t, Q_{i1}, Z_{i1}) . Now stop all the pumps, and after steady conditions have reached, conduct the experiment again with different discharges in each well. After the elapse of time t , note down the second triplet (t, Q_{i2}, Z_{i2}) .

Repeat the experiment n times.

4.3 All the data obtained can be represented in two matrices as shown below :—

$$Q = \begin{bmatrix} Q_{11} & Q_{12} & Q_{13} \dots Q_{1j} \dots Q_{1n} \\ Q_{21} & Q_{22} & Q_{23} \dots Q_{2j} \dots Q_{2n} \\ Q_{31} \\ \dots \\ Q_{n1} & Q_{n2} & Q_{n3} \dots Q_{nj} \dots Q_{nn} \end{bmatrix}$$

The first numeral is the suffix is the pump number and the second the test number.

$$\text{and } Z(t) = \begin{bmatrix} Z_{11}(t) & Z_{12}(t) & \dots & Z_{1j}(t) & \dots & Z_{1n}(t) \\ Z_{21}(t) & Z_{22}(t) & \dots & Z_{2j}(t) & \dots & Z_{2n}(t) \\ \vdots & \vdots & & \vdots & & \vdots \\ Z_{i1}(t) & Z_{i2}(t) & \dots & Z_{ij}(t) & \dots & Z_{in}(t) \\ \vdots & \vdots & & \vdots & & \vdots \\ Z_{n1}(t) & Z_{n2}(t) & \dots & Z_{nj}(t) & \dots & Z_{nn}(t) \end{bmatrix}$$

4.4 In a typical drawdown element $Z_{ij}(t)$, Z refers to drawdown at time t after the simultaneous start of all pumps; i refers to the well in which drawdown is measured and j refers to the test number.

Now, during test j , the discharge vector is

$$\begin{bmatrix} Q_{1j} \\ Q_{2j} \\ \vdots \\ Q_{ij} \\ \vdots \\ Q_{nj} \end{bmatrix}$$

4.5 Let us now define the parameters linking any two wells l and m in the system.

Let $U_{lm} = \frac{d_{lm}^2 S_l}{4T_l t}$, where

d_{lm} = distance separating wells l and m

and $T_l = K_l b_l$ and

$$W(U_{lm})t \triangleq \int_{U_{lm}}^{\infty} \frac{-U_{lm} - \frac{d_{lm}^2}{4B_l^2 U_{lm}}}{U_{lm}} dU_{lm}$$

where $B_l = (T_l b_l / K_l)^{\frac{1}{2}}$

Let us define the drawdown in well l after time t due to pumping in well m as $S_{lm}(t)$

Hence the total drawdown in well l in test j

is $Z_{lj}(t) = \delta_{l1}(t) + \delta_{l2}(t) + \dots + \delta_{lm}(t) + \dots + \delta_{ln}(t)$

and $\delta_{lm}(t) = W(U_{lm})t \frac{Q_{mj}}{4\pi T_m} \cdot P_m$

and if we define $(a_{lm})t \triangleq \frac{W(U_{lm})t \cdot P_m}{4\pi T_m}$

we have $\delta_{lm}(t) = (a_{lm})t \cdot Q_{mj}$

$\therefore Z_{lj}(t) = (a_{l1})t \cdot Q_{1j} + (a_{l2})t \cdot Q_{2j} + \dots + (a_{lm})t \cdot Q_{mj} + \dots + (a_{ln})t \cdot Q_{nj}$

for all $l=1, n$

4.6 These equations can be represented by the following matrix equation.

$$Z(t) = A(t) \cdot Q$$

$$\begin{bmatrix} a_{11}(t) & a_{12}(t) & \dots & a_{1j}(t) & \dots & a_{1n}(t) \\ a_{21}(t) & a_{22}(t) & \dots & a_{2j}(t) & \dots & a_{2n}(t) \\ \vdots & \vdots & & \vdots & & \vdots \\ a_{i1}(t) & a_{i2}(t) & \dots & a_{ij}(t) & \dots & a_{in}(t) \\ \vdots & \vdots & & \vdots & & \vdots \\ a_{n1}(t) & a_{n2}(t) & \dots & a_{nj}(t) & \dots & a_{nn}(t) \end{bmatrix}$$

where $A(t) =$

and $Z(t)$ and Q are defined already.

4.7 Now since $Z(t) = A(t) \cdot Q$,

we have $A(t) = Z(t) \cdot Q^{-1}$

and since $Z(t)$ and Q are available from the n field tests, we can compute $A(t)$ as indicated above.

4.8 If measurements are made over a period of time, $A(t)$ can be represented as a matrix function of

time from start to end and this family of curves can be used to predict long range responses of the aquifer for given Q .

4.9 The above concept is eminently suitable for digital computer use. But if the number of pumps n increases indefinitely the limited memory capacity of any digital computer will of course preclude satisfactory solution of the problem.

5. References

- (1) Roger, J.M. DeWiest : "Geohydrology". John Wiley & Sons., New York, April 1967, pp. 271-282.
- (2) Kumaraswamy, P. (Dec. 1968) : "New Approach suggested for the Design of Electrical Analog Computers for Ground Water Flow Studies". Paper presented at the Symposium of Analog and Digital Computers in Hydrology of the International Association of Science Hydrology at Tucson, Arizona, U.S.A.
- (3) Kumaraswamy, P. : (1969) : "Aquifer Simulation by Digital Computer". Term Project Report at the Centre for Advanced Engineering Study of the Massachusetts Institute of Technology, Cambridge, U.S.A.
- (4) Kumaraswamy, P. : "New Type of Electronic Analog Computer for Ground Water Survey and Control of Aquifer Pumping". Bangalore Seminar on 'Ground Water Potential in Hard Rock Areas of India' conducted by the Institute of Engineers (India), Indian Statistical Institute and Geological Society of India in July 1970.
- (5) Schkodro, N.C. and Maslova, N.M. (1935) : "Determination of the Dielectric Constant of Rocks and the Effect of Moisture in these Rock". *Izv. Akad. Nauk, S.S.S.R., Otd. Matem. i Fstest. Nauk.*, nos. 6-7.
- (6) Tarkhov, A.G., (1948) : "On the Resistivity and Dielectric Constant of Rocks in alternating Electric Field." *Geofizika, VSFGEI, Vol. 12.*
- (7) Veshev, A.V. (1955) : "Laboratory Investigation of the Relationship of Dielectric Constant and Conductivity of Rock Samples to the Frequency of an Electromagnetic Field". *Geofizicheskie Motody Razvedki Gosgeoltekhizdat.*
- (8) Glanville, C.R. (1954) : "Laboratory Study indicates Significant Effects of Pressure on Resistivity of Reservoir Rock". *Jnl. Petrol. Technol.*, Vol. 11, No. 4.
- (9) Hasted, J.B. (1961) : "The Dielectric Properties of Water". in *Progress in Dielectrics, Vol. 3, John Wiley & Sons, New York*, pp. 101.50.
- (10) Volarovich, M.P.; Bondarenko, A.T. and Parkhomenko, E.I. (1962) : "Effect of Pressure on the Electrical Properties of Rocks". *Tr. Inst. Fiz. Semli. Akad. S.S.S.R.*, No. 23.

APPENDIX I

Intraresistances between Wells

1. Concept of Shape Factor

1.1 Figure 3 shows a concentric well system of outer radius R_o and inner radius r_i . The bottom of the electrolytic tank is electrically insulated and the two circular electrodes are made up of conducting material. The tank contains an electrolyte of specific conductivity σ and is of depth d .

1.2 It can be mathematically derived that the conductance G between the two electrodes is

$$G = \frac{2\pi}{\ln\left(\frac{r_o}{r_i}\right)} \cdot \sigma \cdot d$$

The 'shape factor' $\frac{2\pi}{\ln\left(\frac{r_o}{r_i}\right)}$ is now defined as ϕ

(a Tamil letter pronounced as 'Ka')

$$G = \phi \cdot \sigma \cdot d$$

$$\text{or } \phi = \frac{G}{\sigma \cdot d}$$

1.3 The shape factor ϕ , therefore is the conductance between two electrodes per unit specific conductance of the conducting medium per unit depth of the medium.

1.4 Suppose we impress a voltage difference of V between the two electrodes, which results in a flow of a current I ,

we have $I = V \cdot G$

$$= V \cdot \phi \cdot \sigma \cdot d$$

$$\therefore \phi = \frac{I}{V \cdot \sigma \cdot d}$$

In other words, the shape factor can be defined as the current per unit potential difference per unit specific conductance per unit depth in a two-dimensional system.

1.5 The concept of shape factor is universal in application. For example, in a hydraulic system, treating the outer circle as a feed contour and the inner circle as the periphery of a well, we still can say that $Q = H \cdot \phi \cdot K \cdot d$,

$$\text{where } \phi = \frac{2\pi}{\ln\left(\frac{r_o}{r_i}\right)} \text{ again,}$$

and Q is the flow into the well,

K , the permeability coefficient of the aquifer medium

H , the differential head, and
 d , the depth of aquifer.

Therefore the shape factor ϕ can be defined generally as the flux per unit potential difference per unit specific conductance per unit depth in a two-dimensional flow system. This concept is valid for a three-dimensional system also.

2. The Eccentric Well System

2.1 Now let us derive the shape factor for the eccentric well system shown in Figure 4. The inner well with radius r_i is eccentrically situated within the outer well of radius r_o . The eccentricity is δ .

2.2 Previous researchers have solved the above problem only when $r_i \ll r_o$ and not for the cases when r_i is comparable to r_o . The author has solved this problem completely without any such limitation by using Complex Variables theory. The procedure for deriving the shape factor ϕ is given below:—

$$\text{If } m = \frac{r_i}{r_o}, \quad \epsilon = \frac{\delta}{r_o}, \quad \beta = \frac{1+m^2-\epsilon^2}{2m}$$

$$\text{then } \phi = \frac{2\pi}{\cosh^{-1} \beta}$$

To simplify calculations, we can prove that

$$\text{if } r_0 = \beta + \sqrt{\beta^2 - 1},$$

$$\text{then } \cosh^{-1} \beta = \ln r_0$$

where r_0 is the radius of the equivalent concentric outer well with the same shape factor in relation to the inner well.

2.3 Since the above eccentric well problem was completely solved theoretically by the author for the first time, experiments were done to verify the formula.

3. Experiments to verify the Shape Factor for the Eccentric Well System

3.1 An electrolytic tank of outer diameter 800 mm, was fabricated. Internal wells of radii ranging from 3 mm to 200 mm were placed at various eccentricities. Relative resistance for every eccentric location compared to its central location was measured by means of an accurate Impedance Bridge. To avoid D.C. polarisation effects, alternating current of 50 Hz was used. Tapwater and copper sulphate solutions of various concentrations were used for the purpose of varying the parameter σ in the series. The measured shape factor values were compared with the theoretical values and they tallied within ± 1 percent error. Therefore the formulae developed for computing the shape factor for eccentric well systems have been proved to be valid.

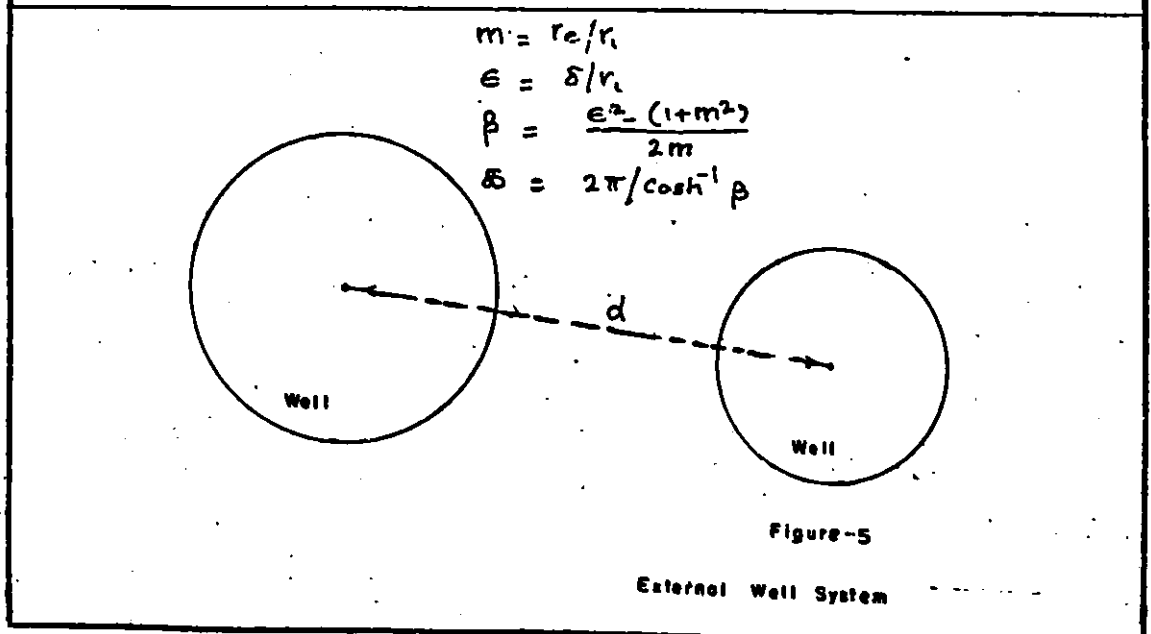
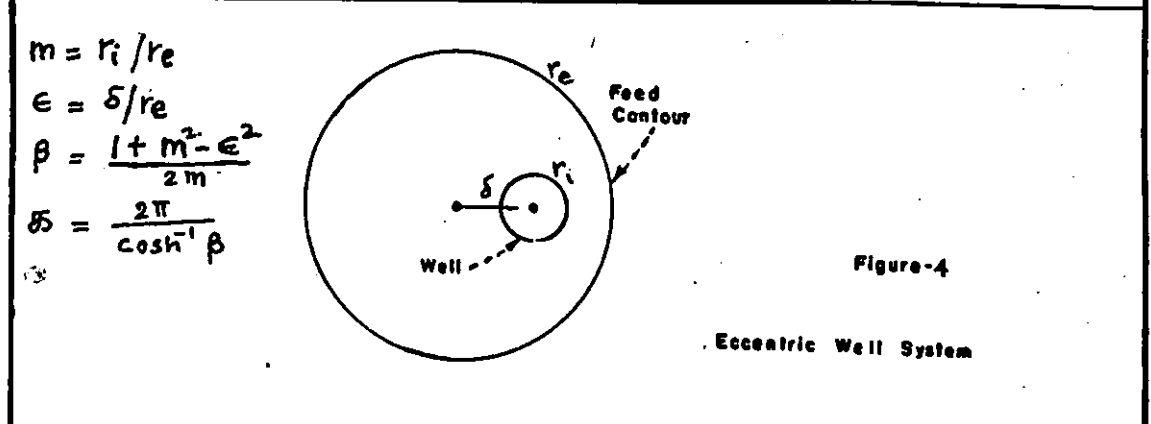
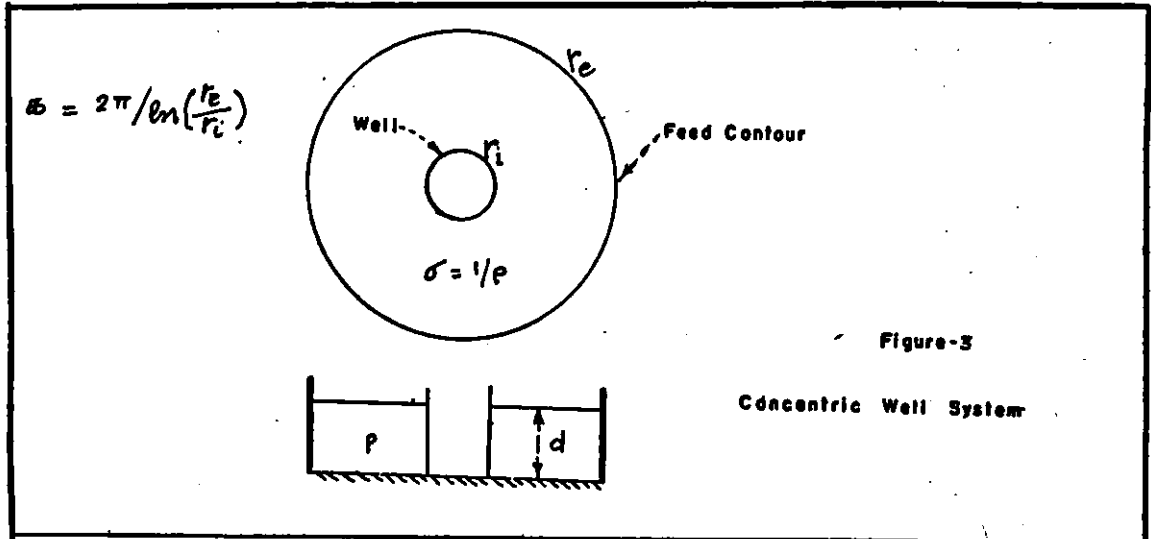

FIGURES 3, 4 and 5 : Shape factors of well systems.

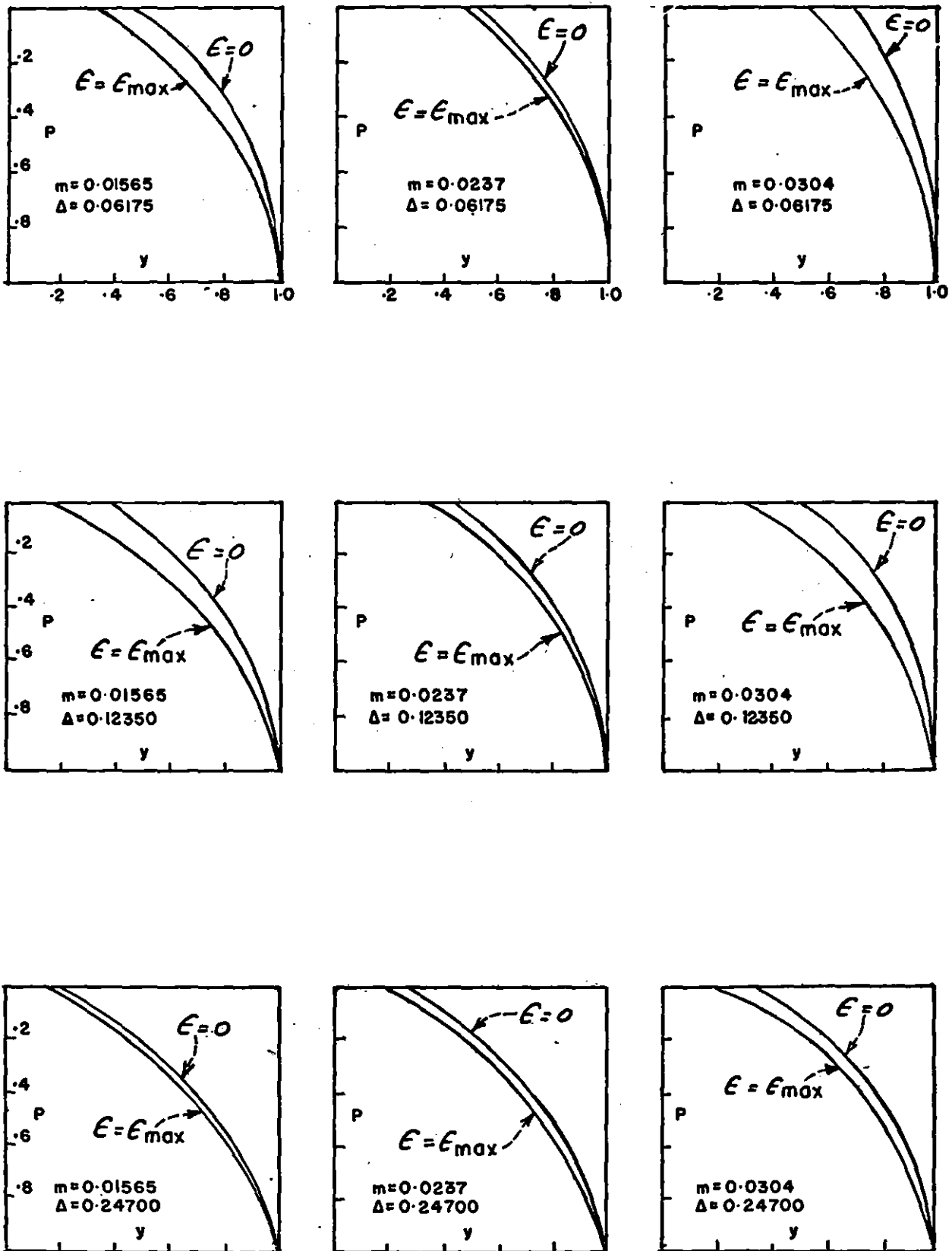

FIGURE 6: Partial penetration coefficients.

3.2 One Example of Application of the Formula

3.2.1 Let $r_o = 300$ m
 $r_i = 10$ m
 $\delta = 150$ m
 $K = 30$ m/day
 $d = 25$ m

If a head difference of 10 m is maintained between the outer feed contour and the eccentric well, compute the water flow Q into the well.

3.2.2 Solution

$$m = \frac{r_i}{r_o} = \frac{10}{300} = 0.033$$

$$\epsilon = \frac{\delta}{r_o} = \frac{150}{300} = 0.5$$

$$\therefore \beta = \frac{1+m^2-\epsilon^2}{2m} = 11.3, \text{ and}$$

$$r_o = \beta + \sqrt{\beta^2 - 1} = 22.55$$

$$\therefore \phi = \frac{2\pi}{\ln r_o} = \frac{2\pi}{\ln 22.55} = 2.01$$

$$\therefore Q = \phi \cdot H \cdot K \cdot d = 2.01 \times 10 \times 30 \times 25 \\ = 15,100 \text{ m}^3/\text{day}$$

4. Intraresistance between two External Wells

4.1 Assume the existence of two wells r_i and r_o external to each other separated by a distance d in an infinite medium (Figure 5). Using the previous technique of complex variables, it has been mathemati-

cally derived that the shape factor for this system can be computed as follows :

$$\text{If } m = \frac{r_o}{r_i} \text{ and } \epsilon = \frac{\delta}{r_i}$$

$$\text{and } \beta = \frac{\epsilon^2 - (1+m^2)}{2m}$$

$$\text{then } \phi = \frac{2\pi}{\cosh^{-1} \beta}$$

5. Intraresistance between an Outer Well and a partially Penetrating Internal Well

5.1 Let us now consider the shape factor between a fully penetrating outer circular well and a partially penetrating inner circular well. The inner well can be either concentric or eccentric. Since a theoretical solution was found intractable, experiments were done with a similar set-up as before and the partial results as obtained are graphed in Figure 6.

Since the shape factor ϕ is a function of m , ϵ , p and Δ where $\Delta = \frac{d}{r_o}$, we can write the shape factor as

$$\phi(m, \epsilon, p, \Delta)$$

Experiments were done with $m = 0.0304, 0.0237$ and 0.01565 with ϵ varying from 0 to the maximum possible, p varying from 0 to 1.0 and Δ with values of 0.0617, 0.1235 and 0.2470.

Let us define $y(m, \epsilon, p, \Delta) = \frac{\phi(m, \epsilon, p, \Delta)}{\phi(m, 0, 1.0, \Delta)}$

and these values of y are graphed in Figure 6.

Further experiments to complete the series are proposed to be taken up shortly.

Techniques and Methods for Development and Assessment of Ground Water Resources

R. P. SHARMA

Director

Land Reclamation, Irrigation and Power Research Institute, Punjab, Amritsar

S. R. SEHGAL

Mathematical Officer

A. D. GULATI

Asstt. Research Officer

SYNOPSIS

Ground water is being increasingly used to meet the growing demands of agricultural production. The paper describes the techniques that are usually employed for locating potential basins of ground water. In this context, the techniques employed both for surface and sub-surface investigations of ground water have been listed and discussed. Methods to evaluate the ground water resources of an area have been reported.

The paper lastly describes the concept of safe yield from the underground reservoir which is of vital importance in any basin-wide ground water development programmes. Different methods which are usually employed for ascertaining the safe yield have been reviewed. It has been concluded that selection of any method depends upon the availability of the relevant data, stage of development of ground water and its exploitation. This paper also suggests the various methods for applications under different situations.

1. Introduction

1.1 India has vast surface and sub-surface water resources. In order to get optimum benefits, it is of utmost importance to make an appraisal of these resources. The appraisal is also necessary for formulation of projects for integrated use of these resources. Of late we have concentrated our efforts on exploitation of surface waters which led to the construction of storage dams and network of canal systems to carry waters to the fields. However, the development of surface water has not been found to cope with the increased demand with the result that emphasis has now shifted to the exploitation of ground waters. Consequently, tube-well pumping is receiving a great fillip under the present circumstances. Apart from the schemes of tube-well construction under the Government Plan Schemes, private parties on their own accord as well as encouraged by way of loans and subsidies have taken to tube-well pumping in a big way in all parts of the country.

2. Utilization of Ground Water Resources

2.1 Indiscriminate use of ground water could lead to

disastrous consequences which would be as challenging as the challenge of growing water shortage. The disastrous consequences of extensive exploitation without proper appraisal of these resources in various countries of the world are already before us and how the water is being returned to the underground reservoir through costlier schemes of recharge in these countries point to the necessity of using this apparently unlimited resource in this country by adoption of scientific and sound practices of development of these vital resources.

3. Appraisal and Development of Ground Water Resources

3.1 Potential basins of underground water could be located and their appraisal made in the following way. Prospecting for ground water in any area should comprise the following investigations.

(i) *Inventory of Existing Wells*: Inventory of all existing wells in the area should be made and all relevant data collected. This should include strata logs, yield, drawdown and depth to water-table and lastly quality of water.

(ii) *Test Holes* : The information obtained *vide* item (i) should be supplemented, if necessary, from results of test holes which should be drilled.

3.2 Contour Maps

The information obtained *vide* items (i) and (ii) could be profitably employed for the preparation of contour maps for demarcation of areas of various thicknesses of the aquifers and depths to aquifers below natural surface.

3.3 Geophysical Methods

3.3.1 Geophysical methods are also being increasingly employed for prospecting for water. These comprise; (a) Resistivity Surveys, (b) Seismic Refraction Method, and (c) Electrical Logging. These methods can give the following information :—

- (i) Depth, thickness and lateral extent of aquifers in sedimentary region.
- (ii) Depth of water-table and bed rock in hard rock areas, thickness of weathered layers.
- (iii) Quality of ground water in terms of salinity. Location of zone of salt water encroachment in coastal areas.

Some details of the methods are given below :—

(a) *Resistivity Surveys* : Resistivity survey is a geophysical prospecting operation in which measurement of earth resistivity is made from the ground surface. Various types of earth materials generally exhibit certain ranges of resistivity values.

Measurement of earth resistivity is made by using four electrodes set in the ground. The current is applied to the ground water through two of these and potential drop across the two is noted. The most common arrangements are the Wenner and Schlumberger configurations. East European countries adopt Schlumberger while the west adopt Wenner configuration.

(b) *Seismic Refraction Method* : Seismic refraction method is based on the principle that shock waves travel through different earth materials—sands, clay and hard rocks at different velocities, the denser the material, the faster the wave travels.

The field measurements of different velocities thus help in identification of different layers of sub-surface materials. The limitation of the method is, however, that it can be used only there the velocity of the shock wave increases with depth.

(c) *Electrical Logging* : Electrical logging has come into widespread use in ground water hydrology during recent years. It helps in the correct locations and identification of ground water zones and in approximately determining the quality of water contained in such formations. The method is an excellent tool for sub-surface correlation.

3.4 Recent Techniques

3.4.1 *Use of Radio Isotopes* : Use of radio isotopes has been made in the solution of problems in the field of water studies. These serve as valuable tools in the determination of many hydrological parameters in ground water and surface water studies. Isotopes techniques are useful in finding out measurement of flow rate, interconnection of aquifers, porosity and permeability, the velocity and direction in ground water flow. A large number of reactor produced isotopes are available but all are not useful tracers in ground water studies. Of the isotopes used in water studies, the most important is tritium. The radioactive material is injected and by measuring the activity of radio tracers at the point of injection and the point of measurement, the time taken for travel between the two points is calculated. In India, Tata Institute of Fundamental Research, Bombay has been equipped in undertaking these studies.

3.4.2 *Use of Electric Analog Model* : The electric analog model, as the name suggests, is an electric model for aquifers prepared on the basis of similarity of :

$$\text{Ohm's law } I = \frac{1}{R} \cdot \frac{E}{L} \text{ with Darcy's law } V = K \cdot \frac{H}{L}$$

$$\frac{1}{R} = \frac{1}{\text{Resistance}} = C = \text{Coefficients of conductivity.}$$

I is current, E difference in voltage in length. Thus electric current I in model corresponds to velocity, i.e., the flow in the prototype. The voltage difference E in model corresponds to head difference H in prototype. The conductivity in model corresponds to the permeability in the prototype. An extensive data of permeability coefficients, storage coefficient, thickness, etc., of aquifers and the boundary conditions are required for construction of such model. On a proved model, any development like artificial recharge, putting a set of new tube-wells, etc., can be put and the corresponding effect on S.W.Ls. can be studied.

4. Yield of Ground Water

4.1 Estimation of Specific Yield from Strata Logs

4.1.1 For estimation of ground water resources, it is very essential to ascertain the specific yield of the sub-strata. Strata log data has been usefully utilised to work out the specific yield of the Upper Bari Doab Tract; Bist Doab Tract and Western Yamuna Canal (East Tract). The procedure involves the classification of well logs data in various classes of materials. Percentage of each class of material is assigned specific yield value based on the work done in U.S.A. and average specific yield for different depth zones can be worked out. Computation procedure to be adopted is explained in case of Shahabad Barara area in Western Yamuna Canal (East Tract), as under.

4.1.2 Well logs in respect of Shahabad Barara area in Western Yamuna Canal (East Tract) were examined. The sub-strata described in the well logs was classified in the following five groups :—

TABLE I
Classification of Materials from logs of wells in Shahabad Barara Area.
(Western Yamuna Canal, East Tract)

Bore Number	Clay, clay with <i>kankar</i> , silty clay, surface clay, hard clay, sandy clay, sand, stone, etc.	Fine sand, light sand, tight gravel and similar other materials	Medium sand, gravel & <i>kankar</i>	Coarse sand, coarse sand and gravel	<i>Bajri</i> , gravel, pebbles, stone, etc.	Total depth (m)
1	2	3	4	5	6	7
5	65.5	21.9	19.2	3.0	1.8	111.4
10	27.7	34.4	9.1	9.1	1.8	82.1
54	33.2	12.2	23.8	13.1	—	82.3
17	50.3	22.6	—	5.5	11.6	90.0
46	26.8	37.2	6.1	12.2	—	82.3
69	88.7	41.4	—	4.0	—	134.1
16	34.8	19.8	16.4	14.9	—	85.2
24	50.9	11.6	13.4	18.9	—	94.8
20	38.1	17.4	14.0	9.7	—	79.2
35	60.0	32.6	13.0	5.5	—	111.1
14	26.8	36.3	9.7	12.5	—	85.3
15	34.7	30.2	6.1	11.3	—	82.3
12	46.3	20.1	—	3.3	15.5	85.2
18	24.4	40.2	—	17.7	—	82.3
37	39.9	29.6	18.9	—	6.1	94.5
65	68.3	22.2	18.6	9.7	6.1	124.9
58	22.2	43.9	11.3	4.9	—	82.3
44	48.5	19.8	—	14.0	6.1	88.4
71	70.4	19.2	20.4	5.8	—	115.8
21	31.4	3.6	31.7	7.6	4.9	79.2
53	46.3	14.6	9.8	14.6	—	85.3
13	32.6	36.6	17.4	4.9	—	91.5
51	34.7	29.3	4.9	16.4	—	85.3
Total	1001.8	596.7	263.8	218.6	53.9	2134.8
Average	—	—	—	—	—	92.8
P. Average	47.0	28.0	12.3	10.2	2.5	—

TABLE II

Estimation of specific yield from strata logs in Shahabad Barara Area.
(Western Yamuna Canal, East Tract)

Material	Specific yield % (assigned)	Percentage depth of material	Percentage yield
1. Clay, clay with <i>kankar</i> , silty clay, surface clay, hard clay, sandy clay, sandstone, etc.	6	47.0	2.82
2. Fine sand, tight sand, tight gravel and similar other material	10	28.0	2.80
3. Medium sand, gravel and <i>kankar</i>	15	12.3	1.85
4. Coarse sand, coarse sand and gravel	20	10.2	2.04
5. <i>Bajri</i> , gravel, pebbles, stones, etc.	25	2.5	0.63
Overall yield			10.14

(i) Clay, clay with *kankar*, silty clay, surface clay, hard clay, sandy clay, etc.

(ii) Fine sand, tight sand, tight gravel and similar other materials.

(iii) Medium sand.

(iv) Coarse sand, coarse sand and gravel.

(v) *Bajri*, gravel, pebbles, stones, etc.

4.1.3 The percentage depth of material for all the five categories was struck off with respect to the total depth of the bores (Table I).

4.1.4 Assigning specific yields of the order of 6, 10, 15, 20 and 25 percent respectively to the above categories based on experimental results obtained in U.S.A., average specific yield for Shahabad Barara area in Western Yamuna Canal (East Tract) was worked out to be 10.14 percent as shown in Table II.

4.2 Estimation of Hydraulic Properties of Aquifers from Pumping Tests

4.2.1 Pumping tests are made to determine the hydraulic characteristics of the aquifers. In areas where ground water is to be used in large quantities, it is important to know the hydraulic properties of the aquifer. A determination of these properties makes it possible to understand the physics of ground water systems and helps to evaluate the ground water resources of an area in relation to its development. The hydraulic properties control the storage capacity, the total amount of water available for withdrawal, and the rate of transmission of water in the aquifer. The estimation of these characteristics, viz., the coefficients of

permeability, transmissibility and storage is essential for the evaluation of the yield from ground water reservoirs. Various formulae have been developed from time to time for ascertaining these hydraulic characteristics from data of pumping tests and are given below.

4.2.2 *Theim Equilibrium Formula* : It enables the aquifer permeability to be determined from a pumped well. It envisages pumping at a uniform rate for a sufficient time to approach a steady state condition and observation wells located close enough to the pumping well so that their drawdowns are appreciable. The formula for determining the permeability of the water bearing formation for confined aquifers is :

$$K = \frac{Q \log_e \frac{\Sigma_2}{\Sigma_1}}{2 \pi b (h_2 - h_1)}$$

where, Σ_1 and Σ_2 are the distances and h_1 and h_2 are the heads of the respective observation wells.

4.2.3 *Theis Non-Equilibrium Formulae* : The development of non-equilibrium formula by Theis (1935) was a major advance in the field of ground water hydraulic. It enables determination of the formation constants, storage and transmissibility by means of pumping tests of wells. Theis formula is :—

$$s = \frac{Q}{4\pi T} W(U)$$

where,

s = drawdown in metres

Q = well discharge in cu m/min.

T = the transmissibility ($m^2/min.$) of aquifer, and

$W(U)$ = the exponential integral termed as "well function" where the argument U is given by :

$$U = \frac{r^2 S}{4 T t}$$

where, ' S ' is the dimensionless storage coefficient, ' r ' is the distance in metres from discharging well to the observation well and ' t ' is the time since pumping started. This has suggested an approximate solution based on a graphical method of super-position for obtaining values of formation constants from pumping tests from the above two relations.

4.2.4 Jacob Method : For small values of ' r ' and large value of ' t ' This non-equilibrium equation can be applied to determine T and S . From pumping tests data, drawdown is plotted against logarithm of time in days which forms a straight line. T and S are obtained from the following equation :

$$T = \frac{2.30 Q}{4 \pi \Delta h}$$

and
$$S = \frac{2.25 T t_0}{r^2}$$

where, Q = discharge cu m/min.

T = transmissibility ($m^2/min.$) of aquifer

S = coefficient of storage

Δh = drawdown difference in metres per log cycle time

t_0 = time intercept on the zero drawdown axis

r = distance of the observation well from the pumped well in metres.

4.2.5 Theis Recovery Formula : The recovery data of a pumped well can be used to find out the value of T . The modified formula is as under :—

$$T = \frac{2.30 Q}{4 \pi s'} \log \frac{t}{t'}$$

where, Q and T are as previously defined

s' = residual drawdown

t = time since pumping started

t' = time since pumping stopped.

4.3 Estimation of Transmissibility Coefficient from Specific Capacity Data

4.3.1 In many ground water investigations especially those of a reconnaissance type, the specific capacities of the wells can be used as a basis for estimating the coefficient of the transmissibility of the aquifer. This, Russel H. Brown, Rexe R. Meyer in Geological Survey Water Supply paper 1536-1 entitled "Methods

of Determining Permeability, Transmissibility and Drawdown" have developed procedure and given charts correlating well diameter, specific capacity of wells, coefficient of transmissibility and storage, from which the transmissibility of the aquifer can be estimated from the known specific capacity of the well.

5. Extent of Utilization of Ground Water Safe Yield

5.1 In basin wide ground water development programmes, the concept of safe yield from the underground reservoirs is of vital importance. It is the amount of water which can be withdrawn from it without producing any undesired effect, may be in the form of permanent depletion of water-table making pumping cost prohibitive. The question generally posed is—What is the safe yield for this particular basin and how do we know that we are overproducing a ground water basin and how can we determine the amount of overdraft.

5.2 Different methods which are usually employed for ascertaining the safe yield are discussed below :

5.2.1 Inventory Method : The most effective method for basing safe yield is the inventory method in which all available methods are utilised to make inventories of the entire water supply area from its entrance into the area as precipitation, stream flow or underground percolation to its exit as evapotranspiration, runoff or underground seepage. It requires the identification of various factors and their evaluation for a particular basin. The usual factors that need to be evaluated in preparation of ground water inventory are :

On Recharge Side

- (i) Rainfall penetration to ground water.
- (ii) Natural influent seepage from stream.
- (iii) Influent seepage from irrigation channels and deep percolation.
- (iv) Inflow of ground water from the area outside the area under investigation.

On Discharge Side

- (i) Effluent seepage of ground water.
- (ii) Losses by evapotranspiration.
- (iii) Artificial removal by seepage drains.
- (iv) Discharge by pumping.
- (v) Outflow.

5.2.1.1 The evaluation of some of the factors requires investigations of the extended nature and as such this method can only be applied in area of some special importance as this would involve establishing of gauging stations on influent streams, evaporation and transpiration studies, rainfall infiltration studies besides a network for measuring seepage losses from irrigation canals which obviously entails lot of experimental work, it being assumed that there already exists a network of rainfall recording station and arrangement for ground water-table observations.

5.2.1.2 Some methods have thus been evolved to compute safe yield in case supply is the governing criterion.

HILL METHOD

Data required for computing safe yield by this method are ground water observations and extent of annual withdrawals. It is also assumed in this method that the water supply to the basin is reasonably constant. Annual change in ground water levels is plotted against annual drafts and a straight line can be fitted to the points. The draft corresponding to zero change in ground water-level from this straight line is read and defined as safe yield.

HARDING METHOD

Annual retained inflow in basin is plotted against annual change in ground water elevation. A straight line is fitted to the plotted points. The retained inflow corresponding to zero change in water-table elevation is the safe yield. It is, however, assumed that draft on the basin should be reasonably constant.

METHOD BASED ON ZERO NET GROUND WATER-LEVEL FLUCTUATIONS

If the ground water elevation at the beginning and end of a period of time extending to several years is the same, the average annual net draft on the basin is a measure of safe yield.

METHOD BASED ON DARCY LAW

If the inflow into a basin is lateral and direction is known, the safe yield can be obtained by Darcy Law. The cross-sectional area can be determined from geological cross-sections, the permeability coefficient from pumping tests and hydraulic gradient by actual observations. The method is most advantageous for confined aquifers having uni-directional flow.

METHOD BASED ON SPECIFIC YIELD AND AVERAGE ANNUAL RISE IN WATER-TABLE

In unconfined aquifers, the annual recharge can be worked out from data of ground water levels and specific yield. It is equal to the product of specific yield, annual rise of water-table and area of the aquifer.

METHOD BASED ON SPECIFIC YIELD AND RISE OF WATER-TABLE FROM JUNE TO OCTOBER

Rainfall in this country is mostly received during monsoon period. Rise of ground water-table from June to October gives the net recharge due to rainfall. Increase in ground water storage due to average least rise of water-table for the period of record can be worked out as above which is the available ground water potential safe for pumpage. In case of high water-table areas, due to formation of water mounds, sufficient amount of it passes into the nearby drainages in the tract.

ESTIMATION OF GROUND WATER POTENTIAL FROM RAINFALL

In case, precipitation is the predominant source for recharge of ground water, the estimation of rainfall per year that contributes to the recharge of ground water would be the available potential loss by the amount of losses through evapotranspiration and sub-surface drainage which may be estimated or assumed. Rainfall recharge relationship can be worked for the area. The empirical relationship as derived by Irrigation Research Institute, Roorkee and is given below can be profitably employed :

$$R_p = 2.0 (R - 15)^{\frac{2}{3}} \text{ (F.P.S. System)}$$

$$R_p = 3.5 (R - 38.10)^{\frac{2}{3}} \text{ (Metric System)}$$

where, R = the average annual rainfall in inches/centimeters

R_p = the annual rainfall penetration to water-table in inches/centimeters.

There is, however, need to develop a relationship that takes into consideration other factors namely, physical characteristics of the soil, slope, rainfall intensity, initial moisture content, etc.

ESTIMATION OF GROUND WATER POTENTIAL IN CASE OF CANAL COMMANDED AREAS

In case of canal commanded areas, in addition to recharge due to rainfall penetration, amount of seepage from main canals, branches, distributaries and on account of deep percolation may be estimated and added to the recharge due to rainfall to get overall potential available for safe pumpage from the two main sources.

5.3 Selection of Technique

5.3.1 The technique that can be adopted for estimation of ground water potential in an area depends upon the availability of relevant data, stage of development of ground water and its exploitation. Most of the methods mentioned above need data relating to the extent of the annual withdrawals that have been affected from year to year and water-table fluctuations. The practice of water-table observations in various areas is prevalent in almost all the States but that of keeping record of withdrawals from the underground is not usually maintained. It is thus of utmost importance that this record of withdrawals of water from the underground be also kept up-to-date for taking up the essential studies. In case of the tracts where ground water development is in initial stages, water balance studies could only give us the requisite information for basing the extent of withdrawals from the basin. Method based on specific yield and average annual rise of water-table can give the requisite information provided data of strata logs of bore-holes and water-table observations extended over a period of years, are

available. This method has been employed in the Irrigation and Power Research Institute for working out the ground water potential in respect of canal irrigated tracts of the Punjab and Haryana.

6. References

- (1) Shah, C. R. and Vyas, S. P. : "Assessment of Ground Water Potential and their Technique". Seminar on Soil Mechanics on the eve of the Zonal Meeting of Central Board of Irrigation and Power (South Zone), Trivandrum, September 1969.
- (2) Sehgal, S. R. and Gulati, A. D. : "Assessment of Ground Water Potential and their Technique". Seminar on Soil Mechanics on the eve of the Zonal Meeting of Central Board of Irrigation and Power (North Zone) held in Bhubaneswar (Orissa), February-March, 1970.
- (3) Sehgal, S. R. and Gulati, A. D. : "Increase in Ground Water Potential due to rise of Water-table in Canal Irrigated Tracts of Punjab and Haryana". Thirty-seventh Annual Research Session, Central Board of Irrigation and Power, Bhubaneswar (Orissa), June 1967.
- (4) Sharma, R. P. and Sehgal, S. R. : "Assessment of Ground Water Resources of the Punjab State". Symposium on Water Resources, Indian Institute of Science, Hydraulics and Civil Engineering Division, Bangalore, May 11 to 15, 1971.
- (5) Todd, D. K. : "Ground Water Hydrology". John Wiley and Sons, Inc., New York, 1959.
- (6) Tolman, C. F. : "Ground Water". McGraw Hill Book Co., New York.
- (7) Proceedings of the Symposium on Ground Water Studies in Arid and Semi-arid Regions". University of Roorkee, October 1966.
- (8) Uppal, H. L. and Sehgal, S. R. : "Ground Water Resources of the Western Yamuna Canal (East Tract)". Journal of the Institution of Engineers (India), Vol. 46, No. 11, Pt. C.L. 6, July 1966.
- (9) Uppal, H. L.; Singh, G. and Singh, R. : "Ground Water Resources of Bari Doab Tract". Annual Bulletin of the International Commission on Irrigation and Drainage, 1964.

SESSION II

PLANNING FOR INTEGRATED DEVELOPMENT OF SURFACE AND SUB-SURFACE WATER RESOURCES

Integrated Development and Conjunctive Use of Surface and Ground Waters

O. P. GUPTA

Member.

Irrigation Commission, Ministry of Irrigation and Power, New Delhi

SYNOPSIS

The paper highlights the existing deficiency of irrigation water in canals, particularly run of the river schemes. It draws attention to develop the soil potential to the full by providing irrigation support for scientific agriculture and intensive cultivation with the same precision as other inputs. It emphasises the role of ground waters for supplementation of surface resources. Examples of integrated development and conjunctive use of surface and ground waters in the country are cited. An estimation is made of available ground water resources and technical details and variables in simultaneous development and conjunctive use examined. Emphasis is laid on integrated development as a safeguard against waterlogging which may occur due to massive application of surface waters.

The paper draws attention to the necessity for ground water legislation to control extraction. It also deals with administrative needs for simultaneous planning of both surface and ground waters by the same Organisation to co-ordinate all technical and administrative problems to constitute a composite, unified and harmonious system of irrigation.

1. Introduction

1.1 Surface waters and ground waters are two important sources for irrigation purposes. Both have been extensively used but generally without integrated planning for co-ordinated development and maximum benefits.

1.2 Inadequacy of water in the irrigation systems of the country, particularly run of the river schemes, is enough well-known to need any amplification. They fail in no small measure to provide assured and timely supplies to support improved agriculture during periods when water requirements for crops are high and river flows and canal deliveries low. These proverbial shortages are so unpredictable that this leaves the cultivator confused and guessing. He can do no advance planning for his agricultural activities in a systematic way nor can he, with any confidence, persuade himself to invest adequately in land improvement or other required inputs.

1.3 Unlike the past, the irrigation development in the future has now to extend much beyond the short-

term concept of insurance against rainfall failures and famine relief and prevention of mass human suffering. The earlier concept of extensive irrigation, where water deficiencies short of complete failures were seldom recognised, has to give place to intensive irrigation and raising high yielding varieties, if the soil potential, to respond to higher inputs such as fertilizer and improved seeds, is to be properly developed. If it remains under-developed as a result of low intensity cultivation due to lack of irrigation water, then a national resource is not contributing any more to country's economy than a river wasting its waters into the seas or ground water potential lying untapped. Rapid development of multi-cropped agriculture is imperative to keep pace with the growth of population. This is equally important to sustain the large percentage of population, which depends on agriculture alone, and enable them to raise more than one crop on their lands in a year for their living.

1.4 Massive surface irrigation works, started a century back, have been vastly accelerated in recent times. But even after harnessing all surface water

resources by storage or diversion works, as may be feasible from economic and technical considerations, not all the irrigable area in the country can be provided with irrigation facilities. Nor would it thus be possible to ensure adequate and timely supplies for high yielding varieties or for multiple cropping.

1.5 Extensive supplementation of surface water with ground water through integrated development and conjunctive use of the two provides the remedy for augmentation of irrigation supplies in order to maximise production from land, to the extent possible, by putting adequate water where it is needed and at the time needed, from either or both of these resources. It would be a combination of the two resources for intensification of irrigation and fulfilment of water requirements for high yielding varieties and even for extension of irrigation on areas at present not properly served by surface resources.

1.6 The process of integrated development must therefore, call for a close examination of the varied types of technical and administrative issues involved, with a view to lay down policies and programmes with regard to balanced and harmonious development of the two resources.

1.7 The opinions expressed or problems posed for consideration in this note present author's individual views. However, the discussions which may ensue may be of help to Central and State organisations and to the Irrigation Commission of Government of India, in the formulation of their opinions on this subject for the future.

2. Some Examples

2.1 The concept of integrated development of surface and ground water resources is by no means a new one. A system of combination of the two has been practised in the country, in a limited manner and in a variety of ways, to fulfil the deficiencies in irrigation supplies. The exploitation of ground waters is carried out either by open wells, open-cum-bored wells, operated either mechanically or with cattle power as possible and convenient, or by shallow or deep tube-wells or by means of filter points.

2.2 In the Central and Peninsular regions in the States of Gujarat, Madhya Pradesh, Andhra Pradesh, Mysore, Tamil Nadu, Maharashtra and Kerala, etc., farmers usually exploit ground waters by constructing open masonry wells on quite a large scale.

2.2.1 In Maharashtra, under Parvata and Godavari Canal systems, supplementation of available canal supplies by such masonry wells sustains production of sugarcane crops to feed numerous cooperative sugar

factories. Raising of sugarcane crops would otherwise suffer badly in the restricted sugarcane area under block system and with water being available from canals only 8 months in a year.

2.2.2 In the delta region of Cauvery, ground water is extracted by farmers in the canal irrigated areas by shallow filter points, to raise paddy seedlings in early June before delta system is opened for irrigation. The water deliveries from these filter points enables them to raise a second rice crop successfully up to March even though the Delta Irrigation system is closed by end of January. But for such conjunctive uses of surface and ground water the agriculture operations in Cauvery Delta would be limited to a single crop only.

2.2.3 In Andhra Pradesh also there is a big programme for construction of tube-wells in the Krishna and Godavari Deltas to enable the cultivators to successfully raise two crops in a year.

2.2.4 In the Indo-Gangetic alluvial zone good progress and contribution has been made both by State and private tube-wells to supplement surface water resources. Canal systems in this region were designed in the past for cropping intensities much lower than the land is capable of enduring. The concept of intensive irrigation and raising high yielding varieties was then unknown. The canal supplies thus fail to furnish the water support for modern intensive agriculture with the same precision with which other inputs can be supplied. Ground water resources now provide additional irrigation facilities to large areas for development of irrigated agriculture on scientific lines.

2.2.5 Along the Western Yamuna Canal in Haryana 256 tube-wells were constructed between 1949 and 1954 to supplement canal supplies by no less than 11.33 cu m/sec (400 cusecs). This process has been continued and another 128 tube-wells were constructed with the same purpose.

2.2.6 In U.P. also, where inadequacy of water in existing surface irrigation system is well-known, the installation of very large number of private tube-wells in these areas is pointed to the endeavour of the cultivator not to depend entirely on the inadequate and uncertain water deliveries from canals. Exploitation of ground water through private tube-wells and its conjunctive use has thus become an established manner of supplementation of canal supplies for multiple cropping and for raising crops of high yielding varieties.

2.3 The progress and contribution which the State tube-wells have made in the recent past in harnessing

ground water resources to provide irrigation facilities mostly to large tracts of unirrigated lands in Northern India is second to none in the scheme of things of irrigation development. There are, at present, about 16,000 State tube-wells in operation in the country. With about 9,700 tube-wells, Uttar Pradesh tops the list. Put together Bihar, Gujarat, Haryana, Punjab and West Bengal account for another 5,600.

2.3.1 These tube-wells command no less than 4 million ha (10 million acres) of area and form a collective capacity of pumping at least 566 cu m/sec (20,000 cusecs) of water. On an approximate estimation these tube-wells would be extracting almost 7,400 to 9,867 cu m (6 to 8 million acre-ft) of water annually from the sub-soil. They would be providing the much needed water for irrigation to an area of almost 0.81 million ha (2 million acres).

3. Technical Aspects

3.1 In a sub-continent like India, with its highly variable physical features of rainfall, soils, geology and underground formations there is hardly any aspect in common with respect to the quantum and quality of ground waters between the alluvial plains of the North to the crystalline, sedimentary or Deccan Traps regions of Central and Peninsular India or to the arid or semi-arid zones of Western India. Extreme degree of variance is in existence in the availability of ground water over the country. In the plateau regions of South India and hilly regions of Central India ground water availability is confined to fossilised water in rock fissure and in stony crevices, with limited possibilities of recharge. Its exploitation is generally limited mostly through open wells.

3.1.1 The coastal areas in Orissa, Andhra Pradesh, Tamil Nadu and parts of Narmada Basin are tracts with good possibilities for extraction of ground water for being put to conjunctive use with surface waters.

3.1.2 The Indo-Gangetic alluvial zones, in comparison to other regions can, however, be classed as a major and large proven ground water reservoir of immense potentialities for integrated development and simultaneous use with surface water resources.

3.2 Approximate estimates, based on general experience and such other data as is available, have been made of ground water resources of the country. In a nutshell there are :

(a) Rainfall infiltration

(i) in alluvial zones of North India of total precipitation,

20% app.

(ii) in hard rock and sandstone zones, 5 to 10% app.

(iii) in Western Rajasthan 2%

(b) Total estimated annual rainfall precipitation in the country 3,700 T.M. cu m (3,000 million acre-ft)

(c) Losses in rainfall precipitation through evaporation 1,233 T.M. cu m (1,000 million acre-ft)

(d) Rainfall runoff in rivers 1,665 T.M. cu m (1,350 million acre-ft)

(e) Balance seeping down the sub-soil $b - (c + d)$ 802 T.M. cu m (650 million acre-ft)

(f) Infiltration arrested in top soil layers as soil moisture 432 T.M. cu m (350 million acre-ft)

(g) Net annual ground water recharge component of rainfall $(e - f)$ 3,707 million cu m (300 million acre-ft)

(h) Recharge component from canal seepage, infiltration of irrigation water and inflow from rivers and streams 54,252 million cu m (44 million acre-ft)

(i) Total ground water recharge component 424,273 million cu m (344 million acre-ft)

(j) Deducting losses in evaporation and sub-surface flows in different percentage in different regions, total available ground water recharge 270 T.M. cu m (219 million acre-ft)

(k) Probable recharge to brackish zones unfit for agricultural purposes 14,800 million cu m (12 million acre-ft)

(l) Total resultant recharge available for ground water development 257 T.M. cu m (207 million acre-ft)

(m) Usable ground water potential 75 to 80 percent of net ground water recharge, i.e. (l) 203,524 million cu m (165 million acre-ft)

(n) Annual draft in the country at the end of 1967-68 from open wells, private and State tube-wells, etc. 74,000 million cu m (60 million acre-ft)

based on average area irrigated by these sources, as collected by Minor Irrigation Branch of the Ministry of Food and Agriculture.

- | | | |
|-----|--|--|
| (o) | Additional unaccounted draft by Public Health Engineering Department, Municipalities, Panchayats, Railways and Industries. | 37,000 million cu m (30 million acre-ft) |
| (p) | Approximate additional draft from open wells private and State tube-wells during the last two years. | 24,669 million cu m (20 million acre-ft) |
| (q) | Net ground water potential available per annum for future exploitation and development m. (n+o+p). | 67,842 million cu m (55 million acre-ft) or 2,400 TMC app. |

3.2.1 Thus no less than 67,842 million cu m (55 million acre-ft) or 2,400 TMC of net ground water potential is available per annum for future exploitation and development. This would very nearly equal the entire potential of all the surface water reservoirs put together constructed so far.

3.2.2 Though only a portion of this vast resource can be used with the surface waters, as some will serve virgin areas, yet the figures reveal the great potentiality of ground water resources for conjunctive use with canals.

3.3 Ground water already contributes as much as 30 percent of the total irrigation of the country. The present 9.5 million ha (24 million acres) irrigated by ground water may, upon full exploitation, increase to 21 million ha (53 million acres). Thus the need for quantifying basinwise resources, surface and underground, computing the cost of their development, their present stage of exploitation and ultimate potential for development and conjunctive use has to be emphasised.

3.3.1 Like surface reservoirs, ground water reservoirs also cannot be utilised to the best advantage if they are kept full or nearly full. The study into the behaviour of ground water reservoirs, many of which can hold far more water than an artificial surface reservoir, with little loss by evaporation is, therefore, of great importance for their planned development conjunctively with surface resources.

3.4 Basically, in respect of any ground water reservoir, extraction must generally not exceed the limits of safe yield. The problem would thus be to establish a hydrological equation between discharge and recharge. It will then be possible to lay down a system for depletion of ground water reservoirs during dry periods to provide storage capacity for the wet season. The vari-

ables and unknown factors affecting ground water recharge have yet not been studied in enough details. When this is done, it will be possible to achieve closer integration of surface and ground water resources. It will then also be possible to analyse the complicated technical issues to evolve a system of ground water exploitation sufficiently flexible to permit heavy pumping, temporarily for short periods to a limited extent, to take full advantage of the aquifer storage during critical periods of plant growth or seasonal peak demands or to alleviate conditions of scarcity over a dry year or a cycle of dry years. In such circumstances conjunctive use can be of the greatest advantage and ground waters can act as a balancing storage for maintaining a steady source of total supplies for the irrigation system.

3.5 Co-ordinating integrated development and combined utilisation of surface and ground water resources would also involve studies of the inter-relation and inter-action of ground water from rainfall, stream flows and seepage recharge from gravity canals and for estimation of possibilities and processes of artificial recharge of underground aquifers. It would besides be necessary to link up the process of pumping to seepage from gravity canal and distributaries of different dimensions and carrying varying discharges, in order to define, with a fair degree of accuracy, the spacing and depth of State and private tube-wells with respect to gravity canals and distributaries as also with respect to one tube-well and the other. This automatically would determine the number and intensity of tube-wells to be permitted in an area and the amount of water that could safely be pumped out without any deformation of the potential and utility of either the canals or the tube-wells.

3.5.1 This would be necessary as much from the economic point of view as from the technical angle, in order to maximising benefits from investments made on them both in public and private sectors. It would be otherwise if private tube-wells, for various reasons and circumstances, are not utilised fully. In Northern States, where private tube-wells have developed on an extensive scale, they generally are grossly under-utilised running hardly 1200 to 1500 hours in a year, if not even less in some regions. Evidently, therefore, the investment on them should be considered as highly uneconomical. What is worse is that the intensity of well population, located haphazardly and catering only to individual needs, would bear no relationship to the overall area to be served. When used intensively in certain months, during periods of low canal supplies, each may interfere with the other. This would defeat, in no small measure, the basic objectives of planned ground water development and give rise to numerous problems varying in severity from one region to another.

3.6 No endeavour can here be made to discuss the details of different variables involved in the process of conjunctive uses of surface and ground waters.

Some of them are :

- (a) Meet kharif demand from gravity canals and give full coverage by tube-wells, either public or private to meet all or most of the early kharif and rabi demands. Rabi surface supplies could then be released and re-allocated to other suitable and needy areas, either in the same or in a different basin.

Besides flexibility of operation the value of a system like this would be enhanced by quicker replenishment of ground water through greater recharge during rainy season even if the aquifers have been strained beyond the capacity of balanced recharge for rabi crops.

The economics of such a system would need to be carefully examined. It may not be any worse as compared to what it is at present, for tube-well even now, State or private, are very little in operation during monsoon period. State or privately owned tube-wells replacing canal irrigation during rabi would have the two-fold advantage of providing assured and timely irrigation to a command and releasing canal water allotted to it for other areas not equally rich in ground water resources.

- (b) Pooling of surface and ground waters on tails of channels which are subject to chronic shortage.
- (c) Having exclusive commands for surface and ground water resources. Tube-wells could then either interperse or fringe the canal command.
- (d) Having inclusive commands, i.e., both the surface and ground water supplies may serve the same area.
- (e) Reduce canal supplies to some extent to private tube-wells' owners. This would automatically improve utilization of private tube-wells considerably without affecting crops adversely.
- (f) Reduce command area on canals and transfer it to tube-wells and utilize released canal supplies elsewhere.
- (g) Augment canal supplies by suitably sited public tube-wells.
- (h) Utilise low quality ground water zones by mixing with surface source and thus increase irrigation supplies.

3.6.1 In the choice for a combination each region will have its own peculiarities and will present problems which would need to be studied and treated in a manner best applicable to it in its socio-economic and technical details. There is little possibility of an approach which may be common or similar in nature all over the country. Solutions, therefore, are bound to differ as much from project to project as from one area to another.

3.6.2 In any case the intensity and location of tube-well population in an area will have to be properly defined. This would be necessary to control any haphazard development and safeguard against undue depletion of ground water-table or tube-wells feeding on surface supplies.

4. Integrated Development—A Safeguard against Water-logging and Salinity

4.1 With the future massive development of surface water resources and in the process of intensification of irrigation and fulfilment of water requirements of high yielding varieties or any indiscriminate and unplanned irrigation from canals, the underground hydrological balance can be disturbed through the process of charging the ground water aquifers in an artificial manner by heavy percolation besides natural process of rainfall infiltration. The rise of water-table, in places to a substantial degree, can, therefore, be a natural consequence. The problem, already acute in some tracts, is thus likely to be aggravated further. Water-table in some tracts in Ganga Basin has now risen quite high causing problems of water-logging and salinity in varying degree of severity. The problem posed by abnormal rise of water-table in portions of Haryana and Punjab States in the process of intensive surface irrigation may also be called alarming. This development, now arrested to some extent, threatened vast areas over these States with danger of water-logging and salinity.

4.2 It is here that integrated development of the two resources, surface and underground, and their conjunctive process of use is most effectively brought into play as much to rectify major deficiencies in surface water supplies as to provide a fundamental safeguard to hold the ground water-table at a safe depth by judicious extraction of water from the sub-soil to prevent water-logging.

4.3 That water-table be maintained sufficiently below the surface to avoid water-logging and salinity is a universally accepted maxim. At what level should it be held and used most profitably and economically still remains a matter mainly for research tempered to some extent by practical considerations. There can, of course, be no criteria for general applicability all over. Each region of physical and climatic similarity and soil texture would have to be considered as a unit in itself, distinct from others, to approach the problem.

4.4 It can, however, be visualised that State enterprise shall have to play a major role in this direction, wherever circumstances demand systematic control to be exercised on ground water-table against risks of water-logging and salinity.

4.4.1 For example the State of Haryana has constructed batteries of tube-wells in Jagadhri and Karnal areas to arrest water-table rising dangerously high. These tube-wells supplement canal supplies besides providing drainage to the area.

5. Saline Aquifers

5.1 An important aspect of conjunctive use of ground waters with canals is in respect of areas having saline aquifers. For any scientific approach to improved agriculture quality of water is as important as quantity.

5.2 Generally speaking ground waters which fall within 1000 parts per million of total dissolved salts are designated as fresh water and can be used directly on crops. Ground water with a quality of 1000 but less than 3000 ppm TDS could be used by dilution by mixing it with fresh water from surface resource. Waters of a quality having more than 3000 ppm TDS may be considered as completely saline and unfit for irrigation purposes.

5.2.1 By and large, the process of dilution of saline water with fresh water would involve elaborate investigations and rigid and careful control. This may not be considered feasible or called for at the present time. Nevertheless in arid areas like that of Rajasthan and Kutch where ground water has been noticed to be brackish, it can be combined with sweet waters from surface supplies like Rajasthan or Chambal Canals and used with advantage for extending irrigation.

5.3 The question of inroad of salinity in delta areas, would also need to be carefully considered and extraction of ground waters on a large scale in these regions guided and controlled with due caution.

6. Irrigation Tariffs for Conjunctive Use

6.1 An important problem associated with conjunctive use of surface and ground water is the matter of irrigation tariffs. Widely divergent patterns of tariffs for canal and tube-well irrigation can complicate matters in no small measure.

6.2 Farmers cannot be expected to forego willingly their claims to cheaper surface irrigation, though inadequate, for the more expensive volumetric system from State tube-wells, even if assured in time and quantity.

6.2.1 It is not that cost of tube-well irrigation is so disproportionate that crops cannot sustain the charge—multitudes of farmers are thriving on it—the problem is of a commodity being so drastically cheaper in comparison, though inferior in quality, that farmers would automatically choose and adhere to canal irrigation as compared to State tube-wells. Yet, Indian farmer, intelligent and progressive as he generally is, and endowed with sound commonsense, can eventually be expected to adopt new systems and techniques. He cannot allow low productivity to persist and must, therefore, orient his operations to maximising his yields and obtaining the best from his holding and improve his economic position.

6.2.2 When suitably educated in the matter of economics of expenditure on the existing canal charges plus

that of supplementation from a private tube-well put together, to the charges for supplementing irrigation from a State tube-well, he would be able to understand that the two bear a close comparison in cost.

6.2.3 In the existing circumstances, therefore, where State tube-wells are being constructed to supplement canal water to individual farmers the proposal to charge him for tube-well water by volume in addition to full canal rates on area basis would be reasonable. This would mean having inclusive command for surface and ground water supplies serving the same area. In Haryana, however, where batteries of tube-wells have been constructed to augment canal supplies the old pattern of irrigation tariffs on area-crop basis has not been disturbed.

6.3 In any case for an ultimate future pattern of possible irrigation tariffs in areas where canal and ground waters are conjunctively utilised on the same land, a thorough study into all the aspects of the matter may lead to evolving a system best suited to the pattern of combination adopted. In doing so the basic approach of volumetric system being more rational and economical in water use will have to be borne in mind. Side by side it would need special attention to provide adequate safeguards against any further slicing of the financial returns from irrigation projects which have already been strained almost to a breaking point.

6.4 To make the concept of integrated development and conjunctive use attractive and acceptable to the farmer, and to achieve a break-through his prevailing prejudices against State tube-wells, it is of paramount importance that the management of State tube-wells, the service against breakdowns and for their repairs, the system of apportionment and conveyance of water, uninterrupted supply of electric energy and general assurance of continuous working during periods of demand, must be guaranteed. It is only thus that the farmer will get convinced of the real utility of the system. It should besides be ensured that command areas in such a system is not in excess of a reasonable limit for multiple cropping and for supply of irrigation water at proper time and in adequate quantities from either or both the resources.

7. Ground Water Legislation

7.1 How to avoid overdrafts on ground water is a highly complicated question, which is not easy to answer.

7.2 The recent massive acceleration in the construction programme of public and private tube-wells and the welcome enormous development of surface wells must invite added emphasis to this problem. It would thus be necessary to exercise, and if need be to impose, suitable controls on the methodology and quantum of extraction of water over space and time.

7.3 Although the present annual draft from the sub-soil over the country still leaves a substantial margin to ultimate development, yet the exploitation of net safe yield or balanced recharge in certain regions may possibly be reaching the apex point. Well population in such areas may already be causing interference in their pumped yields. Well thought out safeguards, imposed well in time, is therefore, a logical sequence and a pressing need, to arrest uncontrolled water extraction from the sub-soil.

7.4 It will, therefore, be in no distant future that public control over abstraction of ground water and suitable ground water legislation may become indispensable. This would be with a view to control, and possibly regulate, the exploitation of ground waters within safe limits so as to safeguard against undue depletion, and may be exhaustion, of this resource.

7.4.1 Ownership of ground water in our country vests with the ownership of land. This, therefore, adds significance and imparts urgency to such a legislation to restrict harmful overdrafts from ground water reservoirs and define ground water rights.

7.5 Ownership and right, quantum, system and regulation of withdrawals, requirements and uses within and outside the ground water reservoir area, etc., would have to be suitably defined in such a legislation. The process of intergration of ground water, efficiently and to the best advantage, with the already public controlled surface resources, will be no less an important matter to be covered in such a legislation. In addition, where concentrated pumping may have to be resorted to over long periods at the expense of possible recharge, general principles will need to be defined in the statute, either to reduce the discharge or increase the recharge artificially.

7.6 Besides a central ground water legislation which demands urgency, there would be need for Regional or State legislations also which may be responsive to regional environments and situations and fulfil local requirements.

8. Administrative Needs

8.1 It appears quite evident that the whole approach to integrated development and conjunctive utilisation of surface and ground water resources needs to be modernised. Irrigation development can no longer be dealt within isolation as between surface and ground waters and must be planned, exploited and managed in intimate co-ordination with each other. Our present planning, by and large side tracks this concept. There is hardly an irrigation scheme for surface water development which at present takes into consideration possibilities and scope of supplementing surface resources from ground waters or the necessity of doing so as a safeguard against water-logging which may result due

to introduction of intensive canal irrigation. In fact the adverse impact of want of integrated planning is already being felt over large regions of the North in no small measure.

8.2 The existing fragmented administrative system may be a major factor that may stem the process of a well co-ordinated approach to overall planning, construction and management in this regard to a long range goal.

8.2.1 Under the present administrative arrangement the Ministry of Irrigation and Power is responsible for all major and medium surface irrigation projects and the Ministry of Food and Agriculture for ground water development.

8.2.2 This division of responsibility militates against the concept of simultaneous planning, and of the conjunctive development and utilisation of all water resources of a river basin, and results in a situation in which planning, exploitation and management of surface water in a basin is done independently by one Organisation without reference to the identical functions performed in respect of ground water by another organisation. Obviously, in a situation of this kind there is every likelihood of a confusion of purpose in planning, and of a conflict of interest in practice.

8.3 Whatever might have been the administrative necessity for such an arrangement in the past, a fresh appraisal of the system, and of the diffused responsibility which has resulted, seems necessary to judge how far it impedes the objective of a co-ordinated approach to overall planning for the optimum conjunctive use of the two resources so that it constitutes a composite, unified and harmonious system of irrigation. It is only when programmes for ground water exploitation are treated as an intrinsic component of a surface irrigation project that it can be considered to be both safe and effective.

8.4 If, therefore, there is to be a co-ordinated programme for surface and ground waters, it would be necessary to have a unified Organisation to control and guide the many complex technical and administrative problems for their simultaneous planning and integrated development. These considerations point to the imperative need for the Ministry of Irrigation and Power, with its expertise in engineering, to reconcile all processes and techniques, through continuous research, to develop a really efficient and effective system.

8.5 Other bodies, like the Committee on Plan Projects in the Planning Commission and the Study Team of the A. R. C. in their report on "Machinery of Government of India and its Procedure of Work" who

have gone into the question in the recent past have made recommendations on similar lines. The A. R. C. has also recommended that the Ministry of Irrigation and Power should be the co-ordinating body for all works relating to the investigation of ground water resources and that the E. T. O. now Ground Water Board should be transferred from the Ministry of Agriculture to Ministry of Irrigation and Power.

8.6 The integration envisaged at the planning stage

will obviate the present unhealthy competition between major and medium schemes on the one hand and minor schemes on the other. Once the interaction of all schemes has been realised, the place of any scheme in a programme will depend on the contribution which it can make to the general purpose of the programme, whether this purpose is to serve as the main source of irrigation or as a supplementary source or as a component of the conjunctive use of ground and surface water in the area.

Need for a National Water Policy*

G. N. KATHPALIA

Director (Irrigation)

N. S. VARADAN

Research Officer

Planning Commission, New Delhi

[This paper will review the availability and current utilisation of the water resources in India, based on existing data and studies. An attempt will be made to project the possible water requirements for various uses for the next 30 years. Some new policies or changes in existing policies will be proposed and the need for a special organisation to formulate national water policies for India will be stressed.]

SYNOPSIS

The total utilisable water resources of India are estimated at 82 million ha m against which the present utilisation for all purposes is estimated to be 40 percent. The next 55 percent of the utilisable quantum is likely to be used in the next 30 years, that is, if care is taken with regard to its utilisation for agriculture, industries and fossil and nuclear power with proper management, specially in the field of agriculture which is the major user of water. If the required efficiency is not achieved with proper water management as assumed in the paper, the water use for the proposed economic growth in various fields is likely to be much higher and may even exceed the total utilisable water resources. The water requirements for agriculture, industrial and power use and domestic water supply have been worked out on the basis of the growth in population and the corresponding growth in the various sectors. The necessity of providing water adequately for recreational facilities and maintaining ecological equilibrium and for controlling water to reduce the damages from floods, water-logging and drainage congestion has also been indicated.

In conclusion, it is seen that water, and not land, would be a limiting factor in the future economic growth of the country. A methodology for economic evaluation of water use for various purposes needs to be developed and, finally, immediate action is necessary to create a Central Water Authority with statutory powers for initiating and coordinating the studies on the various aspects such as assessment, utilisation, conservation, and management of water.

1. Introduction

1.1 The value of water is derived by virtue of its use. The positive values of water include its uses for irrigation, industries, municipal and rural water supplies, hydro-power generation, navigation preservation of fish and wild life and recreation. The negative values include damages caused by floods, water-logging, pollution, etc. Optimal water resources de-

velopment aims at maximising the positive values and minimizing the negative values.

1.2 Water is a dynamic resource and its occurrence and distribution cannot be predicted in a deterministic manner. But it is amenable to statistical and stochastic analysis. Despite the intrinsic variations from day to day and season to season, the quantum of water can be estimated with requisite accuracy and

*The views expressed in this paper are of the authors and not necessarily of the Planning Commission.

sired confidence when considered over a fairly long period of time. Though the value of water use for various purposes is bound to change with the change in the pattern of development, certain broad features can be identified and guidelines can be framed in planning its use over a fairly long period of time.

1.3 Development of water resources is intimately interlinked with land use. Water can change the pattern of land use and bring either economic prosperity or destruction. It influences population distribution and by proper planning it can be the vital incentive for better population distribution and optimum economic growth. In this process, water resources development has to take into account a wide variety of considerations, namely, physical, geological, social, economic, biological, legal, political and aesthetic. Some of these considerations might be quantifiable and others lend themselves amenable, at best, to qualitative estimates. Water resources development which does not recognise and integrate these many quantitative and non-quantitative dimensions to the greatest extent possible fails to achieve the desired objectives. It is, thus, a very broad field involving a variety of interdisciplinary considerations.

1.4 In making the decision relating to water resources development, one must choose between the many alternative uses of water and often many alternative means of accomplishing the development. In a vast country like India which requires development not only in the field of agriculture but also in all the other spheres, the role of water as a resource to achieve the goal of optimum development requires detailed analysis and concentrated attention. Also, this resource is limited and one cannot afford to exploit and pollute it to an unlimited extent. *It has to be conserved, developed and judiciously utilised.*

2. Assessment of Water Resources

2.1 Assessment of water resources as well as the assessment of current utilisation and future requirements is prima facie the basic study in the planning for optimum utilisation. In India, there exist only some broad idea about the availability of surface and ground water resources. These are based on assumed analogies and give data about the annual average rather than the maxima and the minima and seasonal variations and dependence. Also reliable data on the actual utilisation of the water resources, in terms of water, for the various utilities are not available. However, as water is a dynamic resource, the planning and policies would also have to be dynamic, periodically reviewed and improved upon as more and more data become available.

2.2 The estimate for the average runoff for the country made by Khosla⁽¹⁾ was 168 million ha m. This estimate gives only the average annual flow and does not represent the utilisable quantum which will be much less. The utilisable quantum depends on the variations in the flow, the nature of utilisation, the quality of water and the facilities for storing water, that is the

availability of suitable sites for constructing dams or diversion structures. In India the irrigation projects are designed for 75 percent dependability and hydro-power projects for 90 percent dependability. Industrial and domestic water supply projects require a still higher dependability. When the dependability consideration is made, the water available for utilisation is less than the average runoff. Again, against this 75 percent dependable flow, the utilisable quantum will be much less if the quality of water, the physiography and topography in the various regions are considered.

2.3 From the above considerations, the utilisable quantum of surface water for various purposes was estimated as 56 million ha m some 20 years back⁽²⁾. This estimate does not indicate the State-wise or basin-wise distribution. In the estimate of utilisable ground water resources, at the preliminary stage of development, the annual volume of natural recharge to the ground water basin, is generally considered. Rao et al⁽³⁾ have estimated that the total resultant recharge available for ground water development in India is of the order of 26 million ha m (State-wise details are available). *With the above background, as a first approximation, the country's total utilisable water resources can be placed at 82 million ha m.*

3. Development and Utilisation of Water Resources

3.0 A period of 30 years (1970-2000) has been chosen for outlining the development requirements of water resources for various purposes. In a developing country like India, a longer period would be difficult to consider as it may not be possible to project the growth and changes with requisite accuracy. This 30 years' period may again be split into two, namely, the period up to the end of the Fifth Five-Year Plan (1974-79) and the period from 1980-2000. In the first period one cannot expect to feel the effect of changes in the planning policies and strategies, as part of the period would be covered under the Fourth Plan in progress and the remaining part would be influenced by the trend of the Fourth Plan, particularly the major and medium projects of the Fourth Plan, which would spill over into the Fifth Plan. Hence, the effect of new concepts and strategies can possibly be felt fully only in the period beyond 1980.

3.1 The use of water can be considered under three groups. One is the utilisation of both surface and ground water for consumptive or partial consumptive uses such as irrigation, urban and rural water supply and for various industrial uses and thermal and nuclear power generation. Irrigation is a real consumptive use because of the evapotranspirational losses. Uses for domestic and industrial purposes are partially consumptive as most of the water could be renewed for reuse after proper conditioning. The second group is the non-consumptive use of water for hydro-power generation, navigation, pollution control, recreation, preservation of fish and wild life, etc. The third group is not a use in the normal sense of the term but involves control of water to avoid damages from its excess rather than its use

as a resource. Examples are agriculture drainage, urban storm drainage, flood control and the variety of schemes to prevent sedimentation, water-logging, land erosion and inland intrusion of sea water in the coastal areas.

3.2 Consumptive Uses

IRRIGATION

3.2.1 In the case of irrigation, industries and domestic water supply, the magnitude of the development required in each field has been identified first and then the water requirement for ensuring the development has been assessed. For outlining the development in the field of irrigation, following objectives have been kept in view :

- (a) generating an agricultural growth commensurate with the likely population growth ;
- (b) minimising the dependence of agriculture production in the country (particularly, foodgrains) on the unirrigated areas. The production from which is susceptible to the vagaries of the monsoon to a greater degree as compared to the irrigated areas.

In the following paragraphs, trends in population, agriculture production and requirements of major items are discussed.

3.2.2 Pant⁽⁴⁾ has estimated the population growth up to the year 2000-01 (medium variant) and has indicated the production requirements for the principal items for the period up to 1985-86. Extrapolating the production requirements for the principal items on the basis of the estimated population, the requirements up to the period 2000-01 have been computed and are given in Table I.

TABLE I
Estimated population (mid-year) and agriculture production requirements.

	Unit	1973-74	1978-79	1990-91	2000-01
Population	Million	595.8	665.9	795.4	918.7
Foodgrains	Million tonnes	129	155	204	236
Oilseeds	-do-	10.5	14.0	22.1	25.6
Sugarcane	-do-	152	213	306	355
Cotton	Million bales*	8.0	10.4	13.9	16.0

*1 bale=180 kg ; 1 tonne=5.56 bales

3.2.3 Before working out the indicative plan to meet the requirements, the production in the base year 1968-69 requires to be looked into. The area under various crops and production therein as estimated by the Ministry of Agriculture⁽⁶⁾ are given in Table II.

TABLE II
Cropped area and production 1968-69—Principal crops.

	Area* (million hectares)	Production (million tonnes)
Rice	36.97	39.76
Wheat	15.96	16.54
Other Cereals and Pulses	67.50	38.75
Total Foodgrains	120.43	95.05
Oilseeds**	14.60	6.90
Sugarcane	2.46	120.00
Cotton	7.69	5.27 million bales

*The figures for area discussed here and subsequently are all cropped areas unless mentioned otherwise.

**Includes groundnut, castor seed, sesam, rape and mustard, and linseed only.

3.2.4 The above estimates do not give the production from irrigated and unirrigated areas separately and the details of the irrigated areas under each crop are also not reported. To assess the impact of irrigation on production, there is need to determine the yield per hectare for the crops separately under irrigated and unirrigated conditions. After analysing the data available⁽⁶⁾⁽⁷⁾, the yield figures have been arrived at, which are given in Table III. The likely improvements in the yield in the future years have been arrived at, keeping in view the current status of agriculture technology in India, the likely growth of areas under the improved varieties and the possible improvements in the field of water management for agriculture. These estimates may get altered if a major break-through is obtained in the case of cotton, oilseeds, pulses, or if the assumptions regarding water management are not fulfilled.

3.2.5 For the total area under all the crops a growth of 1.1 percent per annum has been assumed for the period up to 1978-79 (Pant⁽⁴⁾ has estimated 1.1 percent up to the year 1985-86). The growth assumed is 0.85 percent from 1979-1991 and 0.45 percent from 1991-2001. A higher growth does not seem to be necessary. The areas under the individual crops have been fixed keeping in view not only the requirements of production but also the trends in the recent past. The cropping intensities assumed are given in Table III. Considering these, the net land use would be 146.5 million ha in 1973-74, 149.7 million ha in 1978-79, 156.2 million ha in 1990-91 and 160.0 million ha in 2000-01,

Area : Million hectares
Yield : Tonnes/Hectare
Production : Million Tonnes

TABLE III

Estimated cropped area, yield and product—Principal crops.

	1968-69			1973-74			1978-79			1990-91			2000-01		
	Irriga- ted	Unirri- gated	Total	Irriga- ted	Unirri- gated	Total	Irriga- ted	Unirri- gated	Total	Irriga- ted	Unirri- gated	Total	Irriga- ted	Unirri- gated	Total
1	2	3	4	5	6	7	8	9	10	11	12	13	14	15	16
1. Total cropped area under all crops	35.90	128.10	164.00	43.00	130.20	173.20	52.00	131.00	183.00	66.70	135.30	202.00	71.50	140.00	211.80
2. Rice :															
Area	14.80	22.20	37.00	18.00	22.00	40.00	21.60	18.40	40.00	24.00	16.00	40.00	24.00	16.00	40.00
Yield	1.30	0.90	1.07	2.10	0.90	1.44	2.50	0.95	1.79	3.33	1.10	2.42	4.20	1.20	3.00
Production	19.24	19.98	39.22	37.80	19.80	57.60	54.00	17.48	71.48	79.20	17.60	96.80	100.80	19.20	120.00
3. Wheat :															
Area	6.80	9.20	16.00	8.50	9.00	17.50	10.40	8.10	18.50	11.00	7.50	18.50	11.00	7.50	18.50
Yield	1.40	0.70	1.00	2.30	0.70	1.48	2.80	0.80	1.93	3.70	1.05	2.61	4.40	1.10	3.06
Production	9.52	6.44	15.96	19.55	6.30	25.85	29.12	6.48	35.60	40.70	7.54	48.24	48.40	8.25	56.65
4. Other Cereals & Pulses :															
Area	6.40	61.00	67.40	8.00	64.70	72.70	9.30	64.90	74.20	12.50	61.70	74.20	14.00	60.20	74.20
Yield	1.00	0.55	0.59	1.05	0.55	0.61	1.10	0.60	0.66	1.50	0.80	0.92	1.80	0.90	1.06
Production	6.40	35.55	39.95	8.40	35.69	44.09	10.23	38.94	49.17	18.75	49.36	68.11	25.20	54.18	79.38

5. Total : Food-grains																
Area	28.00	92.40	120.40	34.50	95.70	130.20	41.30	91.40	132.70	47.50	85.20	132.70	49.00	83.70	132.70	
Production	35.14	59.87	95.01	65.75	61.79	127.54	93.55	62.90	156.25	138.65	78.84	213.49	174.40	81.52	255.92	
6. %age Area under Food-grains to total area under crops																
	78.3	72.2	73.5	80.0	73.2	75.3	79.4	69.8	72.5	71.2	62.9	65.7	68.5	58.8	62.6	
7. Oil Seeds* :																
Area	0.60	14.00	14.60	0.80	14.00	14.80	1.50	18.00	19.50	3.60	28.00	31.60	4.00	32.00	36.00	
Yield	1.00	0.45	0.47	1.10	0.50	0.54	1.20	0.55	0.60	1.40	0.65	0.74	1.60	0.75	0.85	
Production	0.60	6.30	6.90	0.88	7.00	7.88	1.80	9.90	11.70	5.04	18.20	23.24	6.40	24.00	30.40	
8. Sugarcane :																
Area	1.80	0.70	2.50	2.50	0.70	3.20	3.20	0.70	3.90	4.10	0.70	4.80	4.10	0.70	4.80	
Yield	51.00	44.00	49.04	53.00	44.00	51.01	57.00	44.00	54.60	72.00	47.00	68.40	85.00	50.00	80.00	
Production	91.80	30.80	122.60	132.50	30.80	163.30	182.40	30.80	213.12	295.20	32.90	328.10	348.50	35.00	383.50	
9. Cotton :																
Area	1.30	0.40	7.70	2.00	6.50	8.50	3.00	9.00	12.00	3.70	10.50	14.20	4.00	12.00	16.00	
Yield	0.29	0.09	0.123	0.29	0.10	0.145	0.32	0.10	0.151	0.40	0.12	0.190	0.46	0.13	0.210	
Production (Million bales)	2.15	3.20	5.35	3.12	3.61	6.78	5.34	5.00	10.34	8.23	7.01	15.24	10.23	8.67	18.90	
10. Others: Area																
	4.20	14.60	18.80	3.20	13.30	16.50	3.00	11.90	14.90	7.80	11.90	19.70	10.40	11.90	22.30	
11. Cropping																
Intensity	1.200	1.145	1.150	1.300	1.148	1.155	1.450	1.151	1.220	1.700	1.160	1.313	1.800	1.170	1.330	

*Includes groundnut, seasm, rape and mustard, castor seed and linseed only.

compared to 141.8 million ha in 1968-69. The land use in the year 2000-01, in terms of the estimated ultimate arable land of 175 million ha would be 91.4 percent. As the growth rate of net land use in the decade 1990-2000 would be around 0.24 percent, there is no likelihood of dearth of land in the future beyond 2000-01 also. *Thus land is not going to be a limitation in the economic growth of the country.*

3.2.6 Table III gives the estimated area under the various crops. It would be seen that the percentage of area under foodgrains increases slightly in the year 1973-74 as compared to the year 1968-69. This is very much likely in view of the recent improvements in production in the case of rice and wheat. This trend is to bound discontinue with the returns from the commercial crops (once the foodgrain position becomes selfsufficient), becoming better as compared to the returns from the foodgrains. The area under items not covered under the principal crops may increasingly be under pastures, orchards, vegetables and leguminous crops from 1990 onwards.

3.2.7 The estimated production based on the estimated yield and cropped area are also given in Table III. It may be seen that the estimated production in the year 1968-69 tallies well with the actual reported production for all the items and is well within the range of requirements for the future years so far as foodgrains and sugarcane are concerned. But in the case of oilseeds there is deficit up to mid-eighties and in the case of cotton up to the early eighties. *Certain policy measures in fixing the prices and improvements in agriculture techniques can remove these deficits earlier.* The contribution of production from the unirrigated area to the total production of foodgrains decreases from 62.1 percent in the year 1968-69 to 47 percent in the year 1973-74, 40.2 percent in the year 1978-79, 35 percent in the year 1990-91 and 31.9 percent in the year 2000-01.

3.2.8 The estimated ultimate irrigation potential is 45.6 million ha from major and medium schemes, 14.1 million ha from minor surface⁽⁹⁾ and 22.3 million from ground water⁽⁹⁾, the total being 82.0 million ha. Against this, the cumulative development up to the year 1968-69 has been 18.57 million ha in the case of major and medium projects, 8.1 million ha in the case of minor surface projects and 10.86 million ha in the case of ground water, the total being 37.53 million ha. During the Fourth Plan, the additional development is estimated to be 7.99 million ha from all the sources—Table IV. In the case of major and medium projects there is always a time-lag between the development (potential created) and the utilisation (the actual area irrigated). The percentage of utilisation (the area actually benefited as compared to the facility created) was 85 percent in the year 1968-69 from plan schemes* and is likely to be the same at the end of 1973-74 also. As steps are being taken to improve the percentage of

utilisation, the utilisation may be assumed to improve to 86 percent in the year 1978-79, 90 percent in 1990-91 and 92 percent in the year 2000-01. Making allowances for this gap between the development and the utilisation, the development requirements for irrigation have been worked out as given in Table IV. In the case of major and medium projects though all India-wise the required development appears to be well within the achievements during the plan period, yet State-wise very great efforts will be needed particularly in the case of Andhra Pradesh, Madhya Pradesh and Uttar Pradesh. In this connection, it may be mentioned that the most attractive sites for the major and medium projects have already been exploited in most of the States and the future projects would require considerably more complicated investigations and an increased investment per unit quantity of water stored. *Hence, it is intended that the total irrigation development outlined need not be of the conventional type bringing new areas under irrigation at the current level of water use efficiency but a balanced development comprising the existing approach and the new strategy of better water management with adequate water allowances at the proper time.*

TABLE IV
Irrigation Development.

(Thousand hectares)

	Surface Water Major and Medium	Water Minor	Total	Ground Water	Total
1	2	3	4	5	6
1968-69 (cumulative)	18,566*	8,098**	26,664	10,864**	37,528
1969-74 (additional)	4,766*	562+	5,328	2,665+	7,994
1973-74 (cumulative)	23,332	8,660	31,992	13,530	45,522
1974-79 (additional)	5,745	610	5,355	2,900	9,255
1979-91 (additional)	8,460	1,500	9,960	4,750	14,710
1991-2001 (additional)	3,355	1,500	4,855	650	5,505
2000-01 (cumulative)	40,892	12,270	53,162	21,830	74,992
Estimated ultimate potential	45,580*	14,145**	59,725	22,257**	81,982

*The utilisation from pre-Plan irrigation schemes is 100 percent.

TABLE IV (Cont.)

1	2	3	4	5	6
Percentage development by the year 2000-01 reckoned on estimated ultimate potential	89.8	86.8	89.0	98.1	91.6
*Ref. 8	**Ref.	9	+Approximate		

3.2.9 The irrigation development outlined above has been in terms of the area only, which has to be spelt in terms of units of water utilised. Crops require water to meet the consumptive use (amount of water used on a given area in transpiration, building of plant tissues and evaporation from adjacent soil). The consumptive use varies mainly with the climatic conditions and the longer the crop growth period the larger is the consumptive use. But the efficiency with which the crop utilises the water depends on the soil conditions and rooting conditions of the crop. Data on the consumptive use of the various crops under different agro-climatic conditions in the country are yet to be compiled and presented in a readily usable form. Based on the information available^{(10), (11), (12)} the average consumptive use requirements for the various crops can be estimated as 1300 mm for rice, 430 mm for wheat, 450 mm for other cereals and pulses, 600 mm for oil seeds, 1850 mm for sugarcane, 720 mm for cotton and 600 mm for other crops. Considering the cropped area and cropping patterns arrived at in Table III, the average consumptive use per unit cropped area works out to 900 mm in 1968-69, 910 mm in 1973-74, 915 mm in 1978-79, 880 mm in 1990-91 and 860 mm in 2000-01. Part of this can be met by rainfall (this part is known as effective rainfall) and the rest has to be met from irrigation supply.

3.2.10 Data on the net effective rainfall are not available. Hence, a simplified estimation based on broad assumptions has been resorted to. Out of the total average annual rainfall of 1140 mm (45 in.), it is reported⁽⁹⁾ that 380 mm is the evaporational loss and 130 mm is the soil moisture retained at the root-zone of plants. The soil moisture is available in full for plant growth, but the amount actually used by crops in the total evaporational component (termed as evapotranspirational loss) depends on the period for which the crops occupy the land area. With the above consideration, the effective rainfall meeting the crop water requirements works out to 310 mm in 1968-69, 330 mm in 1973-74, 355 mm in 1978-79, 385 mm in 1990-91 and 390 mm in 2000-01. After accounting for this contribution from the rainfall, the irrigation requirement on an average for meeting the crop needs per unit irrigated area works out to 590 mm in 1968-69, 580 mm in 1973-74, 560 mm in 1978-79, 495 mm in 1990-91 and 470 mm in 2000-01.

3.2.11 Compared to the irrigation water requirements for meeting the water requirements of the crops, the

total water required to be supplied will be more on account of the field and transmission losses. From limited unpublished data available, the irrigation efficiency (efficiency = water required for crop use/total water supplied) for the canal systems, measured at the headworks is found to be around 40 percent. In the case of ground water, the canal losses (losses in main canals, branches and distributaries) are not involved and the efficiency measured at the supply head is around 65 percent. The efficiencies can be improved with better water management. It is reported⁽¹³⁾ that 22.2 million ha m of water were used for irrigation from surface sources in the year 1968-69. The area under irrigation⁽⁸⁾ from surface sources was 25 million ha which means a utilisation of 880 mm per unit area irrigated. In the case of ground water in the year 1968-69, it is found from limited data available, that the utilisation was 800 mm per unit area irrigated. With these levels of supply it may be seen that the actual use of irrigation water by the crops was around 352 mm in the case of surface and 520 mm in the case of ground water against the requirement of 590 mm in 1968-69. Hence, the net water supplied to meet the crop requirements needs to be stepped up to improve the yield.

3.2.12 At the current level of water management, if the supply position has to be improved to meet the crop requirements in full, it would involve a supply of 1175 mm in the case of surface water and 725 mm in the case of ground water per unit average area irrigated and a total utilisation* of 78.3 million ha m in the year 2000-01. On the other hand, if the efficiency is improved to 55 percent in the case of surface water and 75 percent in the case of ground water by better water management practices, the utilisation would be 59.3 million ha m in the year 2000-01. Thus, by adopting better water management practices in the field of agriculture, one would be ensuring better supply to meet the crop water requirements and, at the same time, conserving considerable amount of the precious and limited water resources of the country. Table V gives the projections of supply level envisaged for surface water and ground water sources with assumptions regarding the desirable levels of efficiency envisaged and the total utilisation for the period up to 2000-01.

3.3 Partial Consumptive Uses

DOMESTIC AND LIVESTOCK WATER USE

3.3.1 The mid-year population in 1868-69, i.e., estimated⁽¹⁴⁾ as 527 millions. The Expert Committee⁽¹⁵⁾ set up by the Planning Commission has made projections of the urban population up to the year 1981 only. Adopting an urban population growth of average 2.45 percent per annum from 1981-2001, the urban population has been derived. The figures are 103.0 millions in 1968-69, 121.4 millions in 1973-74, 141.9 millions in 1978-79, 191.3 millions in 1990-91 and 243.7 millions in 2000-01.

*By utilisation it is implied water withdrawal and not the consumptive use.

3.3.2 The present position with regard to domestic water supply and what it is likely to be in the year 2000-01 is given in Table VI. The losses in the treatment plant and the distribution system of the water supply are at present estimated to be of the order of 20-25 percent. With improved efficiency, these could be reduced by about 10 percent and thus give better satisfaction to the consumer.

TABLE V
Irrigation Water Use.

	1968-69	1973-74	1978-79	1990-91	2000-01
1. Supply Actual or proposed (mm)					
Surface	880	950	950	900	855
Ground water	800	850	820	685	630
2. Efficiency of use (%)					
Surface	40	40	43	50	55
Ground water	65	66	68	72	75
3. Water Utilisation (Million Hectare Metre)					
Surface	22.2	27.1	34.4	43.5	45.5
Ground water	8.7	11.5	13.5	14.5	13.8
Total	30.9	38.6	47.9	58.0	59.3

TABLE VI
Domestic Water Supply—Assumptions.

	Percentage of Population		Per Capita daily rate in litres	
	1968-69	2000-01	1968-69	2000-01
1. Rural Population :				
(a) served with organised water supply	5	70	45	60
(b) not served with organised water supply	95	30	25	25

2. Urban Population :

(a) served with organised water supply

(i) for domestic purposes excluding water-borne sanitation

40 45 90 115

(ii) for domestic purposes including water-borne sanitation

30 50 135 180

(b) not served with organised water supply

30 5 45 45

3.3.3 As per the 1966 Census⁽¹⁴⁾, the livestock population (including poultry) in India was 459 millions, consisting of 230 million cattle and buffaloes and 229 million goats, sheep, poultry, etc. The growth is estimated at 0.5 percent per annum. Adopting this growth rate and assuming that the present average per capita daily requirement is 40 litres for cattle and buffaloes and 15 litres for goat, sheep, poultry, etc., and providing for an average per capita daily requirement of 50 litres for cattle and buffaloes and 20 litres for the rest by the year 2000-01, the water requirements have been computed. Table VII gives the details of livestock water requirements also.

TABLE VII
Estimated Domestic and Livestock Water Use.
(Thousand hectare metres)

	1968-69	1973-74	1978-79	1990-91	2000-01
Rural	400	465	575	895	1,220
Urban	340	415	525	865	1,280
Livestock	460	480	520	620	700
Total	1,200	1,360	1,620	2,380	3,200

3.3.4 The domestic water supply requirements including livestock needs, would be of the order of 3.2 million ha m, in the year 2000-01. *But in this case, the problem is not one of quantity but of quality, transportation and distribution* involving enormous investment. Already cities like Madras, Bombay, Bangalore, Delhi and, of late, Vizag face the need to transport water over distances of 200 to 250 km. Unless steps are taken to identify the areas of water shortage and allocate water for this vital use as the first priority, such regions of scarcity would pose serious problems.

INDUSTRIAL WATER USE

3.3.5 In the case of industries for the period up to 1980-81, the production requirements for the various items estimated in the perspective plan⁽¹⁶⁾ prepared in the Planning Commission have been adopted. For the period 1981-91, an average annual industrial growth of 10 percent (base 1980-81) has been assumed and for the period 1991-2001, a similar percentage growth, with the base period being 1990-91, have been assumed. The norms of water required per unit quantity of product has been arrived at after analysing the data^{(17),(18),(19)} available. The estimated industrial water requirements are given in Table VIII.

TABLE VIII
Estimated Industrial Water Use.
(Thousand hectare metres)

Industries	1968-69	1973-74	1978-79	1980-81	1990-91	2000-01
1. Food Products	4.3	5.7	7.9	9.1		
2. Textiles	11.0	14.0	19.0	22.0		
3. Paper and Newsprint	7.1	11.7	18.3	22.2		
4. Mines and Metals	192.0	323.8	490.7	588.2		
5. Glass, Cement, Refractories	5.6	8.8	13.5	16.1		
6. Chemical products	15.0	33.3	58.7	70.1		
7. Petroleum products	16.3	27.9	41.4	48.7		
8. Machinery	15.1	24.5	39.2	46.6		
9. Misc. Manufactured Items	0.4	0.7	1.2	1.4		
Total	266.8	450.4	689.9	824.4	2.090	5.520

3.3.6 The figures in Table VIII represent the total intake of water and not the consumptive use. Future technological improvements may reduce the intake of water but such changes could not be identified now to estimate the corresponding water requirements. However, considering the likely pollution hazards on account of industrial waste discharged into the natural watercourses, it appears that in the future years, particularly from 1980 onwards, the industries will have to adopt reuse and recycling processes to a larger extent.

FOSSIL AND NUCLEAR POWER—WATER REQUIREMENTS

3.3.7 In the case of power (electricity), the perspective plan⁽¹³⁾ indicates the total electric power requirements for the period up to 1980-81*. For the decade 1980-90, an average increase of 10 percent per annum (base 1980-81) has been adopted. For the decade 1990-2000, the percentage has been kept the same but the base reckoned is 1990-91. Table IX gives the total electrical energy requirements. The country's ultimate hydro power potential is estimated⁽²⁰⁾ at about 41 million kW and a corresponding annual generation of 216,300 million kWh. Table IX indicates the likely contribution from the hydro sources to the total energy requirement. *It may be seen that by the year 2000-01, almost all the hydro power potential would be exhausted. Also, in view of the limited scope for hydro power generation vis-a-vis the total energy requirements, from the year 1980-81 onwards the fossil and nuclear power (specially nuclear power) would have to play the major role in meeting the country's power demands.*

3.3.8 The principal use of water in the steam electric generation plants is for condenser cooling purposes. Steam, after its use in turbines, is passed through the condenser where it is cooled and condensed and the condensate is pumped back into boilers in close-circuit system. The only consumptive use in the boiler circuit is the feed water make up required to replace losses which are small. But a large separate flow through the condensers (cooling water) is required to carry away the waste heat of condensation (the temperature rise is generally 10°F under Indian conditions). There is very little consumptive use in the condenser flows. The condenser water requirement assumed in the projections (Table IX) is 225 litres/kWh up to the period 1980-81, 200 litres/kWh in 1990-91 and 180 litres/kWh in 2000-01. The decreasing requirements reflect the likely improvements in efficiencies of the plants operating in the future. Compared to the condenser water requirement the actual water intake could be less depending on the recycling methods adopted. Assuming a recycling factor of 1.00 up to 1973-74, 1.10 in 1978-79 and 1980-81, 1.35 in 1990-91 and 1.60 in 2000-01, the water intake for fossil and nuclear power generation has been computed. No assumption has been made regarding the possibility of using saline water for cooling purposes which could also be considered in the coastal areas.

3.4 Total Water Utilisation

3.4.1 The likely water utilisation for irrigation, domestic and livestock use, industries, and fossil and nuclear power are given in Table X.

*For 1973-74, the estimates as revised in July 1971 have been adopted.

TABLE IX

Fossil and Nuclear Power—Water Requirements.

	Unit	1968-69	1973-74	1978-79	1980-81	1990-91	2000-01
Total Power Generation	MkWh	51,700	83,200	144,360	172,210	446,570	1,158,200
Hydro-Power Generation	MkWh	20,745	31,800	46,830	51,000	110,000	210,000
Fossil and Nuclear Power Generation	MkWh	30,955	51,400	97,530	121,210	336,570	948,200
Fossil and Nuclear Power							
(a) Condenser Water Requirement	Thousand hectare metres	695	1,160	2,180	2,730	6,730	17,070
(b) Water Intake		695	1,160	2,000	2,480	5,000	10,670

TABLE X
Total Water Utilisation.

(Thousand Hectare Metres)

	Irrigation	Domestic and Live-stock	Industries	Fossil & Nuclear Power	Total	%age Utilisation*
1	2	3	4	5	6	7
1968-69	30,900	1,200	270	695	33,065	40.3
1973-74	38,600	1,360	450	1,160	41,570	50.7
1978-79	47,900	1,620	690	2,000	52,210	63.7
1990-91	58,000	2,380	2,090	5,000	67,470	82.2
2000-01	59,300	3,200	5,520	10,670	78,690	96.0

*Reckoned on estimated usable quantum of 82 million hectare metres.

3.4.2 In the case of irrigation though the surface and ground water resources have been identified separately, in the actual process of utilisation the two have to be integrated as they form the components of the same hydrological cycle. Also, by the year 2000-01, though the utilisation for all the purposes is around 96 percent of the estimated usable quantum, the estimates will be upset, if water management for agriculture is not practised and efficiency not achieved to the extent assumed, and if the assumed improvements in efficiency and the use of recycling process in the case of fossil and nuclear power plants do not materialise (in such an eventuality, i.e., at the present level of water management and efficiency, the utilisation would be 108.9 million ha m or 133 percent of the estimated usable water). Further, though all-India-wise the utilisation may be 96 percent, yet region-wise utilisation may be more even earlier

leading to conditions of water shortage. In such regions, water transfer from outside the region, ground water recharging, utilisation of saline water for cooling purposes, desalination of sea water (in coastal areas) may be necessary depending on engineering and economic feasibility. Region-wise rate of development of ground water, the technology and economics of shallow tube-wells and deep tube-wells, the stabilisation of water-table and the avoidance of over-capitalisation in the case of shallow tube-wells which are privately owned, would require studies for framing policies. Hence, region-wise comprehensive studies of the total water resources and the utilisable part thereof (depending on the level of operation envisaged) would be necessary to identify regions in which special efforts will be needed to avoid water shortage and the resultant lag in economic growth.

3.5 Non-Consumptive Uses

3.5.1 Non-consumptive uses normally do not require any reservation of water. With proper coordination, water reserved for other purposes can meet the needs of the non-consumptive uses. But under certain circumstances reservation of water for the non-consumptive use also becomes necessary particularly when the facilities to be created under the non-consumptive categories are located downstream of the location of the facilities created for consumptive use. Also, the water released for hydro-power or navigation may not totally coincide with the requirements of say irrigation, and a certain amount is thus not available for total utilisation at the required time.

3.5.2 The water requirements for pollution control have not been felt so far as our utilisation has been of the order of 40 percent only (Table X). With the estimated utilisation of 96 percent of all the estimated usable water by the year 2000-01 the natural untapped flow in the streams to maintain sanitation will be very much less and with the adoption of better manage-

ment techniques particularly in the case of irrigation, it is likely that regeneration of flow will also be reduced. By the year 2001, with about three times increase in domestic and livestock use and twenty times increase in industrial use, as compared to 1968-69, if the river is still made the outlet of the untreated wastes and if natural purification has to take place, the water that would be required to maintain stream sanitation would be enormous but would not be available. For example, the domestic wastes may contain organic impurities with 300 to 600 PPM (parts per million) of BOD (Biological Oxygen Demand) and if stream which has initially a BOD of 2 PPM is to be maintained at a BOD of 4 PPM (allowing slight deterioration in water quality), the natural water required for dilution would be 150 to 300 times the waste water. In the case of industries, the consumptive use is very little and most of the water is returned to the river as waste. Many of the industries in India treat the waste to some degree or the other before discharging into the stream. But, at the same time, the cities like Kanpur, Allahabad, Agra and Delhi already suffer from water pollution problem during the dry season. Certain steps in the form of legislation have already been initiated to prevent pollution (Maharashtra has one such legislation). *Considering the likelihood of nearly 20 times increase in the intake of water for industries by the year 2000-01 as compared to 1968-69, the situation requires sufficient pre-thinking to avoid the problem of increased pollution.* Reuse of the water once taken in by the industries would reduce the pollution hazards as well as their own intake requirements and the natural flow that needs to be maintained in the rivers to effect natural purification. The location of industries as well as the point of discharge of the wastes in the case of domestic uses and the treatment standards for the wastes before discharging them into the rivers have to be determined after studying the availability of flow in the rivers, particularly in the low water seasons, to maintain stream sanitation. Particular caution needs to be exercised at the tail-end of the rivers where the quality of the river would have deteriorated and the normal flow would have already been tapped for the various uses. In the absence of quantitative data, no projections have been attempted with regard to the requirement for the non-consumptive uses. However, it is likely to be quite substantial compared to the water availability during the dry season.

3.6 Recreation and Ecology

3.6.1 In any development planned by man for his welfare, the equilibrium of the natural system is disturbed. Whereas this cannot be eliminated, this can be minimised provided the disturbances are identified in advance and suitable remedial measures are incorporated in the development plan. In the field of water resources development, the natural problems such as sedimentation, and the man-made problems such as water-logging, salinity, chemical, biological, thermal and nuclear pollution, need to be identified and combated. In India, where the current water utilisation is about 40 percent only, the

problems have not yet been felt much. *Water resources development in the next 30 years is bound to disturb the ecological equilibrium also, unless good care is taken to minimise the disturbance.*

3.6.2 In the upper reaches of the river, simultaneously with the construction of dams, soil conservation and other watershed management practices need to be taken up. The upper reaches of rivers in India offer enough scope for the creation of recreation facilities. These also require to be incorporated along with schemes for preserving wild life, fish, etc. In the middle reaches, where the scope for utilisation of water is the maximum, the quality of water needs to be preserved at sufficient level, not only for human use but also for the natural aquatic life. With many of the Indian festivals involving mass bathing in the rivers, provisions need to be made to maintain the requisite quality and quantity of water in the rivers for this recreation. In the tail reaches where due to diminishing natural flow and increased pollution, the natural requirements such as the draft at the harbours and the water requirements for prevention of sea-intrusion in the deltaic area and siltation of harbours, the preservation of fish and other aquatic life, need to be provided for. Special care needs to be exercised in the disposal of industrial and domestic wastes.

3.7 Control of Water to Minimise Damages

3.7.1 It is assumed that while implementing the schemes for irrigation, power, water supply and industrial uses, suitable measures would also be taken for controlling the floods, removing drainage congestion, and water-logging, etc. Identification of flood prone areas and preparation of schemes for the economic development of such areas, keeping the limitations in mind, need to be done well in advance. The flood detention basins in the alluvial regions would help in increasing the recharge to the ground water and the ground water recharged could make more water available and, at the same time, keep a control over the land becoming water-logged. With provision of proper drainage both in rural and urban areas, more water could also be available for reuse subject to its quality. In certain regions where salinity is a problem, and where either natural drainage or pumping is resorted to for removing the saline water, it is necessary that this water is collected and let out separately to a proper place of disposal which may either be the sea or a desiccation pool so as to ensure that it does not disturb the quality of the natural water-courses. *A control would also have to be kept in the coastal areas on the use of ground water so as to prevent inland intrusion of sea water.*

4. Need for a Separate Organisation

4.1 So far about 40 percent of the utilisable water resources have been developed over a long period and as such, the need was not felt with regard to the overall comprehensive planning of water resources. Individual projects were planned in the various

sectors for the various immediate needs. *Now that the rate of development is accelerating, another 56 percent of the water resources are likely to be utilised in the next thirty years, leaving a balance of only 4 percent and this too only if great efforts are put into use the water with increased efficiency in each sector of development of the economy.* Thus, with water being the limiting factor, there would be competing demands needing an overall comprehensive consideration for judicious development of water resources in the most efficient manner. This calls for setting up of an organisation to look into this new and vital task on which action has to be initiated right now.

4.2 The existing organisations in various fields have been developed for specific purposes of investigating, formulating, constructing, operating and maintaining the various water resource projects in the States. At the Centre, the organisations have developed to look into the aspect of designing, research and individual project planning. *Over the years these organisations have developed a certain character or culture of their own like the specialisation of an individual. The tasks on which they are at present engaged, still require great attention and there is scope for further continued improvement.* It would, thus, amount to doing injustice in diverting their attention from the existing tasks by entrusting this work to any single existing organisation. Since each organisation is connected with a specific field of water use, like agriculture, drinking water supply, etc., or the source from which it is developed, that is, surface water or ground water, they have over the years developed a certain bias towards these aspects which is only natural and may be difficult to shed at this stage. In the field of planning for economic development, the Planning Commission was set up some twenty years back in similar circumstances and now the need is felt for setting up Planning Boards, in each State to achieve the integrated approach to planning.

4.3 *It is, thus, felt that a separate organisation which does not, in any way, duplicate the work of the existing organisation and would be free to develop its own character and unbiased opinions on the demands for the various uses and assessment of water resource, needs to be set up to initiate and coordinate, with the help of the existing organisations in the States and Centre, the studies on the various aspects of assessment, utilisation, conservation and management and to formulate short and long-term national and regional water policies.* For such an organisation to be effective, an Independent Central Water Authority with statutory powers constituted by an Act of Parliament is necessary. This would also be empowered to set up units, State-wise and basin-wise. The Parliament could pass the Act invoking the provisions under Seventh Schedule, Article 246-List I-Union List-items 56 of the Indian Constitution. The United Nations at the International Conference on Water Use for Peace (1967)⁽²¹⁾ have also stressed the need for such an organisation. In the U.S.A., U.K., Australia, Israel and Ceylon, such organisations are already functioning, and India has no time to lose.

5. Conclusions

5.1 It is seen from the rough projection done, that water, and not land, would be a limiting factor in the future economic growth of the country. Having developed about 40 percent of the utilisable resource over so many years up-to-date, another 56 percent of water is likely to be utilised in the next thirty years.

5.2 As the existing assessment of water resources is approximate, an assessment based on sound basic data is the first step for water resources development. For the basic data to be sound and reliable, the network and techniques for observation, require to be standardised and improved and implicitly implemented. Particular attention requires to be paid in the case of ground water in the hard rock areas. *The data collected requires to be processed, compiled and published in time and made available readily at one single place.* The data on current utilisation of water and land also needs to be improved. *In short, water balance studies, basin-wise need to be carried out.* Such studies would help to indentify the water short, and surplus areas and the preparation of master plans for development, which may include schemes for water transfer from outside the basin and schemes for recharging ground water, etc.

5.3 Since agriculture is the maximum user of water in India, the greatest economy is possible in this field. *Greater attention needs to be paid for improved water management in this field which would include providing adequate water at proper frequencies and reduction of water losses in the distribution system and in the field.* It may also require introduction of changed cropping pattern for optimum production. For example, the area under sugarcane in the northern region, may be changed over to sugar beet. The policy of multiple cropping, specially of having more than two crops, would need to be looked into. The multiple cropping of more than two crops is technically feasible and may be economical, but it may lead to concentration of water use and thus wealth, which needs to be avoided.

5.4 *Water management in the field of industries and power generation, comprising technological improvements to reduce the quantity of water required per unit of product, recycling and reuse of water, and proper treatment of waste before discharging it into the natural watercourse for minimising pollution, needs to be given greater attention.*

5.5 With growing demand and increased utilization, the development in the various sectors would be highly competitive, requiring sound economic evaluation of the investments and benefits as well as the social considerations. The methodology for economic evaluation of water use for the various utilities needs to be developed and standardised.

5.6 To initiate and coordinate the studies on the various aspects such as assessment, utilisation, conservation and management mentioned above, and to formulate short and long-term national and regional

water policies, *an independent Central Water Authority with statutory powers, set up by an Act of Parliament, would be necessary.*

5.7 Last but not the least, it is essential to enlist the cooperation, by educating the consumer of water and the persons connected with the development and operations of water, in all its aspects, with regard to the proper management and efficient use of water, and in preventing the pollution of water in various ways by different users, to ensure the implementation of the national Water Policy.

6. Bibliography

- (1) Khosla, A.N. : "Appraisal of Water Resources—Analysis and Utilisation of Data". Proceedings of the U.N. Scientific Conference on the Preservation and Utilisation of Resources.
- (2) First Five-Year Plan, Planning Commission, Government of India.
- (3) Raghava Rao, K.V. et al : "An Estimate of the Ground Water Potential of India—First Approximation". Invited Speech during Soil and Water Management Symposium, Hissar, March 1969.
- (4) Pitambar Pant : "Population Economic Development and Food". Southern Regional Conference on Population Policy and Programmes, Madras, April 1970.
- (5) Indian Agriculture Situation, April 1970, Directorate of Economics and Statistics, Ministry of Agriculture, Government of India.
- (6) "Consolidated Estimates of Crop Estimation Survey on Principal Crops, 1967-68". Directorate of National Sample Survey, Agriculture Statistics Division, Central Statistical Organisation.
- (7) "Some Results of the Land Utilisation Survey and Crop Cutting Experiments, 22nd Round, July 1968-June 1969". Department of Statistics, Central Statistical Organisation, Government of India.
- (8) "Fourth Five-Year Plan 1969-74". Planning Commission, Government of India.
- (9) "Report of the Working Group for Formulation of the Fourth Five-Year Plan on Minor Irrigation and Rural Electrification". Ministry of F.A.C.D. & C, Deptt. of Agriculture, Government of India.
- (10) Seventh NESA Irrigation Practices Seminar, Lahore, 1968, pp.144 to 147 and pp. 216 to 237.
- (11) "Planning Strategies in Agriculture". Economic Bulletin for Asia and the Far East, Vol. XX, No. 2, September 1969, p. 22.
- (12) Dastane, et al : "Review of Work done on Water Requirements of Crops in India". Navabharat Prakashan, Poona, India, 1970.
- (13) Framji, K.K. and Mahajan, I.K. : "Irrigation and Drainage in the World". Vol. I (Second Edition 1968), International Commission on Irrigation and Drainage.
- (14) "Basic Statistics relating to Indian Economy". Statistics and Survey Division, Planning Commission, Government of India, December 1969.
- (15) "Report of the Population Projections worked out under the guidance of the Expert Committee set up by the Planning Commission under the Chairmanship of the Registrar General, India". Office of the Registrar General, Ministry of Home Affairs, Government of India.
- (16) Note on "Annual Electric Power Surveys". Power Division, Planning Commission, Government of India, 1971, (unpublished).
- (17) Srinivasan, K.N. : "A Note on the Use of water for Industrial Purposes" (unpublished). Submitted to the Technical Committee on Water, Planning Commission, Government of India, 1968.
- (18) "Water for Industrial Use". U.N. Department of Economic and Social Affairs, New York, 1958.
- (19) Annual Survey of Industries (1964, 1965), Central Statistical Organisation (Industrial Wing), Department of Statistics, Cabinet Secretariat, Government of India.
- (20) Rao, K. L. : "Planning and Development of Water Resources in India". Ministry of Irrigation and Power, Government of India, 1967.
- (21) Deputy Director, Resources and Transport Division, Department of Economic and Social Affairs, U.N. : "Water Policy from the United Nations Point of View". Paper No. 711, International Conference on Water for Peace, Washington, May 1967.

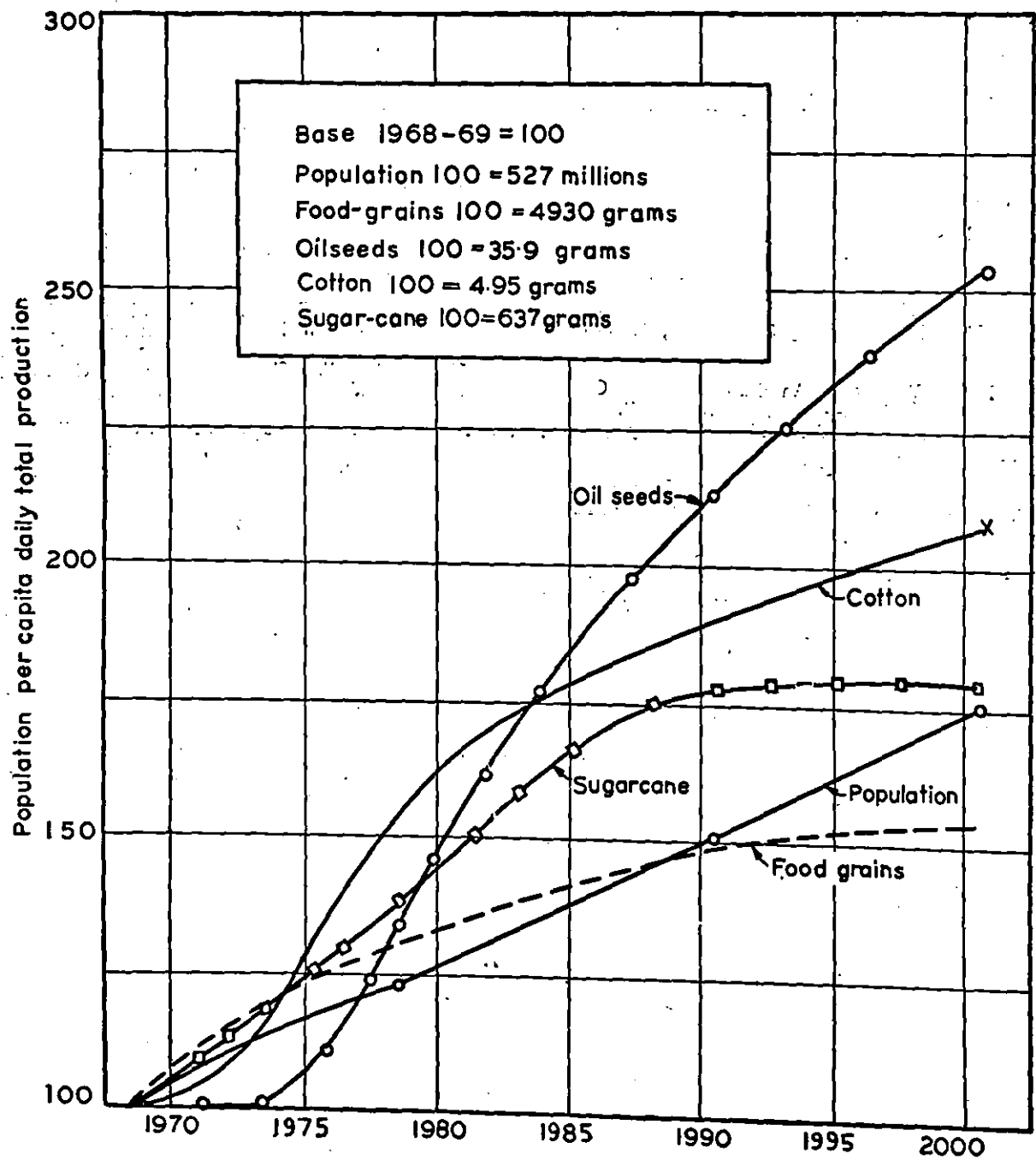

FIGURE 1: Population and per capita daily agriculture production.

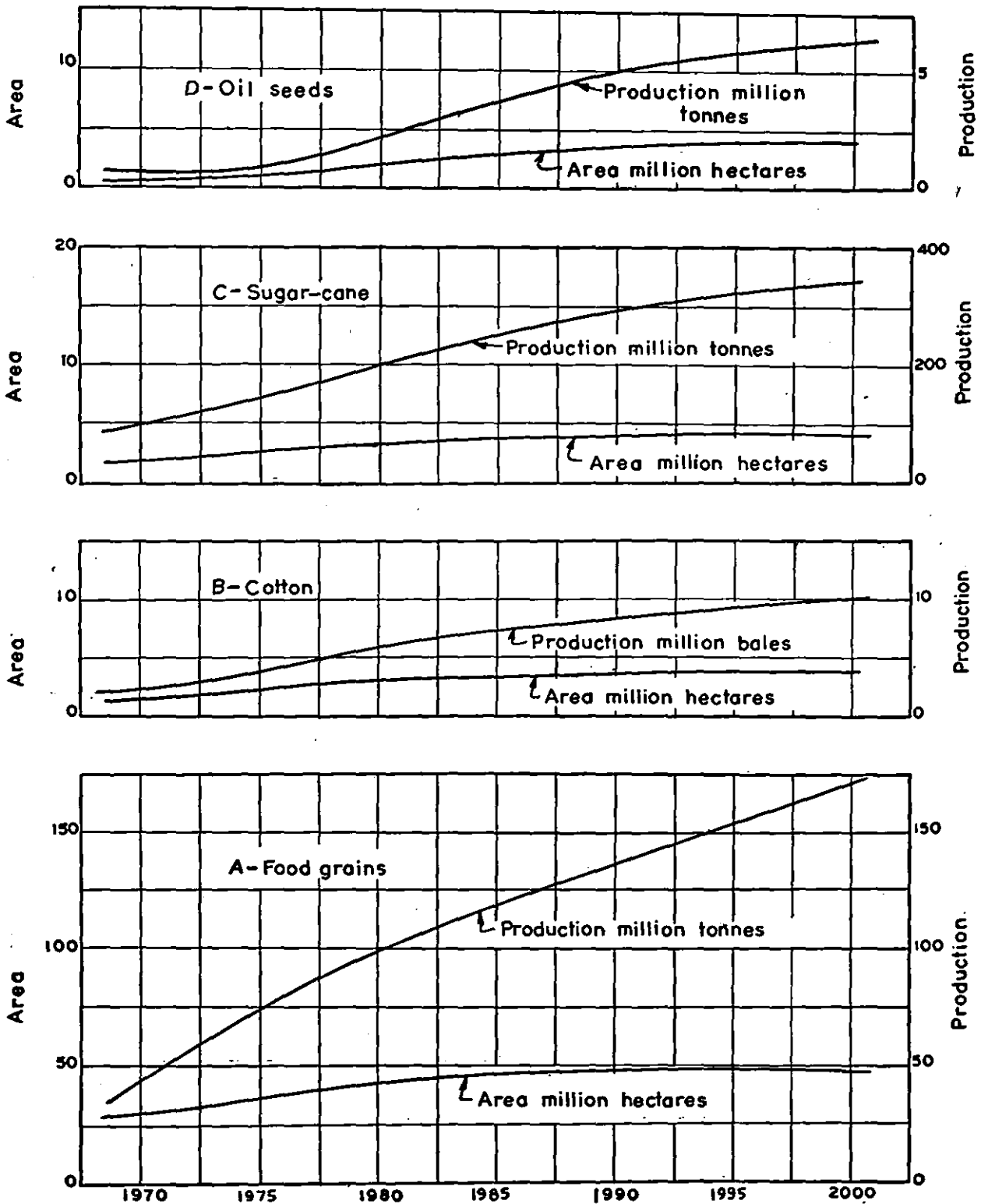

FIGURE 2 : Irrigated area and production.

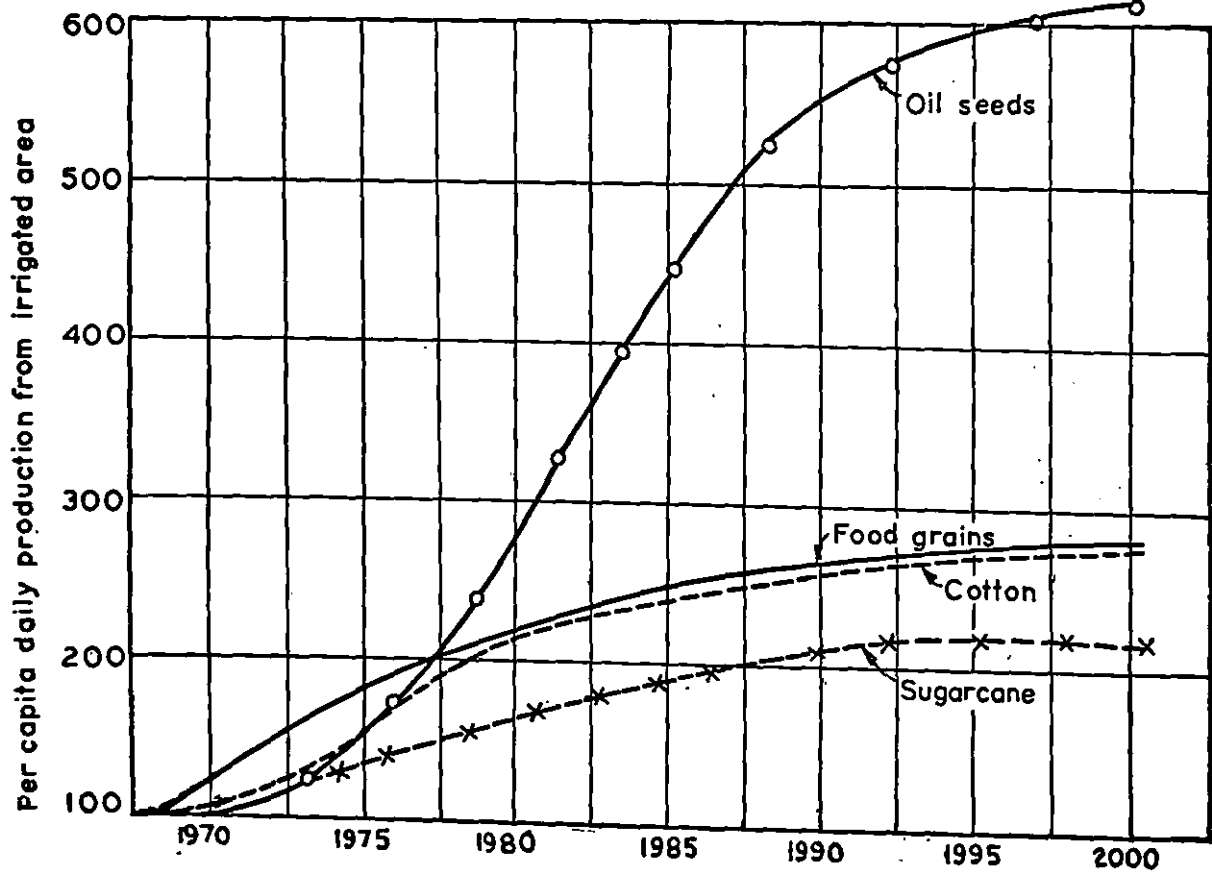
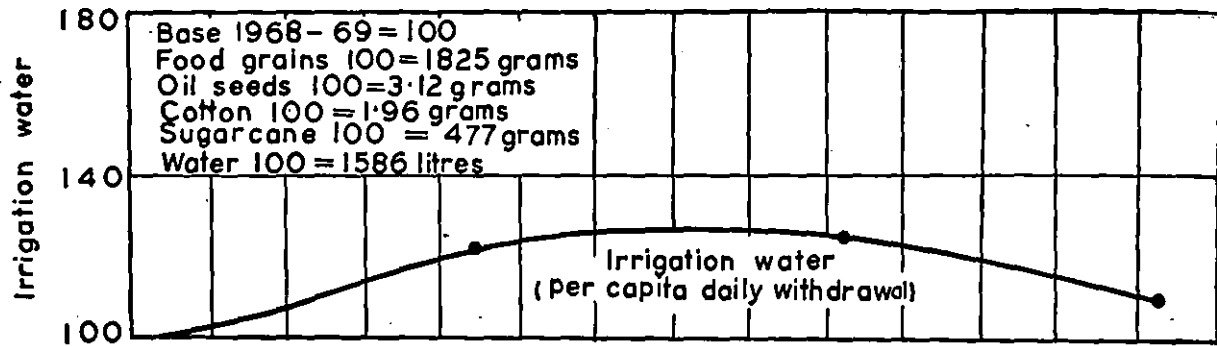

FIGURE 3 : Irrigation water and production from irrigated area.

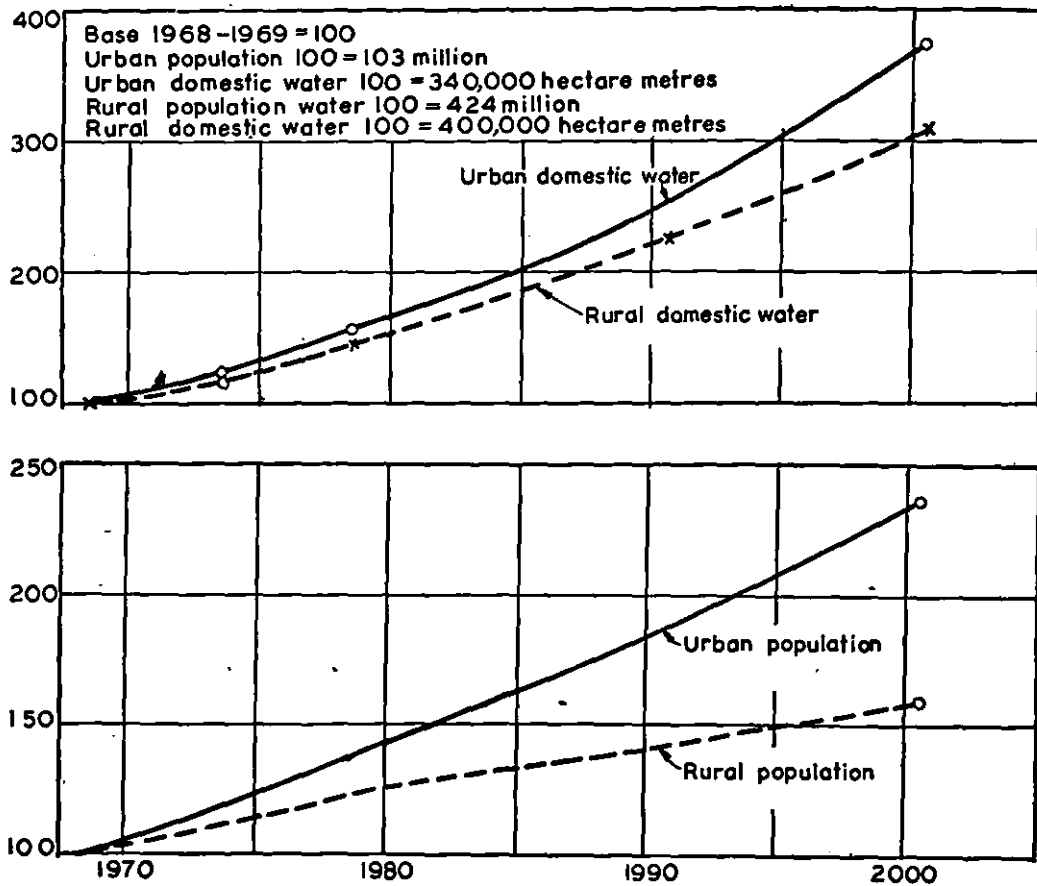

FIGURE 4 : Population and domestic water use.

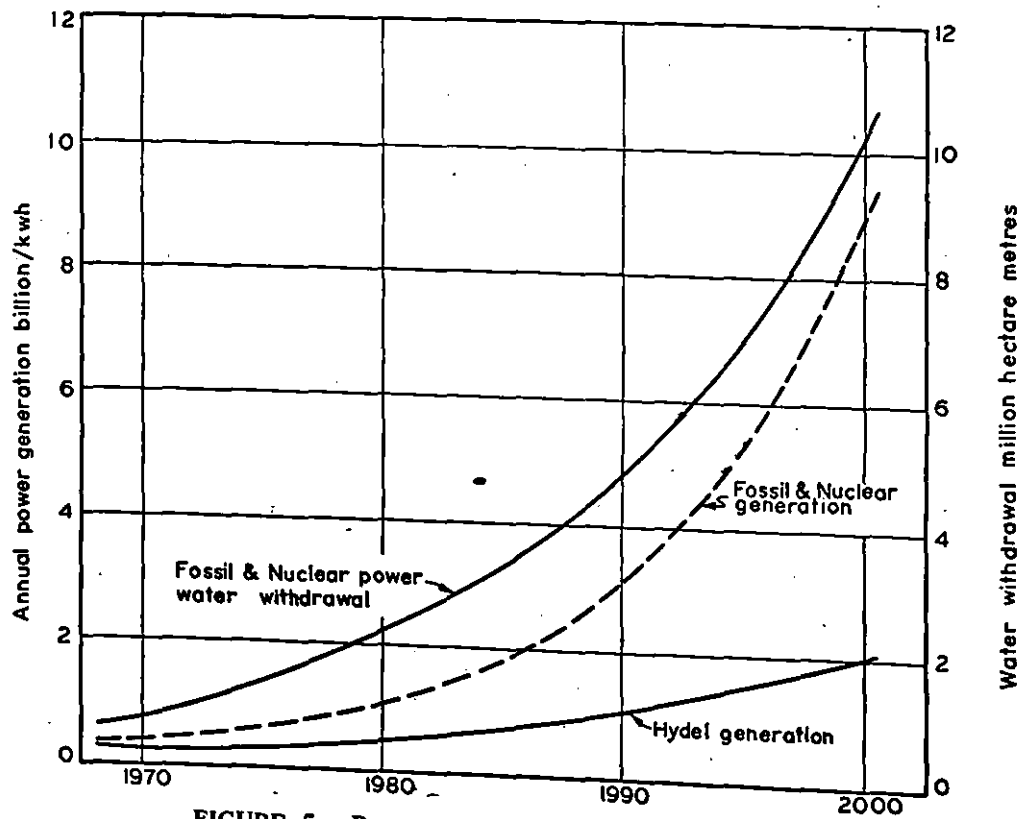
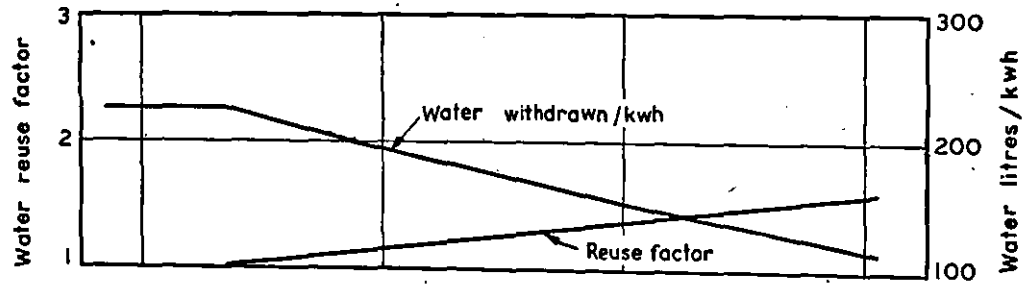

FIGURE 5 : Power generation and water withdrawal.

Use of Statistical Techniques in Planned Development of Sub-Surface Water Resources

A. P. BHATTACHARYA

Research Officer

Irrigation Research Institute, Roorkee

SYNOPSIS

The paper discusses how statistical techniques may be of use in the planned development of sub-surface water resources of any basin. Two topics have been taken into consideration. One relates to an examination of the ground water situation in such regions in which the development of sub-surface water resources is in actual progress. In any basin, there is always a regime or dynamic equilibrium under natural causes. By the introduction of tube-well pumping, it becomes of interest to know whether the recharge due to rainfall is adequate enough to cope with the draft due to pumping which is an extraneous cause. It is possible to seek an answer to this question without any detailed ground water inventorying.

By the application of t-test, it is first found out whether the decline of the surface water-table, if any, is permanent. By considering the first differences of the yearly ground water-table fluctuations, it may also be known if the drop is progressive also with the aid of t-test.

The effects of fluctuations of water-table which are taken to be a dependent variable may be partitioned into those due to rainfall and pumpage which are the two dominant and measurable causes and are taken to be independent variables. This is done by the technique of analysis of variance. The significance of the individual effects of the governing parameters may be known thereby. This determines the ground water situation, indicating whether pumping is being done within safe limits or not. If the rate of pumping is unsafe, it is possible to know which of the causative factors are yielding a significant effect. In the event of unsafe pumping, remedial measures may be called forth.

The next topic is that of the determination of safe yield or safe extraction potential which is of relevance when the development of sub-surface water resources is only partial and it is pertinent to find out what will be the limit up to which sub-surface water resources may be exploited. This has been possible with the aid of an estimating equation, deduced statistically, which gives the limits of extraction for normal rainfall, and assuming either no depletion or a slight depletion of the sub-surface water-table.

1. Introduction

1.1 The search for sources of water for being harnessed for agricultural, industrial and domestic uses is ever on the increase in India due to an accelerated tempo of requirements for development in agricultural and industrial spheres as also rising urbanization.

The position of supplies of water is becoming more and more acute on account of a fast growth rate of population which continues to be 2.5 percent. The total potential of surface water resources in India, i.e., the mean of annual flows or runoff in rivers is 1675×10^9 cu m. But the utilisation till the end of the Third Five-

Year Plan was only 36 percent of the utilisable resources which are 555×10^9 cu m⁽¹⁾.

1.2 The possibilities of diverting the normal flow of rivers into irrigation canals have practically been exhausted. The utilisation of surface water resources is possible at this stage only by impounding the surplus monsoon flows by dams for use in the dry weather. Where flow irrigation is not feasible practically or economically, resort is taken to lift irrigation which may involve the construction of minor irrigation works, such as tanks and wells as also the installation of water lifting devices. The exploitation of surface water resources by major or medium irrigation projects, including dams, is quite expensive and requires considerable foreign exchange. Development of irrigation in this direction, therefore, offers limited possibilities in the present financial state of the country.

1.3 In view of the above, it is manifest that alternative modes of tapping water resources have to be thought of. Among these, sub-surface water offers a rich field for being harnessed for planned development. The object of this paper is to discuss how statistical techniques can be of use in the planned development of sub-surface water resources. The topics which have been considered include a study of the regime or dynamic equilibrium under the influence of tube-well pumping where the latter has been developed to some extent⁽²⁾. Where the stage of development is only partial, it is pertinent to know what will be the safe extraction potential so that decisions may be taken as to how and where the development should proceed.

1.4 Ground water is considered to be in regime or dynamic equilibrium when there are no appreciable downward or upward movements of the ground water-table during the course of a year and the latter is more or less steady at the same level during a particular month of the year. This can happen only when the forces causing its movement are balanced or they are in equilibrium. The forces or factors are generally rainfall, seepage from adjoining water-causes, return flow from irrigation which tend to raise the ground-water-table and drainage or flow towards adjoining water surfaces which tends to lower the water-table. Usually with the onset of monsoons, the water-table starts rising due to the effect of rainfall reaching a peak in October. Thereafter, the water-table starts falling during the dry season and is usually at the lowest level in May before the monsoon season.

1.5. If the water-table is in dynamic equilibrium, the variations of the same from May to following May will be insignificant if the rainfall is normal. If the rainfall is subnormal in a particular year, there may be a transitory decline in water-table which should, however, be resorted to the normal level as and when the rainfall is again normal. If there is abnormal rainfall, the excess accretion to the water-table will be drained away.

1.6 With the introduction of an extraneous cause such as tube-well pumping, a new dynamic equilibrium

may be set up. If the additional draft due to pumping is met within the recharge due to rainfall, the water-table may be unaffected by pumping. It is, however, possible that the regime may be disturbed for a few years with the introduction of pumping but later the recharge or draft may be so adjusted that a fresh regime is set up at a lower level of water-table. If, however, an overdraft is created due to pumping which is not met with by the recharge, the regime is disturbed and the water-table will keep on falling continuously which will create numerous problems in the form of non-availability of drinking water from open wells in the areas within the command of tube-well pumping.

1.7 The ground water regime consequent upon the initiation of pumping can be tested firstly by seeing whether there is any permanent and significant drop in the water-table by analysing its mean fluctuation from May to following May. Where detailed ground water inventorying is not possible due to considerations of cost and requirements of technical personnel, it is possible to study the ground water regime with the aid of statistical methods. Among the causes affecting water-table fluctuations whose records are maintained are pumpage from tube-wells and rainfall. It may be necessary to separate the effect of pumping from that of rainfall, which is done by the usual statistical techniques.

1.8 How statistical methods are employed for studying the ground water regime on the basis of above mentioned investigations has been explained with an example of Hindan-Krishni Doab lying west of the Ganga River in Western U. P.

2. Basic Data

2.1 Generally, the basic data involved in the study of the ground water situation consists of water-table readings and volume of water pumped from tube-wells. As ground water conditions are considered to be more or less similar only within a doab, the analytical investigations are carried out doab-wise. In the example considered herein, namely, Krishni-Hindan Doab, the period considered for the analysis was from 1936-37, the year in which pumping was initiated within the doab, to 1951-52.

2.2 While the data for fluctuations of water-table is maintained in spring level registers, that for volume of water is recorded in history charts of tube-wells. These registers are maintained in Tube-well Divisions of the Irrigation Department. The rainfall data was compiled from the India Meteorological Department.

2.3 In the analytical studies, the fluctuation of water-table from May to following May was indicated as δd , rainfall as R , volume of water pumped as V .

3. Statistical Methods

3.1 As indicated above, two main statistical techniques are utilised in the investigations, namely, t -test for studying the significance of the difference of the mean

fluctuation from zero and analysis of variance for studying the effects of pumpage and rainfall on fluctuation of water-table, particularly, to separate the effect of rainfall from that of pumpage.

3.2 The fluctuation of the water-table, δd , is considered to be the dependent variable, while rainfall, R , and pumpage, V , are taken to be independent variables, because δd , is dependent upon V and R . While R is an independent variable, V is strictly not independent because this depends upon other factors, e.g., demand for irrigation, pump efficiency, yield of wells, which, however, are not pertinent to the analysis.

3.3 The ratio of the mean of the differences to the standard error is usually designated by the small letter t , which is also known as Student's t -test, named after the originator of the test. Values of t are tested at usual levels of significance, viz., 5 percent and 1 percent.

3.4 If we have to test the significance of the difference of two samples whose mean, standard deviation and number of observations are $x_1, x_2; \sigma_1, \sigma_2$ and n_1, n_2 respectively; the value of t is given by :

$$t = \frac{\bar{x}_1 - \bar{x}_2}{\sigma} \sqrt{\frac{n_1 n_2}{n_1 + n_2}} \text{ where } t \text{ is to be}$$

read from tables with $n_1 + n_2 - 2$ degrees of freedom,

$$\text{and } \sigma = \sqrt{\frac{(n_1 - 1) \sigma_1^2 + (n_2 - 1) \sigma_2^2}{n_1 + n_2 - 2}}$$

If the significance of the difference of a mean \bar{x} is to be tested from zero, we have

$$\bar{x} = \frac{\sum (x)}{n},$$

$$\frac{\sigma^2}{n} = \frac{\sum (x - \bar{x})^2}{n(n-1)},$$

$$t = \frac{\bar{x}}{\sigma} \sqrt{\frac{\sigma^2}{n}} \text{ with } n-1$$

degrees of freedom, where σ and n are the standard deviation and number of observations of the sample.

3.5 Table I gives the data with respect to $\delta d, V, R$ for the Krishna-Hindan Doab for the years 1936-37 to 1950-51, which has been analysed statistically. During this period, there has been a drop of 1.58 m in the water-table so that that the mean yearly drop is 0.11 m for the period of investigation. Here, the value of t worked out to 0.8604. This is quite insignificant for 14 degrees of freedom, as the 5 percent level is found to be 2.14 from tables. It is thus clearly indicated that there has not been a permanent decline in water-table in Krishna-Hindan Doab.

3.6 If the difference was significant which would have been the case had the value of t exceeded 2.14 for 14 degrees of freedom, it could have been inferred that there was a permanent drop in the water-table. However, even if the drop is indicated to be permanent, the situation may not necessarily be alarming. It is possible that a new dynamic equilibrium may have been set up at a reduced ground water-level, in other words, the process of drop in the ground water is arrested. It has next to be explored if the drop is progressive, i.e., whether the drop in water-table is continuing. For this, the significance of the first differences of δd has to be tested. Thus, suppose the values of δd are $\delta d_1, \delta d_2, \dots, \delta d_n$; the first differences are $\Delta d_1 = \delta d_2 - \delta d_1, \Delta d_2 = \delta d_3 - \delta d_2, \dots, \Delta d_{n-1} = \delta d_n - \delta d_{n-1}$. The significance of the difference of the mean values Δd from zero is tested with the aid of t -test. If this is significant, the drop is progressive and the situation will then call forth remedial measures which may consist of either reduction in the rate of pumping or abandonment of a few tube-wells. As a last resort, recourse may have to be taken to means of artificial recharge, although the cost may be prohibitive on account of which such means have not been tried in India so far.

4. Analysis of Variance

4.1 This is the second and more refined technique for studying the effect of different factors, namely, R and V , affecting δd . Different sources of variation are thereby isolated, identified and measured. Thus, although it is indicated from the application of t -test that there has not been any significant drop of the water-table for the period under consideration, a more rigorous technique is to carry out an analysis of variance for testing the significance of the effect of pumping on water-table fluctuations after separating the effect of rainfall.

4.2 Table II gives the analysis of variance of Krishna-Hindan Doab in which x_1 is the dependent variable δd , x_2 and x_3 are the independent variables, viz., pumpage, V , and rainfall, R . Amount of variation for each of the causes as also the joint effect of the two besides the residual which is the unexplained part of the variations, is calculated by methods whose details are considered to be beyond the scope of this paper. Degrees of freedom for x_2 and x_3 are one each. As the number of years is 15, the number of degrees of freedom for the total variation is 14, i.e., one less than 15. The number of degrees of freedom for the residual is $14 - 2 = 12$. Variance for each cause is obtained by dividing the amount of variation by the degrees of freedom. Each of the effects is compared with the residual variance. The significance is tested by the residual variance. The significance is tested by the application of what is known as F -test, where F is the ratio of the variance of each cause to that due to the residual. Thus, for testing the significance of X_2 , the pumpage, we get $F = 2.8295/1.1374 = 2.4877$. The significance of this value of F is read from tables. In this case, the degrees of freedom for the larger variance, i.e., $X_2 = 1$, while

TABLE I

Rainfall, fluctuation of ground water-table and volume of water pumped for Krishna-Hindan Doab, west of the Ganga River.

Years	Krishni and Hindan Rivers		
	Average rainfall in mm	Average fluctuation of water-table during the year in cm	Water pumped during the year in million cu m
	<i>R</i>	δd	<i>V</i>
1936-37	10599	12.80	6.564
1937-38	7617	-1.52	27.673
1938-39	3772	-85.04	58.233
1939-40	3772	-85.04	63.787
1940-41	2769	-54.25	70.589
1941-42	3548	-43.28	70.548
1942-43	8705	101.80	53.357
1943-44	5634	7.62	60.437
1944-45	5126	-7.92	64.555
1945-46	5283	-4.57	58.045
1946-47	4343	-6.40	66.354
1947-48	5926	-0.91	70.150
1948-49	5926	40.54	60.759
1949-50	5088	-35.66	77.426
1950-51	8966	2.44	66.010

TABLE II

Analysis of variance for Hindan and Krishna River Doab.

Source of variation in X_1	Amount of Variation	Degree of freedom	Variance
Gross amount explained by X_2	2.8295	1	2.8295
Increment explained by addition of X_3	15.4630	1	15.4630*
Total explained by X_2 and X_3	18.2925	2	9.1425**
Residual unexplained by X_2 and X_3	13.6486	12	1.1374
Total	31.9411	14	2.2815

TABLE III

Rainfall, fluctuations of ground water-table and depth of sub-surface water-table corresponding to the volume of water pumped in Doab No. 1 east of the Ganga River in the Western Uttar Pradesh.

Year	<i>R</i> mm	δd mm	<i>D</i> mm
1938-39	90.8304	-37.1856	3.84
1939-40	84.4296	25.9080	1.98
1940-41	123.7488	0.0000	3.14
1941-42	84.7344	-50.2920	4.48
1942-43	104.2416	71.0184	3.60
1943-44	111.5568	4.2672	3.20
1944-45	75.2856	-23.7744	4.11
1945-46	157.8864	36.5760	4.69
1946-47	106.0704	-8.5344	3.99
1947-48	112.4712	-11.8872	5.49
1948-49	155.1432	-15.8496	4.72
1949-50	124.9680	-15.2400	6.07
1950-51	85.9536	-15.8496	6.07
1951-52	70.7136	-4.2672	5.61
1952-53	81.6864	-6.0960	7.59
1953-54	120.3960	-1.8288	6.31
1954-55	95.4024	2.1336	5.33
1955-56	116.4336	3.6576	5.79
1956-57	102.7176	19.2024	3.35
1957-58	77.4192	-14.9352	6.74
1958-59	105.7656	-11.2776	7.53
1959-60	97.5366	-3.9624	8.32
1960-61	197.5104	2.7433	6.22
1961-62	195.9864	2.7432	5.06
1962-63	113.0808	-2.7432	8.50
1963-64	81.9912	-1.2192	8.87
1964-65	105.1560	-3.9624	7.68
1965-66	51.5112	7.3152	10.58
1966-67	100.2792	-16.7640	11.25
1967-68	136.5504	-1.8288	6.52

those of the smaller variance, i.e., residual=12. So from the tables, we get the values of F as 4.75 and 9.33 for 5 percent and 1 percent levels of significance for $n_1=1$ and $n_2=12$, where n_1, n_2 are the degrees of freedom for the larger and smaller variances. In this way, we find that the effect of pumpage is insignificant, while that of rainfall is highly significant, i.e., at 1 percent level, the variance being marked with two asterisks. If it were significant at 5 percent level, it would have been marked with one asterisk. Again the joint effect of rainfall and pumpage is also highly significant. It is thus clearly indicated from the statistical analysis that the pumpage from the period 1936-37 to 1950-51 did not affect the water-table fluctuations significantly, the effect of rainfall alone being highly significant, which means that the pumping was being done within safe limits.

4.3 Analysis of variance may also be used for testing the uniformity of rainfall within a doab. In the same manner as discussed above, the effect of rainfall is separated between the variation of rainfall from year to year and that from station to station. Each of the variations is tested with the residual variation unexplained by the two effects. Uniformity of rainfall is established only if the variation of rainfall from year to year is found to be significantly higher than that from station to station. The importance of this arises because of the fact that this will decide the method of computation of mean rainfall required in the analysis, mentioned earlier. If the distribution of rainfall for different rainfall stations within a doab is found to be uniform, the mean rainfall may be found by the simple arithmetic mean, otherwise, weights have to be applied for deriving the mean either by the use of Thiessen polygons or by the isohyetal method. For the doab considered herein, uniformity of rainfall had been established earlier, so no weights were required for deriving the mean.

4.4 It will thus be seen that statistical techniques provide a valuable tool for studying the regime of the sub-surface reservoir in any doab. It is thereby possible to know whether there has been a drop or not in the sub-surface water-table due to pumping, and, if there has been a drop, whether it is permanent as well as progressive and whether the same may be attributable to pumping or not. This topic will be pertinent in areas where the development of tube-well irrigation has been significant. The object of this will be to decide whether the harnessing of ground water resources should continue at the existing rate without disturbing the regime. If the regime is disturbed, steps, indicated earlier, viz., reduction in the rate of pumping or abandonment of a few tube-wells or even artificial recharge, will have to be taken. If the regime is undisturbed, it may be pertinent to know if there is any additional scope for further development. These are important questions in the planning of the development of sub-surface water resources within the region.

4.5 But where the development of irrigation based on sub-surface water resources has not reached its limiting stage, the significant question is to know how and where the extraction of additional resources may be possible. This may be done by an estimation of the safe yield or the safe extraction potential of the ground water basin, which discussed below.

5. Safe Yield

5.1 The required data for the estimation of the safe yield will be the same as that for the analysis of variance, viz., fluctuations of ground water-table, rainfall, pumpage, which are easily measurable and whose records are maintained regularly in ground water basins wherein withdrawals are being effected by pumping. A dimensionally balanced equation has been brought out for this purpose as below⁽³⁾⁽⁴⁾ :

$$\delta d = a + bR + cD,$$

where D is the depth corresponding to the volume of water pumped from the doab, obtained by dividing the volume of water pumped by the area under pumping. Here, b and c are dimensionless parameters, while $\delta d, a, R$ and D are all in linear measures of length. The values of a, b and c are calculated by the method of least squares, utilising the data for $R, \delta d$ and D .

5.2 For the assessment of the safe yield or extraction potential from a ground water basin, the value of D has to be found under conditions of normal rainfall, i.e., the normal value of R . For δd , the ideal value should be zero, as this will give D under conditions of dynamic equilibrium for which the corresponding limit of pumpage, which will be the safe yield, may be worked out. There is, however, no harm if D is estimated for a small negative value of δd , such as -7.5 cm, as this may mean the stabilising of the ground water regime at a slightly reduced level, in which there is no danger of any further decline. At the same time, this gives considerable scope for additional pumpage.

5.3 The actual data used for this analysis was that with respect to $\delta d, R$ and V for seven doabs east and five doabs west of the Ganga River in Western Uttar Pradesh. Table III gives the pertinent data for only one doab, viz., Doab No. 1 east of the Ganga River. D was estimated from V by dividing by the area under pumping. Tables IV and V give an idea of the safe extraction potential or safe yield based on the estimating equation. In Table V, values of V , corresponding to estimated D , have been given for doabs west of the Ganga River with $\delta d = 0$ and $\delta d = -7.5$ cm

5.4 The scope for additional pumping for doabs east of the Ganga River has been given for every doab in Table IV, wherefrom it may be seen that such scope exists for additional pumpage in every doab, a finding which is in conformity with that obtained by the analysis of variance. The proportionate number of tube-wells for whose provision scope is indicated from

TABLE IV
Pumpage from Tube-wells in seven Doabs east of the Ganga River, its present status and extraction potential.

Doab No.	Ground water extraction potential in million cu m	Actual pumpage in million cu m	Scope for additional pumpage in million cu m	Additional number of tube-wells which may be provided on the basis of additional pumpage	Remarks
1	77.68	18.24	59.44	261	(1) From the estimating equation, ground water extraction, potential is estimated by taking mean value of rainfall and zero for δd .
2	63.89	13.93	49.96	197	
3	199.51	66.47	133.05	316	(2) Rainfall has been considered for Bareilly which is the only station of the India Meteorological Department in the vicinity of the doabs.
4	56.41	36.93	19.48	58	
5	211.49	98.04	113.45	434	
6	309.91	114.19	195.72	718	
7	141.91	39.87	102.04	417	

the estimating equation based on the estimated additional pumpage has also been given in Table IV. For doabs east of the Ganga, it is manifest that there is extensive scope for the development of additional pumpage even if the value of δd is taken to be zero in the estimating equations.

5.5 For doabs west of the Ganga River, whose findings regarding safe extraction potential are given in Table V, the existing rate of withdrawal by pumpage is indicated to be safe, both by the insignificance of the effect of V on δd in the analysis of variance and the fact that there is considerable margin between actual pumpage and estimated safe limit for pumping. This is so even when $\delta d = 0$, although the scope is considerably enhanced by taking δd to be -7.5 cm. The scope for the development of additional ground water resources is marked only in Doab Nos. 4 and 6, particularly in Doab No. 4.

5.6 It is felt that the approach, given above, for the estimation of safe yield or the safe limit of extraction potential in any ground water basin is quite rational, easy and less time-consuming. To be on surer grounds, a checkup with one of the standards, already in usage, such as the Hill method, will be advisable.

5.7 In the planning and development of ground water resources within any basin, the management should ensure that the safe limit is not touched or exceeded at any time in order to correctly maintain the ground water regime, otherwise, inherent dangers in an overdraft are likely to be brought out within the course of a few years. This, if unchecked, may even necessitate the adoption of the last step of abandonment of withdrawals by pumping which will involve serious economic losses.

5.8 It will thus be seen that statistical techniques provide useful and handy tools for studying both the

TABLE V

Safe limit of ground water extraction potential, as deduced from an estimating equation,
for five doabs west of the Ganga River.

Doab No.	Rainfall Station	Pumpage (V) in million cu m as calculated from the estimating equation		Observed average pumpage (V) in million cu m	Remarks
		$\delta d = a + bR + bV$	$\delta d = -7.5 \text{ cm}$		
1	Meerut (I.M.D. Station)	25.54	39.70	23.53	In the estimating equation, values of a , b , c , have been calculated for Doab Nos. 1, 2, 4, 5, 6.
2	Muzaffarnagar (Sugar Research Station)	78.84	96.54	75.84	
4	Meerut (I.M.D. Station)	101.24	170.63	48.17	V is estimated for two values of δd , viz., 0 and -7.5 cm .
5	Meerut (I.M.D. Station)	52.65	82.16	46.70	
6	Meerut (I.M.D. Station)	225.91	334.83	165.39	

sub-surface water situation, particularly as to how and whether the dynamic equilibrium is being affected by tube-well pumping, and also the safe yield or the safe extraction potential of sub-surface water resources.

6. Conclusions

6.1 Statistical techniques provide useful tools for studying the ground water situation in any ground water basin.

6.2 In such basins in which tapping of sub-surface water resources is being effected by pumping, it is firstly of interest to know whether the regime is being affected due to pumping. This may be done by applying t -test which indicates whether there has been a significant fall or not. It is possible to find out thereby if there has been a permanent and progressive decline of the sub-surface water-table. This has been explained for Krishni-Hindan Doab west of the Ganga River.

6.3 It may also be pertinent to know if there has been a tangible effect of pumping on fluctuations of water-table, which may be done by the technique of analysis of variance. It is thereby possible to partition the effects of the factors affecting ground water-table fluctuations, viz., rainfall and pumpage.

6.4 It is also possible to determine the safe yield or safe extraction potential of a sub-surface water basin with the aid of an estimating equation deduced by the help of statistical techniques. These have been applied in the case of seven doabs east of the Ganga River and five doabs west of the Ganga River in Western Uttar Pradesh.

7. Acknowledgments

The author wishes to express his gratitude to the Director, U.P. Irrigation Research Institute, Roorkee for the help and facilities extended for the preparation and also for the permission for the publication of the paper.

He is also thankful to Sarvashri S. R. Jindal, Statistical Officer and Ram Jeet, Supervisor for the help rendered in the collection of the relevant data and some computations thereof.

8. References

- (1) India, 1969, Publications Division, Ministry of Information and Broadcasting, Government of India, p. 275.
 - (2) Bhattacharya, A. P. : "Aid of Statistical Methods in Ground Water Regime Studies". Symposium on Ground Water Studies in Arid and Semi-arid Regions, University of Roorkee, Roorkee, 1966.
 - (3) Bhattacharya, A. P. : "Statistical Studies on the Ground Water Situation in Western Uttar Pradesh under the Influence of Tube-Well Pumping". 57th Indian Science Congress, Kharagpur, 1970.
 - (4) Bhattacharya, A. P. : "Estimation of Ground Water Extraction Potential." Journal of Mines, Metals and Fuels, December 1969.
-

Conjunctive Development of Surface and Ground Water Resources

M. C. CHATURVEDI

Senior Professor

Indian Institute of Technology, New Delhi

SYNOPSIS

It has increasingly been realised that the development of water resources should be done on a comprehensive basis taking the entire river basin—all the needs and all the available resources. In this context conjunctive use of surface and ground water resources becomes extremely important. Conjunctive use implies not merely development of water resources in addition to surface water resources or the possibility of ground water replenishment but the optimal development of the two considering the land and water the matrix of a dynamic ecological system, taking into account their specific temporal availability, and the variability of each. The variables and parameters are so many that in the past proper analysis was not possible and development had been practised based on judgement. However, now with the development of systems analysis methods and concepts and with the availability of high speed computers it is possible to make mathematical models and devise optimal conjunctive use of the two.

The paper presents a scheme of conjunctive surface and ground water development of a river basin. A three stage iterative development is proposed of which the first stage mathematical model is discussed in detail. The model serves to allocate the surface and ground water resources to the river basin for further development according to later more refined models. The model is discussed in the context of a real life problem.

1. Introduction

1.1 Necessity of comprehensive planning and development of water resources has increasingly been realized of late, even though, so far, it has not been generally carried out in actual practice. Besides jurisdictional and managerial constraints, a major problem has been the complexity and the difficulty of the task. There are too many competing alternatives, with numerous possible variations in capacity and operating policies, to meet the diverse and often competitive demands rendering comprehensive planning by conventional approaches almost impossible.

1.2 With the development of systems engineering concepts and analytical techniques, and availability of high speed digital computers, it is now possible to carry out comprehensive planning. Several areas, of

which water resources development is a prominent one, have received attention. Much effort is, however, yet required to develop these techniques for regular engineering planning. What is needed, is application of these principles and techniques for integrated planning of river valleys. With the exploding population and technological advances, making water more and more scarce and critical resource, this is now mandatory^{(1) (2)}.

1.3 Conjunctive development of surface and ground water resources is an important issue in this context. This specifies not merely development of ground water resources in addition to surface water sources, or the possibility of ground water replenishment, but the optimal development of the two considering the land and water the matrix of a dynamic ecological system, taking into account the specific spatial and temporal

availability and the variability of each, considering total river basins or even their interlinkages, the economics of development and transportation of the total water resources to satisfy the multifarious and often conflicting demands, with due consideration of socio-economic-technological considerations.

1.4 We shall not discuss the diverse questions relating to water resources systems planning and related problems of conjunctive development of surface and ground water resources^{(3) (4) (5)}. We shall restrict ourselves to the procedure of systems planning of large river basins in which both surface and water resources are important and the first stage models necessary for their development. The model shall be developed in terms of a specific river basin under study for the sake of realism and appreciation of related problems. It could be easily modified to any other condition.

2. The River Basin

2.1 The river basin, represents the part of the Indus basin in India. Our objective is to develop the water resources of the area for the needs of the State of Punjab, subject to the existing extra-territorial commitments and constraints. We realize the complexity of the institutional factors but neglect their consideration for the simple reason that the very purpose of the study is to make available to the decision makers a wide spectrum of options and their implications to enable them to make reasoned choices instead of the ad hoc intuitive judgements as at present⁽⁶⁾.

2.2 The area is served by three major rivers, Sutlej, Beas and Ravi, tributaries of River Indus, whose waters have been apportioned to India. Surface waters have been developed over the last century, by diversion works at the foothills as the rivers emerge from the Himalayas. Surface water storage has been recently provided on River Sutlej at Bhakra Dam [live storage capacity 7438 million cu m (6.03 million acre-ft)]. Waters of River Beas are tried to be impounded at Pong Dam [live storage 6907 million cu m (5.60 million acre-ft)] at present under construction. Further upstream on the same river, Pandoh Dam primarily provides for diversion of the waters to River Sutlej, upstream of Bhakra Reservoir, to avail of about 305 m (1,000 ft) differential head. Both these dams are due to be ready in a couple of years. Proposals for constructing a storage dam at River Ravi, at Thiem [live storage 2343.6 million cu m (1.90 million acre-ft)] are underway.

2.3 The waters of Ravi are utilised through Upper Bari Doab Canal, taking off from the Madhopur Headworks. It has at present a capacity of 198.24 cu m/sec (7,000 cusecs). Provision also exists for transferring waters to River Beas through a link canal.

2.4 The Beas waters alongwith residual Sutlej waters are utilised downstream of the confluence with River

Sutlej by diverting waters at Harike Headworks to Rajasthan Canal [523.85 cu m/sec (18,500 cusecs) capacity] and Sirhind Feeder Canal [133 cu m/sec (4,700 cusecs)] and at Ferozepore Headworks to Bikaner Canal [76.45 cu m/sec 2,700 cusecs] and Eastern Canal [76.45 cu m/sec (2,700 cusecs)]. Ferozepore Feeder connects the Harike and Ferozepore Headworks.

2.5 The Sutlej waters, augmented by Beas waters at Pandoh, through a 254.85 cu m/sec (9,000 cusecs) capacity tunnel, are utilised through Bhakra Canal 368 cu m/sec (13,000 cusecs), Sirhind Canal 356.8 cu m/sec (12,600 cusecs) and Bist Boab Canal 42.64 cu m/sec (1,500 cusecs), the former two like the canals taking off at Ferozepore and Harike Headworks supply waters to two adjoining States as well.

2.6 The surface waters have been almost fully utilized and for providing reliable and adequate amount of water ground waters have to be tapped. The average rainfall in the State is about 6.1 cm (24 in.), 80 percent of which takes place during monsoons. Except for the northern part, the area comprises rich alluvial land rich in ground water. It has been estimated that 11101.3 million cu m (9.0 million acre-ft) of ground water to the extent of annual recharge are available. There are saline water zones in several areas. The ground waters are increasingly being tapped by shallow private tube-wells and deep public tube-wells. The ground waters have been constantly rising over the last 100 years and from 30.5 m (100 ft) depth have risen to 1.5 m (5 ft) in several areas.

2.7 The gross area of the State is 5 million ha (12.4 million acres) of which 4.45 million ha (11.0 million acres) is cultivable. About 75 percent of the people derive their livelihood from agriculture which accounts for about 50 percent of the States G. N. P. The present irrigation acreage is about 2.23 million ha (5.5 million acres) representing an annual intensity of about 50 percent. Even after completion of dams at Ravi and Beas the irrigation intensity will be only 65 percent. Besides the requirements for agriculture, water releases have to be made for hydro-electric power and planning has to be done for drinking and industrial water supplies. Later shall be about one-twenty-fifth of the irrigation requirements. Hydel power is a substantial and important part of rapidly increasing power need.

3 The Problem and Systems Approach

3.1 Although the surface water resources are well developed, as usual in the past, developments have been carried out without comprehensive critical integrated planning making almost ad hoc engineering and economic assumptions. These have been discussed in detail in general, as well as for the analogous conditions of West Pakistan^{(6) (7)}. For instance, it has been usual to assume a specified discount rate, adopt irrigation rates fixed long time back and derive cost-benefit ratios without any concern for shadow prices, social discount rate or market imperfections, to name a few issues.

What should be the cropping pattern taking into account the economics of input and output costs and benefits with the land-climatological constraints? What should be optimum development for power and agriculture, what should be the rate of growth of the water derivative inputs to achieve alternative economic growth rates for alternative rates and paths of cropping patterns? Where to develop ground water and surface water to maintain the ground water balance with possible mining at suitable rates to achieve adequate rate of water resources development? These are some of the questions to be answered. Further, since the hydrological inputs are stochastic, the question of uncertainty and loss function cannot be neglected as at present. It is not possible to discuss all the factors necessitating systems approach except stating that a comprehensive project oriented sector planning approach has to be developed to determine the optimum development in the context of the resources endowments and implementation capabilities. To optimally decide these issues, systematic iterative approach as shown in Figure 1 has to be adopted⁽⁸⁾. The first models shall be broad brush models, trying to ascertain the distribution of the resources in various canal commands in terms of which further detailed development in sub-zones shall be planned, iterating further to stochastic and simulation models. The approach is discussed in greater detail elsewhere⁽³⁾⁽⁹⁾.

4. Conjunctive Surface and Ground Water Development Model

4.1 We present the first model to determine broadly, considering the basin as a whole, allocation of surface and water resources. A linear programming model with deterministic hydrological inputs is developed. The objective is to determine the irrigated area, cropping pattern and power development to maximize the annual aggregate benefits subject to constraints. An important one of these is maintenance of ground water balance by specifying the extent of mining, if at all. We could start with the safe-yield concept, with ground water specified at a suitable depth, and through parametric programming determine the depth at which water-table may be stabilised, by taking into account the investment timing of development of alternative sources of water. The ground water balance has to account for the recharge and withdrawals as shown in Figure 2. Surface drains have to be provided for drainage of surface waters as well as control of aquifer by pumping, if need be. These discharge in the river further down.

4.2 The essential features of the river basin are shown schematically in Figure 3. The area is divided into ten canal commands. In each canal command possibility of ground water development exists.

4.3 In each canal command, the surface source has a control point enabling storage (which may be zero), diversion for irrigation, power and interlinkage in general. Although interlinkage is only at

two places it is assumed possible at all points for framing a general model for convenience of computer use. It shall be set to zero if it does not exist and general review shows that it is not warranted. Same considerations apply to storage releases for power and irrigation facilities, and availability of water from surface drainage sources.

4.4 Only major surface water sources have been considered in the model. Possibility of storage at several streams exists and provision for their development shall be made by allocating portion of irrigated area to dependable water from them. Their development in detail shall be considered in later detailed models of each of the commands.

4.5 In the first instance ground water recharge by special measure has not been included. As engineering and economic feasibility studies are available, it could be included without distorting the basic formulation of the model.

4.6 Certain specific characteristics of the system indicate modelling criteria. Since Ravi waters do not have the power potential as at Beas through interlinkage with River Sutlej, these should be used as much for irrigation of upper regions as possible. The upper limit of transfer of Beas waters has also been fixed as of the storage at Pandoh⁽³⁾, Pong⁽⁴⁾, Bhakra⁽⁵⁾. Installed turbine capacities have also been fixed, but these may be increased without too much technical difficulty—same applies to interlinkage capacities. The capacity variables are taken as variables in the model but may be given a constant value as the situation demands.

4.7 For determining the crop water requirements, we start first with the assumption that optimal decision periodwise demand is determined on the basis of land as a constraint, rather than water as a limiting constraint. Latter limiting case shall be studied during canal command optimization.

5. Linear Programming Model

5.1 A linear programming model is used to screen the optimal set. The *capacity variables* to be determined are as follows :

- (i) L_i , the area to be irrigated (in acres), in each canal command i . The area has to be prepared for irrigation. $i=1, \dots, \dots, I$.
- (ii) V_i , the reservoir operative capacity (in 10^6 acre-ft). $i=1, \dots, \dots, I$.
- (iii) Y_i , the delivery capacity of the canal system from the rivers to canal irrigation command. $i=1, \dots, \dots, I$.
- (iv) W_i , is the capacity of interlinkage canal for transfer of water to areas in different States or adjoining rivers. $i=1, \dots, \dots, I$.
- (v) H_i , the capacity of the hydro-electric power houses expressed in terms of installed flow capacity of the turbines (in cusecs). $i=1, \dots, \dots, I$.

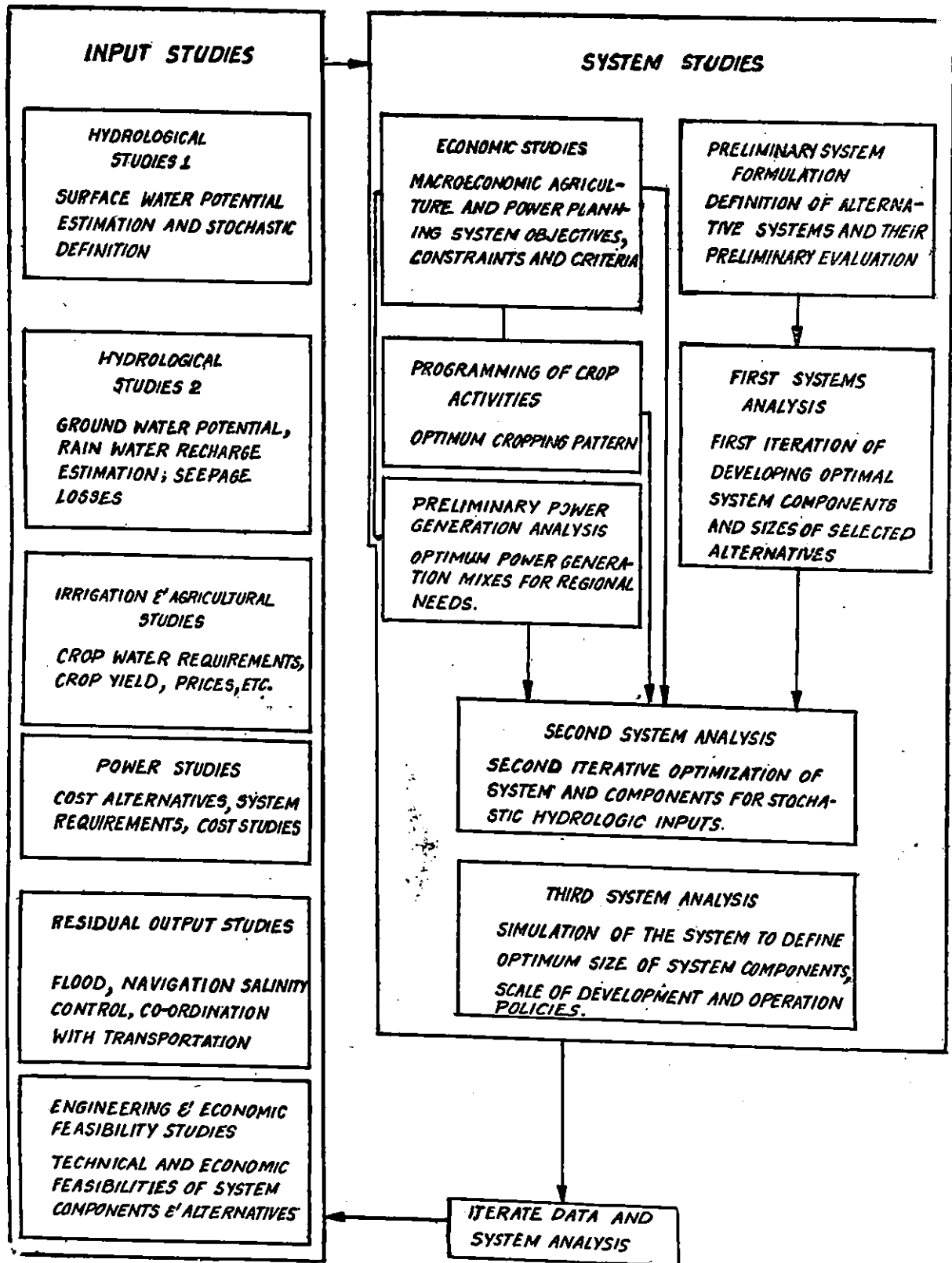

FIGURE 1 : Schematic water resources systems planning scheme.

- (vi) T_i , the total delivery capacity of the tube-wells installed for purposes of supplying irrigation water and controlling aquifer water (in cusecs). $i=1, \dots, I$.
- (vii) Z_i , is the total drainage capacity of the surface drainage works (in cusecs). $i=1, \dots, I$.
- (viii) $\rho_{\alpha ik}$ is the fraction of the irrigation water delivered to the α^{th} point in the system that becomes surface runoff.
- (ix) $\epsilon_{\alpha ik}$ is the fraction of the irrigation water that becomes non-beneficial evapotranspiration at the α^{th} point. A prime denotes the non-beneficial evapotranspiration fraction of precipitation.

5.2 The *operating variables* have to be determined for each decision period, k , which can be a month, fortnight or as specified, and have to be determined for each of the i canal commands under consideration. The cropping pattern may consist of j crops, and we will have to determine how much of area should be allocated to each variety in each command. Constraints may be placed from management considerations. The operating variables to be determined are as follows :

- (i) A_{ij} , the area sown to the j^{th} crop in acres in i^{th} command. $J=1, \dots, J$.
- (ii) $x_{i\kappa}$, the release from the reservoir (in cusecs) during the decision period k .
- (iii) y_{ik} , the flow diverted to canals for irrigation (in cusecs).
- (iv) w_{ik} , the flow diverted to interlinkage canals.
- (v) h_{ik} , the flow through turbines in (cusecs).
- (vi) t_{ik} , the amount of tube-well water pumped (in cusecs) and delivered to field channels.
- (vii) s_{ik} , the amount of tube-well water pumped and delivered to surface drains (in cusecs).
- (viii) z_{ik} , the flow from surface drains or pumps (in cusecs).

(x) $\theta_{\alpha ik}$ is the efficiency of the irrigation system at the α^{th} point. $\theta_{\alpha} = 1 - \rho_{\alpha} - Y_{\alpha} - \epsilon_{\alpha}$.

(xi) η is the annual evaporation.

(xii) ξ_{ik} is the net sub-surface return flow to the river during the k^{th} decision period, in acre-ft.

(xiii) Λ_i is the largest amount of land deemed suitable for irrigation.

(xiv) λ_{ijk} is the land use coefficient for the j^{th} crop during the k^{th} decision period in zone, i . If $\lambda_{ijk}=0$, no land is used by this crop during the k^{th} period ; if $\lambda_{ijk}=1$ the crop is growing during the entire period. Intermediate values signify that all or part of the crop is being planted or harvested during the decision period.

(xv) δ_{ijk} is the water requirement of the j^{th} crop in the k^{th} decision period, in feet, at the i^{th} canal zone. This may be obtained by the latest conventional methods or by the dynamic programming model.

(xvi) π^t is the peak demand factor for tube-wells, that is the ratio of the peak (for example, the ten-day) demand to the average demand over the decision period.

(xvii) π^v is the peak demand factor for canals.

(xviii) π^e is the peak demand factor for surface drainage facilities.

(xix) u is the individual well capacity in cusecs.

5.3 To define the system the following *exogenously given parameters* or variables are assumed to be known from the input studies as shown Figure 1 :

- (i) $r_{i\kappa}$ is the discharge in the rivers to reservoirs or up to diversion points (in cusecs).
- (ii) M_i is the average rate at which ground water may be mined in acre-ft per year. M_i will be an important parameter to be determined by sensitivity analysis.
- (iii) R_i is the net aquifer recharge from horizontal ground water flow in acre-ft per year.
- (iv) u^a is a utilisation factor for wells giving the average fraction of each day that the well is operated.
- (v) u^v is a utilisation factor for canals reflecting canal closure due to emergency repairs or other reason.
- (vi) $Y_{\alpha ik}$ is the fraction of the irrigation water that becomes recharge to aquifer at the α^{th} point. A prime denotes the recharge fraction of precipitation.

5.4 The following elements of prices and cost constitute the *economic parameters*. All capital costs are expressed in terms of an equivalent uniform annual cost.

(i) c_{ij} is the farm cost (exclusive of water) incurred in producing crop, in rupees per acre.

(ii) c_{oi} is the sum of the equivalent uniform annual cost and the annual maintenance expenses as follows : (a) c_{oi}^1 of land preparation in rupees

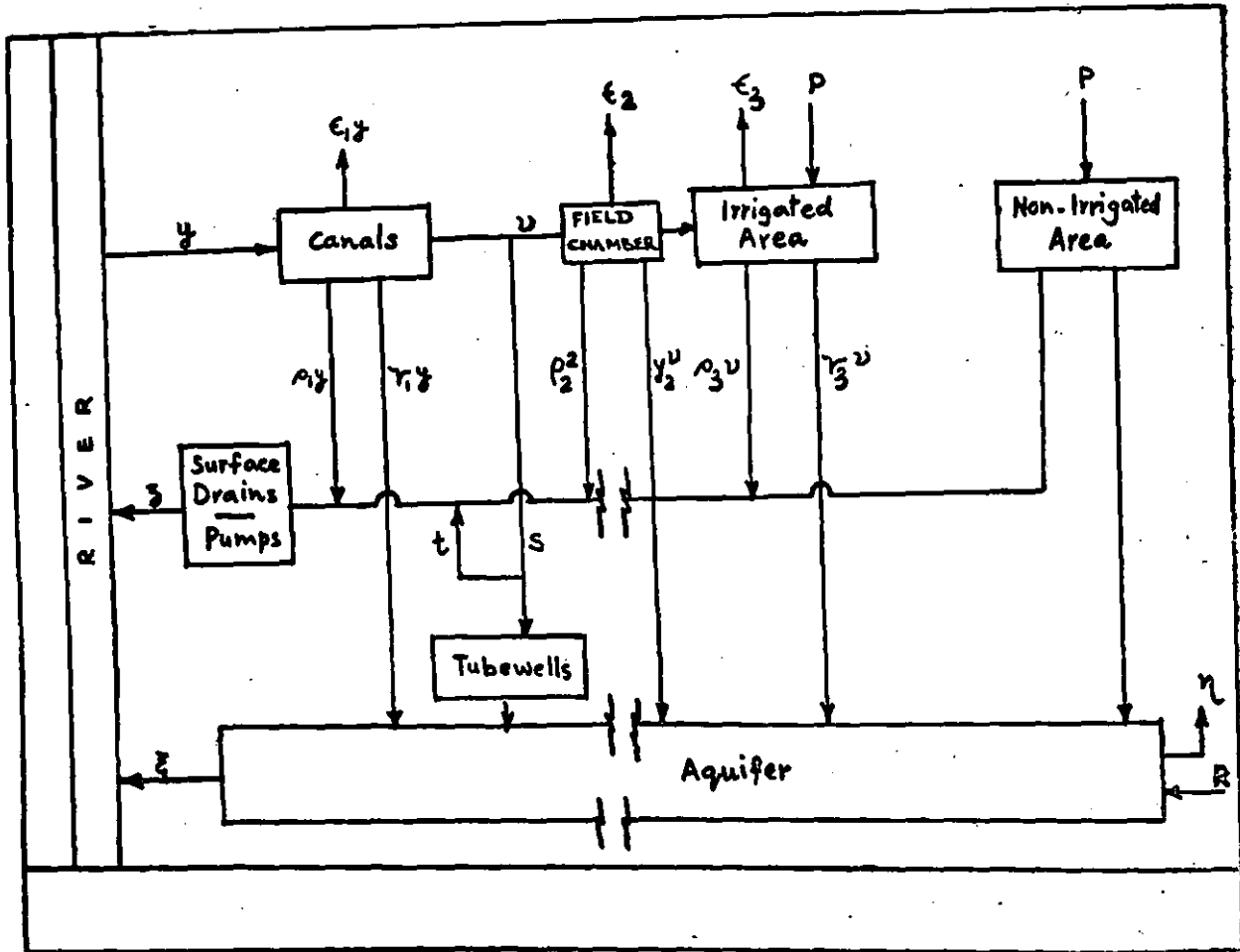

FIGURE 2 : Water resources balance.

- (iii) c_t is the unit power cost in rupees, per acre-ft as follows; (a) c_t^t for well operations, (b) c_t^s for pumping surface water supplies, (c) c_t^z of surface drainage pumping.
- (iv) p_j is the market price (adjusted for taxes and subsidies) of the j^{th} crop in rupees per pound.
- (v) p is the average economic value of production from an acre of unirrigated project lands, in rupees per acre.
- (vi) q_{jt} is the projected average yield, with water control of the j^{th} crop, in rupees per acre. This shall be a function of the water supplied each month, but is determined separately from conventional data or by dynamic programming.
- (vii) P_{it}^p is the market price of power produced in rupees per cusec of discharge. Since head will be different at different sites, a variable figure at different sites and different seasons is used. The value is determined as a constant in the likely range of head at any period, to be determined more correctly by parametric programming later. In this manner the function is kept linear.

5.5 It is assured, in the first instance, that the objective of water resources development is the maximisation of the present value of aggregate consumption

benefits derived from the water derivative demands considered, viz., irrigation and power. The economic detail shall be taken into account in later models^{(5) (10) (11) (12)}.

5.6 The project returns are composed of the following items :—

- (i) The annual return to the project from irrigated agriculture net of farm costs (exclusive of water costs) are :

$$\sum_{i=1}^I \sum_{j=1}^J (p_j^a q_{ij} - C_{ij}) A_{ij}$$

- (ii) The net returns to the proposed project area from agriculture if no water control project is constructed are :

$$\bigwedge p_j L_i$$

- (iii) The annual returns to the project from power are

$$\sum_{i=1}^I \sum_{k=1}^K p_{ik}^p h_{ik}$$

- (iv) The sum of the equivalent uniform cost and the annual maintenance expenses of project facilities is

$$\sum_{i=1}^I \left(c_{oi}^l L_i + c_{oi}^v V_i + c_{oi}^p P_i + \frac{c_{oi}^{ot}}{u} T_i + c_{oi}^y Y_i + c_{oi}^z Z_i + c_{oi}^w W_i \right)$$

- (v) The annual power costs of water use and control are

$$\sum_{i=1}^I \sum_{k=1}^K (S_{ik} + t_{ik}) c_i^t + c_i^y y_{ik} + c_i^z z_{ik}$$

where z_{ik} , the surface drainage is given by

$$z_{ik} = \rho_{ik} y_{ik} + \rho_{2ik} \frac{\sum_{j=1}^J \delta_{ij} A_{jk}}{\theta_{2ik}} + \rho_{3ik} \sum_{j=1}^J \delta_{ij} A_{jk} + \rho'_{3ik} \bigwedge \phi_{ik} \sum_{j=1}^J \lambda_{ij} A_{jk} - \rho'_{3ik} \bigwedge \phi_{ik} \left(\bigwedge - \sum_{j=1}^N \lambda_{ij} A_j \right)$$

The Objective function becomes,

$$\max \left\{ \sum_{i=1}^I \sum_{j=1}^J (p_j^a q_{ij} - \epsilon_{ij}) A_{ij} \right.$$

$$\left. + \sum_{i=1}^I \sum_{k=1}^K p_{ik}^p h_{ik} - \left[\sum_{i=1}^I \bigwedge p_i L_i + \sum_{i=1}^I c_{oi}^l L_i + \sum_{i=1}^I c_{oi}^v V_i + \sum_{i=1}^I c_{oi}^p P_i + \sum_{i=1}^I c_{oi}^t T_i + \sum_{i=1}^I c_{oi}^y y_i + c_{oi}^z z_i \right] - \left[\sum_{i=1}^I \sum_{k=1}^K c_i^t (S_{ik} + t_{ik}) + \sum_{i=1}^I \sum_{k=1}^K c_i^y y_{ik} + \sum_{i=1}^I \sum_{k=1}^K c_i^z z_{ik} + c_i^w z_{ik} \right] \right\}$$

The revenue maximisation is effected subject to following constraints :

- (1) Continuity equation must be met at all storage points, surface diversions or interlinkages.

$$\frac{v}{d_k} V_i^{min} \leq \frac{v}{d_x} \sum_{k=1}^K (V_{ik} - x_{ik} + r_{ik} + z_{k(i-1)}) \leq V_i^{max}$$

for $k=1, \dots, K$
 $i=1, \dots, I$

where v is a conversion factor from acre-ft to cusecs and d_k is number of days.

- (2) Flow to surface irrigation or interlinkage is less than total flow in each decision period at each control site

$$x_{ik} - (y_{ik} + w_{ik}) \geq 0 \quad \text{for } i=1, \dots, I$$

$k=1, \dots, K$

- (3) Flow through turbines is less than or equal to capacity of turbine at each site for each decision period

$$h_{ik} \leq P_{ik} < x_{ik} \quad k=1, \dots, K$$

- (4) The water requirements of the crop must be met exactly in each decision period.

$$\theta_{1ik} y_{ik} + t_{ik} = v \sum_{j=1}^J (\delta_{ij} A_{ij} / \theta_{2ik} \theta_{3ik})$$

for each $i=1, \dots, I$
 $k=1, \dots, K$

- (5) Total available land may not be exceeded

$$\sum_{j=1}^J \lambda_{kj} A_j \leq L \leq \bigwedge$$

for each $i=1, \dots, I$
 $k=1, \dots, K$

- (6) The net amount of ground water removed during a year must not exceed the mining allowance, nor may the water-table show a net rise after lapse of twelve months.

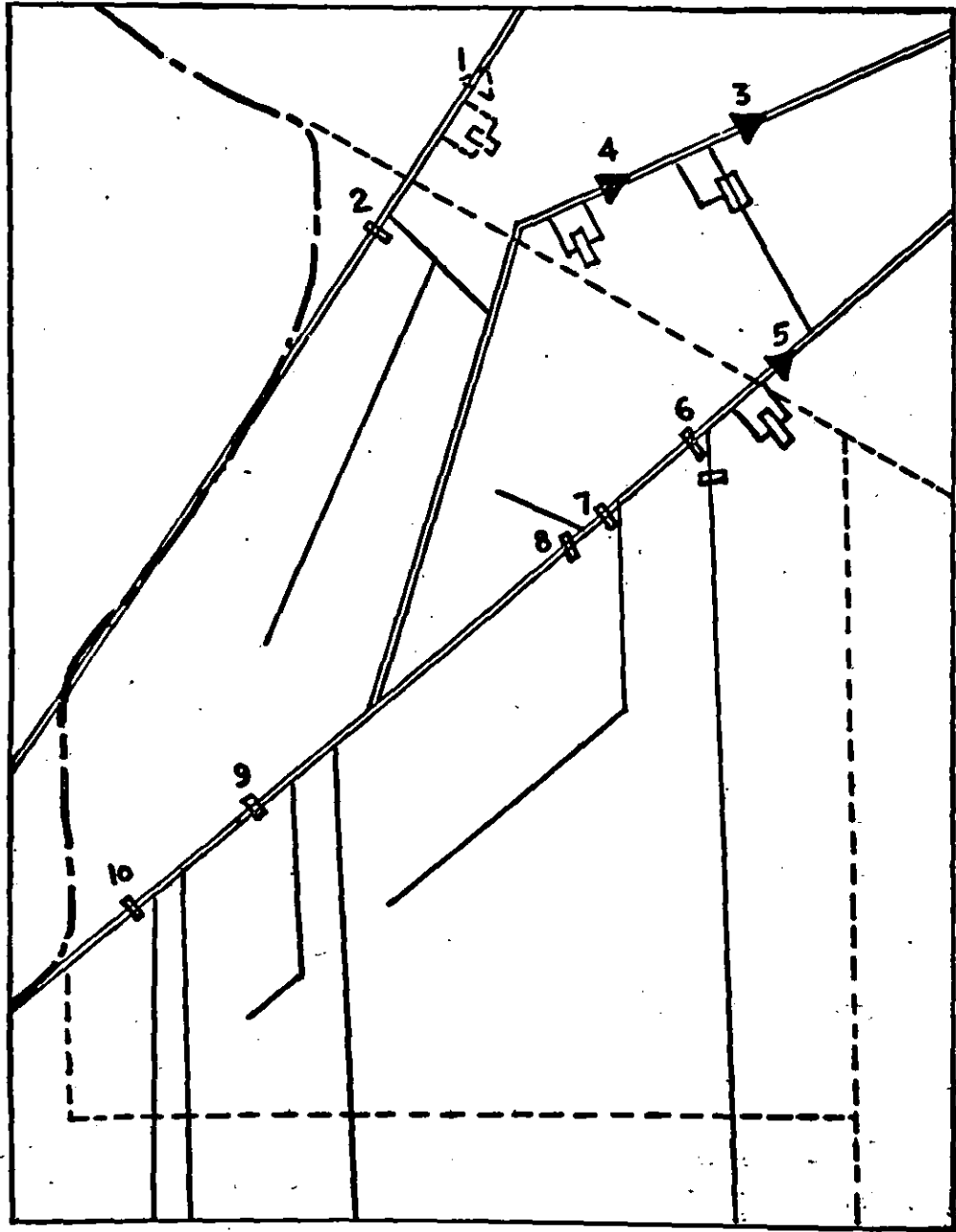

FIGURE 3: Schematic layout of water resources of Punjab.

$$0 \leq \sum_{k=1}^K (1) S_{ik} + (2) t_{ik} + (3) S_{ik} - (4) Y_{1ik} (Y_{ik} + W_{ik})$$

$$- \sum_{j=1}^J (Y_{2j} \delta_{ij} A_{ij} / \theta_{2ik} + Y_{3jk} \delta_{ijk} A_{ij} / \theta_{3ik})$$

$$+ Y_{3ik} \phi_{ik} \lambda_{ijk} A_{ij} - Y_{4ik} \phi_{ik} (\lambda - \sum_{j=1}^J \lambda_{ijk} A_{ij})$$

$$+ \eta_i - R_i \leq M_i$$

The components of recharge in order of the above terms are: (1) return flows to the river, (2) ground water removals for irrigation, (3) ground water removals for sub-surface drainage, (4) canal seepage, (5) seepage from field channels, (6) deep percolation of irrigation water in the fields, (7) rainfall recharge from non-irrigated lands, (8) water-table evaporation, (9) horizontal inflow to aquifer. The determination of the optimum rate of ground water will be developed iteratively and several matters connected with it will have to be considered^{(13) (14) (15)}.

(7) In no months may the amount of ground water pumped exceed the capacity of the wells

$$\pi^v v (t_{ik} + S_{ik}) / d_k u_i^s \leq S_i$$

$$i=1, \dots, I$$

$$k=1, \dots, K$$

where v is a conversion factor from acre-ft per day to cusecs.

(8) Irrigation diversions may not exceed the capacity of canals, where d_k is the number of days in the decision period.

$$(a) \pi^v v y_{ik} / u_i^y d_k \leq \pi^z v z_{ik} u_i^z d_k < Z_i$$

$$(b) \pi^h v h_{ik} / u_i^h d_k \leq W_i$$

$$i=1, \dots, I$$

$$k=1, \dots, K$$

(9) Surface drainage may not exceed the capacity of the surface drainage works.

$$\pi^z v z_{ik} / u_i^z d_k \leq Z_i$$

$$i=1, \dots, I$$

$$k=1, \dots, K$$

6. Conclusions

6.1 Development of water resources as a system, is mandatory and requires comprehensive and critical planning over a river basin to optimally satisfy diverse water derivative demands. This can only be done

through systems analysis, for which an iterative scheme is prepared.

6.2 In the first instance the water resources have to be allocated over the region, developing the surface and ground water resources conjunctively. Conjunctive use is a basic concept in systems analysis.

6.3 After the first broad brush model, more detailed planning in each canal zone will be carried out. The economic implications, and engineering analysis gets continually refined. We continue with deterministic models to be followed by stochastic models and simulation.

6.4 Two important facets of the system have not been considered in the model. One is artificially induced recharge. The second is water quality control. Both these shall be included in later models.

6.5 No budgetary or physical constraints have been employed at this stage. These would be included when study of priorities and investment timing is carried out.

6.6 It is realized that many functions that are basically non-linear have been assumed to be linear. This is not considered to create any particular distortion as realistic values would be adopted or piece-wise linearization may be done.

6.7 The programme shall severely tax computer capabilities but could be handled by the available computers by suitable methods.

7. Acknowledgement

The work owes considerably to the extensive work done in this area by the World Bank for analogous conditions, and by the Centre for Population Studies, particularly as reported in Reference 13.

8. References

- (1) Chaturvedi, M.C.: "National Water Policy and Management". Conference on 'Water in Man's Life' in India sponsored by Indian National Science Academy and National Academy of Sciences, U.S.A., New Delhi, 1971.
- (2) Conclusions, Workshop on 'Water in Man's Life in India' sponsored by National Academy of Science, U.S.A., and Indian National Science Academy, New Delhi, 1971.
- (3) Chaturvedi, M.C.: "Water Resources Systems Engineering". Unpublished.
- (4) Hall, W.A. and Dracup, J.A.: "Water Resources Systems Engineering." McGraw-Hill Inc., New York, 1970.
- (5) Maass, A.; Hufschmidt, M.M.; Dorfman, R.; Thomas, H.A.; Marglin, S.A. and Fair, G.M.: "Design of Water Resource Systems." Harvard University Press, Cambridge, Mass., 1962.
- (6) Lieftinck, P.; Sadove, A.R. and Creyke, T.: "Water and Power Resources of West Pakistan." John Hopkins Press, 1969.

- (7) Dorfman, R.; Roger Revelle and Harold Thomas : "Waterlogging and Salinity in the Indus Plain: Some Basic Considerations." *The Pakistan Development Review*, Vol.V, Autumn, 1965, No.3.
 - (8) Chaturvedi, M.C. : "Water Resources Systems Analysis". 39th Annual Research Session, Central Board of Irrigation and power, Ahmedabad, 1969.
 - (9) Chaturvedi, M.C. : "Water Resources Development-System Approach." Unpublished.
 - (10) Marglin, S. : "Public Investment Criteria." Allen and Unwin, London, 1966.
 - (11) Kneese, A. and Smith, S. (eds) : "Water Research". John Hopkins Press, Baltimore, 1966.
 - (12) Fama, E. : "Multiperiod Consumption Investment Decisions, Report 6B30." Centre for Mathematical Studies in Business and Economics, University of Chicago, May 1969.
 - (13) Smith, D.V. : "Stochastic Irrigation Planning Models." Centre for Population Studies, Harvard University, Cambridge, Mass. 1970.
 - (14) Burt, O.R. : "Economics of Conjunctive Use of Ground and Surface Water." *Hilgardia*, 36, 2, December 1964.
 - (15) Burt, O.R. : "Economic Control of Ground Water Reserves." *Journal of Farm Economics*, 4B, 3-1, 1966.
-

Development of Water Resources—An Integrated Approach and their Environmental Effects

D. R. SIKKA

Secretary

Control Board for Major Projects, M.P., Bhopal

SYNOPSIS

The paper discusses certain factors necessary in the integrated development of surface and sub-surface water resources in India. In this regard establishing scientific watershed management policies have been advocated. The need for creating an agency for water resources development is stressed. The author has suggested that surface water development programme must be properly coupled with power development programme to achieve long-term benefits.

1. Introduction

1.1 Integrated development of surface and sub-surface water resources in our country, is a subject which should need consideration at the highest level on a high priority basis in our National Plans. But it is essential first to recognise the paramount need of the integrated measures and operations for the regions, sub-regions, river basins or a State, in part or as a whole, looking to economic needs and projections of a long-term planning. At present, since India became independent, great attention has no doubt been given to the construction of numerous large and gigantic as well as medium and minor irrigation and hydro-electric projects, priority having been given for the development of irrigated agricultural or industrial water supply operations as an effort to augment the food production towards achieving self-sufficiency targets. In certain cases, flood control and fisheries development works have also been taken up, as a part and out of the multipurpose concept of operations and utilizations in case of large dam projects. Recently measures for infrastructure development and land improvement operation for the ayacut development in the commanded areas of irrigation projects have been initiated, so that there is no time lost between the creation and utilization of irrigation potential to result in overall development of the area in respect of drainage, communications, land holdings, marketing complex and water management practices. Such a venture in the former Punjab, undivided India at the time of construction of large-scale irrigation barrage-

canal systems, by undertaking colonisation and *chakbandi (murraba)* measures resulted in rich dividends.

2. Planning Watershed Development (Madhya Pradesh)

2.1 The latest thinking in this State that an integrated development of irrigation projects would not be completed unless scientific watershed management policies are undertaken upstream of the reservoirs so as to result in sedimentation control and efficient land water use practices, is a further landmark. Towards that end, a high powered Watershed Management Committee under the Chairmanship of the Chief Secretary to work under the overall guidance of the Control Board for Major Projects incharge of planning, investigation and construction of all irrigation and hydro-electric major projects in the State constituted under the Chairmanship of Chief Minister, its PRC (Standing Committee) again headed by Chief Secretary, would reflect the degree of integrated approach towards development of water resources in some of the vital sectors and the importance being attached at the highest level.

2.2 The sub-surface water resources have been mostly tapped by the dug-wells built at the initiatives of the cultivators, large size State owned irrigation and water supply tube-wells and now the cultivators own shallow tube-wells being constructed under the Agriculture Refinance Corporation Programmes.

IMPACTS OF A MAN-MADE LAKE*

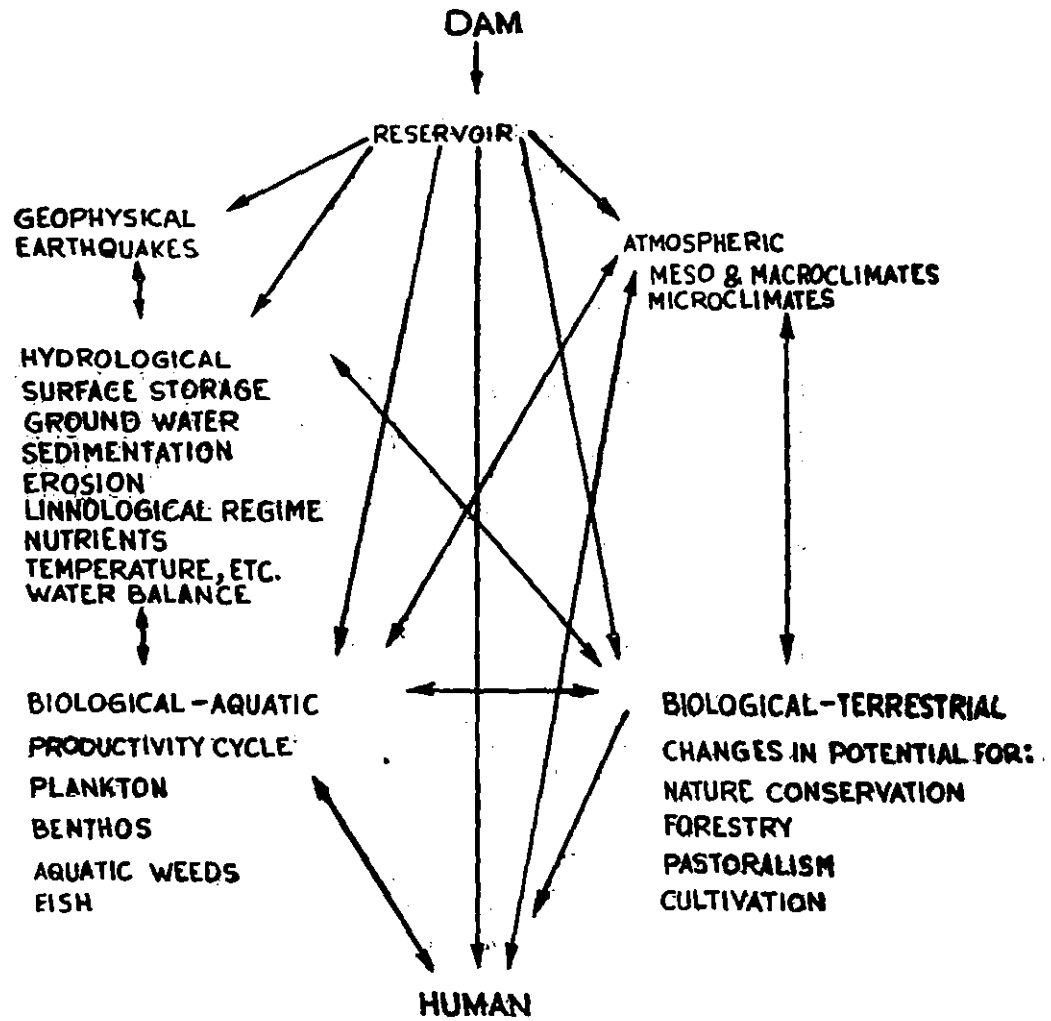

HEALTH
 FISHING
 HUNTING
 ANIMAL INDUSTRY
 PLANT INDUSTRY-ADJACENT; DRAWDOWN
 MANUFACTURING
 TOURISM
 URBANISM

TRANSPORT
 EDUCATION
 HISTORICAL CONTINUITY

* AUTHOR INVITED AS PRINCIPAL SPEAKER

3. Need for Water Resources Development Agency

3.1 All the above activities and forces primarily acting to impound the surface flows and to balance the inequities of seasonal distributions of rainfall and so on have resulted in benefits sometimes not in commensurate with investments, have no scientific co-relation of the surface and sub-surface flows. It would not be incorrect to say that even an effective agency to be overall incharge of water resources development do not exist, instead usually the Irrigation Department is mostly carrying out these operations to fulfil the major requirements of irrigation needs and consumptive use of water and the electric power generation and distribution being under Electricity Boards.

3.2 What is, therefore, most important is first we should have a properly constituted and adequately staffed, clothed with administrative and financial powers, Water Resources Development Agency for each State for consumptive and non-consumptive uses. At the International Symposium on Man-Made Lakes* held at Knoxville, Tennessee Valley, U.S.A. in May 1971, organized by the ICSU, United Nations and various International bodies it was interesting to find without detailing the downstreams uses, the impact of such Man-Made Lakes in respect of following environmental effects and the emphasis laid for recognising the need for taking intergrated advance actions to counteract the problems created.

3.3 This will give an idea of water resources problems again in one sphere. The Constitution of India Item 17 of the 7th Schedule mentions "Waters that is to say water supplies, irrigation and canals, drainage and embankments, water storage subject to...". It would be apparent that this description needs to be enlarged considerably and suitably in case activities for integrated surface water and sub-surface water resources development have to be taken up right now and public awakening with adequate legislative functions enunciated. It will need what is sometimes aimed, integration of technological, political, social and economic functions and deliberations for this crucial activity for the welfare of mankind. Looking to the growing needs of increasing population in the country, it hardly needs to be emphasized that we should be careful in planning, conservation, operation, utilization and development of our water wealth not only for the prime use of irrigation flood control, hydro-electric power, industrial uses and domestic water supply which might carry the first priority but also to see that the newly developed concepts of water budgeting involving appraisal of withdrawals versus augmentations with the time load programmes are implemented, before the coming generation is put to hardships. Adequate water resources laws for the two types of flows have to be formulated.

3.4 With the trends in the development of power generation and distribution for large scale industrial production operations to meet needs of high standard of living, and those in the developing economies, the generation of hydro power in integrated well knit grids of power generations sources namely thermal, nuclear and fossil burning, and the latest of inserting pumped storage, projects, it would be impossible and unfair to presume that surface water development could be tackled alone in isolation as it would need to be correlated with the power development programmes for the needs of the present and of future, as the demand for the two vital items of survival, i.e., water and electricity has to be accepted under short and long-term programmes whether the population is agrarian or highly industrial.

4. Management of Surface and Sub-surface Flow

4.1 Adequate hydrological and meteorological studies have to be incorporated in properly investigated master plans for the unit/region/basins to be decided first, particularly for proper qualitative and quantitative assesment of sub-surface water flows and its relationship with surface flow.

4.2 In particular, it would be worth while to identify deep and shallow aquifers, productive and improductive aquifers and to see that the present withdrawals from the aquifers are done without detriment to the quality and quantity of water. Their investment studies for a safe and continuous supply vis-a-vis surface flows, impoundments, diversions and supplies keeping in view the formers geography, geology, drilling and casting conditions, ground water pumpage, hydrology of aquifers, results of decline in artesian pressures geohydrologic boundaries, practical sustained yields are some of the key notes for ascertaining potential of sub-surface reservoirs.

4.3 In this context examination of irrigation requirements could result in investigations whether construction of dams for the initial requirements to be supplemented by large scale sub-surface exploitation could not result in economy in initial investment and water protection. Dams, big or small, impound water have been responsible for keeping sub-soil water, in the wells sizeable in good stages for the needs of the villagers and people living in that region, a fact well-known since ancient times.

4.4 However, sub-surface water projects if to be taken up in conjunction with surface flow water projects, besides needing first a realistic assessment of the community's needs for supply of water and electricity for various purposes, would also need prior appraisal of certain main factors, suggested below :—

- (1) Studies and results of shallow aquifers to determine potential and to locate areas favourable for ground water development on short-term and long-term basis—looking to needs of economic development and financing available.

*Author invited as Principal Speaker.

- (2) Regional/sub-regional/basin study of aquifer formations to determine water yielding capacities of individual units.
- (3) Study of possible effects of dewatering in above cost studies of impoundage works their distances and locations to surface flow works.
- (4) Study of possible recharge of aquifers from the existing storages, lakes, and whether any possibility for undertaking artificial recharge measures involving latest techniques and advancements could help in better water availability by integrating surface flow and sub-surface flow projects.
- (5) Agencies, type, nature and available, as responsible for programming and implementation of surface and sub-surface works—in public or private sector or on individual basis—size of land holdings with individuals.
- (6) Whether it could be attempted whereby all wastage and excess flows of water in surface flow schemes can help in recharging the sub-surface flows for being utilized at the time of inadequate or non-availability of supplies from surface flow works, thereby creating a cycle of continuous uninterrupted water supplies.
- (7) Quality of water required for the particular needs and that available in sub-surface or surface or by combining both.
- (8) Initial investment and time taken to implement a scheme for the particular needs of the society.
- (9) Making available cheap electric power for sub-surface works, and also by reducing cost of distribution system in otherwise far located dam works.
- (10) Whether surplus electricity outside peaking hours in the integrated grid could be used for such sub-surface works in lieu of pumped storage works.
- (11) Environmental effects and adoptability for the two modes of the people to adjust to water resources laws.
- 4.5 In the above integrated operations for long-term planning, thousands of unemployed engineers at present could be utilized.
- 4.6 It is, however, apparent that for undertaking such a large complicated activity in respect of water resources, requiring painstaking efforts and co-ordination at all levels, it would be necessary, soon after the integrated agency and laws indicated above have been framed, that suitable changes in the present structure, and cadres of the concerned engineering departments are also taken up, wherever necessary by carrying out changes in their service rules conditions set up to meet the challenge by pin pointing job evaluation and functions for each. The present stratification and classification amongst technical people has to go by a new form of personnel administration and a free exchange of technical know-how and its growth has to take place rather than compartmentalization amongst the engineers, added to it their present approach, which at times appears to have come to us from the colonial type of administration of the past when there was comparatively meagre or nil development activity. These days we have to undertake time bound crash programmes by investing on proper planning and supervision and execution, to involve as less as possible of public finance and obtaining benefits as maximum as possible,—“greatest economy if works under the sanctioned programme executed in speediest manner”—and unless we decide to achieve it by introducing the necessary reforms, in practice and in attitudes, not only the community as a whole would suffer considerably for want of achievement of targets and losses due to delays, but also, our plans for future would also be endangered. The attitude of one rupee addition/subtraction mistake in cash book being taken seriously but ignoring losses of *lakhs* and *crores* of rupees by faulty and delayed constructions instead of penalizing, has to be given up, if we intend progressing ahead with times, where we have still to go miles and miles ahead.

Sprinkler Irrigation as a Measure for the Integrated Development of Surface and Sub-surface Water Resources

B. C. SHAH

Director
Engineering Research Institute, Baroda

M. V. BAPAT

Soil Survey Officer
Irrigation Project, Baroda

SYNOPSIS

Conservation and utilization of every drop of available water is a bare necessity in the arid and semi-arid tracts. In the country like Israel, where the natural resources are quite limited, the method of sprinkler irrigation has helped a great deal in the integrated development of surface and sub-surface water resources. At present, almost 90 percent of irrigation is done through sprinkler in that country. A beginning has been made since about last two decades in India and by now, about 20,235 ha (50,000 acres) are brought under sprinkler irrigation. With the knowledge of proper use and economics of the methods, the sprinkler method of irrigation can have wide-spread application all over the country.

Water, a precious commodity, which is made available to the command areas at high costs, needs to be utilized very cautiously and carefully, to produce maximum per unit quantity of water applied to the soil. Sprinkler irrigation has many advantages inasmuch as, not only it helps in careful distribution of water, but saves a large quantity for bringing more areas under cultivation, as compared to flow irrigation through canals and tanks, etc.

In the present paper, the spread of sprinkler irrigation in different countries has been enumerated. The method, its advantages and disadvantages have been described. An experiment on sprinkler irrigation conducted on 'Goradu' soils (loamy to sandy loam) near Baroda indicates that it is possible to save about 30 to 50 percent of the water through this method, as compared to flow irrigation. The paper also describes how sprinkler irrigation can form as a means for the integrated development of surface and sub-surface irrigation. In the canal irrigated tracts, for example, several acres of arable land remain unirrigated, being above canal F.S.L., such tracts can well be brought under irrigation by drawing water through shallow tube-wells. With the use of sprinkler irrigation, these areas can be irrigated with optimum requirements of crops. With the introduction of flow irrigation, the regime of underground water is materially affected, many times creating a problem of high rate of rise and/or water-logging, etc., sprinkler irrigation can serve as an anti-waterlogging measure in such tracts by drawing water from the sub-surface strata. The paper deals with such other aspects also by which sprinkler irrigation can form the best measure for the integrated development.

1. Introduction

1.1 The use of surface and ground waters for irrigation purposes has been in vogue in different parts of the world since times immemorial. Percolation wells,

tanks and small reservoirs have been in use since recent past. The system of irrigation through diversion weirs is of recent origin and is being practised in India since the advent of the British rule. The introduction of

irrigation through canals supplements water to the plants during the non-rainy period. Its proper use and management helps to increase agricultural production per unit cultivated area. The water available through flow irrigation has, however, to be applied with great caution and care. History goes, that great civilizations which once existed in the Euphrates and Tygres valleys, perished due to water-logging and salinity, converting these precious lands into a desolate waste. More intensive irrigation in the southern parts of Egypt, led to the intensification of water-logging in Nile Valley. Many such instances can be quoted where the regime of underground water has been materially affected, bringing the phreatic levels to ground and damaging the once arable lands, permanently.

1.2 The problem is no less acute in India. The following figures speak for the water-logged lands after the introduction of flow irrigation in different States :—

Name of State	Water-logging area in hectares (acres) [—1.5 m to +1.5 m (—5 ft to +5 ft)]
1. Punjab (including Haryana)	14,27,822 (35,69,554)
2. West Bengal	3,09,504 (7,73,760)
3. Uttar Pradesh	6,86,400 (17,16,000)
4. Maharashtra	1,11,481 (2,78,701)
5. Andhra Pradesh	4,183 (10,456)
6. Jammu and Kashmir	10,000 (25,000)
7. Delhi	1,280 (3,200)
Total 25,50,670 ha (63,76,671 acres)	

1.3 The problem of water-logging and drainage is thus of great concern in the areas where irrigation through canals is envisaged, and to arrest the further spread of the evil, it calls for immediate and vigorous preventive and curative measures.

1.4 In the arid and semi-arid regions of the world, there is yet another problem. In the countries like Israel, the sources of water supply being very limited, including the natural precipitation, the water conservation becomes absolutely imminent. In such areas, which also exist in the States like Rajasthan in India, every drop of available water, either from surface or sub-surface water resources, has to be conserved with great care, and utilised for increased agricultural production. In the United States also utmost care is taken for careful utilization of surface and ground waters, particularly in the State of California and other coastal arid regions.

1.5 In such scarcity-stricken arid regions of the world, the drawal of water from the sub-surface becomes a necessity. The main source of water for these confined or unconfined aquifers is, however, the rains. This natural precipitation is stored by various artificial measures like surface lakes, percolation tanks and even through recent methods of percolation reservoirs (as in the U.S.A.). Besides, the water is stored naturally in between the sub-surface impermeable strata like rock or clay layers, as confined and unconfined aquifers. These underground water resources are made available for the agricultural production through pumping. The major source for such drawal was the open-dug-wells, since centuries past. With the charging of the surface aquifers through flow irrigation, shallow tube-wells were introduced (in the Punjab, for example) as an anti-water-logging measure. In the scarcity-stricken areas, deep tube-wells are sunk (U.P. and Gujarat) to avail of the confined waters in deep aquifers.

1.6 These surface and sub-surface resources are harnessed at high costs. Integrated development of these resources through proper soil and water management, without damaging the crops is, therefore, essential.

1.7 The investigations carried out so far have indicated that losses in irrigation water are attributable to the following factors :—

- (i) Losses due to conveyance of water through unlined channels.
- (ii) Inefficient method of leading to deep percolation below the root-zone.
- (iii) Unlevelled fields creating ill-distribution of irrigation water.
- (iv) Too frequent irrigation resulting in excessive losses through fields.
- (v) Non-construction of field watercourses leading to improper distribution of water.

1.8 The ultimate result of these losses from the surface soil or distribution system is the rise in the sub-soil water-table causing deleterious conditions to plant life. It will be interesting to note the figures from the Report of the Central Water and Power Commission indicating the losses of irrigation water through distribution system (Table I).

1.9 It can thus be seen that, notwithstanding all the system lined, the wastage in the field itself affects the ultimate efficiency of irrigation to more than 44 percent.

2. Sprinkler Irrigation as a Measure for Integrated Development

2.1 From the foregoing paragraphs, it is evident that improper utilization of surface and sub-surface waters leads to inefficient irrigation creating problems of water-

TABLE I

System	Losses in			Waste in the field	Consequent utilization by crops. 100-(2+3+4+5)	Recommended intensity of irrigation
	Canals	Distributaries	Water courses			
1. Entire system unlined	15	7	22	27	29	35
2. Only canals lined	4	7	25	30	34	41
3. Canals and distributaries lined	4	2	26	32	36	45
4. Whole system lined	4	2	6	42	46	56

logging in the case of prior, and scarcity in the case of latter. A measure to overcome these difficulties and avoidance of problems, is to introduce a system of irrigation, which will not only conserve every drop of water, but at the same time, will help in the optimum and economic use of this precious commodity. Israel, due to its peculiar conditions of low precipitation and high aridity, has become a pioneering country in the advancement of introducing best methods of irrigation and soil and water conservation. The method of sprinkler irrigation has been found to achieve best results as regards the saving in water as well as its proper and optimum distribution. Having been proved to economise the water resources to the maximum, the spread of sprinkler irrigation system has been quite rapid in the recent past as can be seen from Table II.

TABLE II

Year	Approximate area sprinkled (acres)					
	Israel	Italy	Greece	U.S.A.	Australia	India
1946	—	—	—	2,50,000	—	—
1950	—	110,000	—	—	—	—
1954	225,000	575,000	—	3,000,000	4,00,000	—
1956	—	—	14,000	—	—	—
1958	—	—	37,500	—	—	1,000
1960	300,000	750,000	50,000	4,000,000	700,000	5,000

1 acre = 0.4047 hectares

2.2 Thus, in Israel, more than 90 percent of the area has been brought under sprinkler irrigation by now. The progress of sprinkler irrigation in India in the last two decades was as shown in Table III.

TABLE III

Year	No. of systems	Command area in acres
1956	30	1,000
1960	150	5,000
1962	200	15,000
1964	300	25,000
1966	400	35,000
1968	600	50,000

1 acre = 0.4047 hectares

2.3 Available Water Resources

2.3.1 It is a popular belief that we in India have plenty of water as we have mighty rivers like the Ganga, Brahmaputra, Narmada and Tapi, etc., and gigantic projects like the Damodar Valley, Bhakra Nangal, Kosi and the Ukai Project, etc. It is true that we have the World's largest area under irrigation, covering over 32.38 million ha (80 million acres). But bringing large areas under irrigation alone does not solve our problems. Our conception of irrigation appears to be confined to harnessing water resources and conveying water through miles of canals, mostly unlined. What happens to the water, then at the end of this line? It is this end use of water which has yet to attract due attention. Irrigation implies much more than harnessing and conveyance of water.

2.3.2 Even with 32.38 million ha (80 million acres) under irrigation, we command only about 25 percent of our cultivated area. Hence the irrigation potential is great. According to the Central Water and Power Commission Report, the utilisable flow is only 55.35 million ha m (450 million acre-ft) against our requirement of 76.14 million ha m (619 million acre-ft). We have a deficit of 38 percent. This underlines the importance of conserving water in all directions, and this can be achieved only by using this improved method of irrigation such as Sprinkler Irrigation.

2.4 Advantages and Disadvantages of the Sprinkler Irrigation System

2.4.1 Advantages

- (1) Increased rate of water utilised, by at least 80 percent.
- (2) Yields very good results.
- (3) Resulting increase in yields and improves quality of crops.
- (4) Sprinkling saves a lot of irrigation water in sandy and sandy-loam areas.
- (5) Necessity of spraying insecticides on crops is considerably reduced by its washing action as in the case of rain.

- (6) It is very helpful in scarcity areas where the sub-soil water is very deep and the surface supply is not available.
- (7) It is an ideal method where land is too uneven to permit surface methods of irrigation.
- (8) On hill slopes it has an added advantage of good water head being available at practically no propulsion cost.
- (9) On sloping lands runoff and soil erosion can be eliminated.
- (10) Channels, ditches and furrows become unnecessary. More land is available for cultivation; expenses on erection and maintenance of these structures are saved.
- (11) Soil erosion and water-logging are reduced to a minimum because the application rate can be matched to water intake rate of the soil.
- (12) Light applications (in particular for seed bed preparation and germination) are possible; application can be matched to crop water requirements.
- (13) Liquid fertilizers and other chemical aids can be spread simultaneously, without any extra cost.
- (14) Sprinkler rain is as natural as it can be. Proper rain develops healthy plants, increases yields and effects great economy in water.

2.4.2 Disadvantages and Limitations

- (1) High initial cost of the equipment.
- (2) The fuel or electric energy required to operate the pumping plant represent a major part of the annual cost of operation of sprinkler system. Field charges which include interest on the investment and charges for depreciation of the equipment represent a major item in the annual operating costs.
- (3) Unless the sprinkler system can be operated almost continuously, the investment in equipment may become so high as to make its use prohibitive.
- (4) When the soil is soft and the crop is wet, moving the portable lines is a disagreeable task.
- (5) Mechanical difficulties—sprinklers may fail to rotate, nozzles may clog, couplers may leak or the engine may require attention.

2.4.3 Adaptability

Sprinkler irrigation can be adapted to all tillable soils, to all climates where irrigated agriculture is feasible. Wind problem, if there be any, can be solved with proper selection of equipment and sprinkler spacing. Sprinkler irrigation is well adapted to supply supplemental moisture in those areas, where crops can

be grown without irrigation, but in the case of insufficient rainfall, application of additional moisture is necessitated.

2.4.4 Comparison with other Methods

Irrigation by sprinkling is a superior method of applying water to soils. The purpose of irrigation is to replenish the moisture exhausted from the root-zone by the growing crop, and any method of water application is satisfactory if it fulfills this purpose without undue waste of water, soil or labour.

3. The Sprinkler Irrigation System

3.1 A sprinkler irrigation system consists of a pumping plant for supplying water under pressure, pipelines for conveying the water from pump to all parts of the farm and one or more devices (nozzle lines, perforated pipes or rotating sprinklers) for applying water to the soil. (See Figures 1 & 2 for general layout).

3.2 Rotating sprinkler system is adapted to irrigation of agricultural crops. Particularly slowly revolving sprinkler is commonly used for irrigation of agricultural crops. They vary in size and kinds depending upon pressure at which to be operated. Low pressures are associated with small nozzle diameters, small area coverage and low precipitation rates and high pressure with large nozzle diameters, large area coverage and high precipitation rates.

3.3 Between the small single nozzle sprinkler and the large multiple nozzle sprinkler is the group, usually two nozzle system is successfully utilized for irrigation of wide variety of field crops. They are termed as moderate pressure sprinklers operating at pressures which range between 2.1 and 4.2 kg/sq cm (30 and 60 psi) and capacities of individual sprinklers between 6 and 30 gallons per minute.

3.4 The effective diameter of the area wetted by a sprinkler depends on the pressure at nozzle and the angle at which the jet of water leaves. For any given combination of pressure and water trajectory, a small increase or decrease in area covered can be effected by raising or lowering the height of the sprinkler above the ground. However, in order to minimise the effects of wind on distortion of the spray pattern, the sprinklers are usually mounted not higher than necessary for the water to clear the tops of the crops irrigated.

3.5 Pipeline Assemblage

3.5.1 In order to provide water under pressure at the nozzles, water must be conveyed from the pump to sprinklers in a pipeline assemblage, usually consisting of main line and one or more sprinkler lines referred to as sprinkler laterals. Sprinkler laterals are completely portable and provided with quick couplers.

3.6 Pumping Plant

3.6.1 It is a necessary and important part of sprinkler system. It usually consists of a horizontal centrifugal or a vertical deep well type of pump and of electric

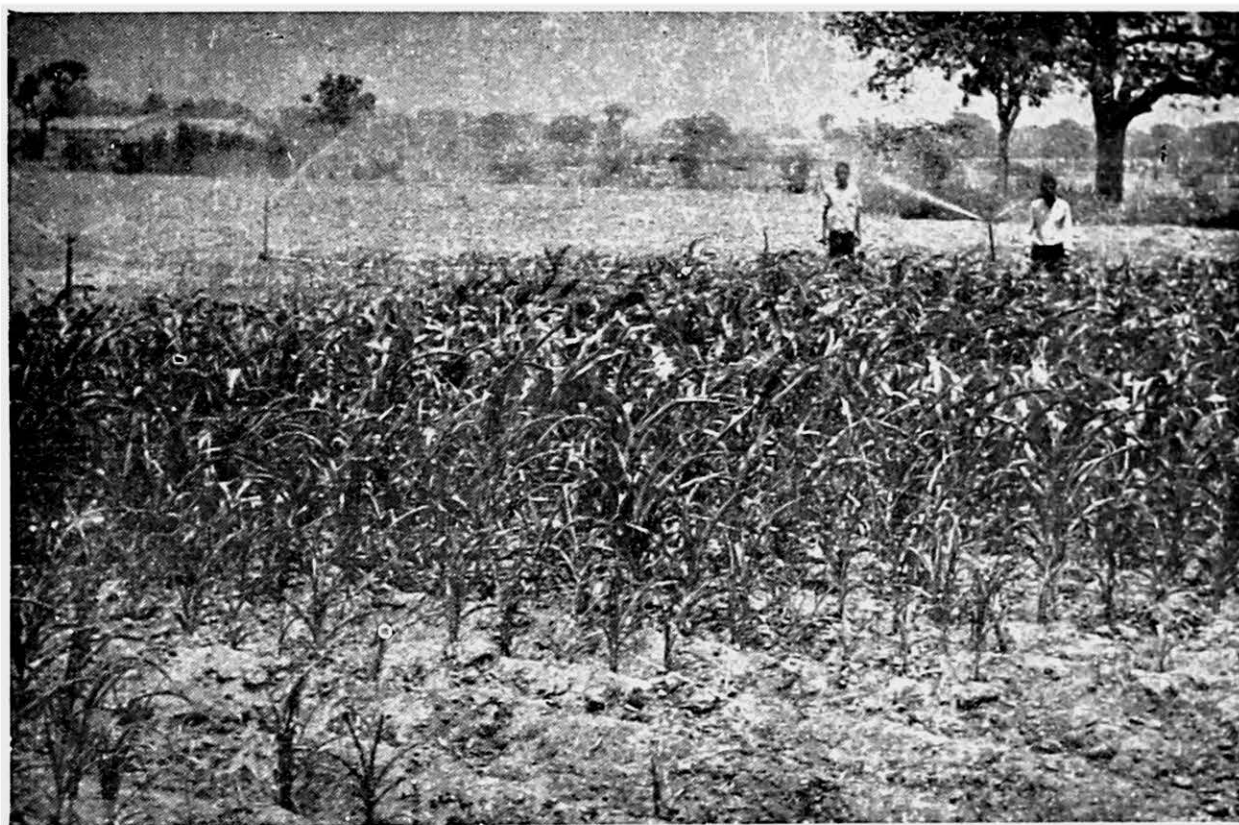

FIGURE 1.

motor or internal combustion engine to supply the water.

3.7 Design of Sprinkler System

Sprinkler system is designed in 3 phases:—

- (1) Inventory of available resources and existing conditions.
- (2) Best suited layout of the system.
- (3) Actual engineering and hydraulic design.

(i) INVENTORY OF RESOURCES AND CONDITIONS

- (a) The size, shape and topography of the area for which irrigation system is to be designed.
- (b) Source of water supply, its availability and dependability.
- (c) Climate determines the quantity of water that will be consumed by the crop.
- (d) Physical characteristics of soil on which rate of water movement and water holding capacity depend.

- (e) Cost and availability of electric power and of fuel of operating internal combustion engines:

(ii) SIZE, SHAPE AND TOPOGRAPHY OF THE AREA

Map of the area to the scale should be drawn and relative elevations of the spots with respect to the proposed pump location or source of water supply should be shown.

3.8 Water Supply

Reliable water supply of good quality is essential.

3.9 Climatic Conditions and Soils

- (a) Radiation intensity is of the major importance, but its measurement is limited to few locations in the world. Temperature is a more universally measured element and is, therefore, used in number of empirical formulae for approximating evapotranspiration or consumptive use of water by crops. These data are also not available everywhere.
- (b) The maximum rates of soil moisture used by crops under different climatic conditions vary from the

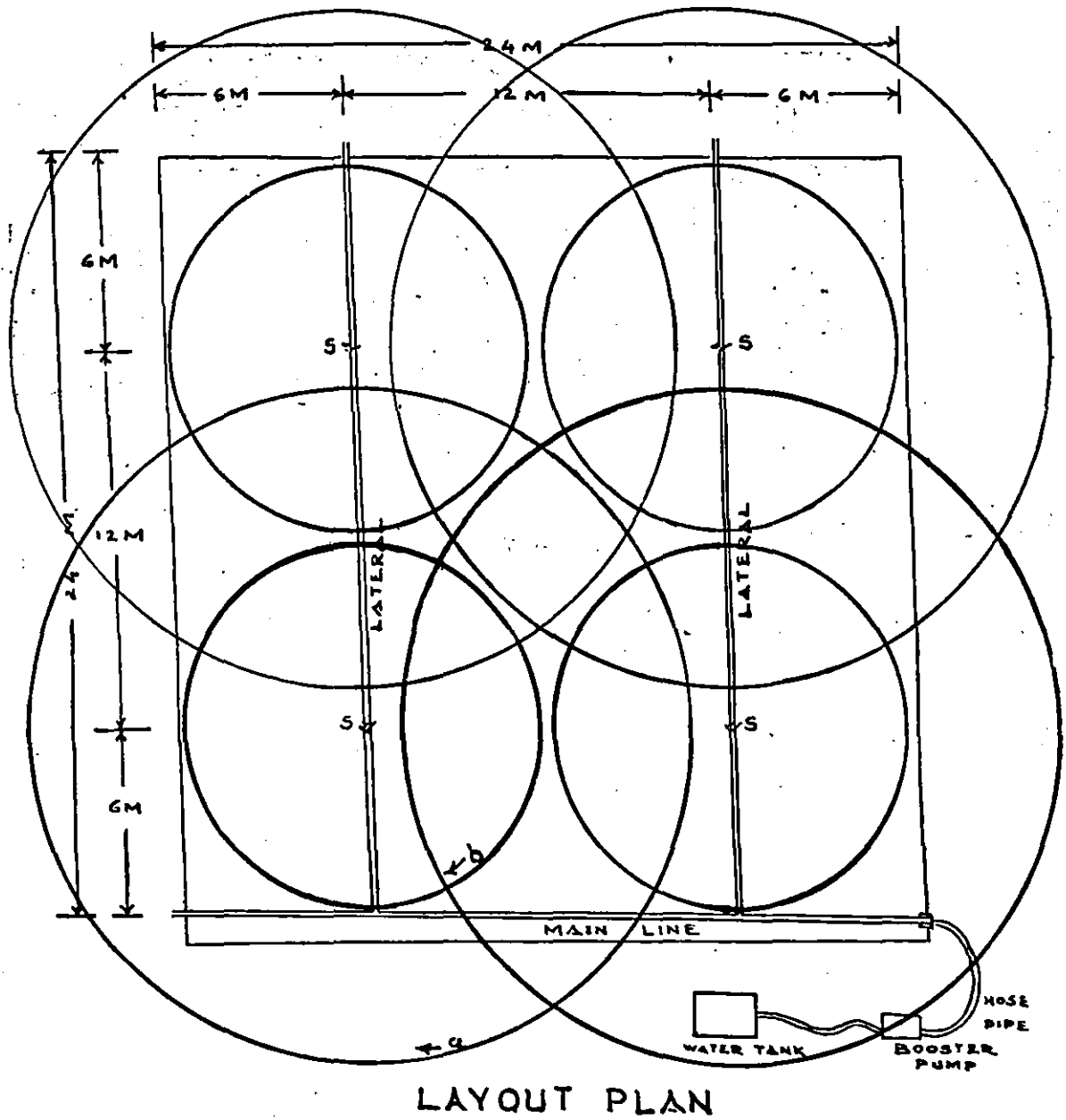

REFERENCES:-

S = SPRINKLER NOZZLES - 4 NOS.

⊙ = COVERAGE OF RAINS

BY SPRINKLERS (a) OUTER-78.9cm

(b) INNER-50.8cm

NOTE:-

1. PRECIPITATION PER HOUR 1.9cm RAIN (2500 G.L)
2. PLOT SIZE - 24M X 24M

FIGURE 2.

peak rate of soil moisture removal of 2.5 mm/day (0.10 in./day) under cool, humid climatic conditions to 7.6 mm/day (0.30 in./day) of moisture removed in hot, dry climatic conditions.

- (c) The texture and structure of soil mass greatly affect the intake rate. The basic rate of water intake varies from 19.0 to 25.5 mm/hour in coarse sands to 7.5 mm/day in clay loam.
- (d) The available moisture holding capacity of soils per unit depth varies from 0.40 mm/cm in the case of very coarse textured sands to 1.70 mm/cm in fine textured sandy clays and clays.
- (e) The depth to which the crops extract available soil moisture from deep well drained soil, ranges widely.

A generally accepted practice is to irrigate the soil when approximately two-thirds of the moisture in the root-zone has been exhausted.

3.10 Power Availability and Probable Cost

Inquiries for electric power, availability and cost involved to bring electric service, etc., will have to be worked out. In case electric power is not available, cost for alternatives with their dependability of the source of fuel, etc., is to be worked out.

4. System Layout

4.1 The size and shape of the field and location of the water supply are the conditions which govern the arrangement or layout of a sprinkler irrigation system.

5. Engineering and Hydraulic Design

5.1 Depth of Water to be Applied

5.1.1 In the process of irrigation, the moisture content of a layer of soil extending from the surface downward is brought up to field capacity. The depth of this layer depends on the depth of water applied and the extent to which the available soil moisture was depleted by the crop previous to application of the water.

Storage capacity of soil = Available moisture per foot of soil depth × root-zone depth of crop.

5.2 Required Frequency of Irrigation

5.2.1 The length of time it will take a crop to remove the available moisture is influenced by the stage

of growth of the crop and the climatic conditions. The stage of growth at which the demand for water for most crops is greatest usually occurs at about the time when evaporative conditions are most severe. It is during this period that requirements for moisture by a crop reach a peak.

5.2.2 Table to show the maximum daily requirements for moisture by various crops under different climatic conditions should be referred. Having known safe limit of available moisture depletion, maximum permissible interval between irrigations can be fixed.

5.3 Time Required to Apply Desired Depth of Water

5.3.1 Allowance for losses by evaporation, percolation should be made. Evaporation losses will be about 5 percent for moderate temperatures and 10 to 12 percent on hot and dry days. Losses due to deep percolation are mainly the result of non-uniformity of application. Criteria given above serve as a guide for determining the maximum rate in inches depth per hour at which water can be applied to soil without causing either ponding or runoff.

5.4 Number of Laterals Required

5.4.1 Having selected the layout of the main line and laterals, and spacing of the sprinklers, the length of time for keeping sprinklers in operation, it is possible to determine number of laterals to be operated at the same time, in order that entire area can be irrigated in maximum permissible time.

5.5 Total Number of Sprinkler Required

$$N = \frac{L - (X + Y)}{S} + 1$$

Where, N = number of sprinklers required per lateral.

S = spacing between sprinklers on lateral.

L = total distance between position of main line and the boundary of the area to be irrigated.

X = distance between main line and nearest sprinkler.

Y = distance between end of lateral (farthest sprinkler and boundary).

5.6 Required Capacity of Individual Sprinklers and of System

$$Q = I \frac{S_1 \times S_2}{96.3} \quad Q = I \frac{S_1 \times S_2}{1,000}$$

in which

Q = required average discharge of individual sprinklers in U.S. gallons per minute.

I = determined rate of application in inches per hour.

S_1 = Spacing between sprinklers along the lateral in feet.

S_2 = Spacing between positions of the lateral in feet.

Total capacity of the entire system $Q = QN$

Where, Q = average capacity of individual sprinklers.

N = number of sprinklers required.

5.7 Selection of Suitable Sprinklers

5.7.1 From the table a sprinkler nozzle combination can be found for any desired capacity between 2 and 600 gallons per minute but that choice between combinations is limited for any specific capacity.

5.8 Adequacy of Selected Spacing

5.8.1 Distribution of water from a single sprinkler is not uniform over the entire wetted circle. With American made sprinklers the greatest depth of application usually occurs near sprinkler, with gradually decreasing depth with distance away from the sprinklers. For this reason, a generous overlap of the sprays from adjoining sprinklers is necessary for uniform distribution (Figure 2).

5.8.2 Approximate rule followed in North America for selecting proper sprinkler spacing :

(a) The distance between sprinklers along a lateral should not exceed 50 percent of the diameter of coverage.

(b) The distance between successive positions of a laterals should not exceed 65 percent of the diameter of coverage.

European designs follow the rules below :

(a) For square spacing, the distance between sprinklers should be 1.41 times the radius of the circle effectively wetted by each sprinkler ($S = R\sqrt{2}$).

in which

Q = required average discharge of individual sprinkler in cubic metres per hour.

I = determined rate of application in millimetres per hour.

S_1 = Spacing between sprinklers along the lateral in metres.

S_2 = Spacing between positions of the lateral in metres.

(b) For triangular spacing, the distance between sprinklers should be 1.73 times the radius of the wetted circle ($S = R\sqrt{3}$).

5.9 Required Size of Main Line

5.9.1 Water flowing in the pipeline meets with frictional resistance. Several formulae such as Scobey formula, William's formula and Manning formula are used for working out the loss in pipeline due to friction.

5.9.2 As a practical guide, it is suggested that friction loss in the main line of the system should not exceed 15 percent of the pressure available at the pump discharge.

5.10 Selection of Size of Sprinkler Laterals

5.10.1 A sprinkler lateral represents a pipeline with number of equally spaced outlets. Therefore, the quantity of water flowing at the beginning of the lateral becomes less at each outlet. Actually about three-fourths of the total frictional loss in a sprinkler lateral occurs in the upper one-fourth of the length of the line and one-fourth of the frictional loss occurs in the remaining three-fourths of the length.

5.10.2 Frictional losses are worked out from the diagrams or standardised tables. Friction loss in a lateral should not exceed 20 percent of the average operating pressure of the sprinklers along the line.

5.11 Determination of Total Dynamic Head

5.11.1 It represents the head by difference in elevations between the source of water supply and that of sprinkler located at the highest point of the field or area, the pressure losses due to friction in mainline, laterals and various special fittings, and the operating pressure at the farthest sprinkler on the lateral.

$$\begin{aligned} \text{Water HP (theoretical)} &= \frac{\text{gal/min} \times \text{Head in feet}}{3960} \\ &= \frac{\text{Lit/sec} \times \text{Head in meters}}{75} \\ &= \frac{\text{m}^3/\text{hr} \times \text{Head in metres}}{270} \end{aligned}$$

$$\text{Shaft HP} = \frac{\text{Water HP}}{\text{Pump efficiency } (E_p)}$$

$$\begin{aligned} \text{Brake HP} &= \frac{\text{Shaft HP}}{\text{Drive Efficiency } (E_d)} \\ &= \frac{\text{Water HP}}{E_p \times E_d} \end{aligned}$$

6. Cost of Irrigation by Sprinkling

6.1 Annual costs of irrigation by sprinkling are of two kinds : (a) Fixed charges or overhead costs, (b) operating costs.

(a) *Fixed Charges* include interest on investment at prevailing rates, and annual depreciation charges computed at the rate of 7 or 8 percent of total investment cost and charges for insurance and taxes.

(b) *Operating Costs* : Expenditure on electricity or fuel, lubricating oil, grease, repairs and labour for operating the system.

Annual maintenance and repairs to main line laterals sprinklers various fittings, etc., 3 percent of the original cost of these items.

Total labour requirement for moving sprinkler laterals is one man hour per acre per irrigation.

7. Sprinkler Irrigation in India

7.1 A spray system is first installed in the country in the early fifties. It is only of late that these systems are being used on a commercial scale and by the end of 1968, 15,235 ha (50,000 acres) have been brought under irrigation under this system. Users prefer a portable irrigation system since, besides being a more economical initial investment, it gives them a great flexibility in operation. Of course, the source of water supply to a portable system work out to about Rs. 1729 per ha (Rs. 700 an acre) with operating costs (including depreciation) of about Rs. 12 an acre inch.

7.2 Experience in India

7.2.1 Sprinkler irrigation systems are gaining ground in India. They are being installed as production-cum-conservation tools. Some of the results reported are as under :

(a) Tea

Germination in nurseries is uniform and rapid. Loss of the young plant in a drought season is less than 2 percent against 70 percent in unirrigated areas. It cuts down the maturing period by at least one year. Yield per acre for matured tea from the irrigated area was 6.9 quintals (18½ maunds) against 4.29 quintals (11½ maunds) from the unirrigated area an increase of over 60 percent. Sprinkled matured tea with an earlier flush gets rid of red spiders. The irrigated area is less susceptible to mites and pests. Vacancies in the irrigated crop are hardly noticed.

(b) Coffee

An increase in yield from 55 to 200 percent. The first crop is picked at the end of the third year instead of after 5 to 6 years.

(c) Chicory

Showed better germination and higher yields.

(d) Cardamon

Showed an increase of 160 percent.

(e) Orchards

Citrus fruits grower reported a saving of water of 50 percent.

7.3 The above extracts are by no means exhaustive, neither should we gain an impression that sprinkler application is confined to only a few crops. Sprinkler irrigation does not replace existing irrigation practices but wherever conditions so warrant and economics so justify, it is a practice worth adopting.

7.4 There are certain problem belts in the country where this method of irrigation holds out a possible remedy. These are waterlogged tracts in Punjab and Uttar Pradesh, those with a higher water-table, the Kosi command area in Bihar and the Rajasthan Canal area (with their light sandy soils), the water scarcity area in Maharashtra, growing cash crops. In addition to the applications discussed above, sprinklers hold out fair promise for crops like cotton, grapes, vegetables and forest nurseries.

7.5 The above reports show that the sprinkler irrigation system is a great boon to agriculturists. By using less land and water, they are able to increase their production. Besides it helps soil and water conservation and has an effective role to play in our irrigation schemes. The sprinkler is an important production-cum-conservation tool and is one of the many devices that can help raise our agricultural productivity.

7.6 In Gujarat State a small experiment on the sprinkler irrigation is being carried out by the Engineering Research Institute, Baroda on the Nizampura Farm near Baroda. The results of the experiment show that there is definitely a saving of water by 50 percent. As the experiment was carried out on the very small area, it did not give appreciable economical advantage. However, looking to the saving in water and better crop,

It is proposed to carry out experiments with sprinkler irrigation on much bigger area which will give much positive and promising results.

8. Conclusions

It is felt that the sprinkler irrigation will be very useful on the undulating areas and also where tube-well irrigation is used and also in the command areas of lift irrigation schemes. With the same quantity of water, it is possible to irrigate double the area. It is very necessary to carry out experiments on extensive scale in all the States on sprinkler irrigation so that the results should be brought to the notice of the farmers and the extension

staff should guide them on the technical know-how under actual field conditions, so that they can cope up with the idea of green revolution in agricultural production in no distant future.

9. References

- (1) "Irrigation by Sprinkling". Published by Food and Agriculture Organization of the United Nations, 1960.
- (2) Jain, B. K. S. : "Sprinkler Irrigation". October 1961.
- (3) Jain, B. K. S. : "Scope of Sprinkler Irrigation in India". January 1969.
- (4) "Sprinkler Irrigation". U. S. Department of the Interior, Bureau of Reclamation.

Conjunctive Utilisation of Surface and Sub-surface Water Resources for Future Water Supply in Chandigarh

N. NARAYANA PILLAI

Associate Professor
Punjab Engineering College, Chandigarh

BALJEET SINGH

Sub-Divisional Engineer
Public Health Sub-Division No. 1
P.W.D., Haryana, Chandigarh

SYNOPSIS

Chandigarh is having its water supply from a number of tube-wells located mostly near the two streams Sukhna Choe on the east side and Patiali Rao to the west. These streams have flow only during the monsoons. A dam in Sukhna Choe forms a beautiful lake near the city.

Chandigarh has a very good drainage and sewerage system, so that most of the storm water and all the sewage escape from the city limits.

Studies of the water-table elevations in 1967 and 1970 have indicated that water-table has depleted in many areas. The water balance study is done with three sub-systems, namely land surface sub-system, lake sub-system and ground water sub-system. Land sub-system has shown that only about $\frac{1}{4}$ th of the water utilised at present for water supply infiltrates and replenishes the water-table. The lake sub-system has shown that a large quantity of water that is seeping from the lake is contributing towards the ground water resources.

However, increase of population in the future and consequent increase in demand of water will result in greater exploitation of the ground water resources. In order to ensure that the required replenishment of the ground water takes place avoiding excessive drawdowns, additional sources of water and methods to cause higher recharge into the area are to be explored.

It is proposed that a dam be constructed across the stream Patiali Rao creating another lake on the west side of Chandigarh. The additional water that is stored in this lake is estimated to increase the ground water resources considerably. Other additional measures are also suggested to meet the future water demand of the city.

1. → Introduction

1.1. The city of Chandigarh : Chandigarh is a well planned modern city. The architect of Chandigarh, Le Corbusier envisaged that the city would breathe the new sublimated spirit of art. The city is composed of many sectors with green strips oriented longitudinally, stretching centrally along the sectors

parallel to the Shivaliks. Each sector is designed to meet the daily needs of its habitants which vary from 5,000 to 25,000. Sukhna Lake which is situated in the north-east of Chandigarh is a good recreational centre. The leisure valley running through the middle of Chandigarh is developed as a long and beautiful garden. Chandigarh has efficient sewerage and drainage systems. Sewage is taken

to the treatment plant situated outside the city limits and is disposed of after treatment.

1.2 Location and Geology

1.2.1 The city is located at the region where the Shivalik Hills terminate in the south and where the plains of Punjab commence. The land slopes down moderately to the south or south-west.

1.2.2 The area is nearly 4,047 ha (10,000 acres) with two streams Sukhna Choe to its east and Patiali Rao to the west. These streams flow only during the monsoon season.

1.2.3 The area is formed of recent alluvial deposits probably from the very streams which exist at present. Sand and clay deposits are intermixed as seen by many bore-holes. Underlying this recent alluvial deposit may be the extension of Shivaliks.

1.3 Past Proposal for Water Supply

1.3.1 In the initial phase of development of Chandigarh it was proposed to construct an artificial lake on Sukhna Choe for meeting the city's demand for water. It was expected that by the time population increased a dam across Ghaggar River could be constructed and water could be supplied from Ghaggar Reservoir for a population over 0.5 million.

1.4 Present Water Supply

1.4.1 The dam across Sukhna Choe was completed. But the water in the lake was inadequate to meet the water demand in the city. The dam across Ghaggar could not be taken up as proposed. This made the authorities search for alternate sources of water.

1.4.2 It was decided to tap the ground water resources of this region. A number of trial bores were made and the study of the geological formations showed that the ground water sources were adequate for the water supply in Chandigarh.

1.4.3 A number of tube-wells were installed especially near the streams on the west and east of Chandigarh. Water is pumped from these tube-wells to underground storage reservoirs of nearly 9.1 million litres (2.0 million gallons) capacity and series of pumps are used to meet the fluctuating demand from overhead reservoirs of 2.3 million litres (50,000 gallons) capacity.

1.4.4 The present population of Chandigarh is estimated to be 0.268 million and average quantity of water utilised per year is 27.7 million cu m (980 million cu ft).

2. Study Regarding Water Resources

2.1 Need for the Study of Water Resources

2.1.1 It has been seen that many wells which have been dug earlier dried up and had to be abandoned. Wells

were dug at alternate sites to meet the demand. Since the water-table has gone down by several feet in many places these wells had to be deeper. In future when the population will increase and more water will be needed and more number of wells will be required the water-table will recede at a higher rate. This in turn will cause higher lifts and increased cost of pumping. In order to estimate the safe withdrawal from ground water resources and to suggest additional sources of water a study of water resources is considered important.

2.2 Water Balance Study for Chandigarh (1)

2.2.1 Water balance study is useful to assess the various components of the surface and ground water systems and to plan optimum utilisation of the water resources in a planned manner. It is recognised that such a water balance study for a small area like Chandigarh with geological boundaries not so well defined and with insufficient data regarding temperature, rainfall, infiltration and with a complex geological formation underneath with lenses of clay in the alluvial deposits is prone to a lot of error. But it is felt that this study will indicate to some extent the magnitude of the various components of the hydrological systems and act as a guide for suggesting improvements in the method of utilisation of our water resources.

3. Boundaries Considered for Water Balance Study

3.1 The boundaries considered in the study are shown in Figure 1. On the west and east are the streams Patiali Rao and Sukhna Choe respectively. On the south and north the boundary conformed roughly to the developed area of Chandigarh. The area enclosed is nearly 3,990 ha (9,680 acres).

4. Division into Sub-systems

4.1 In order to simplify and to help in cross-checking the assessment of various components of the water resources system it was divided into three sub-systems. The land surface sub-system was used to study the rainfall in the area, water utilised for gardening and landscaping evapotranspiration from the area, runoff from the area and the infiltration. The lake sub-system studied rainfall on the lake, the runoff from the catchment area of the lake, the overflow of water above the spillway, the evaporation losses from the lake and the seepage from the lake. The ground water sub-system studied the recharge from the lake, the infiltration from the land surfaces, the recharge across the boundaries from other sources, the water that was pumped from the tube-wells and the depletion of ground water in the area. There were difficulties in the estimation of the various components. But in this analysis some assumptions and some empirical formulae were used. The balancing of one sub-system in some cases provided some unknown component which was used in the

balancing of another sub-system. The quantities were estimated from the data available from 1967-70 and average yearly values were considered.

5. Land Surface Sub-system

5.1 Rainfall over the Area

5.1.1 The average rainfall for the period 1967-70 was found to be 1,013.2 mm/yr. It corresponds to a total volume of 39.2 million cu m/yr (1,386 million cu ft/yr).

5.2 Evapotranspiration

5.2.1 Chandigarh has got 1,502 ha (3,720 acres) area of unpaved open spaces. In addition to this the household gardens and lawns which are mainly watered compose 1,217 ha (2,790 acres). On the average 15.4 million cu m/yr (550 million cu ft/yr) volume of water is utilised for gardening and landscaping.

5.2.2 There are no studies made in Chandigarh on evapotranspiration. It is assumed that nearly the same

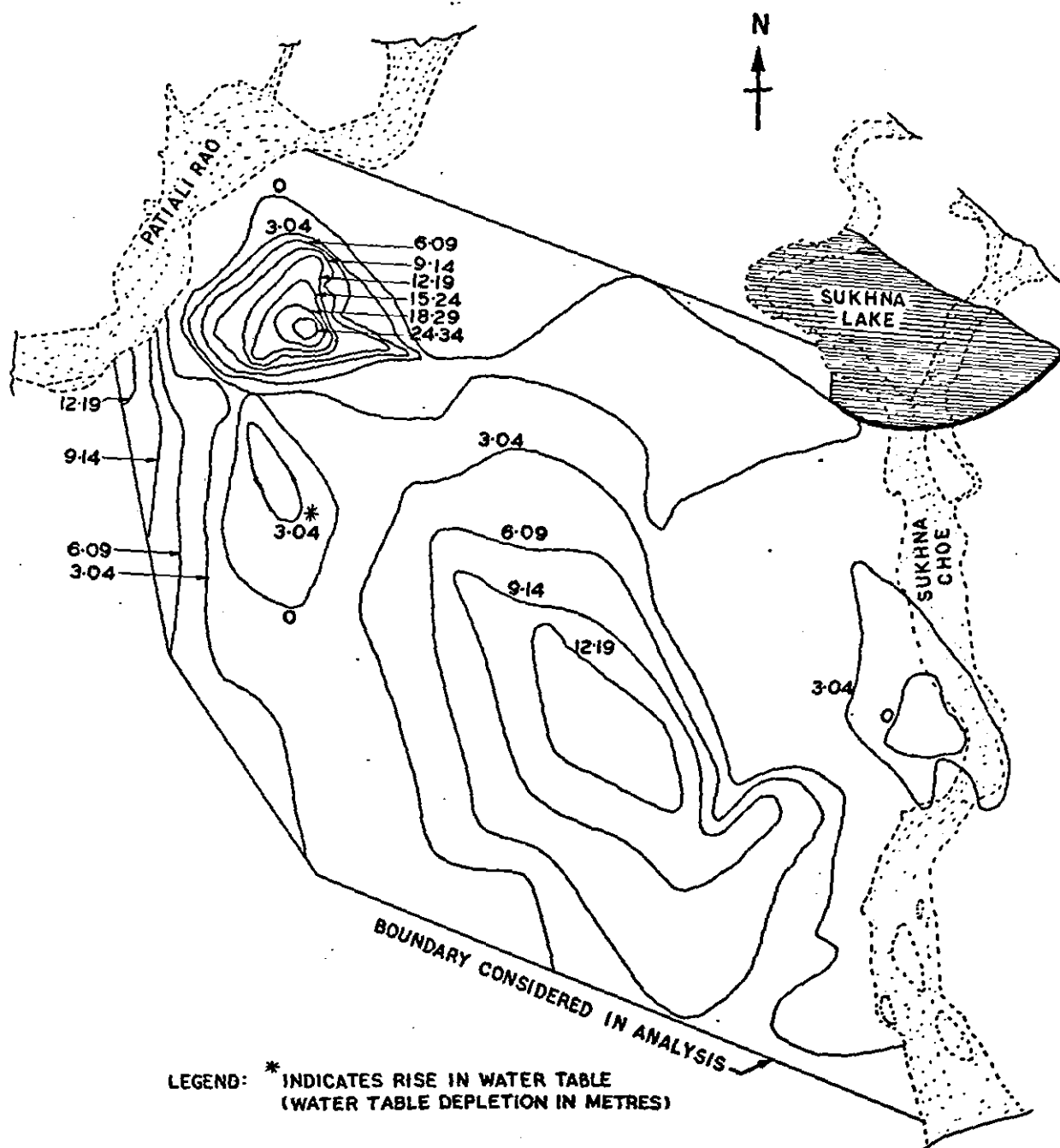

FIGURE 1 : Boundaries of control area and water-table depletion.

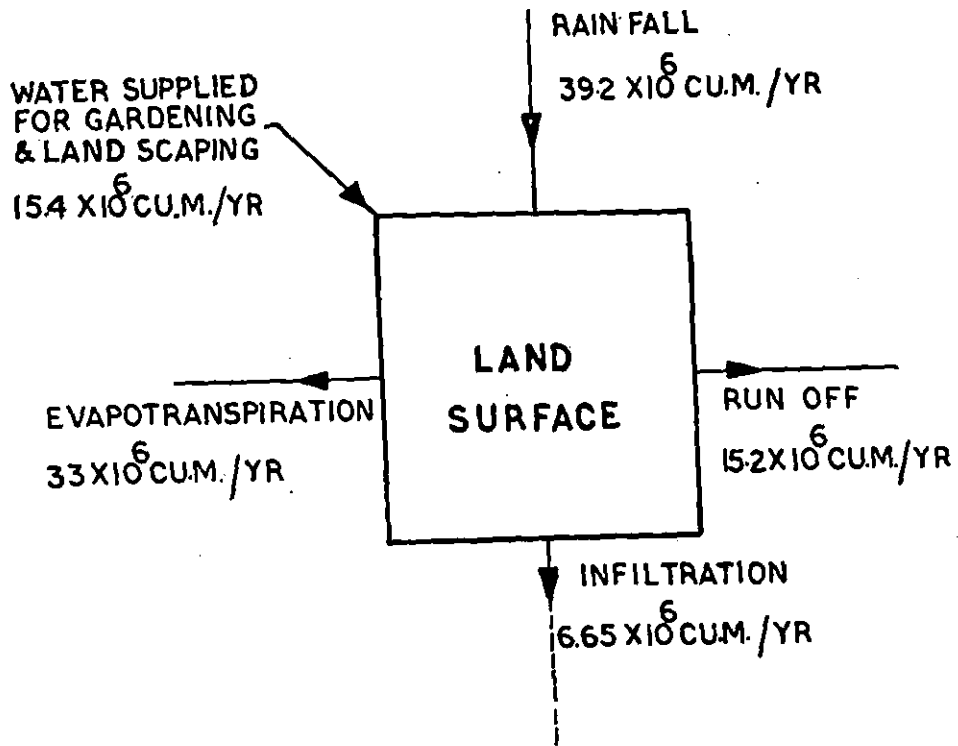

FIGURE 2 Land surface sub-system.

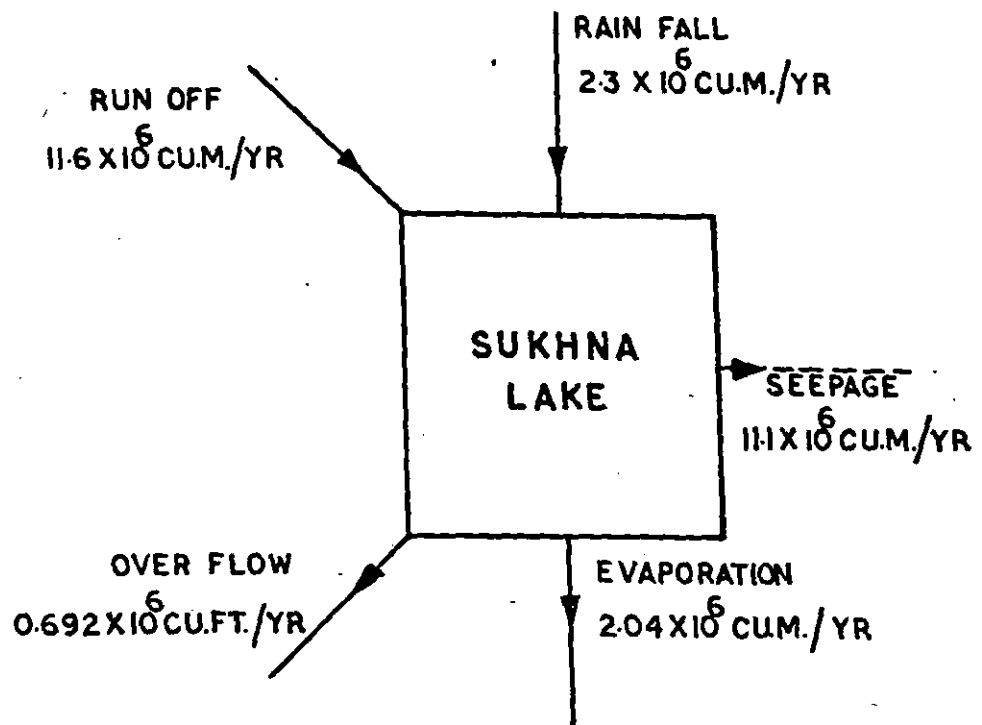

FIGURE 3 : Sukhna lake sub-system.

climatic conditions as in Amritsar prevail in Chandigarh and potential evapotranspiration loss as given by H. L. Uppal and A. D. Gulati⁽²⁾ for Amritsar worked out by Penman's method was used in the analysis. Since the open spaces are mainly gardens and lawns which are watered as required it was assumed that evapotranspiration from the area would be the same as potential evapotranspiration of 122.3 cm. The total evapotranspiration was calculated as 33 million cu m/yr (1,168 million cu ft/yr).

5.3 Runoff

5.3.1 No data regarding runoff is available for the city of Chandigarh. The city has a very good drainage system and hence nearly 100 percent runoff could be assumed from the rainfall on 1,212 ha (3,000 acres) of paved and built-up areas. The lawns and gardens are generally kept in a good condition throughout the year and for the usual moderate rainfall that occurs in Chandigarh very little runoff is produced from the gardens and other un-paved open spaces. It is assumed that about 10 percent of the rain falling on

these areas also contribute to runoff. The average total yearly runoff for the period 1967-70 was calculated as 15.2 million cu m (531.5 million cu ft).

5.3.2 In order to balance the land surface system it was found that nearly 6.65 million cu m/yr (236 million cu ft/yr) of water should infiltrate and replenish the ground water resources.

6. Lake Sub-system

6.1 Catchment area of the lake is nearly 41.44 sq km (16 sq m) and a waterspread area of nearly 231 ha (570 acres) when full. The runoff from the catchment is estimated by Khosla's formula as 11.6 million cu m/yr (480 million cu ft/yr). The volume of water due to rainfall over the lake was estimated to be 2.3 million cu m/yr (82 million cu ft/yr). It is estimated that average outflow of lake during the monsoon season is about 0.69 million cu m/yr (24.3 million cu ft/yr). The evaporation from the lake surface was assumed to be of the same order as that from Bhakra Reservoir, namely 1.2 m (4 ft) per year. It was estimated to be 2.04 million cu m/yr (76.2 million cu ft/yr).

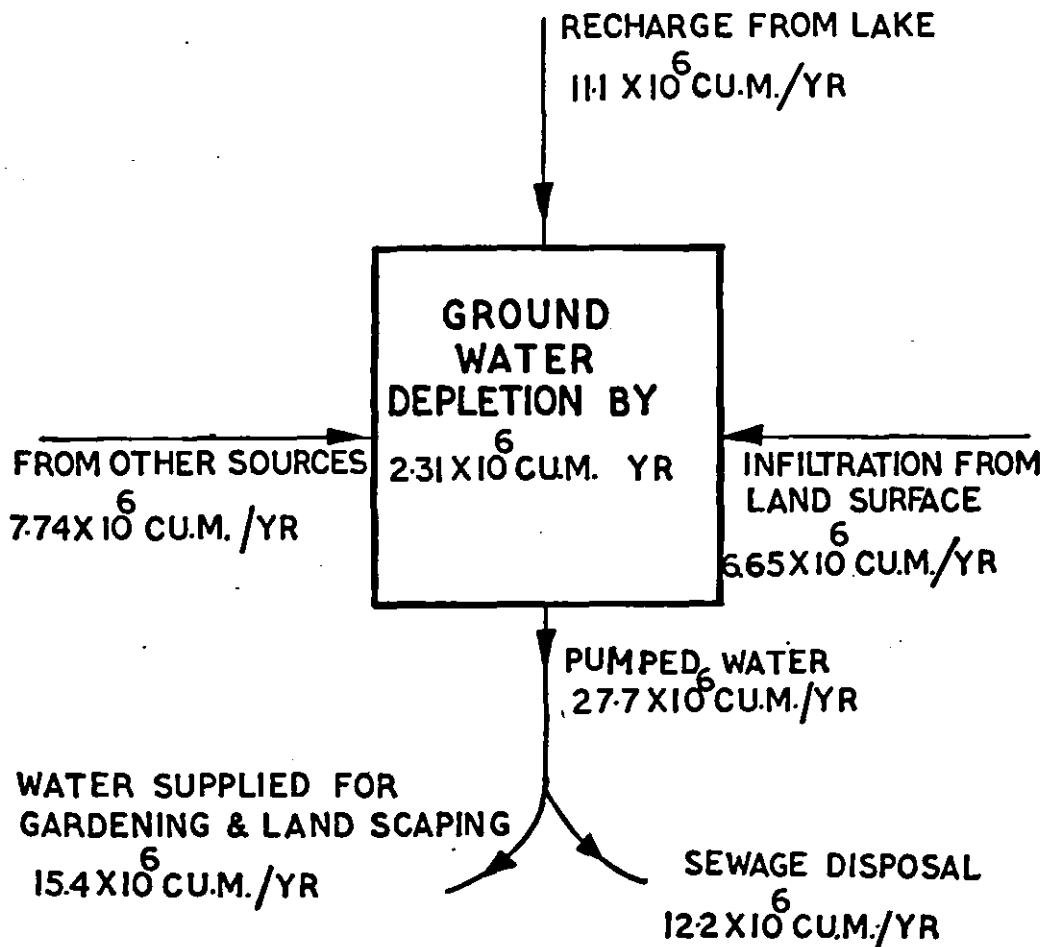

FIGURE 4: Ground water sub-system.

6.2 The components of the lake sub-system are schematically represented in Figure 3. The water balance plot showed that an outflow from the lake of amount 11.1 million cu m/yr (389.5 million cu ft/yr) had to take place from the lake for balancing the various quantities. There are a number of tube-wells located near the lake in the Chandigarh area and the geological formations in general have a slope towards south-west. Hence it was concluded that this amount of water can be attributed to be recharging the ground water by seepage from the lake.

6.3 The lake storage was assumed to be the same at the beginning and the end of the study.

7. Ground Water Sub-system

7.1 The ground water received water by infiltration from land surface of the order of 6.65 million cu m/yr (236 million cu ft/yr), as deduced from Figure 2 and was recharged from the lake at the rate of nearly 11.1 million cu m/yr (389.5 million cu ft/yr) of water. The total water that is pumped per year is of the order of 27.7 million cu m/yr (980 million cu ft/yr).

7.2 The water-table at many places had gone down during the period 1967-70. The water-table contour maps for June 1967 and June 1970 were prepared and by their super-imposition the map depicting change of water-table elevation was prepared⁽¹⁾ as shown in Figure 1. The depletion of the water-table is indicated in the figure at an interval of 3 m (10 ft). The volume of aquifer that is drained because of the depletion of ground water storage was estimated. An average storage coefficient of 20 percent was assumed and the withdrawal from storage was estimated as 2.31 million cu m/yr (81.9 million cu ft/yr).

7.3 In order to balance the system it was found that an amount of water of the order of 7.74 million cu m/yr (272 million cu ft/yr) had to flow into the control region across the boundaries from other sources. Various components of the sub-system are shown in Figure 4.

8. Discussion on the Sub-systems

8.1 It has been seen from the lake sub-system that about 11.1 million cu m/yr (389.5 million cu ft/yr) of

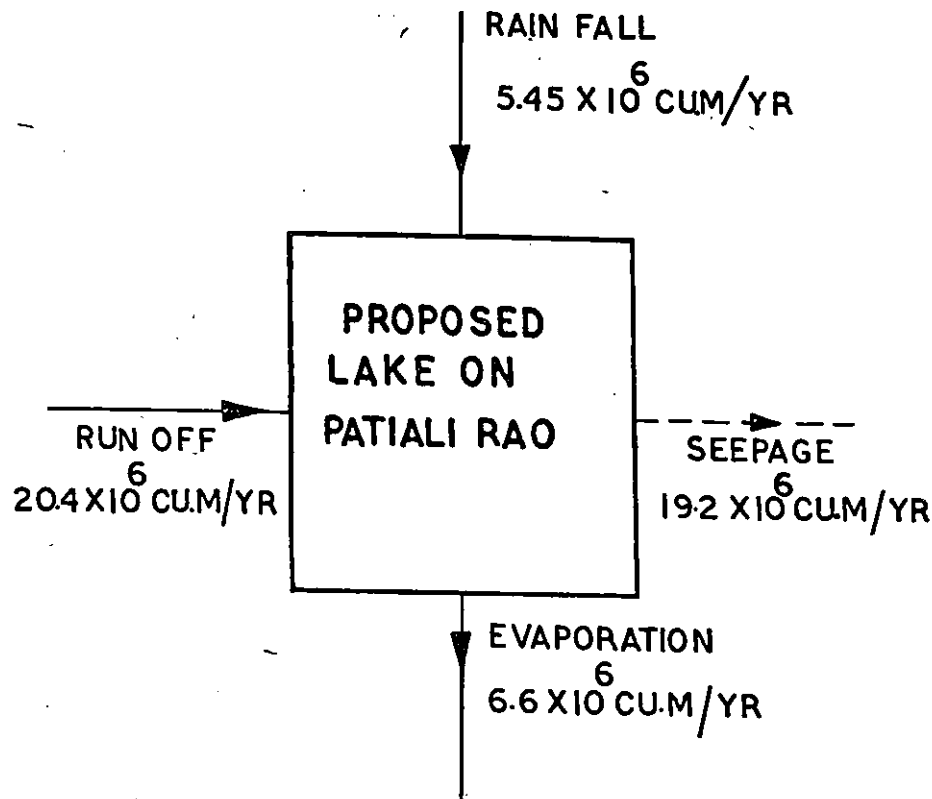

FIGURE 5 : Water balance plot for proposed lake.

water was recharging the ground water in the Chandigarh area. This was a significant factor in the usefulness of the artificial lake near regions of intense exploitation of ground water. Most of the water from the lake is utilised indirectly in an efficient manner and the quantity of overflow is very small.

8.2 As indicated in Figure 1, the ground water-table had gone down in many places by more than 8 m (25 ft) nearly. It is not of much immediate concern, but in future as the city develops the depletion of ground water will be at very high rate. Consequently the pumping cost at the future rate of withdrawal of ground water will go up considerably.

8.3 One factor to be recognised is that the withdrawal rate was greater than the total recharge rate. The problem can be tackled only by the conservation of all the water resources in this region and its utilisation in a planned manner.

9. Proposals for Meeting Increased Demands in Future

9.1 Lake in Patiali Rao

9.1.1 It has been shown in Figure 3, that Sukhna Lake contributes to a large measure for replenishing the ground water in this region.

9.1.2 Another stream Patiali Rao on the western side of Chandigarh has a catchment area of nearly 46.6 sq km (18 sq miles). The largest depletion of ground water tables were located closer to the Patiali Rao. During the monsoons the water-table will again go up and at the same time Patiali Rao will be flowing. It is envisaged that a lake in Patiali Rao will enhance the recharging towards the Chandigarh area as in the case of Sukhna Lake. An analysis of the proposed lake system is shown in Figure 5. It is estimated that if sufficient storage is provided it will increase the ground water potential by nearly 19.2 million cu m/yr (677 million cu ft/yr).

9.2 Other Measures

9.2.1 The following measures can also be used to enhance the available water :

- (a) Reduction of evaporation from the lake by monomolecular films.
- (b) More water can be pumped from tube-wells located near the lake in the monsoon season so that as little of the lake water as possible will overflow the lake.

(c) Proposals for pumping the storm water to the lakes in years of deficient rainfall should be considered.

(d) Efforts could be made to develop techniques for recharging the ground water by using lake and storm water through recharging wells.

10. Results and Conclusions

10.1 Present Water Supply in Chandigarh

10.1.1 Adequate water supply to meet the requirements of the present day population of Chandigarh is available. The water-table elevations are going down. But the quantity of water involved in withdrawal from storage in the ground water is small.

10.2 Future Water Supply Needs

10.2.1 As the population increases the higher demands for water will increase the exploitation of ground water. The depletion of the ground water will be at a much higher rate and the pumping cost will increase considerably. Hence additional sources of water are to be thought of for the future.

10.3 Role of Sukhna Lake

10.3.1 Even though used for recreational purposes and was not considered as a part of the water supply source, Sukhna Lake has been seen to be contributing a large amount of water to the area by seepage.

10.4 Lake in Patiali Rao

10.4.1 It is possible to construct another lake in Patiali Rao and it will enhance the recharge into the Chandigarh area.

10.5 Conjunctive Utilisation of Surface and Sub-surface Waters

10.5.1 Planning for water supply in a region should take into account the interplay of the surface and ground waters because they are so much interrelated as seen by the effect of Sukhna Lake.

10.6 Utility of the Water Balance Study

10.6.1 The estimates of the various components were made by empirical formulae and many assumptions, and involve error. Nevertheless, these estimates indicate the order of magnitude of various components

and the conclusions arrived at are expected to be valid. As more dependable data from runoff, evapotranspiration, water use and groundwater fluctuations are collected, more rigorous analysis could be made.

11. References

- (1) Baljeet Singh : "Water Balance Study of Chandigarh for the period 1967-70". Thesis submitted to the Punjab University in partial fulfilment of the requirements for the degree of Master of Science in Civil Engineering (Irrigation and Hydraulics).
 - (2) Uppal, H. L. and Gulati, A. D. : "Development of Empirical Relations for determining Potential Evapotranspiration from Climatological Data". "Irrigation and Power" Jnl., Vol. 22, No. 4, October 1965.
-