



REPORT
ON
RESIDENTIAL BUILDINGS

COMMITTEE ON PLAN PROJECTS
(Buildings Projects Team)
NEW DELHI
July 1961

Composition of the Team for Selected Buildings Projects.

Leader

Shri S. K. Patil, Minister for Food and Agriculture.

Members

Shri Sarup Singh, I.S.E., (Retd.), formerly Director, National Buildings Organisation.

Shri N. G. Dewan, I.S.E., Chief Engineer, Central Public Works Department.

Maj. Gen. Harkirat Singh, Engineer-in-Chief, Army Head-quarters, New-Delhi.

Dr. Eng. A. Carbone, Consulting Engineer, Calcutta.

Shri C. P. Malik, Director, National Buildings Organisation (*ex-officio*).

Member Secretary

Shri T. S. Vedagiri, Superintending Engineer.

**MINISTER FOR
FOOD AND AGRICULTURE,
New Delhi, January 10, 1961.**

My dear Chairman,

I have great pleasure in forwarding the report of the Selected Buildings Projects Team on Residential Buildings. You will recall that this was one of the major items of study taken up by the Team. Since the outlay on Residential Buildings is substantial, the Team considered it worth while to evaluate certain building projects with a view to minimise the cost of construction commensurate with reasonable living standards so that many more could be given the benefit of accommodation within the limited resources available. The Team set up a Panel of Engineers and Architects for the purpose, under the Chairmanship of Sardar Sarup Singh, I.S.E., (Rtd.), Member-Chief Engineer of the Team. The Panel studied in detail a few selected housing projects put up both in private and public sectors in Madras, Bhopal, Bombay and Bhilai. Many other plans relating to housing colonies were also reviewed.

On the basis of this study, the recommendations contained in this report have been evolved. The Panel observed that there have been wide variations in standards. It has, therefore, laid down certain norms for effective space utilisation and standards and specifications for economical construction. The report includes recommendations on every aspect of building technique such as lay-out, orientation, space utilisation, use of materials, methods of reducing cost of construction, amenities and fittings, organisation, foundation in different soils and construction in different regions including earth-quake regions, etc.

One of the important recommendations, is regarding standards of accommodation for different categories of Staff. The recommendation envisages a saving of 44 per cent. in the element of subsidy and 11 per cent. in the capital costs over standards obtaining at present for Government Construction in Delhi.

With these recommendations given by the Team regarding all essential aspects of residential buildings, I am confident that the Government will be able to realise greater benefit for the money spent on this sector in this and the future Plans. The Team is glad to endorse the views of the Panel and is grateful to them for their valuable recommendations contained in the report.

I take this opportunity of thanking the authorities of the Public and Private Sectors for their co-operation in supplying information required by the Team and for the facilities that they have afforded for site studies and discussions.

Yours sincerely,
S. K. PATIL.

**Chairman,
Committee on Plan Projects,
Government of India,
New Delhi.**

REPORT ON RESIDENTIAL BUILDINGS

CONTENTS

<i>Report</i>		<i>Page No.</i>
	Introduction	
1	Survey of Existing Situation	1
2	Scales of Accommodation	3
3	Planning the Layout	10
4	Specifications	21
5	Amenities and Fittings	44
6	Methods of reducing Cost of Construction	45
7	Administrative and Financial Problems	51
8	Summary of Important Recommendations	56
 <i>Appendices</i>		
I.	Statement showing monthly subsidy for the different types of quarters in various projects.	59
II.	Statement of subsidy as per existing accommodation in Delhi	60
III.	An extract from the Report of Committee of National Buildings Organisation on 'Foundation in Black Cotton Soil'.	61
IV.	An extract from article in the journal of National Buildings Organisation dated October 1958, by Dr. M.L. Puri and N.R. Srinivasan of Central Road Research Institute, New Delhi.	64
V.	An extract from the National Buildings Organisation Technical Information Series—14 on termite and termite proofing.	66
VI.	Madras Terraced roofing with brick on edge, 3 inches concrete, three courses of flat tiles and three coats of lime plaster to top and bottom.	69
VII.	Statement showing built-in furniture and amenities	72
VIII.	Comparison of man hours between conventional and advanced building methods in the construction of masonry wall dwelling.	78
IX.	Savings through use of Modular Coordination as compared with conventional construction methods in the construction of six homes, U.S.A. 1947.	79
X.	Number of man hours required in each main trade for one pair of semi-detached houses.	80
XI.	Flow chart (Administrative)	81
XII.	Western Railway—Joint Accounts and Engineering Circular.	84
XIII.	List of Selected Reference Books	86
 <i>Flates</i>		
I.	Sketches showing balcony and corridor access.	
II.	Charts showing safe soil pressure beneath footings on sand—(a) & (b) as determined by bearing capacity, (c) corresponding to one inch settlement.	
III.	Method of securing the shutter with precast R.C.C. Frames.	

INTRODUCTION

0.1. In the Second Five Year Plan about Rs. 200 crores was provided to be spent on residential buildings alone—a very substantial outlay. In the Third Five Year Plan the outlay is expected to be still larger. Wide variations have been observed in the lay-outs, scales of accommodation and specifications. Even after making due allowance for local conditions, the cost variation from project to project and from department to department is much too much. It is obvious, therefore, that rationalisation in design and uniformity in specifications will result in sizeable saving in the cost of residential buildings.

0.2. With a view to achieving economy in building construction on rational lines, the Committee on Plan Projects constituted the Buildings Projects Team to carry out evaluation of selected building projects and lay down norms and standards. The Buildings Projects Team in turn set up a Panel of experts for the study of the problem. Its composition is given below:

(i) Sardar Sarup Singh, ISE (Retd.), Member-Chief Engineer, Buildings Projects Team	<i>Chairman</i>
(ii) Shri E. A. Nadirshah, Concrete Association of India, Bombay	<i>Member</i>
(iii) Colonel H. C. Vijh, Chief Engineer, Balmer Laurie & Co. Ltd., Calcutta	<i>Member</i>
(iv) Shri R. W. Wilson, Director (Standardisation), Railway Board, New Delhi	<i>Member</i>
(v) Shri K. N. Subbaraman, General Manager (Construction), Hindustan Steel Ltd., New Delhi	<i>Member</i>
(vi) Shri R. L. Gehlote, Senior Architect, C.P.W.D., New Delhi	<i>Member</i>
(vii) Shri M. S. Bhatia, (formerly Housing Adviser, Min. of W.H.&S) Additional Chief Engineer, C.P.W.D., New Delhi	<i>Member</i>
(viii) Prof. G. S. Ramaswamy, Assistant Director, Central Buildings Research Institute, Roorkee.	<i>Member</i>
(ix) Shri N. B. Shroff, Architect to Ministry of Railways, New Delhi	<i>Member</i>
(x) Shri Fayazuddin, Chief Town Planner, Government of Andhra Pradesh, Hyderabad.	<i>Member</i>
(xi) Shri T. S. Vedagiri, Superintending Engineer and Secretary, Buildings Projects Team.	<i>Member Secretary</i>

0.3. When the Panel's work was in progress, Shri Wilson and Shri Gehlote retired from service and in their places Shri D. N. Chopra, Director, Standards (Civil) Railway Board and Shri S. R. Yardi, Senior Architect C.P.W.D. took over as Members.

0.4. We have devoted considerable time to on-the-spot study of the housing colonies put up by various agencies, both public and private. The Projects that have been visited are listed below:—

- | | |
|------------------|----------------------------------|
| Madras | (a) Lower Bhavani Sagar Project. |
| | (b) Neiveli Lignite Project. |

- (ii) Bhopal (a) Tantia Topi Nagar.
(b) Heavy Electricals Project.
- (iii) Bombay (a) Air India International Colony, Santa Cruz, Bombay.
(b) M.E.S. Flats at Colaba.
(c) Railway Flats at Bhadwar Park.
(d) Income Tax Officers Flats at Peddar Road.
(e) Flats for Reserve Bank Officials.
- (iv) Bilai Residential Buildings of Bilai Steel Project.

0.5. During their visits, the Panel held discussions with the local officers on the merits of the types adopted. The report is the result of the case studies, observations and discussions.

1. SURVEY OF THE EXISTING SITUATION

1.1. One of the aftermaths of the Second World War has been the phenomenal rise in the cost of building materials e.g. steel, cement, bricks and timber. The present day prices are of the order of five times the 1939 prices. There has been a similar rise in the cost of labour. The suspension of welfare activities during the last World War, caused serious shortage of buildings in general and residential accommodation in particular. After the War, the builders and the engineers realised that the high wage scales and the commodity prices had come to a stay and they must therefore seek other avenues for reducing the cost of construction. As a result, extensive building studies were undertaken in all advanced countries and research institutions grew up in England, Germany, Holland, United States, Canada, South Africa and Australia. In India, the Government set up the Central Building Research Institute at Roorkee and the National Buildings Organisation in Delhi. There are also State research institutes working in this field.

1.2. The main objectives of the research organisations have been to study the stress pattern in the structures (so as to effect maximum economy in materials), improvement in design techniques (such as the adoption of plastic theory of design for structures), revision of building codes, adoption of functional specifications in preference to dimensional ones, rational space utilisation in buildings, evolution of light-weight materials, modular coordination, advance planning, efficient lay-outs, site management etc. Many more items can be added, but this gives an idea of the trend in which progress has been directed.

1.3. Whereas in India, experimental work is being done by research organisations, the work of case studies and laying down norms and standards for various types of construction (experience has shown that this is a very effective way leading to economy) has been entrusted to the Buildings Projects Team. With the element of repetition which is very pronounced in large housing colonies that are being constructed in cities and industrial townships all over the country, there is great scope for economy in cost as well as building materials if we resort to standardisation and rationalisation of specification.

1.4. In the past, cost of construction was so low that it was rare that Government employees in the higher pay range or even in the middle income group, were required to pay rent at the maximum rate of 10 per cent of the emoluments laid down by the Government. The position has now become different. The cost of construction has risen to such an extent, that the gap between the economic and the recoverable rent has become very wide with the result that the Government has to subsidise the rent throughout, particularly for the lower income groups. The subject has therefore assumed great importance. In the recommendations we have tried to meet the minimum comfort requirements of the user, with minimum cost to the employer.

1.5. It is true that Government is not motivated entirely by commercial considerations in providing accommodation for its employees, but the problem needs to be studied in a manner which, while minimising the subsidy, meets reasonable physical living comforts of the employees. A somewhat different approach may however be justified in the case of Industrial Undertakings, where the quantum of the subsidy has a direct bearing on the earning. Our objectives in this study have therefore been:—

- (a) Evolution of suitable types of accommodation for various categories of the employees;
- (b) Fitting of the types to the pay groups, with a view to reducing the element of subsidy to the minimum;
- (c) Laying down standards for colony layouts, design criteria and construction techniques with a view to securing maximum economy commensurate with reasonable living standards and good building construction specifications.

1.6. We wish to record here our appreciation of the cooperation we received from the officers of the building projects that we visited. We are also grateful to the National Buildings Organisation for their contribution in Chapters 3 & 6 on the subjects of Orientation and Proper choice of materials.

1.7. A bibliography of the literature from which material has been drawn in writing this report is given in Appendix XIII.

2. SCALES OF ACCOMMODATION

2.1. Accommodation for various classes of employees.

With a view to appraising the existing situation in regard to the element of subsidy in the housing estates, we have collated information from a few selected projects, such as, Heavy Electrical Project at Bhopal, Fertilizer Project at Nangal, Steel Projects at Bhilai and Rourkela, Integral Coach Factory at Perambur, Madras and Telephone Factory at Bangalore. In addition to these, information has been collected about the Government residential construction in Delhi.

The number of categories of houses vary from project to project. Their large number, varying in character, makes the comparison difficult. Therefore these categories have been regrouped under six types as shown in the statement in Appendix I and subsidy calculated for 100 numbers of mixed type of quarters.

The subsidy is the difference between the 10% of the emoluments of Government employees entitled to occupy a particular type of quarter and the rent calculated at 6% per annum of the capital cost of construction including the cost of sanitary fittings, water supply, electrical installations but excluding the cost of land and its development (*viz.* expenditure on its preparation, surface drainage, sewage, water supply and street lighting) as defined in Fundamental Rule 45-A.

It would be noticed that the quantum of subsidy is large in the low income group as the bulk of the quarters belong to this class, specially in the pay range upto Rs. 250/- per month. It is, therefore, here that we have to exercise the maximum architectural and engineering skill in obtaining efficient space utilisation and good design: the objectives being, as stated before, to obtain the optimum results from the money spent. Consistent with economy, we have to maintain a certain standard for the various classes of Government employees.

The above observations, obviously call for an attempt to so fit in the types of quarters in the pay ranges, that the total subsidy is reduced to the minimum. In other words it means that the correct approach to the problem is to first lay down suitable types of accommodation and thereafter determine the ranges of pay which will give us the desired objective.

Having given considerable thought to the problem, we recommend the scale of accommodation and other amenities as specified in Table I, for the staff in the various pay ranges. These have been determined after considerable trial to fulfil the objective of reducing the element of subsidy consistent with the utility. We hope that with the improvement in the country's economy it may be possible to raise the standards of accommodation.

TABLE B

RECOMMENDED RESIDENTIAL ACCOMMODATION FOR VARIOUS CLASSES OF EMPLOYEES

Types	Pay range	Accommodation	Floor Area	Plinth Area
Type I	Below Rs. 110/-	A room and cooking verandah/room bath & W.C	22.25 sqm (240 sft)	30.00 sqm (325 sft) S.S. 34.50 sqm (370 sft) D.S.
Type II	Rs. 110/- Rs. 250/-	Two rooms, verandah, kitchen, bath & W.C.	37.00 sqm (400 sft)	50.00 sqm (540 sft) S.S. 55.75 sqm (600 sft) D.S.
Type III	Rs. 251/- Rs. 400/-	Two rooms, kitchen, store, verandah, bath & W.C.	48.25 sqm (520 sft)	58.00 sqm (625 sft) S.S. 65.00 sqm (700 sft) D.S.
Type IV	Rs. 401/- Rs. 800/-	One living room, two bed rooms, Verandah, kitchen, store, servant room, Bath & W.C. One bath & W.C. for servants for 4 flats.	81.75 sqm (880 sft)	97.50 sqm (1050 sft) S.S. 105.00 sqm (1130 sft) D.S.
Type V	Rs. 801/- Rs. 1600/-	One drawing-cum-dining room, study, two bed rooms, servant room, verandah, kitchen, store, 2 baths & 2 W. Cs. One bath and W.C. for two flats of servants & Garage.	134.50 sqm (1450 sft)	162.50 sqm (1750 sft) S.S. 171.75 sqm (1850 sft) D.S. Gar : 18.50 sqm (200 sft)
Type VI	Rs. 1601/- Rs. 3356/-	One drawing-cum-dining room, study, three bed rooms, verandahs, kitchen, & store. Two baths & 2 W. Cs., 2 servant Qrs. with one bath and one W.C. & one garage.	153.00 sqm (1650 sft)	185.50 sqm (2000 sft) S.S. 195.00 sqm (2100 sft) D.S. Ser : 41.75 sqm (450 sft) Gar : 21.00 sqm (225 sft)
Type VII	Above Rs 2250/-	Drawing room, dining room, study, three bed rooms, verandahs, kitchen, pantry store. Three baths & 3 W. Cs. 2 Servant qrs. with one bath and one W.C. and one garage.	190.25 sqm (2050 sft)	232.00 sqm (2500 sft) S.S. 255.25 sqm (2750 sft) D.S. Ser : 41.75 sqm (450 sft) Gar : 21.00 sqm (225 sft)

NOTE :—(1) The plinth areas are for load bearing construction using 9" bricks. These will have to be slightly modified when other materials are used or different types of construction adopted or where seismic forces are to be encountered.

(2) In coastal areas where verandahs are not essential the plinth areas of types V, VI & VII can be suitably reduced.

SCALE OF ACCOMMODATION AS APPROVED BY THE U.G.C. FOR PURPOSES OF GRANT

	Accommodation	Floor Area	Plinth Area
Lecturers	One living room, two bed rooms, a study verandah, kitchen, store, servant room, bath & W.C. One bath & W.C. for servants for 4 flats.	93 sqm (100 sqm)	112 sqm (1200 Sft.) S.S. 119 sqm (1280 sft.) S.S.
Readers	One drawing-cum-dining room, study, two bed rooms, servant room, verandah, kitchen, store, 2 baths & W.Cs. One bath and W.C. for two flats of servants and garage.	134.50 sqm (1400 sft.) Gar:	162.50 sqm (1750 sft.) S.S. 171.75 sqm (1850 sft.) D.S. 18.50 sqm (200 sft.)
Professors	One drawing-cum-dining room, study three bed rooms, verandahs, kitchen. store. Two baths & 2 W.Cs., 2 Servant quarters with one bath and one W.C. & one garage.	153.00 sqm (1650 sft.) Ser: Gar:	185.50 sqm (2000 sft.) S.S. 195.00 sqm (2100 sft.) D.S. 41.75 sqm (450 sft.) 21.00 sqm (225 sft.)
Vice-Chancellors	Drawing room, dining room, study, three bed rooms verandahs, kitchen. Pantry store. Three baths & 3 W.Cs. 2 servant quarters with one bath and one W.C. and one garage.	190.25 sqm (2050 sft.) Ser: Gar:	232.00 sqm (2500 sft.) S.S. 255.25 sqm (2750 sft.) D.S. 41.75 sqm (450 sft.) 21.00 sqm (225 sft.)

- (3) The floor areas given in the table include all living, service & circulation space within the house but exclude common circulation area (vertical and horizontal).
- (4) For garages reference may be made to para 2.4.
- (5) "In laying down the scales of accommodation in this table, the pay scales laid down in the Central Civil Services (Revised pay) Rules, 1960, have been taken into consideration. Type I is meant for class IV employees. The pay scales of junior ministerial staff in some of the States may however be lower. In such cases, type II may be adopted for the junior ministerial staff."
- (6) In case of multi-storeyed buildings (more than two storeys high) floor areas of the ground floor units will be as given in this table, while the plinth area may vary depending upon the number of storeys, type of construction and thickness of walls etc. Floor areas of units other than the ground floor, may be somewhat higher in some cases on account of reduced thickness of walls of the upper floors.
- (7) In case of single and double storeyed houses, from the point of view of financial control, the plinth areas as given in this table will be the governing factor.

The economies to be achieved by the adoption of the above recommendations will be seen from the statements in Appendix II. Subsidy has been worked out for a group of 100 quarters of the existing Government accommodation in New Delhi and a group of 100 quarters of the types recommended by us with the same base number. At present the subsidy works out to Rs. 1819/- per month while for our proposals it would be Rs. 1019/-. Thus there is a saving of 44% in the element of subsidy in addition to reduction in capital cost also to the extent of about 11%.

2.2. *Utilisation of space.*

We have given above the standards of accommodation and the basis on which these have been determined. The utility of the accommodation, however, depends not only on what is given but on how it is given. During our visits to the various housing schemes, we noticed that for a given plinth area there were a number of designs with varying degree of livability. While some are good, many are unsatisfactory in varying degrees. In some cases, sufficient attention does not appear to have been given to the positioning of doors and windows so as to secure good circulation and easy movement. In others, the room itself becomes the passage. Its utility is thus impaired and it is further worsened by the wrong placing of doors and windows. In one instance the ratio of horizontal circulation space to the total plinth area was as high as 40%.

In many designs, little importance has been attached to the use to which the room is to be put, and the shape of the room is decided in relation to the final plan. The factor that determines the shape is the suitability of a room to accommodate its particular furniture. This combined with careful positioning of doors and windows will result in a house much superior to the one not so planned. Authorities would be well advised to issue instructions that all plans submitted to them for housing should invariably show the positioning of the doors and windows and furniture etc.

In the early history of the house, there was a big hall in which every one ate and slept. Out of this emerged bed rooms and then came the dining rooms, the study room, library, kitchen and so on.

The tendency now is to break down these divisions as far as possible and to have what has become known as the "free plan", which is more in line with less formal way of the life today. In short, it presents a combination of modern sociological standards of life with a progressive use of new materials and building techniques.

The free plan is an ideal towards which designers are working and is in effect simply a matter of bringing garden into the house, allowing light and air to pass freely through the structure reducing wall areas and generally keeping in mind the point often forgotten that the house should be a place to live in rather than a place to look at.

As a result of the study of the break-up figures of space utilization in houses constructed in various projects, we consider that the following ranges should produce a balanced arrangement.

	Load bearing construction	Framed construction
(a) Living space i.e. floor areas of living, dining and bed rooms	47—50%	49—54%
(b) Service space covered by kitchen, bath and W. C., etc.	15—20%	14—19%
(c) Horizontal circulation space—passages and verandahs	10—12%	9—11%
(d) Vertical circulation space—stair cases and lifts	4—7%	3—6%
(e) Walls and columns space	15—17%	12—14%

We consider that it will be a good practice if the authorities in charge of designing of residential buildings, indicate on the plan the break-up of the built-up area into the different categories mentioned above. Any variation from the limits suggested, should be justified. This will ensure proper space utilization which we consider the most important factor contributing to economy and efficiency.

2.3. General recommendation for effective space planning.

(a) Living space

The ratio of the living space to the plinth area is a good index of planning efficiency. Endeavour should, therefore, be made to obtain as high a ratio as possible, by reducing to the minimum the circulation space and the area under the walls.

For good livability, an oblong shaped room is superior to square shape. Access to other rooms through the living room should as far as possible be avoided as it affects privacy and lowers the utility of the room. Provision of large number of windows with a view to obtain what is called a good elevation has adversely affected the utility of the room in some of the buildings visited by us. The design should be such that while the window area is sufficient for light and ventilation there should be enough wall space.

(b) Service Space

As mentioned earlier, this covers the area in the kitchen, bath and W.C.s.

Kitchen can be of two kinds:—

- (i) Combined dining and cooking.
- (ii) Cooking only.

In the smaller types of houses the combined type is preferable. For bigger types, separate kitchen may be provided.

The planning of the fixtures in the kitchen should be such that the work of the house-wife is reduced to the minimum. The National Buildings Organisation has published a pamphlet on 'Kitchen Layout' (Platform type) which may be referred to for guidance.

The minimum size of the bath and W.C. for the smallest type of quarter should be 1.5 x 1.25 m and 1.5 m x 1.1 m (*i.e.* 5' x 4' and 5' x 3½') respectively. For bigger types of quarters the area may be appropriately increased. It is conveniently possible to combine the bath and W.C. in about 3.7 sq. m. (*i.e.* 40 sq. ft.).

(c) *Horizontal circulation space*

In the lower type of quarters, it is difficult to provide independent access to all the rooms, but in the case of higher types, it should be possible to provide independent passages. We have, however, observed that sufficient importance has not been given to this convenience in the past. Entrance has often been provided through one of the rooms which naturally lowers the utility of the accommodation. As far as possible, endeavour should be to provide access through a lobby or a verandah. Where it is not possible to avoid passage through the living room the doors should be kept on one side to prevent cross passage. Further, the passage should be along the width and not along the length. Wherever independent passage is provided the clear width need not be more than 1.1 m (3½ ft.). The verandahs should have minimum clear width of 2.2 m (7 ft.) and provided with wiremesh for reasons of security. This confers the advantage of verandahs being used for dining and sleeping which is specially convenient in the smaller types of houses. A verandah which is not considered necessary from the point of view of circulation, may be reckoned as living space.

(d) *Vertical Circulation Space*

In metropolitan cities land values are very high. Multi-storeyed tenement construction is unavoidable. In the design of such buildings the provision of access to the tenements is a matter of major importance. Normally, one stair-case is provided to serve two flats on the same floor. This, however, is costly. Other arrangements to bring down the proportion of the circulation space to the built-up area are:

- (a) Provision of a balcony access or a corridor whereby 4 to 8 flats in each floor can be served by one set of stair-case as shown in Plate No. 1 sketches A & B.
- (b) Planning of flats in a triangular or starshaped pattern as shown in sketch C.

The balcony access is economical but it is inconvenient during stormy weather and reduces the privacy of the flats that have to be crossed in order to gain access to the flats at the other end. The latter drawback can however be overcome by placing the balcony at a level about 1.50 m. below the window sill. The arrangement is technically easy in a frame structure but in load bearing construction it may be costly.

In one case where corridor access was adopted (sketch D) the circulation space was disproportionately high and in another, kitchens

and bath rooms which faced the shaft within the building did not get sufficient light and ventilation (sketch E). The situation in the latter case could have been met to some extent by opening out the shaft as shown in the same sketch.

The star-shaped pattern is good as far as economy in circulation space is concerned but it creates an orientation problem. All the wings cannot receive proper protection from Sun's heat. This can be relieved to a great extent by suitably planting shady trees. Experience shows that all the flats receive sufficient light and ventilation. On the whole we favour the adoption of this pattern for multi-storeyed tenements.

The staircase should be designed to serve efficiently as a fire escape in an emergency. Even single staircase may be adequate as a fire escape if the approach lobby is well ventilated.

(c) Space covered by walls and columns

2.3.13. The thickness of walls and sizes of columns should be primarily controlled by engineering requirements in order to get the maximum living space.

2.4. Servant Quarters and Garages

2.4.1. The scale laid down in Table I recommends a garage each for quarters of types V, VI and VII. In single storey construction for the convenience of occupants, these should be built along with the quarters. In double-storey construction, it would be necessary to build them in separate blocks.

2.4.2. The servants' quarters should be built in a separate block with the requisite number of bath rooms and W.Cs.

For quarter of type IV, garages may be provided at the rate of one for two quarters. It would, however, be better to ascertain by a sample survey, the likely requirements. In any case, space should be left in the lay-out for constructing additional number in the future.

2.4.3. The garages for type IV should be rented separately.

3. PLANNING THE LAYOUT

In the previous chapter the Panel has drawn attention to the importance of space planning evolving an efficient and economical design for a residential building unit. Several such units go in a neighbourhood or a township. The factors which govern the layout of such a neighbourhood or a township to ensure economy and efficiency as a whole are dealt with in this chapter.

3.1. In developing new residential areas, it is essential from the point of view of good planning to ensure that these are made to fit into the general layout of the town so as to derive benefit from the existing facilities with respect to places of work, education, recreation, medical aid and shopping according to the formula of "man, place and work". This is necessary in order to avoid haphazard development, which unfortunately is so common in the country. Extensions not big enough to constitute a Civic Unit with self-contained amenities and sited in isolation from the parent towns are invariably a source of financial and administrative embarrassment. In big towns where a very large number of new homes are to be built, it may be possible to plan a new self-contained community, enjoying a new centre of employment. In such a community due regard must be paid to industrial, social, educational, and recreational centres and their relation to the new development as well as to accommodation for the different classes of people who make a well balanced residential neighbourhood. This means that before housing begins there should be a general development plan for the future of the whole area, flexible enough to be extended as occasion demands; and in addition a provisional and fairly detailed plan showing the possibilities of site development for the areas in which building is immediately contemplated.

3.2. The principle behind the idea of the urban neighbourhood must be not merely to break down the large town into units of a size which will allow a full growth of community spirit and neighbourhood feelings but to ensure that its redevelopment takes place in such a way that each unit, while essentially independent, forms part of a greater whole.

3.3. It is sensible if the ward boundaries of a town follow the boundaries of neighbourhood units, wherever they are strongly defined. The obvious way to delimit the neighbourhoods is by adopting barriers, such as railway lines and main highways as their boundaries and by creating features such as open spaces of the parkway type. These would be sufficient to establish individuality and would not suggest too great a degree of separateness.

3.4. It has been suggested that the desirable social unit is a "neighbourhood" with a population not exceeding 10,000 persons, living in an area where every house is within a compass of about 15 minutes walk from the centre of the neighbourhood. It is large enough to require and support a fairly complete range of communal facilities and yet small enough to bring every house within easy distance of the main neighbourhood shopping and social centre. Having arrived at an approximate size of a neighbourhood for 10,000 persons, the elements of the neighbourhood

plan and their disposition should be carefully considered. Within the neighbourhood it is strongly recommended that variety of dwellings should be provided. Each neighbourhood should be "socially balanced", inhabited by families belonging to different ranges of income groups. The careful disposition of amenities such as parks, playgrounds, recreational facilities, community buildings and shopping centres would go a long way to solve the problem of "social balance", but the main key to the solution would lie in the grouping of the various types of dwellings in such a way that they meet the need of the various social groups in the matter of immediate convenience and use, and yet at the same time form an integral part of the neighbourhood. The siting of the various types of dwellings cannot follow any set formula; but certain principles might be established which would best be placed immediately adjacent to public open space and near to the neighbourhood centre where all kinds of community facilities are provided.

3.5. It is desirable that there should be some principal focal centre in every neighbourhood; and so far as it can be achieved every centre should have its own individual character. Among neighbourhood buildings which may well be at the "centre" are places of worship, a branch library, a cinema, a restaurant and a group of departmental and cooperative stores. In addition to these, shops for catering to the daily needs of the families and primary schools for children should also be provided in different wards. The local shopping centre should be an important element in a neighbourhood plan. One of the key factors in providing adequate facilities for shopping is a knowledge of the number and kinds of shops required for each neighbourhood. They need a location which avoids long run for petty daily necessities.

3.6. On the assumption that the upper limit of 10,000 population is practicable, it is possible to make certain calculations in areas and regulate the density by the number of residential units per acre as the basis. Further it is desirable to take into consideration two standards of residential density—"gross density" and "net residential density". The gross density is the average number of residential units per acre provided over the whole area covered by the site. Net residential density is the average number of residential units per acre excluding roads, open spaces etc. The gross residential density may vary between 10 to 15 units of houses per acre for single storeyed development, 15 to 25 for double storeyed development and 20 to 30 for multi-storeyed development. This would result in an approximate net area of 50-55 per cent. for residential sites 15-20 per cent. for roads, 15-20 per cent. for community open spaces and 10 per cent. for public utility buildings including schools, shopping centres, community halls, and amusement buildings etc. and would also provide suitable sizes of plots with a depth varying from 2 to 2½ times the width facing the road. The economic sizes of plots for high, middle and lower income groups would be as follows:—

High Income Group

23 m x 46 m to 60 m

(75' x 150' to 200')

18 m x 37 m to 46 m

(60' x 120' to 150')

Middle Income Group

15 m x 30 m to 38 m

(50' x 103' to 125')

12 m x 25 m to 30 m

(40' x 80' to 100').

Lower Income Group

9 m x 18 m to 23 m
7.5 m x 15 m to 18 m

(30' x 60' to 75')
(25' x 50' to 60')

3.7. If detached or semi-detached houses are built closer which increases the density of population, a saving in the overall cost of housing is possible, due to the decrease in the length of service roads, drainage, and the reduction in the size of plots. For reasons of health and amenity, however, for low cost housing a saturation point is reached at about 20-25 houses to the acre, above which it becomes necessary to go in for double or multi-storeyed dwellings. This generally increases the direct cost of the dwelling unit in themselves, but considerably reduces the cost of services, as fewer roads are required and the underground services are shorter and connected to fewer points.

3.8. Assuming the same density, flats of an average size upto 3 storeys in height could be built for the same or even less area than required for detached houses on the basis of cost of each dwelling including its own share of cost of services. Taller buildings are justified only if land values are high.

3.9. Approach Roads

3.9.1. The buildings and their approaches should be thought of together. The pattern of domestic roads should generally be of a free and varied rectangular kind, except on hilly sites, with abundance of natural features. A level site is usually the most economical, but a hilly or undulating site offers opportunities which, if used with skill, can give a distinctive character to the scheme. In the former case, a layout of a generally rectangular pattern and making for right-angled street junctions is likely to give the best results, diversity being obtained by the adoption of the squares loop way, or cul-de-sac, close or quadrangle. In the latter case roads may run either with the contours, with buildings on one side only if the slope is steep, or at right angles to the contours with the buildings on both sides of the road facing down the hill and with access by foot-paths.

3.9.2. Roads should be laid out to follow the contours as nearly as possible with a view to facilitating easy planning of buildings and gardens, thus avoiding unnecessary falls in sewers etc. Cost of roads being second only to the cost of residential buildings must be kept low and the most effective way to achieve this is by reducing their length. For those of us who feel that there is great architectural and social unity in house groups around greens than in corridor streets, it is heartening to find that in the green type layout, where skilful use has been made of access paths and narrow carriageways, the cost of roadwork per house can be lower by as much as 20%, than of a normal corridor street layout.

3.9.3. Cross gradients are generally about 1 in 40 to 1 in 60 from the centre of the roads to throw off surface water. Steep cross gradient concentrates the traffic in the centre leading to uneven wear and inconvenience.

3.9.4. Width of roads suitable for a residential neighbourhood are given in the table below.

Sl. No .	Description	Right of way	Carriage way
1	2	3	4
1.	Pathways	10'—12'	..
2.	Service or Back lane	20'—30'	..
3.	Approach Road and Cul-de-Sac	25'—30'	..
4.	Residential Street	30'—45'	18'—24'
5.	Minor Roads (Collector Street)	45'—60'	24'—34'
6.	Major Road	60'—100'	34'—44'

3.9.5. A single traffic lane shall be taken as 12 ft. in width. Pathways are meant for pedestrian traffic with no vehicular traffic of any description. The approach roads should be provided in case of developments along arterial roads, which may be passing within the city limits, linking the State or National Highway Systems.

3.9.6. The major roads within the city connect important localities and carry heavy vehicular traffic. The minor roads collect traffic from different parts of the town to the major roads. But traffic is not permitted on the minor roads.

The rest of the nomenclature does not need any explanation.

3.9.7. The widths proposed above are for normal lengths, but when a street is unusually long, the width may be slightly more to take up increased traffic. Narrow and long streets are monotonous and unpleasant. The defects can be remedied by introducing a space by setting back one or two blocks of houses at suitable intervals. Such setback needs to be at least equal to the depth of the house, so that the end elevation of the front houses comes into prominence. In district towns, building lines are prescribed under the local bye-laws, and vary in relation to the width and type of roads.

3.10. Avenue Trees.

Avenue trees should be planted on both sides simultaneously with the construction of roads, so that when roads and buildings are completed they get the benefit of shade. In cases where single line of trees are to be planted, it should be on the South and West side. Trees already existing on site should be preserved and utilized in the layout as far as possible. It is more satisfactory to plant each street with one type of trees rather than several varieties. Excellent effect could be obtained by the use of flowering and shady trees locally available. The accepted minimum spacing allowed for average size tree when mature is between 9.0 to 12.0 m (30' to 40'). The principle is that the canopies should meet to obtain continuous shaded area.

3.11.1. The following is an illustrative list of services that should be normally provided, depending upon the size of the colony and the existing availability of services in the neighbourhood:

- (i) Engineering services of filtered water supply, unfiltered water for irrigation, drainage system, street lighting, domestic lighting and arrangements for sweepings refuse disposal.

- (ii) Dispensaries and maternity and child welfare centres.
- (iii) Schools.
- (iv) Shops for supplies, vegetables, halwais and cobblers, auto-workshops and cycle shops, restaurants, coal depots and dhobi-ghats, with necessary residential accommodation.
- (v) Police and electric sub-stations and fire stations.
- (vi) Post office and telephone booths.
- (vii) Petrol pumps, bus shelters, taxi, tonga and rikshaw stands.
- (viii) Community centres, cinemas and banks.
- (ix) Religious places.
- (x) Cremation and burial grounds.

The provision of above services is essential and should form an integral part of the colony schemes. Difficulties arise with regard to the sharing of the cost between the Government and the local authorities. In order not to withhold the work, these matters should be decided at an early stage.

There are several factors which affect the cost of services. Some of these are discussed below:

3.11.4. (a) Sewers

(1) The cost of excavation would obviously be low if the sewers are aligned along the natural slope. If the ground is very flat, additional expenditure may have to be incurred on flushing tanks. If on the other hand, the ground has a steep slope, provision has to be made for drop-connections. For flat slopes, the size of the sewers is correspondingly bigger.

(2) The character of the soil such as sandy, clayey or expensive and the sub-soil water level, affect the cost of sewer connections.

(3) The positioning of the sewage disposal works relative to the colony, the pattern of the layout and density of quarter affect the length of the sewers.

(4) If the area is to be developed by stages, it would be necessary to provide egg-shaped sewers. This adds to cost.

3.11.5. (b) Water Supply—Filtered and unfiltered.

(1) The type of soil and the level of sub-soil water directly affect the quantum of excavation.

(2) The distribution system depends upon the density of population in the various zones and on the pattern of the layout of buildings.

(3) Non-availability of cast iron pipes of the required diameter is an important factor, which affects the cost of the water supply as well as the drainage. The Panel for National Water Supply and Sanitation Schemes is making suitable recommendations to the Government to overcome this difficulty. Economy is possible by judicious use of Spun Concrete Pipes, wherever possible and pre-stressed concrete pipes in higher ranges of the sizes. This will conserve cast iron pipes for more profitable use elsewhere.

3.11.6. (a) Storm Water Drains.

(1) The general configuration of the area has a great effect on the cost of storm water drainage system. The volume of excavation will depend upon the direction of the slope of the ground. The normal practice is to go in for open drains upto a depth of about 3 ft. and underground R.C.C. pipes or masonry barrels for greater depth. The topography of the area therefore influences the cost of drainage considerably.

(2) Here also the excavation work depends upon the type and nature of soil and the level of sub-soil water.

(3) The road pattern in the area has a direct bearing on the cost of the storm water drainage system as the length of the drain, number, size and type of culverts and the number of gullies to be provided depend upon it. The position of out-fall and the feasibility of canalisation of the natural drainage channels in the area are other factors which affect the cost.

3.11.7. (d) Street Lighting.

(1) The cost of street lighting is directly dependant upon the length and the pattern of the roads.

(2) The provision of service lanes increases the cost of the lighting as a whole.

(3) The cost of street lighting also depends upon the system of wiring overhead or underground. The underground wiring though costly does not foul with the avenue trees. It will not hinder future widening, if placed initially well remote from the carriageways.

3.12. Orientation.

3.12.1. In the previous paragraphs, general principles governing the layout of a neighbourhood have been outlined. The discussion will not be complete without reference to the principles of orientation. In the following paragraphs broad indications are given regarding the factors that are to be considered in fixing up the proper orientation of buildings.

3.12.2. Temperature, air movement and humidity are the three main factors affecting human comfort. Controlling any of these would enable us to adjust human comfort to some extent. Whereas it is not possible to control humidity without mechanical aid, temperature and air movement can be controlled to some extent by proper orientation of the dwelling unit. Therefore, the two factors in selecting the orientation are:

(a) The incident solar intensities depending on the altitude and azimuth of sun and altitude of the place.

(b) The direction of the prevailing wind during different periods of the year.

3.12.3. Sometimes correct orientation for shielding against summer heat may not be the best from the point of view of ensuring desired amount of air circulation. The choice of orientation is thus largely a matter of compromise.

3.12.4. The orientation of individual buildings in any town is usually decided by various factors like environments, the position of the garden, park etc., the position of the street and its direction, the shape and size of the plot, etc. It is not often possible, when planning individual buildings specially when they are small and when they are to be constructed in a predetermined plot, to orient the building as a whole to what could be the best orientation from consideration of climate. Climatic factors like direction of wind, direction of dust storms, direction of driving rains and insulation both in summer and in winter are very relevant from the point of view of living comfort inside the house. Where due to other factors discussed earlier the best or the most optimum orientation could not be obtained in a site, a knowledge of the principles governing the orientation from point of view of thermal comfort can be helpful in planning the various rooms of buildings in such a way that the ill-effects of any orientation are compensated to the extent possible. In the case of planning of a new town as a whole or where big estates are planned a favourable orientation for a majority of units should, however, be possible.

3.12.5. Orientation should not be fixed with respect to the frontage of a building only. The proper orientation of each room must be worked out taking into account its functional requirements. As an example the garage, staircase and other general service facilities could be grouped on the western side to protect the living areas from the hot afternoon sun. When there are more than one bed room, one of them may preferably have windows on the east and all of them may preferably overlook a street or a garden. Choice of material and type of construction further help the orientation in ensuring comfortable living.

3.12.6. For most of the lower type of houses with two or three rooms, which from point of view of economy have to be constructed in terraces or rows, the principle of orienting each room in a direction most suited to its function cannot be satisfied. It will, therefore, be necessary to orient the buildings or rows as a whole to make the best use of the various facilities that are available.

3.12.7. Every geographical location has its climatic conditions. Every place has its individual characteristics which cannot be typically classified. It is, therefore, not possible to make rigid recommendations with regard to orientation of dwelling units based on broad climatic classifications but it is expected that architects and engineers would build the houses in such a way as to bring out the best of the natural possibilities, depending on location of site, micro-climatic non-climatic factors such as view, privacy etc.

3.12.8. A knowledge of the climatic norms for the particular locality is, of course, absolutely essential when fixing the proper orientation. Such details for the Delhi and Bombay areas have already been published by the National Buildings Organisation, and there is a programme of publishing similar data for other areas also. Detailed climatic factors, throughout the country, are given in "Climatic and Solar Data for India" a publication issued recently by the Central Building Research Institute. It gives temperature, humidity, rainfall, and wind data for all localities in India besides giving the altitudes and azimuths of the sun as viewed from the different Indian latitudes and the total solar load incident per

day on roof surfaces and on walls facing the eight cardinal directions, during different months of the year.

3.12.9. The publication also gives a simple method for designing window louvres and other shading devices.

3.12.10. Broadly the country can be divided into the following climatic regions.

- (a) Hot and humid regions.
- (b) Hot and arid regions.
- (c) Hilly regions.

3.12.11. This perhaps, is an over simplified classification. Climate of a region throughout a year will not generally fall in any of the above categories. It may be hot and humid during certain months and hot and arid during others, or cold and dry. As such, a correct appreciation of the multi-climatic needs of a locality is essential for designing houses for comfortable living all the year round. The various measures outlined in the succeeding paras would serve as a general guide.

(a) *Hot and Humid Regions.*

3.12.12. In hot and humid climate, the prime object of design is to provide free air movement through the building and to prevent the temperature of its inside surfaces rising above shade temperature. The house should face the direction of prevailing wind so that it obtains the maximum benefit from air movement even on days when there is little breeze. Openings of comparatively smaller size on windward side to those provided on the leeward side help to increase the air flow due to pressure gradient created thereby. Windows, however, need not necessarily be facing directly perpendicular to the wind direction. A tilt of up to 45° is permissible as the loss in efficiency is not more than 20 per cent. The window sill should be low to ensure maximum ventilation at the normal living level. Enclosed courtyards are unsuitable, since the walls obstruct air movement.

3.12.13. Walls should be shaded from the sun so as to prevent temperature rise above the shade temperature. Orientation for breeze should be balanced against optimum shade provided by North-South orientation. Protection of openings against rain is also necessary.

3.12.14. Buildings should normally have open planning and as far as possible they should be one room thick so to ensure through ventilation. Dead air pockets in plan and section should be avoided. Multi-storeyed structures in hot and humid zones should, therefore, be designed with the minimum possible depth so that all units may get the benefit of prevailing breeze. The blocks will in that case have to be laid out in parallel series and consequently the road pattern will become simpler but layout of such parallel block of flats appears somewhat prosaic and monotonous when repeated all over the space. The effect could, however, be offset to a large extent by staggering the blocks as mentioned earlier, and by proper landscaping.

3.12.15. A building in the path of the free wind alters its stream lines and introduces shadow regions. The depth of the shadow increases as

the height or length of a building increases while it decreases as the width of the building increases or the building is turned away from facing directly into the wind. In laying out dwelling units, it is, therefore, necessary to locate them away from the shadow regions so that free flow of air may not be affected. Reasonable space should be left between blocks. As stated earlier, if buildings are oriented oblique to the wind direction, the shadow depth decreases and in that case the clear distance required between two rows of quarters could be reduced. A 75 ft. high building turned at 45° to the direction of wind will cast the same shadow as a building 25 ft. high and of same thickness but perpendicular to the wind direction will cast.

3.12.16. Precise data on the subject, *i.e.* eddy-depth pattern of wind flow etc. is not available. However, laboratory facilities exist in the Central Building Research Institute, Roorkee to test the proper positioning of blocks in a layout.

(b) *Hot and Arid Regions,*

3.12.17. The characteristic features of hot and arid climate are high maximum shade temperature of the order of 42°C , a wide diurnal temperature range of 16°C or more, cloudless skies and low relative humidity, and a high incidence of glare. The sunny areas of these regions while hot and dry in the day times are cool to cold at night.

3.12.18. In the hot and arid areas, the main problem is that of providing shade and protection from day time heat and glare in summer and of reducing the rate of heat loss at night in winter. Unlike humid zones, where direction of prevailing wind is the most important factor, in hot and arid zones, houses should be oriented for sun.

3.12.19. The sun's heat is important both positively in cold period and negatively in hot period. The yardstick to measure the length of these periods is the human sensation and physiological reaction.

3.12.20. For comfort in overheated as well as in underheated periods, orientation and construction of houses should be such that:

- (a) there is minimum heat gain in the structure during overheated period;
- (b) minimum heat flow out of the structure during underheated period;
- (c) equal heat gain and heat loss in the period when outside temperature is in the comfort zone.

3.12.21. To minimise the heat gain during summer and to take benefit of solar heat in winter, the longer walls should face North and South and shorter walls East and West, so that the least wall area is exposed to the slanting rays of the sun during forenoons and afternoons. In Northern India, sun is in the South during the hottest part of the day. The altitude of the Sun is high in summer and low in winter. Provision of cantilever chajjas on the Southern walls will give adequate shade to the walls during summer while it will allow direct sunlight in the room in winter. It is known that the daily total of solar incidence on a Southern wall during

the winter months is appreciably greater than even that on the roof; especially in the Northerly latitudes where winter conditions are more severe. Also, the thermal load on a Southern wall in these latitudes during mid-summer is a minimum. These considerations point to a Southern orientation as the most advantageous.

3.12.22. Verandahs are desirable on the South not from the point of view of protection from heat in summer but for sitting out purposes in winter. Openings must be small in the West and should be properly protected. To save on cost of verandahs, the afternoon sun can be kept off by providing louvres or tilted vertical sun breakers. Alternatively a small tilt to the above orientation may be given, away from the West towards South. It is from this point of view that the Ford Foundation Team in their report to the Town Planning Organisation have recommended an orientation of up to 20° East of South for the preparation of the Greater Delhi Regional Master Plan.

3.12.23. During summer, the sun can be in the North even in latitudes North of the Tropic of Cancer. In fact, higher the latitude, the more Northerly is the azimuth of the sun rise or sun set. In the Northern regions of India, the sun will shine on the Northern face till about 9 A.M. in the morning and again after about 3 P.M. in the evening. It is therefore important to keep this in view in choosing the orientation and in providing louvres and other shading devices. Climatic Charts for Delhi, published by National Buildings Organisation give the altitude and azimuth of the sun for different times during different months of the year along with other climatic data and a reference to these for designing buildings in Delhi region will be of help.

3.12.24. As already stated, the longer axis of buildings should run East-West so as to avoid excessive heat from the West side. This would require all the buildings in particular zone to be oriented in one direction. It must be admitted that in a project, all the buildings cannot be oriented alike without jeopardising other features of equal importance. It is, therefore, necessary to study the problem with special reference to local conditions.

3.12.25. A compromise is necessary in this region between the orientations best suited for sun and for wind to make dwellings comfortable during short spell of rainy season and during spring and autumn when certain amount of breeze and ventilation is necessary to ensure comfortable conditions. This can be attained to a certain extent by turning the building slightly towards the direction of prevailing wind.

3.12.26. Research and systematic study to decide the best orientation have been taken up by the National Buildings Organisation in collaboration with Central Building Research Institute. In the meantime an understanding of the factors that create comfort should enable the architects to design the building in such a way as to obtain the desired measure of comfort by suitable arrangements of rooms, chajjas, louvres etc.

3.12.27. Trees, lawns, water ponds and volume effect of buildings are other remedies to reduce the heat intake of buildings. Deciduous trees like gulmohar shade the building in summer but allow the benefit of solar heat in winter.

(c) *Hilly regions.*

3.12.28. In this region higher altitudes are responsible for a fall in average temperatures. Temperature drops by about 3°F for every thousand feet rise in height so that at 4,000 feet above sea level it rarely gets uncomfortably warm.

3.12.29. Buildings should be located on Southern slopes as they receive maximum sunshine for greatest duration of time. The openings in buildings should be so placed as to avoid undesirable cold winds in winter.

3.12.30. There is marked drop in temperature at night. Therefore the time lag of a massive structure with a high heat capacity is useful. At night the heat that it stores during day is welcome except perhaps on very hot day. It is necessary to provide ceilings of good thermal insulation value to reduce loss of heat by radiation to the sky at night.

4. SPECIFICATIONS

The study of residential buildings which have been taken up for evaluation by us reveal wide variations in specifications. In many a case they have been drawn without any regard for economy or functional requirements. We, therefore, consider it desirable to give broad indications with regard to some of the important items such as, foundation, superstructure, roofing, flooring, finishing etc.

4.1. Foundation*

4.1.1. The conventional method of designing foundations is to enlarge the base of the column or wall for the purpose of transmitting the load to the subsoil at a unit pressure suited to the character of the soil. The width of foundation thus depends on the bearing capacity of the soil, but, in many cases of single and double storeyed residential buildings it is determined more by other factors. In deciding the depth of foundation, one of the important considerations for normal soil conditions is that foundation should be immune from the effects of weather.

4.1.2. Failure of foundation may occur in two ways. Firstly, the entire foundation or any of the elements of which it is composed may break into the ground because the soil is incapable of supporting the load without failure. Secondly, the supporting soil may not fail, but the settlement of the structure may be so great or so uneven that the superstructure may become cracked and damaged. These two types of unsatisfactory behaviour have almost independent causes and can usually be investigated separately. The first is a function of the strength of the supporting soil and is known as 'bearing capacity failure'. The second depends upon the stress-deformation characteristic of the soil and is known as 'detrimental settlement'.

4.1.3. For selecting the appropriate type of foundation under a given set of conditions and for predicting the performance of the completed structure with respect to both the types of unsatisfactory behaviour described above a knowledge of the probable behaviour of each type of foundation for each type of subsurface condition is essential. Significant characteristics of the principal types of soil generally met with and the type of foundation suitable are briefly outlined in the following paragraphs.

4.2. (i) Foundations on Sand

4.2.1. If the site is underlain by sand the foundation may consist of footings, rafts or piles. The choice depends primarily on the relative density of sand and on the position of water table. The relative density determines the bearing capacity of footings or rafts and the resistance of piles. It also is the principal factor in determining settlement.

*Material is drawn from 'Foundation Engineer' by Peck, Hanson and Thornburn.

4.2.2. The unit weights of most sands whether dry, moist or saturated lie within a fairly narrow range. Therefore, the unit weight of sand is in itself not an important variable in the determination of the bearing capacity of a footing. However, if the sand is located below the free water surface, only its submerged weight is effective in producing friction. This is half the moist, dry or saturated weight. The value of angle of internal friction is not appreciably changed by submergence. Hence it may be concluded that a rise in water table from a great depth up to the top of surcharge would have the effect of reducing the bearing capacity to about one half of its value for moist dry or saturated sand. Thus the position of water table is of outstanding practical importance in establishing the bearing capacity of a footing on sand.

4.2.3. The net soil pressure at the base of a footing should not exceed about one third of the net ultimate soil pressure. The soil pressure at which the factor of safety against breaking into the ground is equal to 3.0 is referred to as 'safe soil pressure'. It may be determined most readily by means of figures (a) and (b) in plate II. By entering figure (a) with the width of footing B and the value of the penetration resistance N (the number of blows necessary to produce a penetration of one foot) one obtains the safe soil pressure for a footing surrounded by no surcharge. If surcharge exists figure (b) indicates the additional safe soil pressure due to surcharge.

4.2.4. The diagrams are applicable without modification if the ground-water level is at a depth of B or more below the base of the footing. If the groundwater is at the base of the footing, the safe soil pressure obtained from fig. (a) should be divided by 2. If the groundwater is at the top of the surcharge surrounding the footings, the increment of safe soil pressure due to the surcharge, as given in Fig. (b) should also be divided by 2. If the ground water is at some intermediate position, sufficiently accurate values can be obtained by interpolation.

4.2.5. The penetration resistance for the sand at a given site should be determined by making standard penetration tests at a number of points, preferably at least one for every 4 to 6 footings. Values of N should be determined at intervals of $2\frac{1}{2}$ ft. in the vertical direction, and the average N value beneath each point should be determined between the level of the base of the footing and a depth B below this level. The smallest average value of N obtained in this manner should be used for computing the safe load on all the footings.

4.2.6. The settlement of footings on sand is governed by the stress-deformation characteristics of the materials. The rigidity of sand increases markedly with increase in relative density and is approximately proportional to the confining pressure. The confining pressure in a mass of sand is at least roughly proportional to the vertical pressure and is, therefore, also roughly proportional to the unit weight of the sand immediately beneath and beside the footing. If the water table is near the ground surface, the effective vertical pressure in the sand is due only to its submerged weight. Hence if the water table rises to the foundation level, the settlement of a footing is likely to be approximately doubled.

4.2.7. The preceding paragraph leads to the conclusion that, for a given soil pressure, the settlement of a footing on sand depends upon the

relative density and on the position of the water table. Theory, as well as laboratory and field investigations, show that the settlement for a given soil pressure also increases with increasing width of footing. The known facts concerning all these relationships are summarized in Fig. (c)—Plate II. From this figure can be determined the soil pressure which, for a given value of N and a given size of footing will cause the footing to settle 1 in. If the pressure corresponding to some other amount of settlement is desired, it may be computed from the value given by the chart by assuming that the settlement varies directly as the soil pressure.

4.2.8. Figure (c) has also been constructed on the assumption that the water level is at least a distance B below the base of the footing. If the water level is near or above the base of the footing, the pressure corresponding to a 1-in. settlement should be taken as half the value given by the chart. For intermediate positions, the proper pressures may be obtained by interpolation.

4.2.9. Values of N with which to enter the chart in Fig. (c) should be determined by the procedure advocated in connection with Figs. (a) & (b). If the footing is not square, the least dimension should be used for B .

4.2.10. A comparison of Figs. (a), (b) & (c) indicates that the pressure that can safely be carried by most footings at a factor of safety of 3.0 is considerably greater than the pressure that will produce a settlement of 1 in. Therefore, in connection with the design of footings for a building, it is rarely possible to make use of the full strength of the sand. Only if the footings are very narrow, the water table high, and the sand loose, is the soil pressure permitted by the settlement criterion likely to be greater than that corresponding to a factor of safety of 3 against a bearing capacity failure. Both requirements must be checked if a satisfactory foundation is to be achieved.

4.2.11. In practical problems involving building foundations, the following procedure is suggested. The appropriate value of N should be determined according to the rules previously stated. The soil pressure corresponding to a 1 in. maximum settlement should be determined from Fig. (c) for the largest footing in the structure. This value should be compared with the safe soil pressure, Figs. (a) & (b), for this footing and all the narrower footings. Whenever the safe soil pressure is less than that given by Fig. (c) it should be used as the basis for design of the corresponding footings. Whichever of the two values governs the design, is considered to be the allowable soil pressure.

4.2.12. As regards rafts on sand, because of their large size compared to that of footings, the factor of safety against bearing capacity failure of the underlying sand is always very great. Hence the danger of a raft breaking into a sand foundation is too remote to require consideration. Also as the differential settlements of a raft foundation are likely to be less than those of a footing foundation designed for the same soil pressure, it is reasonable to permit larger allowable soil pressure on raft foundations. Experience has shown that a pressure approximately twice as great as that allowed for individual footings may be used because it does not lead to detrimental differential settlement.

4.3. (ii) Foundation on clay

4.3.1. Under various circumstances, footings rafts and piles may be used to support structures on deposits of clay. Independent investigations are required in connection with each type to determine the factor of safety against a bearing capacity failure and the amount of settlement to be expected.

4.3.2. The bearing capacity, depends primarily on the shearing resistance of clay, which may conservatively be taken as one half the unconfined compressive strength, provided the clay is free from secondary structural defects such as hair cracks or slickensides.

4.3.3. The settlement depends primarily on the compressibility of the clay which is intimately related to its history of loading.

4.3.4. In contrast to the safe soil pressure on sands, which for a given settlement decreases with the width of the footing, the safe soil pressure on clay is practically independent of the width of the footing. Therefore, at a given soil pressure large footings on clay are no safer than small ones, and, if the strength of soil decreases with depth, large footings, are less safe.

If the subsoil consists of clay too soft or too compressible for the establishment of footings or of a raft, the weight of the structure may be transferred to piles.

4.4. (iii) Foundations on Filled-up Ground

4.4.1. Filled-up grounds often lead to costly foundations if the entire strip of the fill is to be excavated or a raft is provided. Economy can often be effected by having piles driven into the firm soil below the fill.

4.4.2. The ground beam of reinforced concrete supported on the piles and bearing the superstructure of brick masonry may be designed only for the reduced bending moment due to arch action of brick masonry. Its value is $WL/50$, W being the weight of wall supported on the beam plus the dead and live load shared by the wall, and L being the effective span of the beam. The piles are designed and spread to carry the full load.

4.5. (iv) Foundations on Black cotton soil

Special consideration of the foundation problem becomes necessary while constructing buildings on black cotton soil and other types of expansive clays. The design of foundation in such clays is engaging the attention of many research laboratories both in India and abroad. The black cotton soil in India which covers nearly about 15 per cent of the country is a typical example of expansive clays. A Committee of National Buildings Organisation has recently brought out a report on problem of foundation on black cotton soil. It has outlined some general principles of design which are given in Appendix III.

4.6. Mix of concrete for foundations

4.6.1. For normal foundation work, cement concrete of 1 : 5 : 10 proportion should be adequate for buildings upto two storeys. Where lime is obtainable, lime concrete with 40 per cent of dry mortar may be used.

Pozzolan materials *e.g.* surkhi and cinder should be used as fine aggregates. Cement concrete mix 1:4:8 or even richer may be necessary where subsoil water level is high and there is danger of salt impregnation.

4.6.2. An extract from the work done on surkhi in the Central Road Research Institute is given in Appendix IV. The Indian Standards Institution has drawn specifications for surkhi for use in mortar and concrete (I.S: 1344-1959).

4.6.3. For multi-storeyed buildings of framed construction, the type of foundation depends on the spacing of columns. In one case, the Panel observed that columns were placed so close, due to certain turns in the buildings, that it necessitated the adoption of continuous footings which are costlier than independent footings and require more steel. On the other hand, if columns are spaced with a view to having independent footings, the super-structure may become uneconomical. There should be a judicious choice of the spacing of columns to obtain an economical structure as a whole.

4.7. Plinth Height

4.7.1. The Panel observed that the plinth heights of buildings vary from 15 cms to 76 cms (6" to 2'-6"). For permanent residential buildings, it is desirable to keep the height at least 45 cms (1'-6") above the crown of the approach road, from drainage considerations. This is necessary even otherwise as the level of the road rises in course of time thus reducing the effective plinth height. In areas liable to flooding the plinth height may have to be suitably increased.

4.7.2. It is necessary to point out here the importance of proper drainage. In the process of urbanisation, the obstruction to natural surface flow and the drainage channels, is unavoidable. To prevent flooding and consequent damages, it is essential that there should be an efficient artificial drainage system in modification or replacement of the natural drainage system.

4.7.3. The areas around buildings must drain effectively into the road-side drains which, in turn, must have sufficient slope to discharge water into the branch and main drainage channels, without any ponding. It, therefore, follows that the plinth levels of all buildings must be determined after the drawing up of the drainage scheme. It is recommended that all plinth levels be marked on the layout plan to facilitate the work of the construction engineer.

4.7.4. Where the ground has a marked slope, it may be worth-while to have some ancillary accommodation as a basement floor on the lower side. In some other cases, provision of basement floor may be advantageous due to poor soil conditions and the consequent necessity of going deep. In such cases, the plinth height may have to be kept about 1 m (3 ft. or 4 ft.) above ground level so that proper lighting and ventilation can be arranged for the basement.

4.8. Damp Proofing

4.8.1. It is necessary to adopt suitable measures for preventing dampness in walls and floors of buildings constructed in areas of medium and

high rainfall (20" or more), and also in places where subsoil water table is high. For walls; damp proof course should be introduced at the plinth level and it may normally consist of a layer 1" to 1½" thick of cement concrete 1 : 2 : 4. Where, however, rainfall is heavy or water table is close to the level of foundation, it is necessary to adopt some better specifications for damp proofing which may consist of one or two coats of bitumen (35 to 60 lbs per 100 sq. ft.) and/or integral water proofing compounds added to cement concrete depending upon the local conditions.

4.8.2. In case of concrete floors, dampness is prevented by providing a layer of 4" to 6" of sand as a filling under the base concrete and by avoiding the use of brick ballast in the base concrete. Marble chip mosaic floors are less liable to damp penetration than ordinary concrete floors, and may be provided where the floors are likely to get damp in spite of other precautions.

4.9. Termite Proofing

4.9.1. An extract from the National Buildings Organization, Technical Information Series—14 on Termite and Termite Proofing is given in Appendix V. Termites can be divided into two types on the basis of their habitation *viz.* (1) the ground inhabiting or subterranean termites and (2) the drywood termites. Subterranean termites require moisture to sustain their life. They need access to ground at all times. The drywood termites on the contrary are able to live in fairly drywood and without contact with ground. The former needs a barrier, such as a continuous layer of concrete without cracks or sand layer properly protected or a metal sheet. The latter needs application of preservatives to the timber.

4.9.2. There is no permanently effective and economical method of dealing with termites once the building is affected. Hence the best time to provide protection against termites is during the planning and construction of buildings.

4.9.3. In areas where drywood termites exist, no amount of isolation from ground would keep wooden structures from being attacked. Structural timber in such cases should be made termite proof by adequate preservative treatment.

4.9.4. For detailed study, the reader is referred to the publications mentioned above.

4.10. Ceiling heights

The ceiling heights (floor to ceiling) commonly adopted for residential buildings vary from 3.0 m to 3.50 m (9'-6" to 11'-6"). Experiments conducted in Lucknow by the Railway Research Institute, C.B.R.I. and N.B.O. have proved that the height of ceiling beyond 2.75 m (9 ft.) has little effect on thermal comfort in a room. The ceiling height is therefore determined by other factors, such as height required for the proper working of ceiling fans and pendants, lights etc. The I.S.I. in their model by-laws have laid down that the ceiling height should not be less than 2.75 m (9 ft.). Considering all factors, we consider that for residential buildings the ceiling height may vary from 2.75 m to 3.3 m (9 ft. to 11 ft.) depending upon the type of quarters and whether the building is single or multi-storeyed.

4.11. Superstructure

4.11.1. In most of the residential buildings which we have examined, the walls are in brick work excepting in Bhopal where stone work has been good. Hollow concrete block construction has been adopted to some extent in Rourkela and Neiveli. R.C.C. framework has been used for multi-storeyed residential construction.

4.11.2. Wherever good quality bricks are available at reasonable cost, it is most satisfactory material for residential construction. For single and double storeyed building walls with span up to about 4 metres (12 ft.) one brick thickness will be sufficient except in seismic zones. For longer spans, brick and a half thick wall in ground floor and 22.86 cms (9") one brick thick walls in first floor should be adopted. Load bearing construction with brick walls can be adopted for 3 and 4 storeyed buildings. Where bricks are expensive as in Bombay and Calcutta, load bearing brick walls may be as costly as R.C.C. framework but the former needs no steel.

4.11.3. One brick thick walls without outside plaster do not give adequate protection against moisture penetration. With plastering the resistance is improved, particularly if cement mortar is gauged with lime. Ordinary bricks have a high degree of porosity which is considerably less in machine made compressed or extruded bricks. These have the additional advantage of greater strength, but require superior workmanship in laying to prevent moisture penetration through the joints. The cost of manufacture of these bricks may be a little higher than ordinary bricks, but this is partly compensated by greater uniformity, saving in mortar, and fewer rejects and breakages. Where the cost of bricks is high, reduction in cost may be possible by the use of machine made perforated and hollow bricks.

4.11.4. It is understood that the N.B.O. is working on a scheme for the setting up of a factory for producing extruded perforated bricks. We emphasize the need for pushing through this scheme and to set up such factories at suitable places in the country.

4.11.5. Strength of masonry depends upon strength of bricks and mortar. Rich mortars are unnecessarily specified when the strength of bricks may be low. Experiments are underway at some of the regional research laboratories and the Central Building Research Institute Roorkee on the strength of the brick-masonry made with different mortar mixes.

4.11.6. Experiments at the Building Research Station, England show that for brick possessing a strength upto 1,500 p.s.i. a mortar made up of one part of cement, two parts of lime and nine parts of sand is suitable. For bricks having strength between 3,000 and 4,000 p.s.i. the mortar may be composed of one part of cement, one part of lime and six parts of sand. For bricks with strength greater than 4,000 p.s.i. 1:3 cement mortar may be used. To improve workability the panel would recommend the addition to lime to the extent of 15-20% of cement.

4.11.7. Where building stone is available, stone masonry construction may be adopted provided it is economical in view of the fact that from practical considerations, the wall has to be of a minimum thickness of 15 to 18 inches.

4.11.8. Where suitable bricks or building stones are not available, precast hollow or solid concrete blocks of modular dimensions as specified by I.S.I. should be used. A number of residential buildings in concrete blocks have been constructed in Chittaranjan, Neiveli, Jamshedpur, etc. The mix of concrete should be designed to give a strength of 400 p.s.i. on gross area of the block. Generally it is possible to obtain this strength with a mix of 1:8. The face wall thickness of the blocks should not be less than $1\frac{1}{2}$ " and the net cross sectional area should be 55 to 60 per cent of the gross area. *The block should have either one or two ribs of adequate thickness joining the two longer sides.

4.11.9. The most common size of the blocks are:—

<i>Nominal</i>	<i>Actual</i>
16 in × 8 in × 12 in	$15\text{--}3/4$ in × $7\text{--}3/4$ in × 12 in
16 in × 8 in × 8 in	$15\text{--}3/4$ in × $7\text{--}3/4$ in × 8 in
16 in × 8 in × 4 in	$15\text{--}3/4$ in × $7\text{--}3/4$ in × 4 in

4.11.10. In case no external plaster or paint is to be applied, the mix should have sufficient density to limit the water absorption of the block to 10 per cent of its weight.

4.11.11. Certain simple precautions are, however, required in the manufacture of hollow concrete block masonry. In order to avoid the development of cracks both vertical and horizontal, the uneven settlement of foundations due to local soft areas should be avoided by providing footings of adequate width and thickness. The masonry upto the plinth level should be in solid concrete, by use of solid block or by filling the hollow block. The mortar joint should be thin and properly filled. In case of surfaces exposed to rain, the pointing of the joints should be so finished as to assist the shedding of rain water from the surfaces. The block should be laid in a composite mortar consisting of 1 part of cement, 1 part of hydrated lime and 8 parts of sand, care being taken to add cement not earlier than half an hour before use.

4.11.12. The curing and drying of concrete blocks is of prime importance in avoiding cracking of block masonry and the following procedure is recommended.

4.12. Curing.—The block, after removal from the mould should be kept under shade for 24 hours, and then cured as specified below. If the climate is hot and dry, a fog nozzle may be used for keeping the block in a slightly moist condition during the first 24 hours. The units may then be immersed in a tank for one week. Alternatively, the blocks may be kept completely drenched for one week and in a moist condition for the next 10 days. If stacking of the blocks is necessary due to limited storage space, it should be done only after two days to avoid damage to corners and edges.

4.13.1. Drying.—After curing, the blocks should be dried under shade for four to six weeks before use on work. They should be stacked with cells horizontal to facilitate through passage of air and kept under cover

as far as possible. The stock piles should be narrow, and in localities where the ground is damp, they should be kept on raised stands. The blocks should be protected from rain.

4.13.2. Laboratory test for ensuring that the blocks are ripe for use is that the moisture in the block should not exceed 40 per cent of the maximum moisture which an oven-dry block of identical properties can absorb after immersion in water for a period long enough for complete saturation.

4.13.3. Another way of cheap walling where sand is expensive is the adoption of cinder blocks construction. A mix of 1:6 (1 cement and 6 cinder) or 1:8 is normally adopted. The blocks can be manufactured in any of the hollow blocks making machines. They are however, subject to heavy shrinkage and expansion as a result of which cracks may appear in the walls.

4.13.4. In compelling circumstances where the life of a structure is not a major consideration, soil cement blocks can be used. Successful manufacture of such blocks however requires soil testing facilities and skilled supervision. Ample literature on the subject is available.

4.14. Doors

4.14.1. Joinery is a major item in the overall cost of construction of a building and therefore every economy should be effected. In the buildings inspected by us, the area of doors was found to vary from 20-40 per cent. of the floor area of rooms. These are high figures. Comparatively, a high ratio is understandable in small quarters but it cannot be justified in the case of bigger quarters. The sizes and number of doors should be regulated by functional requirements and kept down to the minimum commensurate with comfort.

4.14.2. Normally, the size of the door frame sections is 10.0 cms. x 7.5 cms (4" x 3"). With seasoned timber (teak or deodar), the section can be reduced to 7.5 cms x 6.5 cms (3" x 2½"). For double shutters, the frame width may be increased to 11.5 cms (5").

4.14.3. Normal thickness of the shutters is 3.8 cms (1½"). A thinner leaf is possible with well-seasoned timber.

4.14.4. Where suitable secondary species of timber is available it should be used. The joinery may be manufactured at some central place and supplied within a radius of economic distance. At these centres seasoning plants can be erected.

4.14.5. Due to the shortage of timber in the country and to effect economy, we suggest the adoption of R.C.C. door frames for the lower type of houses. There is, however, the problem of fixing the shutters securely to the frames without their working loose. The method suggested for the purpose is illustrated in plate III. The use of R.C.C. frames may prove specially economical in extensive and concentrated building work.

4.14.6. Again, to conserve timber, commercial flush doors, wherever possible, should be used in residential buildings. The thickness of this type of doors of block board construction need not be more than 3.2

cms (1½"). As an alternative, built up doors with panels of asbestos cement sheets hard board or ply-wood, can be used. These can serve the purpose very well in the interior locations but they are not suitable in exposed positions.

4.14.7. A factory for the manufacture of hard board has recently started functioning in the country. This should bring down the prices and make flush or composite doors, more economical.

4.15. Windows

4.15.1. In hot and dry climate it is desirable to keep down their sizes with a view to minimise the heat intake and avoid glare.

4.15.2. Heat transmittance through transparent surfaces is much greater than that through opaque surfaces. Therefore the glass area, its kind and orientation are of importance with regard to thermal comfort of a dwelling. For example, during certain hours of the day, for a Westerly oriented unshaded window, the ratio of heat intake of a unit area of glass to unit area of ordinary wall may be as high as 30:1. On an average it may be taken as 10:1 for a shaded window. In hot and arid regions therefore, the area of openings must be kept low. Placement and shape of openings should be decided according to the orientation.

4.15.3. In humid climates, on the other hand, larger size windows with low cills are essential for ventilation.

4.15.4. In their residential buildings taken for evaluation, the area of windows varies from 15 to 25% of the floor area. We recommend that this proportion may be 12 to 15% for hot and dry climate and 15 to 20% for hot and humid climate.

4.15.5. Normally wooden windows are used for residential buildings. Timber has however become expensive and seasoned timber is seldom available. The adoption of R.C.C. frames should therefore be considered. If the windows are manufactured from seasoned timber the thickness of frames can be reduced to 5.75 cms (2¼").

4.15.6. Steel windows possess the advantage of affording greater open area than wooden windows. Maintenance cost is low. With the easing of the steel situation, they may be preferred to wooden windows.

4.15.7. The fitting of doors and windows can be of different materials such as iron, brass, aluminium, bronze etc. Iron fittings being the cheapest are used for lower type of residences. Aluminium fittings now manufactured in India compare favourably with brass fittings in cost. They do not get tarnished and are strong enough for the purpose. For decorative work anodised aluminium fittings can be used.

4.16. Roofing

4.16.1. The type of roof to be adopted depends upon climate, extent, of rainfall, and local materials. In regions of heavy rainfall (above 40") pitched roofs are more suitable.

4.16.2. In areas of moderate rainfall, the general practice is to adopt reinforced concrete slabs, covered with suitable terracing and water proofing. In view of the present shortage of steel, the adoption of Madras terrace type of roofing (Appendix VI) and other flat roofs, which do not require critical materials should be considered. The Madras terrace type, however, involves the use of timber, which as remarked above is getting scarce. In coastal regions, the situation may be met by using timber imported from Andamans.

4.16.3. As an alternative, precast R.C.C. or prestressed concrete joists may be used in Madras terrace roofing.

4.16.4. For small spans, the economics of hollow floor construction are well established. The tiles can be of clay or concrete.

4.16.5. Recently, the Army authorities have used on a large scale, the doubly curved shell units evolved by the C.B.R.I. in their Amar Housing Project at Ambala. This is economical and possesses the advantage of speeding up the construction, as the units can be cast while the work on the foundations and falls is in progress.

4.17. Roof Drainage

4.17.1. Roof drainage assumes special importance in the case of flat roofs. The first essential is to give it adequate slope. This may be achieved either by varying the thickness of the material overlying the flat surface or by constructing the roof with a slope. The outlets and spouts must also be of adequate size as frequently the drainage failure is due to their getting choked.

4.17.2. In single storied quarters of type I & II projecting spouts may be provided. For double storied construction and for higher types of residences it is desirable to drain the roof through down water pipes. Their location in the front side of the buildings should be avoided and as far as possible they should not be in prominent positions.

4.17.3. Parapets are necessary if the roof is required for outdoor sleeping during the summer. Concrete gola with brick drip course should be provided at the junction of the roof and the parapet. When there is no parapet, the roof should project 15 cms to 22 cms (6" to 9") beyond the wall and provided with a drip course.

4.17.4. The down water pipes may normally be of cast iron or asbestos cement the latter being cheaper. They, however, require greater maintenance as they are liable to break in exposed situations. For cheaper type of residential buildings G.I. sheeting pipes may be used specially when the roofing is also of G.I. sheets.

4.18. Water Proofing and Insulation of roofs

4.18.1. Different specifications for the water proofing are in vogue in different parts of the country. In the South the water proofing course consists of brick jelly in lime mortar. In the Punjab and Northern areas mud-phaska and tiles are used. In the Western region, China-mosaic over lime concrete is adopted.

4.18.2. The N.B.O. has collected information on the various types of the water proofing techniques current in the country. The C.B.R.I. are testing the efficiency of these specifications. The Report should be of value to the practising engineer.

4.19. Flooring

4.19.1. The requirements of a good floor are that it should be (i) non-absorbant, (ii) durable, (iii) damp and water proof, and (iv) termite proof, where required.

4.19.2. As in the case of other components of buildings, the flooring specifications vary widely. Generally, in most part of the country, the flooring in the ground floor consists of 10 cms. to 15 cms. (4" to 6") of sand filling, under a layer of 7.5 cms—10.0 cms (3" 4") of lime concrete and a wearing surface. Clean sand filling is essential for making the floor damp and termite proof. When good sand is not available screened cinders may be used. In Bombay, the general practice is to put 23 cms. (9") stone packing, a layer of 6.25 cms. (2½") lean concrete and the wearing coat.

4.19.3. For the upper floors a screed of 2.5 cms—4.9 cms (1"—1½") thick cement concrete is laid directly on the slab or over a cushion of lean concrete. For economy, the cushion may be avoided but in this case the screed should not be less than 4.0 cms. (1½") to avoid separation from the base.

4.19.4. The R.C.C. slab can also be finished with a floating coat of cement, while it is green. This has been done in the quarters built at Delhi but has not proved successful. Terrazo tiles can, however, be laid direct over the slabs. This is costlier, but more convenient and far less liable to separation.

4.19.5. In places where available, stone slab flooring may be adopted. Successful flooring has been done with Shahbad and Cuddapah stone. The Slabs should be laid in cement mortar of uniform consistency over a bed of concrete in lime or cement.

4.19.6. In superior classes of residence, it is desirable to go in for a terrazo flooring *in situ* or in tiles. The *in situ* flooring is liable to separation and development of cracks when laid direct over the R.C.C. slabs. As remarked above, the tile flooring is better in this respect.

4.19.7. In all type of quarters, except type I, terrazo flooring should be adopted in bath rooms and W.Cs.

4.19.8. It is a good practice to depress the floors of bath rooms and W.Cs. in order to accommodate the gully trap and W.C. pans of the Indian type. The step arrangement is very inconvenient.

4.19.9. The finished surface of the bath rooms and the W.Cs. should always be an inch or so lower than the floor level of the adjoining area unless door sills are provided. It is needless to emphasize the importance of giving adequate slope to the floor towards the traps and the outlets.

4.20. Plastering

4.20.1. In the interest of economy, the ceilings of type I & II may not be plastered. To avoid exposure of reinforcements in the slab,

proper cover blocks or concrete rings should be used during pouring of concrete. For higher type of quarters, ceiling plaster is desirable. It need not be more than 1.0 cm (3/8") thick.

4.20.2. As already stated for one brick thick, outside plastering is essential for reasonable protection against moisture penetration. Internal plastering is required to keep the walls clean and sanitary. Dados are necessary in kitchens, baths and W.Cs. In W.Cs. and kitchens, the height should be upto window cills. In bath rooms, it may go upto 1.5 m. to 2.03 m. (5' to 6') near the shower, but in other places, it need only be upto the window cill. Above the wash hand basins 25 cms. dado is necessary, in order to avoid damage to the wall.

4.21. Chulahs

4.21.1. A well designed chulah is obviously an important item of comfort in a house. The essential requirements of a good fire place are:

- (a) Smokelessness.
- (b) Thermal efficiency.
- (c) Simplicity of design and its suitability to available fuel.
- (d) Economy in construction.
- (e) Easy operation and maintenance.

4.21.2. In our opinion, the chulah evolved by the Hyderabad Research Institution well answers these requirements. It consists of an 'L' shaped duct with three holes for cooking pots and an opening for the firewood. At the end of the duct is an arrangement for a big pot of water where the hot gases, before going out, are further utilized, thus providing an automatic supply of hot water for the family. The gases are finally taken out of the cooking range by means of a chimney which can be made of metal, clay pipes, bricks, country tiles or mud masonry built into the wall of the kitchen itself during construction.

4.21.3. The chulah is lighted just like any ordinary Chulah. The flame is maintained by natural draught ensured by the design and there is no need for frequent blowing. The fuel may be firewood, cowdung cakes or other combustible household waste. During cooking or lighting it is important to have all the three holes closed; otherwise there may be a back draught of smoke. At one firing three things can be simultaneously cooked on the three holes with different degrees of heat. To prevent the cracking of the edges of the cooking holes, a circular metal collar may be fixed.

4.21.4. The Chulahs can be built with one or two holes also and at suitable heights.

Improved chulahs of this type have been successfully adopted by the C.P.W.D. in New Delhi. In the Building Material Centre, the NBO is setting up in Delhi, it is suggested that such a chulah is installed on demonstration.

4.22. Grills and Window Bars

4.22.1. For security, protection for windows is necessary. For ordinary construction 5/8" round or square bars can be fixed at 4 1/2" centres.

4.22.2. Normally, window protection is not installed in the upper floors of residential buildings. We recommend that suitable number of bars should be provided in all upper floor windows for reasons of safety. Where necessary complete grills also may be provided.

4.22.3. For ornamental works several types of grills are available in the market.

4.23. Ventilation

4.23.1. For adequate ventilation in a building, it is necessary to provide sufficient open space both in front and the rear and, if possible, on one of the sides as well.

4.23.2. Ventilation openings are classified as permanent or occasional. The former refers to all types of openings that cannot be controlled, such as air bricks and fixed louvers. Occasional openings are regulated to suit individual requirements. The latter category includes windows, doors and adjustable louvers.

4.23.3. The permanent openings ensure that minimum amount of fresh air always enters the room. These are specially necessary for water closets and bath rooms. The occasional openings are intended for promoting indoor comfort particularly during the hot weather. This is achieved by increasing indoor air movement and the displacement of warm air indoors by cooler outside air. To obtain the best advantage, the choice of the type should be influenced by the following.

(a) The Building and the openings should be so orientated that the fullest possible use is made of the prevailing winds during summer time, provided that all glass areas can be shielded from direct solar radiation.

(b) the parts of windows which open on the windward side of houses should preferably be at a low level and may be so designed that incoming air stream is not deflected towards the ceiling but rather over the occupants;

(c) opening should be provided in the leeward side of the house to act as outlet openings. These should not be smaller than the inlet openings.

(d) the resistance in the path of the air as it flows through the buildings should be as low as possible; otherwise the advantage of large inlet and outlet openings are reduced.

4.23.4. The provision of simple opening on top of doors cannot produce the necessary ventilation, as it cannot result in air circulation without an opening on the leeward side. The evolving type of the ventilator induces natural air circulation.

4.24. Plumbing

4.24.1. The internal water supply, sanitary installations and the drainage works account for as much as 10-15% of the total cost of the construction of residential buildings. Efforts for effecting economy in this respect should not therefore be considered as of minor importance.

4.24.2. The object of plumbing is to discharge the waste to the sewers smoothly and swiftly, without permitting the entry of the air displaced from the system into the interior of the buildings. The practice hitherto has been the adoption of two pipe system. Recently, however, one

pipe system has been successfully adopted in European countries. In the U.K., as a result of research, even anti-syphon pipe of the one pipe system has been dispensed with. Certain precautions are however, necessary in this system such as keeping down the length of the connections and the provisions or deep seal traps etc.

4.24.3. For residential buildings whether of single or multi-storeyed construction, the one pipe system can be conveniently adopted by properly grouping the service rooms and the fittings. The one pipe system has been adopted in some important buildings in New Delhi; but to gain greater currency the municipal byelaws will require to be amended.

4.25. Considerations for Design of Buildings Located in Regions Subject to Earth-quakes.

4.25.1. The design of buildings to stand earthquake forces is a vast subject by itself. It is not possible to do justice to it in a report of this nature. But considering the necessity of putting residential buildings of the plan projects in areas subject to seismic disturbances in the country we have considered it expedient to deal with the subject briefly and bring out important points that should be taken into account in design and construction of the building in the danger zones. Some selected references from which the material contained in this chapter has been drawn, are given at the end (*vide* Appendix XIII) which the readers may refer for further study.

4.25.2. The data available in the country on seismic forces and their effects, is very meagre. This is mostly due to lack of adequate instruments for recording the occurrences of shocks. It is encouraging to note that a Research Department of Earthquake Engineering is being set up at the University of Roorkee. We would recommend that the preparatory work be completed as quickly as possible and early start made in the collection of data for future designs.

4.25.3. The Indian Standards Institution has recently, set up an Earthquake Engineering Sub-Committee for the drafting of a code of practice for earthquake resistant design of all types of structures. This will meet a long felt want.

4.25.4. Earthquakes that usually cause damage originate from the release of over-strained rocks 10 to 15 miles below the ground surface. The released energy is dissipated through waves longitudinal, *i.e.*, compression waves, which are the fastest with the shortest period and arrive at surface first of all and shake the structure. They are followed by the transverse *i.e.*, shear waves and the last of all to arrive are the surface waves which are of the longest period. The bulk of the damage is caused by the short period waves but when jumbled up they all contribute towards damage. The surface waves which may even have larger amplitude than the others cause less damage, being slower with longer period and consequential smaller acceleration.

4.25.5. The 'Magnitude' of an earthquake, is a measure of the energy released by the earthquake. Gutenberg and Richter have suggested that the equation:

$$\log 10E = 9.4 + 2.14M - 0.054 M^2$$

where 'M' is the magnitude and 'E' is the energy in ergs, may be used to correlate the magnitude of the earthquake with energy released.

'Magnitude' being a function of the energy released, is a measure of the size of the earthquake, whereas the 'Intensity' is a measure of damage at a particular place due to the earthquake. Thus, the 'Intensity' varies with the distance from the centre of the shock. For instance, a shock of magnitude 8 may be rated to have intensity 'X' near the centre 8th at a distance of 40 miles from the centre and so on.

4.25.6. The magnitude of the earthquakes are classified as a, b, c, and d. "a" covers the range of magnitude of 7.75 or above; "b" 7.0 to 7.7, "c" 6.0 to 6.9. and "d" 5.3 to 5.9. Shocks of magnitude "d" do not cause such damage to structures except in a very small area near the centre.

4.25.7. The 'Intensity' by itself is of no direct value in designing structures. In order to design structures the engineer is primarily concerned with the ground acceleration caused by earthquakes. Several attempts have been made to correlate the 'intensity' and the corresponding 'acceleration'. Hershberger, for example, has come to the conclusion that if the intensity is 'I' and the ground "Acceleration" is 'a' in cm/sec.² the relation,

$$\log_{10} a = I + \frac{9}{10}$$

is approximately correct.

Gutenberg and Richter have given a direct relation between the 'Magnitude' and the 'Acceleration' by stating that

$$\log_{10} \left\{ C \frac{a}{h} (D^2 + h^2) \right\} = 4.7 + 1.07M - 0.027M^2$$

Where 'M' is magnitude, 'a' the acceleration, 'D' the epicentral distance on the surface and 'b' the depth of the "effective centre" below the ground.

4.25.8. The equivalent lateral acceleration is related to the ground acceleration, the rigidity of the structure and the fundamental period of the vibration of the structure. This period of vibration is in turn related to the dimension of the structure by an approximate relation:—

$$T = 0.05 \frac{H}{\sqrt{b}}$$

where 'T' is the fundamental period of vibration of the building in seconds, 'H' is the height of the building in feet and 'b' the breadth of the building in feet in the direction considered. It has often been suggested that, with a view to avoid resonance, the natural period of vibration of the building should be less than the vibration period of the earthquake. Many values have been recommended for each of these, but considerable more data is still needed to come to any definite conclusion for Indian conditions. These considerations become important only in very tall buildings and so lateral force considerations based on suitable coefficient as explained subsequently in this chapter are sufficient for the types of the buildings, adopted in the Seismic Zone of India, at least for the present.

4.25.9. In the absence of seismic instrument the severity of ground motion at a certain location can be estimated only from the damage caused by the earthquake. Three most widely known 'Intensity' scales are the Rossi-Forel (1883), the Mercalli II (1902) and the modified Mercalli (1931). The Second and the Third scales are successive modifications intended to make the assessment of the intensity more accurate.

4.25.10. Earthquakes may be classified as Volcanic, which may involve violent explosions or relatively quiet out-pouring of lava; Plutonic, which connotes disturbances at great depth beneath the surface of the earth and Tectonic, which result in significant surface movements of the earth. Shocks originating within 35 miles of the surface of the earth are termed "shallow". Deep and intermediate shocks seldom cause appreciable damage to structures. It is, however, not possible to save even a well designed structure from failure if it is located in a moving fault zone when the ground surface is undergoing displacement.

4.25.11. The engineering problem consists of classifying the areas with respect to the size of the earthquakes that may be expected, determining what the quake might do in the areas and then devising ways and means to minimise hazard to life and property. This necessitates establishing a relationship between the size of an earthquake and the damage it causes. The extent of damage to structure, however, is a function of (i) type of structure, (ii) material and method of construction, (iii) intensity of ground motion, (iv) duration of ground motion, and (v) the nature of soil on which the structure stands.

4.25.12. Another important factor is the geology of the regions in which a structure stands. The intensity of motion of a point on the surface of the ground depends not only on the amount of energy released by the quake and the distance from the epicentre but also upon the modulus of elasticity and the density of the surrounding ground and the geological characteristics of the region. A structure standing on alluvium receives a greater shaking than the one standing on rock because of the lower elastic modulus of the former. Further, the vibration of very soft alluvium may consolidate it to smaller volume causing excessive settlement, which may be disastrous to the structure standing on it, although it may have by itself been strong enough to bear the shaking otherwise.

4.25.13. Omote and others have studied the effect of overburden over a basement rock on the damage caused during an earthquake and concluded that damage rate increased generally with the depth of the alluvium reaching a critical value for depths of about 115'. These conclusions need to be checked up in India for the Indo-Gangetic plain where the alluvium extends to the depths of as much as 6,500' at places.

4.25.14. Firm soils may remain unaffected by the passage of the earthquake waves. But in case of soft soils, the vibrations have the effect of liquefying the soil masses with extensive vertical acceleration. When the soil underlying a structure undergoes compaction and consolidation, differential settlement causes serious damage, as was evident in the case of a Department Store in Fukui, Japan, in the earthquake of 1948.

4.25.15. The method by which vertical component of seismic effect is accounted for is to reduce the permissible soil pressure. Such reductions vary from 10% for soils with low bearing values of say, one ton per sq. ft. to about 33% for soils for higher bearing values of say, 4 tons per sq. ft. This reduction permits application of extra vertical loads imposed on foundations by earthquakes and diminishes the possibility of uneven sinking through earthquake shocks. To locate structure on unconsolidated soils by reducing the allowable bearing pressure, is not recommended. Buildings located on made-up ground, in filled up tanks, ditches, etc. are liable to be damaged.

4.25.16. For increased safety, pile foundations should be adopted in loose cohesionless soils or highly elastic soil. Buildings of spread of footing may sink at the same rate or faster than the city streets, but structures resting on piles stay at a nearly constant level.

4.25.17. To counter the settlement, several buildings in Mexico city have been designed with concrete box foundations to float in the subsurface "soup". In addition, provision is included to raise them if they should tilt while settling. Buildings need not be designed for simultaneous action of wind and earthquake.

4.25.18. Seismic design computation must be made for structures over 50 ft. high or with a height width ratio over two or intended for use by large groups of people.

4.25.19. As earthquakes occur at long intervals even in the severe zone, an increase of 50% in the permissible stress of building materials such as reinforced concrete and steel is allowed with a view to effect reasonable economy. The permitted increase in concrete is 33 1/3%.

4.25.20. Earthquakes consist of horizontal and vertical ground vibrations. The horizontal motion is usually greater than the vertical. Certain records indicate that the vertical acceleration is about half of the horizontal. This, however, is only true in the case of those particular earthquakes.

4.25.21. The most destructive force is caused by horizontal earth motion. When the ground underneath a structure is moved suddenly to one side, the building will tend to remain in its original position because of its inertia. The acceleration (rate of change of velocity) of the horizontal movement varies and its proportion to gravitational force is called the seismic coefficient. If the maximum acceleration of the horizontal earth movement is one tenth the acceleration due to gravity, it is assumed that the stress in the structures caused by the earthquakes is the same as that produced by horizontal static force, equal to one tenth of gravity forces acting on the building.

4.25.22. The earthquake problem is one of dynamics involving mass, movement, velocity, acceleration, energy and work. The forces, shears and movements are a result of resistance to motion. Deflection is necessary but it must be controlled. All materials that are subject to strain, in addition to mass effect, absorb energy up to the point of failure. Even after rupture, most of these materials absorb more energy under continued earth movement by grinding and hammering together and in finally being dislodged. Materials vary in amount and character over a

wide range and therefore observed results cannot be logically or safely applied in general to all structures.

4.25.23. The vertical motion may have considerable potency because the structure may be quite rigid vertically. Moreover, this vertical component may reduce the weight of some elements, which weight has been relied upon in design to decrease tensile effects or it may cause "vertical" damage leading to lateral failure.

4.25.24. When the horizontal forces have been decided on, the stress can be computed in the manner of determination of wind stresses. A certain percentage of the mass at each floor is assumed to act on that level in the horizontal direction. In addition, since all parts of a building, exterior as well as interior, are subjected to the lateral earthquake forces, they must be considered in the stress analysis. Building should be designed to resist lateral forces in any direction, because an earthquake may occur in any direction. The earth movement, however, can be replaced by two components acting parallel to the axis of the building; therefore, it is sufficient to investigate its strength in two perpendicular directions.

4.25.25. The Meteorological Department of India have prepared a map of India showing the zones liable to damage by earthquakes and epicentral regions of the more serious earthquakes of the recent times. The details are available in IS:875-1957 (Indian Standard-Code of Practice for structural safety of building loading standards).

4.25.26. Most of the earthquake codes specify a single force co-efficient with a few rules for modifying it where necessary and the horizontal force so specified is treated as a static force acting on the structure. Buildings so designed have often satisfactorily resisted earthquakes of the intensities that have occurred in the United States. The single co-efficient cannot, of course, be appropriate to all parts of all structures so that a large factor of safety must be incorporated at correspondingly increased cost. This also has the effect of forcing the designer to choose horizontal rigidity as his guiding principle, though there are cases where to design from flexibility would give greater earthquake strength.

4.25.27. The availability of electrical calculators and the popularity of numerical methods for solution of engineering problems (due mainly to Hardy Cross and K.V. Southwell) have in recent years directed attention to the possibility of tackling, in a rational way, problems which could not be analysed before. It is, however, only in rare cases of exceptionally expensive buildings or in the proto-types of completely new types of buildings or plant such, for example as a nuclear power station, that the cost of a complete dynamic investigation is justified. For the majority of structures, compliance with the local buildings regulations may produce a slightly over-designed structure, but any saving resulting from more accurate designs will be over weighed by the higher design costs.

4.25.28. The following suggestions regarding methods of construction to reduce damage by earthquake are offered:

- (a) Heavy country tiled roof leads to damage during earthquakes and should be avoided.

- (b) Sloping heavy roof resting on load bearing walls often leads to damage during earthquakes and should be avoided.
- (c) Beams either timber or R.C.C. with narrow supports often lead to slipping of beams from their supports. Sufficient bearing should be provided.
- (d) Arches often get damaged and should be avoided.
- (e) The building should be rectangular in plan, the wall components and other features should be such as to make the buildings symmetrical in rigidity.
- (f) The centre of gravity in the structure should be as low as possible.
- (g) Frame structures should be preferred to those with load bearing walls.
- (h) Unnecessary joints should be avoided in the structure.
- (i) It is desirable to make provisions for proper escapes, open spaces shelters etc. in locality planning of zones highly susceptible to earthquakes.
- (j) A continuous spread foundation of reinforced concrete increases the resistance of a building to lateral earthquake forces. The first step of the design of a building, therefore, should be to provide a rigid foundation of reinforced concrete strongly tied together.
 - (i) Materials used for columns and piers should have high shear strength because all vertical members are subjected to considerable shear forces.
 - (ii) Material used in such buildings should be light but strong, because the horizontal earthquake thrusts increase with the mass of the structure.
 - (iii) They should be reliably tested for strength.
 - (iv) The weathering properties of the materials are of importance in so far as the deterioration in quality may reduce the strength of the building as time passes on.
- (k) In danger areas buildings should be symmetrical or as nearly as possible. The height of wall parts should be uniform. It is undesirable that the length of the buildings should be excessive in proportion to its breadth. Floors and walls should be continuous.
- (l) Portions of building of different mass and stiffness should be separated by complete joints, say 4" to 8" wide, to prevent hammering action due to oscillation.
- (m) Cantilever should be avoided. If they cannot be avoided, they should be of small span, say, not more than 3 ft. in projection and be designed for horizontal and vertical seismic forces.
- (n) All parts of a building should be firmly tied together and so safely braced that the building will tend to move as a

unit. Floors and cross-walls should be continuous throughout the building and opening should, as far as possible, be placed away from outside corners, symmetry in the arrangement of cross-walls or approximate coincidence of the centre of the mass and the centre of rigidity will assist in keeping stress caused by earthquake at a low level. If such precautions are not observed, forces due to torsion must be taken into consideration.

4.25.29. The property of fire resistance is one of paramount importance as fire frequently follows in the wake of an earthquake and its ravages are often greater than those of the quake. Reinforced concrete is one of the most suitable materials for earthquake resistance building construction because of its high resistance to fire.

4.25.30. The experience in Japan resulted in the development of special type of construction. The steel skeleton of a multi-storeyed building is composed of angles and channels in built-up sections utilising the maximum overall section modulus possible. After erection the steel skeleton is encased in concrete reinforced further with ordinary bars. The practice has developed due to the fact that it was cheaper to fabricate the built-up section than to utilise standard rolled section of equal section modulus.

4.25.31. The chapter would be incomplete without giving in brief some lessons learnt from 1957 Mexico City earthquake. Examination of many tall buildings in the business and hotel districts which were shaken severely revealed that faulty design and construction practices were responsible for much of the damage. Nevertheless, there were several reasons for believing that the buildings that were designed to the highest current standards and escaped the shock unscathed—including a 43-storey skyscraper—may not be so fortunate in future earthquakes.

4.25.32. A significant factor is the period of the shock waves. There is much evidence that the peak vibrations of the ground in this quake coincided with the natural frequencies of many of the tall buildings that were damaged severely. Thus, with ground and structure moving simultaneously in the same direction, the forces acting on the building built up rapidly and almost tore them apart. It is possible that many of the tall buildings that escaped this earthquake did not have the same natural frequency as the ground movements; in a severe future shock of resonant frequency they may not be so fortunate.

4.25.33. Damage occurred in a very large number of structures of different types, found mainly in the low part of the city, where the subsoil is formed by materials of low resistance and high compressibility. Keeping in view—(a) The seismic experience in other regions of the world, and (b) the preliminary analysis of the damages caused by the earthquake, as far as distribution and magnitude of the more probable accelerations in structures is concerned, (c) the influence of the mechanical properties of the subsoil on the extent and duration of ground vibrations; (d) existence of a predominant frequency in the soft subsoil; (e) contribution of partitions to the rigidity of structures and their action as energy dispersers; (f) breakage of structural components due to the collisions

between adjacent structures that vibrate in different periods; and (g) the possibility of destructive earthquakes striking buildings supported on bearing walls where the ground is rigid and yields very little. The Public Works Department classify the building into three groups, a, b and c depending upon type of occupancy. For example, hospitals, theatres, schools and other important buildings are included in group-a, and small houses in 'c'.

4.25.34. Examination of the damage reveals that in some places, the vibrations may cancel out. In others, they reinforce each other. Emilio Rosenbuth, consulting engineer, Mexico City, believes the magnification factor may reach 12 or more. This can explain why some buildings may have escaped damage while comparable structures nearly suffered severely. In one case, a building previously condemned as unsafe came through the quake without additional injury.

4.25.35. Probably because of the difference between the period of ground vibrations during the quake and their natural period of vibration, nearly all low building Mexico City came through with no serious damage. It is believed that the older low buildings survived because the walls acted as shear walls.

4.25.36. It is also noteworthy that almost all the one-storey, thin-shell-buildings, including Felix Candela's hyperbolic paraboloid umbrella roofs escaped unharmed.

4.25.37. The result of the heavy mass oscillating on the relatively flexible stilt-like columns during the quake was two-fold.

4.25.38. First, the ground cracked all around the buildings. Secondly, the concrete at the inter-section of the haunch and horizontal part of girders spalled, exposing the hooked haunch bars; diagonal cracks extended upward from the inter-section towards the nearby column. Stirrups appeared to be ineffective against the cracks.

4.25.39. Another lesson was that the quality of construction and the degree to which the current knowledge of seismic design is made use of, are far more important in determining the ability of a building to survive an earthquake, than whether the structure has a steel or reinforced concrete frame or whether the walls are masonry, glass or tile. This is proved in several high buildings that escaped damage, whereas adjoining structures were hard hit.

4.25.40. Many examples were evident of reinforced concrete walls sheared through at floor level. In many cases, the walls in addition, cracked away from the columns. Frequently, whole wall panels fell out. There were no dowels between walls and structural frame.

4.25.41. It is significant that none of the tall buildings overturned despite poor foundation conditions.

4.25.42. Adjoining buildings of different heights slammed against each other and ended up considerably out of plumb, with wide V-shaped cracks between them. This also happened to tall buildings subdivided by joints. But the damage was particularly severe where the floor levels

in adjoining buildings did not line up and the floor slabs hammered against the columns. In some cases, reinforced concrete columns were knocked out of alignment.

4.25.43. The most encouraging news from earthquakes-struck Mexico city was that the city's one true skyscraper, the 43-storey Latino-Americana tower, rode the shock waves undamaged, even to its window glass and partitions.

4.25.44. That ground movement occurred at the site is attested by recording instruments installed on the 1st, 25th and 29th floors to measure relative floor displacement. They showed movements of $2\frac{1}{4}$, $2\frac{3}{4}$ and $1\frac{3}{4}$ in., respectively. It is estimated that the sway at the top of the tower was of the order of 12 in. with the building oscillating for the most part in the second mode.

5. AMENITIES AND FITTINGS

5.1. Besides the economic planning of residential buildings, it is also necessary to consider how convenient they can be made for living in. To ensure this, certain amenities should be provided in the form of built-in furniture. The Panel has observed that the scales for the amenities adopted by different agencies vary widely. It is therefore desirable to lay down certain standards. A list of built-in furniture and sanitary fittings that should be provided in the different categories of houses is given in Appendix VII.

5.2. Built in cupboards and wardrobes should be provided in the bed rooms of all types of houses. One of the wardrobes may have shelves and the other may have shelves in half and hanging arrangement in the other half. The depth of wardrobe should not be less than 1'-10½" and its width may vary from 3' to 4'. The height may be 6 ft with the top at the same level as the door. The space above wardrobe can be utilised for storage purposes.

5.3. In the case of quarters of type IV to VI, a display shelf in the living rooms and a similar shelf for keeping crockery, etc. in the dining room may be provided. In Type VII, where there is a separate dining room, a built-in side board may be given.

5.4. In the planning stage itself attention must be paid to the arrangement for drying of clothes and storing of fuel. The former is specially important in humid areas, where in the absence of proper facilities, the balcony or verandah is used for the purpose, which mars the appearance of buildings.

5.5. Where there are more than one W.C. in a residence, one of them should have an independent access, so that guests may use it without passing through the bed room. Where there is only one W.C. the bath room and W.C. should be separate. Wash hand basin may be provided in the rear verandah if considered convenient depending upon the plan of the house. Hooks and the items of rings for fixing chicks, pots and curtain rods should not be lost sight of.

5.6. A list of electrical installations to be provided in each category of houses is also given in Appendix VII. Proper grouping of points should be looked into in the initial stage of planning. The electrical wiring should not interfere with the utility of walls for decorative or other purposes. The location of switch board should be such that it is easily accessible on entry into a room.

6. METHODS OF REDUCING COST OF CONSTRUCTION

6.1. Of the basic necessities of life, next to food and clothing, comes shelter. Considering the magnitude of the problem of housing in the country, the quantum of funds provided in the Second and Third Plans cannot by any means be called adequate. The country's resources, however, do not permit any better allocation. It, therefore, becomes all the more necessary to utilise to the best every rupee spent on buildings.

6.2. It is universally realised that the economy in building construction cannot be achieved except through detailed planning in advance. The word planning here covers architectural and structural, proper choice of materials, planning for execution, etc. Economy can be effected at every stage of planning through careful attention to various factors which govern building cost.

6.3. Architectural Planning

6.3.1. Architectural planning has primary effect on the cost of construction. It covers such items as the size and shape of plots, shape of houses, space utilization, positioning and the number of doors and windows, etc. The layout of the colony should not be spread out over too large an area. The aim should be a compact pattern for the colony as a whole. Rectangular patterns with badly proportioned sides and triangular shapes are not economical.

6.3.2. The question of relative merits of single storey, double-storey or multi-storey constructions have already been briefly discussed in Chapter 3 on Planning. Where land is cheap, single or double storey construction can be adopted. In big cities where the land values are high, recourse has to be taken to multi-storeyed construction. The number of storeys again depends upon the relative economy. Upto four storeys there is no necessity for lifts and the construction cost can be kept down by adopting load bearing construction. For storeys above four, framed construction is the only alternative. The cost of construction including the lift arrangements is bound to be higher. The provisioning of lifts also involves foreign exchange of which we are still short.

6.3.3. The question of space utilization has already been discussed in Chapter II. Consistent with what has already been said there, it is possible to work out a plan with a proportion of floor to plinth area ranging from 75 to 85 per cent. The lower percentage is applicable to smaller houses and the upper to the bigger houses or those of framed construction.

6.3.4. The length of the walls in a building has a direct bearing on cost. The arrangements should be such that it is as low as possible. The buildings can further be constructed in rows to economise on wall length.

6.4. Structural Planning.

6.4.1. The economy that can be achieved through judicious structural planning can be quite considerable. Every component of a structure should receive careful attention. As a rule the foundations will not present any serious difficulty in the case of single or double storeyed construction but foundation design is of importance in multi-storeyed construction. Detailed soil exploration is very essential as in its absence there is tendency to play safe. The matter has already been dealt with in Chapter IV.

6.4.2. The ceiling and the plinth heights also affect the cost of a building. Norms given in the earlier parts of this report should be followed unless there are cogent reasons for deviation.

6.4.3. Purely from structural considerations, 9" thick wall is enough for two storeyed construction. But to prevent moisture penetration they are made thicker or protected with suitable plaster. Another remedy is the use of pressed or extruded bricks as mentioned earlier in Chapter IV. The Municipal regulations specifying wall thicknesses are out-moded and require amendment in the light of latest knowledge.

6.5. Proper Choice of Materials

6.5.1. Sufficient attention is usually not given to using of local materials. In one case, we noticed that sand was being carried over to long distances leading to heavy expenses. Stone was, however, locally available in plenty. It would have been possible to install a crusher and manufacture sand, which would have resulted in economy.

6.5.2. Where stone is available, the possibility of its use for flooring should receive careful consideration. As already stated, in the absence of good bricks and building stone, hollow concrete block or cement soil construction may be adopted.

6.5.3. Economy in the use of cement can be effected by specifying concrete by strength instead of by nominal mix. This, however, requires strict quality control. It may be difficult to do so in case of small jobs, but in big jobs it is essential, in the interest of economy and better quality.

6.5.4. Where cement is in short supply, lime can suitably take its place. The difficulty, however, is that the lime manufacture has not been organised on modern lines.

6.5.5. To ensure quality, hydrated lime should be made available in the market, packed in paper bags. The lime stockist should also sell puzzolanic material, such as surkhi of approved quality. For improvement in lime manufacture we understand that the N.B.O. is considering the setting up a training-cum-demonstration factory in India under the T.C.M. aid programme. We suggest that this scheme should be expedited.

6.5.6. High Tensile Wire.—In India prestressed concrete has been adopted in bridge construction and other long span structures on a noticeable scale, but it has made little progress in building work. The sub

ject was discussed in a Symposium held at Roorkee by the Central Building Research Institute in February, 1958, and the material collected should prove useful to the engineering profession.

6.5.7. Several types of prestressed roof units have been developed in the Hindustan Housing Factory at Delhi and also by other firms in the country. In concentrated work, the adoption of pre-stressed concrete would be economical not only in cost but also in the consumption of steel and cement. It has furthered the advantage of reduction in dead load, elimination of heavy shuttering in the building itself, and quality produced concrete. The draw-back is the cost of transport of prefab parts. Within a radius of 200 miles it is, however, not prohibitive. In repetitive work it should be a practice in establishing a precasting yard at the site.

6.5.8. Prestressed ceramic is another form of construction which can prove economical provided there is development of the manufacture of clay units required for the work. The ceramic elements are set in a row. After tensioning of the wires the concrete is poured in the grooves formed by the ceramic elements. The result is a ceramic beam which can be cut in required lengths. The units possess the advantage of lightness, elimination of shuttering and economy in materials. The system has been successfully adopted both in Italy and France. Steps should be taken by the N.B.O. to develop the technique in the country.

6.5.9. The main deterrent in the increased adoption of pre-stressed concrete in the country has been the difficulty of procuring high tensile wire and tensioning equipment. It is however understood that proposals for putting up plants for manufacturing high tensile wire and equipment are under active consideration. We would recommend that the scheme should be pushed through in order to make the high tensile wire available at an early date.

6.5.10. We are also faced with the paucity of general construction equipment in the country. The success of pre-fabrication is closely related to the availability of erection machinery such as fork-lift trucks, cranes, special tower cranes, and hoists etc.

6.5.11. The design of construction machinery is a subject by itself. In Germany there is an institution which specialises in the design of such equipment. It is essential that a start be made in this direction in India. The work should be sponsored by the National Buildings Organisation.

6.5.12. Wire-Bound Reed Boards.—In the field of cheap partitions or even for the construction of cheaper type of houses, the locally available reeds which at present are waste material, should be utilised for the manufacture of boards. A factory has already been set up in Uttar Pradesh. It is suggested that similar factories should be installed in other parts of the country.

6.5.13. Asphaltic Roofing Materials.—At present, the materials used for sloping roofs are G.I. and asbestos cement sheets, both of which are not only in short supply but expensive. Moreover, for the manufacture of asbestos cement sheets, asbestos fibre worth about Rs. 2 crores is imported every year. It is therefore, in the National interest that a manufacture process should be evolved which will make possible the use of

materials available in the country. An alternative material is asphaltic roofing sheets. A project note on their manufacture in India has been drawn up by the National Building Organisation. It shows that the cost of these roofing sheets will be lower than that of asbestos sheets.

6.5.14. Perforated Extruded Bricks.—This has already been mentioned, earlier. A scheme has been worked out by the National Buildings Organisation for the establishment of a mechanized brick plant for producing perforated bricks.

6.5.15. Light-weight Aggregates.—There are many places in India where stone aggregate has to be carried over long distance. After studying the condition at Calcutta, a project proposal has been prepared by the National Buildings Organisation for the manufacture of light-weight aggregates from the silt available at Palta Water Works near Calcutta. The cost of this aggregate is estimated to be lower than that of stone aggregate. The proposal is receiving the consideration of the West Bengal Government. Such plants should be set up in other places also where soil of the required quality is available and conditions are favourable.

6.5.16. Hollow Clay Tiles.—Hollow clay tiles are used in roofing, floors and walls in many advanced countries. They have been specially developed in Italy. Mention has already been made of the use of ceramic elements in the manufacture of prestressed beams for roofing. The hollow tiles which are a similar product are used in cladding of buildings, in partition walls and in floors as fillers between the T-beams and in roofing even without the covering layer of concrete. The shape of the tiles is such that the top half is adequately strong to take up the compressive stress in a beam.

6.6. Standardization and Modular Co-ordination.

6.6.1. It is needless to emphasize the importance of standardization and modular co-ordination as means for the reduction of cost in building construction. A very large number of building elements can be standardized and manufactured in concentrated building activity, under controlled conditions.

6.6.2. Detailed studies of savings in cost and labour, which can be effected through standardisation, simplification and specialization have been conducted in the United States. Appendix—VIII gives the comparison of man hours between the conventional and the advanced building methods, in the construction of masonry wall dwelling. Appendix IX gives the savings through the use of modular co-ordination as compared to the conventional construction methods in the construction of six houses in the U.S.A. in 1947. The consequential saving in labour is 21 per cent and in overall cost 10 per cent.

6.6.3. We would suggest that studies on these lines should be made in this country also, to determine the economy in labour and materials, that can be effected by the adoption of advanced techniques of construction, viz., modular co-ordination, standardization, mechanization and the co-ordinated employment of trade gangs. The work can be taken up by the National Buildings Organisation.

6.7. Planning for Materials and Execution.

6.7.1. Prior to undertaking the execution of any work, the quantities, of various materials required should be worked out together with the dates on which the supplies are to be delivered. This will enable the orders to be placed in time and will ensure uninterrupted supply during construction. The next step is the preparation of the schedules for the execution of various items of work. This should be strictly adhered to.

6.7.2. To evaluate the advantages of pre-planning a competition was organized in Germany which showed a saving of 51 per cent in labour costs. In support we give below an extract from the Building number epa 35 Mar.—Apr. 1957:—

“The results of the experiment organized by the Applied Research Committee on Building and Housing, in co-operation with the Institute for Scientific Work at Stuttgart showed that the labour costs on the “model site” were 51 per cent lower than on the normal site”.

In putting up the “normal site” building, the contractor worked solely in the light of his own ideas and experience, un-influenced by the authorities or by the preplanner. The other site, called the “model site” was subject to careful preplanning and to supervision of all details in the light of the latest technical discoveries”.

6.7.3. We suggest that the building programme should be drawn up on a 2 to 3 year basis. This will enable the executing agency to arrange for the land, its development and the procurement of the materials. The construction agency can think of the possibility of having their own quarries, kilns and seasoning plants. Timber today is not easily available and its cost has increased two or three folds in recent years. At present, only five primary species of timber are in use in building trade, although as many as 70 secondary species are available. These are not used for lack of facilities for seasoning and preservation.

6.7.4. Recently, a plant for seasoning and preservation has been set up in the Hindustan Housing Factory in New Delhi. A timber seasoning plant was also set up in Rourkela, where it proved to be extremely useful.

6.7.5. Where it is not possible to put up seasoning plants we suggest that the timber required for the work should be purchased well in advance and air-seasoned before use.

6.7.6. New techniques in timber jointings, using connectors, and forms of construction such as glued laminated constructions for beams, arches, etc. are already in vogue in some of the foreign countries. These should be introduced in India, so that wastage in timber can be minimised and even small cutlengths can be advantageously used, in long built-in beams.

6.8. Organization at Site:

6.8.1. This important question has been dealt with in detail in the Team's report on Multi-storeyed buildings. Observations made in other countries indicate that a well-planned construction job can save as much as 20 per cent in labour cost.

Balanced use of labour gangs with a view to minimise the unproductive time, requires intensive study of the process of building construction, and the determination of proper sequence of different operations. Appendix X gives in detail a comparative study of the man-hours required in each main trade for the construction of a pair of semi-detached houses. The chart shows as to how balanced trade gangs working on a rational time schedule, can result in a drastic reduction in unproductive time of labour.

6.9. Organization of the Building Industry

6.9.1. The Selected Buildings Projects Team in its report on Slum Clearance has emphasized the need for the proper organization of the building industry and the manufacture in the country of construction equipment such as mixers, weigh batching units, hoists and cranes. Mechanization of the construction industry is necessary not only in the interest of economy but also for the speedy execution of big jobs. The progress in the country in this respect is slow. We are aware of the argument that mechanization would aggravate unemployment in the country. We do not subscribe to this view. With the increase in the tempo of construction programme the construction industry will not be able to cope with the work if it does not prepare itself in mechanization. Time factor is important and we, therefore, strongly recommend a phased programme of mechanization. A few items of work where mechanization can be advantageously introduced are given below:—

1. Use of portable belt conveyors and tip wagons for removal of debris from building sites.
2. Weigh batching of concrete in portable batching and mixing plants.
3. Handling of building materials and components by hoists and derricks.
4. Use of mechanical devices like scissors lifts for lowering and erection of centering for slabs.
5. Use of mechanical apparatus, like power rammers, for consolidation of earth-fill within and around buildings.
6. Installation of suspended platforms worked by winches, for finishing and cleaning work on the outside walls of tall buildings.

6.9.2. In support of our view, we cite an interesting instance which has come to our notice in this respect in the construction of residential flats in Denmark. During 1955-56 inspite of increased labour and material costs, the price of finished flats fell by 5 per cent due to extensive rationalization and the gradual industrialization part, at least, of the production process. The break up of cost of a traditionally built house compared to the one in which industrial techniques have been adopted, is given below:

Description	Traditionally built	Prefabrication
1. Materials	57%	50%
2. Labour	29%	20%
3. General expenditure risk Project.	14%	30%

The above needs no comments.

7. ADMINISTRATIVE AND FINANCIAL PROBLEMS

7.1. In the previous chapters, the Panel has discussed in detail the problems of planning and execution of Residential Buildings. During the course of study, the Panel also devoted attention to financial and administrative problems which are connected with Residential Projects. As some of these have important bearing on the economic and efficient execution of work, a brief mention is made of them in the following paragraphs.

7.2. The account codes specify certain steps through which any proposal for work should be passed before it is taken up for execution, but the Panel during the study found that the procedure adopted in practice was not the same enjoined in the codes. Provisions in Budget are frequently made before administrative approval and technical sanction are accorded. The Public Works Departments come to know of the work at a late stage and there is a good deal of haste in utilising the budget provisions. Works are taken in hand before acquiring the site and without finalizing architectural and structural details. Tenders in such cases have to be invariably based on incomplete designs and plans. This leads to cropping up of new items, which in turn lead to delay and unnecessary disputes. Case studies of a few of the schemes were made by the Panel and the flow-sheets of the same are given in Appendix XI. It will be observed that the extra cost of items varies from 1.2 per cent to 42 per cent of the cost of work put to tender. Instances of over-estimating also are not wanting. In one case, this amount is as much as 13.2%.

7.3. It has been observed that works which are started without complete planning are never completed within the stipulated time. The extra time taken up for the settlement of disputes etc. more than offsets the early gain in starting the work without adequate planning. It is very clear that this system of calling tenders without sufficient technical data is not conducive to efficiency or economy.

7.4.1. To emphasise our point further we cannot do better than give a few quotations from similar studies made by other responsible bodies. The Royal Institute of Public Administration London in its report on "Building Contracts of Local Authorities" points out that "greatest single factor causing difficulty is the extent to which variations are introduced" and recommends that "in the interest of efficiency and economy any building variations should be avoided if at all practicable". The Anglo-American Productivity Team for Buildings has also stated in its Report that "variations of the work during the progress of the job should be discouraged by all parties as a source of delay and annoyance and loss". The Committee of experts for Buildings appointed by the late Ministry of Works, Production and Supply, have also emphasised that "high degree of efficiency cannot be achieved in any building operation of considerable size unless it is planned in detail before the work is commenced.

7.4.2. In spite of these clear-cut opinions expressed by responsible expert committees, haphazard practices continue to be followed. In fact, the Departments now have got so used to them that it is being regarded as the normal procedure.

7.5. Residential buildings lend themselves easily to a very high degree of standardization. The advantages are obvious. We would very strongly recommend that a set of plans should be standardized by the principal construction agencies in the country after thorough scrutiny by a Committee consisting of senior Engineers and Architects, and they should be followed for a specified period which should not be less than three years. At the end of this period, a thorough survey and evaluation of the designs should be carried out and the plans modified, if necessary. Further construction should then be based upon the revised plans and the procedure continued. On account of the changing conditions, the probability is that the designs would never become absolutely final but the changes would be rational and progressive. The procedure has been followed in countries like Italy, Sweden and Netherlands with great success.

7.6. Budgeting for Materials

It is not commonly appreciated that materials count for nearly 2/3rds of the cost of building works. At present, there does not seem to be any proper budgeting of materials. This results in frequent interruptions in the progress of work, leading to extension of time and other contractual complications. Recently, however, a Committee for Allocation of Materials has been set up under the chairmanship of Cabinet Secretary. A Planning Wing has also been constituted in the D.G.S. & D. With the setting up of these units, we hope it will be possible to make a detailed assessment of the material requirements for various projects in the country and take the effective steps for augmenting the production of materials and its distribution according to well defined priorities.

7.7 Budgeting of Works

The planning of works and planning of materials cannot to be achieved successfully with the present system of year to year allotment of funds. There should be long term planning of works and engineering departments should know of their allotment of funds for various works at least 2 to 3 years in advance. The Panel understands that at Singapore, the Improvement Trust Authorities have obtained excellent results with this method of advance programming and budgeting with necessary priorities. We once again emphasise the recommendations in this regard made earlier by the Team in its Report on Multi-storeyed Buildings.

7.8. Forms of Contracts

Several forms of contracts are in use for letting out the work of building construction. Most of the P.W.Ds. adopt the item rate contract system. The Military Engineering Service have been working on the basis of the lump-sum contracts. This system has certain distinct advantages specially suited to residential construction. When once the plans and details are standardised as recommended by us in the earlier part of this Report, the lump-sum contract system for portions above plinth level is convenient. It radically reduces the drudgery of measurements by the Engineering staff and the clerical check by the office staff.

A survey of the time taken by Sectional Officer on measurements of residential construction shows that one fourth of the time is spent on this. The time thus saved can be more profitably utilised for supervision which will lead to better quality control. The time saved by clerical staff will lead to expeditious payments to the contractors and improvement in the maintenance of accounts. These are very important advantages.

7.9. Time for Completion of Work

7.9.1. None of the works reviewed by the Panel was completed within the stipulated time. Extension of time ranging from 15 per cent to 105 per cent of the original period stipulated in the agreement had been granted. The reasons for extending the time limit were:—

- (1) Difficult nature of soil met with.
- (2) Delayed supply of drawings.
- (3) Delayed supply of materials by the department.
- (4) Fixation of time of completion in an irrational way.
- (5) Lack of co-ordination among the various contractors engaged on the work.

7.9.2. Delay due to the first three reasons can be avoided if the recommendations given by the Panel earlier are adhered to.

7.9.3. Regarding 4 the Panel wishes to point out that the time of completion of work should be fixed on a realistic basis, taking into account the limitations regarding working season in different parts of the country.

7.9.4. To overcome the delay due to lack of co-ordination among the contractors, the Buildings Projects Team has already recommended in its report on Multi-storeyed Buildings that the entire building work should be entrusted to one main contractor who could let out special items of work to other approved sub-contractors. It would be better if the Main contractor specifies at the time of tendering the names of the sub-contractors he intends to employ on the work. It is apprehended in certain quarters that in this case the rates may go up due to the addition of the main Contractor's overhead charges on the specialised items also. It may be true in the initial stage but if the process is continued there is every likelihood of the rates going down. This system has invariably been adopted in all advanced countries, and can be justified by the smoothness of working that will result in the avoidance of many difficulties met with now, in payment of extra claims of different contractors, dismantling and disfiguring of work due to lack of proper co-ordination.

7.9.5. In support of our recommendations above, we place on record that during our inspection we noticed cases where, though the building portion had been completed, the houses could not be occupied as the work on services was not over, leading thereby to loss of revenue. This could be avoided if one general contractor was engaged.

7.10.1. As a result of the work-study of a few building projects, the Panel noticed with satisfaction that as a rule the running payments are made monthly to the contractors. There is, however, noticeable delay in the final payments. The time taken for the settlement of the accounts varied from 5 to 14 months after the completion of work.

7.10.2. The Expert Committee on Buildings appointed by the late Ministry of Works, Production and Supply and the Committee for Rationalisation of Contracts appointed by the Ministry of Works, Housing and Supply have recommended that the final payment should be made within a period of three months from the date of completion of work. This, however, is not always followed in practice. We are of the opinion that if our recommendations, regarding advance planning, both in design and arrangement of materials, proper programming and engagement of general contractor are accepted, there should be no difficulty for the executing agencies to make the final payment to the contractor within a period of three months from the date of completion.

7.10.3. We have come across a Memo. (APPENDIX XII) issued by the Western Railways fixing the time limit for the various sections concerned for the preparation and payment of the bills. We suggest that all executing agencies should determine the time limits on a rational basis and issue similar instructions.

7.11. Closing of Works Accounts.

7.11.1. According to codal instructions, the account of works should be closed soon after its physical completion and the building brought on to the register of buildings maintained in the Divisional Office. We, however, noticed that these instructions were rarely followed. For the works completed a year or two back neither the account had been closed nor the buildings had been brought on the buildings register. The reasons stated for the non-compliance were:

- (i) Delay in settling of contractor's claims.
- (ii) Delay in the clearance of purchase balances that affect the works outlay.
- (iii) Delay in the disposal of surplus materials.

7.11.2. The necessity of prompt payment to the contractors has already been stressed. The delay due to the clearance of suspense balances and disposal of surplus materials can be overcome by passing the materials through Stock Account as recommended by Rates and Cost Committee appointed by the Ministry of Irrigation and Power and already endorsed by the Team in its Report on Multi-storeyed Buildings. The object can be achieved by the creation of a Stores Sub-Division or a Division according to the requirements of a case.

7.12. Other Construction Agencies

7.12.1. In India, at present, there are not many contracting firms with experienced technical staff and adequate construction equipment. Therefore, quite a large proportion of the construction work is handled through contractors who are neither well organised nor adequately equipped. As such, often the quality of the work executed is not upto the mark. Of course, to some extent, the system of accepting the lowest tender regardless of the rates tendered in relation to the standard of work to be performed is responsible for low standard of work. It is necessary that construction departments should, as far as possible, get defective work redone instead of accepting defective portion of the work at reduced rates. Also contractors, who are habitually prone to give substandard work should be weeded out.

7.12.2. The Government had, some time ago, set up an Organization called "National Projects Construction Corporation" for executing irrigation works. It is understood that a similar corporation has been set up to undertake building works. It would be of interest to watch the results achieved by this Corporation in due course.

7.12.3. In order that construction Departments may not be too much dependent on Contractors and in order to improve quality of work and to avoid excessive profits to middlemen, we suggest the adoption of following measures under suitable circumstances:—

- (a) In areas, where contractors are not easily available or they quote unreasonably high rates, works may be executed departmentally. This would, no doubt, require good management and adequate technical staff. For departmental work to be economical, it is necessary to introduce the system of piece-rate or force account for making payment to labour.
- (b) Labour Co-operatives or similar other organizations should be encouraged to take up construction works by giving them certain concessions in respect of award of work, amount of earnest money and security deposits, frequency of payments, etc.
- (c) Greater facilities for the training of artisans should be provided in different parts of the country to increase skilled labour which is now in short supply. The trainees should be selected carefully and the training confined to those who are likely to work as artisans and do not exploit the training merely for earning stipend and later careering in a different line.

Summary of Important Recommendations

1. Till there is improvement in the country's economy, the scale of accommodation and other amenities for various classes of Government employees should be so determined that the element of subsidy is reduced to the minimum. Recommended scales of accommodation to fulfil this objective are given in Table I of the report. (Para 2.1.6.).

2. The break-up of the built-up area of residential buildings should be within the limits specified under para 2.2. and any variation should be justified. General recommendations for effective space planning are outlined in para 2.3. (1.13.)

3. In developing residential areas, there should be general layout plan for the future of the whole area, flexible enough to be extended as occasion demands, and in addition a provisional and fairly detailed plan showing the possibilities of site development for the areas in which building is immediately contemplated. (Para 3.1.).

4. Cost of roads forms a substantial portion of the cost of development and must be kept low. The most effective way to achieve this is by keeping their lengths to a minimum. (Para 3.9.2.).

5. Orientation should be fixed with regard to the functional requirements of rooms and not with respect to the frontage of buildings only. (Para 3.12.5).

6. A knowledge of the probable behaviour of each type of foundation for each type of subsurface condition is essential in selecting the appropriate type of foundation under given set of conditions. Significant characteristics of the principal types of soil generally met with and the type of foundation suitable are briefly discussed. (Paras 4.2.1.12, 4.3.1.5, 4.4.1.2, 4.5.1).

7. For normal foundation work, cement concrete 1:5:10 proportion should be adequate for buildings up to two storeys; 1:4:8 or even a richer mix may be necessary where subsoil water level is high and there is danger of salt impregnation. (Para 4.6.1).

8. Plinth levels of all buildings must be determined from drainage consideration and marked on the layout plan. A Plinth height of at least 45 cms (1'-6") above the crown of the approach road is desirable. (Para 4.7.1).

9. Ceiling height may vary from 2.75 m to 3.3 m (9 ft. to 11 ft.) depending upon the type of quarters and whether the building is single or multi-storeyed. (Para 4.10).

10. Where cost of bricks is high, machine made compressed or extruded bricks may be economical. The scheme for setting up a factory for producing the same which is under consideration by the N.B.O. should be pushed through. (Para 4.11.4).

11. The sizes and number of doors should be regulated by functional requirements and kept down to the minimum commensurate with comfort. (Para 4.14.17).

12. Due to shortage of timber, adoption of R.C.C. door frames is suggested for the lower types of houses. (Para 4.14.5).

13. Area of windows may be 12 to 15 per cent for hot and dry climate and 15 to 20 per cent for hot and humid climate. (Para 4.15.4).

14. Adoption of R.C.C. frames for windows should be considered. With the easing of steel situation, steel windows may be preferred to wooden windows. (Para 4.15.5-6).

15. For security reasons, protection for windows is necessary in the upper floors also. (Para 4.22.2).

16. For the internal water supply, one pipe system can be conveniently adopted. (Para 4.24.2).

17. Factors governing the design and construction of buildings in seismic zones have been discussed in the report. Data available in the country on seismic forces and their effects is very meagre. The work on the Institute of Earthquake Engineering that is being set up at Roorkee should be expedited. (Para 4.25.2).

18. To ensure comfortable living, certain amenities in the form of built-in furniture, (a list of which is given) should be provided in the residential buildings. (Para 5.1).

19. For improvement in lime manufacture, the proposal for setting up a training-cum-demonstration factory under T.C.M. aid programme should be expedited. (Para 6.5.5).

20. To increase the adoption of pre-stressed concrete, proposals to manufacture high tensile wire must be pushed through in order to make it available at an early date. (Para 6.5.9).

21. Where there is concentrated building activity, a very large number of building elements can be standardised and manufactured centrally to reduce cost. (Para 6.6.1).

22. The building programme should be drawn up on a 2 to 3 year basis to enable the executing agency to arrange for land, its development and the procurement of materials. (Para 6.7.3).

23. To avoid wastage of timber new techniques in timber jointing, using connectors and forms of construction such as glued laminated construction for beams arches etc. should be introduced. (Ch. VI. Para 6.7.6).

24. A phased programme for mechanising the construction industry is necessary not only in the interest of economy but for the speedy execution of big jobs. (Para 6.9.1.).

25. To obtain high degree of efficiency in any building operation, it should be planned in detail before the work is commenced. (Para 7.4.1.)

26. As residential buildings lend themselves easily to a very high degree of standardisation, a set of plans should be standardised by the principal construction agencies in the country after thorough scrutiny by a committee consisting of senior engineers and architects and they should be followed for a specified period which should not be less than three years. (Para 7.5).

27. Material requirements of the various projects should be assessed and steps taken to augment their production and its distribution according to well defined priorities. (Para 7.6.).

28. There should be advance programming and budgeting with necessary priorities and Engineering Departments should know their allotment of funds for various works at least 2 to 3 years in advance. (Para 7.7.).

29. Lumpsum contract system for portions above plinth level can be adopted for residential construction. (Para 7.8.).

30. The entire building work should be entrusted to one main contractor who could let out special items of work to other approved sub-contractors. (Para 7.9.4.).

31. Final payment to the contractor should be made within a period of 3 months from the date of completion. (Para 7.10.2.).

32. To improve quality of works and to avoid excessive profits to middlemen, the following measures are suggested for adoption:—

(a) In areas where contractors are not easily available or they quote unreasonably high rates, works should be executed departmentally.

(b) Labour co-operatives or other organisations should be encouraged to take up work by giving certain financial concessions.

(c) Greater facilities for the training of artisans should be provided to increase skilled labour which is now in short supply. (Para 7.12.3.).

APPENDIX I (Para 2.1.2)

Statement showing monthly subsidy for the different types of quarters in the various projects

Scale of Pay	Below Rs. 60	Rs. 61 to Rs. 250	Rs. 251 to Rs. 600	Rs. 601 to Rs. 1200	Rs. 1201 to Rs. 1800	Above Rs. 1800	Total subsidy per month for 100 Qrs.
1	2	3	4	5	6	7	8.
Average percentage of the various types of Quarters.	26.1	52.2	15.2	5.9	0.4	0.2	—
	Rs.	Rs.	Rs.	Rs.	Rs.	Rs.	Rs.
1. Heavy Electrical Project, Bhopal	333	802	266	—	—	—	1401
2. Integral Coach Factory, Madras	228	640	473	119	24	—	1484
3. Hindustan Steel Project, Bhilai	800	1588	510	76	—	—	2974
4. Hindustan Steel Project, Rourkela	377	774	422	110	35	—	1718
5. Nangal Fertilizers, Nangal	333	1044	174	122	2	—	1675
6. Central P. W. D., New Delhi	253	988	601	264	8	—	2114
7. According to Standards laid down by Railways	153	1142	304	121	—	—	1720

Note : The subsidy has been worked out on the basis of average pay of different categories.

APPENDIX II

1. Statement of subsidy as per existing accommodation in Delhi

Sl. No.	Description and Pay range	Percentage of Quarters	Subsidy per month Rs.
1	2	3	4
1.	H-Type — up to Rs. 110/-	26.1	215
2.	G-Type — Rs. 110/- to 209/-	26.1	480
3.	F-Type — Rs. 210/- to 319/-	26.1	497
4.	E-Type — Rs. 320/- to 589/-	14.5	284
5.	DII-Type — Rs. 590/- to 839/-	6.2	296
6.	DI-Type — Rs. 840/- to 1099/-	0.4	21
7.	CII-Type with Servant Quarters and Garage. — Rs. 1100/- to 1499/-	0.3	16
8.	CI-Type with Servant Quarters and Garage — Rs. 500/- 1999/-	0.2	8
9.	A & B Type with Servants Quarters and Garage — Above Rs. 2000/-	0.1	2
TOTAL			1,819

2. Statement of subsidy as per accommodation recommended by the panel-

1.	Type I — Below Rs. 110/-	26.1	248
2.	Type II — Rs. 110/- to 250/-	26.1	427
3.	Type III — Rs. 251/- to 400/-	28.0	211
4.	Type IV — Rs. 401/- to 800/-	18.8	127
5.	Type V — Rs. 801/- to 1600/-	0.7	6
6.	Type VI — Rs. 1601/- to 2,250/-	0.2	—
7.	Type VII — Above Rs. 2500/-	0.1	—
TOTAL			1,019

APPENDIX III

An extract from the Report of Committee of National Buildings Organisation on Foundation in Black Cotton Soil'

While the Committee feels that in its present stage of investigations it is not in a position to give firm recommendations regarding construction of buildings in black cotton soil, the following general principles of design can be enunciated on the basis of the studies so far made of the methods adopted in this country and elsewhere.

The soil in the locality should be investigated completely and a report prepared.

Where the depth of the black cotton soil is shallow, it might be necessary to carry foundations to the inert-soil below the black cotton stratum. While judging the inert nature of soil for founding the structure, mere colour should not be taken for guidance as it is found that even yellow soils met at that depth below B.C. Soil layers exhibit swelling and shrinking properties. The footings may be either continuous footings or of pier on pillar and beam or arch construction. Where the black cotton soil is deep, the footing depth should, wherever practicable, be below the zone of seasonal moisture change (which may extend up to about 12 ft. in some parts of the country) especially for buildings that cannot tolerate any movements. It is cautioned that even this depth may not be sufficient since clays are sometimes desiccated by average climatic conditions to depths far greater than those reached by seasonal variations. In such cases a structure which changes moisture equilibrium over a large area adjacent to it, may cause slow swelling of deep layers with consequent heaving of footing.

In many cases it is impractical or uneconomical to take footings down to soil that will not expand. Under such circumstances the footings may be placed at a higher level, say 5 to 6 ft. below ground level, but the footing pressures may be kept high enough to impede expansion. While it is impractical to design the footing to counteract entirely the expansion pressure the latter is very much reduced if slight expansion is permitted. Thus, if the building superstructure is of a relatively flexible nature and if small movements can be tolerated, a smaller depth than 12 ft. can be considered. Traditional practices of providing rubble filling under foundations and floors and constructing superstructure in coursed rubble in mud or lime mortar provides a certain measure of flexibility.

The Foundation pressure for Dead Load only should not be less than the swelling pressure of the soil where saturated, which is to be determined experimentally. Simultaneously there should be an adequate factor of safety against plastic failure.

The interior footings can be put at shallower depths than the exterior, or can have lighter unit loads if at the same depth. If construction is done where the soils are dry, interior depth and loading conditions should be the same as for the exterior.

It is not practicable always to transmit high pressures by means of continuous strips. The load from the building is then transmitted through masonry pillars or through bored piles which may be under-reamed where necessary. Such piles or pillars may be insulated from the surrounding soil by surrounding them with granular non-cohesive material.

Where the load is transmitted through columns or piers, the superstructure is carried on grade beams resting on these columns. The beam is necessarily placed close to the surface of the ground. It is a good practice to avoid contact of these grade beams with the soil to prevent action of swelling soil on the beam. It is best to have the space between the grade beams and the ground surface empty with a dwarf wall protection on the two faces to prevent entry of materials. This is only a palliative and does not always prevent development of stresses in beams due to swelling of the soil. These beams are designed taking the composite action of the masonry wall coming over it. Design of these beams will be indicated in a subsequent report.

When continuous strip foundation is used, it is sometimes usual to provide reinforced cement concrete bands at plinth level and at lintel level. Design of these bands is empirical and at best they serve only as crack control measures. These beams may be reinforced both at top and bottom. Empirically, the total reinforcement may be kept at $1\frac{1}{2}\%$ of the area of the section for both the layers together.

Raft foundations require careful calculation and have proved successful.

Considering the high cost of foundation of buildings, in black cotton soil, it is uneconomical to construct single storeyed buildings in such areas. Double storeyed buildings not only distribute the cost of foundation over twice the floor area, but also assist in increasing the foundation pressure, to contract the swelling pressure. It was observed that in several areas with identical designs of foundations, the single storeyed buildings suffered greater damage than the double storeyed structures.

The excavations for footings of foundations should not be allowed to become excessively dry, or excessively wet, so as to lose its shear strength. On the other hand undertaking construction during the dry season and completing it before the on set of monsoon has proved successful.

The effects of moisture changes in active soils below the floors can be vertical movements of the order of several inches and such movements are also non-uniform over a large floor area. Design and construction measures to eliminate or minimise such effects should include:—

- (a) removal of as much active soil as practicable.
- (b) replacement by fill of inactive soil properly compacted.
- (c) completion of fill to floor level with properly compacted inactive soil.
- (d) separation of floor slabs from contact with walls, footings, etc.
- (e) support of floor slabs on flexible base such as boulder filling etc. which can provide relief against upward expansion pressures.

- (f) floors suspended from the grade beams in the pile or pier and beam construction are the ideal method of construction, but these are expensive.

Sometimes ponding the area under the floor to an optimum condition before or after the foundations have been constructed is practised. In such cases the soil is allowed to get wet and to swell before the fill is placed. A good judgment is, however, necessary to see that the soil does not swell excessively and soften to such an extent as on reconsolidation will lead to its settlement under the weight of the floor and the fill.

A commonly used specification to interrupt the capillary rise into the fill is by making the bottom one or two feet of fill of clean granular material, continuing upward with cheaper local material and finally topping off with cheaper local material a course of sand at least 8" in thickness just below the floor. In such cases the local soil should be compacted to at least 90% of the optimum density and at 2 or 3% higher than the optimum moisture content. While compacting these fills special precaution must be taken to avoid failure of external walls which might act as retaining walls for this purpose.

The desiccating action of fast growing trees in the vicinity of buildings should be taken into account while planting of trees is done near a newly constructed or existing building on active soils. Similarly removal of trees from the vicinity of buildings and covering up large areas near the building with pavements or starting extensive gardening operations near the building, should be done after careful consideration of their effects on the moisture movement towards and from the building area.

In the case of boiler rooms, hot process units, etc. measures should be taken to prevent the heat from furnaces, including use of insulating materials, provision of air space, forced or natural ventilation, use of cooling water and even carefully regulated irrigation of the surface clay to prevent its drying out.

The racking consequent upon the movement of soil can sometimes be very wide and there is often a tendency to insist on immediate repairs which involves filling the cracks with mortar. This is often a mistake. Cracks of this nature are seasonal and they tend to close in the wet season. The immediate filling of cracks with dense mortar will therefore result in building up of high compressive stresses when the reverse movements take place. It is therefore essential that in such cases before any repairs are attempted the matter should be investigated by a soil engineer. Repair measure may include under-pinning and removal of contact between soils and grade beams in the case of pillar and beam construction, correction of drainage conditions, location and repair of water leaks, establishment of evaporation barriers; alteration of thermal gradient by increasing the paved areas round the building or decreasing it as necessary; and a variety of other operations followed finally by structural repairs.

APPENDIX IV (Para 4.6.2.)

An extract from article in the Journal of National Building Organisation dated October, 1958 by Dr. M. L. Puri & N. R. Srinivasan of Central Road Research Institute, New Delhi.

Mostly Surkhi is prepared by powdering bricks. There has been a great confusion about the degree of burning bricks to get reactive Surkhi. Some laboratories reported that under-burnt bricks gave better results, some recommended use of over-burnt bricks, while some others advocated the use of normally burnt bricks. No one studied the fundamentals of the problem to know the reasons for such variations in the results. The Central Road Research Institute, New Delhi has been engaged upon this problem and their findings can be summarised as below:—

(1) The degree of burning is a function of the mineralogical composition of the clay. Generally mentmerilonite type of clays show their maximum reactivity after being burnt at a temperature between 600° and 800° C. The kaelin and illite types may require higher temperatures of about 800° C and 1000° C respectively.

(2) Impurities like free iron oxide have profound influence, both on the pozzolanic activity and the optimum temperature of burning.

(3) There seems to be a close relationship between the maximum pozzolanic activity and the temperature at which collapse of the clay's lattice structure takes place. Heating either above or below this temperature does not bring out the maximum activity of the pozzolana.

(4) Materials, even though in a fine powder, if found to consist of well developed crystalline structure, will not behave as good pozzolanas.

(5) Pozzolanic activity seems to depend upon the presence of partially decomposed and highly disordered clay structure or a large percentage of the oxides of silicon, aluminium and iron in a very fine state and poor crystallinity as got from clays after the collapse of their structure. Further heating beyond this decomposition point will result both in the improvement in crystallinity and size and also in the disappearance of internal strain in the lattice, thus affecting the growth of stable crystals with poor pozzolanic activity.

(6) The practice of making surkhi from bricks cannot yield surkhi of a high quality since bricks are generally made from loamy soils that contain a high percentage of inert material. The soil for making surkhi should be more clayey and rich in clay minerals which give out the active components on heating. But all clays cannot yield good surkhis. Much depends upon the exact mineral composition and the structural aspects of the clay and the burnt product.

This work has provided the Indian Standards Institution with a good basis for drafting the specification for surkhi which is expected to be finalized shortly.

The exact mechanism of the pozzolanic reaction is still not definitely known. While further research is required to know answers to so many questions, the work already carried out is sufficient to form a basis for the proper selection and burning of the material to produce high grade pozzolanas.

APPENDIX V (Para 4.9.1.)

An extract from the National Buildings Organization, Technical Information Series-14 on Termite and Termite Proofing.

Damage to structures of buildings by termites, specially in the tropics, is considerable. Termites can be divided into two types on the basis of their habitat, viz. (1) the ground inhabiting or subterranean termites and (2) the drywood termites.

A termite colony consists of a pair of reproductives, the so-called king and queen and a large number of sterile workers and soldiers. If, however, the queen is lost or destroyed, her place is taken by a number of supplementary reproductives, thus even by removing the queen, the colony will not be destroyed.

Once termites find a suitable foothold in or near a building, they start spreading slowly from a central nest through underground and over-ground galleries in the case of subterranean termites and galleries within the structural member, once they get direct access to them, in the case of drywood termites. The food of the termite is cellulosic material like timber, grass, stumps of dead trees, droppings of herbivorous animals, paper, etc. In their search for food they bypass any obstacle like concrete or resistant timber to get at suitable food several feet away.

The following conditions are favourable to the growth and spreading of termites:-

- (i) Moist warm soil containing abundant food in the form of wood or other cellulosic material.
- (ii) Timber members of a building in direct contact with the ground.
- (iii) Use of non-resistant and or untreated wood. (A large portion of timber now sold in the market has a high percentage of sapwood and therefore is attractive to termites).
- (iv) Cracks and voids in foundations and floors which make it easy for termites to reach wood that is not otherwise in contact with the soil. Apparently termites sometimes do penetrate concrete. This is more due to the fact that termites in their search for wood are able to find weak spots like cracks and effect their passage through them.

There is no permanently effective and economical method of dealing with termites once the building is affected. Hence the best time to provide protection against termites is during the planning and construction of buildings.

The essential features of termites proofing construction can be summarised under the following general principles:

- (a) Use of resistant wood and/or wood rendered poisonous to termites.

- (b) Creating conditions unfavourable to termite growth in and around buildings.
- (c) Use of soil poisons.
- (d) Use of termite barriers between the likely source of infestation and the susceptible material in buildings.

The use of termite-resistant timbers for structures isolated from the ground and preservative treatment for all timbers coming in contact with the ground are to be strongly recommended. In areas where dry-wood termite exists, no amount of isolation from ground will keep wooden structures from being attacked. Structural timber in such cases is to be made termite-proof by adequate preservative treatment. This will also be a second line of defence against subterranean termites.

The service life of timber will depend on the nature of wood, its position in use, the preservative treatment given to it and the type of termite. It is obvious that highly resistant timber, placed out of contact with earth in localities where the termite attack is mild, will require little or no preservative treatment whereas non-durable timbers in highly termite-infested areas will require preservative treatments to give a high absorption and deep penetration of the preservative in the structural member.

For rough outside work where decorative value is not expected, creosote is the best preservative to combat termites. Impregnation with D.D.T. gives good protection against termites (D.D.T. also leaves wood in a condition that does not interfere with subsequent painting and polishing. Most of the chemicals indicated in the preservatives toxic to termites for use as soil poisons can be used for treating wood to resist termite attack.) In planning and executing a building, it is possible to eliminate conditions that will be favourable for subsequent termite attack. Site clearance is necessary preliminary to all buildings in all cases and specially where the subterranean termites are prevalent. All dead-wood, old tree stumps and other cellulosic materials must be removed. Removal of top 3" of soil which is rich in decaying matter will be a good practice. If there are living termites in the soil they must be destroyed with poisonous chemicals as indicated later.

All underground constructions should be made of materials impervious to termites so as to prevent concealed termite attack. It may consist of brick, stone or concrete or made of timber as in the case of timber piling. The timber should be adequately treated against termite attack by one or other of the recognized processes.

Brick floors are seldom proof against termites. Concrete, especially if it is a good mixture like 1 : 1½ : 3 poured or cast slabs with a plastic pitch or bitumen seals at joints, will be impervious to termites.

Concrete floors are best constructed on gravel base, or clean coarse sand at least 6" thick. Dampness and cracking should be avoided.

The most important aspect of protection against termites in the construction of new buildings is the use of chemical soil poisons to combat termites. Some of the best known preservatives are sodium arsenite and other arsenicals, coal tar creosote, arthodichlorobenzene and Trichlorobenzene.

In the case of the subterranean termites, it has been found that construction techniques which provide a continuous layer of materials like concrete capping over brick work foundation, piers, etc., prevent the access of termites from ground level to any untreated timber above such capping. A bent-over sheet of metal also prevents termites at ground above such shields. This layer is to be of such a nature that it will not be bypassed by termites. Experience in the use of termite shields has shown that they give excellent results when properly made and fitted. Metal turned down at an angle of 45° requires termites to construct a downward gallery and negotiate the edge in order to pass. For some reason the termites are not able to do this.

APPENDIX VI (Para 4.16.2.)

Madras terraced roofing with brick on edge, 3 inches concrete, three courses of flat tiles on the casts of lime, plaster to top and bottom

CLAUSES ADDITIONAL TO "GENERAL" PRECEDING

1. The terrace shall consist of a course of thoroughly burnt approved terrace bricks in standard specification lime mortar, of 1 lime: $1\frac{1}{2}$ sand, the bricks laid on edge diagonally across the joists, and extending for at least 6 inches over the wall. Joints are not to exceed $\frac{3}{8}$ inches thickness. The bricks are to have a slight rise between joists. The terrace bricks shall be immersed in water for 24 hours in advance of the work to ensure that the bricks are well burnt and the skin allowed to dry before use.

After ten days, or when this brick-on-edge course has set, a layer of brick-concrete 4 inches in thickness made of 32 cubic feet broken brick $\frac{3}{4}$ inch gauge and $12\frac{1}{2}$ cubic feet slaked lime (no sand) shall be laid over and well beaten to 3 inches thickness with wooden hand-beaters. The beating shall continue until the concrete is well consolidated and the beater makes no impression, and readily rebounds from the surface when struck on it; the whole shall be constantly wetted by sprinkling lime water. Should this surface, during the process of beating, become so uneven that water lodges, it shall be picked up and fresh concrete added as may be necessary.

2. After six days or after the concrete laid has hardened, three courses of flat tiles shall be laid in standard specification lime mortar 1: $1\frac{1}{2}$, diagonally and breaking joint. The side joints of tiles and the beds shall not be more than $\frac{1}{4}$ inch thick, set full in mortar.

The flat tiles shall be immersed in water for two hours before being used. The joints of the top layer shall be left open to afford a key for the plaster. The top surface and ceiling shall then be plastered three coats of lime mortar, in accordance with the standard specification for same and rubbed to a polished surface.

3. The roof shall ordinarily be laid with a slope of $\frac{1}{4}$ inch to a foot to preclude the possibility of standing water.

In very rainy parts such as Malabar, this slope may be increased—vide Chief Engineer's Memo. No. 2315-Wks./28-C.P., dated 25th July, 1929.

This slope shall be given in the joists themselves and not by increasing the thickness of terracing.

4. Care shall be taken to support the joists from below by wedged uprights while the terrace is being laid. Neglect of this precaution produces sagging at centre of joists and consequent tilting at their ends which disturbs the terrace-work above them and produces cracks in it.

5. The brick jelly for concrete shall be from well burnt broken bricks or clinker bricks and no underburnt ones shall be allowed. The brick jelly shall be soaked in water for a sufficiently long period before mixing with the lime.

6. As the work proceeds, it shall be kept thoroughly wetted until the mortar has set firm and hard. Watering shall be continued for three weeks after construction.

7. Should the mortar perish through neglect of watering the work shall be pulled down and rebuilt at the contractor's expense, or should the contractor fail to water the work to the satisfaction of the officer-in-charge of the work, the latter may supply the requisite men to water the work properly, and charge the cost to the contractor.

8. Special attention is to be paid to drainage openings in parapet and binding walls to ensure that the rain runs off quickly.

N.B.—In the case where shell or fat lime is used, the above specification will be modified to replace one part in three of sand by surkhi in the mortar, or such other proportions as the Executive Engineer may specify.

Madras Terraced Roofing with brick on edge 3 inches concrete, Three courses of Flat Tiles, Three Coats of Lime Plaster to Top and One Coat of Cement Plaster 1 : 3 to Bottom

NOTE.—This roofing will generally be preferable to the preceding specification.

The work shall be executed similar to the standard specification for the same class of work with lime plaster ceiling except that one coat of standard specification "Plastering with cement mortar 1 : 3, $\frac{1}{2}$ inch thick" to bottom, will replace the three coats of lime plaster to bottom.

Terraced Roofing with Brick on Edge, 3 Inches Concrete, Two Courses of Flat Tiles to Top and One Coat of Cement Plaster 1 : 3 to Bottom.

CLAUSES ADDITIONAL TO "GENERAL" PRECEDING.

1. The brick on edge and 3 inches concrete shall be laid in conformity with clause 1, S.S. No. 46-G.

2. After six days or after the concrete laid has hardened, two courses of flat tiles shall be laid in cement mortar 1 : 3 mixed with crude oil. The mortar shall be prepared as instructed in S.S. 47 except that the crude oil is to be in the proportion of 10 percent of the weight of the cement. The tiles shall be laid first course diagonally and second course square to the parapet thus breaking joint. The side joints of tiles shall not be more than $\frac{1}{2}$ inch thick, set full in mortar. The mortar layer bed over the roof slab shall be not less than $\frac{3}{8}$ inch finished thickness after receiving the first layer of tiles and $\frac{3}{8}$ inch thick mortar bed between the two layers of tiles. The flat tiles shall be immersed in water for two hours before being used. The tiles shall be carried through roof parapet walls and finished off as instructed in clause 7, S.S. No.46-J. . Where the roof

abuts against the wall of a higher storey, the tiles shall be carried so as to overlap the extremity of the terrace bearing on the wall.

3. Before the work dries up completely, the tile joints shall be raked out and pointed over with cement mortar 1:3 mixed with crude oil prepared as instructed in clause 2 *supra*. The joints shall be well rubbed over with thin bar trowels and the excess of mortar scraped off, until the surface of the pointing attains a black polish and becomes hard.

4. The ceiling shall be plastered with one coat of standard specification "Plastering with cement mortar 1:3, $\frac{1}{2}$ inch thick" (S.S. No. 61).

5. Clauses 3, 4, 5, 6, 7 and 8 of S.S. No. 46-G shall apply to this specification as also the method of measurement for payment described in clause 7, S.S. No. 46-J.

STATEMENT SHOWING BUILT-IN FURNITURE AND AMENITIES

Types of Residential Buildings	Kitchen or Cooking space	Bath and Washing	W. C.'s	Living Room	Bed Rooms	Back Verandah & stores	Servant Quarters
1	2	3	4	5	6	7	8
I	(1) Tiers of shelves (2) Loft (3) One tap (4) Sunk in floor	(1) One tap (2) One small Shelf (3) Pegs 2 or 3 nos.	(1) Indian type W. C. with flushing cistern (2) One tap desirable	(1) Built-in-Shelf without shutters (2) Pegs 3 or 4 (3) Ledge
II	(1) Tiers of Shelves (2) Loft (3) One tap (4) Sunk in floor (5) Fly proof shutters for door & window	(1) One tap (2) One shower (3) One small Shelf (4) Pegs 2 or 3 nos.	(1) Indian type W. C. with flushing cistern (2) One tap	(1) Built-in-Shelf without shutters (2) Pegs 3 or 4	(1) Cupboard or Ward-robe having seasonal storage space above	Pegs or some arrangement for drying clothes where considered necessary	..
III	(1) Tiers of Shelves (2) Loft (3) One tap (4) Sunk in floor (5) Fly proof shutters for door & window	(1) One tap (2) One Shower (3) One small Shelf (4) Pegs 2 or 3 nos.	(1) Indian type W. C. with flushing cistern (2) One tap	(1) Built-in-Shelf with shutters	(1) Ward-robe half hanging & half shelving	R.C.C. Shelves in stores	..

Contd.

APPENDIX VII (Para 5.1)

1	2	3	4	5	6	7	8.
IV	(1) Tiers of Shelves, partly open & partly having fly proof shutters (2) Loft (3) One tap (4) Sunk in floor (5) Fly proof shutters for doors & windows (6) Sink & draining board	(1) Wash basin mirror & towel rail (2) One shower (3) One tap (4) One small shelf (5) Pegs 2 or 3 nos. Two bath-rooms each having:	(1) Indian type W.C. with flushing cistern (2) One tap	Drawing-cum-dining <i>Drawing portion</i> (1) Display shelf recess in wall 6" deep and 3" projecting, Size 3'-6" x 7'-0" <i>Dining Portion</i> (1) Built-in-Shelf with shutters Drawing-cum-dining.	Ward-robe half hanging & half shelving	R.C.C. Shelves in stores	(1) Shelf with 2 or 3 tiers (2) Ledge (3) Indian type W.C. with flushing cistern. (4) One tap
V	(1) Tiers of Shelves, partly open & partly having fly proof shutters (2) Loft (3) One tap (4) Sunk in floor (5) Fly proof Shutters for doors & windows (6) Sink & draining board. (7) Plate rack (8) Cupboard	(1) Wash basin, mirror & towel rail (2) One shower (3) One tap (4) Glass shelf with chromium plated brackets & rails (5) Pegs 3 or 4 nos.	(1) W.C. with flushing cistern (2) One tap	<i>Drawing Portion</i> (1) Display Shelf recess in wall 6" deep & 3" Projecting. Size 3'-6" x 7'-0" having tiers with fully glazed shutters. <i>Dining Portion.</i> (1) Built-in Shelf with shutters (2) Pelmet & curtain rods (3) Fly-proof shutters for doors & windows	Ward robe half hanging and half shelving.	One wash basin with single tap in verandah where considered, suitable and necessary R.C.C. shelves in Stores	(1) Shelf with 2 or 3 tiers. (2) Ledge (3) Indian type W.C. with flushing cistern (4) One tap

1	2	3	4	5	6	7	8
<p>VI (1) Tiers of Shelves partly open & partly having fly proof shutters. (2) Loft (3) One tap (4) Sunk in floor (5) Fly proof shutters for doors & windows. (6) Sink & draining board. (7) Plate rack (8) Cupboard</p>	<p>Two bath rooms each having (1) Wash hand basin with one tap & Mirror. (2) One shower. (3) Minto plate. (4) Glass shelf with chromium plated brackets & rail. (5) Towel rails. (6) One of the bath rooms to contain:— (a) European type W. C. preferably with low type chinaware cistern. (b) Toilet paper holder. (c) Liquid soap bowl.</p>	<p>(1) W. C. with flushing cistern (2) One tap</p>	<p><i>Drawing-cum-dining portions</i> <i>Drawing Portion</i> (1) Display Shelf recess in wall 6" deep & 3" projecting. Size 3'-6" x 7'-0" having tiers with fully glazed shutters. <i>Dining Portion.</i> (1) Built in shelf with shutters or Boardside. (2) Pelmet & Curtain rods. (3) Fly-proof shutters to doors & windows.</p>	<p>Ward robe, half hanging & half shelving.</p>	<p>One wash basin in verandah with single tap & mirror where considered suitable and necessary. Chromium plated towel rail. Liquid soap bowl, R. C. C. shelves in Stores.</p>	<p>(1) Shelf with 2 or 3 tiers. (2) Ledge (3) Indian type W. C. with flushing cistern. (4) One tap.</p>	
<p>VII Kitchen and Pantry (1) Tiers of Shelves partly open & partly having fly proof shutters. (2) Loft</p>	<p>Three bath rooms each having (1) Wash hand basin with one tap & mirror. (2) Minto plate</p>	<p>(1) W. C. with flushing cistern. (2) One tap.</p>	<p><i>Drawing-cum-dining portions.</i> <i>Drawing Portion</i> (1) Display Shelf, recess in wall 6" deep & 3"</p>	<p>Ward robe, half hanging & half shelving.</p>	<p>One wash basin with double tap & mirror where considered suitable and necessary. Chromium</p>	<p>(1) Shelf with 2 or 3 tiers. (2) Ledge (3) Indian type W. C. with flushing</p>	

contd.

APPENDIX VII (Para 5-1)

1	2	3	4	5	6	7	8												
(3) Low tap with sunk in floor in Kitchen.	(4) Sink with dining board in pantry.	(5) Fly proof shutters for doors & windows.	(6) Plate racks	(7) Cupboard	(8) Meat Safe.	(3) One Shower	(4) Glass shelf with chromium plated brackets & rail.	(5) Towel rails	(6) One of the bath rooms to contain:—	(a) European type W. C. preferably with low type chinaware cistern	(b) Toilet paper holder	(c) Liquid Soap bowl.	projecting, size 3'-6" x 7'-0" having tiers with fully glazed shutters in the Drawing room.	<i>Dining Portion.</i>	(1) Built-in shelf with shutters or Side Board.	(2) Pelmet & Curtain rods.	(3) Fly-proof shutters to doors & windows.	plated towel rail. Liquid soap bowl R. C. C. Shelves in stores.	cistern. (4) One tap.

ELECTRICAL INSTALLATIONS

Type of Residential Building	Type of Wiring	Light points Nos.	Plug points Nos.	Fan points Nos.	Ceiling fans Nos.	Call bell Nos.	Power plugs Nos.
I	2	3	4	5	6	7	8
Type I	V. I. R. wiring in casing and capping in Hot and Arid regions and C.T.S. or T.R.S. wiring in other regions.	3	1	1
Type II	Do.	5	2	2	1
Type III	Do.	8	3	2	2
Type IV	L.S. wiring for hot and arid Regions and LS/C.T.S. wiring in other regions	12	4	3	3	1	1
Type V	<i>Drawing & Dining</i> : Recessed conduit wiring. <i>In other Rooms</i> : L. S. in Hot & Arid & LS/C. T.S. in other Regions.	16	7	6	5	1	2
Type VI	<i>Drawing & Dining</i> : Recessed conduit wiring <i>In other Rooms</i> : L. S. in Hot & Arid Regions. & LS/C.T.S. in other Regions. <i>Servant Qrts</i> : No electrification. <i>Fittings</i> : In drawing and dining superior Type Decorative fittings.	22	8	7	6	2	4

contd.

APPENDIX VII (Para 5.6)

1	2	3	4	5	6	7	8
Type VII	<i>Drawing & Dining: Recessed conduit wirings.</i>	30	8	8	7	2	5
	<i>In other Rooms: L. S. in Hot & Arid Regions and LS/C.T.S. in other Regions.</i>						
	<i>Servant Qris: No electrification.</i>						
	<i>Fittings: In drawing, Dining, Study, & Bed Rooms superior Type Decorative fittings.</i>						

NOTE:—In Types VI & VII one of the two calling bells may be fixed at the entrance door for the visitors and the other at a convenient place in the house for calling the servants.

(2) The number of L.P., and plug points and Fan points may be varied by 10% either way depending upon nature of plan and local considerations.

(3) Also in places with cold climate, number of ceiling fans may be reduced or omitted and number of power plugs increased to suit local requirements.

APPENDIX VIII

(Para 6·6·2)

COMPARISON OF MAN-HOURS BETWEEN CONVENTIONAL AND ADVANCED BUILDING METHODS IN THE CONSTRUCTION OF MASONRY WALL DWELLING*

Item	Man-hours by Building Method	
	Conventional	Advanced
Degree of Skill		
Skilled	140·3	118·4
Unskilled	131·4	80·1
Work Elements :		
Tools	13·3	11·3
Materials	62·9	45·3
Supervise	11·4	6·8
Measure, level, plumb	15·3	10·7
Cut and Chip	2·2	—
Assist	3·4	0·5
Error	0·1	0·5
Idle personnel	7·4	3·8
Idle avoidable	17·2	5·4
Idle unavoidable	23·6	8·2
Temporary construction	11·7	7·1
Lay block and brick	57·5	68·3
Plaster and tool joint	13·7	7·0
Mix and temper	18·0	16·1
Set ties or clips	3·2	1·2
Miscellaneous	10·8	6·2
Total time	271·7	198·5
Productive time	113·6	97·0
Preparation time	109·8	83·6
Non-productive time	48·3	17·9

*The house is of masonry wall construction, with a total area of 811 square feet consisting of 5 rooms and a full basement. The data are adopted from University of Illinois, Small Homes Council, Research Report on a Study of Nonmodular Masonry Construction, Urbana, Ill., 1949, Appendix No. 13.

From Building Industry
Report by the
United States Department of Labour.

APPENDIX IX (Para 6.6.2)

*Savings through use of Modular Co-ordination as compared with conventional construction methods in the construction of 6. Horms., U.S.A. 1947**

Operation	Items included	Man-hours			Percent of		
		By conventional methods	By Modular Co-ordination**	Number saved	Man-Hours savings	Savings in total Labour on job.	Savings in Total Cost***
Foundation and Floor	Excavation, footings, foundation floor, floor Joist and subfloor.	257	231	26	10	1.2	0.6
Exterior wall	Structural framing and sheeting.	262	218	44	18	2.1	1.0
Roof	Roof trusses, gable ends, roof boards, and roofing and cornice	375	277	98	26	4.7	2.2
Interior	Flooring, wall and ceiling material, interior partitions.	412	251	161	38	7.8	3.6
Millwork	Trin, cabinets, windows, painting.	534	440	94	18	4.5	2.1
Mechanical	Plumbing	80	55	25	32	1.2	0.7
	Heating	43	48	—5	—12	—0.2	—0.1
	Wiring.	40	53	—13	—31	—0.6	—0.3
Miscellaneous	Not included in any of the above groups.	75	67	8	10	0.3	0.2
Total for entire house.		2079	1640	439	21	21.0	10.0

79

* The house with total floor area of 811 squares feet, consists of 3 rooms and a full basement. The data are adapted from University of Illinois, Small Homes Council, Construction Methods, Circular Series.

** An average of the houses built by application of modular coordination.

*** Material and labour ; no allowance for contractor's overhead or profit.

From Building Industry
Report by the
United States Department of Labour.

APPENDIX X: (Para 6.8.1)

NUMBER OF MANHOURS REQUIRED IN EACH MAIN TRADE FOR ONE PAIR OF SEMI - DETACHED HOUSES

MAN HOURS

General Labourers	490	
Bricklayers & Labs	1100	
Carpenters	280	
Plasters, & Labs.	330	
Roof Tiler & Mate	50	
Plumber & Mate	120	
Electrician & Mate	50	
Painters	190	

RESULT OF HAPHAZARD SELECTION OF TRADE GANG CONSTRUCTION UNBALANCED WORKING TIMES.

HOURS

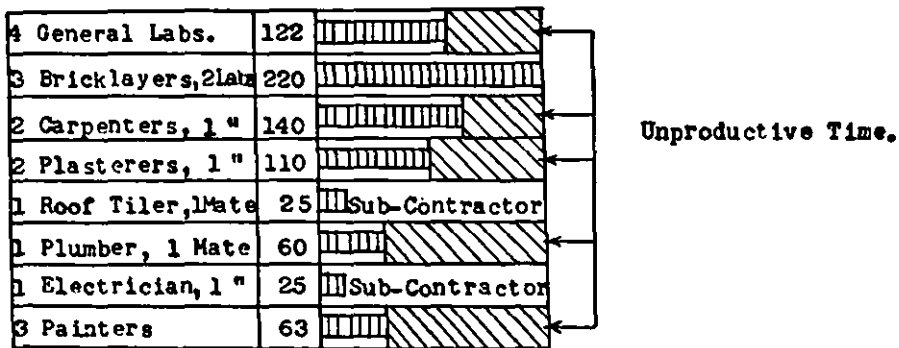

Time Cycle

RESULT OF PLANNED & PHASED PRODUCTION BALANCED TRADE GANGS BALANCED WORKING TIMES TIME-CYCLE & UNPRODUCTIVE TIME REDUCED.

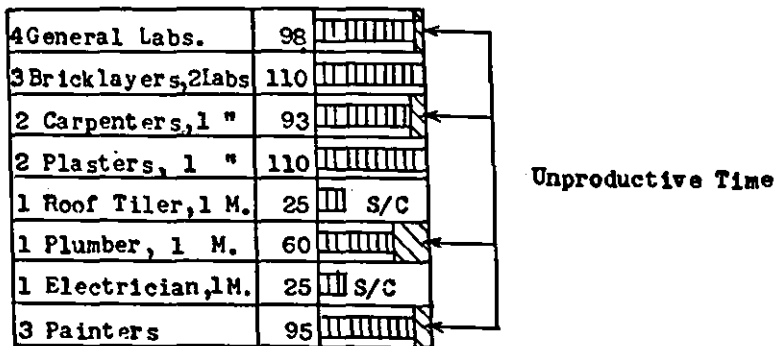

Time Cycle

FLOW CHART (ADMINISTRATIVE)

Sl. No.	Particulars	M.E.S. Qrs. at Bombay 'E' type	M.E.S. Qrs. at Bombay 'E' I type	Western Rly. Qrs. at Bombay Junior Officer's flat	Income Tax Officers flat at Bombay. (Built by C.P.W.D.) Type III flat	Income Tax Officers flat at Bombay (Built by C.P.W.D.) Type-IV flat	C.P.W.D. Qrs. at New Delhi (E) Type	C.P.W.D. Qrs. at New Delhi 'G' Type
1	2	3	4	5	6	7	8	9
1.	Date and amount of Administrative approval.	5-2-54 Rs. 9,55,000	5-2-54 Rs. 8,84,000	Final works programme for 1956-57 Rs. 5,54,000	3-7-54 Rs. 13,87,800 (For the entire project).	3-7-54 Rs. 13,87,800 (For the entire project).	11-6-55	11-2-54
2.	Date of Technical sanction	31-3-54	5-8-54	17-4-56	21-3-55	21-3-55	3-9-55	8-6-54
3.	Date of call of tenders :							
	(i) Pile foundation	4-6-54	20-9-54	24-3-56	} 30-12-55	} 30-12-55	} 29-7-55	} 20-10-54
	(ii) Super structure	3-2-55	1-3-55	23-6-56				
4.	Date of start of work							
	(i) Pile foundation	21-10-54	4-1-55	1-8-56	} 22-2-56	} 15-2-56	} 16-10-55	} 31-12-54
	(ii) Superstructure	2-4-55	2-4-55	1-10-56				
5.	Stipulated time							
	(i) Pile foundation	2 months	2 months	3 months	} 16 months	} 16 months	} 8 months	} 8 months
	(ii) Superstructure	12 months	12 months	10 months				
6.	Time required as per circular of C.E., C.P.W.D., New Delhi.	25 months	25 months	26 months	26 months	28 months	15 months	11 months
7.	Actual time taken :							
	(i) Pile foundation	3 months and 3 weeks	2 months and 22 days	3 months	} 20 months & 27 days.	} 20 months & 3 days.	} 16 months & 16 days.	} 15 months
	(ii) Super structure	19 months and 20 days.	20 months	11 ½ months				

1	2	3	4	5	6	7	8	9
8. Percentage of extra time taken to the stipulated time.								
(i) Pile foundation.	88%	38%	Nil	31%	26%	104%	88%	
(ii) Superstructure	64%	67%	15%					
9. Reasons for delay in execution if any :								
(i) Pile foundation.	(a) Labour strike.	(a) Labour Strike			(a) Supply of materials.	(a) Supply of materials.	(a) Supply of materials.	(a) Supply of materials.
(ii) Superstructure	(a) Late supply of steel. (b) Change in siting of garages. (c) Delay in laying cables. (d) Sub soil water in lift wells. (e) Water proofing of lift wells. (f) Late approval of samples of tiles.	(a) Shortage of stores. (b) Late approval of fittings. (c) Delay in laying cables, by B.E..S.T. (d) Sub soil water in lift wells.	(a) Due to Flu-epidemic at Bombay.		(b) Finalising lift room details.	(b) Finalising machine room details.	(b) Delay in completion of work of other trades engaged in the Building work.	(b) Delay in deciding plinth work (c) Delay in completion of work of other trades engaged in building work.

APPENDIX XI (ii)

1	2	3	4	5	6	7	8	9
10. Amount of contract :								
(i) Pile foundation	Rs. 55,296	Rs. 49,506	Rs. 30,450	} Rs. 3,09,927	} Rs. 5,14,339	} Rs. 12,07,969	} Rs. 3,85,892	
(ii) Superstructure	Rs. 6,74,657	Rs. 6,12,000	Rs. 3,07,300 (Excluding cost of steel and cement.)					
11. No. of items in the contract :								
(i) Pile foundation	Lumpsum contract	Lumpsum contract	1	} 43	} 44	} 60	} 42	
(ii) Superstructure			94					
12. No. and amount of extra items and their percentage to the tendered amount.								
(i) Pile foundation	(i) Rs. 23,121 42%	Rs. 20,060 40%	Nil	} 24 items for Rs. 13,303 4.3%	} 19 items for Rs. 68,096 13.2%	} 30 items for Rs. 25,378 2.1%	} 25 items for Rs. 23,592 6.3%	
(ii) Superstructure	(ii) 21 items for Rs. 43,809 6.5%	23 items for Rs. 48,382 7.9%	14 items for Rs. 4,133 1.2%					
13. Reasons for extra items :								
(i) Pile foundation	(i) (a) deeper foundation	(i) Site conditions.		(a) Due to rocky soil.	(a) Due to rocky soil.	(a) Change in specification.	(a) Change in specification.	
(ii) Superstructure	(ii) (a) Issue of different sections of steel. (b) Structural & architectural changes. (c) Site conditions.	(ii) (a) Non-availability of stores. (b) Site conditions.	(ii) (a) Omission in the schedule of quantities.	(b) Architectural changes. (c) Non-provision of items in the original estimate.	(b) Architectural changes. (c) Change in specification.	(b) Structural & architectural changes.	(b) Structural & architectural changes.	
14. Time taken for final payment after completion of work,								
	4 months and 10 days.	4 months	Final bill not paid.	Final bill not paid,	Final bill not paid,	14 months	12 months.	

APPENDIX XII (Para 7.10.3.)

WESTERN RAILWAY

No. W. 113/14.Vol.II.
 DSS-BCT.BRC. RTM.KTT.AII.JP. RJT. BVP.
 DAOs— -do-

GENERAL OFFICE
 CHURCHGATE—BOMBAY.
 Dated 7th February, 1958.

Joint Accounts & Engineering Circular

Sub:—Contracts—Engineering—Outstanding dues of Contractors.

Ref:—This office Confidential Circular letter Nos. W.118/14 dated 18th January 1957 & 7th May, 1957.

At the time of Divisional Engineers' Conference held on 5th, 6th & 7th December, 1957 in the Headquarters Office, Churchgate, Bombay, the F.A. & C.A.O. and C.E. had pointed out that the Divisional Engineers were taking an unduly long time to finalise the Running and Final Bills. The Divisional Engineers, however, expressed their difficulty in working to the schedule of time laid down in Circular No. W. 118/14 dated 18th January, 1957. The views expressed by the Divisional Engineers have been considered and the following revised procedure in passing 'On account' and 'Final' bills is laid down in supersession of the Circulars quoted above. It must be emphasised that the revised time limit is the maximum allowed and that every effort should be made to pass the bills earlier:—

(i) *Running Bills*

Time allowed for PWI or IOW—	3 days +
	2 days in transit =5
Time allowed for AEN	7 days +2 days
	in transit=9 days.
Time allowed for XEN/DEN	3 days + 1
	day in transit=4 days
Time allowed for Accounts	2 days 2 days
<hr/>	
Total No. of days from taking measurements to Passing the bill by DAO	20 days

(ii) *Final Bills*

(a) Maximum time for preparation of Final bills from date of physical completion of work will be as under :—

Time allowed for PWI or IOW and his office for

- (i) SMALL WORKS 15 days maximum.
- (ii) LARGE WORKS 30 days maximum.
- Period of transit to AEN's office 2 days.

Time allowed for AEN and his office
for checks and preparation of

bills for (i) SMALL WORKS—10 days maximum.
(ii) LARGE WORKS—20 days maximum.

Period of transit to DEN's office.—2 days.

Period in Divisional Office for arithmetic check by Accounts and technical
check by Computer and DEN's own site check etc.

10 days for small works.

20 days for large works.

Period of transit to DAO 1 day.

(b) Period of check by DAOs including disposal of all queries etc for
SMALL WORKS—8 days. LARGE WORKS—15 days.

Thus, in case of final bills for Small Works, the total period that
should not be exceeded will be $(15 + 2 + 10 + 2 + 10 + 1 + 8) = 48$ days, while
for Large Works, the total period allowed will be $(30 + 2 + 20 + 2 + 20 + 1 + 15) = 90$ days.

APPENDIX XIII (Para 1.7)

List of Selected Reference Books

- (1) Indian Railway Standard Code of Practice for Design and construction of Earthquake Resistant Building and Structures (Adopted 1951).
- (2) Bulletin of the Central Building Research Institute (April 1953).
- (3) Proceedings of the World Conference of Earthquake Engineering—Berkeley, California (June 1956).
- (4) Earthquake Engineering Problems in India by Jai Krishna, California Institute of Technology (April 1957).
- (5) Journal of the Structural Division—Volume 84 No. ST4—(July 1958) Part I.
- (6) Earthquake Engineering Seminar held at the University of Roorkee (From 10th to 12th February, 1959).
- (7) Journal of the Structural Division—Volume 85 No. ST2—(February 1959).
(Proceedings of the American Society of Civil Engineers).
- (8) Engineering (13th March, 1959).
- (9) Indian Railway Technical Bulletin (May 1959).

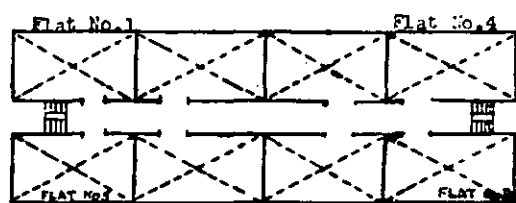

PLAN SHOWING STAIRCASE ACCESS WITH INTERNAL CORRIDORS

SKETCH A

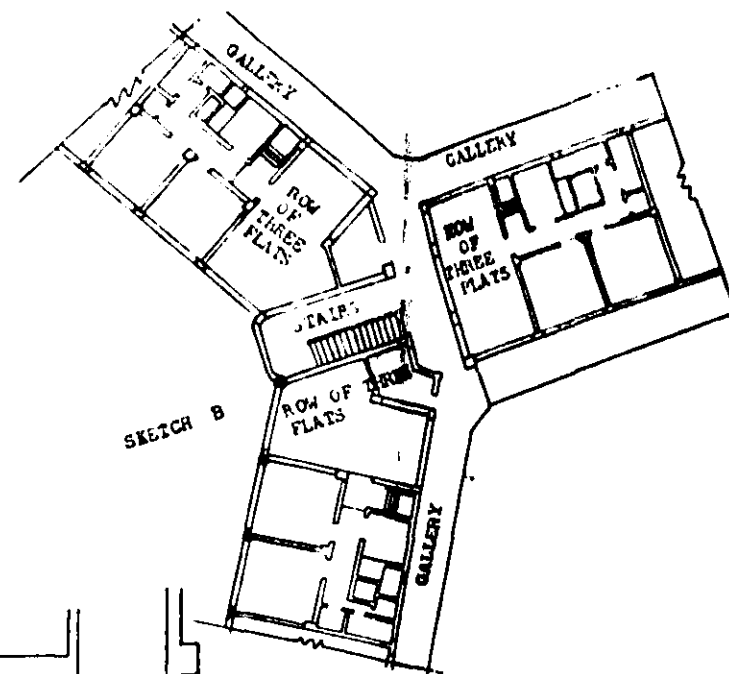

SKETCH B

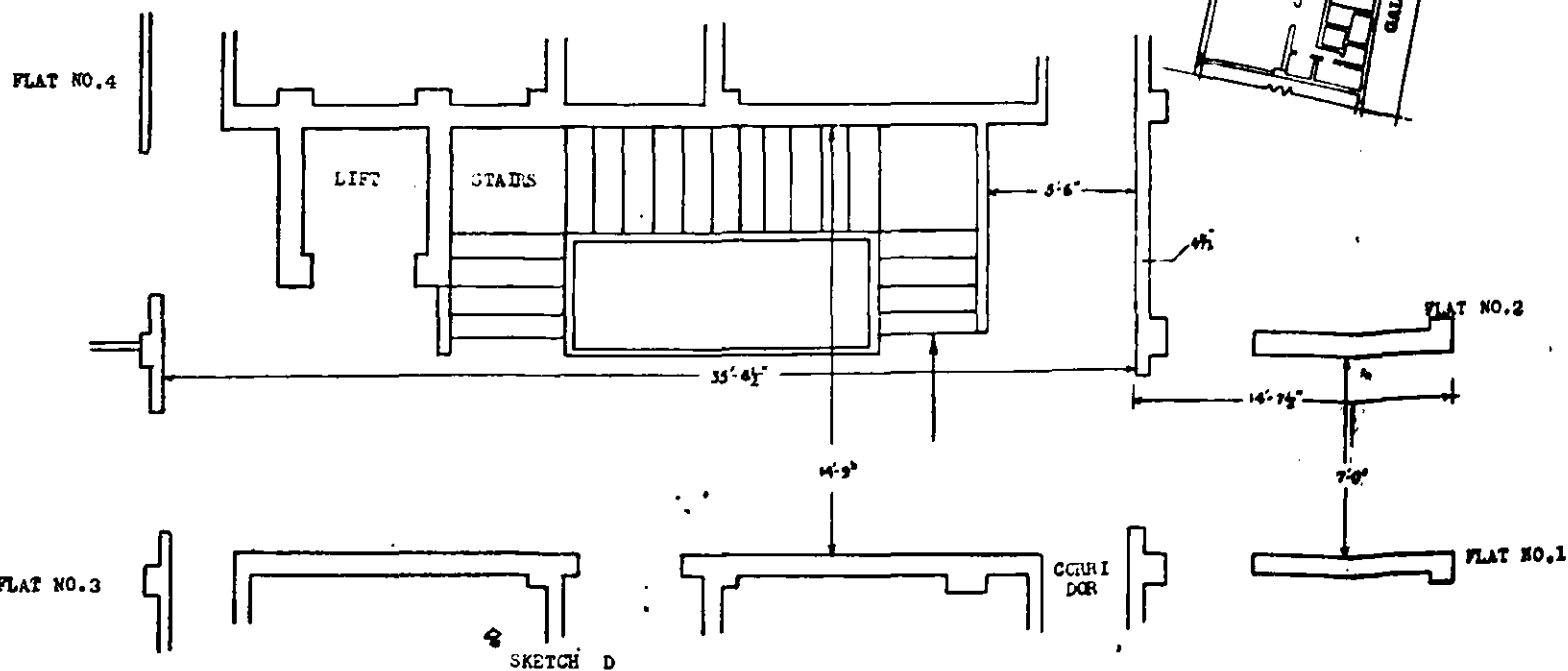

SKETCH D

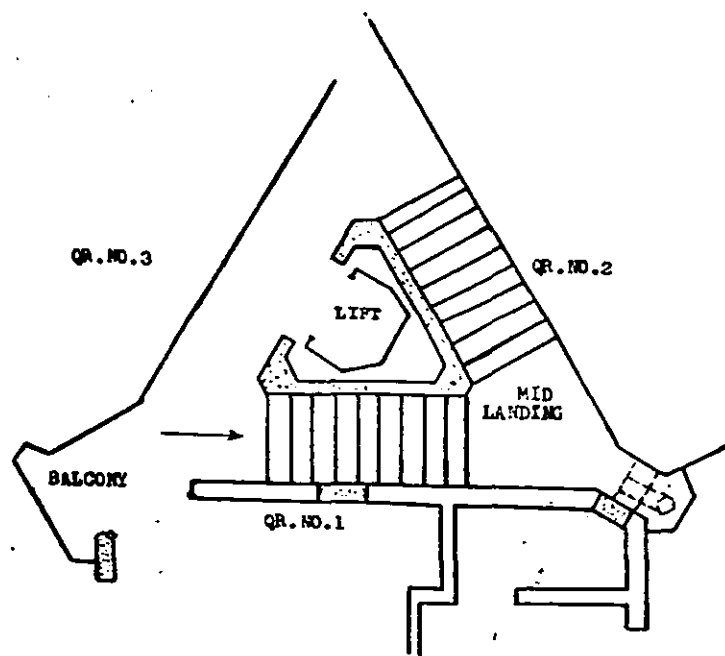

SKETCH C

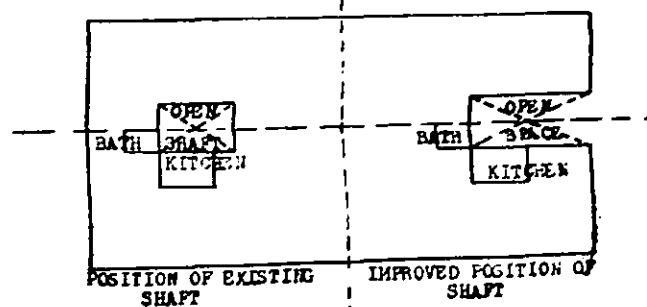

SKETCH E

PLATE I
SKETCHES SHOWING BALCONY
AND CORRIDOR ACCESS

Fig. (a)
Para (4.2.3)

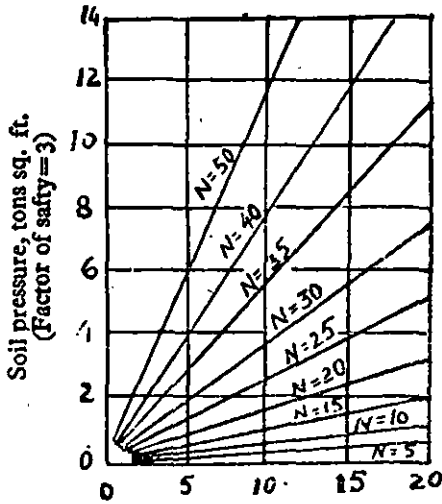

Footing Width, B, Ft. Fig. (a) Safe Soil pressure without Surcharge $D_f=0$

Fig. (b)
Para (4.2.3)

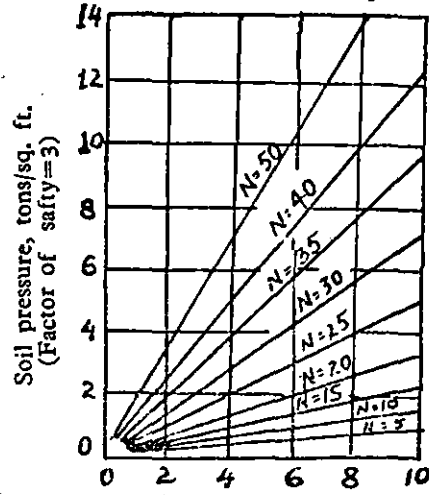

Depth of surcharge, D_f , ft. Fig. (b) Additional safe soil pressure due to surcharge

Charts based on water table not closer than B below base of footing.
Safe soil pressures beneath footings on sand, as determined by bearing capacity.

Fig. (c)
Para (4.2.7)

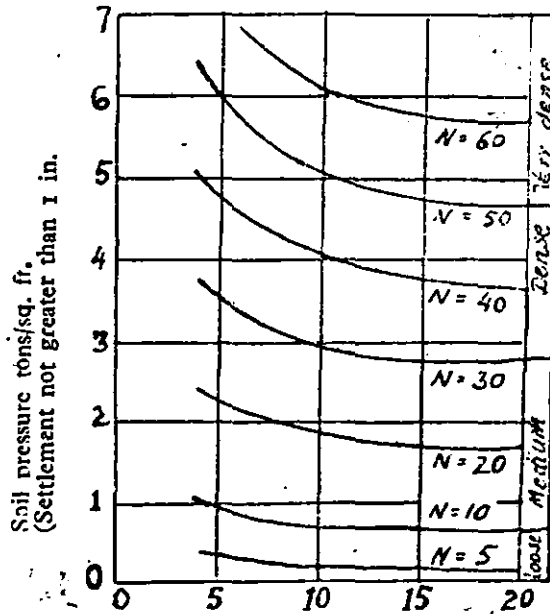

Width of footing, B, ft.

Chart based on water table not closer than B below base of footing.

Fig. (c) Soil pressure corresponding to 1. inch settlement of footings on sand.

PLATE NO. III (Rev. 4.10.65)
METHOD OF SECURING THE SHUTTERS WITH PRECAST R.C. FRAMES.

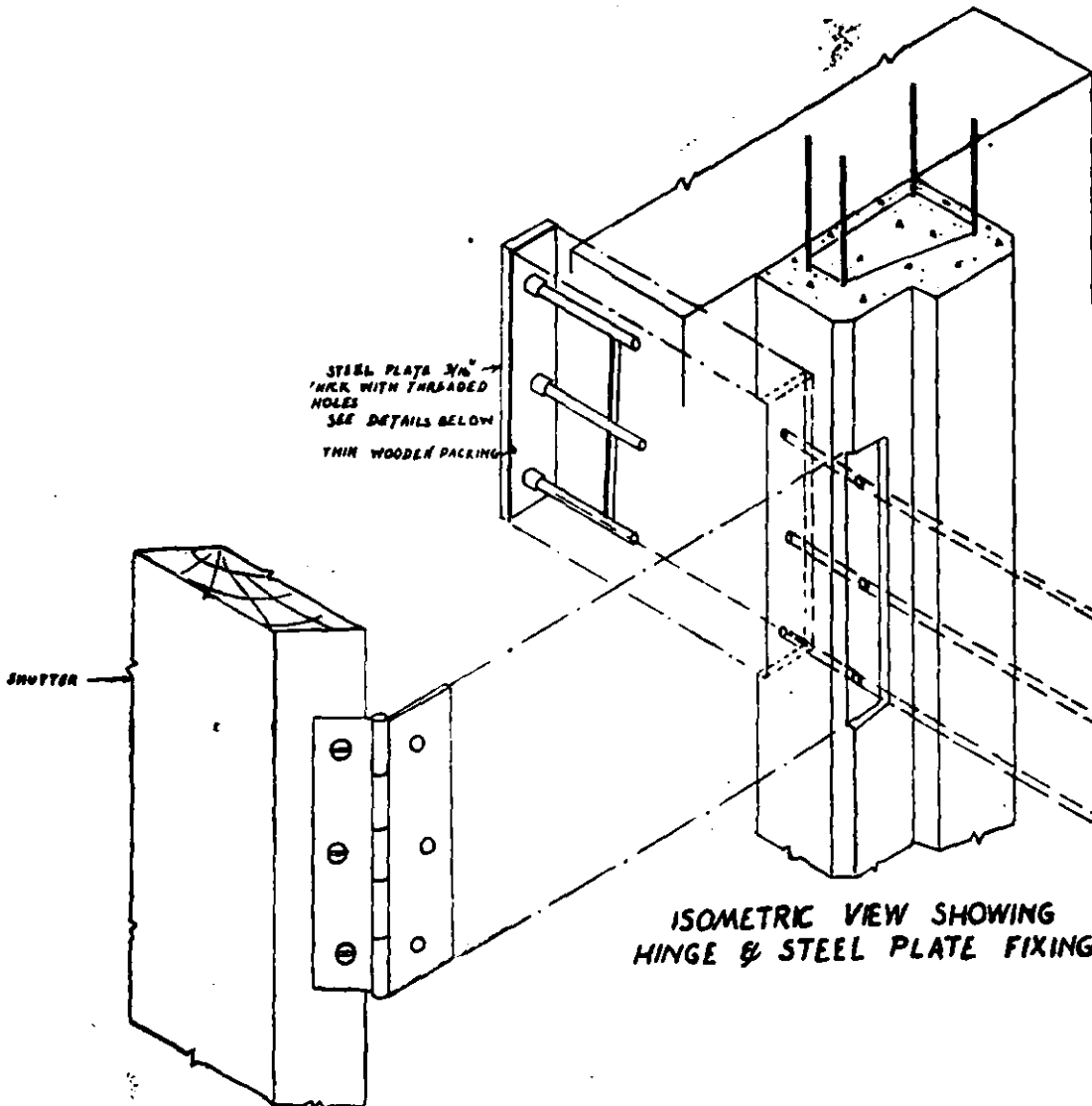

STEEL PLATE $\frac{3}{16}$ " THICK WITH THREADED HOLES

HOLLOW STEEL TUBES FOR THE BOLTS WITH COUNTER SUNK HEADS

THIN WOODEN PACKING

BOLTS WITH COUNTER SUNK HEADS

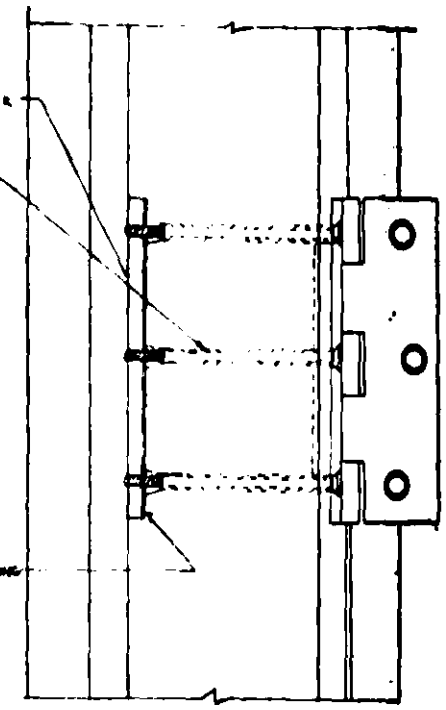

READY MADE FIXTURE TO BE INTRODUCED IN THE R.C. FRAME MOULD BEFORE CONCRETING

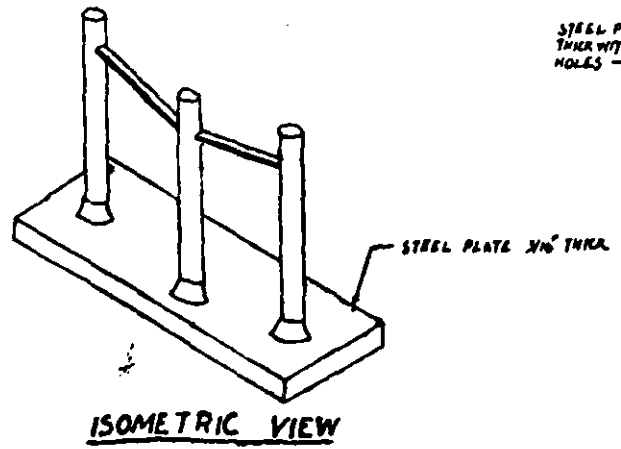
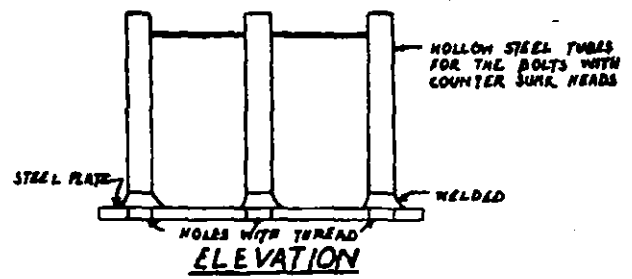

THIN WOODEN PACKING

STEEL PLATE $\frac{3}{16}$ " THICK WITH THREADED HOLES

HOLLOW STEEL TUBES FOR THE BOLTS WITH COUNTER SUNK HEADS

