



REPORT OF
THE SELECTED BUILDINGS PROJECTS TEAM
ON
INDUSTRIAL ESTATES

COMMITTEE ON PLAN PROJECTS
NEW DELHI
May, 1959.

Composition of the Team for Selected Buildings Projects.

Leader

Shri S. K. Patil, Minister of Transport and Communications.

Members

Shri Sarup Singh, ISE(Retd), formerly Director, National Buildings Organization.

Dr. Eng. A. Carbone, M.I.A.B.S.E., Consulting Engineer, Calcutta.

Shri C. P. Malik, Director, National Buildings Organisation
(*ex-officio*).

Secretary

Shri T. S. Vedagiri, Superintending Engineer.

General H. Williams, Director, Central Buildings Research Institute, Roorkee, has also kindly agreed to attend meetings of the Team and the Panels as and when he can spare time. He has, however, placed the facilities of the Central Buildings Research Institute at the disposal of the Team.



**Minister of
Transport and Communications,
INDIA.**

New Delhi, May 31, 1959.

My dear Pantji,

I have great pleasure in forwarding herewith the report of the Selected Buildings Projects Team on Industrial Estates. You will recall that the Team set up a Panel for examining different types of factory buildings. As the outlay on Industrial Estates in the present Plan is substantial, the Team considered that it would be advisable to evaluate some of the Estates from technical and financial points of view. The work was entrusted to the Panel for Factory Buildings.

2. The Panel after examining six of the Industrial Estates recently set up, has come to the conclusion that there is wide variation in design standards and space utilisation. It has therefore laid down certain norms for effective space utilisation and economical construction.

3. It is estimated that about 10,000 tons of structural steel will be required for the programme of Industrial Estates envisaged in the Second Plan. It is possible to save a substantial portion of this, if alternative types of roofing suggested by the Panel are adopted. The suggestion of the Team regarding roofing would also lead to a saving of about Rs. 20 lakhs in financial cost.

4. You will be glad to know that the recommendations contained in the Report have been welcomed both by the Development Commissioner, Small-Scale Industries and by the Adviser (Planning), Planning Commission.

5. The Panel has studied a number of other Industrial Projects. An advance report on the Heavy Electrical Project Bhopal and the Fertilizer Project at Nangal was issued last year and the Panel is studying other Industrial Projects such as Oil Refineries, Coal Washing Plants, etc. Its findings and recommendations on these will be given in the subsequent Reports on Factory Buildings.

6. I take this opportunity of thanking the various authorities in-charge of Industrial Estates for their co-operation in supplying the information required by the Team and the facilities accorded by them for on the spot studies and discussions.

Yours sincerely,
S. K. Patil.

SHRI GOVIND BALLABH PANT,
CHAIRMAN, COMMITTEE ON PLAN PROJECTS &
MINISTER OF HOME AFFAIRS,
NEW DELHI.

REPORT ON INDUSTRIAL ESTATES

CONTENTS

	PAGE
<i>Report</i>	
1. Introduction	1
2. Objective of Industrial Estates	2
3. Approach to the problem	4
4. Main observations	4
5. Planning and layout	5
6. Design details	7
7. Services and other amenities	12
8. Organisation for execution and maintenance	12
9. Recommendations for reducing cost of construction	13
10. General observations	16
<i>Summary of Important Recommendations</i>	18
<i>Remarks by the Selected Buildings Projects Team</i>	19

Appendices

I. Programme and progress of work on Industrial Estates	21
II. Information regarding Industrial Estates visited by the Panel	23
III. Observations and comments on various Industrial Estates visited	25
IV. Cost & Material analysis	31
V. Proforma regarding Industrial Estates	32

Plates

I & II. Design of timber trusses for spans of 30' & 40'	
III & IV. Precast R.C. trusses for spans of 30' & 40'	
V & VI. Design of trusses in steel for spans of 30' & 40'	
VII. Precast prestressed R. C. truss for 40' span	

REPORT ON INDUSTRIAL ESTATES

1. Introduction.

1.1. In view of the large and growing outlay on the plan projects undertaken in the First and Second Five Year Plans, and the necessity to explore all possible avenues of economy in cost and consumption of materials in their execution, the National Development Council constituted the Committee on Plan Projects in September, 1956. As buildings form a substantial portion of the total capital outlay, the Committee on Plan Projects set up the Buildings Projects Team to carry out an evaluation of selected buildings projects particularly with regard to planning and execution with a view to making suggestions for economy in design and execution.

1.2. The Team took up factory buildings as one of the subjects for study and set up a Panel composed of the following:—

Chairman

- (i) Dr. A. Carbone, Consulting Engineer Calcutta, and Member, B. P. Team.

Members

- (ii) Sardar Sarup Singh, ISE (Retd) Member-Chief Engineer, B.P. Team.
- (iii) Shri N. S. Mankiker, Chief Adviser of Factories, Ministry of Labour.
- (iv) Shri H. D. Avasthy, Director, Civil Engineering, Railway Board.
- Shri K. C. Sood, Director, Research Design & Standardisation Organisation, Ministry of Railways (from 18th August, 1958 in place of Shri H. D. Avasthy transferred to Calcutta).
- (v) Shri O. Muthachen, O.S.D., Ministry of Food & Agriculture.
- (vi) Prof. G. S. Ramaswamy, Asstt. Director, Central Buildings Research Institute, Roorkee.
- (vii) Mr. R. Reiser, Consulting Engineer, Delhi (Co-opted on 23rd January, 1958).
- (viii) Shri T. S. Vedagiri, Superintending Engineer and Secretary, Buildings Projects Team.—*Member-Secretary.*

1.3. In view of the large outlay (Rs. 11 crores) envisaged in the Second Five Year Plan for the establishment of Industrial Estates and the large number of factory buildings that are to be constructed under the scheme, the Panel considered that it should be a subject for separate study. This report therefore only deals with Industrial Estates.

2. Objective of Industrial Estates.

2.1. India is a land of small entrepreneurs. Small scale industries suffer from a variety of handicaps such as lack of suitable accommodation, difficulty in obtaining raw materials of the right quality and at the right price, unsatisfactory equipment and lack of contact with modern techniques of production. One of the important measures that the Government have taken to overcome these deficiencies is the establishment of Industrial Estates and the Second Five Year Plan defines the objective in the following terms:—

“A provision of Rs. 10 crores (now increased to Rs. 11 crores) has been made for setting up industrial estates in the Second Five Year Plan with a view to providing conditions favourable to working efficiency, maintenance of uniform standards in production and economic utilisation of materials and equipment. The principal objective is to enable a number of small-scale units to have the advantage of common services and other facilities such as, a good site, electricity, water, gas, steam, compressed air, railway sidings, watch and ward, etc. Being located near one another some units may be better able to use the goods and services of others so that they become interdependent and complementary. Two types of Industrial Estates, large ones costing from Rs. 40 to 50 lakhs and small ones costing from Rs. 20 to 25 lakhs are expected to be established. It is proposed that the responsibility for construction and management should vest in the State Governments but that the Central Government should advance to State Governments the entire cost of the estates in the form of loans. State Governments will run the estates through corporations or such other agencies as they may decide to set up. Sites in the estates will be sold outright to industrial units or given to them on hire purchase terms. In some cases buildings will be erected on sites and let out on rental or a rent-cum-purchase basis or, if necessary, sold outright.”

“The Village and Small Scale Industries Committee expressed the view that industrial estates should be located in such a way that they do not encourage further concentration of population in large urban centres. In deciding the location of the estates especially the smaller estates, this consideration should be kept in view so that preferably they are developed in or near towns of comparatively small size.”

“The technical service schemes of the Centre and the schemes of industrial estates will influence the general direction and the pace of development of small-scale industries but the pattern of development of these industries will really be set by the manner in which various schemes are framed and carried out in the States. The State schemes are broadly of four types, namely,

(a) technical service and research schemes, e.g., training-cum-production or training-cum-demonstration centres and polytechnics;

(b) Production schemes of a pilot character initiated departmentally with a view to being turned over to industrial co-operatives or private enterprises;

(c) Production schemes of a commercial character and loans to private concerns under State Aid to Industries Acts; and

(d) Schemes for supply of power.

"The training and technical service programme in the States will supplement the Central Programme to be implemented through the Small Industries Service Institutes. The need for coordination in this matter as well as in other development activities as between the Small Industries Service Institutes and Industries Departments in the States has been recognised and steps have been taken to define the relative sphere of activity of the two and the manner in which they will coordinate their respective functions. While the Institutes are intended to serve primarily as a technical service agency, State Industries Departments will continue to handle all matters regarding enquiries for starting industries, financial and other forms of assistance needed by industries, organisation of industrial cooperatives, etc. There will be mutual consultation in such matters as pilot schemes of Central Government, such as, model workshops, arranging for the services of technical experts and preparation of lists of industries suitable for different regions. Model schemes for some industries have already been prepared by the office of the Development Commissioner for Small Scale Industries."

"In proposing schemes for developing various small scale industries conditions of demand, availability of raw materials and other relevant factors have to be studied carefully. It could be useful to select for different regions the industries for which favourable conditions exist and which should, therefore, be specially promoted and assisted. In preparing departmental schemes and in scrutinising the applications from private persons for loans and other assistance, reference to lists of selected industries could be of much assistance. Exploratory surveys as well as intensive studies are needed for their preparation and for the necessary modifications in the light of changing conditions. A programme of investigations has already been initiated by the Small-Scale Industries Board and a team has completed reports on four industries in the northern region, namely, sports goods, sewing machines and parts, bicycles and parts and leather footwear and one industry on an all-India basis, namely, automobile batteries for the northern region. Similar teams for the eastern, southern and western regions have also started working.

Pending the completion of these studies, tentative lists of industries could be drawn up by State Industries Departments on the basis of their own experience and judgment, so that a measure of direction and guidance can be given to developments in this field."

3. Approach to the problem.

3.1. A general survey of the Second Plan programme for Industrial Estates and the progress so far made is given in Appendix I.

3.2. Before undertaking the tour of inspection of some of the Industrial Estates, the Panel issued a questionnaire for obtaining information regarding the types of structures adopted for the work sheds and other details. This is tabulated in Appendix II.

3.3. The Panel visited the Industrial Estates at Guindy (Madras), Pappanamgode (Trivandrum), Okhla (New Delhi), Bauripur (West Bengal), Hyderabad (Andhra) and Rajkot (Bombay). Discussions were also held with the authorities in charge of the Industrial Estates and with the Joint Development Commissioner, Small Scale Industries, Ministry of Commerce & Industry. The observations and comments on the Industrial Estates visited are given in Appendix III.

3.4. The terms of reference to the Panel envisaged the study of planning, designing and execution of buildings and other civil engineering works of the Industrial Estates, but during the course of their work the Panel thought that it would be useful to consider the broader aspect of the pattern of development in its relation to the objectives of the Plan. The Panel naturally could not go very deep into this matter and has therefore contented itself in making general observations at the end of the report.

4. Main observations

4.1. Out of the six Estates visited by the Panel four are situated near large cities—Madras, Hyderabad, Delhi and Rajkot. In most cases prior to deciding on the location of the Estate, preliminary survey of a very limited character appears to have been carried out, more from the point of view of making an assessment of the potentiality of finding suitable tenants rather than for the purpose of ascertaining the type of new enterprises or industries that could be established to ensure coordinated development as envisaged in the plan. However, large established concerns which are in a position to expand without Government's assistance as well as service industries such as flour mills and bakeries have been excluded from the Estates, except for a soda water factory established in Rajkot.

4.2. All the factories are privately owned and managed. Except in one solitary instance, there are no cooperatives.

4.3. Appendix II gives information on sizes of plots, land use and sizes of sheds in the Estates visited by the Panel. It would be observed that the variations are wide. The area under roads varies from 25 to 46% with overall widths of 30 ft. to 150 ft. In one case provision has been made for a four lane traffic with cycle and foot

paths which might have been considered more appropriate for a modern metropolitan highway. The sizes of sheds vary widely and the types also differ.

4.4. These divergencies in planning only bring out the need for evolving norms and standards which can be adopted in future for rational planning of the Estates. Our recommendations are given in the subsequent paragraphs.

5. Planning and lay-out

5.1. *Survey of industrial potential.*

5.1.1. As observed earlier, the surveys carried out prior to the decision on the location and size of the Estates have been very limited in scope. If the objectives of the Plan are to be fulfilled and capital utilised to the maximum possible extent, it is essential that the survey should be more thorough. There would be three classes of industries that would be located in an Estate:—

- (a) Established industries shifted from congested parts of a town.
- (b) Extension of existing industries.
- (c) New industries.

The survey should give the work shed area requirements of the three groups, the services desired and the wishes of the entrepreneurs; whether they desire developed land only, or a complete factory to be let on rent or hire purchase system, or outright purchase.

5.1.2. There should be a judicious distribution between the three groups. The setting up of new industries should not suffer because of the ready demand from established industries.

5.1.3. From the survey it should be possible to find out the trend of future development and make provision accordingly.

5.1.4. The authorities concerned with the development of four types of industries enumerated in para 2.1, should be brought in the picture at the planning stage.

5.2. *Choice of site and orientation*

5.2.1. A suitable site for an Industrial Estate should have such geographical features as would permit easy drainage. It should be close to perennial water supply and within a reasonable distance from a reliable source of power. It should preferably be close to a railway station with goods yard facilities.

5.2.2. The shape of a plot and orientation of factory buildings are closely linked. North light roofs can be used with advantage only in regions north of Tropic of Cancer. For regions to the south of Tropic of Cancer, no special advantage is gained by the adoption of north light roofs. Adequate lighting within the factory can be obtained by arranging the work sheds in East and West direction and by providing glazed windows in the North and South walls. This permits the use of ordinary gable roofs which are cheaper than the north light roofs. In no case windows should be placed in the East and West walls of the building.

5.3. Norms in planning

5.3.1. It is needless to emphasise the need for the most economical and efficient utilisation of the land available. The index of good performance is the proportion that the area under factory plots bears to the total area. Normally the area of an Estate can be broadly divided into the following four categories and it should be the endeavour of Engineers and Architects to plan the Estate in such a way that the area under each category conforms to the figures given against each:—

(a) area under factory plot	60 to 65%
(b) area under roads upto	20%
(c) area under open space upto	10%
(d) area under administrative and other buildings.	5 to 10%

5.4. Planning of work-sheds

5.4.1. Considering the functional requirements of small scale industries that may be established in Industrial Estates, there does not appear to be any necessity to adopt a large number of different sizes. Standard spans of 30 ft. and 40 ft. can be adopted in most cases without difficulty. This lends itself to the adoption of standard designs of trusses, which would be conducive to economy. With these standard spans different sizes of sheds can be evolved by varying the lengths.

5.4.2. The minimum size of work shed may be of 600 sft. and the maximum can be placed at 6,000 sft. The plot area for the smaller work sheds may be double the covered area whereas in the case of larger ones the plot area can vary from $1\frac{1}{2}$ to $1\frac{1}{2}$ times the covered area.

5.4.3. It may not, however, be necessary to provide for open area in all the plots. There are some industries which require open area. The Estate must be planned in such a way that work sheds with and without open space are separately grouped. Apart from this there should be long sheds which can be conveniently divided into areas of about 600 sft. for allotment to small entrepreneurs. This will provide the necessary flexibility.

5.4.4. The internal division of the covered area, into workshop, office and store, etc. should be left to the allottee. It is not advisable to effect such distribution without ascertaining the requirements of the users.

5.4.5. The exact method of relative placing of the work sheds is a matter of detail. Several variations were observed in the Industrial Estates visited by the Panel. In many of the Estates, the bigger units were of detached construction and medium ones were semi-detached. In some cases row and back to back construction had been adopted for smaller sheds. When work sheds are planned as semi-detached, there is the possibility of allotting two units to one individual. In row construction, 3 or 4 work sheds can be given to an individual. A particular advantage of back to back, four-in-one-block, construction is that it facilitates allotment of two, three

or even four factories to an individual. But this has a serious defect in that it does not allow for cross ventilation. Therefore no hard and fast rules can be laid for the exact method of planning. We, however, recommend that larger sheds may be detached and medium ones may be semi-detached. The small sheds can be of row construction with 4 or 6 units in a row. As far as possible back to back construction should be avoided.

5.5. Roads

5.5.1. As stated earlier, the gross area under roads should not exceed 20% of the total area of the Estate. Roads are better laid out for one way traffic so that a width of 12 ft. alone requires to be metalled and carpetted whereas ordinary hard standings can be provided for parking, loading and unloading of vehicles. To ensure one way traffic, all roads leading to work sheds can be made to branch off from one incoming road and lead to one common outgoing road.

5.5.2. The overall lane width for ordinary roads may be 45 ft. in case of an ultimate double lane traffic and 33 ft. for a single lane traffic. The former will permit two 12 ft. wide metalled lanes with 7 ft. side walk on one side and 7 ft. strips for the road-side drains. The 33 ft. wide road will allow one lane traffic with 3.5 ft. berms and 7 ft. strips for road-side drain on either side.

5.6. Administrative buildings

5.6.1. We have seen in some cases, administrative buildings planned on a liberal scale. The real necessity for such buildings arises only when the production is in full swing. The expenditure on such construction, therefore, should be avoided in the initial stages. Space must, however, be reserved in the lay out. The building itself may be put up when the Estate develops and the need is felt. In the beginning, some of the vacant work sheds can be utilised for housing the administrative offices.

6. Design details

6.1. Plinth heights

6.1.1. In some of the factory buildings, a plinth height of 3 ft. has been adopted. This seems to be unnecessary. We feel that a plinth height of 1 ft. above the crown of the road is sufficient if satisfactory arrangements are made for surface drainage.

6.2. Height upto tie level of roof from plinth

6.2.1. The height from plinth to the tie level varies from 10 ft. to 15 ft. in the worksheds of various Estates. The Factory regulations recommend that height of roof should be such that the effect of radiant heat does not cause discomfort to the workers. No specific dimensions, however, have been laid down.

6.2.2. The Panel feels that in humid areas the height need not be more than 14 ft. if provision is made for sufficient cross ventilation.

6.2.3. For arid regions, a preliminary study has been conducted by the Chief Adviser of Factories to ascertain the extent to which increasing the heights of sheds with G. I. sheet roofing reduces heat due to radiation from roof at working level. Experiments were conducted in worksheds having a height of 20 ft. from floor to eaves. These experiments show that the variation in the effective temperature within the shed is not significant above a height of 14 ft. Considering the necessity of reducing cost of construction and thereby the economic rent of the factory, the Panel recommends that a height of 14 ft. may be adopted even in arid regions. A sub-ceiling may be provided in special cases.

6.3. Sub-ceiling.

6.3.1. Sub-ceilings can be fitted parallel to the roof at a distance of 12 ins. to 15 ins. from the roof sheeting. If space purlins are used of the type shown in plates V & VI, the ceiling can be fitted directly to the bottom flange of the purlins and no separate supporting structure is required. In such an arrangement, it is preferable to leave a strip of 15" width near the eaves of the building and provide an open air outlet at the upper end of the ceiling near the ridge of the roof. By this means, the sloping void between roof sheeting and sub-ceiling is made to act as a flue which exhausts the used up air from work sheds, creates a draft and thereby improves working conditions.

6.4. Lighting.

6.4.1. In sheds using north lights, as observed earlier, no glazed windows should be provided in East and West walls. In sheds with gabled or similar roof which are to be orientated along East and West direction, the window area should be at least 25 per cent. of the floor area, arranged in the North and South walls. For arid regions the figure can be reduced to 12—15 per cent.

6.4.2. To ensure glare free day-light, the angle between the glazing plane of north lights and the vertical should not be more than the latitude of the place reduced by $22\frac{1}{2}$ degrees. If north lights are to be used, south of the tropic of cancer for any other reasons, the glazing plane must be vertical.

6.4.3. It is not safe to use unreinforced glass for north lights.

6.5. Ventilation.

6.5.1. From the point of view of ventilation at least 15 per cent. of the floor area of work sheds is to be provided with windows and ventilators as suggested below:—

- (a) In sheds where north light roofs are adopted windows are to be fitted in the North and South walls and louvred ventilators in the East and West walls. These ventilators should preferably reach down to about 1 ft. from the floor. In addition to these, open slots shall be provided between the glazing and north light curves. The minimum width of these slots shall be 9 ins., and the maximum 1 ft. The aggregate area of windows, ventilators and these slots shall be about 15 per cent. as mentioned above.

- (b) Where gable roofs are used, windows shall be provided in the North and South walls and ventilators in the East and West walls. Slots of 9 ins. width shall be provided between the wall and the roof along the eaves of the building. Where monitors are provided, the slots can be fitted in it.
- (c) In hot humid climates, the openings shall be 25 per cent. of the floor area.

6.6. Doors.

6.6.1. The number of entrance and exit doors depends upon the requirements of each factory. Normally, two doors are enough. The main door may be 8ft. x 8ft. and the rear door 8 ft. x 6 ft. The shutters may be of the sliding or rolling pattern.

6.7. Flooring.

6.7.1. In many of the Industrial Estates visited the flooring of the workshed has been completed regardless of the functional requirements which obviously are dictated by the nature of work to be carried out in each factory. In some cases, ordinary concrete floor subjected to hammering has badly cracked and in some other cases it had to be dug up for the installation of machinery. It is, therefore, very necessary to defer the floor construction till the allotment is decided. This will enable the authorities to provide the type of floor that is suitable to the work that is to be carried out in the factory.

6.7.2. In general 4½ ins. thick lean concrete with suitable wearing surface over 6 ins. sand filling should suffice. In areas infested by whiteants, the sand filling may have to be 1 ft. deep.

6.8. Roofing.

6.8.1. The roofing of the work-sheds consist mostly of the conventional north light steel trusses with G. I. or A. C. sheets for covering. The consumption of steel is of the order of 5 to 6 lbs/sft. of covered area. In actual practice this figure is likely to be exceeded due to the designed sections not being available. It has generally been the practice to adopt structural steel for roofing. Alternative possibilities do not appear to have been considered at all. Even if steel has to be used for roofing, it is possible to secure economy in its consumption by adopting improved methods of design. This aspect needs careful consideration particularly in view of the scarcity of the material.

6.8.2. There are in general four alternative types of roofing that could be considered for factory buildings in the Industrial Estates. These are (i) timber roofing (ii) reinforced concrete roofing (iii) steel roofing, and (iv) pre-stressed concrete roofing. All these alternatives are considered in detail in the following paragraphs and outline sketches in respect of each type are also appended at the end of this report.

6.8.3. *Timber roofing.*

Timber is not adopted normally for factory construction because of its low fire rating. This objection, however, may not be valid in the case of work sheds in Industrial Estates as operations in most of the sheds may not involve appreciable fire hazard. In such cases, timber truss may prove to be a useful alternative. In recent years, considerable amount of research has been done in the adoption of secondary species of timber for structural purposes. Laminated construction with nailed joints and with connectors has become popular in U. K. and other countries. The Forest Research Institute, Dehra Dun has also conducted useful experiments in this line and has evolved trusses of 50 ft. to 60 ft. span. The important pre-requisite is the facility for seasoning and preservation treatment for the secondary species.

6.8.3.1. The Central Advisory Board of Forest Utilisation which met at Dehra Dun last July has recommended that Government Departments should stipulate in tenders a minimum of 30 per cent treated timber of secondary species. This is to avoid excessive dependence on sal and teak which are in short supply. The programme of Industrial Estates offers a good opportunity for the use of treated timber trusses. The setting up of timber seasoning plants is, however, a prerequisite if secondary species are to be used for the fabrication of trusses. As any Industrial Estate involves several sheds requiring a large number of trusses, the setting up of a small seasoning plant may be justified. Moreover, when once set up, the plant could meet the demand for timber trusses in the neighbourhood and also supply seasoned timber for wood-working industries in the Estate and neighbourhood. Plates I and II at the end of the report give details of timber trusses for 30 ft. and 40 ft. spans developed by the Forest Research Institute, Dehra Dun. These trusses, however, are designed for wind pressures allowed in some foreign codes which are lower than what is recommended by the Indian Standards Institute. Further details can be obtained directly from the Forest Research Institute. We can only emphasise the necessity of adopting timber trusses where possible as this will lead to saving in structural steel which can be more profitably utilised in heavy industrial buildings.

6.8.4. *Reinforced concrete roofing.*

The advantages of precast concrete construction are well known. In the Industrial Estate programme, possessing the advantage of repetitive work, there is considerable scope for this type of construction. Several structural forms are possible. Plates III and IV at the end of the report are indicative plans of pre-cast roof trusses for 30 ft. and 40 ft. spans. These can be cast one over the other on the ground and can be easily lifted in position with the aid of a small derrick or a crane. The purlins can also be precast. The details of joining the purlins with trusses are shown in the plates. Recesses will be left in the rafter at the correct places for receiving the purlins, the steel passing through without a break. The purlins will be cast with steel protruding at either end and placed in position in the recess as shown in details and the joint will be filled with a rich mix concrete. The top bars of the purlins will be taken

below the top bars of the principal rafter. Some additional reinforcement is also provided in the principal rafter to compensate for the recess. Precast construction has been extensively used in Russia and other European countries. The Team in its Report on Slum Clearance has already emphasised the necessity for advancing this technique and recommends its adoption in the construction of Industrial Estates.

6.8.5. *Steel roofing.*

The adoption of steel roofing, for the spans met with in Industrial Estates is not absolutely essential as other suitable alternatives as mentioned above are practical. In case steel has to be used, there are several ways of reducing the consumption of the same. The normal tendency is to adopt the standard north light truss or a fink truss with purlins made up of "I" section or of angles.

6.8.5.1. It is well known that the adoption of space trusses and space purlins would lead to considerable economy in materials. Added to this, is the technique of welding which is now fairly well-established. It will lead to substantial economy both in cost as well as in materials. It may be argued that welding of trusses using small sections will be difficult and that such welding facilities are not available everywhere. But there should not be any objection to try this at least at places where such facilities are available. Plates V and VI give details of such trusses. The possibility of fabricating these at central places and transporting them to the place of construction should also be examined by those incharge of the design and construction of these Estates. Dimensions of the trusses and purlins illustrated in Plates V and VI have been so kept as to facilitate fabrication at a central place and transport to place of erection.

6.8.6. *Pre-stressed concrete roofing.*

The development of pre-stressed concrete as a potential building material in the past two decades has been rapid. The technique is quite well known and it has been successfully adopted for many of the bridge structures in the country. But its application to building construction has not been extensive. The possibilities of applying pre-stressed concrete to buildings were discussed in detail at a symposium held by the Central Building Research Institute at Roorkee in February, 1958. A roof truss of 40 ft. span with a pre-stressed tie beam developed and built by the Central Building Research Institute is shown in Plate VII. This can conveniently be used for the roofing of work sheds in conjunction with pre-cast R.C.C. purlins. The tie alone is pre-stressed by a single straight cable and this reduces considerably the steel consumption and the dead weight of the trusses. It may be possible for the Hindustan Housing Factory to manufacture these precast trusses. But the economy of such a construction will be lost if the lead is more than 100 to 200 miles. The technique involved, however, is so simple that it should be possible to pre-cast and pre-stress the roof trusses even at the site of work. It is very desirable to encourage this technique of pre-stressing and train artisans to execute the work at site.

7. Service and other amenities.

7.1. Sanitation.

For large units, lavatories and wash basins shall be provided in accordance with the provisions of the Factory Act. For work sheds, partitioned into smaller units, common lavatory blocks can be provided.

7.2. Water Supply and drainage.

Arrangements for water supply and drainage must be thought of at the initial stage of planning. In one of the Estates visited, due to lack of proper drainage, the plinth heights of sheds had to be raised. In the same Estate, some factories were lying idle due to want of adequate filtered water supply. It should be possible to avoid such happenings by proper planning at the initial stages.

7.3. Street lighting.

Small scale industries hardly operate more than one shift. There is, therefore, no need for large expenditure for high intensity street lighting and lighting can be confined to a minimum, consistent with security requirements. For the same reasons, attention should also be given to perimeter lighting.

7.4. Telephone.

In view of the high cost of telephone connections in remote places, a local exchange may be installed in the administrative building from which connections may be given to the various factories.

7.5. Fire fighting.

The formation of a Voluntary Fire Brigade Association among the occupiers should be encouraged. The contribution of the occupants should mainly consist in deputing some of their staff as voluntary firemen, and to paying this staff for the time spent in training and practising.

7.6. Canteens.

Canteen either located in the administrative building or separately is essential if the Estate is not to be infested by food hawkers or slummed up by food stalls. Canteens run on a cooperative basis are better. To avoid heavy expenditure in the first instance, the canteen may be set up in a vacant shed. Provision for a permanent canteen must, however, be made in the lay out plan of the Estate.

8. Organisation for Execution and Maintenance.

8.1. Responsibility for construction and management of the Industrial Estates normally is that of the State Governments. Only in two cases, at Okhla (New Delhi) and Naini (Allahabad) the works are being executed by the National Small Industries Corporation. In the rest, the work has been carried out by the P. W. D. or by the Engineering Wing of the Directorate of Industries. In one case, however, the work was entrusted to a private architect. It cannot be said that this has proved satisfactory.

8.2. In general it may be advantageous if the planning and execution is entrusted to the P. W. D. which is equipped for carrying out this type of work and which at the same time affords advantage of better supervision and control over execution. As, however, the P. W. D's. may be heavily loaded with other works, the Chief Engineer should be empowered, at his discretion, to engage a private architect or structural consultant, either for the whole work or for special features of it or to increase the work capacity of the department by setting up a division or circle depending upon the work load exclusively for the work of the Industrial Estate programme.

8.3. The maintenance work of the Industrial Estates can be looked after either by the P. W. D. or by the Engineering Wing of the Directorate of Industries. It would, however, be easier and quicker to get the maintenance work done through technical personnel attached to the Directorate of Industries.

9. Recommendations for reducing cost of construction.

9.1. The success of an Industrial Estate depends to a great extent upon the factor of rent. The Government have proposed to subsidise the rent during the first few years so as to help the entrepreneurs in the teething period. The rent is to be progressively increased year by year so as to reach to economic level at the end of 4 or 5 years. The Buildings Projects Team in its Report on Slum Clearance has pointed out that "an answer to low rent is lower cost of construction and not higher subsidy." We feel that the following steps will go a long way in reducing the capital cost of construction and in making the money allotted for Industrial Estates programme go farther.

9.2. Advance Planning.

9.2.1. Planning of Industrial Estates is not much different from planning of big industrial works. It is not fully appreciated that the time spent on systematic and integrated planning will amply pay itself. Attention to details and advance provisioning of all materials will lead to both saving in cost and time. We would like here to emphasise our recommendations regarding the survey of the industrial potential of the area made in para. 5.1 of the report.

9.2.2. It has been represented to us that the system of allotment of funds on a yearly basis stands, to a great extent, in the way of advance planning. In the absence of any certainty of future allotment of funds, the State authorities find it impossible to plan their project in a co-ordinated and integrated way. There is the additional difficulty of arranging for materials in advance to avoid bottlenecks and hold-ups. If funds are to be utilised to the best advantage, the only possible remedy that appears to us, is the advance allotment of funds for a period of at least three years. A similar recommendation has been made by the Buildings Projects Team in the Report on Multistoreyed Buildings. With the present system, it does not seem possible for the State departments to carry out the surveys, prepare designs and obtain materials according to any programme. A one year period is far too short for economic planning.

9.3. Choice of site.

9.3.1. We have laid down certain norms and standards for space utilisation and structural detailing. Substantial economy can be secured by a proper selection of site. In one case, costly paddy land was acquired for the location of the Industrial Estate, which further necessitated expensive foundations due to the low load bearing capacity of the soil. The cost of land and the development expenditure formed a substantial part of the project estimate and no amount of economy in the design and execution of the structure can off-set the heavy capital expenditure on land. We have, therefore, to emphasize the necessity of utmost care in selecting the site.

9.3.2. The Industrial Estate project should be framed in the same manner as a productive commercial project of the Government. Expenditure under each head, such as and development charges, factory buildings, administrative buildings, canteens and roads, should be separately given under proper sub-heads, before a scheme is sanctioned. The report on the project should fully explain the reasons for a particular location and fully justify excessive expenditure on any item. Alternative sites should be discussed and when the project is once sanctioned, variations of more than 5 per cent. should not be permitted under any head.

9.4. Space utilisation.

9.4.1. As mentioned earlier, there has been a wide divergence in the planning of various Industrial Estates. The efficiency of planning depends upon the proportion of plot area under work sheds to the total area. We have laid down in para 5.3.1 that this proportion should be 60 to 65 per cent. Strict adherence to norms suggested in the said para will lead to better and more economical utilisation of land.

9.5. Standardisation.

9.5.1. The standards and specifications adopted for the various Industrial Estates also vary widely. The construction involves repetitive work. In the interest of economy, standardisation is essential. We have, therefore, recommended the adoption of 30ft. and 40ft. spans for the work sheds in the Industrial Estates. Several alternative indicative designs have been given.

9.5.2. As remarked previously, steel is not indispensable for the roofing of work sheds in Industrial Estates. The alternatives in timber, precast and pre-stressed concrete should always be considered. It is estimated that this will lead to a saving of roughly 10,000 tons of structural steel required for the Industrial Estates programme that remains to be executed, during this plan period. This steel can be diverted profitably to other important uses.

9.5.3. The statement in appendix IV, gives comparative figures of cost and consumption of material per sft. of covered area of workshed for (1) conventional steel trusses and purlins, (2) pre-cast RCC trusses and purlins and (3) pre-stressed concrete trusses and pre-cast R. C. purlins. These figures relate to 40 ft. and 30 ft. spans. In the latter case, however, pre-stressed alternative has not been considered. It can be seen that there is a clear difference of

at least about 50 nP. per sft. between the pre-stressed and precast roofing and the conventional steel roofing which has hitherto been adopted in almost all Industrial Estates. In the Industrial Estate programme of the Plan, which remains to be carried out about 40 to 45 lakh sft. of worksheds will have to be constructed. With the adoption of pre-stressed and precast roofing, as recommended by the Panel, there can be an overall saving of about Rs. 20 lakhs. This is apart from the economies that can be effected by following the norms and standards recommended for space utilisation.

9.5.4. Should the position improve, structural steel design can be adopted if found cheaper. We have given certain indicative plans for steel roofing also on the basis of welded space framed construction. Such a design will require 30 to 40 per cent. less steel than the conventional rivetted truss of the Fink type or the North light type. Keeping in view the necessity of conserving steel even when situation regarding its supply improves in the future, we would recommend the adoption of the welded trusses in the place of conventional types.

9.6. *Hire purchase and outright sale of Worksheds.*

9.6.1. From what has been stated in paragraph 2, it is clear that the intention of the planners is to create conditions favourable to the working efficiency of small scale industries by making available to small scale industrialists in special Industrial Estates,

- (a) Sites on outright sale,
- (b) Sites on hire-purchase terms, and in some cases,
- (c) Complete factory buildings to be let out on rent, or to be let out on a rent-cum-purchase basis.

It has been observed that the method of allotment under (c) has been used almost exclusively although this method was the last alternative mentioned in the plan. Thereby the funds allotted to the scheme have not been put to full advantage as apart from the capital required for the development of the site, capital had also to be used to provide the necessary buildings. We, therefore, consider that alternatives other than pure renting should be vigorously pursued.

9.6.2. In this connection it may also be worthwhile considering whether, if a concession of such nature is made to an established small scale industrialist, there is also justification to allow the industrialist to pay rent at a concessional rate, lower than the rent appropriate to the capital outlay. While such a procedure may be justified in the case of new industries, (whereby the term "new industries" means industries manufacturing a product which has not yet been manufactured in India, or at least in the area which is served by a particular Industrial Estate) there appears to be little justification to rent out on concessional rate basis factory premises to industrialists who have already established a manufacturing process and acquired a steady market.

10. General observations.

10.1. Location.

10.1.1. Apart from the technical aspect of planning and designing of the Industrial Estates, there is the important question of the location of such Estates *vis-a-vis* large urban areas, towns of moderate size or the rural areas. As already remarked, out of the six Industrial Estates visited by the Panel, four are located near large urban areas. One at Papanamgode is situated close to Trivandrum and the other at Bauripur in the rural area near Calcutta. One of the objectives of the Plan was that Industrial Estates should not result in further concentration of population in urban centres.

10.1.2. Each case has its own merits and de-merits. In the case of large urban centres, there is the facility of a ready market which is specially important for the small entrepreneur, and the availability of skilled labour. Further, such areas are highly congested and shifting of a certain number of industries will automatically help in the direction of slum clearance, provided there is a proper co-ordination between the shifting of industries and slum clearance operations. Without a planned approach, there is the danger that the entrepreneur, while availing of the new accommodation will continue to function in the congested part of the town as well, thus enjoying a new facility without giving any relief to the social problem of slum clearance.

10.1.3. However, as far as possible, large urban centres should be avoided and the industries should be located near small towns having a population of about 50,000. These towns normally have all the facilities necessary for setting up of the Estates. Land near about such towns is likely to be comparatively less expensive. The housing shortage, however, is general and it will be advantageous to combine a housing scheme with an Industrial Estate.

10.1.4. Location of Industrial Estates in rural areas will provide opportunities for employment to the villagers, without, in any way, creating a housing problem. The villagers can continue to reside in their ancestral homes, travel a short distance on bicycles to the factory and return in the evening. In such cases, however, it will be more difficult to find skilled labour unless it is imported from urban centres. This involves additional expense for the entrepreneurs. The location of industries in rural areas is not an easy proposition. In the first instance, the Estates should be on an experimental basis; their development should be carefully watched and extended only if they prove a success.

10.2. Allocation.

10.2.1. In most of the cases, the factory units have been allotted to industrialists who have shifted their establishments from other parts of the city. One of the objects in setting up such Industrial Estates was to give opportunities to new entrepreneurs. The number of such new industries which have come up in these Industrial Estates is unfortunately limited.

10.2.2. It appears that the existing industries have availed of the facilities now provided. Thus, to a large extent, the projects have been more of the nature of re-housing or expansion of the existing small industrial units. Most of the authorities concerned appear to have been satisfied with utilising the funds allotted for the Industrial Estates, without fulfilling the specific objectives of the Plan.

10.2.3. In the case of allotment of plots to established industries, there appears to be no justification for any concession in the scale of rent which, in such cases, should be the economic rent from the very start.

10.3. *Coordination.*

10.3.1. There should be proper coordination between the various Departments concerned with the development of Small Scale Industries. In one case a wood working training centre has been put up but the work sheds in the Estate have been allotted to industries which have no connection with wood working nor are in a position to take advantage of the training centre. This emphasises the need for proper coordination and planning in the initial stages.

10.4. *Technical Assistance to entrepreneurs and quality control.*

10.4.1. Evidently, no technical assistance is availed of by the new factories in the Industrial Estates as envisaged in the Plan. Individual experience has been the sole guiding factor in each case. Foundry rejection in one case was as high as 60%. The practice adopted for some important processes like case hardening and plating are unsafe or even dangerous. Considering the outlay in providing services and facilities which may compare favourably with similar developments in advanced countries, the conditions in the factories which have been set up leave much to be desired. In most cases, it is still the same backyard factory from the congested part of the town which has shifted to new premises.

10.4.2. In many cases, the floor area within the factory has not been put to optimum use. A preliminary study made in one of the Estates revealed that space utilisation was less than 40%.

10.4.3. These deficiencies can be overcome if the entrepreneurs make more positive use of the service institutes which have been set up for the purpose and there is the proper technical supervisory staff provided in each Estate. All this, however, needs careful and co-ordinated planning which, it is hoped, would be forthcoming in further development of Industrial Estates.

SUMMARY OF IMPORTANT RECOMMENDATIONS

S. Reference
No. to para No.

- 1 5.1 A detailed survey must be carried out in and around the town near which an Industrial Estate is proposed to be set up.
 - 2 5.3.1 It must be the endeavour of engineers and architects to plan the Estate in such a way that area under factory plot is about 60-65% of total area.
 - 3 5.4.1 Standard spans of 30 ft. and 40 ft. can be adopted for work sheds.
 - 4 5.4.4 The internal division of the covered area of the worksheds into workshops, office, stores etc. should be left to the allottee.
 - 5 5.4.5 Large sheds may be detached, medium ones can be semi-detached and the smaller ones can be of row construction.
 - 6 5.5.1 Area under roads should not exceed 20% of the total area of the Estate.
 - 7 5.6 Expenditure on unproductive works such as administrative buildings etc. should be avoided in the initial stages.
 - 8 6.8.3.1 Where possible, timber trusses should be adopted for the sheds.
 - 9 6.8.4 Pre-cast RCC trusses and purlins should be adopted for roofing of worksheds.
 - 10 6.8.6 It is essential to foster the technique of pre-stressing and train, if necessary, more people who can guide the work at site.
 - 11 9.2.2 Financial allocations for various Industrial Estates should be made in advance in order to help advance planning.
 - 12 9.3.1 Utmost care must be exercised in selecting the site for Industrial Estates.
 - 13 9.6.1 The hire-purchase and outright sale of worksheds deserve greater attention.
 - 14 10.1.2 Where an Industrial Estate is located near a city, the project should be co-ordinated with city improvement and slum clearance schemes.
 - 15 10.1.3 It is desirable to locate Industrial Estates near towns with a population of about 50,000.
 - 16 10.1.4 In the first instance, location of Industrial Estates in rural areas should be on an experimental basis and extended only if it proves a success.
 - 17 10.4.3 Entrepreneurs should make more positive use of the service institutes.
-

Remarks of the Team

The report on Industrial Estates it is hoped, will answer the need for guidance in the planning and designing of such Estates. The Industrial Estate Programme is a new one and a modest start was made in the First Plan. In the Second Plan, however, considering the potentialities of the scheme a larger provision was made which was further enhanced later. But in the absence of broad norms and standards, the planning of Industrial Estates all over the country showed a marked degree of variation in several aspects. The Panel, therefore, has studied a few of the typical Estates and has laid down norms for planning and designing which we hope will be a useful guide to the planners. The Team fully participated in the deliberations of the Panel and two of its Members were associated with it, one of them as its Chairman. The Team, while recording its appreciation of the work done by the Panel, would like to emphasise a few important points as it feels that a proper consideration of these will lead to considerable economy and increase in efficiency.

2. One of the important recommendations of the Panel concerns space utilisation within the Estate. The Panel has laid down that the effective plot area must account for 60% to 65% of the total area of the Estate. It must be the endeavour of the Architects and Planners to achieve this target.

3. The second important recommendation to which the Team wants to draw attention relates to the type of roofing adopted for worksheds in Industrial Estates. For any type of industrial building, it has been the custom to adopt only steel roofing without even considering other alternatives. The Panel has suggested a number of alternative types of roofing and has given indicative sketches of the same. The Designers of the Estates should consider all these alternatives before deciding upon the type of roofing to be adopted for worksheds. The Team will, however, like to emphasize the necessity for avoiding structural steel when other suitable alternatives are possible.

4. The Team would also like to focus attention on the suggestions made by the Panel for reducing cost of construction and capital investment. The authorities concerned may consider the possibility of allotting developed plots of land on which the entrepreneurs can build structures of their own according to their requirements but conforming to the standards laid down by the Estate authorities. Another point that deserves equal consideration is the question of co-operatives. Instead of Government taking the entire burden of constructing and letting out worksheds, it may give grants to co-operatives to the extent of 50% or 60% of the cost of a scheme. The rest of the money may be found by the co-operatives themselves. This the Team feels, would enable more Estates to be put

up with the money allotted for this purpose and will also help draw out savings of entrepreneurs.

5. The report contains certain norms and standards for the planning of Industrial Estates but these would be of no use if they are not translated into practice. To ensure compliance it is desirable if along with any estimate for Industrial Estate a proforma is sent setting forth the norms for various items laid down by the Team and the extent to which these are realised in the particular case. The Team has drawn out a proforma of this character which is given in Appendix V.

APPENDIX I*

Programme and progress of work on Industrial Estates

The programme of establishment of Industrial Estates was initiated at the end of the First Five Year Plan. Proposals for the setting up of nine Industrial Estates were sanctioned during the year 1955-56 and loans aggregating to Rs. 58 lakhs were advanced to the State Government for this purpose.

2. In the Second Five Year Plan, a provision of Rs. 10 crores (now increased to Rs. 11 crores) has been made for the setting up of Industrial Estates. A total number of 110 Industrial Estates have been planned to be set up all over the country, of which 72 (including Okhla and Naini) have been sanctioned so far. A sum of Rs. 427.81 lakhs has so far been sanctioned as loans to the State Governments during the period 1955—1959, out of which Rs. 368 lakhs have been spent up to 30th September 1957. Seventeen of the Industrial Estates have started functioning and other twenty are in an advanced stage of construction.

3. As a general rule, the management of the Industrial Estates, rests with the State Government. But in the case of the Industrial Estates at Okhla (New Delhi) and Naini (U.P.), the construction and management have been entrusted by the Government to the National Small Scale Industries Corporation.

*Details obtained from the office of the Development Commissioner, Small Scale Industries, Ministry of Commerce and Industry.

APPENDIX II

Information regarding Industrial Estates Visited by the Panel

1. Name	Guindy (Madras)	Okhla (New Delhi)	Rajkot (Bombay)	Sanath Nagar (Hyderabad)	Bauripur (West Bengal)	Papanamgode (Trivandrum)
2. Location	Nearly 8 miles from Madras Egmore Station	About 6 Miles from New Delhi	About 1 1/2 miles from Rajkot City.	Adjacent to Hyderabad City.	Nearly 1 mile from Railway Station.	Nearly 4 miles from Trivandrum Central Terminus
3. Total area of Estate	44.5 Acres	33 acres	20.7 Acres	43.8 Acres	1,23,300 Sft.	25 Acres.
4. Type of Sheds	Detached, with compound	2 to 4 units attached with compound	Units 120'x60' without compound	Two units attached with compound	Detached units with compound	Attached units with compound
5. No. of Sheds	A (Single) 5 Nos. B (Single) 6 " C (Single) 7 " A (Double) 8 " B (Double) 7 " C (Double) 21 "	7 of 10,000 Sft. 5 of 9,000 Sft. 4 of 6,000 Sft. 10 of 5,000 Sft. 2 of 4,000 Sft. 1 of 3,000 Sft. 2 of 2,700 Sft. 1 of 2,500 Sft. 3 of 2,000 Sft.	108 sheds each measuring 60'x30'	A—4 Nos. B—16 Nos. C—10 Nos.	A—2 Nos. B—5 Nos. C—2 Nos. D—4 Nos. E—4 Nos. F—3 Nos.	A—2 Nos. B—8 Nos. C—37 Nos.
6. Coverage of area						
(a) Total plot area	10,90,600 Sft. 54.5% of (3)	4,86,800 Sft. 35.8% of (3)	3,54,600 Sft. 39.4% of (3)	10,94,000 Sft. 57.6% of (3)	65,000 Sft. 52.7% of (3)	4,17,000 Sft. 38.2% of (3)
(b) Area under ancillary Buildings, such as Administration, Canteen etc.	1,10,000 Sft. 5.5% of (3)	1,81,350 Sft. 13.2% of (3)	24,000 Sft. 2.7% of (3)	63,000 Sft. 3.3% of (3)	11,000 Sft. 9.0% of (3)	84,000 Sft. 7.7% of (3)
(c) Area under roads	6,90,000 Sft. 34.5% of (3)	5,32,000 Sft. 39.1% of (3)	4,19,400 Sft. 46.6% of (3)	5,00,000 Sft. 26.3% of (3)	34,300 Sft. 27.8% of (3)	2,74,000 Sft. 25.1% of (3)
(d) Area under open space	1,09,400 Sft. 5.5% of (3)	1,56,500 Sft. 11.9% of (3)	1,02,000 Sft. 11.3% of (3)	2,43,000 Sft. 12.8% of (3)	13,000 Sft. 10.5% of (3)	2,83,000 Sft. 29.0% of (3)
TOTAL	20,00,000 Sft.	13,56,650 Sft.	9,00,000 Sft.	19,00,000 Sft.	1,23,300 Sft.	10,58,000 Sft.

	Guindy		Okhla		Rajkot		Sanath Nagar		Bauripur		Papanamgode	
	Sizes	%age	Sizes	%age	Sizes	%age	Sizes	%age	Sizes	%age	Sizes	%age
7. Sizes of sheds and percentage of builtup area to plot area.	46'-3" × 158'-1½" 89'-4½" × 158'-1½" 48'-3" × 118'-1½" 89'-4½" × 118'-1½" 38'-3" × 93'-1½" 69'-4½" × 93'-1½"	43.8 63.0 48.0 62.5 43.2 59.0	Varying sizes from 2,000 sq. ft. to 10,000 sq. ft.	About 65% of plot area	Units 120' × 60' divided into four sub-units each measuring 60' × 30'	Same as plot area i.e. 100%	A—80' × 80' B—80' × 40' C—53' × 40'	16.25 19.2 16.4	A—75' × 40' B—50' × 40' C—50' × 33' D—25' × 43' E—25' × 33' F—20' × 30'	60.0 48.9 37.1 54.8 42.1 39.5	A—40' × 80' B—2 halls each 30' × 60' in one block C—2 halls each 20' × 25' in one block.	34.9 64.5 53.8
8. Width of roads	80', 70', 60', 50', 40', 33'		Four lane traffic roads with cycle tracks & foot paths total width nearly 150 ft.	45', 30'		Main Road 80' Roads in the Estate 60'		Main Road—40' Foot Path—6'		40', 24', 16'		
9. Plinth Height	Approximately 1'-0"		1'-6"	2'-6"		1'-6"		1'-0"		A & B—1'-6" C—2'-0"		
10. Height from the Plinth level to tie level	Approximately 14 ft.		14 ft. (minimum)	14ft.		15 ft.		12 to 16 ft		14ft.		
11. Super-structure	Country brick in C. M. 1:5 for Factory portion. Gable wall 1'-1½" thick Panel wall- 9" thick Office portion wall 1'-1½" thick.		14" thick brick masonry walls in cement lime mortar 1:5:18	UCR stone masonry in lime mortar 15" thick Inner wall BB masonry in lime mortar 15" thick	Brick masonry walls, 1'-6" thick in lime mortar plastered with lime mortar on both faces.	10" thick walls in lime concrete	Laterite masonry walls in lime mortar 1:2. 1'-3" thick Pillars 1-10½" size					
12. Flooring	A bed of cement concrete 1:4:10, 4" thick and top finished with layer of ¾" thick cement concrete 1:3:7½ granolithic flooring using blue granite jelly of size 3/8" (and below) and surface rubbed smooth.		4½" lime concrete and granolithic cement concrete	Either Cement flooring black stone paving or no flooring	Cement concrete flooring 1:2:4 6" thick over the filling up of morum in basement	4" cement concrete, 6" to 12" according to special needs.	Flooring with 1½" metal concrete in cement mortar 1:3:6, 3" thick and plastered with cement mortar 1:3, ½" thick one coat floated hard and travelled smooth.					
13. Roofing	North light steel roof truss with Asbestos cement sheets for roofing for factory portion & R.C.C. roof slab with 'T' beams for office portion		North light trusses and C.G.I. Sheets for roofing	North light steel truss with A. C. sheets for roofing	North light roof; sheet over steel tooth trusses	A.C. saw- Galvanised Corrugated Asbestos sheets.	A—A.C. Sheets. on steel trusses of 40' span. B—Tile roofing and wooden trusses of 30' span. C— Tile roofing on rafters.					
14. Steel used per sq. ft. of covered area	A (Single) 5.93 lbs. B (Single) 5.73 lbs. C (Single) 4.58 lbs. A (Double) 5.68 lbs. B (Double) 5.85 lbs. C (Double) 4.08 lbs.		About 5 lbs. in 13 factories and 8 lbs. in 22 factories	About 5 lbs.	About 5 lbs.	Tubular trusses adopted	About 4.85 lbs.					

APPENDIX III

Observations and comments on the various Industrial Estates visited.

(1) Guindy (Madras)

On the morning of 13th November 1957, the Panel visited the Industrial Estate that is being set up in Guindy by the Industries Department of Madras. They had discussion with the following officers:—

Shri T. K. Palaniappan, IAS. Director of Industries.

Shri V. S. Raghavan, Joint Director.

Shri S. Basheer Ahmed, Deputy Director.

Shri N. K. Pillai, Superintending Engineer.

It was explained to the Panel that it was intended to set up six more Estates at Virudunagar, Erode, Coimbatore, Trichinopoly, Madura and Tinnevelly. About 60% of the work at Madras had been completed at the time of the Panel's visit. It was understood that in Virudunagar out of the 40 sheds, about 15 had been taken up for construction. In Erode out of the 12 units, 2 had been started and 3 more were to be taken up shortly.

The work sheds are of three types, A, B and C. The former two have a span of 40 ft. and the last 30 ft. The floor areas of the sheds are 4280 Sft., 3044 Sft. and 1836 Sft. respectively.

The worksheds consist of brick masonry pillars, mild steel trusses and A.C. sheeting. The steel consumption comes to about 5-6 lbs. per sq. ft.

The element of the cost of land is about 20% of the total cost of the project. The area under roads is about 35% and under open spaces about 5%.

The construction work is being carried out by one Superintending Engineer, assisted by three Executive Engineers, working directly under the Director of Industries. The Superintending Engineer has powers of Chief Engineer in all technical matters.

Comments

It struck the Panel that expensive paddy land had been taken up and this has further involved heavy cost on foundations on account of special soil conditions. The authorities, however, explained that according to their preliminary enquiry, the entrepreneurs did not like the idea of a greater distance from the city. We agree that this is an aspect of the question that always needs careful consideration.

Whereas the area under open spaces is reasonable, the area under roads is high. It would be difficult to justify an 80 ft. and 60 ft. wide central road, specially the former when there is no through traffic. As a general rule the road width should be gradually reduced as the intensity of traffic decreases.

Steel trusses involved not only the use of steel which is in scarce supply, but are also expensive. It was stated that the reason for adoption of this pattern of roofing was that some dismantled trusses were available with the Government and further there was lack of suitable construction agency for doing even ordinary R.C.C. work. The argument did not appeal to the Panel.

(2) Papanamgode (Trivandrum)

The Factory Panel stayed at Trivandrum from 19th to 21st, November 1957, had meetings with the Joint Director of Industries and visited the Industrial Estate at Papanamgode.

Construction work was in progress. Here also, there are three types of sheds, A, B and C. 'A' has a span of 40 ft. 'B' 30 ft. and 'C' 20 ft. Steel trusses have been adopted for the A type sheds and timber trusses for B & C type sheds.

The trusses follow the conventional pattern. The amount of steel per sq. ft. of plinth area is of the order of 5 lbs.

The pilasters are 1 ft. 10½ in. square with filler walls of 13½ in. thick. Wooden purlins have been used both in B and C type sheds.

The foundations and the plinth masonry is in rubble which is stated to be cheap at Trivandrum. Services had not been laid out at the time of the visit. Six out of the eight Estates are under construction. The intention is to have one Industrial Estate in each district. All of them follow the same pattern.

Comments

With thick brick pillars, the 13½ in. thick filler wall appears to be unnecessary. 'One brick thick' walls should have sufficed. The window frames are also heavy. It is, however, satisfactory to note that a serious attempt has been made to utilise local materials, rubble and timber.

(3) Okhla (New Delhi)

The Panel visited the Industrial Estate at Okhla on the 11th December 1957 and had discussion with Col. Nehra, the Manager of the Estate. The first phase of construction consists of 35 factories, one administrative block, two canteens, a hospital, a fire station and other services. The revised project estimate amount to about Rs. 46 lakhs out of which the expenditure on the work-sheds is Rs. 23.22 lakhs which is about 50 per cent of the total cost. The rest of the expenditure is on the ancillaries such as the administrative buildings, canteens and road etc.

The worksheds consist of load bearing masonry walls on the outside and rolled steel columns inside at 19 ft. centres both ways, steel trusses and G.I. sheet roofing.

The Panel was informed that the original plan was to adopt timber roof trusses and the planning of the worksheds was on this basis. The design was changed later as the work had to be completed in a time shorter than originally anticipated. R.C.C. construction was ruled out in view of the limited time in which the work had to be completed. To secure extra space mezzanine floor has been provided inside the factory with heavy girders at close intervals. The workmanship of the trusses was found to be defective. In the flooring in many cases, the corners of the slabs had lifted and the floor was also cracked. The R.C.C. work in the administrative building which was under construction at the time of the visit, was of poor quality. The reinforcements were non-symmetrical and almost visible on one side. They were being covered with thick plaster. The authorities later claimed that the construction defects have been removed at the expense of the contractors.

The central road, as planned, consists of four traffic lanes with a middle strip, two foot paths and cycle tracks on either side. In addition, there are a number of parking places, and 50 ft. wide roads round the workshop.

Comments

The facts as narrated above, show that half the money has been spent on works other than the factory buildings. The area utilised for the plots is only 36 per cent and the area utilised for roads, open spaces and ancilliary buildings is 64 per cent. With proper planning, it should have been possible to have increased the area under the plots to about 60 per cent. It is difficult for the panel to understand the necessity of a 150 ft. wide high way within the Industrial Estate.

The money spent on the ancilliary buildings could have been more usefully utilised on the factory buildings, which, after all, is the essence of a project.

Steel construction has been justified on grounds of shortage of time. In actual fact, however, there has been considerable delay in the completion of the work. One set of factories which were to be completed in 5½ months actually took 13½ months. The construction of the floor inside the workshop should have been postponed till after the allotment of the sheds, to suit the nature of work to be carried out.

(4) Bauripur (West Bengal)

The Panel visited the Bauripur Industrial Estate of the West Bengal Government on the 10th May 1958. The Estate is situated in the midst of rich agricultural land and is about a mile away from the railway station. The authorities stated that they were not considering the question of the railway siding at present as road transport was available and could meet the requirements of the Estate.

There are six types of sheds. The spans adopted are 20 ft. to 30 ft. In both cases, tubular steel trusses have been used. These rest on pilaster 15 in. square. The filler walls are 10 in. thick.

The rent has been worked out at the rate of Rs. 10 per 100 sq. ft. and the Panel was informed that the open platform on either side of the shed will also be included in the area for which rent would be recovered.

Comments

The adoption of tubular steel trusses is a good feature. The provision of longitudinal bracing appear to be unnecessary, specially when there are gables at the ends. In any case, the bracing should have been arranged diagonally, to prove more effective. The doors and window chowkhats could have been of R.C.C. construction, to reduce cost. Ventilation arrangements within the sheds were not adequate. Openings for exhaust fans should have been made in the gables or some fixed ventilation arrangement provided with jali frames or honey-comb brick work.

The break-up figures of cost show that the bulk of expenditure has gone to the worksheds. The cost of ancillaries is reasonable.

An uptodate wood work training shop has been put up in the Estate but the actual work that is to be executed in the Estate, bears no relationship to the training workshop.

(5) Sanath Nagar (Hyderabad)

The Industrial Estate at Sanath Nagar near Hyderabad was visited on the 10th August 1958 and the Panel had discussion with the Secretary, Department of Industries, Director of Industries and other officers connected with the project.

The worksheds constructed fall into three categories, A, B and C, of sizes 80 ft. x 80 ft., 80 ft. x 40 ft. and 53 ft. x 40 ft. respectively.

Steel trusses with north light have been used and the consumption of steel is of the order of 5 lbs. per sq. ft. The cladding and partition walls are 18 in. thick and this is justified on account of the poor quality of the bricks. It was stated that hollow block construction would have proved more expensive.

Rolling shutters have been installed between two adjoining workshops.

The main road has been kept 80 ft. wide and all other roads 60 ft. wide. The total area under roads comes to 26 per cent.

Comments

The provision of north-light trusses does not appear to be necessary in all cases. The factory units can be reorientated in East and West directions so as to obtain the required light from the windows in the North and South walls.

While the size of the administrative block is reasonable, the space utilised for the worksheds is very low. The open space left in the plots is on too liberal a scale. By reducing this, a great number of factory sheds could have been accommodated in the same area.

It was stated that rolling shutters have been provided to facilitate allotment of two workshops to one entrepreneur. This, however, appears to be unnecessary as the opening could have been bricked up to be opened out later when necessary.

The area under the roads is 26 per cent. This is not very high, but it is still difficult to justify the provision of 80 ft. and 60 ft. wide roads. There is no necessity for the internal roads to be wider than about 45 ft.

Again, the office and the storage space provided for within the worksheds is on the high side. In the smaller worksheds, provision of separate office accommodation does not appear to be necessary. Specially when two units are combined, the entrepreneur would not need twice the office area. It is a better procedure to construct the worksheds without the sub-division of the area and leave it to the entrepreneur to divide it up according to his requirements.

The smallest size of the workshed is 2,120 sq. ft. This is likely to prove too big for a man of limited means.

(6) Rajkot (Bombay)

The Rajkot Estate in Saurashtra was visited on the 24th August, 1958 in company with the Dy. Director of Industries Shri Dharwarkar, the Manager of the Estate Shri Shingale and Shri Nagesh of the T.C.M. proto-type-cum-training centre. Detailed information about the working of the Estate, the number of factories rehabilitated from the town and their progress in the new premises was collected by the Productivity Centre under the direction of Shri Mankiker. This information proved of great assistance to the Panel in properly understanding the position.

The panel also had discussions in Bombay with Shri V. V. Apte, Joint Director of Industries, Bombay and Shri M. Bhatnagar, Joint Development Commissioner, Industrial Estates.

The total number of factories constructed is 68, out of which 55 had been allotted, 6 were under different stages of allotment and 7 or 8 unallotted. Out of the 55, 40 were working and 15 were temporarily closed due to want of raw material.

Due to lack of adequate water supply, one of the factories had to close down.

The size of the factory units is 120 ft. x 60 ft. They are ordinarily divided into four sub-units each measuring 60 ft. x 30 ft. The original proposal was that an area of 45 ft. x 30 ft. should be covered and the remaining 30 ft. x 15 ft. left open. But ultimately the whole area was covered.

The height of the plinth varies from 6 ins. to 2½ ft. above the ground. The high plinth is justified on grounds of flooding. This could have been avoided by proper surface drainage arrangements. No such scheme had however been prepared.

The height from the plinth to the roof level is 12 ft. in earlier factories and 14 ft. in those constructed later. Roofing is of north light trusses with G.I. sheets. In some of the factories sub-ceiling has also been provided.

Each factory has got two doors, one with rolling type shutter and the other with sliding shutter. The width of the opening was initially kept at 10 ft. × 10 ft., but later it was reduced to 6 ft. × 8 ft.

The main roads are 45 ft. wide and the service roads 30 ft. wide without any foot-path or road-side drains. The total area under roads is 47 per cent.

No open yard has been given to any factory and they have to carry out their entire operations in the covered area.

Comments

The Panel feels that each unit should have some open space for storage and for foundry work that they may have to carry out. The management, however, explained that as a result of their experience they are now changing the design to provide for some open space for those who have to carry out foundry operations.

The superstructure of factories consists of 2 ft. × 2 ft. pilasters and 15 in. thick stone-walls. With the provision of such thick walls, the necessity for pilasters is questionable.

There are very few factories which have taken to new line of production. Most of them have been shifted from congested areas of the town. Our enquiry showed that many of the entrepreneurs were perfectly willing to construct their own factory sheds if they were given developed plots, i.e. plots laid out with roads, water-supply and electricity. It is a matter for serious consideration whether the policy of investing so much capital straightaway for the acquisition of land, its development and construction of worksheds etc. does not need reconsideration. If developed land is given to entrepreneurs who are willing to put up worksheds according to some pattern fixed by the Estate authorities, the funds earmarked for the Industrial Estate Programme can be spread out on a greater number of Estates.

Although the roads are not very wide the proportion of the area under roads is very high. This is because of excessive number of roads.

APPENDIX IV

Cost and Material Analysis

	Trusses having clear span of 40'-0" (Trusses @ 12'-0" c/c)			Trusses having clear span of 30'-0" (Trusses @ 12'-0" c/c)	
	Steel truss	Precast R.C.C. Truss	Prestressed Truss (precast)	Steel truss	Precast R.C.C. Truss
1. Approximate weight of one truss only	11.75 cwts	49.0 cwts	28 cwts	8.5 cwts	22.8 cwts
2. Approximate weight of the truss and purlins	22.72 cwts	94.0 cwts	51 cwts	18.3 cwts	51.0 cwts
3. Cement required per sq. ft. of covered area	..	3.08 lbs	1.67 lbs	..	2.2 lbs
4. Mild steel required per sq. ft. of covered area	5.00 lbs	2.5 lbs	1.30 lbs	5.5 lbs	2.0 lbs
5. High tensile steel required per sq. ft. of covered area	0.038 lbs
6. Cost per sq. ft. of covered area excluding columns and sheeting	Rs. 2.18	Rs. 2.18	Rs. 1.60	Rs. 2.40	Rs. 1.67

N.B.—A more economical solution for 40 ft span is to use two 20 ft. span north light trusses of R.C.C. with an intermediate column. The cost per sq. ft. of covered area will then be Rs. 1.7. Another advantage of this is the ease of handling and erection.

APPENDIX V

Proforma Regarding Industrial Estates

Location of Estate

Agency for planning & designing

Agency for construction

Sl. No.	Particulars	Recommendations of the Selected Buildings Projects Team	Realised figures in the particular case	Remarks or reasons for deviation, if any
1	2	3	4	5

Planning & lay out

- | | | |
|---|--|---|
| 1 | Survey of industrial potential | A through survey must be conducted. |
| 2 | Choice of site | The site should be capable of easy drainage, should be close to perennial water supply and within a reasonable range from source of power. |
| 3 | Siting of Estate | Preferably near towns having a population of about 50,000. |
| 4 | Distance from Railway Station | It should be preferably close to Railway Station with goods yards facilities. |
| 5 | Availability of residential accommodation. | The location of Industrial Estate should not result in further concentration of population. It would be advantageous to combine a housing scheme with an Industrial Estate. |

- | | | |
|----|--|---|
| 6 | Total area of Estate |
This should be 60 to 65 % of the total Estate area. |
| 7 | Area under factory plots | This should not be more than 20% of the total area of the Estate. |
| 8 | Area under roads | This can be upto 10% of the total area of the Estate. |
| 9 | Area of open space | This can vary between 5 to 10% of the total area of the Estate. |
| 10 | Area under administrative and other buildings. | It is not necessary to adopt a large number of different sizes. |
| 11 | Number and types of worksheds | 600 Sft. |
| 12 | The minimum size of worksheds | 6,000 Sft. |
| 13 | Maximum size of worksheds | This should not be less than 50% of the plot area. It is also not necessary to provide for open space in all worksheds. |
| 14 | Covered area of worksheds | |

Design details:

- | | | |
|----|--|---|
| 15 | Plinth height | A plinth height of 1 ft. above crown of the road will be sufficient if satisfactory arrangements are made for surface drainage. |
| 16 | Height upto tie level of roof from plinth. | 14 ft. |
| 17 | Windows and ventilators. | The area of these should not be more than 25% of floor area in humid regions and not more than 15% in hot dry regions. |
| 18 | Number of doors. | Normally two doors are sufficient. |
| 19 | Size of doors | Main door 8' x 8' and rear door 8' x 6'. |
| 20 | Flooring | This must be decided upon only after the allotment. |
| 21 | Roofing. | This must be decided after considering all the alternatives suggested in the Report. |
| 22 | Water supply & drainage | This must be provided for at the initial stage of planning. |

DESIGN OF TIMBER TRUSS

SPAN = 30'-0"

INDICATIVE SKETCH
PLATE NO I

(DISTANCE BETWEEN TRUSSES AS SHOWN BELOW IN PLAN)

DETAILS AT ①
SCALE 3" = 1'

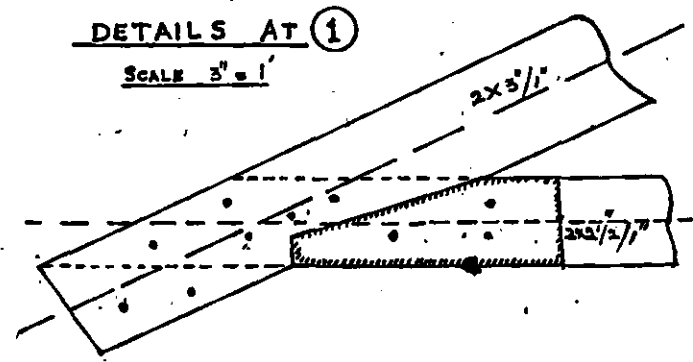

DETAILS AT ③
SCALE 3" = 1'

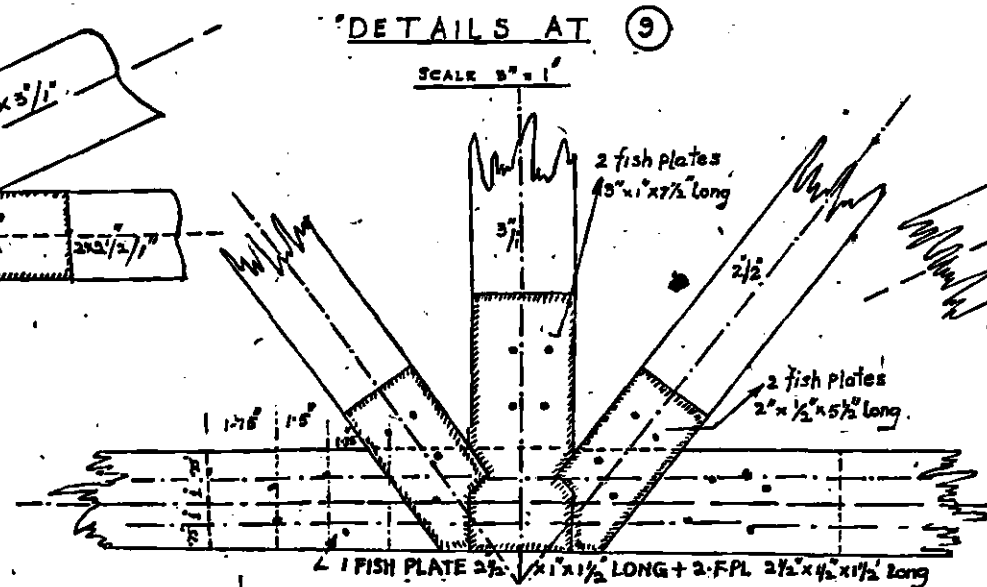

DETAILS AT ⑧
SCALE 3" = 1'

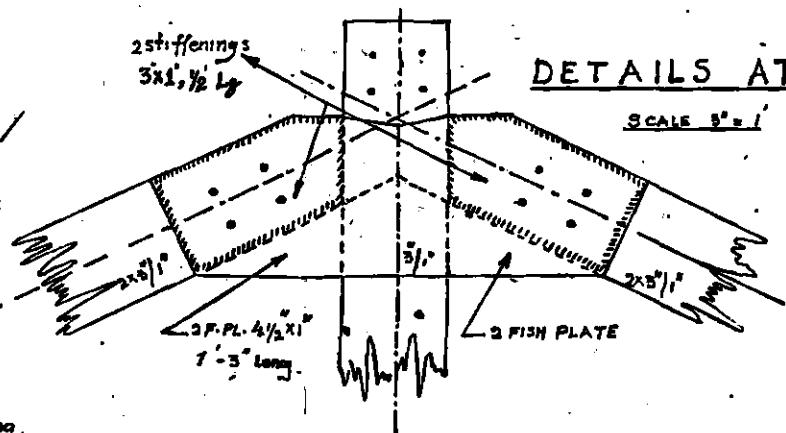

SCALE = 1" = 1'

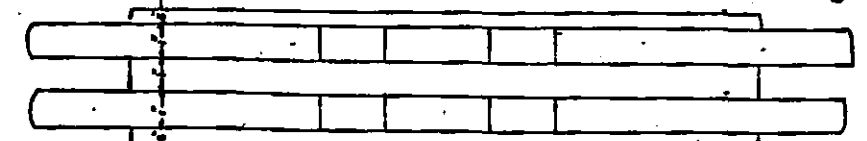

Plan Omitting Diagonals.



PLANED ON 3 SIDES
FINISHED $\approx 7/8 \times 5 1/2$

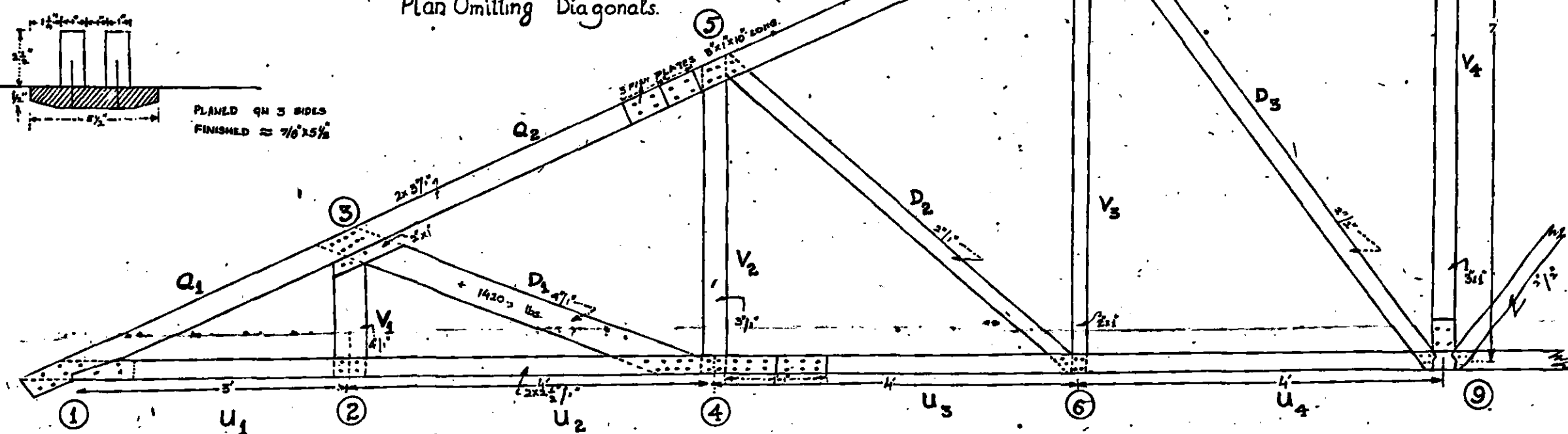

- TIMBER USED DEODAR OR ANY OTHER OF THE FOLLOWING STRENGTH STRENGTH :-
1. f_t = TENSION ALONG GRAIN = 1830 lbs PER in^2
 2. S = SHEAR HORIZONTAL = 100 lbs PER in^2
 3. f_c = COMPRESSION PARALLEL TO GRAIN = 1100 lbs PER in^2
 4. f_{\perp} = COMPRESSION PERPENDICULAR TO GRAIN = 500 lbs PER in^2

DESIGN DATA

1. DISTANCE OF TRUSSED RAFTERS C/C = 5'-1"
2. HEIGHT OF BUILDING = BETWEEN 26' & 66'
3. ANGLE OF INCLINATION = 25°
4. MAXM. VELOCITY OR V = 84.5 M/P.H.
5. IMPACT PRESSURE OR q_i = 16.4 lbs/sq.ft.
6. WIND PRESSURE ON -
WIND WARD SIDE ONLY
(CONSIDERING WIND PRESSURE ONLY & NO SUCTION ACCORDING TO OLD PRACTICE) = 9 lbs/sq.ft. OF ROOF AREA
7. DEAD LOAD - C/C WEIGHT OF C.G.I. SHEET ROOFING, BATTENS & TRUSSES ITSELF ACTING AT THE TOP BOOMS = 8 lbs/sq.ft. OF GROUND AREA
8. CEILING LOAD ACTING AT THE BOTTOM BOOM = 4 lbs/sq.ft. OF GROUND AREA.

NOTE - THIS IS NOT A WORKING DRAWING.

NOTE-
THE DESIGN CAN BE USED UP TO 40'-0" SPAN

DESIGN DATA	
DISTANCE OF TRUSSES $\frac{1}{2}$	12'-0"
HEIGHT OF STRUCTURE $\frac{1}{2}$	BELOW 26'-0"
ANGLE OF INCLINATION	25%
MAXIMUM VELOCITY V	66.9 M.P.H.
IMPACT PRESSURE q	10.2 lbs/sq. ft.
WIND PRESSURE ON WINDWARD SIDE ONLY	
WIND SUCTION ON LEEWARD SIDE ONLY	
DEAD LOAD	10 lbs/sq. ft. OF ROOF AREA.

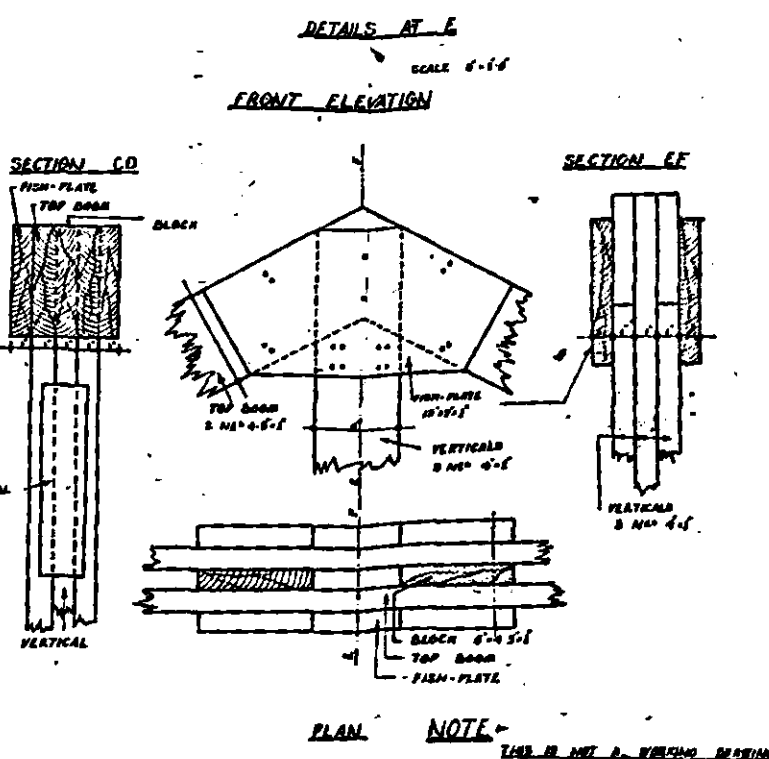
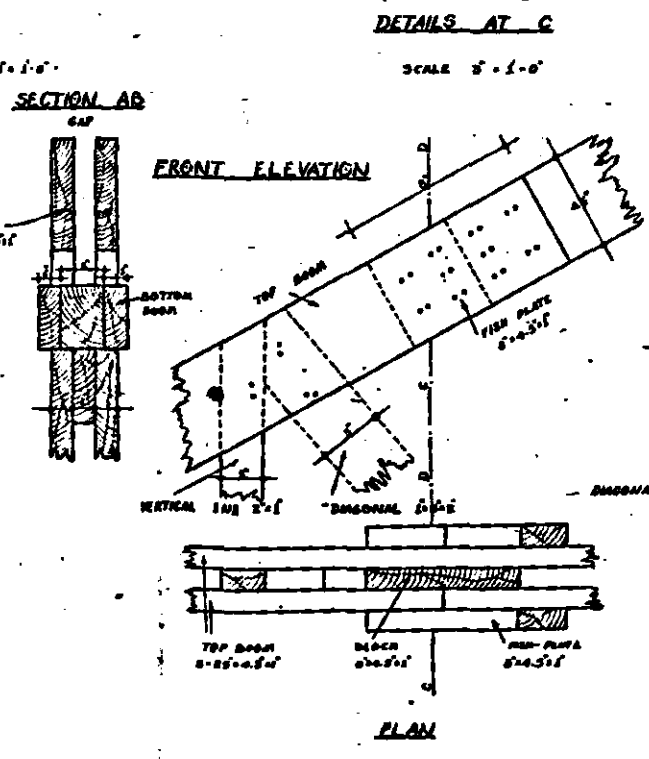
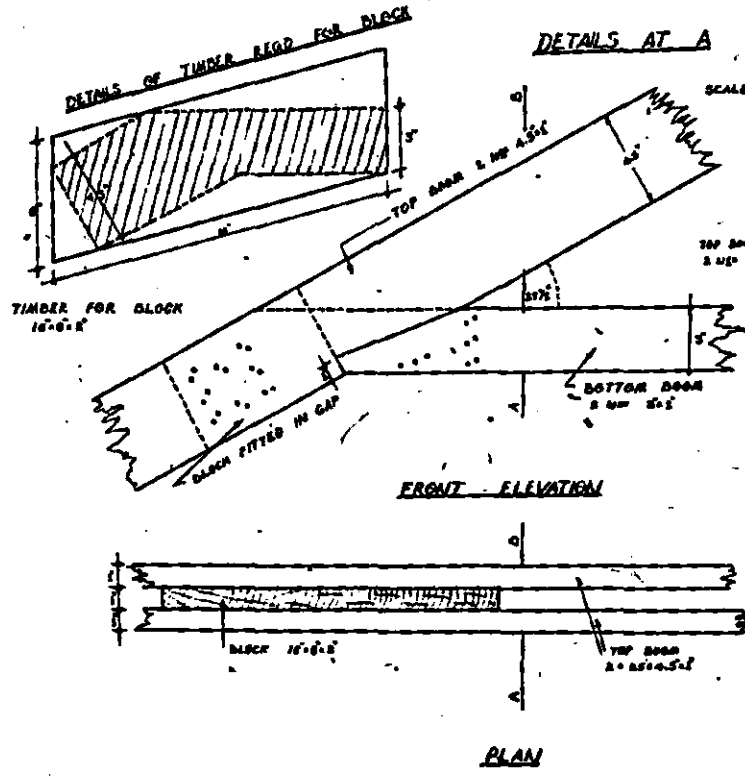
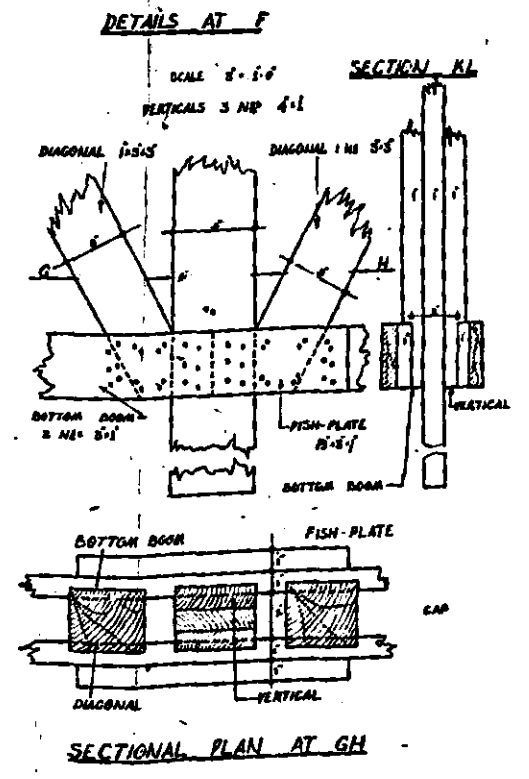
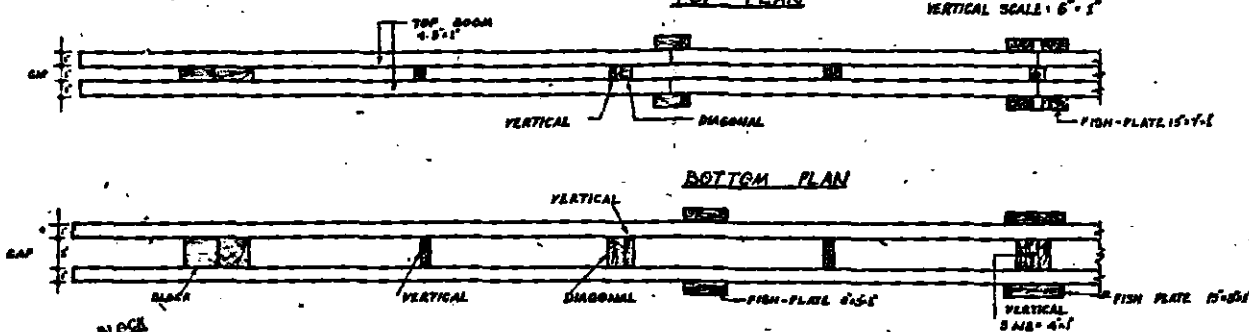
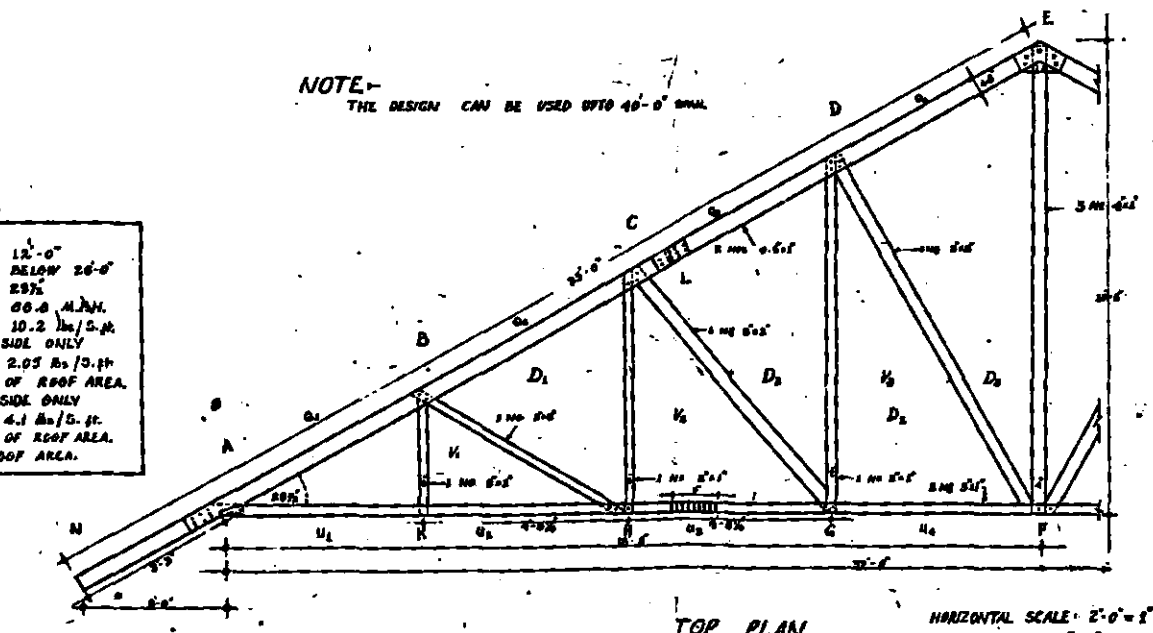

NOTE-
THIS IS NOT A WORKING DRAWING

INDICATIVE SKETCH
PLATE NR III

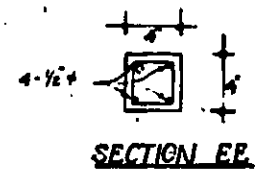
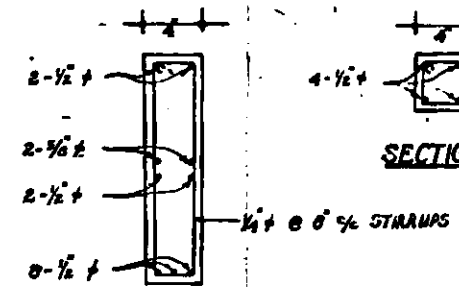
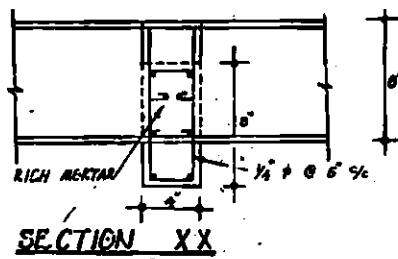
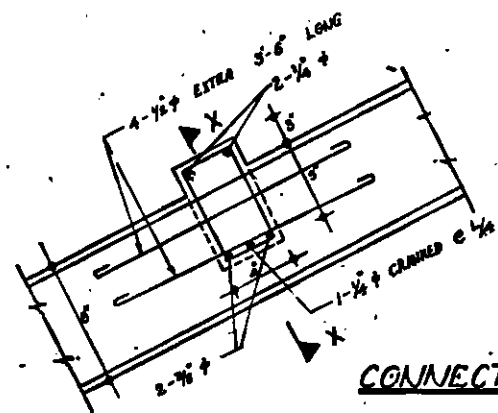

CONNECTION WITH PURLIN
& RAFTER

KEY-PLAN
(NOT IN SCALE)

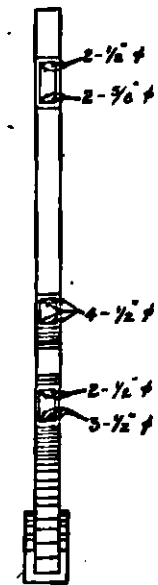
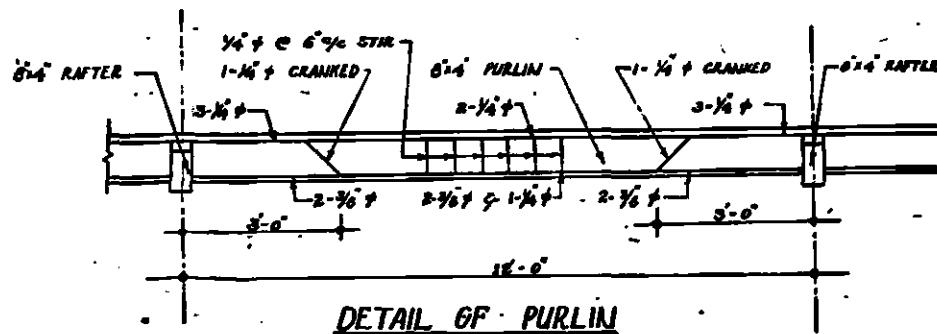
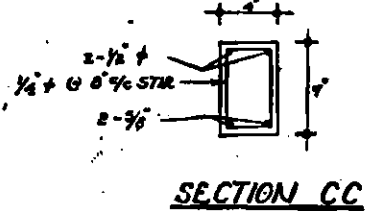
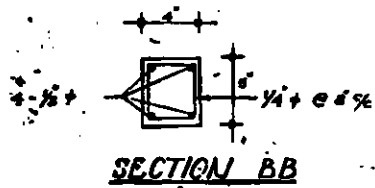
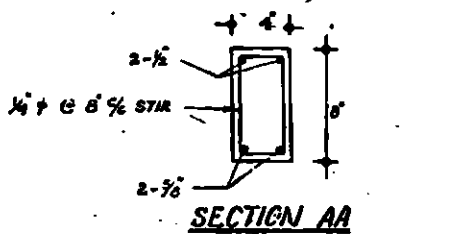
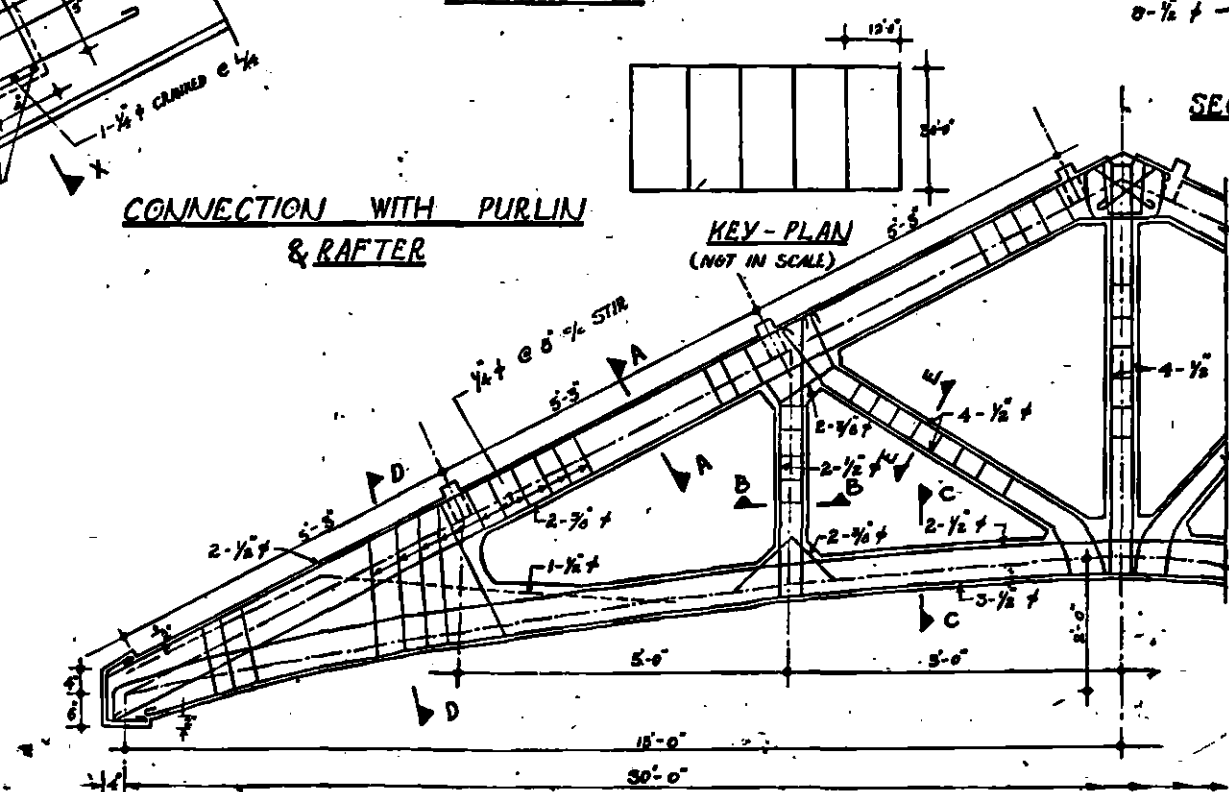

NOTE:-

STEEL STRESS 18,000 P.S.I.
CONC. STRESS IN PRECAST ELEMENT 1,000 P.S.I.
WIND LOAD 15 lbs/S.FT.

NOTE:-

THIS IS NOT A WORKING DRAWING.

TYPICAL DESIGN FOR 30'
SPAN ROOF TRUSS.

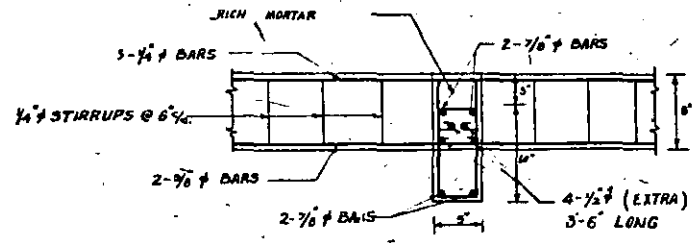

SECTION D-D
SCALE 1" = 1'-0"

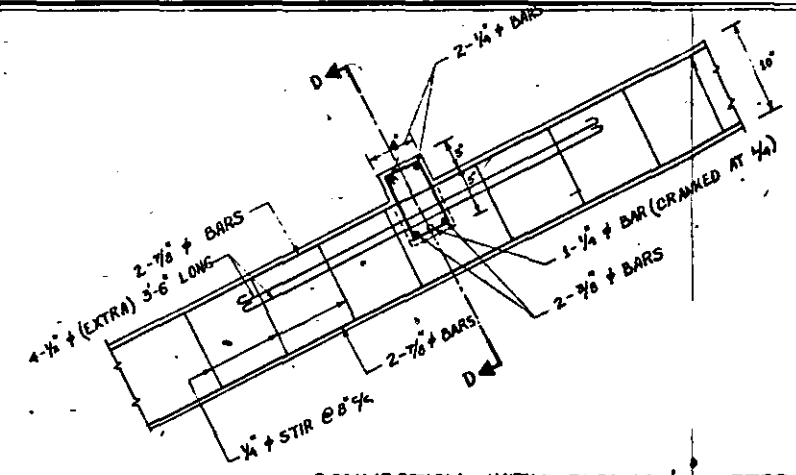

CONNECTION WITH PURLIN & RAFTER
SCALE 1" = 1'-0"

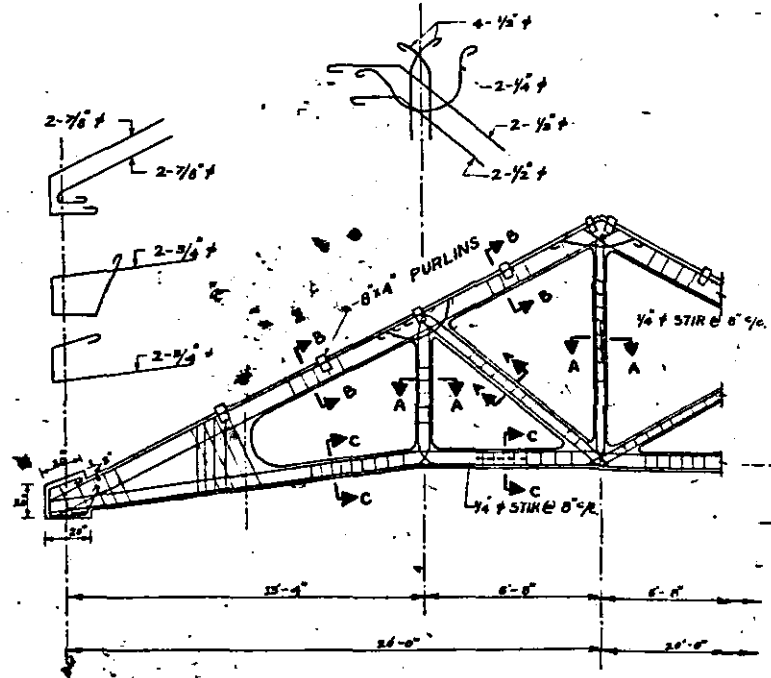

SCALE 1" = 50'

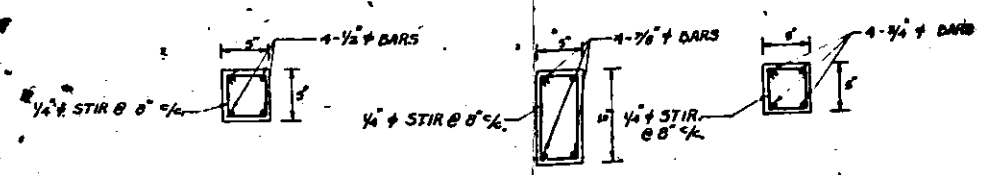

SECTION A-A
SCALE 1" = 1'-0"

SECTION B-B
SCALE 1" = 1'-0"

SECTION C-C
SCALE 1" = 1'-0"

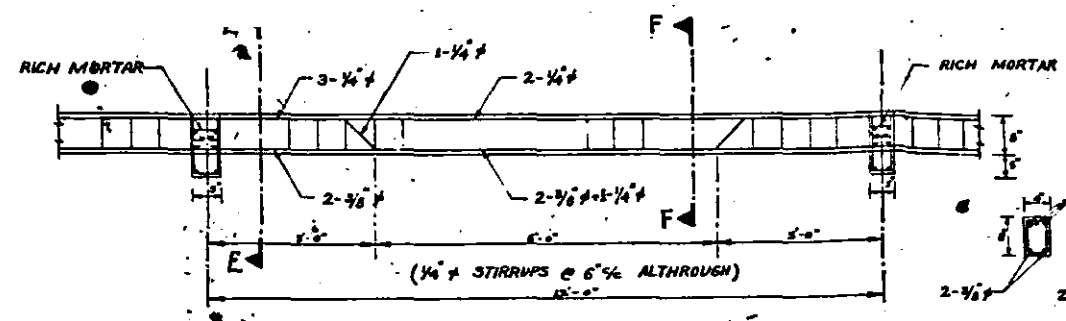

DETAILS OF PURLIN
SCALE 1/2" = 1'-0"

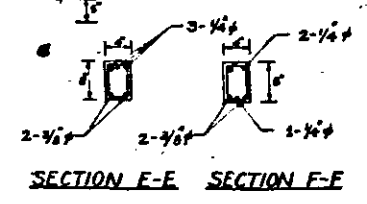

SECTION E-E SECTION F-F

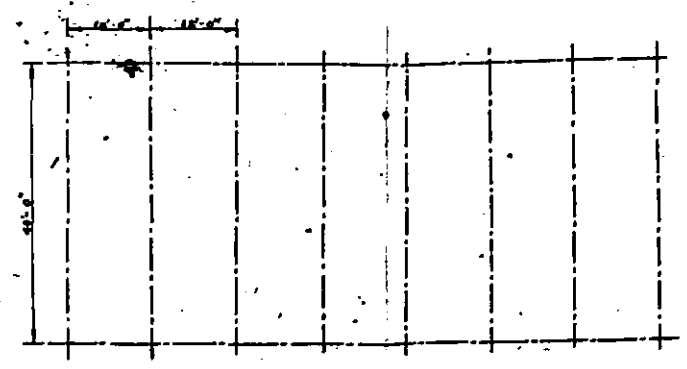

LAY-OUT PLAN
SCALE 1/16" = 1'-0"

NOTE:-
STEEL STRESS 18,000 p.s.i.
CONC. STRESS IN PRECAST ELEMENT 1,000 p.s.i.
NOTE:- THIS IS NOT A WORKING DRAWING.

TYPICAL DESIGN OF
40'-0" SPAN

SCALE = 1/32", 1/8", 1/16", 1/4" = 1'-0"

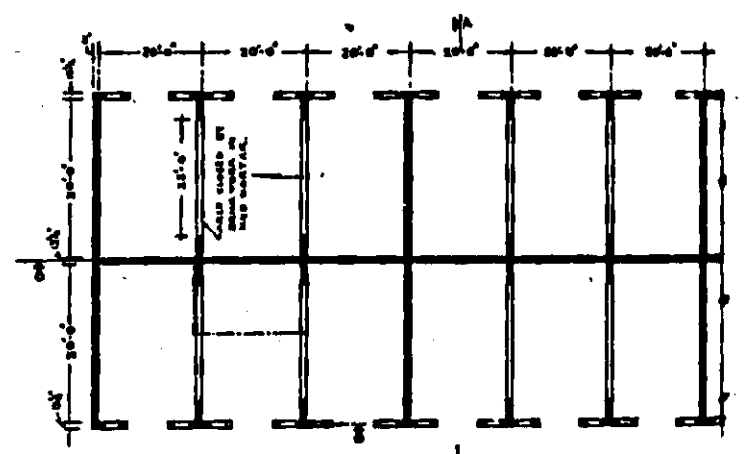
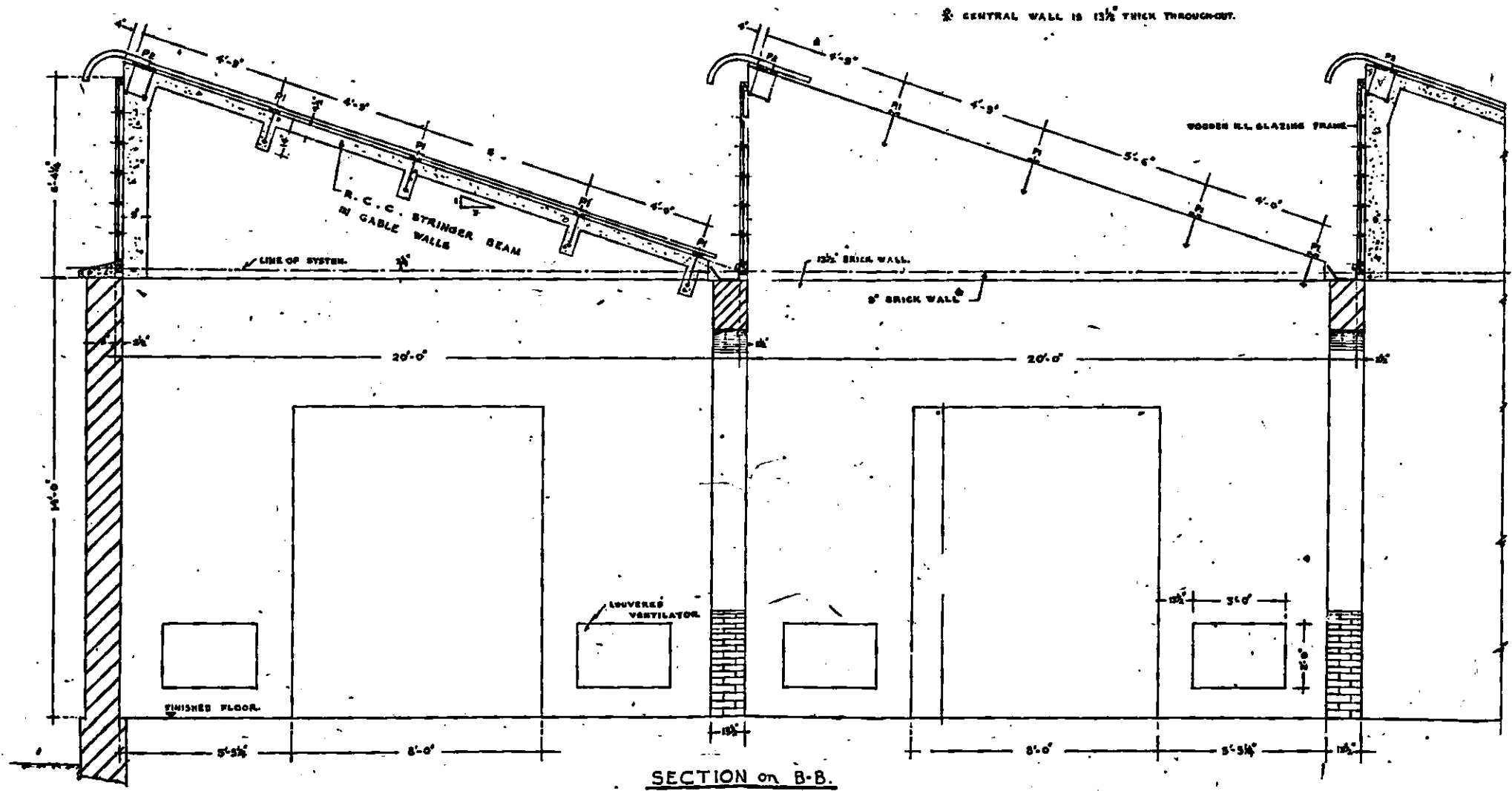

WEIGHTS 6 BAYS SHED.

PURLIN P1	20 nos @ 182 lb	= 3640.00
PURLIN P2	6 nos @ 210 lb	= 1260.00
TOTAL		4900.00

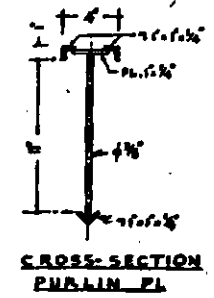
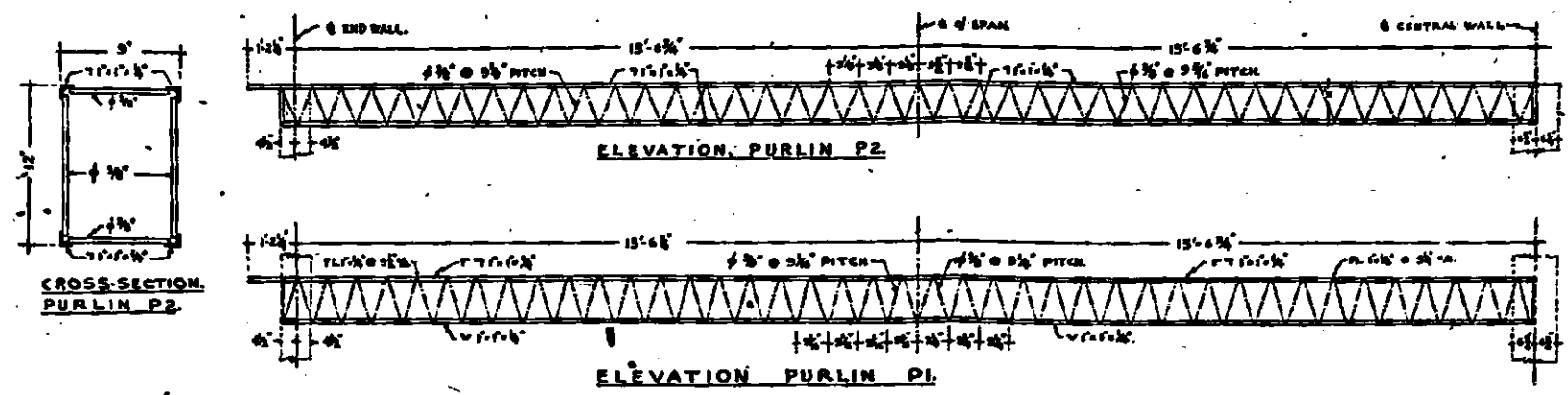
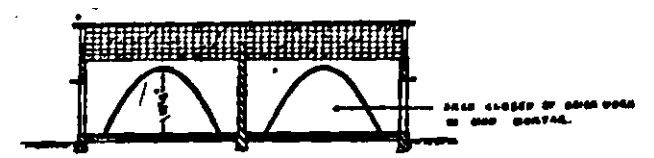

30 FT. SHED FOR LIGHT WORKSHOP OR STORE.

NOTE - THIS IS NOT A WORKING DRAWING.

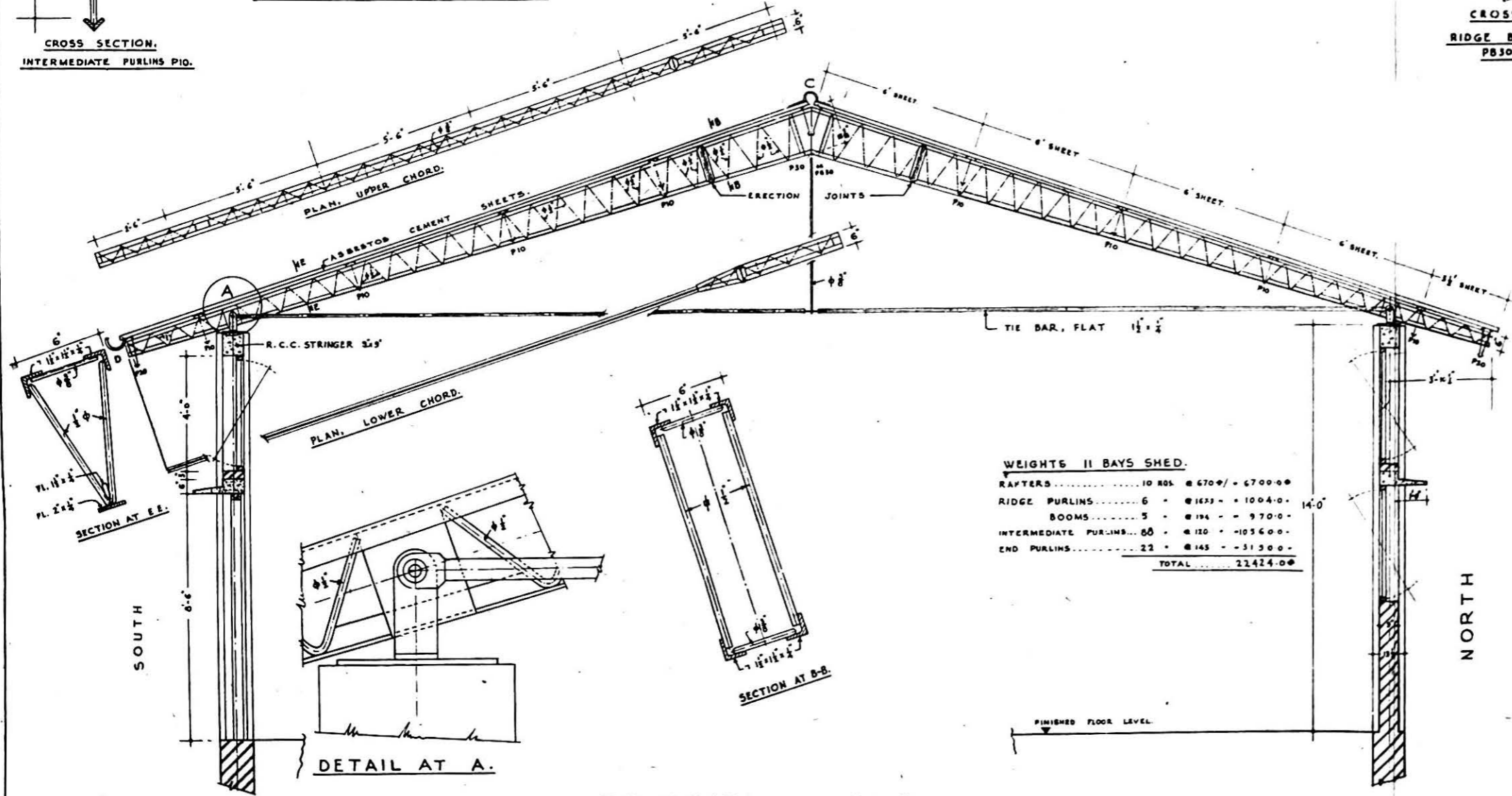
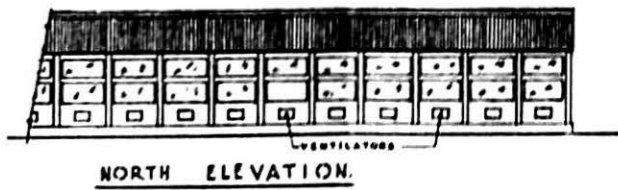
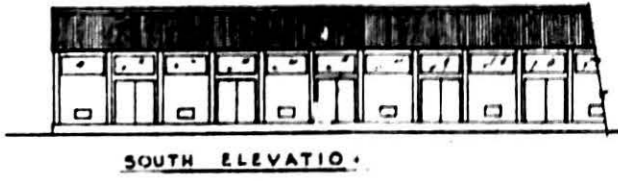
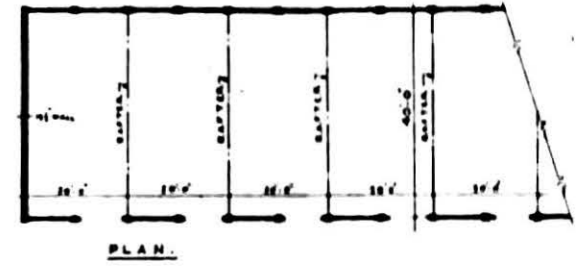
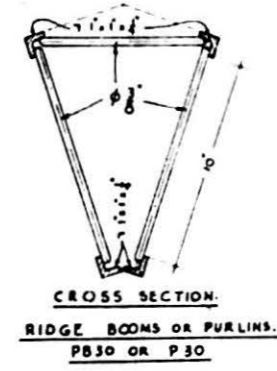
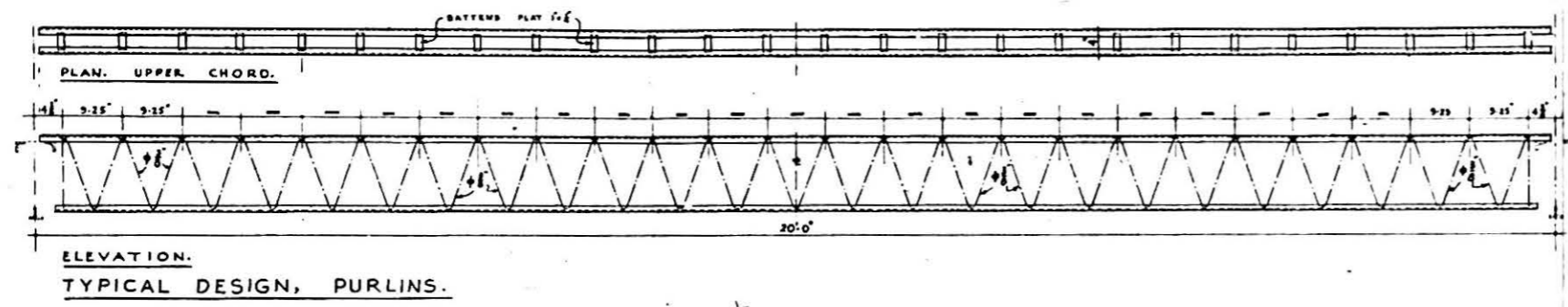
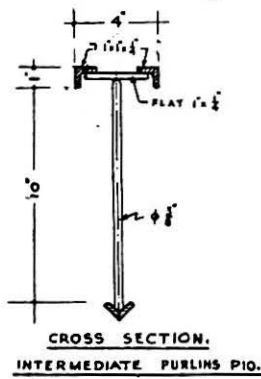

WEIGHTS 11 BAYS SHED.

RAFTERS	10 ROL @ 670.00	= 6700.00
RIDGE PURLINS	6 @ 167.33	= 1004.00
BOOMS	5 @ 194.00	= 970.00
INTERMEDIATE PURLINS	88 @ 120.00	= 10560.00
END PURLINS	22 @ 145.00	= 3190.00
TOTAL		22424.00

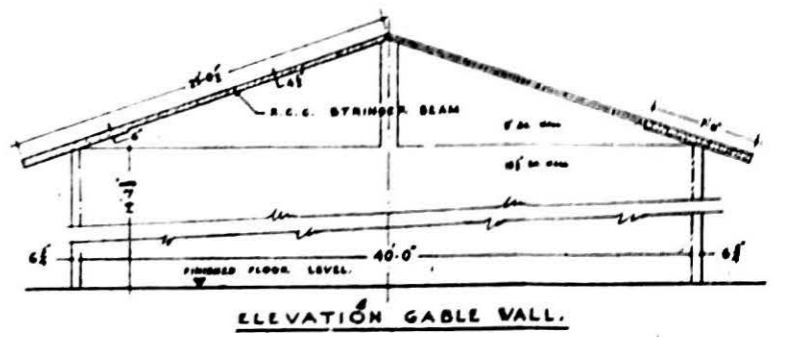

40 FT. SHED FOR LIGHT WORKSHOP OR STORE.
NOTE - THIS IS NOT A WORKING DRAWING.

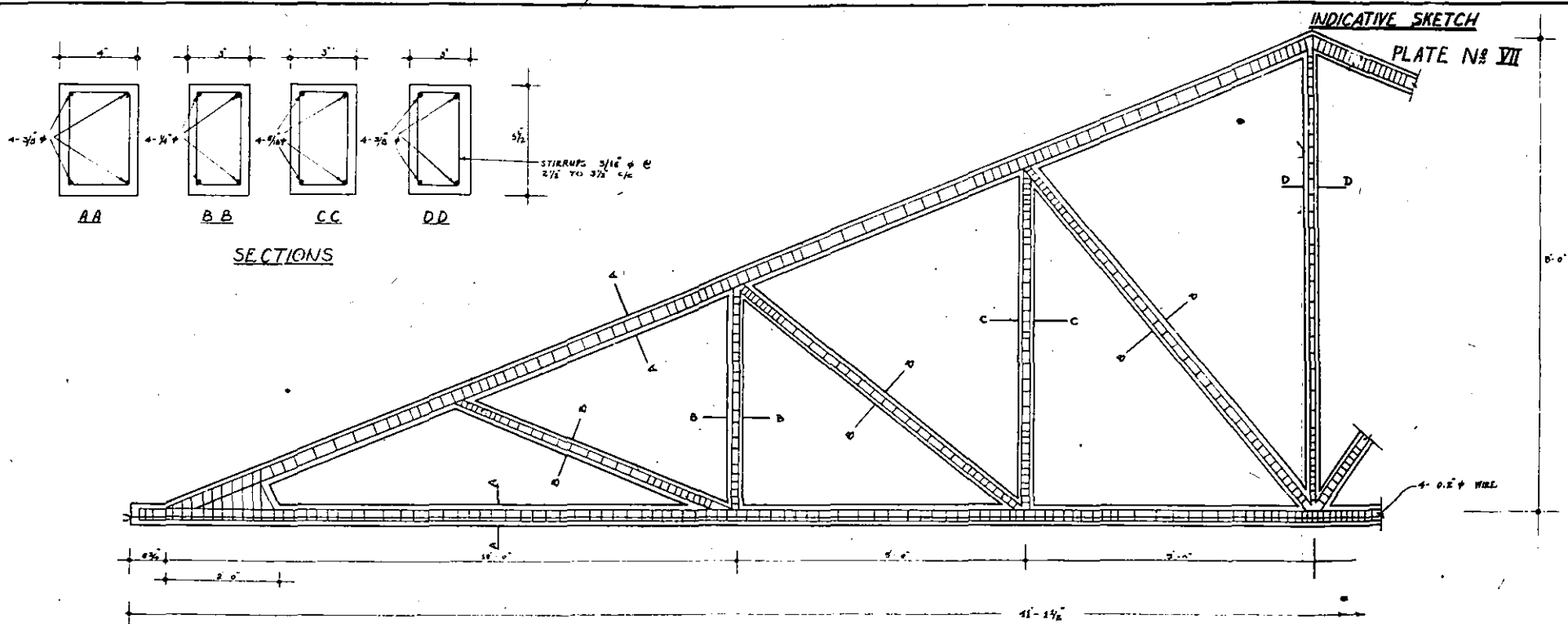

SKETCH SHOWING R.C.C. PURLIN WITH
DETAILS OF SEATING (NOT TO SCALE)

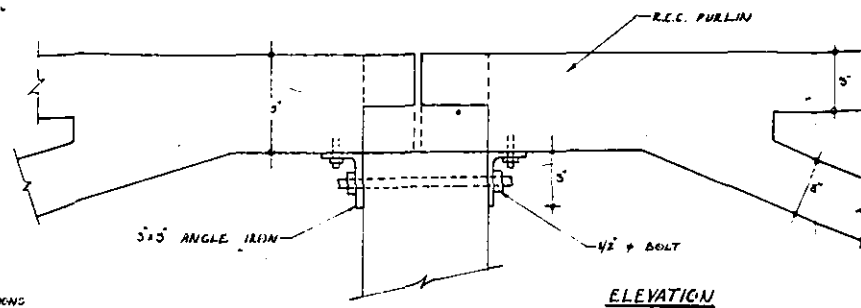
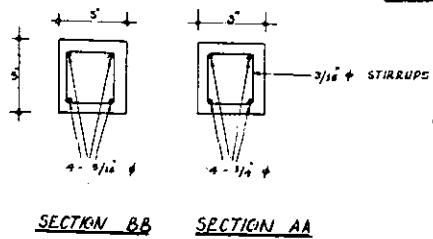
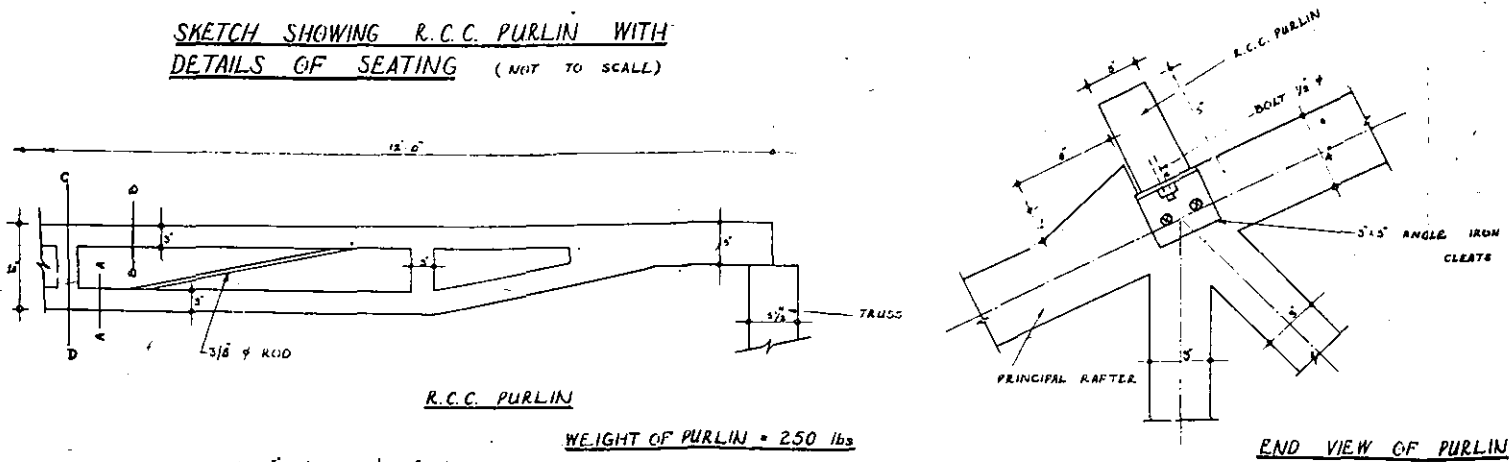

NOTE-

- (1) LOADS AT NODAL POINTS 2000 lbs + WIND LOAD AS PER I.S.I. SPECIFICATIONS
- (2) STRENGTH OF CONCRETE 3000 P.S.I. AT 28 DAYS.
- (3) " " STEEL 12000 "
- (4) WT OF TRUSS 28 CUFF.
- (5) STEEL REQD /U TRUSS ONLY 62 lbs

H.T. STEEL 0.053 lbs/ft M 0.11 lbs/ft M.G. (IN COST)

NOTE:-

THIS IS NOT A WORKING DRAWING.