

CCPP/PWB/Ser.5/59



REPORT OF
THE SELECTED BUILDINGS PROJECTS TEAM
ON
INDUSTRIAL ESTATES

COMMITTEE ON PLAN PROJECTS

NEW DELHI

May, 1959

Composition of the Team for Selected Buildings Projects.

Leader

Shri S. K. Patil, Minister of Transport and Communications.

Members

Shri Sarup Singh, ISE(Retd), formerly Director, National Buildings Organization.

Dr. Eng. A. Carbone, M.I.A.B.S.E., Consulting Engineer, Calcutta.

Shri C. P. Malik, Director, National Buildings Organisation
(*ex-officio*).

Secretary

Shri T. S. Vedagiri, Superintending Engineer.

General H. Williams, Director, Central Buildings Research Institute, Roorkee, has also kindly agreed to attend meetings of the Team and the Panels as and when he can spare time. He has, however, placed the facilities of the Central Buildings Research Institute at the disposal of the Team.



**Minister of
Transport and Communications,
INDIA.**

New Delhi, May 31, 1959.

My dear Pantji,

I have great pleasure in forwarding herewith the report of the Selected Buildings Projects Team on Industrial Estates. You will recall that the Team set up a Panel for examining different types of factory buildings. As the outlay on Industrial Estates in the present Plan is substantial, the Team considered that it would be advisable to evaluate some of the Estates from technical and financial points of view. The work was entrusted to the Panel for Factory Buildings.

2. The Panel after examining six of the Industrial Estates recently set up, has come to the conclusion that there is wide variation in design standards and space utilisation. It has therefore laid down certain norms for effective space utilisation and economical construction.

3. It is estimated that about 10,000 tons of structural steel will be required for the programme of Industrial Estates envisaged in the Second Plan. It is possible to save a substantial portion of this, if alternative types of roofing suggested by the Panel are adopted. The suggestion of the Team regarding roofing would also lead to a saving of about Rs. 20 lakhs in financial cost.

4. You will be glad to know that the recommendations contained in the Report have been welcomed both by the Development Commissioner, Small-Scale Industries and by the Adviser (Planning), Planning Commission.

5. The Panel has studied a number of other Industrial Projects. An advance report on the Heavy Electrical Project Bhopal and the Fertilizer Project at Nangal was issued last year and the Panel is studying other Industrial Projects such as Oil Refineries, Coal Washing Plants, etc. Its findings and recommendations on these will be given in the subsequent Reports on Factory Buildings.

6. I take this opportunity of thanking the various authorities in-charge of Industrial Estates for their co-operation in supplying the information required by the Team and the facilities accorded by them for on the spot studies and discussions.

**Yours sincerely,
S. K. Patil.**

**SHRI GOVIND BALLABH PANT,
CHAIRMAN, COMMITTEE ON PLAN PROJECTS &
MINISTER OF HOME AFFAIRS,
NEW DELHI.**

REPORT ON INDUSTRIAL ESTATES

CONTENTS

	PAGE
<i>Report</i>	
1. Introduction	1
2. Objective of Industrial Estates	2
3. Approach to the problem	4
4. Main observations	4
5. Planning and layout	5
6. Design details	7
7. Services and other amenities	12
8. Organisation for execution and maintenance	12
9. Recommendations for reducing cost of construction	13
10. General observations	16
<i>Summary of Important Recommendations</i>	18
<i>Remarks by the Selected Buildings Projects Team</i>	19

Appendices

I. Programme and progress of work on Industrial Estates	21
II. Information regarding Industrial Estates visited by the Panel	23
III. Observations and comments on various Industrial Estates visited	25
IV. Cost & Material analysis	31
V. Proforma regarding Industrial Estates	32

Plates

I & II. Design of timber trusses for spans of 30' & 40'	
III & IV. Precast R.C. trusses for spans of 30' & 40'	
V & VI. Design of trusses in steel for spans of 30' & 40'	
VII. Precast prestressed R. C. truss for 40' span	

APPENDIX I*

Programme and progress of work on Industrial Estates

The programme of establishment of Industrial Estates was initiated at the end of the First Five Year Plan. Proposals for the setting up of nine Industrial Estates were sanctioned during the year 1955-56 and loans aggregating to Rs. 58 lakhs were advanced to the State Government for this purpose.

2. In the Second Five Year Plan, a provision of Rs. 10 crores (now increased to Rs. 11 crores) has been made for the setting up of Industrial Estates. A total number of 110 Industrial Estates have been planned to be set up all over the country, of which 72 (including Okhla and Naini) have been sanctioned so far. A sum of Rs. 427.81 lakhs has so far been sanctioned as loans to the State Governments during the period 1955—1959, out of which Rs. 368 lakhs have been spent up to 30th September 1957. Seventeen of the Industrial Estates have started functioning and other twenty are in an advanced stage of construction.

3. As a general rule, the management of the Industrial Estates, rests with the State Government. But in the case of the Industrial Estates at Okhla (New Delhi) and Naini (U.P.), the construction and management have been entrusted by the Government to the National Small Scale Industries Corporation.

*Details obtained from the office of the Development Commissioner, Small Scale Industries, Ministry of Commerce and Industry.

APPENDIX II

Information regarding Industrial Estates Visited by the Panel

1. Name	Guindy (Madras)	Okhla (New Delhi)	Rajkot (Bombay)	Sanath Nagar (Hyderabad)	Bauripur (West Bengal)	Papanamgode (Trivandrum)
2. Location	Nearly 8 miles from Madras Egmore Station	About 6 Miles from New Delhi	About 1 1/2 miles from Rajkot City.	Adjacent to Hyderabad City.	Nearly 1 mile from Railway Station.	Nearly 4 miles from Trivandrum Central Terminus
3. Total area of Estate	44.5 Acres	33 acres	20.7 Acres	43.8 Acres	1,23,300 Sft.	25 Acres.
4. Type of Sheds	Detached, with compound	2 to 4 units attached with compound	Units 120'x60' without compound	Two units attached with compound	Detached units with compound	Attached units with compound
5. No. of Sheds	A (Single) 5 Nos. B (Single) 6 " C (Single) 7 " A (Double) 8 " B (Double) 7 " C (Double) 21 "	7 of 10,000 Sft. 5 of 9,000 Sft. 4 of 6,000 Sft. 10 of 5,000 Sft. 2 of 4,000 Sft. 1 of 3,000 Sft. 2 of 2,700 Sft. 1 of 2,500 Sft. 3 of 2,000 Sft.	108 sheds each measuring 60'x30'	A—4 Nos. B—16 Nos. C—10 Nos.	A—2 Nos. B—5 Nos. C—2 Nos. D—4 Nos. E—4 Nos. F—3 Nos.	A—2 Nos. B—8 Nos. C—37 Nos.
6. Coverage of area						
(a) Total plot area	10,90,600 Sft. 54.5% of (3)	4,86,800 Sft. 35.8% of (3)	3,54,600 Sft. 39.4% of (3)	10,94,000 Sft. 57.6% of (3)	65,000 Sft. 52.7% of (3)	4,17,000 Sft. 38.2% of (3)
(b) Area under ancillary Buildings, such as Administration, Canteen etc.	1,10,000 Sft. 5.5% of (3)	1,81,350 Sft. 13.2% of (3)	24,000 Sft. 2.7% of (3)	63,000 Sft. 3.3% of (3)	11,000 Sft. 9.0% of (3)	84,000 Sft. 7.7% of (3)
(c) Area under roads	6,90,000 Sft. 34.5% of (3)	5,32,000 Sft. 39.1% of (3)	4,19,400 Sft. 46.6% of (3)	5,00,000 Sft. 26.3% of (3)	34,300 Sft. 27.8% of (3)	2,74,000 Sft. 25.1% of (3)
(d) Area under open space	1,09,400 Sft. 5.5% of (3)	1,56,500 Sft. 11.9% of (3)	1,02,000 Sft. 11.3% of (3)	2,43,000 Sft. 12.8% of (3)	13,000 Sft. 10.5% of (3)	2,83,000 Sft. 29.0% of (3)
TOTAL	20,00,000 Sft.	13,56,650 Sft.	9,00,000 Sft.	19,00,000 Sft.	1,23,300 Sft.	10,58,000 Sft.

	Guindy		Okhla		Rajkot		Sanath Nagar		Bauripur		Papanamgode	
	Sizes	%age	Sizes	%age	Sizes	%age	Sizes	%age	Sizes	%age	Sizes	%age
7. Sizes of sheds and percentage of builtup area to plot area.	46'-3" × 158'-1½" 89'-4½" × 158'-1½" 48'-3" × 118'-1½" 89'-4½" × 118'-1½" 38'-3" × 93'-1½" 69'-4½" × 93'-1½"	43.8 63.0 48.0 62.5 43.2 59.0	Varying sizes from 2,000 sqft. to 10,000 sqft.	About 65% of plot area	Units 120' × 60' divided into four sub-units each measuring 60' × 30'	Same as plot area i.e. 100%	A—80' × 80' B—80' × 40' C—53' × 40'	16.25 19.2 16.4	A—75' × 40' B—50' × 40' C—50' × 33' D—25' × 43' E—25' × 33' F—20' × 30'	60.0 48.9 37.1 54.8 42.1 39.5	A—40' × 80' B—2 halls each 30' × 60' in one block C—2 halls each 20' × 25' in one block.	34.9 64.5 53.8
8. Width of roads	80', 70', 60', 50', 40', 33'		Four lane traffic roads with cycle tracks & foot paths total width nearly 150 ft.		45', 30'		Main Road 80' Roads in the Estate 60'		Main Road—40' Foot Path—6'		40', 24', 16'	
9. Plinth Height	Approximately 1'-0"		1'-6"		2'-6"		1'-6"		1'-0"		A & B—1'-6" C—2'-0"	
10. Height from the Plinth level to tie level	Approximately 14 ft.		14 ft. (minimum)		14ft.		15 ft.		12 to 16 ft		14ft.	
11. Super-structure	Country brick in C. M. 1:5 for Factory portion. Gable wall 1'-1½" thick Panel wall- 9" thick Office portion wall 1'-1½" thick.		14" thick brick masonry walls in cement lime mortar 1:5:18		UCR stone masonry in lime mortar 15" thick Inner wall BB masonry in lime mortar 15" thick		Brick masonry walls, 1'-6" thick in lime mortar plastered with lime mortar on both faces		10" thick walls in lime concrete		Laterite masonry walls in lime mortar 1:2. 1'-3" thick Pillars 1-10½' size	
12. Flooring	A bed of cement concrete 1:4:10, 4" thick and top finished with layer of ¾" thick cement concrete 1:3:7½ granolithic flooring using blue granite jelly of size 3/8" (and below) and surface rubbed smooth		4½" lime concrete and granolithic cement concrete		Either Cement flooring black stone paving or no flooring		Cement concrete flooring 1:2:4 6" thick over the filling up of morum in basement		4" cement concrete, 6" to 12" according to special needs.		Flooring with 1½" metal concrete in cement mortar 1:3:6, 3" thick and plastered with cement mortar 1:3, ½" thick one coat floated hard and travelled smooth.	
13. Roofing	North light steel roof truss with Asbestos cement sheets for roofing for factory portion & R.C.C. roof slab with 'T' beams for office portion		North light trusses and C.G.I. Sheets for roofing		North light steel truss with A. C. sheets for roofing		North light roof; sheet over steel tooth trusses		A.C. Galvanised Corrugated Asbestos sheets.		A—A.C. Sheets on steel trusses of 40' span. B—Tile roofing and wooden trusses of 30' span. C—Tile roofing on rafters.	
14. Steel used per sqft. of covered area	A (Single) 5.93 lbs. B (Single) 5.73 lbs. C (Single) 4.58 lbs. A (Double) 5.68 lbs. B (Double) 5.85 lbs. C (Double) 4.08 lbs.		About 5 lbs. in 13 factories and 8 lbs. in 22 factories		About 5 lbs.		About 5 lbs.		Tubular trusses adopted		About 4.85 lbs.	

APPENDIX III

Observations and comments on the various Industrial Estates visited.

(1) Guindy (Madras)

On the morning of 13th November 1957, the Panel visited the Industrial Estate that is being set up in Guindy by the Industries Department of Madras. They had discussion with the following officers:—

Shri T. K. Palaniappan, IAS. Director of Industries.

Shri V. S. Raghavan, Joint Director.

Shri S. Basheer Ahmed, Deputy Director.

Shri N. K. Pillai, Superintending Engineer.

It was explained to the Panel that it was intended to set up six more Estates at Virudunagar, Erode, Coimbatore, Trichinopoly, Madura and Tinnevelley. About 60% of the work at Madras had been completed at the time of the Panel's visit. It was understood that in Virudunagar out of the 40 sheds, about 15 had been taken up for construction. In Erode, out of the 12 units, 2 had been started and 3 more were to be taken up shortly.

The work sheds are of three types, A, B and C. The former two have a span of 40 ft. and the last 30 ft. The floor areas of the sheds are 4280 Sft., 3044 Sft. and 1836 Sft. respectively.

The worksheds consist of brick masonry pillars, mild steel trusses and A.C. sheeting. The steel consumption comes to about 5-6 lbs. per sq. ft.

The element of the cost of land is about 20% of the total cost of the project. The area under roads is about 35% and under open spaces about 5%.

The construction work is being carried out by one Superintending Engineer, assisted by three Executive Engineers, working directly under the Director of Industries. The Superintending Engineer has powers of Chief Engineer in all technical matters.

Comments

It struck the Panel that expensive paddy land had been taken up and this has further involved heavy cost on foundations on account of special soil conditions. The authorities, however, explained that according to their preliminary enquiry, the entrepreneurs did not like the idea of a greater distance from the city. We agree that this is an aspect of the question that always needs careful consideration.

Whereas the area under open spaces is reasonable, the area under roads is high. It would be difficult to justify an 80 ft. and 60 ft. wide central road, specially the former when there is no through traffic. As a general rule the road width should be gradually reduced as the intensity of traffic decreases.

Steel trusses involved not only the use of steel which is in scarce supply, but are also expensive. It was stated that the reason for adoption of this pattern of roofing was that some dismantled trusses were available with the Government and further there was lack of suitable construction agency for doing even ordinary R.C.C. work. The argument did not appeal to the Panel.

(2) Papanamgode (Trivandrum)

The Factory Panel stayed at Trivandrum from 19th to 21st, November 1957, had meetings with the Joint Director of Industries and visited the Industrial Estate at Papanamgode.

Construction work was in progress. Here also, there are three types of sheds, A, B and C. 'A' has a span of 40 ft. 'B' 30 ft. and 'C' 20 ft. Steel trusses have been adopted for the A type sheds and timber trusses for B & C type sheds.

The trusses follow the conventional pattern. The amount of steel per sq. ft. of plinth area is of the order of 5 lbs.

The pilasters are 1 ft. 10½ in. square with filler walls of 13½ in. thick. Wooden purlins have been used both in B and C type sheds.

The foundations and the plinth masonry is in rubble which is stated to be cheap at Trivandrum. Services had not been laid out at the time of the visit. Six out of the eight Estates are under construction. The intention is to have one Industrial Estate in each district. All of them follow the same pattern.

Comments

With thick brick pillars, the 13½ in. thick filler wall appears to be unnecessary. 'One brick thick' walls should have sufficed. The window frames are also heavy. It is, however, satisfactory to note that a serious attempt has been made to utilise local materials, rubble and timber.

(3) Okhla (New Delhi)

The Panel visited the Industrial Estate at Okhla on the 11th December 1957 and had discussion with Col. Nehra, the Manager of the Estate. The first phase of construction consists of 35 factories, one administrative block, two canteens, a hospital, a fire station and other services. The revised project estimate amount to about Rs. 46 lakhs out of which the expenditure on the work-sheds is Rs. 23.22 lakhs which is about 50 per cent of the total cost. The rest of the expenditure is on the ancillaries such as the administrative buildings, canteens and road etc.

The worksheds consist of load bearing masonry walls on the outside and rolled steel columns inside at 19 ft. centres both ways, steel trusses and G.I. sheet roofing.

The Panel was informed that the original plan was to adopt timber roof trusses and the planning of the worksheds was on this basis. The design was changed later as the work had to be completed in a time shorter than originally anticipated. R.C.C. construction was ruled out in view of the limited time in which the work had to be completed. To secure extra space mezzanine floor has been provided inside the factory with heavy girders at close intervals. The workmanship of the trusses was found to be defective. In the flooring in many cases, the corners of the slabs had lifted and the floor was also cracked. The R.C.C. work in the administrative building which was under construction at the time of the visit, was of poor quality. The reinforcements were non-symmetrical and almost visible on one side. They were being covered with thick plaster. The authorities later claimed that the construction defects have been removed at the expense of the contractors.

The central road, as planned, consists of four traffic lanes with a middle strip, two foot paths and cycle tracks on either side. In addition, there are a number of parking places, and 50 ft. wide roads round the workshop.

Comments

The facts as narrated above, show that half the money has been spent on works other than the factory buildings. The area utilised for the plots is only 36 per cent and the area utilised for roads, open spaces and ancilliary buildings is 64 per cent. With proper planning, it should have been possible to have increased the area under the plots to about 60 per cent. It is difficult for the panel to understand the necessity of a 150 ft. wide high way within the Industrial Estate.

The money spent on the ancilliary buildings could have been more usefully utilised on the factory buildings, which, after all, is the essence of a project.

Steel construction has been justified on grounds of shortage of time. In actual fact, however, there has been considerable delay in the completion of the work. One set of factories which were to be completed in 5½ months actually took 13½ months. The construction of the floor inside the workshop should have been postponed till after the allotment of the sheds, to suit the nature of work to be carried out.

(4) Bauripur (West Bengal)

The Panel visited the Bauripur Industrial Estate of the West Bengal Government on the 10th May 1958. The Estate is situated in the midst of rich agricultural land and is about a mile away from the railway station. The authorities stated that they were not considering the question of the railway siding at present as road transport was available and could meet the requirements of the Estate.

There are six types of sheds. The spans adopted are 20 ft. to 30 ft. In both cases, tubular steel trusses have been used. These rest on pilaster 15 in. square. The filler walls are 10 in. thick.

The rent has been worked out at the rate of Rs. 10 per 100 sq. ft. and the Panel was informed that the open platform on either side of the shed will also be included in the area for which rent would be recovered.

Comments

The adoption of tubular steel trusses is a good feature. The provision of longitudinal bracing appear to be unnecessary, specially when there are gables at the ends. In any case, the bracing should have been arranged diagonally, to prove more effective. The doors and window chowkhats could have been of R.C.C. construction, to reduce cost. Ventilation arrangements within the sheds were not adequate. Openings for exhaust fans should have been made in the gables or some fixed ventilation arrangement provided with jali frames or honey-comb brick work.

The break-up figures of cost show that the bulk of expenditure has gone to the workshops. The cost of ancillaries is reasonable.

An upto-date wood work training shop has been put up in the Estate but the actual work that is to be executed in the Estate, bears no relationship to the training workshop.

(5) Sanath Nagar (Hyderabad)

The Industrial Estate at Sanath Nagar near Hyderabad was visited on the 10th August 1958 and the Panel had discussion with the Secretary, Department of Industries, Director of Industries and other officers connected with the project.

The workshops constructed fall into three categories, A, B and C, of sizes 80 ft. x 80 ft., 80 ft. x 40 ft. and 53 ft. x 40 ft. respectively.

Steel trusses with north light have been used and the consumption of steel is of the order of 5 lbs. per sq. ft. The cladding and partition walls are 18 in. thick and this is justified on account of the poor quality of the bricks. It was stated that hollow block construction would have proved more expensive.

Rolling shutters have been installed between two adjoining workshops.

The main road has been kept 80 ft. wide and all other roads 60 ft. wide. The total area under roads comes to 26 per cent.

Comments

The provision of north-light trusses does not appear to be necessary in all cases. The factory units can be reorientated in East and West directions so as to obtain the required light from the windows in the North and South walls.

While the size of the administrative block is reasonable, the space utilised for the worksheds is very low. The open space left in the plots is on too liberal a scale. By reducing this, a great number of factory sheds could have been accommodated in the same area.

It was stated that rolling shutters have been provided to facilitate allotment of two workshops to one entrepreneur. This, however, appears to be unnecessary as the opening could have been bricked up to be opened out later when necessary.

The area under the roads is 26 per cent. This is not very high, but it is still difficult to justify the provision of 80 ft. and 60 ft. wide roads. There is no necessity for the internal roads to be wider than about 45 ft.

Again, the office and the storage space provided for within the worksheds is on the high side. In the smaller worksheds, provision of separate office accommodation does not appear to be necessary. Specially when two units are combined, the entrepreneur would not need twice the office area. It is a better procedure to construct the worksheds without the sub-division of the area and leave it to the entrepreneur to divide it up according to his requirements.

The smallest size of the workshed is 2,120 sq. ft. This is likely to prove too big for a man of limited means.

(6) Rajkot (Bombay)

The Rajkot Estate in Saurashtra was visited on the 24th August, 1958 in company with the Dy. Director of Industries Shri Dharwarkar, the Manager of the Estate Shri Shingale and Shri Nagesh of the T.C.M. proto-type-cum-training centre. Detailed information about the working of the Estate, the number of factories rehabilitated from the town and their progress in the new premises was collected by the Productivity Centre under the direction of Shri Mankiker. This information proved of great assistance to the Panel in properly understanding the position.

The panel also had discussions in Bombay with Shri V. V. Apte, Joint Director of Industries, Bombay and Shri M. Bhatnagar, Joint Development Commissioner, Industrial Estates.

The total number of factories constructed is 68, out of which 55 had been allotted, 6 were under different stages of allotment and 7 or 8 unallotted. Out of the 55, 40 were working and 15 were temporarily closed due to want of raw material.

Due to lack of adequate water supply, one of the factories had to close down.

The size of the factory units is 120 ft. x 60 ft. They are ordinarily divided into four sub-units each measuring 60 ft. x 30 ft. The original proposal was that an area of 45 ft. x 30 ft. should be covered and the remaining 30 ft. x 15 ft. left open. But ultimately the whole area was covered.

The height of the plinth varies from 6 ins. to 2½ ft. above the ground. The high plinth is justified on grounds of flooding. This could have been avoided by proper surface drainage arrangements. No such scheme had however been prepared.

The height from the plinth to the roof level is 12 ft. in earlier factories and 14 ft. in those constructed later. Roofing is of north light trusses with G.I. sheets. In some of the factories sub-ceiling has also been provided.

Each factory has got two doors, one with rolling type shutter and the other with sliding shutter. The width of the opening was initially kept at 10 ft. × 10 ft., but later it was reduced to 6 ft. × 8 ft.

The main roads are 45 ft. wide and the service roads 30 ft. wide without any foot-path or road-side drains. The total area under roads is 47 per cent.

No open yard has been given to any factory and they have to carry out their entire operations in the covered area.

Comments

The Panel feels that each unit should have some open space for storage and for foundry work that they may have to carry out. The management, however, explained that as a result of their experience they are now changing the design to provide for some open space for those who have to carry out foundry operations.

The superstructure of factories consists of 2 ft. × 2 ft. pilasters and 15 in. thick stone-walls. With the provision of such thick walls, the necessity for pilasters is questionable.

There are very few factories which have taken to new line of production. Most of them have been shifted from congested areas of the town. Our enquiry showed that many of the entrepreneurs were perfectly willing to construct their own factory sheds if they were given developed plots, i.e. plots laid out with roads, water-supply and electricity. It is a matter for serious consideration whether the policy of investing so much capital straightaway for the acquisition of land, its development and construction of worksheds etc. does not need reconsideration. If developed land is given to entrepreneurs who are willing to put up worksheds according to some pattern fixed by the Estate authorities, the funds earmarked for the Industrial Estate Programme can be spread out on a greater number of Estates.

Although the roads are not very wide the proportion of the area under roads is very high. This is because of excessive number of roads.

APPENDIX IV

Cost and Material Analysis

	Trusses having clear span of 40'-0" (Trusses @ 12'-0" c/c)			Trusses having clear span of 30'-0" (Trusses @ 12'-0" c/c)	
	Steel truss	Precast R.C.C. Truss	Prestressed Truss (precast)	Steel truss	Precast R.C.C. Truss
1. Approximate weight of one truss only	11.75 cwts	49.0 cwts	28 cwts	8.5 cwts	22.8 cwts
2. Approximate weight of the truss and purlins	22.72 cwts	94.0 cwts	51 cwts	18.3 cwts	51.0 cwts
3. Cement required per sq. ft. of covered area	..	3.08 lbs	1.67 lbs	..	2.2 lbs
4. Mild steel required per sq. ft. of covered area	5.00 lbs	2.5 lbs	1.30 lbs	5.5 lbs	2.0 lbs
5. High tensile steel required per sq. ft. of covered area	0.038 lbs
6. Cost per sq. ft. of covered area excluding columns and sheeting	Rs. 2.18	Rs. 2.18	Rs. 1.60	Rs. 2.40	Rs. 1.67

N.B.—A more economical solution for 40 ft span is to use two 20 ft. span north light trusses of R.C.C. with an intermediate column. The cost per sq. ft. of covered area will then be Rs. 1.7. Another advantage of this is the ease of handling and erection.

APPENDIX V

Proforma Regarding Industrial Estates

Location of Estate

Agency for planning & designing

Agency for construction

Sl. No.	Particulars	Recommendations of the Selected Buildings Projects Team	Realised figures in the particular case	Remarks or reasons for deviation, if any
1	2	3	4	5

Planning & lay out

1	Survey of industrial potential	A through survey must be conducted.		
2	Choice of site	The site should be capable of easy drainage, should be close to perennial water supply and within a reasonable range from source of power.		
3	Siting of Estate	Preferably near towns having a population of about 50,000.		
4	Distance from Railway Station	It should be preferably close to Railway Station with goods yards facilities.		
5	Availability of residential accommodation.	The location of Industrial Estate should not result in further concentration of population. It would be advantageous to combine a housing scheme with an Industrial Estate.		

- | | | |
|----|--|---|
| 6 | Total area of Estate | |
| 7 | Area under factory plots | This should be 60 to 65 % of the total Estate area. |
| 8 | Area under roads | This should not be more than 20% of the total area of the Estate. |
| 9 | Area of open space | This can be upto 10% of the total area of the Estate. |
| 10 | Area under administrative and other buildings. | This can vary between 5 to 10% of the total area of the Estate. |
| 11 | Number and types of worksheds | It is not necessary to adopt a large number of different sizes. |
| 12 | The minimum size of worksheds | 600 Sft. |
| 13 | Maximum size of worksheds | 6,000 Sft. |
| 14 | Covered area of worksheds | This should not be less than 50% of the plot area. It is also not necessary to provide for open space in all worksheds. |

Design details:

- | | | |
|----|--|---|
| 15 | Plinth height | A plinth height of 1 ft. above crown of the road will be sufficient if satisfactory arrangements are made for surface drainage. |
| 16 | Height upto tie level of roof from plinth. | 14 ft. |
| 17 | Windows and ventilators. | The area of these should not be more than 25% of floor area in humid regions and not more than 15% in hot dry regions. |
| 18 | Number of doors. | Normally two doors are sufficient. |
| 19 | Size of doors | Main door 8' x 8' and rear door 8' x 6'. |
| 20 | Flooring | This must be decided upon only after the allotment. |
| 21 | Roofing. | This must be decided after considering all the alternatives suggested in the Report. |
| 22 | Water supply & drainage | This must be provided for at the initial stage of planning. |

DESIGN OF TIMBER TRUSS

SPAN = 30'-0"

INDICATIVE SKETCH
PLATE NO I

(DISTANCE BETWEEN TRUSSES AS SHOWN BELOW IN PLAN)

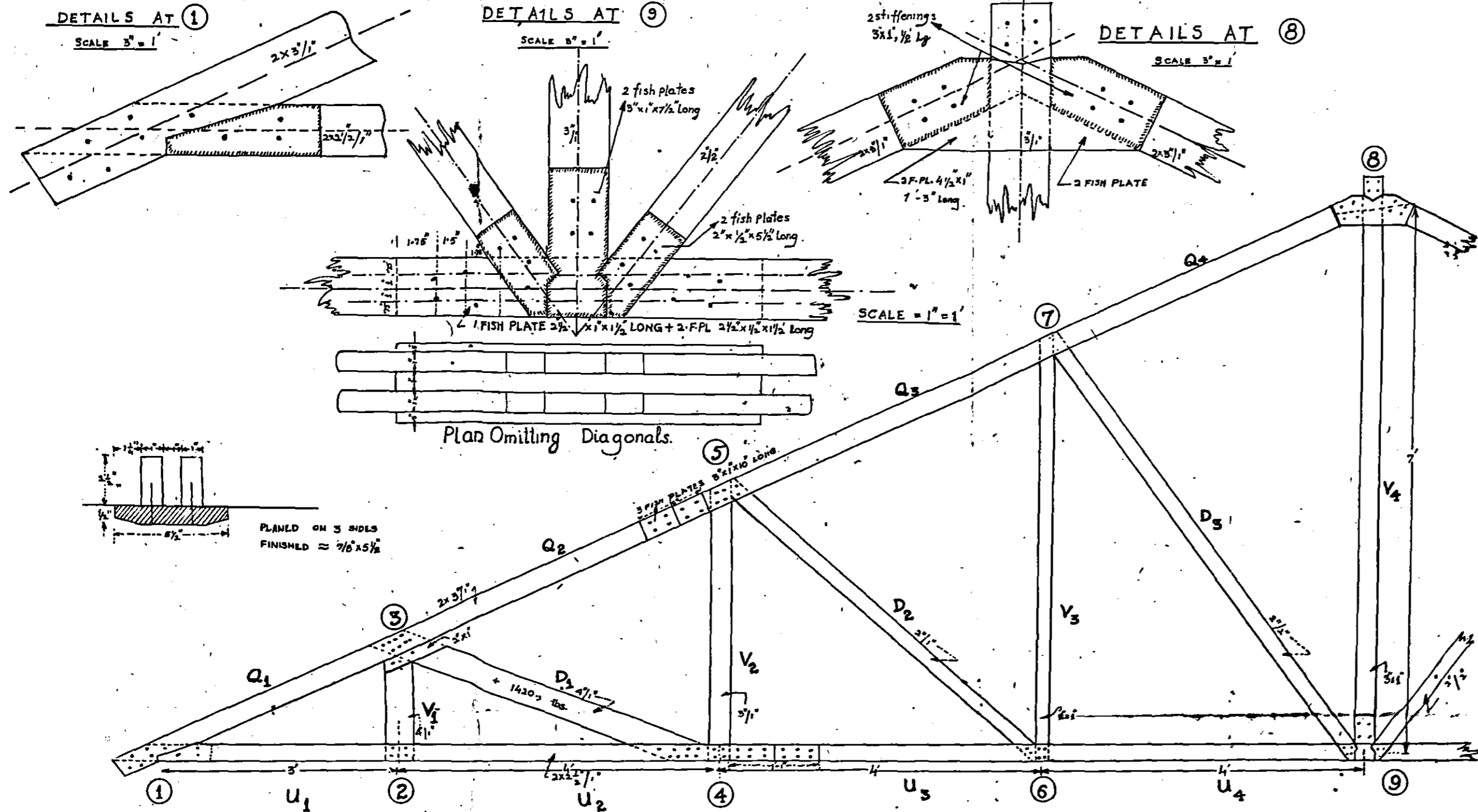

- TIMBER USED DECODAR OR ANY OTHER OF THE FOLLOWING STRENGTH STRENGTH :-
1. f_t = TENSION ALONG GRAIN = 1830 lbs PER in^2
 2. S = SHEAR HORIZONTAL = 100 lbs PER in^2
 3. f_c = COMPRESSION PARALLEL TO GRAIN = 1100 lbs PER in^2
 4. f_{\perp} = COMPRESSION PERPENDICULAR TO GRAIN = 390 lbs PER in^2

DESIGN DATA

1. DISTANCE OF TRUSSED RAFTERS C/C = 5'-1"
2. HEIGHT OF BUILDING = BETWEEN 26' & 66'
3. ANGLE OF INCLINATION = 25°
4. MAXM. VELOCITY OR V = 84.5 M.P.H.
5. IMPACT PRESSURE OR q = 16.4 lbs / sq-ft.
6. WIND PRESSURE ON -
WIND WARD SIDE ONLY
(CONSIDERING WIND PRESSURE ONLY & NO SUCTION ACCORDING TO OLD PRACTICE) = 9 lbs / sq-ft. OF ROOF AREA
7. DEAD LOAD - C/C. WEIGHT OF C.G.I. SHEET ROOFING, BATTENS & TRUSS ITSELF ACTING AT THE TOP BOOMS = 8 lbs / sq-ft. OF GROUND AREA
8. CEILING LOAD ACTING AT THE BOTTOM BOOM = 4 lbs / sq-ft. OF GROUND AREA.

NOTE: THIS IS NOT A WORKING DRAWING.

INDICATIVE SKETCH
PLATE NR II

NOTE-
THE DESIGN CAN BE USED UP TO 40'-0" SPAN

DESIGN DATA	
DISTANCE OF TRUSSES $\frac{1}{2}$	12'-0"
HEIGHT OF STRUCTURE	BELOW 26'-0"
ANGLE OF INCLINATION	25%
MAXIMUM VELOCITY V	66.3 M.P.H.
IMPACT PRESSURE P	10.2 $\text{lb}/\text{sq. ft.}$
WIND PRESSURE ON WINDWARD SIDE ONLY	2.05 $\text{lb}/\text{sq. ft.}$
WIND SUCTION ON LEEWARD SIDE ONLY	4.1 $\text{lb}/\text{sq. ft.}$
DEAD LOAD	10' $\text{lb}/\text{sq. ft.}$ OF ROOF AREA.

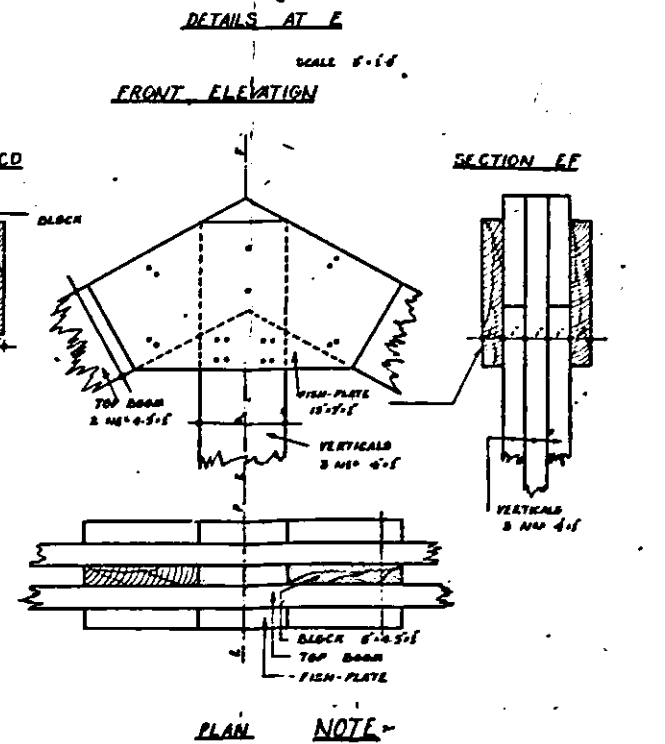
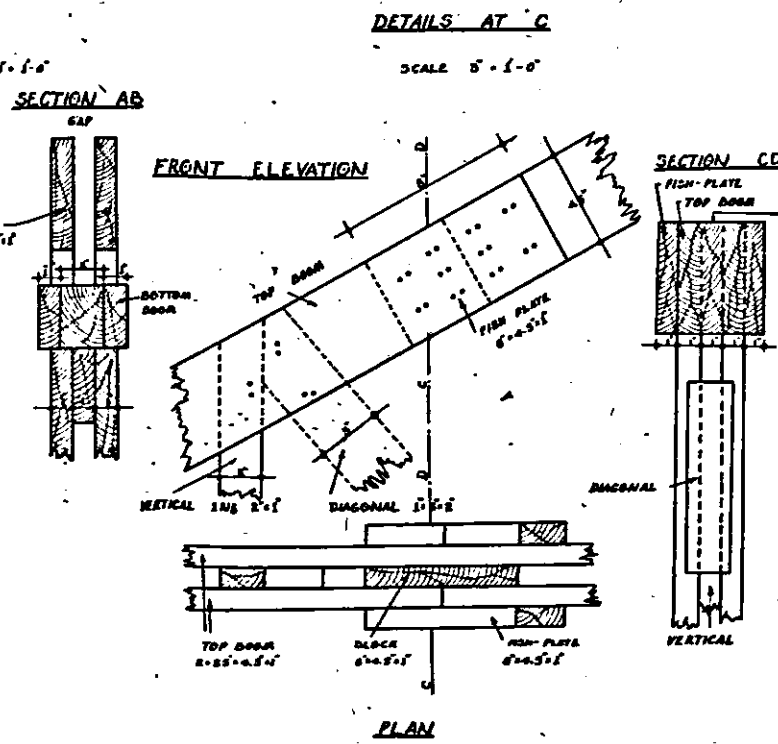
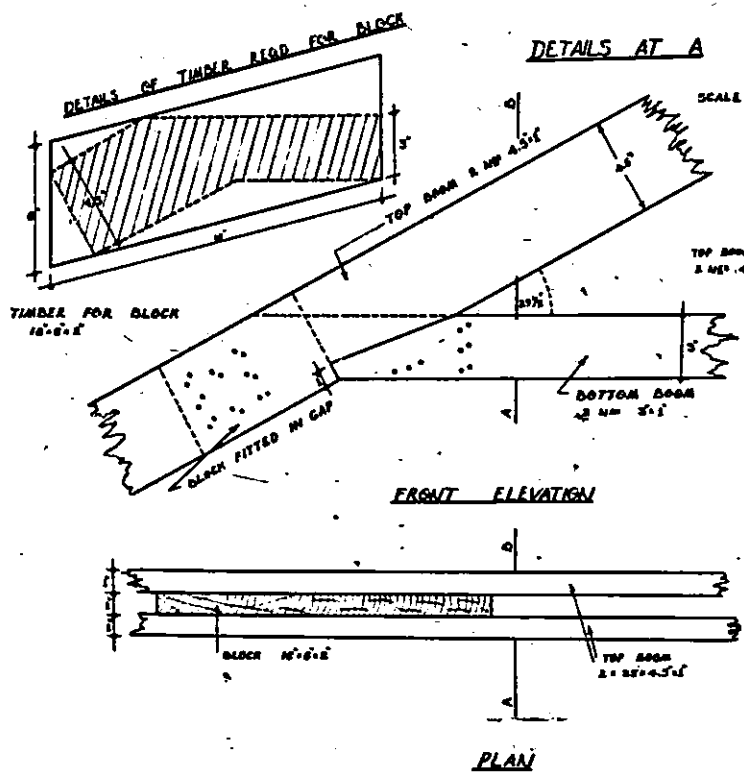
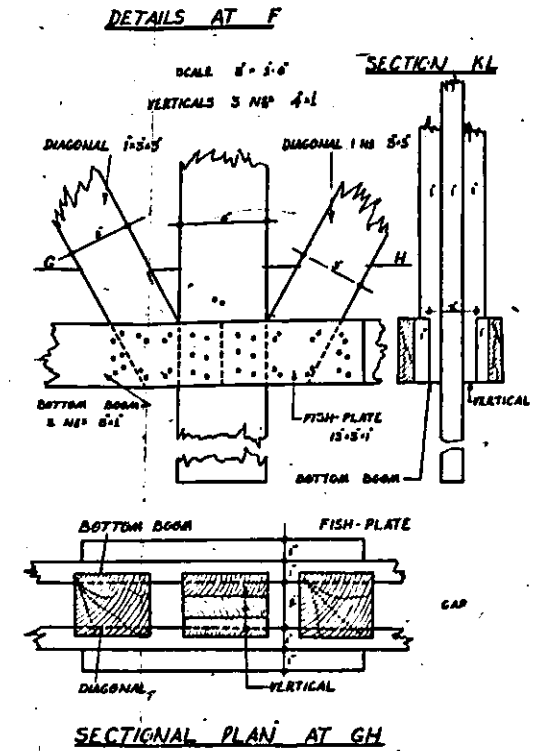
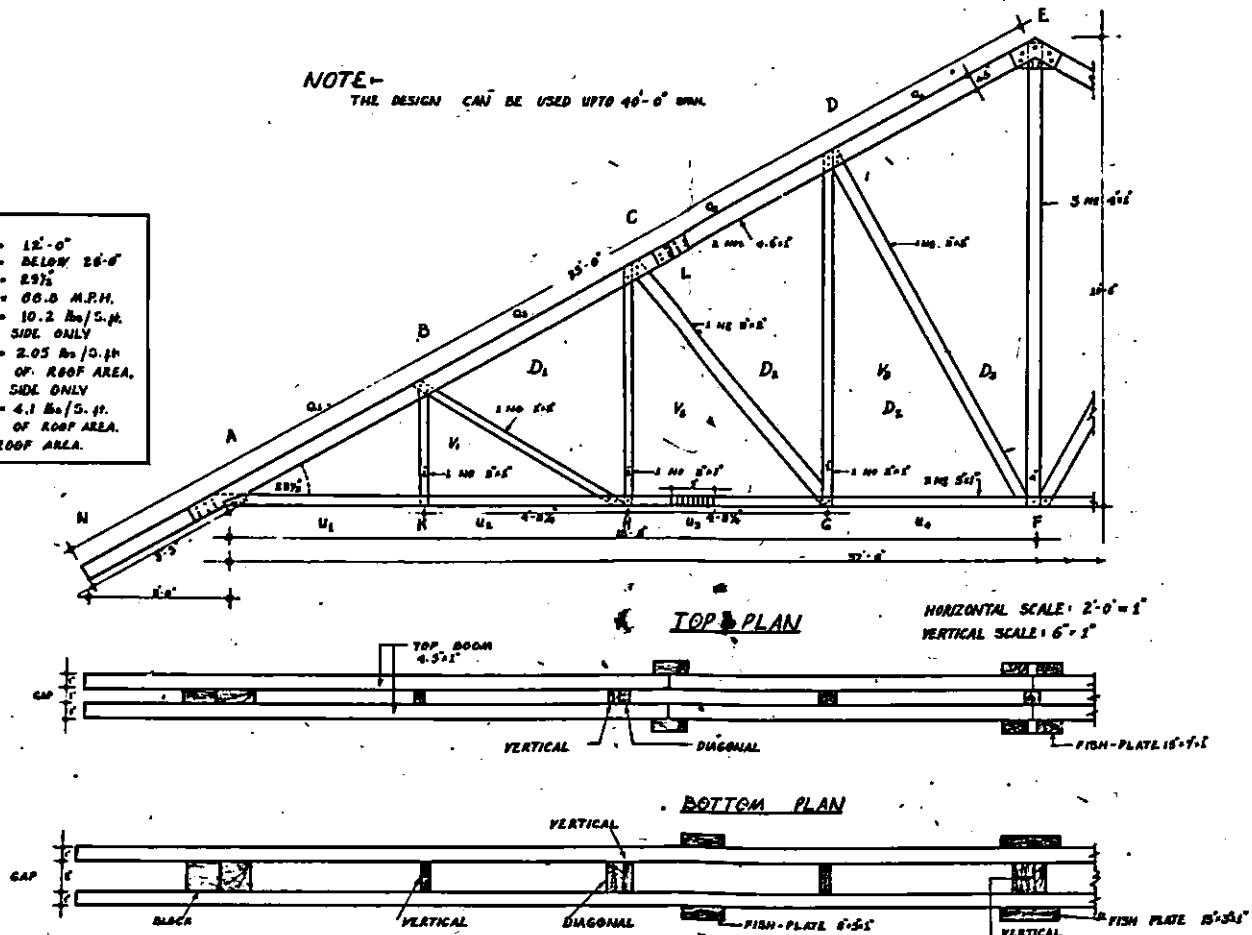

NOTE-
THIS IS NOT A WORKING DRAWING

INDICATIVE SKETCH
PLATE NR III

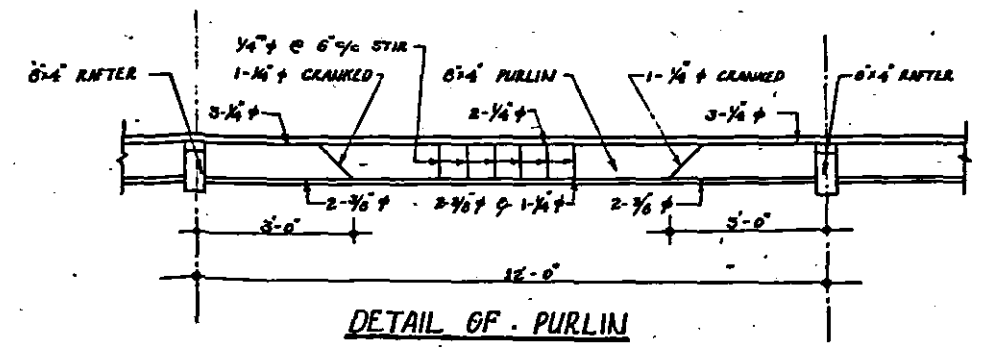
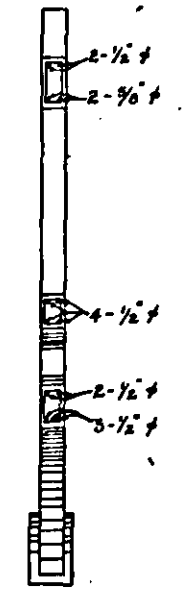
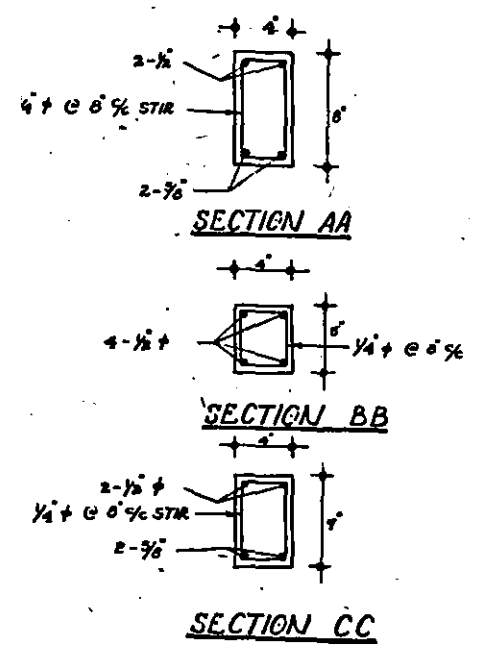
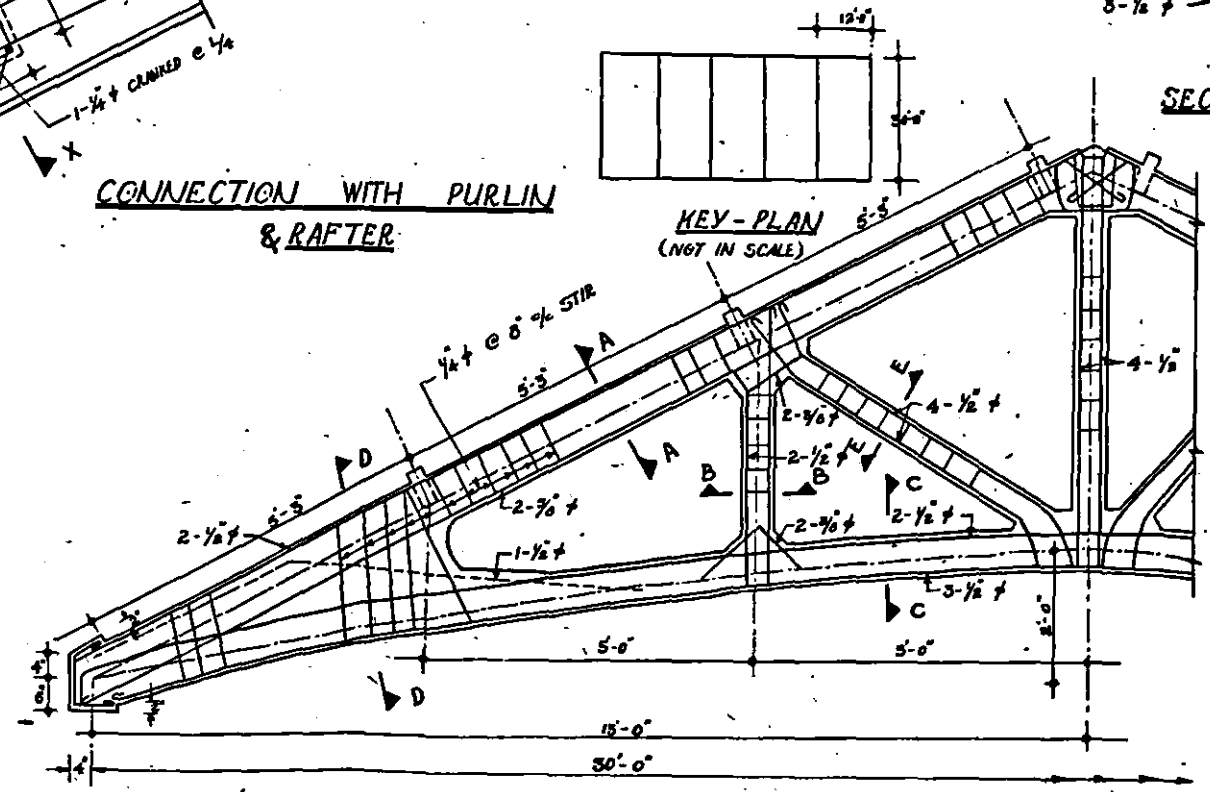
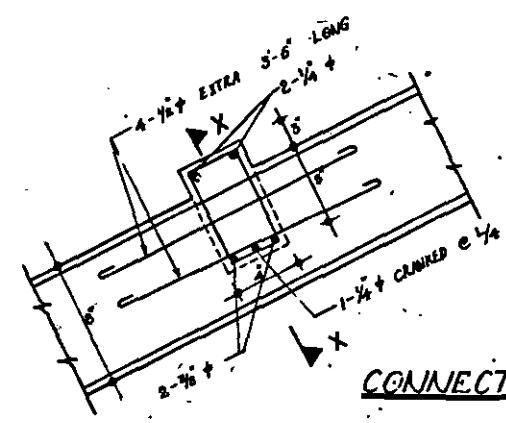
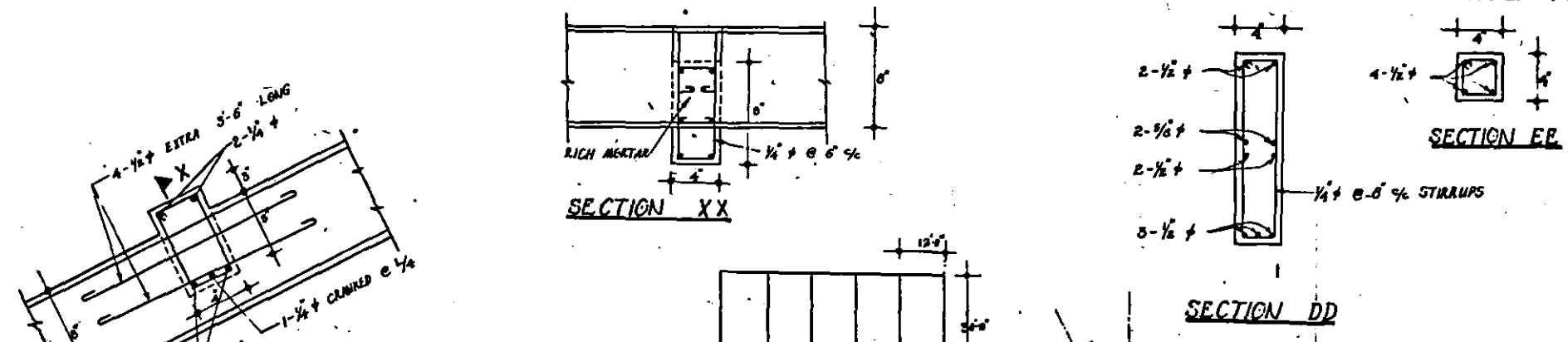

NOTE:-
 STEEL STRESS 18,000 P.S.I.
 CONC. STRESS IN PRECAST ELEMENT 1,000 P.S.I.
 WIND LOAD 15 lbs./S.F.T.

NOTE -
 THIS IS NOT A WORKING DRAWING.

TYPICAL DESIGN FOR 30'-0" SPAN ROOF TRUSS.

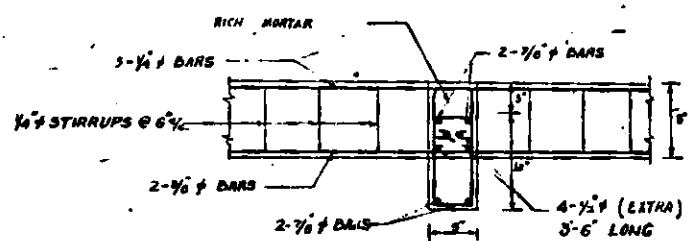

SECTION D-D
SCALE 1" = 1'-0"

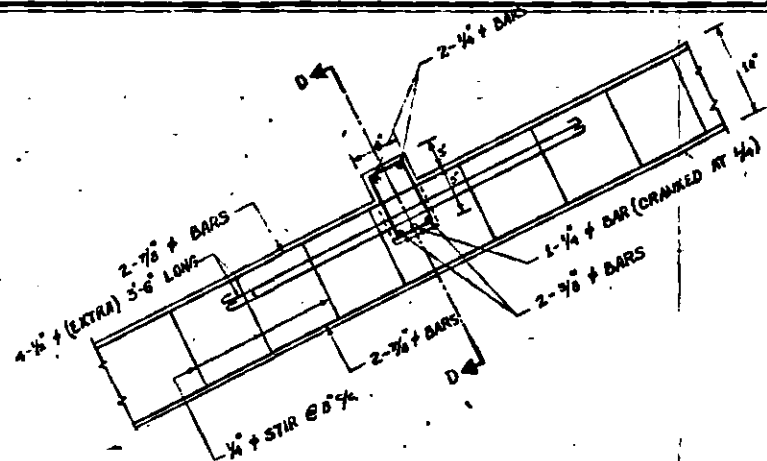

CONNECTION WITH PURLIN & RAFTER
SCALE 1" = 1'-0"

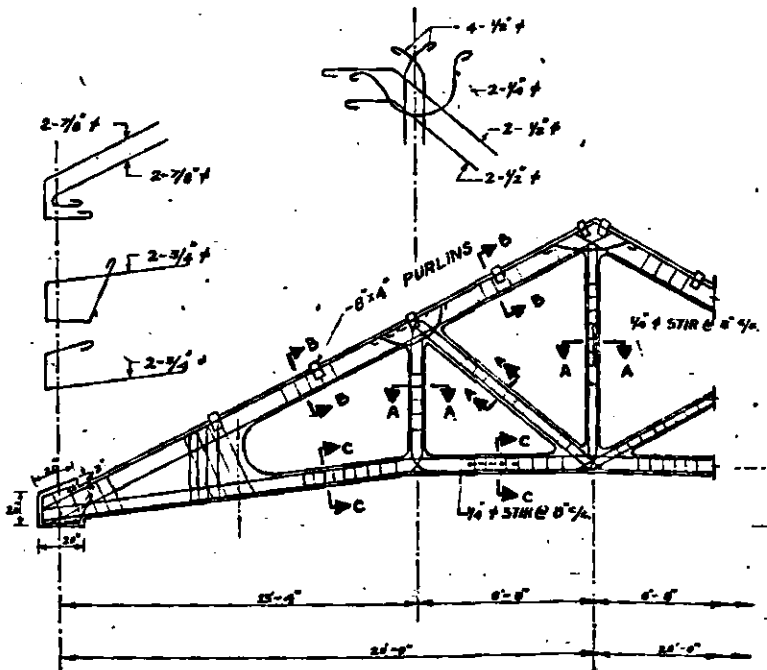

SCALE 1" = 50'



SECTION A-A
SCALE 1" = 1'-0"

SECTION B-B
SCALE 1" = 1'-0"

SECTION C-C
SCALE 1" = 1'-0"

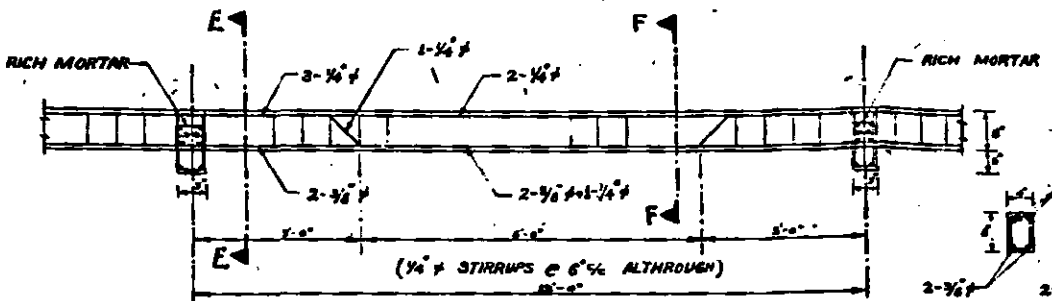

DETAILS OF PURLIN
SCALE 1/2" = 1'-0"

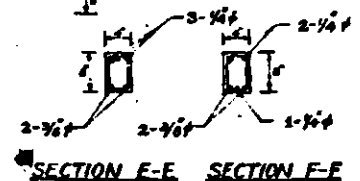

SECTION E-E SECTION F-F

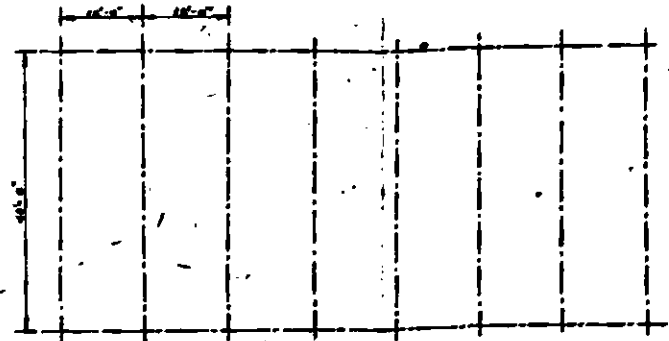

LAY-OUT PLAN
SCALE 1/16" = 1'-0"

NOTE:-
STEEL STRESS 18,000 p.s.i.
CONC. STRESS IN PRECAST ELEMENT 1,000 p.s.i.
NOTE:- THIS IS NOT A WORKING DRAWING.

TYPICAL DESIGN OF
40'-0" SPAN

SCALE - 1/32", 1/16", 1/8", 1/4", 1/2"

* CENTRAL WALL IS 15 1/2" THICK THROUGHOUT.

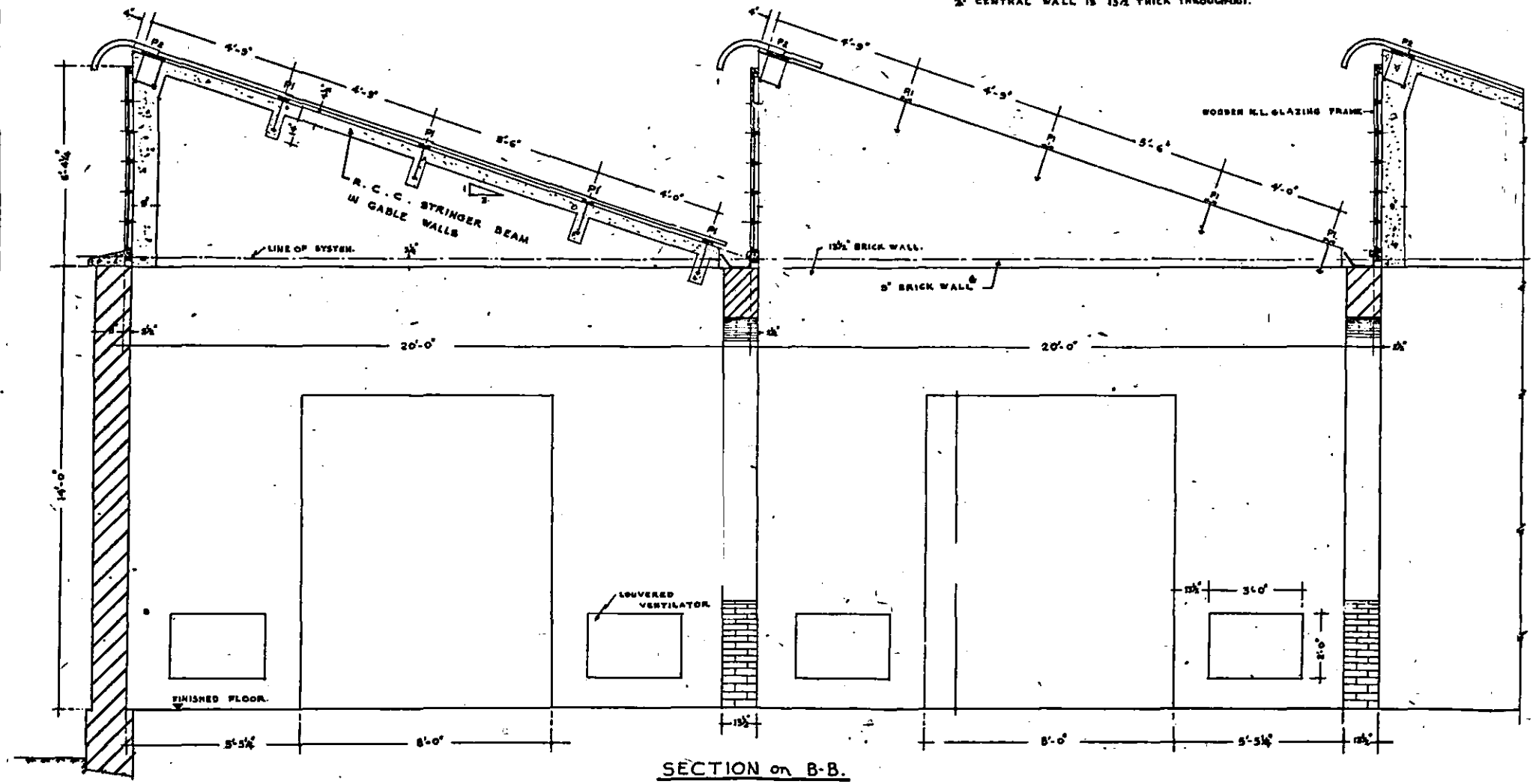

SECTION on B-B.

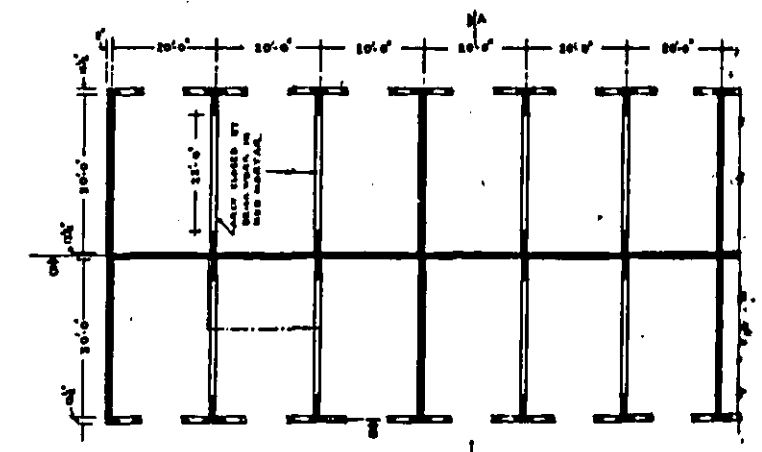

PLAN.

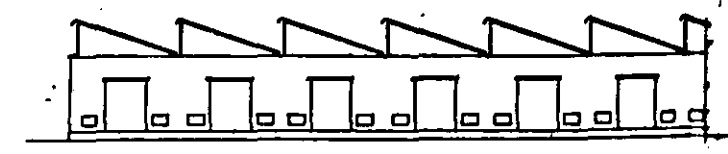

WEST ELEVATION.

WEIGHTS 6 BAYS SHED.

PURLIN P1	24 NOS @ 185 lb	= 4440.00
PURLIN P2	6 NOS @ 210 lb	= 1260.00
		TOTAL = 5700.00

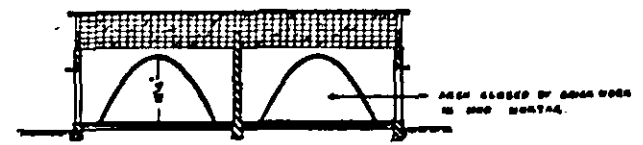

SECTION AA.

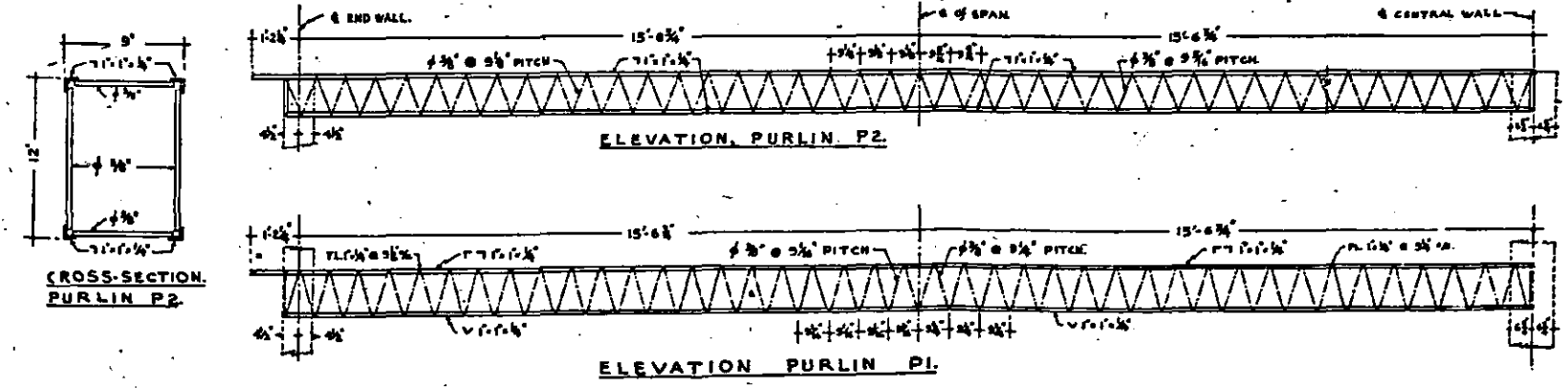

ELEVATION PURLIN P2.

ELEVATION PURLIN P1.

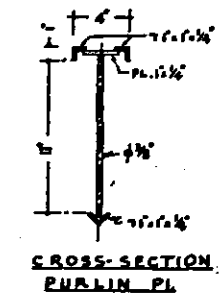

CROSS-SECTION PURLIN P1.

CROSS-SECTION PURLIN P2.

30 FT. SHED FOR LIGHT WORKSHOP OR STORE.

NOTE - THIS IS NOT A WORKING DRAWING.

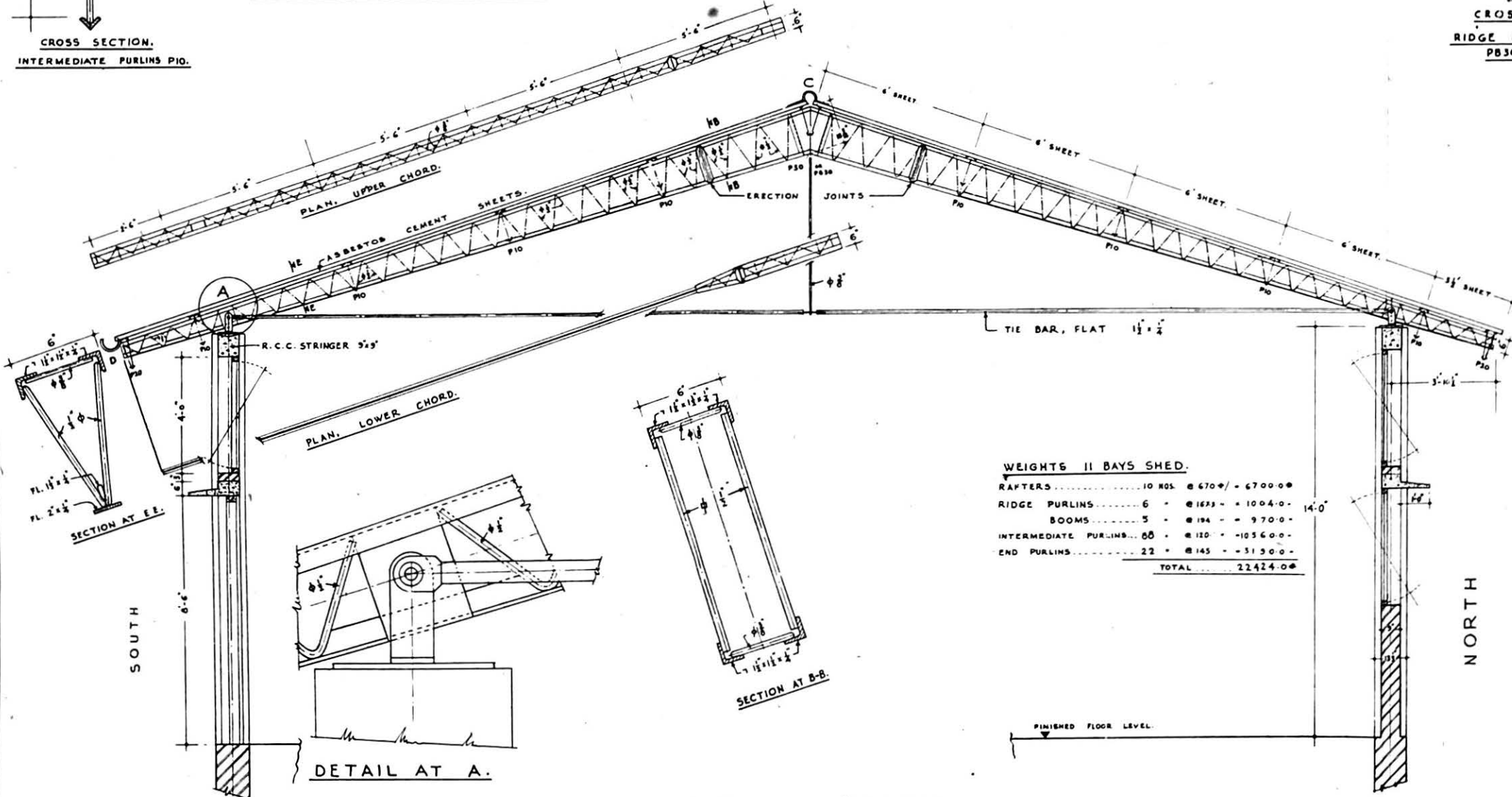
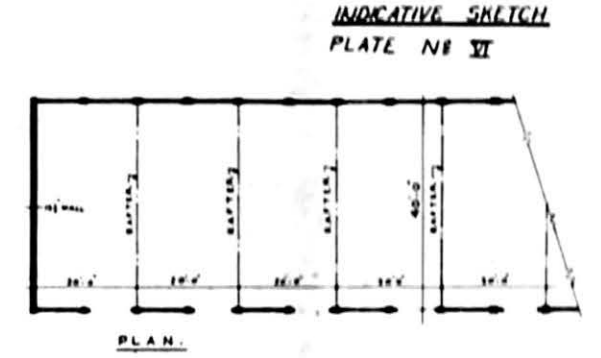
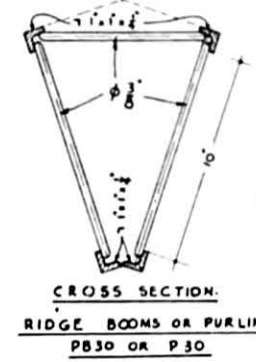
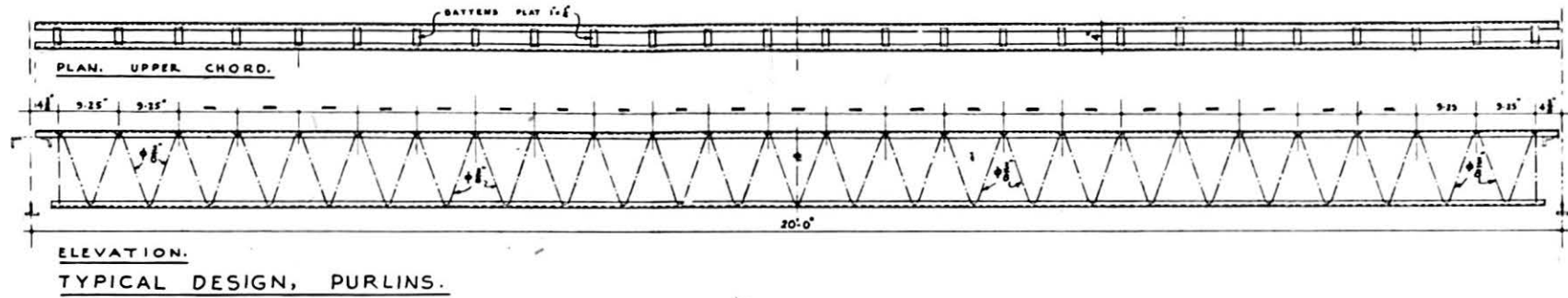
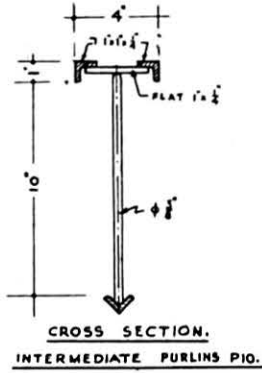

WEIGHTS II BAYS SHED.

RAFTERS	10 NOS.	@ 670.00	= 6700.00
RIDGE PURLINS	6	@ 162.00	= 1004.00
BOOMS	5	@ 194.00	= 970.00
INTERMEDIATE PURLINS	22	@ 110.00	= 2420.00
END PURLINS	22	@ 145.00	= 3190.00
TOTAL			22424.00

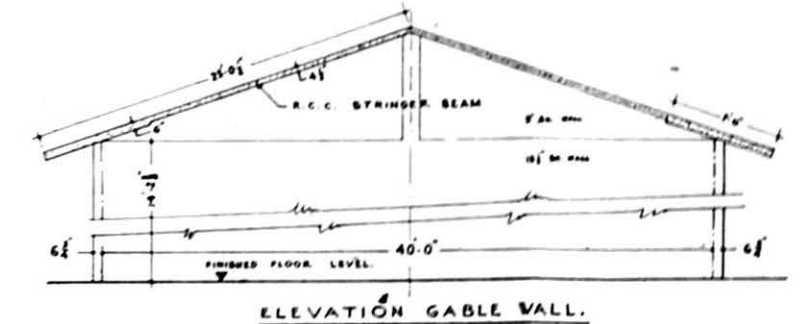
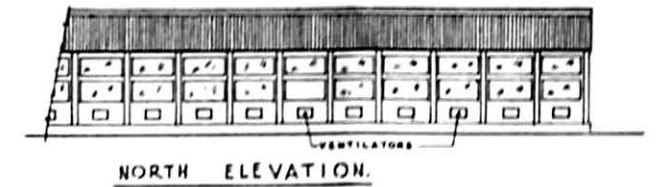
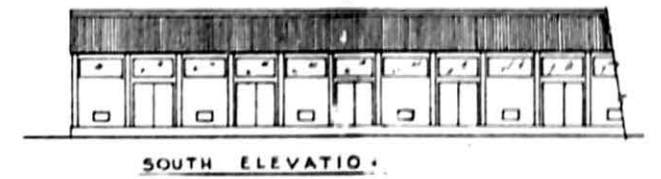

PRINCIPAL SECTION.

40 FT. SHED FOR LIGHT WORKSHOP OR STORE.
NOTE - THIS IS NOT A WORKING DRAWING.

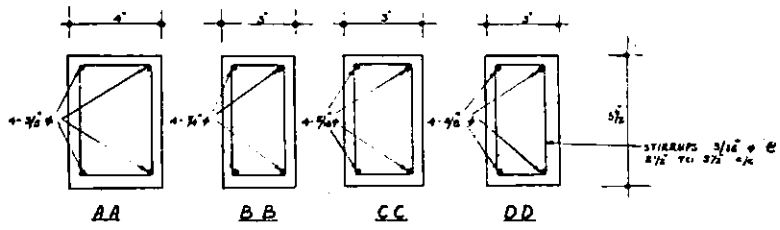

SECTIONS

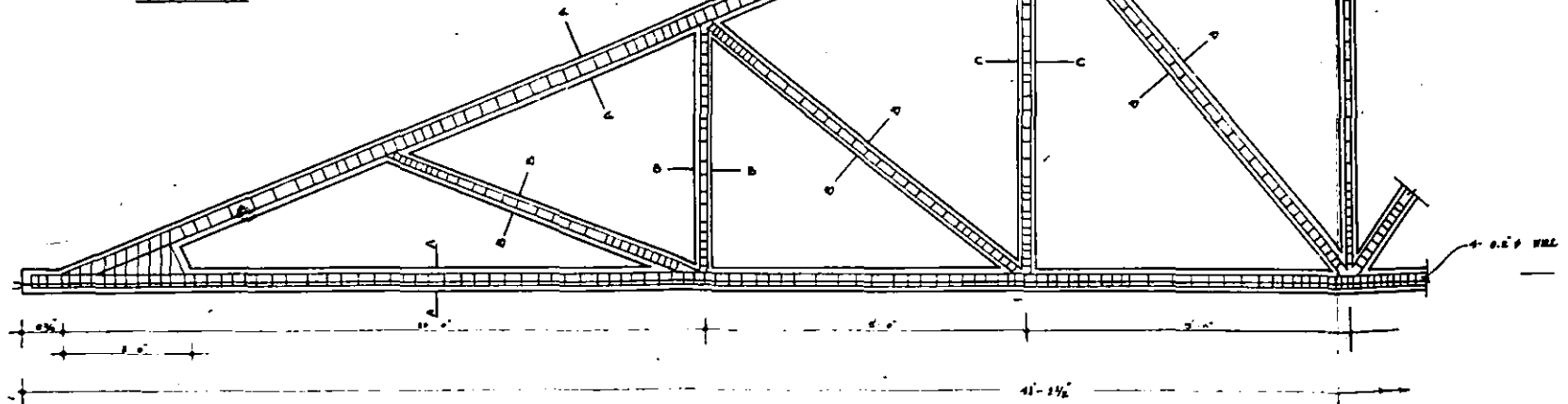

PRESTRESSED CONCRETE TRUSS

SKETCH SHOWING R.C.C. PURLIN WITH
DETAILS OF SEATING (NOT TO SCALE)

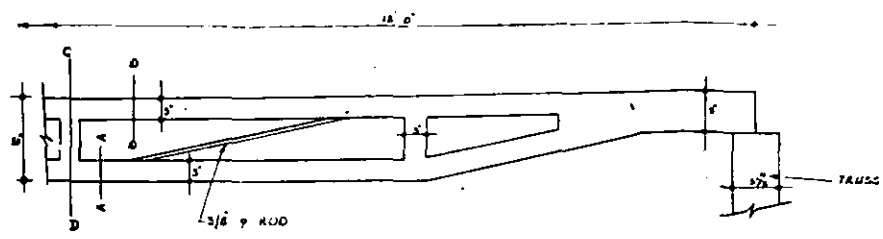

R.C.C. PURLIN

WEIGHT OF PURLIN = 250 lbs

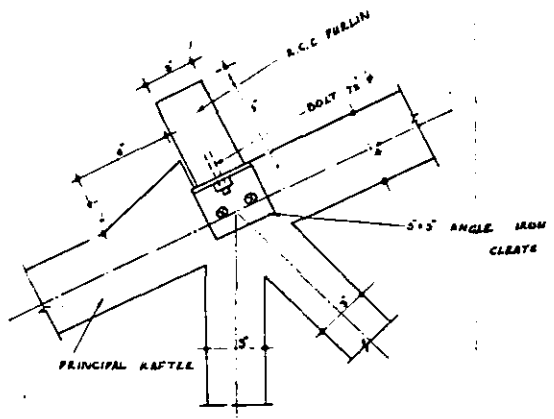

END VIEW OF PURLIN

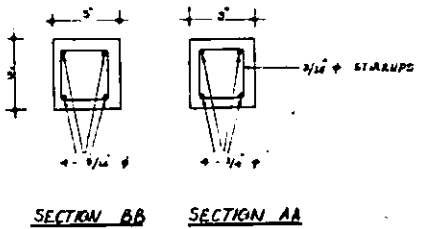

SECTION BB SECTION AA

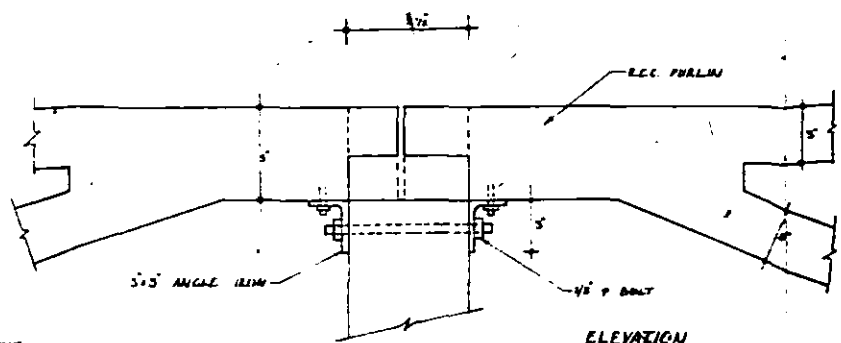

ELEVATION

NOTE-

- (1) LOADS AT NODEL POINTS 2000 lbs. WIND LOAD AS PER I.S.I. SPECIFICATIONS
- (2) STRENGTH OF CONCRETE 3000 P.S.I. AT 28 DAYS.
- (3) " " " " STEEL 18000 " "
- (4) WT OF TRUSS 20 CWT
- (5) STEEL REGR /d/ TRUSS ONLY - 62 lbs

N.T. STEEL 0.033 lbs/ft = 0.0 lbs/ft M.S. (IN COST)

NOTE-

THIS IS NOT A WORKING DRAWING.