

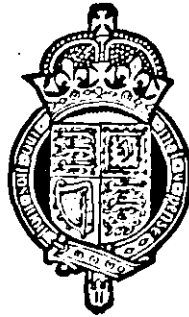
POST-WAR BUILDING STUDIES

NO. 22

FARM BUILDINGS FOR SCOTLAND

BY

A COMMITTEE APPOINTED BY THE
SECRETARY OF STATE FOR SCOTLAND



LONDON: 1946

PUBLISHED FOR THE MINISTRY OF

BY HIS MAJESTY'S STATIONERY OFFICE

THREE SHILLINGS NET

MINISTRY OF WORKS

POST-WAR BUILDING STUDIES

The series of Reports being published under the title of Post-War Building Studies owes its origin to a desire expressed by professional and other institutions connected with the building and civil engineering industries to assist and support the Ministry of Works in regard to post-war plans. During the latter part of 1941 the then Minister, in order to take advantage of these offers of assistance which he was receiving from all quarters, encouraged the establishment of a series of Committees to investigate and report on the major problems which were likely to affect peacetime building. He also offered, on behalf of the Ministry, to provide the necessary staff and organization to co-ordinate the various inquiries, in such a way as to avoid duplication of effort and to secure so far as possible uniform direction and policy.

A list of the Reports in this series is given on the back page of the cover.

The Committees were either appointed by a Government Department or convened by a professional institution, a research association or a trade federation. The one seemed most appropriate in each case; they were so constituted as to ensure that the Reports contain the considered views of experts and others closely connected with the subject. The Minister gratefully acknowledges the work of the Committees and the valuable assistance given both by the various convening bodies and by the individual members. The Reports are not official publications and it is not intended to give the impression that the Government as such is responsible for or necessarily accepts the views expressed, but their contents are authoritative and cannot but be of interest to all concerned with building.

COMMITTEE ON FARM BUILDINGS FOR SCOTLAND

TO THE RIGHT HONOURABLE JOSEPH WESTWOOD, M.P.,
SECRETARY OF STATE FOR SCOTLAND

SIR, We were appointed by your predecessor, the Rt. Hon. Thomas Johnston, M.P., on 4th August 1943, under the scheme of Post-War Building Studies promoted by the Ministry of Works, as a Committee "to consider and make recommendations regarding the layout, design, and construction of farm buildings after the war."

In interpreting our remit we have assumed it to cover the buildings required for general farming operations. Dwelling-houses have been excluded from the review as well as buildings for poultry, market gardening, and other specialized enterprises undertaken on farms.

We have held thirty-two meetings of the full Committee, and a number of additional meetings have been held by the Technical and Drafting Sub-Committees appointed in the course of our work. Our first step was to ask for the views of the leading organizations concerned with farming, and we subsequently consulted individuals and business firms on specific problems. In order to review the present stage of development of farming and farm buildings, we visited numbers of representative farms in various parts of the country, as well as farms with features of special interest. We were shown the buildings of the three Agricultural Colleges, and of the Hannah Dairy Research Institute. We give a list of the organizations consulted, and of the farms visited by the whole Committee or by groups of members, in Appendix I.

In Appendix VI a section on farm buildings extracted from the Report of the Electrical Installations Committee is reproduced. The report of the Electrical Installations Committee is published as No. 11 of this series.

In view of the conditions imposed by war, we have been unable to undertake a full review of the considerable literature on farm buildings published in technical journals, etc., in the Dominions and America. References are, however, given in footnotes to a number of useful publications relating to the subject of this Report.

Valuable assistance has been rendered by the Hannah Dairy Research Institute, which has undertaken special inquiries on ventilation at our request, and we take this opportunity of expressing our thanks to them. We also tender our thanks to the various organizations, firms, and individuals who supplied us with information and otherwise assisted us in our investigations.

We desire to place on record our warm appreciation of the great assistance which we have received from the Assessors to the Committee, Mr. C. H. Chalmers, Mr. A. G. Ingham, and Mr. John Wilson and for their valuable advice on many aspects of our investigations and in the drafting of the Report.

A Technical Sub-Committee under the Chairmanship of Mr. Ingham was appointed to prepare the plans accompanying the Report. This work made heavy demands upon Mr. Ingham and his staff, and we would like to express our appreciation of the valuable help rendered by them and particularly by Mr. D. P. Bee.

We also desire to record our thanks to Mr. W. M. Calder, who acted as Secretary of the Committee until he received an appointment on 24th May 1945, with the Allied Control Commission in Germany. The efficiency with which he summarized the voluminous evidence received by us greatly lightened our work. We also record our thanks to Mr. G. M. Simpson who has acted as Secretary to the Committee since Mr. Calder's resignation.

MEMBERS OF COMMITTEE

William C. Davidson, O.B.E., J.P., F.S.I., Deputy Chairman, Scottish Special Housing Association Limited; formerly Secretary and Factor, Barnton, Sauchie and Bannockburn Estates; and Factor to the Commissioners of Crown Lands in Stirlingshire, *Chairman*.

Charles Jamieson, Organiser, Scottish Farm Servants' Section of Transport and General Workers' Union; Member of Scottish Agricultural Wages Board; Member of Scottish Housing Advisory Committee.

Alexander Kirkpatrick, Farmer; Member of the Scottish Milk Marketing Board; Member of the Agricultural Executive Committee for Dumfriesshire; Past President of the Ayrshire Cattle Herd Book Society.

J. R. Lockie, O.B.E., B.L. (N.Z.),¹ County Clerk, Ayr County.

Major J. G. McGregor, T.D., M.R.C.V.S., Superintending Inspector, Animal Health Division of the Ministry of Agriculture and Fisheries; Member of the Board of Management of the Royal Dick Veterinary College, Edinburgh.

John Mackie, Farmer; Member of the Board of Governors of the North of Scotland College of Agriculture; Member of the Scottish Agricultural Advisory Council; Member of the Agricultural Executive Committee for Kincardineshire.

The Rt. Hon. The Earl of Mansfield, B.A. (Oxon), F.Z.S., Landowner; Member of the Agricultural Executive Committee for East Perthshire; Member of Perth County Council; formerly Member of the Board of Governors of the Edinburgh and East of Scotland College of Agriculture.

William Salmond, F.R.I.B.A., F.S.I.,⁴ Partner of the firm of Messrs. Maclaren, Soutar and Salmond, Chartered Architects and Surveyors, Dundee.

C. H. Chalmers, B.Sc. (Edin.), N.D.A.,² Chief Milk Inspector, Department of Health for Scotland; formerly Lecturer, University of Leeds.

A. G. Ingham, A.M.Inst.C.E., F.S.I.,^{2,4} Registered Architect, M.R.San.I., Chief Engineer and Surveyor, Department of Agriculture for Scotland; Assessor, Building Research Board.

John Wilson, O.B.E., F.R.I.B.A., F.R.S.E.,^{2,4} Ministry of Works; formerly Chief Architect, Department of Health for Scotland.

W. M. Calder, M.A. (Oxon),² Department of Agriculture for Scotland, *Secretary*.

G. M. Simpson, Department of Agriculture for Scotland, *Secretary*.

¹ Resigned 30th January 1945, on appointment to U.N.R.R.A.

² Assessor to the Committee.

³ Resigned 24th May 1945, on appointment to the Allied Control Commission in Germany, from which date Mr. G. M. Simpson acted as Secretary.

⁴ Member of Technical Sub-Committee.

TERMS OF REFERENCE

To consider and make recommendations regarding the layout, design, and construction of farm buildings after the war.

CONTENTS

| | PARAGRAPH |
|--|-----------|
| INTRODUCTION | 1-6 |
| SECTION I. FARM BUILDINGS IN RELATION TO ANIMAL COMFORT | |
| BASIC ASSUMPTIONS | 8 |
| CATTLE | |
| Warmth | 9 |
| Ventilation | 10 |
| HORSES | |
| Warmth and Ventilation | 11 |
| PIGS | |
| Warmth | 12 |
| Ventilation and Humidity | 13 |
| RESEARCH | |
| The Need for Research | 14 |
| Practical Experiments | 15 |
| SECTION II. MECHANIZATION, LABOUR, AND THE SIZE OF FARMS | |
| MECHANIZATION | 16-17 |
| ECONOMIC OPERATION | 18 |
| SIZE OF FARMS | 19-21 |
| ASSUMPTIONS IN PLANS AND RECOMMENDATIONS | 22-24 |
| SECTION III. PLANNING THE STEADING | |
| TOWN AND COUNTRY PLANNING | 25 |
| SITE | 26-28 |
| SAVING OF LABOUR | 29-30 |
| ADAPTATIONS AND EXTENSIONS | 31 |
| MECHANICAL CONVEYORS AND TROLLIES | 32 |
| COMPACTNESS AND SPACING | 33 |
| PREVENTION OF INFECTION | 34-35 |
| PROTECTION AGAINST VERMIN | 36-37 |
| FIRE PREVENTION | 38-42 |
| SANITARY ACCOMMODATION | 43 |
| SHELTER | 44 |
| SUNLIGHT | 45 |
| DWELLING-HOUSES | 46 |
| THE STEADING LAYOUT PLANS—(16 designs). See List of Plans, page 8 | 47-66 |
| THE AMERICAN "BARN" | 67 |

FARM BUILDINGS FOR SCOTLAND

SECTION IV. BUILDINGS FOR DAIRY, LIVESTOCK, AND ARABLE FARMING

| NOTE | PARAGRAPH |
|--|-----------|
| | 68 |
| THE DAIRY BYRE | 69 |
| Early Byres | 70 |
| First Modern Byre | 71 |
| Modern Developments | 72-73 |
| Present Practice | 74 |
| Feeding Passages | 75 |
| Multiple Byre | 76 |
| Disadvantages of the Byre | 77 |
| DESIGNS FOR BYRES | 78 |
| DESIGN FOR DOUBLE DAIRY-COW BYRE | |
| Floor | 79-80 |
| Size of Standings | 81-82 |
| Grip and Gangway | 83-85 |
| Ventilation Inlets | 86-87 |
| Ventilation Outlets | 88 |
| Lighting | 89-90 |
| Stall Divisions | 91-93 |
| Tyings | 94-95 |
| Troughs | 96 |
| Drinking Bowls | 97 |
| Other Structural Features | 98-100 |
| Water | 101 |
| DESIGN FOR SINGLE DAIRY-COW BYRE | 102-103 |
| DRY COW, CALVING, AND ISOLATION BYRES | 104 |
| FEEDING AND YOUNG STOCK BYRES | 105 |
| CATTLE COURTS | 106-107 |
| Position | 108 |
| Construction | 109 |
| Feeding | 110 |
| Watering | 111 |
| Drainage and Flooring | 112 |
| Courts for Dairy Herds | 113-118 |
| Feeding Courts | 119 |
| Breeding and Rearing Courts | 120 |
| MILKING PARLOURS AND BAILS | |
| Bail System in Scotland | 121 |
| Design of Milking Parlours | 122 |
| Structural Features | 123-125 |
| Heating | 126-127 |
| | 128 |

CONTENTS

| | PARAGRAPH |
|---------------------------------------|-----------|
| DAIRY PREMISES | 129 |
| Structural Features | 130-136 |
| COMMUNICATION BETWEEN DAIRY BUILDINGS | 137 |
| BULL PENS | 138-141 |
| ROOT AND FEED STORAGE | 142-145 |
| STABLES | 146 |
| Structural Features | 147-152 |
| Troughs, Hecks, and Bowls | 153-155 |
| Loose Boxes | 156 |
| Young Horses | 157 |
| PIGGERIES | 158-161 |
| PIGGERY PLANS | 162-167 |
| STRUCTURAL FEATURES OF PIGGERIES | |
| Walls | 168 |
| Roofs | 169 |
| Floors | 170-172 |
| Size of Pens | 173 |
| Pen Divisions | 174-176 |
| Farrowing Crate | 177 |
| Feeding Methods | 178-180 |
| Ventilation | 181 |
| Lighting | 182 |
| Water | 183 |
| Dung and Sewage Disposal | 184 |
| DUNGSTEADS | |
| Dungsteads | 185-189 |
| Carting System | 190 |

SECTION V. BUILDINGS FOR ARABLE, SHEEP FARMING, AND CROFTS

| | |
|-----------------------------|---------|
| MACHINERY AND IMPLEMENTS | 191-193 |
| BARNs, SHEDs, AND GRANARIES | 194-195 |
| SILOS | 196-198 |
| POTATO SHEDS | 199-200 |
| GRAIN-DRYING RACKS | 201-202 |
| STACKYARDS | 203 |
| BUILDINGS FOR SHEEP FARMING | 204 |
| Tanks and Dippers | 205-207 |
| Covered Pens | 208 |
| HIGHLAND CROFT BUILDINGS | 209-210 |

FARM BUILDINGS FOR SCOTLAND

SECTION VI. MATERIALS AND CONSTRUCTIONAL METHODS

| | PARAGRAPH |
|-----------------------------------|-----------|
| BUILDING STANDARDS | 211 |
| MATERIALS | 212-213 |
| ROOFS | 214-218 |
| FLOORS | 219-221 |
| PREFABRICATION | 222-223 |
| HANGARS AND CORRUGATED STEEL HUTS | 224 |

SECTION VII. SERVICES

| | |
|----------------------|---------|
| WATER | 225-232 |
| ELECTRICITY | 233-234 |
| GAS | 235 |
| DRAINAGE | 236-237 |
| Intercepting Chamber | 238 |
| Aidle Tank | 239 |
| Sedimentation Tank | 240 |
| Effluents | 241 |
| Drain Pipes | 242-244 |
| ROADS | 245-246 |
| Construction | 247 |
| Loading Ramps | 248 |

SECTION VIII. AN ADVISORY SERVICE

| | |
|------------------------------------|---------|
| TRADITIONAL SOURCES OF INFORMATION | 249-251 |
| NEW FACTORS | 252-255 |
| PRACTICAL EXPERIENCE | 256 |
| NEED FOR ADVISORY SERVICE | 257 |
| FUNCTIONS OF SERVICE | 258-259 |
| FORM OF SERVICE | 260 |

SECTION IX. RECOMMENDATIONS REGARDING THE DAIRY BYELAWS

| | |
|--------------------------------|-----|
| THE MODEL DAIRY BYELAWS | 261 |
| LOCAL VARIATIONS | 262 |
| RECOMMENDATIONS FOR AMENDMENTS | 263 |

APPENDICES

- I. ORGANIZATIONS CONSULTED AND FARMS VISITED
- II. LIST GIVING DIMENSIONS OF PRINCIPAL POWER AND HORSE-DRAWN IMPLEMENTS
- III. ECONOMIC CLASSIFICATION OF AGRICULTURAL HOLDINGS, 1927
- IV. NUMBER AND AVERAGE ACREAGES OF TYPES OF SCOTTISH FARMS, 1927
- V. NUMBER OF VARIOUS SIZES OF HOLDINGS IN SCOTLAND, 1938
- VI. EXTRACT FROM POST-WAR BUILDING STUDIES NO. 11, ELECTRICAL INSTALLATIONS

CONTENTS

ILLUSTRATIONS

| FIGURE | | PAGE |
|--------|---|------|
| 1 | Double Dairy-Cow Byre—interior perspective | 27 |
| 2 | Inlet Ventilator (downward type), Cowbed or Standing, Grip, Fireclay Trough, etc. | 28 |
| 3 | Inlet Ventilator—Baffle or Disc type | 28 |
| 4 & 5 | Details as in Figs. 2 and 3 but with Moulded Troughs | 29 |
| 6 | Alternative Methods of Floor Construction for Standings or Cowbeds | 30 |
| 7 | Quick-Release Tie Slide | 33 |
| 8 | Chain Tie | 33 |
| 9 | Chain Tie (Dutch type) | 33 |
| 10 | Yoke Tie | 33 |
| 11 | Single Dairy-Cow Byre—interior perspective | 34 |
| 12 | Lifting Gate for Cow Courts | 37 |
| 13 | Timber Yoke for Cow Courts | 37 |
| 14 | Lifting Hay Heck for Courts | 38 |
| 15 | Travelling Hay Heck for Courts | 38 |
| 16 | Milking Parlour suitable for wide building | 41 |
| 17 | Milking Parlour suitable for narrow building | 41 |
| 18 | Milking Parlour suitable for a corner in a range of buildings | 41 |
| 19 | Dairy Premises suitable for Bucket System of Mechanical Milking | 42 |
| 20 | Dairy Premises suitable for Direct Piping System of Mechanical Milking | 42 |
| 21 | Single Bull Pen and Exercise Yard | 45 |
| 22 | Single Bull Pen with Service Box and Exercise Yard | 45 |
| 23 | Double Bull Pen and Exercise Yard | 45 |
| 24 | Bull Pen with Escape Passage, Service Box, and Exercise Yard | 45 |
| 25 | Stable—interior perspective | 46 |
| 26 | Piggery with Open Runs | 49 |
| 27 | Piggery with Feeding and Dunging Passages | 51 |
| 28 | Piggery with Feeding Passage and Small Food Cooking Room, Boiler House, etc. | 51 |
| 29 | Piggery for 1000 pigs, including Breeding, Rearing, and Fattening Pens, Food Preparation Room, etc. | 52 |
| 30 | Design for inexpensive methods of Roof Construction in Piggeries | 55 |
| 31 | Design for inexpensive methods of Roof Construction in Piggeries | 55 |
| 32 | Design for inexpensive methods of Roof Construction in Piggeries | 55 |
| 33 | Pig Trough with fixed wall at front of Pen | 55 |
| 34 | Pig Trough with "flap door" forming front of Pen | 55 |
| 35 | Pig Trough with open rail front to Pen | 55 |
| 36 | Dungstead with Roof | 56 |
| 37 | Grain-Drying Rack (Richmond type) | 61 |
| 38 | Grain-Drying Rack (Dual purpose type) | 61 |

FARM BUILDINGS FOR SCOTLAND

| FIGURE | | PAGE |
|--------|--|------|
| 39 | Plan of Sheep-Dipper and Collecting Pens or Fanks | 63 |
| 40 | Design for Sheep-Dipper | 64 |
| 41 | Light-Weight Timber Roof Truss suitable for large spans and corrugated steel or asbestos cement sheets | 66 |
| 42 | Light-Weight Steel Roof Truss suitable for large spans and corrugated steel or asbestos cement sheets | 66 |
| 43 | Light-Weight Timber Roof Truss suitable for large spans and curved corrugated steel or asbestos cement sheets or felt covering | 66 |

PLANS

| PLAN | | PLANS |
|------|--|-------|
| A | Steading for Mixed Arable and Dairy Farm (Byre System) for 200 to 250 acres | 1 |
| B | Alternative for Design A adapted for the Bucket System of Mechanical Milking | 1 |
| C | Steading for Mixed Arable and Dairy Farm (Byre System) for 200 to 250 acres | 2 |
| D | Steading for Mixed Arable and Dairy Farm (Byre System) for 200 to 250 acres | 3 |
| E | Steading for Mixed Arable and Dairy Farm (Cow Court System) for 200 to 250 acres | 4 |
| F | Steading for Mixed Arable and Dairy Farm (Cow Court System) for 200 to 250 acres | 5 |
| G | Steading for Mixed Arable and Dairy Farm (Cow Court System) for 200 to 250 acres | 6 |
| H | Steading for Mixed Arable and Dairy Farm (Cow Court System) for 200 to 250 acres | 7 |
| J | Dairy Steading for 224 cows, etc. | 8 |
| K | Commercial Cattle Breeding and Feeding Farm for 200 to 250 acres | 9 |
| L | Cattle Feeding Farm for 200 to 250 acres | 10 |
| M | Steading for Mixed Arable and Dairy Farm (Byre System) for 75 acres | 11 |
| N | Steading for Mixed Arable and Dairy Farm (Cow Court System) for 75 acres | 12 |
| O | Steading for Farm of 20 to 30 acres | 13 |
| P | Steading for Farm of 20 to 30 acres | 13 |
| Q | Highland Croft Steading for 5 to 10 acres | 14 |

FARM BUILDINGS FOR SCOTLAND

A REPORT BY A COMMITTEE APPOINTED BY THE
SECRETARY OF STATE FOR SCOTLAND

INTRODUCTION

1. Our remit is "to consider and make recommendations regarding the layout, design, and construction of farm buildings after the war."
2. Throughout our investigations and in drawing up the Report we have kept in mind the fact that agriculture is the greatest single industry in the country. In reaching our conclusions we have had regard to the following main factors which will affect post-war construction, namely (a) that a very large proportion of the work will consist of the modernization of existing buildings, (b) that new buildings or ranges of buildings may have to be added to existing buildings to meet modern requirements, and (c) that in certain circumstances it may be desirable to demolish existing antiquated buildings and provide completely new ones.
3. In each case a large capital outlay will be necessary. Some of the memoranda of evidence presented to us have been concerned with the economic fortunes of the farming industry and the heavy burden of taxation imposed on it; but as these subjects are outwith our remit we content ourselves with reporting that they weigh heavily in the calculations of those concerned with farming and estate management.
4. In considering the needs of the agricultural community we have decided in preparing our layout plans to deal mainly with steadings for farms of approximately 200 to 250 acres engaged in a mixed type of husbandry, *i.e.* partly arable, partly milk production. The plans of the various "units" printed in the Report can, however, be adapted to suit almost any size of farm. (See also paragraphs 23 and 24.)
5. The plans and specifications have been prepared in such a way that they will be equally applicable whether new building or remodelling of existing buildings is contemplated. It is not intended to suggest that they represent the only solutions of the numerous problems which arise, but they should provide useful guidance as to unit requirements and general layout, and assist in solving particular problems arising from the reconstruction or rearrangement of existing buildings or from the construction of new buildings.
6. The Report has been drawn up in the light of the information available so as to provide a convenient book of reference for those concerned with farm buildings and farm and estate management.

SECTION I. FARM BUILDINGS IN RELATION TO ANIMAL HEALTH

BASIC ASSUMPTIONS

7. In the absence of adequate scientific research and practical tests under Scottish conditions, no final conclusions on the problems of ventilation and temperature in livestock buildings can be put forward. In paragraphs 14 and 15 and in Section VIII we make recommendations on the subject of research, and on the dissemination of the results obtained by research.

FARM BUILDINGS FOR SCOTLAND

8. It has, however, been necessary to proceed on certain assumptions throughout the general and specific recommendations made in Sections IV and V of the Report. These are referred to in the following paragraphs.

CATTLE

9. *Warmth.* The evidence available suggests that all types of cattle need a good supply of fresh air, but that they require only a moderate degree of warmth. The most suitable temperature in a byre is thought to be about 50° Fahr. Under North American conditions it has been noted that milk yields have not been reduced with temperatures as low as 18° Fahr. In no circumstances should it be necessary to sacrifice good ventilation in order to raise the temperature. Properly constructed buildings affording protection against wind and rain, and well ventilated, should be warm enough for the comfort of all stock. The common practice of keeping fattening bullocks in an overheated byre is probably harmful rather than beneficial. On the other hand, the practice of accustoming young stock and stores to hardy conditions is unlikely to harm them, and is probably a wise one. In certain parts of Scotland cattle have been kept in the open, but, in general, byres or wholly or partly covered courts are probably more satisfactory. It is a wise precaution to give the best possible protection compatible with good ventilation to dairy cows. When dairy cows are normally kept in a warm atmosphere, they may take harm if suddenly exposed to the cold. Thus milking parlours require some form of heating on very cold days. (See paragraph 128.)

10. *Ventilation.* Cattle should be kept in an atmosphere which feels fresh and congenial to human beings. A stuffy and humid atmosphere is not good for the animals' comfort and health. The preliminary experiments carried out by the Hannah Dairy Research Institute at the instigation of this Committee tend to show that the first essential in ventilation is for adequate provision at the ridge of the building and that, where suitable outlet ventilators have been provided, the question of the position and extent of the inlets is of relatively small importance. The experiments go to show that with an adequate ridge ventilator, air is admitted as well as discharged at the ridge and the general diffusion of fresh air is satisfactory. This was demonstrated by the uniformity in the distribution of carbon dioxide (CO₂) content of the atmosphere throughout the byres. The utmost importance is therefore attached to the provision of adequate open ridge ventilation. With the degree of ridge ventilation proposed, it would appear that there is no need for an unduly large allocation of cubic air space per animal. The designs for double byres in paragraphs 79 to 101 allow about 530 cu. ft. per animal, while the design for the single byre, in paragraphs 102 and 103, works out at about 548 cu. ft. per animal.

HORSES

11. *Warmth and Ventilation.* Such evidence as is available suggests that the best stable temperature may be in the region of 50° to 55° Fahr., or slightly higher than that for byres. General experience, however, suggests that horses, like cattle, are hardy, and little affected by cold. Ventilation should function on the same system as in a byre, but in a stable a controlled outlet is more necessary. This is because in a stable with the stall and passage dimensions and wall height necessary for comfort and convenient working, cubic space per animal will be considerably greater than in a cow byre, while the number of animals in a stable is also liable to vary more proportionately than in a byre.

PIGS

12. *Warmth.* Pigs should be kept in a warmer atmosphere than is necessary for other stock. There is good evidence that with low temperatures losses and illness occur.¹ The lowest satisfactory temperature is probably about 55° Fahr., while

¹ See *The Veterinary Record*, June 13, 1942

INTRODUCTION

the ideal range may be within the limits of 58° to 65°, and somewhat higher temperatures, if they can be combined with good ventilation, are not to be regarded as harmful. Much evidence based on practical experience suggests that it is an advantage to keep fattening pigs warm. In Scottish conditions the object should be to provide all pigs with sleeping accommodation in which their body heat will raise the temperature to something near 65°. All stock, and particularly breeding and rearing stock, may usefully be provided in addition with open runs, which contribute to general health and hardiness.

13. *Ventilation and Humidity.* With the higher temperature required in piggeries as compared with byres, it is more difficult to ensure good ventilation and moderate humidity. High temperatures attained by absence of ventilation will tend to raise the humidity of the air in the piggery to a level where it may become harmful. Under average conditions in Scotland, it should be possible to combine adequate warmth with good ventilation by ensuring (1) that the roof of the piggery is of moderate height, so that the volume of air to be heated is not too great; (2) that floor, walls, and roof are of such construction as to produce a dry and well-insulated building; (3) that the building is adequately stocked with pigs, since an under-stocked building will naturally tend to be cold. A well-stocked building of the right dimensions and construction can be ventilated by a ridge ventilator and wall inlets without reducing the temperature below the desirable level. In piggeries, some form of controllable ridge ventilation is desirable to allow for adjustments under conditions of extreme heat or cold. Any calculation of the amount of air space necessary per pig is rendered difficult by the great variation in the number of animals kept in a pen at any one time.

RESEARCH

14. *The Need for Research.* The principles of construction for satisfactory warmth and ventilation above outlined may be put forward with reasonable assurance, as justified alike by practical experience in Scotland, and by such research work as has been devoted to the subject, in the main outside the United Kingdom. The health of farm animals and the need for appropriate and economic building are, however, matters of such consequence to the farming industry that they should not be allowed to rest permanently on assumptions which have not been scientifically tested on an adequate scale. The most suitable temperature, maximum humidity, maximum air movement allowable from the point of view of draughts, etc., should be ascertained in relation to each type of animal. The systems of ventilation employed in this country and elsewhere should be tested under varying conditions as to cubic capacity per animal, outside air temperature, etc., to ascertain whether they provide the conditions requisite for good health. Particular attention should be paid to experimentation on dairy cattle and pigs. For dairy cattle, experiments must be closely related to milk yields and feeds supplied. A further field of research affecting this type of stock is a suitable material for the cowbed (see paragraphs 79 to 82). In the case of pigs inquiry is needed to show the precise conditions under which each class of stock, and particularly fattening pigs, can be most economically fed and kept.

15. *Practical experiments* in this field will have to be carried out in existing and specially constructed livestock buildings of several different types. As experiments carried out by the Hannah Dairy Research Institute have shown, a whole season may have to be devoted to a single experiment in one building to yield reliable conclusions. In order that early results may be obtained, it is suggested that the Institutes and Colleges which possess farm buildings, and others willing to co-operate, should engage on a common programme of experiments which would, so far as Scotland is concerned, be co-ordinated by the advisory body recommended in Section VIII.

FARM BUILDINGS FOR SCOTLAND

SECTION II. MECHANIZATION, LABOUR, AND THE SIZE OF FARMS

MECHANIZATION

16. The modern era of agriculture has been characterized hitherto by a steady improvement in the machinery and equipment available to farmers, and in recent years the substitution of machine-power for man-power and horse-power has taken on the character of a revolution. It is likely to increase, and spread to other and new operations. An attempt is made in the detailed recommendations to allow for the operation of some machines which are not in common use to-day but which may be widely used in the near future, and to provide for adaptability and space for such machines at those points in the steading where heavy labour is still performed by hand.

17. As examples of mechanical equipment whose use is still exceptional the combine-harvester and the manure-loader may be quoted. To allow for their employment it is recommended that field gates and doorways and access to cattle courts and dungsteads should be of adequate width and height. Appendix II shows the sizes necessary for openings to permit of the use of many of these appliances. The machines themselves may not be owned by individual farmers, for their economic operation may depend on their serving large numbers of farms. A similar type of plant is the grain drier. It has not been treated as a farm building because at the present stage of development its scale of efficient operation greatly exceeds the grain-producing capacity of any but the largest farms. Grain drying is accordingly regarded rather as a community service which will have to be provided in some form in the grain-growing areas. Other types of equipment are, however, intimately bound up with the scale of farming operation they serve. The use of mechanical milking plant, and in particular of a milking parlour, may not be economically justified where a milking herd of only a few animals is kept. Mechanical milking is, however, justified with a medium sized herd and indispensable with the largest herds. The use of a milking parlour may affect the entire layout of the steading. The dairy premises and feed stores for the largest herds are not necessarily best laid out as a larger replica of such premises on a medium sized farm. The greater degree of mechanization in moving feeds, etc., justified by the larger output may call for entirely different layout plans. As regards buildings for arable operations, the provision of space and plant for the mechanical conveyance of grain and straw, the cutting and blowing of straw, and the mixing of feeds must be planned in relation to a predetermined turnover of bulk and weight. The larger the operation the more justification will there be for mechanization. The greater the degree of mechanization the greater will be the opportunities for economic elaboration of plant which has to be housed in buildings of appropriate design. Both in the dairy farm and in the arable farm the degree of mechanization justified by the scale of the farming operations will have an important bearing on the layout plan and the design of the individual buildings comprising the steading.

ECONOMIC OPERATION

18. The problem of the economic working of the farm in regard to labour may also find a solution through the development of mechanization, which up to now has favoured the larger farm. On the dairy farm in particular the long and unbroken labour routine presents this problem in a specially acute form, and here again mechanization with the possible increase in the size of herd may prove to have advantages in that the larger farm can be worked on a system permitting leisure and off-days for the whole staff in rotation.

MECHANIZATION, LABOUR, AND THE SIZE OF FARMS

SIZE OF FARMS

19. There is little clear evidence showing an increase in the size of farms since the advent of "mechanization." In the first period of rapid farming progress in Scotland around the end of the eighteenth century there was without doubt a considerable increase in the size of the holding capable of taking full advantage of the methods then introduced. In the past hundred years this process has continued, but more gradually; and since the publication of statistics began the overall size has remained comparatively steady. There are, however, reasons for doubting whether the average for all holdings is a true reflection of the economic forces at work in shaping the pattern of the future. Land settlement policy has added to the number of small sized holdings, and the increase in the area managed as one unit has often occurred through the working of two or more farms by one occupier. While the condition of the farming industry has long been such that capital has not been forthcoming to a sufficient extent for re-equipment or development, the tendency has probably been for the unit capable of making full use of mechanical aids to grow in size as the degree of mechanization increased.

20. It is not within our remit to make recommendations in favour of a particular size of farm, and we recognize that this question of small-scale or large-scale farming is a social as well as an agricultural one. There are, furthermore, many arguments founded on farming efficiency in favour of the small farm, particularly the small family dairy farm. Our aim in reviewing probable future developments is to relate our detailed recommendations to the type of buildings which may be required. The recommendations on individual buildings will in general be found applicable to any size of farm, but the requirements in regard to layout and accommodation will differ for varying sizes and types of farm.

21. We have been furnished with the latest detailed classification of Scottish farms prepared by the Department of Agriculture for Scotland. Some figures extracted from it are reproduced in Appendices III, IV, and V. These show the average size of various types of holding, and have been accepted as the most reliable indication available of the size of the present holdings. (See paragraph 24.)

ASSUMPTIONS IN PLANS AND RECOMMENDATIONS

22. It is necessary to consider carefully what size of farm—or more precisely what quantities of crops and stock in relation to particular buildings—should be assumed in designing the individual buildings and the layouts. Substantial new building may, apart from replacement of fire losses, occur in the main where capital and management are available to work a much increased area of farmland, and where the superseded steadings are no longer adequate to the task. If that were to be the main line of development, recommendations on farm buildings would rightly treat the equipment of the large farm in greatest detail. But there are contrary considerations. The majority in an industry so extensive as farming will always follow far behind the fastest advance, and even if the direction of progress were towards enlargement, the major part of the new buildings erected in the next two decades will, no doubt, consist of improvements and reconstruction of existing steadings. The Hot Springs¹ policy may also have some effect on the future. It demands intensive production, and in this country intensive production implies mixed farming. The future may therefore bring a greater variety of enterprises on the traditional size of farm rather than specialization in larger units—although the two tendencies are not contradictory. It may at any rate be assumed that the demand for increased supplies of milk on nutritional grounds will lead to the conversion to dairying of farms in areas now devoted to arable farming and feeding, and also that existing farms will require the buildings necessary for an increased use of home-grown "feeds." All farms will need more adequate accommodation for tractors and implements.

¹ See Final Act of the United Nations Conference on Food and Agriculture (cmd. 6451) 1943.

FARM BUILDINGS FOR SCOTLAND

23. In view of the many uncertainties which surround the future of farming, it is preferable not to forecast, but to relate designs in the main to the present sizes of the various types of farm. An exception to this rule is made in the layout and milking parlour design suggested for a large dairy farm. Most of the remaining layouts are related to the buildings necessary for the crops and stock which could be maintained by modern methods of working, and with certain necessary outside purchases, on the present average size of farm. In the plans of individual buildings we suggest designs which are to be regarded as typical of each class.

24. In accordance with the principle of accommodating our recommendations to the actual sizes of Scottish farms, we have suggested layout plans for steadings suitable for 200 to 250 acre farms, for larger milk producing farms, and for the smaller holdings. In view of the recommendations contained in the Report on "Land Settlement in Scotland"¹ a layout design is shown for holdings of about 75 acres, and for the common size of small holding in the region of 20 to 30 acres. For the Highland "croft" of 5 to 10 acres of arable land, buildings of a kind necessary to house the stock, implements, and crops are shown.

SECTION III. PLANNING THE STEADING

TOWN AND COUNTRY PLANNING

25. It is possible that in certain cases the large scale planning and utilization of our land may result in the rearrangement of the boundaries of agricultural land; and, should this occur, care will have to be taken by planning authorities that the siting of farm buildings is given special attention in respect of farming needs, rather than that the farms should have to be adapted to conform to town and country planning.

SITE

26. The site of farm buildings will, in most cases, be largely determined by the site of existing buildings, but where there is a freedom of choice, consideration should be given not only to agricultural convenience but to the proximity of roads, transport, water supplies, drainage facilities, and electricity. Buildings should be so situated as to permit of the most convenient access from all fields of the farm, and the chosen site need not necessarily be in a central position. The buildings should be so arranged that they are not intersected by public or private roads, and while convenient access to public roads is desirable, the site chosen should be such as to place the stock and farming operations out of reach of danger or inconvenience from public traffic. Again, if there are agricultural considerations obviously pointing to one site rather than another, proximity of water or electricity supplies, etc., to the latter should not be allowed to have an undue influence in the final decision. It may well pay in the long run to carry the services to the farm buildings rather than sacrifice any features of a site which may be of permanent value in the working of the farm.

27. Advantage should be taken of any fall in the ground surface which will facilitate drainage, and there should be sufficient space between buildings and streams for the treatment of any effluents likely to cause pollution. Apart from drainage, the slope of the ground should where practicable be utilized to permit of the formation of loading ramps, access for vehicles to upper floors, the construction of chutes permitting the tipping of turnips into sheds, and otherwise to facilitate the movement of feeds, fodder, dung, or other heavy material for the farming operations.

¹ See Report by the Land Settlement Committee (cmd. 6577) 1945.

PLANNING THE STEADING

28. Choice of site as well as layout of buildings should have regard to the normal weather conditions. Where practicable the site should be sheltered from the prevailing winds and should slope southwards, so as to secure the greatest amount of sunshine. Sites which are cold, foggy, or damp as a result of their position or because of the nature of the subsoil should be avoided.

SAVING OF LABOUR

29. The farm buildings should be so laid out as to save and lighten labour, and reduce travelling to and fro between buildings to the smallest possible amount. In the smaller size of farm, which is less able to repay the installation of mechanical equipment, it is probable that labour efficiency can best be ensured by compactness. In the larger farm where conveyors and mechanical hoists can be used, wider spacing of the buildings is possible, and is desirable on other grounds, such as safety from fire and segregation against disease. In both types of farm buildings every effort should be made to obtain the full benefits available by working from a high level downwards to the lowest level; in other words, by exploiting the force of gravity to the utmost.

30. Compactness may best be ensured by grouping livestock buildings close to stores of feeds, hay, and straw, and compact designs of this kind based on a minimum handling after the threshing operation are suggested in the layout plans. Storage of hay, cake, and grain on a floor above ground level can be adopted in many cases and will tend to ease the distribution of feeds. As an example of what can be done in this direction, reference is made in paragraph 67 to the compactness and use of gravity in the American "barn" type of farm building.

ADAPTATIONS AND EXTENSIONS

31. In view of the constant changes in the methods and type of farming occurring on the mixed farms of this country, the original layout should be planned to allow for adaptations and extensions. Buildings for the threshing and storage of grain crops, and for the storage of roots and potatoes, are generally designed for the probable cropping practice of the particular farm, and are likely to require little alteration so long as the size of the farm, the machinery, and the rotation of cropping remain unchanged. Livestock buildings, however, may have to be extended to cope with large additions of stock fed perhaps on bought-in feeds. The original byre, courts, piggeries, etc., will probably be grouped around feed and straw stores or milking parlours, with a view to easy working, and it is evident that extensions can be most conveniently worked if they are added to, or adjoin, the original building and are not erected on a new site remote from the necessary facilities. Livestock buildings should, therefore, be so placed in relation to other buildings as to allow of extensions to existing buildings. Implement sheds, workshops, and tractor sheds should be capable of extension or addition. In erecting new buildings adaptability to changing uses should be planned for whenever possible, although less provision can be made for this in the case of livestock buildings, which are generally suited to a specific purpose. Storage buildings for crops, implements, and fertilizers should, however, be adaptable to general use. Entrances should be wide and high; the inside should not be obstructed by supports, and internal partitions should be readily movable.

MECHANICAL CONVEYORS AND TROLLIES

32. The design of buildings likely to be served by mechanical conveyors requires special consideration. In particular, adequate support must be provided to carry the weight and stresses set up by overhead conveyors. Entrances leading to dunging passages and feeding passages, and the passages themselves, should have sufficient breadth to admit trollies, and there should be no steps or obstructions to prevent their use.

FARM BUILDINGS FOR SCOTLAND .

COMPACTNESS AND SPACING

33. The layout suggested by the need for adaptability and safety from fire and disease is somewhat in conflict with that required for economy in building and operation. The decision as to which principles should be followed must depend on the type and scale of farming. In the case of large steadings with sufficient mechanical equipment, particularly on arable farms, there is much to be said in favour of adequate spacing, but for smaller steadings of all types the arguments in favour of building compactly weigh more heavily.

PREVENTION OF INFECTION

34. On all farm steadings and, in particular, on dairy farms, the livestock buildings should be laid out so as to minimize as far as possible the risk of the spread of disease. On dairy farms, poultry should be kept in segregated units, and not in and about the farm buildings; the dairy stock should be kept in enclosures to which pigs, poultry, and other stock have no access.

35. Land used for soakaways, rubbish dumps, etc., should be as far removed from the farm buildings as practicable, and should be properly fenced round. All stagnant water, or ponds, etc., from which cattle might drink water they have fouled, should be fenced off.

PROTECTION AGAINST VERMIN

36. The prevalence of vermin in and about farm buildings is the cause of direct and serious loss to the farmer through the consumption of foodstuffs. Infestation by rats also causes indirect loss by the disturbance of stock and the spreading of disease. Farm buildings, therefore, should be built and managed so as to reduce rat infestation to a minimum. Granaries and feed stores in particular should be built for their complete exclusion.

37. When new buildings are planned, care should be taken to clear the site of rats. The main precautions that can be taken to prevent their entry into buildings, and to prevent their free movement through a range, are the following:

- a. Floors and walls should be of solid construction, without cracks or crevices at junctions or corners.
- b. As rats burrow as much as 18 in. below ground level to gain access to a building, care should be taken that where floors are not rat-proof the foundations of walls are at least that depth below the ground surface.
- c. Doors should be close fitting, and have thresholds of hard material and a metal bound strip at the bottom.
- d. Any windows or readily accessible ventilators permanently left open should be protected by $\frac{1}{2}$ in. mesh screens.
- e. Wallheads should be solidly beamfilled.
- f. Inlets to the drains should be protected by grids with openings not exceeding $\frac{1}{2}$ in. square. These may be made to lift or hinge at the top for cleaning purposes.
- g. Where walls or floors are pierced for the entry of pipes, etc., the holes should be solidly filled in again.
- h. Trap doors into granaries on upper floors should be close fitting and metal bound.
- i. Holes for hoist ropes should leave no room for entry of vermin. A short metal tube (slightly larger than the thickness of the rope) fixed in the floor is a great help in this direction.
- j. Roof ventilators should be protected by $\frac{1}{2}$ in. wire mesh netting, since rats can climb a smooth 8 ft. wall and over a rhone.

PLANNING THE STEADING

FIRE PREVENTION

38. Experience has shown that the most prevalent cause of fires is the throwing down of unextinguished cigarette ends and matches, and these causes, as well as the danger of fire from backfire in oil and petrol engines and sparks from chimneys, go to emphasize the general nature of the risk and the need for planning to minimize fire-spread once an outbreak has occurred. The general use of properly installed plant and lighting systems using electricity helps to reduce fire risk.

39. Oil and petrol engines and boilers with stores of liquid and solid fuel should be placed in isolated buildings, or separated from other premises by solid and incombustible walls and floors. The roofs of such premises should be constructed of incombustible material. Tanks for fuel (such as petrol and paraffin) should be underground and preferably not inside buildings. The fuel should be obtained for use by suitably closed pumps with flexible hose to deliver into the fuel tanks of the vehicles. No smoking or naked lights should be allowed near by when filling of tanks is in progress, particularly where filling is done from cans.

40. Fire-resisting building materials will generally help to arrest the spread of a fire, but they do not normally survive a large and sustained fire. The best precaution to take in construction is the introduction of frequent firebreaks. When firebreaks cannot be provided by the construction of isolated buildings, the next best thing in helping to prevent the spread of fire is the construction of parapet or division walls carried through the roofs. These should be at least 1 ft. 6 in. above roof level, and preferably 3 ft. Where buildings are in compact blocks or in a continuous range, particular care should be taken to isolate the hay and straw sheds with dividing walls, and to keep the livestock buildings as far away from the hay and straw as convenient. Quick-release ties for stock are an advantage in case of fire. Implement and tractor sheds, garages, and workshops should be isolated from other buildings where practicable. In large buildings there should, if possible, be alternative exits.

41. In many of the layout plans firebreaks are not provided at all points where they are suggested in the above sections. The danger of fire on the one hand, and economy in building and operation on the other, have to be balanced against each other in deciding for or against firebreaks.

42. Careful attention should be paid to the provision of proper fire-fighting equipment and facilities. In this connection the farm water supply should be taken into account. It is a common experience to find that the pipes leading water to a farm steading may be sufficient in size to deliver an adequate supply of water for normal use, but quite inadequate to supply water at the rate required for fire extinguishing purposes. Accordingly too much reliance should not be placed on hydrants attached to mains, and reserves of static water should be maintained where practicable in milldams and other ponds. Chemical extinguishers are effective provided they are conveniently placed in sufficient numbers and are maintained in working order and applied in the early stages of the fire. Too much importance cannot be attached to the necessity for testing and inspecting the apparatus at least once a year. Chemical extinguishers normally exhaust themselves in two minutes; hence the need for promptness in application and sufficiency in numbers.

SANITARY ACCOMMODATION

43. There is a general lack of sanitary accommodation in the farm buildings, and it is considered that w.c.s. should be provided. Cloakroom accommodation is also justified, and provision for this on smaller farms may be made in the form of a vestibule or lobby leading to the w.c. apartment. Where practicable, wash-hand basins should also be provided, and in dairy or other farms where there is a boiler and means of providing a hot water circulation, a drying room where the workers can hang up their clothes is of advantage.

FARM BUILDINGS FOR SCOTLAND

SHELTER

44. Shelter from the wind adds much to the comfort of workers and stock, particularly on the upland and hill farms, and should be provided wherever practicable. The layout of the farm buildings should be designed to give shelter from the prevailing wind. A continuous range of buildings, such as Dutch barns or implement sheds, may be built along the windward side. It is a distinct advantage if this range has an unbroken wall facing outwards and the remaining buildings can be grouped behind its protection. Piggeries should not be incorporated in the range on the windward side. In windswept areas the protection afforded by a suitably placed strip of plantation is of considerable benefit.

SUNLIGHT

45. The steading should have the greatest possible amount of sunlight on all livestock buildings, and particularly on the housing for young cattle. This can perhaps best be ensured by building an east-to-west range with wings projecting to the south. Special considerations apply in the case of piggeries. (See paragraph 182.)

DWELLING-HOUSES

46. The steading should stand apart from all dwelling-houses, and be as far removed as is compatible with efficient supervision. Access to the dwelling-houses should not be through the steading. It may not be possible to give effect to these principles unless a new dwelling or steading is being erected or major reconstructions are being carried out.

THE STEADING LAYOUT PLANS

47. The layout plans which follow have been designed to illustrate the recommendations on layout contained in the preceding sections. Alternative ideas are shown to meet the necessities of a variety of cases.

48. The layout plans are arranged to facilitate the working of the farms by giving the maximum cover and comfort to both man and animals. At the same time economy in labour has been sought after by arranging the layout on the principle of the "manufacturers' assembly line," where one process leads to another till the final article is produced, and there is a minimum of overlapping and retracing of steps. The plans are so designed as to facilitate their extension and adaptation if occasion arises, and they make provision for safety from fire, shelter from prevailing winds, and the best use of sunlight. They may in some features appear to be uneconomic, but they have been designed to ensure the convenience and comfort of workers as much as the well-being of the stock.

49. The layouts proposed make use of individual units such as a byre, stable, milking parlour, dairy unit, etc. In Sections IV and V drawings are given showing the details of these units. With this information those concerned with the erection of new buildings or the adaptation of existing buildings will be able to select the appropriate features of the various unit and layout plans and apply the ideas to their own particular situation.

50. The designs submitted are mainly applicable to mixed and dairy farms. Where stock rearing farms are concerned, the principal variation would be in the omission of the dairy premises and milking parlour where shown, and possibly in some modification in respect of the isolation premises. Piggeries should in general be sited in relation to the dungstead and should be downwind from other premises.

51. *Plan A.* (Plate 1.) This design shows accommodation based on the typical dairy byre system. Food preparation and bedding are conveniently situated in relation to the animals housed, and the work in connection with these operations can be carried out entirely under cover, except for attention to the isolation premises. The milk cows follow a circuit through the waiting stalls, thence to

PLANNING THE STEADING

the milking stalls, into the exercising yard and back to the byre. The milk room and dairy scullery are in a position convenient to the milking, and to the despatch centre. The calf and young stock byres are of similar dimensions to the dairy byre. This arrangement will permit of the doubling of the dairy herd, if a young stock byre is erected elsewhere. The steading as shown includes an implement shed, workshop, dungstead, potato store, garage, bull pen, and isolation premises, and a site is shown on which a silo might be situated. In this design firebreaks are provided between the stores of combustible materials and the buildings where the animals are housed.

52. *Plan B.* (Plate 1.) The inset marked B shows the position of the dairy premises if the bucket system of milking is adopted under Plan A.

53. *Plan C.* (Plate 2.) This is designed to give effect to the structural recommendations in as economical a manner as possible. Compactness has been achieved by placing the byres in the centre of the block and the other buildings around them. Adequate breaks are provided to isolate the principal units in the event of fire. Shelter is obtained from the range of buildings on the north and east sides. By the use of hollow walls to ventilate the inner rows the byres can be built against the root store and meal house. This lightens the labour of feeding, as does the placing of hay and straw sheds on either side of the byres. Two large loose boxes are shown as well as isolation premises and bull box with yard. Both a dungstead and a covered stance for the carting system are shown; and the hay and straw sheds on the west side are separated to provide a short passage from byres to dungstead. By placing the dairy byre on the west side, and the scullery and dairy immediately to the south, room is left for a possible extension of the dairy herd by converting the young stock byre into a dairy byre and adding a milking parlour to the existing scullery and dairy unit.

54. *Plan D.* (Plate 3.) In this design the "working side" of the farm is contained in the implement and tractor shed, workshop, and potato store, and this block lies to the north of the main block and shelters it. The span for this block is 40 ft., making for economy in construction. The main portion of the steading on the south side consists of accommodation for 40 cows and their followers, along with root and grain store and hay and straw barn with accommodation for a threshing mill. In this section roof spans are 26 ft., and the buildings are laid out in such a way that roots, hay, straw, and feed are in a central position for all stock, and can be transported to the stock in quantities by trolleys. Mucking of the main byres is done by trolley to the dungstead on the west side. There is room for a silo near the main cow byre on the east side, and space is allowed for a Dutch barn across the roadway to the east of the main barn to hold the winter supply of hay. The calving byre, calf pens and bull pens are placed so that mucking can be done by trolley to the dungstead across the road. The mill is so placed that the loads of sheaves can be drawn in and threshed under cover. To the south of these buildings are the milking parlour and dairy premises, and on either side of these the collecting pens for summer milking.

55. *Plan E.* (Plate 4.) This design gives a layout for a steading where the cow court system of housing the milk cows is adopted. Practically all operations are under cover, and the maximum use is made of party walls. The design, however, does not readily lend itself to the creation of effective firebreaks between the hay and straw sheds and the cow courts. Such breaks could be provided if the sheds were placed on the north side of the roadway, but the result of this would be to lose the advantage of having all work done under cover. The arrows on the courts and assembly pen indicate the circuit which the animals will make from courts to assembly pen, waiting stalls, milking stalls, dispersal pen, and thence to their respective courts.

56. *Plan F.* (Plate 5.) This shows a steading which is also laid out on the cow court system, and in which compactness has been achieved by placing the

FARM BUILDINGS FOR SCOTLAND

courts in the centre of the block with the other buildings around them. In this design it will be observed that the hay and straw sheds have been divided up so as to be convenient to the different courts, and it will also be noticed that the threshing mill is placed in a covered yard forming an annexe to the central roots and meal store with granary over. In this design the idea is that the grain would be elevated and conveyed to the granary, whilst straw would be blown to the respective straw sheds. In addition to the cow courts, there are provided a calving byre and calf house, loose box, stable, and isolation byre, etc., with workshop and machinery store, a court for young cattle, and a potato store. The dairy premises are separated from the cow courts and provide a milking parlour with milk room, dairy scullery, etc. There are firebreaks to isolate the principal units, and the central part of the steading is sheltered by the range of buildings on the north-east and west sides.

57. *Plan G.* (Plate 6.) This is designed for the cow court system on a mixed crop and dairy farm. The barn buildings to the east of the straw barn have an upper floor where grain and concentrates can be stored, and whence they can be fed to machines on the ground floor, and from there passed to the place of consumption. The upper floor of the turnip shed is the grain store, and it is carried across the roadway at a height of 14 ft. to meet the upper floor over the barn. The passages at the sides of the turnip shed would be flat roofed to avoid valley gutters. The roadway separating the cow courts from the milking parlour, etc., is divided by swing gates to form an assembly or collecting pen and a dispersal pen for the cows in their circuit to and from the milking parlour. The courts could be adapted as double dairy byres or as feeding byres. The steading is designed for convenient working on the assumption that modern mechanical equipment is installed.

58. *Plan H.* (Plate 7.) This layout is designed for the court system of dairying. Owing to the amount of straw required for bedding courts, barn space is very much larger than would be needed under the byre system. Two small courts are provided for keeping young cattle or dry cows. A calving byre and calving boxes are also provided and a small dungstead near by. Three spans running the whole length north and south will cover the main part of the steading. The working part to the north of the main block consists of the implement and tractor shed, workshop, and potato store; and this lies to the north of the main block and shelters it. The span for this block is 40 ft. The layout can be conveniently converted into a feeding steading by turning the calving byre and calving boxes into another court.

59. *Plan J.* (Plate 8.) This plan provides for the accommodation of a dairy herd of 224 cows and the "followers" are assumed to be housed on other premises. The layout plan, therefore, does not include the buildings which go to form an ordinary steading, it being assumed that appropriate buildings will be provided independently of the milk production unit. The plan provides for byres with appropriate premises for the storing and preparation of the feeding stuffs. There are also shown a suitable milking parlour and dairy premises, the latter being designed to include, amongst other things, a recording office, cold room, and loading bank. Attention is drawn to the position of the bull pens and the collecting and dispersal pens. The latter will permit of systematic working of the milking parlour whether the cows be tethered in the byres during the colder periods of the year or out to grass during the warmer season.

60. *Plan K.* (Plate 9.) This layout is designed for a steading suitable for a commercial cattle breeding and feeding farm of 200 to 250 acres in extent. The plan provides for 3 cattle courts accommodating altogether 51 cattle, together with a calving byre for 11 cows. The calving byre is a single row byre with calf pens behind the cows for ease in suckling. Eleven loose boxes suitable for young bulls, etc., are included, together with 2 bull pens and exercising yards. An isolation

PLANNING THE STEADING

byre and 3-stalled stable, etc., form part of the buildings. A potato store, implement shed, and workshop with Dutch barn are also included. Placed in a central situation in the main block will be found a straw and hay store with loft over and 2 stores for roots. It will be observed that a somewhat larger loft space has been provided in this design in order to allow for the greater extent of crops likely to be grown on this type of farm.

61. *Plan L*. (Plate 10.) This design is for a steading suitable for a cattle feeding farm of 200 to 250 acres in extent. The accommodation includes 7 courts, capable of accommodating about 120 animals. There are also provided a byre for 4 milk cows with milk room and dairy scullery, a 3-stalled stable with loose box, cart shed, machinery and implement store, workshop, potato store, and Dutch barn. A hay and straw shed with granary over, and root and feed stores are centrally placed to minimize labour in the distribution of food.

62. *Plan M* (Plate 11) provides steading accommodation suitable for a mixed arable and dairy farm of about 75 acres in extent. Included in the design is provision for a dairy byre for 23 cows, a young stock byre for 12 animals, a central root, hay, and straw store with granary over; the intention being in this case, that threshing and baling should be done outside. The grain would be elevated and conveyed to the granary. Dairy premises are provided in a convenient situation in relation to the dairy byre, and there are included in the design a 2-stalled stable, loose box, adequate implement and cart shed, a potato store, etc. A feature of this design is the fact that all the stock management operations can be carried out under cover.

63. *Plan N* (Plate 12) shows a layout suitable for a holding of about 75 acres where the cow court system of keeping milk cows is adopted. The design provides accommodation for 30 dairy cows in 3 courts conveniently situated in relation to the milking parlour and dairy premises. A young stock byre for 8 animals is provided with a suitable hay and straw shed and root store with granary over. There are also included in the design an implement and cart shed with potato store, dungstead; etc. In this design it will be noted that the intention is to provide for the use of baled straw, and it will be seen that in general all operations are under one roof, except the movement of the animals between the cow courts and the milking parlour.

64. *Plan O*. (Plate 13.) The design is for a small farm of 20 to 30 acres. The position of the house in relation to the operations performed on the farm by the women folk has been taken into consideration. The dairy would be placed near the domestic scullery, and easily accessible from it, so that in the event of a small boiler being installed in either apartment the maximum benefit could be obtained from it in the other. The layout is also planned to enable the feeding of the roots and concentrates to the stock to be done under cover. Accommodation for a stock of 10 to 20 cows and an equal number of followers is provided. The square formation has been chosen for compactness and shelter, the fourth side being reserved for a stack yard.

65. *Plan P* (Plate 13) is suggested as one suitable for a holding of 20 to 30 acres of arable land where it is intended to keep about 12 dairy cows and 6 young animals. A 2-stalled stable is also provided with root store, granary, hay and straw shed, and a small implement and cart shed. The buildings are compact and take the form of the letter "L," thus providing a certain amount of shelter. Stock management can be carried out under cover.

66. *Plan Q* (Plate 14) shows the layout for the accommodation required for an ordinary Highland croft holding of say 5 to 10 acres of arable land. The building is in one range and consists of a byre for say 2 cows and 2 stirks, a stable for a pony with odd stall, a cart shed and a barn or straw shed. A feature of the straw shed is the louvred panels at the front and back of the straw barn providing for a through ventilation of the barn and a ready means of drying crops in a wet

FARM BUILDINGS FOR SCOTLAND

climate. All operations can be carried out under cover, and it is intended that any milk stored would be kept in suitable premises attached to the dwelling-house. (See also paragraphs 209 and 210.)

AMERICAN "BARN" ¹

67. In discussing the layout of farm steadings, it is appropriate to mention a type of design which is very popular in the greater part of North America. This design is known as the American "barn," and consists of a two- or three-storey building. The advantage which the "barn" brings to the United States farmer lies doubtless in the fact that it is a single building which may contain, under one roof, his byre, stable, and hay and feed store. Only the ground floor walls need be of solid building material; timber can be utilized for the superstructure. The building is often recessed into a hill-slope, which provides a ready access for lorries to the first floor level where the various feeds are kept, and whence they are conveyed to the byre section by chutes. The layout is cheap and compact, and has possibilities for labour-saving in the use of gravity to move feeds into the cattle troughs. In point of fact the "barn" generally has one or more chutes serving distribution points in the byre below; but not enough to serve each trough or double stall directly from above. It is not yet clear that with this system there is any appreciable saving of labour as compared with the common custom in this country of placing feed and straw stores close to the stock buildings and on the same level. In either case, the feed or straw has to be loaded at the permanent storage point, transported to the stall and unloaded. That the problem of ventilating a livestock building with a ceiling and floors above can be solved by the provision of ducts leading to the roof would seem to be proved by the American record in animal health. The American "barn" is no doubt particularly suitable for a very cold climate, against which it protects both man and beast, but its labour-saving possibilities may be more apparent than real. It may, however, prove to have such possibilities, and experiments (possibly by one of the Research Institutes or Agricultural Colleges) should be undertaken with it in this country.

SECTION IV. BUILDINGS FOR DAIRY, LIVESTOCK, AND ARABLE FARMING

NOTE

68. *In Sections IV and V on individual buildings, a discussion on the best type of building for each purpose is followed by a detailed description of features, based on the accompanying drawings. In all particulars of design, measurement, and specification, the drawings convey the considered views of the Committee. It is not intended to suggest that the drawings represent the only possible solution of the numerous problems which arise in building steadings, and adaptations to the individual case may be necessary in all the designs suggested. The drawings and accompanying descriptions should, however, be sufficiently informative to enable those interested to proceed to the solution of their problems in accordance with up-to-date ideas on design. In many instances designs for the same building show different types of floors, air inlets, troughs, etc. It is to be understood that these are variant forms, and they are shown in the same design to avoid duplication of drawings.*

THE DAIRY BYRE

69. The first aim in housing a dairy herd should be provision of accommodation for the cows where the production of clean milk can be ensured, along with convenience of working. In addition, and no less important from the point of view of a disease free herd and good milk yields, is consideration for the comfort of

¹ See *Plans of Farm Buildings for the North Eastern States*—U.S. Department of Agriculture Miscellaneous Publications No. 278.

DAIRY, LIVESTOCK, AND ARABLE FARMING

the animals. The feeding arrangements should ensure to each cow her full rations and clean drinking water. Other important objects are the conservation of the dung and urine.

EARLY BYRES

70. In the past, milk has been produced and kept in very insanitary surroundings. Milk cows, like other stock, were once housed in the same building as their peasant owners, and contributed to its heating with their body warmth. More recently they have been accommodated in byres with cobbled floors and wooden divisions of a type that is still common. Milk for the towns used to be produced by cows housed in sheds in the narrow lanes.

THE FIRST MODERN BYRE¹

71. Early in the nineteenth century William Harley of Glasgow instituted Willowbank Dairy for the production and sale of pure clean milk on a large scale. This enterprise was started in order to supply milk to the users of the public baths erected by Harley. His first byre contained 24 cows and the business continued to grow until there were 260 cows in milk and a system of distribution which covered the city. There were eventually three byres each containing stalls for 100 cows. In byre construction and layout Harley introduced ideas which have stood the test of time and have been little improved upon since his day. He accommodated his cows in the first floor of the building; this allowed the grips to be cleaned through traps in the floor which deposited the dung into carts beneath. The floor of the cow stalls was 6 inches above the level of the gangway behind, and the front half was made of composition to give ease to the forefeet of the cows, while the rear half was of hewn stone grooved to prevent slipping. The grips were 18 in. wide, 6 in. deep at the gable ends of the rows and 12 in. deep at the centre. By an ingenious system the urine of the cows was collected into a tank, separate from the dung. The value at that time of the total manure from each cow was estimated at £5 per annum. Feeding passages were provided in front of the cows; the troughs were of stone, and a wire-meshed hay heck, which could be raised by mechanical means, extended across the width of each double stall behind the troughs. This arrangement permitted feed to be placed in the troughs from the feeding passage. The windows, of which there were 30 in the roof as well as many in the walls, provided light and ventilation, and as the roof was covered with slates hung by pins on the rafters there was ample exit ventilation between the overlapping slates. It is interesting to note that there was a steam engine in use at the dairy at this early date. A threshing machine, turnip cutter, hay and straw cutter, corn bruiser, and churning apparatus were operated by it. The whole establishment was heated by steam pipes and there was an abundance of hot water. The stock contained in the Harleian Dairy was composed of cattle of the Ayrshire breed. Willowbank Dairy attained considerable fame. In 1814 a delegation from the Highland Society reported favourably on it and it attracted visits from foreigners, among them the Grand Duke Nicholas, afterwards Emperor of Russia.

MODERN DEVELOPMENTS

72. The twentieth century has seen two main developments. Social hygiene has altered the whole approach to the problem of providing clean and wholesome food for the population, and in the farming industry it is perhaps on milk that the greatest efforts have been concentrated. In the second place, the practice of establishing byres and dairies within the densely built-up areas of cities and towns has for a variety of reasons been abandoned, and the milk is produced in the agricultural areas.

¹ See *The Harleian System*, 1829, by William Harley.

FARM BUILDINGS FOR SCOTLAND

73 The regulations issued by Local Authorities on the lines of the *Model Dairy Byelaws* of 1926 (cf. paragraph 262) govern in great measure the detailed design and construction of existing dairy byres in Scotland.

PRESENT PRACTICE¹

74. Where new dairy byres have been constructed in recent years they have for the most part been double byres, usually without head feeding passage, the cows standing with heads to the outside walls. Single byres are usual where the herd is a small one, and where reconstructions have been effected within the narrow compass of the older type of steading. Head feeding passages are not common, neither are byres with cows standing with heads to a central feeding passage. The two-storey "barn" of the U.S.A. is unknown here, and the byre with more than two rows of cows is very infrequent. Nevertheless, besides the almost universal use of the two-storey "barn" the U.S.A. provides many examples of four rows of cows, and head feeding passages are the rule rather than the exception. Double byres are built in America with central feeding passage and two manure passages, an indication of the importance attached to head feeding, since this method implies that ease of distribution of feed is as important as the removal of dung. The record of the United States in the production of clean milk proves that these constructional features are no handicap.

FEEDING PASSAGES

75. American experience with the feeding passage speaks in its favour; but either the dislike of cattlemen, the extra structural cost, or some other factor has militated against its installation in Scotland. Where they have been installed they have all too frequently been used for purposes for which they were not intended—to the detriment of ventilation and cleanliness. It is evident that in a large byre with the cows on high standings feeding from the gangway is difficult. A saving in labour can be effected by enabling feed to be distributed without the worker having to enter each stall separately across the grip, yet many large byres recently erected lack this facility. The reason is that so far no completely satisfactory form of barrier between the cows and the feeding passage has been evolved. If the barrier is too high and too dense, if it consists of solid walls or closely spaced bars, it interferes with the operation of distributing feed from the passage. If the bars are widely spaced, too low or too far back, the cow can stand far forward and foul her stall. No form of tethering commonly used here solves the problem: probably the best for use with a feeding passage is a fixed vertical chain in the centre of the stall with the tethering chain sliding on it by rings.

THE MULTIPLE BYRE

76. As has been mentioned above, byres with more than two rows of animals are not common in Scotland. Their chief merit is that they reduce the distance the worker has to cover in distributing feeds from a single store servicing the byre, and it is clear that this advantage can only be of real consequence where the herd is a very large one, and the worker would have to travel considerable distances to and fro to reach the farthest stalls. Even with herds of up to 80 cows, working efficiency is as high if the feeds and straw are introduced at the centre of a long double byre, as it would be if the cows were arranged in four rows and the feeds and straw introduced at one end. The same principle applies where, as in the American "barn," the feeds and straw are stored above the animals. The greater the numbers, the greater the saving that can be effected by compactness.

DISADVANTAGES OF THE BYRE

77. The modern dairy byre, as used with variations in most countries of advanced

¹ See *Transactions* of the Highland and Agricultural Society of Scotland, 1922, "Construction of Dairy Byres," by Charles Douglas, C.B., D.Sc.

DAIRY, LIVESTOCK, AND ARABLE FARMING

agricultural development, serves as an arrangement under which cows can be kept clean, and fed and watered in hygienic conditions. There are, however, many reasons for questioning whether it is in all respects the best housing for the herd. With its cow-beds, stall divisions, troughs, and grips,¹ it is an expensive building to construct. The cleaning of the grips is a heavy task, even with mechanical aids, as is also the distribution of feeds, despite the saving which can be effected by a feeding passage. Urine is generally wasted: there are a few byres in Scotland with two-way switches on the grip to divert urine into an aidle tank, but even where these are installed their proper use is far from general. The stalls of a byre are generally designed in length and breadth for one size of cow, and a change of breed may result in the dimensions being unsatisfactory. A problem still to be solved is the nature of the cow-bed: as yet no material has been found for this purpose which is at once resistant to wear, warm, and resilient enough for comfort. Bruised hocks, and udder troubles also, are believed to be largely due to the cold concrete cow-bed surface generally in use. The Hannah Dairy Research Institute and the Animal Diseases Research Association are engaged on experiments on this problem, and promising results have been achieved, but the new surfacing materials have still to face the test of general use.² An alternative method of accommodating the dairy herd is considered in paragraphs 113 to 118.

DESIGNS FOR BYRES

78. The drawings show sections of different types of byres, and include byres with one row and with two rows of cows. From the evidence submitted to us it appears that the general opinion in Scotland does not favour head feeding, and the designs provide only for feeding from the gangway. If it be desired to provide for head feeding, it is a simple matter in designing a new byre to increase the width so as to include the necessary passages, each of which should be about 4 ft. 6 in. wide.

DESIGN FOR DOUBLE DAIRY-COW BYRE (FIG. I)

FLOOR (Figs. 1, 2, 4, and 6)

79. The floor is laid on a foundation of broken stone, and a bituminous damp-proof course is laid on the bottoming for the whole length of the standings. One set of standings is shown paved with brick grouted in cement, another with the standings formed with hollow brick blocks which, in turn, are covered with a layer of fine granolithic concrete $1\frac{1}{2}$ in. thick. A slope of 3 in. for the standing is recommended.

80. Where the standing is finished with granolithic, the surface should be brought to a regular grade with a plasterer's wood float. Just before the initial set of the cement takes place, the concrete should be "bounced" with a hard brush in order to produce a non-slip finish. Indented, chequered, and grooved floor surfaces are not recommended as these are more difficult to keep clean.

SIZE OF STANDINGS (Figs. 1, 2, and 4)

81. The grip is shown as being 2 ft. 9 in. wide, while the byre itself is 26 ft. in total width, and the centre gangway is 5 ft. 6 in. in width. If the byre is built to these dimensions, it will be suitable for the accommodation of medium-sized types of milk cows. If it be desired to accommodate cows of the larger breeds, the length of the standing can be increased by reducing the width of the grip a few inches, without affecting the overall dimensions of the byre. Consideration has been given to the question whether or not provision should be made by varying the lengths of the standings for cows of varying size in the same herd. On theor-

¹ Grip, greep, gripe, groop, gruiop.

² See *Scottish Journal of Agriculture*, 1933 and 1938. Articles on "Construction and Equipment of Cattle Byres," by A. B. Fowler, B.Sc., Hannah Dairy Research Institute.

FARM BUILDINGS FOR SCOTLAND

etical grounds there is something to be said for the idea, but experience has shown that there is little to be gained by making such provision.

82. If the standings in a byre are comfortable, and the length suitable to cows tethered, there should be less tendency for them to stand back into the grip. Accordingly there should be no need for heel or tail wires in a byre. The use of these contrivances is to be deprecated on hygienic grounds.

GRIP AND GANGWAY (Figs. 1, 2, and 4)

83. The grip as shown is sufficiently wide to allow of the modification indicated to meet alternative sizes of standings. The grip should be formed with a breast or step not less than 6 in. deep at the cow standing side, a cross-fall of $\frac{1}{2}$ in., and a breast or step of 1 in. to 2 in. at the gangway side. The grip should have a fall along the length of the byre of about 1 in 80 (say 1 in. to each double stall) and the byre floor should be graded to correspond. The edges of the grip should be slightly rounded (a "pencil" aris) to prevent chipping and damage to animals should they stumble, and the angles where the steps meet the bottom of the grip should be rounded (formed as a "cove") so that there are no corners where dung may lodge and not be brushed out. The grip should be brush-finished except for a width of about 4 in. next to the gangway, and this should be polished with a plasterer's steel float. Where practicable the grips should run clear from one end of the byre to the other. The formation of special urine channels within the grip, covered by chequered plates or gratings, is to be deprecated, but where the grip has to cross a gangway or passage, there is no objection to a movable chequered plate set in grooves so that the surface is flush with the gangway.

84. In double byres the gangway should have a camber of $\frac{1}{2}$ in., while in single byres, the slope of the gangway from wall to grip should also be about $\frac{1}{2}$ in. All the gangways should be surfaced with granolithic sprinkled with carborundum, or other similar material, and finished with a plasterer's wood float.

85. The liquid and washing water from the byre grips should pass by means of an opening through the wall to the outside and discharge on to the top of a trap connected to the drainage system. There should be no internal connection between the byre and the drainage system.

VENTILATION INLETS (Figs. 2, 3, 4, and 5)

86. The preliminary investigations made by the Hannah Dairy Research Institute at the instigation of the Committee show, as has been mentioned in paragraph 10, that there is some considerable doubt as to the need for air inlets as ordinarily understood so long as there is adequate provision for change of air made by roof ventilation. Notwithstanding this the provision of air inlets has been of such long standing, and the evident relish with which tethered cattle "nose" the air inlets suggest that the time is not yet ripe for the entire elimination of this adjunct of ventilation. Looked at from this point of view there would appear to be advantages in having the animals tethered so that they face outside walls, since this permits the construction of fresh air inlets giving direct communication with the outside atmosphere. There are, however, circumstances in which this method is not practicable, and in these cases fresh air can be introduced by means of ducts either specially constructed for the purpose or in the form of cavities in hollow walls. Where resort is made to the use of ducts they should be amply proportioned in relation to the number of cows to be supplied with air. No definite rule can, as yet, be laid down except to say that a small pipe 4 in. or 5 in. in diameter is not regarded as being satisfactory for this purpose, and, as regards the cavities in hollow walls, these should be at least 3 in. in width. In cases where ducts and wall cavities are used for introduction of air to the byres, they should be so constructed that it is not possible for the air to blow straight through the ducts; they should be provided with "blind ends" or "stops" so that the only

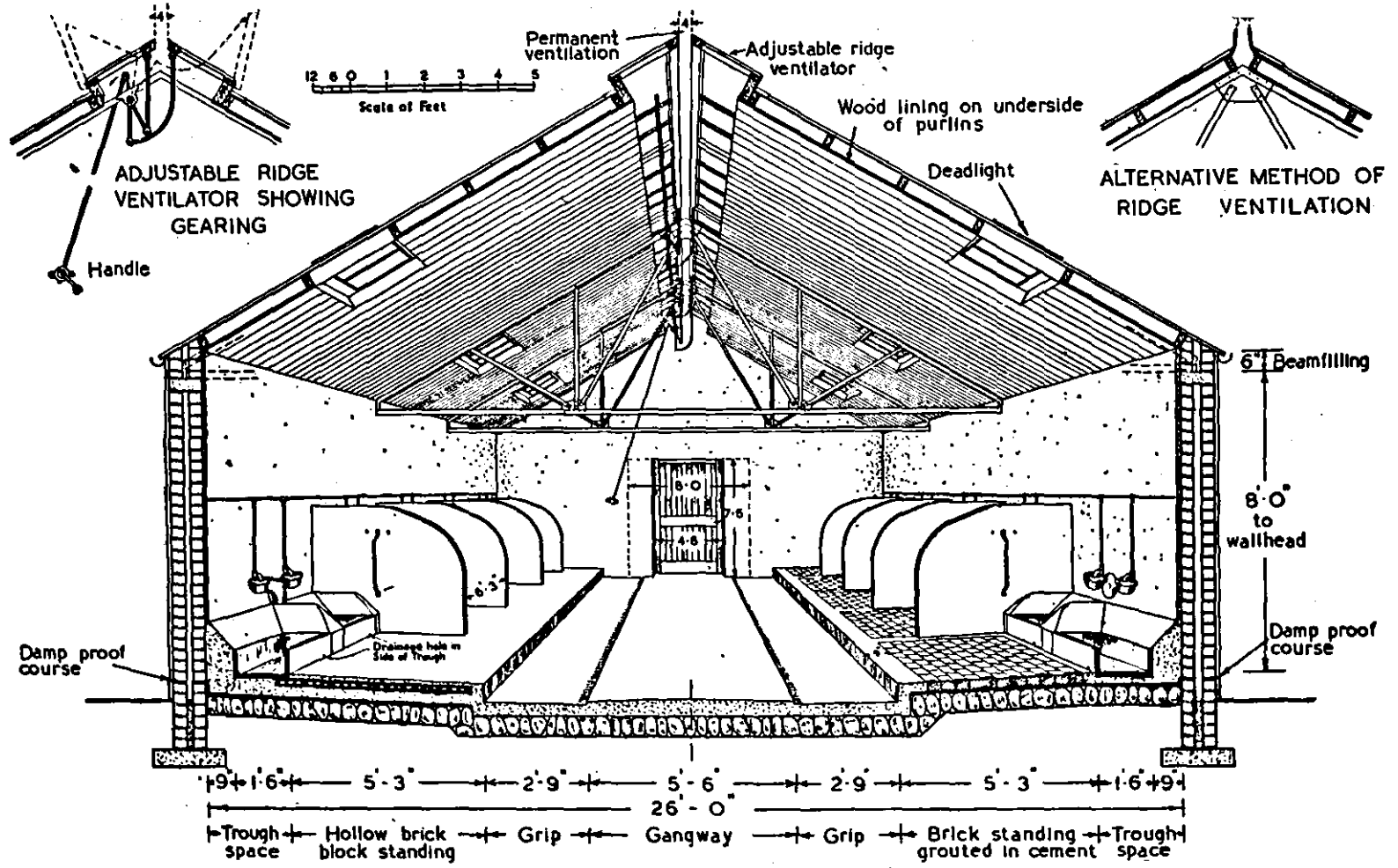
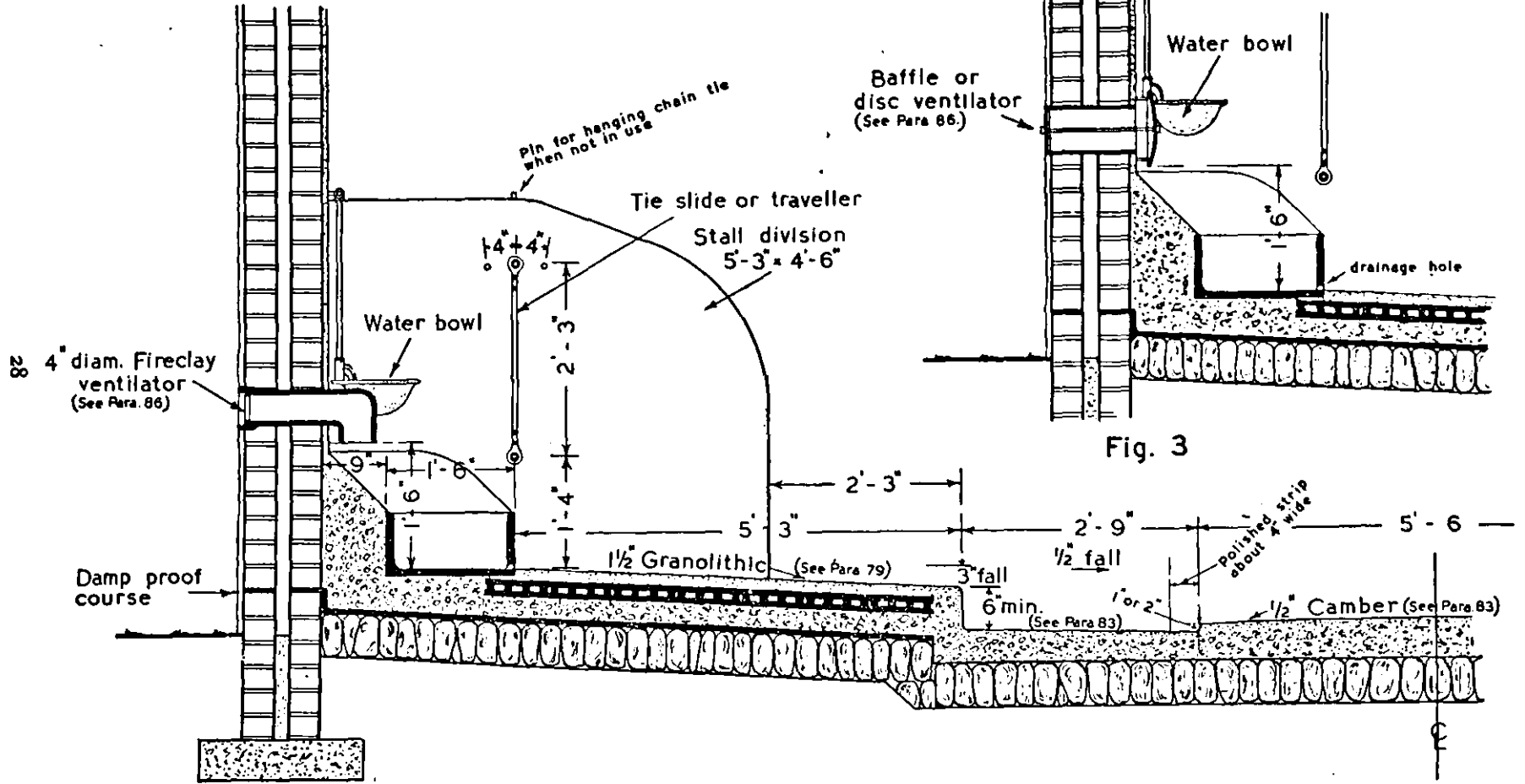
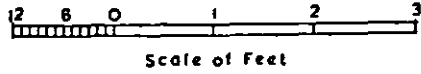


Fig. 1. Double Dairy-Cow Byre (Interior Perspective)



Baffle or disc ventilator (See Para 86.)

Water bowl

drainage hole

Fig. 3

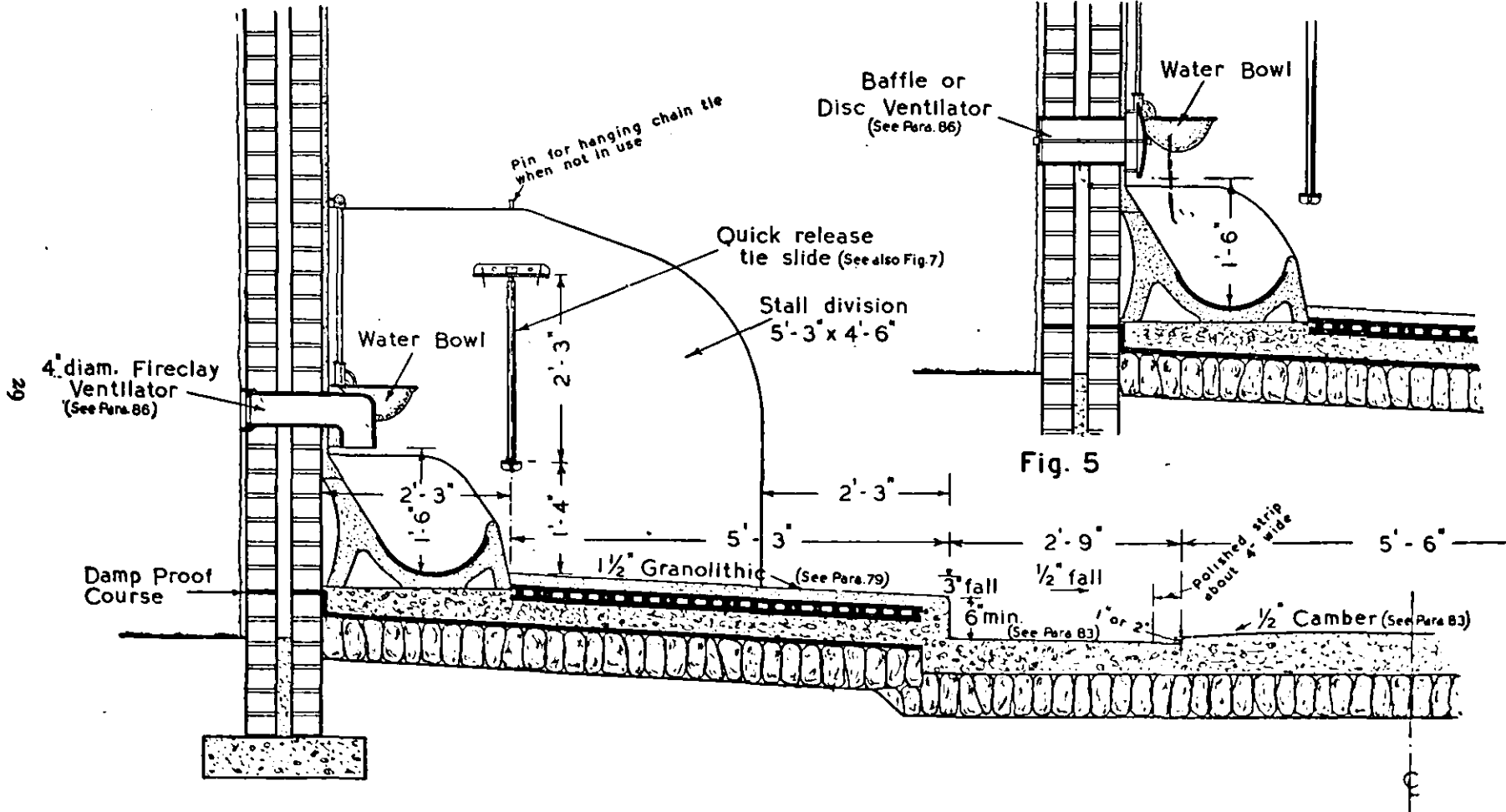
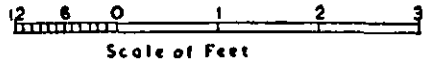


Fig. 4. Byre Details

0 1 2 3 4 5
Scale of Feet

30

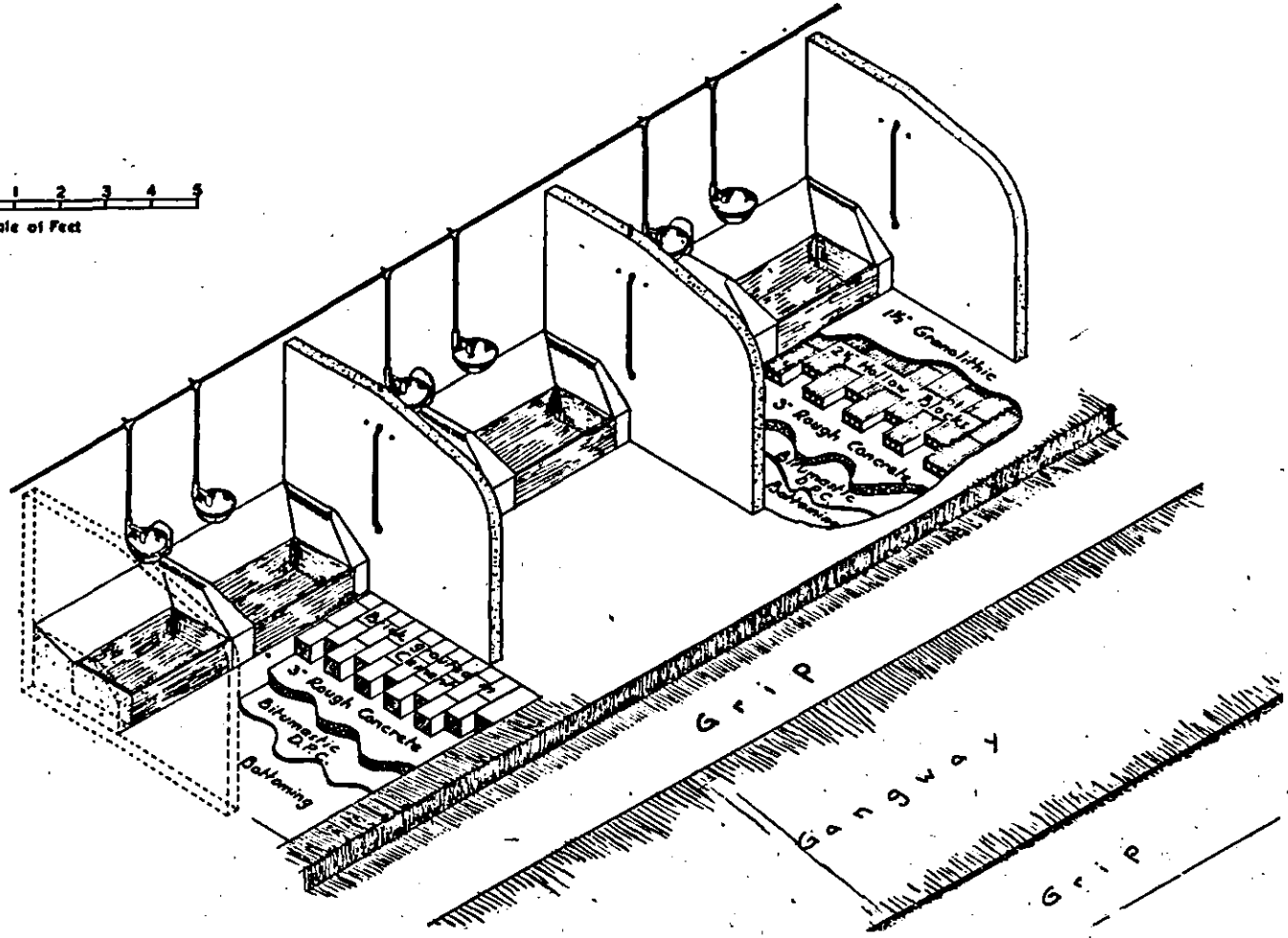


Fig. 6. Alternative Methods of Byre Floor Construction

DAIRY, LIVESTOCK, AND ARABLE FARMING

outlet for the air in the duct is by means of the air inlet into the byre. The inlets, ventilation cavities, and ducts should be provided with vermin-proof gratings.

87. The air inlets to byres should be at least 1 ft. 6 in. and not more than 4 ft. 6 in. above the level of the standing. Two different types are shown on the drawings; on the one side a 6 in. diameter "straight through" fireclay inlet pipe fitted with fireclay or galvanized baffle plate or disc; and on the other a 4 in. diameter fireclay pipe with a sharp bend.

VENTILATION OUTLETS (Figs. 1 and 11)

88. Reference has already been made to the preliminary investigations of the Hannah Dairy Research Institute into the question of outlet ventilation, and the present state of the investigations shows that under certain atmospheric conditions a 4 in. open uncovered ridge gives a sufficient degree of ventilation, but that under other conditions it is desirable to have a much wider opening, possibly as much as 10 in. or 12 in. in width and extending practically the whole length of the byre. Accordingly, in the designs for the byres shown in Figs. 1 and 11, provision has been made for opening ridge ventilators so designed that there is a permanent *uncovered* ventilation opening of at least 4 in. in width, and allowing of this being increased when required to as much as 2 ft. 9 in. in width. Various forms of gearing are on the market for the operation of this type of ventilator. As an alternative to the adjustable open ridge ventilator, there is shown a design for a permanent ridge opening at 4 in. in width, but by adjusting the position of the purlins in the roof it is quite possible to increase this opening to any width desired. There are a number of proprietary makes of open ridge ventilators obtainable, and there is a modification taking the form of the upcast roof light type of ventilator, but in regard to the latter there is, as yet, no known scientific data available as to its efficacy. These adjustable ventilators may be glazed, thereby contributing to the lighting, or they may be of suitable wood frames covered with sheet metal or wood lining leaving the natural lighting to be provided exclusively by the dead roof lights suggested for that specific purpose.

LIGHTING (Figs. 1 and 11)

89. The natural lighting of byres should be ample and so arranged as to avoid blinding or local overheating by direct rays of the sun on the animals. Adequate lighting can usually be achieved by the use of roof lights. For every cow there should be at least 3 sq. ft. of roof light suitably distributed.

90. For working during the darker periods of the year much more artificial light should be installed than is normally the case. The lights should be so arranged as to give good illumination at the rear of the cows. At least one 60 watt lamp, controlled by a waterproof switch, should be placed over the gangway for every 12 ft. length of double byre.

STALL DIVISIONS (Figs. 2 and 4)

91. The stall divisions should be of reinforced concrete $2\frac{1}{2}$ in. to 3 in. thick. The heel of the stall divisions should be 2 ft. 3 in. from the edge of the grip, and the length of the stall divisions will vary in accordance with the type of cattle for which the byre is built, and the length of the standing provided. The divisions should be about 4 ft. 6 in. in height at the head and 3 ft. 6 in. above cow-bed level at the heel of the stall.

92. In districts where flagstones or slate slabs are readily obtainable it may be found preferable to use these materials for stall divisions. Tubular divisions are also used, but the preference appears to be for solid divisions.

93. The views submitted on the clear width between stall divisions vary from 5 ft. 9 in. for the small breeds to 7 ft. for the largest. It is suggested that 6 ft. 3 in.

FARM BUILDINGS FOR SCOTLAND

clear width is the most suitable width for the Ayrshire breed, with an additional 3 in. for Friesians, and 3 in. less for Channel Island breeds.

TYINGS (Figs. 2, 4, 6, 7, 8, 9, and 10)

94. The tie slides or travellers shown are adjustable (by means of three holes in the solid stall division) in order to permit of control of the position in which the animal stands. By altering the position of the slide, the cow can be discouraged from standing in the grip, or alternatively from standing too far forward. A quick-release cow slide is shown in Fig. 7, the use of which makes it possible by withdrawing a pin to release instantly any animal that may be in difficulty or danger of strangulation. Pins are shown on the stall division for hanging up the tying chains when not in use.

95. The object of the tying is to leave the cow the greatest possible liberty of movement generally while preventing excessive backward or forward motion. No tying has yet been evolved which performs this function wholly successfully. The metal yoke tying commonly used in byres with feeding passages allows the cow considerable freedom of movement backwards and forwards. For a byre without feeding passage, in which forward movement is restricted by the wall, no tying is appreciably more effective than the common Scottish tethering to a slide on the side of the stall division. It has been mentioned in paragraph 75 that when a feeding passage is installed the most effective tying is probably a vertical chain with the tethering chain sliding on it by rings.

TROUGHS (Figs. 2, 3, 4, 5, and 6)

96. The troughs are set out from the wall and stall divisions so as to provide horn room. The bottom of the trough is shown as being level with the standing.

DRINKING BOWLS (Figs. 1, 2, 3, 4, 5, 6, and 11)

97. While many opposing views on the position of the bowl have been expressed, the weight of evidence appears to favour the view that corner bowls are undesirable, because they impede the rising of the cow and create difficulty in cleaning. Further, there is little evidence to show that single or double bowls in the centre of the stalls lead to the spread of disease. The most desirable arrangement for watering is probably two single bowls near the centre of the stall—about 10 in. or 12 in. apart. The general view on the height of the bowl is that it should be 2 ft. to 2 ft. 6 in. above cow-bed level. All bowls should have vertical levers.¹

OTHER STRUCTURAL FEATURES

98. The internal surface of all walls of the byre, wherever exposed, should be rendered smooth with an impervious material such as cement plaster.

99. In Figs. 1 and 11 two sizes are given for the width of the doorway in the end wall. The decision as to which is preferable will depend on the method by which it is intended to remove dung from the byre. In any event the door should be at least 4 ft. 6 in. wide and 7 ft. 6 in. high.

100. In Figs. 1 and 11, the walls are shown as being cavity brickwork. The roofs are supported by steel trusses, the underside being lined with "V" jointed lining, (match boarding, or flat asbestos cement sheets, are also satisfactory), with the twofold object of minimising heat loss and making it easy to keep the roof clean.

WATER

101. Water should be laid on to all byres for cleaning purposes.

¹ See footnote 2 on page 25.

12 6 0 1 2 3 4 5
Scale of feet.

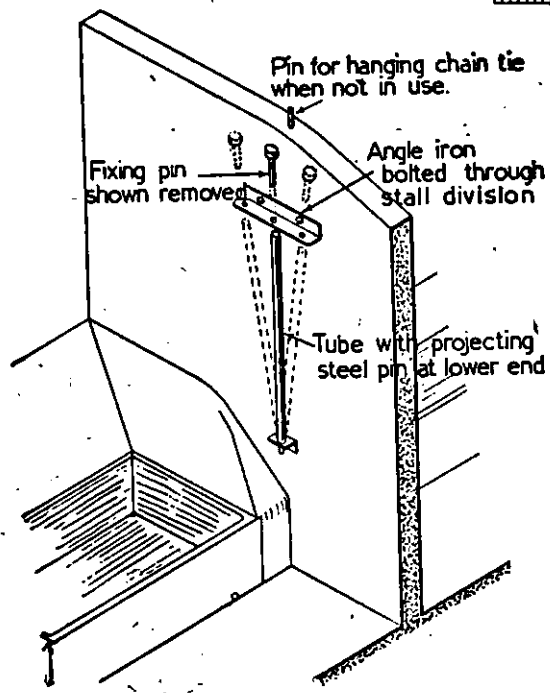


Fig. 7. Quick-Release Tie Slide

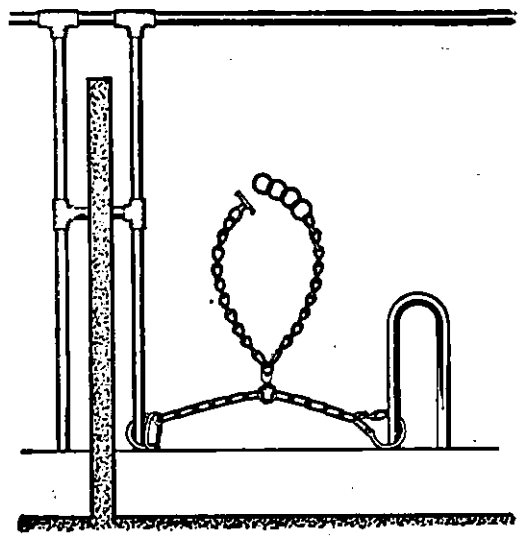


Fig. 8. Chain Tie

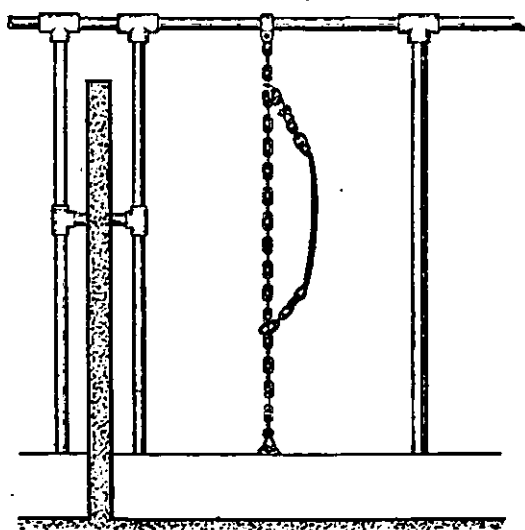


Fig. 9. Chain Tie "Dutch" Type

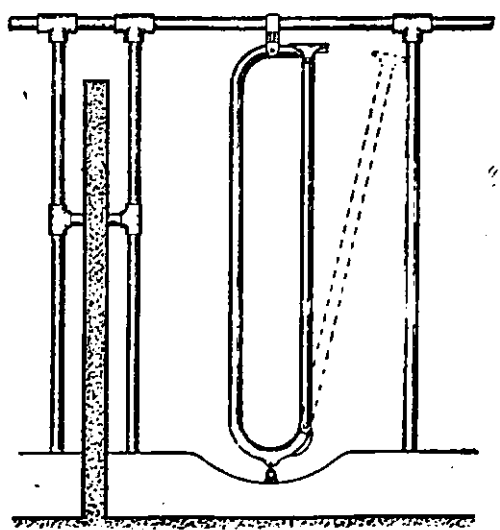


Fig. 10. Yoke Tie

CATTLE TIES

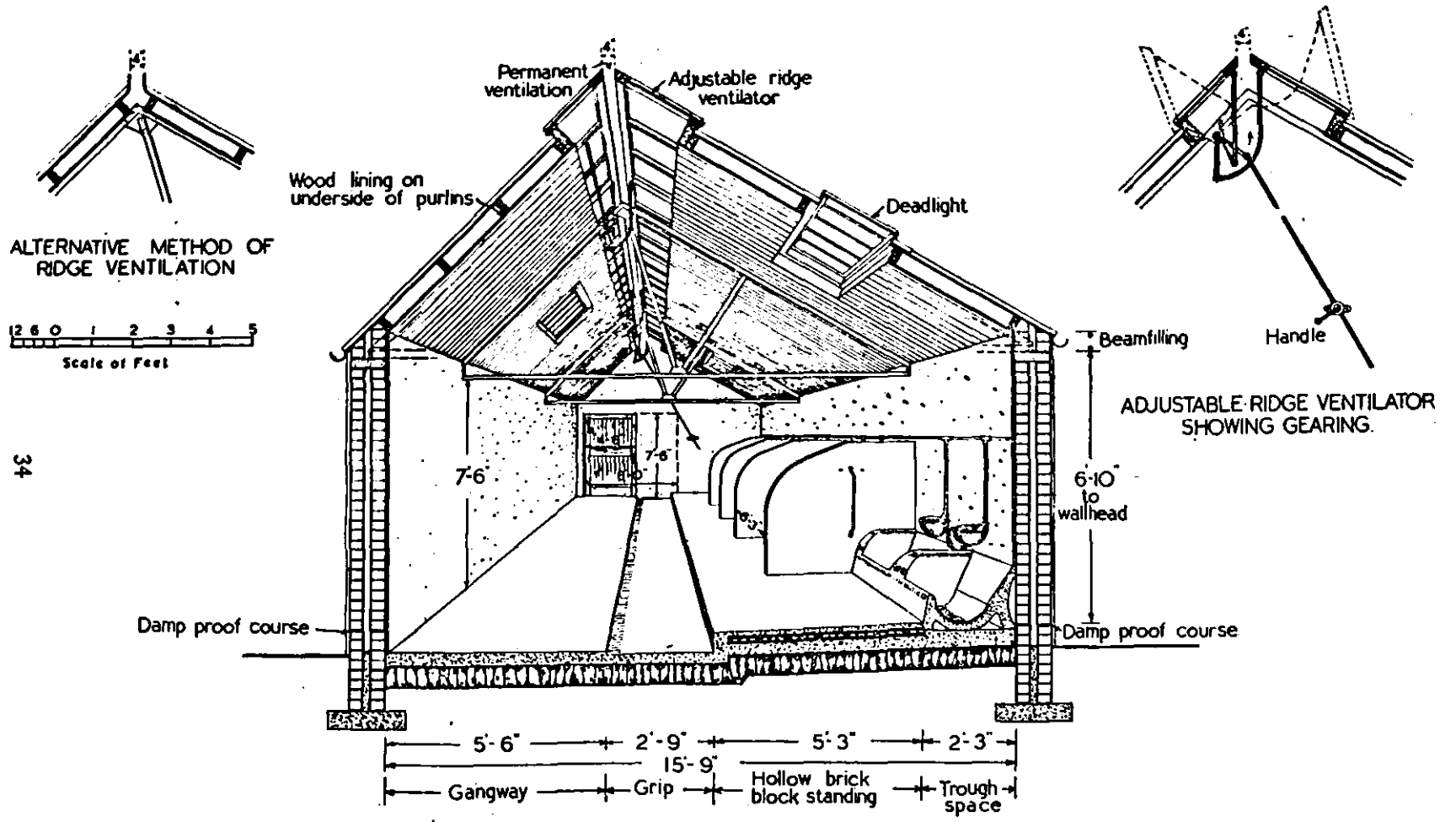


Fig. 11. Single Dairy-Cow Byre (Interior Perspective)

DAIRY, LIVESTOCK, AND ARABLE FARMING

DESIGN FOR SINGLE DAIRY-COW BYRE (FIG. 11)

102. Situations may arise in which there is not sufficient width to erect a double byre, and it is a frequent experience in altering or adapting existing buildings to find that use must be made of narrow buildings. Fig. 11 provides some suggestions to meet this contingency. The general principles as described in the double byre have been followed. The roof suggested is of the "factory" or "northern light" type with alternative designs for an open ridge ventilator. The use of this type of roof will prevent drips falling on the cows. If the ordinary coupled roof be adopted for a single byre, the best form of air outlet is the upcast ventilating roof light placed over the gangway. The design provides about 548 cubic feet of air space per cow.

103. Provision is made for the natural lighting of the byre from both sides of the roof by means of dead lights. As in the double byre, ample artificial light should be provided. It may be found convenient to provide wall brackets for the lights placed at suitable intervals near the wallhead level. The gangway is provided with a cross-slope of $\frac{1}{2}$ in. as distinct from the camber which is suggested in the double byre. The troughs in the single byre are shown as cast concrete or special earthenware troughs of the "swept" type, by way of illustration of one of the possible alternatives. (See Figs. 4 and 5.)

DRY COW, CALVING, AND ISOLATION BYRES

104. Accommodation should be provided for dry cows equivalent to 20 per cent of the milking herd, and in addition there should be an isolation unit, calving byre, calf house, and bull pens. The calf house can be for general utility service, and may be used as a maternity pen or for the penning of calves as occasion arises. The calving and dry cow byres are shown as being of the same width as the single byre giving a width of gangway of 5 ft. 6 in. If this standard width is adopted the byre can be utilised, if need be, for general purposes. The construction of the byres is similar to that previously described except that the roofs are of the ordinary type without an open ridge. Ventilation can be provided and controlled by means of upcast ventilating roof lights. In this way it will be possible to have some control over temperature, even when there are only a small number of animals in the byre. Air inlets, cow slides and tyings, water bowls, and stall divisions would be similar to those already described.

FEEDING AND YOUNG STOCK BYRES

105. It is unlikely that many new feeding byres will be erected in the near future, but where such buildings are erected they should generally follow the lines laid down for the construction of dairy byres, except that there is not the same need for smooth and impervious walls. It is advantageous to have head feeding passages about 4 ft. 6 in. wide for convenience of feeding and safety of workers. There are conflicting views as to whether or not feeding byres should have the length of standings graded to suit varying sizes and ages of animals. Since absolute cleanliness is not so necessary as in the case of dairy cows, and the variation in size of animal is much greater, a uniform standing 5 ft. to 5 ft. 6 in. in length will probably prove more suitable. The young stock byre, and feeding byres, should be constructed so as to give the same degree of comfort and ventilation as that provided for the milk cows, and of dimensions which will facilitate adaptation for other purposes.

CATTLE COURTS¹

106. Courts occupied by cattle are used for varying purposes in different parts

¹ Courts, folds, yards, reeds.

FARM BUILDINGS FOR SCOTLAND

of the country. Their construction depends to a great extent on their surroundings, the district in which they are situated, and, obviously, the use to which they are put.

107. The main essentials common to all courts may be stated briefly as follows.

POSITION

108. Courts should be situated conveniently to the feed stores, and they should also be placed in such a position as will facilitate the removal of dung and the provision of straw for feed and bedding.

CONSTRUCTION

109. As regards the construction of the courts, the walls should be solidly built of stone or brick, or constructed of concrete, to a height of at least 6 ft. Above this height the walls may be continued to a convenient height in relation to the rest of the steading, and the upper part of the walls and the gables can, in suitable circumstances, be constructed of a timber framing covered with spars or sarking boards having spaces of, say, $1\frac{1}{2}$ in. to $2\frac{1}{2}$ in. between them. The roof should be in one span, and provision should be made (a) for natural lighting at the rate of 3 sq. ft. per 100 sq. ft. of floor area in a court completely roofed over, and (b) for effective outlet ventilation. Some assistance in this direction may be obtained from the use of slotted asbestos cement or corrugated steel sheets. In order to facilitate the passage of the cows from one court to another it is desirable to instal a gate capable of being raised as the straw level rises. A simple and suitable type of gate is illustrated in Fig. 12.

FEEDING (Figs. 13, 14, and 15)

110. In the construction of the courts care should be taken that there is ready access to passages from which the troughs may be supplied with food. Experience has shown that individual troughs are preferable, and these should be of an impervious material such as glazed fireclay or earthenware. Trough space of 3 ft. should be allowed for each dairy cow, but from 2 ft. to 3 ft. per animal is sufficient for feeding or young stock where continuous troughs are used. Travelling hay racks in courts are recommended—details of these are shown in Fig. 15.

WATERING

111. There should be a water trough about 3 ft. in length to each court. Alternatively, water bowls should be provided.

DRAINAGE AND FLOORING

112. All roof and surface water should be excluded from courts. The floors of courts should be slightly "dished" to the centre and, where practicable, advantage should be taken of any slope on the ground tending to facilitate this. The floors should be bottomed with broken stones or hard core and blinded with ashes. Concrete is not recommended as a flooring material for courts.

COURTS FOR DAIRY HERDS

113. In districts where straw is plentiful, and likely to be so, there is a growing disposition to favour the housing of dairy herds in courts or reeds. In such courts the animals keep clean as a result of the larger space at their disposal, and the labour of cleaning and bedding is much reduced. The manurial value of both dung and urine is thus conserved in the best possible manner. Where this method of housing the dairy herd is adopted, the courts can be managed in a completely satisfactory manner provided the standards as to court area per cow are carefully observed. The system is to be recommended for the dairies in all areas where straw is available in ample quantities. Many old steadings can readily be converted

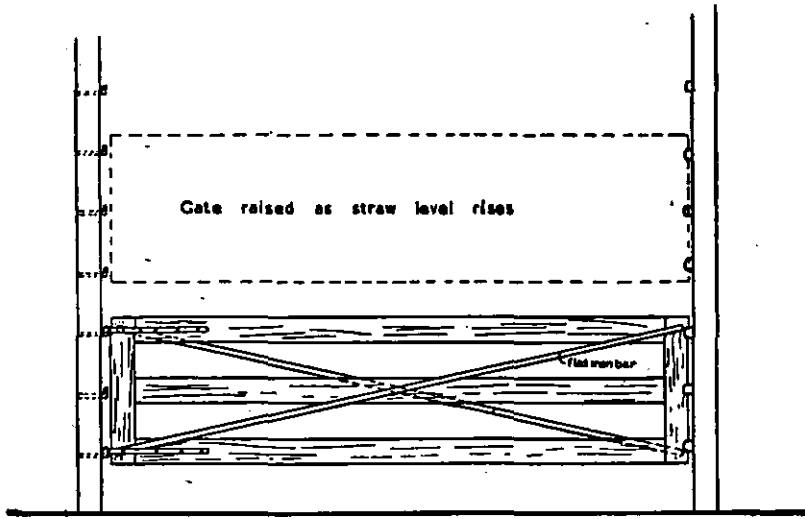


Fig. 12. Lifting Gate for Cow Courts .

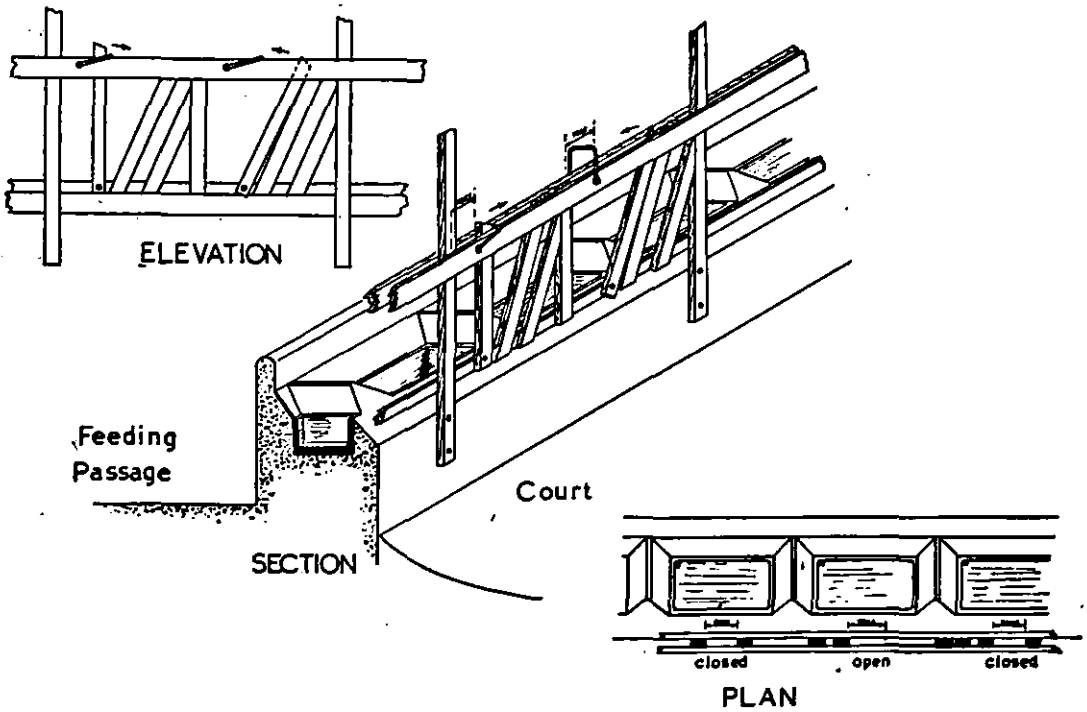
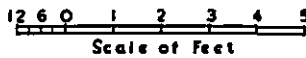


Fig. 13. Timber Yoke for Cow Courts

Fig. 14. Lifting Hay Heck for Courts

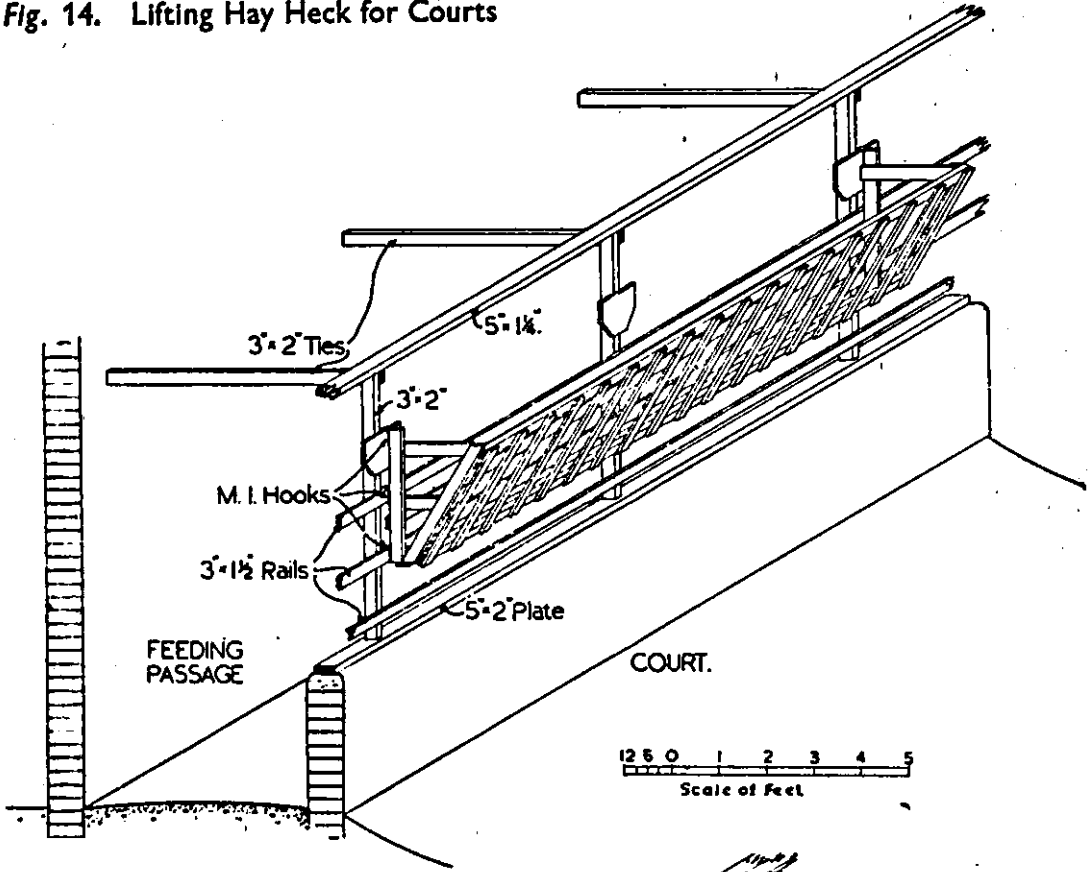
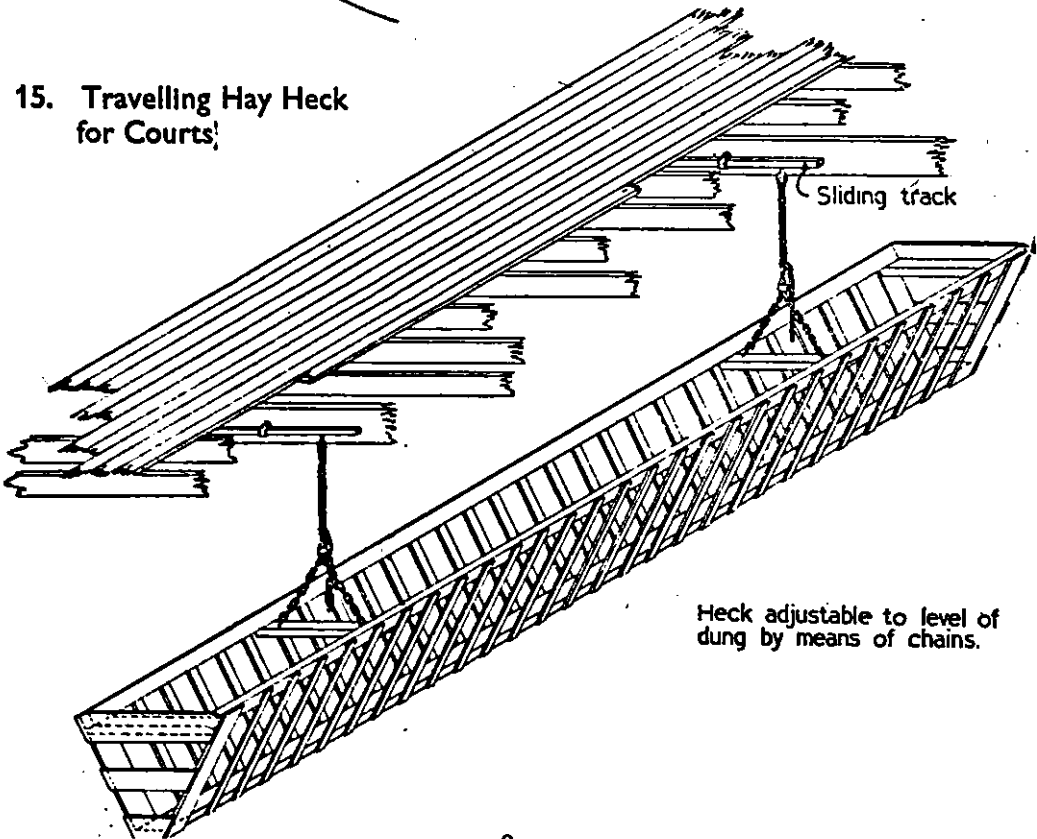


Fig. 15. Travelling Hay Heck for Courts



DAIRY, LIVESTOCK, AND ARABLE FARMING

into courts and accommodation for the milking parlour, but care should be taken to see that the courts are conveniently situated in relation to the assembly pen and milking parlour. Courts should not be used for dairying purposes unless there is a milking parlour, or a byre suitable for milking.

114. Objections to the cow court system are commonly voiced, such as that the cows will bully each other and in particular newcomers, and that the system will lead to victimization at feeding time. These objections have, in practice, been overcome by dehorning, and by the provision of suitable feeding troughs fitted with some form of yoke so that each animal may be assured of its fair share of food. Fig. 13 shows such a type of yoke constructed of timber. If timber is objected to, there should be no difficulty in achieving the same result by utilizing a tubular construction on similar lines to that used by the makers of proprietary designs of cattle pens, etc.

115. A disadvantage in the use of covered or partly covered courts for dairy herds lies not so much in the method as in its liability to abuse. Insufficient bedding or overcrowded courts may lead to insanitary conditions, and the difficulty of laying down and enforcing precise standards in these matters is evident.

116. There are instances of 15 cows being accommodated in a single court without any trouble, and there seems to be no reason why as many as 20 cows should not be penned in one court. In courts containing 10 to 20 animals, 100 sq. ft. per animal should be sufficient. Where it is intended to pen less than 10 animals in one court, the standard of 100 sq. ft. becomes inadequate, and at the level of 6 or 7 animals the allocation of floor space should be raised to 125 sq. ft. per head. In general, no court should be less than 500 sq. ft. in size.

117. Courts in which dairying herds are housed should in general be completely roofed over, although there are areas in the country with low rainfall where courts might be only partially covered.

118. In the working of cow courts, it should be a requirement that stable, pig manure, and manure from feeding byres, etc., and general refuse should not be deposited in the courts, and that the courts should be emptied and cleaned at least once a year. It is an advantage if the design of the court facilitates the mechanical loading of the dung for removal.

FEEDING COURTS

119. The general construction of feeding courts should follow the lines indicated. For this purpose an area of not less than 60 sq. ft. per animal is required. Such courts may with advantage be wholly covered but much depends upon climatic conditions.

BREEDING AND REARING COURTS

120. Courts used for these purposes should be partially open, with sufficient protection for the animals when feeding. The general construction and location would follow the lines laid down for the other types of court, and the floor area should be not less than 60 sq. ft. per animal. Breeding and rearing courts should, where practicable, be so arranged as to have the shelter of other buildings, and, at the same time, be open to sunlight, *i.e.* they should face the south or south-west.

MILKING PARLOURS AND BAILS (FIGS. 16, 17 AND 18)

121. The milking parlour and movable field bail have made it possible to milk a dairy herd in an ideal environment.

BAIL SYSTEM IN SCOTLAND

122. Cows have been kept in the open field and milked in bails in certain parts of Scotland, but in view of the small scale of the operation it is impossible to state

FARM BUILDINGS FOR SCOTLAND

authoritatively whether animal health and milk yields are increased or reduced under such hardy conditions. Owing to the lack of practical experience on the question in this country, no recommendations are made as to the arrangements or equipment necessary for the bail system of dairying.

DESIGN OF MILKING PARLOURS

123. Figs. 16, 17, and 18 illustrate different types of milking parlour. The designs are such as to fit in with the varying conditions likely to be found in the modernization of existing buildings, and will be equally suitable when new buildings are erected. Figs. 17 and 18 in particular are designed for cases where narrow buildings have to be used to accommodate the milking parlour.

124. It is important that there should be a clear space not less than 6 ft. in width behind the milking stalls. The width of the exit passage in front of the milking stalls should be 3 ft. 6 in.

125. Fig. 16 shows a layout of four milking points and six waiting stalls suitable for premises where a building 29 ft. to 30 ft. wide can be provided. The floor is sloped in such a way that the water used in the waiting stalls is drained towards the tails of the cows and in the milking stalls towards the heads of the animals.

STRUCTURAL FEATURES

126. In the design of the milking parlour the ceiling height should be at least 7 ft. 6 in. above the floor level and ample natural and artificial light should be provided, particularly on the rear quarters of the cows. The window or roof light area should be at least equal to 10 sq. ft. to every 100 sq. ft. of floor area. Artificial lighting should be equivalent to at least one 60 watt lamp per 150 sq. ft. of floor space. One milking point should be provided for every 12 or 13 cows. In order to minimize the risk of the cows crushing each other not more than nine points should open on to one corridor. Where cow courts are used, three pin plugs for cables for electric clippers should be fixed at convenient points on the wall adjoining the waiting pens and about 6 ft. or 7 ft. above the floor level.

127. The roof should be provided with a ceiling lined on the underside with "V" jointed lining, match boarding, or flat asbestos cement sheets, or if preferred the ceiling may be plastered, but in any event it should be of a dustproof nature. There is no objection to an upper floor over the milking parlour provided it is dustproof and does not interfere with the ventilation. The provision for outlet ventilation should be equivalent to at least 50 sq. in. per 100 sq. ft. of floor area, and through ventilation should be provided. The walls should be smooth and impervious, and the floors finished in fine cement concrete with a sprinkling of carborundum or similar material. There should be no drain inlets inside the building, and where a court communicates direct with a milking parlour the slope of the floor of the court should be away from the milking parlour. Water should be laid on and wash-hand basins provided.

HEATING

128. It is advisable to provide some method of artificial heating in order to avoid risk of chill to the animals while being washed and milked. This may be done conveniently by means of hot water or steam radiators supplied from the dairy boiler, or by means of electric radiators (with or without blowers) placed high up on the walls.

DAIRY PREMISES (FIGS. 19 AND 20)

129. In a modern dairy farm the dairy premises may be divided into two groups, those where the bucket type of milking machine is used, and those where the milk is piped direct to the cooler. Figs. 19 and 20 show designs for both systems.

Fig. 16

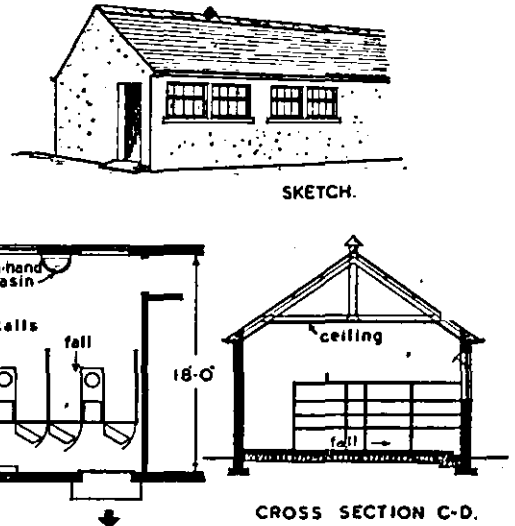
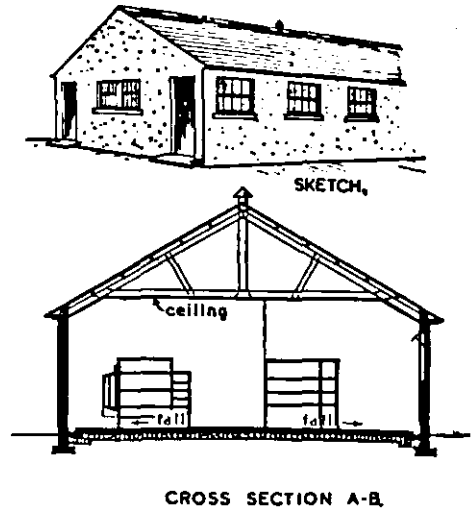
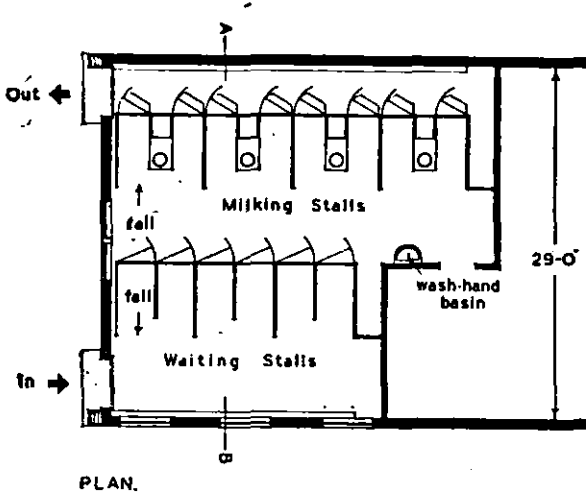


Fig. 17

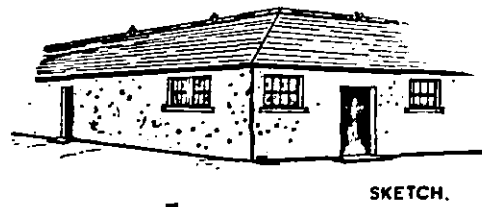
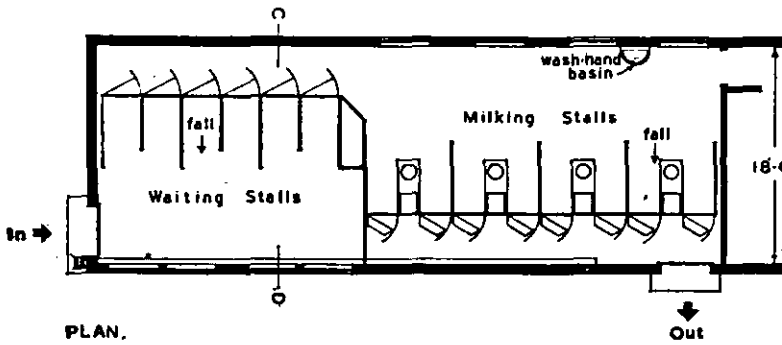
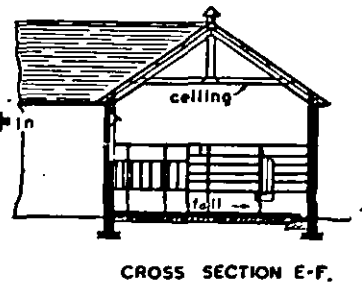
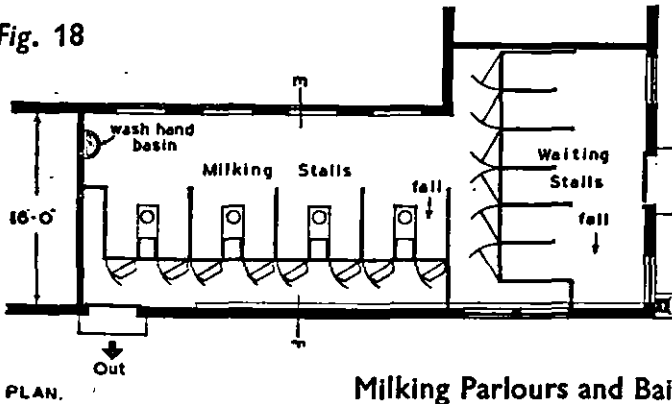
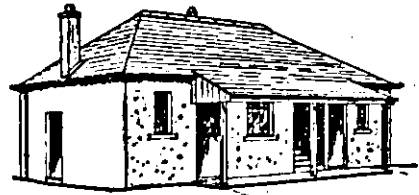
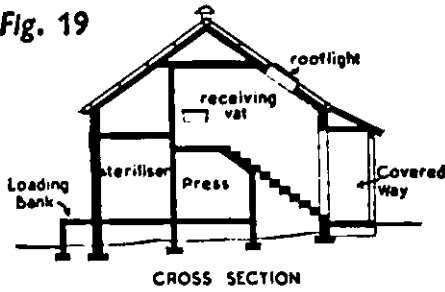


Fig. 18



Milking Parlours and Bails

Fig. 19



SKETCH

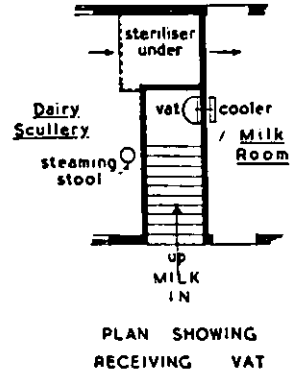
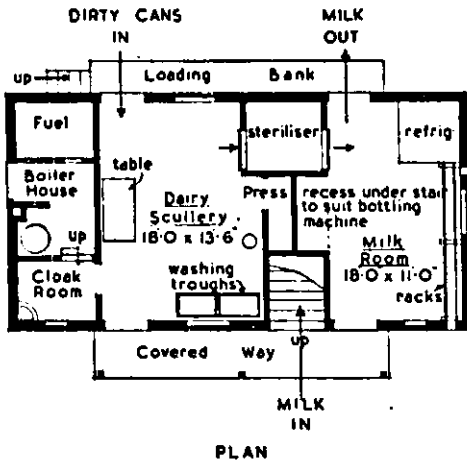
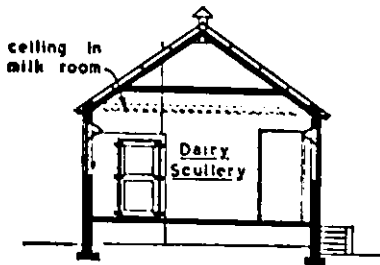
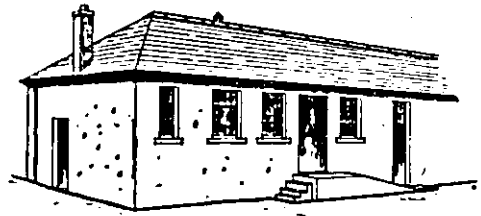


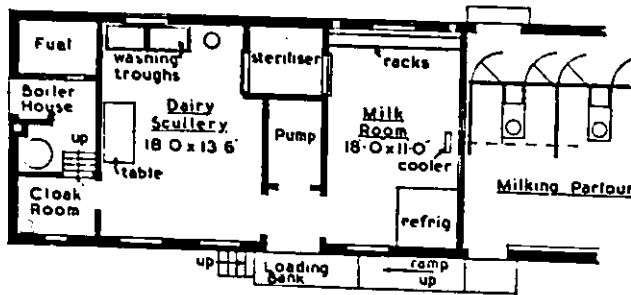
Fig. 20



CROSS SECTION THRO' SCULLERY



SKETCH



PLAN

Dairy Premises

DAIRY, LIVESTOCK, AND ARABLE FARMING

STRUCTURAL FEATURES

130. Constructionally both sets of premises are similar. They should be built of solid material and rendered on the inner surface with an impervious material such as polished cement rendering. Floors should be of concrete, the milk room provided with a ceiling, and the dairy scullery with ample outlets for the escape of steam. The windows and doors should be so arranged as to give through ventilation, the windows being equal to at least 10 sq. ft. to every 100 sq. ft. of floor area. At least one-third of the area of each window should be made to open, the opening portion being at the top. Wall surfaces should not be lime washed or whitewashed. Where a surface treatment is desired, one or other of the proprietary preparations which produce a glazed surface may be used.

131. The liquid and washing water from the operations carried on in the dairy scullery and milk room should pass by means of a pipe through the wall to the outside and discharge on to the top of a trap connected to the drainage system. There should be no internal connection between the dairy premises and the drainage system.

132. It is always advisable to allow ample floor space in dairy premises. For medium- and larger-sized premises the space allotted should be about 3 sq. ft. of floor space per gallon of milk produced per day. In the case of the smallest dairies, this ratio of floor space to milk produced will cease to apply, and the dairy premises should be designed to provide an overall minimum floor area of 200 sq. ft. In a large farm the dairy premises may usefully be designed to include a small room for office work, records, etc.

133. Where the cooler is large or where the cooling agent is brine, ethyl chloride, etc., special provision should be made for sterilizing it by means of a portable hood. The object is to localize the heat, and thereby promote efficiency in the sterilization process, while avoiding undue raising of the temperature of the milk room.

134. Fig. 19, illustrating the dairy premises using the bucket system, shows a scullery in which will be situated the table, washing troughs, and steaming stool; from there utensils will be passed into the sterilizing chamber from which, after treatment, they will be withdrawn directly into the milk room. The sterilizing chamber is intentionally so designed that it cannot conveniently be used by the staff as a passageway between scullery and milk room. If the sterilizing chamber is constructed of brick it should be rendered smooth and impervious on the exposed surface. If constructed of steel it must be insulated to prevent it from heating the milk room. The suction pipe line of the milking machine should be extended into the dairy scullery in order to facilitate the drawing of water through the milking machine units during the cleaning process. Suitable attachments to the steam pipe in the scullery should be made for steaming the milking machine teat cups. Adjoining the scullery is a cloakroom with a wash-hand basin and also a boiler and fuel store. In the milk room there are a refrigerator and racks for the utensils. All fittings standing on the floor of the scullery, except the steaming stool, are portable, and suitable arrangements must be made for outlets from the washing troughs.

135. The plan shown in Fig. 19 is so designed that the buckets of milk brought from the byre can be carried up a flight of steps at the top of which there is a receiving vat at a convenient height relative to the stair head for tipping the milk bucket. From this receiving vat the milk passes to the cooler in the milk room which, in turn, is at a sufficient height to enable the bottling machine to be placed beneath it. The wall in the milk room is recessed beneath the cooler for the purpose of facilitating the installation of a bottling machine.

FARM BUILDINGS FOR SCOTLAND

136. Fig. 20 shows a suitable arrangement in a case where the milk is to be piped direct to the milk room. The general construction would remain the same as for the premises already described. The arrangements would differ in that there would be no need for the stair, and the space so released would be occupied (where electrical current is available) by the pump chamber. In this case the cooler would be placed in the wall adjacent to the milking parlour, thereby reducing the length of piping required. The arrangement as shown would permit of the provision of fixed windows or a glazed partition between the milk room and milking parlour.

COMMUNICATION BETWEEN DAIRY PREMISES AND OTHER BUILDINGS

137. There should normally be no direct communication between cow courts, byres, and dairy premises, and never between the dwelling-house and the milking parlour or dairy premises. In the milking parlour, however, where the milk is not exposed to the air, there is no objection to a direct communication between this building and a cow court. Where direct communication between the buildings is difficult to dispense with arrangements should be made for an intervening ventilated passage.

BULL PENS (FIGS. 21, 22, 23, AND 24)

138. These drawings illustrate designs for bull pens which might be either detached or linked up with the main farm building system. The principle to be followed in the design of bull pens is to combine the comfort of the animal with the convenience and safety of the man in charge of the bull. To this end the pen should be designed so that the animal may be fed and watered without the attendant having to enter the pen, and the pen and exercising court or yard should be so designed that the door closing the pen can be controlled without entering the yard or the pen. There is a variety of satisfactory proprietary designs for trapping the bull.

139. Fig. 21 illustrates a bull pen 17 ft. 6 in. by 15 ft. with an annexe utilized as a food store and feeding passage. The animal can be fed without the cattleman having to enter the pen. The door giving access to the exercise yard can be opened and closed without exposing the cattleman to any risk. Fig. 22 illustrates a different layout, the bull pen being 12 ft. by 11 ft., with a feeding passage. Attached to this bull pen is a service pen as well as exercising yard. In this case the sliding door to the bull pen will require to be operated by means of an iron rod or cleek. Fig. 23 shows twin bull pens, each 12 ft. by 10 ft. with individual feeding passages and exercising yards. Fig. 24 is a design for a bull pen in which by means of a passage it is possible for the attendant to approach the bull from three sides without entering the pen.

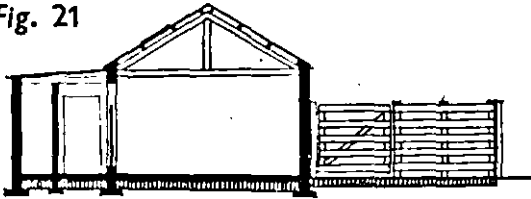
140. In the designs for pens and exercising yards the fences are so arranged that the animal can see any movement which may be taking place around the pen and is thus not kept in solitary confinement.

141. There is no accepted size for bull pens, but each pen should be at least 10 ft. by 10 ft. with exercise yard in addition. The buildings should be of solid construction, well lighted, and with graded concrete floors to run the urine away.

ROOT AND FEED STORAGE

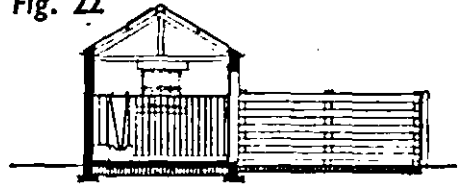
142. For the convenient working of a farm adequate provision should be made for the storage of root crops such as turnips. Where there are spaces between the buildings (firebreaks, etc.) it may be found practicable for the turnip store to be arranged so that it may be filled through doorways in the side or end without interfering with the internal arrangements for withdrawal of the feeding material.

Fig. 21

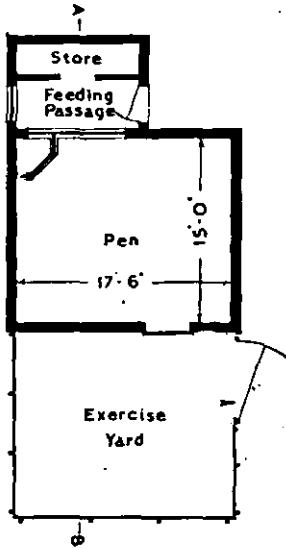


SECTION A - B

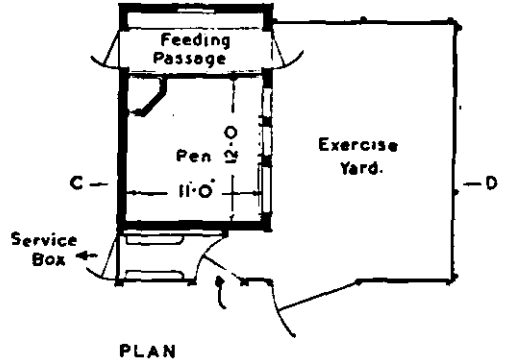
Fig. 22



SECTION C - D



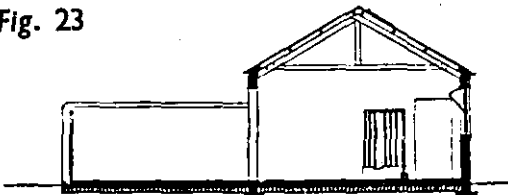
PLAN



PLAN

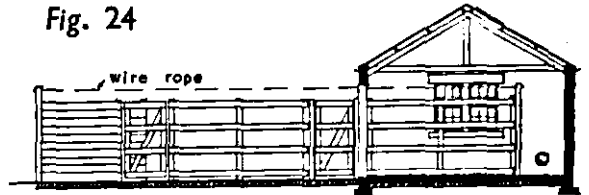


Fig. 23

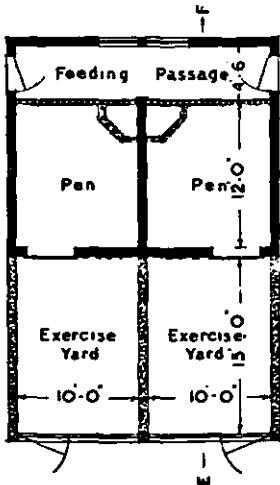


SECTION E - F

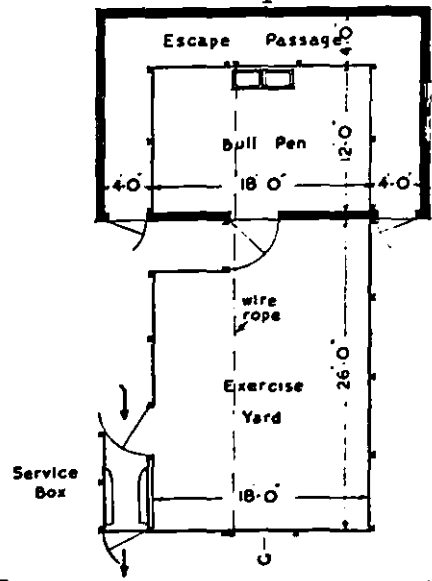
Fig. 24



SECTION G - H



PLAN



PLAN

Bull Pens

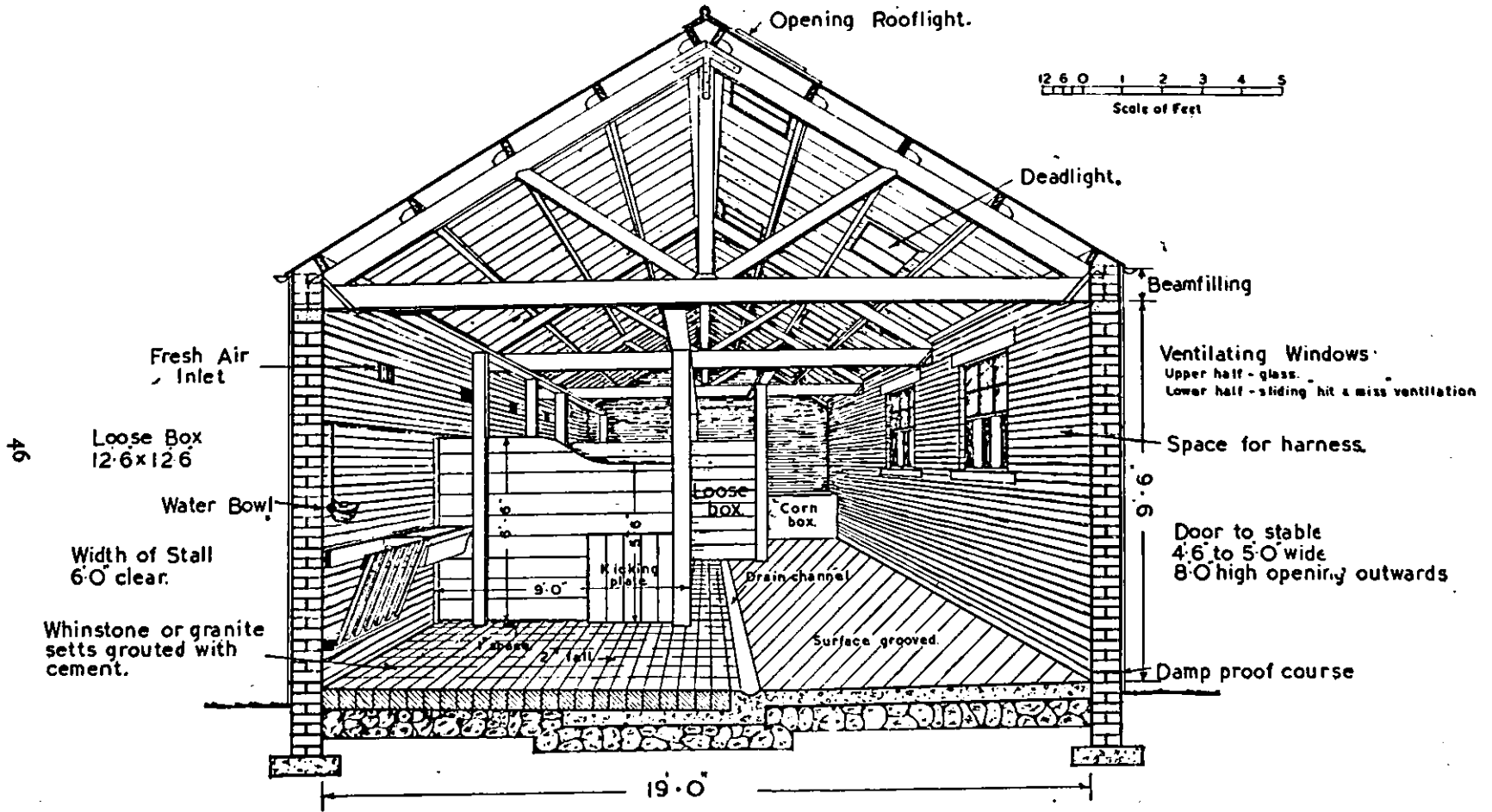


Fig. 25. Stable (Interior Perspective)

DAIRY, LIVESTOCK, AND ARABLE FARMING

In cases where the root store forms the central building between byres or cow courts, such an arrangement may not be possible.

143. It will frequently be found convenient to arrange for the storage of concentrates and other feeds on a floor above the root store. In these circumstances, it will generally be possible to provide chutes to deliver the feeds into coolers or conveyors for delivery to the byres, etc. Possible sites for the root store in relation to the other buildings are shown in the layout plans.

144. Structurally the building should be of a character to exclude frost, and the upper floor must be capable of carrying a considerable weight.

145. The size of the root store will depend on the amount of roots to be stored, and accordingly will vary as the practice in this respect varies throughout the country. As a rough guide it can be assumed that a cubic yard of turnips is sufficient to feed about 36 cows for 1 day at a ration of 40 lb. per head. When the number of cows to be fed and the number of weeks for which storage to be provided are known it is possible to calculate the bulk of roots to be stored from the figure mentioned, and from that the dimensions of the building.

STABLES (FIG. 25)

146. In the modern farm the stable is likely to be of much less importance than previously. Nevertheless, there is always likely to be use for horses in farm work, and some provision will accordingly be required. Its extent will depend on the type of farm and the personal preference of the occupier. The stable is at present in many cases one of the least satisfactory buildings on the steading, and it is desirable that standards of lighting and ventilation should be much improved.

STRUCTURAL FEATURES

147. Fig. 25 illustrates the principles to be followed in the design of the stable.

148. The overall width of the stable should be 18 ft. if a harness room is provided, but if harness is to be hung on the stable wall, overall width should be 19 ft.

149. Stables should be provided with ample ventilation, both inlet and outlet, and natural lighting should be from the roof and/or the wall in the rear of the horses. The glass area should be not less than 3 sq. ft. per horse. Electric lighting should be by lamps so placed as to light the stables effectively. The lamps should be controlled by high level waterproof switches.

150. The width of the stalls should be not more than 6 ft. clear between the trevis boarding. The length of the stall should be 9 ft., allowing a wide passage in the rear of the animal. Trevises should be formed of dressed boarding 2 in. thick, the planks being fixed together with hardwood dowels, and saugh willow kicking plates 2 in. thick should be provided on both sides of the trevis. The trevis boarding should be kept about 1 in. above the floor level. Trevises should not be of concrete, nor should they have metal kicking plates.

151. Stable doors should be 8 ft. high and 4 ft. 6 in. to 5 ft. wide and should open outwards.

152. The floors of the stalls are best paved with whinstone or granite setts grouted with cement, but granite concrete finished with grooved surfaces is sufficient for the passage. The floor of the stable should be laid on a 6 in. thick layer of broken stones as bottoming, and there is considerable advantage in providing a concrete bed about 4 ft. wide below the causeway in the position where horses affected with leg mange stamp their hind feet. This condition, very prevalent in horses of the heavier breeds, can be cured by treatment, and damage to the floors of the stalls thereby prevented. The slope of the stalls should not be more than 2 in.

FARM BUILDINGS FOR SCOTLAND

TROUGHS, HECKS, AND BOWLS

153. Troughs should be of glazed fireclay with a flange on the back and two ends, but not on the front. It would appear to be a matter of personal preference whether the trough is placed on the near or off side of the horse. Conflicting opinions have been received on this point.

154. Hay hecks should be of the same height as the trough and should have a top rail of black birch or other hardwood with an iron strap to prevent gnawing. High hay hecks are not advocated.

155. A regular supply of water is as necessary to horses' health as to that of cows. If bowls are fitted in the stalls there will be a saving of labour, and at the same time less tendency for the animal to drink excessive quantities of water on being stabled after work. Further, if a small controlled tank is provided in the stable, the water would be at stable temperature, which would reduce the risk of chill to the animals when drinking. The water bowls should be as high as the horse can conveniently reach (about 3 ft. 6 in. above floor level) and they should be saucer shaped with nose pressure lever. The bowls should be on the side away from the feeding trough.

LOOSE BOXES

156. Each stable should be provided with one or more loose boxes which should measure at least 12 ft. square. Doors of loose boxes should open into the stable and direct access from the outside to the loose box is also desirable.

YOUNG HORSES

157. In those parts of the country where some protection is needed for young horses this should be in the form of open fronted boxes, courts, or sheds, with free access to pasture at all times. In such boxes it should be possible to feed from a head passage, or exclude the colts from the boxes until the feed is placed in the mangers.

PIGGERIES (FIGS. 26, 27, 28, AND 29)

158. The design of piggeries should, in general, follow the principles which have been laid down for the design of farm steadings. The buildings should be laid out to provide the maximum convenience for their working whilst at the same time affording the maximum comfort both to the stock and the workers. They should be well lighted and ventilated and constructed of impervious materials which will facilitate cleansing and disinfection.

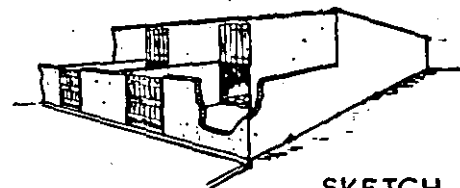
159. The particular plan to be adopted is dependent on the district and the number of pigs to be kept. In some cases a small number of pigs may be reared as a convenient side line to the general farming operations, whilst in others the practice may be to breed and sell off young stock, and again there is the genuine pig farm specializing exclusively in pig production and so organized that it may breed, rear, and fatten or merely rear and fatten according to the process which for the time being may be most profitable.

160. The method of keeping pigs in the open, with no other buildings than movable wooden huts, has been tried in Scotland, in a comparatively small number of cases. The evidence is as yet insufficient to warrant definite conclusions. It suggests that in regions with a favourable climate, breeding and rearing by this method can be successfully undertaken; throughout the major part of Scotland, however, and particularly in the East, this method probably gives inadequate protection even to breeding or rearing stock.

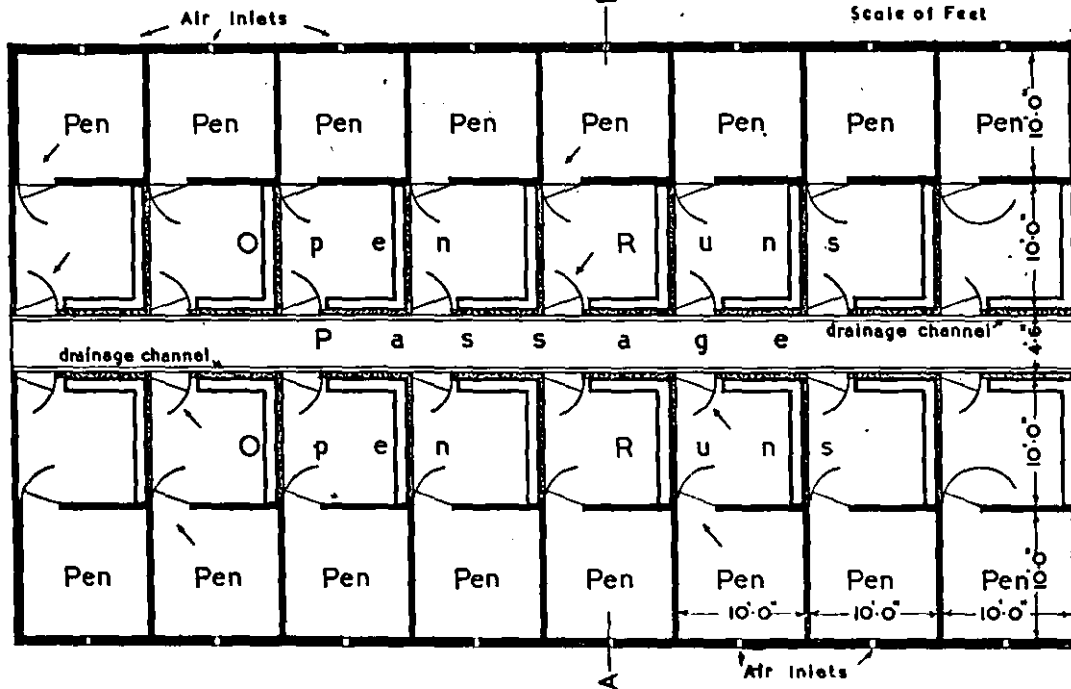
161. In view of the prevalent opinion that the introduction of uncooked swill has some connection with outbreaks of foot and mouth disease, the methods of preparing and handling this food demand careful attention. To minimize risk



SECTION A - B



SKETCH

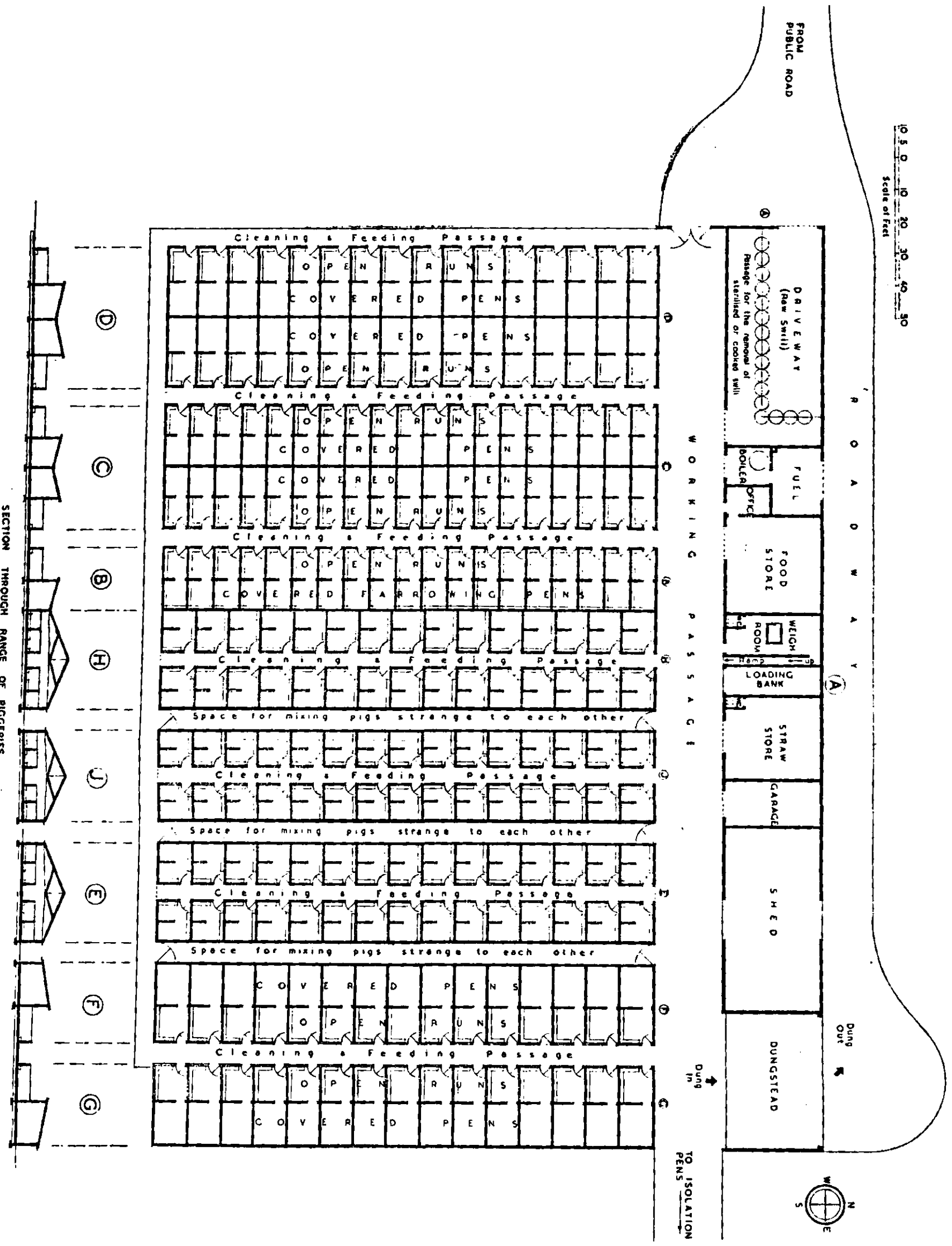


PLAN

Fig. 26. Piggery with Open Runs

10 5 0 10 20 30 40 50
Scale of Feet

FROM PUBLIC ROAD



SECTION THROUGH RANGE OF PIGGERIES
Fig. 29. Piggery for 1000 Pigs

DAIRY, LIVESTOCK, AND ARABLE FARMING

as 11 in. brick cavity walls, and if "no-fines" or "cellular" concrete is used, the walls should be at least 8 in. thick. A proper damp-proof course should be provided above ground level and connected to the damp-proof bitumen layer, below the floors. The height of the walls should be limited as much as possible, consistent with convenience in working, and a height of 5 ft. 6 in. to the wallhead or say 6 ft. to the top of the beam filling is suggested.

Roofs

169. The roofs of piggeries should be constructed so as to minimize heat losses in winter and heat absorption in summer. A convenient and cheap method of roofing is by means of roof trusses, purlins, and corrugated asbestos cement sheets, provided the underside of the roof is covered with V-jointed or similar lining or half-checked sarking. Experience has shown that this eliminates condensation in winter and overheating during the summer. Designs suitable for piggery roofs are illustrated in Figs. 30, 31, and 32.

Floors

170. Floors of piggeries should be constructed of impervious material such as cement concrete and laid to falls or gradients so as to draw off all liquid and keep the beds of the pens as dry as possible. The general cross-fall from wall to drainage channel should be about 1 in 40, and the fall or gradient of the drainage channel itself should be at least 1 in 80. The general opinion of pig breeders appears to be that a portion of the pen should be about 3 in. or 4 in. higher in level than the remainder of the pen, the higher portion being used as sleeping quarters by the animals. This raised bed should be laid on a foundation of broken stone with a bituminous damp-proof course laid over the whole area. The bed may be formed with brick grouted in cement or alternatively it may be formed with hollow brick blocks which, in turn, are covered with a layer of fine granolithic concrete $1\frac{1}{2}$ in. thick. The provision of the damp-proof course under the pig bed, by keeping down ground damp, results in more comfortable sleeping quarters.

171. Other types of beds such as timber have the advantage of warmth but are difficult to keep free from infection and insect infestation. Brick grouted in cement and natural flagstone pavement have been found to be suitable forms of bed. The use of the latter permits of the provision of an air-space below the floor with consequent improvement in the comfort of the animals.

172. Experience in regard to dunging passages appears to be somewhat conflicting, but there is evidence suggesting that where these are not provided, the pig will use the highest corner of the pen (other than the bed) as a dunging place, and for this reason some pig keepers favour a distinct raising at one corner of the court or pig run. Dunging passages should be well lit, and wide enough for the pigs to turn in. (See also paragraph 180.)

Size of Pens

173. No hard and fast rule can be laid down for the size of pens, since so many factors enter into the consideration of this question, such as number, age, and size of animals and the purpose for which they are being kept. On broad lines it may be said that a convenient size for a farrowing pen is about 9 ft. by 9 ft., although there are many such pens which only measure 8 ft. by 8 ft., and even less. As regards the other pens, the following figures will give guidance in determining the size of pens, once the number of pigs to be provided for has been decided:

| | |
|------------|------------------------------|
| Pork pigs | say 10 to 14 sq. ft. per pig |
| Bacon | „ „ 20 „ „ |
| Brood sows | „ 25 to 30 „ „ |
| Boars | „ 40 to 50 „ „ |

FARM BUILDINGS FOR SCOTLAND

of infection from this source, piggeries should be so laid out that there is a minimum of contact between the receiving and distributing sides of the cooking and sterilizing premises. In some cases this end is achieved by the swill being cooked at central depots by Local Authorities and distributed to the piggeries. Where uncooked swill is brought on to the farm, the cooking premises should be situated at some distance from the pigsties, and laid out on the lines indicated.

PIGGERY PLANS

162. Following the method adopted in regard to general steading layout plans, plans for piggeries of varying sizes are shown.

163. *Plan 26.* This design provides for 16 pens with open courts. The open courts are approached by a central passage from which food is distributed. No provision is made in this design for food preparation, it being assumed that there is accommodation in existing buildings suitable for this purpose.

164. *Plan 27.* The plan provides for 18 full-sized pens and 2 small ones with mixing and cooking room and food store at one end and dungstead at the other. Dunging passages are provided and there is accommodation for a weighing machine and the boar. The whole structure is under one roof, and the animals are fed from a central passage.

165. *Plan 28.* This plan provides for 28 pens in all, together with a mixing and cooking room, boiler room, and food store. Three of the pens have been reserved for farrowing, and screen walls are provided in each of the rearing and fattening pens, the idea being that the young pigs will take shelter behind these walls and will be less disturbed by traffic up and down the passages. The whole building is roofed. The plan has been prepared with the object of reducing the risk of spread of infection by contact of the pigman with the uncooked swill.

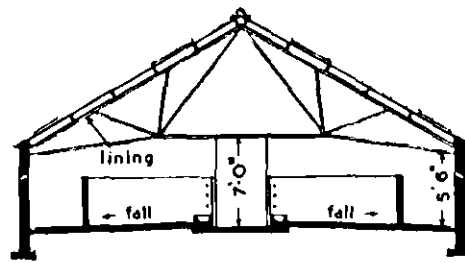
166. *Plan 29.* This is the layout plan for a pig farm accommodating about 1000 pigs and consists of nine ranges of buildings. The plan is designed in such a way as to meet varying conditions as between breeding, rearing, and fattening and merely rearing and fattening. The range of buildings marked "A" provides for ample steaming and cooking facilities arranged as suggested in paragraph 165, an adequate food store, record office, weighing room, loading bank, straw store, and sanitary accommodation. Range "B" consists of 19 farrowing pens with open runs, the pens being built adjacent to the food preparation range already referred to. These pens would be fitted with farrowing rails. Range "C" consists of 38 covered pens, each with an open run. These pens are unrailed and are intended for sows with litters, but they could be used for the feeding of "stores." Range "D" consists of 32 covered pens, each with an open run and each intended to house 15 or 16 young "stores." Ranges "H," "J," and "E" are wholly covered buildings to be used for fattening purposes, the number of pigs per pen being reduced as their size increases, whilst the range of buildings "F" and "G" are covered pens with open courts which may also be used for "stores."

167. It will be noted that spaces are provided between the ranges of covered buildings, and these serve the dual purpose of facilitating (a) ventilation of the buildings and (b) the "mixing" of pigs strange to each other. For the latter purpose gates are required at each end.

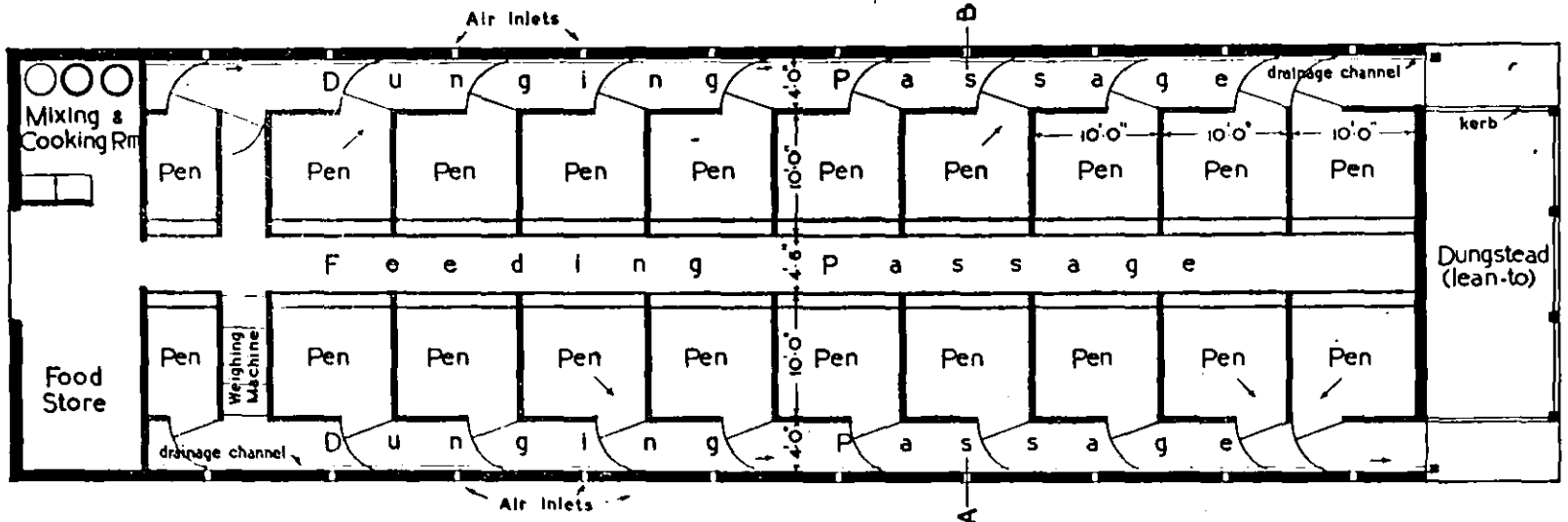
STRUCTURAL FEATURES OF PIGGERIES

Walls

168. The outside walls of piggeries should be of solid construction, such as brickwork or concrete, and they should be of a thickness sufficient to prevent the penetration of driving rain and an excessive loss of heat during cold and frosty weather. Accordingly, it is recommended that the outside walls should be built

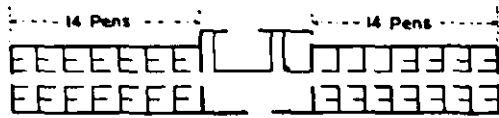


SECTION A-B

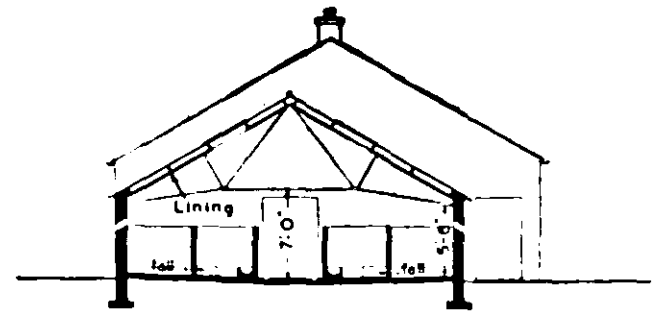


PLAN

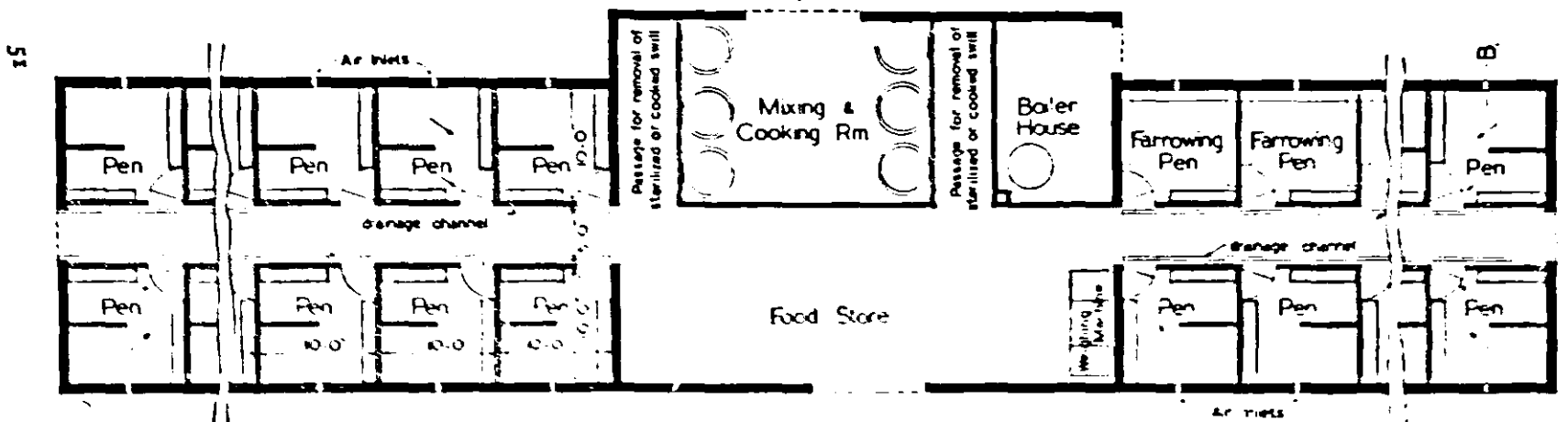
Fig. 27. Piggery with Feeding and Dunging Passages



KEY PLAN.



SECTION A-B



PLAN

Fig. 28. Piggery with Feeding Passage and Small Food Cooking Room

FARM BUILDINGS FOR SCOTLAND

Pen Divisions, etc.

174. The walls separating the pens should be about 4 ft. high to prevent pigs from scrambling over. The divisions between the pens should be of solid construction. Some pig keepers favour open railed fronts to the pens, whilst others prefer that the pen should be closed on all sides, arguing that with this method the pigs are less disturbed by the movement of workers in the piggery.

175. The walls of the piggery and the pen divisions should be cement plastered or rendered, and it is preferable that the junction with the floor should be formed as a rounded "cove" to facilitate cleaning.

176. The doors to the pens should be the same height as the division walls. They should be creosoted to deter animals from gnawing and, if necessary, protected with metal sheets. They should be hung on crook and band hinges built into walls, and not on wood door posts, which cause endless trouble by breaking away from their fastening and by rotting at ground level.

Farrowing Crate

177. There has been a tendency amongst pig breeders in recent years to adopt the use of specially constructed crates for the farrowing of the brood sows. There are proprietary makes of these crates to be purchased and the broad principle on which they are designed is to confine a sow so that she cannot turn round and bite the new-born pigs nor can she overlay them, but at the same time she has sufficient space in which to lie down. These crates are not buildings in the ordinarily accepted sense of the word, and therefore do not come within the terms of our remit, but mention of them is made for the reason that where farrowing crates are used there is not the same need to occupy space in buildings by reserving pens for farrowing purposes, nor is there the same need for the provision in such buildings of farrowing rails.

Feeding Methods

178. It will be noticed from the various layout plans that in some cases it is possible to supply food without entering the pens, while in others it is necessary that the pens be entered in order that food be supplied. One school of thought holds that there should be a screen wall in each pen (see paragraph 165), and that the pigman should of necessity enter each pen, and thus have an early opportunity of observing if any of the pigs are ailing and lying concealed behind the wall. The other holds that the screen wall is unnecessary and that the pigs should be fed from the passageway, so that they will be disturbed as little as possible in the process. Various alternatives have been suggested (and are illustrated in drawings, Figs. 33, 34, and 35) for dealing with the filling of the troughs. In Fig. 33 is shown a cement trough with a fixed wall above it so arranged that the food can be put in from the feeding passage without the pigman entering the pen. This avoids the use of all moving parts. An alternative method is shown in Fig. 34 where a flap door is provided which can be bolted on the "in" or "out" side of the trough, depending on whether the trough is being cleaned or filled or whether the pigs are eating. Fig. 35 shows troughs with an open rail front permitting of the filling of the troughs and general observation of the pigs at all times. In addition to the methods described there are various types of hopper in use, and as already mentioned the type necessitating the pigman entering the pen for feeding purposes.

179. The troughs should be formed of split fireclay glazed pipes 8 in. to 12 in. in diameter bedded in fine concrete and provided with concrete ends, except in cases where, in order to accommodate a particular method of filling, specially moulded troughs are preferred. About 12 in. of trough space is required for each pig, except in the case of very small pigs.

Fig. 30

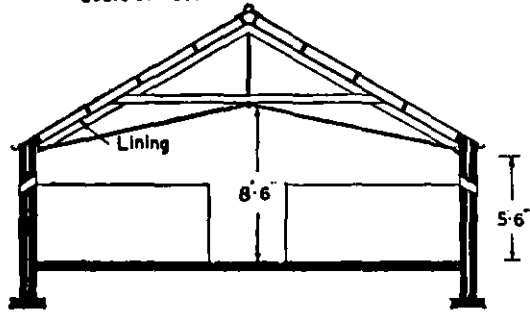


Fig. 31

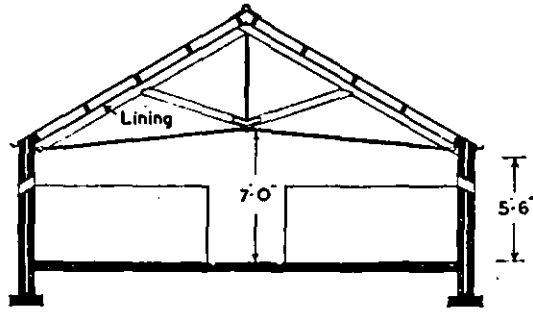
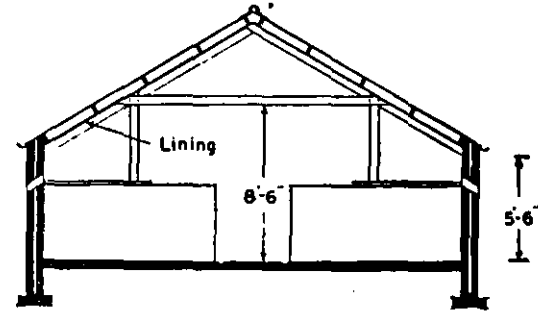


Fig. 32



Inexpensive Methods of Roof Construction in Piggeries

55

Fig. 33

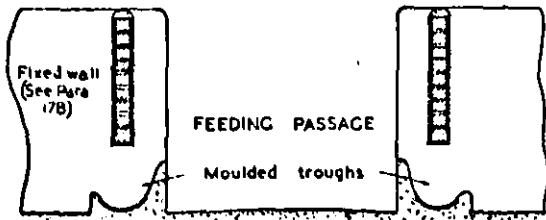


Fig. 34

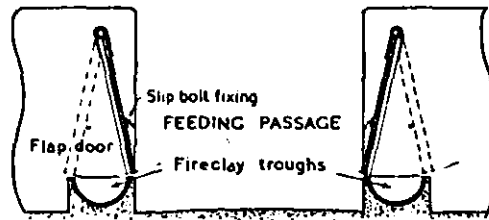
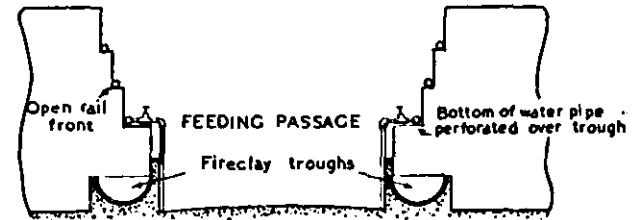
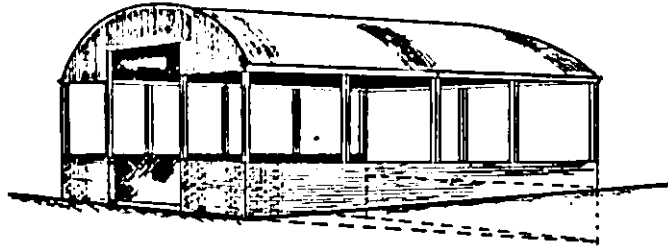


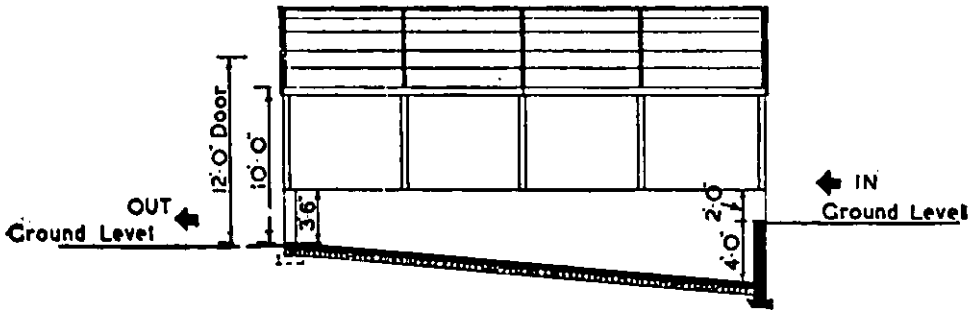
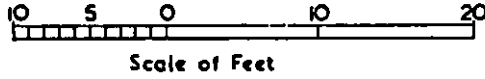
Fig. 35



Alternative Designs for Troughs in Piggeries



SKETCH.



LONGITUDINAL SECTION.

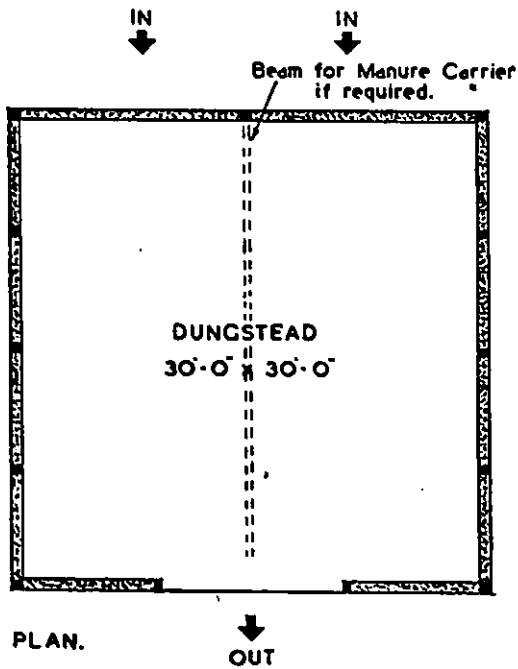


Fig. 36. Dungstead

DAIRY, LIVESTOCK, AND ARABLE FARMING

180. Feeding passages and dunging passages and their main doors should all be at least 4 ft. wide to permit of convenient working with barrows and food coolers.

Ventilation

181. In cases where pig pens are entirely roofed, it is necessary to provide ample ventilation. The ventilation can be provided by means of air inlets which should be 3 ft. to 4 ft. above floor level, and by means of a suitable ridge ventilator. In piggeries, as distinct from cow byres, uncovered ridge ventilators are not recommended. The air inlets may take the form of straight pipes built into the wall at the same slope as the roof, or they may be "quarter bends" in fireclay built in with the inlet upturned.

Lighting

182. Lighting should be on the basis of the area of glass being about one-fifteenth of the floor space in the piggery. It is very important to arrange the light in such a manner as to avoid the risk of the pigs suffering damage by direct rays of the sun through the glass. Artificial lighting is mainly required to facilitate feeding during the darker periods of the year, and a 40 watt lamp for every 4 pens should be sufficient.

Water

183. The water supply should be laid on to all piggeries, for both cleansing and drinking purposes. As regards the latter, mention may be made of the fact that suitable automatic drinking bowls are obtainable and may be installed where dry-feeding is practised.

Dung and Sewage Disposal

184. Very ample provision must be made for the accommodation of the dung from piggeries, and great care is required in the disposal of the liquid from the dung and the pens. Various methods have been tried, including settling tank, coarse and fine filters, and surface irrigation. We were impressed by a novel arrangement at one large piggery where a preliminary filtration of the liquor was achieved by passing it through chambers tightly packed with straw, the straw being renewed every day. Thereafter the liquor was passed through a chamber in which it remained for about 48 hours, and any solids settling were drawn to a sump and periodically pumped out by a sludge pump. Whatever method of purification be attempted, in the absence of connection to a public sewer it is essential that a considerable dilution of the effluent should take place on discharge into any water course.

DUNGSTEADS (FIG. 36)

185. In storing the dung produced on a farm, the aims are (a) to ensure its best possible utilization as manure, and (b) especially on dairy farms, to prevent its becoming a breeding ground for flies.

186. Where stock is kept under cover, and ample straw or other litter is available, the best means of achieving both these objects with the least amount of labour is probably the littered court for the livestock. It may not often be possible to keep all the stock of every kind in courts, but where the main part of the stock is in courts, a small dungstead will suffice for dung from the stable or young stock byres.

DUNGSTEADS

187. In many areas the nature of the soil and the rainfall may make constant carting of dung difficult, and permanent dungsteads within easy reach of the steading are required.

FARM BUILDINGS FOR SCOTLAND

188. Dungsteads should, where practicable, be downwind of the steading in districts where there is a pronounced and prevailing direction of wind, and as far removed from the steading as is compatible with convenient working. They should be not less than 10 yards distant from any dairy building. In construction the dungstead should have solid walls and preferably a firm floor similar to that required in a cattle court to facilitate removal of dung. The floor should be strong enough to stand the weight of the heaviest implements likely to be used for clearing it, and the width of entrance and height of roof should be sufficient to admit manure loaders. The dimension suggested for width and height of entrance is about 12 ft. There should be no supporting pillars or other obstructions in the dungstead to interfere with clearing. It should be roofed over to conserve manurial value. The dungstead should be sloped towards one or more drains, guarded to prevent choking, and these should be led to the aidle or septic tank. The slope of the ground, if any, should be used to provide an adequate height for the operation of unloading into the dungstead.

189. The size of dungstead required will depend on the frequency with which it is emptied. Where stock is kept in byres, about 10 cu. yd. of dung per dairy cow is produced in the year, and perhaps half as much per head of feeding or young stock. The dungstead should be designed with these figures in mind. If it is emptied more than once a year, it need not of course provide for the full amount produced annually. Most of the layout plans show ordinary dungsteads, while Plan C shows the ordinary dungstead together with the carting system of removal. Fig. 36 gives details of a covered dungstead in which both an overhead conveyor and a dung loader could be used.

CARTING SYSTEM

190. Where stock is kept in stalls, the regular removal of dung will be necessary. The best practice in this case is probably the carting system whereby the dung is removed as quickly as possible on to the fields, or to a distant manure heap. Under this system the desired result is attained by making the doorway and gangway of the byre wide enough to allow the use of a cart or trailer, which can convey the dung directly to the fields; or alternatively a stance consisting of a ramp or paved sump may be constructed where carts are kept ready to receive the dung as it is removed from the byre. The carts can be emptied periodically when routine allows. Such stances should be roofed over like a dungstead, to conserve manurial value. (See Plate 2.)

SECTION V. BUILDINGS FOR ARABLE, SHEEP FARMING, AND CROFTS

See note under Section IV

MACHINERY AND IMPLEMENTS

191. One of the chief developments on farms since the beginning of the century has been the increase in mechanization and the consequent need for additional machinery and implement storage. Such storage can most effectively be provided by a lightweight building with the floor space unimpeded by pillars. The shed should be so placed as to permit of a through passage, whereby the tractor drawing the implements in may proceed on its journey without reversing or turning, when the implements have been disconnected and are moved into their storage position. The dimensions suggested for a 200 to 250 acre farm are about 30 ft. to 40 ft. by 60 ft. New implement sheds should always be of larger dimension than seems necessary at the time of erection in view of the constantly increasing range and size of agricultural machinery. The shed should be so designed as to include arrangements for lifting heavy parts by block and tackle. Natural lighting should

ARABLE, SHEEP FARMING, AND CROFTS

preferably be from both roof and sides, with ventilation through opening skylights. The floors should be of concrete. The doors should slide on the inside face of the wall to prevent weather damage, and minimize the risk of damage by contact with vehicles. The doorway should be about 14 ft. to 16 ft. wide and 12 ft. to 14 ft. high, to admit modern agricultural machinery. Spares for individual machines may conveniently be hung on the walls or placed on shelves immediately behind the appropriate machine.

192. The modern farm should also be equipped with a convenient workshop having a well-lighted bench along one wall. It should contain racks for the smaller spare parts. Good natural and artificial lighting are essential in the workshop.

193. Reference to the layout plans shows that it may not always be practicable to have the implement store and the workshop adjoining each other. In these circumstances general convenience must determine the exact location of the buildings.

BARN, SHEDS, AND GRANARIES

194. We have considered various possible plans for the layout of barn, granary, and threshing arrangements, and have reached the conclusion that the best way of dealing with the design of these buildings is by considering them in relation to the layout of the steading as a whole. Under modern conditions it has been found more advantageous, particularly on larger farms, to have mobile threshing machines, and accordingly the barn arrangements should be such as will permit the use of a mobile thresher, with mechanical elevators for conveying the sheaves to the thresher and the grain to the loft, the straw barn being on ground floor level. If a suitable straw blower, grain conveyor, and sack lifter are installed in the appropriate positions, the necessity for the straw barn and grain loft being in close proximity to each other largely if not entirely disappears. The layout plans are so arranged as to permit of the carrying through of the threshing operations with a mobile thresher and mechanical conveyors.

195. On the question of power for the working of various appliances used in food preparation, etc., it is better to instal a number of small motors to suit the individual machines rather than a single large one involving the use of shafts and belting and generally run with an inefficient load factor. In cases where the use of belts is unavoidable, they should always be properly and permanently protected by fencing or netting at all points where there is any risk that workers and others will come close to them. Gearing, flywheels, etc., should be similarly protected.

SILOS¹

196. In recent years there has been some reaction against the use of silage for stock-feeding, particularly on feeding farms, and many solidly constructed silos are now in disuse or inadequately used. However, on dairy farms, in particular, silage is often successfully used.

197. A silo must be airtight, and solidly built to permit of tight packing. Lightly constructed silos, or sectional structures of wood or concrete have certain advantages, but the best type for general purposes is probably the pit silo. It can be rendered airtight, and can be tightly packed by driving over the silage as it is deposited. Permanent tower silos also provide good conditions for packing silage, and are justified where the scale of operations is large.

198. The selection of a site for a pit silo will depend very largely on the contours of the ground in the vicinity of the steading. It is suggested that where practicable the best type of silo can be formed by excavating into a hill face and forming a cavity or sump into which the silage can be carted and deposited. Where the silage rises above ground level as in a clamp with sides of banked earth, or where the subsoil is of a loose friable nature, it will be necessary to support the sides

¹ See also *Silos and Silage*, by H. I. Moore, 1941.

FARM BUILDINGS FOR SCOTLAND

with walls. If an adequate slope or batter be given (say 4 in. to the foot), there is no need for the wall to be more than 9 in. thick. In favourable circumstances, it may be possible to select a site where the material can be driven in from the upper side, thereby reducing the work of forking.

POTATO SHEDS

199. In the potato growing districts, a preference is developing for the storage of potatoes in a building erected for the purpose, instead of in pits in the field. In the layout plans there is provision for a potato store of suitable size in the 200 to 250 acre farms planned for dairying and mixed arable farming. The building can also be used for the storage of fertilizers and for other purposes between seasons.

200. The size of the potato store will be dependent on the area likely to be under this crop in any one year. One square yard of floor space piled 6 ft. high will accommodate one ton of potatoes. The building should be of solid construction, and it should be provided with a door through which a lorry can be driven. There should be no pillars or obstructions on the floor area to interfere with the movement of the lorry. The shed should be frost proof, and to this end it is suggested that double glazing of the windows would be helpful. Although the exclusion of frost is essential, it is necessary to have good lighting so as to permit dressing and other operations being carried on when work is impossible outside. Where the slope of the ground allows convenient access for vehicles to an upper floor, there are advantages in constructing the potato shed as a two-storey building, the lower floor being used for storing ware, and the upper floor for the boxing and sprouting of seed potatoes. The ceiling of the lower storey should be at least 11 ft. high. As the building would conform to normal constructional methods, no special drawings or specifications are necessary.

GRAIN-DRYING RACKS (FIGS. 37 AND 38)

201. In districts where the harvests are late and wet, there is much to commend the use of grain-drying racks. By their use it is possible to bring the grain out of the field even when it is in such condition that it cannot be stacked. While the use of racks entails double handling of the sheaves and increases loss of grain by shaking and possibly by the depredations of birds and ground vermin, their use ensures the ingathering of the crop in a reasonably good condition. With the development of early varieties of oats, and the increased speed in harvesting operations which is possible when modern machinery is used, the need for drying racks is less urgent. Nevertheless, they may in certain circumstances be desirable. During the Great War the then Board of Agriculture for Scotland encouraged the erection of grain-drying sheds, but despite their many apparent advantages, very few were in fact erected.

202. Various alternatives have been proposed for grain-drying racks, from the simple Richmond rack (Fig. 37) to the dual purpose shed (Fig. 38), which can be used seasonally for the harvest and for the rest of the year as an implement or hay shed.¹ The main considerations to be borne in mind in the design of grain-drying racks are that they must be firmly built to carry a considerable weight, and that the sheds must be adequately braced against wind pressure. The wires must be so spaced that they will permit of the easy insertion of the sheaves, but will not waste space. The horizontal wires should be strained reasonably tight but should be free to slide vertically within certain limits in order to facilitate filling the rack. This result can be achieved by fixing vertical wires to the uprights and placing the horizontal wires behind these. The lowest position of each horizontal wire is fixed by a staple through which the vertical wire is passed, but the horizontal wires are free to move vertically between any pair of staples. Racks should not

¹ See *Scottish Journal of Agriculture*, 1918, "Grain-Drying Sheds," by G. W. Constable, F.S.I.

Fig. 37. Richmond Type

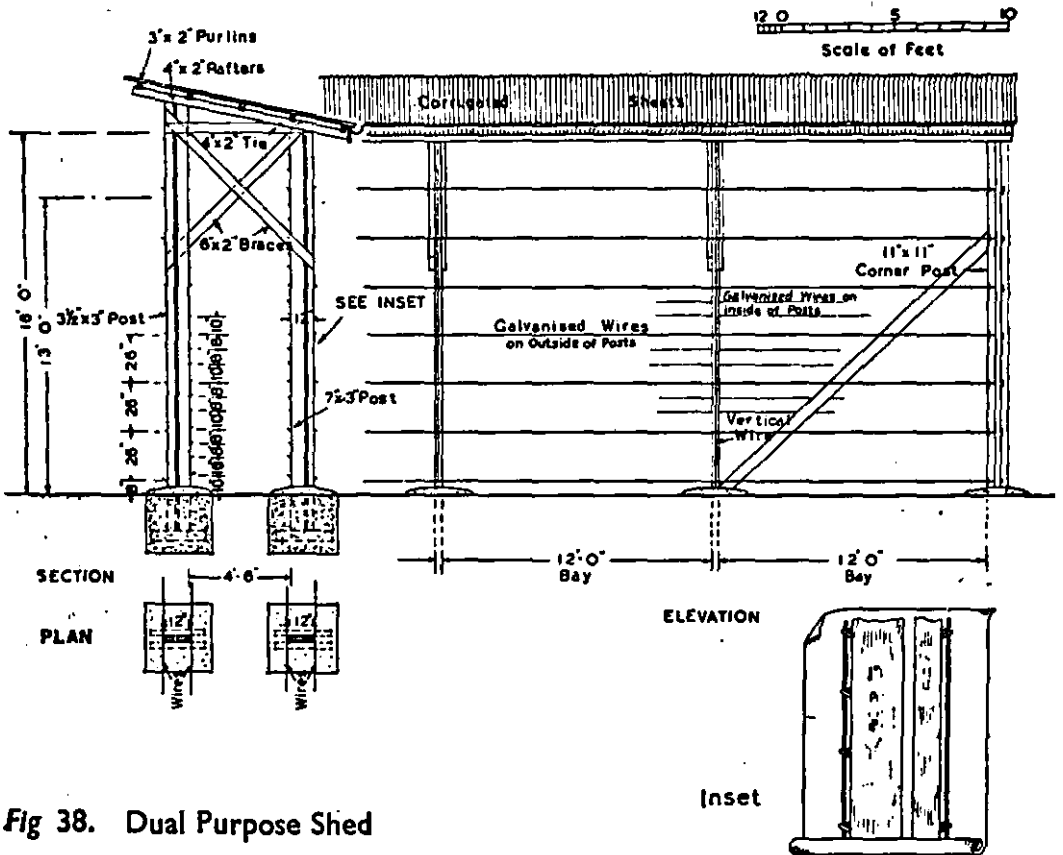
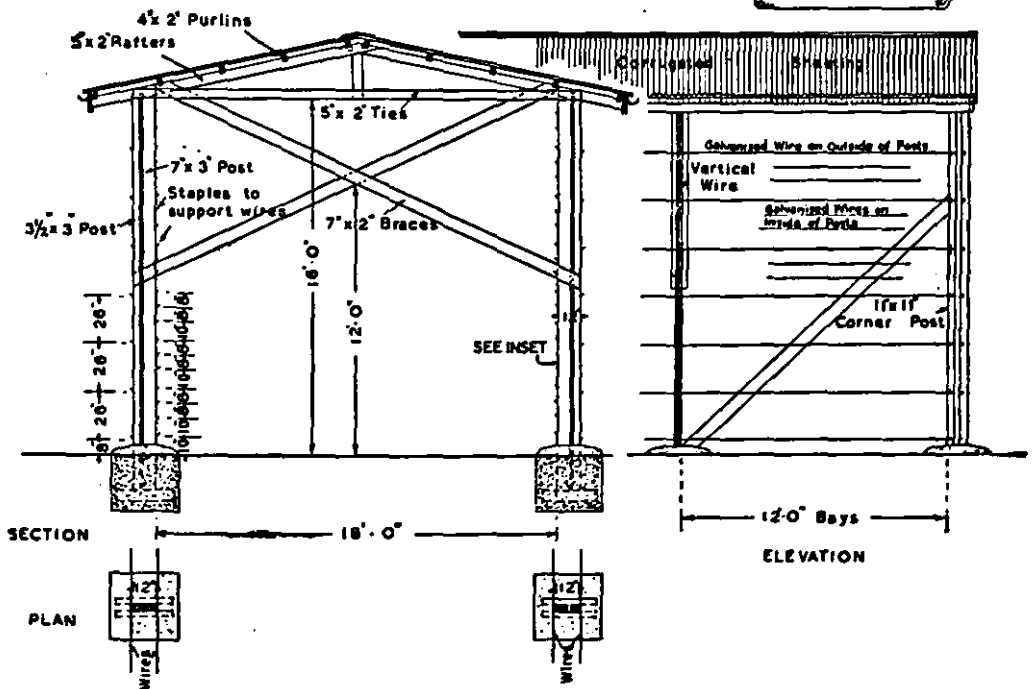


Fig 38. Dual Purpose Shed



GRAIN-DRYING RACKS

FARM BUILDINGS FOR SCOTLAND

be constructed to too great a height, since in practice considerable difficulty is found in filling the upper layers and the lighter types are more liable to be blown over. In siting the grain-drying rack, care should be taken to place it end-on to the prevailing wind, and as far as possible from the shelter of buildings and trees.

STACKYARDS

203. In permanent stackyards it is an advantage to have stands to keep the sheaves off the ground for protection against vermin and ground moisture. These stands should be mushroom-shaped and about 2 ft. in height. Where stack props are used they should be fitted with metal collars to prevent the ascent of rats, and for the same reason it is important that ropes should not trail from the stacks to the ground.

BUILDINGS FOR SHEEP FARMING (FIGS. 39 AND 40)

204. The buildings required on the average hill sheep farm in this country are of a relatively simple nature. They consist mainly of provision for horses and cows, the barn accommodation necessary for the cultivation of the small area of arable land or "inbye" meadows normally attached to the farm, and a hay shed for winter feeding during periods of storm. With regard to the special buildings needed on a sheep farm, particular attention has been given to the arrangement of the collecting pens, dippers, etc., necessary for the working of this class of farm.

TANKS AND DIPPERS (Figs. 39 and 40)

205. An essential requisite for the control of certain forms of disease on a sheep farm is the provision of adequate arrangements for the dipping of the sheep stock. For this purpose pens should be provided sufficient to handle a day's dipping of, say, four to five hundred sheep with lambs. As part of the equipment there should be a shed to accommodate, say, two hundred sheep for use as a standby in the event of a change in weather during dipping operations. In suitable weather the sheep should be kept in the open as far as possible. Fig. 39 shows an arrangement of pens designed to reduce labour in handling.

206. In regard to dippers there is a divergence of opinion on the question whether the sheep should be merely "dipped" or forced to "swim" through the bath. In view of this two designs for baths are shown (Fig. 40), the one for a dipper of about 300 gallons capacity and the other for a swimmer of about 750 gallons capacity. A foot bath should be placed beside the dipping tanks. In the design of the dipper the object is to obviate the waste of dip as far as possible while preventing droppings from being washed back and fouling the bath. For this purpose it is desirable to have a trap or settling chamber to settle the fluid before it returns to the dipper. It is also desirable to have a controlled intercepting drain to run off rainwater, and thereby prevent dilution of the dipping solution contained in the bath.

207. The disposal of the spent dip is a problem which frequently causes difficulty. The only practical solution is to run it into a "soakaway" formed in the earth. A large pit should be sunk and filled with broken stones loosely packed so that the dip discharged into the pit will gradually soak away into the surrounding subsoil, without gaining direct access to any open water course or underground drain. In cases where the dipping tanks are situated on rocky ground the most practical method of disposing of the spent dip is to conduct it by pipes to the nearest suitable point for the construction of a soakaway as referred to above. Spent dip and disinfectants should not be discharged into septic tanks, as they arrest bacterial action. The location of dippers should be selected so as to obviate risk of pollution of the gathering grounds for public or private water supplies.

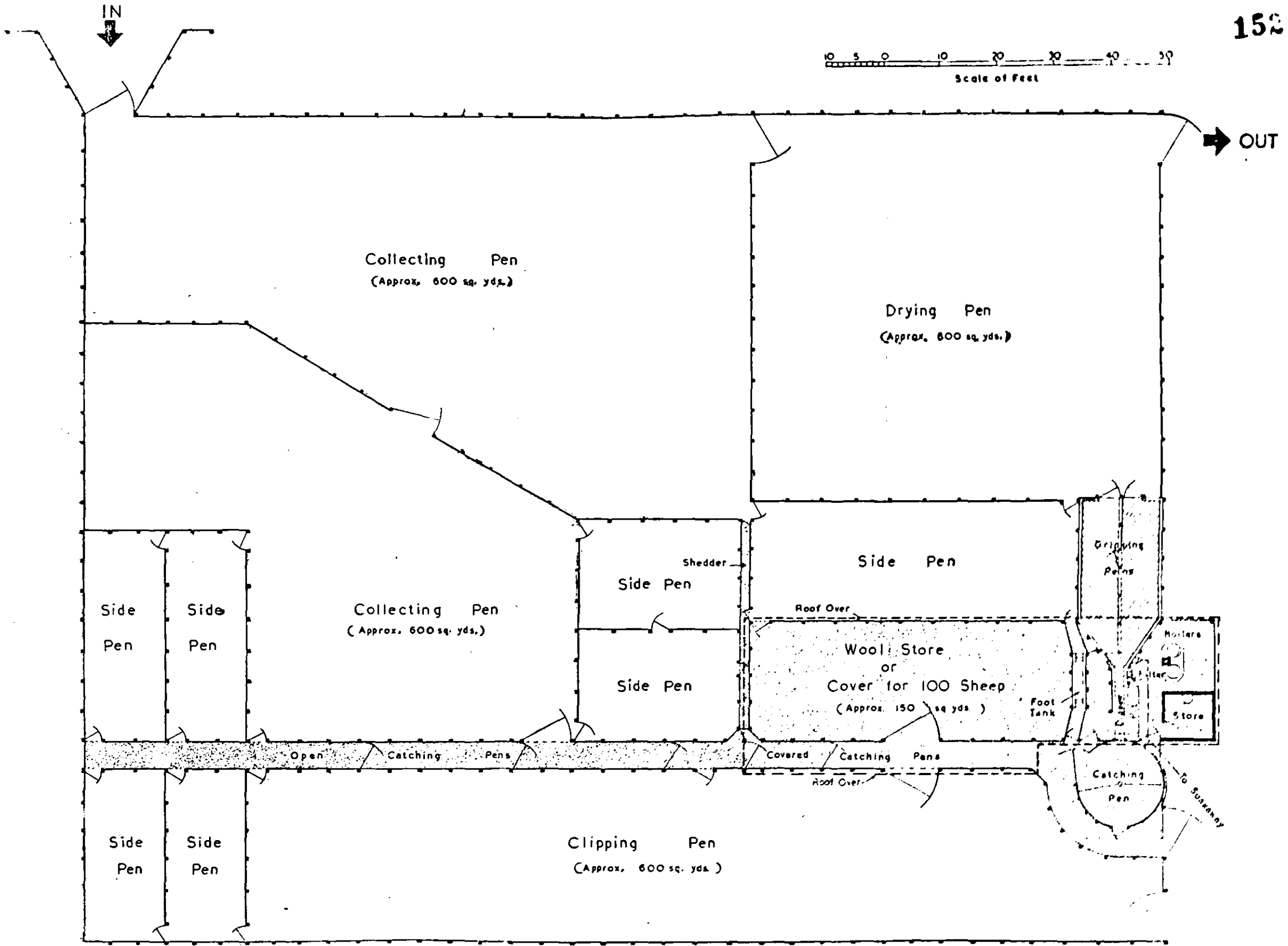
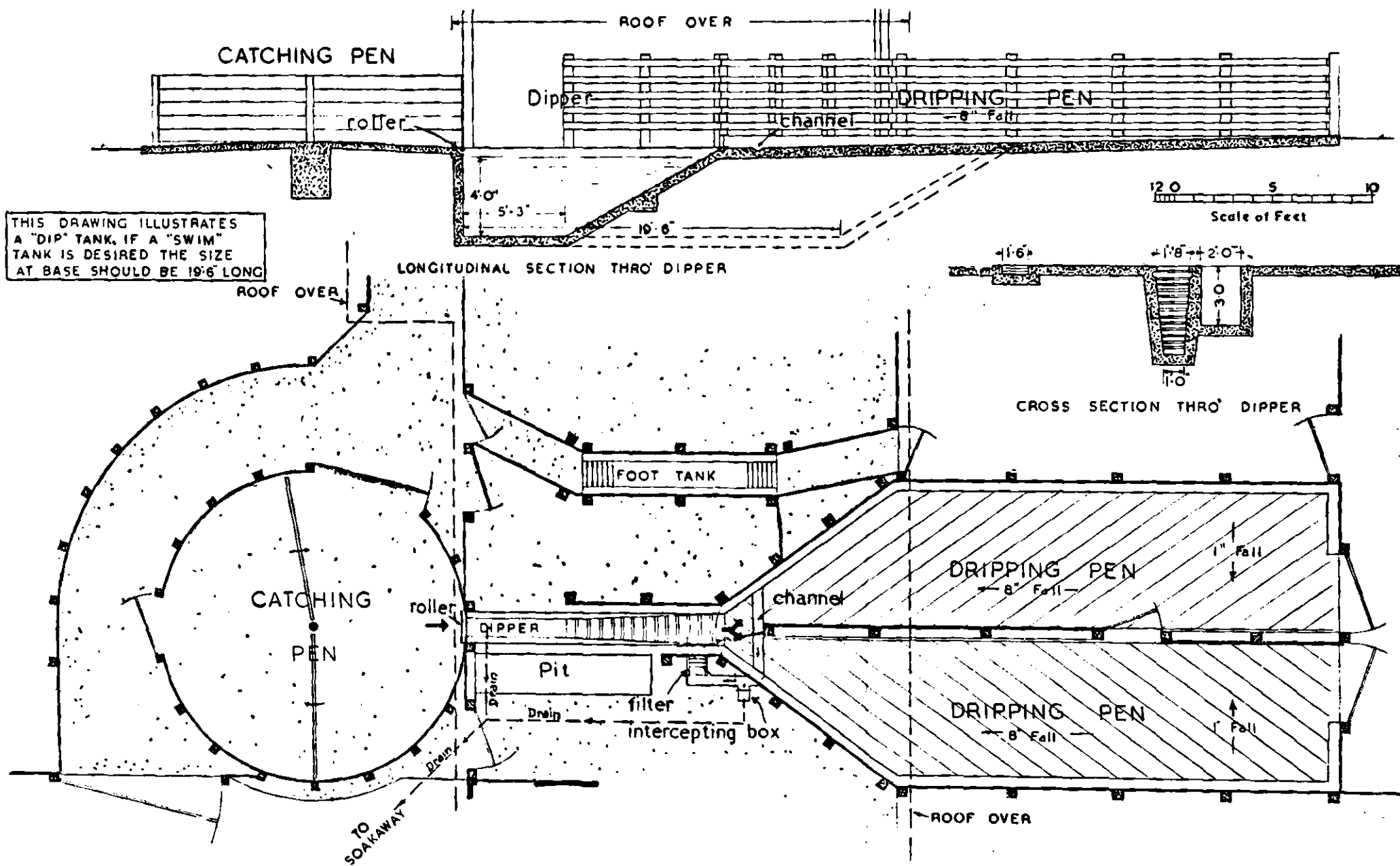


Fig. 39. Plan of Sheep-Dipper and Collecting Pens or Fanks



THIS DRAWING ILLUSTRATES A "DIP" TANK. IF A "SWIM" TANK IS DESIRED THE SIZE AT BASE SHOULD BE 19'-6" LONG

Fig. 40. Design for Sheep-Dipper

ARABLE, SHEEP FARMING, AND CROFTS

COVERED PENS

208. The covered portion of the unit should consist of a number of the pens, the dipper, the dripper, the boiler, and a store. On farms where the dipping unit is placed at some distance from the steading, it is an advantage to have a small shed with a fireplace, accommodation for implements, medicines, clothing, etc., as well as space for a small portable engine for shearing.

HIGHLAND CROFT BUILDINGS

209. Layout plan Q, previously referred to in paragraph 66, shows the accommodation normally required for an ordinary Highland croft holding of 5 to 10 acres. Attention is drawn to an effective method of crop drying which is commonly incorporated into the croft buildings from Argyll to Ross-shire. This consists essentially of large ventilating openings in the windward and lee sides of the barn. These extend from about 1 ft. or 1 ft. 6 in. above floor level to the eaves, and are 3 ft. to 4 ft. wide on either side of the door and 6 ft. to 10 ft. wide in the rear side. In the old form of barn these openings were covered by a row of upright poles with heather interlaced, to prevent the entry of rain. The hay or grain crop was placed on poles within the barn sloping towards the eaves of the windward wall. In the most modern barns of this type the upright poles and heather are replaced by a rainproof louvre ventilating grating made of timber slats. The effect is to allow a constant stream of air to pass through the barn, while excluding rain. This idea is recommended to farmers working in windy districts with heavy rainfall.

210. The buildings as a whole should normally be erected of stone, built in lime or cement mortar, or of cement concrete. They should preferably be roofed with slates, but galvanized corrugated steel or corrugated asbestos-cement sheets also provide an effective covering. In districts relatively near to the sea-shore, and particularly in buildings subject to the humid conditions usually associated with the housing of animals, it has been found that galvanized corrugated steel has a comparatively short life. On the other hand, genuine puddled iron corrugated sheets when galvanized have a remarkably long period of usefulness. Where corrugated asbestos-cement sheets are used they should, in the interests of amenity, be coloured.

SECTION VI. MATERIALS AND CONSTRUCTIONAL METHODS

BUILDING STANDARDS

211. On a long-term view of building works, it is inadvisable to seek economy in the erection of steadings by lowering the standards of building construction. The most appropriate materials, methods of construction, and fittings should be used, and economy in building should be achieved by skilful planning and arrangement. The construction of solid floors and walls can be reduced in proportion as the steading is concentrated into smaller space, but a balance has ultimately to be struck between economy in building and the essential minimum accommodation required for the holding, and the labour-saving arrangements for work within the buildings.

MATERIALS

212. Under modern conditions the diversity of materials of construction available is very great.

Fig. 41. Timber Truss

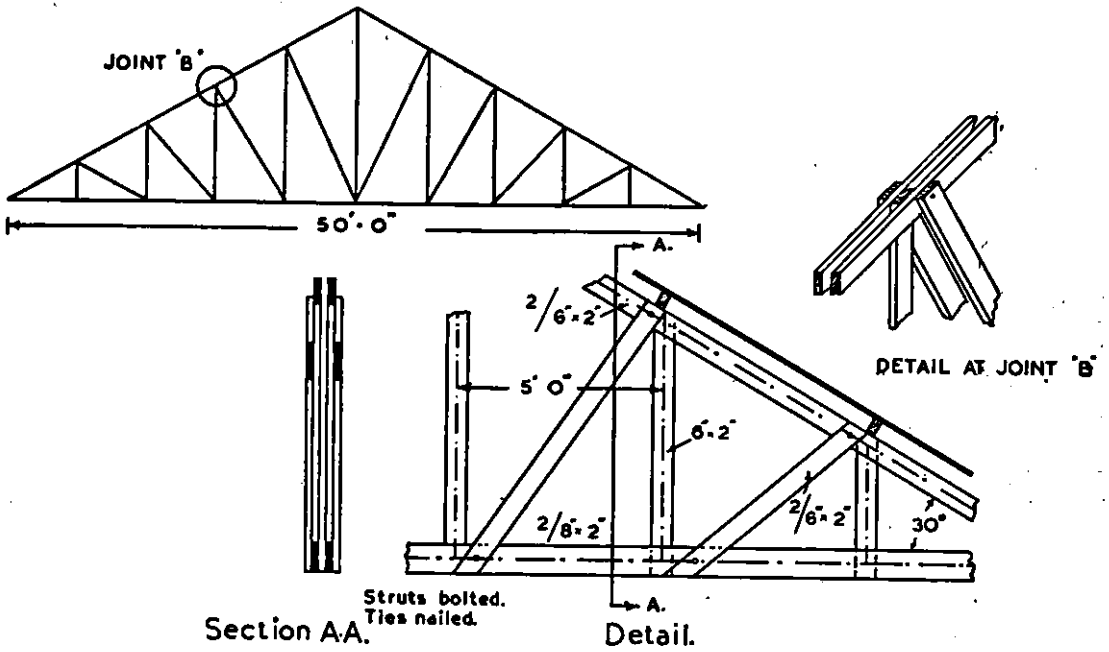


Fig. 42. Steel Truss

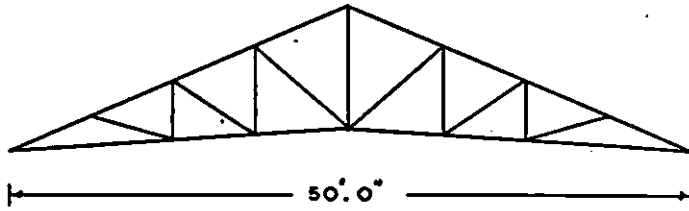
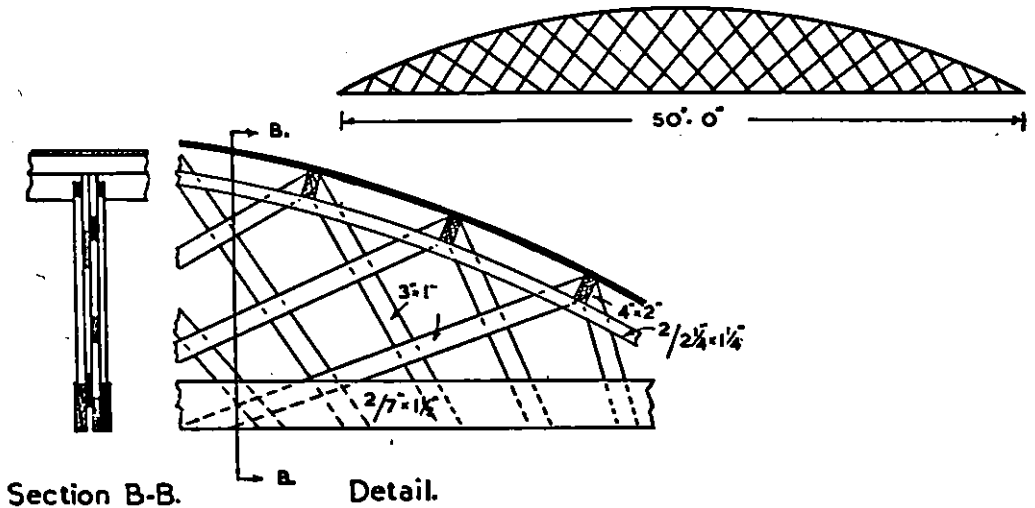


Fig. 43. Timber Truss—Belfast Type



LIGHT-WEIGHT ROOF TRUSSES

MATERIALS AND CONSTRUCTIONAL METHODS

213. The cost of transport is a ruling factor in the choice of materials. A generation ago transport was of a relatively elementary character; and as a consequence the material which was most plentiful in a given locality was used for construction and came to be accepted as the standard material for that locality. Thus in one part of the country one would find whinstone rubble recognized as the best and only suitable material for walling, while in others there would be strong prejudices against the use of whinstone, and in these districts freestone might find favour. In other parts of the country the accepted material was flagstone and in others brick. With the advent of long distance and relatively cheap door-to-door transport there has been a tendency for local customs to lose their hold, and it may be stated that the present trend is towards the use of standardized materials such as brick, or plastic materials such as concrete. In the drawings the use of these materials is envisaged. In cases where they are not available it will be a simple matter to adapt the designs to meet the circumstances.

ROOFS (Figs. 41, 42, and 43)

214. The selection of roofing materials gives an opportunity for a variety of treatments and a number of important considerations arise. In buildings of large span, weight of materials has to be taken into account. We have at our disposal roofing materials which were not available to our forefathers, and which permit of the covering of large areas with the aid of relatively light-weight trusses, such as ridged or curved roofs constructed in timber or steel. These are illustrated in Figs. 41, 42, and 43. The type to be adopted is a matter of personal choice. When these are used it is possible to cover a roof with light-weight materials such as corrugated asbestos-cement sheeting, sarking, and felt, or corrugated iron or steel which may be either painted, galvanized, or treated on both faces with a proprietary bituminous preparation. As stated in paragraph 210 it has been found from experience that puddled iron used for corrugated sheets has a much longer period of usefulness than steel similarly used, but unless a special order is given, corrugated steel is the normal article supplied by manufacturers.

215. The light-weight roofs shown would not normally be suitable for the support of conveyors, although they could be structurally designed to take the vibration and loading stresses set up by these appliances.

216. In considering the light-weight roofs referred to it must be borne in mind that their heat insulation properties are low. Buildings so roofed are apt to be hot in summer and cold in winter, and under certain conditions of internal and external temperature, trouble with condensation and drip is difficult to avoid.

217. With the use of roofs of this type it should be possible to cover large areas, leaving the internal subdivisions of the building to be formed by simple light-weight partitions which, being independent of the roof, can be taken down or altered as circumstances demand.

218. When heavier types of roof-covering are desired the cost of large span trusses increases substantially and their use becomes uneconomic. The standard type of roof covering, namely slates and clay tiles, is heavy and necessitates heavy timber, as does the use of concrete or heavy asbestos tiles.

FLOORS

219. The ground floors of all buildings in the steading with the exception of courts should have strong and impervious floors. The use of beaten earth, cobbles, and similar types should be strongly discouraged.

220. Amongst the materials which form satisfactory floors, that most commonly used to-day is cement concrete. Before laying cement concrete floors care should be taken to lay a proper foundation or bottoming of broken stones, and to ensure that the areas laid in one operation are limited in size so as to minimize cracking as the

FARM BUILDINGS FOR SCOTLAND

concrete sets. Ordinary concrete floors are apt to be dusty, but this fault can largely be overcome by the use of granite chips and a silicate hardening solution when laying the floor. No concrete or stone floor laid on the ground is completely impervious to moisture, and in cases where absolute dryness is essential, the desired end can be attained by laying a layer of bituminous asphalt over the bottoming before laying the concrete. This layer should make contact at the edges with the damp-proof course in the walls. Nowadays the provision of a damp-proof layer of this type can be achieved by the use of colloidal bituminous solution—a liquid which can be poured on cold and hardens on exposure to the air. Its use eliminates the need for the transport and employment of “tar boilers.”

221. Where floors require to be brushed, or must be dustless, the use of tar macadam is not advocated. Asphalt floors do not have the dust or damp problems associated with concrete floors. They have, however, certain other defects, though the chief of these, slipperiness, is said to be absent in the case of certain proprietary makes.

PREFABRICATION

222. The use of prefabricated materials for farm buildings should be carefully considered, and attention is drawn to the possibilities of this method of manufacture for such articles as stall divisions and more modern and hygienic troughs, and generally for the design of sectional buildings. The standardization and prefabrication of fittings is, however, likely to be of much more benefit to the farming community than any attempt to prefabricate the buildings, since in the latter case transport considerations become a matter of prime importance.

223. It is possible that for some time after the end of the war, there may be a scarcity of certain classes of building materials, and alternatives for the standard types of construction may have to be found. Reference may be made to various proprietary systems of precast concrete roof trusses and roof coverings which are on the market. It is, however, thought that the main help in this connection will be the use of concrete for walls instead of masonry or brickwork.

HANGARS AND CORRUGATED STEEL HUTS

224. The possibility of using disused hangars and corrugated steel huts as steady buildings has been considered. Although large numbers of these structures will become available at a time when building operations will be restricted, we have come to the conclusion that their utilization on farms will in the majority of cases not be justified, partly on account of their unsuitability for agricultural purposes, and partly because of the cost which would be incurred in removal, adaptation, and re-erection. Further, all buildings suffer in the process of transfer, and accordingly the life of the adapted buildings would be considerably lessened as compared with new structures. However, in view of the inevitable scarcity of labour and building materials after the war, these wartime structures should be made available to farmers who wish to use them.

SECTION VII. SERVICES

The term “Services” is used in the sense given to the word in the architectural profession. It includes such matters as water supplies, electricity, gas, drainage, roads, etc.

WATER

225. An adequate water supply is essential to all premises where animals are kept. In planning supplies every effort should be made to ensure that the supply is sufficient both in quantity and in pressure.

SERVICES

226. To save labour water should be laid on for all regular uses, such as the watering of the livestock and flushing of byres and dairy buildings, etc., and further, an adequate number of taps throughout the steading should be provided for occasional use.

227. The piping for a water supply should be laid at a sufficient depth below the ground to ensure safety from the risk of damage by frost or traffic. In the designing of the water-supply system, it is advisable to lay mains of a size sufficient to supply fire-extinguishing appliances. Where this is not practicable the piping system should (unless local storage is provided) be of a capacity sufficient to deal with one-fourth of the daily demand in one hour.

228. In many cases a supply of this sort will only be practicable when connection can be made to the mains of the Local Authority.

229. In the layout of the buildings and water-supply system, economy in working costs and also in the quantity of water consumed may be effected by the construction of underground storage tanks into which the water from the cooler, and in certain circumstances water from the roofs, may be discharged. Such water can, by means of a suitable pump, be utilized for the flushing of byres and other farm purposes.

230. There is considerable uncertainty as to the demand for water which may be experienced on a farm, and some guidance in estimating this is desirable. From the literature which has been published on the subject, the general opinion would appear to be that an allowance of 25 to 30 gallons per head of milk cows on a farm, with supplies for the remainder of the stock, will give a reasonable approximation to the requirements. Stated in another way, the requirements of water may be approximately estimated from the following figures:

| | | | | | |
|---------------------------------------|-------|---------|---------|----------|-------------------------------|
| Milk cows | about | 12 | gallons | per head | per day |
| Milk cooling | " | 3 to 4 | " | " | gallon of milk cooled per day |
| Byre, dairy and utensil washing, etc. | " | 7 | " | " | cow per day |
| Other cattle | " | 7 to 10 | " | " | head per day |
| Horses | " | 10 | " | " | " " |
| Pigs | " | 2 | " | " | " " |
| Poultry | " | 4 to 5 | " | " | 100 birds per day |
| Sanitary conveniences | " | 10 | " | " | person per day |

231. As an alternative to the foregoing method of estimating, the consumpt on a mixed arable and dairy farm may be estimated on the basis that the stock and personnel employed on the farm will consume water equivalent to about 7 to 9 gallons per acre on the holding per day.

232. All the figures mentioned apply to times and cases where all water is drawn from the mains, but in summer time when stock may be drinking from streams, the consumpt might be expected to be less. Obviously where grazings are watered by troughs supplied from the mains, this reduction cannot be looked for.

ELECTRICITY

233. Whenever practicable, electricity should be introduced into farm buildings. There is reproduced in Appendix VI the section dealing with farm buildings from the report of the Electrical Installations Committee, Post-War Building Studies No. 11. We are in general agreement with the conclusions of this report. In regard to two points of detail, however, we consider that cord-operated switches should not be installed in farm buildings, as they are difficult to find in the dark and liable to be damaged by rough use; and that farm steadings should be wired for electricity on the conduit or steel tubing system.

FARM BUILDINGS FOR SCOTLAND

234. Where the cost of transmission lines is such as to render the use of electricity generated by public concerns uneconomic, possible alternative sources of supply are generators driven by petrol, paraffin, or diesel engines, or by waterpower or a windmill. These alternatives are, however, useful in the main for lighting purposes, but necessitate the use of starting and/or storage batteries.

GAS

235. In certain districts, gas may be obtained by connection to long distance mains, and in some cases it may be convenient to utilize cylinders of compressed gas of various proprietary makes. This alternative is mentioned more for the possibilities it offers for such purposes as local heating and processing than from the point of view of illumination. If gas lighting is attempted, very special precautions will be required to minimize risk of fire, from contact with the gas flame or from matches used for ignition.

DRAINAGE

236. Apart from the disposal of roof and surface water, the main objects of drainage works round about farm buildings are the conservation and use of the manurial values of urine and the prevention of pollution of streams by harmful effluents.

237. It is suggested in paragraph 113 that the conservation of manurial values can be best achieved by keeping livestock in littered courts. Where this method of keeping stock is not employed, the conservation of liquid manure can only be effected by a special drainage system leading to an aidle tank. From observations in visits to farms and from consultation with witnesses, it is concluded that aidle tanks are not used now to the same extent as in the past. Various reasons have been assigned for this, particularly the cheapness of artificial fertilizers.

INTERCEPTING CHAMBER

238. As farm drainage frequently contains a considerable amount of heavy material, as well as flocculent material, it is advisable to provide a settling or intercepting chamber as close to the steading as possible so that such material may be collected at the earliest possible point and removed periodically, instead of being allowed to flow down the drain with the risk of chokage. This chamber should be constructed of solid material and the inner surface should be rendered smooth with Portland cement mortar. The cover of the chamber should be of such dimensions that it can be easily removed for inspection and cleaning of the chamber.

AIDLE TANK

239. If aidle tanks are to be used, the drains leading to them should be provided with a bypass, so as to permit byre, etc., washings to be passed direct to the septic tank, leaving the more concentrated urine to be stored in the aidle tank. No rule can be given as to the size of an aidle tank, since this will depend upon the size of the herd and the frequency with which it is proposed to empty the tank and distribute the urine over the land. If such a tank be provided, it should be constructed of concrete or brickwork in cement, and made watertight by a two-coat rendering of cement plaster. The roof should be strong enough to carry the weight of a loaded cart, and provision should be made for the pump, and for access by manhole to the tank.

SEDIMENTATION TANK

240. The state of knowledge in regard to purification works for small quantities of sewage is such as to prevent any final conclusion being reached, and research work on this subject is at the present time being undertaken by the Water Pollution Research Board at the suggestion of this Committee through the Department of Health for Scotland. Considerable variety of opinion exists as to the period for

SERVICES

which sewage should be retained in the tank, and the latest publication on the subject (*Housing Manual 1944—Technical Appendices*) prepared by the Ministry of Health and Ministry of Works suggests the following figures as a basis for design:

| ASSUMED DAILY FLOW IN GALLONS | TANK CAPACITY |
|----------------------------------|---------------|
| 200 | 24 hours flow |
| 400 | 20 " " |
| 600 | 18 " " |
| 1200 | 15 " " |
| 2000 | 12 " " |

In making the calculations of probable discharge of sewage, it may be assumed that the water consumed by stock (as in paragraph 230) will require to be disposed of as sewage, but that water from milk cooling may be disposed of otherwise.

The walls and floor of the sedimentation tank should be of solid construction and the inner surface rendered with cement mortar. The covering of the tank should be so designed that it can be readily removed for inspection and cleaning.

EFFLUENTS

241. The drainage system should be trapped off from the sedimentation tank, and care should be taken that the effluent from this tank is discharged either into a suitable outfall drain where it can cause no offence, or alternatively into a water course with a sufficient flow of water to provide adequate dilution. Silage effluent tends to choke drains, and should be drained into a soakaway with the shortest possible pipe. Effluent from piggeries should be subjected to special treatment independent of the remaining drainage system, as described in paragraph 184.

DRAIN PIPES

242. The general steading drainage system should be laid with self-cleansing gradients, and deep enough to avoid freezing or any possibility of damage arising from traffic. In cases where the tops of the pipes are less than 2 ft. 6 in. below the surface of the ground, they should be protected with concrete. Proper faucet holes should be cut, and the pipes laid on the solid bottom of the trench.

243. Drains will usually be found to be self-cleansing when laid at gradients not flatter than the following:

| DIAMETER | GRADIENT | APPROXIMATE FALL IN INCHES PER YARD |
|----------|----------|--|
| 4" | 1 in 40 | $\frac{7}{8}$ " |
| 5" | 1 in 50 | $\frac{3}{4}$ " |
| 6" | 1 in 60 | $\frac{5}{8}$ " |

244. All branches and junctions should be provided with inspection chambers, and there should be proper traps at the termination of the drains where byre or roof water is discharged into them.

ROADS

245. For the convenient working of all farm buildings properly built roads and courtyards round about the various premises are essential. They are necessary for the comfort and efficiency of the workers, and facilitate the keeping clean of premises where food is produced.

246. The roads should be laid out to give access to all points where goods are handled in bulk, so that labour may be reduced to the minimum. The layout plans are all designed to give maximum access for vehicles to barns and storage sheds, and to permit of circulation of stock, fodder, and goods as required. In the layout of roads, care should be taken to ensure that at proper points there is

FARM BUILDINGS FOR SCOTLAND

sufficient width for the parking and passing of vehicles, and that adequate space is allowed for turning and manœuvring of large lorries. There should be no blind corners, and entrances to fields and yards as well as buildings should be of sufficient width to admit the passage of modern farming machinery. For this purpose, it is suggested that the gateways to fields should be 15 ft. wide, the gates being formed in two halves.

CONSTRUCTION

247. Various methods of road construction have been tried, and experience has shown that the only systems which will stand up to modern conditions are those in which a proper foundation is provided with an adequate wearing surface of properly bound and solidified material. Farm roads in and about the steadings should accordingly be constructed with stone bottoming 9 in. thick. This bottoming should be blinded with ashes, rolled, and the surface covered with 4 in. to 5 in. of sealed and rolled tar macadam, or alternatively whinstone concrete, consisting of 4 parts broken whinstone (the stones being broken to pass through a 2 in. ring), together with 2 parts sand and 1 part Portland cement. The whole should be laid to grade, slightly cambered and well drained. For areas which are likely to be much brushed, concrete should be used.

LOADING RAMPS

248. In the siting of the buildings and in the formation of the roads, advantage should be taken of any natural slope in the ground which will permit of the formation of loading ramps or platforms. Where there are no such gradients, consideration should be given to the desirability of forming loading pits in which vehicles could stand and readily drive out after being loaded. The drainage of such pits is important.

SECTION VIII. AN ADVISORY SERVICE

TRADITIONAL SOURCES OF INFORMATION

249. The design of farm buildings in this country in the past has been the result of a gradual process of evolution. Local traditions have been continuously modified by a variety of sources of information and ideas.

250. Old established local tradition has persisted till the present day in many points of detail design such as the form of roof truss, and the use of local materials. Of the forces making for innovations, probably the most important have been the improving landlord and farm tenant, putting into practice their own ideas and the results of a knowledge wider than the local traditions. In the past such natural extension of the more advanced ideas through those responsible for land management has been a factor making for progress. There is no doubt that Scotland's leadership in methods of farming and farming equipment early in the last century was achieved by the spreading of knowledge locally through individual precept and example. For a long time past the process of education has been aided by the publications of Societies interested in agriculture, and the Journals of the Department of Agriculture for Scotland and the Ministry of Agriculture and Fisheries. More recently the weekly agricultural press have contributed to the published material on farm buildings. The activities of the Agricultural Colleges, possessing buildings of their own, have not been without effect, and we mention in paragraph 262 the useful influence of the Dairy Byelaws in the improvement of the buildings whose construction they govern.

251. All these influences have in our view been of the greatest benefit in the development of ideas on farm buildings, and it would be wrong to suppose that the

AN ADVISORY SERVICE

backward state of the capital equipment of a large proportion of Scottish farms is due to lack of information. Nevertheless, there are a number of considerations suggesting the need for an improvement in the method of dissemination of available knowledge to those concerned with the provision of buildings on farms.

NEW FACTORS

252. In the first place, scientific investigation and experimentation is now being applied increasingly to the solution of problems of animal health, such as ventilation, warmth, and bodily comfort. A considerable amount of work has been done in other countries on these problems, and here also a start has been made. We recommend in paragraph 15 the undertaking of a programme of research aiming at practical results bearing on the design and construction of buildings.

253. Secondly, new building materials and methods of construction are constantly being evolved and applied in general building practice. In Section VI we review the present position in this respect.

254. Thirdly, the introduction of new machines and mechanical aids is constantly affecting building requirements both in major considerations of layout and type of building and in details involving suitability for the use of particular machines. We deal with this question in paragraphs 16 and 17.

255. Of these three important factors, the first two, namely animal health and the methods and materials of construction of buildings, are of a technical nature and the results achieved cannot easily be assessed by the layman. In the present phase of rapid development in all the scientific aspects of farming, it will be increasingly difficult for anyone other than a specialist in farm buildings to co-ordinate the results of scientific advance in the various fields of inquiry. The ideas of the individual landlord, or of the contributors to the agricultural press and to the Transactions of Societies, will continue to perform a useful function in the furtherance of good design, but these traditional sources of information cannot be expected to keep abreast of all modern developments.

PRACTICAL EXPERIENCE

256. Another defect of the unco-ordinated efforts of the past is that there has been no possibility of the farming industry as a whole learning from past failures. No design or method of building can be regarded as of proved value until it has been tested by practical experience, and in the past progress has been achieved very largely by the process of trial and error. Practical experience rather than independent scientific inquiry has been the means of establishing such principles of good design as are generally accepted. This experimentation has been carried out by large numbers of individuals working in ignorance of or at best with a very limited knowledge of results achieved elsewhere. The consequence has been that much practical knowledge acquired by individuals has been lost. The unsuccessful experiment has remained isolated local knowledge, and the causes of failure have not been ascertained and checked against similar experience elsewhere. Equally the example of successful building has had a limited educational effect, and contributed less than it might to the ascertainment of sound principles of building. To remedy the failure to benefit from practical experience, is, like the adequate assessment of scientific progress, beyond the capacity of existing channels of information.

NEED FOR ADVISORY SERVICE

257. As a large amount of new building and reconstruction will be needed in the coming years to make up for a long period of depression and neglect, and for the reasons given in the preceding paragraphs, this is an appropriate time to begin with the provision of authoritative architectural and other scientific advice. In

FARM BUILDINGS FOR SCOTLAND

the present Report we specify the most suitable types of buildings for various purposes and give detailed recommendations on their design and construction. However, it has not been possible to review all the types of building more or less suitable for use in this country, and expert advice will therefore be required on the many problems which will arise. Further, our Report cannot cope with the special needs of the individual case, and it will in course of time have to be supplemented as new methods and materials become available. To provide the necessary help a permanent advisory service should be established for the regular collection and dissemination of advice on farm buildings.

FUNCTIONS OF SERVICE

258. The functions of the service in the matter of acquiring information would be the following:

1. To review the results of scientific experimentation conducted in the research institutes of all countries of advanced agriculture and initiate further programmes of research in the light of the practical problems of this country's farming industry still awaiting solution.
2. To keep under review the published material on farm buildings appearing in the agricultural, architectural, and general scientific press of this and other countries.
3. To consult and exchange information with the equivalent technical sections of other agricultural departments, and keep their publications under review.
To study systematically the modern farm buildings in Scotland, and to draw conclusions from the practical experience of those working in them; and further to enlist the co-operation of individuals erecting new buildings in practical experiments designed to test the results of research and other information.

259. The service should co-ordinate the results of its various sources of information, and assess them in the light of Scottish conditions, including climate, local materials, characteristics of animal breeds, and farming methods. They should convey their conclusions to the farming industry in the form of plans and specifications of buildings appropriate to our conditions. Advice on particular projects should be regularly available on application by the individual farmer, landlord, architect, or other interested parties. General directions and model plans should also be published from time to time to illustrate new methods and materials, both in the form of separate bulletins and in any other form that may lead to adequate publicity.

FORM OF SERVICE

260. To discharge these functions adequately, the service would have to be a single one for the whole of Scotland. It would lead to duplication of effort, and unsatisfactory results, if the task were spread over a number of local bodies, each acting in its own area. It is our view that the service could best be provided by the Department of Agriculture for Scotland, who should be entrusted with the collection, assessment, and dissemination of information about farm buildings. The Department has the necessary regional machinery for local inquiry. It should be assisted by an Advisory Committee representative of all interests concerned with farm buildings, and including representation of the Research Institutes and Agricultural Colleges, and it will also be able to maintain contact with Local Authorities, who exercise powers in regard to hygiene and planning.

THE DAIRY BYELAWS

SECTION IX. THE DAIRY BYELAWS

THE MODEL DAIRY BYELAWS

261. The Milk and Dairies (Scotland) Act, 1914, required local authorities to make byelaws providing among other things "for prescribing and regulating the structure, lighting, ventilation (including air and floor space), cleansing, drainage, washing, and scalding facilities, and water supplies of dairies and their appurtenants." The war of 1914-18 and its after-effects caused a setback in the implementation of this Act, and it was not until 1926 that the then Scottish Board of Health issued *Model Dairy Byelaws* specifying the manner of laying down structural standards for dairy buildings. In the years following, local authorities enacted byelaws within the framework suggested by the Board of Health, and these at present govern the general structure of dairy buildings.

LOCAL VARIATIONS

262. The several local authority byelaws, which have been applied under the supervision of the officers of county councils and of town councils of large burghs, have undoubtedly contributed to the raising of the standards of premises in which milk is produced, and to the education of farming opinion. We feel, however, that it is no detraction from the valuable work that has been done by these councils and their officers to draw attention to the wide diversity in the standards set by different local authorities, and to the variety of views to which authorities give effect in their decisions on matters which are left to their discretion under the byelaws. The local authorities' standards vary in the case of the minimum requirement of air space per cow in a new byre from 400 to 800 cubic feet, and in the case of minimum lighting area in a new byre from $1\frac{1}{2}$ to 4 sq. ft. per cow; on the whole standards grow more strict in the areas with a shorter tradition of dairy farming. There is also a marked difference between the standards applied to new buildings as compared with existing ones. Standards so divergent cannot all be right, and we have as a result of our investigations come to the conclusion that the standards are in fact in some cases too exacting and in others too lax. Similarly we are of opinion that the divergence in the views of local authority officers, though a natural outcome of independent local responsibility, has caused justified irritation among farmers who are forced to conform to standards which they see disregarded in neighbouring counties.

RECOMMENDATIONS FOR AMENDMENT

263. We recommend that the dairy byelaws, so far as they relate to buildings, be made uniform over the whole area of Scotland, and that provision be made for referring problems arising out of the application of such byelaws to the Secretary of State for Scotland.

We have the honour to be, Sir, Your obedient servants,

WM. C. DAVIDSON, *Chairman*.

JOHN MACKIE.

CHARLES JAMIESON.

MANSFIELD.

ALEXR. KIRKPATRICK.

WM. SALMOND.

J. GILLRAY MCGREGOR.

G. M. SIMPSON, *Secretary*.

17th July 1945.

FARM BUILDINGS FOR SCOTLAND

APPENDIX I

ORGANIZATIONS CONSULTED

Air Ministry.
Association of Certified and T.T. Milk Producers.
Association of County Councils in Scotland.
Ayr County Council.
Ayrshire Cattle Herd Book Society.
Cement and Concrete Association.
Chartered Surveyors' Institution (Scottish Branch).
Department of Agriculture for Scotland.
Department of Health for Scotland.
Department of Scientific and Industrial Research, Building Research Station,
Watford.
Edinburgh and East of Scotland College of Agriculture.
Fire Offices' Scottish Standing Committee.
Hannah Dairy Research Institute.
Highland and Agricultural Society of Scotland.
Institution of Electrical Engineers.
Kirkcudbright County Council.
Land Agents' Society (Inc.) Scottish Branch.
Ministry of Agriculture and Fisheries.
National Farmers' Union and Chamber of Agriculture of Scotland.
National Federation of Building Trades Operatives, Scottish Regional Council.
National Veterinary Medical Association.
North of Scotland College of Agriculture.
Rowett Research Institute.
Royal Incorporation of Architects in Scotland.
Royal Institute of British Architects.
Royal Sanitary Association of Scotland.
Sanitary Inspectors' Association of Scotland.
Scottish Farm Servants' Section, Transport and General Workers' Union.
Scottish Land and Property Federation.
Scottish Pig Producers' Association.
Society of Medical Officers of Health (Scottish Branch).
Stirling County Council.
West of Scotland Agricultural College.

FARMS VISITED

Auchincruive, Ayrshire.
Avernish, Lochalsh, Ross-shire.

Backies, Deskford, Banffshire.
Backmains, Skene, Aberdeenshire.
Balboughty, Scone, Perthshire.
Balgay, Inchtute, Perthshire.
Balig, Ballantrae, Ayrshire.
Balig, Ayr.
Barr, Sanquhar, Dumfriesshire.

APPENDICES

Bent, Laurencekirk, Kincardineshire.
 Blythbank, West Linton, Peeblesshire.
 Bogs of Foudland, Inch, Aberdeenshire.
 Boquhan, Gargunnoch, Stirlingshire.
 Borgue House Estates, Borgue, Kirkcudbrightshire.
 Braehead, Drumblade, Aberdeenshire.
 Broom, Logie, Stirlingshire.
 Broomhill, Drumblade, Aberdeenshire.
 Burnside of Enzie, Rathven, Banffshire.

Carbeth, Killearn, Stirlingshire.
 Chapelford, Rathven, Banffshire.
 Clochmacreich, Deskford, Banffshire.
 Clune, Deskford, Banffshire.
 Corseclays, Colmonell, Ayrshire.
 Cockburn, Balerno, Midlothian.
 Connage, Rathven, Banffshire.
 No. 1 Corntown, Urquhart, Ross-shire.
 No. 7 Corntown, Urquhart, Ross-shire.
 Cotterton, Knockbain, Ross-shire.
 Craibstone, Newhills, Aberdeenshire.
 Cullen House, Cullen, Banffshire.
 Cuttlebrae, Rathven, Banffshire!

No. 118 Drumbuie, Lochalsh, Ross-shire.
 Drumnagair, Marykirk, Kincardineshire.
 Nos. 88 and 89 Durinish, Lochalsh, Ross-shire.
 Duthie Stock Farm, Newhills, Aberdeenshire.
 Dykeside, Alves, Morayshire.

East Barns, Dunbar, East Lothian.
 East Craigs, Corstorphine, Midlothian.
 Easter Ardross, Rosskeen, Ross-shire.
 Easter Urray, Urray, Ross-shire.
 East Fenton, Dirleton, East Lothian.
 No. 127 Erbusaig, Lochalsh, Ross-shire.

Fairburn Tower, Urray, Ross-shire.
 Fenton Barns, Dirleton, East Lothian.
 Ferrygate, Dirleton, East Lothian.
 Fiddlefield, Urray, Ross-shire.
 Findowrie, Brechin, Angus.
 Foot O'Green, St. Ninians, Stirlingshire.

Glasterim, Rathven, Banffshire.
 Gourdie, Liff and Benvie, Angus.
 Grandhome Mains, Oldmachar, Aberdeenshire.
 Greenan, Maybole, Ayrshire.

Hannah Dairy Research Institute, Kirkhill, Ayrshire.
 Heugh, North Berwick, East Lothian.
 Hillbrae, Culsalmond, Aberdeenshire.
 Hill of Corskie, Cluny, Aberdeenshire.
 Hobsland, Monkton, Ayrshire.
 Holl, Rathven, Banffshire.
 Humble, Kirknewton, Midlothian.

FARM BUILDINGS FOR SCOTLAND

Kindrum Park, Logiealmond, Perthshire.
Kirkton, Lochalsh, Ross-shire.
Knockycoid, Colmonell, Ayrshire.

Ladykirk Home Farm, Monkton, Ayrshire.
Level, Birnie, Morayshire.
Linkwood, Elgin, Morayshire.
Lochton, Longforgan, Perthshire.

Malcolmburn, Boharm, Banffshire.
Megginch, Errol, Perthshire.
Mersington, Greenlaw, Berwickshire.
Midtown of Badenspink, Fordyce, Banffshire.
Milton of Noth, Rhynie, Aberdeenshire.
Moncur, Inchtute, Perthshire.
Muirton, Tibbermore, Perthshire.

Newbigging, Rathven, Banffshire.
Northfoot, Grangemouth, Stirlingshire.

Ordens, Boyndie, Banffshire.
Oxhill Mains, Rathven, Banffshire.

Pathhead, Spott, East Lothian.
Perryston, Ayr.
Pitglassie, Dingwall, Ross-shire.
No. 215 Plockton, Lochalsh, Ross-shire.

Rhumore, Lochalsh, Ross-shire.

No. 454 Sallachy, Lochalsh, Ross-shire.
Seton Mains, Gladsmuir, East Lothian.
Shothead, Balerno, Midlothian.
Skares, Culsalmond, Aberdeenshire.
Skateraw, Innerwick, East Lothian.
Slackend, Rathven, Banffshire.
Smerick, Rathven, Banffshire.
South Auchenbrain, Mauchline, Ayrshire.
Sunnybrae, Rathven, Banffshire.
Sunnyside, Prestonkirk, East Lothian.

Tillyfour, Tough, Aberdeenshire.
Tillynaught, Fordyce, Banffshire.

Upper Corskie, Cluny, Aberdeenshire.
Urquhart Farm, Urquhart, Ross-shire.

Walston Mansion, Walston, Lanarkshire.
Wellheads, Fordyce, Banffshire.
West Fonet, Skene, Aberdeenshire.
West Roucan, Torthorwald, Dumfriesshire.
Whinbraes, Drumblade, Aberdeenshire.
Woolfords, Carnwath, Lanarkshire.

* The breadths given in Appendix II on opposite page for power-drawn Sower and for horse-drawn Broadcaster and Harrow are for those machines when in use in the field. When in transit from field to field they do not require the same width.

APPENDIX II

LIST GIVING DIMENSIONS OF PRINCIPAL POWER AND HORSE-DRAWN IMPLEMENTS

| DESCRIPTION | LENGTH | BREADTH | HEIGHT | ESTIMATED DIAM. OF TURNING CIRCLE |
|--|------------------|------------------|-----------------|--------------------------------------|
| POWER | | | | |
| Baler—large | 22' 0" | 8' 0" | 8' 6" | 60' 0" |
| Baler—small | 6' 0" | 7' 6" | 6' 0" | — |
| Binder | 13' 0" to 14' 3" | 7' 0" to 8' 5" | 6' 8" to 9' 0" | 24' 0" to 32' 0" |
| Bottle Filling Machine | 2' 0" | 2' 6" | 4' 0" | — |
| Breaker—Cake | 2' 6" | 3' 6" | 4' 2" | — |
| Cooler—Food | 5' 0" | 3' 0" | 2' 6" | 10' 0" |
| Cooler—Milk | 2' 6" | 3' 0" | 6' 8" | — |
| Crimper—Straw | 10' 0" | 5' 6" | 6' 0" | 26' 0" |
| Cultivator | 8' 6" | 7' 3" | 4' 6" | 20' 0" |
| Cutlift | 12' 0" | 12' 0" | 10' 6" | 28' 0" |
| Cutter—Turnip | 4' 3" | 4' 0" | 4' 6" | 12' 0" |
| Digger—Potato | 7' 0" to 11' 3" | 3' 3" to 7' 6" | 4' 0" to 5' 9" | 18' 0" to 26' 0" |
| Digger—Potato, with picker attached | 18' 0" | 7' 6" | 4' 6" | 46' 0" |
| Driller—Seed | 6' 0" to 10' 0" | 10' 0" to 24' 6" | 4' 0" to 6' 0" | 24' 0" to 60' 0" |
| Elevator—Grass | 12' 6" | 7' 0" | 7' 0" | 30' 0" |
| Float—Sheep and Cattle | 26' 6" | 7' 3" | 10' 0" | 60' 0" |
| Float—Trailer | 20' 0" | 7' 3" | 10' 0" | 50' 0" |
| Harrow—Disc | 7' 0" to 13' 0" | 8' 9" to 10' 0" | 2' 6" to 6' 0" | 22' 0" to 32' 0" |
| Harvester—Combine | 23' 0" | 13' 6" | 10' 10" | 56' 0" |
| Manure Spreader—Cart | 15' 0" | 6' 0" | 3' 4' 9" | 36' 0" |
| Manure Distributor | 6' 0" to 7' 0" | 10' 0" to 10' 8" | 3' 9" to 4' 0" | 24' 0" to 26' 0" |
| Matting Machine—Straw | 3' 0" | 6' 4' 6" | 4' 4' 6" | — |
| Mill—Threshing | 13' 0" to 22' 3" | 6' 0" to 8' 0" | 9' 6" to 11' 0" | 30' 0" to 50' 0" |
| Mower | 8' 4" | 5' 8" | 6' 0" | 20' 0" |
| Plough—Single furrow | 4' 8" to 8' 0" | 3' 6" to 4' 3" | 3' 6" to 5' 6" | 20' 0" |
| Plough—Two furrow | 10' 0" to 11' 0" | 4' 4" to 4' 6" | 3' 6" to 5' 4" | 26' 0" to 32' 0" |
| Plough—Three furrow | 12' 0" | 4' 4" to 4' 6" | 3' 6" to 5' 4" | 32' 0" to 34' 0" |
| Plough—Four furrow | 11' 9" to 16' 0" | 4' 9" to 6' 3" | 5' 0" to 6' 0" | 32' 0" to 42' 0" |
| Plough—Three Drill | 4' 0" | 7' 0" | 3' 6" | 70' 0" |
| Reaper | 8' 0" | 9' 0" | 3' 6" | 24' 0" |
| Roller | 4' 6" to 8' 0" | 7' 0" to 8' 4" | 2' 0" to 2' 3" | 20' 0" |
| Separator—Milk | 2' 0" | 2' 0" | 3' 9" | — |
| Sorter—Potato | 18' 0" | 3' 9" | 5' 0" | — |
| Sower* | 6' 0" | 16' 0" | 4' 0" | 26' 0" |
| Spraying Machine | 10' 0" | 16' 0" | 9' 0" | 30' 0" |
| Sweep | 12' 0" | 10' 0" | 3' 3" | — |
| Tractor | 7' 7" to 10' 6" | 4' 4" to 7' 3" | 4' 2" to 6' 8" | 15' 0" to 40' 0" |
| Trailer | 14' 0" to 16' 6" | 6' 6" to 7' 6" | 3' 4" to 6' 0" | 32' 0" to 40' 0" |
| Truck | 16' 0" | 6' 0" | 4' 6" | 36' 0" |
| HORSE | | | | |
| Broadcaster | 12' 0" | 18' 0" | 3' 6" | 36' 0" |
| Cart—Box | 13' 0" | 5' 0" | 6' 0" | 30' 0" |
| Cart—Corn | 18' 0" | 6' 3" | 4' 10" | 40' 0" |
| Collector—Hay | 6' 0" | 10' 0" | 2' 6" | — |
| Coverer—Potato—3 Drill | 12' 0" | 6' 0" | 2' 3' 6" | 30' 0" |
| Cultivator | 5' 0" to 6' 0" | 7' 3" to 7' 6" | 2' 3" to 4' 0" | 16' 0" |
| Digger—Potato | 14' 6" | 5' 6" | 4' 9" | 32' 0" |
| Driller—Seed [Cart | 17' 0" | 9' 0" | 4' 6" | 40' 0" |
| Frame—Harvest for Box | 8' 6" | 6' 6" | 1' 6" | — |
| Harrow* | 6' 0" | 18' 0" | 2' 0" | 16' 0" |
| Lorry | 19' 0" | 5' 0" | 3' 4" | 42' 0" |
| Planter—Cabbage | 8' 2" | 4' 6" | 3' 3" | 20' 0" |
| Planter—Potato | 13' 0" | 5' 6" | 4' 6" | 30' 0" |
| Plough—Single furrow | 11' 0" | 2' 4" | 2' 9" | 26' 0" |
| Plough—Drill | 12' 0" | 2' 0" | 2' 6" | 28' 0" |
| Rake | 12' 0" | 9' 0" | 5' 0" | 28' 0" |
| Reaper | 15' 0" | 10' 0" | 5' 6" | 34' 0" |
| Roller | 12' 0" to 14' 6" | 6' 9" to 10' 6" | 3' 0" to 3' 9" | 28' 0" to 32' 0" |
| Sowing Machine—Turnip | 10' 0" | 4' 8" | 3' 0" | 24' 0" |
| Turner—Hay | 9' 0" | 7' 0" | 5' 0" | 30' 0" |
| HAND | | | | |
| Barrow | 5' 9" | 2' 8" | 2' 0" | — |

APPENDIX III
ECONOMIC CLASSIFICATION OF AGRICULTURAL HOLDINGS, 1927

| TYPE OF HOLDING | SCOTLAND | | | HIGHLAND COUNTIES (a) | | | OTHER COUNTIES | | |
|--------------------------|-----------------|---------------------------------------|-----------------------------|-----------------------|---------------------------------------|-----------------------------|-----------------|---------------------------------------|-----------------------------|
| | No. of Holdings | Total Acreage including Rough Grazing | Average Acreage per Holding | No. of Holdings | Total Acreage including Rough Grazing | Average Acreage per Holding | No. of Holdings | Total Acreage including Rough Grazing | Average Acreage per Holding |
| Dairy Farms (b) | 7,165 | 1,544,324 | 215·5 | 542 | 149,958 | 276·7 | 6,623 | 1,394,366 | 210·5 |
| Hill Sheep Farms (c) | 1,866 | 6,098,865 | 3268·4 | 821 | 3,987,519 | 4856·9 | 1,045 | 2,111,346 | 2020·4 |
| Other Farms (d) | 14,251 | 3,980,315 | 279·3 | 2,845 | 1,109,857 | 390·1 | 11,406 | 2,870,458 | 251·7 |
| Dairy Small Holdings (e) | 1,930 | 77,717 | 40·3 | 387 | 17,915 | 46·3 | 1,543 | 59,802 | 38·8 |
| Other Small Holdings (f) | 10,339 | 864,075 | 83·6 | 5,531 | 619,176 | 111·9 | 4,808 | 244,899 | 50·9 |
| All Other Holdings (g) | 32,246 | 2,002,308 | 62·1 | 20,746 | 1,816,158 | 87·5 | 11,500 | 186,150 | 16·2 |
| All Types | 67,797 | 14,567,604 | 214·9 | 30,872 | 7,700,583 | 249·4 | 36,925 | 6,867,021 | 186·0 |

APPENDIX III (continued).

TILLAGE AREA AND NUMBERS OF CERTAIN CLASSES OF LIVESTOCK
AVERAGE PER HOLDING—SCOTLAND, 1927

| TYPE OF HOLDING | TILLAGE AREA | DAIRY CATTLE | OTHER CATTLE | HORSES | EWES | PIGS |
|--------------------------|--------------|--------------|--------------|--------|-------|------|
| | Acres | No. | No. | No. | No. | No. |
| Dairy Farms (b) | 46.6 | 30.0 | 20.4 | 5.3 | 39.5 | 8.6 |
| Hill Sheep Farms (c) | 13.1 | 9.7 | 19.5 | 2.6 | 780.3 | 1.6 |
| Other Farms (d) | 71.9 | 9.6 | 30.4 | 6.2 | 90.5 | 6.1 |
| Dairy Small Holdings (e) | 11.7 | 9.4 | 4.1 | 2.0 | 6.0 | 2.7 |

- (a) Zetland, Orkney, Caithness, Sutherland, Ross, Inverness, Argyll, and Perth.
- (b) All farms in which farming activities tended to be subordinated to the requirements of the dairy herd (but see (e)).
- (c) Large specialized farms with few cattle and little arable, the income of which is derived mainly from store lambs, draft ewes, and wool.
- (d) Farms not specialized in the manner of types (b) or (c) above. The type of cultivation followed varies widely in accord with regional differences.
- (e) Full time holdings generally within the statutory "small holding" limits (£50 rent or 50 acres size) where dairying is the major part of the enterprise.
- (f) Full time poultry, pig and mixed small holdings generally within the statutory "small holding" limits (£50 rent or 50 acres size).
- (g) All other holdings including supplementary (or part-time) small holdings considered insufficient to support a family without additional sources of income, non-agricultural holdings, ungroupable holdings, landless holdings, and market gardens. Acreages of common returns and common grazings are included here.

APPENDIX IV
NUMBER AND AVERAGE ACREAGES OF TYPES OF
SCOTTISH FARMS, 1927

| | DAIRY FARM | | HILL SHEEP | | OTHER | | DAIRY SMALL HOLDINGS | |
|---|------------|----------|------------|----------|--------|----------|----------------------|----------|
| | NOS. | ACREAGES | NOS. | ACREAGES | NOS. | ACREAGES | NOS. | ACREAGES |
| Aberdeen | 344 | 138 | 25 | 2,732 | 3,326 | 164 | 245 | 26 |
| Angus | 159 | 199 | 55 | 2,290 | 985 | 254 | 85 | 27 |
| Argyll | 231 | 355 | 330 | 3,621 | 318 | 595 | 51 | 62 |
| Ayr | 1,559 | 186 | 117 | 1,960 | 423 | 261 | 115 | 35 |
| Banff | 51 | 155 | 4 | 2,304 | 779 | 202 | 82 | 45 |
| Berwick | 8 | 191 | 8 | 2,300 | 463 | 508 | 23 | 40 |
| Bute | 97 | 251 | 12 | 2,182 | 25 | 1,073 | 155 | 69 |
| Caithness | 39 | 328 | 30 | 5,427 | 187 | 448 | 43 | 61 |
| Clackmannan | 24 | 206 | 4 | 2,472 | 43 | 220 | 7 | 31 |
| Dumbarton | 207 | 186 | 31 | 2,067 | 65 | 249 | 31 | 51 |
| Dumfries | 420 | 322 | 181 | 1,781 | 700 | 230 | 91 | 47 |
| East Lothian | 21 | 293 | 13 | 2,216 | 263 | 429 | 19 | 25 |
| Fife | 270 | 200 | 1 | 2,200 | 742 | 255 | 63 | 29 |
| Inverness | 55 | 200 | 120 | 6,975 | 273 | 609 | 71 | 53 |
| Kincardine | 147 | 137 | 11 | 2,236 | 563 | 192 | 53 | 31 |
| Kinross | 26 | 233 | 2 | 1,725 | 133 | 265 | 1 | 120 |
| Kirkcudbright | 373 | 317 | 146 | 1,913 | 402 | 296 | 47 | 40 |
| Lanark | 1,201 | 185 | 69 | 2,131 | 300 | 241 | 153 | 30 |
| Midlothian | 138 | 230 | 29 | 1,762 | 267 | 380 | 46 | 23 |
| Moray | 46 | 358 | 11 | 2,299 | 446 | 244 | 15 | 47 |
| Nairn | 47 | 303 | 4 | 2,464 | 97 | 438 | 14 | 65 |
| Orkney | 5 | 70 | — | — | 177 | 327 | 13 | 48 |
| Peebles | 36 | 363 | 76 | 2,071 | 99 | 436 | 13 | 49 |
| Perth | 174 | 199 | 245 | 3,036 | 1,488 | 263 | 87 | 32 |
| Renfrew | 409 | 162 | 11 | 2,298 | 147 | 154 | 50 | 30 |
| Ross | 29 | 236 | 40 | 10,120 | 357 | 559 | 25 | 36 |
| Roxburgh | 37 | 321 | 83 | 2,071 | 459 | 445 | 18 | 29 |
| Selkirk | 13 | 769 | 70 | 1,863 | 50 | 571 | 14 | 63 |
| Stirling | 313 | 174 | 40 | 3,005 | 342 | 212 | 85 | 40 |
| Sutherland | 3 | 217 | 41 | 15,334 | 34 | 461 | 17 | 40 |
| West Lothian | 186 | 173 | — | — | 104 | 245 | 24 | 25 |
| Wigtown | 491 | 276 | 42 | 1,432 | 183 | 394 | 94 | 52 |
| Zetland | 6 | 260 | 15 | 1,017 | 11 | 562 | 80 | 42 |
| Total number of Holdings in each of the above classes | 7,165 | — | 1,866 | — | 14,251 | — | 1,930 | — |
| Average acreage | — | 216 | — | 3,268 | — | 279 | — | 40 |

APPENDIX V

NUMBER OF VARIOUS SIZES OF HOLDINGS IN SCOTLAND, 1938

| | ACRES 1-5 | ACRES 5-15 | ACRES 15-30 | ACRES 30-50 | ACRES TOTAL 1-50 | ACRES 50-75 | ACRES 75-100 | ACRES 100-150 | ACRES 150-300 | ACRES OVER 300 | ACRES TOTAL OVER 50 | TOTAL NUMBER OF AGRICULTURAL HOLDINGS | NUMBER OF HOLDINGS OF MOUNTAIN AND HEATH LAND ONLY |
|---|--------------|---------------|----------------|----------------|------------------------|----------------|-----------------|------------------|------------------|----------------------|---------------------------|--|--|
| Argyll, Inverness, Ross and Cromarty, Sutherland, Zetland | 10,144 | 7,719 | 2,519 | 1,172 | 21,554 | 578 | 333 | 343 | 381 | 133 | 1,768 | 23,322 | 667 |
| All other Counties | 6,235 | 10,413 | 5,688 | 5,143 | 27,479 | 5,088 | 4,031 | 5,528 | 6,334 | 2,235 | 23,216 | 50,695 | 963 |
| Total in Scotland | 16,379 | 18,132 | 8,207 | 6,315 | 49,033 | 5,666 | 4,364 | 5,871 | 6,715 | 2,368 | 24,984 | 74,017 | 1,630 |

FARM BUILDINGS FOR SCOTLAND

APPENDIX VI

ELECTRICITY IN FARM BUILDINGS

(EXTRACT FROM POST-WAR BUILDING STUDIES NO. II, ELECTRICAL INSTALLATIONS)

POST-WAR FARM BUILDINGS

385. Post-war development appears likely to consist mainly of the modernization and reconstruction of existing farms by the erection of new specialized buildings, or the replacement or extension of existing buildings. It is probable, however, that a relatively small number of new farms will be required, either to replace obsolete farms or for reasons of change in the method or type of farming.

386. Our recommendations have been so prepared as to ensure adequate electrical installations both in these and in existing farm buildings. In England and Wales there is no legal obligation for a landlord to compensate a departing tenant for the improvement of farm property by installing electricity, whereas there is such an obligation in Scotland. This has a serious effect on the provision by English tenants of adequate and satisfactory installations. So long as this situation continues we consider that greater co-operation between landlord and tenant is an essential factor.

387. An essential first step in electrification is that full consultation should take place between the farmer, the architect and/or builder, the electricity supply engineer, the electrical contractor, and possibly the maker of any new type of equipment which may be under consideration. The decision whether the supply shall be given from underground or overhead will be taken by the supply engineer, who should also specify the requirements for external fixtures or the like that may be necessary, and the provision to be made for earthing. At this stage consideration should also be given to the route of supply lines, and to the placing of poles with due regard to farming operations and to rural amenities.

388. The use of mechanized methods may influence the design of farm buildings. Thus, a two-storey layout is preferable where electrically driven mechanical feed handling and storage is to be adopted, so as to provide for gravity feed from the first floor to the ground floor. This also involves the provision of a structure adequate to support considerable storage weight. Or again, in a dairy no separate boiler room is required when electrical sterilization is employed. In the consultations referred to above, consideration should be given to such factors, in so far as they may influence the design of new farm buildings or of modifications or extensions to existing farms.

FARM ELECTRIFICATION

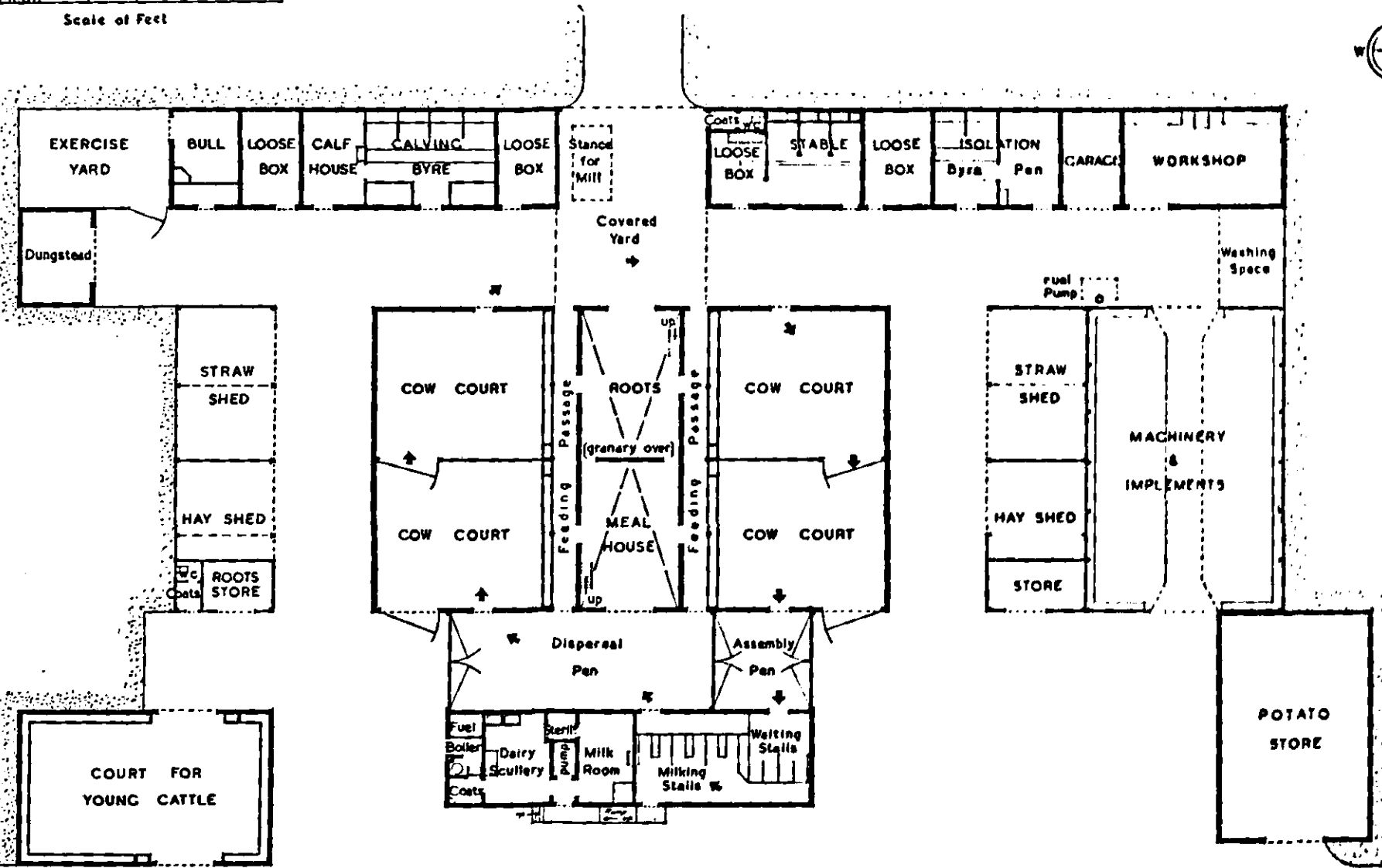
389. In pre-war years electricity had already found a wide variety of applications on the farm. Electric lighting, pumping, milking, cooling, sterilizing, water heating, incubation and rearing, feed grinding, cutting, pulping, threshing, and sawing may be mentioned as typical established practices. A wide variety of other major and minor applications are either established or in course of development both in this country and abroad. Apart from any intrinsic merits of electrically operated processes, increased cost of farm labour will encourage mechanization and automatically controlled processes, and the necessity for making farm work more attractive by reducing heavy manual and repetitive work and minimizing attendance outside normal working hours will have a similar effect.

390. In addition, the necessity for providing domestic amenities in farmhouse and cottage equivalent to those available in towns is of increasing importance.



SOUTH ELEVATION

ROUTE FOR COWS USING MILKING PARLOUR INDICATED THUS → →



TO PUBLIC ROAD

F A R M R O A D W A Y

Plate 5. Plan F. Steading for Mixed Arable and Dairy Farm (Cow Court System) for 200 to 250 Acres
(See paragraph 56)

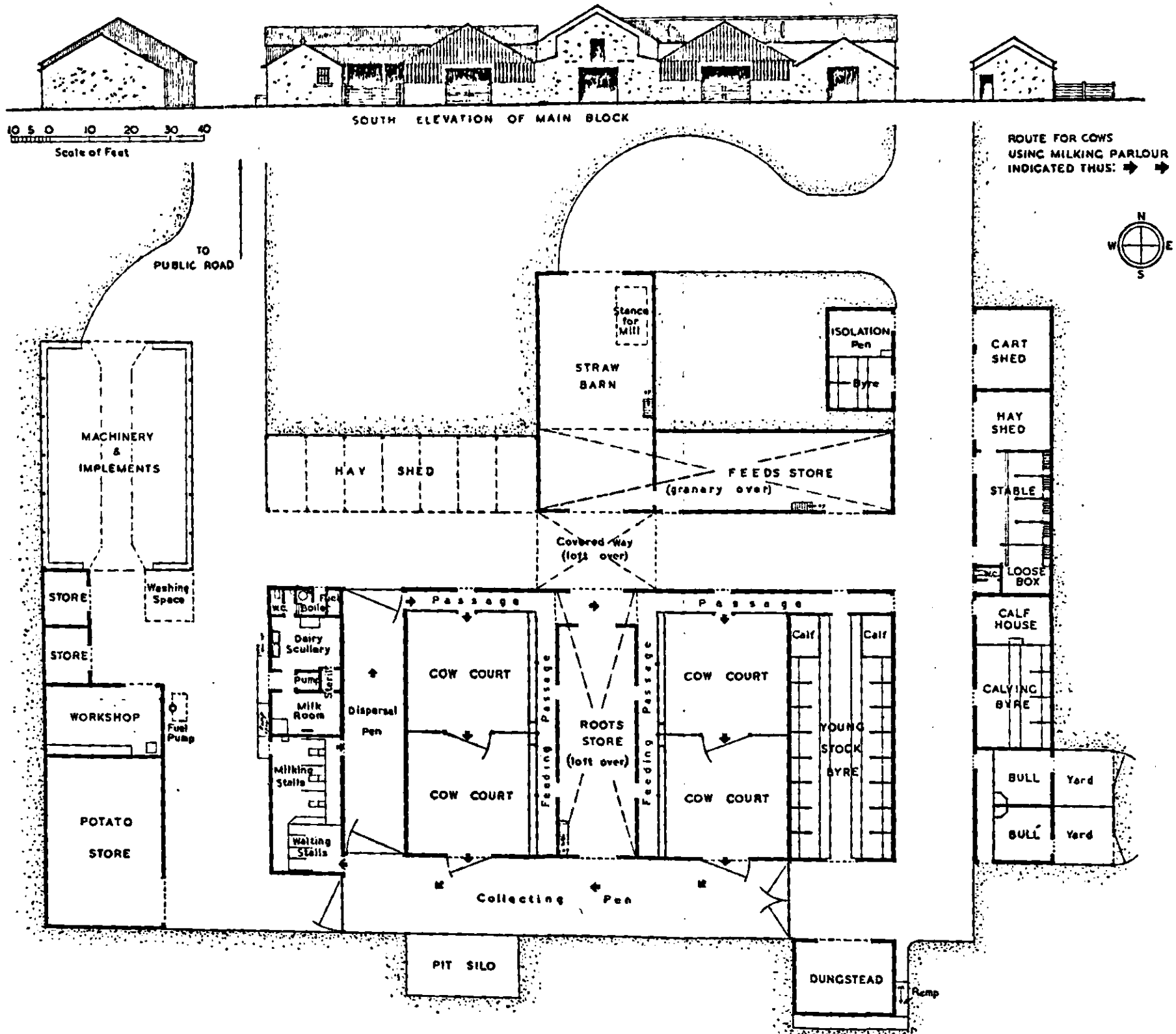


Plate 6. Plan G. Steading for Mixed Arable and Dairy Farm (Cow Court System) for 200 to 250 Acres
(See paragraph 57)

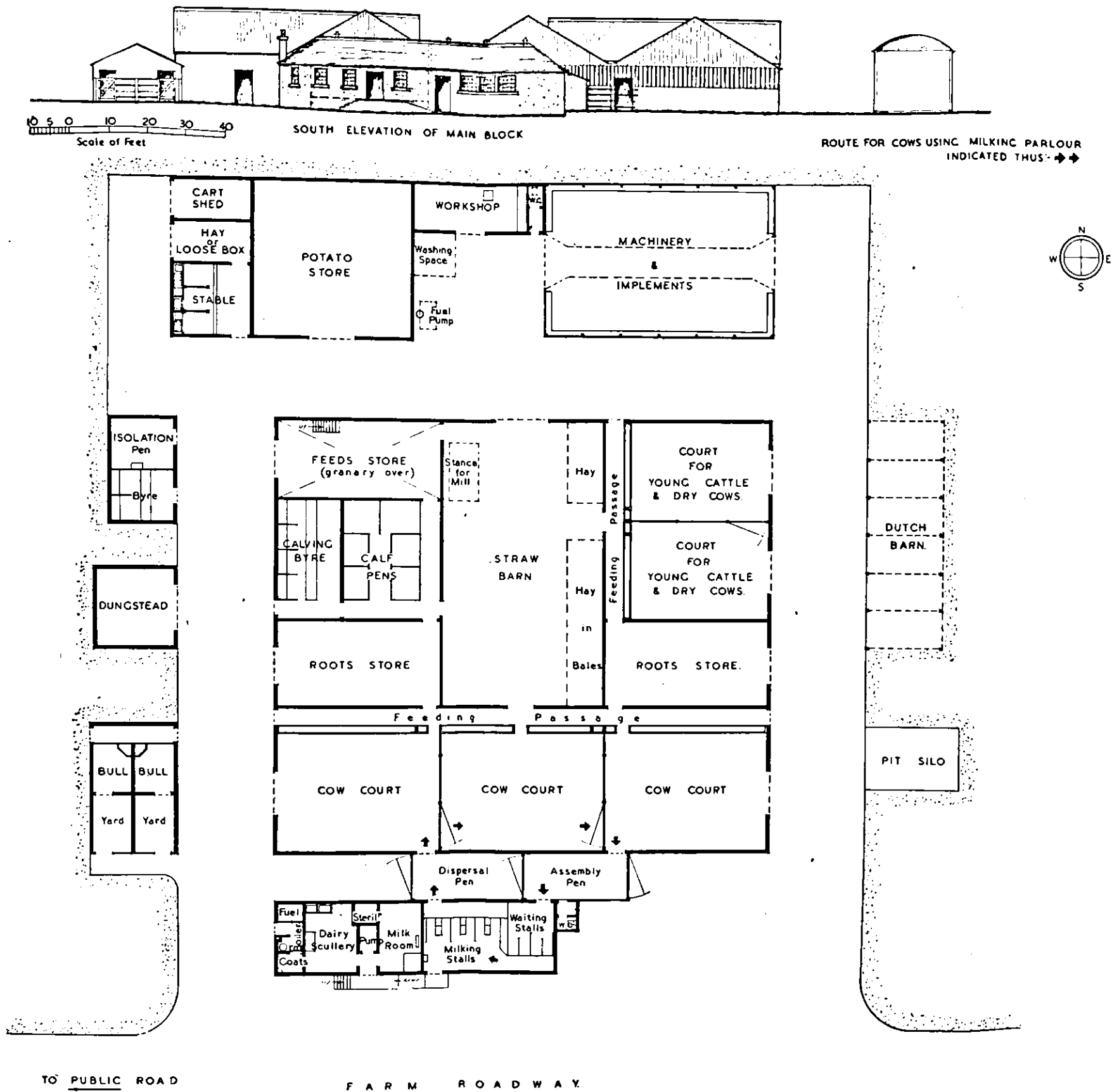


Plate 7. Plan H. Steading for Mixed Arable and Dairy Farm (Cow Court System) for 200 to 250 Acres

(See paragraph 58)

10 5 0 10 20 30 40 50
Scale of Feet

ROUTE FOR COWS USING MILKING PARLOUR
INDICATED THUS -
WINTER MILKING ◀ ▶
SUMMER MILKING ◊ ◊

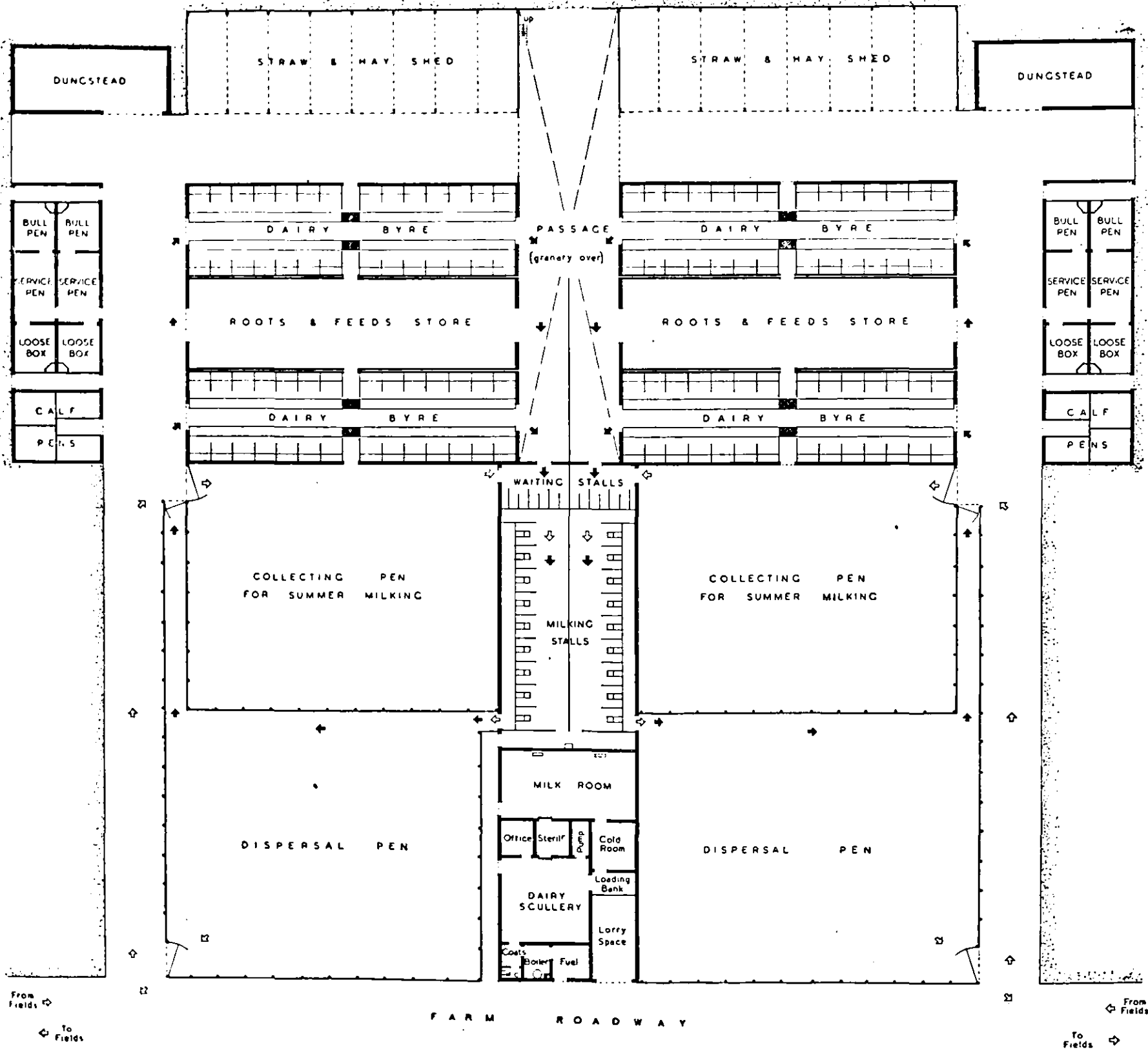


Plate 8. Plan J. Dairy Steading for 224 Cows
(See paragraph 59)



10 5 0 10 20 30 40 50
Scale of Feet

SOUTH ELEVATION OF MAIN BLOCKS

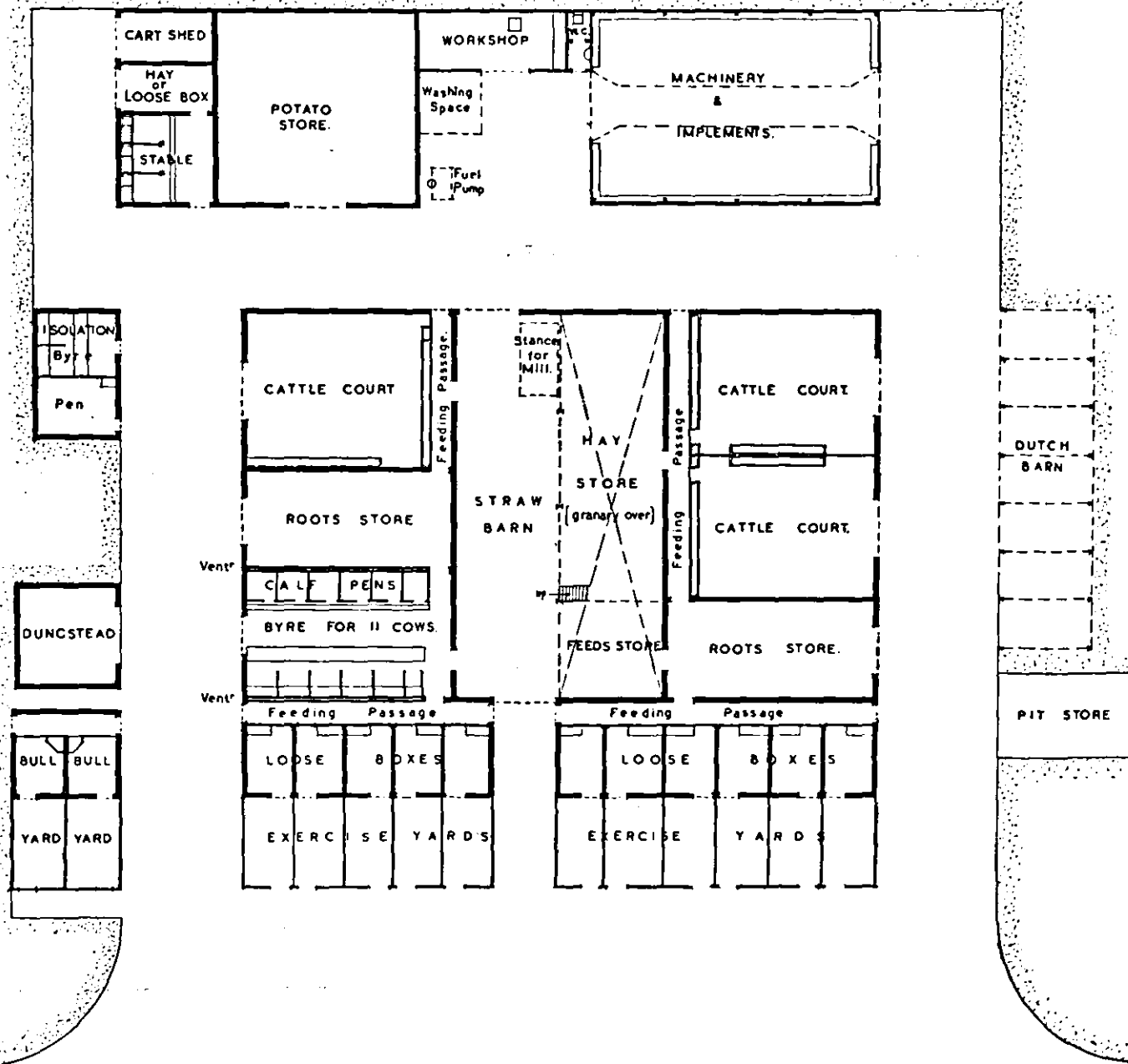
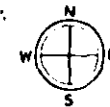
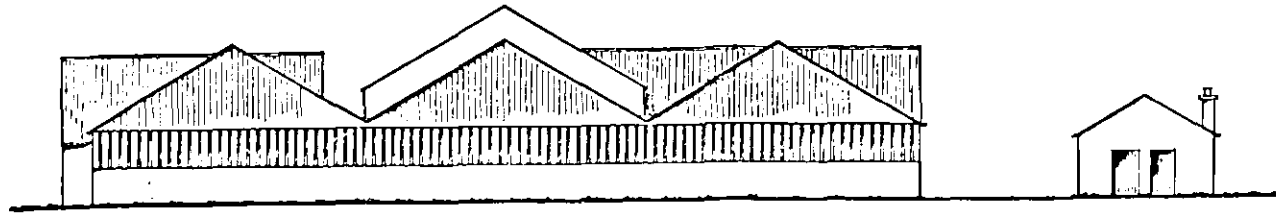
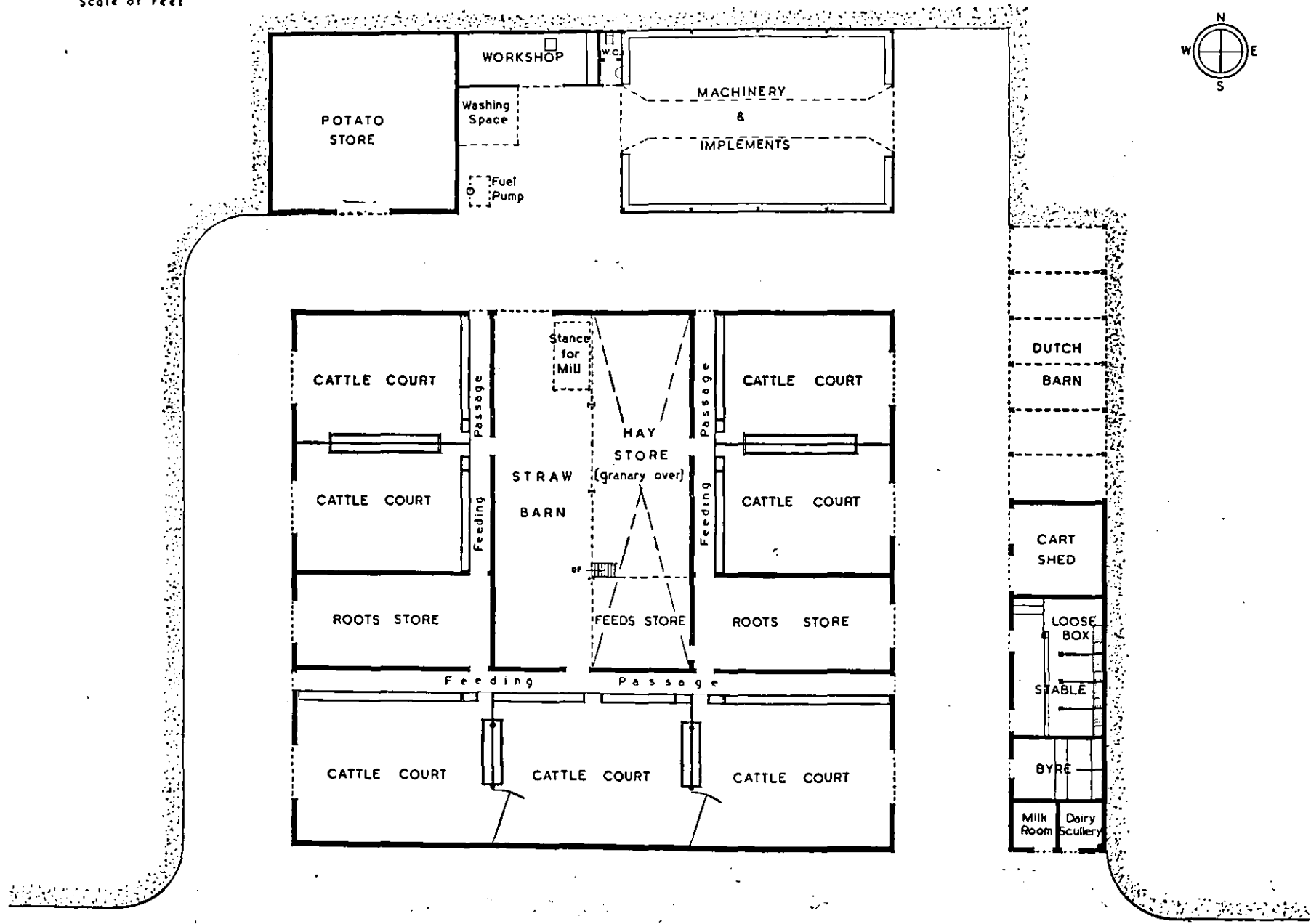
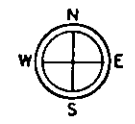
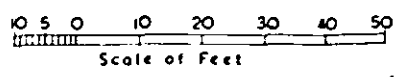


Plate 9. Plan K. Commercial Cattle Breeding and Feeding Farm for 200 to 250 Acres
(See paragraph 60)



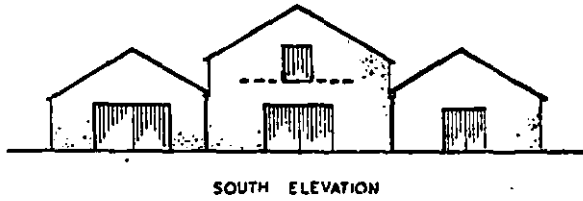
SOUTH ELEVATION OF MAIN BLOCK



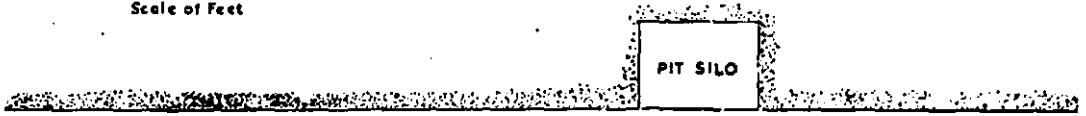
TO PUBLIC ROAD

FARM ROADWAY

Plate 10. Plan L. Cattle Feeding Farm for 200 to 250 Acres
(See paragraph 61)



SOUTH ELEVATION



TO PUBLIC ROAD

FARM ROADWAY

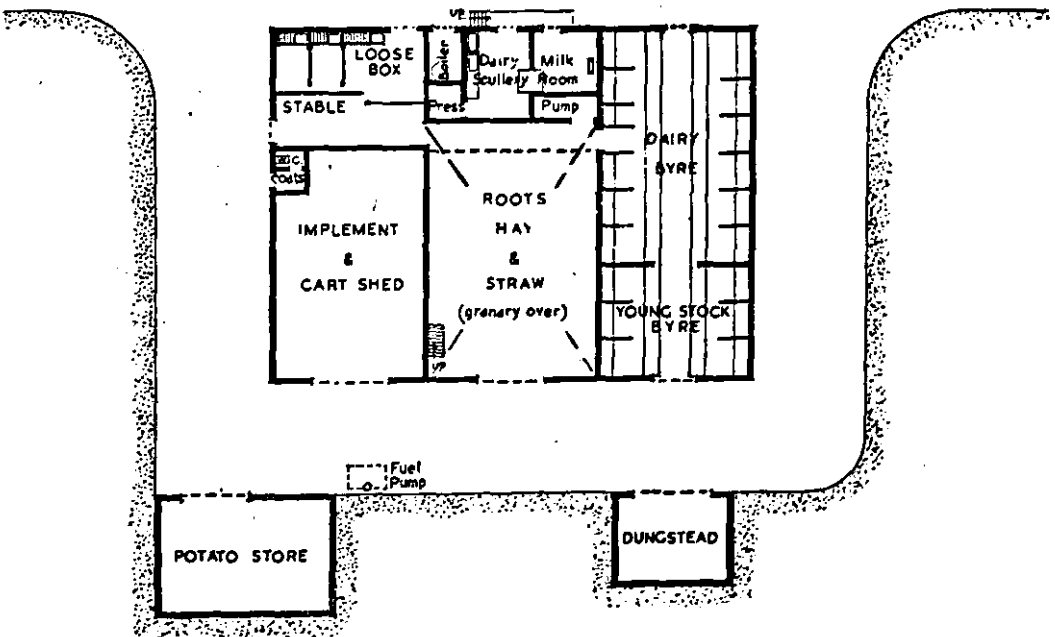
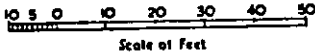


Plate 11. Plan M. Steading for Mixed Arable and Dairy Farm
(Byre System) for 75 Acres
(See paragraph 62)



SOUTH ELEVATION



ROUTE FOR COWS USING MILKING PARLOUR INDICATED THUS → →

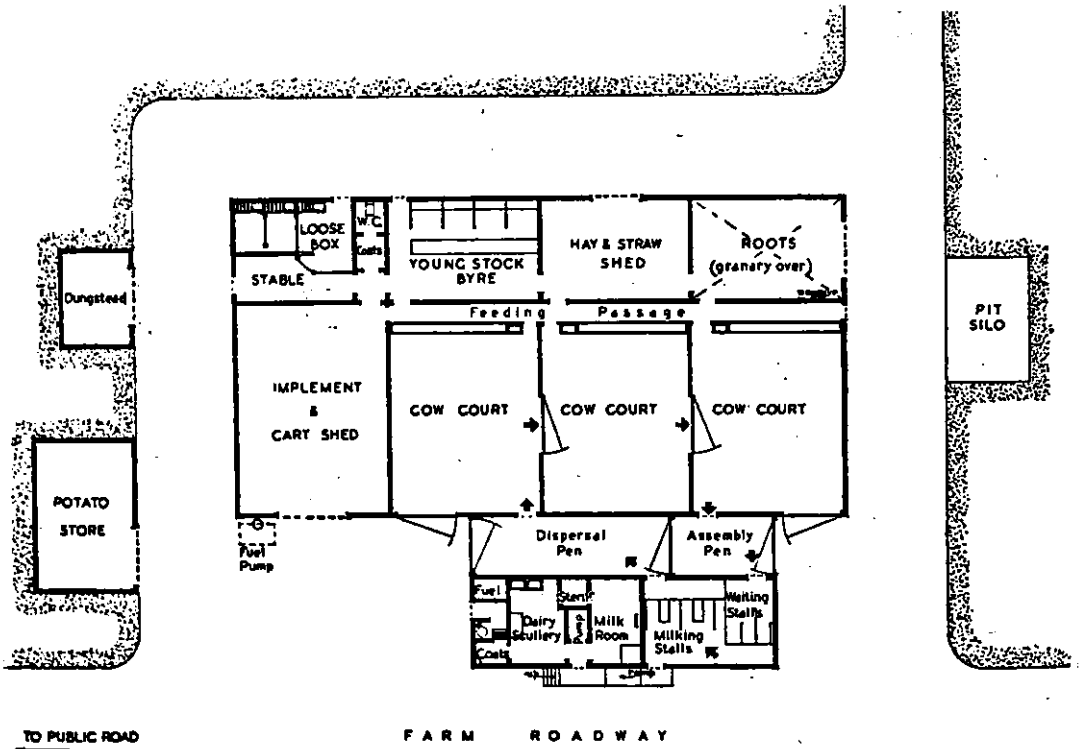
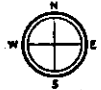
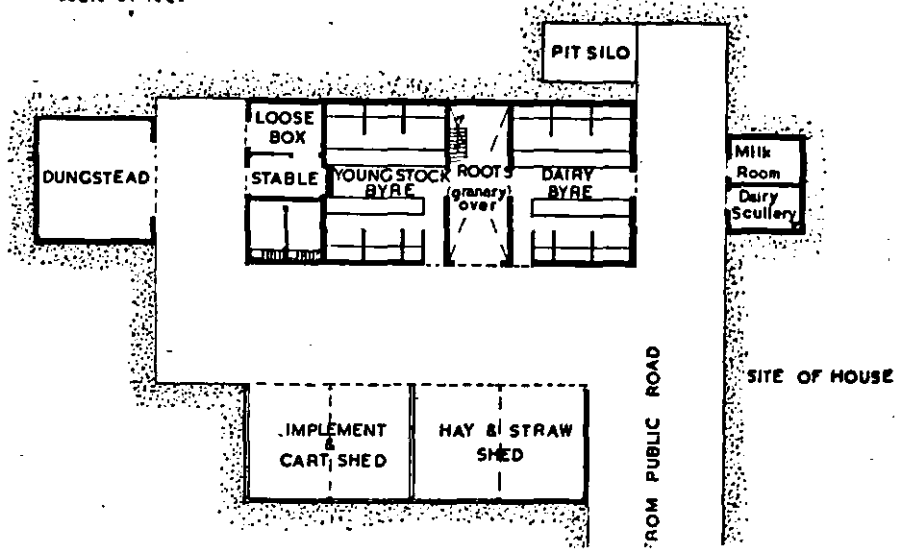


Plate 12. Plan N. Steading for Mixed Arable and Dairy Farm (Cow Court System) for 75 Acres (See paragraph 63)



SOUTH ELEVATION



SOUTH ELEVATION

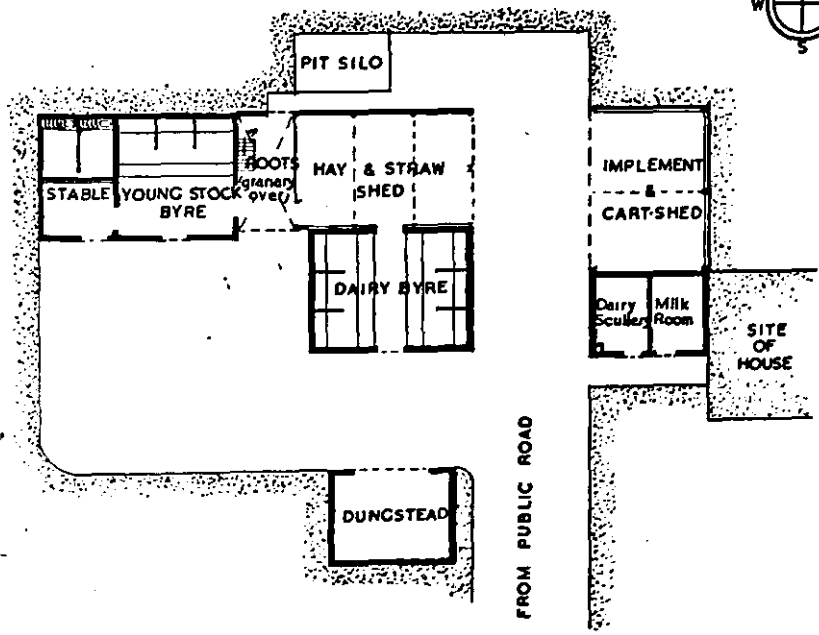
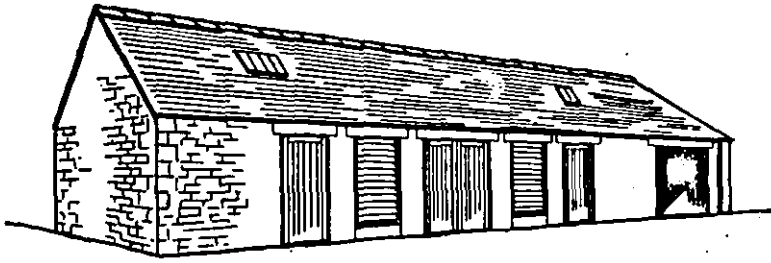
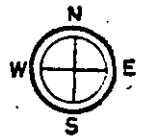
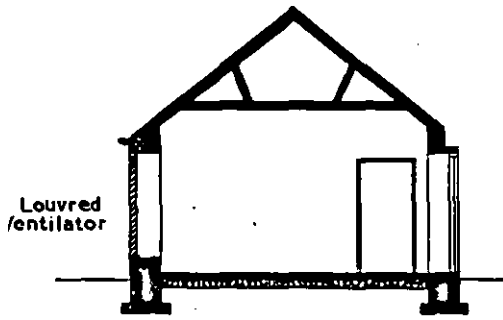
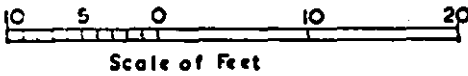


Plate 13. Plan O. Steading for Farm of 20 to 30 Acres
Plan P. Steading for Farm of 20 to 30 Acres
(See paragraphs 64 and 65)



PERSPECTIVE.



SECTION A-B.

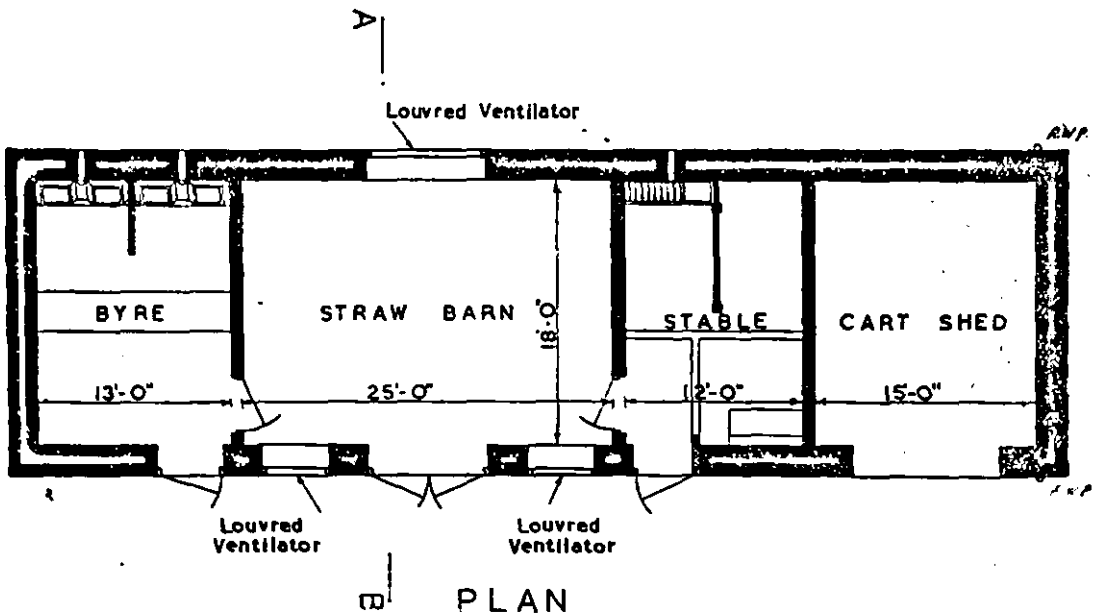


Plate 14. Plan Q. Highland Croft Steading for 5 to 10 Acres
(See paragraph 66)

APPENDICES

WATER SUPPLY

391. In localities in which there is no public water supply, but where there is a suitable local source of water, an automatic electric pumping system will give the same convenience. Where the source is constant, as is generally the case, the pressure tank system may be used in order to dispense with the need for storage tanks and the structural provision required for them, and to give the benefit of a high-pressure water supply. On the other hand, a storage tank system ensures a reasonable reserve of water at times when the pumping plant may be receiving maintenance attention.

TYPE OF ELECTRICITY SUPPLY

392. We assume that after the war electricity will be made generally available in rural areas, and that the great majority of farms will be connected to public supply mains. Although rural three-phase supplies will probably continue to expand, an increasing proportion of farm supplies will be single-phase, particularly in view of the trend towards lower apparatus loadings referred to in paragraph 395.

393. If cases should occur of private generating plant being installed as a temporary measure, we recommend that the wiring installation should conform to the requirements for mains supply so that this may be connected without difficulty when it is made available.

THE FARM LOAD AND ITS BEARING ON THE WIRING INSTALLATION

394. An investigation and survey of existing dairy and arable farms has been made, and has been of substantial advantage to us in reaching conclusions and in formulating our recommendations.

395. The majority of farm electrical appliances depend for their operation on motors or heaters of ratings 0.5 kw. to 10 kw. (*i.e.* $\frac{1}{2}$ to 10 h.p. approximately). Appliances which in the past have exceeded this range of ratings are grinding mills, dairy sterilizers, and steam boilers, for which ratings up to 20 kw. have been common. In both cases, however, recent research and experimental operation have shown that equally effective results can be obtained with equipment of much lower loading. It may be expected that soon after the war grinding and sterilizing appliances having, say, only one-quarter of the rating of those previously used may become generally available. We therefore assume that the majority of new farm appliances will not exceed 5 kw. in rating, though larger motors of, say, 10 to 20 h.p. (*i.e.* 10 to 20 kw. approximately) may be required for grain-drying or grass-drying plant, and a transportable motor of similar rating may be required for threshing or silo filling.

396. We have reached the conclusion that the heavier loads are generally grouped fairly closely together, or can be so grouped. Although electricity is essentially a flexible service which enables plant to be placed in any desired location, we recommend that where conveniently possible the main load appliances, *e.g.* for sterilizing, grinding, pulping, etc., should be grouped together so that the cost of power wiring may be minimized.

397. The following examples, taken from modern practice of applications of electricity on the farm, indicate the range of service for which an adequate electrical installation should provide.

i. MILK PRODUCTION

a. *Cowhouse*

Lighting. In a typical single range shed, lighting may be by means of ceiling fittings in a central passageway, or bulkhead fittings on the wall behind the cows.

FARM BUILDINGS FOR SCOTLAND

Socket-Outlets. A number of suitably placed standard socket-outlets (see paragraph 400) for supplying hand lamps, clipping machines, etc., should be provided. These are essential if the best use is to be made of the installation.

Ventilation. A fan may be provided in the roof or gable if mechanical ventilation is required.

Power. The milking machine motor, which may be situated in the dairy, or other room adjoining the cowhouse, or, alternatively, in a milking parlour, will have a rating of $\frac{1}{2}$ to 1 h.p.

b. Dairy

Lighting, and one or two socket-outlets for fan, bottle washers, etc. will be required.

| | |
|-------------------------|---|
| Sterilizer | 4 to 9 kw. (These ratings cover the range of requirements of herds of 20 to 40 cows.) |
| Water heater | 1 to 3 kw. |
| Cooler | $\frac{3}{4}$ to 2 h.p. |
| Water pump, if required | $\frac{1}{2}$ to 1 h.p. |

c. Food Store and Mixing Room

| | |
|-------------------------------|-------------------------|
| A small hoist may be required | $\frac{1}{2}$ to 1 h.p. |
| Mixing machine | 5 h.p. |
| Grinding mill (new type) | 3 h.p. |
| Cake breaker | 2 h.p. |

Some of these machines may be situated in the barn or other buildings according to the layout of the farm.

ii. MIXED FARMING

In the case of mixed farming, but where no dairy herd is kept, provision for the following machinery may have to be made:

| | |
|---|---------------|
| Grinding mill (new type) | 3 h.p. |
| Chaff cutting, root cutting, or cake breaking | 10 h.p. |
| Mixing machines | 5 h.p. |
| Hoist | 1 h.p. |
| Threshing, sawing, or power for crop dryer | 10 to 20 h.p. |
| Water pumping | 1 h.p. |

In most cases it will be more convenient for each of the above machines to be fitted with its own motor, but where barn machines, such as a chaff cutter, root cutter, and cake breaker, can be fixed fairly near to each other, one motor may be used to drive all the machines by shaft and belting, without undue loss of power in friction.

Threshers, saws, elevators, silo fitters, and other machines used out of doors around the farm buildings may be driven by weatherproof motors mounted on skids or wheels for convenient handling. Such motors can be supplied by means of trailing cables from a few watertight socket-outlets fixed on the outside of farm buildings in positions chosen so that the trailing cable is not likely to lie across a roadway.

iii. POULTRY PRODUCTION

The wiring installation will be required to provide a number of 3-pin standard socket-outlets distributed throughout the buildings for the convenient connection

APPENDICES

of incubators, brooders, etc., the total load of which may be roughly estimated as follows:

| | |
|--|---|
| Incubator room | $\frac{1}{4}$ to 1 watt per egg. |
| Rearing houses | $1\frac{1}{2}$ to $2\frac{1}{2}$ watts per chick. |
| Laying houses; lights and drinking water warmers | 2 to 3 watts per bird. |

LIGHTING

398. Electric lighting can of itself greatly improve working conditions and cleanliness in farm buildings, and care should be taken in planning the wiring of both new and existing premises that adequate lighting provision is made in the buildings and where necessary in the farmyard and approaches. The number and size of lamps should be arranged to provide good illumination over all working areas; for example, in a single range cowshed for twelve cows, two lights on the wall along the feeding passage and at least three lights on the wall behind the cows are advisable. Bulkhead type fittings to take 60 or 100 watt lamps are suitable for wall mounting, and should be of waterproof pattern in cowsheds and dairies. In other buildings also this type of fitting has advantages from the point of view of robustness and easy cleaning. Yard and roadway lights should be fixed as high as possible on poles or gable ends, so as to give good illumination without glare. Portable hand lamps should be of Home Office shock-proof type, as described in the Factory Regulations.

LIGHT SWITCHES

399. Economy in wiring and convenience in use is promoted by grouped switching of light circuits rather than by individual switches for each light. Two- or three-way switching should be used in buildings with more than one entrance and for outside lights. In the latter case, one switch should be provided in the farmhouse. Cord-operated ceiling switches may present advantages in certain situations, such as dairies, and will effect some economy in wiring.

GENERAL UTILITY SOCKET-OUTLETS

400. Provision should be made for the use of appliances of moderate power in all buildings. For this purpose 3-pin standard socket-outlets are recommended. These will facilitate the use of hand lamps, portable tools, and many existing small appliances and also make it generally possible to take advantage of new applications and appliances, which may reasonably be anticipated. Socket-outlet circuits would radiate from the service position through the various farm buildings. In new farms and in certain layouts of existing buildings, consideration should be given to one or more ring circuits to carry all the general utility socket-outlets.

401. Having regard to the present trend towards mechanization we consider it important that provision for the use of small electrically driven tools and for battery chargers (for vehicles and electric fences) should be made in the implements shed or workshop and in the garage.

FITTINGS AND ACCESSORIES

402. It is generally desirable that socket-outlets and plugs, lamp holders, switches, joint boxes, etc., should be of the insulated type. Also, having regard to the possibility of accidental damage in many farm situations, these fittings should be of more robust construction than is generally considered necessary for domestic purposes. Where exposed to water and moisture, fittings such as joint boxes should be filled or plugged with suitable waterproof compound.

FARM BUILDINGS FOR SCOTLAND

FUSING

403. Single-pole fusing should be used in conformity with standard practice (see paragraph 34). The use of rewirable porcelain fuses should be discouraged and their place should be taken by standard enclosed cartridge-type fuses. Fuses of different ratings should not be interchangeable. The ratings should be clearly and indelibly marked on fuses, and it should be readily possible to distinguish between new and blown fuses by the appearance.

CIRCUIT BREAKERS

404. Consideration may be given to the use of quick-acting circuit breakers in place of the consumer's main switch, and possibly in place of circuit fuses.

SYSTEMS OF WIRING

405. We have considered the various wiring systems which have been used in the past in this country, in the United States, and in Europe. We are satisfied that of the systems previously used in this country none is completely satisfactory under all farm conditions; certain qualifications and reservations apply to every system.

406. We consider that the adoption of a single system of wiring for farms, which could be recognized as standard, would greatly simplify the reliable and economic electrification of farm buildings, both from the aspects of manufacture and installation.

407. A standard farm wiring system should satisfy the following main conditions:

- i. The cable must be mechanically strong and resistant to ammoniacal fumes, steam, and damp.
- ii. Its cost should be reasonable.
- iii. Its installation should not require such a high degree of skill as to limit unduly the rate of introduction.

408. A wiring system which complies with these requirements was used to an increasing extent in pre-war years on Swedish and German farms. It uses a metal-taped insulated cable, generally similar to that covered by *B.S. 7*, and provides mechanical, chemical, and electrical protection for the conductors. Although this system would fulfil the requirements of a standard farm system, we consider that it is not to be recommended in view of the relatively high cost of continuous armouring which, however, is essential for only a small proportion of a farm installation. We estimate that the cost of an installation completed in metal-taped cable would be approximately equal to one in vulcanized rubber-insulated cable run in screwed galvanized iron conduit. Both would represent good practice, but we consider that the system recommended in the next paragraph, although less robust than either of these alternatives, provides a satisfactory and less expensive solution, which would facilitate more rapid extensions in the immediate post-war years.

409. We recommend for use as a general purpose cable, and for adoption as the basis of a standard system of farm wiring, tough rubber-sheathed cable, protected with cotton braid vulcanized on and compounded over.

410. Cable of this type is particularly suitable for the wiring of existing farm buildings which, as already stated (paragraph 385), are likely to form the major part of the post-war farm electrification programme.

411. This cable fulfils the requirements stated above except in respect of its limited mechanical protection. A high degree of mechanical protection is, however, necessary only in a limited number of locations, and here suitable protection may be provided by means of insulating conduit. Metal conduit is

APPENDICES

not recommended since, for safety reasons, it would require to be separately earthed and unless galvanized would be liable to corrosion. As regards the possibility of attack by vermin, practical experience shows the risk to be negligible, if care is taken to avoid rat runs when installing the cable.

412. Since metal-cased appliances requiring to be earthed will be used in farms, the proposed cable should contain an earth continuity conductor.

413. We consider that similar cable insulated with polyvinyl chloride (P.V.C.) would form a satisfactory alternative, to which the possibility of post-war rubber shortage gives added importance. Such cable may be expected to be generally available in the near future and may, in certain characteristics, possess better qualities than the recommended special T.R.S. cable. For example, P.V.C. cable is understood to possess exceptional resistance to damp, corrosive conditions.

414. To reduce the risk of mechanical damage and of accidental contact it is recommended that the wiring should be installed high and well out of normal reach. In dairies, cleat mounting may be used, as this permits of thorough cleansing by hosing down. Mechanical protection is recommended for down-drops to socket-outlets or for connection to appliances where these are likely to be subject to damage. Alternatively, to avoid mechanical or chemical damage it may in certain cases be practicable to run the wiring more safely on the outside of the building and to bring it in where necessary. If a motor has to be mounted on the floor some distance away from the wall on which the wiring is run, care should be taken to provide adequate mechanical protection for the wiring between the wall and the motor terminal box.

415. A permanent diagram showing the position of all cable runs should be provided at the service position.

EARTHING

416. Earthed appliances will invariably be used, and one or other of the following earthing arrangements should be made in consultation with the supply undertaking.

- i. To the water-supply main where this is available.
- ii. To the lead sheath, if any, of the undertaking's service cable, where this is regarded as satisfactory and acceptable by the undertaking.
- iii. To an effective earth electrode or electrodes which should be subject to inspection by the supply undertaking at the time of installation, and to subsequent periodic inspections by a competent person.
- iv. If the earth resistance in a locality is too high for safety to be obtained by means of direct connection to an earth electrode system, and if methods (i) and (ii) are impracticable, provision for protection may be made either by means of an earth leakage circuit breaker of appropriate rating or by means of protective multiple earthing, if this method is adopted by the supply undertaking.

SERVICE POSITION AND ACCOMMODATION

417. We recommend that the electricity service, which will generally be by overhead line, should terminate when convenient at the centre of the heavier loads. The supply control, consisting of the undertaking's main fuse and meter, also the main switch and fuses controlling the installation, should be fixed in a clean, dry, and easily accessible position. On large farms a separate small room might well be provided to accommodate this equipment. Our recommendations for consumers' supply controls in domestic premises (paragraphs 30-44) should be borne in mind in appropriate cases.

FARM BUILDINGS FOR SCOTLAND

ELECTRICITY SUPPLY TO OUT-BUILDINGS AND FIELD LOCATIONS

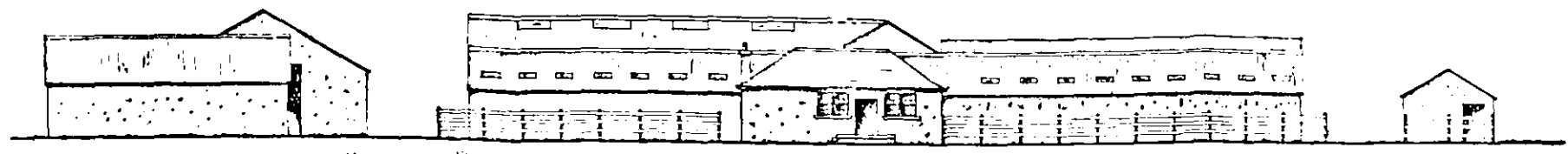
418. To supply near-by out-buildings, the proposed special T.R.S. cable or P.V.C. cable may be slung from a catenary. For more distant buildings or field locations for hay elevating, sheep shearing, etc., a light open line should be used. In special cases consideration may also be given to the possibility of deriving a convenient supply by tapping the incoming overhead supply line to the farm.

ELECTRIC FENCES

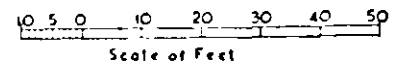
419. Detailed consideration of electric fences has not been undertaken, since these are for field use and do not lie within the scope of the present study. Reference has, however, been made in paragraph 401 to charging facilities for the low voltage batteries from which the apparatus required derives its supply. Electrical fences are growing in popularity in this country, and it may be noted that their characteristics are being considered by the British Standards Institution.

TELECOMMUNICATIONS

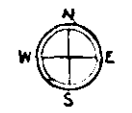
420. Provision for a telephone and for radio reception will generally be made at the farmhouse. The recommendations contained in paragraphs 106 to 129 are generally applicable.



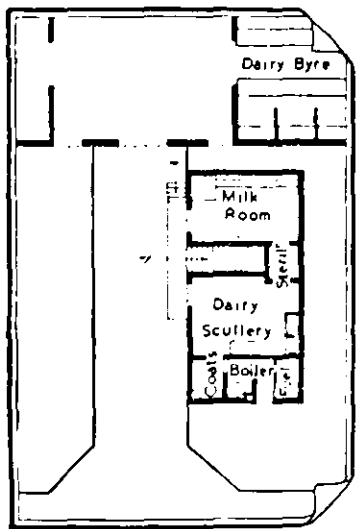
SOUTH ELEVATION



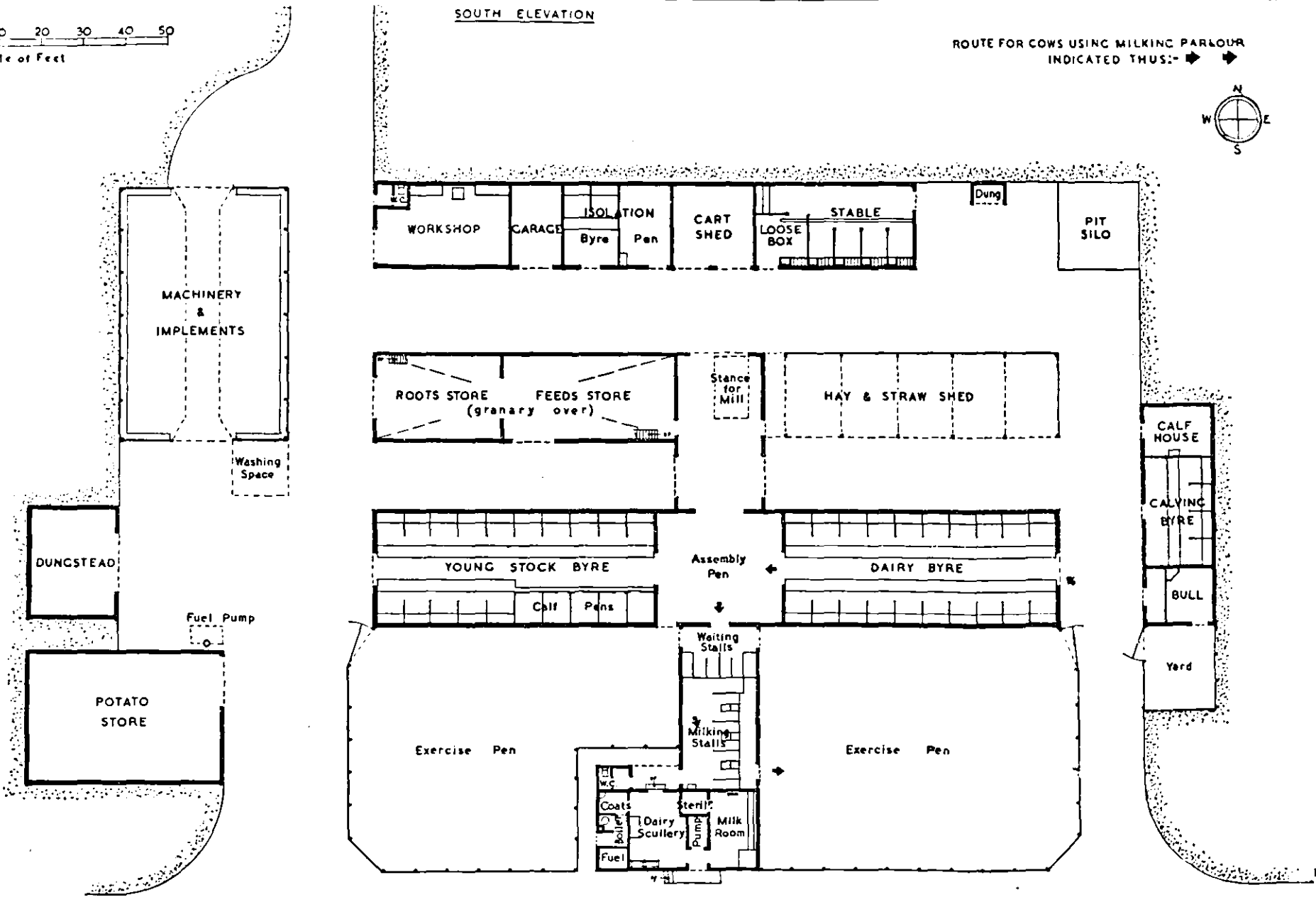
ROUTE FOR COWS USING MILKING PARLOUR INDICATED THUS: → →



PLAN B



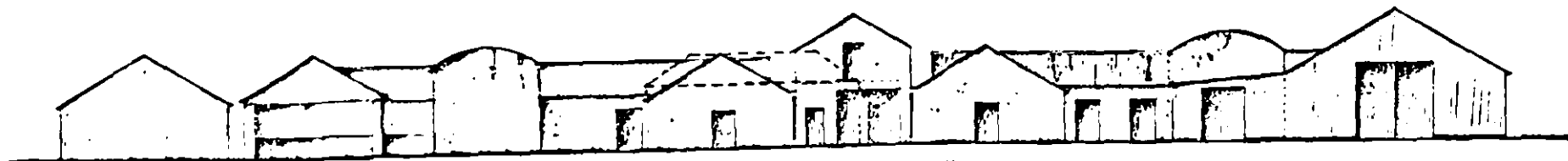
ALTERNATIVE SCHEME FOR BUCKET SYSTEM OF MECHANICAL MILKING



TO PUBLIC ROAD
←

F A R M R O A D W A Y

Plate 1. Plan A. Steading for Mixed Arable and Dairy Farm (Byre System) for 200 to 250 Acres
(See paragraph 51)



SOUTH ELEVATION OF MAIN BLOCKS

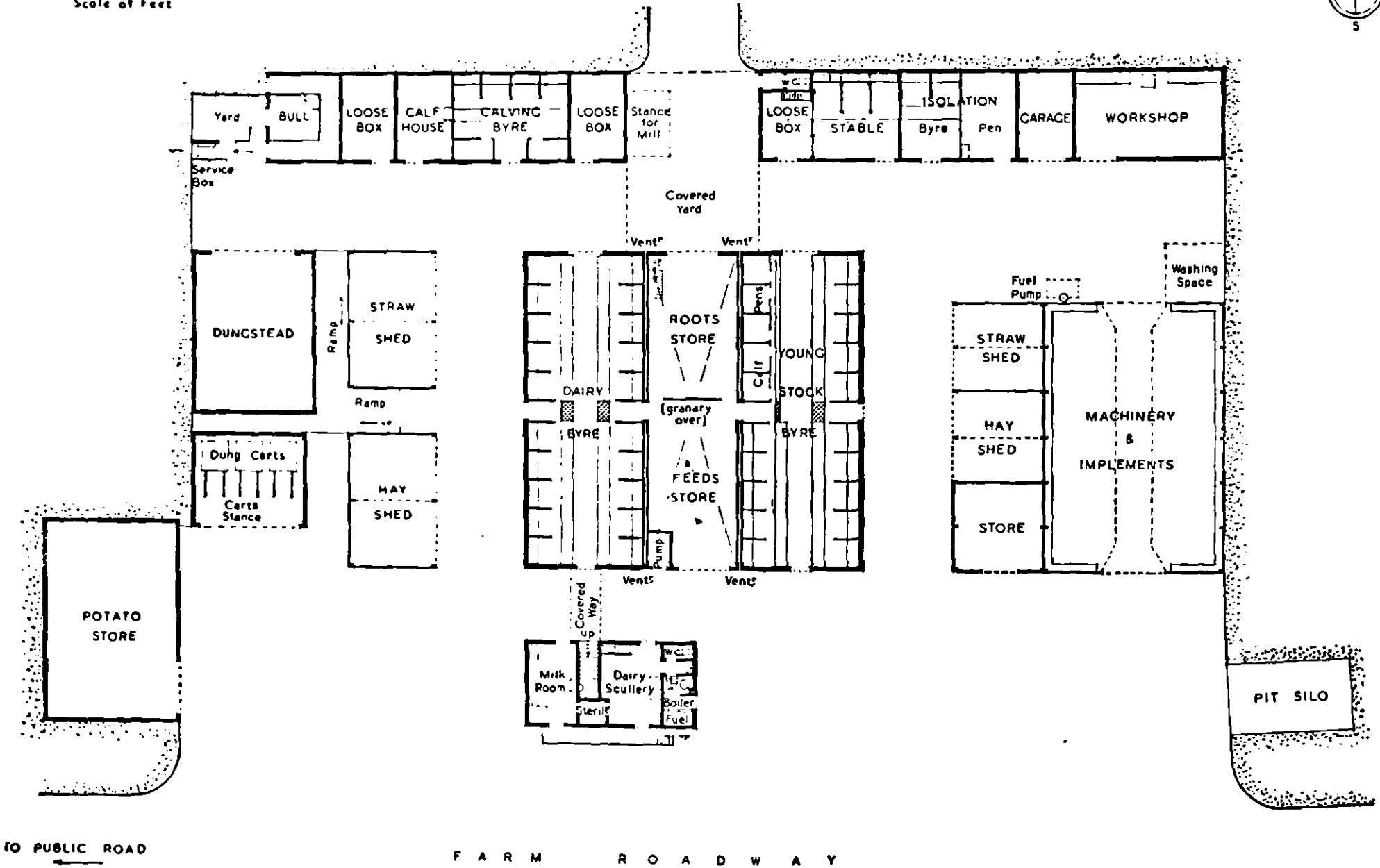
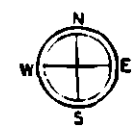
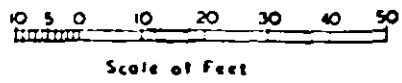
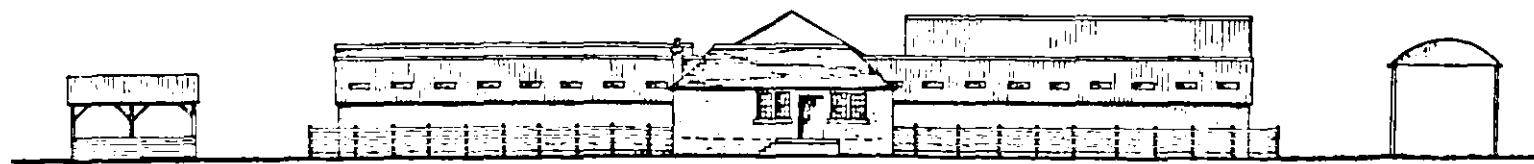
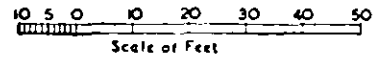


Plate 2. Plan C. Steading for Mixed Arable and Dairy Farm (Byre System) for 200 to 250 Acres
(See paragraph 53)



SOUTH ELEVATION



ROUTE FOR COWS USING MILKING PARLOUR INDICATED THUS:-
 WINTER MILKING → →
 SUMMER MILKING ⇨ ⇨

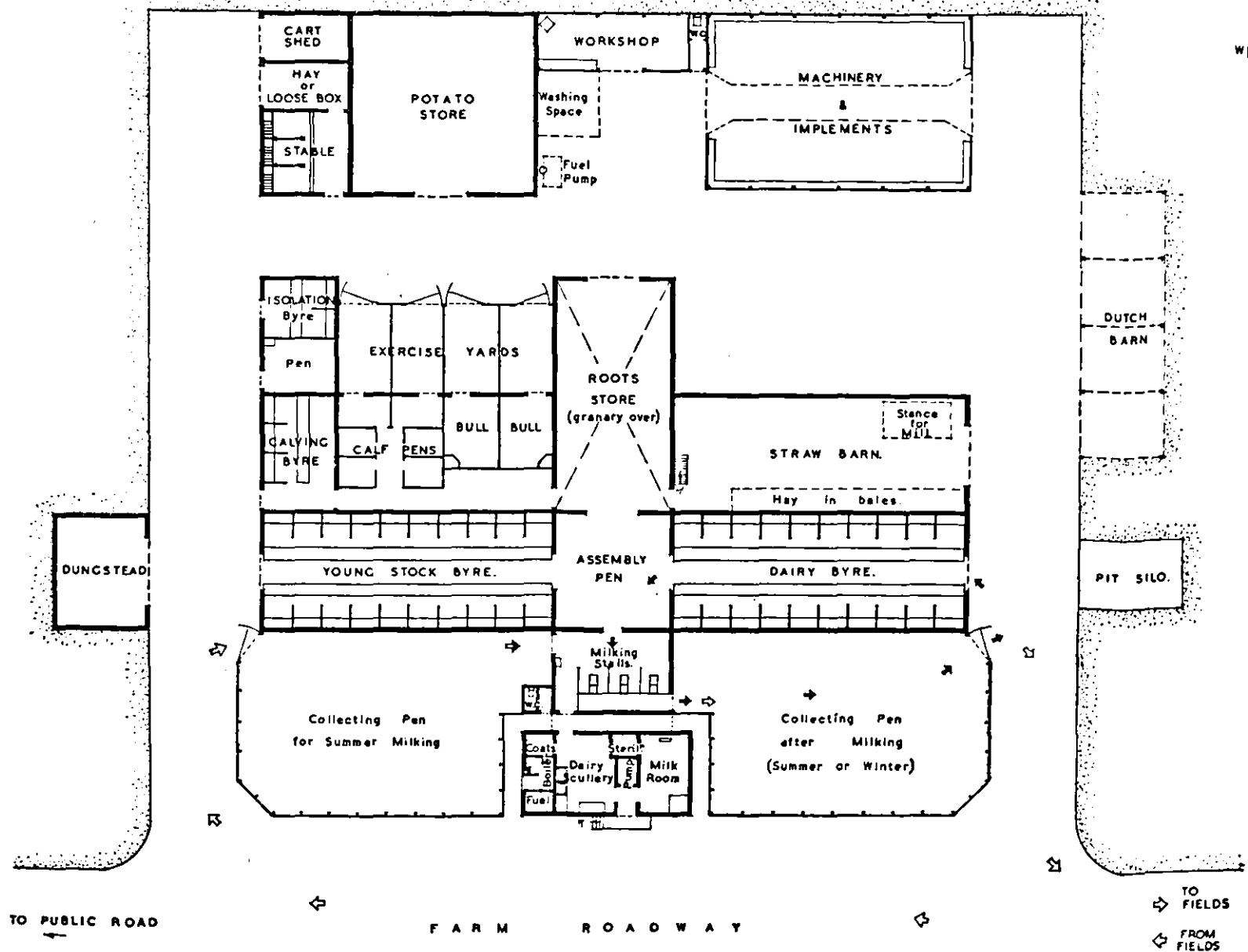
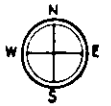
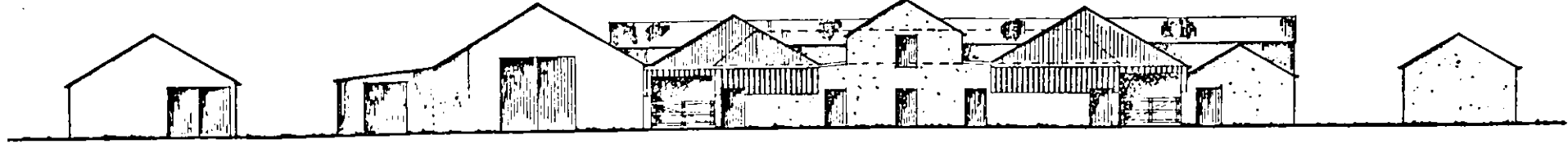
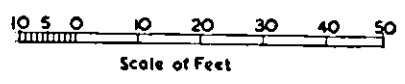


Plate 3. Plan D. Steading for Mixed Arable and Dairy Farm (Byre System) for 200 to 250 Acres
 (See paragraph 54)



SOUTH ELEVATION OF MAIN BLOCK



ROUTE FOR COWS USING MILKING PARLOUR INDICATED THUS - → →

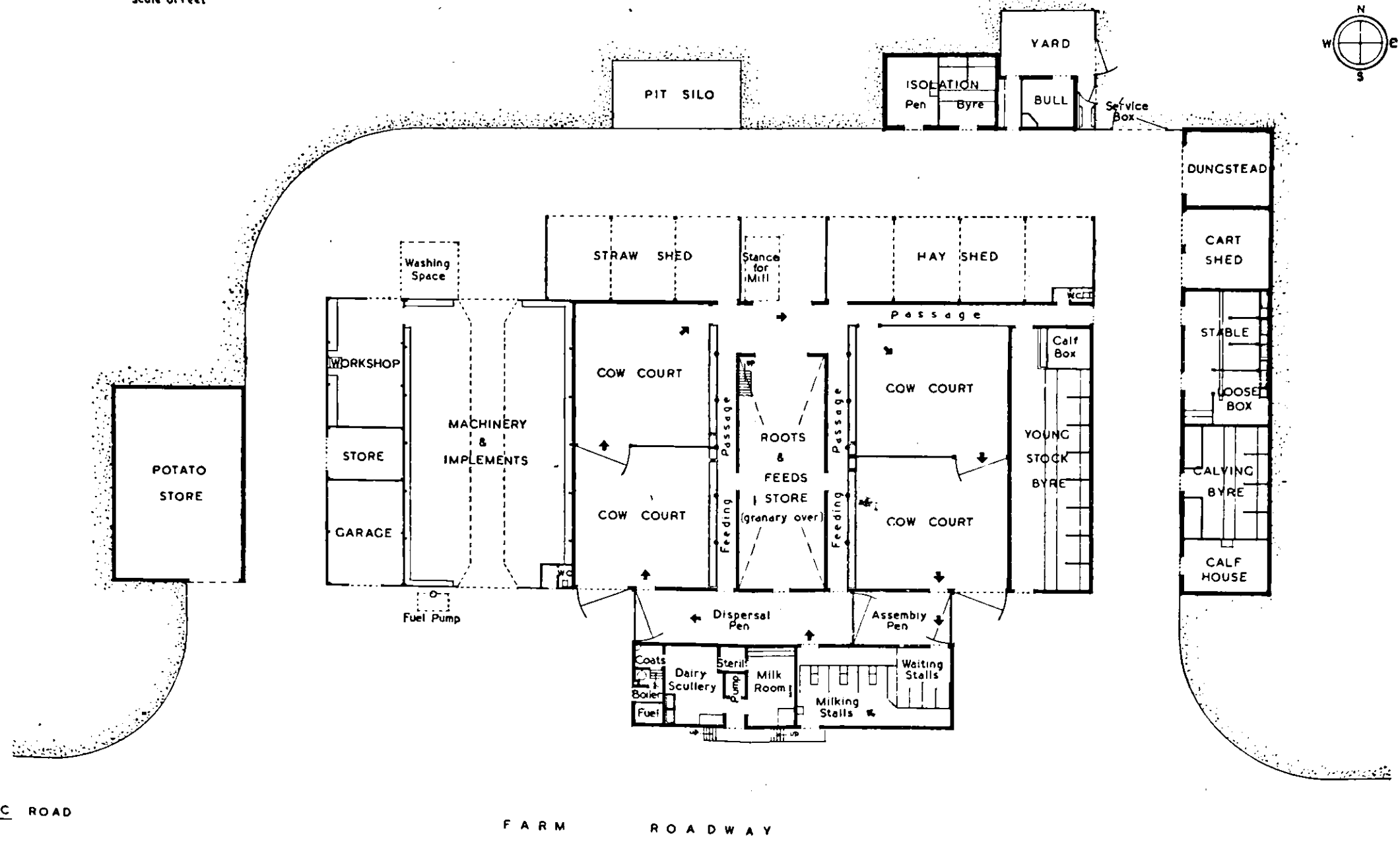
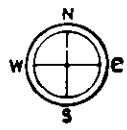


Plate 4. Plan E. Steading for Mixed Arable and Dairy Farm (Cow Court System) for 200 to 250 Acres
(See paragraph 55)

POST-WAR BUILDING STUDIES

1. HOUSE CONSTRUCTION. 2s. (2s. 3d.)
2. *(Now obsolete.)*
3. PLASTICS. 1s. (1s. 2d.)
4. PLUMBING. 1s. (1s. 2d.)
5. THE PAINTING OF BUILDINGS. 1s. (1s. 2d.)
6. GAS INSTALLATIONS. 6d. (8d.)
7. STEEL STRUCTURES. *Out of print.*
8. REINFORCED CONCRETE STRUCTURES. *Out of print.*
9. MECHANICAL INSTALLATIONS. 2s. (2s. 3d.)
10. SOLID FUEL INSTALLATIONS. 9d. (11d.)
11. ELECTRICAL INSTALLATIONS. 1s. 6d. (1s. 8d.)
12. THE LIGHTING OF BUILDINGS. 2s. 6d. (2s. 9d.)
13. NON-FERROUS METALS. 1s. (1s. 2d.)
14. SOUND INSULATION AND ACOUSTICS. 1s. 9d. (1s. 11d.)
15. WALLS, FLOORS AND ROOFS. 9d. (11d.)
16. BUSINESS BUILDINGS. 1s. (1s. 2d.)
17. FARM BUILDINGS. 3s. (3s. 4d.)
18. THE ARCHITECTURAL USE OF BUILDING MATERIALS.
2s. 6d. (2s. 9d.)
19. HEATING AND VENTILATION OF DWELLINGS. 2s. 6d. (2s. 10d.)
20. FIRE GRADING OF BUILDINGS. Part I. 1s. 6d. (1s. 8d.)
21. SCHOOL BUILDINGS FOR SCOTLAND. 1s. (1s. 2d.)
22. FARM BUILDINGS FOR SCOTLAND. 3s. (3s. 3d.)
23. HOUSE CONSTRUCTION. SECOND REPORT (see No. 1 above).
1s. 6d. (1s. 8d.)
24. SCHOOL FURNITURE AND EQUIPMENT. 6d. (7d.)
25. HOUSE CONSTRUCTION. THIRD REPORT (see Nos. 1 and 23
above). 6d. (7d.)
26. DOMESTIC DRAINAGE. 6d. (7d.)
27. HEATING AND VENTILATION OF SCHOOLS. 6d. (7d.)
28. PRECAUTIONS AGAINST FIRE AND EXPLOSION IN
UNDERGROUND CAR PARKS. 1s. (1s. 2d.)

Prices in brackets include postage

HIS MAJESTY'S STATIONERY OFFICE

*At the addresses shown overleaf
or through any bookseller*

CROWN COPYRIGHT RESERVED

PUBLISHED BY HIS MAJESTY'S STATIONERY OFFICE

To be purchased from

York House, Kingsway, LONDON, W.C.2 429 Oxford Street, LONDON, W.1

P.O. Box 569, LONDON, S.E.1

13a Castle Street, EDINBURGH, 2

1 St. Andrew's Crescent, CARDIFF

39 King Street, MANCHESTER, 2

Tower Lane, BRISTOL, 1

2 Edmund Street, BIRMINGHAM, 3

80 Chichester Street, BELFAST

or from any Bookseller

1946

(reprinted 1950)

Price 3s. *od.* net

**Printed under the authority of HIS MAJESTY'S STATIONERY OFFICE
by T. and A. CONSTABLE LTD., Edinburgh**

Wt. 72801 K6 12/50 53*2611