

Air Publication 1269B

1st EDITION, 1946

AIR MINISTRY

HANDBOOK
of
PREVENTIVE
MEDICINE

HIS MAJESTY'S STATIONERY OFFICE.

1947

Price 7s. 6d. net

Air Publication 1269B

1st EDITION, 1946

AIR MINISTRY

HANDBOOK
of
PREVENTIVE
MEDICINE

CROWN COPYRIGHT RESERVED

LONDON: HIS MAJESTY'S STATIONERY OFFICE

1947

Price 7s. 6d. net

Issued for the information and guidance of all
concerned.

J. H. Barnes

By Command of the Air Council

AIR MINISTRY
Published 1947

FOREWORD

The aim of preventive medicine is to preserve and improve health by the interception or removal of all factors which may exert an adverse influence on individual well-being.

In the Royal Air Force emphasis is placed on the ultimate responsibility of commanders for the health of their men. An equally great responsibility rests on medical officers to advise their commanders of the measures necessary to protect the personnel under their care, as far as possible, against communicable disease and any defects of habit or environment which may impair their vitality, as well as measures to improve their efficiency even beyond what is accepted as normal.

It is of the utmost importance not only that loss of man hours through sickness should be kept to a minimum, but that all personnel on duty should be at the peak of their efficiency. That outmoded word *debility* has a real meaning when applied to an individual whose physical and mental vigour has been sapped by sub-clinical malaria or a diet lacking in vitamin B.

In all wars disease has been responsible for many more admissions to hospital than has enemy action. In Macedonia, during the war of 1914-1918, 27 cases of disease, chiefly malaria, were admitted to hospital for every wounded patient; while in East Africa, where dysentery was the principal foe, the ratio was as high as 33 to 1. The Serbian Army was defeated by typhus, not by the Bulgars. In 1943 the incidence of malaria in certain islands in the South West Pacific rose to 80 per 1,000 a week (over 4,000 per 1,000 per annum), while a similar incidence for dysentery was encountered in parts of Burma.

Medical recommendations may clash with strategical and tactical considerations and may therefore be impossible to fulfil. The ruthless removal of a native village from the outskirts of a military camp, however desirable from the view point of the hygienist, may have to be renounced for political reasons. The only suitable ground for a landing strip may be alongside a malarial marsh. Compromise is often inevitable. It may not be possible to ensure an absolute minimum of avoidable disease, but the most strenuous efforts must always be made to reduce ill-health, and sub-health, to the lowest possible level, by applying the principles of preventive medicine which are set out in this publication.

H. E. WHITTINGHAM,

Director-General of Medical Services,
Royal Air Force.

February, 1946.

CONTENTS

<i>Foreword</i>		
<i>Chapter</i>	<i>Subject</i>	<i>Page</i>
I—PERSONAL HYGIENE	1-5
II—WATER	7-21
III—FOOD AND NUTRITION	22-38
IV—ENVIRONMENT	39-110
Section	I Climatology	39-54
,,	II Pathological effects of great heat ..	54-67
,,	III Pathological effects of extreme cold ..	67-70
,,	IV Buildings	70-80
,,	V Clothing	80-85
,,	VI Heating	86-88
,,	VII Lighting	88-98
,,	VIII Ventilation	99-103
,,	IX Hygiene and sanitation of tented camps	103-106
,,	X Industrial hazards	106-110
V—CONSERVANCY	111-147
Section	I Sewage disposal works	111-120
,,	II Field sanitary appliances—urinals ..	121-126
,,	III Field sanitary appliances—latrines ..	127-134
,,	IV Disposal of sullage water	135-138
,,	V Refuse disposal in the field	139-147
VI—COMMUNICABLE DISEASES	148-191
Section	I Control, general measures	148-149
,,	II Control of the droplet infections ..	149-155
,,	III Control of individual diseases ..	156-191
VII—DISINFECTION AND DISINFESTATION	192-205
Section	I Disinfection	192-198
,,	II Disinfestation	198-200
,,	III DDT	200-205
,,	IV Other insecticides and repellents ..	205
	<i>Index</i>	206-213

INDEX TO ILLUSTRATIONS AND TABLES

<i>Subject</i>	<i>Page</i>
Buildings :	
Chimney flashings	Fig. 10 .. 74-75
Cookhouse, 1,000 men, layout ..	Table X .. 79
Damp courses, hollow walls	Fig. 8 .. 72
Damp courses, solid walls	Fig. 9 .. 73
Climate :	
Basic scale of corrected effective (or effective) temperature	Fig. 7 .. 62
Climate map	Fig. 5 .. 53
Relative humidity table	Table VII .. 51
Normal scale of corrected effective (or effective) temperature	Fig. 6 .. 60
Temperature-humidity records at selected places on the globe.	Table VI .. 42-49
Clothing :	
Cold climate scale	Table XI .. 81
For special occupations	Table XII .. 84-85
Communicable diseases :	
Droplet infections—incubation and isolation periods	Table XXIV .. 151
Louse—life cycle	Fig. 38 .. 185
Mosquitoes	Fig. 36 .. 169
Schistosomiasis	Fig. 37 .. 179
Dental :	
Tooth brushing	Fig. 1 .. vi
Diet :	
Balanced diet	Table III .. 34
Calories—daily requirements	Table II .. 34
Foodstuffs—nutritive value of	Table I .. 30-31
Minerals—daily requirements	Table IV .. 34
Vitamins—daily requirements	Table IV .. 34
Disinfectors :	
Improved box-type, steam	Fig. 39 .. 193
Portable, large, Type B	Fig. 40 .. 194
Portable, small, Type B	Fig. 41 .. 195
Table of steam temperature variations according to pressure ..	Table XXV .. 196
Disinfestation :	
DDT—solvents	Table XXVI .. 204
DDT—useful data	Table XXVII .. 205

	<i>Subject</i>	<i>Page</i>
Food Handling :		
	Period of exclusion from food handling after apparent cure Table V	.. 37
Incinerators :		
	Bailleul Fig. 29	.. 143
	Beehive Fig. 30	.. 144
	Cairn Fig. 35	.. 147
	Corrugated iron, portable Fig. 33	.. 147
	Horsfall destructor Fig. 28	.. 141
	Inclined plane Fig. 34	.. 144
	Open circular Fig. 31	.. 145
	Open square Fig. 32	.. 145
Latrines :		
	Bored hole Fig. 24	.. 132
	Deep trench Fig. 23	.. 129
	Pail Fig. 25	.. 133
	Shallow trench Fig. 22	.. 129
Lighting :		
	Coefficient of utilization Table XVII	.. 97
	Lamp spacing Table XIV	.. 94
	Lighting fixtures, design Fig. 12	.. 92
	Light reflection, factors Table XVI	.. 96
	Lumen ratings, electric discharge lamps	Table XIX .. 98
	Lumen ratings, gas filled lamps Table XVIII	.. 98
	Natural lighting, sky angle Fig. 11	.. 90
	Room lighting index Table XV	.. 95
	Standards of illumination Table XIII	.. 91
Refuse :		
	Common means of disposal in the field	Table XXIII .. 146
Sewage :		
	Activated sludge (Simplex process) .. Fig. 16	.. 118
	Horizontal-flow tanks Fig. 14	.. 112
	Sedimentation tank and filter, upward flow Fig. 15	.. 115
	Septic tank Fig. 17	.. 119-120
Sullage :		
	Cold water grease trap Fig. 27	.. 136
Tents :		
	Daily airing Fig. 13	.. 104
	Types and capacity Table XXII	.. 104

	<i>Subject</i>	<i>Page</i>
Urinals :		
Funnel	Fig. 18	.. 122-123
Oil drum	Fig. 20	.. 124
Petrol drum	Fig. 21	.. 126
Soakage pit	Fig. 18	.. 123
Trough	Fig. 19	.. 124
Ventilation :		
Fans, extractor—running speeds and output	Table XXI	.. 101
Natural ventilation—scales	Table XX	.. 100
Tents	Fig. 13	.. 104
Water :		
Basic requirements—guide	Table VIII	.. 57
Metafilter purifying apparatus	Fig. 3 10
Sources of supply	Fig. 2 6
Sweat loss in pints per hour	Table IX	.. 58
Two-bottle method of purification	Fig. 4 14

FIG. 1

UPPER

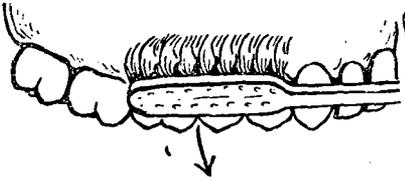

Position 1

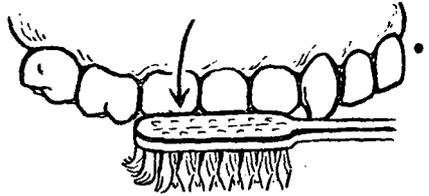

Position 2

LOWER

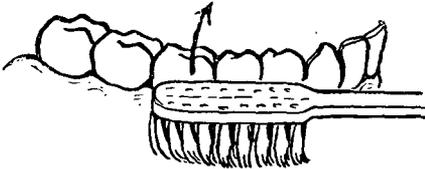

Position 1

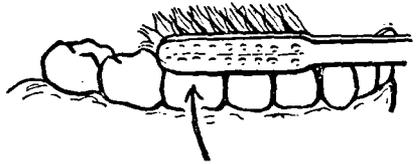

Position 2



Position 3

CHAPTER I

PERSONAL HYGIENE

Strict attention to personal cleanliness will go far to prevent contraction of many parasitic and fungal infections. Early treatment of such conditions is necessary for the protection of others.

1. Personal precautions

(a) *The hair* should be washed once a week, as a precaution against parasitic and bacterial infections.

(b) *The teeth* should be cleaned last thing at night and first thing in the morning. A small brush is better than a large one and the bristles should not be too stiff. Brushing the teeth from side to side does harm to both teeth and gums. The correct method is to place the brush with the bristles on the gums (horizontally for the back teeth and vertically for the front six teeth); then sweep the bristles over the gums towards the tips of the teeth at least six times, being careful to brush in one direction only, that is, upwards for the lower teeth and downwards for the upper, as illustrated in Fig. 1. This technique enables the bristles to enter the spaces between the teeth and remove food particles which are liable to lead to decay, and by massaging the gums helps to maintain resistance against gum inflammation and pyorrhoea. A dentrifice or tooth paste, although pleasant, is not essential. A very reliable and easily obtained dentrifice is a mixture of common salt and bicarbonate of soda in equal quantities.

(c) Pathogenic organisms can be projected thirty feet or more by an unguarded cough or sneeze, which should always be trapped in the handkerchief or hand. Tubercle bacilli can survive for long periods in dried sputum. This is one of the chief reasons why the objectionable habit of spitting is no longer tolerated by civilised communities.

(d) *Personal cleanliness* is particularly important in hot countries, where skin infections are so readily acquired, but even in cold and temperate climates at least one hot bath a week is necessary. Particular care must be paid to washing of the armpits, the crutch, the cleft between the buttocks, beneath the fore-skin and between the toes. The toes, crutch and armpits must be thoroughly dried, for the skin of these parts when sodden with acid sweat is especially liable to fungus infections. The use of a simple dusting powder for these places assists drying and is a wise additional precaution in hot climates.

2. Specific infections and infestations

(a) *Pediculosis*.—Lice may transmit typhus, relapsing fever and trench fever. Three varieties of lice cause infestation in human beings—the head louse, the body louse and the pubic or crab louse.

The head louse is common among women recruits but relatively rare among men. The eggs or nits are minute, yellowish bodies which resemble dandruff but remain adherent to the hair when this is drawn through the fingers.

Treatment.—Two drachms of medicated hair oil, which contains Lethane 384 Special, are required for the treatment of each head. The hair oil should be demanded in the usual way from the Medical Equipment Depot, Chessington. The use of too much oil should be avoided. It must be placed on the scalp itself, by pulling aside the hair with one hand and applying the liquid from a small vessel or pipette held in the other. This should be done at eight spots, four on each side of the scalp. The oil is then distributed over the scalp by massaging with the fingers, not by combing. The insecticide kills both lice and eggs and remains effective for eight or nine days. The hair must not be washed for at least a week after treatment, when a thorough shampoo should be followed by the use of a fine comb to remove the dead nits.

The body louse is dealt with under typhus in Chapter VI.

The pubic louse, which may also infest the armpits and eyebrows, causes much irritation and even extensive inflammation.

Treatment.—One application of less than 10 cc of the following emulsion is effective. Shaving is unnecessary:—

Lauryl thiocyanate	' 50 cc
Lanette wax S.X.	2 grammes
Water	950 cc

Melt the lanette wax on a water bath and add the lauryl thiocyanate. Heat the mixture to 60°–70° C. and add to the water, which should be at the same temperature. Stir until cold.

(b) *Scabies.*—This condition is caused by the itch mite (*Sarcoptes scabiei*). The female burrows under the skin and lays 24–48 eggs during its life of two to three months. The eggs hatch into six-legged larvæ in about seven days. The larva, after one moult, becomes an eight-legged nymph, which later matures to the adult stage after two further moults. The males die after pairing with the females, which then cast their skins and begin their subcutaneous egg-laying. The adult mite can live for 10 days in the absence of a host, provided the atmosphere is warm and moist.

The diagnosis of scabies may be difficult in the mild cases when the itching, typically worse at night, is absent. Signs of scratching, and the scattered reddish papules which follow scratching, should be searched for on the chest, abdomen, legs and arms. Vesicles indicate the presence of the living mite and should be sought on and between the fingers, on the front of the ulnar margin of the wrist, on the elbows, the front of the axillæ, the penis, scrotum and buttocks and around the ankles.

Treatment.—Emulsio benzylis benzoatis, which contains 25 per cent of benzyl benzoate, is the approved standard remedy. This may be demanded in the usual way from the Medical Equipment Depot, R.A.F., Chessington.

The patient should first soak himself in a warm bath for 10 minutes, or stand under a warm shower for 5 minutes. He then soaps himself freely and rubs himself with a rough flannel, but not a scrubbing brush, after which the soap is rinsed off. He is then dried and, in a warm room, the benzyl benzoate emulsion is applied over the whole body from the

neck downwards with an ordinary flat paint brush about 2 inches wide. When the application is dry, clean under-clothing is put on and the patient returns to duty.

Two treatments are necessary, on consecutive days or within a period of eight days.

Irritation may persist for a few days after successful treatment and is made worse by the further application of sarcopticides.

(c) *Impetigo contagiosa*.—This condition is usually considered to be due to a primary streptococcal infection upon which a secondary infection with *Staphylococcus aureus* is often superimposed.

Treatment.—Mild cases may be bathed with alibour water,* for three minutes every 2 hours for three days. This is followed by removal of the crusts, preferably with a starch poultice, and renewed applications of alibour water if the lesions still ooze. If the skin is then dry, or only a little moist, Lassar's paste containing two per cent ammoniated mercury should be used.

Severe cases in which the lesions spread rapidly and become confluent should be treated with sulphathiazole 2 grammes three times a day by mouth for four days. Crusts should be removed *at the beginning* of treatment and alibour water applied as already described. Sulphonamides may be applied locally, but not for more than seven days owing to the risk of induced sensitization. Two per cent ammoniated mercury in zinc paste may be used if the alibour water causes excessive drying of the skin.

Chronic persistent lesions should be treated by careful removal of the crusts and application of one per cent silver nitrate lotion. Penicillin is effective and may be useful in resistant cases. Ung. benzoylis peroxidi is a satisfactory ointment if one is needed. Care must be taken to avoid irritation of the skin by over-treatment of these cases.

Shaving of the affected areas must be avoided in all cases of impetigo.

(d) *Tinea of the groin, axilla and foot*.—Unless the fungus concerned has been identified with certainty, for which cultural methods are usually required, the term tinea or dermatophytosis is preferable to epidermophytosis and trichophytosis.

Infection is spread by infected clothing, socks and towels or from the wet boards, floors and mats of ablution centres, swimming baths and hotel or private house bath rooms. The infection may also be acquired from lavatory seats and bed pans.

The incubation period may vary from a few days to a few weeks.

(i) *Tinea cruris*.—Round, red papules in the groin rapidly become confluent until the typical, itchy, sharply defined, erythematous rash is seen. The rash spreads peripherally and symmetrically on the inner sides of the thighs, the scrotum and between the buttocks; it has a festooned,

* Alibour water: Copper sulphate, 4 grains, zinc sulphate, 6 grains, camphor water to 1 ounce.

raised and often scaly edge. Maceration and oozing may occur, followed by secondary infection with pyogenic organisms.

(ii) *Tinea axillaris*.—The clinical appearance and course are the same as in *tinea cruris*, but the possibility of the condition being secondary to a primary infection of the feet or groin must always be borne in mind.

(iii) *Tinea pedis*.—Three types are recognised and occasionally two, or all three, may be found co-existent.

The *intertriginous type* is the commonest. The skin between the toes, particularly the fourth and fifth, becomes white and sodden. In places it rubs off, leaving a raw surface.

The *vesicular type* often originates on the sides of the toes and then appears on the insteps, or the tops of the feet, where it forms a reddened, vesicular area, usually with a definite border. Scales, vesicles and scattered pustules may all be found.

The *hyperkeratotic type* affects the horny layer of the soles, which become thickened diffusely or in patches. Exfoliation and fissures appear in the thickened skin.

Similar lesions to the above three types may sometimes be found on the hands.

(iv) *Dermatophytides*.—'Sensitization' of other areas of the skin may result from circulation in the blood and lymph of toxins produced by a *tinea fungus*. The type of eruption most commonly seen is a crop of small blisters or vesicles on the hands. No fungus can be recovered from such lesions and they quickly disappear when the primary infection is adequately treated. *Tinea cruris* rarely gives rise to dermatophytides.

Treatment of tinea: Treatment with antiseptics or keratolytics will aggravate many skin conditions, such as eczema, and they must not be employed until a diagnosis of tinea is certain.

Acute infections with moist, raw surfaces must not be treated with ointments. One of the following methods should be used until the skin is thoroughly dry:—

Two per cent aqueous gentian violet, applied as a paint every 6 hours.

1/3000 aqueous perchloride of mercury, applied as soaks every 6 hours.

1/1000 aqueous potassium permanganate, applied as a five-minute bath twice daily and followed by calamine lotion.

Castellani's paint (pigmentum carbol-fuchsin), applied once or twice daily until all scaling has disappeared and for a week thereafter. Old clothing should be worn, as fabrics will be deeply stained.

In non-acute phases of tinea, ointments or pastes may be used, of which three examples are given below. A simple ointment such as the first named should be applied once nightly for at least a week after apparent cure, and then once weekly for three months.

Ung. iodi denigrescens, thoroughly rubbed in twice daily.

Ung. acidi salicyli et acidi benzoici (Whitfield's ointment) is particularly indicated for the hyperkeratotic type of tinea pedis, but should not be used for the vesicular type.

Ung. dithranol, as dithranol added to soft paraffin or Lassar's paste, and applied twice daily; 1 to 2 per cent dithranol is the standard strength, which should be reduced to 0.5 per cent for sensitive areas or increased to 3 per cent for resistant cases.

Prophylaxis: Boots, socks, sports kit, other clothing and towels should never be shared.

When tinea is prevalent, floors and duckboards in ablution centres and swimming baths should be washed down frequently with disinfectant. Coconut matting should be removed. Socks and underclothing of sufferers should be disinfected by heat, and boots by swabbing with formalin. Footbaths containing bleach solution (1 drachm of bleaching powder to 1 gallon of water) or sodium thiosulphate (1 drachm to 1 ounce of water) should be provided at ablution centres and swimming baths. Dusting powder* should be made available for all ranks.

(e) *Prickly heat*.—The etiology of this condition is still the subject of dispute. It is associated with excessive sweating, may be due to a fungus and is common in warm climates during the hot months of the year. Fat, flabby individuals who take little exercise are especially prone to the condition.

The rash consists of innumerable, pin-point papules or vesicles and is intensely itchy. It is most profuse where the clothing is tightest, especially round the waist, but it may occur on any part of the body except the palms and soles. Anything which provokes sweating, even a cup of tea or plate of hot soup, will bring on an immediate outburst of severe itching. Maceration and secondary infection may complicate the condition, which, however, subsides rapidly with the onset of the cool weather.

Prophylactic measures include the use of medicated soaps, especially those containing carbolic acid and mercury biniodide; a dusting powder containing equal parts of boric acid, zinc oxide and starch used freely after the twice-daily bath; the use of spirit lotions containing salicylic acid (1 drachm to 8 ounces of spirit) or 1/1000 mercury biniodide is an additional precaution which receives considerable support; salt and non-alcoholic fluid intake should be increased. Calamine lotion, with or without hydrocyanic or carbolic acid, may be used for cases with extreme itching of the skin.

* Pulv. zinc. co. with acid salicyl.; or camphor 5 grains, boric acid 7½ grains, pulv. talcum 1 ounce.

FIG. 2

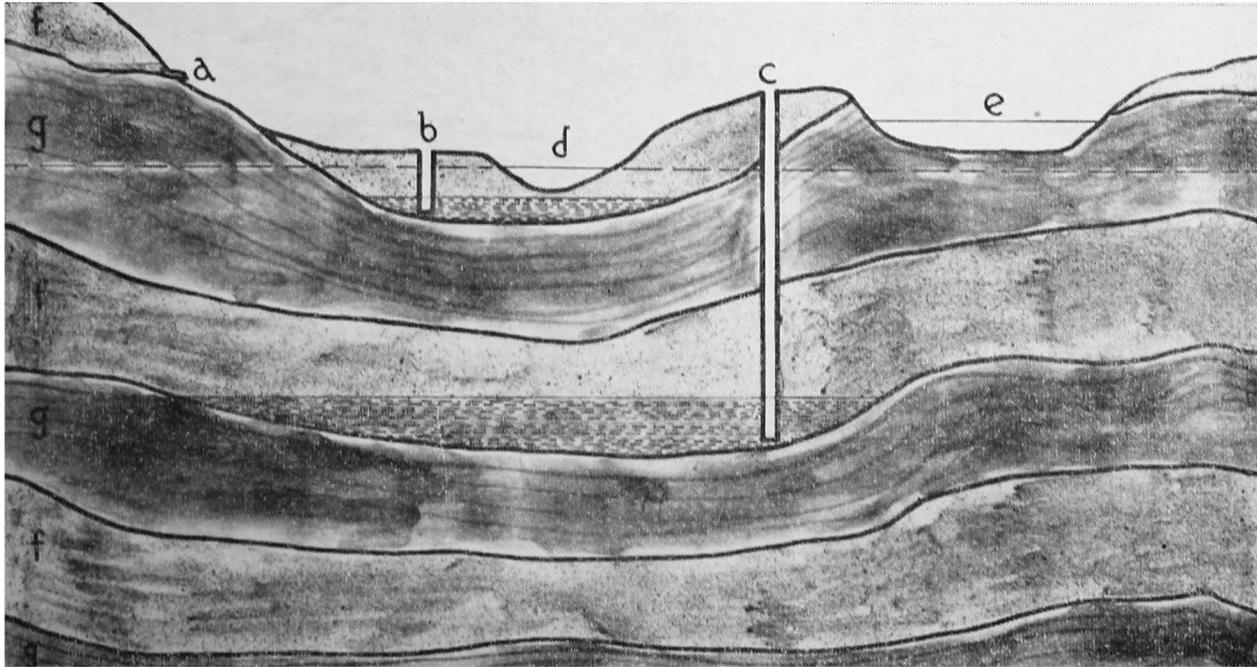

9

WATER SOURCES

A—Spring.
B—Shallow well.

C—Deep well.
D—Stream.

E—Lake.
F—Permeable strata.

G—Impermeable strata.

CHAPTER II

WATER

1. Water supplies

An adequate supply of safe water is needed for drinking and cooking purposes. In addition, water is required daily for ablutions, for laundry purposes, for the washing down and replenishing of radiator water of mechanical transport vehicles, for the flushing of sanitary appliances, where installed, and for industrial purposes. The quantity of water which should be allowed at R.A.F. units for daily use is approximately :—

Stations where waterborne sewerage exists ..	30	galls.	per head
Stations where no waterborne sewerage exists	10	"	"
Hospitals where waterborne sewerage exists ..	50	"	"
Hospitals where no waterborne sewerage exists	40	"	"
Temporary camps	5	"	"
Temporary camps (drinking and cooking purposes only)	1	"	"

Air Ministry Works Directorate is responsible for the provision and maintenance of a water supply as detailed in K.R. and A.C.I., paras. 1820 and 1859. The duty of the medical officer is to satisfy himself that the supply is safe and protected from contamination at all stages of delivery and storage (*see* K.R. and A.C.I., para. 1487). For small units in the field it may be necessary for the medical officer to undertake more than this and to supervise the purification of water by one of the methods described later.

2. Sources of supply

(a) Water evaporated from the earth's surface rises into the air and is ultimately condensed and falls back to the earth as rain, hail or snow. Of that portion which falls upon land some evaporates, some runs off in streams or rivers and the remainder percolates into the ground. Water for domestic supplies may be derived from surface sources, e.g., streams, rivers, lakes, collected rain or from underground sources such as wells or springs.

(b) *Surface sources.*—(i) *Stream or river water* in uninhabited country may be safe, but if the country is populated pollution soon occurs. The stream joins a river which, flowing through villages and towns, receives sewage and other forms of pollution. The water becomes discoloured and turbid and completely unfit for domestic use without treatment. The water of lakes is similar to that of streams or rivers flowing through them. Although it may receive some natural purification by the settlement of solids and the destruction of bacteria by oxygenation and sunlight, it should not be used for drinking without sterilisation. In times of heavy rain, streams, rivers and lakes become even more impure as pollution is washed from the banks by the increased flow of water.

(ii) *Ponds* are usually heavily contaminated and water from them must be treated. In summer they often become green with vegetable growth and the water has an unpleasant taste and odour. Many ponds dry up completely in summer and they are therefore not reliable sources.

(iii) *Rain water* collected from roofs contains impurities absorbed from the air and washed from the collecting surface. It is 'flat' and unpalatable but is soft and very suitable for laundry and ablution purposes. If the collecting surface is protected and proper storage tanks are provided the water will be safe for drinking—otherwise sterilisation will be necessary.

(c) *Underground sources.*—(i) *Shallow wells.*—Rain soaks into the ground until it reaches a stratum, such as clay or rock, through which it cannot pass. To a certain height above the impervious stratum the porous earth becomes saturated with water and a well sunk into it will fill up to this level. Such a well is called a shallow well and the water from it, owing to probable surface pollution, is unfit for domestic purposes without previous sterilisation.

(ii) *Springs.*—If the impervious stratum, following a level or downward trend, outcrops at the side of a hill a surface spring may be found at the outcrop. As the water is derived from above the impervious stratum it is subject to pollution as in the case of shallow wells.

(iii) *Deep wells.*—A deep well extends down into a water-bearing stratum below the uppermost impervious stratum. Consequently, if the water from the ground above the uppermost impervious stratum is excluded from the well, the water from the deep well is limited to that flowing below the impervious stratum. This water has come from comparatively remote surface sources and the contamination which it might have derived from these remote sources has been removed by filtration through the earth. An artesian well is a deep well in which the water below the impervious stratum is under pressure and rises in the tube of the well. Although the water from deep sources may be safe for drinking purposes, deep wells must be properly constructed and maintained to exclude contamination through the walls of the bore from the surface and the subsoil. The bore should have a watertight lining extending from about a foot above the surface of the ground to the first impervious stratum. The ground for 6 feet around the well should be concreted to exclude polluted surface water. A watertight and dustproof cover is necessary and should always be kept locked. Water should be drawn from the well by means of a pump, the suction pipe of which is a permanent fixture. Drawing water from the well in buckets should not be allowed as there is a grave risk that dirt would be carried down the well on the buckets. An area around the head of the well should be fenced off to prevent the entry of animals or unauthorised persons. The minimum permissible distance from a well of a possible source of contamination, such as a manure heap or a cesspool, when conditions such as the absence of chalk, limestone or other fissured formations and the direction of flow of subsoil water are satisfactory, is 100 feet.

3. Impurities in water

Chemical impurities.—(i) Hardness is due to sulphates and carbonates of calcium and magnesium and other salts in solution. It causes wastage of soap and forms deposits in hot water pipes and boilers. Temporary hardness, which is caused by bicarbonates, is readily removed by boiling the water. Permanent hardness is caused by sulphates and cannot be removed by boiling. Water softening on a large scale is not normally carried out in the R.A.F. if the water is intended solely for drinking, but small plants are sometimes supplied for reducing the hardness of water used for cookhouse appliances, engine radiators, boilers and hot water systems.

(ii) *Lead* may be dissolved out from lead pipes and cisterns if the water contains dilute acid, as is common with soft, peaty, water supplies. Water containing more than 0.1 p.p.m. of lead is generally considered to be unsafe for human consumption.

(iii) *Zinc* may be dissolved out from galvanised pipes but does not constitute a danger in the small quantities that usually appear in solution.

(iv) *Iron* in solution in the water in small quantities may lead to the incrustation of pipes. Larger quantities will make the water unpalatable.

(v) *Copper* is now sometimes employed for water pipes and this metal may be taken into solution, with resultant green staining of basins, baths, and washing materials if an alkaline soap is used. The permissible limit is 1.4 p.p.m.

(vi) *War chemicals* may contaminate water supplies. If this is suspected the Case, Water Testing, Poisons, should be used for their detection.

Bacteriological impurities and helminths.—The organisms responsible for cholera, diarrhoea, dysentery, typhoid fever, paratyphoid fever and spirochaetal jaundice and the larval stages of certain worms live in water. Persons drinking such contaminated water may become infected. The organisms and immature stages of the worms may be passed out in the faeces or urine of a carrier of the disease and may be deposited directly into a water supply, or indirectly, by soaking through the ground. Organisms of disease are also to be found in dust and may be carried with it into a water supply.

4. Purification of water

The majority of water supplies require some treatment to destroy disease organisms or to guard against intermittent pollution. *In the field all sources should be regarded as unsafe and the water purified before use.* The purification of water consists of *clarification* to remove solids in suspension, and *sterilisation* to destroy the organisms of disease. It should be noted that clarification is generally necessary as well as sterilisation, because suspended organic matter can protect bacteria from the effect of the chemicals used, and so make necessary the addition of very heavy doses to make the water safe. Clarification is carried out by filtration or sedimentation and sterilisation is effected by boiling, chlorination, chloramination or superchlorination followed by dechlorination.

FIG. 3

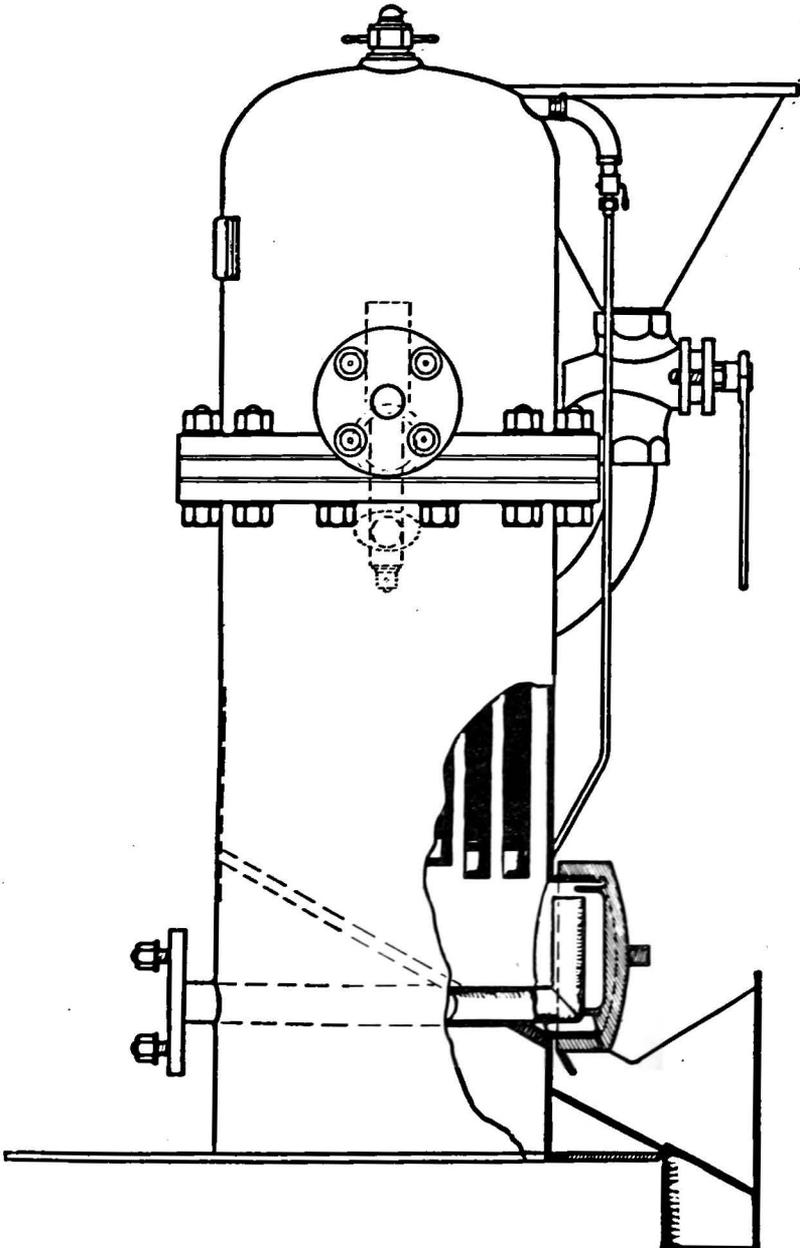

THE METAFILTER
(sectional elevation)

5. Filtration

In the various types of filters used, a cloth or bed of media is provided to prevent the passage of suspended matter.

(a) *Passing water through cloth* is suitable for the preliminary filtration of extremely dirty water or as an expedient when no better method is available. The efficiency of this method is increased by adding clarifying powder (Stores reference 33C/542) in the proportion of 10 grains to each gallon of the water to be filtered.

(b) *Mechanical filters* usually take the form of metal 'candles,' constructed either of metal washers kept separate by bosses on their surfaces or of spirally wound metal wire, or wire mesh screens. Upon these candles or mesh screens is deposited a layer of diatomaceous earth (kieselguhr) from a watery suspension. This forms a highly efficient filter medium.

(c) *Sand filtration* may be used in the large scale purification of water or for improvised filters in the field. The addition of clarifying powder to the water before filtration will result in the formation of a floccular deposit of aluminium hydroxide which will greatly increase the efficiency of the filter.

6. Sedimentation

If water is allowed to remain undisturbed in tanks, a large proportion of the solid matter will sink to the bottom and clear water may be drawn off the top. The addition of clarifying powder, aluminium sulphate or aluminoferric will form a heavy flocculant precipitate which on sinking carries the suspended matter with it to the bottom and accelerates the rate of sedimentation. About 3-5 grains of alum per gallon of water should be used. The alum should be intimately mixed with the water before being allowed to settle. Sedimentation will not be complete for from 2 to 4 hours. This method is seldom used for small quantities of water.

7. Boiling

The sterilisation of water by boiling is effective but suitable only for small quantities. The water should be boiled for at least five minutes.

8. Chlorination

(a) Small doses of chlorine added to water have a marked germicidal effect; the power to kill organisms of disease increases with the dosage of chlorine and with the period of contact. If the water contains large amounts of organic matter the chlorine may be diverted to combine with it without killing the bacteria and other organisms. The water should therefore be clarified before being sterilised; this will reduce the dose of chlorine necessary for effective sterilisation and so reduce the risk of leaving an unpleasant taste in the water. When using chlorine to sterilise a water supply the following points must be observed :—

(i) Sufficient must be added to destroy all disease organisms and leave a *small* residual to guard against later contamination.

(iii) The chlorine must remain in contact with the water long enough for sterilisation to take place before the water is used.

As the dosage quantities are very small, some fairly accurate method of determining the required amount is necessary. The Horrocks' test is usually carried out, using the Case, Water Testing, Sterilisation.

(b) *Chlorine* may be added to water in one of several forms. For drinking water the dose varies according to the initial purity of the water and is usually from one to four parts of chlorine per million. The object is to leave a residual of approximately one part per million at the end of the sterilising period, which should be at least 30 minutes.

(i) *Gaseous chlorine*.—This method is favoured for large, permanent water undertakings; it is not recommended for use in the field owing to the difficulty and danger of handling the cylinders in which the gas is contained.

(ii) *Water sterilising powder or chloride of lime*.—This is a powder containing a large amount of available chlorine (chlorosene or tropical bleach, 30 per cent; water sterilising powder, 25 per cent). The powder rapidly loses its chlorine content if exposed to the air. It is always used as an emulsion, prepared by the gradual addition of water with constant stirring, to form first a smooth paste; more water is then added to make a weak emulsion.

(iii) *Chloros*.—This is a proprietary liquid containing 10 per cent available chlorine. It is supplied in large carboys or small glass ampoules. It is used for purification of temporary swimming baths and with the Steriliser, Water, 10-Gallons (Stores reference 21C/1777).

9.

Chloramination

Chloramines, formed by the interaction of ammonia and chlorine in water, have certain advantages over chlorine, viz. :—

(a) Taste troubles are reduced or even eliminated up to a dosage of 2 p.p.m.

(b) Chloramines are not deviated by organic matter and a fixed dosage can be used, dispensing with the preliminary testing of the water.

(c) Their germicidal action is more prolonged, so providing a safeguard against contamination after sterilisation.

Their one important disadvantage is that their action is slower and at least one hour is required for sterilisation to take place. The standard fixed dosage for water of average purity is 2 p.p.m., effected by the addition of 10 grains of ammonium chloride and 60 grains of water sterilising powder to every 100 gallons of water. *The ammonium chloride must always be added first, after grinding up the tablets in a little water to form a solution.*

10.

Superchlorination and dechlorination

In this method the water is sterilised (15 minutes contact period) by a comparatively large dose of chlorine, after which the residual chlorine is removed to make the water palatable. At

least 2 p.p.m. of free chlorine should be present in the water at the end of the contact period. This is removed by the addition of sodium thiosulphate (1 gramme per 100 gallons) or, as in the Steriliser, Water, 10-Gallons, by passing the water through a filter of activated charcoal.

11. Tests for free chlorine

When water has been sterilised by the addition of chlorine one of the following tests may be applied to see that the water is safe before use :—

(a) Add three drops of cadmium iodide and starch indicator solution to one Horrocks' white cupful of treated water. A definite blue colour should be produced (*see* para. 15).

(b) Chlorotex Test (*see* para. 16).

12. Water supplies on permanent stations

(a) Water is often obtained from the mains of nearby towns, the station main being connected to the town main and water supplied in the same way as it would be to any private consumer. Purification is undertaken by the water company or local authority responsible for the safety of the water in its mains. The possibility of contamination of the water after leaving the town mains cannot be overlooked; cases have arisen where the station supply has been contaminated by leaking mains, dirty storage tanks or mains under repair. If the water supply is turned off at any time or the pressure in the main is reduced, dirt from the surrounding ground may enter if there is a leak in the pipe. The medical officer must therefore keep all water supplies under observation; he should keep himself informed of any repairs or alterations being undertaken so that he can assure himself that proper steps are taken during and after this work to remove any risk of contamination.

(b) Where the water is not obtained from a local water company the station supply will be drawn from a permanent source and treated, if necessary, by permanent filters and chlorinators of one of the commercial types in common use.

13. Water supplies in the field

Various measures are adopted for the purification of supplies in the field, according to the quantity of water required.

(a) *Boiling*.—For very small supplies, water may be boiled for five minutes before use. If very turbid it is preferable that it should be clarified before boiling.

(b) *Water sterilising tablets*.—These are small white tablets. They are packed in first-aid kits in aircraft, and in dinghies and other emergency apparatus. The tablets may also be issued in certain special circumstances where bulky equipment cannot be carried. Instructions for using the tablets are to be found on the containers and should be followed closely. One white tablet is added to a full water bottle and dissolved by shaking; the water is then allowed to stand for 30 minutes before being used. De-tasting tablets (sodium thiosulphate) are also supplied. These are coloured blue and one tablet should be added to the water 30 minutes after the sterilising tablet has been dissolved.

FIG. 4

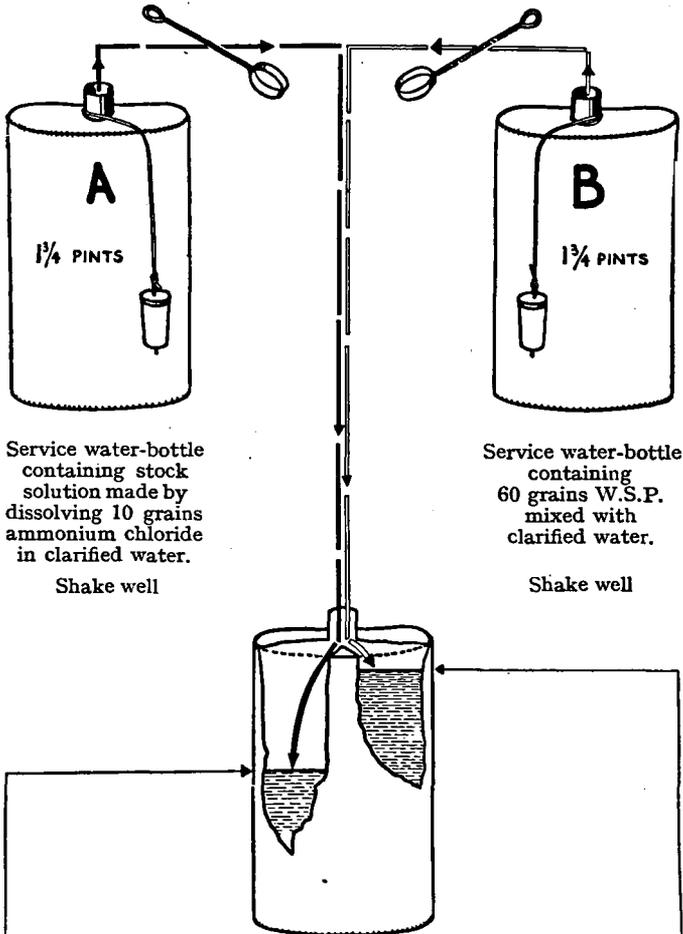

WATER STERILISATION: TWO-BOTTLE METHOD

Instructions

1. Half fill water-bottle with clarified water and add one scoop ammonium chloride solution A.
Shake well.
2. After charging with ammonium chloride, fill up bottle with clarified water and add one scoop W.S.P. mixture B.
Shake well.
3. Do not use sterilised water before one hour has elapsed.

(c) *Two-bottle method of water purification.*—Water already clarified should be used and chloramination is the sterilising process. Take 2 ordinary water bottles 'A' and 'B' and fill them. In 'A' dissolve 10 grains of ammonium chloride and in 'B' 60 grains (2 Horrocks' scoopfuls) of water sterilising powder. Each man half fills his own water bottle and to it is added one Horrocks' scoopful of the contents of bottle 'A.' The man then fills his water bottle and one Horrocks' scoopful of the contents of bottle 'B' is added. The water bottle should then be shaken. The water must not be used for at least one hour.

(d) *Two-tank method.*—This is normally used for bulk supplies but can be adapted to meet most circumstances. Chloramination is the sterilising process. Two tanks are erected near the water source and fenced off. The first tank, if possible, should be raised to allow siphonage into the second tank. While water is being pumped into the first tank, clarifying powder is added to give a dosage of 10 grains per gallon to the water. After mixing, a settlement period of 2-4 hours is allowed and the water is then siphoned or pumped to the second tank, in which it is dosed with the sterilising chemicals. To obtain thorough mixing, add the ammonium chloride (10 grains per 100 gallons) in solution when the tank is one-third full, and the water sterilising powder (60 grains per 100 gallons) as an emulsion when it is two-thirds full. Allow the tank to fill, stand for one hour, test for free chlorine, and then issue if satisfactorily purified. The tanks should be covered.

(e) *Mobile water purification plants.*—These may be either tenders or trailers and are usually provided with kieselguhr, filtration apparatus and means for chloramination by hand.

14. Water contaminated with *Schistosoma cercariae*

The following information is supplementary to that given in A.P. 1269, para. 682.

(a) Snails can be destroyed by adding copper sulphate to the water in the proportion of 1 p.p.m. (1 lb. for every 100,000 gallons).

(b) Methods of clarification either by sedimentation with alum or filtration through sand or cloth filters do not hold back cercariae. Filters of the Metafilter type may possibly remove these infective agents.

(c) Superchlorination kills cercariae in 30 minutes.

(d) Chloramine in doses of 3 p.p.m. will kill them in one hour.

15. The Horrocks' test

(a) *The Case, Water Testing, Sterilisation.*—This outfit was designed to determine the amount of water sterilising powder required to sterilise 100 gallons of water, which was the approximate content of the original regimental water cart.

(b) *Description of contents.*

6 white enamelled cups, each holding $\frac{1}{2}$ pint of water when filled nearly to the brim ;

1 black enamelled cup, with a mark on the inside ;

2½ metal scoops, each holding 30 grains when filled level with the brim with water sterilising powder. They are similar to the measure contained in the ¼-lb. tin of water sterilising powder ;

1 stock bottle of cadmium iodide and starch indicator solution, and 1 drop bottle. Three drops of the indicator solution give a definite blue colour with water containing 1 part of free chlorine in 1,000,000 parts of water ;

6 glass tubes, or pipettes, each of such dimensions that a drop of standard water sterilising powder solution delivered by it, when held in a vertical position, into a white cup filled with water, gives a dilution of chlorine of 1 part in 1,000,000, providing that the water sterilising powder is up to strength ;

4 glass stirring rods ;

25 tablets of sodium thiosulphate, gr. 1½ ;

50 tablets of acid sodium sulphate, gr. 15 ;

12 pipe cleaners ; .

2 copies of instructions.

(b) *Method of using.*—Clarified water is used. The test is best carried out while the tank of the water purification plant is being filled, an operation which may take anything over half-an-hour.

(i) Prepare a standard emulsion of water sterilising powder in the black cup by putting into it one level scoopful of the water sterilising powder, making it into a smooth paste with a little clarified water by stirring it with a glass rod and carefully breaking up all lumps, adding more water gradually to the paste until the mark on the inside of the cup is reached. Stir vigorously and leave the glass rod in the black cup. This solution is never clear, as it contains lime in suspension, which, however, gradually settles.

(ii) Fill the 6 white cups with clarified water to within a quarter of an inch of the top.

(iii) Add drops of the standard water sterilising powder solution by means of a pipette to the water in the white cups, so that they contain 1, 2, 3, 4, 5 and 6 drops respectively. In order to add even drops of the standard water sterilising powder solution to the cups, it is necessary that the top of the pipette and also the finger should be quite dry.

(iv) Stir the contents of each thoroughly with a clean stirring rod and leave this stirring rod in the black cup.

(v) Allow the cups to stand for half-an-hour.

(vi) After half-an-hour add 3 drops of the indicator solution from the drop bottle to each of the white cups, and stir each with a clean stirring rod. Some of the 6 white cups will show no colour, some will show a blue colour. The first of the cups showing a blue colour, that is the one containing the smallest number of drops, is noted. Say cups 1, 2, 3, show no colour, but cups 4, 5, 6, show a blue colour, then cup 4 is the one to be noted. If none of the cups show a blue colour, the cups are washed out and the test is performed again with 7, 8, 9, 10, 11 and 12 drops of the water sterilising powder solution in the cups. Each drop of water sterilising powder solution in a white cup corresponds to a scoopful of water

sterilising powder to 100 gallons of water. In the above example 4 scoopfuls of water sterilising powder are thus required for the sterilisation of 100 gallons of water.

(c) *Test to determine amount of free chlorine in water.*—The Case, Water Testing, Sterilisation, is also used for this test.

(i) Dissolve 3 tablets ($1\frac{1}{2}$ grains each) of sodium thiosulphate in a white cupful of *unsterilised* water and mix thoroughly.

(ii) Fill a second white cup with the *sterilised* water to within one-eighth of an inch of the brim.

(iii) Add 10 drops cadmium iodide and starch indicator solution to the *sterilised* water in the cup and stir. If chlorine is present a blue colour will appear.

(iv) Add sodium thiosulphate drop by drop from a Horrocks' pipette, stirring continuously and counting the number of drops, until the blue colour in the sterilised water just disappears.

(v) The number of drops of sodium thiosulphate solution required to remove the blue colour divided by ten gives the amount of free chlorine in parts per million.

16. Chlorotex test

This test is employed to determine amount of free chlorine in sterilised water and is carried out as follows :—

(a) Place 50 c.cs. of the sterilised water in one of the glass cylinders.

(b) Place 5 c.cs. of chlorotex reagent (using pipette) into the other cylinder.

(c) Pour the water into the chlorotex reagent, stir, and leave for a few minutes.

(d) Compare the colour produced with graduated chart and read off amount of chlorine in parts per million.

17. Despatch of water samples for analysis

Samples for examination and analysis from R.A.F. Stations in the United Kingdom will be sent to :—

The Officer Commanding,

R.A.F. Institute of Pathology and Tropical Medicine,

Halton Camp,

Nr. Aylesbury, Bucks.

18. Permanent water supplies

(a) Medical officers, on being posted to a station, should familiarise themselves, by consultation with the Works representative and by inspection, with the source of water supplied, and with the situation and condition of storage tanks and purifying plant, if installed.

(b) Permanent water supplies for established Royal Air Force Stations in the United Kingdom are in the majority of cases derived either from Air Ministry wells on or near the station, or

from Public Water Supply Companies. Air Ministry wells are of the deep variety, protected as far as possible against surface or remote pollution.

(c) *Routine analysis of permanent water supplies.*—(i) Water from Air Ministry wells should normally be submitted for bacteriological analysis at quarterly intervals. Chemical analysis is only required for new wells.

(ii) Water from public supply companies should normally be submitted for bacteriological analysis annually. Public companies are required by law to supply pure water, and this routine analysis serves mainly as a check on the integrity of pipework and the cleanliness of storage tanks on the station. Routine chemical analysis is not required.

(d) *Special analysis of permanent water supplies.*—Special analysis of permanent water supplies is necessary :—

(i) when suspicion is aroused regarding the purity of the water, by an outbreak of enteritis or other disease capable of being waterborne ;

(ii) when inspection of storage tanks or piping suggests that contamination has probably occurred ;

(iii) after new pipework or new storage tanks are installed or after repairs to existing installations are made ;

(iv) when water from a new source is added to existing supplies.

Bacteriological examination will suffice in the circumstances of (i), (ii) and (iii) above, but *chemical analysis* may be necessary in regard to (iv) if the water from the new source is likely to be acid and thereby possibly plumbo-solvent or if it is likely to be very hard. If the purity of the water is suspected, sterilisation by boiling or chloramination should be instituted until analysis shows it to be fit for drinking.

19. Action in the event of contamination

If contamination is reported as a result of analysis, action is needed to sterilise sufficient water for drinking and culinary use, and to discover and eliminate the source of contamination.

Sterilisation of permanent supplies.—(a) *Boiling.*—This is an unsatisfactory method except for small numbers of personnel for a short time. It may, however, be the only method immediately applicable and care must be taken to ensure that the water is actually boiled, that it is stored in vessels suitably protected from dust or other contamination, that personnel are only allowed to drink boiled water and that dishes are not washed in unboiled water.

(b) *Chemical sterilisation.*—Chlorination (or chloramination) is the method of choice, and the need for this should be reported immediately to the commanding officer of the station. If plant cannot be supplied rapidly by the Works Department it may be possible to utilise a water tender or trailer.

(c) *Localisation of contamination.*—This is carried out by inspection and by intelligent sampling at different points in the supply. It is essential to be aware of the track of the water supply through the station. Inspection should be directed first towards

obvious sources of pollution, such as dirty storage tanks (e.g., dead birds in the tanks) or fractures in the piping. Sampling is used to confirm the results of inspection, or to localise the origin of contamination for which no cause is apparent. In the latter case, the first sample should be taken at the entrance of the water to the station system. It should be remembered that after establishment of a pure supply, some time will elapse before all contamination is cleared from the piping; flushing of the system with hyper-chlorinated water (10-50 p.p.m. chlorine), will hasten cleansing.

(d) It must be emphasised that suitable action to remedy defects discovered must be taken. If sampling has been carried out correctly, nothing is gained by submitting further samples until such action is completed.

(e) When deciding where samples for analysis should be taken, the co-operation of the local representative of the Works Directorate should always be obtained.

20. **New stations**

The permanent water supply to new stations is liable to show pollution for a short time, due to soil organisms derived from the new pipework, and in the case of a well supply, from work in the well itself. Bacteriological analysis of water derived from new supplies is usually carried out monthly for three months after installation, or until the supply is satisfactory, when the normal quarterly routine is adopted.

21. **Casual supplies**

(a) It is sometimes necessary to use water from casual and uncontrolled sources, either to supplement permanent supplies or to provide for temporary quarters, camps or aerodromes. These sources may be rivers, streams, shallow wells, or springs. It may be stated broadly that no such source produces pure drinking water and all water so obtained should be sterilised before use.

(b) *Analysis of casual supplies.*—Many requests are made for examination of samples from sources obviously polluted or liable to intermittent pollution. Examination of such supplies imposes needless work on the laboratory and results are of no value in assessing the continued purity of the supply. All casual supplies, therefore, must be considered as polluted and should be sterilised before use. Samples should not be sent for bacteriological analysis, though an analysis for chemical impurities may be necessary in certain instances, especially when enemy action is suspected. In addition, chemical analysis may be needed occasionally to assess the potability of a supply which appears to contain suspended matter or when there is reason to suspect plumbo-solvency or excessive hardness.

22. **Technique of sampling and information required by the laboratory**

The water should be collected :—

- (a) for *chemical* analysis in a Winchester quart bottle ;
- (b) for *bacteriological* examination in a sterilised 8-oz

In the United Kingdom these bottles and containers will be supplied, ready for immediate use, by the Officer Commanding, R.A.F. Institute of Pathology and Tropical Medicine, Halton, Bucks. When a medical officer has to prepare his own bottles, the simplest procedure is to cleanse a Winchester quart bottle with a little weak sulphuric acid, afterwards removing all traces of the acid by repeated washings with the water to be examined. A bottle that has contained ammonia should never be used. The bottle should be closed with a well-fitting glass stopper, or a new, freshly-boiled cork. For bacteriological examination an 8-oz. medicine bottle and a new cork should be boiled in a steriliser or saucepan for 30 minutes; the boiling water is poured off, the bottle stoppered with the aid of sterile forceps, and allowed to cool before use.

(c) *The collection of water samples* should be carried out under the direct personal supervision of the medical officer of the unit concerned and the samples collected under similar conditions to those under which the water is drawn for drinking purposes. At R.A.F. units, the water samples normally should be collected from the drinking water supply in the airmen's kitchen. Specimens for chemical and bacteriological examination from any one source should be taken at the same point and at the same time. Before the bottles are filled they should be rinsed out thoroughly with the water to be examined.

(i) In the case of a *tap*, the water should be taken from the lowest tap supplied by the cistern, which is usually that in the kitchen, in order to obtain water which has run the greatest distance in the pipes. The mouth of the tap should be cleaned with a plug of lint to remove gross particles, flamed for a minute with a spirit lamp and then the water should be run to waste for five minutes before the samples are collected. Care should be taken that the cork or the inside of the neck of the bottle are not contaminated by the fingers or any other object during sampling. Do not sample from a tap with a leaking joint, which allows water to trickle down the outside of the tap into the sampling bottle.

(ii) A *well* should be pumped vigorously for five minutes before the water is collected. This aids in the detection of any flaw or contamination in the drainage area.

(iii) *River, reservoir, and lake waters* require a different procedure. A stout piece of string should be tied securely round the neck of the bottle in such a way as to leave a short and long end. The short end of the string, should be about a foot in length and should have fixed to it a stone or weight sufficiently heavy to immerse the bottle below the surface of the water. The longer end, several feet in length, should be held in the hand of the collector to enable him to regulate the position of the bottle. A second piece of string should be attached to the stopper enabling the stopper to be removed from the bottle when the latter is immersed. In this manner contamination of the sample with the surface scum will be avoided.

(iv) In every case the bottle should be filled completely so as to exclude all air, and then firmly stoppered. Stoppers should be tied with string and finally secured with sealing wax.

(d) Immediately after collection all samples must be clearly labelled, giving the following particulars :—

- (i) Name of station.
- (ii) Date and hour of collection.
- (iii) Source of sample (tap, well, spring, name of building, etc.).
- (iv) Method of collection.
- (v) Geological character of soil and sub-soil of district.
- (vi) Nature and distance of evident or possible source of pollution.
- (vii) Rainfall during previous week (nil, small, moderate or great).
- (viii) Any special treatment that the water has received (boiling, chlorination, softening or clarification).
- (ix) Reason for desiring analysis.
- (x) Signature of officer sending the sample.

CHAPTER III

FOOD AND NUTRITION

1. Introduction

Food intake should be irreproachable as to the quantity and quality of its various constituents. The latter must be sufficient to sustain all vital processes and all harmful elements must be excluded from the daily diet.

There are five recognized components of an adequate diet, namely :

protein, fat, carbohydrate, minerals and vitamins.

The amounts of these substances that are needed by the human body are fairly accurately known, although the vitamin contents of some foodstuffs are still the subject of debate and it is probable that many other accessory food factors still remain to be discovered.

It has become customary to describe the fuel requirements of the human body in terms of calories, these being units of heat which are produced by the combustion of specified weights of foodstuff. A calorie (or 1 kilo calorie) is the amount of heat necessary to raise the temperature of 1 kilogramme of water by 1° C. To speak of a 3,000 calorie diet means that, if a man eats that diet, absorbs and burns it completely in his body, he will produce sufficient heat to raise the temperature of 3,000 kilogrammes of water by 1° C. or 30 kilogrammes (about 7 gallons) of ice water to boiling point.

2. Protein

Protein is an essential constituent of the diet, since it is the only foodstuff containing nitrogen and sulphur in a state in which they can be used for tissue repair. It also provides the amino-acids used for the manufacture of certain essential secretions and enzymes. It stimulates general metabolic activities and is a source of energy.

Animal proteins contain all the essential amino-acids and are therefore referred to as *first-class protein*, which should comprise rather more than a third of the total protein intake of the diet. 100 grammes is generally accepted as the necessary daily intake. This quantity allows a safety margin over the minimum amount necessary to maintain nitrogenous equilibrium, when the nitrogen lost in the excreta is exactly balanced by that taken in as protein. Vegetable proteins, of which potatoes, rice and wheat provide the most satisfactory sources, are termed *second-class protein*.

1 gramme protein = 4.1 calories.

3. Fat

Fat is particularly necessary in the diet when energy expenditure is high, either from heavy work or from exposure to cold. Canadian lumbermen, whose diet contains 8,000-9,000 calories, obtain much of this huge intake from fat. The

Inter-Allied Food Commission adopted 57 grammes of fat as the daily minimum ration during the war of 1914-18, although the average intake recommended is 100 grammes.

1 gramme fat = 9.3 calories.

4. Carbohydrate

Carbohydrates are cheap, easily obtained and provide more than half the energy content of the average diet. A big reduction in carbohydrates will be followed by incomplete oxidation of the fats in the diet and ketosis will result. The normal daily diet should contain about 500 grammes of carbohydrate.

1 gramme carbohydrate = 4.1 calories.

5. Minerals

(a) *Calcium* is required for ossification of bone, the regulation of nerve excitability, contraction of heart muscle, clotting of blood and milk and the maintenance of capillary endothelium. It is particularly necessary in childhood when it should be provided in the form of at least one pint of milk daily. The chief sources are milk, cheese and green vegetables. 680 mgms. a day are required.

(b) *Phosphorus* is required as an integral part of most cell structures, for the transportation and metabolism of fat, as a constituent of bone and in buffer substances to maintain H⁺ ion concentration in the cells, blood and urine. The chief sources are milk, eggs, brain, liver and pancreas. 680 mgms. a day are required.

(c) *Iron* and *copper* are necessary for the formation of red blood cells and haemoglobin. Iron is provided chiefly by whole-meal bread and animal tissues, especially liver and kidney. Green vegetables, especially spinach, are also good sources. 15 mgms. of iron and traces of copper are the daily requirements.

(d) *Iodine* is essential for the formation of thyroxine, the active principle of the thyroid gland. The usual source is drinking water, but where this is deficient in iodine, as in Derbyshire and some of the Swiss Cantons, simple goitre is endemic. In such circumstances iodized table salt should be used. Sea fish are an excellent source of iodine. 1/10 mgm. is required in the daily diet.

(e) *Sodium*, *potassium*, *magnesium*, *sulphur* and *chlorine* are all needed by the body tissues but deficiencies can practically never occur under normal conditions of diet, health and climate.

(f) *Manganese* is concerned in haemoglobin formation and *zinc* is present in insulin. Small traces of *cobalt* also, are probably necessary for blood formation.

6. Vitamins

(a) *Vitamin A* is found in fats of animal origin, especially milk, butter, cream, eggs, beef fat, liver fat and fish liver oils. Green vegetables, carrots and some fruits such as apricots and bananas contain carotene, the precursor of vitamin A, which can be

transformed into the vitamin on ingestion. This vitamin is heat stable and is little affected by the ordinary processes of cooking, preserving and canning.

Changes in the skin and poor dark adaptation are the earliest signs of a deficiency in vitamin A. A dry, rough skin, often associated with papular eruptions, more common in children and native races on inadequate diets, often referred to locally as 'toad skin' or 'shark skin,' is typical. Vitamin A is believed to combine with protein to form visual purple, which is a component of the retinal rod system essential for night vision. Augmentation of the vitamin A intake can only improve night visual acuity in individuals whose diet is lacking in this substance. It is given in capsular form to night flying personnel in order to ensure that their intake of this vitamin cannot fall below the minimum requirement. Other results of vitamin A lack are seen in the keratinisation of the conjunctiva and corneal changes; the latter may progress to complete destruction of the cornea. Structural changes in epithelial linings, especially the mucous membranes of the respiratory and gastro-intestinal tracts, may occur, thereby rendering these tissues particularly liable to secondary infection. Broncho-pneumonia and enteritis may ensue.

(b) *Vitamin B* is a complex structure made up of a number of factors. The chief sources are wheat germ, whole meal cereals, yeast, yeast extracts, pulses (especially soya beans) and peanuts. The principal components of the B complex are listed below:—

(i) B_1 : Syn: aneurin, thiamine.

Heat labile, but withstands moderate heat including short periods of boiling. It is destroyed by high temperature canning processes, and in the presence of alkalies or sulphites.

Deficiency eventually results in beri-beri, which is preceded by fatigue, headache, loss of appetite, dyspepsia, dizziness and slow pulse. In the absence of this vitamin pyruvic acid, formed during the breakdown of carbohydrates in nervous tissue, is not removed, and nerve-cell metabolism comes to a standstill. It is not yet clear whether this vitamin is essential for carbohydrate metabolism in other tissues of the body.

(ii) *Riboflavin*.—Reasonably heat stable and not destroyed by ordinary cooking processes, except in the presence of alkalies. Deficiency results in angular stomatitis, glossitis, a seborrhoeic type of dermatitis and eye changes. The latter are associated with photophobia, burning and itching, which respond rapidly to riboflavin by mouth. Slit lamp examination of the eye shows early, typical vascularisation of the cornea by invading capillary loops.

(iii) *Nicotinic acid*.—One of the most stable of all vitamins, being unaffected by heat even under pressure or in the presence of alkalies.

The syndrome of pellagra is largely due to a deficiency of this vitamin, although the lack of other components of the B complex, notably B_1 and riboflavin, also plays a part. The pigmented, desquamative dermatitis of parts

of the body exposed to light, glossitis (which does not respond to riboflavin), diarrhoea with sprue-like stools and mental changes progressing to dementia are the symptoms of pellagra which are generally attributed to nicotinic acid deficiency. Sprue, pellagra, idiopathic steatorrhoea, pernicious anaemia, the Plummer-Vinson syndrome and sulphonamide intolerance all present similar clinical features which, post hoc or propter hoc, may be linked with a B complex deficiency and are alleviated by administration of one or more of the B factors. Unpleasant side effects are often produced when nicotinic acid is prescribed, due to its vaso-dilator effect. Flushing, urticaria, pruritus, palpitation and headaches are common, but fortunately they are transitory and generally pass off within half an hour. Nicotinamide, given in the same dosage as nicotinic acid, seems to be equally effective and does not cause these unpleasant symptoms.

Apart from adenylic acid, pantothenic acid and B6, which are needed in the treatment of pellagra and beriberi, and are best prescribed as yeast, or yeast concentrate, liver and liver extract, the remaining members of the B complex are still mainly of academic interest. They are concerned in various developmental problems in experimental animals, such as faulty growth, alopecia, greying of the hair, failure of lactation and dermatitis. Their applications to similar defects in human beings have not yet been fully confirmed. The following represent present known components of the B complex :—

B1
 B2
 B3
 B4
 B5
 B6 (pyridoxin)
 Factor U
 Factor W
 Rice polish factor
 Bios
 Biotin (vitamin H)
 Vitamins L₁ and L₂
 Vitamin M
 Choline
 p-aminobenzoic acid
 pantothenic acid
 adenylic acid

(c) *Vitamin C*, or ascorbic acid, is the anti-scurvy vitamin. Black currants, hips and haws are even better sources than the citrus fruits, with which gooseberries, strawberries and raspberries are about on a par. The autumn fruits (apples, pears, plums) are almost useless as a source of this vitamin. Among the vegetables, cabbage, cauliflower and brussels sprouts provide

large quantities, especially if eaten raw, and deserve more popularity in this country as constituents of salads; celery, lettuce and cucumber contain disappointingly small amounts. Cooked potatoes provide a large proportion of the vitamin C in the normal diet. Vitamin C is rapidly lost in storage. Destruction does not occur in boiling and steaming, but only a loss by extraction. Contrary to general opinion, the addition of soda to cooking water does not affect to any appreciable extent this loss by extraction. In this connection it may be noted that cabbage water and orange juice have the same vitamin C content. Frying, owing to high temperature, and stewing or baking, due to the slowness of these processes, are much more destructive in their effects on this vitamin. Canned foods are often good sources of vitamin C; in many instances better than the same food carelessly cooked in the household. Dehydrated vegetables retain the bulk of their vitamin C.

Pathological changes which follow a deficiency in vitamin C are due to failure of certain tissues to lay down and maintain normal intercellular ground substance. The materials chiefly involved are the collagen of fibrous tissue, the matrix of bone and cartilage, dentine in the teeth and the cement substance of the lining of blood capillaries. The haemorrhages of scurvy are due to the absence of cement substance in capillary linings. The healing of fractures, wound repair and the organisation of blood clot fail for lack of these various intercellular substances when the diet is deficient in vitamin C. Vitamin C also seems to be concerned in bactericidal and antitoxic action and may act as a detoxicating agent in poisoning by arsphenamine, lead, gold, sulphonamides and other inorganic poisons. The phenomenon of capillary fragility, however, is not entirely due to a lack of ascorbic acid. Another factor, associated in nature with vitamin C, is also concerned. This factor is now known as vitamin P or citrin.

(d) *Vitamin D* is the anti-rachitic or calcifying vitamin. It is formed in the skin by the action of the sun on the animal sterol, 7—dehydrocholesterol, or can be prepared artificially by irradiation of the vegetable sterol, ergosterol. In the latter form it is known as calciferol. An important source of vitamin D for man is sunlight, which by its activating effect on the skin produces the vitamin. Ultra-violet radiation is equally effective. The chief dietetic sources are dairy products such as milk, eggs and butter, and the fat sea fish such as cod, halibut, herring, pilchards, sardines and salmon. The vitamin D content of certain foods may be increased by artificial re-inforcement, either by the addition of calciferol or by irradiation. Margarine in this country must now contain 60 international units of vitamin D per ounce, generally as added calciferol. Milk may be re-inforced by the addition of calciferol, by irradiating the cow, by irradiating the milk or by adding vitamin D to the cow's food. Vitamin D is not lost or destroyed by cooking, canning, storage or drying.

Deficiency of vitamin D causes rickets, which is characterised by deformities resulting from the bending, under the weight of the body, of bones which are soft from deficient deposition of calcium salts. The action of the vitamin is probably to promote the absorption of calcium and phosphate from the bowel. Poorly

developed teeth also result when the diet is lacking in this vitamin during the formative period. When the calcium as well as the vitamin D content of the diet is low, tetany may develop as a complication of rickets; or osteomalacia, an adult form of the disease in women which particularly affects the pelvis, may occur.

(e) *Vitamin E*, which is found chiefly in wheat germ oil and green leafy vegetables, has been demonstrably effective in the treatment of habitual or recurrent abortion and the muscular dystrophies.

(f) *Vitamin K* is a generic term applied to a group of naturally occurring substances, in the absence of which a haemorrhagic tendency develops. Green plants, especially lucerne and spinach, are rich sources of this vitamin, which is also found in cauliflower, cabbage, carrot tops, soya bean, pine needles, seaweed, tomatoes, bran and orange peel. The action of this vitamin is either as an element in the formation of prothrombin or it stimulates the liver to produce prothrombin. A deficiency in the diet of vitamin K, or failure to absorb it, will result in hypoprothrombinaemia, which may be latent or spontaneous. In the latent type, operation wounds begin to ooze or the gums bleed easily when the teeth are brushed. Spontaneous hypoprothrombinaemia is seen in the new born, in idiopathic steatorrhoea, obstructive jaundice or severe parenchymatous liver disease and is characterised by large haematomata, haematemesis, haemarthrosis, epistaxis, haematuria or melaena. The blood coagulation time is prolonged but capillary fragility is unaltered. Vitamin K therapy is valueless in haemophilia, purpura and diseases of the blood-forming organs and is ineffective for the control of haemorrhage in the normal individual. In large doses vitamin K acts as a respiratory depressant and produces acute vascular congestion.

7. Dietary requirements

The energy value of the diet required for the average airman has been estimated at about 3,500 calories and for the airwoman at about 3,150 calories. These figures represent the values of the foodstuffs that arrive at cookhouses, not the calculated values of the items in the ration scales. The latter must provide a wide margin and include numerous alternative items, in order to ensure that local deficiencies, such as a seasonal shortage of potatoes, and faulty distribution, due to such causes as lack of transport or refrigeration facilities, do not reduce the total energy value of the food that appears on the plate. It is most important that frequent and regular checks should be made of the total calorie value of the rations as received at the kitchens.

A diet that supplies the necessary energy value will normally contain sufficient amounts of all essential nutrients including vitamins and minerals. Iron, calcium and vitamins B1 and C are the elements most likely to be deficient in the modern diet. When essential nutrients are known to be lacking, it is best to ensure that the best available foodstuffs are included in the rations before resorting to synthetic supplements such as vitamin pills. The utmost use should be made of national wheatmeal (80 per cent

extraction) or wholemeal flours, rather than white flours artificially fortified with vitamin B1 and calcium; dried vegetables, dried meat, dried pulses (peas, beans, soya beans, peanuts), dried sweet peppers (paprika) and food yeast are all highly palatable and retain a large proportion of the vitamin content they possessed before processing.

The preparation, cooking and serving of foodstuffs must have the dual aim of preserving, or enhancing, their palatability with the minimum loss of nutritive value. Destruction by heat and extraction by water are the chief causes of loss of vitamin content. Food should be served as soon as possible after cooking and not allowed to simmer needlessly on stoves or stand on hot plates for long periods. Potatoes are a main source of vitamin C and an important source of vitamin B1. In the mashed form especially, they should be served at the latest possible moment. Green vegetables are rich sources of mineral salts, the vitamin B complex and vitamin C.

The following rules are especially applicable to the cooking of vegetables on a large scale :—

- (a) Obtain as fresh as possible.
- (b) Avoid crushing and bruising during transport and storage.
- (c) Store in a cool place.
- (d) Soak only in *salt* water (1 lb. salt to 10 gallons water) for as short a time as possible.
- (e) Cook in the *minimum quantity of water*.
- (f) Add salt to the water *before* adding the vegetables. *Never* add baking soda or washing soda, as these alkalies increase the destruction of some vitamins, especially factors of the B complex.
- (g) Do not add the vegetables until the water is boiling vigorously. This minimizes vitamin destruction.
- (h) *Add the vegetables gradually, to prevent the water going off the boil.*
- (i) Stop cooking when the vegetables are tender.
- (j) *Serve as soon after cooking as possible.*
- (k) Use remainder of cooking water, which now contains minerals and vitamins, for soups and gravies.

The nutrients present in meat, fish, milk, cheese and eggs are not destroyed to any great extent by cooking. Much of the nutritive value, as opposed to energy value, of flour is destroyed by baking powder, and its vitamin B1 is almost completely destroyed. Yeast, therefore, should be used whenever possible rather than baking powder, as a leavening agent for the cooking of buns, scones, boiled and steamed puddings.

The content of a unit's swill bins is a good index of the quality of its messing. Much 'plate waste' means poor cooking. Good supervision is needed to ensure that waste does not occur either in the preparation or the consumption of rations, otherwise a large

proportion of their calorie value will satisfy the needs of somebody's pigs rather than the airmen for whom they have been provided.

8. Alteration of the normal diet required by various conditions

(a) *Muscular work.*—Appetite is automatically increased and should be satisfied with additional carbohydrate and fat, to provide the extra fuel needed. There need be no increase in protein, but bacon, ham and wholemeal bread are useful supplements since they are good sources of the vitamin B1 which will be needed to assist the breakdown of the additional carbohydrate. Fatigue will develop more readily in the absence of an adequate amount of this vitamin.* The vitamin C intake should be stepped up, since severe work makes heavy demands on the body reserves of this substance.

(b) *Athletic contests.*—Training should be carried out on a simple but full diet. Plenty of carbohydrate should be taken for a day or two before the test, in order to build up a good reserve of glycogen in the liver. Only light exercise should be taken during this period. One or two tablespoons of sugar immediately before the contest will not improve performance but will lessen the exhaustion which is likely to result.

(c) *Mental work.*—"There is no special brain food" (Hutchinson).* Small, rather frequent and easily digested meals are needed. Protein, mostly animal as this is more compact and digestible, should predominate over carbohydrate and fat.

(d) *Hot climates.*—Fluid intake should be greatly increased in order to allow the maximum perspiration, and consequent cooling. Additional salt, from $\frac{1}{2}$ to 1 ounce more a day, is needed to offset that lost in the sweat. The specific dynamic action of protein, which results in the production of heat without a corresponding increase in muscular energy, should be counteracted by the use of vegetable rather than animal protein, since the former has a lower specific dynamic action. The protein, too, should be spread over several meals rather than taken in a lump, in order to lessen this useless heat production effect. Since there is but little lowering of the basal metabolism in the tropics, there will be no appreciable change in the total amount of calories required in the diet from that taken under the same circumstances of muscular effort in a temperate zone. The cooling effect of iced drinks is largely illusory. Two pints of iced water will take up only about 40 calories from the body, while an equal amount of hot fluid at 45° C. will add only 8 calories; such amounts will have no appreciable effect on the body temperature.

(e) *Cold climates.*—The body temperature can be maintained up to a point by decreasing heat loss, mainly by an increase of clothing. With a further fall in external temperature, heat production must be augmented by an increase in food consumption. Fat produces the most calories for the least bulk, and is generally preferred since it is easier to obtain in Arctic and sub-Arctic regions and has the additional merit of not overloading the stomach. An extra 300 calories a day for each 9° F. drop in temperature is advisable.

* HUTCHINSON, R., & MOTTRAM, W. H., *Food and dietetics.*

TABLE I
THE COMPOSITION OF FOOD†
All values are per oz. of edible portion .

	Waste	Calo-ries	Pro-te-in	Fat	Carbo-hydrate	Calcium	Iron	Vita-min A	Vita-min B ₁	Ribo-flavin	Nico-tinic acid	Vita-min C	Vita-min D
	Per cent.		g.	g.	g.	mg.	mg.	i.u.	mg.	mg.	mg.	mg.	i.u.
1. Cereals :													
Barley, pearl	0	97	2.2	0.5	20.8	3	0.2	0	0.03	0.01	0.7	0	0
Biscuits—													
plain	0	116	2.9	2.1	20.8	8	0.4	0	0.08	0.03	0.3	0	0
sweet	0	126	1.9	3.9	20.0	3	0.4	0	0.07	0.03	0.3	0	0
Bread—													
white 70-72% extraction ..	0	73	2.3	0.2	15.6	4	0.2	0	0.01	0.01	0.2	0	0
National 85% extraction ..	0	72	2.4	0.4	14.6	4*(16)	0.5	0	0.05	0.03	0.3	0	0
wholemeal 92% extraction ..	0	65	3.1	0.6	11.2	7	0.7	0	0.09	0.05	0.6	0	0
Flour—													
white	0	98	2.3	0.3	21.6	5	0.4	0	0.02	0.01	0.3	0	0
National	0	97	2.5	0.4	20.9	6*(25)	0.7	0	0.07	0.04	0.4	0	0
wholemeal	0	95	4.3	0.9	17.4	10	1.0	0	0.13	0.06	0.8	0	0
Oatmeal	0	111	3.4	2.5	18.6	16	1.2	0	0.13	0.04	0.3	0	0
Rice	0	99	1.8	0.3	22.2	1	0.1	0	0.02	0.02	0.3	0	0
Wheatflakes, shredded wheat ..	0	97	3.9	0.7	18.7	10	1.4	0	0.01	0.02	0.3	0	0
2. Dairy products :													
Butter	0	211	0.1	23.4	0	4	0	1,140	0	0	0	0	17
Cheese	5 (rind)	117	7.1	9.8	0	230	0.2	370	0.01	0.14	0.1	0	10
Egg—													
fresh	12 (shell)	45	3.5	3.3	0.3	17	0.8	280	0.04	0.11	0	0	17
dried	0	163	13.0	11.9	0.9	62	3.1	850	0.11	0.37	0.1	0	68

† By courtesy of the Ministry of Food (*Manual of Nutrition*, 1945, 63-64).

* The figures in brackets show the calcium content after the addition of chalk to the flour.

Milk—														
whole	0	17	0.9	1.0	1.2	34	0	30	0.01	0.04	0	0.3	0.3	
evaporated (condensed un-														
sweetened)	0	40	2.0	2.3	2.7	69	0.1	90	0.01	0.10	0.1	0	1	
condensed, sweetened	0	89	2.3	2.6	14.1	82	0.1	105	0.03	0.10	0.1	1	1	
dried, whole	0	138	7.3	7.6	10.1	254	0.2	300	0.08	0.33	0.2	0	3	
dried, skim	0	97	10.2	0.2	13.6	348	0.3	9	0.11	0.45	0.3	0	0	
3. Fats :														
Cooking fat, lard, etc.	0	253	0	23.1	0	0	0	0	0	0	0	0	0	
Margarine	0	218	0	24.1	0	1	0.1	450	0	0	0	0	56	
4. Fish :														
Dried fish	35	52	11.9	0.4	0	18	0.7	0	0.02	0.12	1.8	0	0	
White fish, cod, etc.	45	21	4.5	0.3	0	7	0.3	0	0.02	0.04	0.6	0	0	
Fried fish		62	5.2	4.0	0	7	0.4	0	0.02	0.08	0.5	0	0	
Fish paste	0	47	3.8	2.5	2.2	41	1.7	0	0.01	0.02	0.3	0	0	
Herring	30	47	4.5	3.3	0	28	0.4	42	0	0.08	1.0	0	240	
Salmon—canned	0	48	5.7	2.8	0	85	0.4	71	0.01	0.06	1.8	0	170	
Sardine—canned	0	84	5.7	6.8	0	114	1.1	77	0.01	0.08	1.3	0	280	
5. Meat :														
Bacon	12	128	3.1	12.8	0	3	0.3	0	0.17	0.06	1.2	0	0	
Beef—														
corned	0	69	7.1	4.5	0	3	3.1	0	0	0.04	0.5	0	0	
fresh, average good quality ..	17	89	4.2	8.0	0	3	1.1	14	0.02	0.07	1.3	0	0	
stewing	25	60	4.8	4.5	0	3	1.1	14	0.02	0.07	1.3	0	0	
Kidney	0	36	4.5	2.0	0	3	3.8	280	0.07	0.37	3.8	0	0	
Liver—ox	0	40	4.8	1.7	1.4	3	3.9	4,260	0.11	0.85	3.8	0	0	
Meat pie	0	103	3.1	6.5	8.0	4	0.6	0	0.03	0.03	0.5	0	0	
Meat paste	0	45	3.4	2.3	2.6	7	1.0	0	0.01	0.03	0.6	0	0	
Mutton	17	94	3.7	8.8	0	3	0.6	14	0.04	0.05	1.2	0	0	
"Points" meat, spam, etc.	0	75	4.3	7.5	0	0	0.6	0	0.13	0.04	0.7	0	0	
Pork	15	116	3.4	11.4	0	3	0.3	0	0.20	0.06	1.7	0	0	
Sausage, pork	0	73	3.0	5.1	3.7	9	0.3	0	0.05	0.02	0.5	0	0	
Shepherd's pie, etc.	0	78	2.8	5.0	5.5	8	0.2	0	0.02	0	0.2	0	0	

THE COMPOSITION OF FOOD†—continued

All values are per oz. of edible portion

	Waste	Calo-ries	Pro-tein	Fat	Carbo-hydrate	Calcium	Iron	Vita-min A	Vita-min B ₁	Ribo-flavin	Nico-tinic acid	Vita-min C	Vita-min D
	Per Cent.		g.	g.	g.	mg.	mg.	i.u.	mg.	mg.	mg.	mg.	i.u.
6. Vegetables :													
Beans :													
baked, canned	0	25	1.7	0	4.5	16	0.7	47	0.02	0.01	0.2	0	0
haricot	0	71	6.1	0	11.6	51	1.9	0	0.13	0.08	0.6	0	0
soya, dried whole	0	114	8.5	4.3	9.4	67	2.6	25	0.24	0.06	1.2	0	0
Cabbage	30	7	0.4	0	1.4	18	0.3	85	0.02	0.02	0.1	20	0
Carrot	5-20	6	0.2	0	1.4	14	0.2	1,730	0.02	0.01	0.2	3	0
Cauliflower	30	6	0.7	0	0.8	14	0.2	0	0.02	0.02	0.2	20	0
Lentil	0	82	6.8	0	13.6	11	2.2	5	0.13	0.02	0.9	0	0
Lettuce	20	3	0.3	0	0.5	7	0.2	380	0.02	0.02	0.1	4	0
Onion	5	6	0.3	0	1.3	9	0.1	0	0.01	0.01	0	3	0
Peas—													
green	60	17	1.6	0	2.7	4	0.5	47	0.12	0.03	0.2	8	0
dried	0	85	7.0	0	14.2	17	1.3	19	0.13	0.08	0.6	0	0
Potato—													
fresh	7-25	21	0.6	0	4.6	2	0.2	0	0.03	0.02	0.3	2-8	0
chips	0	66	1.1	2.6	9.5	4	0.4	0	0.03	0.02	0.3	2	0
Spinach	25	6	0.8	0	0.7	20	0.9	1,230	0.03	0.06	0.1	18	0
Tomato	15	4	0.3	0	0.7	4	0.1	280	0.02	0.01	0.1	7	0
Turnip	35	5	0.2	0	1.0	17	0.1	0	0.01	0.01	0.3	7	0
Watercress	15	4	0.8	0	0.2	63	0.4	475	0.03	0.02	0.5	17	0
7. Fruit :													
Apple—													
fresh	20	12	0.1	0	3.0	1	0.1	4	0.01	0	0.1	1	0
dried	0	52	0.6	0	12.5	8	0.6	8	0	0.01	0.4	0	0
Apricot—													
fresh	8	7	0.2	0	2.0	5	0.1	71	0.01	0.21	0.1	3	0
canned	0	14	0.1	0	3.5	4	0.1	47	0	0.02	0.1	1	0
dried	0	50	1.4	0	11.1	26	1.2	473	0	0.12	0.6	0	0

Banana	40	21	0.3	0	4.9	2	0.1	8	0.01	0.01	0.2	3	0
Blackcurrant	0	8	0.3	0	1.7	17	0.4	9	0.01	0.01	0.1	57	0
Date	14	68	0.6	0	16.3	19	0.4	9	0	0.01	0.1	0	0
Fig—dried	0	58	1.0	0	13.5	81	1.2	9	0	0.08	0.5	0	0
Lemon	30	5	0.2	0	0.8	20	0.1	0	0.01	0	0	12	0
Melon	45	6	0.2	0	1.3	4	0.1	8	0.01	0.01	0.2	3	0
Orange	25	10	0.2	0	2.2	12	0.1	28	0.02	0.01	0.1	16	0
Peach—canned	0	16	0.1	0	3.9	2	0.2	47	0	0	0	1	0
Pear	25	11	0.1	0	2.7	2	0.1	1	0.01	0.01	0.1	1	0
Pineapple—canned	0	20	0.1	0	4.9	3	0.2	6	0.01	0.02	0	3	0
Plum	6	7	0.2	0	1.6	4	0.1	38	0.01	0.01	0.02	1	0
Prune—dried	17	44	0.7	0	10.3	11	0.8	237	0	0.04	0.6	0	0
Raisin	8	67	0.3	0	16.5	17	0.5	5	0	0.01	0.1	0	0
8. Nuts :													
Coconut	30	100	1.1	10.2	0.9	4	0.6	0	0.01	0.03	0.1	0	0
Peanut	30	166	8.0	13.9	2.2	17	0.7	0	0.25	0.08	2.6	0	0
9. Preserves, etc. :													
Chocolate—plain	0	148	1.3	9.2	15.0	7	0.9	7	0.03	0.07	0.3	0	0
Jam	0	71	0.1	0	17.6	3	0.3	2	0	0	0	3	0
Sugar	0	108	0	0	27.0	0	0	0	0	0	0	0	0
Syrup	0	81	0.1	0	20.2	7	0.4	0	0	0	0	0	0
10. Beverages :													
Beer—mild	0	10	0.1	0	1.5	3	0	0	0	0.01	0.4	0	0
Cocoa—as drunk with milk and sugar	0	6	0.2	0.2	0.9	3	0	3	0	0	0	0	0
powder	0	125	5.8	7.3	8.9	14	4.1	14	0.03	0.08	0.3	0	0
Tea—as drunk with milk and sugar	0	5	0.1	0.1	0.8	3	0	4	0	0.01	0	0	0
11. Cakes and puddings :													
Cakes, plain	0	89	2.8	1.4	16.2	14	0.6	85	0.03	0.01	0.1	0	0
Bun	0	85	2.3	2.2	13.9	10	0.6	0	0.04	0.03	0.3	0	0
Custard	0	33	0.9	1.1	5.0	35	0	20	0.01	0.02	0	0	0
Rice pudding	0	40	1.1	1.6	5.3	35	0	23	0.01	0.01	0	0	0
Steamed pudding	0	86	1.1	4.4	0.6	15	0.2	0	0.02	0.01	0	0	0
Yorkshire pudding	0	62	2.0	2.7	7.5	28	0.2	0	0.02	0.01	0.1	0	0

TABLE II

GROSS DAILY CALORIE REQUIREMENTS, INCLUDING WASTAGE IN
COOKING AND DIGESTION

Sedentary work	2,900	calories
Light work	3,100	..
Moderate work	3,500	..
Heavy work	4,000	..
Very heavy work	5,000	..

TABLE III

BALANCED DIET

Protein	100 grammes =	410	calories daily
Fat	100 grammes =	930
Carbohydrate	500 grammes =	2,050
Total	<u>3,390</u>	.. .

TABLE IV

VITAMINS AND MINERALS, DAILY REQUIREMENTS OF

Vitamin A	4,000	international units
Vitamin B1	400	international units
Riboflavin	2	mgms.
Nicotinic acid	20	mgms.
Vitamin C	50	mgms.
Vitamin D	500	international units
Calcium	680	mgms.
Phosphorus	680	mgms.
Iron	15	mgms.
Iodine	1/10	mgm.

9. Examination of foodstuffs

(a) *Meat*.—Should be light red in colour, firm, not too moist, marbled with fat, and have no unpleasant odour. Fat should represent about 15 per cent and bone, 20 per cent; but the edible portion of the meat ration as received from contractors in some overseas areas may be only 50 per cent at certain seasons of the year.

Horseflesh is sometimes substituted for beef. It may be recognised by its dark, coarse appearance, sickly odour, soapy feel and yellow fat. Owing to its higher glycogen content a violet colouration will be obtained by the application of a few drops of iodine—potassium iodide (Lugol's) solution.

When expert opinion is not available, a medical officer should not hesitate to condemn meat which appears to be diseased or unwholesome. Any part of a carcass which shows evidence of tuberculosis in its substance, on its capsule or in the associated lymph glands, must be condemned. The presence of caseous lymphadenitis, which causes the formation of nodules in the lymphatic glands of sheep and, occasionally, cattle, rabbits and chickens, also demands condemnation of the part affected. Evidence of widespread, active tuberculosis or caseous lymphadenitis brands the entire carcass, irrespective of the wholesome appearance of particular parts, as unfit for consumption. Anthrax, which is characterised by enlargement of the spleen, 'tarry' blood and widespread haemorrhages, requires condemnation of the entire carcass, cessation of all slaughtering and immediate investigation of the premises by a veterinary expert. Parasitic infections such as onchocerciasis ('worm nests'), distomatosis ('liver rot,' 'pipey liver') and hydatid cysts generally require no more than condemnation of the part or organ affected; but when the small, cysticercal stages of tapeworms ('beef measles,' 'pork measles') are found it is advisable to condemn the whole carcass. White moulds do not penetrate and only require removal by wiping with a damp cloth; 'black spot' moulds may require excision, which should include any surrounding areas of putrefaction.

(b) *Fish*.—The signs of decomposition are—sunken eyes, discoloured gills, unpleasant smell and soft flesh which separates readily from skin and bone.

(c) *Bread*.—Should be well risen, with a silky, glossy crumb which is of elastic texture, evenly aerated and free from large cavities. The crust should be thin, crisp and unbroken and a rich, bright brown in colour. The loaf should be sufficiently moist and soft to remain so for a reasonable time without becoming sour or musty.

(d) *Eggs*.—Fresh eggs sink in water and are translucent. Preserved eggs show a purple stain when a drop of phenol phtalein is placed on the shell and their yolks are invariably found to be broken on being turned out.

(e) *Tinned food*.—Inspection, palpation and percussion are the methods employed to detect unsound tins of food. Extensive rust, much indentation or signs of gross ill-usage lead to suspicion, as perforation of the tin may have resulted. The actual presence

of holes is cause for condemnation. Swelling of a tin is the first sign of gas formation due to fermentative micro-organisms; the resistance of this gas to pressure is detected by palpation and confirmation of its presence obtained by the resonant note emitted on percussing the tin with another or with a piece of wood. A sloppy sound produced on shaking a tin of 'solid pack' food, such as meat, indicates advanced decomposition and liquefaction.

It should be realised that canning processes do not as a rule sterilise the contents of the cans. Non-pathogenic micro-organisms are commonly found on bacteriological examination. Decomposition may take place without gas formation, but a 'blown' tin should always be considered as unsafe for human consumption.

(f) *Preserved food*.—Food may be preserved from decomposition by refrigeration, drying, smoking, exclusion of air, replacement of air by inert gases and by the addition of chemicals. The only chemical preservatives permitted in the United Kingdom are sulphur dioxide and benzoic acid, but the term 'preservative' does not include salt, saltpetre, sugar, vinegar, glycerine, acetic acid, alcohol, spices or the minute quantities of chemical substances used in the process of smoking.

10. Cookhouses and food handlers

(a) The most rigorous *standards of cleanliness* must be exacted in cookhouses at all times. The personal cleanliness of cooks must be above reproach. The hands, and particularly the nails (which should be kept short) of all cookhouse employees should be inspected daily. A good appearance when food is being served is important and for these occasions clean 'whites' should be worn. Blue overalls should be used for the dirtier tasks in a cookhouse.

(b) *Kitchens and messes* should be kept free from flies and scrupulously clean. Tables, shelves, chopping blocks, baking boards, draining boards and sinks should be scrubbed daily with hot water, soap and soda and when possible dried in the sun; dish cloths, drying cloths and scrubbing brushes should be boiled daily after use; floors should be washed daily with weak cresol solution or other disinfectant. Cooking utensils should be scoured after use; clean wood ashes or sand, which should be sterilised by baking, may be used for this purpose, but not ordinary soil as this may contain dangerous bacteria or helminths.

(c) All *garbage* should be placed in metal refuse bins outside the cookhouse. These should stand on a cement or other impervious base, for which drainage should be provided. It is most important that lids for refuse bins should be fitted, and maintained in a serviceable condition or replaced by fly-proof improvisations; kitchen refuse is second only to manure as a breeding place for flies.

(d) The *hygienic control of cooks and other food handlers* is of paramount importance in limiting the spread of the ingestion diseases. Microscopical and bacteriological examination of faeces is of value and should always be carried out, if possible, before engagement of cookhouse employees and others occupied on

duties of a domestic nature, with the object of detecting dysentery, typhoid group and helminth carriers. Abroad, it is desirable for re-examinations to be carried out every three months. The results of all examinations should be recorded on nominal rolls, signed by the medical officer, which should be fixed to the inside of the door of the cookhouse concerned. The apparent absence of intestinal pathogens from the stools on one or two occasions of search, however, is liable to lead to a false sense of security. It should be remembered that these organisms, particularly those of the typhoid-paratyphoid group, often appear in the stools only in 'showers,' and periods may intervene when they cannot be detected by the most intensive search. Again, urinary carriers of typhoid are by no means uncommon, are frequently intermittent and are not detected by stool examination. Thirdly, the isolation and identification of pathogenic micro-organisms from the stools is a highly technical and time-consuming operation which involves the use of several different culture media and the exercise of a considerable knowledge of bacteriology. The limitations of stool culture as the sole aid to control of food-borne infections are becoming more widely recognised and the process should be supported by other techniques, such as the examination of blood sera for the presence of Vi agglutinins of the typhoid bacillus and sigmoidoscopy in the dysenteries.

(e) *Cooks, batmen, batwomen, waitresses and any other personnel employed on duties which involve food handling* who are suffering from, or are found to be carriers of, the conditions detailed below should be at once removed from such duties. They should not be re-employed thereon for the periods stated and, after fulfilling the necessary laboratory requirements, until certified by a medical officer as being no longer disease carriers.

TABLE V
PERIOD OF EXCLUSION FROM FOOD HANDLING AFTER
APPARENT CURE

	Period of exclusion	Laboratory requirements
Typhoid fever	9 months	See paragraph 10 (h)
Paratyphoid fever	9 months	See paragraph 10 (h)
Undulant fever	6 months	Nil
Dysentery	3 months	} Absence of infecting organism from seven daily stools
Cholera	3 months	
Intestinal worm infections	Nil	} Absence of infecting organism from three daily urines
Leptospirosis	1 month	

(f) *Remustering on medical grounds*, in respect of any of the above-mentioned conditions, under the provisions of A.M.Os. A.45/44 and A.454/44 should only be recommended when, after a period of not less than one year has elapsed since the original infection was contracted, there seems to be no reasonable prospect of recovery from a carrier state.

(g) Personnel employed on food handling duties who contract *venereal disease* should be removed therefrom as soon as they are diagnosed as suffering from such a condition, but may be re-employed on these duties after discharge from hospital or sick quarters on completion of the initial treatment for their condition, when they can be considered as no longer infective as regards food handling.

(h) It is of the utmost importance that *carriers* of the enteric group of organisms should not be allowed to engage in any form of food handling, an occupation which is legally prohibited in this country for typhoid, paratyphoid and dysentery carriers. Before cases of enteric fever are discharged from hospital, it is necessary to obtain 14 consecutive negative cultures from daily specimens of both faeces and urine, at least two of the faecal samples having been collected after calomel and salts. For typhoid cases, and suspected typhoid carriers, the Vi agglutination test should also be performed and, if positive, repeated in three months' time. If the Vi agglutinin titre is then at the same level or higher, the individual must be regarded as a potential typhoid carrier and six further specimens of faeces and urine examined. Whether or not confirmation of the carrier state is obtained by these repeated stool and urine examinations, the complete history of the individual concerned should be referred at this stage to Air Ministry (D. of H.) for consideration and for notification to the Ministry of Health, where a register of proved and potential carriers is maintained.

(i) In the control of an outbreak of *diarrhoea, dysentery or enteric fever*, attention should first be directed towards the cleanliness of all cooks and food handlers, their apparatus and their methods of work. Steps must also be taken to ensure the safety of water, milk and food supplies. The N.C.O. in charge of each cookhouse should be instructed to report immediately to the medical officer any food handler whom he believes to be suffering, or to have recently suffered, from diarrhoea. Any such person should be suspended from food handling duties until proved non-infective. Provision of adequate washing facilities and disinfectant solution for the hands must be ensured in all cookhouses, including canteen kitchens. It is a wise plan to encourage disinfection of the hands after defaecation by providing disinfectant solution at all latrines. A further useful measure of control is the disinfection of the handles of cistern chains and of latrine seats. One per cent cresol solution (1½ ozs. to 1 gallon of water) is a satisfactory all-purpose disinfectant. Simultaneously with the institution of the above, a search for carriers should be started. It is not enough to limit this search to those who are legitimately employed on food handling duties. The guilty party is frequently found to be an individual whose aid has been unofficially enlisted for such jobs as serving, washing up, collecting dirty plates or peeling vegetables. This is especially likely to occur on stations abroad, where any passing native, who may be a sweeper employed on cleaning out latrines, is at the call of a British N.C.O. who needs temporary help in his cookhouse.

CHAPTER IV

ENVIRONMENT

Environment can be considered to include all objects and circumstances which react upon the individual during his waking and sleeping, working and leisure hours. These range from the adverse effects of severe heat and cold to the beneficial influence of well planned working hours and attractive meals.

Protection from the elements is second in importance only to food and drink. For this reason, a knowledge of the vagaries of climate in most quarters of the globe must be a working necessity for the Service hygienist, for whom clothing and the siting, construction, ventilation, heating and lighting of buildings present problems of varied complexity. The succeeding chapter will discuss these problems, and other facets of the airman's environment, under the following Sections:—

Contents

Section

- I—Climatology
- II—Pathological effects of great heat
- III—Pathological effects of extreme cold
- IV—Clothing
- V—Buildings
- VI—Heating
- VII—Lighting
- VIII—Ventilation
- IX—Hygiene and sanitation of tented camps
- X—Industrial hazards

SECTION I

CLIMATOLOGY

1. "Man can apparently live in any region where he can obtain food, but his physical and mental energy and his moral character reach their highest development only in a few strictly limited areas."*

The limitation of these areas, throughout the ages, has been climatic. It is evident that life cannot survive at all, unaided, in a true desert. On the other hand, the luxuriant flora and fauna of the Congo are not paralleled by the industry or intelligence of its native inhabitants. It is probable, too, that the great civilizations of the past reached their zeniths at periods when climatic changes had produced conditions resembling those now enjoyed by Western Europe and other favoured regions.

Temperature, humidity and winds are the climatic components which chiefly determine the suitability of a country for human habitation. Broadly speaking, temperature range increases with distance from the ocean. This "continentality" effect, as it is termed, is particularly noticeable in the so-called temperate zones. The farther east one travels through Europe towards the heart of Asia, the hotter become the summers and the colder the winters. Temperature decreases with altitude, roughly to the extent of a 1° F. fall for every 300 feet rise in height. The relative proportions and global situation of the great land and ocean masses determine the direction, seasonal flow, strength and rain-bearing capacity of the winds.

* ELLSWORTH HUNTINGTON (1924), *Civilisation and climate*.

2. **Effects of temperature**

Of the climatic factors which influence the life of man, temperature has the most effect. There is considerable evidence to show that health and efficiency, both physical and mental, are depressed by marked variations from optimal temperatures, which have been assessed at 64° F. for physical and 38° F. for mental effort. But, although marked variations from these optima are harmful, it is fairly well established that moderate temperature fluctuations are very desirable, both from season to season and from day to day. A uniform temperature, even in the neighbourhood of the theoretical optimum, leads eventually to either physical or mental inertia, or both. Only in the 'strictly limited areas' to which reference is made in the preceding paragraph, and which will be discussed later, do moderate variations in the temperature occur, and only in these areas do the indigenous inhabitants reach the highest developmental level. The optimal temperature range of 38° F. to 64° F. was obtained from a large accumulation of experimental data. From other evidence it has been assumed that seasonal changes within and around this range are only beneficial if they fall within the wider scale of 19·4° F. to 73·4° F.

3. **Effects of storms**

Day to day variations in temperature are chiefly due to the effect, nearby or remote, of storms—the cyclones and anti-cyclones, or 'depressions' and 'areas of high pressure' as they are termed by the meteorologist. It is the stimulant action of these short term variations in temperature, within the framework of a suitable seasonal range, that has such a salutary effect on human, animal and even plant life. A constant succession of stormy days, however, is liable to prove over-stimulating and a high incidence of cyclonic activity can be correlated in some countries with an increase in physical and nervous disorders. A total of 20 cyclonic storm centres per year passing over a locality has been accepted as the optimum figure for assessing this factor in the climatic value of any particular region. In addition to temperature variations, storms bring in their train changes in wind direction and velocity, rainfall, cloud, sunshine, fog and other weather manifestations, all of which play their part in influencing health and energy.

4. **Effects of humidity**

Atmospheric humidity is almost equal to temperature in its influence on work and health, especially in conditions of great heat. The humid tropics are notoriously more enervating than areas in which the heat is as great, or even greater, but where the air is correspondingly dry. Unfortunately, records of the moisture content of the air in the various parts of the world are not nearly so complete as temperature records. For this reason, the mathematical comparison of human health and achievement with relative humidity does not rest on as secure a foundation as their relation to temperature. Humidity is dependent upon temperature and the local availability of moisture, which comes from rainfall and other precipitation or from rivers, lakes and seas and

is then taken up as vapour by the air. Rainfall may be of the thunderstorm type, falling in heavy showers at the hottest time of the day, as on the Guinea coast of Africa; or cyclonic, as in the British Isles, falling less heavily, for longer periods and irrespective of the time of day. The seasonal distribution of rainfall can be classified under six main headings:—

(a) *Equatorial*.—This type occurs only within a few degrees of the equator and results in two seasons of heavy rain at about the times when the sun is overhead (the spring or autumn equinox). During the intervening period there is much less rain but no pronounced dry season, *e.g.*, Lagos.

(b) *Tropical*.—The zone of tropical rainfall lies between that of the equatorial type and the tropics of Cancer and Capricorn. Up to about 15° from the equator there is a similar double maximum rainfall, but the peaks are closer together and there is a dry period during the winter. As the distance from the equator increases still further, the two periods of maximum rainfall coalesce and a long dry season results, as at Khartoum where the bulk of the year's scanty rain falls in July and August.

(c) *Monsoon*.—Heavy rain during the hot summer months and a long dry season. The term is most commonly applied to the period in India, Burma and Malay, from mid-June to mid-September, when the drenching rainfall of the south-westerly monsoon winds prevails. In Japan and on the China coast, however, the rain-bearing monsoon is south-easterly.

(d) *Mediterranean*.—In this area most rain falls in the winter six months, with either a single maximum in November or December or with two peaks in autumn and spring respectively. The summer is almost, or quite, rainless, *e.g.*, Athens.

(e) *Temperate continental latitudes*.—In these regions rain falls mostly in the summer. The winters are drier but not rainless.

(f) *West coasts of continents* in temperate latitudes have abundant rain throughout the year, with the heaviest fall in autumn or winter.

5.

The ideal climate

The nearest approach to an ideal climate, judged by effect on health and energy, is found in England, New Zealand and the central Pacific coast of North America. Other areas which are favourably situated, although not to the same extent, are Western Europe, the central and east coast states of the U.S.A., Japan, South-west Australia and Tasmania. No portion of the globe's surface within 30° north or south of the equator approaches these few areas as regards excellence of climate from the standpoint of continued, as opposed to seasonal, residence. Only between 30° N. and 60° N. are there large areas where the necessary desiderata of equable (but varying) temperature, moderate humidity and sufficient periods of storm can be found.

TABLE VI
TEMPERATURE-HUMIDITY RECORDS AT SELECTED PLACES IN THE WORLD
(in shade temperatures Fahrenheit)

EUROPE

Place	Altitude in feet	Lat.	Long.	Jan.	Feb.	Mar.	Apr.	May	June	July	Aug.	Sept.	Oct.	Nov.	Dec.	Year	Annual range	Remarks	
Athens ..	A R	351	38° N	24° E	46.4 2.0	47.5 1.5	52.3 1.3	58.8 0.8	67.8 0.7	75.7 0.6	80.6 0.3	79.9 0.4	73.9 0.6	66.0 1.7	57.0 3.0	50.0 2.4	63.0 15.4	34.2	
Berlin ..	A b c d e R	164	52.5° N	13.5° E	31.3 47 11 57 -13 1.5	32.5 49 16 60 -13 1.3	37.0 60 21 73 -2 1.7	45.9 70 31 81 20 1.4	54.9 84 38 96 27 2.0	62.1 88 46 95 39 2.0	64.6 89 50 99 43 3.1	63.3 85 49 97 40 2.2	57.0 79 42 91 31 1.8	48.2 68 54 79 66 1.8	38.1 54 23 66 58 1.6	32.7 48 16 99 6 -3	47.3 — — 99 -13 22.2	34.3	1881-1910 Ditto 77 years Ditto
Budapest ..	A R	509	48° N	19° E	28.2 1.4	31.6 1.1	39.9 1.7	51.1 2.0	60.1 2.8	66.7 2.5	70.3 2.0	68.5 1.9	61.0 1.8	51.1 2.2	39.0 1.9	30.6 1.8	49.8 23.1	42.1	
Bukarest ..	A R	279	44° N	26° E	25.5 1.2	29.3 1.1	39.7 1.7	51.8 2.0	61.3 2.5	68.2 3.3	73.0 2.8	71.4 1.9	63.7 1.5	53.6 1.5	40.5 1.9	30.2 1.7	50.7 23.0	47.5	
Gibraltar ..	A R	49	36° N	5° W	54.0 4.3	55.0 3.5	56.3 4.4	60.6 2.8	64.6 1.7	70.2 0.4	73.9 —	74.3 0.1	71.1 1.2	64.8 3.3	59.0 4.5	54.7 6.1	63.1 32.3	20.3	
Kola (U.S.S.R.)	A b c d e R	33	69° N	33° E	10.8 34 -22 40 -39 0.3	12.4 32 -26 38 -35 0.3	18.1 37 -16 44 -38 0.2	28.8 49 -2 55 -18 0.3	38.7 60 18 83 8 0.6	48.6 75 30 82 8 0.7	54.1 77 30 84 33 1.4	51.8 71 59 78 32 1.3	42.8 59 27 63 22 1.0	31.1 47 9 63 56 0.8	19.4 39 -23 44 -20 0.6	12.4 3 — 41 -35 0.3	30.7 — — 84 -39 7.8	43.3	Near Murmansk 1871-1908; 1912-13 Ditto Ditto Ditto Ditto Ditto Ditto

Key :- A : mean monthly temperature
b : mean monthly maximum temperature

c : mean monthly minimum temperature
d : absolute maximum temperature

e : absolute minimum temperature
R : mean monthly rainfall (in inches)

London	.. A	18	51° 5' N	0°	38.9	40.1	42.4	47.3	53.4	59.2	62.7	61.6	57.1	49.9	44.0	40.3	49.7	23.8	1881-1915				
	b				53	54	60	67	75	80	82	81	75	65	54	—	—			—	—	Ditto	
	c				22	24	26	31	35	42	47	45	38	32	28	25	—			—	—	—	Ditto
	d				57	62	68	80	87	88	90	94	92	83	63	59	94			—	—	—	1871-1937
	R				9	11	17	26	30	37	43	41	31	25	20	11	9			—	—	—	Ditto
					1.9	1.7	1.8	1.5	1.8	2.0	2.4	2.2	1.8	2.6	2.4	2.4	2.4	2.4	—				
Marseilles	.. A	246	43° 5' N	5° 5' E	43.3	45.3	46.6	54.7	61.0	67.6	72.1	71.1	66.0	58.1	49.8	44.1	56.8	28.8	58 years				
	b				61	64	68	75	82	87	91	91	85	77	69	62	—			—	—	Ditto	
	c				25	27	29	35	42	49	53	53	47	38	31	25	—			—	—	Ditto	
	d				69	71	79	83	93	94	100	101	92	86	76	70	101			—	—	—	1823-1923
	R				14	18	20	30	32	41	47	47	41	27	21	11	11			—	—	—	Ditto
					1.9	1.4	1.6	1.7	1.9	1.0	0.6	0.9	2.5	4.0	3.1	2.0	22.6	—					
Moscow	.. A	480	56° N	38° E	12.2	14.7	23.4	38.3	53.1	61.5	66.0	62.8	52.2	39.7	27.7	17.2	39.0	53.8	10 years				
	b				35	35	43	65	77	84	86	83	73	60	42	36	—			—	—	Ditto.	
	c				-16	-9	-1	17	30	39	46	41	31	23	6	-16	—			—	—	—	
	d				41	41	59	73	89	95	98	96	75	55	42	98	—			—	—	—	
	R				-41	-41	-22	-6	19	28	34	30	17	-5	-27	-38	-41			—	—	—	—
					1.1	0.9	1.2	1.5	1.9	2.0	2.8	2.9	2.2	1.4	1.6	1.5	21.0	—					
Paris	.. A	164	49° N	2° 5' E	36.5	39.0	43.2	50.5	56.1	62.4	65.5	64.4	59.0	50.5	42.8	37.2	50.5	29.0					
	R				1.5	1.2	1.6	1.7	2.1	2.3	2.2	2.2	2.0	2.3	1.8	1.7	22.6						
Stykkisholmur (Iceland)	b	82	65° N	23° W	45	44	45	49	55	61	63	62	58	52	48	45	—	1874-1932					
	c				10	9	9	16	26	34	39	37	31	24	16	13	—		Ditto				
	d				49	49	53	57	68	68	73	72	64	59	53	62	73		—	Ditto			
	e				-21	-9	-13	-6	17	28	33	30	24	15	0	-4	-21		—	Ditto			
Vienna..	.. A	656	48° N	16° E	28.9	32.4	39.0	48.9	57.2	63.9	67.3	65.8	59.4	49.6	38.3	30.9	48.6	38.4					
	R				1.5	1.3	1.8	2.0	2.8	2.8	2.8	2.8	1.7	1.9	1.6	1.7	24.5						

Key :- A : mean monthly temperature
b : mean monthly maximum temperature

c : mean monthly minimum temperature
d : absolute maximum temperature

e : absolute minimum temperature
R : mean monthly rainfall (in inches)

TABLE VI—continued

AFRICA

Place	Altitude in feet	Lat.	Long.	Jan.	Feb.	Mar.	Apr.	May	June	July	Aug.	Sept.	Oct.	Nov.	Dec.	Year	Annual range	Remarks	
Alexandria ..	A R	105	31° N	30° E	56·1 2·1	57·2 0·9	60·1 0·5	63·7 0·2	68·5 —	73·4 —	77·0 —	78·1 —	76·3 —	73·0 0·3	66·4 1·3	59·4 2·6	67·5 8·0	22·0	
Algiers ..	A R	72	37° N	3° E	53·4 4·2	55·4 3·5	57·6 3·5	61·0 2·3	65·8 1·3	71·4 0·6	77·0 0·1	77·5 0·3	74·8 1·1	68·5 3·1	62·4 4·6	55·6 5·4	64·9 30·0	24·1	
Berbera ..	A R	31	10·5° N	45·5° E	76·1 0·1	76·1 0·3	78·1 0·7	81·7 0·5	87·3 0·4	95·7 —	97·4 0·1	96·6 0·1	91·2 —	83·3 0·1	79·1 —	77·1 0·1	85·0 2·4	21·3	
Cairo ..	A b c d e R	67	30° N	31·5° E	52·7 74 40 80 92 99 36 0·4	55·4 81 41 92 99 109 37 0·2	60·8 91 44 49 109 108 37 0·2	67·6 100 49 56 111 108 46 0·1	74·1 104 56 62 111 109 53 —	79·0 106 62 68 106 106 58 —	81·0 103 68 68 106 106 66 —	80·6 101 68 64 106 106 65 —	76·1 97 66 64 100 100 60 —	71·8 96 59 50 43 82 111 —	64·0 89 79 50 43 82 111 —	55·9 79 — 58·2 68·2 68·2 68·2 68·2	68·2 68·2 68·2 68·2 68·2 68·2 68·2 68·2	28·3	1918-1932 Ditto Ditto Ditto
Entebbe (Uganda)	A R	3,863	0°	32·5° E	72·7 2·6	72·4 3·6	71·8 5·8	70·2 9·8	71·2 8·5	70·9 5·1	70·0 3·0	70·5 3·0	71·8 3·1	72·5 3·5	72·2 4·9	71·5 5·1	71·5 58·	2·7	
Khartoum ..	A R	1,280	15·5° N	32·5° E	70·3 —	73·4 —	79·2 —	86·0 —	90·7 0·1	91·4 0·3	88·5 1·6	86·5 2·2	88·2 0·7	87·4 0·2	80·2 —	72·1 —	82·8 5·1	21·1	
Lagos ..	A b c d e R	13	6·5° N	3·5° E	80·2 91 90 70 95 96 63 1·1	81·1 92 93 71 72 96 66 2·0	82·0 93 92 71 72 99 60 3·7	81·5 92 91 72 73 99 69 6·3	80·2 91 88 72 72 104 69 10·1	77·2 86 86 72 72 93 68 19·2	76·1 86 86 72 72 93 67 10·2	75·7 86 87 72 72 96 67 2·4	77·0 87 88 72 72 96 67 5·3	78·3 88 91 72 72 99 70 8·6	80·4 91 91 71 71 99 66 2·4	80·4 91 91 71 71 99 66 0·9	79·2 — — — — 104 60 72·2	6·3	28 years Ditto 32 years Ditto

Key :— A : mean monthly temperature
b : mean monthly maximum temperature

c : mean monthly minimum temperature
d : absolute maximum temperature

e : absolute minimum temperature
R : mean monthly rainfall (in inches)

Nairobi..	..	A b c d e R	5,450	1° S	37° E	63.8	64.7	65.2	63.9	63.4	61.6	58.5	59.9	61.6	64.8	64.0	62.3	63.2	6.7	1904-1921 Ditto 17 years Ditto		
	82					84	84	81	77	76	77	78	81	82	79	79	—	—			—	—
	44					44	46	51	47	44	42	42	43	46	48	45	—	—			—	—
	86					89	87	87	79	80	82	81	86	86	84	82	89	—			—	—
	40					40	40	47	43	39	34	37	38	40	43	40	34	—			—	—
Mombasa	A b c d e R	50	4° S	40° E	79.9	80.3	81.8	80.6	78.4	76.5	75.8	75.7	77.0	78.4	79.4	79.9	78.5	6.5	1931-1937 Ditto 24 years Ditto		
	91					93	94	93	88	87	84	85	86	88	91	92	—	—			—	
	73					74	75	74	71	70	69	68	70	71	73	73	—	—			—	
	93					94	95	96	90	89	86	86	90	90	92	93	96	—			—	
	70					70	71	69	67	61	65	64	64	64	69	69	61	—			—	
Port Sudan	A R	18	19.5° N	37° E	73.2	73.0	74.7	79.2	84.0	88.3	92.1	92.3	88.3	83.7	80.4	75.9	82.0	19.3			
	0.4					0.2	0.1	—	—	—	0.4	—	—	0.8	1.7	0.7	3.9					
Tripoli	A b c d e R	56	33° N	13° E	53.1	55.9	59.5	64.7	68.9	74.5	78.4	79.5	78.1	73.8	65.3	57.2	67.5	26.4	19-20 years Ditto Ditto Ditto		
	68					75	83	93	95	101	98	97	98	93	84	72	—	—				
	40					43	44	49	54	61	66	68	65	59	50	43	—	—				
	79					90	95	104	104	109	109	106	109	102	95	79	109	—				
	85					37	40	45	49	57	62	64	61	53	42	39	35	—				
ASIA—Near East																						
Aden	A R	94	13° N	45° E	75.7	76.6	78.5	81.4	86.0	88.6	87.6	85.9	82.4	78.8	76.6	82.1	21.9				
	0.3					0.2	0.7	0.3	0.2	—	—	0.1	0.2	—	0.1	0.1	2.3					
Baghdad	A b c d e R	112	33.5° N	44.5° E	46.8	53.0	60.3	70.2	80.7	89.6	94.0	93.8	86.9	76.3	60.7	50.3	71.9	47.2	25 years Ditto Ditto Ditto		
	68					74	84	93	104	112	116	117	112	102	86	71	—	—				
	29					34	40	50	58	69	73	72	63	54	40	33	—	—				
	80					85	89	108	113	119	123	121	117	108	95	81	123	—				
	21					28	33	44	47	63	70	69	58	47	29	19	19	—				
Basrah	A	26	30.5° N	47.5° E	49.8	55.8	64.1	74.0	84.1	90.1	92.5	91.9	86.9	76.7	64.7	53.2	71.9	42.7			

Key :— A : mean monthly temperature
b : mean monthly maximum temperature

c : mean monthly minimum temperature
d : absolute maximum temperature

e : absolute minimum temperature
R : mean monthly rainfall (in inches)

TABLE VI—continued

INDIA AND CEYLON

Place	Altitude in feet	Lat.	Long.	Jan.	Feb.	Mar.	Apr.	May	June	July	Aug.	Sept.	Oct.	Nov.	Dec.	Year	Annual range	Remarks
Bombay .. A	37	19° N	73° E	74.5	74.8	78.0	82.1	84.6	82.4	79.5	79.4	79.4	80.7	79.9	76.4	79.3	10.1	
R				0.1	—	0.1	—	0.7	20.6	27.3	16.0	11.8	2.4	0.4	—			
Calcutta .. A	21	23° N	88° E	65.2	70.3	79.3	85.0	85.7	84.5	83.0	82.4	82.6	80.0	72.4	65.3	77.9	20.5	
R				0.4	1.1	1.4	2.0	5.0	11.2	12.1	11.5	9.0	4.3	0.5	0.2	58.8		
Colombo .. A	25	7° N	80° E	79.0	79.7	80.6	81.5	82.1	80.4	80.0	80.5	80.4	79.3	79.5	79.2	80.2	3.1	8 years Ditto 12 years Ditto
b				90	91	91	90	89	87	86	86	86	87	88	88	—		
c				68	67	69	72	72	73	72	72	73	72	70	68	—		
d				94	97	97	95	93	91	89	90	91	91	92	92	97		
e				82	82	65	69	69	71	70	70	71	68	64	63	62		
R				8.5	1.9	4.5	7.8	13.0	7.7	6.5	8.0	5.9	13.1	11.0	5.2	83.1		
Delhi .. A	718	28.5° N	77.5° E	57.9	62.2	74.1	86.2	91.7	92.2	86.4	84.5	83.9	78.5	67.6	59.6	77.1	34.3	
R				1.0	0.6	0.5	0.4	0.7	2.9	7.6	7.0	4.7	0.5	0.1	0.4	26.2		
Karachi .. A	13	25° N	67.5° E	65.3	68.4	75.0	80.6	84.7	86.8	84.3	82.4	82.0	80.0	74.0	67.4	77.6	21.5	
R				9.5	0.5	9.4	9.2	0.1	0.9	2.9	1.5	0.5	—	0.1	0.1	7.6		
Lahore .. A	702	32° N	74° E	53.0	67.3	69.0	80.9	88.9	93.0	89.1	87.1	84.6	75.7	63.2	54.6	74.7	40.0	
R				0.9	1.0	0.8	0.5	0.7	1.4	5.1	4.7	2.3	0.3	0.1	0.1	0.4		
Mooltan .. A	420	30° N	72° E	55.6	59.8	71.6	82.0	91.4	94.9	92.7	90.4	86.0	78.6	67.1	57.7	77.8	39.3	
R				0.4	0.8	0.4	0.3	0.3	0.5	1.9	1.7	0.6	0.1	0.1	0.2	6.8		
Peshawar .. A	1,113	34° N	72° E	49.7	53.8	63.8	73.5	84.0	91.2	90.8	87.6	82.1	71.4	59.1	51.1	71.4	41.5	
R				1.5	1.2	2.0	1.7	0.7	0.8	1.2	2.1	0.8	0.2	0.4	0.6	12.6		

Key :— A : mean monthly temperature
b : mean monthly maximum temperature

o : mean monthly minimum temperature
d : absolute maximum temperature

e : absolute minimum temperature
R : mean monthly rainfall (in inches)

ASIA—Far East

Hong-Kong ..	A	108	22° N	114° E	59.7	57.7	63.0	70.3	76.8	80.6	81.7	81.1	80.2	76.1	69.1	62.6	71.6	24.0	
	R				1.4	1.1	2.6	5.6	19.2	16.1	11.4	14.0	11.5	4.6	1.6	1.3	80.1		
Pekin (Peiping)	A	131	39.5° N	117° E	23.5	29.3	41.0	56.7	67.8	76.1	78.8	76.5	67.6	54.5	38.5	27.3	53.1	55.3	
	R				0.1	0.2	0.2	0.6	1.4	3.0	9.4	6.3	2.6	0.6	0.8	0.1	24.9		
Rangoon ..	A	18	17° N	96° E	74.7	77.3	81.2	85.0	82.2	79.5	78.8	78.7	79.1	80.0	78.8	75.6	79.2	10.3	
	R				0.2	0.2	0.3	1.6	12.0	18.0	21.4	19.9	15.3	6.9	2.8	0.4	99.0		
Shanghai ..	A	33	31.5° N	121° E	87.6	89.2	46.0	56.3	65.5	73.4	80.4	80.2	72.9	63.3	51.3	42.1	59.0	42.3	
	R				2.8	2.0	3.9	4.4	3.3	6.6	7.4	4.7	3.9	3.7	1.7	1.3	45.8		
Singapore ..	A	10	1.5° N	104° E	78.3	79.0	80.2	80.6	81.5	81.1	81.0	80.6	80.4	80.1	79.3	78.6	80.1	3.2	
	b				69	61	62	61	62	61	61	61	61	61	61	60	—		
	c				70	70	71	72	73	72	72	72	72	72	72	71	—		
	d				68	64	64	65	67	65	63	63	63	62	63	63	67		
	e				48	46	47	70	70	70	69	69	69	69	69	68	66		
	R				6.5	6.1	6.5	6.9	7.2	6.7	6.3	3.5	7.1	3.2	10.0	10.4	92.9		
Tokio ..	A	69	35.5° N	140° E	37.2	38.3	44.1	54.3	61.5	68.9	75.0	77.7	71.6	60.8	50.4	41.4	56.3	40.5	
	b				46	46	48	75	80	87	91	92	89	79	72	64	—		
	c				22	23	27	35	43	54	62	65	56	43	33	25	—		
	d				72	69	74	83	85	93	98	96	95	90	77	74	98		
	e				47	18	22	30	36	47	55	40	51	36	26	20	17		
	R				2.0	2.6	4.3	5.3	5.9	6.3	5.6	4.6	7.5	7.2	4.3	2.3	57.9		
Verkhoyansk (U.S.S.R.)	A	330	68° N	134° E	-38.9	-47.4	-24.0	7.8	35.4	64.5	59.7	49.8	36.3	3.2	-34.4	-32.6	2.7	113.8	
	b				-22	-9	12	36	59	80	83	77	60	36	4	-17	—		
	c				-60	-75	-63	-32	-4	31	36	23	11	-33	-63	-78	—		
	d				-4	9	39	50	68	89	91	86	69	48	20	19	91		
	e				-80	-94	-77	-43	-30	19	23	13	4	-48	-72	-84	-64		
	R				0.2	0.1	—	0.1	0.2	0.5	1.2	0.9	0.2	0.2	0.2	0.2	3.9		
																		39 years	
																			Ditto
																			Ditto
																			Ditto
																			1884-1920
																			Ditto
																			Ditto
																			Ditto
																			Ditto
																			1884-95; 1898-1908
																			Ditto
																			Ditto
																			Ditto
																			Ditto

Key :- A : mean monthly temperature
b : mean monthly maximum temperature

c : mean monthly minimum temperature
d : absolute maximum temperature

e : absolute minimum temperature
R : mean monthly rainfall (in inches)

TABLE VI—continued

AUSTRALASIA

Place	Altitude in feet	Lat.	Long.	Jan.	Feb.	Mar.	Apr.	May	June	July	Aug.	Sept.	Oct.	Nov.	Dec.	Year	Annual range	Remarks	
Alice Springs ..	A R	2,000	23° S	134° E	84.0 1.8	82.3 1.7	76.7 1.3	68.1 0.9	59.7 0.6	54.4 0.6	52.4 0.4	58.3 0.4	65.6 0.4	73.5 0.7	79.5 0.9	82.4 1.3	69.7 11.1	31.6	
Darwin..	A R	97	11.5° S	132° E	84.0 15.3	83.4 13.0	84.1 9.7	84.2 4.5	81.9 0.7	78.9 0.2	77.2 0.1	79.5 0.1	82.7 0.5	85.5 2.1	85.7 5.2	85.3 10.3	82.7 61.7	8.5	
Perth ..	A R	197	32° S	116° E	73.5 0.3	74.1 0.3	71.1 0.7	66.4 1.7	60.4 4.9	56.2 6.6	55.0 6.4	55.9 5.6	58.0 3.3	60.9 2.1	65.4 0.8	70.6 0.6	64.0 33.3	19.1	
Sydney ..	A b c d e R	146	33.5° S	151° E	71.6 94 58 109 51 3.6	71.0 91 58 102 49 4.4	69.2 89 56 103 49 4.4	64.5 81 50 91 45 5.4	58.6 74 45 86 40 5.1	54.3 68 42 80 38 4.8	52.3 68 40 75 36 5.0	54.8 74 41 44 37 3.0	58.8 81 44 82 41 2.9	63.4 88 48 100 42 2.9	67.0 91 52 103 48 2.8	70.0 95 55 107 48 2.8	63.0 — — 109 36 47.7	19.3	67 years Ditto Ditto Ditto
Auckland (N.Z.)	A R	260	37° S	175° E	66.6 2.6	67.3 3.0	65.7 3.1	61.3 3.3	57.0 4.4	53.8 4.8	52.0 5.0	52.0 4.2	54.5 3.6	57.0 3.6	60.4 3.3	64.2 2.9	59.4 43.8	15.3	
Dunedin (N.Z.)	A R	500	46° S	170.5° E	57.7 3.4	57.4 2.7	55.4 3.0	51.4 2.7	47.3 3.2	44.1 3.1	42.4 3.0	44.1 3.1	46.8 2.7	50.7 3.0	53.2 3.3	56.3 3.5	50.5 36.8	15.3	
Wellington	A R	142	41.5° S	175° E	62.4 3.3	62.2 3.2	61.0 3.3	57.4 3.8	52.9 4.7	49.6 4.9	47.5 5.6	48.6 4.4	51.1 4.0	54.0 4.1	56.8 3.5	60.8 3.2	55.2 48.1	14.9	
NORTH AMERICA																			
Denver..	A R	5,272	40° N	105° W	29.6 0.5	32.1 0.5	39.0 1.0	47.4 2.1	56.4 2.6	66.1 1.5	71.8 1.6	70.7 1.3	62.4 0.9	49.6 1.0	39.1 0.5	32.5 0.6	49.7 14.1	42.2	

Key:— A: mean monthly temperature
b: mean monthly maximum temperature

c: mean monthly minimum temperature
d: absolute maximum temperature

e: absolute minimum temperature
R: mean monthly rainfall (in inches)

Kingston (Jamaica)	A R	49	18° N	77° W	75.7 1.0	75.7 0.7	76.5 1.0	78.3 1.0	79.9 4.6	81.1 4.4	81.7 1.8	81.0 8.9	80.6 4.2	79.3 8.1	78.6 3.0	76.8 1.8	78.8 35.6	6.0
New York ..	A b c d e R	10	41° N	74° W	30.3 55 5 67 -6 3.3	30.6 55 7 69 -7 8.3	37.7 70 17 78 3 8.5	48.5 81 28 91 20 8.5	59.4 85 41 95 34 3.5	69.0 92 52 99 45 3.4	81.7 95 58 99 50 4.1	81.0 93 89 102 51 4.4	80.6 89 56 100 38 3.4	79.3 81 47 88 31 3.4	78.6 81 36 88 7 3.6	76.8 70 28 68 -13 3.3	78.8 51.8 — 102 -13 42.5	44.2
St. Louis ..	A R	568	39.5° N	90.5° W	31.0 2.3	33.5 2.6	43.5 3.6	56.1 3.6	66.5 4.5	75.1 4.8	79.1 3.7	77.2 3.5	70.0 3.0	58.4 2.8	43.4 3.0	35.5 2.6	55.8 40.0	48.1
San Francisco ..	A R	207	38° N	122.5° W	49.5 4.8	51.3 3.6	52.7 3.3	53.7 1.7	55.5 0.7	57.0 —	57.3 —	58.0 —	59.3 0.3	58.4 1.0	55.5 2.6	50.9 4.7	54.9 22.7	9.8
Toronto ..	A R	350	44° N	79.5° W	22.9 2.8	21.1 2.4	30.2 2.1	43.1 2.4	53.6 2.9	64.8 2.6	69.1 3.0	67.2 2.6	60.8 2.8	48.3 2.6	37.4 2.6	27.7 2.6	45.5 31.4	48.0
Victoria (B.C.) ..	A R	85	70° N	106° W	39.2 4.5	40.3 3.5	43.1 2.5	47.7 1.7	53.0 1.3	57.1 0.9	60.3 0.4	60.0 0.6	55.6 2.0	50.4 2.5	44.5 6.5	41.5 5.9	49.4 32.5	21.1
SOUTH AMERICA																		
Buenos Aires ..	A R	72	34.5° S	58.5° W	73.6 3.0	73.0 2.5	69.6 4.6	61.9 3.0	55.9 2.8	51.1 2.7	50.2 2.2	52.3 2.4	57.1 3.0	61.0 3.6	67.3 2.8	71.4 3.9	61.9 36.5	23.4
Georgetown (Br. Guiana)	A R	10	7° N	58° W	78.4 7.6	78.4 5.7	79.0 5.7	79.5 6.5	79.3 10.9	78.8 12.0	79.0 9.7	79.7 6.7	81.0 2.7	81.1 2.4	80.4 5.7	79.0 11.3	79.5 86.9	2.7
Rio de Janeiro ..	A R	197	23° S	43° W	77.5 5.0	78.1 4.3	77.2 5.3	74.1 4.4	70.7 3.5	68.2 2.0	67.5 1.6	68.7 1.8	69.4 2.6	71.2 3.2	73.4 4.3	74.8 5.4	72.5 43.4	10.6
Santiago (Chile)	A R	1,703	33.5° S	70.5° W	67.7 —	66.8 0.1	63.2 0.2	56.7 0.6	51.7 2.3	48.3 3.2	46.9 3.4	48.4 2.4	54.5 1.2	56.3 0.6	61.9 0.2	65.2 0.2	55.6 14.4	20.8

1909-1928
Ditto
48 years
Ditto

Key :— A : mean monthly temperature
b : mean monthly maximum temperature

c : mean monthly minimum temperature
d : absolute maximum temperature

e : absolute minimum temperature
R : mean monthly rainfall (in inches)

6. Classification of climates

For Service purposes climates may be considered as tropical, sub-tropical, temperate and cold. They will be dealt with under these headings in the paragraphs that follow. It will first be necessary, however, to define a few technical terms and discuss their application.

7. Technical terms

(a) *Temperature*.—All temperatures quoted in Table VI are shade temperatures Fahrenheit.

(i) *Daily mean*.—The mean of the highest and lowest temperatures occurring each day over a period of, usually, not less than 35 years.

(ii) *Monthly mean*.—The mean of the daily means in the month stated.

(iii) *Annual mean*.—The mean of the 12 monthly means.

(iv) *Mean monthly maximum/minimum*.—The average over a number of years, usually 35 or more, of the highest/lowest temperature reached each year in the month stated.

(v) *Absolute monthly maximum/minimum*.—The highest/lowest temperature ever recorded at the place stated.

(vi) *Diurnal range*.—The difference between the mean daily maximum and the mean daily minimum for the period given, which is usually a month.

(vii) *Annual range*.—The difference between the mean monthly temperatures of the warmest and coldest months.

(viii) *Isotherm*.—A line connecting places which have the same mean temperature for the period stated, usually a month.

(b) *Humidity*.—The amount of aqueous vapour which can be retained by a given volume of air varies directly with atmospheric temperature.

(i) *Absolute humidity*.—The actual weight of moisture present in a cubic foot of air.

(ii) *Relative humidity*.—The percentage amount of moisture in the air, regarding complete saturation as 100 per cent.

8. Tropical climates

There can be no hard and fast boundary lines which delimit climatic areas, but recent American research has produced a sound working rule which broadly defines the true tropics as those areas in which the mean monthly temperature for the coolest month in the year is not less than 68° F. It is interesting to note that the 68° F. mean monthly isotherm demarcates an irregular equatorial belt, the northern and southern projections of which are limited by the Tropic of Cancer and the Tropic of Capricorn (23° 27' north and south latitudes); moreover, it is a belt beyond which the growth of the coconut palm, often taken as an indication of a true tropical climate, does not occur. There are regions outside the 68° F. isotherm where tropical

Dry bulb temperature

TABLE VII
RELATIVE HUMIDITY TABLE

Dry bulb temperature

Difference between dry and wet bulb temperatures

° F.	0	1	2	3	4	5	6	7	8	9	10	11	12	13	14	15	16	17	18	19	20	21	22	23	24	25	26	27	28	29	30	° F		
30	100	89	78	67	57	47	36	26	17																								30	
35	100	91	82	73	65	54	45	37	28	19	12	3																					35	
40	100	92	84	76	68	60	53	45	38	30	22	16	8	1																			40	
45	100	92	85	78	71	64	56	51	44	38	32	25	18	13	7	1																		45
50	100	93	87	80	74	67	61	55	50	44	38	33	27	22	16	11	6	1																50
55	100	94	88	82	76	70	65	59	54	49	43	39	34	29	24	19	16	10																55
60	100	94	89	84	78	73	66	63	58	53	48	44	39	34	30	26	22	18	14															60
65	100	95	90	85	80	75	70	65	61	56	52	48	44	39	35	31	28	24	20															65
70	100	95	90	86	81	77	72	68	64	60	55	52	48	44	40	36	33	29	26	23														70
75	100	95	91	87	82	78	74	70	66	62	58	55	51	47	44	40	37	34	31	27	24													75
80	100	96	92	87	83	79	75	72	68	64	61	57	54	51	47	44	41	38	35	32	29													80
85	100	96	92	88	84	80	77	73	70	66	63	60	58	55	52	49	47	44	41	38	36	33												85
90	100	96	92	88	85	81	78	75	71	68	65	62	59	56	53	50	47	44	41	39	36	34												90
95	100	96	93	89	86	82	79	76	72	69	66	63	60	58	55	52	49	47	44	42	39	37	36											95
100	100	97	93	90	86	83	80	77	74	71	68	65	62	59	57	54	51	49	47	44	42	39	37	35										100
105	100	97	93	90	87	84	81	78	75	72	69	66	64	61	58	56	53	51	49	46	44	42	40	38	35									105
110	100	97	94	90	87	84	81	78	76	73	70	67	65	62	60	57	55	53	50	48	46	44	42	40	38	36								110
115	100	97	94	91	88	85	82	79	76	74	71	69	66	64	61	59	57	54	52	50	48	46	44	42	40	38	36	34						115
120	100	97	94	91	88	85	83	80	77	75	72	70	67	65	62	60	58	56	54	51	49	47	45	44	42	40	38	36	35	33				120
125	100	97	94	91	88	86	83	80	78	75	73	70	68	66	64	62	59	57	55	53	51	49	47	45	43	42	40	38	37	35	33			125
130	100	97	94	91	89	86	83	81	78	76	74	71	69	67	65	62	60	58	56	54	52	50	49	47	45	43	42	40	38	37	35			130
135	100	97	94	92	89	86	84	81	79	77	74	72	70	68	65	63	61	59	57	55	53	51	50	48	46	45	43	41	40	38	37			135
140	100	97	95	92	89	87	84	82	79	77	75	73	71	68	66	64	62	60	58	56	55	53	51	49	48	46	45	43	41	40	38			140

conditions are experienced for part of each year, but only within this line is the climate truly tropical for the whole twelve months. The tropics, however, may be further sub-divided into wet and dry sections.

(a) *Humid tropics*.—The arbitrary limits for the humid tropics are fixed by the 68° F. average isotherm for the coolest month, an average of 3 inches or more rain per month and a mean relative humidity of 70 per cent or more for the driest month. In these regions the average maximum shade temperature is 85° F., although in some areas an absolute extreme of 100° F. may be encountered. The annual range of temperature is seldom more than 9° F. and usually much less. In Singapore, for example, which lies 1° north of the equator, the mean monthly temperature in January is 78.3° F., and in June 81.5° F., an annual range of 3.2° F. The diurnal range here is also limited, averaging 19° F. for each month in the year except February and March, when it rises to 21° F. (*cf.* Lagos, AR = 6.3°, DR = 18°, and Nairobi, AR = 6.7°, DR = 35°).

(b) *Dry tropics*.—The humid tropics, with their dense jungle and rain forests, shade off through regions of diminishing vegetation into desert zones. The characteristics of these tropical deserts are an average temperature of 68° F. for the coolest month, a rainfall that averages less than 3 inches a month and a relative humidity of 60 to 70 per cent for the wettest month. Desert zones of this type are fewer and smaller than might be expected. The southern Sahara, parts of the Sudan, the Somalilands, the coast of Arabia and both coasts of the Red Sea include the largest of them, although in the southern half of the Red Sea area the relative humidity is more than 80 per cent in several months of the year. The Sind desert of north-west India cannot be accepted as falling within this category of true tropical desert. In the dry tropics cool nights and hot days are the rule, the diurnal range being from a minimum of 60° F. to a maximum of 100° F., with absolute extremes of 40° F. and 120° F. It should be quite clearly understood that hot, dry, desert areas exist outside the tropic zone where even higher temperatures than these occur during certain periods of the year. Such places are Ghadames in the northern Sahara (30° N., 9° E.), and Shaibah, at the head of the Persian Gulf, where shade temperatures of 131° F. and 128° F. respectively have been recorded.

9.

Sub-tropical climates

As has already been stated, tropical conditions are encountered during some months in the year in areas far beyond the true tropics. Areas such as these can be considered as falling within the sub-tropical category if the temperature for at least one month of the year averages 68° F. These areas can best be envisaged by reference to the map at Figure 5 (p. 53).

FIG. 5

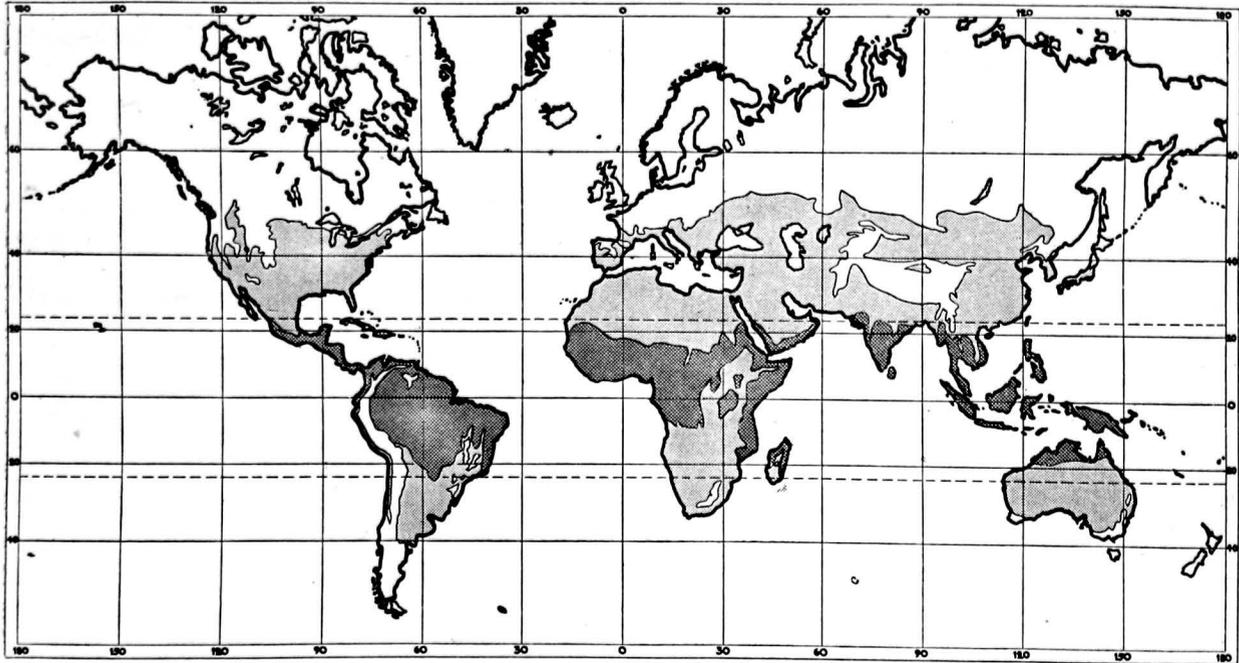

CLIMATE MAP

Key: Dark areas indicate tropical regions where the average temperature of the coolest month is 68° F.

Light grey indicates regions in which the temperature averages 68° F or over for at least one month of the year.

10.

Temperate climates

A temperate climate is best exemplified by that of north-west Europe, which is characterised by mild winters, cool summers and high atmospheric humidity resulting in much cloud. Sunshine is scanty, abundant rain falls in all seasons but mostly in the autumn, while spring is usually the driest period of the year. The seasons will differ with locality, but the cycle of changes in any temperate climate is roughly that described for this quarter of the globe.

11.

Cold climates

These vary from the comparatively mild, insular climate of Iceland, where the mean monthly temperatures range from 44° F. in February to 63° F. in July, to the extreme conditions of North East Siberia, which is more bitterly cold in winter than any known area, not excepting the Polar regions. At Verkhoyansk, for example, the mean temperature for January is -58.9° F. and for July 59.7° F. Although the winter months within the Arctic circle (66° 32' N) impose certain limitations on dress and manner of life, yet equally severe conditions which necessitate similar precautions for the preservation of life and health are found far south of this parallel, in North America, Asia and Europe alike.

SECTION II**PATHOLOGICAL EFFECTS OF GREAT HEAT**

1.

Physiological principles

(a) *Body temperature* depends upon the relation between heat gain and heat loss. Heat gains accrue from metabolic processes within the body and from warmth reaching it from external heat sources. Heat is lost from the body by radiation from its surface, conduction through cooler surfaces with which it is in contact, convection of air currents passing over it, by excretion of urine and faeces, by exhalation of warmed gases and moisture from the lungs and, the most important of all, by evaporation of sweat from the skin surface.

(b) *The temperature of the skin* is normally lower than that of the internal organs by some 5° F. When skin temperature rises to the level of body temperature, or near it, the outward flow of heat ceases and heat accumulates within the body. This occurs normally during muscular work in a hot environment, and internal temperatures of 102° F. are often reached during exercise without ill effects. A rectal temperature of more than this is a danger signal and indicates that the heat load is greater than can be eliminated by the cooling mechanisms, natural and artificial, that are available at that time to the heat stressed body.

2.

Reaction to a hot environment

(a) The body reacts to an unfavourable thermal environment chiefly by an increase of the blood supply to the skin and by an increase in the amount of sweating. *Raising of the skin temperature* by dilation of the capillaries allows increased heat

loss from the body surface. If this is not sufficient to bring about the required cooling, sweating begins (at a skin temperature of about 93° F.) and its evaporation from the skin produces a higher rate of heat loss. If, however, the surrounding air is already saturated with moisture, the necessary evaporation of sweat cannot take place. Even with less than complete saturation of the atmosphere, or of that part of it in immediate contact with the skin, evaporative cooling is greatly impeded at high temperatures. It has been calculated that a dry bulb temperature of 90° F. with a relative humidity of only 55 per cent will prohibit severe muscular exercise (at 425 kg. calories per hour)—simply because the air under those conditions cannot absorb sufficient moisture from the skin to cool the body and maintain it in thermal equilibrium. But other factors, as yet not understood, are involved which permit trained men to endure worse conditions than these. Observations upon selected Kaffir miners showed that they remained in thermal equilibrium while shovelling rocks in an atmosphere of still air at 95° F. and 95 per cent relative humidity. Neither body build, surface area nor total amount of sweat produced could be correlated in these experiments with individual tolerance of heat. The maximum degree of cooling that can be effected by evaporation from the body surface depends upon the amount of sweat that can be produced by the body and the amount that can be removed, having regard to the relative humidity of the surrounding air and the velocity of its movement over and away from the body surface. Extreme muscular exertion may produce up to 600 kg. calories per hour. Each litre of sweat evaporated will remove 580 kg. calories. A man can produce about 1 litre of sweat per hour, perhaps 2 or even 3 litres under great heat stress and when fully acclimatised.

(b) *Effect of clothing.*—Clothing absorbs sweat, which, if it evaporates from the garment, draws the required heat of vaporisation from the air and the fabric, and not from the body. It is therefore a hindrance to evaporative cooling. The insulation effect of clothing is only an advantage with dry air and a high temperature. In other circumstances its value, as insulation against radiant heat, is counterbalanced by its interference with evaporation. Moreover, fluid lost from the body must be replaced. Sweat absorbed by the clothing is wasted as a cooling agent and creates a demand for more drinking water than is physiologically necessary—a point of importance when water, as in forced landings or campaigns in desert regions, must be conserved to the utmost.

When the risk of minor skin injuries, snake and insect bites is not important, when sun tan has been acquired and modesty permits, the nearest approach to nudity is usually the most compatible with comfort and heat tolerance. There is, however, an exception to the golden rule of 'stripping to the waist for a hot job.' In conditions of extreme heat, a hot dry wind can remove sweat from the skin faster than it can be replaced. The skin temperature then rapidly rises to dangerous levels, heat flow from within outwards is arrested and body temperature builds up until heat exhaustion or heat hyperpyrexia supervenes.

When clothing is essential it appears that the more porous or permeable fabrics are most comfortable in conditions of dry heat, but that in a hot, humid atmosphere evaporative cooling becomes

less efficient as the permeability of the material increases. In both conditions, coolness is gained by loosely cut clothing that allows the fullest air circulation and by the use of materials that are good reflectors of radiant heat, as is the traditional white suit of the tropics.

The sun helmet or topee shades only about 16 per cent of the body surface from vertical radiation, or even less if secondary radiation from the ground is considered. A lighter covering, such as the Australian slouch hat, is more comfortable and gives adequate protection. It is unlikely that the influence on body cooling afforded by headwear is sufficient to delay the onset of heat stroke appreciably in the absence of other safety measures. It has been shown in animal and human experiments that the bare head may be exposed with impunity to the most intense tropical sunlight, provided the body is sufficiently cooled, as is usual, for example, while swimming. Rabbits with shaved heads exposed to the sun but with their bodies enclosed in cooled boxes suffer no apparent ill effects, while control animals not so enclosed rapidly succumb to the effects of heat.

(c) *Effect of air movement.*—Hot air in motion brings additional heat to the body surface but, provided it is not already fully saturated with moisture, that is, with a relative humidity of 100 per cent, it also removes sweat and thereby cools the body. In an atmosphere with a high relative humidity, a breeze or draught, however slight is always helpful. In a hot, dry atmosphere, however, slight air movement does more harm than good and an air current with a velocity of 500 feet per minute is necessary before its evaporative cooling effect outweighs the direct heating effect. In this connection, the velocity that constitutes a 'perceptible draught' is generally accepted as 180 feet per minute.

(d) *Acclimatisation.*—Adjustment of the body mechanisms to enable them better to withstand continued heat stress takes place rapidly, reaching a high level within a few days but probably not reaching a maximum for two or more weeks, depending upon individual characteristics, prevalent conditions and other factors. In the acclimatised individual, sweating begins more quickly as a reaction to heat stress, the sweat is less salty and the quantity that can be excreted in response to the cooling demand increases. Other changes also take place, resulting in a lowering of the rise in body temperature that occurs on exertion and in the performance of muscular work with greater ease and less conscious effort. It is apparent, from investigations on South African miners, that a small percentage of individuals have excellent heat regulating mechanisms and require little or no preliminary training or acclimatisation before exposure to severe heat stress. Most men are not so adaptable and for this reason should not be allowed to undertake severe muscular exercise or work in the heat until acclimatisation has been achieved. Opportunities for at least partial acclimatisation are afforded by the gradually increasing temperatures met with during east-bound voyages, and by the physical fitness training that is customary on board troopships. Even after a voyage of this nature it is advisable to allow a week to elapse, after first arrival in a hot climate during the summer

months, before strenuous efforts are called for in the heat of the day. Marching, especially when loaded with kit bags, is especially liable in these circumstances to lead to cases of heat stroke amongst newcomers when they first disembark. It should be the invariable practice to provide transport or delay their onward movement until a cooler time of the day. Frequent reliefs should be provided for such personnel if circumstances compel their employment on duties connected with unloading cargo or as 'baggage parties.'

A few individuals seem incapable of acclimatisation and always remain especially prone to the effects of heat. Such individuals consistently show a rectal temperature of more than 102° F. after an hour's work (150 kg. calories per hour) carried out daily for a week in a hot chamber maintained at 95° F. and .95 per cent relative humidity. Naturally heat-tolerant individuals, and those who become acclimatised during this period, equally consistently show temperatures below 102° F. either from the very beginning or by the end of the week. It is seldom possible to subject individuals to a heat tolerance test of this nature, and thereby eliminate those few who remain unfit for posting to a hot climate. A careful watch should be kept, however, especially during the first hot season after their arrival, for otherwise unexplainable rises in rectal temperature above the 102° level, that occur during spells of extreme heat in men who seem off colour or who complain of lassitude and prostration during or after work.

(e) *Water balance.*—The minimal water requirements for the average man, resting in the shade throughout the 24 hours, varies considerably with temperature. In cool conditions, fluid balance can be maintained in the non-sweating individual by an intake of about 1½ pints daily. If food consumption is kept low, survival for many days is possible on 1 pint of water daily, although dehydration is slowly proceeding with a daily debit balance of ½ pint. Dehydration amounting to a loss of 5 pints will affect performance; a loss of 10 pints may cause death, but a loss of 15 or even 25 pints of fluid can be withstood by some individuals.

TABLE VIII
GUIDE TO BASIC WATER REQUIREMENTS AT VARYING
MEAN DAILY TEMPERATURES

Mean of the daily maximum and minimum temperatures	Basic daily water need
<i>Below °F.</i>	<i>Pints</i>
70	1.75
80	2.80
90	6.30
100	11.30

TABLE IX

SWEAT LOSS IN PINTS PER HOUR

Mean temperature of environment	Resting in shade	Moderate activity	Strenuous exercise
°F.			
50	0·07	0·18	0·21
60	0·07	0·26	0·35
70	0·07	0·35	0·51
80	0·11	0·46	0·70
90	0·21	0·65	1·23
100	0·61	1·20	1·79
110	1·12	1·76	2·36
120	1·62	2·30	2·92

(f) Sweat loss, in acclimatised individuals, caused by work will vary from 0·3 to nearly 3 pints per hour, depending upon the severity of the effort and the temperature at which it is carried out. The application of sweat loss to water requirements can be exemplified by the needs of a man marching for 8 hours, at 3½ to 4 in.p.h., during the hottest part of a day with the mean temperature of 90° F. At this temperature, 6·30 pints would be his basic requirement for the 24 hours, plus 9·84 pints to cover sweat loss caused while marching, plus 5·20 pints to cover sweat loss during eight hours of moderate activity—that is, a total of just over 21 pints. Even higher quantities than this have been found necessary in actual practice for heavy workers in very hot areas such as the Deccan in India and Boulder Dam in California.

In less trying conditions or when the muscular effort is not so vigorous as in the example given above, much smaller water intakes are sufficient. In hot, humid climates (95° F., 80 to 85 per cent relative humidity) an allowance of 12 pints per day for a man undertaking moderate physical effort is usually adequate. In desert conditions (100° to 120° F., 25 to 30 per cent relative humidity) from 8 to 16 pints are necessary, again for moderate work.

In severe heat, if performance is to be maintained, water should be taken from hour to hour, as fast as it is lost. Physical exhaustion rapidly becomes apparent, usually in 4 to 8 hours, sometimes within 2 hours, if water is withheld during a period of rapid dehydration that leads to a sweat loss of only some 5 pints. It has been found, too, that thirst during such a period of dehydration does not keep pace with fluid loss and is not an adequate stimulus for its replacement. In other words, more water should be taken than is necessary to satisfy thirst if water balance in conditions of heat stress is to be maintained.

(g) *Salt requirements.*—In hot environments the body loses much salt in the sweat, to the amount of some 2 grammes per hour of work. A total daily intake, during hot weather, of 20 to 30 grammes should be the aim. Much of this is supplied in the normal ration scales, but it is advisable to add salt to the drinking water, in a proportion of about ¼ oz. to the gallon, or a saltspoonful to a ½-pint tumbler, in order to ensure that a high intake is actually obtained. This amount does not make the water unpalatable, especially if it is well cooled. Salted drinking water should be an invariable rule for febrile patients, and during post-febrile convalescent states.

3. Assessment of thermal environment

(a) Perceptible warmth or cold depends upon, chiefly,

- (i) dry bulb temperature
- (ii) wet bulb temperature
- (iii) air movement
- (iv) radiation

(b) *Thermometers*.—The wet and dry bulb thermometers are essential instruments, the day to day readings from which should be available to all medical officers or authorities responsible for the health of personnel stationed in hot countries. They are sometimes mounted to permit swinging, and in this form constitute a sling psychrometer. From them can be obtained the shade temperature and relative humidity.

A recording maximum and minimum thermometer, such as Six's, is also useful, for the determination of the mean diurnal temperature and range.

Air movement at low velocities can be obtained from the katablometer or, for research purposes, the fine, hot wire anemometer. Neither of these indicate the direction of the air currents they measure, for which purpose and for higher velocities, the deflecting vane anemometer, the revolving vane (propeller) anemometer or the Pitot tube is employed. Rough indications of the direction of air currents can be determined visually from smoke drifts obtained preferably as cold smoke from the interaction of ammonia and hydrochloric acid fumes or by a mixture in equal proportions of potassium chlorate and powdered sugar which can be fired by a match.

The intensity of radiant heat is usually measured by the solar radiation thermometer, which is simply a black bulb thermometer in a glass globe from which all the air has been exhausted to form a vacuum. The Vernon globe thermometer, which is encased in a blackened, hollow, copper sphere, or Missenard's dry resultant thermometer, are also used for this purpose.

The katablometer provides an indication of the cooling power of the air, from the rate at which heat is lost from its bulb surface. It is a spirit thermometer with a large bulb, marked on the stem at 95° and 100° F. It is heated in warm water till the spirit is well above the 100° mark and the cooling time from 100° to 95° is then taken with a stop watch. The individual factor for the thermometer, which is marked on its stem, divided by this cooling time in seconds gives the cooling power of the air in the position where the thermometer was suspended during cooling. Both dry and wet cooling powers are usually taken, the latter being obtained with the thermometer bulb encased in a fabric sleeve, which is slipped on before it is heated in the warm water. The dry katablometer figure records the heat loss due to radiation and convection; the wet katablometer figure includes the additional factor of evaporative cooling, which is affected by changes in atmospheric humidity. Relatively slight increases in the velocity of air currents round the katablometer have a much greater effect on its rate of cooling than they will produce on the human body. For this reason, the instrument cannot be accepted as an entirely reliable guide to comfort conditions except in still air or at absolutely minimal air velocities. The figures usually taken as an

FIG. 6

CHART SHOWING NORMAL SCALE OF CORRECTED
EFFECTIVE (OR EFFECTIVE) TEMPERATURE

Reproduced by courtesy of the Medical Research Council (*Environmental warmth and its measurement*, a book of reference prepared for the Royal Naval Personnel Research Committee by T. Bedford, Medical Research Council War Memorandum, No. 17).

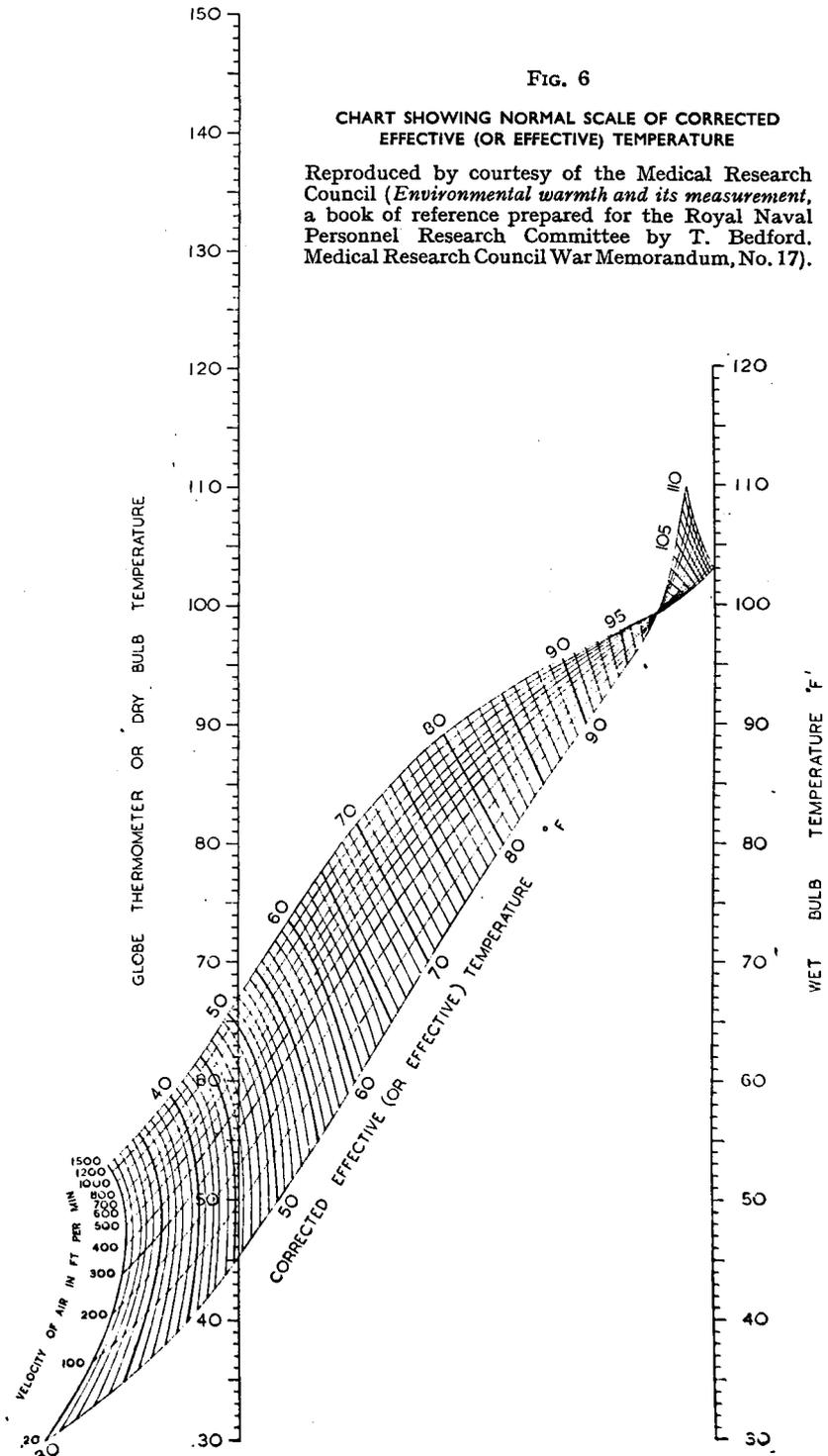

indication of satisfactory conditions for sedentary workers are a dry kata cooling power of not less than 6, and a wet kata figure of not less than 18. For active effort, higher figures are desirable.

(c) Various attempts have been made to devise a scale by which thermal environments can be compared, as regards the combined effect of temperature, humidity, air movement and radiation upon the comfort and efficiency of those exposed to them. It has long been widely recognised that a comparison of shade temperatures taken with a dry bulb thermometer is not a sufficient guide; 85° F. in Khartoum bears little resemblance to 85° F. in a humid climate like that of Singapore. The most successful of these attempts to find a suitable yardstick, although it takes no account of the effects of radiation, resulted in the effective temperature index.

(d) *Effective temperature.*—The effective temperature scale was obtained by calibrating the opinions of a group of trained observers who passed back and forth between two adjoining air-conditioned rooms in which the temperature was varied, but the air maintained fully saturated and the ventilation rate (air movement) constant. Effective temperature has been defined as 'that temperature of saturated, motionless air which would produce the same sensation of warmth or coolness as that produced by the combination of temperature, humidity and air motion under observation.' The scale is particularly applicable to the comparison of air-conditioned environments or to climatic conditions and the stresses that the latter impose. It has been possible to postulate 'comfort zones' of effective temperatures within which the majority of individuals will be content and able to work at maximum efficiency. It has also been possible to determine with some accuracy the danger levels, or critical effective temperatures, above which damage to the human economy will result.

It has been found that the comfort zones for winter and summer conditions indoors in Great Britain are centred about the effective temperatures of 62° and 67° respectively, when radiation effects are excluded and an occupancy of more than three hours allows adaptation to become effective. In America, the corresponding figures are rather higher, 67° and 71° respectively. For summer conditions in hot climates, a range between 66° and 76° effective temperature, with an optimum of 69° to 73°, will probably be found comfortable by the large majority of individuals. For air conditioning purposes the figure of 76° should be the highest permissible effective temperature if maximum efficiency is to be obtained from sedentary workers.

In hot environments, discomfort becomes manifest, and in some individuals prohibits physical effort unless a grave risk of heat stroke is accepted, when the wet bulb thermometer records temperatures over 80° F. and wet kata thermometer readings drop below 12.5. It is probable that the critical effective temperature lies between 85° and 90°. The former temperature is very trying. When muscular effort is attempted at the latter figure, the rectal temperature rises rapidly to dangerous levels and the danger of complete disorganisation of the body's heat regulating mechanism is always imminent.

From Figs. 6 and 7, pp. 60 and 62, the effective temperatures resulting from the three factors of dry bulb or globe thermometer temperature, wet bulb temperature and some air velocities can be

FIG. 7

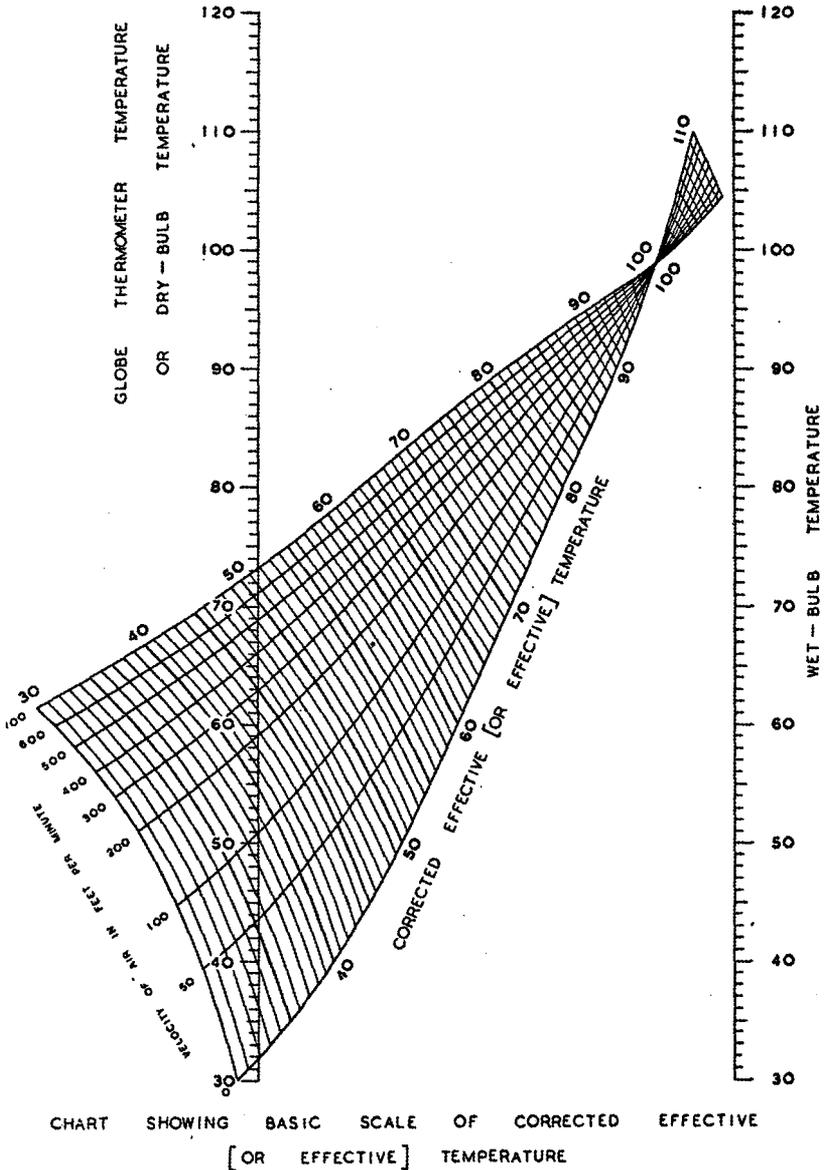

Reproduced by courtesy of the Medical Research Council (*Environmental warmth and its measurement*, a book of reference prepared for the Royal Naval Personnel Research Committee by T. Bedford. Medical Research Council War Memorandum, No. 17).

determined. Air velocities can be calculated from the readings of high temperature silvered kata thermometers. Fig. 6 represents the basic scale for persons who are stripped to the waist. Fig. 7 represents the scale for persons wearing light indoor clothing. When there is little disparity between the air temperature and that of the immediate surroundings, such as walls and other surfaces, the uncorrected effective temperature is an adequate measurement of warmth as felt by the individual. When radiant heat from nearby sources is noticeable, a more accurate guide is provided by the corrected effective temperature, for which it is necessary to use globe thermometer readings on the left-hand vertical scales instead of ordinary dry bulb thermometer temperatures.

Fortunately, effective temperatures as high as 90° are rarely met with under natural conditions. Local circumstances, however, may necessitate work at effective temperatures even higher than this. As an example, men employed on welding leaks inside a tank in a floating dock at Massawa had to endure an E.T. of 102° (dry bulb 102° F., wet bulb 100° F., relative humidity 93 per cent, air velocity 30 feet per minute). One-hour shifts only were possible. In such conditions, every effort should be made to increase air movement by trunking conditioned air to the working site, by fans or improvised punkahs, or even by playing air over the individuals from a hose line led from an air compressor.

4. Clinical effects of heat

(a) The effects of heat on human metabolism result in heat cramps ('stokers' cramp'), heat exhaustion or heat hyperpyrexia (heat stroke).

(b) *Heat cramps*.—These are caused by salt depletion without adequate replacement. The power to secrete sweat with a lowered chloride content is rapidly gained in hot weather but equally rapidly lost after only a few days of relatively cold weather. Hence, seasoned individuals who have not maintained their salt intake are as likely to develop heat cramps as are unacclimatized new arrivals.

(c) *Heat exhaustion*.—The essential etiology of this phase lies in the excessive diversion of blood to the surface capillaries and increased sweating, as an attempt to eliminate the heat load. An insufficient return of blood to the heart follows and the symptoms that present are largely those of cardiac embarrassment. The syndrome is in some part a protective mechanism which enforces rest and thereby relieves the strain on the heart. Recovery, in a previously fit individual, rapidly follows removal to a cool environment and replacement of salt and water loss.

The classical description by Marsh* of the clinical symptoms can hardly be bettered. Of heat exhaustion, he writes:—

"The patient walks in or is brought to the out-patient department complaining of weakness, languor, limpness, lassitude, weakness in the legs, exhaustion, faintness, dizziness, nausea, anorexia, abdominal discomfort, headache, constipation, sleeplessness and mild or severe cramps in

* MARSH F. (1937), *British Encyclopædia of Medical Practice*, vi, 396.

voluntary muscles. The patient may have fainted at his work and be carried in unconscious. Many patients faint while having their fingers pricked or veins punctured for blood samples. Diarrhoea and vomiting are common symptoms. The pulse is rapid and of low tension, the expression is anxious and there may be a temperature of 103° F. in the mouth. The skin may be moist or dry. The temporal hollows and cheeks fall in."

The dry skin type of case is more likely to occur towards the end of the hot weather, especially in those who have suffered from severe prickly heat, and is also characterized by frequency of micturition.

Cases with vomiting, cramps, dysuria and obvious dehydration are more common at the height of a heat wave and often give a history of loss of weight and diminished urinary output.

(d) *Heat hyperpyrexia*.—The syndrome of heat hyperpyrexia is due to failure of the central control of heat regulation. It is not a simple corollary of suppressed sweating, which does not in fact become manifest until the onset of the stuporose stage. Again to quote Marsh:—

"The patient is admitted unconscious, with the face suffused or cyanosed, a hot dry skin, a bounding pulse, stertorous breathing, a rectal temperature of 108° to 112°, and urinary and faecal incontinence. Sometimes heat stroke develops in a patient under treatment in an uncooled ward for some intercurrent disorder, and cessation of sweating may be a warning sign in such cases. Less severe cases are seen if the patients are brought in early. 'Flash' cases which develop in a night are seen occasionally in young unacclimatised men or in elderly persons."

Temperatures of more than 106° F. are of grave prognostic significance; recovery can be expected after the 109° F. mark has been reached if unconsciousness has not persisted for more than 1½ hours, but not if it has lasted as long as 3 hours; 115° F. has been attained with subsequent survival; 117·8° F. has been recorded before death.

The primary aim in treatment of heat hyperpyrexia is the reduction of body temperature to 102° F., taken per rectum, at which level active cooling measures should be stopped, or the temperature will fall still further, even as low as 91° F. when collapse and death from chilling may result. Many ingenious devices, to accord with physical laws and physiological principles, are used to bring about this essential reduction in temperature, but as the last resort, recourse is always had to ice, with which the body may be scrubbed, clystered and surrounded.

When malaria cannot be definitely excluded as a causative factor of hyperpyrexia it is always advisable to begin treatment with an intravenous injection of quinine, grs. 10.

5.

Prophylaxis of heat effects

(a) The source of heat in hot climates is the sun and therefore uncontrollable. Limitation of its effects upon the body can be achieved by insulation against radiation, by reinforcement of

the body's natural defences and by provision of naturally or artificially cooled environments in which refuge can be taken for all or part of the time during which heat stresses are excessive.

(b) *Insulation.*—The design and structure of buildings in the tropics, and their influence on heat insulation, will be discussed in a later section of this chapter. Where there is a significant difference between night and day temperature, and the construction of the building is such that heat gains within it are relatively slow, the practice of opening all windows, doors and ventilators at night in order to equalise indoor and outdoor temperatures and closing them shortly after dawn in order to trap the cool night air, should be an invariable rule. This trapping of cool night air may be aided by attic fans which draw air, if necessary at a sufficiently high rate to create perceptible air movement, through the whole house. These fans generally range in capacity from 8,000–16,000 cubic feet per minute and use about 50 watts an hour for every 1,000 c.f.m. of output. Where the diurnal range of temperature is small, or the buildings are of flimsy construction, with resultant rapid heating of the interior during the daytime and but little cooling at night, it is better to leave all apertures open throughout the 24 hours in order to obtain the greatest possible gain from whatever natural air movement occurs.

As has already been pointed out, the insulation effect of clothing only outweighs its interference with evaporative cooling of the body in the presence of a hot, dry wind of considerable velocity. (See page 55).

(c) *Reinforcement of natural body cooling.*—Natural cooling of the body is effected chiefly by the evaporation of sweat. It should therefore be provided with sufficient water and salt for the production of this sweat. Increased air movement will accelerate its evaporation and the provision of fans, punkahs or forced draught ventilation represents the maximum assistance that can be offered, short of full air conditioning. Some attempts at cooling the circumambient atmosphere can be provided by khus khus tatties. These are simply matting screens, kept wet with water, and so placed that a natural breeze or artificial draught created by fans, blows through them and is thereby cooled by evaporation.

(d) *Air conditioning.*—Air conditioning units may perform some or all of the functions of cooling, dehumidifying, filtering (of particles and odours), air circulation, heating and humidifying according to the particular requirements for which they are installed.

The modern type of cooling unit depends upon the compression of a refrigerant gas, such as freon 12 (dichloro-difluoromethane), methyl chloride or ammonia. The compressed gas then passes through a condenser, usually cooled by the circulation of water, and is thereby transformed to its liquid state, with consequent loss to the cooling water of the latent heat generated by its previous compression. The pressure on the liquid refrigerant is then released through an expansion valve and it re-evaporates, usually in an evaporating coil, extracting the necessary heat for this process from the surrounding medium—air or water in an air conditioning plant, brine in a food refrigeration system.

All hospitals in tropical and sub-tropical climates should have an air conditioned operating theatre and at least one air conditioned ward. Sleeping quarters claim a high priority, closely followed by recreation rooms. Unless buildings are specially constructed for the purpose, the subsequent installation of air conditioning is very costly. For workers in particularly hot occupations the provision of 'spot cooling' with a blanket of conditioned air from an overhead canopy, and the air conditioned suit resembling a diver's outfit, are likely to become more generally used.

(e) *Educative measures.*—Propaganda should begin just before the onset of the hot weather. Lectures on hot weather precautions, notices in routine orders and the display of such posters as '**DRINK MORE WATER**' and '**EAT MORE SALT**' are of great value.

(f) *Exercise.*—Outdoor games and exercise, within reasonable limits and not during the early afternoon, should be encouraged, except at the height of an unusually hot spell. Seasoned personnel in good physical condition attain a high degree of resistance to heat.

(g) *Diet.*—Additional salt and water are necessary during hot weather. Fatty foods, especially hot, are usually found distasteful. Protein can well be cut down, since the excretion of each gramme of urea needs 20 cc. of water for its elimination. Alcohol is not contra-indicated but its use, as always, should be in moderation.

(h) *Hours of work.*—During the height of the hot season every advantage should be taken of the cooler morning hours, provided there is not interference with a good night's sleep. The working day can well be started soon after first light and, when operational or other commitments allow, should end before or shortly after noon. The hot afternoon should be devoted to rest and the evening to recreational activities. It is now well accepted that output cannot be maintained in a temperate climate if the weekly working hours exceed 55–60. A considerably lower figure than this is the probable optimum in a hot climate. In Iraq, for example, 42–48 hours per week should be the maximum between June and September if maximum efficiency and freedom from ill health is to be maintained.

(i) *Rest and leave.*—At least one whole day in each seven should be a complete holiday. A few days' break in a cooler environment after 12 weeks of very hot weather is desirable. Rest and leave camps should be established for this purpose in accessible hill districts where these exist.

(j) *Medical observation.*—A close watch on temperature conditions and reactions of personnel to them should be kept by medical officers. Those working inside aircraft in the open, and in other thin-skinned structures, are especially exposed to risk, owing to the tendency for heat to build up rapidly in these situations to well above the outside shade temperature and to the lack of air movement within them. A medical officer should never hesitate to urge strict limitation of work, generally or in special places, or even its complete cessation, when the critical

level of 85° is reached on the effective temperature scale (see Fig. 6). Occasional checks of urinary chloride content, and of rectal temperature, should be performed on all personnel exposed to special risk of heat stroke.

The test for urinary chlorides should be a matter of daily routine for all febrile patients during the hot season. To 5 cc. of urine in a test tube add 5 drops of pure concentrated nitric acid and a few drops of 1 per cent silver nitrate solution. A thick, curdy, white precipitate appears if chlorides are present in their normal amount. A slight haze only or no change indicates their absence and the need for salt therapy.

(k) *Heat stroke centres.*—These should be maintained in constant readiness during the hot weather in all areas where heat stroke is liable to develop. A sufficient supply of ice should always be available in default of a fully air conditioned ward. Electric fans are almost equally essential if anything more than simple emergency treatment is contemplated.

(l) *Siting of camps.*—It is possible that areas with a high level of sub-soil water and a moderate amount of vegetation, in spite of their greater humidity, are appreciably less dangerous than desert regions with similar dry bulb temperatures. Evaporation from the surfaces of irrigation channels and transudation from foliage will undoubtedly cool the surrounding atmosphere by evaporation and may cause a significant lowering of the effective temperature. This theory, for it is as yet by no means established as fact, presents an argument in favour of an irrigated, garden area such as Basrah, as opposed to the arid, desert area of Shaibah some 15 miles distant; or alternatively, for the artificial cultivation of lawns and gardens in desert camps if the associated risk of insect breeding does not outweigh their other advantages or can be overcome. Whether or not there is less risk of heat effects developing in the hot, humid districts, the hot, dry areas seem to be preferred by those who have experienced both.

SECTION III

PATHOLOGICAL EFFECTS OF EXTREME COLD

1.

Frostbite

Although exposure to an extremely cold environment will eventually result in death, the only pathological effects of cold which are of practical importance are frostbite and the allied conditions, trench foot and immersion foot.

2.

Etiology and pathology

The essential etiology of frostbite lies in an initial contraction or spasm of terminal arterioles. This is followed later by capillary transudation of fluid, but rarely of blood cells, into the surrounding tissues. According to the degree of exposure to cold, three clinical types of frostbite are recognised. At first the exposed parts, especially the fingers, become waxy white, anaesthetic and rigid. This stage, which is due to vasoconstriction, is followed either by blister formation and oedema due to

vasodilation, or by mummification caused by thrombosis affecting both arterioles and venules. Even in cases where circulatory recovery follows, damage to nerves and nerve endings, muscle fibres and sweat glands leads to hyperaesthesia, pain, hyperhidrosis and finally fibrosis of periarticular tissues, tendon sheaths and muscles.

The critical air temperature at which frostbite occurs may be as high as -6°C . or even -4.4°C . if there is a wind, but the absence of air movement may lower this critical temperature to the region of -13°C .

The actual freezing point of the skin has been found to vary between -2.2°C . and -25°C ., depending upon the oil/water ratio in the skin and underlying tissues. In the presence of a high fat content the skin is more resistant to chilling. Wet, sodden skin freezes more readily than a dry skin. The advocacy of inunction with whale oil or lanolin as a preventive measure is based upon this rationale. The practice, however, is not successful unless the grease is rubbed well into the skin and no surplus remains upon its surface to be absorbed by gloves and socks and thereby facilitates the collection of moisture in close contact with the hands and feet.

Factors which accelerate the development of or accentuate frostbite are damp, warmth applied to the affected part after it has been chilled, venous stagnation, anoxia, trauma and nutritional deficiencies, especially scurvy.

The etiology of trench foot and immersion foot, and their prevention and treatment are very similar to that of frostbite.

3. Prevention

Attention to the following points is necessary.

(a) *Maintenance of a good, peripheral circulation.*—The fit, trained man is more resistant to frostbite, but even for him exercise and massage of the limbs should be kept up during prolonged exposure to severe cold.

(b) *Avoidance of positions which impede peripheral circulation; e.g., sitting positions which compress the thighs and reduce the blood flow to the legs and feet.*

(c) *Avoidance of constricting garments* such as tight gloves, tight socks, tight boots.

(d) *Avoidance of damp clothing.*—It is particularly important to ensure that all flying clothing, especially gloves, socks, boots and underclothing, is thoroughly dry before wear.

(e) *Protection against wind.*—The principle of clothing for warmth is to surround the body with a zone of still air. Several layers of loose fitting, loosely woven clothing are warmer than an equal weight of fabric disposed in fewer layers. The stillness of the insulating layers of air is ensured by an outermost garment of wind proof material, such as leather or a closely woven fabric as was prepared for the Mt. Everest expedition. If this principle, however, is carried to excess and no means of ventilation is provided, the

enclosed air becomes saturated with moisture and sweat can no longer evaporate. Body cooling by this means falls off and, during heavy work in cold climates, the body temperature may rise to dangerous levels. The Brynje clothing system is designed to guard against this danger, by using basic garments made of string netting with a mesh of about $\frac{1}{2}$ to 1 inch. These vests and pants replace the ordinary woollen ones, although owing to discomfort the pants are seldom worn. The string mesh provides a deep insulating layer of air next the skin and precludes to some extent the production of a soaked, clammy layer of clothing in contact with the skin after sweating. An essential feature of the Brynje system is the provision of an outer, wind proof garment which can be quickly and easily undone at the neck. During exercise the neck is kept open to allow the evaporation of sweat; shortly after ceasing exercise the neck portion is fastened and sealed with a scarf in order to retain the heat.

(f) *Adequate oxygenation.*—Anoxia due to pathological conditions such as anaemia, heart failure, severe haemorrhage, wound shock and carbon monoxide poisoning predisposes to frostbite. The anoxia resulting from decreased pressure of atmospheric oxygen due to altitude is of importance to the aviator. It is essential to use oxygen breathing apparatus in aircraft at all heights above 10,000 feet if full efficiency is to be maintained.

(g) *Avoidance of contact with frozen metal.*—Frostbite will develop in a few seconds if a freezing piece of metal is touched with the bare skin.

(h) *Augmentation of body heat.*—Heat may be applied to the body by radiation from a distant source by convection of warm air currents, by direct application of chemically or electrically heated pads and items of clothing, and by the intake of hot drinks and food.

4.

Treatment

(a) *Rest the affected part.*—For frostbitten fingers the arm should be kept in a sling. A man with only slightly frostbitten feet is a stretcher case. Severe cases should invariably be nursed in bed. Elevation of the frostbitten limb is indicated in every case, till oedema has subsided and absorption of blister fluid has begun.

(b) *Avoid local warmth.*—Thawing of an affected part by gentle warming at a temperature not more than that of the body is a legitimate procedure. The application of a warm hand to an ear or nose that has been observed to blanch suddenly is a first aid measure that is traditionally effective and often results in saving the tissues concerned. But it must always be remembered that the application of heat to a frostbitten limb in any form at a temperature higher than 37° C. is likely to increase the damage that has already been done and will almost certainly delay reparative processes. Local warmth increases local metabolism. It leads to increased local accumulation of tissue breakdown products and to increased local oxygen requirements. It favours bacterial growth and, therefore, aids the establishment of secondary infection. It does *not* overcome the local arteriolar spasm, and the need for increased blood supply that it creates

vasodilation, or by mummification caused by thrombosis affecting both arterioles and venules. Even in cases where circulatory recovery follows, damage to nerves and nerve endings, muscle fibres and sweat glands leads to hyperaesthesia, pain, hyperhidrosis and finally fibrosis of periarticular tissues, tendon sheaths and muscles.

The critical air temperature at which frostbite occurs may be as high as -6°C . or even -4.4°C . if there is a wind, but the absence of air movement may lower this critical temperature to the region of -13°C .

The actual freezing point of the skin has been found to vary between -2.2°C . and -25°C ., depending upon the oil/water ratio in the skin and underlying tissues. In the presence of a high fat content the skin is more resistant to chilling. Wet, sodden skin freezes more readily than a dry skin. The advocacy of inunction with whale oil or lanolin as a preventive measure is based upon this rationale. The practice, however, is not successful unless the grease is rubbed well into the skin and no surplus remains upon its surface to be absorbed by gloves and socks and thereby facilitates the collection of moisture in close contact with the hands and feet.

Factors which accelerate the development of or accentuate frostbite are damp, warmth applied to the affected part after it has been chilled, venous stagnation, anoxia, trauma and nutritional deficiencies, especially scurvy.

The etiology of trench foot and immersion foot, and their prevention and treatment are very similar to that of frostbite.

3.

Prevention

Attention to the following points is necessary.

(a) *Maintenance of a good, peripheral circulation.*—The fit, trained man is more resistant to frostbite, but even for him exercise and massage of the limbs should be kept up during prolonged exposure to severe cold.

(b) *Avoidance of positions which impede peripheral circulation; e.g., sitting positions which compress the thighs and reduce the blood flow to the legs and feet.*

(c) *Avoidance of constricting garments* such as tight gloves, tight socks, tight boots.

(d) *Avoidance of damp clothing.*—It is particularly important to ensure that all flying clothing, especially gloves, socks, boots and underclothing, is thoroughly dry before wear.

(e) *Protection against wind.*—The principle of clothing for warmth is to surround the body with a zone of still air. Several layers of loose fitting, loosely woven clothing are warmer than an equal weight of fabric disposed in fewer layers. The stillness of the insulating layers of air is ensured by an outermost garment of wind proof material, such as leather or a closely woven fabric as was prepared for the Mt. Everest expedition. If this principle, however, is carried to excess and no means of ventilation is provided, the

enclosed air becomes saturated with moisture and sweat can no longer evaporate. Body cooling by this means falls off and, during heavy work in cold climates, the body temperature may rise to dangerous levels. The Brynje clothing system is designed to guard against this danger, by using basic garments made of string netting with a mesh of about $\frac{1}{2}$ to 1 inch. These vests and pants replace the ordinary woollen ones, although owing to discomfort the pants are seldom worn. The string mesh provides a deep insulating layer of air next the skin and precludes to some extent the production of a soaked, clammy layer of clothing in contact with the skin after sweating. An essential feature of the Brynje system is the provision of an outer, wind proof garment which can be quickly and easily undone at the neck. During exercise the neck is kept open to allow the evaporation of sweat; shortly after ceasing exercise the neck portion is fastened and sealed with a scarf in order to retain the heat.

(f) *Adequate oxygenation.*—Anoxia due to pathological conditions such as anaemia, heart failure, severe haemorrhage, wound shock and carbon monoxide poisoning predisposes to frostbite. The anoxia resulting from decreased pressure of atmospheric oxygen due to altitude is of importance to the aviator. It is essential to use oxygen breathing apparatus in aircraft at all heights above 10,000 feet if full efficiency is to be maintained.

(g) *Avoidance of contact with frozen metal.*—Frostbite will develop in a few seconds if a freezing piece of metal is touched with the bare skin.

(h) *Augmentation of body heat.*—Heat may be applied to the body by radiation from a distant source by convection of warm air currents, by direct application of chemically or electrically heated pads and items of clothing, and by the intake of hot drinks and food.

4.

Treatment

(a) *Rest the affected part.*—For frostbitten fingers the arm should be kept in a sling. A man with only slightly frostbitten feet is a stretcher case. Severe cases should invariably be nursed in bed. Elevation of the frostbitten limb is indicated in every case, till oedema has subsided and absorption of blister fluid has begun.

(b) *Avoid local warmth.*—Thawing of an affected part by gentle warming at a temperature not more than that of the body is a legitimate procedure. The application of a warm hand to an ear or nose that has been observed to blanch suddenly is a first aid measure that is traditionally effective and often results in saving the tissues concerned. But it must always be remembered that the application of heat to a frostbitten limb in any form at a temperature higher than 37° C. is likely to increase the damage that has already been done and will almost certainly delay reparative processes. Local warmth increases local metabolism. It leads to increased local accumulation of tissue breakdown products and to increased local oxygen requirements. It favours bacterial growth and, therefore, aids the establishment of secondary infection. It does *not* overcome the local arteriolar spasm, and the need for increased blood supply that it creates

cannot be met until this spasm has disappeared. Exposure to room temperature or cooling the air with a fan are preferable to active chilling by ice packs or special refrigerant apparatus.

(c) *Avoid trauma.*—On no account should a frostbitten part be rubbed with snow, towelling or anything else. This practice is often advised on the pretext of 'restoring the circulation.' It is an excellent procedure to counteract mere chilling, but is useless once the arterioles have gone into spasm and then only causes additional damage to tissues that are already injured.

(d) *Maintain and augment general body heat,* by placing the patient in bed and giving hot drinks.

(e) *Give oxygen* at a rate of 8 litres per hour for at least half an hour after the patient has been put to bed.

(f) *Give anti-tetanic serum as a routine,* as tetanus is particularly liable to develop in frost-bitten individuals.

(g) *Dust blisters or broken skin with a sulphonamide powder and enclose the affected part in sterile dressings.*—Infection and gangrene, once established, must be treated according to general surgical principles.

SECTION IV

BUILDINGS

1. The siting and construction of buildings is well controlled in the United Kingdom by legislation. Although some of the principles which receive attention in this section are applicable to buildings in any part of the world, consideration is given chiefly to the problems of hot climates, for which the construction methods and designs used in temperate zones are often entirely unsuited.

2.

Sites

The ideal site should have a dry, porous subsoil. It should be sufficiently elevated to enable easy drainage, but not so hilly as to make road access difficult. A potable water supply should be available and due regard should be paid to the directions of the prevailing winds and their rain and dust bearing propensities. In regions where insect borne diseases such as malaria, are endemic, the breeding grounds of such insects should be well beyond their normal flight range or should be readily controllable, preferably by permanent measures rather than by those which involve recurring labour or maintenance costs. A site should never be chosen within half a mile of any native village, unless strategic or economic considerations are of over-riding importance. Generally speaking, the following sites are unsuitable:—

- (a) Steep slopes.
- (b) Bases or summits of hills.
- (c) Bottoms of narrow valleys.

- (d) River beds.
- (e) Low meadows.
- (f) Clay soil.
- (g) Newly turned soil.
- (h) Ground close to villages and graveyards.

3.

Lay-out

(a) The necessity for adequate natural lighting and for the free circulation of air through and around dwellings has become more and more appreciated during the present century and has influenced building design and site planning to a marked extent. In order to avoid congestion and the creation of slum areas, standards have now been devised which limit the number of houses that can be erected, in accordance with a sliding scale of net residential densities. The net residential density figure is in respect of the curtilage of the dwellings, access roads, minor open spaces and half the boundary roads up to a maximum of 20 feet. In the United Kingdom the highest permissible net density is now accepted as 200 persons per acre, and this only in such circumstances as blocks of flats situated centrally in a large town. The lower figure of 120 persons per acre for central areas of large towns is more generally desirable and should only be exceeded, even for concentrated development areas, in exceptional circumstances. For normal barrack and mess lay-outs a net residential density of more than 100 per acre should seldom be necessary. A more generous space allowance is often possible.

(b) *Domestic services.*—The economical provision of piped water supply, drainage, gas, electricity or central steam heating often dictates the manner in which buildings are grouped. Nevertheless, it is important that these considerations should not permit encroachment on open spaces that have been allotted, or seem suitable, for recreational facilities. Nor should the need for compactness outweigh unduly the psychological value of an attractive design or setting. The opposite extreme of wide dispersal, made necessary by modern warfare, introduces new problems and considerable hardship. It should be axiomatic that a distance of 1 mile between living and working sites is not exceeded unless transport is provided. Even this distance is excessive in a hot climate, especially in hilly districts.

(c) In the lay-out of a temporary or tented camp the sleeping and messing accommodation should be on the windward side and the conservancy area, containing latrines and refuse disposal arrangements, concentrated to leeward. Roads through the camp should be planned to avoid blanketing the cooking and messing area with dust during dry weather. In tented camps enough space should be allowed to permit the moving of tents one tent space forward or to the side, in order that the underlying ground can be kept in a sanitary condition. The special problems of hygiene and sanitation of tented camps are dealt with on pp. 103–106.

FIG. 8

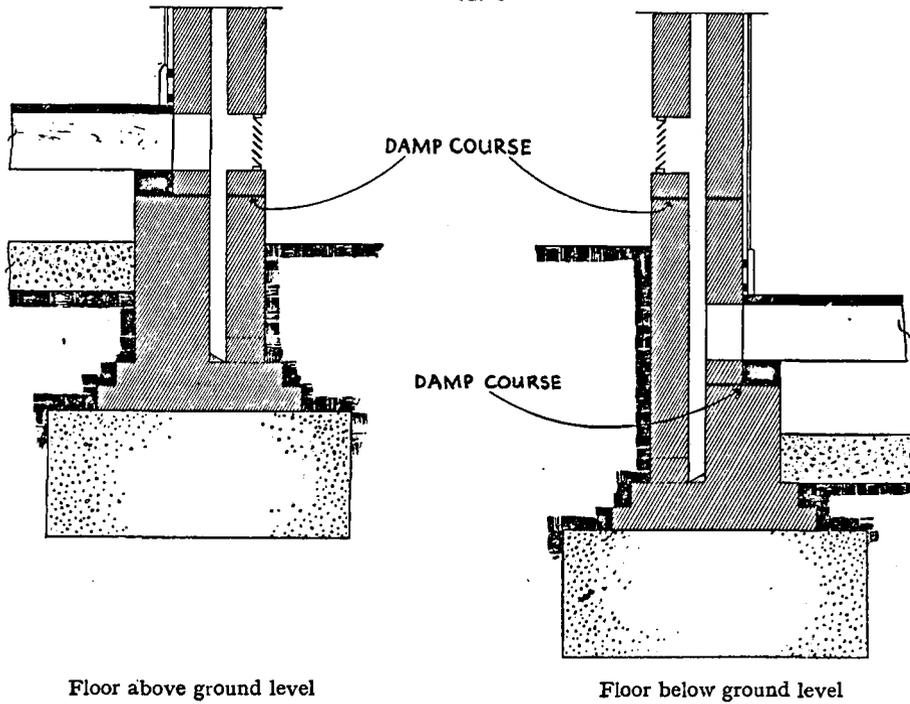

DAMP COURSES IN HOLLOW WALLS

FIG. 9

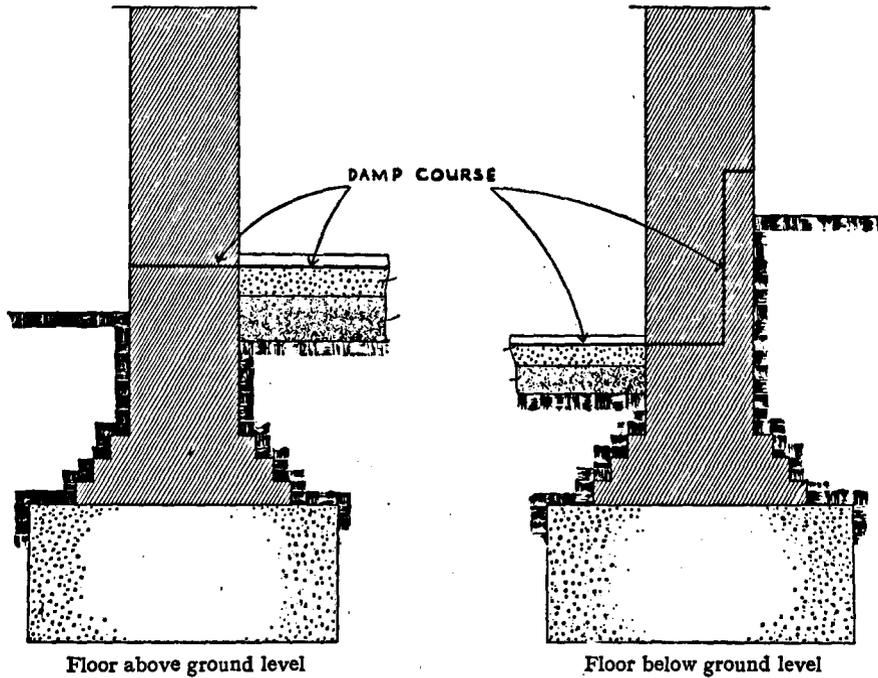

Floor above ground level

Floor below ground level

DAMP COURSES IN SOLID WALLS

FIG. 10

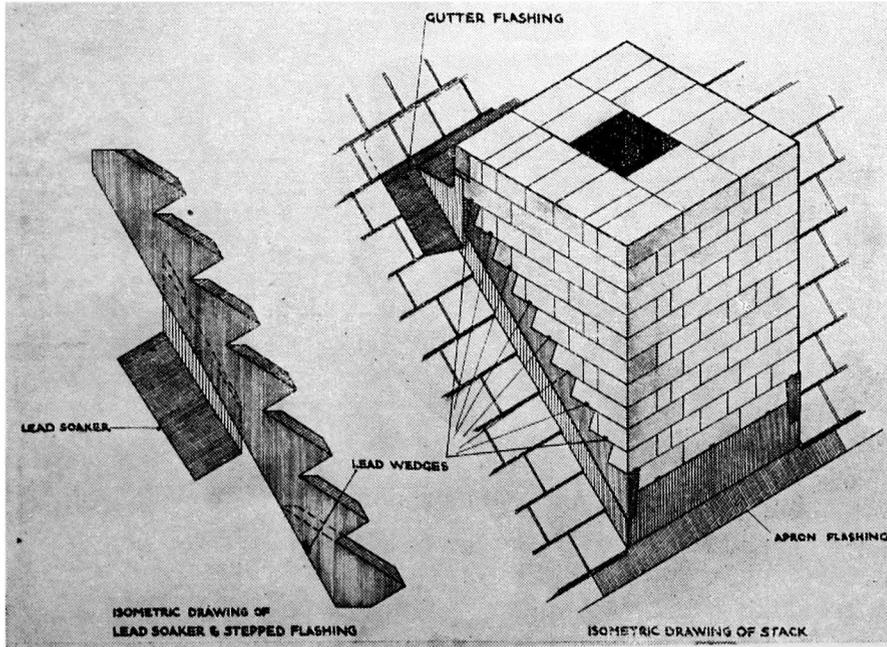

CHIMNEY FLASHINGS

FIG. 10—continued

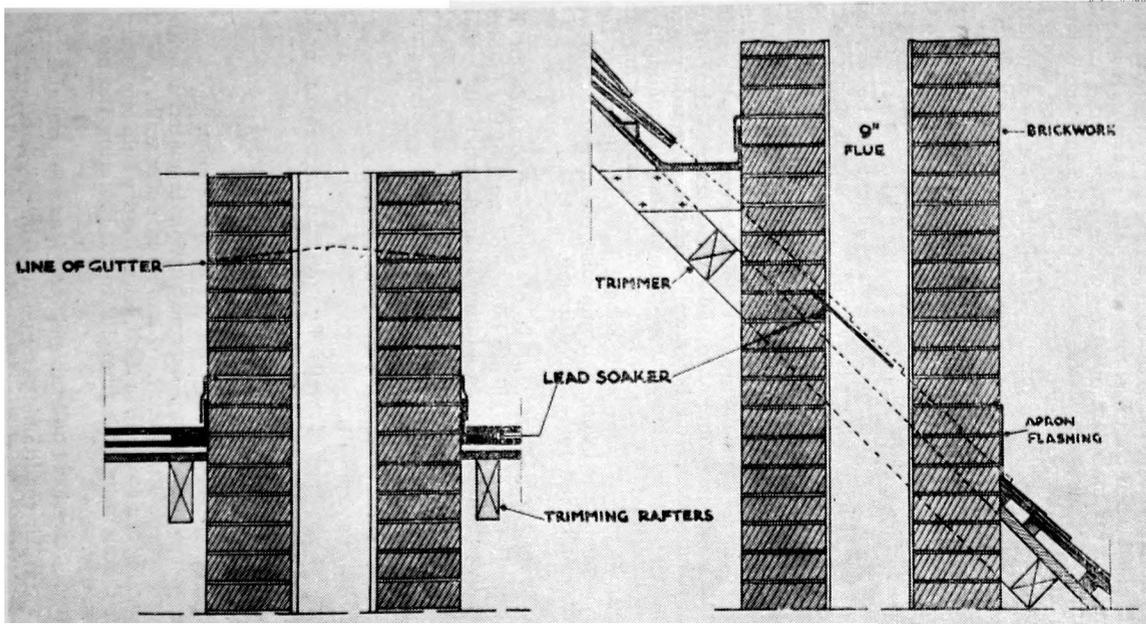

Section across slope of roof

Section along slope of roof

CHIMNEY FLASHINGS

4.

Construction

(a) The construction of any permanent building should be such as to guard against subsequent dampness. This usually results from moisture rising through the walls by capillary action and is aided when cheap, porous materials are used. A layer of concrete or tar macadam over the whole site and the provision of damp-proof courses near the base of both internal and external walls are the best defence against dampness rising from the ground. Board or timber joist flooring laid above this foundation must be placed above the damp-proof courses and should have good ventilation beneath it. If a solid floor is laid directly on the ground it should be made resistant to the passage of moisture by the insertion below it of a waterproof membrane joined to the damp-proof courses in the walls. These latter are generally composed of lead, slate, asphalt or vitrified brick. The resistance to infiltration of rain through the walls should not be less than that of an 11-inch brick cavity wall. A 9-inch brick wall is regarded as unsatisfactory unless it is rendered, rough cast, pebble-dashed, tile-hung or clad externally with impermeable sheeting. Lead flashing round the bases of chimney stacks that emerge through the roof prevents access of rain to the buildings at these points. Capillary grooves should be cut beneath window sills and projecting courses, to allow water to drip clear of the walls. Condensation on inner wall surfaces is a troublesome, though not very common, cause of dampness in buildings. It is best combated by the provision of adequate heating and ventilation, but internal walls should have porous rather than impervious surfaces in order to minimise the appearance of wet, steaming walls and to reduce dripping.

(b) *Protection against heat* is of great importance in hot climates. It is achieved chiefly by one or more of the following means, those which provide additional insulation being equally effective against cold:—

(i) Sinking of rooms wholly or partially below ground level, *e.g.* the Turkish serdab.

(ii) Thick outer walls and roof.

(iii) Cavity walls.

(iv) Shading of walls by overhanging eaves or by verandahs.

(v) Double roofs.

(vi) Thatched roofs.

(vii) Ventilation of roof space above ceilings.

(viii) Whitewashing, or construction in materials with a high reflecting capacity, of roofs and outer walls. Whitewashing of a roof will, in itself, lower the dry bulb temperature in the room below it from 10° to 20° F. during the heat of the day.

(ix) Overhead and table electric fans and punkahs.

(x) Air conditioning (*see* pp. 65–66).

(c) *Verandahs* for tropical houses should be at least 10 feet wide. They should be ventilated at the junction of their roofs with the house walls, to avoid the accumulation of a cushion of hot,

stagnant air against the wall of the building. Mosquito proofing of verandahs in malarious areas, or where biting insects are a pest, should be the accepted practice. In some hot countries a *patio design* is preferred to the outside verandah type, with the living rooms opening on to a central square or patio, and with but few windows in the outer walls.

(d) *Rooms* in hot climates should not be less than 10 feet in height, since the heat radiated from a roof is in inverse proportion to the square of the distance.

(e) In general, *windows* in the tropics should be as few in number and size as will provide sufficient light and ventilation, especially in the east and west walls. They should be fitted with louvred shutters of a non-conducting material such as wood, or should be shielded from direct sun glare and radiant heat from the ground or nearby buildings. Double windows with an intervening air space reduce heat transference either inwards or outwards and help sound proofing. Small, clerestory windows placed high up aid in lighting and ventilation and avoid the production of draughts.

(f) *Roof gutters* should be omitted in areas where they are a source of mosquito, especially *Aedes*, breeding and the roof eaves continued far enough to allow rain to drip into ground gutters.

(g) In the construction of *mosquito proof buildings* all doors should be double, made to open outwards and provided with automatic closing devices.

(h) All *unnecessary woodwork* such as picture rails and skirting boards should be omitted from the structure of buildings in places where bed bug infestation is prevalent.

(i) *Rat proofing* of buildings is very necessary in some districts, especially where plague is endemic. The lower edges of all outer doors should be guarded with metal sheathing to prevent the rats gnawing entry holes. The exits of all water, gas, electricity and drain piping should be sealed. It is sometimes considered advisable to raise buildings, especially warehouses and store rooms, on pillars which are guarded by projecting metal shelves of sufficient width to prevent rats climbing over them. An objection to all raised buildings, especially overseas, is that the ground beneath is used as a convenient place in which to dump any unwanted rubbish—an unsightly and insanitary practice.

5.

Design

(a) *Barrack blocks*.—The present tendency in barrack design is to provide dormitories housing up to 20 men, with separate cubicles for N.C.Os. Some of these dormitories may be divided by partitions into four-bunk compartments, and a further percentage of barrack buildings composed entirely of single cubicles. Advancement to, or reversion from, 'cubicle status' can be made a useful privilege or disciplinary measure, with a resultant beneficial effect on morale. The usual form of construction is in blocks of rarely more than two storeys, with separate sanitary and ablution facilities for each floor. Since many individuals spend some part of their off-duty time in their barrack rooms, these should be provided with chairs, tables and good lighting and should be painted in light colours. Drying rooms are necessary and whenever possible should be an integral part of the barrack block.

If they have to be sited elsewhere, space for hanging wet clothing should be allowed for without encroaching on the dormitory space. A large cupboard, or small room for brooms and cleaning materials should be placed on each floor. The importance of through ventilation must be borne in mind. Central heating is preferable to open fires and stoves, although these are more generally appreciated. It is probable that the habit of clustering round a fire or open stove is responsible in large measure for the spread of droplet infections among the occupants of barrack rooms. There is much to be said for the more modern practice, adopted by Continental military architects, of housing personnel in separate small bungalows, each holding only 12 or 14 individuals and each with its own rest room. Such a scheme is particularly valuable in limiting the spread of epidemics and for this reason deserves very favourable consideration in planning the accommodation for stations concerned with the training of young personnel and apprentices and for recruit centres.

(b) *Cookhouses and messes.*—The collection under one roof of feeding and cooking facilities has much to recommend it. In Service life, indoor recreational facilities are better sited in a separate Institute building, where alternative evening meals may be purchased at reasonable prices with the added attraction of different surroundings. In the design of any cookhouse particular attention must be paid to the provision of effective ventilation. Full air conditioning is rarely feasible, but exhaust ventilation should be installed whenever possible, especially in hot climates. Ample space must be allowed, particularly in the immediate neighbourhood of working appliances that are sources of much radiant heat. Although ranges and ovens are generally grouped centrally in kitchens, it is really preferable to place these at the sides and adopt the 'back-firing' system, by which they are stoked in furnace rooms outside the kitchen proper. In this system, oven shelves run on rails and can be pulled out into the kitchen for loading and unloading. Where steam cooking appliances are employed, as is now usual, a detached boiler house is required in order to eliminate this additional source of 'wild' heat from the kitchen itself. Drainage of cookhouses requires some care. Floors should fall to sunk channels, the main branches of these channels being covered with removable, perforated, cast-iron grids. Grease interceptors or, for larger cookhouses, grease recovery traps should be incorporated in the drainage system, at sufficient distances from sink outlets to enable preliminary cooling of waste waters to occur before reaching the trap. A run of 10 to 15 feet in an open gully drain is generally sufficient for this to be effected. An impervious platform, drained to the existing drainage system or to a soak pit, is necessary for swill bins and should be sited externally near a convenient door. Fly-proofing is generally considered necessary for cookhouses, especially overseas, but must be of robust construction and kept in good repair, otherwise the building becomes a gigantic fly trap. A common fault is the construction of fly-proof doors in which the wire gauze is continued to the bottom of the door. As this is frequently kicked, the lower one or two feet should be of solid wood or metal. The layout of any cookhouse is largely dependent upon the equipment it is to contain, but certain broad principles should be observed. These have the underlying object of lessening

the work of the staff and thereby increasing their efficiency. A continuous flow through the building should be the aim, from the delivery of the raw materials through storage, preparation and cooking to the finished article as it leaves the servery, less the waste products that have arisen during its processing. In any but the smallest cookhouse, separate rooms are usually allotted, for these purposes and to contain the equipment shown below in a suggested layout for a cookhouse catering for approximately 1,000 men.

TABLE X
SUGGESTED LAYOUT FOR A COOKHOUSE CATERING
FOR 1,000 MEN

<i>Rooms</i>	<i>Equipment</i>	<i>Remarks</i>
Staff cloak room ..	W.Cs., lavatory basins, lock-up closets for clothing	
Mess office ..	—	—
Cold room ..	350 to 500 cubic feet refrigerator space.	All storage rooms should be on the north or north-east fronts of the building; vice-versa in the southern hemisphere
Larder or butcher's shop	Slate top bench, batten shelves, chopping block	
Vegetable store ..	Racks, tins and shelving	
Dry goods store ..	Shelving	
Pastry and meat preparation room	Meat slicing and mincing machines, mixing machine, sink	
Vegetable preparation room	Potato peeling machine, potato chipping machine, vegetable trough, two sinks	
Main kitchen ..	Steam boiling pans, wet steam ovens, hot air ovens, grills, fish friers, water boilers, working tables or benches, steam hot closets, sink	Apparatus that generates heat or steam to be under canopies, connected to exhaust ventilation system
Pan room ..	Racks, shelves, large metal sink	
By-products room	By-product and fat clarifying boilers, sink	
Wash-up room ..	Dish-washing machines, stripping table with swill bins under, 2 sinks	22-foot wall space required for dish-washing machine. This room should communicate by hatches with dining hall and hot closets in serving counter
Boiler house ..	—	—
Fuel stores ..	—	—

Kitchen and dining halls should be separated only by serving counters about 30 feet in length, incorporating hot closets and hot plates and fitted with shelves for cold plates and dishes. Every effort should be made to decorate the dining halls as attractively as possible. Contrast colour schemes for walls, ceilings and floors present a cheerful appearance and form an excellent aid to digestion. All wall-surfaces in both cookhouse and dining halls, to a height of not less than 5 feet should be tiled or rendered in a smooth washable surface. The junctions of wall and floor surfaces should be coved to facilitate cleaning.

SECTION V

CLOTHING

1.

Introduction

The chief function of clothing is to protect the body from wind and weather, but there are many other considerations which must be taken into account. Military forces must be provided with scales of clothing that are suitable for operations in climates ranging from tropical to arctic. Adaptations must be devised that will blend with the background and so camouflage the wearer from observation by the enemy. The value to morale of smart, well-fitting 'walking-out dress' must not be forgotten, nor should uniforms inflict discomfort upon the wearer. The chafing effect of the old type, high-necked uniform was associated in the Royal Air Force with a high proportion of septic spots and boils on the neck. It has now been replaced by the open neck tunic worn with a soft collar and tie. Special fabrics that will resist penetration by thorns and biting insects may be necessary, especially in jungle campaigns. The impregnation of materials with insecticides, insect repellents and other chemicals is a rapidly developing practice. Special protective clothing is required for various industrial occupations.

2.

Cold weather clothing

This may range from the addition to normal winter dress of a few items such as greased boots, heavy socks, woollen under-clothing, sweater, gloves, scarf and leather jerkin to the provision of a complete arctic scale of clothing. The length and degree of exposure to cold must be the deciding factor. An office worker in an East German town will require additional clothing items in the winter months, but not to the same extent as a man employed on refuelling aircraft at a nearby airfield, for whom a fairly elaborate outfit will be necessary. (See also pp. 84-85).

TABLE XI
CLOTHING SCALES FOR COLD CLIMATES
(from Air Publication 830, Part C)

<i>Section</i>	<i>Ref Nos.</i>	<i>Description</i>
21E	709	Mattresses, tropical
	717	Bags, sleeping, outer
	715	Covers, bedding roll
22B	178-193	Vests, winter.
	203-206	Vests, string
	116-121	Drawers, woollen, long
	209-217	Shirts, angola, drab
	207	Neck squares
22D	560-568	Boots, ankle, grooved heel (for skis)
	666-674	Boots, heavy, greased
	622-630	Boots, knee, felt
	579-587	Boots, knee, arctic
	570-578	Insoles, felt
22G	964-967	Socks, wool, heavy
	900	Stockings, footless
	901	Goggles, snow
	902	Gloves, 3 compartment wool
	957	Gauntlets, leather, white
	963	Mittens, long, wool
	936-950	Caps, fur
	958	Helmets, woollen, drab
	959-962	Jerseys, heavy, drab
	1007-1010	Jackets, padded, cold climates
	1012-1015	Trousers, padded, cold climates
	1017-1020	Coats, outer, cold climates
	1040-1043	Coats, duffel, white
1048-1051	Trousers, windproof	
1044-1047	Smocks, windproof	

3. Hot weather clothing

The discarding of tunics for working parades may be sufficient for comfort during heat waves in temperate climates. In tropical conditions it has been shown that, for those possessing an adequate sun tan, the nearest permissible approach to nudity, provides the greatest safety and comfort, unless a very hot, dry wind is blowing. At these times sweat may be evaporated from the skin surface faster than it can be replaced. Evaporative cooling ceases and direct heating of the body by the hot wind may occur, possibly to a dangerous level. Scales of clothing for hot climates are noteworthy in that the bush shirt, which consists of an open neck tunic of khaki material worn as a shirt but outside the trousers, now replaces the ordinary khaki shirt of

the past. The bush shirt has been found by experience to be a very comfortable garment in hot weather. It does not interfere with the free circulation of air to the same extent as the old fashioned shirt, nor does it ruck up round the waist to form a sweat sodden roll and thus predispose towards prickly heat. Sun topees are no longer regarded as necessary and have been supplanted by the Australian type of slouch hat. The latter scores heavily over the topee, being lighter in weight, of equal or greater shade value and much easier to pack either as an individual item of kit or for bulk storage.

4. Flying clothing

Flying clothing is intended primarily as protection against cold and its design is governed by the principles discussed under the heading of frostbite. Its requirement varies with crew positions, types of aircraft and climatic conditions. In the last respect, however, it should be remembered that frostbite can readily occur at altitudes of 20,000 feet or more even at the height of an African summer. The practice of flying in shorts and short sleeved shirts during hot weather may lead to burning over a considerable area of the body in the event of the aircraft catching fire. The protection against flash burns that is afforded by full length trousers is considerable, and insufficiently realised. Better still is a light weight overall suit made of flame-proofed material. It is the extent rather than the severity of burns that determines whether or not the victim survives. Additional items of clothing provided for air crews range from fleece lined boots, jackets and trousers which may be worn over kapok quilted linings, to garments which are electrically heated and include gloves, socks and waistcoats. Special wool and rayon mixture underwear, long stockings and sweaters are also issued on occasion. Helmets, goggles and flying spectacles vary in design. Safety equipment includes inflatable life saving waistcoats, commonly called 'Mae Wests,' or water-tight flying suits which provide buoyancy by means of flotation pads. Blue combination overalls are available for warm weather flying. Special lightweight flying overalls have recently been introduced which are made of wind and shower proof gabardine, linen or cotton with an attached silk scarf. These overalls are fitted with special pockets in which various items of equipment are placed which are designed to provide the means of survival if the individual makes a forced landing or bales out into unfavourable territory. These items include first aid kit, emergency rations, fishing tackle, pocket-knife, machete, burning lens, waterproof matches, heliograph, cigarettes, waterproof electric torch, compass, rabbit snare, water carrier and needles and thread. One of the pockets contains also a back pack in which all these articles can be carried.

5. Mosquito-proof clothing

As this is needed most in hot countries it should be made of a sufficiently light fabric not to cause discomfort in wear. Specially woven gabardine which cannot be penetrated by the mosquito proboscis is used for the purpose. In addition, head veils and sleeves that fit over the hands made from wide mesh fish netting and impregnated with a mosquito repellent such as dimethyl phthalate have proved very effective.

6. **Mite-proof clothing**

Impregnation at fortnightly intervals of the clothing, including the socks, with dibutyl phthalate has proved very successful as a protective measure against the larval mites that cause scrub typhus. Dimethyl phthalate is also used for this purpose but has the disadvantage of being removed easily by washing. Dibutyl phthalate, on the other hand, is still effective after eight washes, provided the garments are not boiled. These substances are not repellents, but kill the mites within a few minutes after contact.

7. **Louse-proof clothing**

D.D.T. (dichloro-diphenyl-trichloroethane) is a rapid lousicide and can be used in an oily solution for the impregnation of shirts or underclothing to an amount equivalent to 1 per cent. of the weight of the garment. Specially woven belts, incorporating numerous pleats which make attractive harbourage for the lice, have been impregnated with Lethane 384 or lauryl thiocyanate for wear next the skin. These are very effective for natives but cause skin irritation when worn by whites.

8. **Gas-proof clothing**

Clothing may be proof against the blister gases by virtue of its resistance to penetration or because of its impregnation with chlorine compounds which render these gases chemically inert. The former type is worn as overall garments in the shape of cap and helmet covers, hoods, tunics, trousers, gloves and boots made from different grades of material which vary in weight and the duration of their resistance to blistering agents. They possess the inherent fault of all impermeable garments—their interference with body cooling by the evaporation of sweat. Hard muscular work while wearing these heavier grades of gas proof clothing can only be done for periods of 10 to 20 minutes at a stretch. Fabric overalls worn outside these garments, and kept wet with water, act as an artificial skin and by evaporation from their surface provide a certain amount of additional cooling, but not to an extent that will greatly prolong the tolerable working period. Chemical proofing of ordinary fabrics such as those used for uniforms, does not present this disadvantage of over heating. Some of the substances employed have proved very effective anti-gas agents.

9. **Protective clothing for special occupations**

This includes leaded aprons for radiographers, denim overalls for those employed on dirty processes, special goggles for arc welders, clogs for cooks, crash helmets for despatch riders, armoured gloves for personnel engaged in bomb and ammunition storage, respirators for paint, dope and preservative sprayers and other items detailed below. It should always be remembered that the need for protective clothing is an admission that the particular occupation for which it is provided cannot be, or has not been, rendered harmless to the unprotected worker. The first reaction of the industrial medical specialist to a dangerous or toxic process should be to devise means by which the process can be made safe; for example, by guards on a machine, by the

substitution of a non-toxic substance which is technically as effective as the toxic one, or by the removal of a poisonous dust or fume at the source of its evolution. Only if such measures as these are impracticable should recourse be had to protection of the worker himself. Here again traps await the unwary. Welders' goggles require care in their prescribing, depending on the type and the amperage of the current used. Different shades of glass are required which must fulfil British Standards Specifications. The use of respirators for a process in which toxic fumes are generated may seem a simple solution, but is a step which seldom can be justified unless supervision of the workers who wear them and maintenance of the respirators themselves are constant, and careful. Respirator filters, whether mechanical or chemical, need renewal at fairly frequent intervals. If these intervals are exceeded, the respirators become worse than useless. This objection does not apply to air line or oxygen respirators, but these must be well constructed, with properly designed outlet valves and well fitting face-pieces. A disadvantage of respirators with rubber face pieces is their tendency to cause dermatitis in some individuals who become sensitised to certain constituents of the rubber. Scales of working clothing have been included in Air Publication 830, Part C, for a considerable time, but many items, not in the scales, have been and are brought into use when necessary for protection against special hazards. Such items are not introduced into the A.P. 830 scales unless there is a continued widespread demand for their supply from Royal Air Force Equipment sources.

TABLE XII
CLOTHING SCALES FOR SPECIAL OCCUPATIONS
(from Air Publication 830 Scales, Part C)

<i>Scale</i>	<i>Section</i>	<i>Ref. Nos.</i>	<i>Description</i>	<i>Use</i>
C.32	Motor cyclists and M.T. drivers
C.33	Armoured car crews
C.34	Magazine clothing
C.35	Sanitary squads
C.36	Metal workers, blacksmiths, acetylene welders
C.37	Cooks and butchers
C.39	Moulders
C.50	Other trades
C.50	1A	6	Aprons, brown, basil	Bulk transportation of caustic soda, etc.
..	22C	431-433 & 992-993	Gloves, chamois & leather	Work on ball and roller bearings
..	22D	414-424	Clogs, wooden sole	Engine and boiler rooms, handling titanium tetrachloride and stannic chloride, handling ashes from incinerators

TABLE XII—continued

Scale	Section	Ref. Nos.	Description	Use
C.50	22G	395	Aprons, rubber proofed	Sorting soiled hospital linen, washing up duties in cookhouses, filling practice bombs with titanium tetrachloride
"	"	437	Coats, white drill	Laboratory assistants
"	"	396-397	Gloves, armoured	Handling barbed wire, sheet metal or heavy metal equipment
"	"	360-361	Gloves, hedging	Bulk transportation of caustic soda, etc.; engine and boiler rooms; handling timber, aircraft packing cases, alloy metal equipment
"	"	587-592	Gloves, M.T. drivers	Engine test benches during winter months
"	"	866-899	" rubber common N.P.	Handling acids, alkalis or titanium tetrachloride
"	"	593-596	" rubber, electricians'	Handling high tension work
"	"	597-599	" rubber, photographers	Photographers
"	"	383	Goggles, grinding	Forge welding, grinding machines, emery wheels, etc.
"	"	476	" M.T.	Saw benches; bulk transportation of caustic soda, etc.; handling acids and alkalis; holding down aircraft tails
"	"	603-606	Hats, sou'wester	
"	"	610-612	Jackets, fearnought	} Engine and boiler rooms
"	"	758-760	Trousers, fearnought	
"	"	698-701	Suits, combination, fearnought	Engine test benches (worn beneath 22G/720-733)
"	"	720-733	Suits, combination, blue	
"	"	734-739	Suits, combination, tropical	
"	"	637-639	Jackets, oilskin	} Bulk transportation of caustic soda, etc.
"	"	655-701	Leggings, ..	

SECTION VI

HEATING

1. Temperature requirements

Adequate warmth is essential if health, comfort and efficiency are to be maintained. A reasonable, but undefined, temperature in all workplaces is a legal requirement under the Factories Act of 1937. In addition, this Act lays down that, in every work-room where a substantial proportion of the work is done sitting and does not involve serious physical effort, a temperature of not less than 60° F. must be maintained, after the first hour, while work is going on. But this temperature should be regarded as a minimum requirement, and not an ideal at which to aim. Higher figures have for long been considered necessary on the Continent. Temperatures of 63° to 68° F. were put forward by French and German industrial hygienists as desirable for office and other sedentary workers as long ago as 1909 and 65° F. is now considered to be the optimum temperature for people similarly employed in this country. Evidence has been collected to show that not only comfort but efficiency is very much influenced by the temperature in which work is carried on. In one factory, for example, it was shown that cuts and minor accidents were at a minimum when the temperature inside the building was between 65° and 69° F. Below and above this range the accident figures increased markedly. A rising accident rate in coal mines can often be correlated with a temperature rising above the normal figure. Or again absences from schools in the winter months, not attributable to sickness, vary in direct proportion to the degree of heating provided in each school. It is apparent that 65° F. should be regarded as the necessary temperature for winter work of a sedentary nature, rather than the 60° F. prescribed as a minimum by the Factories Act.

2. Temperature measurement

No special regard need be paid to the factors of humidity and air movement, as these affect the comfort and efficiency of the worker, when the temperature range in an enclosed workplace is centred on 65° F. It is unlikely that adverse effects from an excess of moisture or extreme dryness will result at this temperature. The ordinary dry bulb thermometer will provide a sufficient check on the atmospheric conditions for all but exceptional occasions or processes. The provision of this instrument in workplaces is also a statutory requirement under the Factories Act, but the use of a maximum and minimum recording thermometer is more satisfactory as it will allow easy observation of deviations from the required temperature range.

3. Cooling requirements

When summer conditions prevail, temperatures in workplaces will often exceed 65° F. and humidity and air movement become of some importance in their effect on the worker. The problem is then one of reducing the effective temperature and is considered in Section II of this chapter.

4. Methods of heating

Heating systems depend chiefly upon radiation and convection for their effects. *Radiant heat* sources, such as open fires, braziers, gas stoves and electric radiators, heat directly the objects upon which their rays impinge, without appreciably warming the walls and furniture of a room, secondary convection heating currents and reflected radiation arise. Heat loss to adjoining rooms or to the outside air will also take place from the walls. Broadly speaking, any heat source which presents a visible flame or glowing surface can be considered as primarily a source of radiant heat. Those in which the heat source is enclosed, such as the hot water or steam 'radiator,' electric panel heaters and the more modern gas stoves, are *convection heaters*. These warm the air in their immediate vicinity and set up convection currents which, helped by normal ventilation, distribute warm air throughout the room, and, if necessary to other rooms by means of suitable ducting. Convection heating is a slower method of warming a room than radiant heating and is therefore not suitable for rooms which are used only for short periods. It would be uneconomical, for example, in a bedroom, whose occupants require rapidly appreciable warmth, such as that provided by an electric radiator, while dressing and undressing. *Conduction* is never used as a primary method of heating, although its secondary effects come into play in the exhaust heated footwarmers in motor cars, in similarly heated metal seating in some aircraft and in the general heating of schoolrooms by means of hot water pipes running below the floor.

Open fireplaces are undoubtedly the most pleasant form of heating, but are grossly extravagant in fuel consumption. With some designs of grate and chimney as much as 75 per cent of the heat derived from the fuel is lost to the outside air, either up the chimney or through the walls. In other words, these grates are only 25 per cent efficient as heat sources. Few grates are better than 60 to 65 per cent efficient. *Open braziers* are dangerous, owing to their associated risk of carbon monoxide poisoning. They should always be fitted with an efficiently designed flue leading to the outside air. Centrally placed *closed stoves* with a small flue pipe are probably the best means of heating barrack rooms. The rate of combustion in these stoves should be controlled by variable air inlets below the grate, rather than by dampers in the flue. The latter often become blocked or rusted up and thus cause a danger of reversed currents of partially consumed gases and carbon monoxide. There is much to be said for the comparatively new practice of providing continuous 'background' heating to a temperature of 50° to 60° F. by such means as central heating by hot water pipes, and 'topping up' to the comfort range of 65° to 68° F. at times and in places as necessary by means of auxiliary local heating with fires, stoves, radiators or electric panel heaters. This system is economical in maintenance costs. Heating of large sheds and hangars, which may be used as workshops or storage space, is a very difficult problem in winter. One of the most successful solutions has been the installation of large blowers along the walls which project air, warmed by passing over a furnace, heated plates or steam pipes, into the hangar at a velocity usually of about

800 feet per minute. Auxiliary local heating by stoves, radiators or low pressure hot water pipes placed near the work benches may be necessary in addition to these warm air blowers if a reasonable temperature is to be maintained. The technical and hygienic disadvantages of *central heating by hot air* are, however, considerable. Humidification and dust filtration, although highly desirable, are often not included in this method. *Central heating by hot water*, using either the low or high pressure system, is preferable. Temperature control is simple, heating surfaces can be increased or eliminated with ease according to the demand and there is no risk of contaminating the atmosphere with combustion products or of altering its humidity or dust content. *Central heating by steam* again can be either at low or high pressure. High pressure methods for both steam and hot water pipes have been largely abandoned owing to their numerous technical disadvantages. The chief advantage of steam heating over hot water heating is that it can heat at much greater distances, up to about one third of a mile. The so-called *vacuum system of steam heating* is popular in the United States. In this system, separate pipes take off the air and condensed water and the steam circulation is reduced to a pressure slightly less than one atmosphere by means of a suction pump attached to the return pipes. *Electrical heating* is coming more into general use, in spite of its high cost. It can be applied either by fires or radiators, panels in the walls or ceilings, exposed tubes (usually at skirting level) or as wire gridding embodied in the ceiling or walls in paper covers.

SECTION VII

LIGHTING

1.

Introduction

The visual capacity to appreciate the shape and size of an object depends chiefly upon the degree of illumination received by it. The quantity of light reaching an object is measured by a unit known as the foot candle, which is the illumination produced at a distance of one foot by one standard candle. The standard candle is a spermaceti candle weighing one-sixth of a pound and burning at a rate of 120 grains an hour. The light emitted at the source, on the other hand, is measured in lumens. One lumen will light a surface of one square foot, every point of which is at a distance of one foot, to an average illumination of one foot candle. A light source of one standard candle emits a total light flux of 12·57 lumens. Portable photometers are now used extensively for the direct measurement of illumination. The instruments are generally calibrated in foot candles, except Continental makes which may be marked in lux values. 10·764 lux are equivalent to one foot candle.

The threshold of vision is 0·000001 foot candles. Illumination by the full moon amounts to approximately 0·01 foot candles and that of the summer sun to about 10,000 foot candles. Reading is possible between these last two intensities, but neither provides anything resembling good illumination. Only for two or three weeks of the year in the United Kingdom is the daylight illumination value between 9 a.m. and 3 p.m. less than 100 foot candles. For more than half the year it is greater than 1,000 foot candles,

2. Quality of illumination

Quality as well as quantity of illumination must be considered. Good but not excessive contrasts of light and shade are desirable if the form of an object is to be appreciated properly. Strong contrasts are tiring to the eye and in natural out-of-door conditions rarely exceed 40 to 1. The object viewed should be the brightest thing seen. If other objects are brighter they result in glare and distract the attention.

Glare may be either direct from a lamp or window, or reflected from a surface. It should always be eliminated wherever possible and special care should be taken to ensure that the background of a task is not in itself a source of glare. Background glare is often due to such causes as shiny writing paper, especially when indelible pencil is being used, or a highly polished desk top. The cure is usually found in adjustment of the source of light or the replacement of a shiny surface by a matt one.

Window design is of great importance. The tall, narrow, Georgian type of window, set in a thick wall, with deep reveals sloping away from the window surface both inside and out, resulted in very pleasant seeing conditions within the room. A tall window gives deeper penetration of light, and a slightly larger illuminated area than the lower types which are now usual. Deep internal reveals associated with a narrow aperture avoid too strong a contrast and apparent glare from the sky. With modern thin walls the effect of these reveals can be obtained to some extent by running the window glazing to meet the side walls which then act as reveals.

Care must be paid to *tone values*. Light walls, ceilings and decorations are desirable. If they are too dark, the light source appears too bright in contrast, although the illumination it provides may be only just sufficient for visual purposes. Gradation of tones to lead the eye from comparatively dark interiors to the strong contrast of the sky outside has a restful effect which is probably not entirely psychological.

In *industrial lighting* it is particularly important to provide even illumination over the working plane. To do this, lamp units must be properly spaced on a symmetrical plan and the correct ratio must be kept between mounting height and spacing. The distance between lamp units should not be more than one and a half times their height above the working plane. If this distance is exceeded, positions midway between them will be insufficiently lighted and harsh shadows will be thrown.

3. Natural lighting

The utmost value from natural daylight should always be obtained by the suitable design and placing of windows, and by the proper orientation of buildings so as to secure the maximum amount of summer and winter sunlight. In this connection it must be remembered that the sun rises in the south-east and sets in the south-west; and that in summer it reaches a maximum elevation above the horizon of 61° but in winter its solstice attains only 15°. Due regard, therefore, must be paid to obstructions such as nearby trees and buildings that cut off, not

only sunlight, but any part of the sky that is visible from a window. In assessing the daylight illumination of a room it is necessary to observe that the 'sky angle' at table level and two-thirds of the depth of the room from the windows should never be less than 5° . This angle is subtended by the arc of sky visible through the window from the point of observation. It can be appreciated more readily from the accompanying diagrams.

FIG. 11

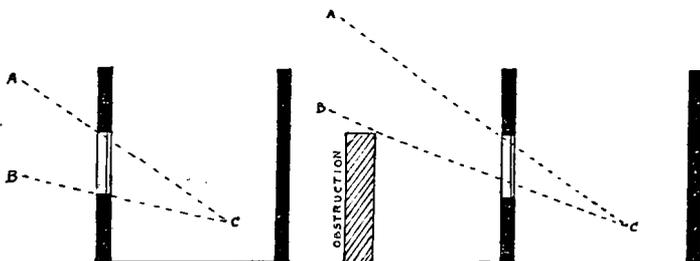

In each diagram the point C is at table level and two-thirds of the depth of the room from the window. A C B is the sky angle.

It is now customary in architectural work to consider natural lighting from a more scientific aspect than in the past. To do this it has been necessary to devise a yardstick with which daylight effect can be compared consistently, despite the variable factors of time, weather and season. This has been achieved by the adoption of a standard known as the 'daylight factor,' which is usually represented by the abbreviation of 'd.f.' A daylight factor of 1 per cent is equivalent to 1 per cent of the light which would reach the point of observation if the whole hemisphere of sky were visible at that point at that time. The d.f. at any point in a room can be calculated mathematically, obtained graphically from specially constructed diagrams or determined more simply by the application to a sketch plan of the room in question of the Daylight Factor Protractors produced by the Building Research Board. In well-lighted rooms values of up to 20 and 30 per cent d.f. are found near the windows. A daylight factor of 1 per cent should be regarded as the minimum value at table level and a distance of seven or eight feet from the window for an ordinary living room; 2 per cent is needed for the working area of a kitchen; 5 per cent for the working area of a school class room and 10 per cent for visual tasks in which fine detail must be discriminated. In rooms of greater width than 22 feet and with ceilings less than 11 feet high, natural lighting from one side only will not give satisfactory illumination near the internal wall at all times of the day for anything other than tasks requiring only casual observation. In such circumstances, supplementary artificial lighting should be installed. Photo-electric control of supplementary lighting is always desirable as it eliminates the human element in deciding whether or not light values have deteriorated sufficiently to justify it being switched on.

4. Artificial lighting

The suitability of artificial lighting is determined by its constancy and uniformity, the absence of direct or reflected glare, its freedom from shadows and its colour. Gas lighting is being rapidly superseded by electric light and it seems probable that fluorescent discharge lamps with their many advantages will soon become more generally used. The usual form of fluorescent lamp is tubular in shape, about five feet in length and $1\frac{1}{2}$ inches in diameter. They contain a little mercury and a small amount of argon. The inner walls are coated with fluorescent salts such as zinc silicate, calcium tungstate and cadmium borate. Ultra-violet radiations from the mercury are produced by an electric discharge between the anode at one end of the tube and the cathode at the other. The ultra violet rays cause the salts to fluoresce and emit a glowing light which can be of almost any approximation to daylight that is desired according to their composition and proportions. These lamps are highly efficient, giving approximately three times as much light for the same current consumption as the ordinary 'coiled coil' tungsten filament lamp and having a working life of nearly double the number of hours. Their large area gives them a relatively low surface brightness which is well below the permissible limit of 10 foot candles per square inch. A particular application of these lamps is for class-rooms, lecture theatres, operations rooms and other places where coloured chalks, maps and diagrams are used. With ordinary artificial lighting some colours, particularly blues and greens, or reds, browns and blacks, are often indistinguishable, whereas with the daylight approximation of fluorescent lamps no difficulty is experienced.

Standards of illumination

TABLE XIII

STANDARDS OF ILLUMINATION (Illuminating Engineering Society Code)	
<i>Recommended foot candles</i>	<i>Class of task</i>
2-4	Casual observation where no specific work is performed.
4-6	Work of simple character not involving close attention to detail.
6-10	Less exacting visual tasks, such as casual reading and large assembly work.
10-15	Visual tasks such as medium machine and bench work and sustained reading.
15-25	Prolonged critical visual tasks, such as proof reading, fine assembling and fine machine work.
25-50	Severe and prolonged visual tasks; discrimination or inspection of fine details of low contrast.
Above 50	Precision work to a high degree of accuracy; tasks requiring rapid discrimination; displays.

In addition to the above approved standards, there are the statutory requirements of the Factories (Standards of Lighting) Regulations, 1941. The main provisions of this Regulation stipulate that illumination at the place of work shall be not less than 6 foot candles at a working plane of 3 feet; they require the prevention of shadow formation and glare and prohibit lighting fittings with a surface brightness of more than 10 candles per square inch at an angle of elevation above eye level of less than 20°.

6. Lighting design

In the design of a lighting system the following procedure is now customary :—

- (a) Decide the illumination in foot candles required for the particular task.
- (b) Decide which type of lighting fixture—direct, indirect or general—is the most suitable.

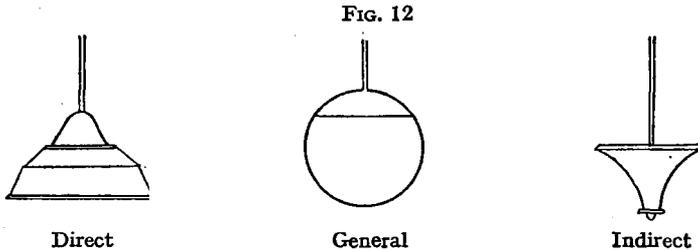

LIGHTING FIXTURES, DESIGN

(c) Determine the number, height and position of lamps that will provide even illumination over the working plane, which is generally taken as being 2 feet 9 inches.

(d) Determine the size of lamp unit which will provide the illumination in foot candles that is required for the particular task. This last step needs calculation from the formula :—

$$L = \frac{FC \times A \times DF}{U}$$

Where L = lamp lumens per unit,

FC = foot candles required for type of work,

A = floor area in square feet per lamp unit,

DF = a constant depreciation factor, usually taken as 1.43, to allow for dust on lamps, walls and other reflecting surfaces, and lamp ageing,

and U = the coefficient of utilisation, which depends on the size of room, mounting height and spacing of lamps and the reflecting capacity of the walls and ceiling. It is determined from the tables at the end of this Section.

7. Use of lighting Formula

First determine the number of lamp units that are required to give even illumination over the working plane. This is most easily done from a scale plan of the room, with reference to the spacing figures provided in Table XIV, p. 94. The room index is then obtained from Table XV, p. 95 and the reflection factors of walls and ceiling from Table XVI, p. 96. The coefficient of utilization can then be determined from Table XVII, p. 97.

Example.—Adequate lighting is required in a carpenter's shop 20 feet wide and 35 feet long. The ceiling is white in colour and the walls light stone. Benches against the wall are to be used as well as those in the centre of the room. Direct lighting with open reflectors has been decided upon. The mounting height for lamp units will be 5 feet above the working plane. The current available is 230 volts.

(a) FC = foot candles required = 12 (Illuminating Engineering Society Code) or 6 (legal minimum).

(b) From Table XIV it is seen that the maximum permissible distance between lamp points is $7\frac{1}{2}$ feet and that they should not be more than $2\frac{1}{2}$ feet from the side walls. Symmetrical distribution can be obtained with three rows of five lamps in each row, making a total of 15 lamp units.

Hence $A = \frac{20 \times 35}{15} = 47$ sq. ft. floor area per lamp unit.

(c) From Table XV the room index is found to lie between B and C and is therefore taken as B.

(d) Table XVI shows the reflection factors of ceiling and walls to be 84 per cent and 58 per cent respectively.

(e) The coefficient of utilization, U, can now be obtained from Table XVII and is shown as 0.41.

(f) Substituting in the formula $L = \frac{FC \times A \times DF}{U}$

$$\begin{aligned} \text{we obtain } L &= \frac{12 \times 47 \times 1.43}{0.41} \\ &= 1,967 \text{ lumens} \\ &\quad \text{per lamp unit.} \end{aligned}$$

From Table XVIII, p. 98, it is seen that 150-watt lamps will provide almost exactly this number of lumens, or 75-watt lamps if the minimum legal standard of 6 foot candles is accepted as adequate lighting.

TABLE XIV
LAMP SPACING
(in feet)

Mounting height above working plane	Maximum distance between points	Maximum distance between points and walls		Distance from ceiling to top of reflector (indirect units)
		Aisles or storage next to wall	Desks or benches next to wall	
4	6	3	2	1
5	7½	3½	2½	1½
6	9	4½	3	1¾
7	10½	5	3½	1½
8	12	6	4	2
9	13½	6½	4½	2½
10	15	7½	5	2½
11	16½	8	5½	2½
12	18	9	6	3
13	19½	9½	6½	3½
14	21	10½	7	3½
15	22½	11	7½	3½
16	24	12	8	4
18	27	13½	9	4½
20	30	15	10	5
22	33	16½	11	5½
24	36	18	12	6
27	40½	20	13½	6½
30	45	22½	15	7½
35	52½	26	17½	8½
40	60	30	20	10

TABLE XV
ROOM LIGHTING INDEX

Use upper column headings for direct or general lighting units and lower column headings for indirect lighting units. If the room index falls between two letters, interpolate or use the letter first in alphabetical sequence.

Room width in feet	Room length in feet	Height of fitting above plane of work in feet						
		5	10	14	18	22	26	30
8	10	A*	—	—	—	—	—	—
	12	A*	—	—	—	—	—	—
	16	B	—	—	—	—	—	—
	24	B	—	—	—	—	—	—
	35	B	—	—	—	—	—	—
	50	C	A	—	—	—	—	—
10	10	B*	—	—	—	—	—	—
	14	B*	—	—	—	—	—	—
	20	B	—	—	—	—	—	—
	30	C	—	—	—	—	—	—
	40	C	A	—	—	—	—	—
	70	C	B	A	—	—	—	—
12	12	B*	—	—	—	—	—	—
	18	B*	—	—	—	—	—	—
	24	C	A	—	—	—	—	—
	35	C	A	—	—	—	—	—
	50	D	B	—	—	—	—	—
	90	D	B	A	—	—	—	—
16	16	C*	A*	—	—	—	—	—
	30	D	B	—	—	—	—	—
	50	D	B	A	—	—	—	—
	80	D	C	B	—	—	—	—
	120	D	C	B	A	—	—	—
	20	20	D	B	A	—	—	—
40		D	B	A	—	—	—	—
60		D	C	B	A	—	—	—
100		D	C	B	B	—	—	—
140		D	C	B	B	A	—	—
30		30	E	C	B	A	—	—
	60	E	D	B	B	A	—	—
	100	E	D	C	B	A	—	—
	140	E	D	D	B	B	A	A
	40	40	F	D	C	B	A	—
80		E	D	D	B	B	—	—
140		E	D	D	C	B	B	B
60	60	F	E	D	C	B	B	B
	100	F	E	D	C	C	B	B
	200	F	E	E	D	D	C	C
80	80	F	E	E	D	C	D	B
	140	F	E	E	D	D	C	C
100	100	F	F	E	D	D	C	C
	120	F	F	E	E	D	D	D
120	120	F	F	E	E	D	D	D
	200	F	F	F	E	E	D	D
		7½	15	21	27	33	39	45
Ceiling height in feet above plane of work.								

* Room indices marked thus should be advanced two letters when only a single light fitting is employed; A* becomes C.

TABLE XVI
LIGHT REFLECTION FACTORS

References are to British standard colours for ready mixed paints
(B.S.S. 381)

Colour	Standard Colour No.	Reflection factor (expressed as a percentage)
White paper	—	84
Golden yellow	56	80
Pale cream	52	76
Primrose	54	76
Deep cream	53	70
Lemon	55	69
Portland stone	64	62
Light buff	58	61
Light stone	61	58
Middle buff	59	54
Eau de nil green	16	47
Salmon pink	43	44
Orange	57	42
Sea green	17	38
Silver grey	28	37
Middle stone	62	37
French grey	30	36
Dark stone	63	33
Light battleship grey ..	31	31
Deep buff	60	31
Quaker grey	29	30
Sky blue	1	30
Light brown	10	27
Golden brown	14	25
Sage green	19	19
Grass green	18	18
Post Office red	38	17
Turquoise blue	2	15
Middle brown	11	12
Dark battleship grey ..	32	11
Peacock blue	3	11
Crimson	40	6

TABLE XVII
COEFFICIENT OF UTILIZATION

Type of lighting unit	Room lighting index	Ceilings			
		Fairly light (40%)		Very light (70%)	
		Walls			
		Fairly dark (25%)	Fairly light (50%)	Fairly dark (25%)	Fairly light (50%)
Coefficients of utilization					
Direct (with open reflectors)	A	0.33	0.37	0.33	0.38
	B	0.37	0.40	0.37	0.41
	C	0.43	0.46	0.43	0.47
	D	0.47	0.50	0.48	0.51
	E	0.52	0.55	0.53	0.56
	F	0.56	0.58	0.57	0.60
Direct (with globe enclosed)	A	0.24	0.27	0.25	0.29
	B	0.27	0.30	0.28	0.32
	C	0.31	0.33	0.32	0.36
	D	0.35	0.36	0.36	0.40
	E	0.39	0.40	0.40	0.44
	F	0.42	0.44	0.45	0.48
General	A	0.20	0.24	0.23	0.28
	B	0.23	0.27	0.26	0.32
	C	0.29	0.32	0.33	0.38
	D	0.32	0.36	0.37	0.43
	E	0.38	0.42	0.44	0.49
	F	0.43	0.46	0.50	0.55
Indirect	A	0.08	0.10	0.15	0.18
	B	0.10	0.12	0.18	0.22
	C	0.13	0.15	0.23	0.27
	D	0.16	0.18	0.26	0.30
	E	0.19	0.21	0.32	0.36
	F	0.22	0.24	0.38	0.42

TABLE XVIII
LUMEN RATINGS OF GAS-FILLED LAMPS
(of 200/250 volts)

Watts	Nominal lumens
15	124
25	225
40	324
60	582
75	795
100	1,160
150	1,920
200	2,660
300	4,260
500	7,700
1,000	17,400
1,500	27,900

TABLE XIX
LUMEN RATINGS OF ELECTRIC DISCHARGE LAMPS

Watts	Type	Shape	Nominal lumens
80	Mercury	Pear.. ..	3,040
125	Mercury	Pear.. ..	5,000
250	Mercury	Pear.. ..	9,000
400	Mercury	Pear.. ..	18,000
400	Fluorescent mercury ..	Isothermal ..	15,200
80	Fluorescent mercury ..	5-ft. tube ..	2,400

SECTION VIII

VENTILATION

1.

Introduction

Atmospheric comfort and safety demand the supply of sufficient air at the right temperature and humidity levels and free from obnoxious odours, harmful dusts and toxic fumes or vapours. The quantity of fresh air required by an individual varies between 1,000 and 3,000 cubic feet an hour, or, at the latter rate of ventilation, 6 air changes per hour for the average work room space allowance of 500 cubic feet. For comfort, an atmospheric environment should be cool rather than hot, dry rather than moist, variable rather than uniform in temperature and moving rather than still. The figures below are a rough indication of these requirements.

Temperature	..	60° to 68° F.
Relative humidity	..	not more than 70 per cent.
Air movement	∴	about 30 feet per minute in winter, more in summer. Less than 20 f.p.m. causes a sensation of deadness and stuffiness in the air; more than 180 f.p.m. causes a sensation of draught.

The estimation of the carbon dioxide content of the air as a measure of the efficacy of ventilation is now discredited. The CO₂ content of the air in caissons, submarines and the fermentation vats of breweries may often exceed 2 per cent, yet workers under these conditions suffer no ill effects. It is not till the CO₂ content reaches 3 per cent or 4 per cent and the oxygen drops to 17 per cent or 16 per cent that discomfort in breathing appears. The old permissible limit of 0.06 per cent of CO₂ in the air bore a purely coincidental relationship to the foulness of the atmosphere. It is increasing heat and moisture, associated with lack of air movement and aided by the presence of body odours and, perhaps, tobacco smoke that induces the sensation of stuffiness in an inadequately ventilated room. It was upon the old standard of 0.06 per cent CO₂ that the higher ventilation requirement of 3,000 cubic feet per head per hour was originally based.

2.

Natural ventilation

For rooms and small halls up to about 2,500 square feet floor area and containing less than fifty people, natural ventilation is usually sufficient. Natural ventilation depends upon the tendency for warm air to rise, with a consequent flowing in of colder air to take its place. A temperature difference of about 10° F. is sufficient to set up convection currents which will sufficiently ventilate a room, provided the inlets and outlets are large enough. Windows and chimneys form the usual inlets and outlets. An ordinary fireplace will remove from three to six cubic feet of air a second, and up to eight cubic feet with a strong fire burning in the grate. Various devices are used to aid natural ventilation, such as *Tobin's tube*, *Sheringham's valve*,

Cooper's pane and the *air brick*. These all serve as inlets and are intended to limit draught production. *Flap valves*, opening high up into the chimney and designed so as to prevent reflux of smoke and gases into the room, are sometimes used as additional outlets. *Louved clerestories* running along roof ridges are commonly used for laundries. *Shafts* or *flues* carried up within buildings, so as to take advantage of any warmth available, and emerging through the roof are another form of outlet. These are often capped with special extractor cowls which utilise the vacuum effect of the wind passing through or past them to suck air up the vent pipes to which they are attached. The extractor cowls on the roofs of railway coaches work on the same principle. The air flow in any form of natural ventilation can be improved two to five times by the use of heating elements placed below the inlets and within the outlet flues. The so-called '*window supply gravity exhaust*' system will give from three to five air changes an hour in rooms up to about 16,000 cubic feet and containing as many as 50 people. In this system, radiators, which must run the whole length of the windows, warm the incoming air. Deflectors, in the form of vertical panes of glass one foot high, or incorporated as hopper windows opening inwards, lead the entering air upwards to join the ascending flow above the radiators. Fanless exhaust ducts, which for a room of this size should not be less in total area than 400 square feet, open out of the opposite wall. Air flow in these ducts may be assisted by heating elements if desired. The simplest means of using warmth as an aid to ventilation, however, is seen in the practice of opening the top halves of windows on the sunny side of a building and the lower halves on the shady side. Natural ventilation is generally sufficient if the rough working rule is observed of 5 square feet of ventilation opening for every 100 square feet of floor area, but rather better results can be expected from the use of Angus' opening figure. This figure is obtained by dividing the total area in square feet of effective free openings, including doors, windows and ventilators, by the cubic content in feet of the room or building and multiplying the dividend by 1,000. Additional ventilation is required if the appropriate opening figure is less than that shown in Table XX below.

TABLE XX

NATURAL VENTILATION SCALES

	<i>Opening figure</i>
Offices	—
Laboratories	4-5
Light manual work (cool processes)	5-6
Light manual work (in moderate heat)	6-7
Heavy work in great heat	9-11

3. Artificial ventilation

(a) For rooms where much heat, dust or fumes are generated, or where there is insufficient space allowance for the occupants, natural ventilation will not be enough and artificial ventilation must be adopted. This may be applied as an exhaust system, a

positive pressure system or as a combination of the two. Whichever system is employed, care must be taken to avoid the production of draughts and the fresh air entering the room should be clean and at the correct temperature and humidity levels. The provision of filtered, washed air that is dried or humidified and heated or cooled according to the existing need is termed full air conditioning and is described on pp. 65-66. In some ventilation systems completely fresh air is continuously supplied, in others the same air is re-circulated and in yet others a small percentage of fresh air is constantly added to that circulating in a closed system. Closed circulation systems are economical in running costs but cannot be used where noxious vapours or dusts are generated unless special provision is made for their removal, otherwise these will accumulate and soon reach dangerous proportions. An example is seen in the air conditioning of operating theatres, where the fire risk would be enhanced and the surgeons and attendants exposed to stupefying effects if anæsthetic vapours were allowed to accumulate, as would occur in a closed system with re-circulation of all or part of the air.

(b) *Exhaust systems.*—Extractor fans revolve at comparatively high speeds and their efficiency is lessened by marked increase or decrease in the speeds for which they are designed. Their output can be computed from the formula $C = K \times N \times D^3$, where

C = air flow in cubic feet per minute,

K = a constant, usually taken as 0.6,

N = number of revolutions per minute, and

D = the diameter of the fan in feet measured from blade tip to blade tip.

TABLE XXI
SPEEDS FOR RUNNING EXTRACTOR FANS
AND THEIR OUTPUT

Diameter of fan (in feet)	Speed (in r.p.m.)	Output (in c.f.m.)
1	1,300-2,100	780-1,260
1.5	850-1,400	1,720-2,835
2	630-1,050	3,020-5,040

It is important in exhaust ventilation systems to provide air inlets, on the opposite side of the room to the fans, with a total surface area of not less than three times the total disc area of the fans.

(c) *Pressure systems.*—Positive pressure or plenum systems, as they are sometimes called, are adopted when very large volumes of air must be supplied, for which purpose exhaust systems usually fail owing to their liability to create draughts. Pressure fans do not resemble the simple propeller type of exhaust fan. They are in effect relatively slow moving, helicoidal turbines which draw

air along their axes and fling it from their vane tips against the wall of a containing envelope, from which it is led by trunking to the places where ventilation is required. Very careful attention to the planning of this trunking is necessary if an even flow of air to all parts of a building is to be obtained without the creation of eddies and turbulence. Bends must be gradual and no branch duct should leave a stem at an angle greater than 30°. The cross sectional area of any duct immediately preceding a bifurcation should slightly exceed the cross section of the two branches. Discharge openings should be above the heads of workers, but at a sufficient height and so placed as to prevent their subjection to draughts. The velocity of the air as it leaves a duct to enter a room should not exceed 300 feet per minute. The following formula can be applied to these systems :—

$$Q = A \times V \times 60, \text{ where}$$

Q = volume of air delivered per hour in cubic feet,

A = area of the duct in square feet and

V = velocity of the air as it leaves the duct in feet per minute.

(d) *Combined exhaust and pressure systems.*—Exhaust ventilation is sometimes used to supplement a pressure system in order to counteract any tendency to the formation of stagnant pockets of air in places that are not reached by the pressure flow. It is, however, for the removal of excessive heat in the neighbourhood of special apparatus, or for the extraction of harmful dusts and vapours, that additional exhaust ventilation is most usually employed. It is most necessary that installations for this purpose are carefully designed in order that a sufficient air velocity is applied for the removal of offending particles or fumes as near to their source of production as possible. A large canopy several feet above a smoke-bomb filling machine, with a small extractor fan attached to it by a long flue in which there are several right angle bends, is the type of useless installation that is not uncommonly seen. The efficiency of dust extraction can be judged by observing the actual movement of a particulate cloud and the freedom of the working surfaces from layers of dust. The efficiency of vapour extraction can be simply tested by a puff of tobacco smoke. Examples of the velocities needed for the removal of solid particles are given below. Fan sizes and the areas of hood inlets necessary to provide any required velocity can be calculated from the two formulas $C = K \times N \times D^3$ and $Q = A \times V \times 60$.

Sawdust	1,050–1,500 f.p.m.
Fine coal dust	4,400 f.p.m.
Brass turnings	3,000–5,000 f.p.m.

4. Assessment of ventilation

In assessing the adequacy of ventilation in a room, account must be taken of its size, the number of occupants, their activity and the presence of any processes that result in the generation of heat or harmful substances. In determining the cubic capacity of a room, its height above 10 feet, or 14 feet in workshops affected by the Factories Act of 1937, should be disregarded. Allowance must be made for the volume of any furniture or

machinery and 3 cubic feet deducted for each individual normally present. Legal and recommended standards for space allowance should be observed. In the Royal Air Force in peace time, 600 cubic feet is permitted in barrack rooms at home, 800 cubic feet in sub-tropical areas and 1,000 cubic feet in the tropics. Under the provisions of the Factories Act of 1937 not less than 400 cubic feet per head must be allowed in work rooms. The lowest legal standards of sleeping accommodation are those for Lascar seamen and other seamen which are respectively 72 and 120 cubic feet, under the terms of the Merchant Shipping Act of 1926. The directional flow and velocity of air currents may be measured by various types of anemometers. The kata thermometer can be used for measurement of low velocities and this instrument, coupled with the observation of smoke drifts, is all that is needed for the investigation of natural ventilation systems. The immediate impression of freshness or stuffiness that is obtained on entering a room at the time of its maximum ventilation requirements, *e.g.* a dormitory during the night or a workshop just before the end of a shift, is an excellent and perhaps the most delicate test of the adequacy of its ventilation—but sensory impressions are not always convincing to others unless backed by scientific evidence.

SECTION IX

HYGIENE AND SANITATION OF TENTED CAMPS

1. Site

The following sites should be avoided, as far as possible :—

- Steep slopes.
- Bases or summits of hills.
- Bottoms of narrow valleys.
- River beds.
- Low meadows.
- Clay soil.
- Newly turned soil.
- Ground close to villages and graveyards.

2. Lay-out

The lay-out of the camp depends greatly on the administrative requirements and the ground available. It is, however, important to avoid straggling camps. Enough space should be allowed to enable tents to be moved one tent space forward or to the side.

3. Water supply

A good water supply is essential, preferably a supply from a public water company. Should this not be available use may have to be made of water-purification plants.

TABLE XXII
TENTS

Type of Tent	Dimensions	Floor space	Pitching space
(a) Bell tent ..	13ft. 6in. dia.	144 sq. ft.	20 ft. dia.
(b) Hospital marquee (small)	20ft. × 17ft.	340 sq. ft.	45ft. × 40ft.
(c) Hospital marquee (large)	35ft. × 17ft.	595 sq. ft.	81ft. × 45ft.
(d) Tents, ridged, double ..	14ft. × 14ft.	196 sq. ft.	44ft. × 28ft.
(e) Store tent ..	50ft. × 20ft.	1,000 sq. ft.	76ft. × 60ft.

Tents should be sited with flaps facing away from the prevailing wind, and should be placed 20 feet apart, so as to allow of an alternative site for each tent.

5. Routine under canvas

Particular attention should be paid to the following points :—

(a) Flies should be looped up all round each morning in fine weather, and on the lee side only if the weather is inclement.

(b) Blankets and bedding should be aired daily by hanging them over suitably erected wires provided for the purpose.

(c) Tents should be provided with wooden floor boards, which should be raised daily by means of tent pegs (see diagram below) to allow air to pass underneath, in order to keep the ground sweet.

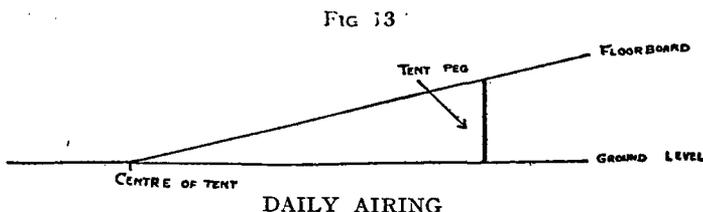

(d) A system of surface drainage, based on the natural run of rain-water, should be constructed as soon as possible and particular attention should be paid to the manner in which trenches around the tents are dug.

6. Conservancy arrangements

(a) *Latrines*.—(i) Where permanent latrines are not available, latrines should be erected on the bucket system, and semi-permanent places built to accommodate them on a scale of 5 per cent for all ranks. Separate latrines should be erected for officers, warrant officers, N.C.O.s and airmen.

(ii) Latrines should be sited to leeward of the camp and particular care should be taken to ensure that no fouling of water supplies can result.

(iii) The latrines should be erected on an impermeable base, for example, asphalt or concrete, and should be fly-proof. Where possible, arrangements should be made for emptying buckets down the nearest available inspection chamber of the camp sewage system. This will require the erection of a platform for buckets, and water-supply for the flushing of the drains. Where this method of disposal is not possible, it will be necessary to dispose of the bucket contents by incineration, or by removal by a contractor.

(iv) Trough urinals may have to be constructed for use during the day-time. One trough 8 feet long is required for each 100 men and, where station sewers are not available, urine should be disposed of by soakage pits.

(b) *Night buckets* and *refuse bins* should be supplied on a scale of one bucket and one refuse bin for every four ridge tents.

7. Ablution arrangements

(i) Where station ablution rooms are not available, ablution places should be erected, if possible on a concrete base. Arrangements should be made for a supply of hot water. One double-sided ablution bench 9 feet long is required for each 50 men.

(ii) Where possible, the waste water should be run into the station foul drain in order to avoid having to make use of grease-traps and soakaways.

8. Grease traps

If soakage pits are used for the disposal of waste water from ablution places and sullage water from kitchens, the water must first be passed through a grease-trap.

9. Incineration

Where dry refuse cannot be removed from the camp by a contractor, incinerators must be constructed. For standing camps closed incinerators of the Bailleul type are recommended. This is designed to produce little or no smoke, and if the incinerator is placed under a tree such smoke as issues is dissipated in the branches, a point of advantage in preventing tell-tale smoke from giving away the aerodrome site to enemy aircraft. Such an incinerator can be used to burn faeces if necessary. If the camp is temporary, however, the open or semi-closed type of incinerator will suffice.

10. Sanitary supervision

A responsible N.C.O. should be placed in charge of sanitation, and civilians or aircrew hands employed as sanitary orderlies. The medical officer should inspect the camp at least twice weekly, and especially after a heavy rainfall.

11. **Paths**

So that airmen may move about the camp and remain dry-shod and so that the floors of the tents may be kept clean, paths should be provided along the front of rows of tents. The following are suitable for paths :—

duck-boards ; cinders ; asphalt ; tarmacadam ;
as determined by materials available and by the duration of the camp.

12. **Flies and fly-proofing**

Fly-proof stores are essential. Fly-proof safes, large enough to hang carcasses, should be constructed well before the fly season ; and stores of substances for anti-fly measures should be obtained as laid down in Air Publications 830, Part B, Scale B.252.

13. **Canteens**

These should be made as attractive as possible : tables and serving counters should be kept clean ; if the surfaces are rough, they should be covered with oil-cloth. Games such as darts, table tennis and skittles should be provided for the men.

14. **Mobile water carts**

The main troubles encountered in the conservancy of water carts are due to freezing up when left in the open during severe cold weather, the parts suffering most being the pumps, the pipes leading from the tank to the draw-off taps, and the timing-tubes. Water carts should be placed under cover even if it be only the leeside of a tree or hedge. In addition, the three catalytic lamps provided should be placed under cover of the hood over the pumps, filter and engine. A lamp should be placed under the water cart in the vicinity of the draw-off taps.

SECTION X

INDUSTRIAL HAZARDS

1. It is essential, in the Royal Air Force, that medical officers should be thoroughly conversant with the numerous industrial processes which are now part of the daily routine on many stations. The unit medical officer must make himself familiar with the working conditions of each individual under his care. He must constantly strive to ensure not only that these working conditions are in no way dangerous to the health of the worker, but that they are such as to permit him to perform his task with the maximum efficiency and the least expenditure of effort.

The medical officer must be always on the alert for breaches of industrial discipline—the arc welder who is not wearing his goggles ; the mug of tea beside the man who is breaking up accumulator plates ; the exhaust fans switched off on a cold, wintry morning ; the use of lip-stick in the luminising room ; the failure to provide ferrous sulphate in the First Aid Box of the

electro-plating shop. The prohibition of such sins of omission and commission by routine orders and the display of placards is not sufficient. No health safeguard that depends upon the cooperation of the workers can be wholly relied upon. Constant supervision is necessary to ensure that measures designed to protect them are observed or maintained effectively, unless these measures are completely beyond their control.

In industrial preventive medicine, attention must be directed in particular to the following points:—

Lighting, heating and ventilation (*see* pp. 88-98, and 99-103).

Hours of work.

Posture.

Protection against machinery, heat effects, burns, and high voltage electricity.

Protection against toxic hazards.

Welfare measures.

2.

Hours of work

It has been amply borne out by experience and research, especially during the wars of 1914-1918 and 1939-1945, that the weekly number of hours worked can reach a limit beyond which any increase results in a lowering of output. This fall in output is accompanied not only by a decrease in individual efficiency, but by an increase in absenteeism from sickness and other causes. The fall in output caused by too long hours was strikingly in evidence after the evacuation from Dunkirk in May, 1940. An immense effort was then put forth by industrial workers throughout the United Kingdom and the average weekly working hours in some factories rose to as much as 73½. An immediate increase in output was obtained, but by the end of August production was below the pre-Dunkirk level and remained there, despite the longer hours, till the spring of 1941. It was subsequently found that the Ministry of Supply output during the three months of May, June and July, 1941, when more reasonable hours obtained, was one third greater than that of the three months' almost superhuman effort that immediately followed Dunkirk. It is now well established that working hours for *men* should not exceed 60 per week and for *women* 55 per week. It is, indeed, probable that even shorter hours than these will be equally or more productive. It must be remembered that a spurt in production will follow an increase in working hours beyond these maxima, provided there is sufficient incentive for the workers; but if the extra hours are maintained for more than three or four weeks, output will decline to a level which is usually much below that existing before the longer hours were imposed. Moreover, if the shorter hours are then restored a considerable period, possibly extending into months, is usually noticeable before output reaches its original level. On the other hand, it must not be expected that an immediate increase in production will follow a reduction in working hours, when these have been too long. A preliminary fall, which may last for several weeks is to be expected before any beneficial effects are observed. At a fuse factory employing women workers during the war of 1914-1918, a 74½ hour

week was changed first to a 63½ hour week, and finally to a 55½ hour week with no Sunday work. During the first month of the Sunday free work there was no rise in output, but in the succeeding four weeks output steadily increased to an average level of 13 per cent. more than was obtained with the 74½ hour week, and remained at that level for an observed period of five months.

Whatever the weekly working period may be, it is important that it should be as productive as possible. A summary of principles to be observed in maintaining quantity and quality of production while safeguarding the health and efficiency of the workers follows :—

- | | |
|------------------------|--|
| Hours of work per day | Not more than ten. |
| Hours of work per week | Not more than 60 for men
not more than 55 for women
less for heavy, manual
workers. |
| Rest pauses | Shifts should be broken by rest
pauses of 10–15 minutes,
when light refreshments
should be available. Few
individuals can maintain
their peak rate of work for
more than two hours at a
stretch and rest pauses both
morning and afternoon are
therefore indicated. For
heavy work, rest pauses of
5–10 minutes every hour
are more effective. |
| Holidays | At least one full day's holiday a
week, but preferably both
Saturday afternoon and the
whole of Sunday, and a com-
plete fortnight once a year
should be regarded as the
minimal requirement. |
| Night work | Only in exceptional circum-
stances and when special
sleeping quarters are pro-
vided should individuals be
kept on night shifts for more
than a week, or at most a
fortnight, at a time ; at least
eight consecutive hours' sleep
should be obtained in each 24
and not more than six night
shifts per week should be
permitted. |
| Repetitive work .. | Repetitive work is boring and
can be enlivened by occasion-
al half hour interludes of
' music while you work '. |

Fatigue

Fatigue is reflected in lowered output, lowered quality of work and an increase in the number of accidents. It should be dissociated from boredom, which may cause complaints of fatigue. These complaints are soon dropped, however, if more interesting work is allotted or when work is over for the day.

Incentives

Efficiency and health both benefit by interest in the work done. Interest can be increased by stimulating the group competitive spirit by the display of production charts, and by talks, diagrams, photo-displays and films describing the subsequent use of products. Alternation of work also helps to maintain interest. The award of small privileges is useful.

3.**Posture**

For sedentary work, seats that are comfortable and have back rests adjustable both for height and angle of tilt are desirable. Foot rests may be necessary and can be attached to the seat or fixed to the bench. Under the Factories Act the provision of seats is compulsory for all women whose work is done standing, so that they can take advantage of any opportunity for rest that occurs during their employment. Bench height is important and should be 37 inches for the average standing woman and 38 inches for the average man, except for sedentary work when 36 inches is usually adopted for both sexes.

4.**Accident precautions**

Although it is well recognised that some individuals are accident prone, and that the vast majority of factory accidents fall to their lot, there is as yet no psychological or other test that will weed out these individuals before they become liabilities. Only a succession of cuts, bruises or more serious incidents stamps a man as falling in this category. The responsibility must still be accepted of rendering machinery and apparatus as foolproof from the accident standpoint as possible. Fences and guard rails must be provided. Clothing should be free from belts, external buttons and other projections which may get caught in moving parts and drag the wearer into danger. Special armoured gloves and metal protected footwear are advisable for personnel handling heavy metal equipment, bombs and ammunition. An objection to metal footguards is that, when subjected to a load greater than they can withstand, the metal may be fractured or twisted and driven into the foot, thus turning an injury of comparative simplicity into one of much graver

report. It should be seldom, however, that a suitable design of foot guard cannot be devised to meet this objection.

5. Toxic hazards

(a) Injurious substances may be divided into dusts, liquids, vapours and rays. They may be inhaled or swallowed. They may be absorbed by or attack the skin. Their effects may be manifest immediately, after a short period of exposure, only after years of exposure or only after a period of years has elapsed since the exposure. With the increasing complexity of modern industry, new substances are taken into use almost overnight, often with no attempt on the part of either the manufacturer or the user to ascertain their toxicity. This is particularly true of the organic solvents, which are numerous enough in themselves, but in trade preparations combined with other substances are positively legion. The reticence of a manufacturer to divulge a trade formula is understandable, but a medical officer should never hesitate to withhold his approval for the use of a trade preparation unless its constituents are made known to him or, alternatively, he is aware that its use has been sanctioned by the Air Ministry.

(b) Methods of protection. Attempts to lessen the risks to the worker in any process generally include one or more of the following measures. Their application to any toxic hazards that exist on his station should be considered by the unit medical officer. It must be remembered that any or all of these measures may be enforced under existing legislation.

(i) Substitution of a harmless for an injurious substance, *e.g.*, non-siliceous abrasives instead of sand in sand-blasting and sparking-plug cleaning apparatus.

(ii) Enclosure of processes, *e.g.*, covered tanks for degreasing with trichlorethylene.

(iii) Use of wet methods, *e.g.*, the use of paraffin while de-carbonising engines which have run on leaded fuel.

(iv) Exhaust ventilation.

(v) Vacuum cleaning or wet cleaning.

(vi) No food, smoking or cosmetics in certain work rooms.

(vii) Protective clothing, respirators and goggles.

(viii) Air or oxygen breathing apparatus and life-lines, operated by a 'safety-man.'

(ix) Alternation of work, or restriction of length of exposure to a toxic risk.

(x) Instruction of workers in precautions required.

(xi) Periodical medical examinations.

(xii) Provision of first aid equipment.

6. Welfare measures

The provision of canteens, cloakrooms, rest rooms, drying rooms and adequate ablution and sanitary facilities may be required by law in some circumstances. The capital cost of such installations is well repaid by the increased efficiency of the workers.

CHAPTER V

CONSERVANCY

After ensuring the safety of water and food supplies and the provision of adequate shelter, the most immediate concern in protecting the health of a community must be arrangements for sound conservancy. By this term is meant the sanitary disposal of excreta, sullage water and refuse. The management of sewage disposal works, the construction and maintenance of field sanitary appliances and the disposal of sullage water and refuse will be dealt with in the sections of this chapter that follow.

SECTION I

SEWAGE DISPOSAL WORKS

1.

Introduction

The Works Directorate-General is responsible for the provision, maintenance and technical efficiency of all sewage disposal works, but medical officers must be prepared to advise their commanding officers on the efficiency or otherwise of station sewage disposal arrangements.

Sewage consists of waste matters in solution and suspension in water. On an average, the amount of solid matter present is only about 1 lb. in 100 gallons of fluid, roughly half of this quantity being in the form of suspended particles and the remainder in solution. The chief sources of sewage are water closets, urinals, baths, cookhouse sinks and gullies; but other places such as workshops, laundries and laboratories may be drained into the sewer and sometimes the discharge of excessive quantities of waste matters, oil and chemicals from these places has completely altered the character of the sewage and disorganised or damaged the purification plant.

Water collected from roofs, roads and other impervious surfaces often gains access to the foul water sewers and subsoil water may enter through leaky joints of drain pipes or the walls of manholes. The quantity of *surface water* entering the sewer will vary with the rainfall and may reach an amount far in excess of that with which the works are capable of dealing. It is therefore advisable that all roof gutters, road gullies and drains receiving clean water should be excluded from the foul water sewer. This relatively unpolluted water should be disposed of direct to streams, ditches, soakaways or by other means.

On stations with a complete water carriage system of drainage, some 20 to 40 gallons of sewage per head will be produced each day. When the higher figure is approached, it generally indicates that a waste of water is taking place or that subsoil water is gaining access to the sewers. If the quantity of sewage is high after heavy rainfall, steps should be taken to locate and eliminate the sources of storm water that is entering the sewers.

Except in coastal areas, where crude or screened sewage is often discharged directly into the sea below low water level, effluents from sewage disposal works ultimately find their way to ditches, streams, rivers or other water courses. Where purification is not carried out properly a nuisance and danger to health may be caused by decomposition of the sewage. Apart from foul odours and unsightly appearances that arise, fish life is

FIG. 14

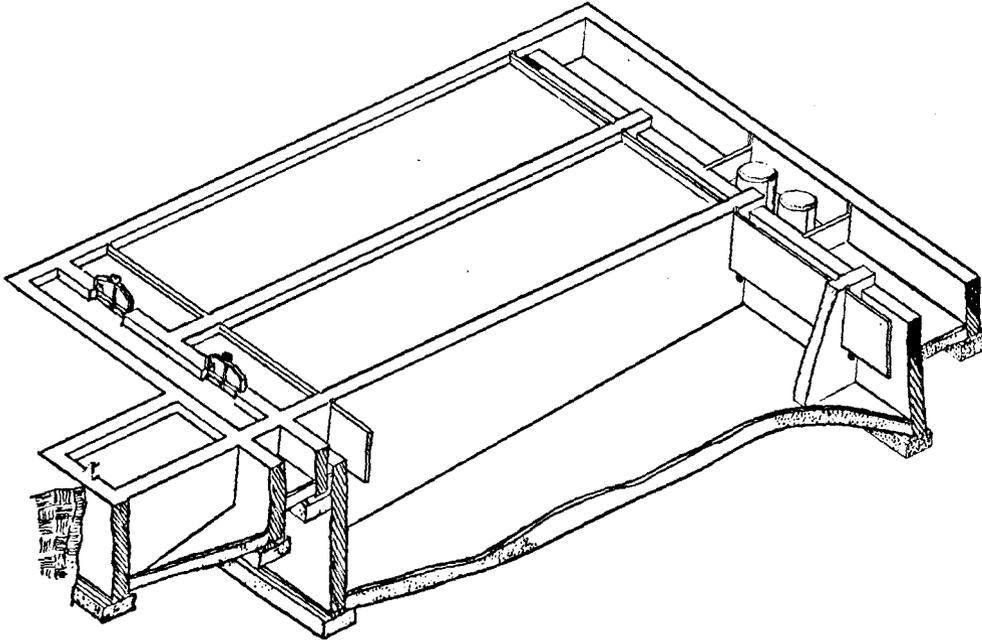

HORIZONTAL FLOW TANK

endangered, the silting up of waterways becomes more frequent and there is a serious danger to persons whose water supply is obtained down-stream.

2. Principles of sewage purification

(a) *Screening*.—Crude sewage arriving at a sewage disposal works passes first through a screening chamber, sometimes called a grit chamber or detritus tank. This is so constructed that heavy particles such as grit and stones fall to the bottom. Lighter but bulky objects such as large faecal masses, aggregations of paper and twigs from trees are withheld from onward passage by a screen of iron bars, placed about $1\frac{1}{2}$ inches apart.

(b) *Tank treatment*.—After screening, the crude sewage passes to primary sedimentation tanks, where much of the solid matter settles to the bottom as sludge and a thick scum forms on the surface. Beneath this scum, anaerobic bacteria multiply and convert some of the remaining suspended solids to liquid or gas.

(c) *Sludge disposal*.—Sludge drying beds are necessary to reduce in bulk the sludge, which is 95 per cent water, that accumulates in the sedimentation tanks. These beds should be underdrained, unless the subsoil permits soakage, or the effluent from them should be returned to the sedimentation tanks.

(d) *Filtration*.—The trickling or percolating filters to which the sewage is led after tank treatment are not intended to act as true filters, but to provide a large surface area and adequate oxygenation for the jelly-like film of aerobic bacteria that forms in them. These aerobic bacteria deal with the suspended solids still remaining and with the solids in solution, transforming them into inoffensive substances.

(e) *Humus tanks*.—Fine suspended matter, resembling humus or leaf mould and generally non-putrescible, still remains in the effluent from the filters. This is allowed to settle in the secondary sedimentation, or, as it is more often termed, humus tank. The settled deposit is either pumped back to the primary sedimentation tanks, transferred to trenches and buried or disposed of in sludge beds arranged similarly to those provided for the sludge from the primary sedimentation tanks.

(f) *Final effluent*.—The effluent from the humus tank is discharged usually to a ditch or stream. Chlorination of final effluents has not met with general approval in the United Kingdom.

3. Rules of management for R.A.F. sewage disposal works

Instructions on the management of sewage disposal works are contained in R.A.F. Form 724, a copy of which should be posted in a prominent position in the Tool Shed at each R.A.F. sewage works.

4. Screening chamber

The screen should be raked twice daily and the chamber emptied with a long-handled scoop weekly. Rakings and deposit should be disposed of by burial.

5. Sedimentation tanks

Two main types of sedimentation tank are used in the Royal Air Force, the 'horizontal flow' and the 'upward flow.'

(a) *Horizontal flow tanks* are rectangular in shape (Fig. 14, p. 112). Screened sewage passes over a weir extending across the whole

breadth of the tank and flows out over a similar weir at the other end of the tank. Vertical baffles or scum boards are fixed a few inches from each weir, dipping about 18 inches below the surface of the liquid to retain floating solids in the tanks. The floor of the tank slopes down towards the inlet end and a sludge draw-off pipe is provided at the lowest point. These tanks are usually installed in duplicate. Their efficiency depends largely upon liquids passing through them with a steady flow and low velocity. Each tank should be of sufficient capacity to hold eight to twelve hours' flow of sewage. Too rapid a flow through the tanks does not allow proper sedimentation, the sludge at the bottom may be stirred up and too great a proportion of solids will arrive at the filter and cause it to become choked. Too slow a flow will allow the sewage to putrefy before it reaches the real purifying section of the plant, the percolating filter. Under normal loading conditions, sludge should be removed and the tanks cleaned once a month. When the plant is overloaded, weekly de-sludging may be necessary. Sludge removal is carried out by decanting or pumping the supernatant liquid into the adjoining tank, then running off the sludge through the sludge well to the drying beds. When scum forms rapidly it should be removed at intervals of about three days. Disturbance of the tank contents by too frequent skimming is undesirable. The scum should be of manageable thickness, 1 to 2 inches, before removal is attempted. It should be buried, not deposited on the sludge drying beds.

(b) The *upward, vertical or radial flow type of sedimentation tank* (Fig. 15, p. 115) is generally constructed in the form of an inverted pyramid and is much deeper than the horizontal flow tank. The inlet is in the centre near the surface level and is surrounded by a baffle extending to a depth of 5 to 6 feet below the level of the sewage. The outlet is a channel round the upper edge of the tank which the liquor enters over a weir and from it discharges through a pipe to the percolating filter. Floating solids are prevented from entering the channel by scum boards round the perimeter of the tank rim. In operation the sewage passes from the top of the inlet pipe, down and under the inlet baffle, then upwards towards the surface and finally, after the solids have been deposited, under the scum board and over the weir to the outlet channel. As in the horizontal flow tank, a slow and uniform velocity is essential, although in the upward flow tank its additional depth reduces the risk of the deposited sludge being stirred up. In summer it may be necessary to de-sludge this type of tank every two days. During this process the water level must not be dropped below the level of the scum boards and the sludge should be removed by two or three successive withdrawals, with short intervals of about five minutes between them to allow sludge to settle into the pyramidal bottom of the tank. The aim is to remove the sludge with the minimum of liquid. Scum should be removed only when the level of the liquor has been lowered during de-sludging operations.

The effluent from sedimentation tanks should contain a minimum of suspended solids, an excess of which would choke the filter medium. It should not contain more than 10 to 15 parts per 100,000 suspended solids. The condition of the tank effluent should be examined from time to time to ensure that too much solid matter is not reaching the filters. A bottle of the tank

effluent allowed to stand and sediment will give a good indication of the efficiency of the tank treatment, if compared with a similarly treated sample of the sewage entering the tank.

FIG. 15

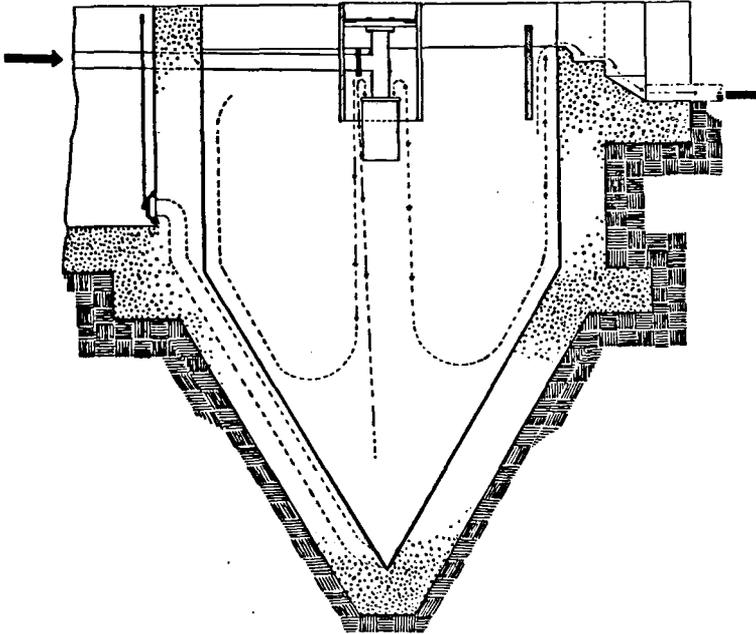

SEDIMENTATION TANK AND FILTER, UPWARD FLOW

6. Percolating filters

The *filter* consists of a bed of a suitable medium $4\frac{1}{2}$ to 6 feet deep. The essential features of a good medium are hardness, strength, durability and a rough texture surface for film adhesion. "Clinkers," which usually is mainly composed of ash, or material which rapidly disintegrates, is useless. Material should never be dumped directly from vehicles into the beds. It should be unloaded and subsequently deposited in such a way as to reduce fine material and dust to a minimum. The bed should be graded from about $\frac{1}{2}$ -inch material in the top layers to $2\frac{1}{4}$ -inch material in the lower layers. Larger pieces of 4 to 6-inch medium are placed on the bottom of the bed surrounding the drainage pipes which lead to the outlet. Effluent from the sedimentation tanks passes into a dosing tank, from which it is discharged at intervals by an automatic syphon. In the usual type of filter, distribution over the surface is by rotating, perforated arms into which liquid flows from a central hollow pillar fed from below by a pipe from the dosing tank. In time the filter medium becomes coated with a slime of organic matter, in which aerobic bacteria flourish and attack and break down the sewage. An abundant supply

of oxygen is necessary to maintain their existence. If the effluent from the sedimentation tanks contains an excess of suspended solids, the top layers of the filter become clogged and liquid forms in ponds on the surface of the filter. Ponding is often caused by a pocket of unsuitable medium. When extensive ponding occurs, the surface should be forked over and raked to a depth of about 4 inches. The rate of percolation must depend on the strength of the sewage, but as a rule not more than 80 gallons per day per cubic yard should be applied when the sewage is weak. This amount should be reduced to 45 and 60 gallons for strong and medium sewage respectively.

7. Humus tank

The *humus tank* is a sedimentation tank, which may be of either the horizontal or vertical flow type, but is considerably smaller in size than a primary sedimentation tank. Horizontal flow types should be cleaned out weekly, but vertical flow types require cleaning every four or five days. If humus is observed to be passing over the outlet weir, more frequent cleaning is obviously necessary. Walls, floors and scum boards should be thoroughly brushed and cleansed each time the tank is emptied.

8. Analysis of sewage effluents

Samples are taken at intervals by local authorities in charge of the various rivers of the British Isles of sewage effluents that are discharged within their catchment areas.

All R.A.F. stations at home that have their own sewage purification works will have a sample of the effluent examined at least once a year. The necessary apparatus will be supplied from the R.A.F. Institute of Pathology and Tropical Medicine, Halton, Bucks., where the samples should be returned as detailed for water samples. The effluent should be collected from the pipe or channel which discharges from the humus tank, unless otherwise directed. A Winchester quart bottle should be completely filled for the chemical analysis and an 8-ounce bottle for a bacteriological examination, if this is required. The following particulars will help the analyst in formulating his report :

- (a) Site of sewage disposal works.
- (b) Date and hour of collection.
- (c) Type of treatment plant :—
 - (i) Sedimentation (septic tank) only.
 - (ii) Sedimentation and filtration.
 - (iii) Sedimentation, filtration and humus settlement.
 - (iv) Activated sludge (Simplex process).
- (d) Method of effluent disposal :—
 - (i) To ditch or stream.
 - (ii) Surface irrigation.
 - (iii) Soakaways.
- (e) Approximate estimate of the relative volumes of the effluent and receiving stream, where discharge is to the latter.
- (f) Point of collection of sample, *e.g.*, at humus tank, at entry to stream, at boundary of Air Ministry property.
- (g) Rainfall during week preceding collection of sample. *e.g.*, nil, slight, moderate or great.

(h) Other information, *e.g.*, use of chemicals during treatment, chlorination of effluent, entry of surface water to foul drainage system.

(i) Reason for desiring analysis.

(j) Signature of officer sending the sample.

9. Interpretation of analyses

(a) *Suspended solids*.—Raw sewage in the United Kingdom usually contains about 40 parts per 100,000. A figure much below this indicates either waste of water or the entry of ground or storm water into the system. The difference between the figures for raw and settled sewage measures the efficiency of sedimentation. Less than a 60 per cent reduction indicates either overloading, bad design or short-circuiting. More than 70 per cent reduction is good. A high suspended solids figure in the final effluent usually points to insufficient sedimentation or, when associated with a low oxygen demand, incomplete humus removal.

Accepted standards: Not more than 3 parts per 100,000, unless there is considerable dilution of the effluent by a stream or river into which it discharges. A maximum of 6 parts per 100,000 may be permitted if the receiving stream is 150 to 300 times the volume of the effluent. 15 parts per 100,000 are permitted with a dilution of 300 to 500 times, and no tests are required when dilution is more than 500 times.

(b) *Biochemical oxygen demand (B.O.D.)*.—Raw sewage usually has a B.O.D. of 30 to 40 parts per 100,000. A high figure in the final effluent generally indicates unsatisfactory filter treatment, especially if associated with low or absent nitrates.

Accepted standards: Not more than 2 parts per 100,000, unless the effluent is diluted more than 150 times by the receiving water course, when this test may be omitted.

(c) *Nitrates*.—Nitrates represent the final stage in the oxidation of matter derived from proteins. In a percolating filter, sugars and starches are oxidised first and ammonia last. A high nitrate figure is always accompanied by a low B.O.D. and any effluent that contains 1 or more parts per 100,000 of nitrogen as nitrates may be passed as well oxidised. An effluent from an activated sludge plant may have a low nitrate figure accompanied by a low B.O.D.

(d) *Field tests*.—The operator in charge of a sewage disposal plant can obtain useful information by physical examination of samples taken daily and kept for a week. A good effluent has the appearance of rain water, with little colour, turbidity, deposit or suspended matter. Frothing should disappear quickly after shaking. The samples should not putrefy or decompose and should not possess a faecal odour.

10. Variations of standard plants

(a) *Activated sludge (Simplex) process*.—The biological treatment in this system differs considerably from that already described. Instead of obtaining oxidisation of the effluent from the sedimentation tanks by subjecting it to the action of aerobic bacteria in percolating filters, this effluent is passed to aeration

Fig. 16

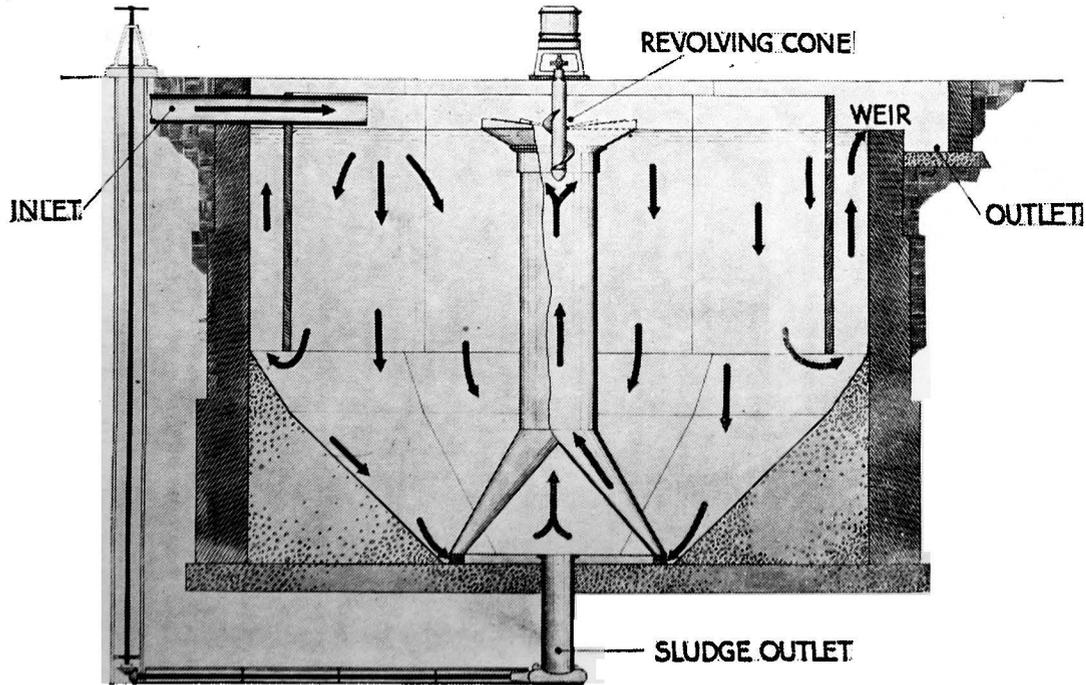

ACTIVATED SLUDGE (SIMPLEX PROCESS)

tanks and mixed there with "ripe" sludge rich in bacterial life by a system of mechanical agitation and aeration. From these aeration tanks the effluent is passed to final settling tanks. Sludge from the aeration tanks is removed at intervals and dried in the usual way. (Fig. 16, p. 118.)

(b) *Secondary filtration.*—A second set of percolating filters is sometimes installed to receive the effluent from the primary filters.

(c) *Sand filters.*—A sand filter bed about 18 inches deep placed immediately after the humus tank will ensure the removal of the last traces of suspended matter and allow of some bacterial purification.

(d) *Partitioned sedimentation tanks.*—A transverse partition is constructed across the sedimentation tank. An additional scum board holds back the floating solids and beneath it the liquid passes to flow over a weir into the second part of the tank beyond the partition.

(e) *Septic tanks with soakaways.*—These are occasionally installed where the volume of sewage that requires disposal is small and the ground is suitable for soakage. Sewage is received into a sealed underground tank. Solids are liquefied to some extent by anaerobic action and the liquid passes out to an underground system of unjointed drain pipes. Not more than 50 per cent of the solids deposited in a septic tank can be converted into liquid, gas and soluble substances. The thick sludge remaining must be cleaned out at intervals or it will be washed into the drainage system and choke it. A well designed tank of sufficient capacity may well be left for three years without de-sludging. (See Fig. 17.)

FIG. 17

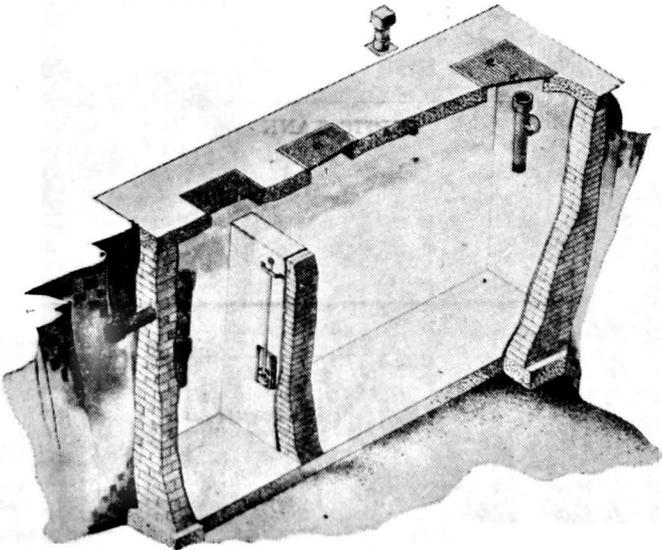

SEPTIC TANK

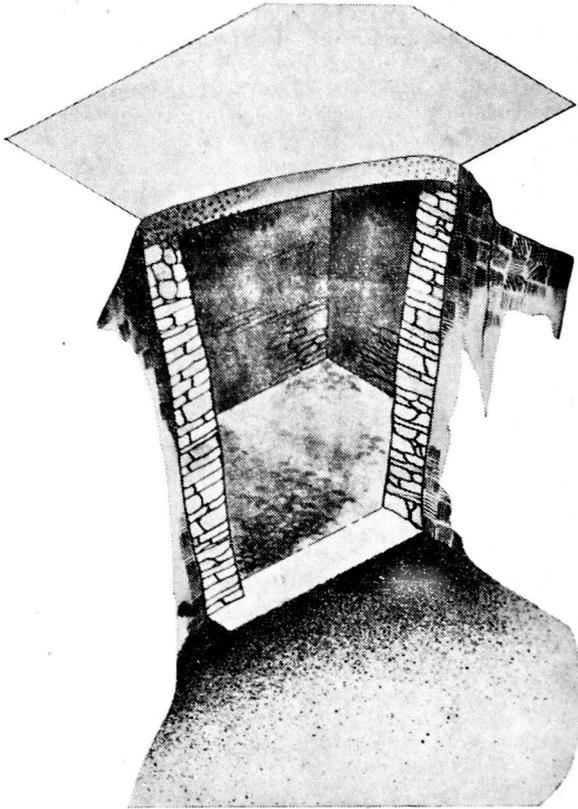
FIG. 17—*continued*

SEPTIC TANK

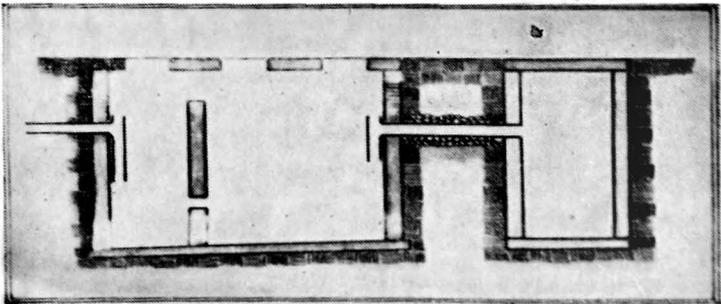
SEPTIC TANK
(Section)

SECTION II

FIELD SANITARY APPLIANCES—URINALS**1. Introduction**

Urinals are constructed either for the disposal of urine direct into the ground as in the shallow trench, funnel and trough types, or for storage pending disposal as in the pail urinal. On average, 100 men produce 30 gallons of urine per day.

All materials which are likely to come into contact with urine must be impervious. Urinals should be constructed so that they can be easily used and that liquid is not splashed on to the ground, woodwork or other porous surfaces which would absorb it and become foul. Openings of funnels and troughs should be at a level of 2 feet 3 inches above the ground. Duckboards, paving or paths should be provided and the urinals screened from view and protected from the weather.

Urinals must be accessible, otherwise men will micturate somewhere nearby in preference to walking to the urinal, but they should not be too close to habitations, especially to cookhouses. If possible, they should be close to latrines to encourage men to make use of the urinal before using the latrine. This arrangement also facilitates supervision by the sanitary staff and makes it possible to employ the same screens and path for both latrines and urinals. Night urinals, especially of the pail type, should be placed near the sleeping quarters.

The dangers of polluting subsoil water by urine from soakage pits must not be overlooked where water for domestic use is derived from underground sources.

2. Shallow trench urinal

A trench 10 feet long by 3 feet wide and 6 inches deep, with the excavated earth banked up on three sides, is sufficient for 250 men. The floor of the trench should be forked over to assist soakage. At the end of 24 hours the trench should be filled in and the turf replaced. A urinal of this type should be used only for short halts and temporary camps.

3. Funnel urinal

Conical tubes are built into each corner of a soakage pit, the wide upper ends of the tubes being provided with strainers. The soakage pit is a 4 feet cube filled to within 6 inches of the surface of the ground with stones, rubble and perforated, burnt-out tins; these are covered with a layer of oiled sacking and the earth replaced to ground level. The funnels discharging into the soakage pit should end near the centre to avoid earth being washed from the sides and clogging the pit. The funnels can be constructed from sheet metal, *e.g.*, old oil drums, tapered from 12 inches diameter at the top to 2 inches at the bottom. A detachable wire or perforated metal strainer should be inserted about 6 inches from the top of each funnel. (*See Fig. 18, pp. 122-123.*)

FIG. 18—*continued*

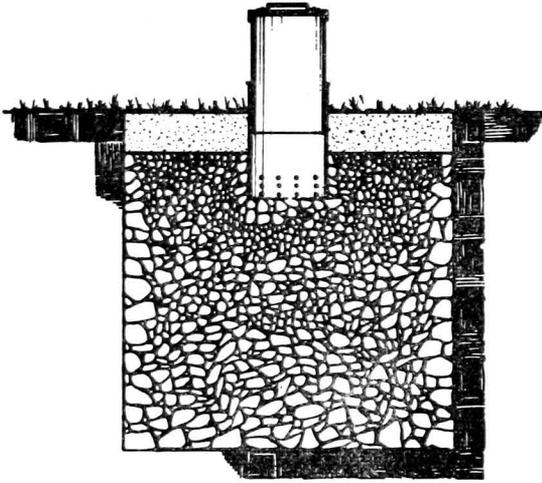

FUNNEL URINAL
(soakage pit)

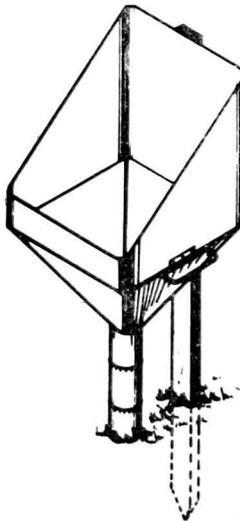

FUNNEL URINAL

FIG. 19

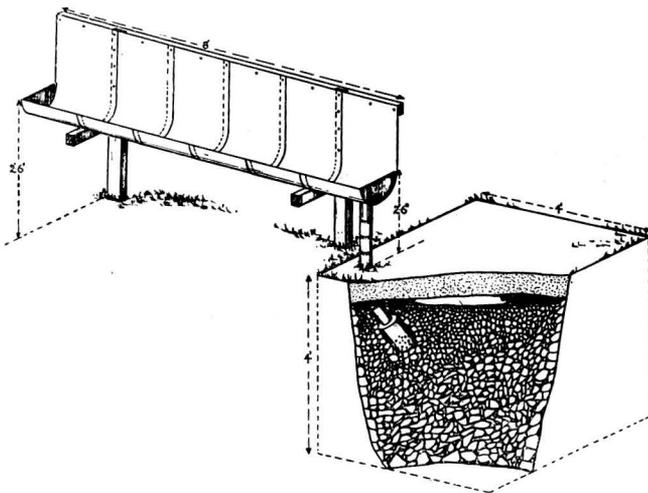

TROUGH URINAL

FIG. 20

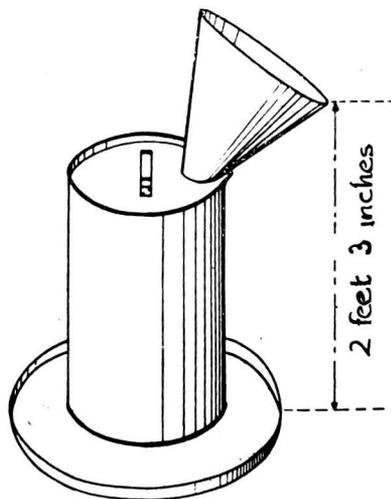
IMPROVED PAIL URINAL
(from an oil drum)

4. Trough urinal

A trough 8 feet long is sufficient for 100 men ; it should have a fall of 6 inches towards the outlet which is connected to a soakage pit similar to that described for the funnel urinal. The trough may be made from a sheet of corrugated iron or from a sheet made up from oil drums or kerosene tins. Fig. 18 shows a trough made from six oil drums, the joints being lapped 1 inch and soldered. The metal is carried up to form a back to the trough and the whole is supported by timber uprights and brackets. Any suitable pipe of 2-3 inches in diameter, of metal, stoneware, or other impervious material, may be used as an outlet pipe, or one may be built up from sheet metal with a seamed joint or from small tins with their ends removed. A strainer must be provided at the head of the outlet pipe. (Fig. 19.)

5. Pail urinal

A pail or other suitable container is placed on an impervious platform and the contents emptied periodically. It is useful for situations where soakage into the ground is not practicable, for a night urinal, or for use in conjunction with pail latrines. It must be placed where it is not liable to be knocked over and care must be taken to avoid spilling the contents while emptying. The container must be of impervious material, have a handle and, if possible, a lip for easy emptying. The top should be wide or fitted with a funnel and the whole raised, if necessary, so that the top is 2 feet 3 inches from the ground. Small containers rapidly become full and overflow, while larger sizes are difficult to empty ; 4 gallons is the most suitable capacity. Fig. 20 depicts an oil drum with bunghole enlarged and a funnel, of the type used in the funnel urinal, inserted. A lip for easy emptying is formed by bending outwards the raised rim beside the bunghole. This type is easily transported without spilling and is flyproof. Fig. 21 shows a rectangular 4-gallon petrol tin with half of another tin, cut diagonally, perforated to act as a strainer (p. 124.)

6. Disposal

The contents of urinals may be disposed of in soakage pits. (Fig. 18, p. 123.) Where 4 feet cube pits cannot be employed, owing to the high level of subsoil water, the system of shallow trenches may be used. The trenches are dug as deeply as circumstances permit and filled to within 6 inches of ground level with material similar to that used in the soakage pit. A layer of oiled sacking or other suitable material is placed over the stones before the earth is replaced. A number of detached short trenches may be connected and arranged in a herringbone system.

Urinals should receive frequent attention from the sanitary squad. Leaves, paper and other rubbish should be removed from the trough or funnels and the strainers cleaned at least daily. Pails should be emptied at least once a day and should not be allowed to become more than three-quarters full. They should always be left empty for night use. A coating of oil on surfaces of troughs, funnels and pails acts as a fly deterrent ; oil must not be used in excess as this will lead to the soakaway becoming choked.

FIG. 21

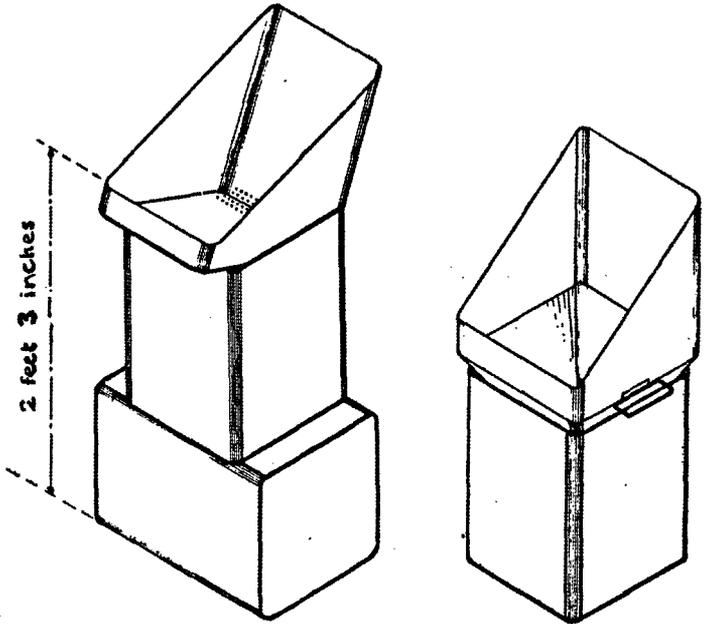

PAIL URINAL
(from 4-gallon petrol tin)

PAIL URINAL
improvised from 4-gallon
petrol tin

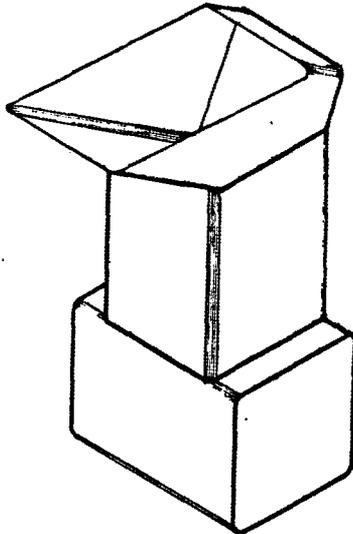

PAIL URINAL
improvised from 4-gallon petrol tin

SECTION III

FIELD SANITARY APPLIANCES—LATRINES

1. Introduction

On permanent stations and in urban areas, water closets are usually provided and removal of excreta is by a 'water-carriage' system of drainage, in which solids and liquids are carried by a flow of water to a suitable disposal point.

In many places water-borne drainage is not available, such as in rural areas and in the field; also, when the sewage disposal plant of a 'water-carriage' system is temporarily unserviceable or incapable of dealing with an increased flow of sewage. In these circumstances it may be necessary to provide field latrines.

2. Types of field latrine

(a) *The 'excavated' types* include the shallow and the deep trench latrine and the bored-hole latrine. Excreta is deposited direct into an excavation, the nature of which depends upon the type of latrine. These latrines possess the advantage that excreta is disposed of finally without further removal. Care must, however, be taken in siting them to ensure that water supplies from underground sources in the locality are not endangered by their use. It must be borne in mind that fissures often exist in the strata, especially at distances below the surface, and also near the surface after spells of hot and dry weather, and that pollution from a trench latrine or a bored-hole latrine may travel direct into the subsoil water without any purification. There is a greater danger of this happening with deep excavations than with shallow ones. By proper construction and supervision of the latrine flies must be prevented from breeding in the excreta.

(b) *The 'container' types* include the pail latrine and various types of chemical closet. The chief disadvantage of the container types is that frequent emptying and disposal of the contents are necessary.

Factors which influence the type and construction of latrine are :—

(i) *Duration of use and number of personnel.*—At any site which is continually or frequently occupied and every place where personnel are assembled, including halts on a journey, latrine accommodation must be arranged. For short stays or for places very lightly manned, simple types which do not involve great expenditure of time, labour or materials should be employed, but for longer stays or for more than just a very few personnel, some more elaborate type is indicated.

(ii) *Subsoil.*—Where the ground is composed of hard rock, or is so waterlogged that excavations rapidly fill with water, the 'excavated' types are unsuitable.

(iii) *Labour, tools and materials available.*—The latrines illustrated at Figs. 22, 23, 24, and 25 show the methods to be used when a supply of timber and other materials is available. In time of war, and in isolated places, there is frequently a shortage of materials and labour, and it is then necessary to construct sanitary

appliances with whatever happens to be available on the site. The substitution of an oil drum or petrol tin for the pail in a pail latrine, or perhaps the covering of the superstructure of a deep trench latrine with metal salvaged from oil drums in place of match-boarding, or similar improvisations may be necessary.

(iv) In foreign countries the habits, customs and religious principles of some sects and tribes prevent them from using certain types of latrines and special types of accommodation must be provided.

3. General principles of construction

There are certain general principles which apply to the construction of all latrines :—

(a) *The site.*—This should be chosen to the leeward of the camp, and in a position that will not lead to the fouling of the water supply. It should be easily accessible but should be as far as practicable from inhabited areas and should be not less than 100 yards, if possible, from places where food is prepared, stored or served.

(b) *Flies.*—Precautions should be taken to prevent flies coming into contact with, or breeding in excreta. Flies feed on excreta and they become contaminated with it; they are also attracted by milk, jam, sugar and other food, and germs deposited upon food either from the legs and body of the fly or from its digestive tract, may cause disease in the human subject. Latrine seats should always have a self-closing lid to keep flies away from the excreta and, when excreta is buried, a layer of oiled sacking or other material should be used to prevent fly larvae finding their way to the surface of the ground.

(c) *Coverings, screens, duckboards, etc.*—Except in a camp which is to be used for a very short period only, latrines should be roofed over to give protection from the weather. Duckboards and paths should be provided as far as possible to prevent the ground becoming foul. The latrine should be surrounded by a screen and, if necessary, a shallow trench to divert surface water. Toilet paper should be provided and protected from the weather. Urinals should be constructed nearby. Personnel should be impressed with the need for washing the hands after using the latrine and, if possible, facilities should be provided for this purpose.

4. Shallow trench latrine

(a) *The shallow trench latrine*, for short halts and temporary camps of not more than three days' duration, consists of a row of trenches, two feet apart, each trench being three feet long by one wide and two deep. The latrine is used by squatting astride the trench, each man covering his excreta with earth. Five trenches are sufficient for 100 men, three more trenches being required for each additional 100 men. (See Fig. 22, p. 129).

FIG. 22

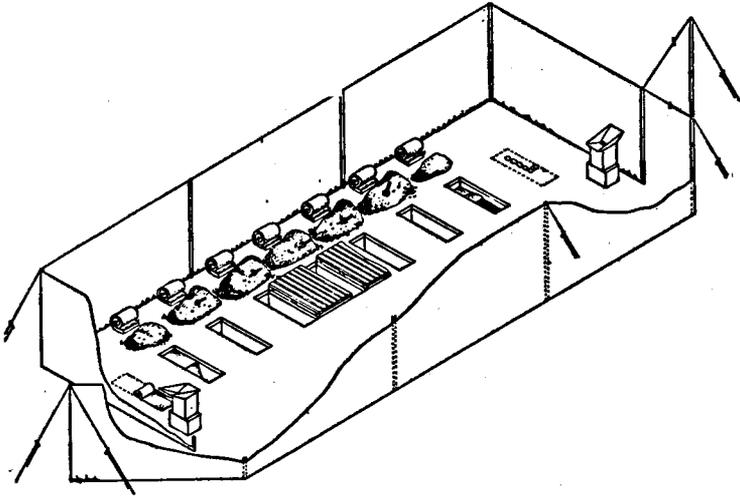

SHALLOW TRENCH LATRINE

FIG. 23

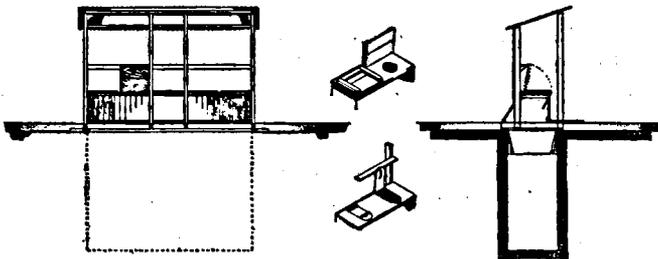

DEEP TRENCH LATRINE

(b) *Construction.*—The trenches should be marked out on the chosen site. The turf should be cut and rolled and the trenches excavated, the sides being dressed and the soil placed in tidy heaps together with the turf at the heads of the trenches: this soil is used for covering excreta and should be broken up. A scoop made from a tin or piece of board should be placed on each heap. The latrine should be surrounded by a screen and, if necessary, a shallow trench or gutter to divert surface water. Canvas screens 45 feet long complete with guy ropes and poles (reference: screen latrine, Mark iii, 20/115) may be used, two such screens being sufficient to surround nine trenches if arranged as shown in Fig. 22. If canvas screens are not available, a screen may have to be constructed of some local material or its necessity avoided by choosing a secluded or naturally screened site.

(c) *Period of use.*—After twenty-four hours, or when a trench becomes filled to within six inches of the top, the surface must be covered with a layer of oiled sacking or several thicknesses of oiled paper, to prevent fly-larvae reaching the surface, and the trench filled with soil to ground level and well consolidated; the turf must be replaced and the whole rammed down tightly, the site of the trench being marked with whitened stones in the form of a letter 'L' to avoid other persons excavating or otherwise using the same place.

(d) *Supervision.*—The efficient working of this type of latrine depends upon its being properly used and, as men do not always appreciate the dangers that arise from the misuse of the latrine, close supervision must be maintained—by sanitary police, if necessary—to ensure that the following rules are observed:—

(i) Urine should not be passed into the trenches. Use must be made of the urinal situated nearby.

(ii) Fouling of the surface of the ground and the sides of the trenches with urine and fæces must be avoided. Men must squat astride the centre of the trench.

(iii) Paper must be deposited in the trenches after use. It must not be allowed to be blown about by the wind.

(iv) All excreta and paper must be covered immediately with earth by the person using the latrine. The scoops provided must be used: the earth must not be scraped into the trench with the boots or thrown in with the hands, otherwise worm infections may occur.

(v) After using the latrine all men must wash their hands.

5.

Deep trench latrine

(a) *The deep trench latrine* is a trench 6 to 8 feet deep, 3 feet wide and 12 feet 6 inches long, with a suitable seat and covering to exclude flies. A trench 12 feet 6 inches long is sufficient for five seats; if fewer seats are required, the length of the trench should be reduced in proportion. (See Fig. 23, p. 129.)

(b) *Construction.*—A trench 12 feet 6 inches by 3 feet should be marked out and excavated to a depth of 6 to 8 feet, the excavated material being placed not less than 5 feet from the edge of the trench. If the earth is liable to collapse, the sides of the trench should be supported by timber, but cross struts must be spaced so as not to come directly under the seat openings. A superstructure should be built (see Fig. 23, p. 129). This may be a timber framing covered with tongued and grooved boarding, sheet metal, canvas or other suitable material but it must be fly-proof. The openings in the seat should have close-fitting lids, attached in such a way that they close automatically when not supported—this is easily effected by a bar at the back arranged to arrest the lid before it reaches a vertical position. The openings should be arranged above the centre of the trench and a sheet metal deflector should be placed below and in front of each opening to deflect urine into the centre and thus prevent fouling of the sides of the trench. The soil should be removed to a depth of 6 inches for a distance of 4 feet from the trench. This area should be covered with oiled sacking, turning the ends down over the sides of the trench. The superstructure should be placed in position, supported on timbers at back and front. The soil, mixed with heavy oil, should be replaced on the sacking and rammed well down to form a barrier to any fly larvae which may hatch out in the trench. A duckboard should be placed at the front of the superstructure and a screen erected around it. If necessary, a gutter should be dug around the latrine to deflect surface water.

(c) *Period of use.*—When the trench becomes filled to within 2 feet of the surface, the superstructure, duckboard and screen should be removed to another trench previously prepared, the contents of the old trench being covered with oiled sacking and the trench filled with earth, rammed and prominently labelled.

6.

Bored-hole latrine

(a) *The bored-hole latrine* is a vertical boring usually 16 inches diameter and anything up to 20 feet deep. A concrete ring may be fitted to protect the top and a seat and fly-proof superstructure should be provided. (See Fig. 24, p. 132.)

(b) *Construction.*—The boring is made by a special hand-operated auger, the shaft of which is made in sections for easy transport and to allow lengths to be added as the work proceeds. Shear legs are erected over the site of the boring to act as a guide for the upper end of the shaft and to provide a support for a pulley block used in withdrawing the auger from the ground. The auger is rotated by man-power applied to a detachable cross-T handle, which can be adjusted on the shaft as the boring deepens. A guide may be necessary at ground level to keep the boring vertical. In some soils it is necessary to line the whole or part of the boring to prevent it caving in, but the area of the wall is so small that collapse occurs only in exceptionally loose soils. Suitable linings may be made from galvanised iron sheets pierced with holes, iron reinforcing fabric, wood, concrete or basket work and lowered into the boring.

FIG. 24

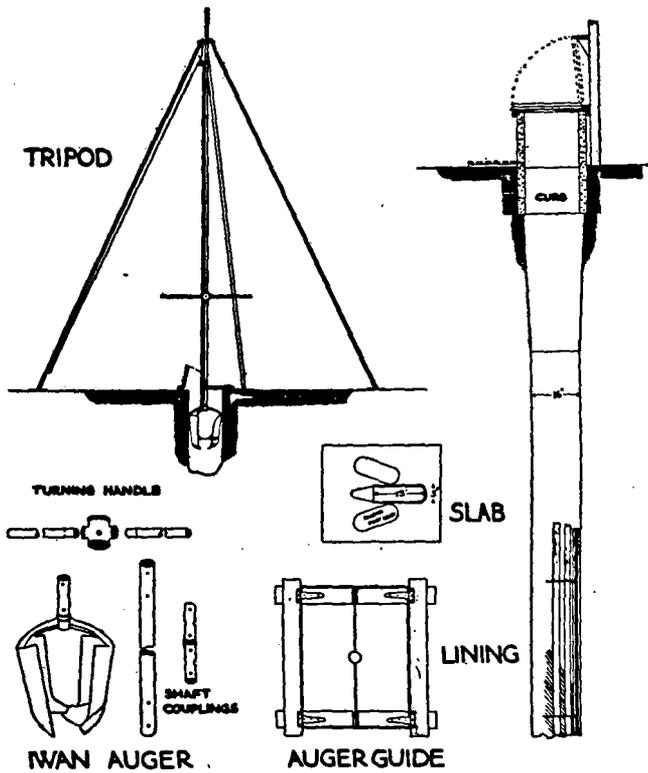

BORED-HOLE LATRINE

7.

Pail latrine

(a) *The pail latrine* consists of a container surmounted by a seat with fly-proof lid. The container must be impervious and watertight, easily cleansed, of sufficient strength to withstand the stresses of use and provided with a handle to facilitate emptying. The top must be flat to fit tightly against the seat. The container should have a capacity of about one cubic foot; smaller sizes necessitate too frequent emptying and larger ones are too heavy to handle when full. When the standard type (reference: Bucket, dry earth, 21C/311) is unobtainable, receptacles must be improvised from oil drums and other metal containers. The seat must rest evenly on the rim of the container and there must be no space through which flies can pass. As buckets and other containers will vary in height, the seat must be attached by a slot and pivot device which will render it adjustable for up and down movement. The lid must be self closing and fit accurately (reference: Seat, latrine, 21C/949). A superstructure is necessary to support the seat, and the usual roofing, screen and duckboards are required. (See Fig. 25.)

FIG. 25

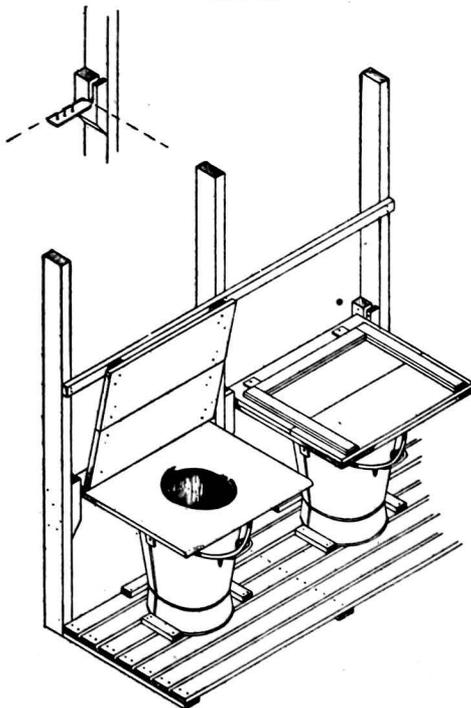

PAIL LATRINE

(b) *Maintenance.*—The pail latrine system requires constant attention by the sanitary staff. Containers should be emptied at least once each day and when they become about three-quarters full. Unless a sewage disposal plant is available disposal

of the contents may be by incineration, the Otway pit or burial. Where the former method is used, urine should be drained off from the containers into a soakage pit. After emptying, the buckets should be scrubbed out with a 2½ per cent solution of cresol; a coating of thick oil on the bucket acts as a fly deterrent and a very small quantity of the disinfectant left in the bottom makes it easier to clean next time. An area with an impervious surface, draining to a soakaway is required for the cleaning of the buckets.

8. The Otway pit

(a) *The Otway pit* is a simple form of septic tank suitable for the disposal of the contents of latrine pails. It consists of a pit dug in porous ground and protected by a flyproof cover; the lower part of the pit should be waterlogged or otherwise impervious. Pail latrine contents emptied into the pit are decomposed, a thick scum forming on the surface excludes the air. Liquefaction of the excreta is brought about by anaerobic bacteria, the resultant liquid soaking away through the walls of the pit as the level rises. The amount of residual solid matter is not great and the pit will last a long time before becoming full.

(b) *Construction.*—A suitable size for the pit is 10 feet long by 3 feet wide and 6 to 8 feet deep, although the condition of the ground may make it necessary to use other dimensions. In loose soils the walls of the pit should be supported by face and cross struts. As a flyproof measure, a layer of oiled sacking 4 feet wide should be buried 6 inches under the ground around the pit and the edges turned down into the pit. The cover of the pit may be made from timber and covered with oiled sacking to make it fly-proof. The inlet is formed by an oil drum or other suitable container, with the bottom removed, fixed over a hole near one end of the cover. This inlet should have a close-fitting lid which should be removed only when pails are being emptied into the pit and replaced immediately. A hole is left in the cover at the end remote from the inlet and a flytrap placed over it so that any flies in the pit will be attracted by the light and enter the trap. The flies are destroyed periodically and removed from the trap. If large numbers of flies are found to be breeding in the pit they may be exterminated by lowering through the inlet a bucket containing about a pound of burning sulphur, replacing the lid and preventing fumes from escaping through the fly trap; the pit should be left closed for four hours.

(c) *Maintenance.*—Sufficient water or urine should be poured into the pit from time to time to keep the contents in a liquid state and the bottom of the pit waterlogged; the surface scum should be disturbed as little as possible when pail contents are poured into the pit—for this reason the inlet is placed near to one end of the cover. No disinfectant should be poured into the pit as this will impede bacterial action.

(d) *Period of use.*—When the pit has been in use for some time and the contents have reached to within 2 feet of ground level, the cover should be removed to another excavation prepared in advance—a layer of oiled sacking placed over the contents of the first pit, and the earth replaced and rammed to ground level.

SECTION IV

DISPOSAL OF SULLAGE WATER**1. Introduction**

Sullage water is waste water from cookhouse, dining halls, ablutions and laundries. It may contain varying quantities of grease, soap, solid matter, such as vegetable trimmings or tea leaves, and chemicals such as washing-soda.

Failure to remove from sullage water as much grease and soap as possible will result in drainage systems becoming choked, soakage pits and irrigation trenches becoming clogged and water courses fouled. Moreover, it is necessary in wartime to salvage grease and fats to the maximum extent.

The satisfactory treatment of sullage water depends upon :—

- (a) grease and soap separation ;
- (b) disposal of the effluent ; and
- (c) disposal of the solids that remain.

2. Grease and soap separation

Strainer traps, cold water grease traps or chemical precipitation are used for this purpose either individually or in combination, the choice depending on local conditions such as the type and situation of the camp, the porosity of the soil and the availability of materials.

3. Strainer traps

Strainer traps are intended for use on temporary camps or for increasing the efficiency of a cold water trap system. Grass, straw, bracken, furze or similar materials placed in a container of suitable proportions will keep back gross particles of suspended matter and some of the grease and soap. The straining action can be considerably improved by the weight of a few stones placed suitably on top of the straining material. Straining material must be removed daily and either buried or burned.

4. Cold water grease traps

(a) Cold water grease traps are far more effective than strainer traps and are in general use on semi-permanent and permanent stations. They work on the principle that if warm water containing grease is run into an adequate amount of cold water, the grease will solidify and float to the surface from where it can be removed easily. Constructional details of these traps vary according to circumstances. Those built of concrete or brickwork, rendered in cement-mortar, are the best and are usually designed and built by the Works Directorate in accordance with standard specifications. Improvised traps, constructed from packing cases, metal tanks or drums of suitable size, can, however, be used when it is not possible to instal the more durable type. Whether permanent or improvised the traps must be adequate in size, watertight, easy to clean, provided with fly-proof covers and simple in design and construction. (See Fig. 27).

FIG. 27

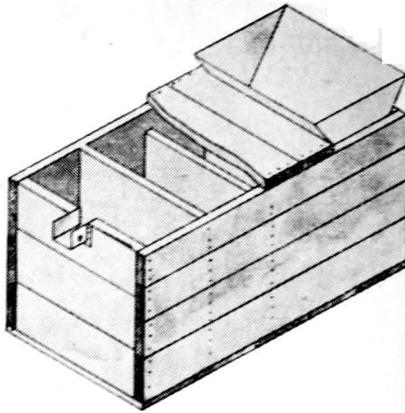

COLD WATER GREASE TRAP

Scale: 1 inch to the foot

(b) *Capacity.*—The smallest should hold 50 gallons of water (i.e., 8 cubic feet and suitable dimensions are 3 feet long, 16 inches wide and 2 feet deep). The maximum capacity should be 250 gallons—a trap of greater capacity than this will become virtually a cesspool. Within these limits the size may be roughly calculated by rule that the capacity of the grease trap should be at least five times the amount of hot greasy water to enter it at any one discharge. When the maximum flow requires a grease trap of more than 250 gallons capacity, or if an existing trap proves to be too small, it is advisable to use two traps arranged in series, with their united capacity equal to that required by calculation. In fact, it has been found, when dealing with large quantities of hot greasy or soapy water, that two traps of reasonable size are more efficient than one large grease trap.

(c) The relative dimensions of the grease trap are very important to ensure that a steady flow will take place. The length should be about three times the width and the depth should always exceed the width.

(d) Two detachable baffles should be provided. Their main purpose is to prevent undue disturbance of the solidified grease and to check any tendency for the surface layer to break up, with the risk of pieces of grease being carried away by the effluent. The space between the baffles should be as great as possible and they should be fixed not more than 6 inches from each end. Each baffle should extend downwards to a distance equal to about three quarters of the depth of the trap. At one time, it was usual to fix a third baffle near the centre, but experience has shown that this only adds to the difficulties of construction and maintenance.

(e) Preliminary straining to remove large particles, food debris and gross refuse such as vegetable trimmings is usually necessary. Where permanent drainage systems exist, the iron grids over standard gullies are sufficient. When these are absent

wire or tin strainers may be improvised. Such strainers should be placed as near as possible to the outfall of the water from the kitchen, ablution room, etc.

(f) When large quantities of hot greasy water are to be dealt with it is good practice to interpose an open gully drain of from 10 to 15 feet in length between the outfall and the grease trap. This permits preliminary cooling of the water and more efficient separation of the grease when it reaches the trap.

(g) Cold water grease traps are usually fitted below the surface of the ground. Where traps are used in connection with a water carriage system of drainage, the layout of the latter will, in itself, govern the level of the grease trap. In other circumstances (e.g., in the field), the trap should be embedded so that the cover is just above ground level. Any slight leakage, which is likely from improvised traps, will then cause no nuisance.

(h) The proper maintenance of sanitary fittings is of the utmost importance. In particular does this apply to the cold water grease trap as, no matter how well it may be designed or constructed, satisfactory results will not be obtained if it is neglected. The solidified grease should be removed at least every other day and put in a suitable covered metal receptacle, such as a refuse bin, for salvage. It is usual for the cookhouse personnel to render down this fat before it is reclaimed. Any sediment at the bottom of the trap should be removed at least twice weekly.

5. Chemical precipitation

(a) *Chemical precipitation* will remove grease and soap from water almost completely. The method may be used where there is no water carriage system on the camp and the soil is unsuitable for the employment of soakage pits. When water is in short supply, as may be the case overseas, recourse to chemical precipitation will clarify sullage to such an extent as to allow its use again for ablution purposes.

(b) Ferrous sulphate (copperas) and lime form the most effective precipitant. Ferrous sulphate is readily soluble in water and when lime is added a precipitate is produced. This precipitate carries down grease and suspended particles as it settles, leaving the supernatant water clear. The lime is necessary to alkalinize the water and so assist in the formation of the precipitate. The degree of alkalinity necessary is about pH9, at which level the colourless indicator phenolphthalein will turn pink. The standard dosage per gallon of water is 30 grains of ferrous sulphate and 30-40 grains of lime. The amount of lime required is largely determined by the quantities of washing-soda (sodium carbonate) present in the water from cookhouses, and may vary slightly from the limits given.

(c) The sullage is collected into tanks of suitable size, which should be constructed in pairs so that one can be filled while the contents of the other are being treated. The precipitant chemicals are added in solution and the tank contents well agitated. Moderate clarification should occur within one hour, but a longer contact period will give better results. Mechanical contrivances for the addition of the precipitants and agitation of the tank contents are sometimes used.

(d) Drying beds are necessary for the disposal of the sludge which accumulates in the bottom of the tanks. These beds

should be constructed of hard clinker, about $1\frac{1}{2}$ to 2 feet in depth. The crude sludge should not cover the drying beds to a greater depth than 9 inches. The sludge when dried should be buried. It is of no value as a fertiliser.

6. Disposal of sullage effluents

(a) The effluent from grease traps or chemical precipitation tanks may be disposed of by soakage pits, herring-bone drainage or evaporating pans. None of these will function satisfactorily if the grease trap system is not maintained efficiently. If it has been sufficiently clarified effluent may be led directly into a water course.

(b) *Soakage pits*.—The dimensions of these are generally 4 feet by 4 feet by 4 feet, but larger and more elaborate pits, sometimes lined with open brickwork, may be constructed by the Works Directorate. The pits should be filled with stones, old bricks or perforated tins and the contents graded so that the largest fragments are at the bottom and the smallest at the top. The pipe or gully which conveys water to a soakage pit should discharge at or over the centre of the pit. The common practice of sealing soakage pits with oiled sacking is unnecessary as flies do not breed in them.

(c) *Herring-bone drainage*.—This method is of service when level of sub-soil water is too high to permit the use of soakage pits. A series of connecting channels, 1 foot wide and 1 foot deep are dug in a herring-bone pattern. Different sections of the channels should be used alternately. Both soakage and evaporation take place and to facilitate these processes the sides of the channels should be cleaned and the earth at the bottom loosened from time to time.

(d) *Evaporating pans*.—They can only be used in a dry climate where rain is seasonal and of small amount. A series of level pans, each measuring about 30 feet by 30 feet are constructed by building up low earth walls to a height of about 1 foot. The pans are used in rotation for each day's flow of sullage and sufficient must be constructed to ensure that the first is completely dried off by the time its turn to be refilled comes round again. This will depend on the climatic conditions, the time of the year and the quantity of water to be dealt with. Six pans will generally be found sufficient for 300–400 men. The depth of water must never be allowed to exceed 9 inches at any point in a pan. Each pan must be shut off when this level is reached or at the end of the day's flow, whichever is the first to occur. Evaporation, which is assisted to a varying extent by soakage through the underlying soil, is generally complete in from 2 to 5 days. A grey, flaky deposit is left. This should be removed with a metal or wooden scraper and burned or buried. The top layer of soil, to a depth of 1 inch, should be scraped off every 2 or 3 months. There is little nuisance from smell but the pans should be sited 300 yards or more downwind from the camp. Sullage water should be led to them in pipes or open cement gullies. Simple earth ditches may be used but these become clogged with an offensive slime rapidly. There is no risk of fly or mosquito breeding associated with these pans. The planting of cannae lilies and the cultivation of maize and vegetables round the pans will accelerate the disposal of the sullage water and can be made a source of considerable income to unit funds.

SECTION V

REFUSE DISPOSAL IN THE FIELD

1. *Refuse*, unless frequently collected and disposed of properly, attracts rats and is a breeding ground for flies. It provides these pests with food and a home and it contains germs with which they may contaminate the food of human beings.

(a) *A suitable type of receptacle* should be provided wherever refuse is produced. It should be made of impervious material and should be light and easily carried. It should have a fly-proof lid, which must always be kept in position. The bin should be of sufficient size (or a sufficient number should be provided) to hold all the refuse that is likely to be produced between the times of emptying, but each bin should not be so large that it cannot be easily handled when full; two cubic feet is a convenient capacity. The standard type of galvanised iron dustbin is very suitable. The bin should stand on an impervious platform, should be accessible to persons who have to use it and should be sited in a sheltered, shady place.

(b) *Frequent emptying of the bin* and disposal of the contents are necessary and in no case should refuse be left in the bin long enough for flies' eggs to hatch and reach the adult stage; nor should the bin be allowed to overfill so that refuse becomes scattered on the ground. In hot climates the bins should be emptied daily if possible and the contents disposed of at once. In cooler climates, less frequent emptying may have to be accepted. Bins should be emptied completely on each occasion and care taken that no refuse is left adhering inside. Bins which are used for wet refuse or swill should be washed out after emptying; this is essential in the case of pails and containers used for excreta. Contracts for the removal of swill or for the emptying of pail latrines should include clauses for the cleansing of containers.

(c) *Vehicles used for carrying dry refuse* should be provided with a cover to prevent light refuse blowing away and to exclude flies. The side, or end, over which bins are emptied should not be too high as this favours spilling. For conveying wet refuse or swill a water-tight vehicle is necessary such as some type of mobile tanker or a large galvanised tank carried on a lorry. Alternatively, the full containers may be removed and replaced by empty ones.

(d) *Full latrine buckets* should be taken to the point of disposal for emptying, clean buckets being left in their place. After emptying, the buckets should be washed and made ready for use at the next block of latrines. An impervious platform on which to wash the buckets is required at the disposal point, the dirty water passing into a drain or through a strainer into a soakaway.

2. The two methods of disposal usually available are *incineration* and *burial*.

(a) *Incineration*.—(i) Dry refuse is easily reduced to a small volume of innocuous ash by burning, but with wet refuse it is usually necessary to add some fuel to assist evaporation of

moisture and combustion. Various forms of incinerators are in common use and the choice of type depends upon the materials available, the quantity of refuse to be burned, and the length of time for which it will be required.

(ii) The *characteristic of a good incinerator* is that the combustion is complete; this means that no unburned refuse should remain in the incinerator or be mixed with the ashes after burning, and smoke should be reduced to a minimum. A baffle is usually built inside the incinerator, so arranged that smoke emitted by the burning refuse is deflected through the hottest part of the fire and consumed.

(iii) *Incineration of faeces.*—The closed types of incinerator are capable, with proper attention to stoking, of burning wet refuse and faeces; the process must be assisted by the addition of dry refuse, straw, wood, coke or other suitable fuel. A fire is started in the incinerator. When it is burning strongly, half the contents of a latrine bucket, from which surplus liquid has been drained and disposed of, is tipped into the incinerator. Care must be taken not to overload and thus put out the fire. When the fire has burned up again, another half bucketful of faeces is put on. Fuel is added, as necessary, between the charges of faeces to keep the fire going. Careful stoking and raking are necessary to keep the fire going and to prevent the faeces from forming into a solid mass.

(b) *Burial.*—This method of disposal has the advantage that no smoke is produced and no more apparatus than a pick and shovel is required. Rigid control is essential because if refuse is merely deposited in a heap the following nuisances may be expected :—

- (i) Flies breed in the refuse and carry germs from it to food.
- (ii) Rats and other pests are attracted.
- (iii) Light refuse is scattered by the wind.
- (iv) Very large heaps of refuse may catch fire by spontaneous combustion.
- (v) Liquid draining from the heap may find its way into a water supply.

For the burial of refuse a well-drained site that can be easily excavated is required, but its position must not endanger any water supply. All refuse should be buried as soon as it is brought to the site and at the end of each day's work there should be no refuse which is not covered with at least one foot of well rammed soil. It is desirable to excavate in advance sufficient ground for two or three days' refuse, so that material brought on to the site can be emptied forthwith. Wet and offensive refuse should always be dumped as near to the bottom of the trench as possible, the dry refuse being placed on top of this and finally covered with at least one foot of earth and the whole well rammed down. As an additional fly preventive, the refuse may be sprayed with waste oil, or the surface covered with a layer of oiled sacking before the covering of earth is spread. Existing excavations may be used, but refuse should never be deposited in masses more than 5 feet deep, owing to the danger of its decomposing and becoming alight through spontaneous combustion.

FIG. 28

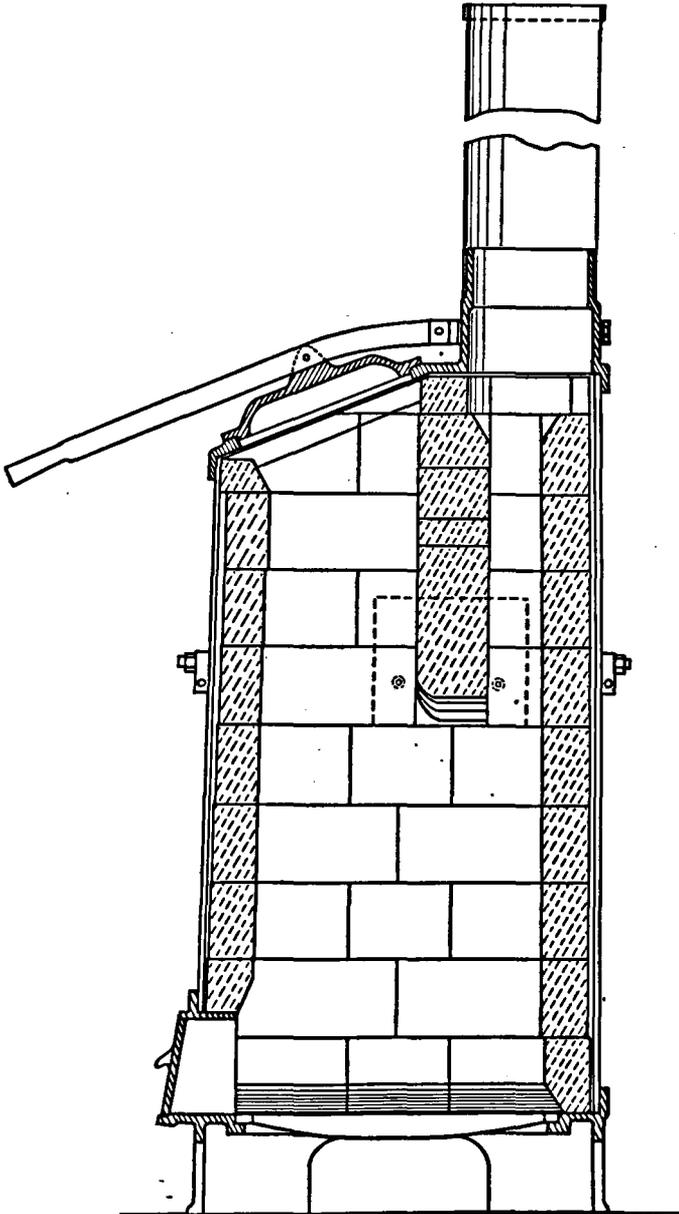

HORSFALL DESTROYER

3. Types of incinerator

(a) *The Horsfall destructor* is built of steel plates and lined with firebricks—it is supplied complete by the manufacturers and, not being portable, is used only for permanent stations. A baffle arch within the destructor directs smoke and fumes through the hottest part of the fire before emission through the flue. (Fig. 28).

(b) *The Bailleul incinerator* may be constructed locally, the walls being of brick, stone, sheet metal or large rectangular tins filled with earth, and the chimney of sheet metal or cylindrical metal drums; sheet metal is required for the raking and feeding doors and a number of iron rods for fire bars. A supply of hot water for use at the incinerator site may be obtained by building an oil drum boiler into one of the walls. Fig. 29 illustrates such an incinerator built of brick, but they can be made from biscuit tins solidly filled with clay and wired together. For prolonged use the interior should be lined with firebricks (p. 143).

(c) *The closed beehive incinerator* can be built of brick, stone, concrete or mud reinforced with metal bars and wire netting. It is circular and has the feeding door near the top. The raking door is on a level with the firebars and four large holes at ground level serve for the removal of ashes and as air inlets. The central chimney extends downwards inside the incinerator so that the lower end, which is supported by iron bars across the chamber is just above the level of the feeding door. (Fig. 30, p. 144.)

(d) *Open circular incinerator.* The walls are built to a height of 4 feet 6 inches of bricks or stones laid dry or cemented together, or of turfs 9 inches wide. Four draught holes are left at the base of the walls and iron firebars 2 inches apart are built-in 9 inches from the ground. (Fig. 31, p. 145.)

(e) *Open square incinerator.* The walls may be constructed of rectangular tins solidly filled with clay, wired together and reinforced with iron bars. As before, openings in the base of the walls serve as air inlets and raking doors for the removal of ashes. Iron firebars are built-in 9 inches from the ground. (Fig. 32, p. 145.)

(f) *Portable corrugated iron incinerator.* This type of incinerator is easily constructed from sheets of corrugated iron, a dozen iron bars and 20 feet of strong iron wire. Air inlets 12 inches long and 9 inches high are cut from the base of each sheet; slots for the firebars are made with a cold chisel in two of the sheets and an opening for a raking door cut in one of them just above the firebar slots. Air inlet holes are punched in each sheet on a level with the raking door. The four sheets are then wired together at the edges to form a rectangular box and the firebars inserted. A raking door of corrugated iron is made and hinged into position. A drying shelf of iron bars, formed across the incinerator about three feet above the firebars, will break the fall of refuse and prevent it smothering the fire during stoking. The incinerator is easily dismantled for transport by withdrawing the firebars, removing the wire ties from one edge and folding the four sides together. When assembled for use, the feet of the incinerator should be anchored down. A cowl may be made from a piece of sheet metal to prevent the damping of the fire by heavy rain. (Fig. 33, p. 147.)

FIG. 29

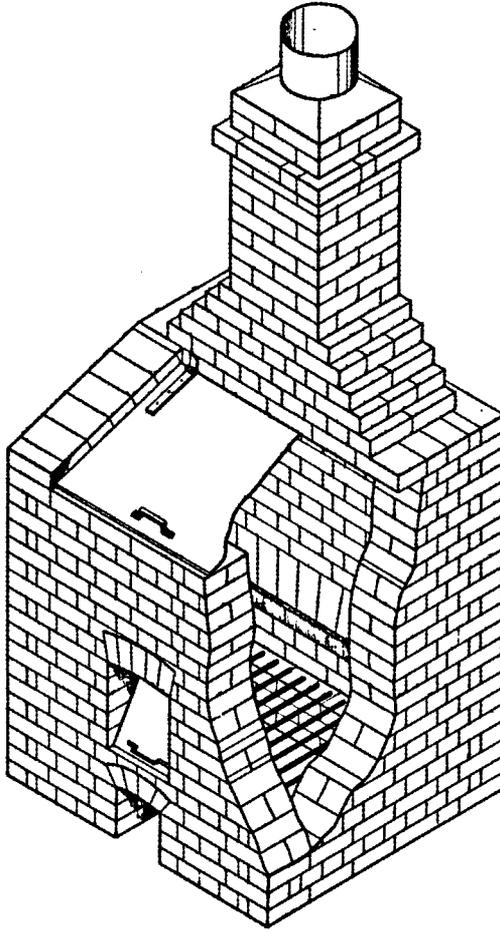

BAILLEUL INCINERATOR

FIG. 30

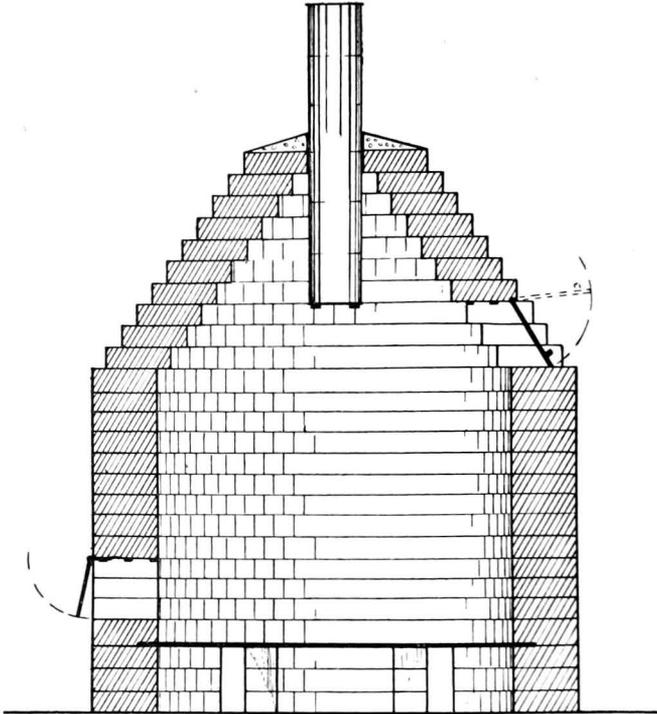

CLOSED BEEHIVE INCINERATOR

FIG. 34

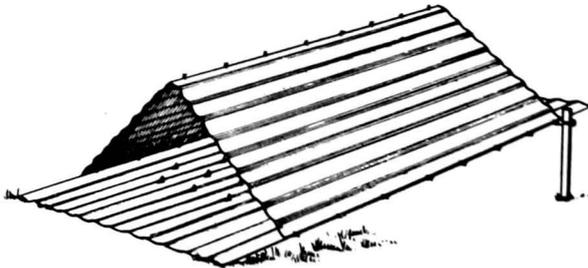

INCLINED PLANE INCINERATOR

FIG. 31

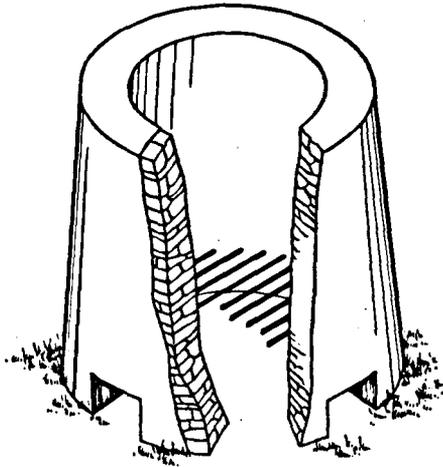

OPEN CIRCULAR INCINERATOR

FIG. 32

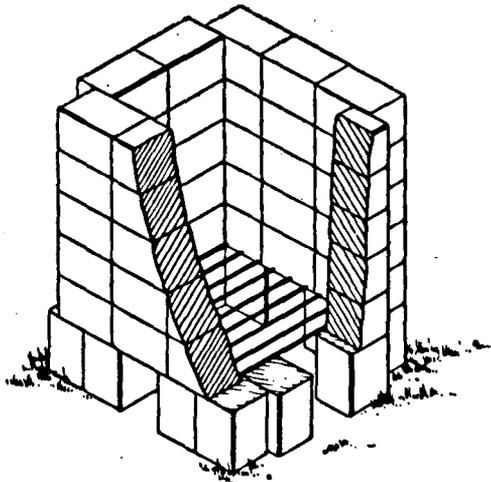

OPEN SQUARE INCINERATOR

(g) *The inclined plane incinerator.* This incinerator is made from 3 sheets of corrugated iron fixed together by wire and raised at one end by iron supports. V-shaped cuts are made at intervals in the lower sheet of iron forming the base of the incinerator and the metal turned up to form projections. These projections prevent refuse slipping down to the other end of the incinerator too rapidly. Refuse is fed in at the raised end. When in use the lower end should be so placed as to face the direction of the wind. (Fig. 34, p. 144.)

(h) *Cairn incinerator.* A saucer shaped depression 6 to 10 feet in diameter and not more than 2 feet deep in the centre is lined with large stones, and a cone of large stones is built up in the centre with its apex 2 feet above the level of the rim of the depression. Dry material is used to start the fire. The stones become very hot and help to evaporate any moisture in the refuse. Air is drawn through the spaces between the stones to the fire; these spaces soon become choked with ashes, however, and the incinerator must be dismantled and cleared out frequently. (Fig. 35, p. 147.)

TABLE XXIII

4. Common means of disposal of refuse in the field

<i>Types of refuse</i>	<i>Disposal</i>
(a) <i>Liquid refuse.</i> Sullage water from kitchens or ablutions, urine, etc.	(i) Removal of grease and solid matter and disposal of liquid in a soakage pit. (ii) Chemical precipitation with disposal of effluent to a ditch or watercourse.
(b) <i>Swill.</i> Refuse from kitchen containing a high proportion of vegetable refuse and food waste.	Usually finds a ready market as feeding for pigs. Where it cannot be so disposed of, surplus liquid should be drained off and treated as sullage and the solid matter burned or buried.
(c) <i>Dry Camp refuse.</i> Floor sweepings, waste paper, etc.	After useful material has been salvaged, the residue may be burned or buried. It usually contains a large proportion of combustible material which will assist in the burning of wet refuse.
(d) <i>Contents of latrine pails.</i>	(i) Incineration. (ii) Otway's pit. (iii) Burial.
(e) <i>Manure.</i>	This is not usually produced in any quantity at R.A.F. units. It can be disposed of as a fertiliser, or, if necessary, by burning, burial or the method known as "tight packing".
(f) <i>Ashes, etc.</i>	May be used for making paths and other useful purposes. It is often possible to sift out the cinders which will assist in the combustion of other refuse.

FIG. 33

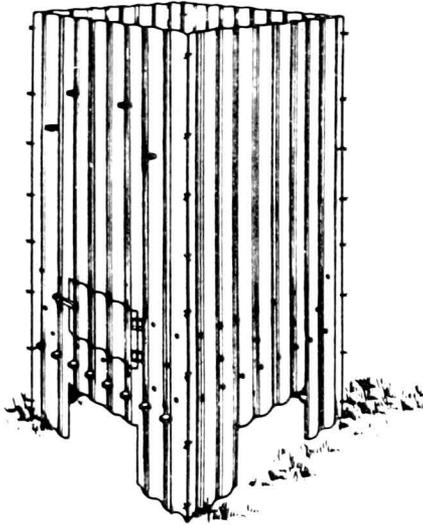

PORTABLE CORRUGATED IRON INCINERATOR

FIG. 35

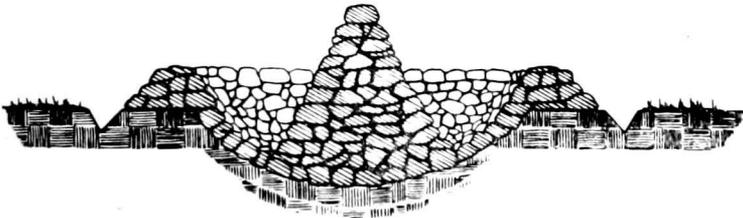

CAIRN INCINERATOR

CHAPTER VI

COMMUNICABLE DISEASES

SECTION I

CONTROL, GENERAL MEASURES

The *control of communicable diseases* depends upon the application of certain general principles which vary according to the method by which the infecting organism is spread. These principles are aimed at breaking the chain of infection which leads from the infected individual—who may be obviously ill, in a clinically inapparent phase of the disease or an immune carrier—to the susceptible individual.

The control measures involved include :—

(a) *Isolation*.—This entails the confinement, under medical supervision in a specified building, of infected individuals and suspects.

(b) *Quarantine or observation*.—This may be necessary for contacts for whom isolation is not considered essential. It implies limitation of their movements for a time equal to the incubation period of the disease to which they have been exposed.

(c) *Surveillance*.—This is a less stringent measure than quarantine and can be applied to travellers when interruption of their journey cannot be warranted. It does not necessitate limitation of movement, but requires notification of individuals under surveillance to the sanitary authorities of places whither they are bound and their medical examination at intervals during the incubation period in which they are liable to develop a disease.

(d) *Segregation*.—This is particularly applicable to the separation of susceptible from immune persons when the latter are liable to acquire a carrier state, as in diphtheria.

(e) *Immunisation*.—This is applied for susceptible individuals.

(f) *Chemoprophylaxis*.

(g) *Sterilisation of contaminated water, food and milk supplies*.

(h) *Control of insect vectors* and the protection of susceptible individuals from them.

(i) *Current disinfection* of the discharges from, and the bed linen and articles used by, infected individuals.

(j) *Terminal disinfection* at the end of an illness is now limited in almost all infectious conditions to a thorough 'spring cleaning', without fumigation, of the room in which a patient has been treated and steam disinfection of bed linen and clothing.

(k) *General measures* such as free ventilation, spacing out of beds, limitation of overcrowding (especially in churches, canteens and cinemas), sterilisation of eating utensils, wearing of masks, aerial disinfection and dust control.

The importance of a favourable environment and the maintenance of a satisfactory level of nutrition, as they affect the limitation of epidemic diseases, must be emphasized. Improved sanitation and the reduction of overcrowding, especially in slum areas, were the vital first steps towards reducing morbidity from typhoid fever and tuberculosis respectively. It is notorious that famine paves the way, in countries such as India, for devastating epidemics of cholera and malaria. It is not necessary, however, to travel the whole way down the slippery path of malnutrition before its harmful results become so clearly manifest and it is now accepted that an adequate and balanced diet is necessary to maintain resistance to infection. Unless good feeding and sound hygiene, in all its protean implications, go hand in hand, communicable disease will always flourish.

SECTION II

CONTROL OF THE DROPLET INFECTIONS

1. Introduction

The infections which are considered to be spread usually by droplet infection include cerebro-spinal fever, the common cold, diphtheria, influenza, measles, mumps, pneumonic plague, poliomyelitis, scarlet fever and streptococcal sore throat and whooping cough.

Droplet infection may be short range in its origin, as in the direct person to person transmission of infective droplets by a cough or sneeze; or comparatively remote, due to the carriage in air currents of very small droplet nuclei containing infective bacteria or viruses. Direct contamination of the atmosphere by droplet nuclei from the mouth and nose does not occur to any great extent, except from unguarded coughs and sneezes. Most droplets fall downwards and do not travel more than about one foot horizontally during ordinary breathing and talking. The scattering of dried particles from droplets which have fallen on the clothing and bed coverings is probably the most important mechanism by which the droplet infections are spread. Bed-making, and the disturbance of bedclothes and outdoor clothing in dormitories at reveille, are especially potent factors in the transmission of these diseases.

2. Ventilation

The individual requirement is generally accepted as being 1,000 cubic feet of fresh air an hour and a guide to the ventilation openings necessary to provide this quantity is given by Angus' 'opening figure' in the table below. This figure is obtained by dividing the total area in square feet of effective free openings

(windows, doors, ventilators) by the cubic content of the room or building and multiplying the dividend by 1,000. Additional ventilation openings should be provided if the appropriate 'opening figure' is less than that given in the table below.

	<i>Opening figure</i>
Offices	3
Laboratories	4-5
Light manual work (cool processes)	5-6
Light manual work (in moderate heat)	6-7
Heavy work in great heat	9-11

Blackout arrangements should be such that adequate ventilation without draughts can be maintained.

3. **Open-air exercise**

Open-air exercise is of very great value during epidemics of the droplet infections and plays a large part in freeing the upper respiratory tract of pathogenic organisms and so reducing the number of carriers. Open-air games, runs and P.T. should be organised and made compulsory for all during epidemics.

4. **Avoidance of overcrowding**

(a) One of the first cares of the medical officer faced with an outbreak of infectious disease of droplet origin must be to ensure that beds are spaced to the maximum distance possible and that their occupants are staggered head to toe. Face-to-face positions in offices and workrooms must be altered if possible. It may be even considered expedient to run meals on the shift system to overcome the same risk of droplet transmission. Enforced silence during meals is an extreme measure which may be thought necessary in some circumstances.

(b) During epidemics of droplet diseases, especially cerebro-spinal fever and acute poliomyelitis, careful consideration must be given to the advisability of limiting the numbers present at any time in canteens, cinemas, churches and other places where personnel congregate. It may be necessary to close such places altogether.

5. **Quarantine**

(a) Isolation of cases of infectious disease must be regarded as essential. Quarantine of contacts, on the other hand, is generally replaced nowadays by daily medical examination. This should be continued for each contact until the limit of the incubation period of the disease concerned, reckoning from the last exposure to infection from a known case.

TABLE XXIV

(b) Incubation and isolation periods for the commoner droplet infections are :—

	Incubation period	Isolation of patient	Quarantine of contacts
Cerebro-spinal fever	1-10 days	14 days from onset, or 2 negative naso-pharyngeal swabs taken at 4-day intervals.	Nil
Common cold	1-2 days	Nil	Nil
Diphtheria ..	2-5 days (usual) 1-7 days (limits)	Till 2 weeks after cessation of all symptoms and discharges. 3 consecutive daily negative naso-pharyngeal swabs required	Nil
Influenza ..	1-3 days	During acute stage of illness	Nil
Measles ..	7-18 days	9 days from onset..	Nil
Mumps ..	14-28 days	Until glands normal	Nil
Plague, pneumonic	3-7 days (usual) 3-14 days (limits)	Until convalescent	7 days
Poliomyelitis	2-10 days (usual) 2-14 days (limits)	3 weeks from onset	Children and adults in contact with children, or who are food handlers—14 days from last exposure
Rubella ..	9-19 days	Nil, except for children	Nil
Scarlet fever..	2-4 days (usual) 1-7 days (limits)	4 weeks from onset	Nil
Whooping cough	3-10 days	Till 14 days after last whoop; or minimum of 6 weeks	Nil

(c) *Acute poliomyelitis*.—Adult carriers rarely transmit this infection but child contacts are highly dangerous and should be strictly segregated for 14 days. Nasal sprays, douches and gargling are not advocated as a prophylactic measure. The results obtained from prophylactic vaccines and convalescent serum are not conclusive. Intensive search for mild, missed and abortive cases and their isolation when found are important control measures. Patients' faeces should be disinfected before disposal.

(d) *Cerebro-spinal fever*.—Swabbing to detect carriers, and their segregation are not now considered necessary. Mass chemo-prophylaxis is not advisable, owing to the risk of creating drug resistant strains of the organism and the possibility of inducing hyper-sensitivity to sulphonamides in the individual—see para. 13. Immunisation with vaccines or toxins is not a practicable measure.

(e) *Scarlet fever*.—If possible, contacts should be segregated in working quarantine, paraded daily for medical examination and isolated at the first sign of tonsillitis. Contacts should include close friends of cases and those occupying the same bench in the workshop or classroom, as well as all occupants of the same sleeping accommodation. Since the proportion of personnel carrying hæmolytic streptococci in their throats during an epidemic is usually over 40 per cent and often as high as 60 per cent, swabbing to detect carriers is largely a waste of time. With such large numbers the bacteriological typing of streptococci found in throat swabs, even if limited to the determination of Lancefield's Group A, which includes the only types of epidemiological importance, is an enormous task which is seldom justifiable.

6. Personal hygiene

Avoidance of spitting and the use of the handkerchief to trap the products of coughs and sneezes are more than ever necessary during epidemics.

7. Gargling and nasal douching

(a) Gargles and nasal douches, to be really effective, would require to be maintained permanently in a lethal concentration throughout the naso-pharyngeal tract, since many viruses are capable of entering the tissue cells within a few minutes of contact. To maintain such a concentration is not a practical possibility.

(b) Antiseptic gargles and douches may irritate the delicate mucous membrane of the upper respiratory passages.

8. Masks

The ordinary gauze mask is practically useless but a visor type of mask suspended from an improvised wire spectacle frame or similar contrivance and constructed from light cardboard or cellulose acetate sheeting is worthy of adoption in certain circumstances; for example, when 24-hour watches must be maintained under conditions of bad ventilation and overcrowding.

9. Sterilisation of eating and drinking utensils

Attention must be paid to the arrangements for *washing up after meals* and, if necessary, additional facilities installed for the sterilisation of eating and drinking utensils. A steam tank may be improvised from an inverted oil drum or dustbin. One minute contact period is sufficient when current steam is used by the downward displacement method. Bleach solution, in a strength of 200 p.p.m. free chlorine may be employed after preliminary washing in hot, soapy water. The contact period for such a solution should be 5 minutes and its temperature should not exceed 100° F. Rinsing in clean water, to remove the taste of chlorine, is advisable after sterilisation by bleach.

10. Aerial disinfection

(a) *Germicidal vapours* such as formaldehyde have the general disadvantage that they are either injurious to the tissues or intolerable to the senses, and often both, in the concentrations which are necessary for them to be effective.

(b) *Ultra-violet light* is highly effective against moist organisms in droplets but not so effective against dry organisms in dust. The cost of installation and technical difficulties of application have prohibited its general use up to the present, but it may be more widely employed in the future.

(c) *Bactericidal mists* or aerosols, defined as having a particulate diameter of 1 micro-millimetre or less and produced by special sprays, are the most promising means of aerial disinfection which are available at the moment. Sodium hypochlorite is cheap, non-toxic and in concentrations as low as 5 c.c. of a 1 per cent solution per 1,000 cubic feet of air is highly effective. Unfortunately, this substance is corrosive to metals and bleaches coloured fabrics, which factors limit considerably its application. Hexyl resorcinol, generally used as a 10 per cent solution in propylene glycol, is persistent, non-irritant and an excellent germicide. Propylene glycol alone, when vaporised by a small flame, will reduce naso-pharyngeal organisms in the air by 90 per cent in a dosage of 0.5 parts of liquid vaporised per million parts of air.

(d) Various balsams and wood dusts when burned in specially prepared candles produce highly germicidal and non-irritant smokes.

(e) *Aerial disinfection* is still in the experimental stage and a pronouncement as to the efficacy of any of the above measures would be, at present, untimely.

11. Dust

Organisms such as the streptococcus, the diphtheria bacillus, the tubercle bacillus and the virus of smallpox will survive drying for long periods. They will persist in dust and, although in this state they hardly come under the heading of droplets, are a particular problem in hospitals, where the fluff and dust from the blankets and bed linen of patients make cross infection a much more common occurrence than is generally realised. *Dust dispersal*

may be controlled to a great extent by damp sweeping and dusting, vacuum cleaning, free use of soap and water, sewing of blankets inside cotton sheets, treatment of blankets with technical white oil, e.g., Olinol I, and the treatment of floors with crude liquid paraffin or spindle oil. The two latter measures are particularly valuable and are becoming widely employed. The blankets should be treated in a hospital washing machine with a watery emulsion of the oil, the excess of which is then removed in the hydro-extractor, leaving the blankets non-oily to the touch. One application of spindle oil to the floor will remain effective for four weeks, but the floor must not be polished after its use.

12.

Specific immunisation

(a) *When two or more immunising agents are given simultaneously* they may be injected into adjacent sites, but should never be mixed and given in the same syringe.

(b) *Diphtheria*.—(i) The proportion of non-immunes on R.A.F. stations has been found to average 25 per cent, although the number of Schick positive reactors in the 20–30 age group may be as low as 12 per cent in a strictly urban population. It is not necessary therefore to resort to an intensive immunisation campaign during an epidemic, unless the outbreak involves large numbers of young personnel or W.A.A.F. personnel who may not have acquired herd immunity, or in the event of an unusually virulent strain of organism or the failure of other preventive measures.

(ii) *Indiscriminate active immunisation* during an epidemic must never be employed. Schick testing and throat and nose swabbing of all those at risk must be carried out. Swab positive individuals may be either carriers or incubating the disease and should be isolated until they are no longer a danger to the community. Only the Schick-positive, swab-negative individuals should receive active immunisation.

(iii) The substance recommended for active immunisation is T.A.F. (toxoid anti-toxin floccules); to be given in three fortnightly doses of 1 c.c.

(iv) *Passive immunisation* by injection of 1,000 units of anti-toxin should only be used for close contacts who are in immediate danger of contracting the disease. The immunity thus provided is only of about 2 weeks' duration.

(c) *Scarlet fever*.—Active immunisation against scarlet fever requires 5 injections and protects mainly against the erythrogenic or rash-producing factor of certain types of haemolytic streptococcus. The invasive and toxigenic properties of this organism are not affected. The procedure is definitely dangerous, since true scarlet fever may be masked by protection against the rash and nephritis or rheumatism may follow what appeared at the time to be a simple sore throat.

(d) *Measles*.—(i) Immune serum will protect an individual from measles if given before the 5th day after exposure. Except in the case of sickly individuals and children under three, it is better to inject the serum between the 5th and 9th day after exposure. This results in the development of a modified attack of measles, which appears to confer life-long immunity.

(ii) Active immunisation by the use of attenuated virus is not yet considered sufficiently free from risk to be advocated for general employment.

(e) *Whooping cough*.—(i) Morbidity is considerably reduced by the prophylactic use of pertussis vaccine. Modified attacks, which confer a lasting immunity, are usual in those who do not obtain complete protection.

(ii) Simultaneous inoculation in infancy (9 months to 1 year) against both whooping cough and diphtheria is strongly recommended by some authorities.

(f) *Influenza*.—Encouraging results have been obtained from the use of influenza A virus vaccines, but the immunity produced is generally of only a few months' duration.

(g) *Common cold*.—Several large scale, controlled experiments have proved the futility of inoculation against the common cold with stock 'anti-catarrhal' vaccines.

13. Chemoprophylaxis

(a) The inviting prospect of chemoprophylaxis by means of the sulphonamide drugs, in epidemics of such conditions as streptococcal sore throat and cerebro-spinal meningitis, can rarely be reconciled with the attendant risks.

(b) Drug-fast strains of organisms may be created which, even after transmission to new hosts, will resist future medication with any member of the sulphonamide group.

(c) Furthermore, individuals who have received prophylactic doses of a sulphonamide may become sensitised to these drugs and intolerant of therapeutic doses which may be necessary at a later date.

14. Ultra-violet light

No satisfactory evidence has yet been produced that exposure to ultra-violet light in graduated doses will decrease an individual's liability to contract infectious disease.

15. Diet

While malnutrition undoubtedly affects susceptibility to infectious disease, the addition of extra vitamins or special food components to the diet of a well-nourished individual has not been shown to increase resistance to epidemic organisms.

SECTION III

CONTROL OF INDIVIDUAL DISEASES

1. Cerebro-spinal fever

(a) *Cerebro-spinal fever*, or meningococcus meningitis, is caused by the meningococcus or *Neisseria meningitidis*. Susceptibility to the disease is slight, but is highest in the younger age groups, especially boy entrants and recruits.

(b) Source of infection.—Airborne droplets emitted from the nose and throat of patients and carriers. A carrier rate as high as 50 per cent may occur in the absence of cases of the disease.

(c) Method of spread.—Droplet infection.

(d) Incubation period.—Usually 7 days; limits, 1 to 10 days.

(e) Period of infectivity.—While meningococci are present in the nose and throat of the patient. Adequate sulphonamide dosage will cause their disappearance, usually within 24 hours.

(f) Isolation of the patient.—For 14 days from onset or until 2 negative naso-pharyngeal swabs have been obtained, taken with an interval of 4 days.

(g) Quarantine of contacts.—Nil.

(h) Immunisation.—Nil.

(i) Chemoprophylaxis.—This may be legitimately employed for a closed community exposed to unusual risk. Strict medical supervision is necessary. Sulphadiazine, sulphanilamide, sulphathiazole or sulphapyridine are, in this order, the drugs of choice. Dosage should be 1 gramme for 3 days, which will permit full duties other than high altitude flying.

(j) Current disinfection.—Of nose and throat discharges, handkerchiefs, pillow slips, sheets and bed attire.

(k) Terminal disinfection.—Cleaning.

(l) General control measures.—Free ventilation of living and sleeping accommodation. Spacing out of beds. Avoidance of overcrowding. Open air exercise. Swabbing for the detection of carriers is a waste of time. Gargling and nasal douching are not advised. Chilling and fatigue should be avoided by those at risk. (See also pp. 148–155.)

(m) Notification.—Competent medical authority and Air Ministry, by signal. Form 418—to Service authorities and local M.O.H.

2.

Chancroid

(a) *Chancroid* or soft chancre is a venereal disease caused by *Haemophilus ducreyi*. There is no evidence of natural or acquired immunity and an attack does not protect against subsequent infection.

(b) Source of infection.—Discharges from lesions.

(c) Method of spread.—Venereal; but accidental inoculation of children and, rarely, of the hands of doctors and nurses through professional contact with infected persons, may occur. Indirect transmission through articles soiled with moist discharges from lesions is rare.

(d) Incubation period.—Usually 3 to 5 days; limits, 1 to 10 days.

(e) Period of infectivity.—During persistence of organism in original lesion or regional adenitis. There is some evidence that carriers of the organism may result from former but healed chancroidal lesions.

(f) Isolation.—Exclusion from intimate personal contact with others until lesions have healed.

(g) Quarantine.—Nil.

(h) Immunisation.—Nil.

(i) Chemoprophylaxis.—Local application of prophylactic ointment before, during and after exposure.

(j) Current disinfection.—Discharges from lesions and articles soiled therewith.

(k) Terminal disinfection.—Nil.

(l) General control measures.—As for gonorrhoea.

(m) Notification.—Include in weekly return of communicable diseases.

3.

Chicken pox

(a) *Chicken pox* is caused by a filterable virus, which seems to be identical with that of *herpes zoster*. Almost all individuals who have not had the disease are susceptible, but an attack almost invariably confers life-long immunity.

(b) Source of infection.—Skin lesions and respiratory tract.

(c) Method of spread.—Direct contact, fomites and droplet infection.

(d) Incubation period.—2 to 3 weeks.

(e) Period of infectivity.—Up to 6 days from the appearance of the first vesicles. Droplet infection is possible before vesicles appear.

(f) Isolation.—Exclude infected children from school and segregate cases from non-immunes.

(g) Quarantine of contacts.—Nil.

(h) Immunisation.—Nil.

(i) Chemoprophylaxis.—Nil.

(j) Current disinfection.—Articles soiled by lesions and by nose and throat discharges.

(k) Terminal disinfection.—Cleaning.

(l) General control measures.—Small pox must be eliminated as a diagnosis, especially in individuals over 15 years of age.

(m) Notification.—Form 418 to Service authorities and, in some districts, local M.O.H.

4.

Cholera

(a) *Cholera* is caused by the *Vibrio comma*. Most individuals are susceptible, though a limited degree of natural immunity seems to exist.

(b) Source of infection.—Stools and vomit of patients. Faeces of carriers, who may be convalescent cases or infected, healthy contacts. The carrier state rarely persists for more than three months.

(c) Method of spread.—Water. Uncooked food, especially fruit and vegetables. Flies. Direct contact. Food handlers.

(d) Incubation period.—Usually 3 days; limits, a few hours to 5 days.

(e) Period of infectivity.—Usually 7 to 14 days, until the organism disappears from the stools.

(f) Isolation of patient in fly-proofed room for period of infectivity.

(g) Quarantine of contacts for 5 days from last exposure. Isolate if cholera vibrio found in stools, which should be examined daily.

(h) Immunisation.—All those exposed to risk should be inoculated with cholera vaccine. The duration of immunity conferred by inoculation is not more than 6 to 12 months.

(i) Chemoprophylaxis.—Nil.

(j) Current disinfection.—Must be prompt and thorough for stools, vomit and all articles used by or in connection with patient. Any food uneaten by patient should be burned.

(k) Terminal disinfection.—Thorough cleaning.

(l) General measures.—Scrupulous cleanliness for nursing staff and sick attendants, who must be rigidly excluded from food preparation. Sterilisation of water supplies. Prohibition of all uncooked food. Fly control. Bacteriological search for carriers among contacts and, especially, food handlers. Control of movements of local native population and their inoculation if considered advisable.

(m) Notification.—Form 418 to Service and Civil authorities.

5.

Dengue

(a) *Dengue* is a mosquito-borne disease caused by a filterable virus. Susceptibility is apparently universal and permanent immunity is usually acquired by an attack.

(b) Source of infection.—Blood of infected individuals during first 3 to 5 days of the disease.

(c) Method of spread.—The bite of infected *Aedes aegypti* or *Aedes albopictus* mosquitoes, which become infective for their lifetime from the 11th day after biting.

(d) Incubation period.—Usually 5 or 6 days; limits, 3 to 15 days.

(e) Period of infectivity.—From the day before onset to the 5th day of the disease.

(f) Isolation.—Nurse cases under a mosquito net.

(g) Quarantine.—Nil.

(h) Immunisation.—Nil.

(i) Chemoprophylaxis.—Nil.

(j) Current disinfection.—Nil.

(k) Terminal disinfection.—Nil.

(l) General control measures.—Personal protection from vector, which bites voraciously at any hour, but particularly in the afternoon and early morning. Elimination of breeding places of vector. Killing of adult mosquitoes. Use of DDT (and see *Yellow fever*, pp. 190–191).

(m) Notification.—As a local requirement only.

6.

Diphtheria

(a) *Diphtheria* is caused by the *Corynebacterium diphtheriae*, the Klebs Loeffler bacillus. Young infants lose their congenital immunity generally by the sixth month. Natural acquired immunity is common in older children and adults who have been exposed to sub-infective doses, especially among the inhabitants of large towns, but is less common in rural areas. Recovery from an attack, especially if anti-toxin has been used, does not necessarily confer active immunity. Non-immunes among R.A.F. personnel will be found to average about 25 per cent on most stations.

(b) Source of infection.—Discharges from diphtheritic lesions of the nose, throat, conjunctiva, vagina and skin. Secretions from the nose and throat of carriers.

(c) Method of spread.—Personal contact, fomites, droplet infection, contaminated milk and milk products.

(d) Incubation period.—Usually 2 to 5 days; limits, 1 to 7 days, but may be longer if disease supervenes in a susceptible carrier.

(e) Period of infectivity.—Usually 2 weeks, or less; seldom more than $\frac{4}{5}$ weeks.

(f) Isolation.—Until 3 consecutive daily swabs from nose and throat have been negative for virulent bacilli.

(g) Quarantine.—Nil, except for intimate child contacts, and adults in close contact with children, or who are food handlers, until carrier state has been excluded bacteriologically.

(h) Immunisation.—Infants should be immunised with diphtheria toxoid by the age of 6 months and a single reinforcing dose given on entrance to school. Children not done in infancy should be immunised at the age of 6 years. Schick positive adults especially exposed to risk should be actively immunised, preferably with toxoid-antitoxin-floccules, as this rarely causes an untoward reaction. Passive immunisation with antitoxin for close contacts is only advisable for children under 5 years; for others daily medical examination is sufficient.

(i) Chemoprophylaxis.—Nil.

(j) Current disinfection.—All articles which have been in contact with, or soiled by, the patient.

(k) Terminal disinfection.—Thorough airing, sunning and cleaning.

(l) General control measures.—Pasteurisation or boiling of all milk. If several cases occur at about the same time, Schick testing and nose and throat swabbing of all those at risk is generally advisable. Swab positive individuals may be either carriers or incubating the disease and should be isolated until they are no longer a danger to the community. Schick positive, swab negative individuals should receive active immunisation.

(m) Notification.—Form 418 to Service and Civil authorities.

7.

Dysentery, amoebic

(a) *Amoebic dysentery* is caused by the *Entamoeba histolytica*. Although susceptibility to infection is general, relatively few infected individuals develop clinical symptoms.

(b) Source of infection.—Stools of infected persons.

(c) Method of spread.—Contaminated food, especially if cold and moist, such as fruit and fresh vegetables; contaminated water; flies; infected food handlers.

(d) Incubation period.—Usually 3 to 4 weeks; limits, 2 days to several months.

(e) Period of infectivity.—While active or cystic forms of E.H. are present in the bowel, which may be for many years.

(f) Isolation.—Nil.

(g) Quarantine.—Nil.

(h) Immunisation.—Nil.

(i) Chemoprophylaxis.—Nil.

(j) Current disinfection.—Sanitary disposal of stools. Hand washing after defæcation.

(k) Terminal disinfection.—Cleaning.

(l) General control measures.—Sound conservancy methods. Protection of water supplies against contamination and their sterilisation where necessary. It should be noted that the usual chlorination processes do not destroy E.H. cysts. Kitchen cleanliness. Hygienic control of cooks and food handlers. Fly control. Energetic treatment of carrier problem by adequate treatment of cases and a requirement of 7 negative stools before their discharge to duty. (See also pp. 36-38.)

(m) Notification.—Form 418 to Service and Civil authorities.

8.

Dysentery, bacillary

(a) *Bacillary dysentery* is caused by the *Flexner*, *Sonné*, *Shiga* and other species of dysentery bacilli. Control measures directed against dysentery are also applicable to outbreaks of epidemic diarrhoea and acute infective enteritis.

(b) Source of infection.—Stools of infected individuals. Healthy carriers are common.

(c) Method of spread.—Contaminated water and food supplies; flies; food handlers.

(d) Incubation period.—1 to 7 days, usually less than 4 days.

(e) Period of infectivity.—Until the infecting organism is absent from the bowel. A few days' sulphonamide treatment will effect this, but the organism generally disappears from the stools in a few weeks without specific treatment.

(f) Isolation of cases during period when organism is present in the stools.

(g) Quarantine.—Nil.

(h) Immunisation.—No satisfactory vaccine or other preparation yet available.

(i) Chemoprophylaxis.—For closed communities exposed to special risk, sulphaguanidine or, for Sonné outbreaks, succinylsulphathiazole may be used in 2 gramme dosage daily for not more than 3 days under strict medical supervision.

(j) Current disinfection.—Stools should be treated with disinfectant or burned.

(k) Terminal disinfection.—Cleaning.

(l) General control measures.—Sound conservancy. Protection and sterilisation of water supplies. Pasteurisation or boiling of all milk. Clean kitchens. Hygienic control of cooks and food handlers. Fly control. Rigid cleanliness for sick attendants. (See also pp. 35-38).

(m) Notification.—Form 418 to Service and Civil authorities.

9.

Enteric fever

(a) *Enteric fever* includes typhoid fever due to *Eberihella typhi* and the paratyphoid fevers A, B and C, due to *Salmonella paratyphi*, *schottmulleri* and *hirschfeldii*. Many adults possess a naturally acquired immunity and permanent immunity usually follows recovery from the disease. 2 to 5 per cent of patients become permanent carriers.

(b) Source of infection.—Faeces or urine of cases and carriers.

(c) Method of spread.—Direct contact with patient or carrier; contaminated food, water, milk and shell fish; flies; food handlers.

(d) Incubation period.—Typhoid fever: usually 7-14 days; limits 3-38 days. Paratyphoid fever: 1 to 10 days.

(e) Period of infectivity.—From the appearance of prodromal symptoms till the disappearance of the infecting organism from the excreta.

(f) Isolation.—In flyproof room until 14 consecutive negative cultures have been obtained from daily specimens of both faeces and urine, at least two of the faecal samples having been collected after calomel and salts. For typhoid cases, and suspected typhoid carriers, the Vi agglutination test should also be performed before discharge from hospital and, if positive, repeated in 3 months' time. If the Vi agglutination titre is then at the same level or higher, the individual must be regarded as a potential typhoid carrier and 6 further specimens of faeces and urine examined. Whether or not confirmation of the carrier state is obtained by these repeated stool and urine examinations, the complete history

of the individual concerned should be referred at this stage to the Air Ministry (D. of H.) for consideration and for notification to the Ministry of Health, where a register of proved and potential carriers is maintained.

(g) Quarantine.—Nil.

(h) Immunisation.—Of R.A.F. personnel, annually at home and abroad. Initial dosage 0.25 and 0.5 c.c. of TABC vaccine with interval of not less than 14 days but preferably 3 weeks intervening between the doses ; re-inoculation dosage 0.25 c.c. Inoculation or re-inoculation of all unprotected personnel is advisable in the presence of an epidemic. Initial depression of immunity immediately following inoculation is now accepted as not constituting a danger and is not a valid objection to this procedure.

(i) Chemoprophylaxis.—Nil.

(j) Current disinfection.—All faeces, urine and articles soiled by them. Use 2½ per cent cresol for 2 hours.

(k) Terminal disinfection.—Cleaning.

(l) General control measures.—Sound conservancy. Protection and sterilisation of water supplies. Pasteurisation or boiling of all milk. Pasteurisation of milk products and ageing of cheese for not less than 60 days at 2° C. Prohibition of uncooked food. Mineral waters, ice cream and shellfish from approved sources only. Clean kitchens. Hygienic control of cooks and food handlers. Fly control. Strict cleanliness for attendants on sick. Search for source of infection, with special consideration of carriers, unreported cases and contaminated food, water, milk and shellfish. (See also pp. 36-38).

(m) Notification.—Form 418 to Service and Civil authorities. 'Enteric group (clinical)' to be notified in addition to cases proved bacteriologically.

10.

Food poisoning

The symptoms of *food poisoning* may be due to substances elaborated by intrinsically toxic plants, including the poisonous fungi, hemlock, henbane, aconite, certain vetches (lathyrism), ackee fruit, manioc, datura, coral plant and others ; or they may be caused by inorganic poisons which have gained access to food, e.g. arsenic from the sulphuric acid contained in the brewing glucose that may be used in making beer or home-made wine, antimony dissolved out from cheap enamel ware by acid drinks such as lemonade, and preservatives such as boron, formaldehyde, salicylates and fluorine which are now illegal in the United Kingdom but may be encountered in preserved foods overseas. From the epidemiological standpoint, however, food poisoning due to bacterial infection of foodstuffs is of prime importance. Such infections may be non-specific or due to the staphylococcus, the Salmonella group of organisms or the *Clostridium botulinum*, and will be discussed under these sub-headings.

(a) *Non-specific bacterial food poisoning*.—A mass infection of a foodstuff by certain non-specific bacteria such as *B. proteus*, *B. prodigiosus*, *B. pyocyaneus* or even *B. coli* will cause symptoms of food poisoning in the consumers of the food. As putrefaction usually accompanies extensive multiplication of these organisms,

the taste is generally sufficient to discourage further eating and outbreaks of food poisoning due to this cause are rare. The same proviso applies to poisoning by ptomaines, which are break-down products of protein molecules, are not very toxic and only become evident after at least a week's decomposition of the food.

(b) *Staphylococcus food poisoning*

(i) Due to a heat stable toxin elaborated by certain strains of staphylococcus believed to be of human origin. It is probably the commonest form of acute food poisoning.

(ii) Source of infection.—Not always traceable.

(iii) Method of spread.—Custard filled pastry, processed meats (especially ham) or milk are the usual vehicles of infection.

(iv) Incubation period.—Usually 2 to 4 hours ; limits, one half to 4 hours.

(v) Period of infectivity.—Nil.

(vi) Isolation.—Nil.

(vii) Quarantine.—Nil.

(viii) Immunisation.—Nil.

(ix) Chemoprophylaxis.—Nil.

(x) Current disinfection.—Nil.

(xi) Terminal disinfection.—Nil.

(xii) General control measures.—Individuals with pyogenic skin infections, especially of the hands, should be temporarily excluded from food handling. Sliced and chopped meats, custards and cream fillings, should be refrigerated promptly after preparation in order to prevent multiplication of staphylococci that may have been introduced. Alternatively, foods with custard or cream fillings should be heat treated after preparation.

(xiii) Notification.—Forms 418 to R.A.F. medical authorities.

(c) *Salmonellosis*

(i) The Salmonella group of organisms comprises more than 100 species. It contains the paratyphoid bacilli, as well as those responsible for outbreaks of food poisoning, diarrhoea and enteritis of which the ones most often incriminated are *Salmonella typhimurium* (Aertrycke), *S. enteritidis* (Gaertner) and *S. suispestifer*. Many outbreaks of diarrhoea following public dinners are due to this group of organisms.

(ii) Source of infection.—Usually animal. Faeces of patients and convalescent carriers. Chronic carriers are rare.

(iii) Method of spread.—Contamination of food by droppings of infected rats and mice. The meat or milk of infected animals. Eggs of infected ducks. Contamination of food or milk by infected food handlers. There is no obvious decomposition of the food affected.

(iv) Incubation period.—Usually about 24 hours; limits, 6 to 48 hours.

(v) Period of infectivity.—Throughout illness. Secondary cases, however, are uncommon.

(vi) Isolation.—Nil, but exclude patients from food handling and child care until recovered.

(vii) Quarantine.—Nil.

(viii) Immunisation.—Nil.

(ix) Chemoprophylaxis.—Nil.

(x) Current disinfection.—Stools and articles soiled by them.

(xi) Terminal disinfection.—Cleaning.

(xii) General control measures.—Elimination of rodents and other vermin and protection of foodstuffs from them. Refrigeration of foodstuffs, especially made up meat dishes and tinned foods not consumed shortly after removal from the tin, in order to prevent multiplication of organisms which may be very rapid in the summer months. Strict cleanliness of food handlers, kitchen premises and utensils. Exclusion from work of food handlers suffering from diarrhoea.

(xiii) Notification.—Forms 418 to R.A.F. medical authorities.

(d) Botulism

(i) Botulism is a form of food poisoning with a very high fatality rate caused by the heat labile toxins produced by the various strains of *Clostridium botulinum* and *Cl. parabotulinum*.

(ii) Source of infection.—Usually preserved foods in tins, glass or stoneware which have been inadequately heat treated. Home canned peas and beans especially.

(iii) Method of spread.—Consumption of food containing toxin which has not been destroyed by heat.

(iv) Incubation period.—Usually less than 24 hours.

(v) Period of infectivity.—Not applicable.

(vi) Isolation.—Nil.

(vii) Quarantine.—Nil.

(viii) Immunisation.—Nil.

(ix) Chemoprophylaxis.—Nil.

(x) Current disinfection.—Nil.

(xi) Terminal disinfection.—Nil.

(xii) General control measures.—Nil.

(xiii) Notification.—Forms 418 to R.A.F. medical authorities.

11.

German measles

(a) *German measles* is caused by a filterable virus. Susceptibility is general among young children and common among young adults. Permanent immunity usually results from an attack.

(b) Source of infection.—Mouth and possibly nose secretions of patients.

(c) Method of spread.—Droplet infection. Articles recently soiled by nose and throat discharges of patient.

(d) Incubation period.—Usually about 16 days; limits, 14 to 21 days.

(e) Period of infectivity.—From onset of catarrhal symptoms for a period of 4 to 7 days.

(f) Isolation.—Of no practical value.

(g) Quarantine.—Nil.

(h) Immunisation.—Nil.

(i) Chemoprophylaxis.—Nil.

(j) Current disinfection.—Nil.

(k) Terminal disinfection.—Nil.

(l) General control measures.—See pages 148–155.

(m) Notification.—Nil.

12.

Gonorrhœa

(a) *Gonorrhœa* is caused by the gonococcus, *Neisseria gonorrhœae*. Susceptibility seems to be general and an attack does not confer immunity.

(b) Source of infection.—Discharges from mucous membranes and glands of infected individuals.

(c) Method of spread.—Direct personal contact with an infected person or, rarely, indirectly through articles freshly soiled by the discharges of an infected person.

(d) Incubation period.—Usually 3 to 5 days; limits, 1 to 8 days, rarely longer.

(e) Period of infectivity.—During persistence of the gonococcus in any discharging lesion.

(f) Isolation.—During period of infectivity.

(g) Quarantine of contacts.—Nil.

(h) Immunisation.—Nil.

(i) Chemoprophylaxis.—Oral prophylaxis not advisable owing to the marked tendency of the gonococcus to become sulphonamide resistant. Local application of prophylactic ointment before, during and after exposure.

(j) Current disinfection.—Discharges and articles soiled therewith.

(k) Terminal disinfection.—Nil.

(l) General control measures.—Education of personnel on dangers of the disease and the use of early treatment facilities after exposure to infection. Co-operation with civil authorities in tracing sex contacts. Exclusion of cases from food handling until certified as being non-infective.

(m) Notification.—Include in weekly return through usual channels.

13.

Influenza

(a) A highly infectious condition due to a filterable virus of which two distinct strains have been isolated. Type A has been associated with the more widespread epidemics. Type B outbreaks are usually more localized. In some epidemics neither type has been found. Up to 50 per cent of a population may be affected, but a natural immunity appears to exist in from 25 per cent to 75 per cent of people. Natural immunity following an attack seems to last for only a few months to a year and is conferred only against a specific strain of virus. Artificial active immunity is still only in the experimental stage.

(b) Source of infection.—Throat and nose discharges of infected persons and articles freshly soiled with these discharges.

(c) Method of spread.—Droplet infection or by contact with articles freshly soiled with infectious throat and nose discharges.

(d) Incubation period.—1 to 3 days.

(e) Period of infectivity.—Possibly in the prodromal as well as the febrile period.

(f) Isolation.—During acute stage of illness.

(g) Quarantine.—Nil.

(h) Immunisation.—Experimental only.

(i) Chemoprophylaxis.—Nil.

(j) Current disinfection.—Nose and throat discharges.

(k) Terminal disinfection.—Nil.

(l) General control measures.—Reduce overcrowding. Improve ventilation. Space out beds. Increase open air exercise. Avoid kissing and the use of common towels, glasses, eating utensils and toilet articles when possible. Buildings to augment sick quarter accommodation should be earmarked at the beginning of the winter for use in the event of an epidemic, so as to ensure no delay in the prompt isolation and treatment of infected individuals. Prophylactic gargling is not advised (*see* pp. 152, 174 and 178).

(m) Notification.—Forms 418 to R.A.F. and Civil medical authorities for cases diagnosed as 'Pneumonia, acute influenzal'. Influenza cases to be recorded in weekly return of communicable diseases rendered through usual channels.

14. **Jaundice, acute, catarrhal (acute infective hepatitis)**

(a) This condition is due to a specific filterable virus and may or may not be associated with evident icterus. It is most common in children and young adults and is usually of longer duration and greater severity in adults. Second attacks have not been reported.

(b) Source of infection.—Discharges from the alimentary tract of infected persons and possibly also from the nose and mouth. The blood may contain the infective agent and infection may be transmitted by syringes which have been used for the extraction of blood and have not been adequately sterilised subsequently. Carriers may occur.

(c) Method of spread.—Unknown, but seems to be related to insanitary conditions.

(d) Incubation period.—Usually 21 to 35 days.

(e) Period of infectivity.—Unknown.

(f) Isolation.—During the first week of illness.

(g) Quarantine.—Nil.

(h) Immunisation.—Nil.

(i) Chemoprophylaxis.—Nil.

(j) Current disinfection.—Nose, throat and bowel discharges.

(k) Terminal disinfection.—Nil.

(l) General control measures.—In the presence of an epidemic, until the mode of transmission of this disease is better understood, it is advisable to employ the general measures aimed at the control of both droplet infections and those conditions spread by bowel discharges, such as enteric fever.

(m) Notification.—Form 418 to R.A.F. medical authorities. Information of outbreak to local Civil health authority. Weekly return of communicable diseases through usual channels.

15. Jaundice, haemorrhagic (Weil's disease, icterohaemorrhagic spirochaetosis)

(a) A condition caused by *Leptospira icterohaemorrhagiae* and occasionally by *L. canicola*, which is accompanied by jaundice in only about 50 per cent of cases. Transient immunity may last for a considerable period after an attack.

(b) Source of infection.—Urine and faeces of rats, dogs, foxes, sheep, cats and sometimes mice. Wild rats are persistent carriers.

(c) Method of spread.—Ingestion of contaminated food and water. Through damaged or intact skin exposed to alkaline waters containing leptospira. Sewer workers, fish dealers, miners, veterinary workers and canal bathers most commonly contract the infection.

(d) Incubation period.—Usually 9 to 10 days; limits, 4 to 19 days.

(e) Period of infectivity.—Urine may contain the infecting organism for months after convalescence, but direct contact cases are almost unknown.

(f) Isolation.—Nil.

(g) Quarantine.—Nil.

(h) Immunisation.—Nil.

(i) Chemoprophylaxis.—Nil.

(j) Current disinfection.—Urine and other discharges.

(k) Terminal disinfection.—Nil.

(l) General control measures.—Rat control. Prohibition of bathing in waters with rat infested banks. Sound conservancy.

(m) Notification.—Form 418 to R.A.F. medical authorities. Weekly return of communicable diseases through usual channels.

Malaria

16.

(a) *Malaria* is caused by infection with one or more of four species of Plasmodia—*Plasmodium vivax* (causing BT or benign tertian malaria), *P. malariae* (causing quartan malaria), *P. falciparum* (causing malignant sub-tertian malaria) and *P. ovale*. Susceptibility is universal. Relative immunity to clinical attacks can be acquired only against specific strains of parasites after repeated infections with these strains. Immunity to other species of Plasmodia is not developed in this way; and only slight immunity to other strains of the same species.

(b) Source of infection.—Blood of an infected individual.

(c) Method of spread.—The bites of infected anopheline mosquitoes. Blood transfusion. Common use of an unsterilized syringe, as by drug addicts. A mosquito that has bitten an infected individual cannot transmit the infection until the completion within its body of the sporogonic cycle. This cycle, under favourable conditions of temperature and humidity, takes 10 to 14 days or, for the quartan parasite, 21 days. (See Fig. 36, p. 169).

(d) Incubation period.—This varies with the species of parasite and the amount of infection. After a sufficient exposure to the bites of infected mosquitoes, tertian malaria usually develops in about 14 days. The infection, however, may remain latent for many weeks or even months until a clinical attack is precipitated by some illness, accident or other event that lowers general bodily resistance.

(e) Period of infectivity.—As long as the sexual forms (gametocytes) of the malaria parasite are present in the circulating blood in sufficient numbers to infect mosquitoes. This may last for months in both treated and untreated cases, except as regards *P. falciparum* which can now be completely eliminated from the human body by mepacrine.

(f) Isolation.—Cases should be nursed under a mosquito net.

(g) Quarantine.—Nil.

(h) Immunisation.—Nil.

(i) Chemoprophylaxis.—Suppressive mepacrine (quinacrine, atebrine) is advisable for personnel exposed to special risk. A blood level of 100 mgms. per cent is considered necessary to control infection. This level should be built up by administration of mepacrine for 21 days before the malarious area is entered, using a daily dosage of 0.05 gramme for the first week and 0.1 gramme subsequently. This period of 21 days can be considerably curtailed in an emergency by stepping up the dosage to 0.2 gramme or even 0.3 gramme daily. It is probable that, by using a preliminary 'loading' dose of 1 gramme in 3 days, and following this by 0.1 gramme daily, the necessary blood level can be attained in 4 days and kept at that level in most individuals. Suppressing dosage during stay in a malarious area should be 0.1 gramme daily. This dosage should be kept up for 28 days after leaving the area to ensure the burning out of residual malignant tertian parasites, but it must be remembered that

FIG. 36

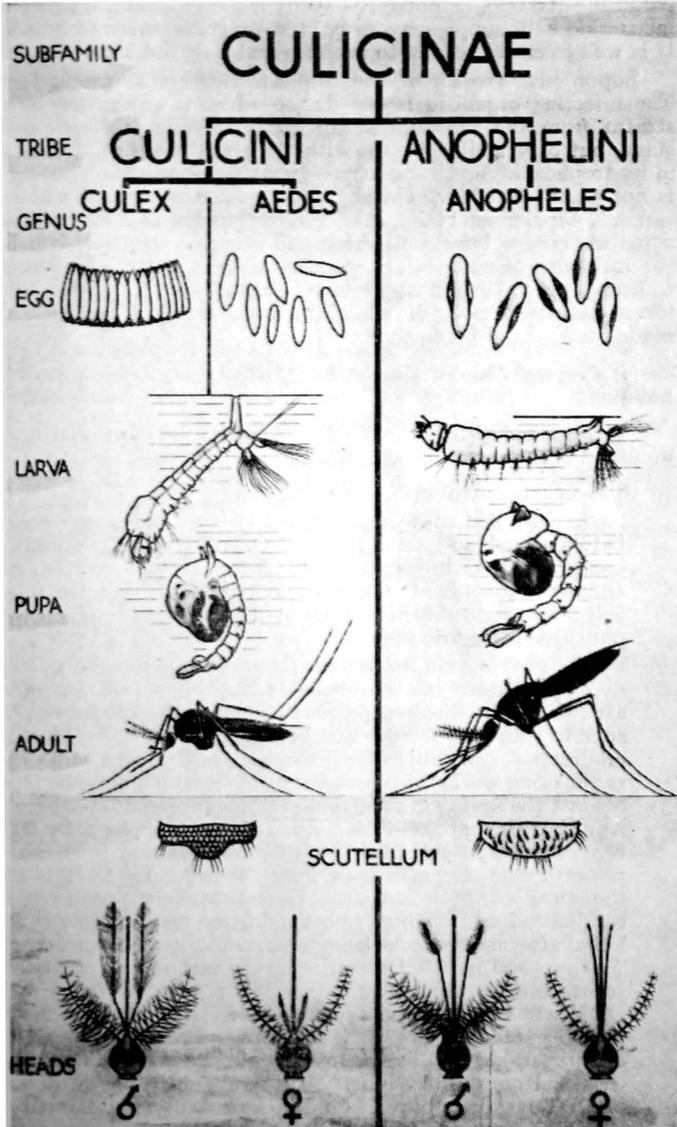

MOSQUITOES

clinical attacks of benign tertian malaria may still occur after suppressive treatment on these lines has been faithfully carried out. The new drug, paludrine M.4888 (not to be confused with paludrine M.3349), is probably equally if not more efficacious than mepacrine as a suppressive drug, and much superior to quinine. It is well tolerated, cheap to produce and does not stain the skin.

Suppressive treatment does not constitute true prophylaxis. The infecting organism is not destroyed as it enters the blood stream from the mosquito's salivary glands in the sporozoite stage, but only as it develops within the red blood cells, that is, in its trophozoite and gametocyte forms. Suppressive treatment is not a substitute for general control measures against malaria, but only supplements them in special circumstances; for example, when the risk of infection is high and other methods of reducing the incidence of malaria are insufficient, or when it is necessary to keep a special group of personnel entirely free from symptoms for a definite period, or when the local hospital facilities are inadequate or too far distant.

(j) Current disinfection.—Nil. Destruction of mosquitoes in building.

(k) Terminal disinfection.—Nil. Destruction of mosquitoes in building.

(l) General control measures :—

(i) Personal protection. Long sleeves and long trousers between dusk and dawn (*see* A.M.O. A.8/1945); two pairs of socks, gaiters or mosquito boots; fish net veils, mittens and anklets impregnated with dimethyl phthalate or other repellent; wire screening of buildings; mosquito nets; repellents; punkahs or electric fans.

(ii) Elimination of anopheline mosquitoes. Any steps taken to reduce the anopheline mosquito population of an area should be directed primarily against the species responsible in that area for the transmission of malaria. Complete eradication generally requires extensive drainage and other engineering works, the initial expense of which must be offset against the saving in recurring maintenance and labour costs. As a short-term policy, the control of breeding places by DDT has been very successful, both by aircraft and by hand or power operated sprays used from the ground. DDT is also the most effective anti-adult insecticide yet produced, its residual effect by which one application to a surface is still lethal after many weeks being a particularly valuable feature. The use of oil and Paris Green as larvicides has been practically superseded by this substance. A summary of the uses of DDT will be found on pp. 200–204. Anti-larval measures should extend at least half a mile from all living quarters, but preferably to a radius equal to the normal flight range of the local mosquito vector. Anti-adult measures, in default of DDT residual spray, should include daily spraying with a suitable insecticide of all sleeping quarters and other rooms that are used between dusk and dawn.

(iii) Camp siting. In malarious areas, no living quarters should be sited within flight range of anopheline mosquito breeding areas unless these are strictly controlled. No

native habitations should be permitted within half a mile, preferably one mile, of living quarters situated in malarious districts.

(iv) The enforcement of anti-malaria measures is primarily the responsibility of Commanding Officers and their duties in this respect require strong emphasis and support from the highest executive authorities, especially under field or mobile conditions.

(m) Notification.—Form 418 to Service and Civil authorities. Weekly return of communicable diseases, through usual channels.

17.

Measles

(a) *Measles* is caused by a filterable virus. Susceptibility is general. An attack confers permanent immunity.

(b) Source of infection.—Mouth and nose secretions of an infected individual.

(c) Method of spread.—Droplet infection. Indirectly through articles freshly soiled with mouth and nose discharges of an infected person.

(d) Incubation period.—About 10 days; limits, 7 to 18 days.

(e) Period of infectivity.—During period of catarrhal symptoms, about 9 days in all, from 4 days before to 5 days after the appearance of the rash.

(f) Isolation.—During period of infectivity or for 9 days from onset.

(g) Quarantine.—Nil, except for children in special circumstances, but contacts should be medically examined daily. Isolate as suspects any individuals showing a temperature rise of 1° F.

(h) Immunisation.—Passive immunity, lasting for not more than 4 weeks, sufficient to avert an attack completely or at least modify it considerably, can be obtained by the use of immune or convalescent serum or a preparation of immune globulins if it is injected within 5 days after exposure to infection. Given later than this, but before clinical symptoms are evident, modification of the severity of attack will still be obtained, with conferment of the usual lasting immunity subsequently. Immunisation is always advisable for children under 3 years when exposed to infection.

(i) Chemoprophylaxis.—Nil.

(j) Current disinfection.—All articles soiled with mouth and nose secretions.

(k) Terminal disinfection.—Thorough cleaning.

(l) General control measures.—Nil.

(m) Notification.—Form 418 to Service and Civil authorities. Weekly return of communicable diseases through usual channels.

18.

Mumps

(a) *Mumps* is caused by a filterable virus. Susceptibility is probably general. An attack confers immunity, but second attacks are not rare.

(b) Source of infection.—Mouth, and possibly nose, secretions,

(c) Method of spread.—Droplet infection. Articles freshly soiled with throat and nose discharges of infected individuals. Carriers are not known to occur.

(d) Incubation period.—Usually 18 days ; limits, 12 to 26 days.

(e) Period of infectivity.—Probably beginning at least 1 to 2 days before distinctive symptoms develop, but persisting no longer than salivary gland swellings are evident.

(f) Isolation.—Segregation from non-immunes until glands are normal may limit epidemic spread.

(g) Quarantine.—Nil.

(h) Immunisation.—Brief passive immunity may follow inoculation with convalescent serum or whole blood but the procedure is practically valueless as a control measure.

(i) Chemoprophylaxis.—Nil.

(j) Current disinfection.—Nil.

(k) Terminal disinfection.—Nil.

(l) General control measures.—Nil.

(m) Notification.—Weekly return through usual channels.

19.

Plague

(a) *Plague* is caused by the bacillus, *Pasteurella pestis*. Susceptibility is general, particularly to the pneumonic form which is intensely communicable during the stage of acute symptoms. Natural immunity is rare. Recovery from an attack is almost always followed by lasting immunity.

(b) Source of infection.—Blood of infected rodents, including rats, gerbilles and ground squirrels. Sputum of human pneumonic cases.

(c) Method of spread.—Droplet infection in the pneumonic form. Bubonic and septicaemic forms are generally transmitted by the bites of fleas which leave dead or dying rodents in search of other hosts.

(d) Incubation period.—Usually 3 to 6 days, occasionally longer.

(e) Period of infectivity.—Pneumonic form, during stage of acute symptoms. Bubonic form not communicable by droplet infection or direct contact.

(f) Isolation.—In hospital for one month.

(g) Quarantine of contacts for 6 days.—Their protection by serum and vaccine is advisable.

(h) Immunisation.—For persons exposed to unusual risks of infection. Passive immunity of about 3 to 4 weeks duration can be obtained by anti-plague serum. Active immunity from plague vaccine of about 6 months' duration may be relied upon.

(i) Chemoprophylaxis.—Nil.

(j) Current disinfection.—Sputum and articles soiled therewith, in pneumonic form of disease. Evacuation, thorough cleaning and fumigation of premises in which bubonic cases have occurred. Personnel undertaking these duties to be protected with gumboots, gauntlets and overalls.

(R) Terminal disinfection.—Thorough cleaning and fumigation to destroy rats and fleas. Bodies of persons dead from plague should be handled with strict antiseptic precautions.

(l) General control measures.—Unremitting anti-rat measures in endemic districts, especially in dock areas. Immediate active immunisation of all at risk on first signs of rat epizootic. Protection of sick attendants by immunisation, hoods with mica or plastic windows, rubber gloves, gum boots and long gowns or overalls. Dead rats must be picked up only with tongs or other implement. Use of DDT.

(m) Notification.—Form 418 to Service and Civil authorities.

20.

Pneumonia

(a) *Acute lobar pneumonia* is due to the pneumococcus. Other bacteria such as streptococcus, staphylococcus, *Klebsiella pneumoniae* (Friedlander's bacillus) and *Haemophilus influenzae*, also cause pneumonic conditions, often associated with or as complication of respiratory virus diseases. Primary atypical pneumonia in most cases is probably caused by a virus.

(b) Sources of infection.—Probably discharges from the mouth and nose of infected persons, and articles freshly soiled with such discharges.

(c) Method of spread.—Droplet infection. Direct contact with infected persons or with articles freshly soiled with their nose and throat discharges.

(d) Incubation period.—

Pneumococcal pneumonia.—Usually 1 to 3 days.

Bacterial pneumonia.—Variable, usually short.

Primary atypical pneumonia.—Believed 7 to 21 days.

(e) Period of infectivity.—Unknown. Presumably while virulent organisms are given off in nose and throat discharges.

(f) Isolation.—Medical aseptic technique.

(g) Quarantine.—Nil.

(h) Immunisation.—Nil.

(i) Chemoprophylaxis.—Nil.

(j) Current disinfection.—Discharges from nose and throat of patient.

(k) Terminal disinfection.—Thorough cleaning and airing.

(l) General control measures.—See page 148-155.

(m) Notification.—Forms 418 to Service and Civil authorities for cases of acute influenzal and acute primary pneumonia. All cases to be recorded in weekly return of communicable diseases rendered through usual channels.

21.

Poliomyelitis

(a) *Acute anterior poliomyelitis* and *acute poliioencephalitis* are caused by a filterable virus. Immunity is usually high among adults who have lived in large cities. Even during epidemics only one person in several hundred suffers a clinical attack of the disease.

(b) Source of infection.—Nose and throat discharges of infected persons, more frequently those not suffering from a clinical attack. Stools also contain the virus.

(c) Method of spread.—Droplet or alimentary infection, presumably from a carrier or a person with a sub-clinical infection in most instances. The virus has been recovered from flies and sewage effluents, but there is as yet no reliable evidence that the former act as vectors or that water supplies form a route of transmission.

(d) Incubation period.—Considered to be 7 to 14 days.

(e) Period of infectivity.—Not definitely known, but apparently covered by the latter part of the incubation period and the first week or two of the disease—possibly much longer in a few cases.

(f) Isolation.—For 3 weeks from onset.

(g) Quarantine.—For children, and adults in contact with children, or who are food handlers—14 days from last exposure.

(h) Immunisation.—Nil. Neither vaccines nor convalescent serum have proved of value.

(i) Chemoprophylaxis.—Nil.

(j) Current disinfection.—Nose, throat and bowel discharges and articles soiled therewith.

(k) Terminal disinfection.—Nil.

(l) General control measures.—Intensive search for mild, missed and abortive cases and their isolation when found. Prophylactic gargling is not advisable. For closed communities, limitation of travel is a useful measure which may reduce incidence in the presence of an epidemic.

(m) Notification.—Form 418 to Service and Civil authorities. Weekly return of communicable diseases through usual channels.

22.

Rabies

(a) *Rabies* is an invariably fatal acute encephalitis caused by a filterable virus. Natural immunity is not known to exist.

(b) Source of infection.—Infected animals, chiefly dogs; vampire bats in limited areas, notably Trinidad.

(c) Method of spread.—Usually bites by a rabid animal; occasionally through contact of a rabid animal's saliva with a scratch or broken skin.

(d) Incubation period.—Usually 2 to 6 weeks; may be prolonged to 6 months or even more, depending upon the extent of laceration, the site of the wound in relation to richness of nerve supply and the length of nerve supply to the brain.

(e) Period of infectivity.—In the dog, from 8 to 10 days before the onset of its clinical symptoms. Rarely, if ever, communicated from man to man.

(f) Isolation.—Nil if attendants are aware of possibility of infection by human saliva.

(g) Quarantine.—Nil for human contacts. Animals suspected of infection should be kept in quarantine and observed for at least 10 days, by the end of which time symptoms should be in evidence.

(h) Immunisation.—Prophylactic anti-rabic inoculation of infected humans will prevent development of the disease with rare exceptions, if begun soon after the injury and the site of the

wound is not extensive in the distribution of the facial nerve. It should be afforded to persons bitten by or intimately exposed to the saliva of a rabid animal, or suspected rabid animal, especially a dog, unless the animal is proved not to be rabid by subsequent observation or by microscopic examination of its brain and spinal cord. The wound should be immediately treated to its depths with fuming nitric acid, care being taken to protect the eyes when the bite is on or near the face. The usual course of anti-rabic vaccine requires 15 days for completion.

(i) Chemoprophylaxis.—Nil.

(j) Current disinfection.—Saliva of patients and articles soiled therewith.

(k) Terminal disinfection.—Nil.

(l) General control measures.—Detention and examination of suspected rabid dogs, which should not be killed until they have been observed for at least 10 days or have been confirmed as suffering from rabies on clinical evidence. Destruction of ownerless dogs. Dogs to be kept on leash in congested areas. Muzzling orders if canine rabies prevalent. Artificial active immunity can be developed in a majority of dogs by anti-rabic vaccine.

(m) Notification.—Form 418 to Service and, in some districts, to Civil authorities. Notification by signal to D.G.M.S. for Home Commands, or to competent medical authority in Overseas Commands, of cases requiring specific anti-rabic treatment. Notification, in duplicate, by medical officer attending the case to the competent medical authority of the following particulars :—

- (i) Name, rank, age and unit of the person bitten ;
- (ii) Time and date when bitten ;
- (iii) Locality where injury occurred ;
- (iv) Part of body bitten and whether through clothing ;
- (v) Number of bites received and their severity ;
- (vi) Kind of animal causing bite ;
- (vii) Whether animal was captured and what action has been taken regarding it ;
- (viii) Whether rabies has been diagnosed in the animal and by whom ;
- (ix) Name and address of owner of animal, or other information which will enable the animal to be identified.

23.

Relapsing fever

(a) Louse-borne type

(i) This form is caused by the spirochaete, *Borrelia recurrentis*. Acquired immunity after a clinical attack, in which there may be 1 to 10 relapses, probably does not last more than 1 or 2 years.

(ii) Sources of infection.—Infected lice, whose natural reservoir of infection is not known.

(iii) Method of spread.—After biting an infected individual the louse (*Pediculus humanus*) becomes infective in about 16 days and remains so throughout the remainder of its life of 30 to 40 days. Hereditary transmission in lice through

the egg to the larval form is reported to occur. Transmission of the organism to man is effected, not by the bite, but by crushing an infected louse into a bite wound or scratch or by rubbing louse excreta into an abrasion.

(iv) Incubation period.—About 7 days; limit 12 days.

(v) Period of infectivity.—Dependent upon presence of lice.

(xii) General control measures.—Reduction of human lousiness.

(b) *Tick-borne type*

(i) This form differs from the louse-borne type of relapsing fever in the vector, the species of spirochaete (*Borrelia duttoni*) and in the number of relapses which are rarely more than 3 in number. Acquired immunity after a clinical attack, as with the louse-borne type, probably does not last more than 1 or 2 years.

(ii) Source of infection.—Infected ticks of the genus *Ornithodoros*. The condition is primarily an infection of wild rodents, which form the natural reservoir.

(iii) Method of spread.—Bites of infected ticks.

(iv) Incubation period.—Usually 3 to 6 days; limits 2 to 12 days.

(v) Period of infectivity.—Not communicable from man to man except through intervention of tick vector.

(xii) General control measures.—Avoidance of tick infested caves, ground areas, native camp sites and camel halts. The ticks live in the soil and bite during darkness. They can survive for years without feeding and remain infective. Tick repellents should be used on socks and trousers in infested areas. Sitting or resting on the ground should be avoided. Clothing and body should be searched for ticks each night and morning.

Both types

(vi) Isolation.—Nil.

(vii) Quarantine.—Nil.

(viii) Immunisation.—Nil.

(ix) Chemoprophylaxis.—Nil.

(x) Current disinfection.—Nil.

(xi) Terminal disinfection.—Nil.

(xiii) Notification.—Form 418 to Service and Civil authorities.

24. **Sandfly fever**

(a) *Sandfly* or *phlebotomus fever* is caused by a filterable virus, to which susceptibility is apparently universal. Acquired immunity is usually lasting. Immunity of native populations in sandfly areas is probably attributable to infection early in life. The disease is seasonal, between April and October, and is particularly liable to affect personnel who have recently arrived from a non-endemic area.

(b) Source of infection.—The blood of an infected person.

(c) Method of spread.—The bite of *Phlebotomus papatasi*, a small, hairy, blood-sucking midge which does most of its biting at night. Other species of phlebotomus may also carry the virus.

(d) Incubation period.—Usually 3 to 4 days; limits, 2½ to 6 days.

(e) Period of infectivity.—The virus is present in the blood of an infected person at least 24 hours before and after the onset of fever.

(f) Isolation.—Nurse cases under sandfly net (45 meshes to the inch).

(g) Quarantine.—Nil.

(h) Immunisation.—Nil.

(i) Chemoprophylaxis.—Nil.

(j) Current disinfection.—Nil.

(k) Terminal disinfection.—Nil.

(l) General control measures.—Use of insect repellents and sandfly bed nets. Control of sandfly breeding. Destruction of adult insects. Use of DDT.

(m) Notification.—A local Service requirement only.

25.

Scarlet fever

(a) It should be clearly realised that the development of a rash in *scarlet fever* merely indicates that the individual concerned is susceptible to the erythrogenic toxin produced by some strains of *Lancefield's Group A haemolytic streptococci*; and that the particular strain responsible for his infection does in fact elaborate this toxin. Streptococcal sore throat without scarlatina can be just as serious a condition as frank scarlet fever, and may be attended by the same grave complications. The paragraphs that follow are applicable to streptococcal sore throat with or without a rash.

(b) Source of infection.—Discharges from the nose, throat or purulent complications of acutely ill or convalescent patients, or carriers, or objects contaminated with such discharges.

(c) Method of spread.—Direct contact. Droplet infection. Floor dust. Explosive outbreaks may follow the ingestion of contaminated milk or other food.

(d) Incubation period.—Usually 2 to 4 days; limits, 1 to 7 days.

(e) Period of infectivity.—Not definitely known, but can persist until the infectious process is healed. Purulent discharges may spread infection for many weeks. In uncomplicated cases the danger of spreading infection comes to an end with recovery from the infection, which usually takes place within 2 weeks.

(f) Isolation.—For uncomplicated cases 2 weeks, preferably in a separate cubicle, is now generally considered sufficient, but the period of isolation should be determined on the basis of the clinical course of the infection.

(g) Quarantine.—Nil.

(h) Immunisation.—Active immunisation will protect against the erythrogenic or rash-producing toxin of those types of haemolytic streptococci that elaborate it. It will not protect against their other toxins nor is it a safeguard against their

invasive properties. The procedure is definitely dangerous, since the appearance of a rash is a clear indication that what might have appeared to be a simple sore throat is in fact an infection with a virulent type of haemolytic streptococcus and may well be followed by nephritis or rheumatic fever.

(i) Chemoprophylaxis.—The majority of persons exposed to haemolytic streptococcal infections can be protected by the administration of sulphadiazine in a daily dosage of 1 gramme. The procedure is not free from danger and should only be employed under strict medical supervision and for a period of not more than 10 days.

(j) Current disinfection.—All articles soiled with purulent discharges or which have been in contact with the patient.

(k) Terminal disinfection.—Thorough cleaning of contaminated objects, scrubbing of floors and sunning of blankets.

(l) General control measures.—Daily medical examination of personnel exposed to risk. Segregation of individuals with evidence of upper respiratory infection throughout the course of their illness. Swabbing to detect carriers is of no practical value unless the serological type of the streptococcus responsible for the outbreak can be determined. In most epidemics in the Royal Air Force the percentage of individuals carrying haemolytic streptococci varies between 40 and 60 per cent, and the labour involved in typing such large numbers of cultures is usually beyond the powers of most laboratories. Prompt investigation of the possibility of milk borne spread is advisable, and boiling or pasteurization of the milk supply should be enforced. Infected individuals or those carrying the streptococcal type responsible for an epidemic should be excluded from food handling if milk or food is suspected as the vehicle of infection. Prophylactic gargling is inadvisable.

(m) Notification.—Form 418 to Service and Civil authorities.

26.

Schistosomiasis

(a) *Schistosomiasis* is an infestation by small trematode worms which enter the human body while in the larval stage, from water inhabited by the snails that are their intermediate hosts. The adult worms inhabit the rectal and vesical venous plexuses and the pathological effects of the disease result from the irritation set up by the very large numbers of eggs deposited by them in the mucous membranes of the rectum and bladder. Three species of these flukes mature in man, *Schistosoma mansoni*, *S. hæmatobium* and *S. japonicum*.

(b) Source of infection.—Fresh water inhabited by the intermediary snail hosts which has been contaminated by human excreta containing the ova of the parasite. (See Fig. 37, p. 179).

(c) Method of spread.—Ova are discharged in the stools or urine of an infected individual. The ova hatch into free swimming larvæ (myracidia) that are infectious only to the snail. Further development takes place within the liver of the snail and later stage larvæ, the fork tailed cercariæ, are liberated. These, too, are free swimming and must gain access to man, their host, within 48 hours if they are to survive. They are capable of penetrating the unbroken skin, often causing an irritative dermatitis at the site of entry, and then enter the blood stream.

Fig. 37

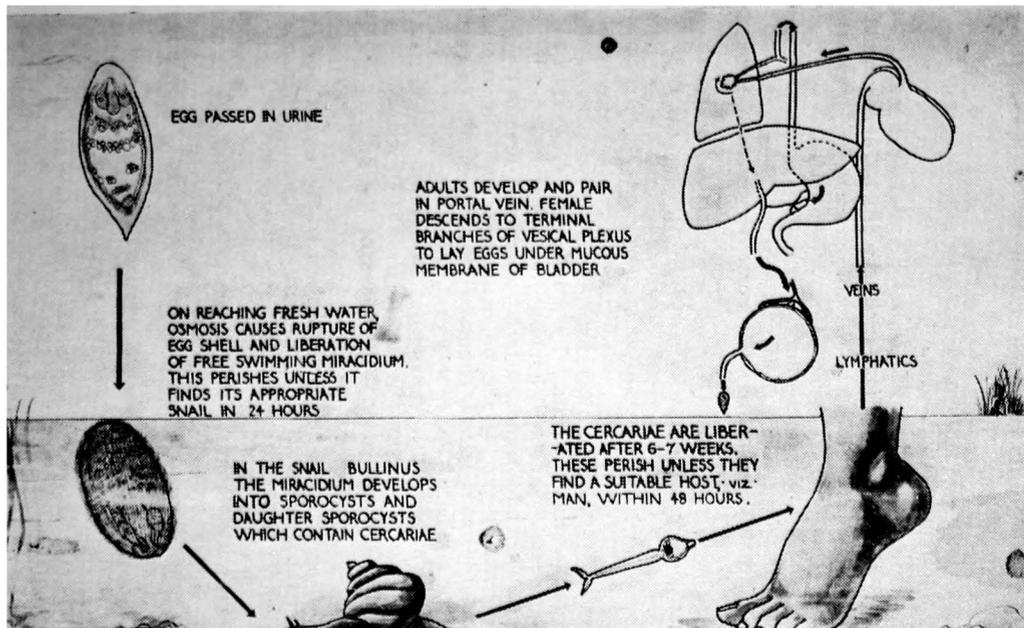

SCHISTOSOMIASIS

(d) Incubation period.—A period of at least one month, usually three, elapses after infection before ova are found in the stools or urine.

(e) Period of infectivity.—As long as ova are discharged in the stools or urine; but infection of other individuals can only take place if the life cycle of the parasite can be completed by the intervention of its intermediate host, the snail.

(f) Isolation.—Nil.

(g) Quarantine.—Nil.

(h) Immunisation.—Nil.

(i) Chemoprophylaxis.—Nil.

(j) Current disinfection.—Sanitary disposal of faeces and urine.

(k) Terminal disinfection.—Nil.

(l) General control measures.—Sound conservancy. Treatment of infected individuals. Examination of local streams, lakes and other collections of fresh water for infected snails. Prohibition of bathing in contaminated waters and sterilisation of drinking and washing water if this must unavoidably be taken from them. (see page 15).

(m) Notification.—Form 418 to competent R.A.F. medical authority.

27.

Smallpox

(a) *Smallpox* is caused by a filterable virus. Susceptibility is universal. Acquired immunity following an attack is usually permanent and second attacks are rare. Artificial immunity conferred by vaccination commonly lasts for 5 to 20 years. A higher degree of vaccinal immunity is required to protect against severe strains of smallpox virus, which may cause a mortality rate of 30 per cent, than against mild strains, which may be associated with a mortality rate of less than 1 per cent.

(b) Source of infection.—Lesions of the mucous membranes and skin of infected persons.

(c) Method of spread.—Direct contact, not necessarily intimate. Articles freshly contaminated with discharges from patient. Aerial transmission, except over short distances, appears to be unlikely.

(d) Incubation period.—Usually 12 days; limits, 7 to 21 days. The milder types tend to have longer incubation periods.

(e) Period of infectivity.—From first symptoms to the disappearance of all scabs and crusts. Most communicable in the early stages of the disease.

(f) Isolation.—In hospital until end of period of infectivity.

(g) Quarantine.—Of all contacts for 12 days after last exposure. Surveillance may be substituted for travellers.

(h) Immunisation.—Only dermal vaccination is recommended. Vaccination requirements for R.A.F. and W.A.A.F. are as shown below.

On enlistment.—One insertion only is necessary.

When proceeding overseas, other than to N.W. Europe.—Vaccination or re-vaccination with three insertions not less than 14 days and not more than two years previously

When proceeding to N.W. Europe.—Vaccination or re-vaccination with three insertions not less than 14 days and not more than 5 years previously.

During service at home and in N.W. Europe.—Re-vaccination every 5 years with three insertions.

During service overseas, other than in N.W. Europe.—Re-vaccination every 2 years with three insertions or at such shorter intervals as may be considered necessary by a local commander on the advice of his competent medical authority.

Insertions should be linear incisions, $\frac{1}{4}$ inch in length and 1 inch apart, made through the lymph with the point of a sterile needle, scalpel or other suitable instrument, deeply enough to draw a little blood without causing free bleeding. A protective dressing should be applied when the lymph has dried. Alcohol, ether, methylated spirits or other such agents should not be used for preliminary cleansing of the skin, owing to the risk of their inactivating the virus. Soap and water should be used for skin cleansing, followed by careful drying with a sterile swab.

Vaccination sites should be inspected seven days after vaccination. When vesicle formation is present, the result should be recorded as 'successful.' When there is no vesicle formation, re-vaccination must be carried out immediately with three insertions. Inspection is again carried out seven days later and when vesicle formation is present the result should be recorded as 'successful.' All other cases should be recorded as 'I.T.V.' (insusceptible to vaccination). Individuals who are recorded as 'I.T.V.' should be re-vaccinated at the intervals required for those who have been successfully vaccinated.

Vaccination results must be recorded in Form 48 (Medical History Envelope) for all ranks, in Form 1427 (Officer's Medical Record Card) for officers, and in Form 64 (Pay Book) for airmen. All entries must be signed and dated by the medical officer. Vaccination registers must be kept at all units, containing the numbers, ranks and names of individuals vaccinated, the results of their vaccination and the batch numbers and manufacturers' numbers of the lymph used.

Calf lymph should be stored in a refrigerator. The potency of lymph that has been exposed to temperatures greater than 10° C. cannot be guaranteed for a period of more than seven days.

In the event of a case of post-vaccinal encephalitis occurring, a report is to be forwarded to Air Ministry (MA4), giving the batch number and manufacturer's number of the lymph used, together with a copy of the case sheet.

(i) Chemoprophylaxis.—Nil.

(j) Current disinfection.—No article to leave the surroundings of the patient without boiling or effective sterilisation.

(k) Terminal disinfection.—Thorough cleaning and disinfection of premises.

(l) General control measures.—General vaccination in early infancy, but not before two months of age. Re-vaccination on school entry. Vaccination of population at risk in the presence of an epidemic of severe form. Preservation of smallpox vaccine

below freezing point up to the hour of vaccination. Vaccine cannot be considered of full potency unless it gives at least 50 per cent vaccinoid reactions in persons re-vaccinated more than 10 years after their first vaccination.

(m) Notification.—Form 418 to Service and Civil authorities.

28.

Syphilis

(a) *Syphilis* is caused by the spirochaete, *Treponema pallidum*. Recovery from the disease, following specific treatment, does not protect against subsequent infection.

(b) Source of infection.—Discharges from obvious or concealed lesions of the skin and mucous membranes, semen, blood, and, rarely, articles freshly soiled with such discharges or blood containing the spirochaete.

(c) Method of spread.—Direct contact with infected persons, blood transfusion, kissing (occasionally), dental or other surgical or technical accidents, indirect contact with infected articles (rarely), congenital from syphilitic mother through placenta.

(d) Incubation period.—About 3 weeks; limits, 10 days to 6 weeks, occasionally longer.

(e) Period of infectivity.—During primary and secondary stages and muco-cutaneous recurrences until the disease process has been controlled by treatment. Inadequately treated patients may transmit infection through sexual intercourse for a period up to approximately five years, but the most important period of communicability is during the earliest months or year or two of infection. Congenital transmission by the inadequately treated mother may take place throughout the child-bearing period.

(f) Isolation.—During period of infectivity.

(g) Quarantine.—Nil.

(h) Immunisation.—Nil.

(i) Chemoprophylaxis.—Local application of prophylactic ointment before, during and after exposure.

(j) Current disinfection.—Discharges from open lesions and all articles soiled therewith.

(k) Terminal disinfection.—Nil.

(l) General control measures.—Education of personnel on the dangers of the disease and the prevention of infection, especially of early treatment facilities after exposure to infection. Co-operation with civil authorities in tracing sex contacts. Exclusion of cases from food handling until certified as being non-infective.

(m) Notification.—Include in weekly return of communicable diseases. Notification and Progress Reports on Form 2769.

29.

Trichinosis

(a) *Trichinosis* is caused by the nematode worms, *Trichinella spiralis*, which are set free as larvae from the cystic stage in which they occur in the pig, when infested pork or pork sausages are

eaten without having been cooked at a sufficiently high temperature. The adult worms inhabit the small intestine, into which viviparous embryos are liberated. These latter travel by lymphatics and veins, finally to encyst once more in striated muscle.

(b) Source of infection.—Insufficiently cooked pork or pork products.

(c) Method of spread.—Only through consumption of meat containing viable larvae.

(d) Incubation period.—Onset of symptoms usually 6 to 7 days after ingestion of the infested meat. In heavy infections, gastrointestinal symptoms may appear in 24 hours.

(e) Period of infectivity.—The disease is not transmitted from man to man.

(f) Isolation.—Nil.

(g) Quarantine.—Nil.

(h) Immunisation.—Nil.

(i) Chemoprophylaxis.—Nil.

(j) Current disinfection.—Nil.

(k) Terminal disinfection.—Nil.

(l) General control measures.—Cooking of pork and pork products that will ensure a temperature of 150° F, being reached in all parts of the meat. Sound hygiene of pig farms, and their immediate neighbourhood, including control of rats, which are the normal intermediary hosts, and the prohibition of feeding uncooked garbage and swill to pigs.

(m) Notification.—Not an official requirement, but competent R.A.F. medical authority should be informed if cases occur.

30.

Tuberculosis, pulmonary

(a) *Pulmonary tuberculosis* is caused by the human tubercle bacillus, *Mycobacterium tuberculosis (hominis)*, except for rare cases caused by the bovine type. It is doubtful if the avian type can infect humans.

(b) Source of infection.—Persons with open pulmonary tuberculosis; rarely, tuberculous cattle.

(c) Method of spread.—Droplet infection, kissing, the use of contaminated eating and drinking utensils, and possibly by dust and flies. The continued type of exposure characteristic of family relationship is almost invariably necessary for infection to take place.

(d) Incubation period.—Variable, dependent on the type of disease, dosage, age and other factors.

(e) Period of infectivity.—As long as the organism is being discharged by the patient, *i.e.*, from the time that a lesion becomes open until it heals or death occurs.

(f) Isolation.—During period of infectivity or until discharge from the Service.

(g) Quarantine.—Nil.

(h) Immunisation.—Nil.

(i) Chemoprophylaxis.—Nil.

- (j) Current disinfection.—Sputum and articles soiled therewith.
- (k) Terminal disinfection.—Cleaning.
- (l) General control measures.—Mass miniature radiography to detect early cases. Elimination of inhalation risk from silica dust. Heat treatment of milk. Education in necessity for guarding of coughs and sneezes and for abstention from spitting. Separation of babies from tuberculous mothers at birth.
- (m) Notification.—Form 418 to Service and Civil authorities.

31. Tuberculosis, non-pulmonary

- (a) *Non-pulmonary tuberculosis* may be caused by either the human or bovine type of the bacillus.
- (b) Source of infection.—Persons with open pulmonary tuberculosis, or (less frequently) cattle.
- (c) Method of spread.—Direct contact with infected persons, infected or contaminated milk or food, and possibly through articles freshly soiled with the discharges of infected persons.
- (d) Incubation period.—Unknown.
- (e) Period of infectivity.—Until discharging lesions are healed.
- (f) Isolation.—Nil.
- (g) Quarantine.—Nil.
- (h) Immunisation.—Nil.
- (i) Chemoprophylaxis.—Nil.
- (j) Current disinfection.—Discharges and articles freshly soiled therewith.
- (k) Terminal disinfection.—Cleaning.
- (l) General control measures.—Heat treatment of milk and milk products. Exclusion from food handling or attendance upon children of persons with open lesions.
- (m) Notification.—Form 418 to Service and Civil authorities.

32. Typhus

The *typhus group of fevers*, each of which is caused by a species of *Rickettsia*, are most readily classified by their arthropod vectors. The classical epidemic typhus is louse borne; endemic typhus may be spread by fleas, ticks or mites. Susceptibility to all types is general. An attack confers immunity, which is not always permanent.

- (a) *Epidemic or classical typhus (louse borne)*
 - (i) Caused by *Rickettsia prowazeki* var. *prowazeki*. Weil Felix reaction: OX 19 positive.
 - (ii) Source of infection.—Infected persons.
 - (iii) Method of spread.—By lice (*Pediculus humanus*).

Inoculation of the organism takes place by crushing infected lice or their faeces into a bite wound or skin abrasion. In heavily louse-infested individuals the garments become impregnated with louse faeces, which may be inhaled as a fine red dust and cause infection. (See Fig. 38, p. 185.)

FIG. 38

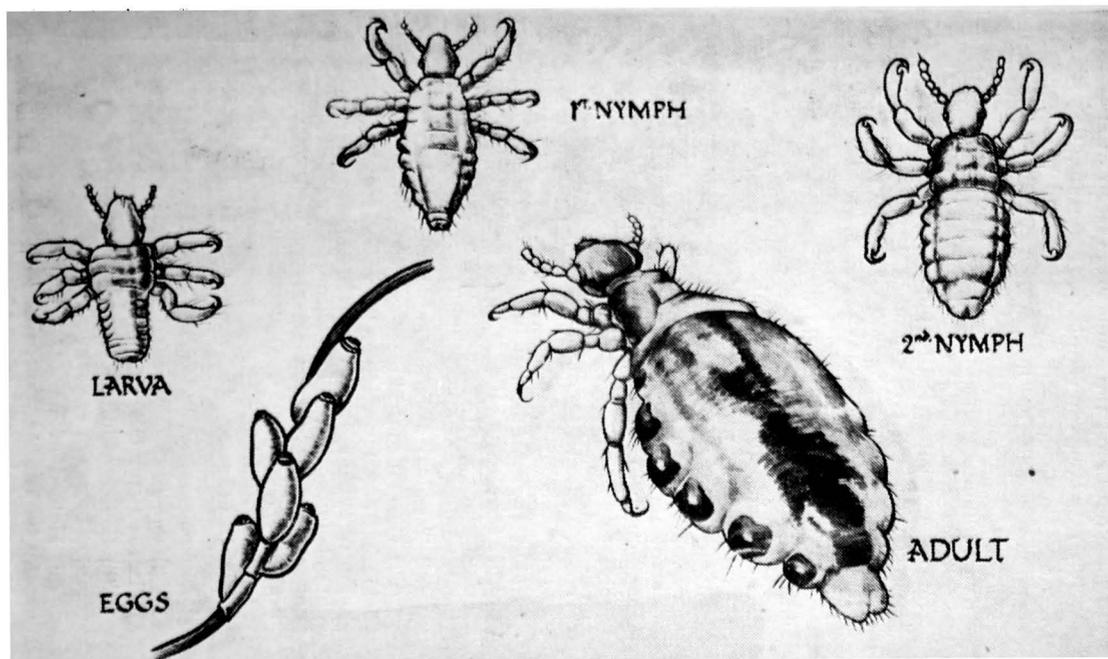

LIFE CYCLE OF THE BODY LOUSE
(*Pediculus corporis*)

(iv) Incubation period.—Commonly days; limits, 6 to 15 days.

(v) Period of infectivity.—The patient is capable of infecting lice during the febrile period and possibly for two to three days after the temperature returns to normal.

(vi) Isolation.—In vermin-free room, after delousing.

(vii) Quarantine.—In the presence of lice, exposed susceptibles should be quarantined for 15 days after last exposure.

(viii) Immunisation.—Cox type vaccines, consisting of rickettsias grown in the yolk sac of the developing chick embryo and subsequently killed with formalin or phenol, give considerable protection. Three doses are needed for initial protection, and single stimulation doses at three monthly intervals are advisable under conditions of risk. In inoculated individuals the risk of infection is reduced, the course of the disease modified and the case fatality rate lowered.

(ix) Chemoprophylaxis.—Nil.

(x) Current disinfection.—Delousing of patients and contacts and their bedding, by the use of insecticide powders, especially those containing DDT. Special treatment of hair to eradicate louse eggs or nits (*see* Chapter I, paragraph 2 (a)). Destruction of rickettsia contained in louse excreta by steam disinfection of patients' clothing, preceded by its immersion in a 2½ per cent solution (four ounces to the gallon) of cresol. Special protective clothing (rubber shoes, overalls, gloves, headdress, mask and eye shield), daily bathing, typhus inoculation and the free use of insecticide powder are essential for personnel handling typhus cases and their clothing until the necessary delousing and disinfection has been done.

(xi) Terminal disinfection.—Nil.

(xii) General control measures.—Organised and systematic delousing and inoculation, especially centred about households of typhus cases. Infected areas should be placed out of bounds. Travel in public vehicles should be prohibited unless they have been effectively disinfected or are a negligible source of louse infestation.

(xiii) Notification.—R.A.F. competent medical authority should be informed of all cases of typhus.

(b) *Endemic murine typhus (flea borne)*

(i) Caused by *Rickettsia prowazeki* var. *mooseri*. Weil Felix reaction: OX 19 positive.

(ii) Source of infection.—Infected rodents, especially the common brown or sewer rat.

(iii) Method of spread.—From rodent to man by fleas, usually the rat flea *Xenopsylla cheopis*.

(iv) Incubation period.—Usually 12 days; limits, 6 to 14 days.

(v) Period of infectivity.—Not communicable from man to man.

(vi) Isolation.—Nil.

(vii) Quarantine.—Nil.

(viii) Immunisation.—As yet no definite evidence of the efficacy of vaccines prepared in the same way as those for louse-borne typhus.

(ix) Chemoprophylaxis.—Nil.

(x) Current disinfection.—Nil.

(xi) Terminal disinfection.—Nil.

(xii) General control measures.—Rodent control.

(xiii) Notification.—R.A.F. competent medical authority should be informed of all cases of murine typhus.

(c) *Rocky Mountain spotted fever (tick borne)*

(i) Caused by *Rickettsia rickettsii*.

Weil Felix reaction : OX 19 sometimes positive.

OX 2 usually positive.

Other forms of tick borne typhus are those of South America, East Africa and India, some of which are caused by larval stages of ticks ; that of the Mediterranean area and North and West Africa carried by dog ticks ; and the Q fever of Queensland and the Western U.S.A.

(ii) Source of infection.—Infected ticks—especially *Dermacentor variabilis*, a dog tick ; *Dermacentor andersoni*, a wood tick ; *Amblyomma americanum* and *Amblyomma cajennense*.

(iii) Method of spread.—Bite of tick or contact of tick blood or faeces with unbroken skin.

(iv) Incubation period.—3 to 10 days.

(v) Period of infectivity.—Not communicable from man to man.

(vi) Isolation.—Nil.

(vii) Quarantine.—Nil.

(viii) Immunisation.—Vaccines are available which confer protection for one to two years. Hyper-immune rabbit serum may be valuable in treatment if given before or about the time of appearance of the rash.

(ix) Chemoprophylaxis.—Nil.

(x) Current disinfection.—De-ticking of patient.

(xi) Terminal disinfection.—Nil.

(xii) General control measures.—Avoidance of tick-infested areas. Careful and prompt removal of ticks from the person, without crushing and with protected hands.

(xiii) Notification.—R.A.F. competent medical authority should be informed of all cases of tick typhus.

(d) *Scrub typhus (mite borne)*

(i) Caused by *Rickettsia orientalis*.

Weil Felix reaction : OX 19 usually negative.

OX 2 usually negative.

OXK positive.

Synonyms : Tsutsugamushi fever ; Japanese river fever.

(ii) Source of infection.—Hexapod larval mites of *Trombicula akamushi* and related species. The infection is passed from generation to generation of mites and is maintained by feeding upon susceptible wild rodents, especially rats and mice.

(iii) Method of spread.—Bite of infected mites.

(iv) Incubation period.—About 7 to 10 days; up to 14 days.

(v) Period of infectivity.—Not communicable from man to man.

(vi) Isolation.—Nil.

(vii) Quarantine.—Nil.

(viii) Immunisation.—In experimental stage.

(ix) Chemoprophylaxis.—Nil.

(x) Current disinfection.—Nil.

(xi) Terminal disinfection.—Nil.

(xii) General control measures.—Careful selection and preparation of camp sites, avoiding kunai grass where possible, otherwise cutting or burning all grass on site. Construction of hard-surface paths. Avoidance of jungle-fringed streams. Mites do not climb higher than one foot from the ground, therefore seats, beds and hammocks should always be above this level and individuals should never sit or lie on the ground. Impregnation of clothing, especially socks and trousers, with dibutyl phthalate or other miticide is an invaluable safety measure.

(xiii) Notification.—R.A.F. competent medical authority should be informed of all cases of scrub typhus.

33.

Undulant fever

(a) *Undulant fever* is caused by the organisms *Brucella melitensis*, *Br. abortus* and *Br. suis*, which are found in goats, cattle and swine respectively, with a world-wide distribution. Most persons have some degree of resistance to infection, especially to *Br. abortus*, or have acquired partial immunity by ingestion of sub-infective doses of these organisms.

(b) Source of infection.—Tissues, blood, milk and urine of infected animals. Laboratory infection is readily acquired.

(c) Method of spread.—Ingestion of milk from infected animals or, especially in farm and veterinary workers, by direct contact with infected animals or animal products.

(d) Incubation period.—6 to 30 days or more.

(e) Period of infectivity.—Practically not communicable from person to person, but the organism may be present in the urine or other discharges.

(f) Isolation.—Nil.

(g) Quarantine.—Nil.

(h) Immunisation.—Nil.

(i) Chemoprophylaxis.—Nil.

(j) Current disinfection.—Ordinary sanitary precautions. Extreme care is necessary for laboratory workers engaged in the isolation of *Brucella* organisms.

(k) Terminal disinfection.—Nil.

(l) General control measures.—Pasteurisation of cows' and goats' milk. Care in handling carcasses of infected animals. Elimination of infected animals from herds. Vaccination of calves is still experimental.

(m) Notification.—Form 418 to Service authorities.

34.

Whooping cough

(a) *Whooping cough* is caused by the pertussis bacillus of Bordet and Gengou, *Hæmophilus pertussis*. There is no natural immunity to the disease. Immunity conferred by an attack is definite and prolonged, although second attacks do occur. Both passive and active artificial immunity may be developed by inoculation.

(b) Source of infection.—Discharges from the laryngeal and bronchial mucous membranes of infected persons.

(c) Method of spread.—Droplet infection. Contact with articles freshly soiled with the discharges of an infected individual. Carriers are not known to occur.

(d) Incubation period.—Usually 7 days, almost uniformly within 10 days and not exceeding 21 days.

(e) Period of infectivity.—Particularly communicable in the early catarrhal period before the typical cough confirms the clinical diagnosis. After the typical paroxysms are established, infectivity declines and becomes negligible for ordinary non-familial contact in about three weeks even though the spasmodic cough with whoop may persist. The period of infectivity must be considered to extend from seven days after exposure to an infected individual to three weeks after the onset of typical paroxysms.

(f) Isolation.—For 28 days after onset of symptoms.

(g) Quarantine.—Contacts should be segregated from non-immunes for 21 days after last exposure and medically examined daily.

(h) Immunisation.—Brief passive immunity by the administration of convalescent serum or similar agents may be considered advisable in some circumstances for young children, especially those under three years of age. Artificial active immunisation by vaccines is sometimes recommended. Morbidity is likely to be reduced and modified attacks, which confer a lasting immunity, are usual in those who do not obtain complete protection. The procedure is hardly worth while except for young children and infants over three months.

(i) Chemoprophylaxis.—Nil.

(j) Current disinfection.—Nose and throat discharges and articles soiled therewith.

(k) Terminal disinfection.—Thorough cleaning.

(l) General control measures.—As for droplet infections (*see* pp. 149–155).

(m) Notification.—Form 418 to Service and Civil authorities.

35.

Yellow fever

(a) *Yellow fever* is caused by a filterable virus. There is no natural immunity, but recovery from an attack is followed by immunity that lasts apparently for life. Brief artificial immunity may be developed by the use of convalescent serum. The inoculation of living virus, modified by tissue culture, is followed by active immunity which is effective for at least 4 years.

(b) Source of infection.—The blood of infected persons, monkeys, marmosets and probably other wild animals.

(c) Method of spread.—The bite of infected *Aedes aegypti* mosquitoes and a number of other bush mosquitoes. It is possible that some other biting insect may be capable of transmitting the disease.

(d) Incubation period.—3 to 6 days, rarely longer.

(e) Period of infectivity.—For two days prior to the onset of fever and for the first three, possibly four, days of fever. *Aedes aegypti* can infect from the 10th day after biting an infected person till the end of its life.

(f) Isolation.—Nurse cases under mosquito net, in room which is kept free from mosquitoes, for the first four days of fever.

(g) Quarantine.—Individuals not in possession of a valid yellow fever inoculation certificate may be subjected to quarantine in screened quarters for six days, or in India nine days, after arrival from an endemic area at a place where conditions permit the development of yellow fever, or after arrival in India by an aircraft which has passed through or come from an endemic area.

(h) Immunisation.—A single inoculation with an attenuated strain of living virus will protect for four years and probably longer. There is no danger of transmitting infective hepatitis with the vaccines that are now in use. Persons inoculated for the first time are protected on and after the 10th day reckoned from the date of inoculation. Re-inoculated individuals are protected forthwith for a further period of four years.

(i) Chemoprophylaxis.—Nil.

(j) Current disinfection.—Nil. Destruction of mosquitoes in the neighbourhood of buildings used for isolation of patients.

(k) Terminal disinfection.—Nil.

(l) General control measures.—Control of *Aedes aegypti* and other potential mosquito vectors of yellow fever, particularly in the vicinity of aerodromes, townships, ports, stopping places along transport routes and on board ships engaged in coastal and inter-continental traffic. The degree of control of *Aedes* breeding aimed at in urban areas should maintain the *Aedes index* at not more than 1 per cent, *i.e.* *Aedes* larvae should not be found in more than 1 per cent of dwellings at any time of examination, premises occupied by a single family to count as a dwelling. In endemic areas, mosquito control should be effective within and for half a mile around the perimeters of all aerodromes, especially those on trunk routes, not only for *Aedes* but for all other species concerned in the transmission of disease. *Aedes* species breed in barrels, puddles, cisterns, rain gutters, water containers in houses, flower vases, rot holes in trees, dead leaves, banana palms, old tins, cocoanut shells, palm fronds and similar *small* collections of water, particularly in and around dwellings.

Early detection and correct diagnosis of the disease, with notification and isolation of cases. In endemic areas a sample of blood for a yellow fever immunity test should be taken from each person suffering from an undiagnosed fever and stored at a low temperature. A second sample should be taken at the end of the third week from the onset of illness if the diagnosis is then still in doubt. Both samples should then be sent to the nearest laboratory that undertakes immunity tests. If a patient dies within 10 days from the onset of the illness, a specimen of liver tissues should be sent to the nearest laboratory that undertakes the histological diagnosis of yellow fever.

Inoculation against yellow fever of all travellers within, or passing through, endemic areas.

Effective quarantine measures, including adequate screened accommodation for non-immunised persons.

Effective disinsectisation of all aircraft moving within or through endemic areas.

Maintenance of a building-free zone 440 yards in depth round the perimeter of all aerodromes on main air lines of communication within the endemic area. Through roads and railways which are under proper police control need not be excluded from the building free zone. Pending the freeing of this zone from buildings, all habitations should be sprayed with an insecticide once a week and all persons living in the zone should be inoculated against yellow fever. The perimeter of an airfield is defined as the line enclosing the area containing airfield buildings and any land used or intended to be used for the parking of aircraft.

(m) Notification.—Form 418 to Service and Civil authorities.

CHAPTER VII

DISINFECTION AND DISINFESTATION

SECTION I

DISINFECTION1. **General**

The purpose of disinfection is to destroy pathogenic micro-organisms and thus limit the spread of disease. It is applied particularly to the excreta and discharges of individuals suffering from communicable diseases, and to articles that have been contaminated by contact with these individuals, or their excreta or discharges. If concurrent disinfection of all infectious material is carried out properly during the illness of a patient, the practice of terminal disinfection at the conclusion of the illness can generally be limited to thorough cleaning with soap and water of the bed itself, the wall and floor surfaces for a distance of six feet round the bed and all objects within this area. Concurrent disinfection is necessary for such items as sputum, urine, faeces, skin debris, wound dressings, handkerchiefs, towels, bed linen, clothing and any articles such as feeding utensils, bed pans or urine bottles which have been contaminated with infectious material.

2. **Methods of disinfection**

(a) *Dry heat*.—Burning may be employed for paper handkerchiefs and articles of little value. A temperature of 150° C. will kill all micro-organisms including their spores, if applied for one hour. Few fabrics, however, will withstand a temperature of more than 110° C. without damage, while leather and fur articles should not be exposed to a temperature of more than 70° C. except for a very brief period.

(b) *Boiling*.—All micro-organisms, except for a few spore bearers, are destroyed by boiling for five minutes, a method of disinfection that can be usefully employed for feeding utensils, crockery, glass, towels and linen. Stains should be removed from fabrics, by soaking in cold water or other means, before these are boiled, or they become fixed.

(c) *Flowing or current steam*.—Current steam has a temperature of 100° C. and is used in many forms of portable, field and improvised disinfectors, some examples of which are illustrated in Figs. 40, 41, 42. Disinfectors in which current steam is used should always be so constructed that the steam entry is at the top of the disinfecting chamber and the exit below any articles that it may contain. In this way, the air content of the disinfecting chamber is displaced downwards and finally driven out by the steam and inadequately heated pockets of air cannot be left behind.

FIG. 39

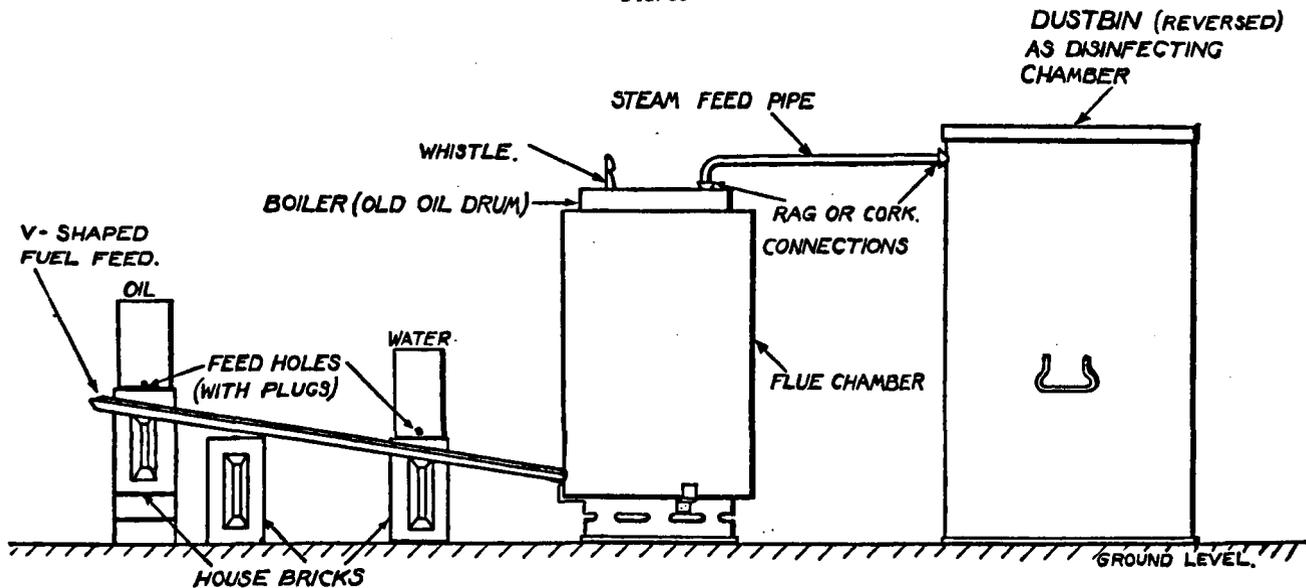

IMPROVED BOX-TYPE STEAM DISINFECTOR

FIG. 40

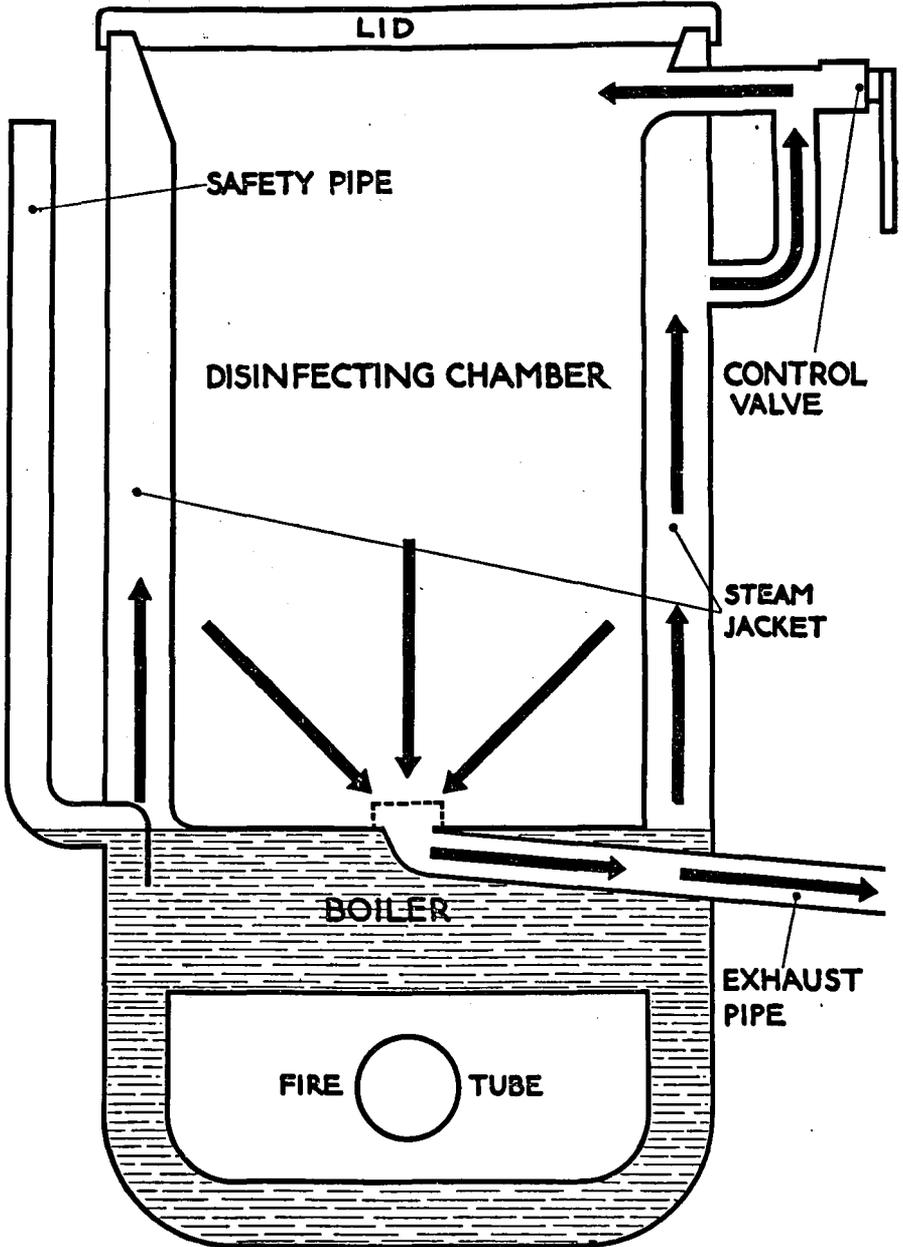

DISINFECTOR, PORTABLE, LARGE TYPE B

FIG. 41

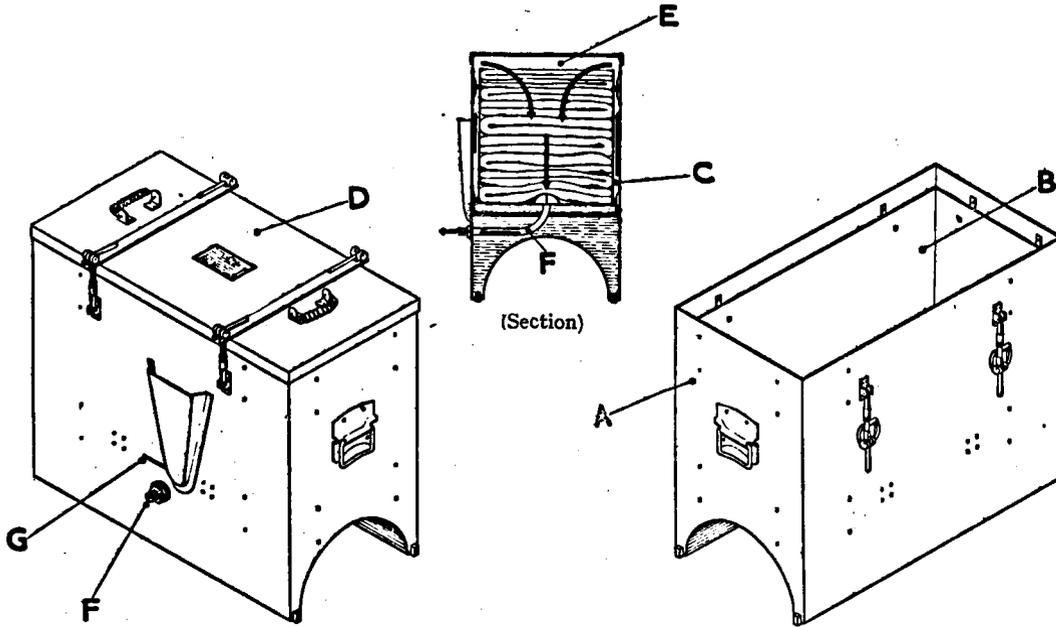

DISINFECTOR, PORTABLE, SMALL TYPE B

Key: A—Outer casing C—Steam space (sides) E—Steam space (top) G—Water level
B—Inner container D—Lid F—Steam exit pipe

(d) *Pressure steam.*—The temperature of steam varies directly as the pressure under which it is contained, as may be seen from the table below.

TABLE XXV
STEAM TEMPERATURE VARIATION ACCORDING TO
PRESSURE

lb./sq. inch	Temperature	
	Centigrade	Fahrenheit
0	100	212
5	109	228
10	116	240
15	122	251
20	127	260
30	134	273
40	142	287
45	144	291

Large capacity disinfectors using steam at a pressure of 10 to 30 pounds to the square inch are usually installed in hospitals. In these high pressure disinfectors, the disinfecting chamber is surrounded by a jacket to which steam is admitted and maintained at a slightly higher pressure, and therefore temperature. This prevents condensation of steam on the walls of the inner chamber. All air is evacuated from the disinfecting chamber after it has been loaded with contaminated articles. Steam is then admitted and disinfection is allowed to proceed for a total contact time at the pressures for which the machine is designed of from 15 to 20 minutes. The vacuum is then re-formed and hot air is admitted to remove any remaining traces of dampness.

(e) *Gaseous disinfection.*—Gases have little power of penetration and cannot be relied on as the sole means of disinfecting a room containing clothing or bedding. These should receive proper treatment by heat or fluid disinfectants. Formaldehyde is a very effective germicide, but its use for terminal disinfection of a room is rarely necessary. Sulphur dioxide and hydrocyanic acid gas are poor germicides and are more often employed for disinfestation purposes. Formaldehyde can be used with relative safety, since it can be readily detected by smell. It has the added advantage of being harmless to leather, fur, rubber, canvas and coloured fabrics. It is produced by the action of bleaching powder or potassium permanganate crystals on formalin. Two pints of formalin and two pounds of bleaching powder or one pint of formalin and two and a half ounces of potassium permanganate are required for every 1,000 cubic feet of space in the room to be disinfected. As the evolution of the gas is accompanied by much frothing, these quantities, and no more, should be placed in each of the requisite number of buckets evenly dispersed about the floor. All doors, windows and other apertures must be sealed to prevent the escape of gas. This can be done with gummed paper.

(f) *Fluid disinfectants.*—(i) *Cresol or Liquor cresoli saponatus.*—A $2\frac{1}{2}$ per cent solution (four ounces to the gallon) will disinfect fabrics in half an hour. One per cent solution may be used for floors, lavatory seats and other purposes for which a short contact period is not needed.

(ii) *Formalin.*—A 5 per cent solution (eight ounces to the gallon) may be used as a spray when droplet infections are prevalent. Wall surfaces should be sprayed from below upwards, using one gallon of the solution for every 400 square feet. Volatilization of formaldehyde gas takes place from the wetted surfaces, which are themselves sterilized by the fluid. Spraying should only be done when rooms are unoccupied.

(iii) *Carbolic acid.*—Crude carbolic acid is a mixture of para-cresols. It can be used for surgical purposes in a 5 per cent solution. It is liable to stain fabrics.

(iv) *Phenol.*—Pure phenol, in 1 per cent solution, will kill most organisms, except spores, in 20 minutes.

(v) *Lysol.*—Lysol contains 50 to 60 per cent cresol and is generally used as a 1 per cent solution.

(vi) *Lime.*—A 1 per cent solution of lime (CaO) will kill all organisms, other than spores, in a few hours. Twenty per cent added to faeces in equal bulk will sterilize them in one hour. Freshly slaked lime is a particularly useful disinfectant when applied as lime wash to walls, stables, stands for refuse bins, urinals and other places liable to fouling. It is prepared by the addition of half a gallon of quick lime to each gallon of water.

(vii) *Liquor chloroxylenolis (B.P.).*—Numerous proprietary preparations, such as Dettol, Strepn, O-Syl and Zant, contain chlorinated xylenol as the active principle. This disinfectant can be used undiluted without harm to the skin, or even mucous membranes, but is generally used as a 20 per cent solution.

3. Application of disinfection methods

(a) When infectious disease occurs (whether in hospital, sick quarters or barracks), bedding, clothing and other articles which may have been exposed to infection should not be sent to the laundry or returned to store until disinfected under the supervision of the medical officer. If a case is suspected to be of an infectious nature, the bedding, clothing, etc., should be kept separate until it is known that disinfection is not required.

(b) Rooms.—Thorough cleaning with soap and water, or $2\frac{1}{2}$ per cent cresol solution, of all surfaces and articles within a six foot radius of the bed is now accepted as being sufficient terminal disinfection after all infectious diseases, unless an arthropod vector may be concerned with further spread. In the latter event, as after plague, fumigation with formaldehyde gas may be considered necessary although careful treatment of the room with DDT residual spray or powder will usually be sufficient.

(c) Bed linen and other linen or cotton materials.—Steam disinfection, boiling or soaking for half an hour in $2\frac{1}{2}$ per cent cresol are the accepted methods.

(d) Mattresses and pillows.—Unless soiled with excreta, discharges or infective skin debris, exposure to the fresh air for

24 hours is sufficient for these articles. When soiled, high pressure steam disinfection is advisable. Subsequent drying is made difficult when current steam disinfection is used.

(e) Blankets and woollen goods.—White blankets do not stand steam disinfection well, owing to its tendency to fix stains indelibly and to alter their texture and colour. Brown or grey Service blankets are less noticeably affected. A temperature of 127° C. for half an hour will make flannel brittle, but this brittleness is removed if the articles are hung out on lines in the open. Blankets must be disinfected on interchange between personnel when sheets are not in use, on return to store or when considered necessary by medical authorities.

(f) Boots, shoes, belts and leather, rubber or felt articles.—These should be well swabbed with formalin solution (one ounce to the pint of water). A contact period of five minutes is sufficient to destroy micro-organisms and fungi. Footwear should be dried and well aired after treatment with formalin. Two and a half per cent cresol solution may also be used, but is not effective against fungi. Leather will withstand a temperature of 60° C., but more than 30 minutes at this temperature is likely to damage furs. Exposure to formalin vapour in a disinfector chamber or other sealed space for 45 minutes is also an effective means of disinfecting articles that are liable to damage by heat.

(g) Crockery, glass, feeding utensils.—Boiling for 10 minutes is advisable for these articles.

(h) Bedpans and urinals.—Washing with 2½ per cent cresol solution, boiling or steam disinfection is necessary when these have been used for patients with infectious excreta.

(i) Dressings.—Wound dressings or those soiled with infective discharges should, as a rule, be burned.

SECTION II

DISINFESTATION

1.

General

Disinfestation is directed against insects or other arthropods that are vectors of disease or, like bed bugs, merely contribute to human discomfort. To be fully effective it should result in the destruction of eggs as well as adults. Disinfection processes can be relied on to disinfest an article, but the converse is by no means true. Micro-organisms are a low, but highly resistant, form of life and are often unaffected by a disinfestation process that rapidly destroys the more complex, but more delicate, structure of insect life. Hot air disinfestation may result in complete destruction of lice and their eggs, but typhus rickettsia contained in the lice and their faeces may remain alive and capable of producing infection.

2.

Methods of disinfestation

(a) *Dry heat*.—The Millbank portable hot air disinfector, Stores Ref. 21C/1983, consists of two, double-walled, canvas chambers, into which air heated by two oil-fired pressure burners is driven by a fan. The air is maintained in a closed

FIG. 42

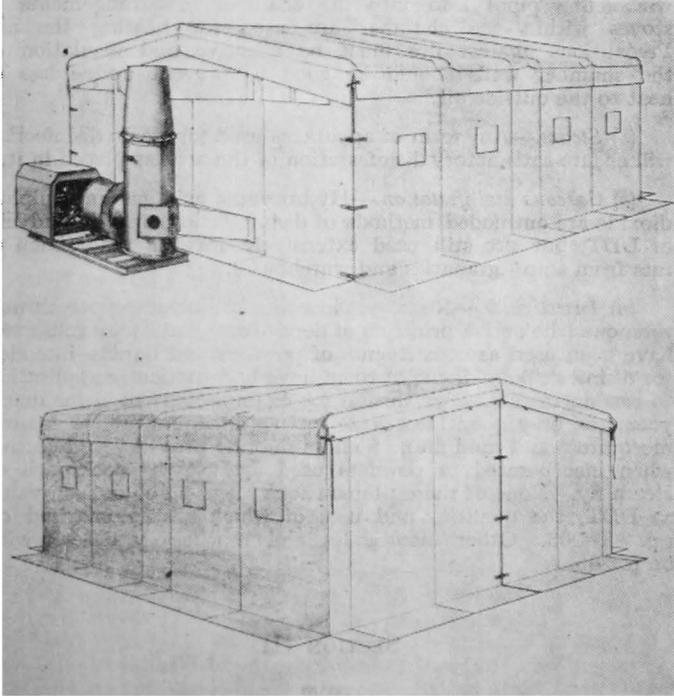

MILLBANK PORTABLE HOT AIR DISINFESTOR
(Stores refs. 21C/1983)

circuit and a temperature of 70° C. can be held for as long as required. The output is 200 blankets per hour. Moderately wet clothing can be dried in an hour. Sodden clothing, after wringing, requires one and a half to two hours. Sodden blankets, after wringing, need three to four hours. When erected on its tubular metal framework, the complete, double-chambered disinfestor measures twelve feet by six feet by six feet high. When dismantled the entire apparatus, including the 6 h.p. petrol engine that drives the fan, can be packed on a 30 cwt. truck.

Various types of huts and underground chambers have been improvised for hot air disinfestation. Braziers from which flue pipes lead into the chamber or arrangements of stoves within the chamber are used for heating the air. Precautions against fire must be effective and insulation of the chamber walls should be good to prevent undue loss of heat to the outside air.

(b) *Steam*.—Any form of apparatus used for steam disinfection will ensure satisfactory disinfestation of the articles placed in it.

(c) *Gaseous disinfestation*.—Hydrocyanic acid gas and sulphur dioxide are outmoded methods of disinfestation since the advent of DDT, but are still used extensively for the eradication of rats from ships, granaries and warehouses.

(d) *Insecticides*.—Numerous insecticides, including pyrethrum, rotenone (the active principle of derris root) and sodium fluoride, have been used as constituents of powders and liquids intended for disinfestation. Some of them have had particular application to certain insects. Pyrethrum, for example, has been for many years the only good insecticide for use in liquid sprays against mosquitoes and sand flies. Sodium fluoride proved very effective when incorporated in powders used against the cockroach or steam fly. None of these preparations seems to be of such value as DDT, the qualities and uses of which are summarised on pp. 200–205. Other insecticides and repellents are dealt with on p. 205.

SECTION III

DDT

1. Characteristics

Dichlor-diphenyl-trichloroethane, or DDT, is a fine, white, crystalline powder that is remarkably stable and non-volatile. It is insoluble in water, but readily soluble in most oils and many other organic solvents. It is not affected by tropical temperatures and has a melting point of 108° C. Its molecular weight is 354.5 and it has a density of 1.6 grammes per millilitre. It acts as a contact poison on most forms of insect life and is practically non-toxic to man in the preparations and circumstances in which it is normally used. As prepared commercially it has a pure DDT content of 60 to 70 per cent. It has no repellent or fungicidal action.

2.

Toxicity

The dry powder is not absorbed through the skin and no danger is likely to result from the inhalation of dusts or liquid sprays during insecticidal work. Ingestion of DDT may be followed by toxic symptoms and contamination of food with dusts or sprays should be carefully avoided. Prolonged skin contact with an oily solution of DDT may result in poisoning, especially in a hot environment. Tiredness, heaviness or aching in the limbs, mental anxiety, weakness and sensory changes are symptomatic of toxic absorption. Blood examination may show a mild anaemia. A sufficiently large dose of DDT taken by mouth may cause rapid death from respiratory failure, possibly preceded by convulsions and coma. Extensive liver and kidney damage is likely to remain after recovery from the ingestion of a large dose of DDT.

3.

Preparations of DDT

(a) *Undiluted commercial product*, containing 60 to 70 per cent of pure DDT.

(b) *A.L. 63, Mark III*.—A dusting powder containing 5 per cent DDT in china clay.

(c) *A.L. 63, Mark IV*.—A dusting powder containing 10 per cent DDT in china clay.

(d) *Non-residual spray* (for indoor use).—The addition of pyrethrum, to ensure a quick knock down, and of sesame oil, which has an activating effect on the pyrethrum, are necessary.

The following preparations have been found 100 per cent effective :

0.05 per cent pyrethrins + 0.3 per cent DDT } in a kerosene
or } base + 5 per
0.03 per cent pyrethrins + 0.5 per cent DDT } cent sesame oil

These sprays can be applied by ordinary hand sprayers ('flit guns') or by power sprayers. Their use should be combined with residual spray.

(v) *Residual Spray*.—A 5 per cent solution of DDT in kerosene is generally used. A surface that has been sprayed with such a solution remains lethal to insects for many weeks. In preparing residual spray solution, one ounce by weight of DDT to the pint of kerosene, or one pound to two gallons, is required. All lumps should be broken down to powder. Sufficient kerosene is then mixed with the DDT to form a cream or thin paste. This cream is then added to the remainder of the kerosene which should be stirred or agitated at intervals until complete solution is obtained. If the work is carried out in the open under a hot sun, stirring for half an hour in the morning and afternoon for three days will generally be sufficient. A paint spray gun, operated by a power-driven air compressor, and with a nozzle adjustment that will give a relatively wet spray is the most efficient equipment for treating large surfaces. Knapsack sprayers, 'Kent' pressure sprayers, stirrup pump sprayers and even hand painting with brushes may be used.* After spraying, the surface should appear slightly moist and not dripping wet. Spraying should not be necessary at intervals more frequent than a fortnight between the first two sprayings and a month between subsequent sprayings. (Stores Ref. 33F/394.)

* Two pints of a 5 per cent solution per 1,000 square feet of surface is the recommended dosage. This is equivalent to 50 mgms. DDT per square foot.

(vi) *Emulsion concentrates*.—Concentrates of DDT that will permit subsequent mixing with water are likely to prove the most economical means of dispensing DDT. The production of such a concentrate on a commercial scale will abolish the need for transporting large quantities of kerosene or other solvents.

(vii) *Aircraft sprays*.—Solvents for DDT used from aircraft need special care in their selection, owing to the necessity of obtaining the correct spreading pressure for an oily larvicide and the correct density for the production of an aerosol and to the need for avoiding repellents such as some Diesel oils. Dusts are unsuitable for use from aircraft owing to their tendency to lump.

(viii) *Aerosols*.—An aerosol will form a mist of droplets so small that they will remain suspended in the air and will be carried by natural air currents without falling to the ground. The mists produced by ordinary spray nozzles and pressures do not fall in this category. The Insecticide Dispenser (Aerosol Bomb), Stores Ref. 33F/385, from which the insecticide content of about 18 ounces is expelled by the gas freon (dichlor-difluoromethane), produces an effective aerosol mist. One bomb contains sufficient insecticide to spray continuously for 15 minutes. The dosage is 4 seconds spraying for each 1,000 cubic feet of space, except for the disinsectisation of aircraft for which 17 seconds spraying per 1,000 cubic feet is necessary. Sparklet soda syphon bulbs, using CO₂ as the propellant, also form effective aerosol dispensers. Each bulb has a discharge time of 4 to 8 seconds and is intended for the disinsectisation of 1,000 cubic feet of space.

(ix) *Smokes*.—Bombs, tear gas generators, smoke generators and aircraft exhausts have been used with varying success for dispersing DDT as an aerosol or smoke. Smoke bombs or candles charged with DDT have been reported on as an effective method of ridding native villages of their mosquito population.

(x) *Paints and distempers*.—Promising results have been obtained by using the residual effect of DDT contained in paints and distempers.

4. Insect control with DDT

(i) *Mosquitoes*.—For adults indoors residual spray combined with routine spraying of non-residual spray or an aerosol should be used. The recommended dosage of residual spray is 50 mgms. DDT per square foot.

For adults outdoors, area spraying from the ground or from the air can be employed. The residual effect and its duration is very variable and dependent upon such factors as foliage density and rainfall. The inclusion of a mosquito irritant such as cyclohexanone (5 per cent) may stimulate the mosquitoes to fly about, and thus ensure a higher kill. The creation of a barrier zone 70 yards wide round a temporary camp may be a useful measure in controlling the immigration of mosquitoes from surrounding areas. A dosage of five gallons of 5 per cent solution per acre has been used for this purpose with good effects.

For larvicidal effects, a 5 per cent oil solution is used in doses of one to two quarts per acre, but owing to the difficulty of obtaining sufficient coverage with this concentration it may be

found better to use five quarts of 2 per cent oil solution per acre. Fuel oil, diesel oil and waste crank case oil, as well as kerosene, may be used for this purpose. Thick oils may be thinned with lighter oils. Application may be by spraying from the ground or from the air; or by oiled sawdust, oiled sacking or bricks soaked in the solution, although these latter methods are much less efficient. The addition of a spread-aider such as oleic acid (0.5 per cent) or castor oil (1 per cent) is recommended. Good control of culicine larvae as well as an almost complete kill of anopheline larvae is obtained in the treated areas. Concentrations in water of more than one part in ten million are lethal to fish. DDT dusts may also be used as larvicides, but are not so satisfactory as oil emulsions.

(ii) *Houseflies*.—The residual effect of DDT against adult flies should be exploited to the utmost extent. Eggs are not affected and larvae only to an insignificant degree. Five per cent Residual Spray should be used on window ledges, window and door screens and other surfaces on which flies rest. Stables, barns and manure heaps are also suitable for treatment with Residual Spray. Flies are killed for upwards of six weeks after a surface coverage of 100 mgms. DDT per square foot.

(iii) *Lice*.—A.L. 63, Mark III, 5 per cent DDT in china clay, is a very effective delousing powder. It is best applied by power-operated blowers when large numbers of persons require de-lousing although hand-operated dust guns or even individual shaker tins can be used. A dosage of 1½ ounces of this powder is generally considered necessary for each individual. Three treatments at weekly intervals are necessary to kill successive generations of lice as they hatch out from the eggs. Specially trained dusting teams should be employed for large-scale dusting operations. Shirts impregnated with DDT in white spirit at the rate of 1 per cent DDT weight for weight of the garment are useful when it is necessary to protect personnel with restricted hygiene facilities against acquiring louse infestation. These shirts will withstand two washings by laundry processes without loss of insecticidal efficiency, but should be re-impregnated during the third laundering. Preparations containing DDT are used for the treatment of individual cases of infestation with head, body and crab lice, and are also of value in the treatment of scabies.

(iv) *Bedbugs*.—Five per cent residual spray should be used. Mattresses, pillows and bedframes require thorough treatment; but it is rarely necessary to include blankets. There is no need to spray wall crevices and other remote hiding places of bedbugs, since the insects will obtain a lethal dose when they leave these places to visit the bed for a blood meal. Five gallons of 5 per cent. solution should be sufficient to treat the beds and bedding of 100 men.

(v) *Cockroaches*.—Five per cent sprays with a 200 mgms. per square foot coverage or 10 per cent dusts are most efficacious against cockroaches. It may be necessary to remove boarding that covers steam pipes and other warm places in kitchens where cockroaches hide. The small, light brown, German cockroach is more resistant than other species.

(vi) *Fleas*.—DDT is effective against both adults and larvae in either spray or dust form. Five per cent residual spray should be applied to the floor and for 2 feet up the walls, using a coverage of 100 mgms. to the square foot.

(vii) *Ticks*.—Some species of dog and cattle ticks have proved susceptible to the use of DDT applied as a wash or in a specially prepared non-drying adhesive.

(viii) *Mites*.—DDT is not employed to any extent as a protective measure against scrub typhus, although a marked reduction in mites on ground treated with 30 pounds of 2 per cent DDT per acre has been reported.

(ix) *Spiders, scorpions and centipedes*.—DDT cannot be depended upon to kill these arthropods.

5. Precautions

Foodstuffs should be protected from DDT dusts, solutions and emulsions and great care must be taken to ensure that DDT powders are not mistaken for flour or baking powder and used for cooking purposes. No special precautions for personnel are needed when DDT dusts are being used for insecticidal work.

When solutions or emulsions are being sprayed, an eyeshield and some form of dust respirator—a handkerchief or four layers of gauze will suffice—should be worn; overalls and gum boots are advisable and the former should be washed before wearing again if they have been heavily splashed with solution; any contaminated skin surfaces should be washed when spraying is completed. Fire precautions are necessary while spraying kerosene or other inflammable solutions of DDT.

TABLE XXVI

6. Solubility

<i>Solvent</i>	<i>Solubility in grammes per 100 millilitres</i>
Cyclohexanone	140—120
Benzene	91—100
Trichlorethylene	72—83
O-dichlorobenzene	63—71
Xylene	56—62
Acetone	50—55
Carbon tetrachloride	46—48
Benzyl benzoate	39—41
Dimethyl phthalate	31—33
Ether	27—28
Sesame oil	about 10
Diesel oil No. 2 10
Kerosene, crude 8
Diesel oil No. 1 8
Castor oil 5
Kerosene, refined, odourless 4
Ethyl alcohol, 95 per cent 1.5

TABLE XXVII

7.

Useful Data

1 gallon	= 1.2 U.S. gallons
1.76 pints	= 1 litre
1 ounce	= 28.35 gms. = 28,350 mgms.
1 pound	= 453.6 gms.
2,240 pounds	= 1 ton = 1.02 metric tons
1 acre	= 4,840 sq. yards = 4046.85 sq. metres
1 mgm. per sq. ft.	= 10 mgms. approx., per sq. metre
1 c.c. 5 per cent solution		= 50 mgms. DDT per sq. ft.
per sq. ft.		
2 pints 5 per cent solution		= 50 mgms. DDT per sq. ft.
per 1,000 sq. ft.		
8 oz. DDT to 1 Imperial		= 5 per cent solution
gallon.		
7 oz. DDT to 1 U.S. gallon		= 5 per cent solution

SECTION IV

OTHER INSECTICIDES AND REPELLENTS

1. Gammexane (666).—This insecticide is the gamma isomer of benzene hexachloride. It is of low toxicity, although slightly more toxic than DDT. The penetrating odour of the commercial product has prevented its employment on a wide scale, although it is highly effective against many insects, including mosquito larvae, both as a dust and in solution. It is stable and has a residual effect similar to that of DDT and is soluble, though not to the same degree as DDT, in most organic solvents.

2. Dibutyl phthalate (DBP).—This substance is largely used for the impregnation of clothing as protection against the mite vectors of scrub typhus. It kills these larval mites rather less rapidly than dimethyl phthalate, but is not so readily washed out of the clothing, being still effective after eight washes whereas dimethyl phthalate cannot be relied upon after the third wash. One ounce per man at risk each fortnight is the usual issue. Careful training and supervision is necessary to ensure that each man carries out properly the impregnation of his own socks, trousers and shirt. DBP also has some repellent effect.

3. Dimethyl phthalate.—This substance, like DBP, is a substantially colourless fluid. Its chief use is as a repellent against mosquitoes and sandflies. It can generally be relied upon to give complete protection from bites for from two to five hours. An even more effective repellent is a mixture of dimethyl phthalate, Indalone and Rutger's 612 in the proportions 6 : 2 : 2 respectively. Indalone is dimethyl-carbobutoxy-dihydro-pyrone and Rutger's 612 is a hexanediol.

	<i>Page</i>		<i>Page</i>
Accident precautions ..	108-109	Carbohydrate, daily minimum ..	23
Acclimatization ..	56-57	Carbon dioxide, content of air ..	99
Activated sludge process ..	118	Carotene ..	23
Adenylic acid ..	25	Carriers 36-37, 156, 157, 158, 159,	160, 161, 166, 178
Aedes aegypti ..	77, 158, 169, 190	Castellani's paint ..	4
albopictus ..	158	Centipedes ..	203
index ..	190	Central heating ..	78
Aerial disinfection ..	153	by hot air ..	88
Aerosols ..	153	by hot water ..	88
Aertrycke ..	163	by steam ..	88
Air brick ..	100	Cerebro-spinal fever ..	151, 152, 156
conditioning ..	65-66, 101	Chancroid ..	156-157
movement, comfort level ..	59, 61, 86	Cheese ..	23
velocities ..	61	Chemical preservatives permis-	
Albour water ..	3	sible in U.K. in food ..	36
Aneurin ..	24	Chemoprophylaxis ..	148, 155, 156-191
Angus' opening figure ..	150	Chicken pox ..	157
Anthrax present in meat ..	35	Chimney flashings ..	74, 75
Anti-amaryl measures ..	190-191	Chlorides, test and urinary ..	67
catarrhal vaccine ..	155	Chlorine in diet ..	23
scurvy vitamin ..	25	Chlorotex test ..	17
Antimony from enamelware ..	102	Cholera ..	37, 158
Anti-tetanic serum ..	70	Civilization and climate ..	39
Arid desert area, camps in ..	67	Climates, classification of ..	50
Arthropods ..	184, 198, 204	cold ..	54
Artificial cultivation, desert		ideal ..	41
camps lighting ..	67	sub-tropical ..	52
Ascorbic acid ..	25-26	temperate ..	54
Ashes, disposal ..	146	tropical ..	50-53
Atebrin ..	168	world map ..	53
Athletic contests, diet require-		Climatology—terms ..	50
ments ..	29	Closed circulation system ..	101
Atmospheric comfort ..	99	Closure assembly places ..	150
Attenuated virus ..	155, 190	Clothing, cold weather ..	80, 81
Bactericidal mists ..	153	discarding for comfort ..	65, 81
Bailleul incinerator ..	146	effective materials in dry and	
Baking ..	26	humid heat ..	55-56
Balanced diet components ..	22, 34	flying ..	82
Barehead ..	56	gas-proof ..	83
Barracks—design ..	77-78	hot weather ..	81-82
Bathing, prohibition of ..	167, 180	in hot environment ..	55-56
Batman—hygiene ..	37	louse-proof ..	83
Bed bugs ..	203	mite-proof ..	83
Beehive incinerator ..	146	mosquito-proof ..	82
Beri-beri ..	24	personal—risks on sharing ..	5
Bites—risk ..	168, 174, 175, 177, 186-	special occupations ..	83-84
	188, 190	Cobalt in diet ..	23
Blanket oiling ..	154	Cockroaches ..	203
Bleeding gums ..	27	Cold climates, range ..	54
Body temperature ..	54	extreme—pathological effects	
Botulism ..	164	of ..	66-70
Bread—examination of ..	35	variation from normal diet	
Brynje clothing ..	69	required ..	29
Bubonic plague ..	172	water grease traps ..	135-139
Buildings, construction ..	70, 76-77	Comfort zones, effective tem-	
design ..	77-80	peratures ..	61
heating ..	87-88	Common cold ..	151, 155
insulation ..	65	Communicable diseases, control ..	148-
lay out ..	71		191
lighting ..	71	Conduction heating ..	87
siting ..	70-71	Conservancy ..	104-105, 111-147
Burial of refuse ..	140	Construction ..	76-77
Burns, protection against ..	82	Contacts, quarantine of ..	148, 150, 158,
Bush shirt ..	82	159, 171, 172, 174, 186, 188, 189,	190
Cairn incinerator ..	146	Control of individual diseases	
Calcium in diet ..	23	outbreaks, action ..	156-191
Calorie requirements ..	34	Convection heating ..	87
Camp siting in hot environment ..	67,	Cookhouses—design ..	77-78
	170-171, 188	hygiene ..	36
Camps, tented ..	71, 103-106	Cooking processes ..	28

	<i>Page</i>		<i>Page</i>
Cooks, hygiene of	36-38	Electrical heating	88
Cooling requirements	86	Ellsworth Huntington	39
Cooper's pane	100	Enteric carriers	38
Copper in diet	23	fever	38, 161-162
in water	9	Environment	39-110
Cox type vaccines	186	Epidemics—control	148-155
Culicinae	169	Epidermophytosis	3
Current disinfection	148	Epistaxis	27
Curtilage	71	Equatorial rainfall	41
Cyclonic activity—effects	40	Escape kit	82
		Evaporating pans	138
		Evaporation of sullage	138
		Exercise in hot climates	66
		open air	150, 156
		Extractor fans	101
Damp cleaning	154		
Dampness (buildings)	76	Fabrics, notes on	55-56, 68-69
Daylight factor protractor	90	Face masks	152
DBF	205	Factories Act, 1937—cubic	
DDT	200-205	space allowance	102
insect control by	159, 170, 177, 202-204	Factories (Standards of Lighting) Regulations, 1941	92
precautions in use	204	Faeces—disposal	140
preparations	201-202	Famine	149
solubility	204	Fans extractor	65, 101
toxicity	201	running speeds	101
useful data	205	velocities, removal of solid particles	102
Dehumidifying	76	Fat—daily minimum	22-23
Dehydrated vegetables	26	Fatigue	109
Dehydration	37, 58	Feeding utensils—sterilization	153
Dengue	158-159	Field latrines	127-134
Dermatophytides	4	Fish—examination	35
Dermatophytosis	3	Flap valves	100
Diarrhoea	38, 64, 163	Fleas	203
Diet	22-34	Flexner bacillus	160
alterations required by varying conditions	29	Floorspra	103
and resistance to disease	155	Fluorescent lighting	91
balanced	34	Flyproofing	78, 106, 128, 134, 161
components of adequate energy value for R.A.F. and W.A.A.F.	27	Food composition	30-33
for athletic contests	29	handlers—hygiene	36-38, 184
cold climates	29	periods of exclusion after	
hot climates	29, 66	apparent cure	37
mental work	29	poisoning	162-163
muscular work	29	botulism	164
Dietary requirements	27-29	non-specific bacterial	162-163
Dining halls	80	Salmonellosis	163-164
Diphtheria	151, 154, 159-160	staphylococcus	163
Disinfectants	197	various other sources	162
Disinfection	153, 192-198	preservatives permitted in	
Disinfestation	198-200	U.K.	36
Domestic services (buildings)	71	serving of	28
Dried foodstuffs	26	Foods, prepared, precautions	163
Droplet infections—control	149-155	Foodstuffs—examination	35-36
quarantine periods	150	Footbaths	5
Dust—control	153-154	Foot candles	88
dispersal	153-154	Formaldehyde	162, 197
extraction	100, 102	Formalin	197
Dusting powder	1, 5	Freon	67
Dysentery, amoebic	37, 38, 160	Fresh air per person	99
bacillary	160-161	Frostbite	
Dysuria	64	aetiology	67-68
		pathology	67-70
		prevention	68-69
		treatment	69-70
Eating utensils, sterilization	153	Frying	26
Effective temperature	60, 62	Funnel urinal	121-124
Eggs—examination	35		

	<i>Page</i>		<i>Page</i>
Gaertner	163	Illumination—	
Gametocyte	168-170	coefficient of utilization	97
Gammexane	205	daylight factor	90
Garbage—disposal	36-183	fluorescent	91
feeding to pigs, warning		foot candles	91
Gargling—inadvisable		full moon	89
instances	152, 166, 174, 178	industrial	89
Gentian violet	4	lamp spacing	94
German measles	164-165	lumen ratings (gas-filled	
Germicidal smokes	153	lamps)	98
Glare	89	(electric discharge lamps)	98
Goitre	23	lux values	89
Gonorrhoea	165	photo-electric control	90
Grease traps	78, 135, 137, 138	quality	89-92
Green vegetables	23	reflection factors	96
Haemolytic streptococcus	177	room index	95
Haemophilia	27	sky angle	90
Hair	25	standards	91
Heat—acclimatization to	56-57	summer sun	89
clinical effects	63-64	tone values	89
cramps	64	Immersion foot	67-70
exhaustion	63-64	Immunization 148, 155, 158, 159,	
hyperpyrexia	64	162, 171, 172, 174, 186, 187, 190	
insulation	65	danger	177-178
intolerance	57	indiscriminate active	154
physiological principles	54	infants	159, 189
prickly	5, 64	passive	154, 159
prophylaxis	64-67	Schick testing	159
protection against (buildings)	76-77	specific 154, 155, 158, 159, 162,	
reaction to	54-58, 63-64	171, 172, 186, 187, 190	
stroke centres	67	value doubtful 154, 155, 161,	
Heating :	86-88	166, 172, 174, 187, 188	
of buildings	86, 87-88	Impetigo	3
Hepatitis—acute infective	166-167	Incentive	107
Herpes zoster	157	Incineration	105, 139-140
Herring bone drainage	138	Incinerators—	
Horrocks' test	15-17	Baillou	142
Horseflesh	35	beehive	142
Horsfall destructor	142	cain	146
Hot climate—acclimatization		characteristics of good	140
diet	66	Horsfall	142
educative measures	66	inclined plane	146
environment—		open types	142
air movement	86	portable	142
camp siting	67	Incubation periods, droplet in-	
clothing	55-56	fections	151
discomfort level	61	Indalone	205
marching in	57	Industrial	106-110
pathological effects	54-67	accident precautions	108-109
prophylaxis	64-67	bench height	109
reinforcement—natural		breaches discipline	106
body cooling	64, 65	clothing	80, 83, 84-85
rest and leave	66	hours of work	107-108
variation of normal diet		medical officers' duties	106
required	66	posture	108
Hours of work—		principles of health—	
hot environment	63, 66	seats, women workers	109
industry	107-108	toxic hazards	109
Houseflies	203	welfare	109, 150
Humidity—		Infections, specific	1-5
absolute	50	Infestations, specific	1-5
effects of	40-41	Influenza	154, 166
relative	50, 51	virus vaccine	155
technical terms	49	Inoculation	154-155
Humus tank	113	Insecticides	200
Hygienist's responsibility	39	Insect vectors, control	148, 198
Hyperpyrexia	64	Insulation of buildings (tropics)	65
Ice cream	162	Inter-Allied Food Commission	
Ictero-haemorrhagic spiro-		(fat minimum)	23
chaetosis	167	Intestinal worm infections	37

	<i>Page</i>		<i>Page</i>
Notifiable diseases—		Panthothenic acid	25
Botulism	164	Paprika	28
Cerebro-spinal fever	156	Paratyphoid fever	37
Chancroid	156-157	Paris green	170
Chicken pox	157	Pasteurization	160, 162, 178, 189
Cholera	158	Patio	77
Dengue	158-159	Pediculosis	1
Diphtheria	159-160	Pellagra	24
Dysentery	160-161	Penicillin	3
Enteric fever	161-162	Perceptible draught	56
bact. proven	162	Percolating filters	113
clinical	162	Perimeter of an airfield, definition	191
Food poisoning	162-164	Personal hygiene	1-5, 152
salmonellosis	163-164	Persons per acre	71
staphylococcus	163	Phlebotomus fever	176-177
Gonorrhoea	165	papatasi	177
Influenza	166	Phosphorus in diet	23
Jaundice, acute catarrhal	166-167	Pig farm hygiene	183
haemorrhagic	167	Pitot tube	59
Malaria	168-171	Plague	77, 151, 172-173
Measles	171	Plasmodium falciparum	168
Mumps	171-172	malariae	168
Phlebotomus fever	176-177	ovale	168
Plague	172-173	vivax	168
Pneumonia	173	Plate waste	28
acute influenzal	166	Plenum system, ventilation	101-102
Polioccephalitis	173-174	Plummer-Vinson syndrome	25
Poliomyelitis	173-174	Pneumonia	166, 173
Rabies	174-175	Pneumonic plague	151-172
Relapsing fever	175-176	Poisoning, detoxicating agent	173-174
Sandfly fever	176-177	Polioccephalitis	151, 152, 173-174
Scarlet fever	177-178	Poliomyelitis	151, 173-174
Schistosomiasis	178-180	Pork—cooking warning	182-183
Smallpox	180-182	Posture	106
Syphilis	182	Potassium in diet	23
Trichinosis	182-183	Potatoes	28
Tuberculosis	183-184	Preservatives, food	162
Typhus	184-188	illegal in U.K.	162
murine	186-187	permitted in U.K.	36
scrub	187	Preserved food—examination	35-36
tick	187	Pressure fans	101-102
Undulant fever	188-189	Prickly heat	51
Weil's disease	187	Protein, daily minimum	22
Whooping cough	189	Protection of sick attendants	172
Yellow fever	190-191	Pruritis	25
Nutrition	149	P.T., compulsory	150
Nutritive components of food-stuffs	31-34	Ptomaine poisoning	163
		Punkahs	63, 77, 170
Observation	148		
Open braziers	87	Quarantine	148, 150, 158, 159, 171, 172, 174, 180, 186, 189, 190
fireplace	89	periods, droplet infections	150
Opening figure	150	Quinacrine	168
Oral prophylaxis, when moderate	176	Quinine	170
Ornithodoros	176		
Otway pit	134	Rabies	174-175
Overcrowding	150	Radiant heat sources	87
OX 2	187	Rainfall, types	41
OX 19	186, 187	Rash (in scarlet fever)	177
OXX	187	Rats	77, 163, 164, 167, 173
Oxygen, when to give	70	Rectal temperature danger level	54
		Reflection factors	96
Paints (British standard)	96		
colours for ready-mixed)	170		
Paludrine	170		

	<i>Page</i>		<i>Page</i>
Refrigerants	67	Six-One-Two (612)	205
Refuse disposal	139-147	Six's thermometer	59
burial	140	Six-Six-Six (666)	205
dry	139-140, 146	Size of lamp unit, estimation	92
liquid	146	Skin injuries, minor	55
swill	146	temperature	54
Relapsing fever	175-176	Sky angle	98
Remustering on medical grounds	37	Sling psychrometer	59
Repellents	205	Slouch hat	56
Repetitive work	108	Smallpox	180-181
Rest, in hot environment	66	Soakage pits	123, 138, 157
pauses	181	Sodium in diet	23
Re-vaccination—technique	24	Solar radiation thermometer	59
Riboflavin	184	Sonné	160
Rickettsia types	187	Sore throat, streptococcal	177
Rocky Mountain spotted fever	77	Space allowance standards, R.A.F.	103
Roof gutters	95	in workrooms	103
Room lighting index	77	Spiders	203
Rooms, hot climates	151	Spinach	23
Rubella	205	Spitting	1, 152, 184, 188
Rutgers 612	26	Spot cooling	66
Salads	163-164	Spotted fever	156
Salmonellosis	58, 63	Staggered beds	149, 150
Salt depletion	66	Staphylococcus food poisoning	163
'Eat more'	58	Steam disinfection	192
requirements in hot environ- ments	176-177	Steaming (cooking)	26
Sandfly fever	183	Sterilization, eating and drinking utensils	153
Sausages—cooking warning	2-3	food, milk, water	148
Scabies	177	Stewing	26
Scarlatina	151, 152, 154, 177-178	Stokers' cramp	63
Scarlet fever	159	Storms, effect of	40
Schick testing	178-180	Stripping to waist	65
Schistosomiasis	203	Sub-tropical climates	52
Scorpions	187-188	Sub-tropics, definition	52
Scrub typhus	26	Sullage	135-138
Scurvy	113	chemical precipitation	137
Sedimentation tanks— horizontal flow	114	cold water grease traps	135-137
upward flow	148	disposal effluents	138
Segregation	119-120	evaporation	138
Septic tanks	111	grease and soap separation	135
Sewage—amount per head per day	116-117	strainer traps	135
analyses interpretation	111	Sulphadiazine	156
composition	111-113	Sulpha guanidine	161
disposal works	116-117	Sulphanilamides	156
effluent-analysis	117	Sulphathiazole	156, 161
field test	46	Sulphonamide intolerance	25, 155
humus tank	113	Sulphonamides	155
management R.A.F. sewage works	115-116	Sulphur in diet	23
percolating filters	113	Sun helmet	56
principles of purification	113	Surveillance, definition	148
screening chamber	113	Swabbing when no value	154, 178
sedimentation tanks	111	Sweat—cessation of	58
sources	111	evaporation	58
standard pattern, variations in	117-119	loss, rates production	58
Shellfish	162	Swill bins	28
Sheringham valve	99	feeding to pigs, warning	183
Shiga bacillus	160	Syphilis	182
Silica dust risk	110	T.A.B.C.	162
Simplex process	118	T.A.F.	154
		Tsutsugamushi fever	187
		Teeth	vi
		Temperate climate, definition	41
		rainfall	41

	Page		Page
Temperature—comfort ..	86	Vacuum heating, steam ..	88
effective scales ..	60-62	Vegetables, large-scale cooking ..	28
effects of ..	40	Veneral disease—	
measurement ..	86	chancroid ..	156-157
monthly mean, selected places		early treatment ..	165, 182
of prognostic significance ..	42-49	gonorrhoea ..	165
optimal, for mental and		in food handlers ..	38
physical effort ..	61	prevention ..	182
requirements in buildings ..	86	syphilis ..	182
technical terms ..	50	Ventilation ..	99-103, 149-150
Temporary camps, lay-out ..	71	artificial ..	100-102
Tented camps ..	103-106	assessment of adequacy ..	102-103
Terminal disinfection ..	148	combined exhaust and	
Tetanus ..	70	pressure systems ..	102
Thermal environment, assess-		exhaust systems ..	78, 100
ment ..	59-63	extractor cowls ..	100
Thermometers, various ..	59	fanless exhaust ducts ..	100
Thiamine ..	24	flap valves ..	100
Threshold of vision ..	88	individual needs ..	149
Thyroxine ..	23	kouvred clerestories ..	100
Ticks ..	176, 203	natural ..	99-100
Tinea ..	3-4	opening figure ..	150
Tinned food, examination ..	35-36	pressure systems ..	101-102
Tobin's tube ..	99	warmth as aid to ..	100
Toilet paper ..	128, 130	window supply gravity	
Topee ..	56	exhaust ..	101
Toxic hazards in industry, pre-		Verandahs ..	76-77
cautions ..	109	Vernon globe thermometer ..	59
Trade preparations, toxicity ..	110	Vi agglutination ..	161
Trematode worms ..	178	Vibrio comma ..	158
Trench foot ..	67-70	Vision at night ..	24
Trench latrine ..	128-130	Visual purple ..	24
Trench urinal for 250 men ..	121	Visual threshold ..	88
Treponema pallidum ..	182	Vitamins—	
Trichinosis ..	182-183	Daily requirements, ..	34
Tropical climates ..	50-52	A signs of deficiency ..	23
rainfall ..	41	sources ..	24
Tropics, dry ..	52	B factors of ..	24
humid ..	52	sources ..	24
true, definition ..	50	B ₁ components ..	25
Trough urinal ..	125	results of deficiency ..	25
Tuberculosis, non-pulmonary ..	184	B complex ..	24-25
pulmonary ..	183-184	C deficiency effects ..	25-26
Typhoid carriers ..	37	destruction factors ..	26
Typhus ..	184-188	properties ..	26
flea-borne ..	184-186	sources ..	25-26
louse-borne ..	184	D action ..	26-27
mite-borne ..	188	deficiency effects ..	26
tick-borne ..	187	sources ..	27
Ultra-violet light ..	91, 153, 155	E effects ..	27
Undulant fever ..	37, 188-189	sources ..	27
Urinals ..	121-126	K action ..	27
disposal contents ..	125	effects ..	27
field ..	121-126	sources ..	27
funnel ..	121-124	P ..	26
pail ..	125	Walls ..	72, 73, 76
shallow trench ..	121	War chemicals in water ..	9
trough ..	125	Washing-up after meals ..	153
Urinary chlorides, test for ..	67	Water ..	6, 21
Urine, pollution subsoil ..	121	analysis ..	18
production per day ..	121	bact. examination ..	18
Vaccination ..	180-182	balance in hot environment ..	57
of calves (experimental) ..	189	basic needs at varying mean	
reactions ..	181	temperatures ..	57
requirements for R.A.F. and		boiling of ..	9
W.A.A.F. ..	180-181	casual supplies precautions ..	19
		chemical analysis ..	19
		chloramination ..	12
		chlorination ..	11-12
		Chlorotex test ..	17

	<i>Page</i>		<i>Page</i>
Water—(cont.)		Welfare of industrial workers	110
contaminated supplies, action	15,	West coasts of continents,	
	18-19	rainfall	41
daily requirements	7	Wet and dry bulb thermometers	59
dechlorination	12-13	Whitewashing	76
'Drink more'	66	Whitfield's ointment	5
field supplies, action	13-15	Whooping cough	151, 155, 189
filtration	9	Windows—	
Horrocks' test	15-17	clerestory	100
impurities	9	design	89
mobile water carts	15, 106	in hot climates	77
M.O.s responsibility	7, 17	Wire screening	170
new stations, permanent sup- plies	19	Woodwork in buildings in hot climates	77
permanent stations, supplies	13	Working hours	63
permanent water supplies ..	17-18	Work places, heating	86
purification	9	lighting	88-98
quantities required	7	ventilation	99-103
samples for analysis	17		
Schistosomes in	15	Xenopsylla cheopsis	186
sedimentation	9	X-ray mass miniature	184
sources of supply	6, 7-8		
sterilization by chlorine	11-12	Yeast	25, 28
sterilizing tablets	13-15	Yellow fever	190-191
superchlorination	12-13	immunization	190
supplies required daily per head at an R.A.F. unit	7		
technique of sampling	19-21	Zinc in water	9
tests for free chlorine	13		
treatment in field	13-15		
Weather manifestations, effect on health	40		
Weill's disease	167		
Weill Felix reaction	186, 187		
Welders' goggles	106		

LONDON

PRINTED AND PUBLISHED BY HIS MAJESTY'S STATIONERY OFFICE

To be purchased directly from H.M. STATIONERY OFFICE at the following addresses:

York House, Kingsway, London, W.C.2 ; 13a Castle Street, Edinburgh 2 ;

39-41 King Street, Manchester 2 ; 1 St. Andrew's Crescent, Cardiff ;

80 Chichester Street, Belfast ;

or through any bookseller

1947

Price 7s. 6d. net