

Correspondents are requested to write  
on only one side of paper, and to  
address all letters: "The Director of  
Education, Wellington, C.1"

Telegraphic address:  
"Education, Wellington."

NEW ZEALAND.

Education Department,

WELLINGTON, C.1.

3rd November 1936

Mr. R. Kodanda Rao,  
Secretary,  
Servants of India Society,  
POONA INDIA.

Dear Mr. Rao,

Under separate cover, I am sending you, as  
promised, a parcel containing specimens of our instruction  
papers, enrolment forms, Monthly Circulars, and so forth.

I am also enclosing some publications recently  
received from Achimota Native College, on the Gold Coast  
of West Africa. Although these are marked to be returned  
to me, you may retain them for your own use if you wish.  
They show that a very fine work is being undertaken there  
for the education of native leaders of the African peoples.

I should like to thank you again for the great  
pleasure you gave me through your address to the Wellington  
Institute of International Affairs and in our personal  
subsequent intercourse and I shall be glad if you can find  
time to write to me regarding your work in India, in which  
I am greatly interested.

I have arranged to have a copy of our forthcoming  
annual magazine, "The Postman", forwarded to you when it is  
published at the end of the year.

With kind regards,

Yours faithfully,

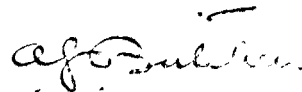

Headmaster, Correspondence School.

usual limits of distance  
 Under 7 years 2 miles  
 Between 7 and 11 years 3 miles  
 Over 11 years 3½ miles

**CORRESPONDENCE SCHOOL.**

**3**

**Form of Application for Enrolment.**

**NOTES FOR PARENTS OR GUARDIANS.**

EDUCATION by correspondence is not intended for children who can reasonably be expected to attend public school. If this application is made on grounds of ill-health, a medical certificate should be forwarded herewith, unless the home is at least four miles from the school.

The teacher of the nearest school must also sign this application if such school is less than four miles from the applicant's residence.

The form, after being properly filled in, is to be posted to THE SENIOR INSPECTOR, EDUCATION OFFICE, of the Education District in which the applicant resides. [Auckland, New Plymouth, Wanganui, Napier, Wellington, Nelson, Christchurch, Dunedin, or Invercargill.]

Please write all particulars PLAINLY.

Name of parent or guardian: \_\_\_\_\_

Postal address: \_\_\_\_\_

How frequently are mails received: \_\_\_\_\_

Name of nearest school: \_\_\_\_\_

Distance by road from home to nearest school: \_\_\_\_\_

Nature of the road (metalled, unmetalled, track, hilly, dangerous cliffs, &c.): \_\_\_\_\_

Is there a governess or teacher of any kind employed? \_\_\_\_\_

Who will supervise the pupil's work? \_\_\_\_\_

Will you undertake to see that each pupil devotes daily to school-lessons the time specified by the Head

Teacher of the Correspondence School? \_\_\_\_\_

Reason for not attending a school if within four miles of your residence: \_\_\_\_\_

Names (in full) of Children for Enrolment (Christian names first). <small>Underline name by which child is usually called.</small>	Age last Birthday.	Date of Birth.			Present Class.	Last School attended (if any), and Date of Leaving.	By whom (Teacher, Governess, or Parent) and on what Date was the Child promoted to his present Class?
		Day.	Month.	Year.			

Date: \_\_\_\_\_ **Signature of Parent:** \_\_\_\_\_

**Certificate to be filled in if the Applicant's Residence is less than Four Miles from a Public School.**

HEREBY, certify, that the above-named children cannot reasonably be expected to attend my school.  
The reason is as follows: \_\_\_\_\_

(Signed) \_\_\_\_\_

Teacher of \_\_\_\_\_ School.

Recommendation and remarks by Senior Inspector: \_\_\_\_\_

**Signature of Senior Inspector:** \_\_\_\_\_

Decision of Department: \_\_\_\_\_

**Signature of officer:** \_\_\_\_\_

To be sent to The Senior Inspector of Schools. (See paragraph 1 below.)

NEW ZEALAND.—EDUCATION DEPARTMENT.

No 100

CORRESPONDENCE SCHOOL  
(SECONDARY DIVISION).

APPLICATION FOR ENROLMENT.

N.B.—Before filling in please read page 2 carefully.

This form, when completed, should be posted to THE SENIOR INSPECTOR, EDUCATION Office [Auckland, New Plymouth, Wanganui, Napier, Wellington, Nelson, Christchurch, Dunedin, or Invercargill] of the Education District in which the applicant resides. Page 3 of the form, together with the book-order, should be posted at the same time direct to the Headmaster, Correspondence School, Education Department, Wellington.

Name of parent or guardian: \_\_\_\_\_  
 Postal address: \_\_\_\_\_ Railway Station: \_\_\_\_\_  
 Nearest post-primary school: \_\_\_\_\_ Distance from home by road: \_\_\_\_\_  
 Nature of the road (metalled, unmetalled, track, hilly, dangerous cliffs, &c.): \_\_\_\_\_

Special Information re Railway Facilities.

- (a) Distance of home from station: \_\_\_\_\_ miles.
- (b) Distance of post-primary school town by rail: \_\_\_\_\_ miles.
- (c) Train leaves home station for post-primary school town \_\_\_\_\_ a.m.; arrives \_\_\_\_\_ a.m.
- (d) Train departs from post-primary school town \_\_\_\_\_ p.m.; arrives home station \_\_\_\_\_ p.m.

Nearest primary school: \_\_\_\_\_ Grade of school: \_\_\_\_\_ Distance from home: \_\_\_\_\_

Teacher in charge of primary school: \_\_\_\_\_

Who will supervise the pupil's work? \_\_\_\_\_

Will the supervisor undertake to see that each pupil devotes daily to school-lessons the time specified by the Headmaster of the Correspondence School? \_\_\_\_\_

Has the pupil previously attended a post-primary school? \_\_\_\_\_

If so, please give on a separate sheet full particulars, including (a) name of school; (b) duration of attendance thereat; (c) subjects studied and stage reached in each. (Please send, if possible, copy of last school report.)

Does the pupil suffer from any physical disability? If so, please state its nature: \_\_\_\_\_

Which course of instruction does the pupil wish to take? (Strike out all but the course desired.)

- A.                      B.                      C.                      D.

(Full information in regard to the courses is supplied on page 2 of this Form.)

For how many years does the pupil intend to continue his or her post-primary studies? \_\_\_\_\_

Names (in full) of Children for Enrolment. (Surname last.) <small>(Underline Christian name usually used)</small>	Age last Birthday.	DATE OF BIRTH.			Last School attended, and Date of Leaving.	Date when, and School in which, Proficiency Certificate or Senior Free Place obtained.
		Day.	Month	Year of Birth.		

Date of application: \_\_\_\_\_ Signature of parent or guardian: \_\_\_\_\_

Recommendation, and remarks by the Senior Inspector—e.g., course of instruction most suitable for pupil: \_\_\_\_\_

Grading No. of primary teacher: \_\_\_\_\_

Signature of Senior Inspector: \_\_\_\_\_

Decision of Department: \_\_\_\_\_

TO BE RETAINED BY THE PARENT.

**Education Department's Correspondence School.  
SECONDARY DIVISION.**

**INFORMATION IN REGARD TO COURSES OF STUDY.**

The Secondary Division of the Correspondence School does not enrol young persons that can reasonably be expected to attend a post-primary school (Secondary, Technical, Combined, or District High School).

Pupils holding Proficiency Certificates are entitled to three years' tenure of their junior free place in the Secondary Division of the Correspondence School.

Pupils holding Certificates of Competency may be enrolled provided they are fourteen years of age and are not within convenient reach of a District High School.

In order to qualify for a Senior Free Place (Intermediate Certificate) they must include in their course of study English, History and Civics, Arithmetic, and a Science subject. The Science subjects taught by correspondence are Agriculture, Home Science, and Hygiene. At least one of these three subjects must therefore be included in the course.

Provision is made for pupils who fail to qualify for a Senior Free Place at the end of their third year to continue as fee-paying pupils, if desired, until such time as they obtain the Intermediate Certificate. The fees in such cases are those payable in the secondary departments of District High Schools—namely, 15s. per term, payable in advance.

Pupils holding Intermediate Certificates are entitled to continued free secondary education until the end of the term in which they become nineteen years of age.

Pupils are classified A, B, C, or D according to the courses studied, as follows:—

**COURSE A.**—Course A fulfils the requirements for all the following certificates and examinations: Intermediate, School, and Higher Leaving Certificates, and University and Training College Entrance Examinations.

The subjects suggested for this course are English, History, Geography, Arithmetic, Algebra, Geometry, Latin, and a Science subject; also, for pupils intending to become teachers, Drawing. Girls may study Needlecraft in addition, if desired.

Notes.—(1) French may be substituted for Latin, but Latin is recommended owing to the special difficulty of teaching French pronunciation by correspondence. This will be met as far as possible by a series of broadcast lessons. Pupils studying French should therefore be in a position to listen to broadcasts from 2YA, Wellington, if arrangements for such can be made.

(2) The sciences taught are Agriculture, Home Science, and Hygiene. The Correspondence School course in Agriculture is a very good one and has been successfully taken right through to the Matriculation stage by girls as well as boys. The course in Home Science is for girls only. This subject presents special difficulties when taught by correspondence, the chief of which is that of carrying out the necessary laboratory work in Physics and Chemistry. The Correspondence School endeavours to overcome this difficulty by assembling pupils who have satisfactorily completed at least one and a half year's work in this subject, for one week's intensive laboratory work at a neighbouring high school, which parents and pupils must be prepared for in the second or third year of the course. Similar arrangements are made in the case of pupils studying Agriculture.

Hygiene is definitely the least difficult of the three science subjects. It includes the study of physiology, the laws of health, and first aid, and is recommended as an excellent subject for its own sake. Hygiene is not a Matriculation subject, but satisfies the requirements of the Free Place regulations regarding the study of Science. It may be presented also for the School Certificate Examination.

**COURSE B** in future will be a special course for girls only, fulfilling the requirements for Intermediate, School, and Higher Leaving Certificates, and for University Entrance (Matriculation), but not for the Training College Entrance Examination.

It consists of the following subjects: English, History, Geography, Arithmetic (*without* Algebra or Geometry), Latin, Home Science, Hygiene, Needlecraft.

Note.—French may be substituted for Latin, but see Note (1), Course A, above.

**COURSE C** is sufficient for Intermediate, School, and Higher Leaving Certificates. This course is strongly recommended for all girls and boys who do not require to matriculate, but wish for a sound, cultural, and practical secondary education. It does not admit to the University.

The subjects suggested are English, History, Geography, Arithmetic (*without* Algebra or Geometry), Agriculture, Hygiene, Needlecraft (for girls), Drawing, Book-keeping.

Note.—(1) Agriculture is optional for girls, but compulsory for boys, unless special exemption is granted by the Headmaster.

(2) Book-keeping and Drawing are optional, and one or both may be omitted from the course.

(3) Needle-craft and Hygiene must be studied by all girls taking this course.

**COURSE D.**—Course D is an abbreviated course consisting of English and one or more special subjects in addition. It is intended for pupils who are unable to devote full time to study and can only be taken by special permission. It must be emphasized that this is not an examination course, and that it is not sufficient for Intermediate Certificate (Senior Free Place).

**GENERAL COMMENTS**

(1) Experience has shown definitely that pupils of the Secondary Division of the Correspondence School *make the best progress studying privately in their own homes*, given the following conditions:—

- (a) The pupil must be provided with a satisfactory room in which to study.
- (b) A reasonably large table or desk of the proper height should be provided, with suitable chair.
- (c) The lighting should be good and the pupil's table or desk should be placed so that the light shines from the left upon the pupil's work.
- (d) Parents must undertake to see that the pupil has full time in which to undertake the work—namely, five hours daily from Monday to Friday. A detailed time-table of studies is provided as a guide for parents and pupils.

(2) Parents are strongly urged to consult the Headmaster regarding their children's courses of study. If an indication is given of the length of time for which it is expected they will continue their secondary education (whether wholly by correspondence or partly by correspondence and later at a secondary school), and of the subsequent occupation or career towards which they wish their children's education to be directed, a suitable course will be planned and the parents advised accordingly.

(3) The number of years normally required from the Proficiency Certificate standard to qualify for the various certificates and examinations is as follows:—

For Intermediate Certificate: From two to three years.

For School Certificate and University Entrance Examination: Four years.

For Higher Leaving Certificate and Training College Entrance examination: Five years.



This sheet to be detached and posted to—

The Headmaster, Correspondence School,  
Education Department,  
Wellington.

6.

Nº .00

**NEW ZEALAND.—EDUCATION DEPARTMENT.**

**CORRESPONDENCE SCHOOL.—SECONDARY DIVISION.**

NOTE.—This advice form is to be posted **direct** to the Headmaster, Correspondence School, Wellington, at the same time as the formal application for enrolment is forwarded to the Senior Inspector of Schools for the district in which the pupil resides. Any books required should be stated below, and payment in accordance with the book-list supplied herewith made by money-order or postal notes sent with this advice.

THE HEADMASTER,  
CORRESPONDENCE SCHOOL,  
EDUCATION DEPARTMENT,  
WELLINGTON.

I have to advise you that I have to-day forwarded to the Senior Inspector of Schools at \_\_\_\_\_ an application for the enrolment of my [son] [daughter] \_\_\_\_\_ as a pupil in the Secondary Division of the Correspondence School.

If the application for enrolment is accepted, please supply the undermentioned books and stationery, for which I enclose \_\_\_\_\_ for £ / / as payment.  
(Orders, Postal notes.)

Signature of parent: \_\_\_\_\_

Full postal address: \_\_\_\_\_

Date: \_\_\_\_\_, 193 \_\_\_\_\_

**PARTICULARS OF APPLICATION.**

Course of study applied for (Strike out all but one):

A.            B.            C.            D.

Number of years the pupil intends to pursue his or her post-primary studies: \_\_\_\_\_

**LIST OF BOOKS, ETC., REQUIRED.**

N.B.—As many of the text-books used by the Correspondence School are obtainable **only from the School Book Store**, parents will save themselves much delay and disappointment by sending their book orders direct to the School. In cases where the selection of the subjects of study is left to the Headmaster it is suggested that parents forward the sum of thirty shillings on account, the balance, if any, to be remitted immediately the books and requisites are received from the Correspondence School. A copy of the book-list is enclosed herewith.

\_\_\_\_\_  
\_\_\_\_\_  
\_\_\_\_\_  
\_\_\_\_\_  
\_\_\_\_\_  
\_\_\_\_\_  
\_\_\_\_\_

Dear little new people.

I think it must be such fun to get lessons through the post. Every envelope looks so fat and important when I send it to you. Perhaps Mother lets you open yours, does she?

Now here are all kinds of lessons for you - not the least bit hard - drawings, sums, games to play and pictures to colour. Oh! ever so many more things to do, so that you will just love school.

I know that you will try very hard. I am sending you a book in which to put your drawings, cutting out, numbers and other things. Next time I want you to make your own.

What fun we are going to have.

Can you tell Mother about my pictures? Mary is having a happy time with her little family. I wonder if her babies like having their bath. I don't think they do. I expect they know that means bedtime.

Betty and John are going to build a tower, up and up and up. I hope it doesn't fall over before they reach the top.

I wish I could hear about your toys, but as I can't, will you draw your favourite toy for me. I wonder what it will be!

Best wishes  
from

I. Burton

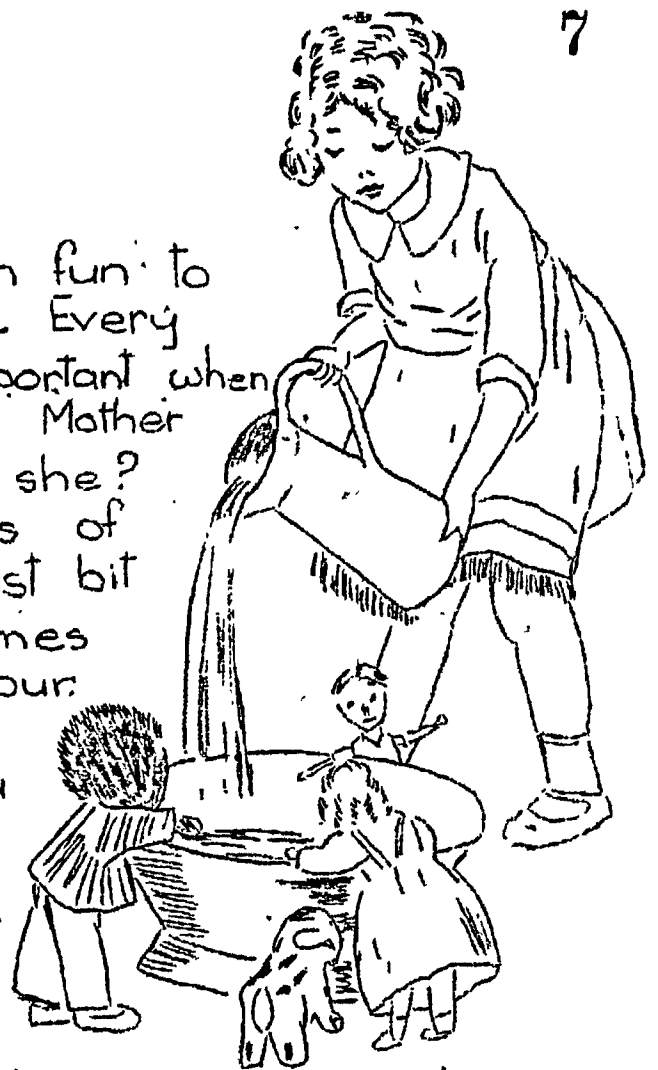
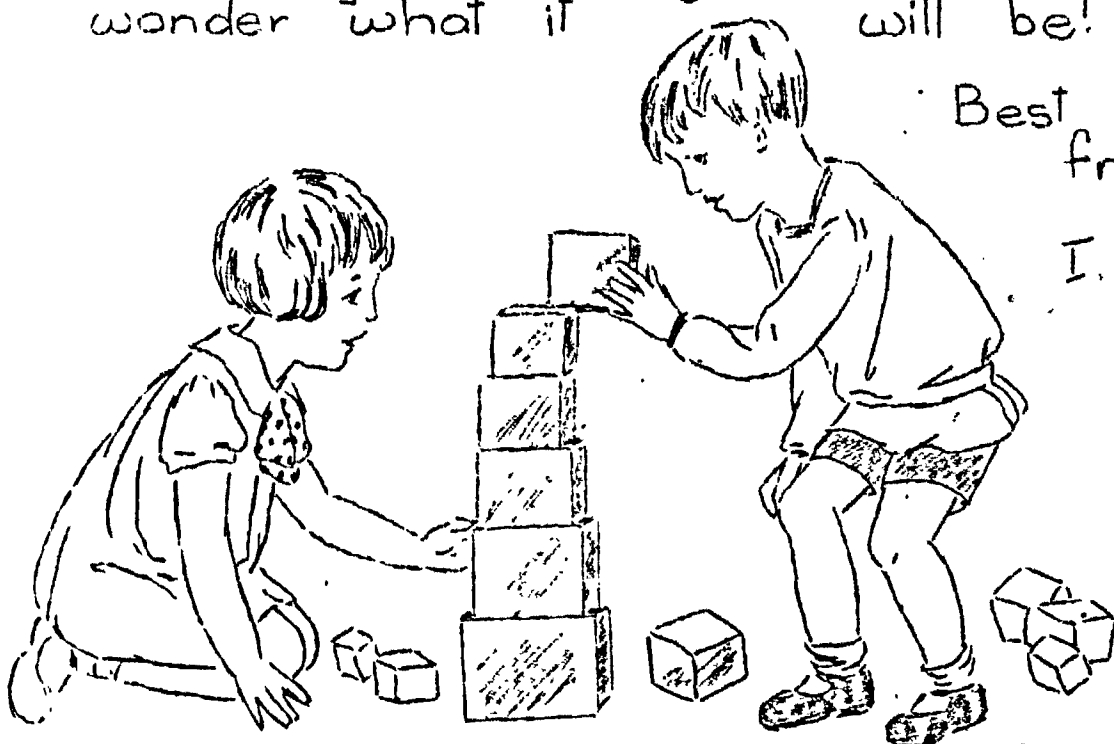

How do you like my gollywog? Isn't he a beauty? He will look much finer when you have coloured him very carefully with your crayons. Give him a red coat, blue trousers, green bow, white shirt, black face, hair and hands. Paste him carefully on cardboard and cut him out. (If it is very stiff Mother will help you.)

Paste the strip on his back and he will stand up.

I want to see him when he is finished - he will fit in your envelope without being folded.

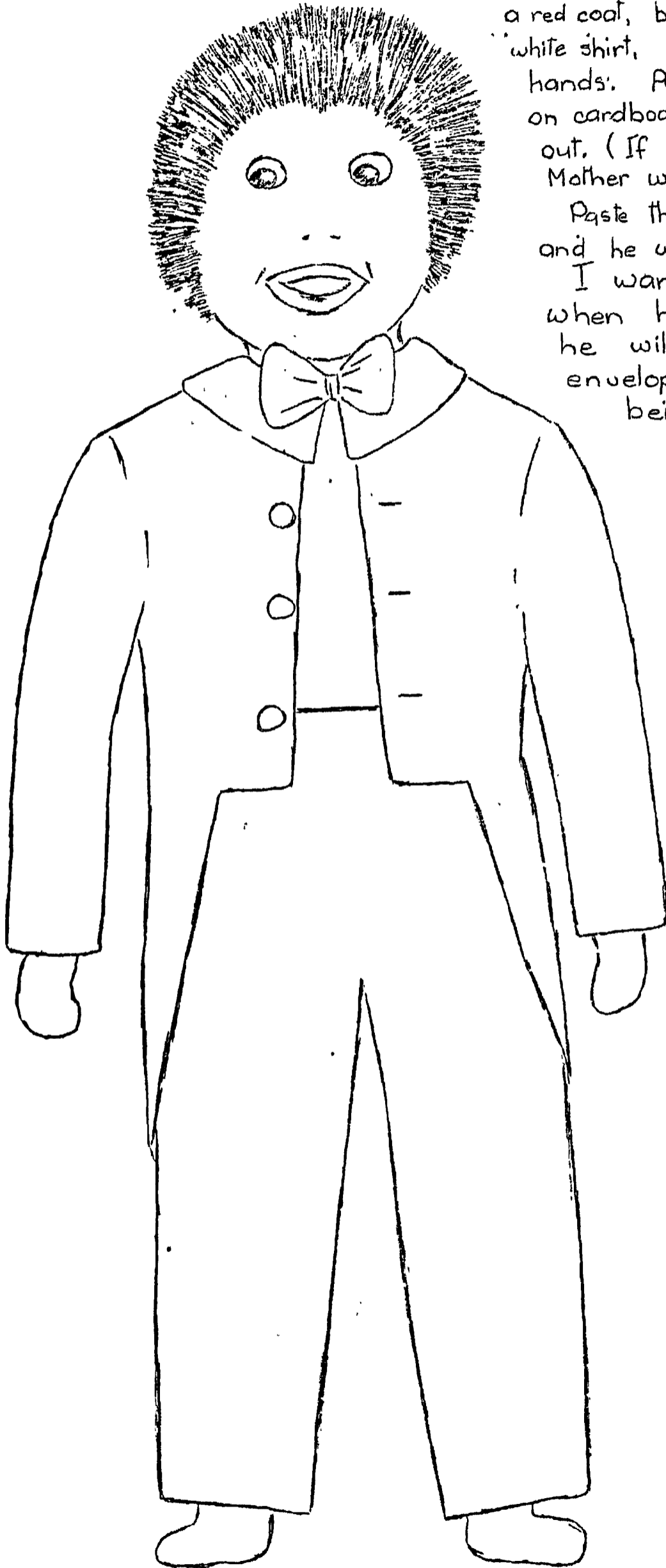





Stick this square on golly's back and he will be able to stand up. Bend here a little.

# Word-matching

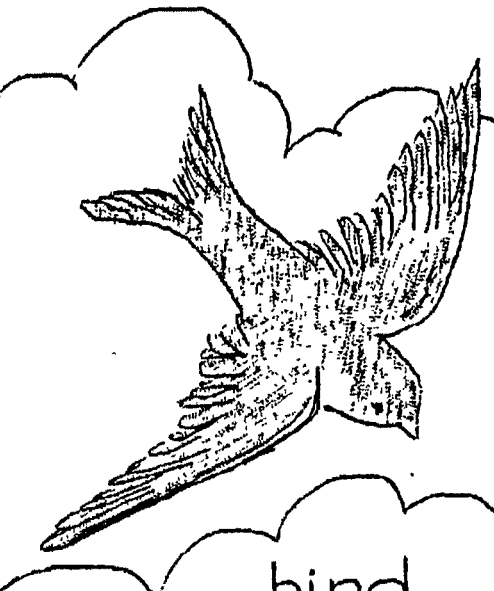
Mount the cards below on cardboard. Cut out the words on the small card separately and give plenty of practise in placing them on the corresponding picture. The words should be learnt as a whole - not on any account spelt or split up into separate sounds. This step comes later.

The words may be written and also made in plasticine. An attempt to draw the objects named should also be made. These word-matching puzzles are of great value to the child and should be kept in a box and used constantly.

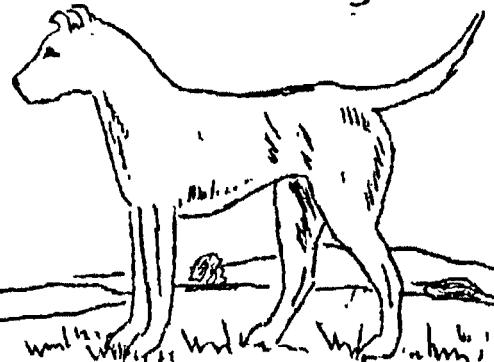
 <p>girl</p>	 <p>bird</p>	 <p>boy</p>
--	---	---

<p>dog</p> 	<p>cat</p> 	 <p>woman</p>
--	---	--

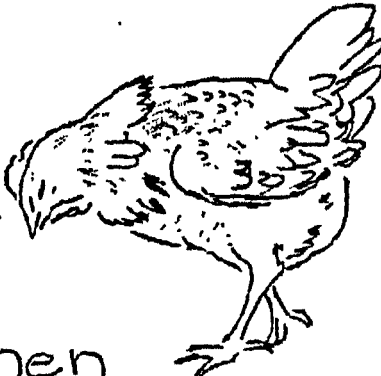
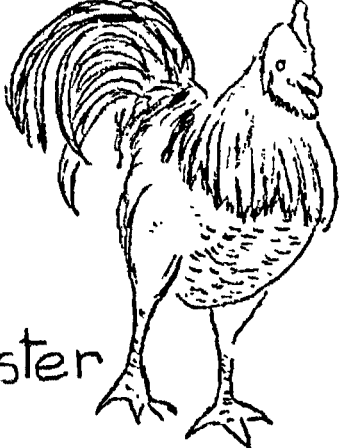
<p>baby</p> 	<p>hen</p> 	 <p>rooster</p>
---	---	--

bird | cat

boy | baby | dog | girl

woman | rooster | hen

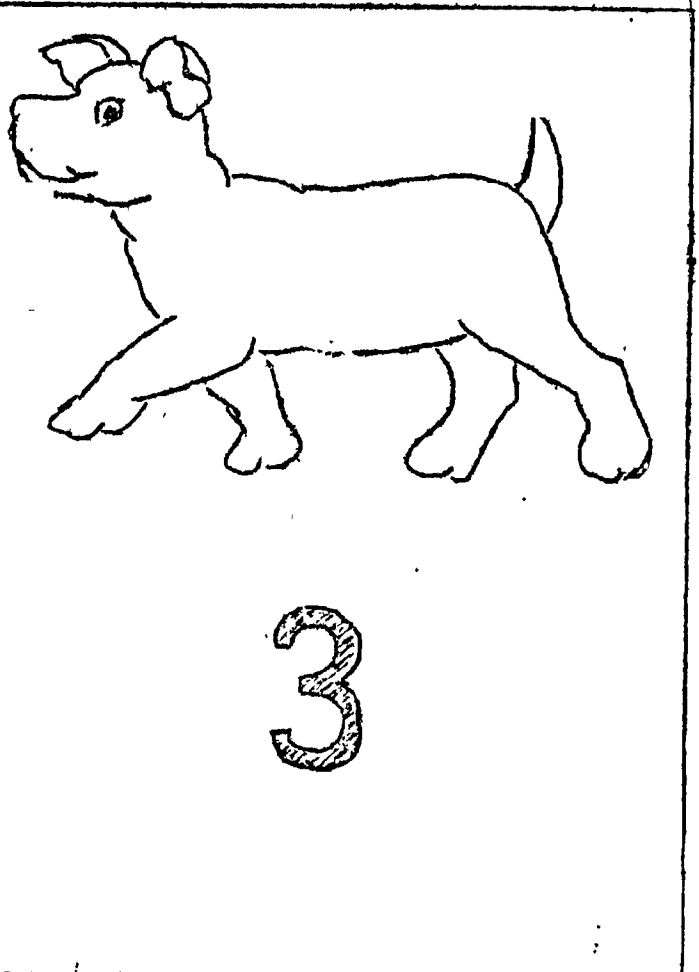
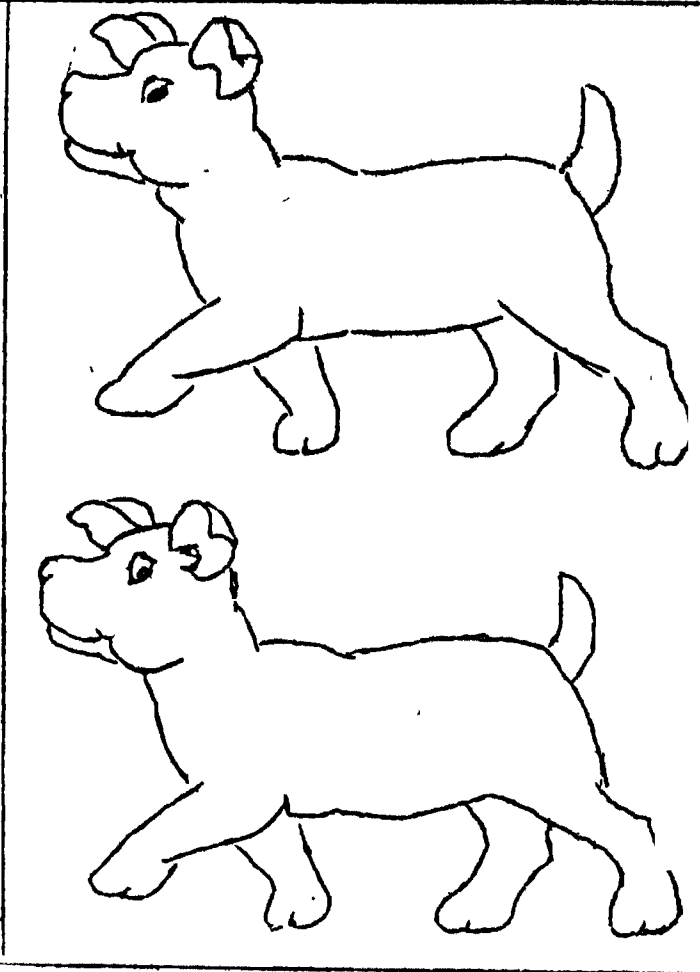
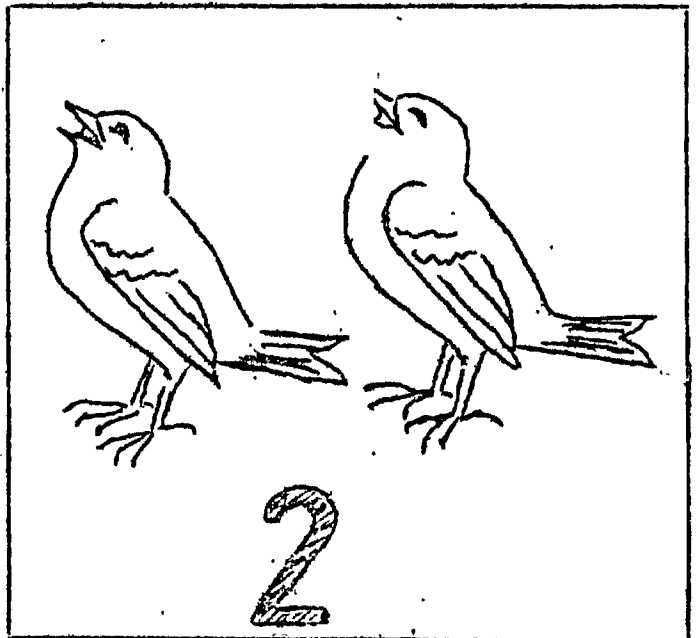
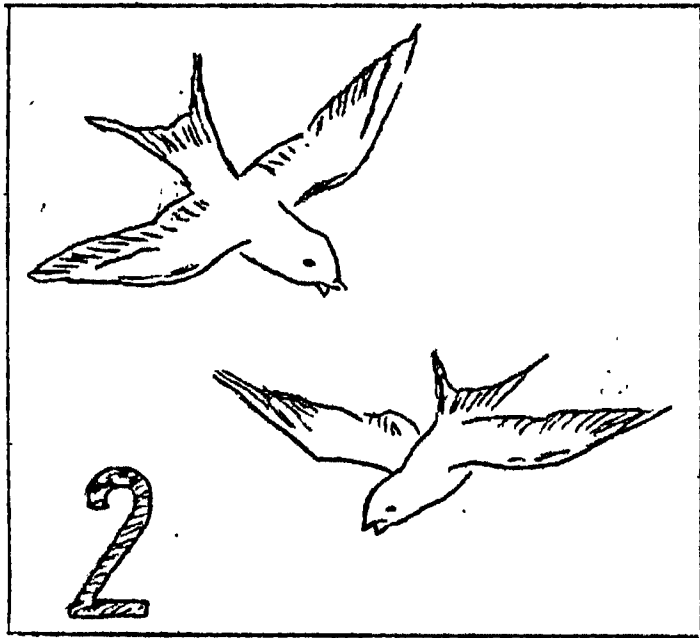
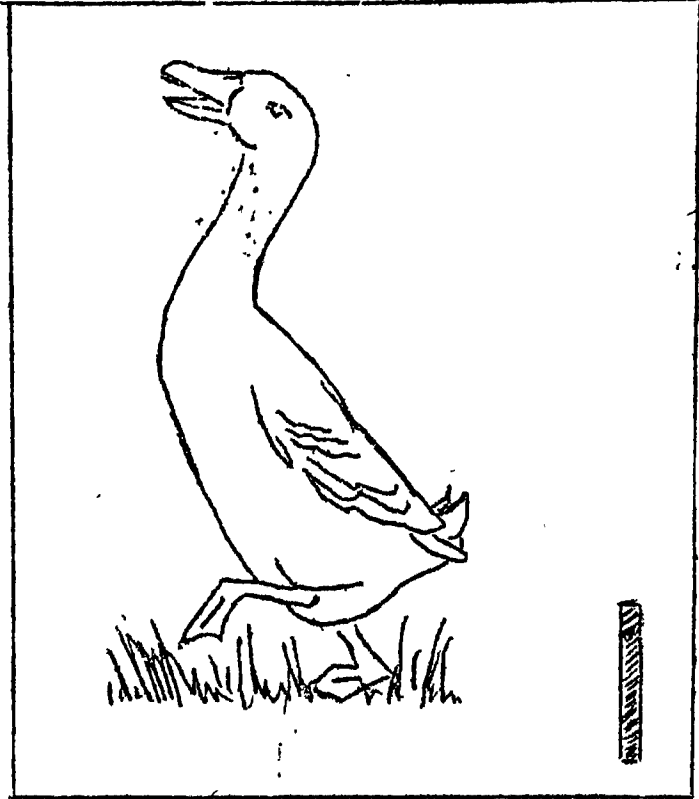
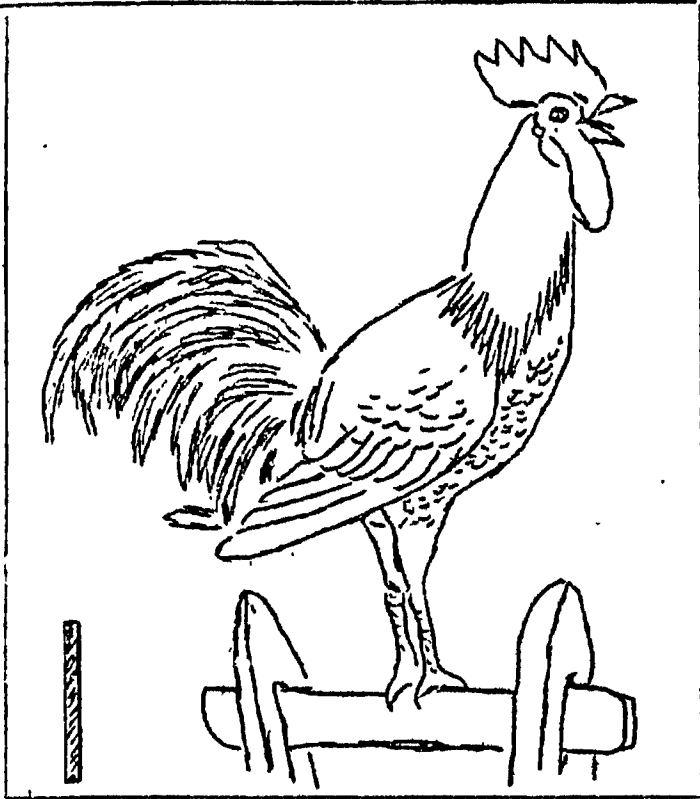

# Number work.

Can you count to 3. Say slowly after  
Mother 1. 2. 3.  
How many roosters are there on the picture page?  
How many ducks?  
How many birds flying?  
How many pups?  
Clap 3 times, counting each clap, jump  
Jump 3 " " " " " jump  
Hop 3 " " " " " hop.  
Show Mother 1 finger.  
" " 2 fingers.  
" " 3 fingers.

Cut along this line and put the lower half of the page in your book.

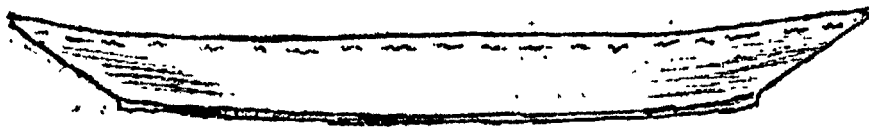

Onto this dish put 3 apples  
(Use your crayons.)

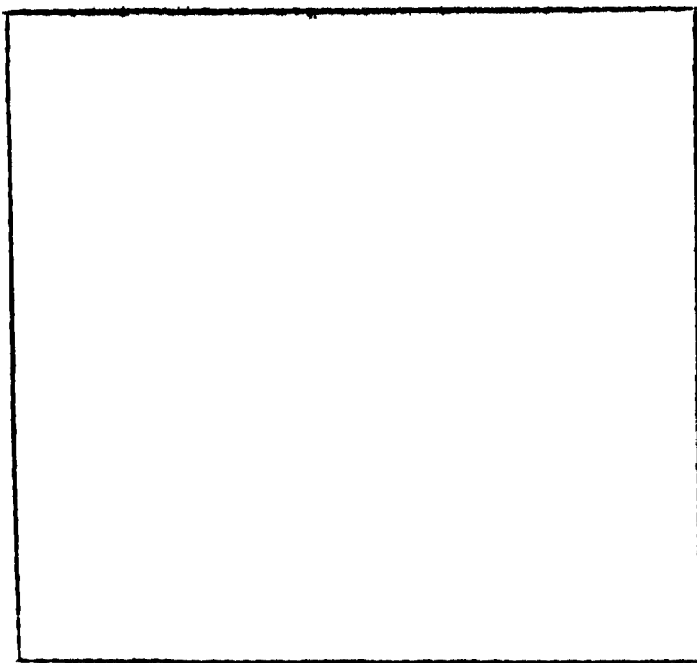

Into this box put 2  
balls.  
Into the vase put 1 lovely  
flower.

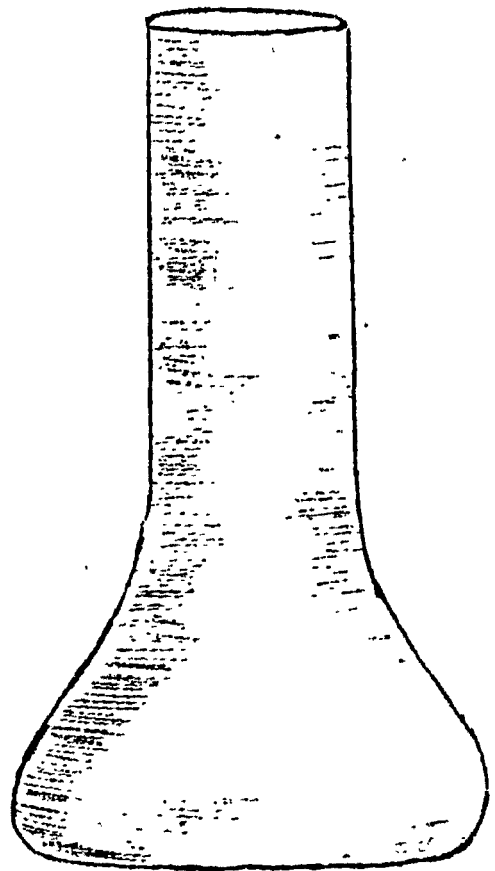

## Mother's page.

From time to time I shall send to you action songs and games. The music will be sent for those of you who have pianos, but if you have not, do not let that prevent you teaching the songs etc. to your children. The words are invariably simple and can be sung to any simple tunes. Nursery rhymes such as "Here we go round the mulberry bush" and "A-hunting we will go" are very suitable. It is surprising too; how readily children make up their own little tunes and it is well to encourage them to do so.

Let there be as much variety of movement as possible. Accept and make use of the children's own suggestions. Little children delight in movement, so let them have frequent short intervals during lessons, for various kinds of marching eg. walking, running, slow march, quick march, walking on tiptoes (fairy steps), long strides (giant steps), lifting knees up, tripping. In fine weather this should be taken outside and the children could sing or hum the tune.

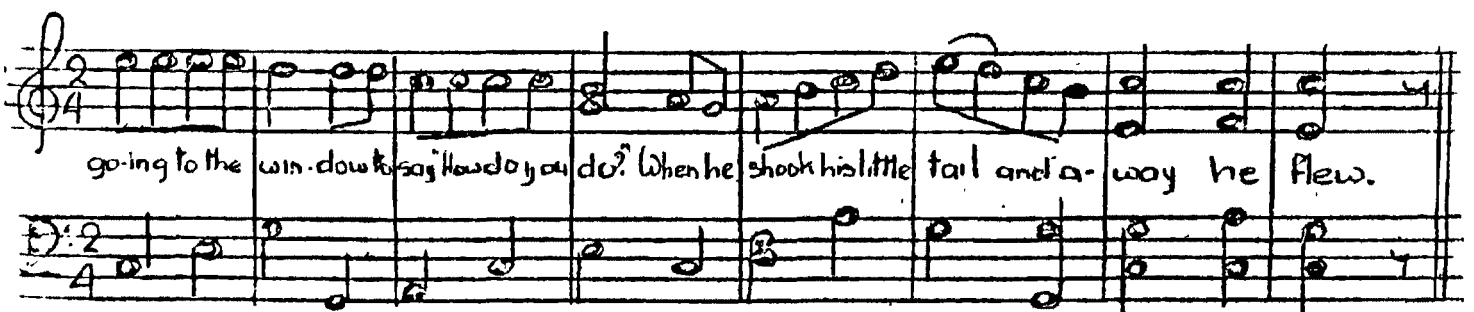
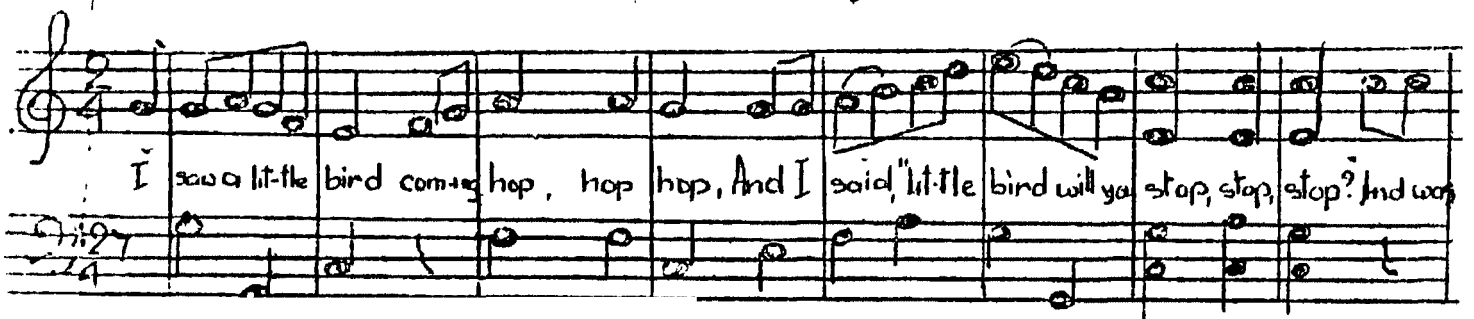

### Actions

- Line 1 Point first finger and hop three times.
- Line 2. Shake finger at imaginary bird.
- Line 3. Walk towards window and imitate hand-shaking.
- Line 4. Place hands on hips, shake bodies. Then spread arms out sideways and trip round the room, imitating flight.



# PLASTICINE

My dears, you are going to have lots of fun with your new plasticine! First of spread a sheet of thick paper on the table and place your plasticine on it. Break off a small piece and roll it round in the palms of your hands. Isn't that lovely? You have made a little ball. Make some more in the same way - some bigger, some smaller.



Balls

Bowl Button

Now push your thumb down in one of the balls and you have a bowl, or flatten it a little more - poke four holes with a meat skewer and you have a button. You'll be able to make many other things from a ball - apples, plates, cups etc.

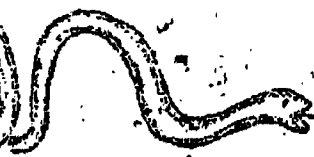
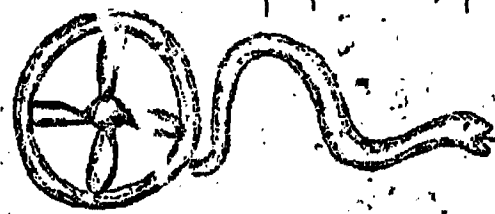
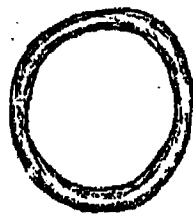
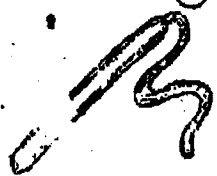

Whip Hoop Wheel Snake Basket

To make all the jolly things I have drawn above you roll and roll a piece of plasticine in the palms of your hands until it is long and thin. Then twist it to make the thing you want. Now make up some for yourselves.





Morning

Number



Count for Mother clapping hands, or stamping, or hopping. Now, counter boxes ready! I wonder if you have pebbles, or shells or match-sticks. I hope you will tell me. Now you are ready to do little sums for Mother. 10 or 15 minutes.

Games



Such a jolly time this is! If it is not raining, play your games outside. I am sure you can soon learn the tunes and sing them without the piano. Now you are fresh and happy for your next lesson. 15 minutes.

Word-work



Letter sounds. Say them to Mother. 'Go round the room with your pointer saying the words Mother has put up on the wall.



Now while Mother is busy you can write them on your board, and sometimes make them in plasticine. 30 minutes.

Recitation or nature talk or a song.

A talking lesson comes after a quiet one, you see.

First, always use your handkerchief and breathe in deeply several times through your nose. Now you are ready. 10 minutes.



# A BUSY DAY

Afternoon.

What a happy, happy-time this is. Shall we play with our word-matching puzzles? This is good fun, and we need not worry Mother at all. We can do it all without her. We will get it all right and then ask her to look. We must just point to the words and say them to show her that we really know them all.

Drawing

Nearly always use your board and chalk, but sometimes use crayons and brown paper. Perhaps Mother will suggest something for you to draw, or perhaps you may do anything you like. I hope you will often draw pictures about the stories she tells you.

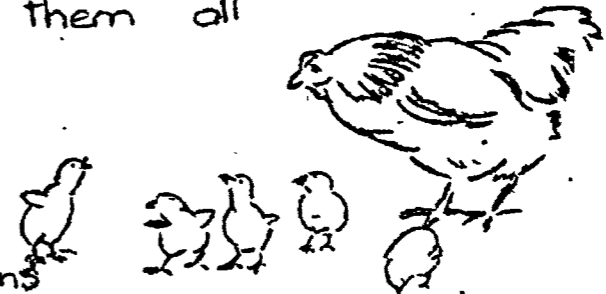

Plasticine work or paper cutting.

You can make lovely story-pictures with your plasticine. Sometimes you will do paper-cutting instead.

Story. This is the very best time of all, when you cuddle up close to Mother and she tells you stories. Give her a rest sometimes and tell one to her.

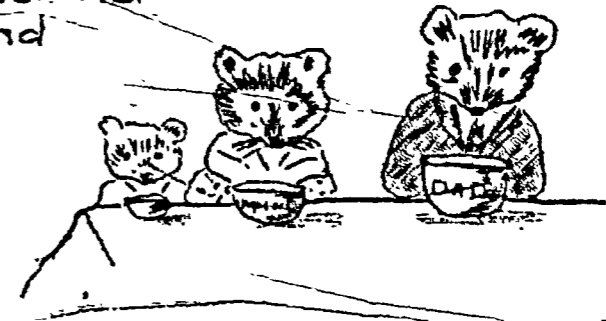

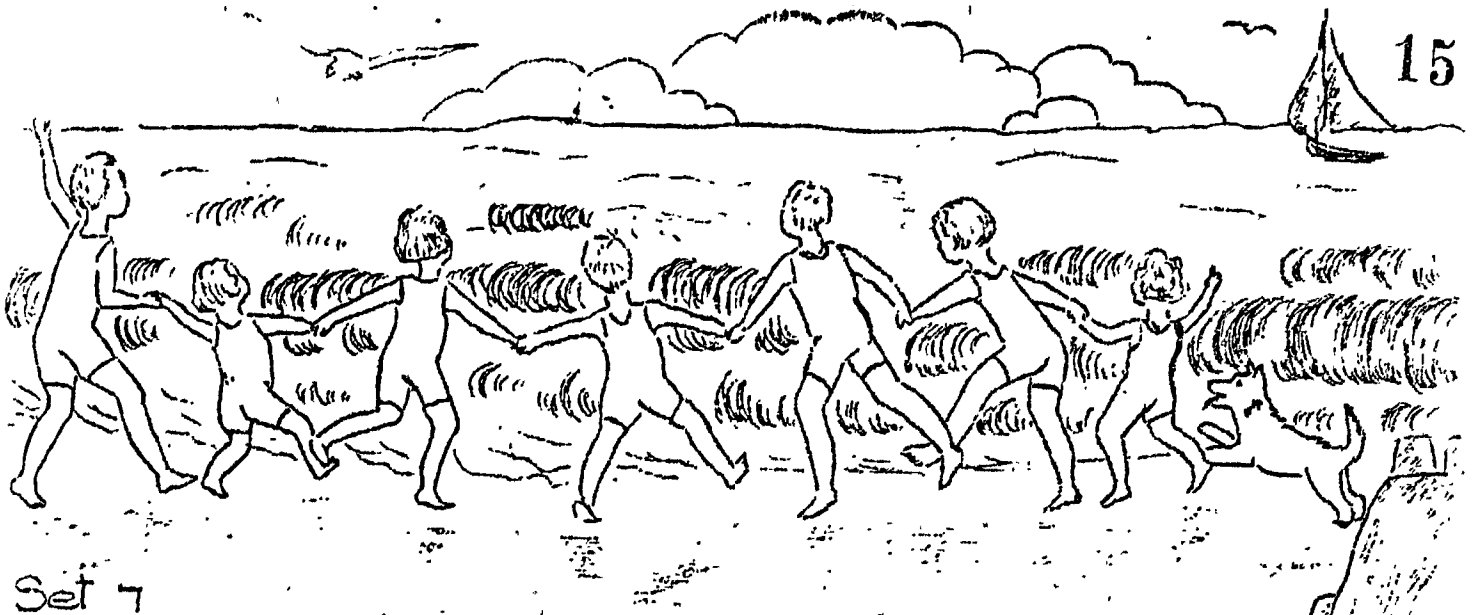

Set 7

Dear little people.

I have had such a happy letter from my two little friends Betty and Peter. They are staying in a little cottage close by the sea for their holidays. They are having lovely happy sunny days on the beach. Sometimes they dig and make castles in the sand and then sometimes they go for a treasure hunt.

What wonderful things they find in the little pools in the rocks! One day they thought they had found a beautiful flower growing on a rock just under the water - but it was nothing of the kind. It was a little animal! Its name was anemone. It was bright pink and had pretty wavy petals floating about in the water, but as soon as Peter touched it very gently, they all closed up tightly. Then Peter tried to pick it up, but it was stuck too firmly to the rock.

They have collected some lovely seaweed too. Some is white, some is bright green and some is a lovely pink. The sea has plants you see, just as your garden has, and so very pretty too. They have found lots of shells and have drawn some of them for me. I expect they will come home with a box full of treasures.

Now many of you live near the sea. I want you to go for a treasure hunt too, and write and tell me what you find. Keep your two eyes wide open and you will be surprised at the wonderful things you will see!

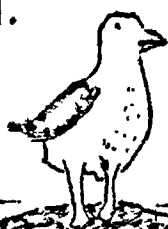

Even if you do not live at the sea there are heaps of wonderful things for you to find. Go for a walk into the bush, or the fields or by the river one day, and remember - keep your eyes open and you will find plenty of treasures to write to me about.

Goodbye little ones.

I. Burton.

This is an extra-special set and I want you to make the cover look pretty. We shall call it

## MY TREASURE BOOK

(Don't forget your name of course!) Use plain brown paper for the cover. Now we shall decorate it. Colour and cut out the shells, seaweed, fishes. Arrange them prettily and paste them on your cover.

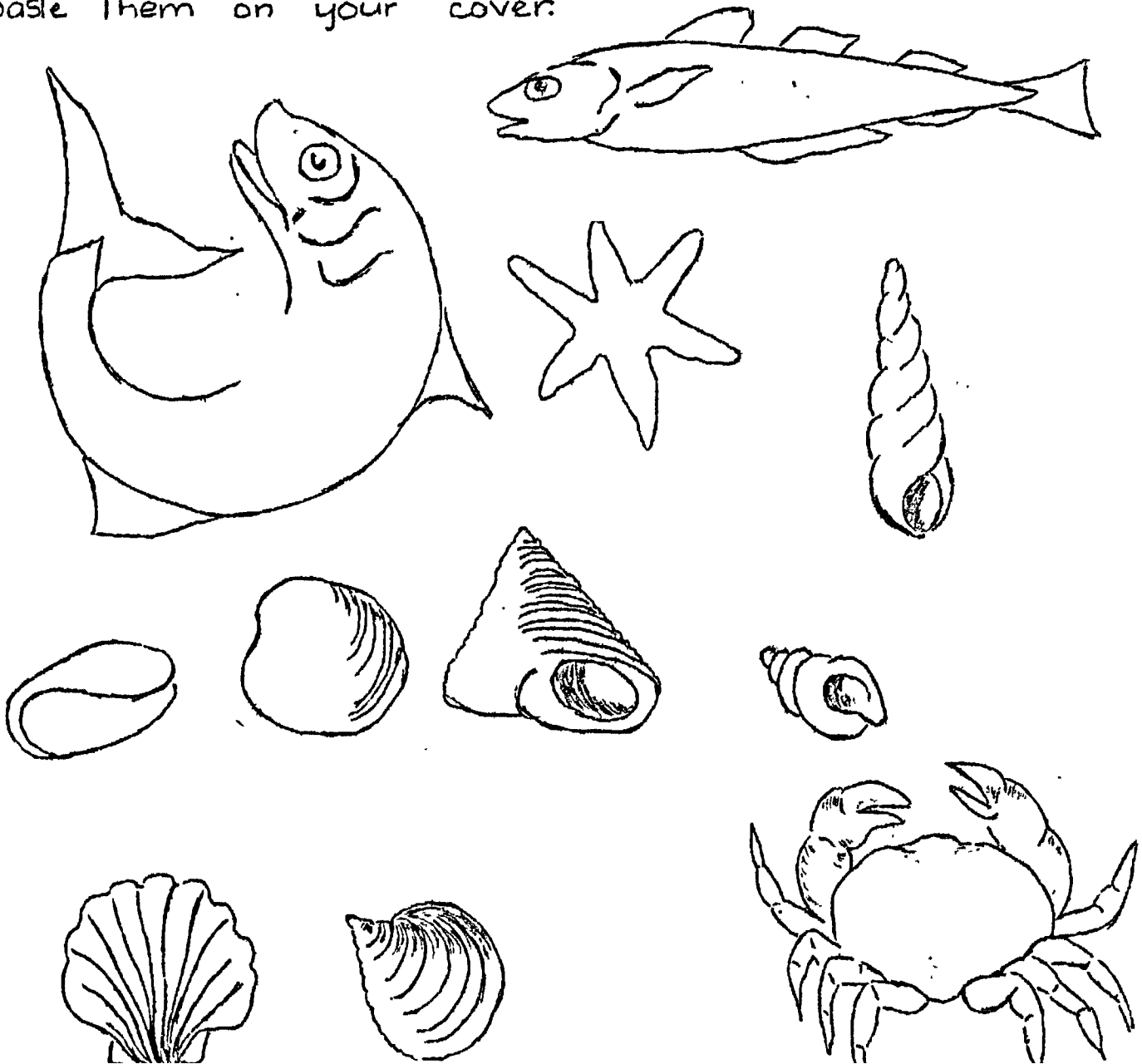

## Word work

I hope that you have practised building up words containing these sounds.

fl. dr. sp. ng. mp. nk.



tent

se	<input type="checkbox"/>
be	<input type="checkbox"/>
pu	<input type="checkbox"/>
gru	<input type="checkbox"/>
mi	<input type="checkbox"/>

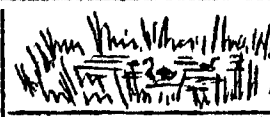

pond

be	<input type="checkbox"/>
se	<input type="checkbox"/>
ha	<input type="checkbox"/>
wi	<input type="checkbox"/>
la	<input type="checkbox"/>



crab

<input type="checkbox"/>	ack
<input type="checkbox"/>	oss
<input type="checkbox"/>	eep
<input type="checkbox"/>	ess
<input type="checkbox"/>	umb

Learn to sound these words, then write ten of them in your book with a wee picture.

Here is a very easy reading test for you!



Don went for a run one day. He was a bad dog. He upset the can of milk and he upset the pram with the doll in it. He ran off with Tom's cap. He ran after Nell and she fell in the mud. Bad dog! Then he went and hid in his kennel.

Underline the words you don't know.  
Time taken to read \_\_\_\_\_

### Drawing:

I saw three ships a-sailing,  
A-sailing on the sea.  
Can you make me a picture of that little  
verse?

### Plasticine.

Bucket and spade.  
Shells and fishes.  
Anything you like.

# A game number page.

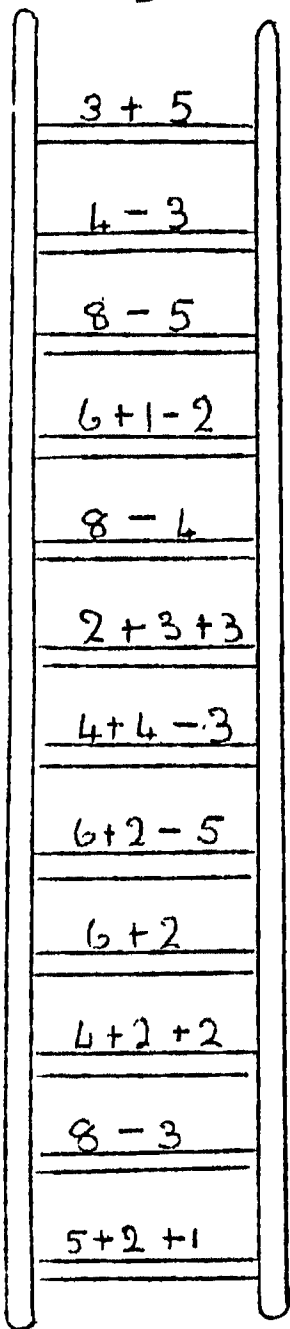

Paste the ladder and answers on cardboard. Cut up the answer strip and place each one by the right sum. At first it will take you a long time to go up the ladder, but practise it and learn to do it quickly.

When you send in your set, tell me how long it takes you to climb to the top.

The answers to the following sums are in these squares. Which are they?

4	7	8
8	3	4
6	5	3
6	0	2

- $4 + 4$
  - $2 \times 3 - 2$
  - $8 - 1$
  - $8 - 5$
  - $8 - 4$
  - $3 \times 2$
- 

- $6 + 2$
- $8 + 2$
- $2 \times 2 + 1$
- $8 - 8$
- $3 \times 2 - 3$
- $8 - 6$

You can have lots of fun with ninepins. If you haven't any proper ones, you could make some with plasticine. Make a little ball too. Now stand up the little men and see how many points you can get for knocking them over. You can have three turns. Aim at the ones that are worth most. You may be able to knock over more than one at a time. (You will have to do some adding sums!) Perhaps you will play with your brother or sister.

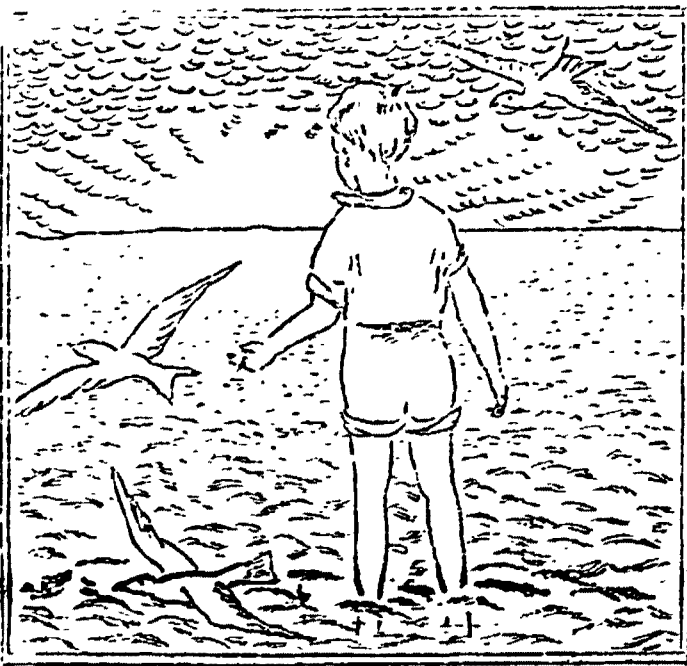

I'm standing in the dancing  
 sea,  
 Not very far from land  
 The little wavelets run to me,  
 And tumble on the sand.  
 And do you know what I should  
 wish,  
 If someone said 'Suppose'?  
 I'd love a tiny silver fish  
 To swim between my toes!

Musical notation for the first line of the song. It consists of a treble clef, a key signature of one sharp (F#), and a 2/4 time signature. The melody is written on a single staff with lyrics underneath: "I'm standing in the dancing sea, Not very far from land The".

Musical notation for the second line of the song. It continues the melody from the first line. The lyrics are: "little wavelets run to me and tumble on the sand. And do you know what I should wish, If-".

Musical notation for the third line of the song. The lyrics are: "someone said 'Suppose?' I'd love a tiny silver fish to swim between my toes! I'd".

Musical notation for the fourth line of the song. The lyrics are: "love a tiny silver fish, to swim between my toes!". The notation ends with a double bar line and a final chord.

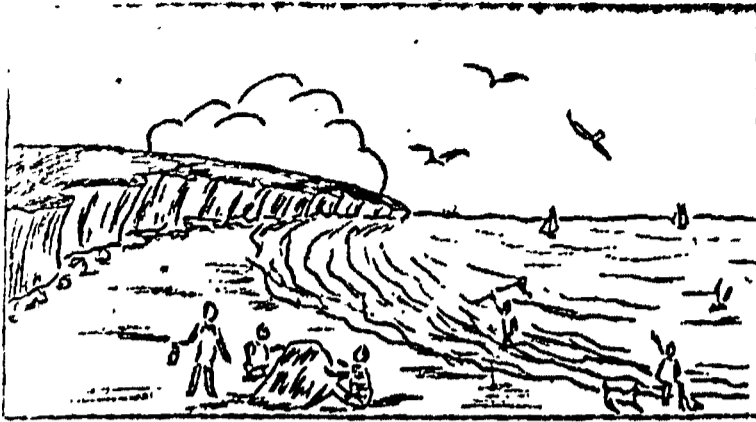

How to make our cut-out  
seaside picture. 20

This little sketch shows you how  
it will look when finished.

On a large sheet of brown  
paper draw your background—  
a blue sky, blue sea with a  
bit of green in it and just

near the sand the ripples will be tipped with white. The sand  
should be a golden brownish colour. Colour the top of the cliffs  
green. Very carefully colour and cut out all the things I

have drawn for you, children, seagulls, ships, and cliffs.  
Cliffs and seagulls should be left white. Paste them on to  
your picture without smudging, and there you are!

I am looking forward so much to seeing them all.

I wonder how many seaside pictures you can collect from  
old books and papers. I want you to find as many as  
you can and fasten them in your book. Write a little story  
or sentence with each one. I am sure some of you will  
make a real picture book for me.

Here is the first picture  
for your collection.



Writing

I sing and play and build all  
day,

Upon the windy shore.

The top of the cliffs is covered with grass - so colour it green. Leave the rest white.







Correspondence School,  
Education Department  
Wellington.

Dear Little Ones,

Do you know what I think is almost the nicest place in all Wellington? Well I think it is the Zoo. I went one day just a little while ago and I had such a lovely time. I couldn't tell you all the things I saw, but I shall pick out a few you would have loved if you had been there.

I always hurry to the monkey houses near the gate. There are big monkeys, little monkeys, some with tails and some without. Such a noisy chatty crowd they are. A little brown monkey like this sat and begged for nuts.

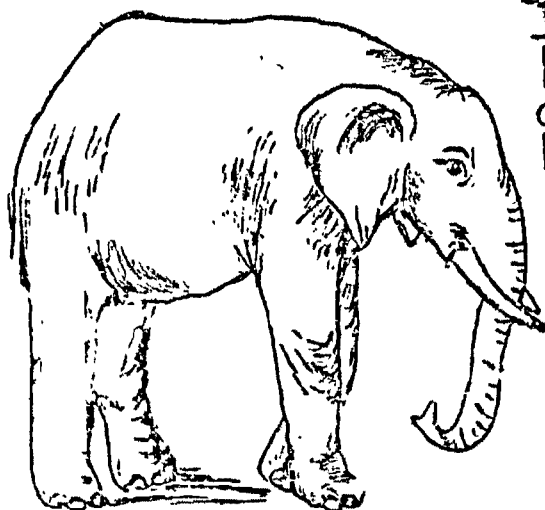

I saw Nelli the Elephant having a bath, not in a tub - just a shower bath from the keeper's hose. I should have liked a ride on her back, but the keeper said, 'Only Children Allowed.'



I saw lions and tigers too, but they were so sleepy. When I spoke to them they just opened their eyes and blinked at me. They are not so sleepy when the keeper gives them food. How they roar and growl then!

There were hundreds of lovely birds in bird-houses and wading in the creeks. There were long-legged storks pelicans with tremendous bills and little waddy penguins. I haven't room to tell you about the others but perhaps some day you shall be able to see them for yourself.

DA

### THINGS TO DO

- (1) Read this letter and 'tell back' to mother as much of it as you can remember.
- (2) If you have been to a Zoo tell me what you saw there.

If you have not been to a Zoo, write a story about the picture at the top of the page.

- (3) On another page you will see outlines of animals and birds. Use these to make a jungle picture or if you wish a Noah's Ark picture.

**A POEM TO LEARN.** AND SOMETHING TO DO. 23

Such a jolly poem this is - all about tails. Do you think you could make a Book of Tails - just a wee book and on each page draw a different kind of tail and write a story about it.

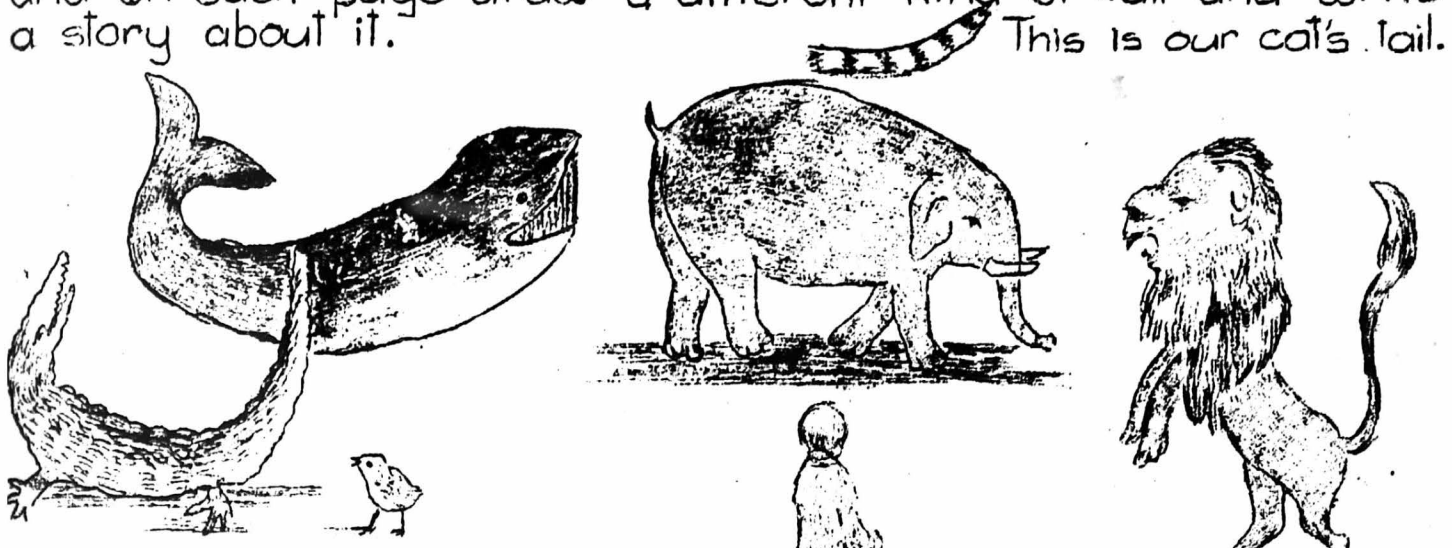

**IN THE FASHION.**

A lion has a tail, and a very fine tail.

And so has an elephant, and so has a whale,  
And so has a crocodile, and so has a quail -  
They've all got tails but me.

If I had sixpence I would buy one,  
I'd say to the shopman, "Let me try one,"  
I'd say to the elephant, "This is my one."  
They'd all come round to see.



Then I'd say to the lion, "Why you've got a tail,"  
And so has an elephant and so has a whale,  
And look! There's a crocodile.  
He's got a tail.

**"You've all got tails like me!"**

Writing and Drawing

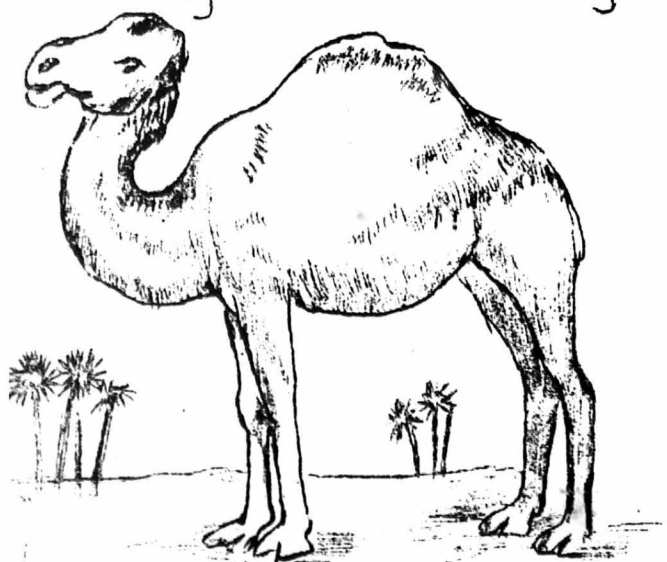

The camel can cross the desert.

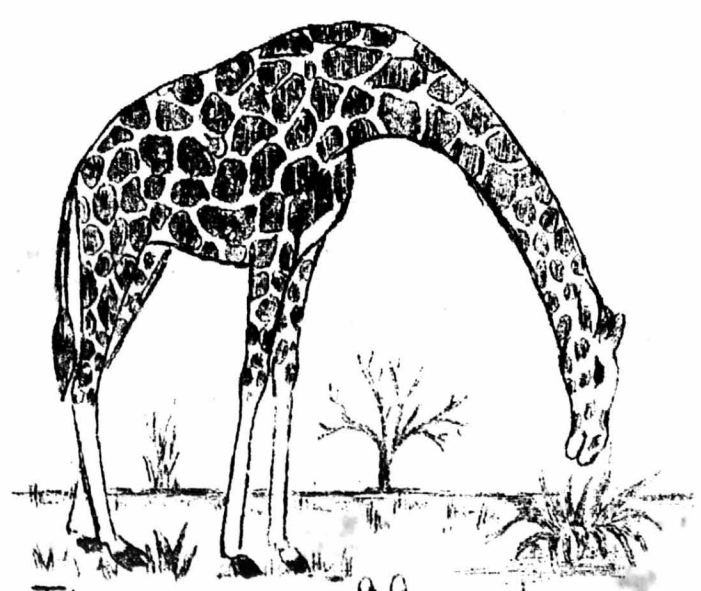

The giraffe has a very long neck.

ea

You have come across ea before, but in this family it has a different sound. e sings its own song and a is quiet.

 bread

feather  
 thread  
 weather  
 meadow  
 spread  
 tear  
 leather

Sound and say each of the words in turn. Tell mother stories using them. Write them on your board and make a picture of each one. When you know the words you will be able to read this story.

It was cold weather. Ned was crossing the meadow. He saw a dead bird. Its feathers were limp. Its breast was cold. It hung its head. "I fear it is dead," said Ned, but he took it home and put it in a warm place near the fire. By-and-by its breath returned. It got up and hopped about looking for bread-crumbs.



or

Sound horn slowly and listen to the song or sings. Sound and say the family.

 horn

st  m  
 h  se  
 st  k  
 f  k  
 th  ns  
 t  n  
 m  ning  
 sh  t.

WRITE OUT THE OR FAMILY FOR ME AND MAKE A PICTURE OF EACH WORD.

One spring morning, Ben took his dad to the fields. Rover got a thorn in his foot but Ben got it out. They saw a cow with short horns. Rover wanted to chase it but Ben put a cord round his neck to keep him back. "You must not do that, Rover" said he. But Rover thought it good sport.



Here are some pictures. Write the correct 'ea' or 'or' word by each one. You may return this piece of the page to me.

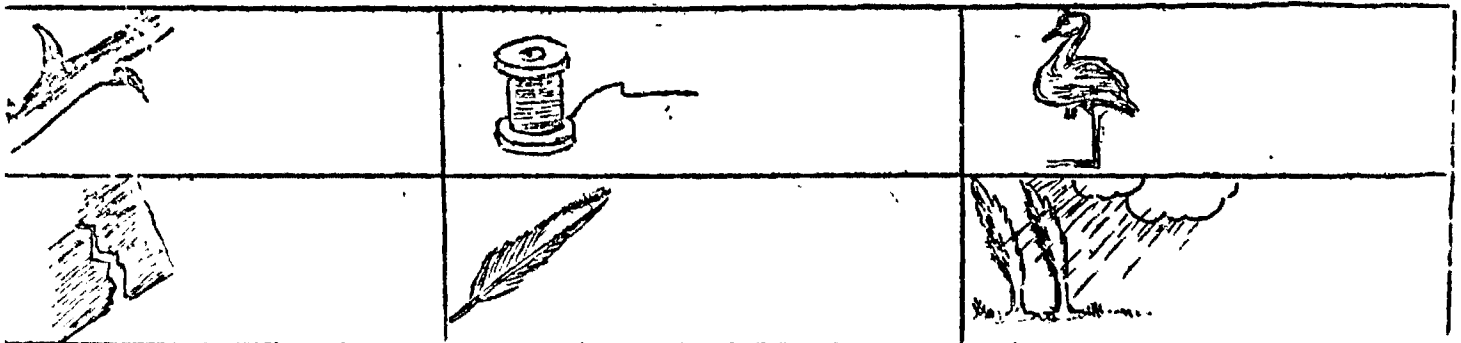

Fill in the missing words. You have learned them all.  
 There was clover in the ..... That is a silver .....  
 The shoe was made of brown ..... The ..... is fresh.  
 I get up early in the ..... Blow the .....

# AN ELEPHANT IN PLASTICINE

Nella I made a model of her. After having a good look at you will be able to do so too. If you follow very carefully

Start with the body - you need a fair sized lump of plasticine - work it first into a soft ball, and then into a shape like a potato (1). Next, take a smaller ball for the head - flatten it slightly (2) then make the trunk from a roll and join to the head, smoothing with your finger tips until the joins are hidden. (3)

Now you have the legs to make, the fore legs as you see are a little different from the hind ones. Notice how the lumps of plasticine are added to give the right shape, (5), (6). Join the legs firmly to the body (7). Add a little tail, big flat ears, two tusks, match ends or quills would do, two black beads for eyes, and Nella is complete.

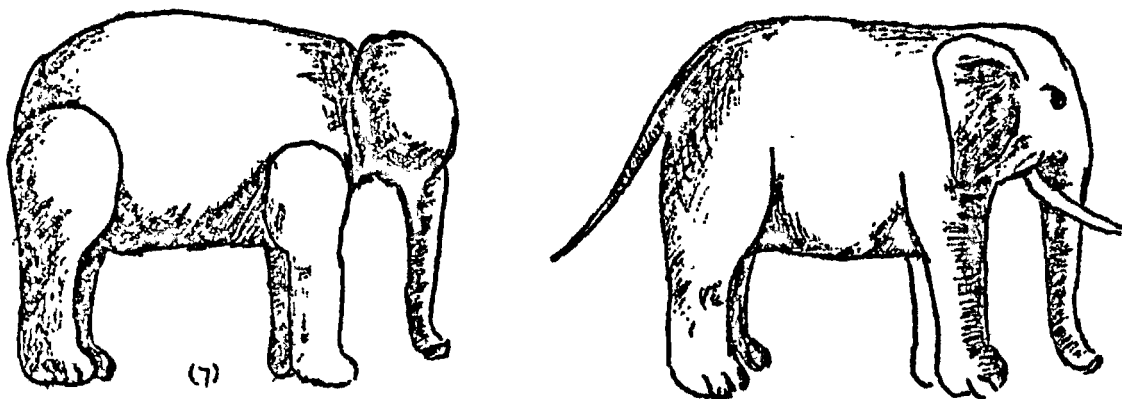
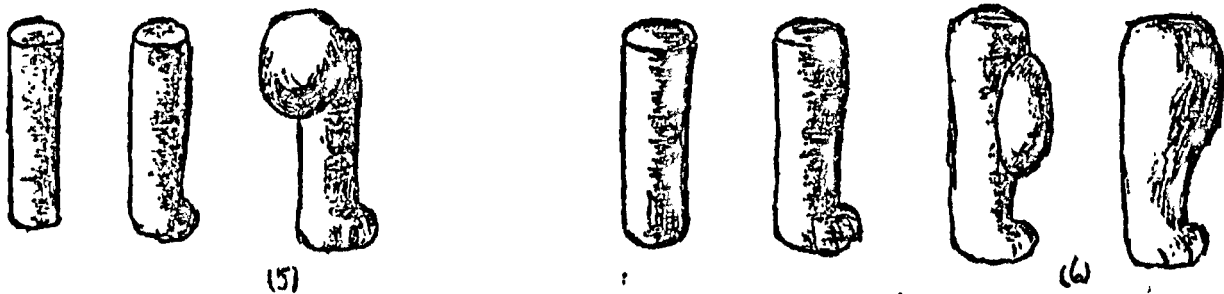
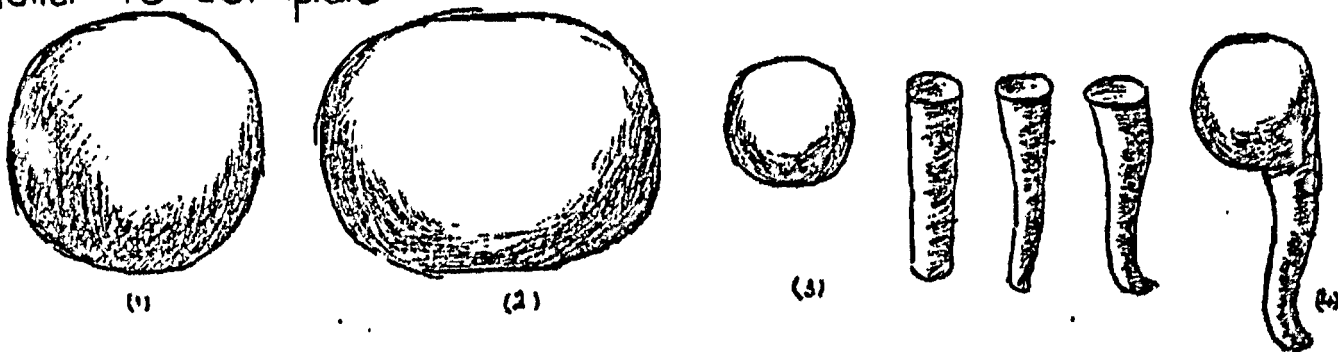

## HOW TO USE THE ANIMAL CUT-OUT.

like to make a Noah's Ark book? Fold the pages I have enclosed in half and draw the Ark to fill the half sheet. Cut through all

the sheets so that the pages are the same size. On each page paste one of the cut out animals. Colour, and then write a story below.

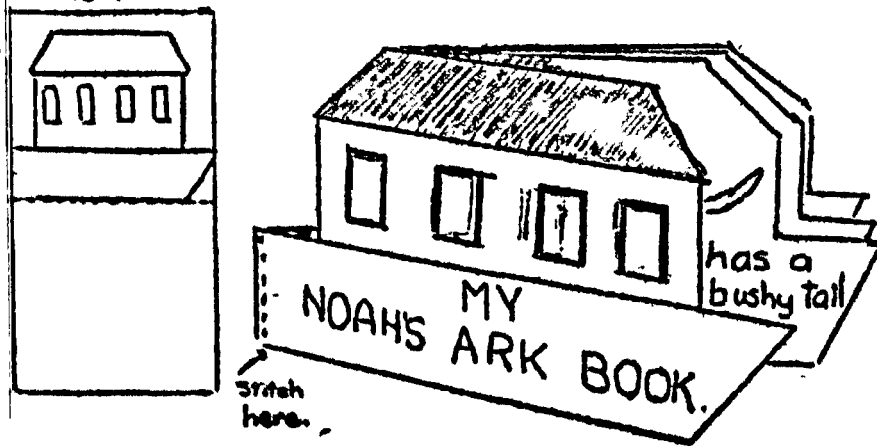

If you don't wish to make a book perhaps you would make a jungle picture.

# Revision Exercises on Numbers to 14. 26

$$\begin{array}{ccccccc}
 7 + 5 = & 8 + 3 = & 7 + 7 = & 6 + 3 = & 7 + 2 = & 9 + 4 = & 10 + 2 = \\
 4 + 6 = & 3 + 7 = & 5 + 4 = & 2 + 8 = & 6 + 4 = & 2 + 6 = & 4 + 4 = \\
 2 + 3 = & 6 + 6 = & 7 + 3 = & 5 + 5 = & 2 + 8 = & 3 + 3 = & 5 + 3 =
 \end{array}$$

$$\begin{array}{cccccc}
 6 \text{ from } 9? & 4 \text{ from } 10? & 3 \text{ from } 12? & 5 \text{ from } 10? & 2 \text{ from } 11? & \\
 7 \text{ from } 14? & 8 \text{ from } 12? & 3 \text{ from } 11? & 2 \text{ from } 12? & 7 \text{ from } 11? & \\
 5 \text{ from } 8? & 3 \text{ from } 9? & 2 \text{ from } 8? & 3 \text{ from } 6? & 8 \text{ from } 13? &
 \end{array}$$

1) May had 6 dolls, Jean 5. How many altogether? How many more had May than Jean? How many less had Jean than May?

2) Which would you rather have? 12 marbles or 5 and 4? 12 balls or 6 and 4? Why?

3) 6 drums. How many sticks? 5 drums. How many sticks? 10 drums. How many sticks?

4) Tops. 4 large 6 small. How many? 9 large 5 small. How many? 8 large 2 middle sized 1 small. How many?

1) A father and mother in the shop. They looked at 13 Teddy Bears. Bought 3. How many left?

They looked at 9 balls. Bought 4. How many left?

They looked at 12 tops and bought 6. How many left? So in their parcel were 3 Teddy Bears, 4 balls and 6 tops. How many Toys?

### Drawing Exercises.

- (1) Draw enough balls for 4 boys to have 3 each.
- (2) Draw enough eggs for 12 people to have 1 each.
- (3) Draw enough cherries for 2 girls to have 4 each.
- (4) Draw enough flags for 3 boys to have 3 each and 4 for yourself.
- (5) Draw 14 apples putting half in each line.

Draw these boxes of sweets on your B.B.

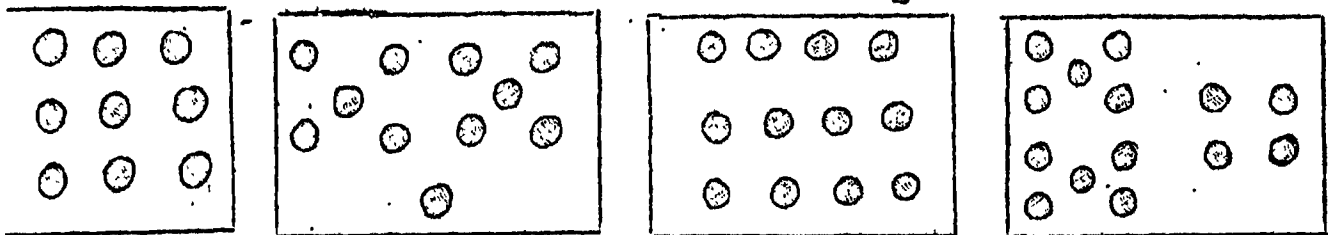

If these really were boxes of sweets which would you rather have?

Which box has most? Which has least?

How many more in the second than in the first?

How many less in the third than in the fourth?

Write the number clearly by each box.

### 7 Game.

8	6	5	12
10	4	14	7
3	8	2	9
1	13	0	11

Each of these squares is a box of apples. Ask questions about one or two numbers. Children are to point to the box containing the answer.

- (1) I want a box with enough apples to give 3 boys 2 apples each. (Points to 6)
- (2) Mother wants to make 3 apple dumplings each for father, herself and you. How many. (Points to 9)
- (3) Point to the box with most apples in it. Point to the box with least.
- (4) 5 boys and 8 girls came to tea. I gave them one apple each. Which box did I go to?



Write for  
me the  
names of  
all these  
animals,  
and birds.

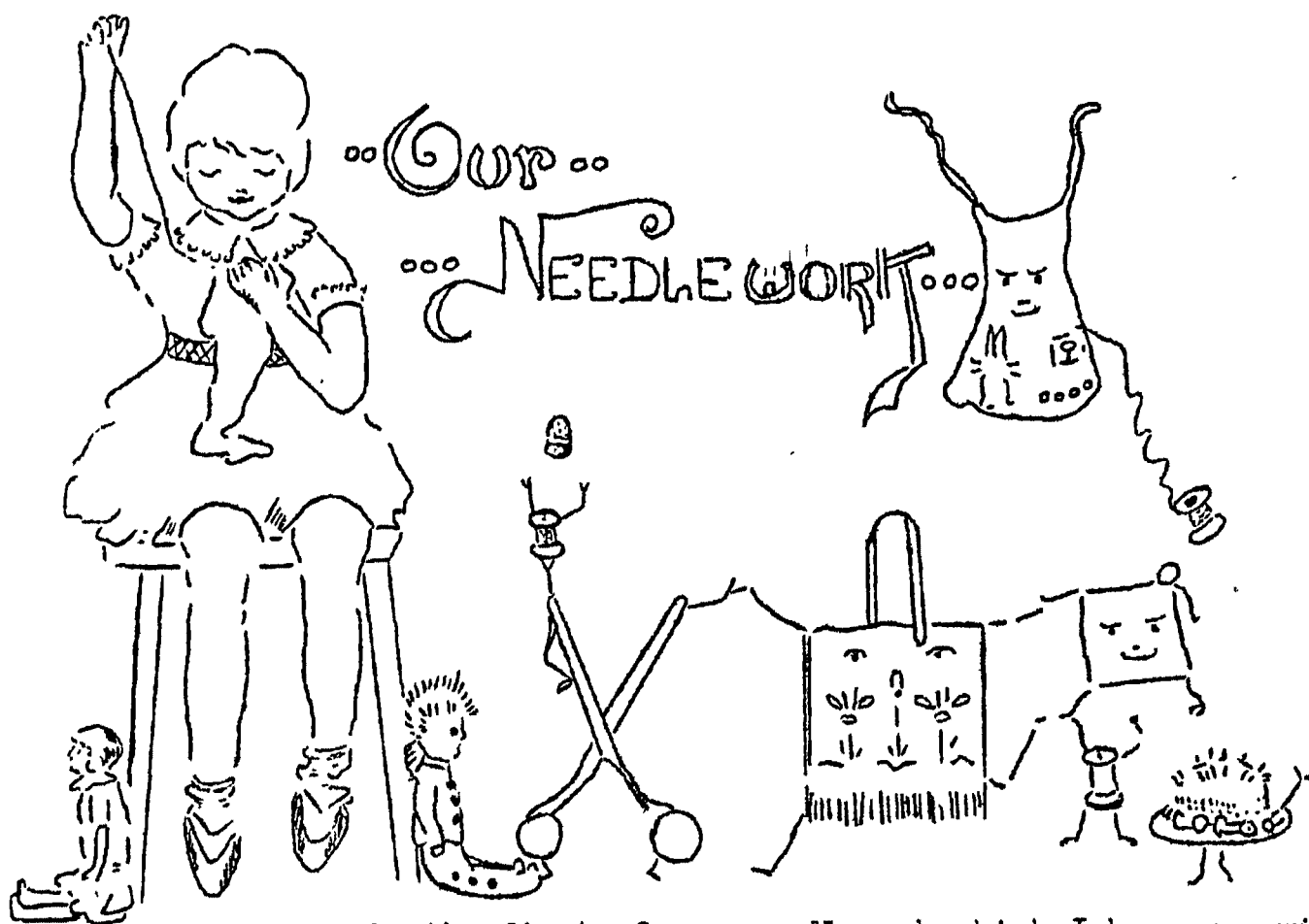

Here is the first of our needlework which I know you will all love. You are going to be shown how to make pretty things for yourselves and for the home. Many of these will do for presents.

#### THINGS YOU MUST KNOW

Sewing is one of the most natural things for girls to do and to like doing so we are going to take it naturally. Sit comfortably in a good light - it is better not to be in the bright sunshine. Hold the work easily - about twelve inches away from your eyes. Do not use too long a thread because it may get knotted, then you will need to break it and begin again. A good needlewoman always keeps her sewing and her knitting fresh and dainty, so we shall always begin with carefully washed hands, fold the work neatly when we have finished, and keep it in a little work box or bag.



#### THINGS I WANT TO KNOW

When sending in your work enclose a little note to let me know if you found it easy or hard to follow. Tell me what you found hard. Also about how long it took you to do the work. Did you enjoy doing it? Is there something that you very much want to learn to do?

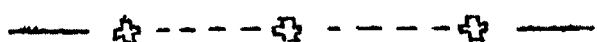



A SEWING BOOK

Many ways of doing things are given you once only. These rules will not be repeated. As when doing the later lessons you will often need to refer to the earlier ones, you will find it a good plan to make these pages into a needlework book. You are sure to want to make a pretty cover for your book.



WHAT EVERY GIRL LIKES

Every little girl should have a properly stocked work-box. There is no need to buy an expensive one or indeed to buy one at all. Make your own. It will be much nicer. You will be supplied with all needles and cottons suited to the work that you are asked to do. But get your box properly stocked. See how little it will cost you to do this.

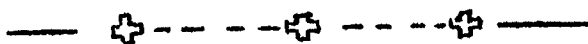

THINGS YOU NEED

Pins (a packet, or Mother will give you some. Make a tiny pincushion).

Needles (Sharps - one packet mixed 5-9).

Darning needles (Mother will give you two or three of these).

A needle-book (Can you make one? Later on you will be shown how to do this).

Tape measure

Thimble

Scissors

Cottons - (as you require them).



SOFT, COOL HANDS

Some girls get very hot moist hands which make it hard for them to sew. If you get a tin of dusting powder such as Mother uses for the baby, and sprinkle a very little on your hands, you will be surprised to find how easily the needle slips in and out. If you haven't got any powder, a little cornflour, or even a little powdered starch will do quite well. Oatmeal is also very good.





THE WORK

Send each article in for me to see as soon as you finish it. The senior girls who are given the first lessons will be advanced to the more difficult work as soon as they show that they are ready.

And now for the work itself.

— Aunt-Susan

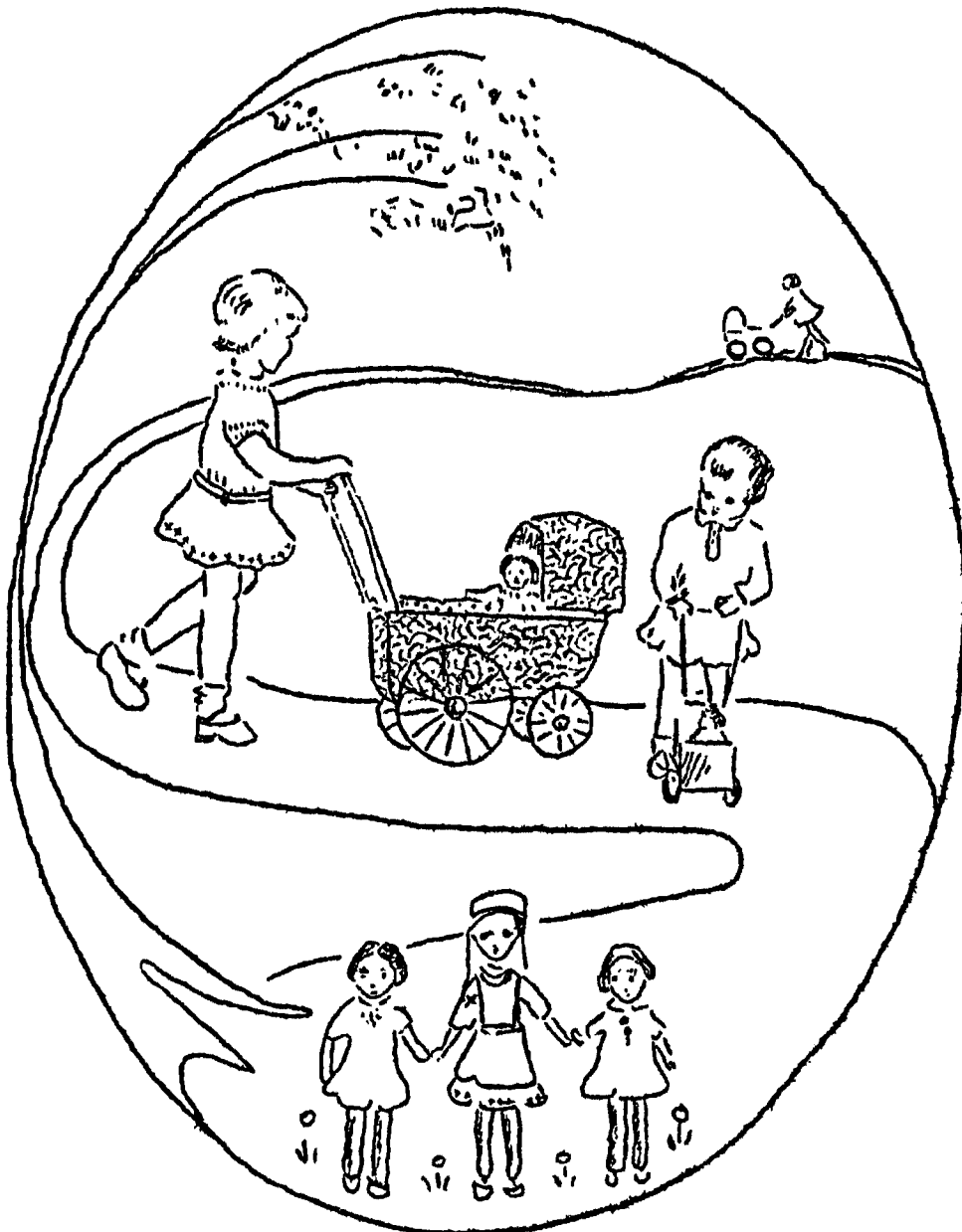

## Our Needlework

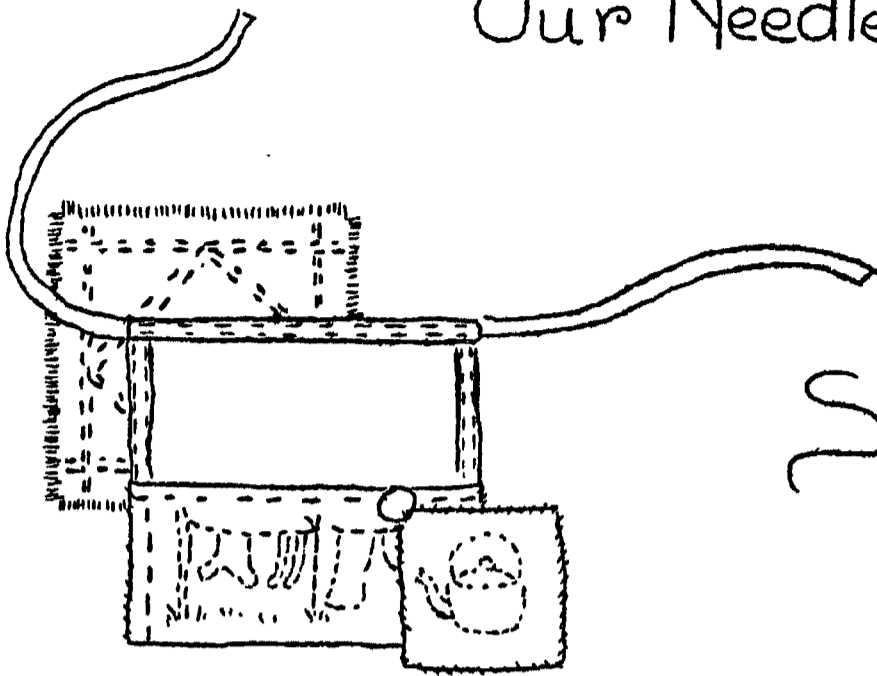
Sugar Bag  
Work

Here is a surprise!

I know that you have been thinking that you would begin your needlework with a small piece of fine, white cloth, a fine needle, and white cotton! But no, Stage I folk, you are going to learn how to make really beautiful things with sacking and in your first lessons all your sewing is to be done with brightly coloured wool or cotton. Now what do you think of that? Later, you will come to finer materials and cottons.

You all have lots of old sugar bags at home?

Should you not have one that you can use, a grocer will sell one. We pay 3d each.

PREPARATION OF BAG

Washing: This is most important. You want your bag to be the very nicest ever, don't you? And it does not matter how beautiful your stitching is, your first articles will all be spoiled if your bag is not properly washed and ironed. So you will see how important it is that you should follow these directions.

Unpick the Bag first. It is very easy to undo the machine stitching if you find the right end to pull. Notice this is a chain stitch.

Pull undone the side first. The bottom of the bag next.

Soak the bag first in soapy water. It is a good plan to use water after Mother has finished washing. Use the washing board to cleanse it thoroughly. Rinse in two waters. Dry on line.

If your bag is not really quite clean, wash it a second time, or get Mother to boil it. Iron it while it is slightly damp, but do not put it away until it is properly dry.

(If there are two or three children in the family wash several bags together).

Now the bag is fit for anything.

#### THINGS TO MAKE

From this sugar bag you should be able to make a small mat for your doll's house or for a table, two kettle holders, and a bag - either a shopping bag, a peg bag, or a wall pocket.

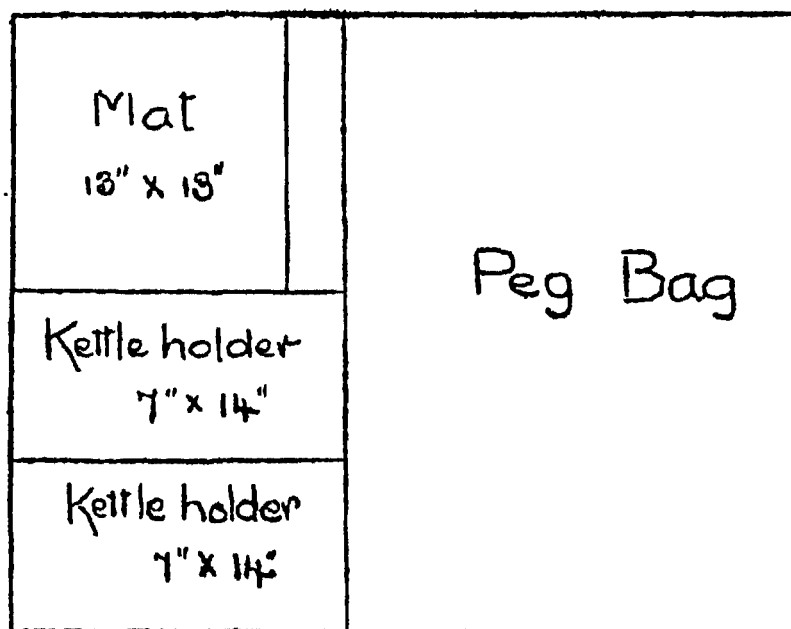

*Aunt Susan*

#### NOTE

If another time you want a carrying bag, you will need strips of sacking for handles.

Correspondence School

Education Department

## Our Needlework

Stage I

Lesson I



# Something for Your Dolly

Wouldn't you like to make a mat to put beside Dolly's bed? Here is a picture of a pretty one.

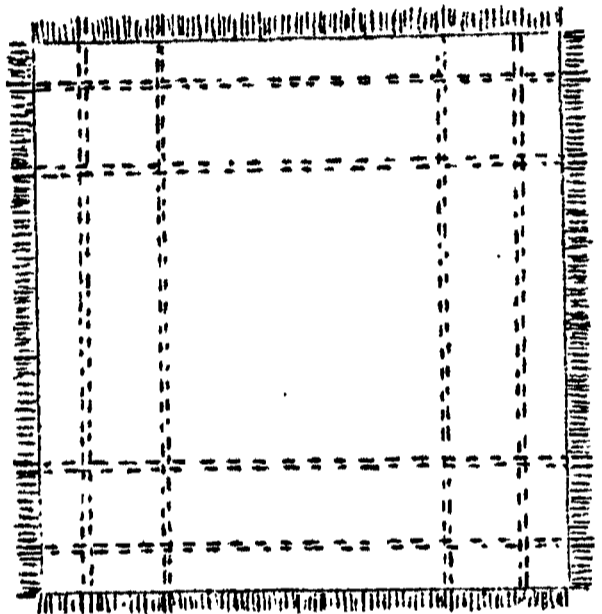
TO MAKE

Measure on the floor the size you would like the mat to be. Let's suppose it is 13" along one edge and 13" along the other.

Cut a piece of paper the size of the little mat, 13" x 13".

Mother will show you how to measure this. Place your pattern on your sack and cut out the mat. You must be careful to cut along one thread of the material. A good way is to pull out a thread and cut along this line but be careful that you don't pull too far.

Fringe it all round.

Do you know how to do this? You just pull out threads until the fringe is wide enough. The one in the picture is  $\frac{3}{4}$ " wide.

You have a ruler with which to measure ? Now for the pretty pattern.

You now get ready for sewing. Here is your wool. You will need one of these coarse needles to take it.

Can you thread a needle with wool ? Mother will show you how to double back the thread, pull it over the point, hold it firmly between the first finger and thumb, then put it double through the eye.

Practise until you can do it by yourself. Now this is most important:-

You will never be a good little needlewoman unless you use a thimble. It helps to drive the needle through the material.

Put it on the middle finger of your right hand. Try to use yours whenever you sew.

#### MAKING A MAT.

Look at the picture of a complete mat. Do you see that it has two rows of stitches round four sides and two running each way through the middle.

#### Running stitch.

This is the stitch we are going to make. It is the easiest of all stitches. It is sometimes used to decorate as when it is worked with coloured wool on a mat.

In working running you pass over some threads and then take up the same amount on your needle.

Try to keep straight and try to make your stitches even, but do it without counting threads. Look at this little sketch - it shows the size you should make them.

Begin work at the right hand end as the design shows you. Leave your end of wool the same length as the fringe. It might be a good plan, when you are beginning, to have a longer thread and cut it off the right length later.

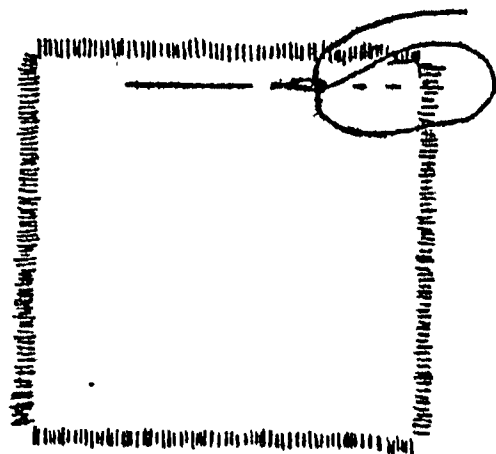

- 3 -

When you come to the other fringe cut off the wool the right length and then do the second row exactly under the first. Like this:-

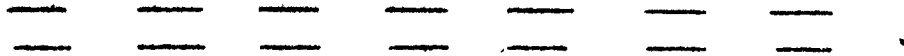

Turn the mat up and work side 2 and then 3 and 4.

It's beginning to look pretty isn't it ? I think we shall put some running in the middle too, don't you ? Look at the picture again and follow this.

To make the decoration look brighter use your second coloured wool.

Don't try to join a thread. Should your wool be getting short rethread your needle before beginning a new row.

Now isn't Dolly very pleased indeed ?

Send your mat in for me to see.

#### ANOTHER MAT.

You will probably want to make another mat for Dolly's room. This time, decorate with a different pattern in the running stitch.

Here is a pretty pattern:-

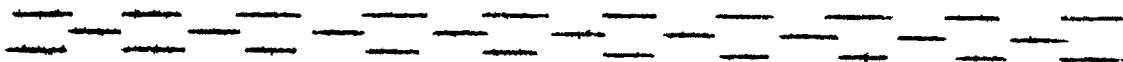

The top line and the lower are worked in one colour, the middle in a different colour.

Dorothy Graham's precious  
Angela is very proud of the mat  
which is beside her cradle.  
Here it is.

*Aunt Susan*

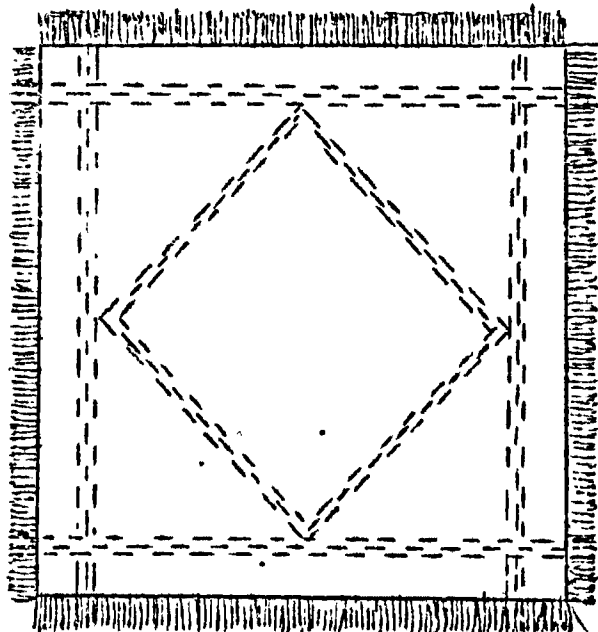

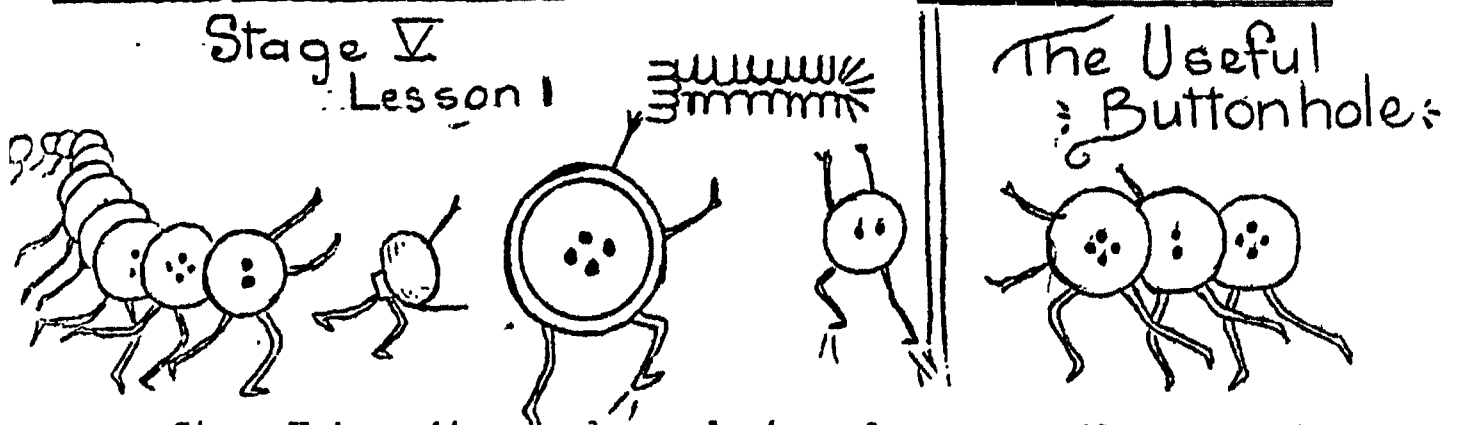

Stage V is quite an advanced stage for our needleworkers to have reached. You should now know all the simple stitches and where they are used, two ways of making seams, different ways of finishing the neck and sleeves of garments, also simple repairing of garments and household articles.

You probably help with the making of your own clothes now as well as with the household making and mending.

There are several processes which you have not yet been given. Buttonholing is one, and this is the one you are to practise today.

A few years ago, buttonholes were used much more than at the present time. Our garments are made more simply now and it is possible to have a set of undergarments and a simple frock without even one buttonhole.

But you cannot do very much advanced sewing without needing a buttonhole and you have perhaps found that buttonholes are very often needed on the garments of small children. Your brother's shirts also need buttonholes.

Before beginning buttonholing, you need to learn about the "way of the stuff".

All materials are composed of two sets of threads, the selvedge and the weft.

In manufacturing a material, the threads which stretch the whole length of the material are placed in position.

Like this:



A bobbin is then wound with thread and it passes backwards and forwards, alternately over and under the selvedge threads.

This makes a plain weave. Examine the material of the frock you are wearing and you will probably find that the weave is like this.

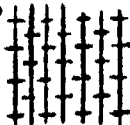

P.T.O.

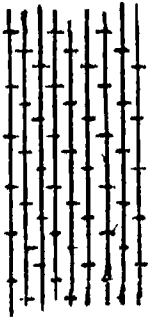

Britway, calico, fugi, are all woven in this way.

Sometimes the bobbin goes over 1 and under 2. This is called twilled material. You probably have twilled pillow cases and sheets. A material woven in this way is said to be stronger and

to wear much longer. Examine different kinds of articles - quilts, towels, dresses, and notice how the materials are woven.

-----

Take a small piece of calico in your left hand, and at a distance of a few inches apart, pull it, Examine it, and you will find that one side has stretched out of shape, the other has remained quite firm.

The threads which have remained firm are the selvedge threads.

Those which stretched are the weft.

When cutting out a garment we must pay attention to this and place the garment so that it will not stretch when it is being worn.

The selvedge threads should run from the neck to the knee in garments, from the shoulder to the wrist in sleeves.

Bands are always cut with the selvedge running length ways. If cut the other way they would stretch out of position.

-----

To practise buttonholing, tear a piece of material 5" x 4". The selvedge measure is always given first. Be sure to get it correct or your buttonholes will not be easy to work.

Right and wrong sides of material. Hold the material over your fingers to the light - first one side, then the other. The smooth side of calico is the right side. In some materials there is no difference, so that you must use your own judgment and take one for the right.



To prepare a band:

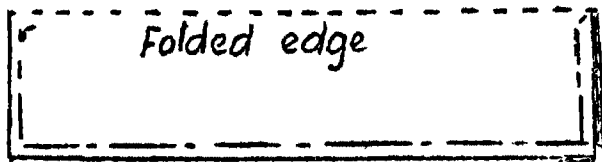
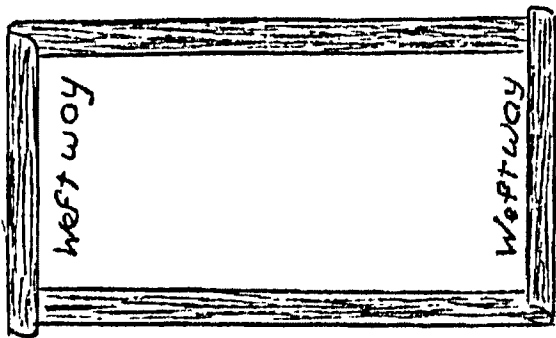

1. Take your piece of material and pull it diagonally to straighten it before any turning is done so that it may set flatly when folded together.

2. Turn the selvedge sides of the band first. Be careful to get it quite straight by one line of threads.

3. Turn the weft sides in the same way, pleating the fold between the thumb and finger to prevent stretching, and keeping the corners quite to a right angle.

4. Fold the long selvedge sides together, holding the corners in the hands and again pulling the band to straighten it.

5. Tack the band on the right side all round the turned down edges to keep the band flat.

BUTTONHOLES.

A buttonhole is a "slit" worked all round with a knotted edge. The ends of the slit can be varied by making them either square, or round, according to that part of the garment for which the hole is needed.

Look at various buttonholes worked on garments. You will see that there is a knotted edge and that the stitches are very close together. You will notice, too, that the buttonholes on men's suits are beautifully made - these are tailor's buttonholes. You are to practise the kind ordinarily used on underclothing and cotton frocks.

CUTTING THE HOLE.

Be careful to cut the slit exactly right otherwise it is impossible to work the buttonhole correctly.

Buttonholes are always worked on two thicknesses of material, sometimes three. Should a hole be needed on any part of a garment where there is only one thickness a single piece of material must be hemmed on the wrong side for strength.

The buttonhole should be slightly (barely an eighth of an inch) longer than the button.

Cut it about  $\frac{1}{4}$ " from the edge of the band and for your first practice one  $\frac{1}{2}$ " long.

P.T.D.

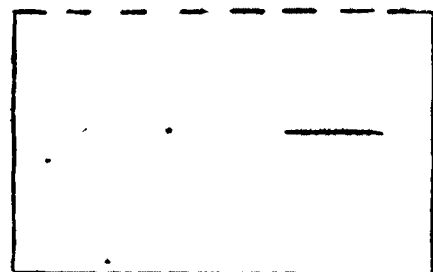

The cotton used should be about as stout as the threads of the material. For ordinary practice use No. 50 or 40. The end must be threaded as it comes from the reel, otherwise the fibres are broken and the cotton will knot!

The work is held with the slit parallel to the worker and along the finger.

The rounded end of the buttonhole must be kept to the right hand of the worker.

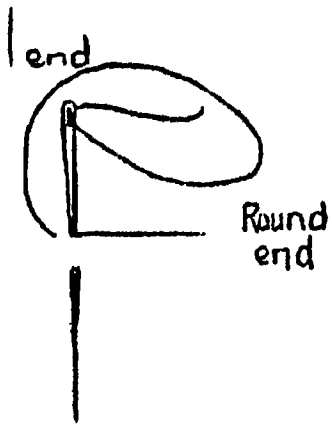

Insert the needle in the way shown in the diagram. Work from left to right. \*Bring the double end of the cotton, that which comes from the eye of the needle, round the point from left to right, and draw upwards from the worker, inclining to the left. Bring the knotted edge on top of

the raw edge at the inside of the buttonhole. \*

Place the needle in position again and repeat from \* to \* being careful to get the stitches close together.

Work this way until you come to the end.

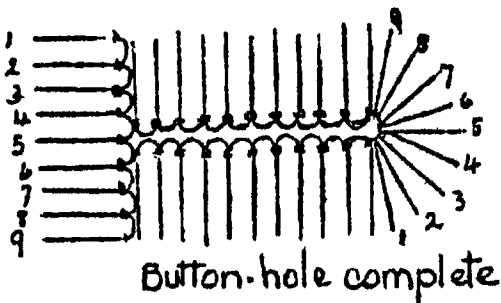

Round end. To make the round end, over-sew in the way shown in the diagram. The middle stitch, the fifth, should come straight from the centre. When you have finished the round end do the second side.

Square End. Notice that the squared end is made of nine button-hole stitches forming a bar and that the stitches are worked right across as far as the buttonhole stitches go.

To fasten off. Pass the needle to the wrong side just where the last stitch ends and secure the cotton by a backstitch before slipping the needle between the folds.

A join in working the slit. If the thread should snap closely one stitch should be unpicked so that an end of about  $\frac{1}{6}$  " remains.

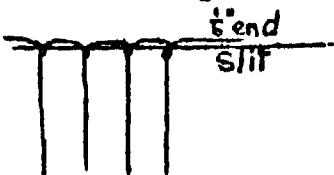

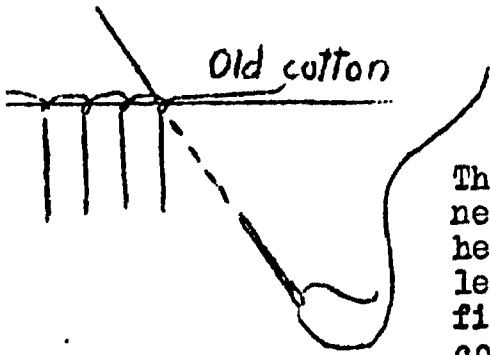

The needle should be threaded with the new cotton and slipped upwards, then brought out at the top of the knot of the last stitch.

The worked slit and the new cotton should be held firmly between the left hand thumb and fore-finger during the commencement.

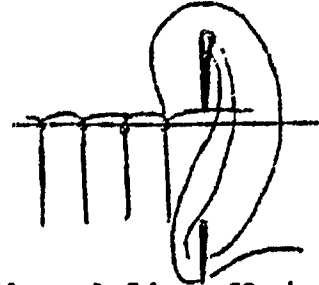

As you will see in the diagrams the old thread lies flat along the top and the buttonhole stitches are worked over it. A join should be strong and invisible.

#### THE POSITION OF THE HOLES IN GARMENTS.

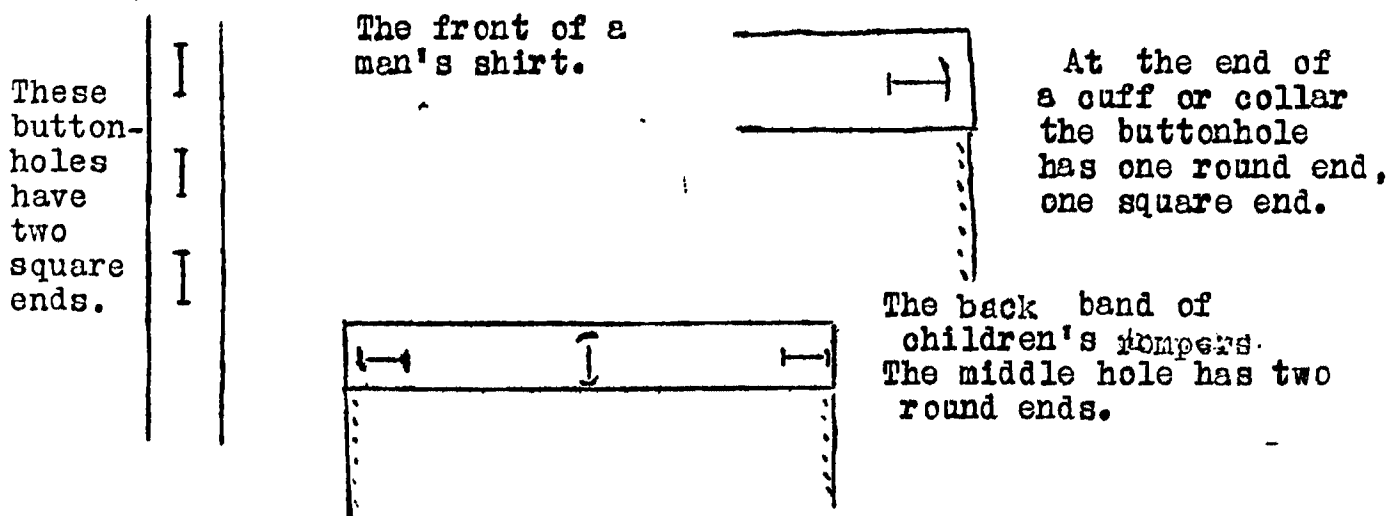

#### APPLICATION OF THE STITCH TO OTHER PURPOSES.

Tape Ends. If tape is narrow, the ends are often buttonholed for neatness as hemming would be clumsy.

Openings in Garments. Where there is any strain in the opening of a garment, buttonhole stitches are sometimes worked as these help to keep it firm.

Mending skin Gloves. Work the ordinary buttonhole stitch all round the raw edge of the hole, then sew the knots of the stitch together on the right side. Use silk that matches the glove in colour, and the mend will be successful. This plan is very effectual when a glove tears at the gusset of the thumb.

-----

Make several buttonholes for practice. You will find it well worth while to learn to do them well.

-----

Aunt Susan

## Our Needlework

## - Textiles -

Have you ever wondered how the sheep's wool, the silk-worm's cocoon, or the soft fluffy cotton balls are woven into the serge gym tunic, the Fuji silk blouse, or the print dress you wear every day; or why it is that such things as spider web, kapoc, dandelion or thistle down, although so soft, cannot be used for textile manufacture?

A fibre, before it can be woven into material must have certain properties which are:-

1. Cohesiveness i.e. the fibres must be capable of holding together to make a continuous thread.

Wool has scales.

Cotton has twists.

Linen has jutting out pieces and length.

Silk has great length.

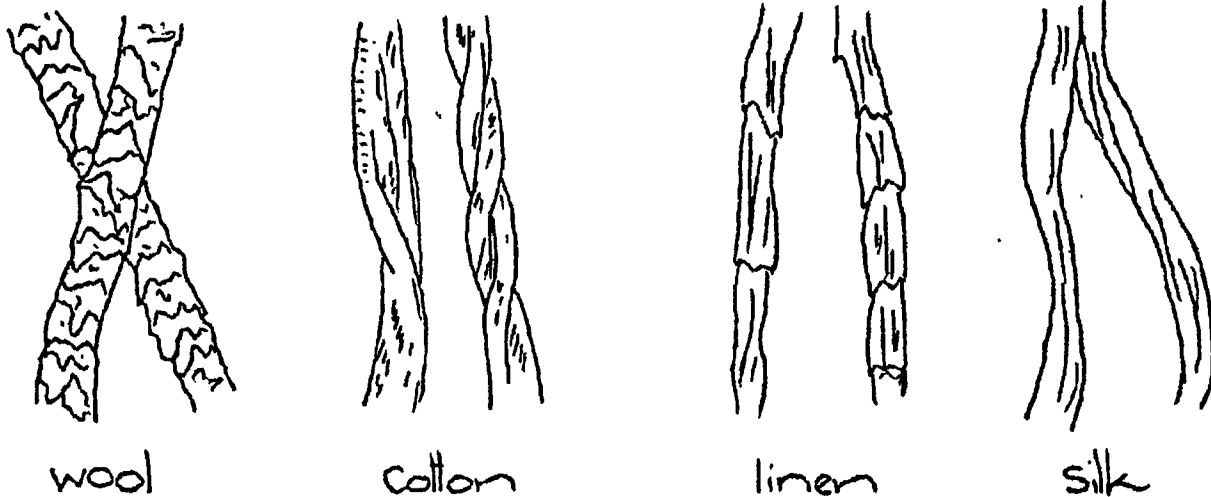

wool

cotton

linen

silk

## Textile Fibres as shown by a Microscope

Kapoc, spider web, and thistle down do not have any cohesive properties.

2. Tensile strength i.e. strong enough to stand the strain of spinning and weaving. A thread of silk is  $\frac{1}{3}$  as strong as the finest steel wire.
3. Pliability and elasticity - helps material to keep its shape.
4. Fineness. New Zealand flax is much too coarse for materials but is excellent for ropes.
5. Uniformity, i.e. evenness in length and diameter of the fibre.
6. Porosity i.e. capable of absorbing moisture, so that it will dye.

7. Lustre.

8. Sufficient production to make it valuable.

The fibres in common use are classified as follows:-

1. Animal - silk, wool.
2. Vegetable - cotton, linen.
3. Artificial - rayon or art silk.

Each fibre has its characteristic properties, necessitating different methods of preparation and dyeing.

Silk is the oldest of the fibres as it was used in China as early as 3000 B.C. The Chinese were jealous of their art and it was not till many centuries later when the Persians learnt the secrets, that silk weaving spread to other countries.

Linen comes next, and was, till 1500 A.D. the most used fibre. As far back as 2000 B.C. the finest linen was grown and woven in Egypt. It was usually dyed with "purple" - the dye from a Mediterranean shell-fish which yields either red or purple dye.

Wool was used by the Romans in very early times, and they, at the time of the Conquest, taught the Northerners how to use it, and established wool-weaving centres in various countries. One of the most notable is Winchester in England, which they founded in 400 A.D. The industry did not progress until the Flemish came to England during the 17th Century and introduced new methods.

Cotton was first used in India and Peru; and is mentioned in the Bible in the time of King Solomon. It was introduced into Europe by the Moors about 900 A.D.

Rayon is an artificial fibre prepared from wood cellulose, New Zealand flax, cotton and sometimes from gelatine. It was first made about the end of the 19th century, but was not used to any extent till after the Great War.

Before any fibre can be woven into cloth it has to be cleaned, spun into a thread and usually dyed. Each fibre is prepared in a different way, but the weaving processes of all are similar.

Over and under, through and through,  
Take the stripes and weave them true;  
Over and under, through and through,  
Blossom-pink and soft sky-blue.

With all the stripes of pink and blue,  
Hold sweet thoughts to weave in, too;  
Over and under, through and through,  
Hold them fast and weave them true.

Thoughts of the spring's soft skies of blue;  
Thoughts of apple blossoms, too.  
Thoughts of the Robin's song all through,  
Weave, my dears, in pink and blue.

(From "Constructive and Decorative  
Stitchery" by Mrs. L. Glasier Foster.)

WEAVING is the interlacing of materials, set at right angles, one set being the warp or selvedge, and the other known as the weft, woof or filling.

Probably our fore-fathers set up their loom by hanging beams across a tree, threaded it with the warp threads, then using their hands or a piece of reed around which thread was wound, wove in the woof threads.

Improvements were gradually made; first came the distaff and spindle, then various wheels, and then the old treadle spinning-wheel such as our great-grandmothers used. Since the Industrial Revolution the manufacture of materials has progressed by leaps and bounds until today electrically driven machines do the work of many men.

#### COMMON WEAVES

1. Tabby - this is the most common weave, where the weft threads go over and under alternate single warp threads as in darning.

This weave is used for cotton materials such as azlin, calico, for Fuji and Jap silk, for flannel, broad-cloth, velours and some tweeds;

2. Twill where the weft thread is passed over and under two, three or more warp threads in regular succession, but there is no tabby weave between. The twill may be right or left handed.

This weave is used for sheeting, serges, gaberdine, and blankets.

3. Basket is similar to a tabby weave; only the weft threads go over then under, two or more warp threads for two or more rows, then the weaving is reversed.

It is used chiefly to produce a fancy weave in woollens.

4. Poplin or Repp is made by the weft threads going over two and under two warp ones on alternate rows. Usually the weft thread is thick to give the corded effect.

It is used for silk and wool poplins, grograine, and repp. P.T.O.

5. Satin is an irregular twill weave, where the loosely twisted weft thread passes under one, and over 3-7 warp threads. The long "floats" give the lustre to satin.

It is used for sateen and satins.

6. Pile where the weft thread passes over two warp threads and a fine wire, which when removed leaves loops. These are cut with a knife and attached to the wire.

It is the weave used for producing velvets and velvetan.

7. Damask is used for table linen and is done with a special loom known as the Jacquard loom.

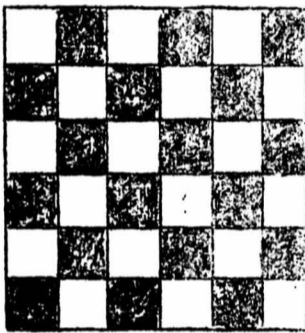

Tabby

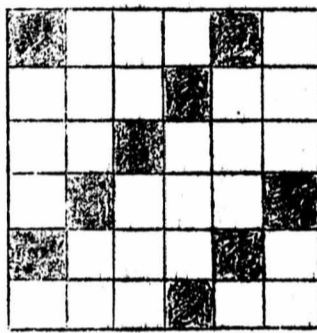

Right-Hand Twill

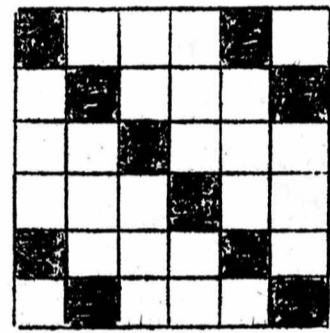

Left-Hand Twill

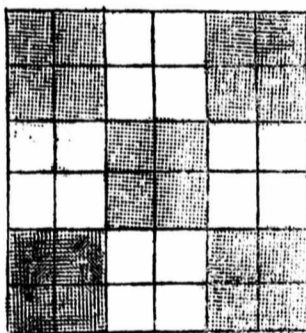

Basket

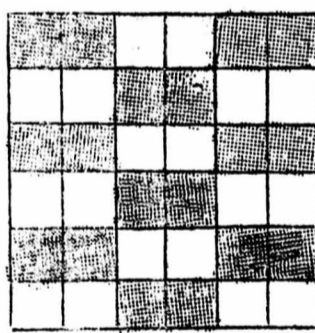

Poplin or Repp

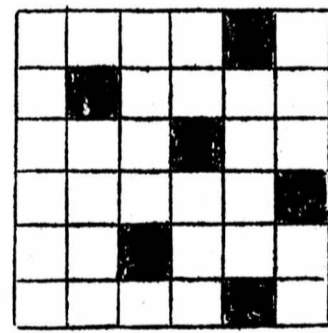

Satin

### Samples of common Weaves

In the packet are pieces of coloured paper cut into strips, which you are to use for illustrating the different weaves shown in the diagrams. When finished paste the "weaves" in your needlework note book with samples of any materials you may have showing that particular weave e.g. by the tabby weave you will have pieces of flannel, calico, and Fuji silk.

As you progress with your dressmaking you will receive lessons on the various fibres, so that you will know <sup>how</sup> they are produced and manufactured. A good housewife needs to know the weaving qualities of the materials she uses, and these lessons are to help you to shop successfully.



There is an endless variety of interesting studies awaiting your pencil! So let us to work!

In learning to draw, a great deal of practice is necessary - just as if one were learning to play the piano or violin - but the method of practice is more interesting and varied.

As far back as we can go in history, we find primitive man making efforts to draw. But he saw only width and height. Apparently he had no idea of depth.

Here are some of his drawings.

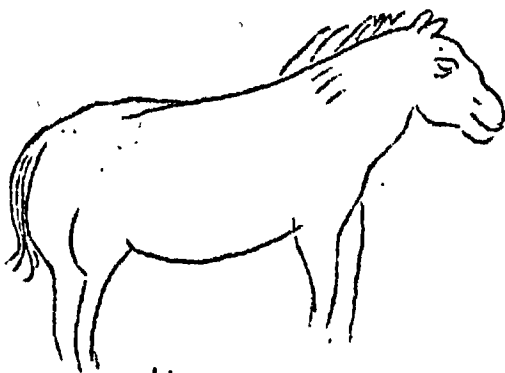

Horse

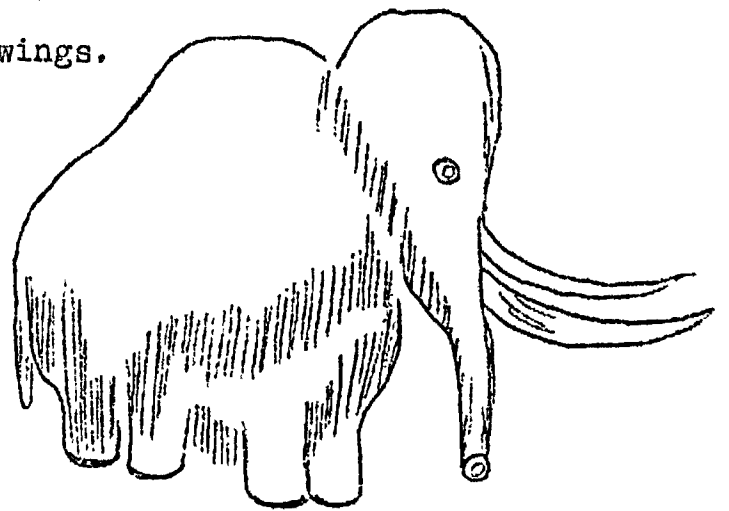

A mammoth from a painting on a cave wall.

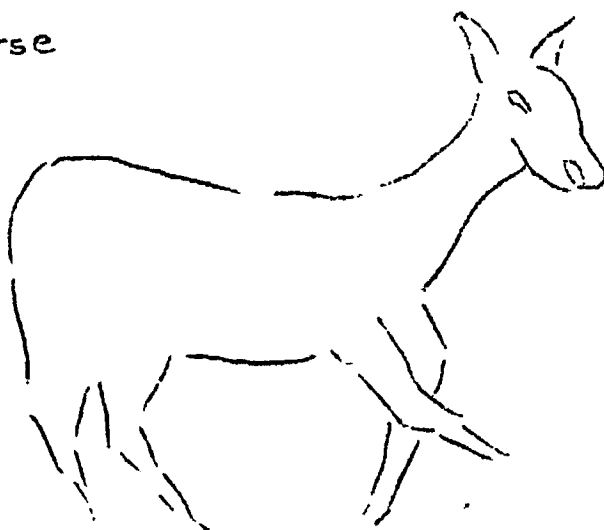

Primitive drawings are rather rare of course, but you have seen some sketches that could easily be mistaken for drawings by primitive peoples and I expect you are not altogether guiltless of having made some yourself in your earlier days!



Here they are -

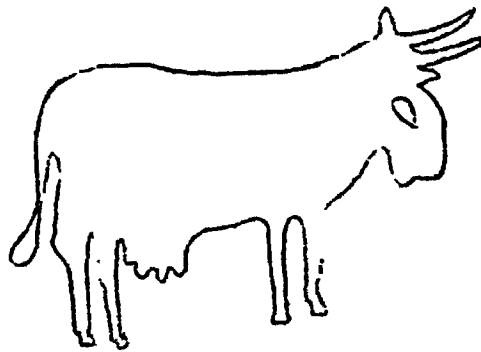

A cow.

Little brother is doubtless quite proud of his efforts for he has not yet learned to observe very carefully.

In later times it was found that depth could be suggested by tones, and it is by SHADING that the TONES are made. There may be light tones, middle tones, and dark tones.

Mark how the shading suggests the depth of the head, cap and coat.



There are many mediums for drawing - chalk, pastel, crayon, charcoal, ink and paint - but as the pencil is the most easily obtainable and is one of the most useful mediums we shall consider its possibilities first.

You need three pencils - two soft ones 2B, and one hard HB.

Here are three methods of shading with pencil.

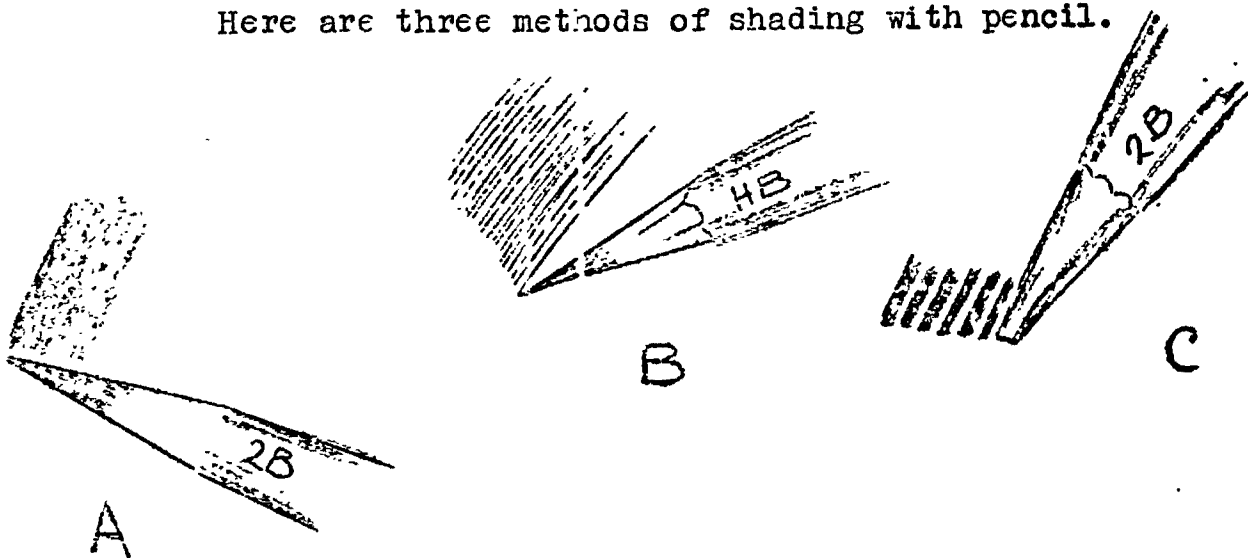

In method A, the pencil must have a long sharp point and be held in almost a horizontal position.

In B the pencil must have a sharp point and be used from the point.

The pencil for C has a rather flat point with a chisel-like edge. This point can be secured by holding the pencil almost vertical and rubbing it across a piece of sandpaper until the point becomes chisel like.

When using the chisel edged pencil if you wish to draw fine lines turn the pencil in your hand and use the end edge. You may vary the effects by increasing the pressure. A light grey tone may be obtained with a light pressure, and a darker tone by a heavier pressure.

Keep your lines CRISP and do not be tempted into scribbling your shading. Make each line count. The best way at present for you to shade with pencil is by up and down lines.

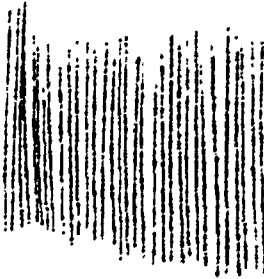

If you should wish to darken certain points cross-hatch with parallel lines crossing the others at an angle. This is called cross-hatching.

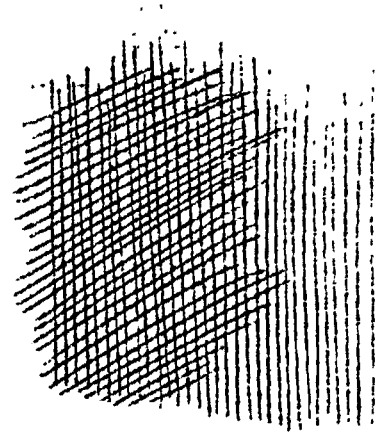

The lines are purposely placed wide apart so that the diagram will be clearer. In pencil shading the lines may be placed close together.

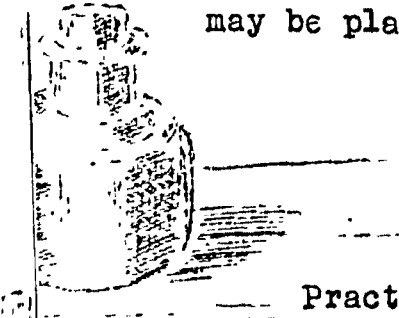

Practise making parallel lines and cross-hatching. You will soon become quite proficient. HOLD YOUR PENCIL LIGHTLY.

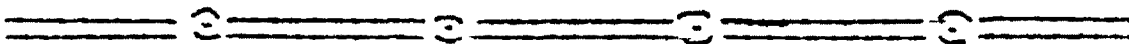

Now, a drawing always looks more effective if placed nicely on the paper, so it is a good idea to regard the four sides of your paper as frame lines, or you may draw frame lines with your pencil. Trim any ragged edges on your paper.

### Set out with thought

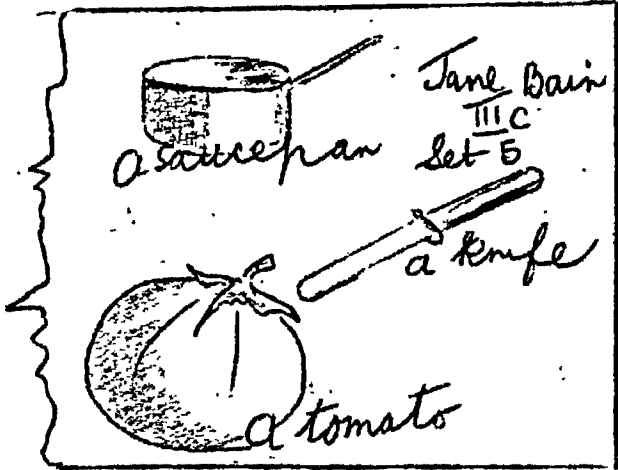

Higgledy piggedy!

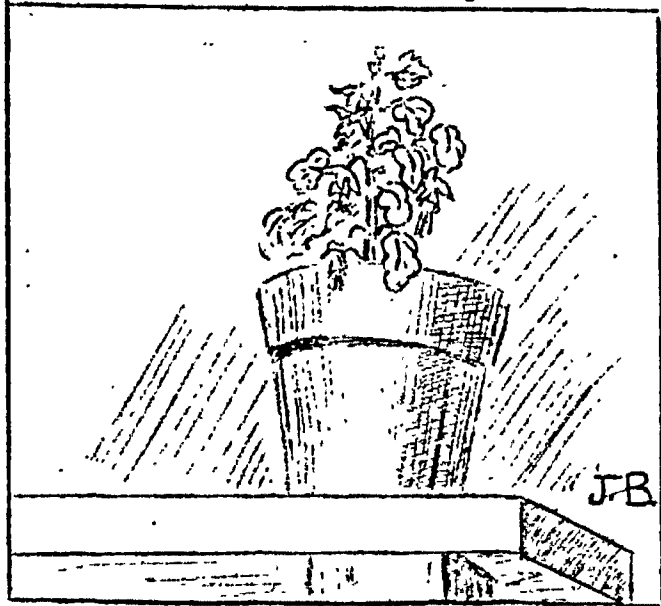

Note the difference!

Try to make each study an artistic picture in itself. Sometimes it will be ~~more~~ effective if you suggest a background.

Always suggest that the object is standing on something. A few straight lines are sufficient for this.

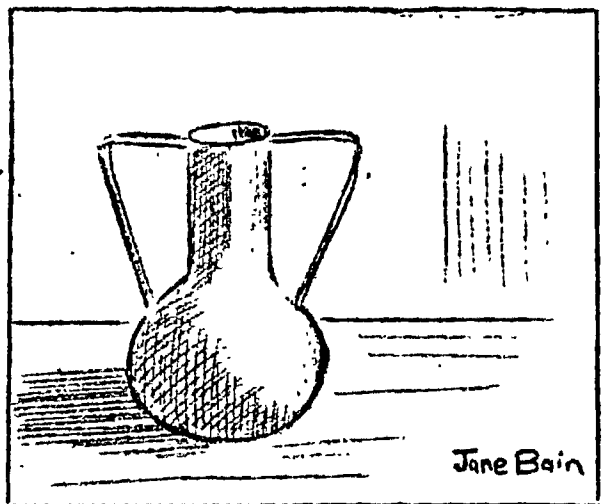

Place your name, form and number of set on the BACK of your paper and if you ~~sign your name~~ at the foot of your drawing, do so neatly.



You would find a drawing board very useful and could doubtless make one for yourself; 16 inches by 14 inches would be a suitable size. Find a flat board this size or join two boards carefully together. Plane or sandpaper the surface smooth.

Nail a thick piece of wood 2 inches deep along the under short side. Saw or plane the edge so that it will sit down without rocking, and then you will have a sloping surface to work on. The drawing board may be used on the table.

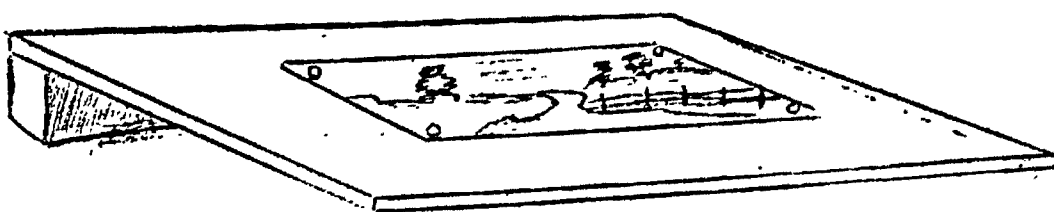

If your board is not perfectly smooth cover with a sheet of cardboard tacked round the edges. You will need drawing pins to hold your paper in position while you work.

In each assignment BEFORE BEGINNING TO DRAW ANY OF THE EXERCISES, READ EVERY WORD OF THE INSTRUCTIONS CAREFULLY. Underline in red any points that you need to keep in mind.

You may have had contact before with certain points in these lessons but each as it comes must be regarded as worthy of your whole attention.

Try not to pre-judge your drawings at this stage. Do your very best and send in. When your work returns the criticisms will help you pass a fairer judgment upon it.

The following exercises will show how you are progressing with the pencil shading. Use the pencils as indicated. Copy the drawings and shade carefully. You may trace if you wish. One way to do this is to place a sheet of transparent paper (butter paper would do) over the drawing to be copied. Trace round the outline carefully. Then place your traced drawing against the glass of a window pane. It will show through the paper clearly. Draw round it carefully with a soft pencil so that your paper has a drawing on each side. Now fix it in place on your drawing paper with the first tracing uppermost. Draw carefully round the outline being careful not to move your paper. Lift the tracing paper off and you will find that you have transferred the outline drawing to your paper.

Place each drawing carefully on your page.

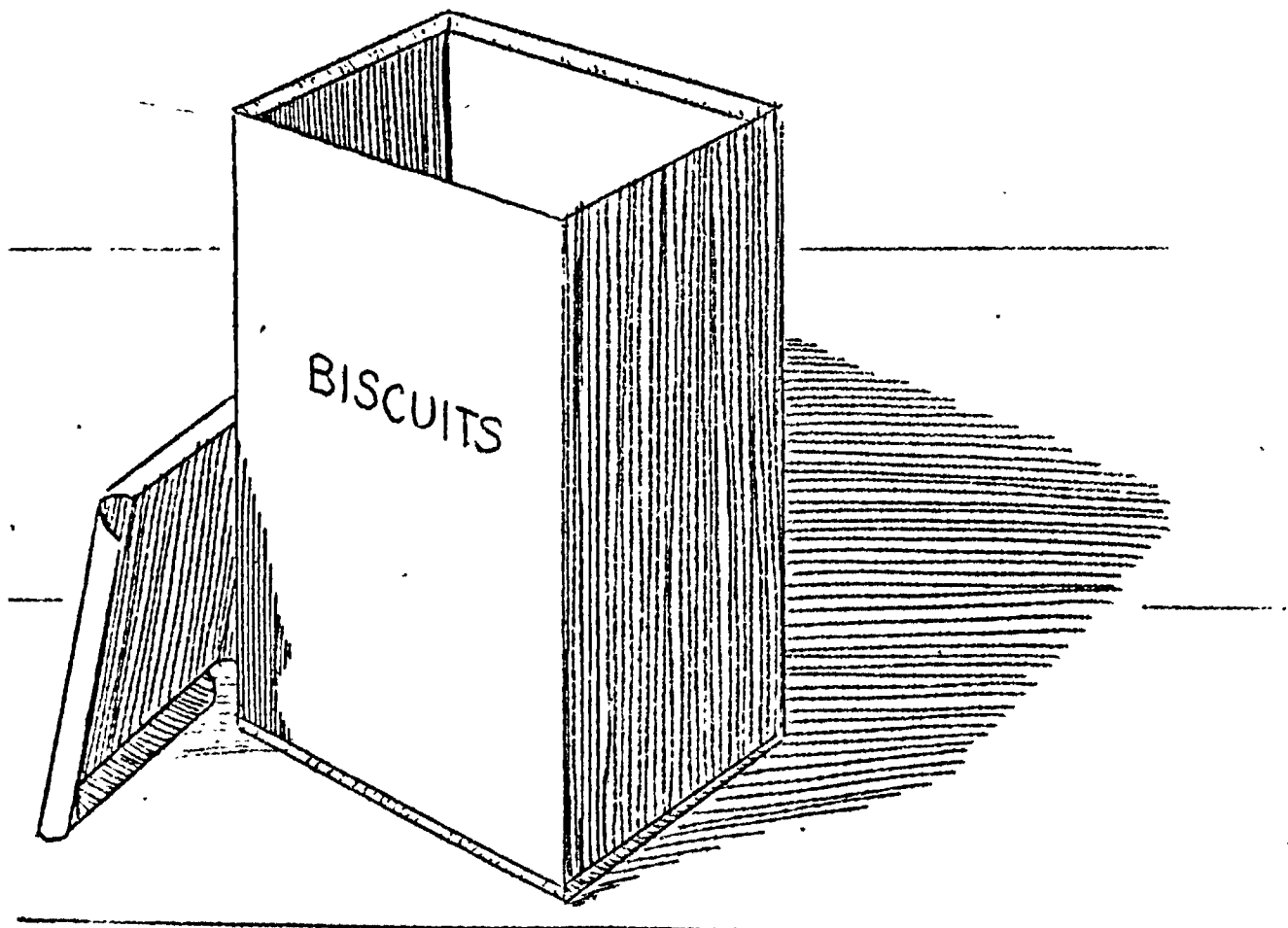

For shading. use pencil as shown at C, page 2.

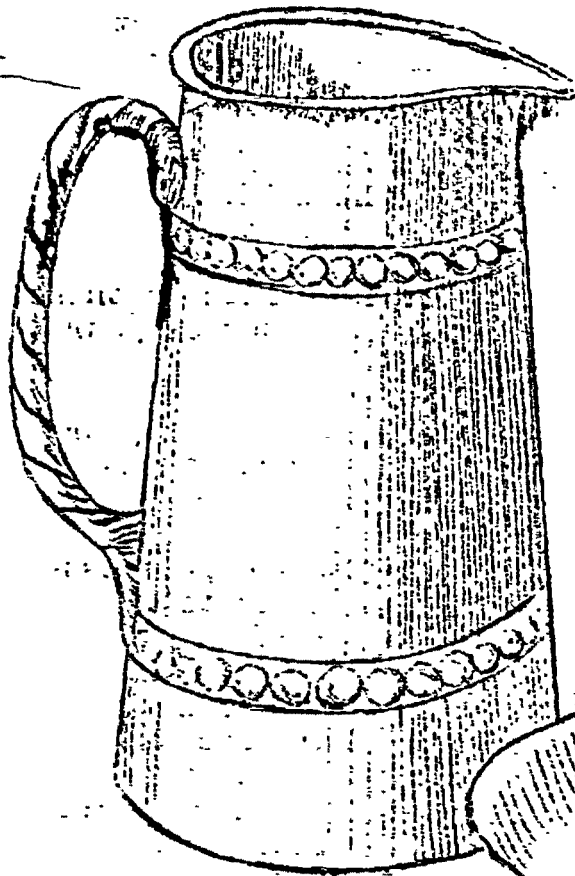

For shading use pencil in position C, page 2

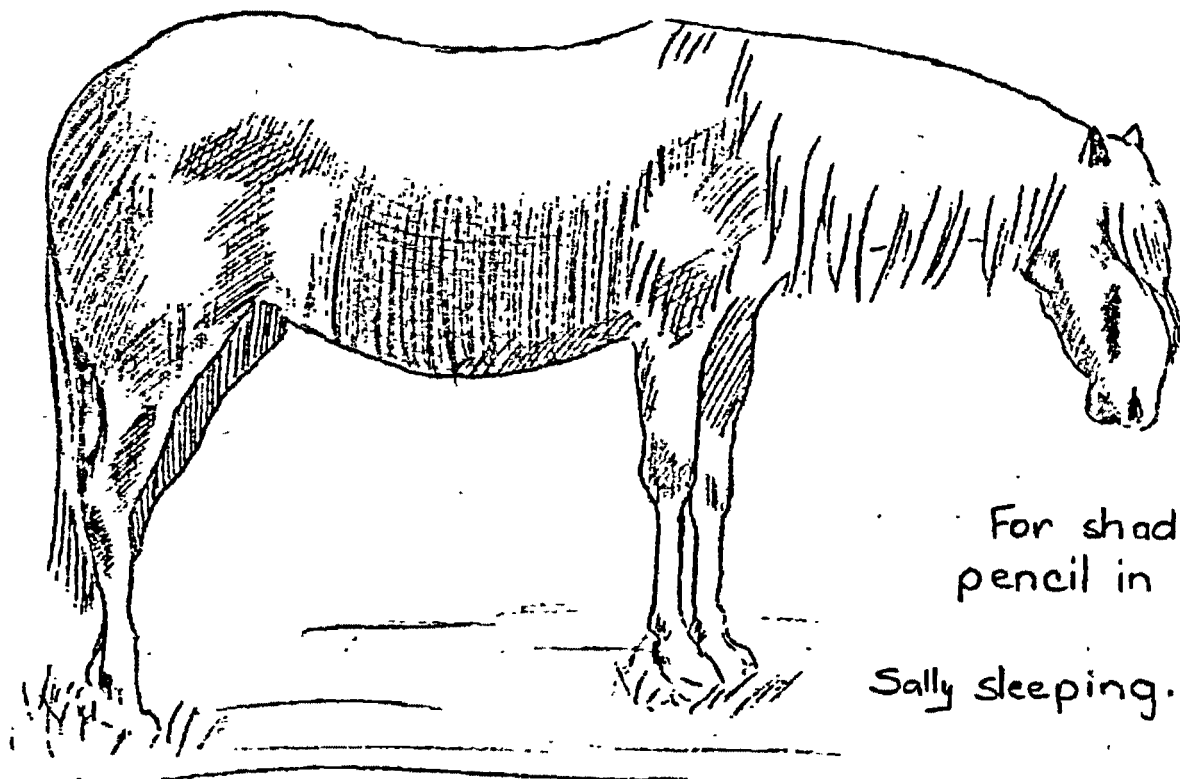
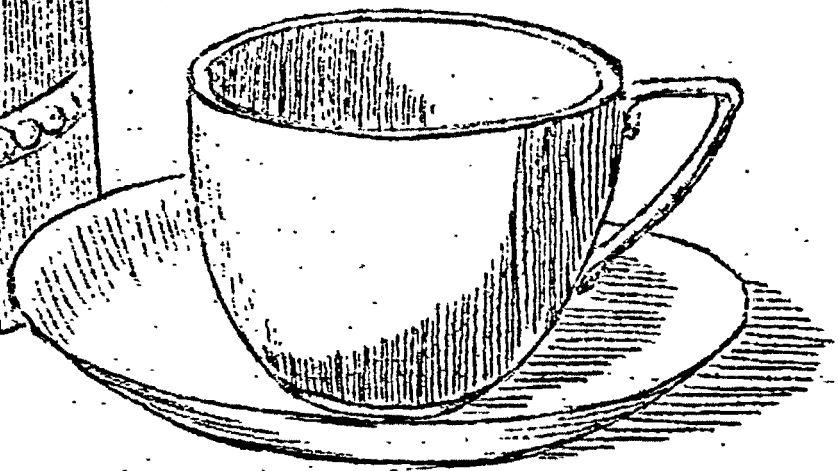

For shading use pencil in position A.

Sally sleeping.

For shading use pencil in position B, and cross hatch.

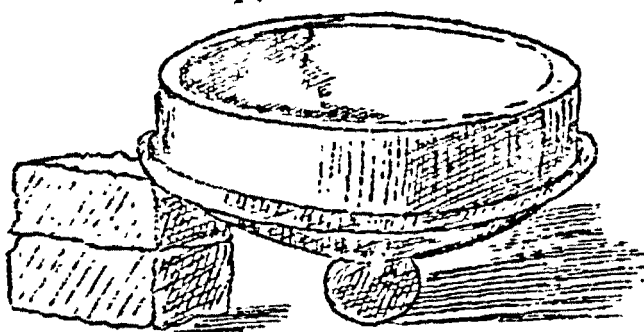

Teapot lid resting on two lumps of sugar.

NOTE.

When shading your drawings do not be influenced by the way in which the drawings in the assignment are shaded. Before these are printed they are drawn with a blunt instrument on a waxed sheet, so it is not possible to shade as one would with a lead pencil.

For instance, the biscuit tin, jug, and cup and saucer are to be shaded by the C method. This means that they are to be shaded by a pencil sharpened so that it has a broad edge like a chisel. The shading strokes therefore in your drawing will be much broader than they are in the assignment.

The horse is to be shaded by the A method, so in your drawing the shading should not be done with separate strokes as in the drawing on page 6, but with a kind of rubbing movement of the pencil point as shown on page 2. For darker shading by this method press more heavily on your pencil.

CROSS HATCH.

If you spend a few minutes each day drawing short parallel lines freehand you will soon become expert at shading by the cross hatch method.

For daily practice

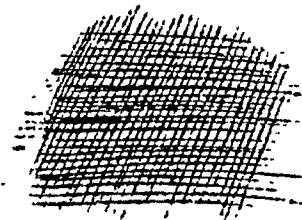
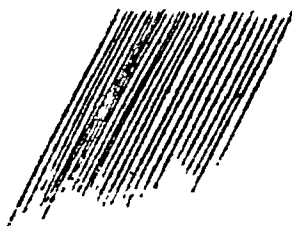
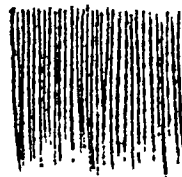

OUTLINES.

You will notice in the printed sets that drawings have lines for outlines, but in your drawings whenever possible make the shading form the outline instead of drawing it separately with a single pencil line.

In one instance this has been done in this assignment. Note on page 6 how the shading inside the lid of the teapot suggests the inner edge of the rim instead of a heavy line being drawn.

WORK TO SEND IN.

Drawings of the objects shown on pages 5 and 6, and shaded by the methods indicated.

1935

CORNERS.

Have you ever thought of looking for interest in corners - not dark hidey ones of course, but corners of cupboards, buildings, chimneys, tables, boxes, window sills, stones, brick walls, etc.

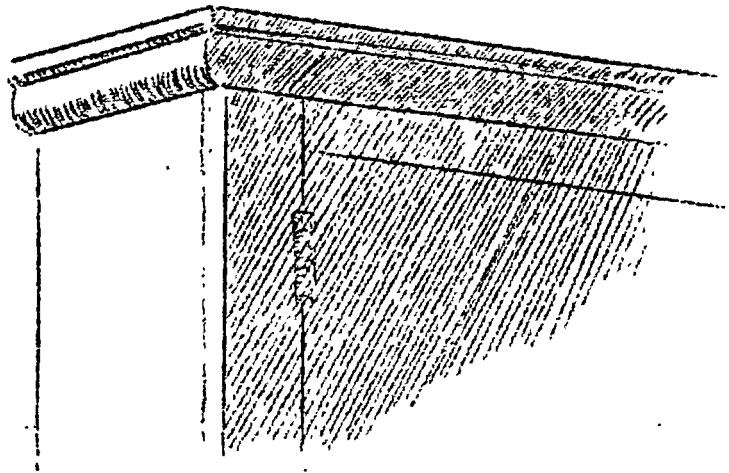

Who would have thought of looking for beauty in the corner of a plain wooden cupboard! Yet even this rough sketch shows a certain amount of interest.

Do you see what makes it interesting? It is not so much the shape as the CONTRAST of LIGHT and SHADE. A corner always presents more than one angle, and surfaces at different angles rarely catch the same degree of light.

Glancing round indoors you will find many odd corners presenting special interest to the eye that is looking for contrasting masses of light and shade.

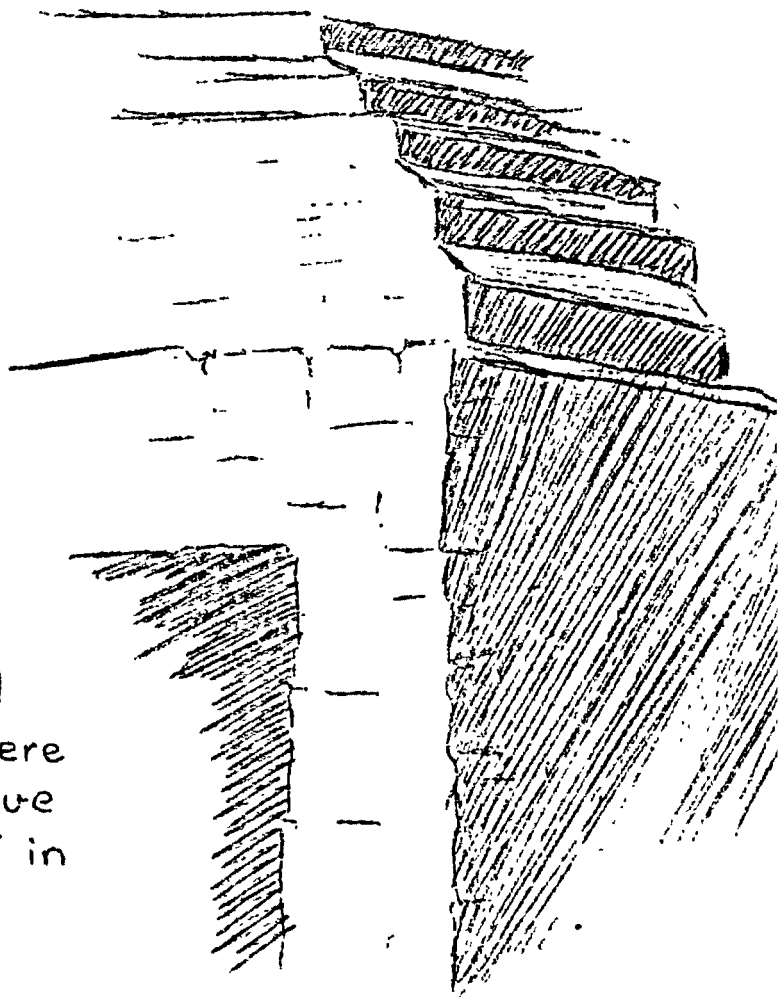

There would be nothing attractive about this old chimney piece if it were not that the angles give an interesting contrast in light and shade.

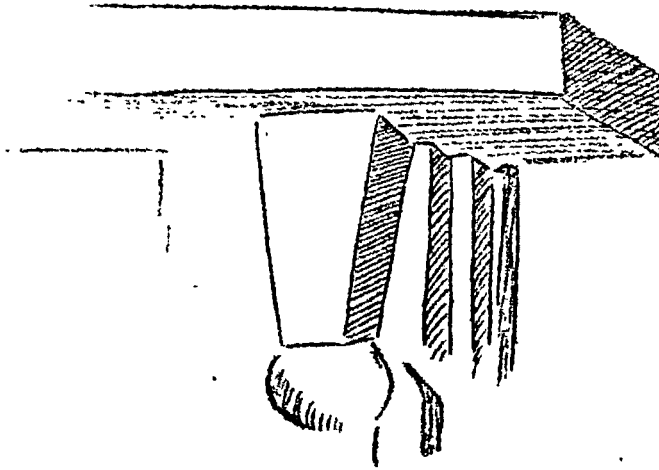

Nor would this corner of an ordinary mantel-piece be worth a second glance if it were not for the sharp division of light from dark parts.

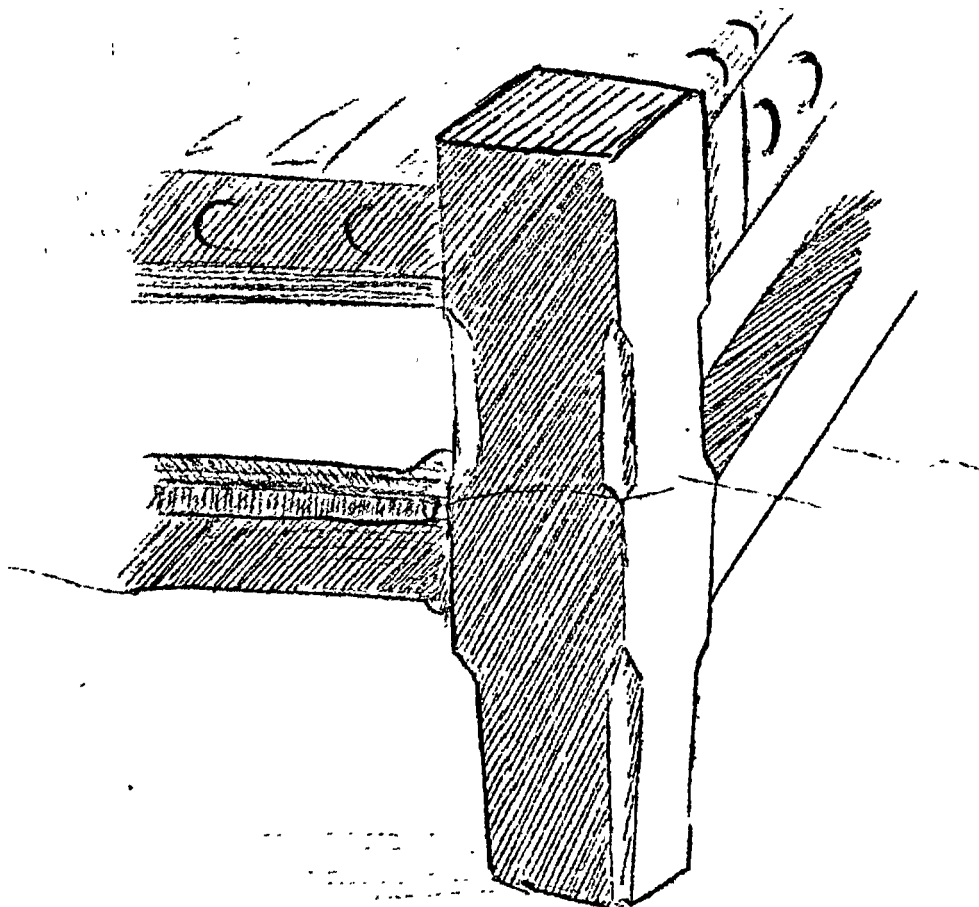

See how interesting this corner of a low stool becomes when you see it in this way!



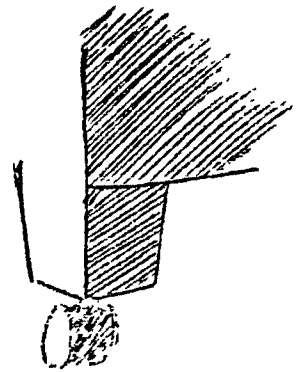
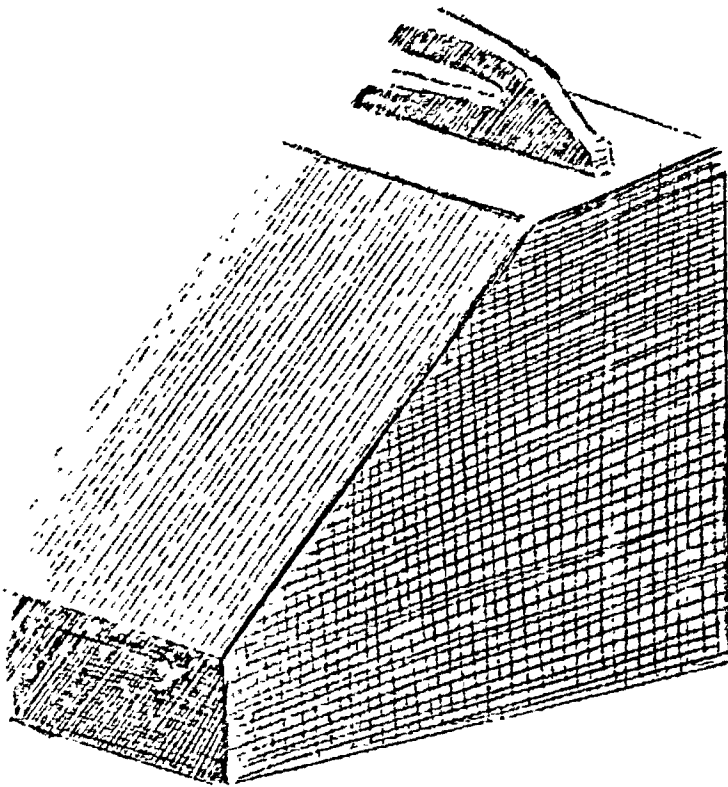

Even the lowly wooden coal-scuttle is worthy of our attention. You can scarcely believe that it is a black coal-scuttle now, because the surfaces, at four different angles, present four tones of shading, ranging from very dark to light. The leg of the armchair is worth a glance too.

Out-of-doors you will find an endless variety of interesting corners.

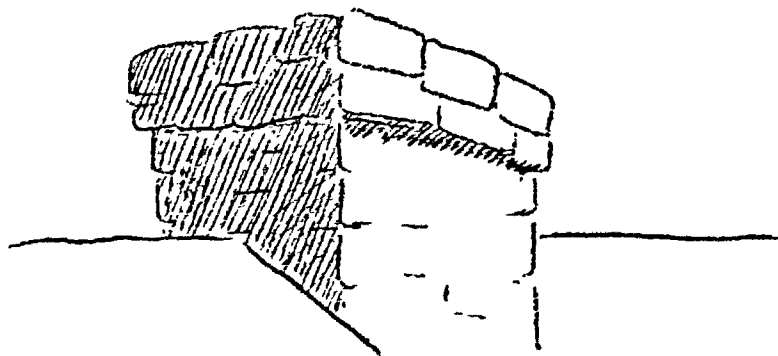

Here is a brick chimney on a house-top, encouraged by the sunlight to show its humble beauty.

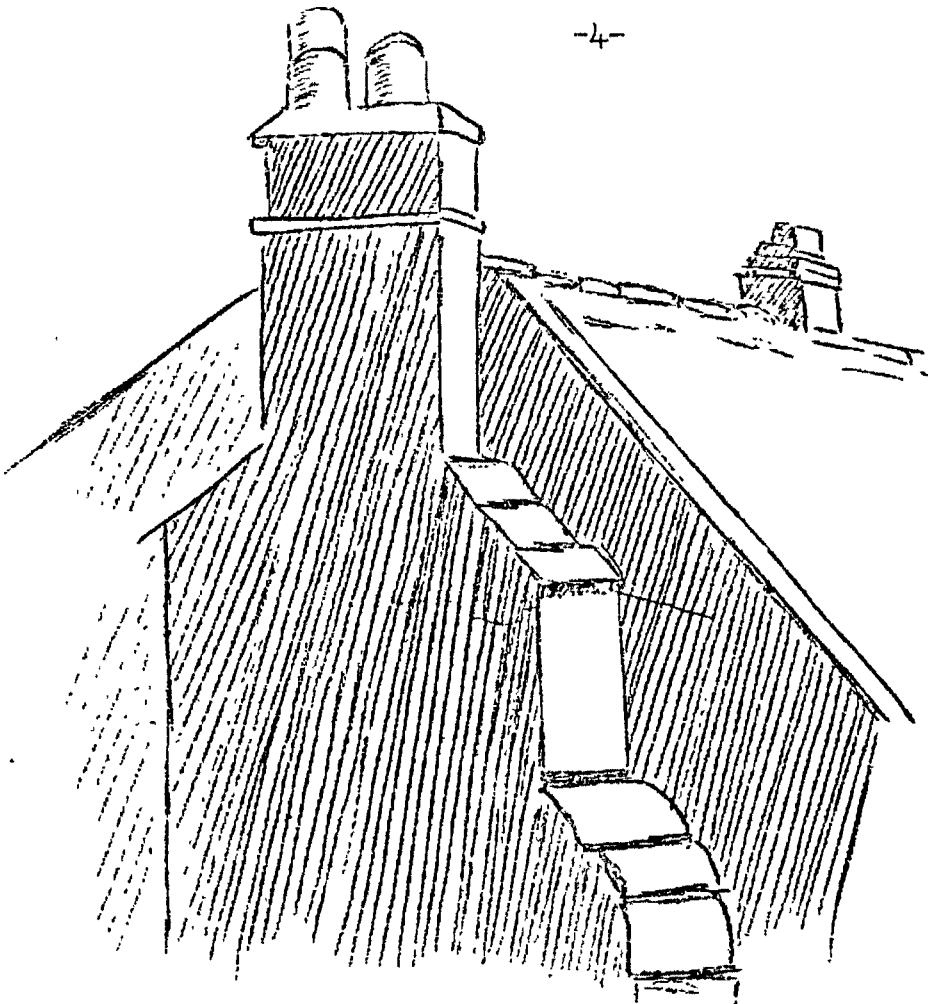

This old-fashioned chimney looks its best on a sunny

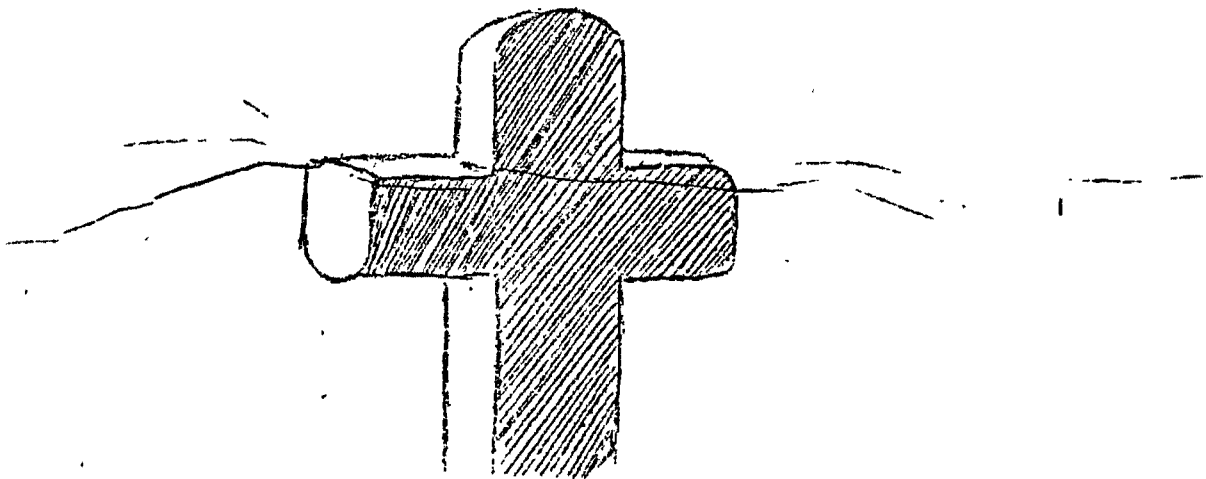

In this top of a tall old wooden cross the contrast in light and shade exposes unexpected beauty.

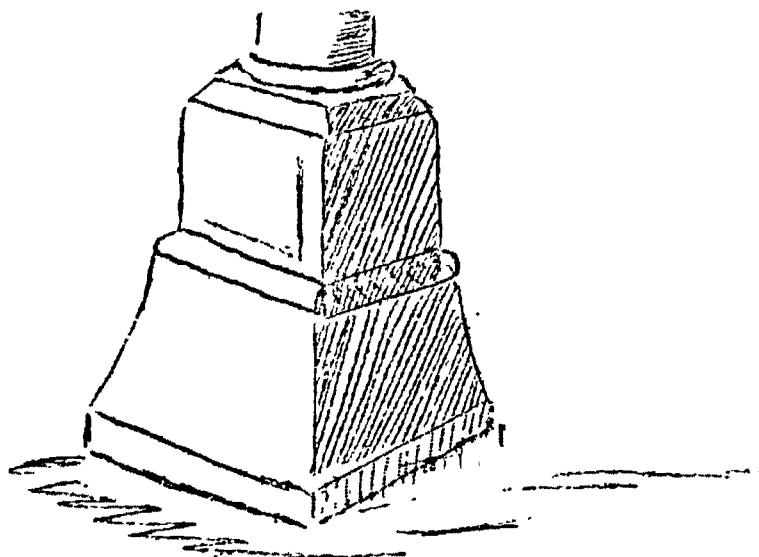

Even this street lamp pedestal is attractive to the eye that is able to see it as a mass of light and shade.

At this point revise Set 2 so that what you have learned about perspective will be fresh in your mind. You learned there to notice that parallel lines running away from you appear to slope towards one another, so that, if they were long enough, they would appear to meet at a point and disappear altogether. We call that point vanishing point (V.P. for short) and it would be on a level with your eyes.

If the lines are ABOVE eye-level they will appear to slope DOWNWARDS and if they are BELOW eye-level they will appear to slope UPWARDS until they meet.

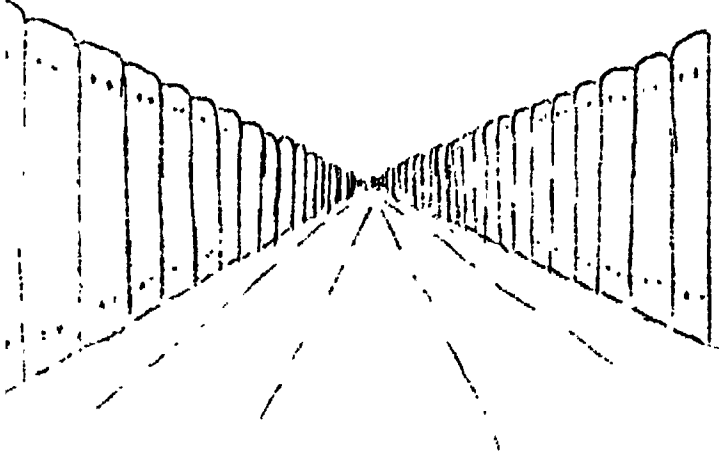

In each of these tall wooden fences the top is above eye-level and the bottom below eye-level. So the line representing the top slopes downwards and the line representing the base slopes upwards in each fence.

Sometimes there are no lines to guide the eye, as in a valley, yet perspective is still at work.

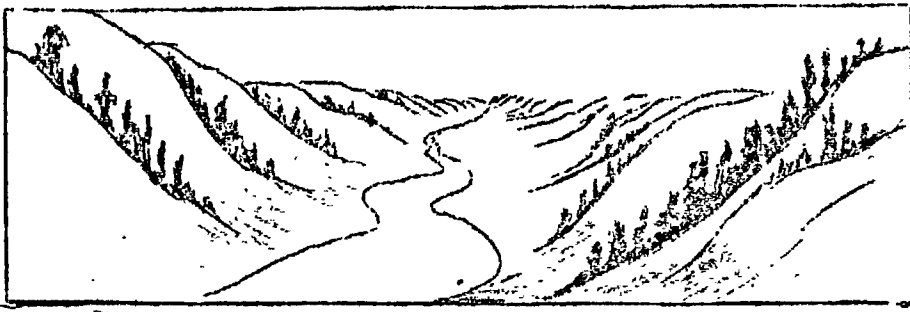

The tops of the hills would be more or less parallel with the base, and one row of hills would be more or less parallel with the other. So the base and the tops in each row would appear to get closer and closer together in the distance, and the two rows of hills would appear to run towards one another.

Continue having perspective hunts outside. You will find perspective peeping at you from all kinds of unexpected places; the banks of a stream for instance, and the tennis court, clothes on the line, rows of trees, roads and buildings.

Now for a study of smaller things where appearance is affected by perspective. In Set 2 you noticed how a box or book appears when placed straight in front of you. Find a small box - a boot box would do - and place it in that position. (See Fig.1)

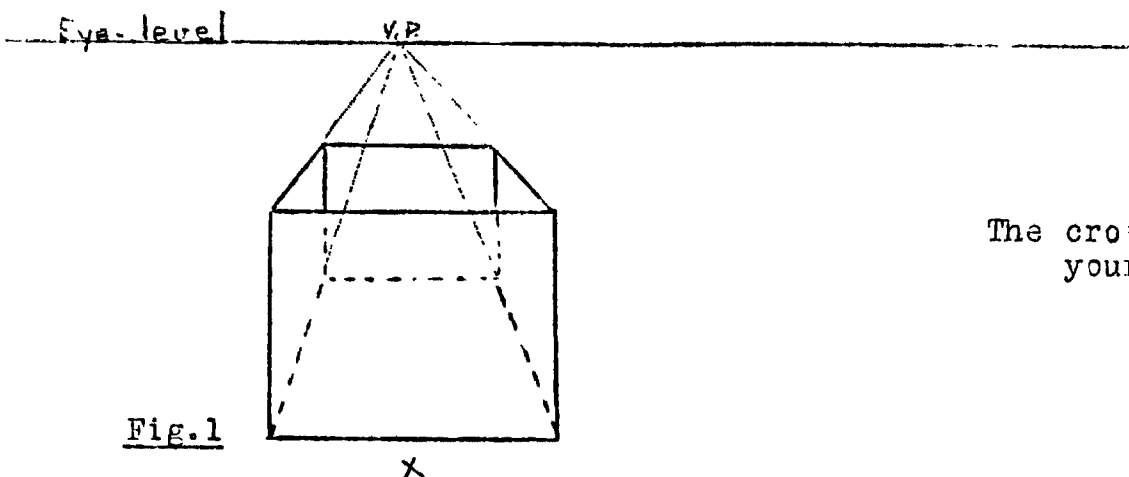

The cross indicates your position.

Fig.1

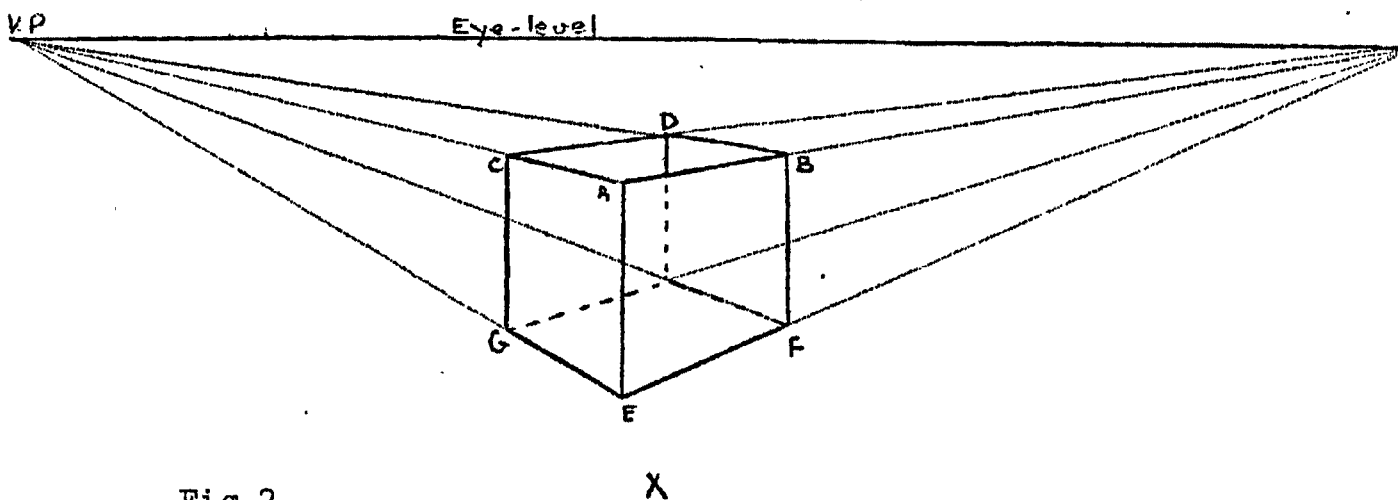
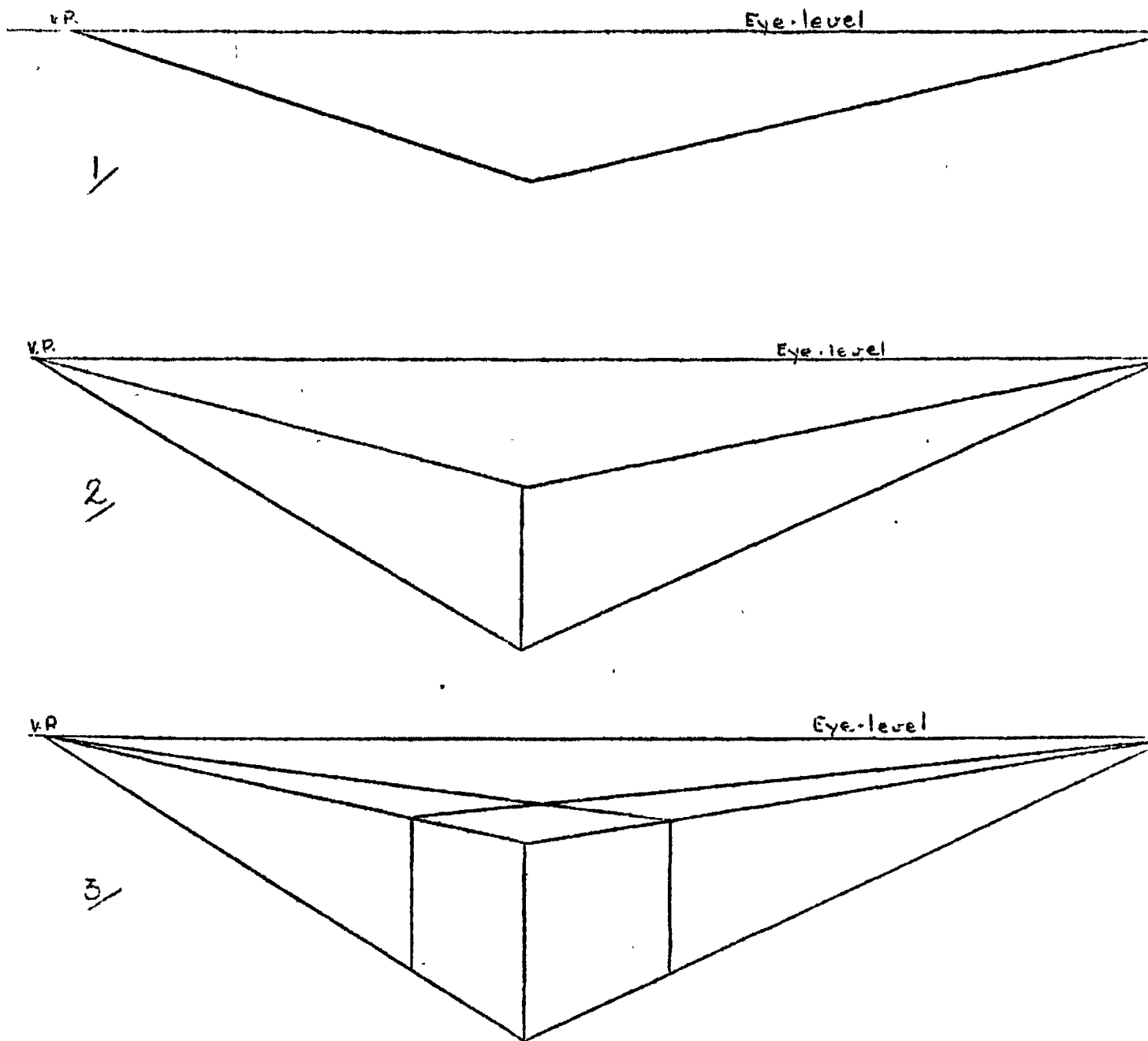
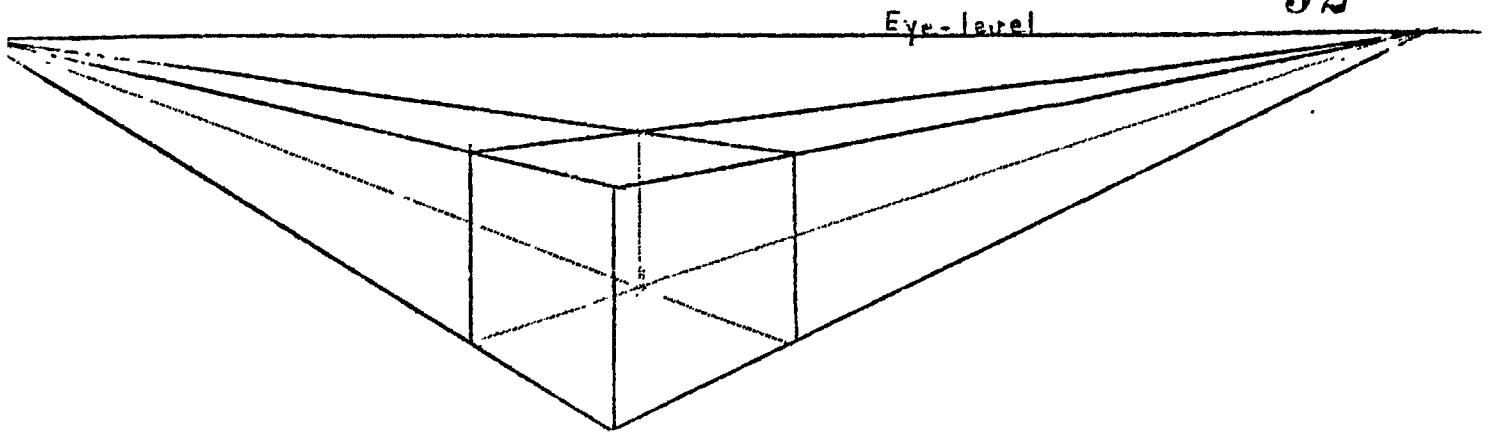

Fig.2

Now turn your box so that it is cornerways on. (See Fig.2) The cross again indicates your position. Fig.2 shows how it appears. A-B,C-D,E-F are parallel lines so they all appear to run towards one another as they slope away from you. If continued they would meet at V.P. somewhere on a line representing eye-level. A-C,B-D,E-G, (running in the other direction) are also parallel and so appear to run towards one another as they slope away from you. If continued they would meet at a point somewhere on eye-level. (The dotted lines on the box show the lines that cannot be seen through the sides of the box.)

Here are the four stages in drawing the box.





A Building.

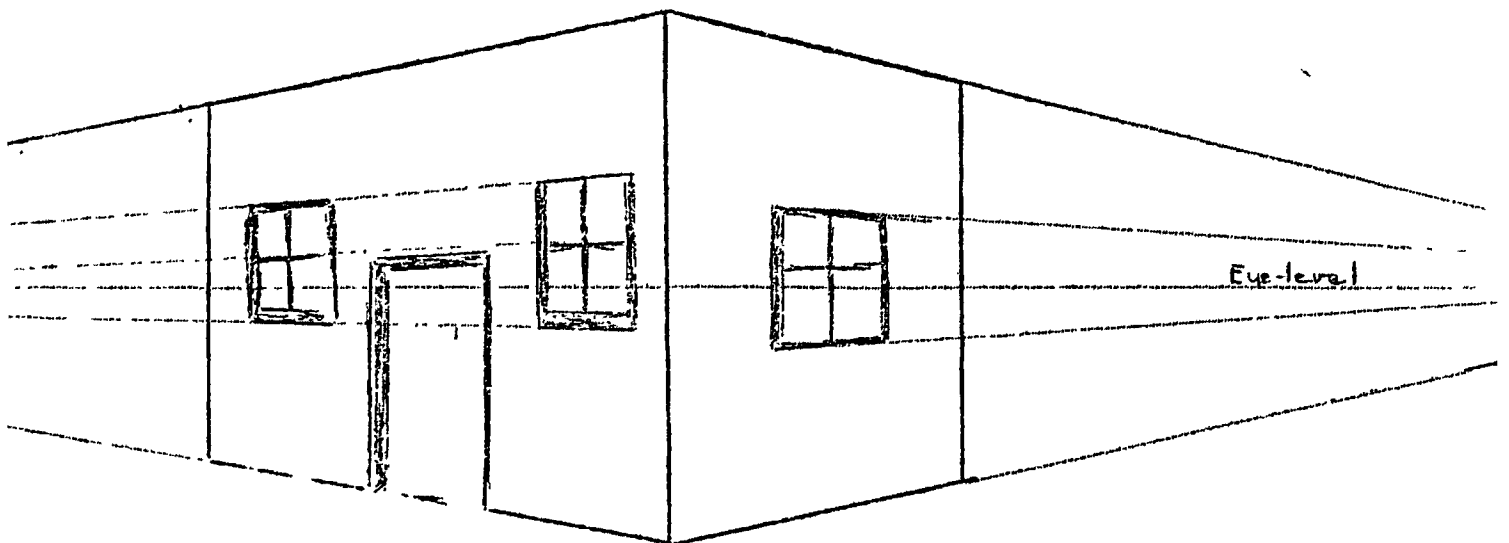

Here are the walls of a building viewed at the same angle as the box in Fig.2. but as the top of the walls is above eye-level the top of one wall appears to run down to the right and the top of the other down to the left. If the lines representing top and base of the wall in each case were continued they would eventually meet at a point on eye-level.

EYE-LEVEL is generally reckoned as being about FIVE FEET from the ground, which is the average height of the human eye from the ground. Notice how the top and lower lines of door and window frames appear to slope also.

Notice in the preceding sketches of corners how the lines in the top of the cupboard, the chimney piece, the mantel piece and the chimney run downwards as they slope away from you. They are ABOVE EYE-LEVEL. Notice also how the lines in the corner of the stool, the coalscuttle, the armchair leg, and the street lamp pedestal, slope upwards as they run away from you. They are BELOW EYE-LEVEL.

There is an endless variety of corners for you to enjoy now that you have been initiated into the secret of how to see them. When looking at the corners notice also how perspective is at work and note the slope of lines.

WORK TO SEND IN.

1. Draw and shade one corner of the desk or table at which you are sitting. (You will need to move away from it to see it cornerways on.)
2. Draw and shade a corner of the outside of your house. Colour this with flat washes of paint. If your house is white leave the white paper showing for the lighter side and colour the darker side grey.
3. Draw and shade a book placed cornerways on the table.

NOTE. MAKE LARGE DRAWINGS and SHADE BROADLY, that is, show just dark and light, and try to set your work out artistically.

THE ELLIPSE.

Does a circle always appear as a circle? You can find the answer in this way. Cut a piece of stiff paper 4 inches square. With your compasses draw a circle in the centre with a radius of  $1\frac{1}{2}$  inches. Cut this out carefully with a sharp pointed pocket knife.

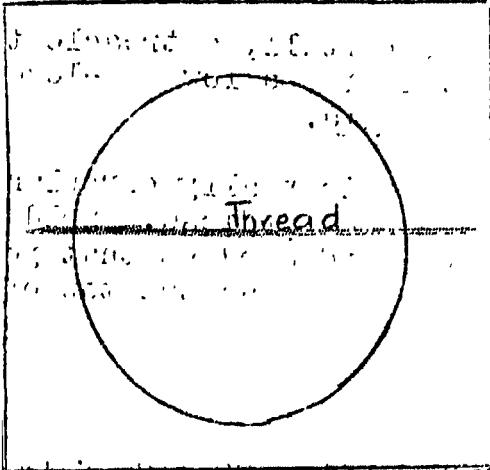

Fig. 1

Then replace the round piece and paste or gum a stout thread right across the diameter as shown. Leave to dry. Then this will serve as a hinge on which to swing your window open.

Now you have a round window like the porthole of a ship. Hold the card a little away from you and level with your eyes and with one finger push the window open a little; and there you have your answer to the question.

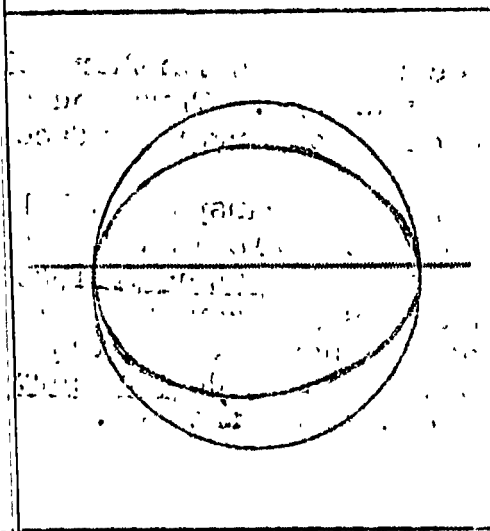

Fig. 2

Your once circular window appears as an ellipse and no longer looks large enough to fill the window-frame.

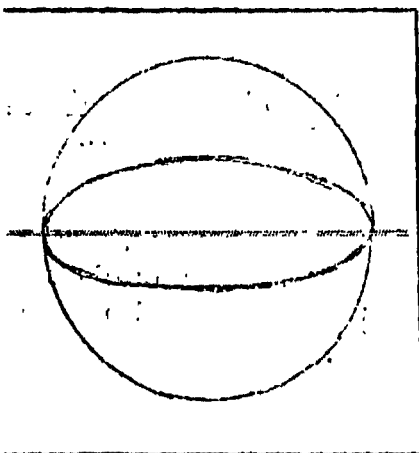

Fig. 3

Open the window a little wider and now it looks as if it never could fill the frame!

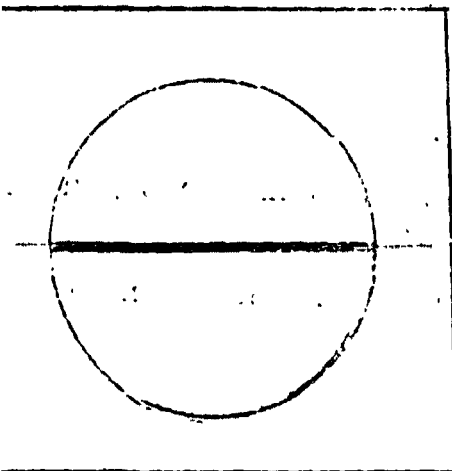

Fig. 4

Now open it as wide as it will go and hold the card so that the open window is exactly level with your eyes. Now this surprising window appears as a straight line!

Do you understand that the term "eye-level" means that which is exactly on a level with your eyes? If a thing is below eye-level you look down on it. If it is above eye-level you look up to it. Your feet are below eye-level. The crown of your hat is above eye-level.

On a piece of cardboard draw with your compasses a circle with a radius of about  $1\frac{1}{2}$  inches. Cut this out with a sharp pointed pocket-knife. The flat top of a honey carton or a round flat tin lid would do very well instead.

Find a baking-powder, a cocoa, or better still, a treacle tin. Place it on the table so that the top is a little below eye-level that is, you will see part of the top of the lid.

Top

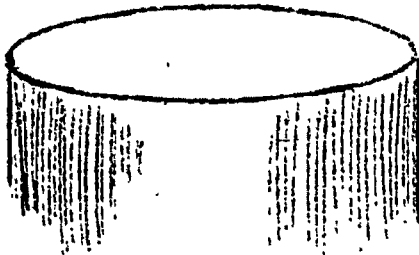

Fig. 5

The top, which is really circular appears as a narrow ellipse. Hold your round piece of cardboard so that you see it the same shape as the top of the tin.

Now, keeping the round card in the same position, lower it until level with the bottom of the tin. Do you see that it appears as a wider ellipse?

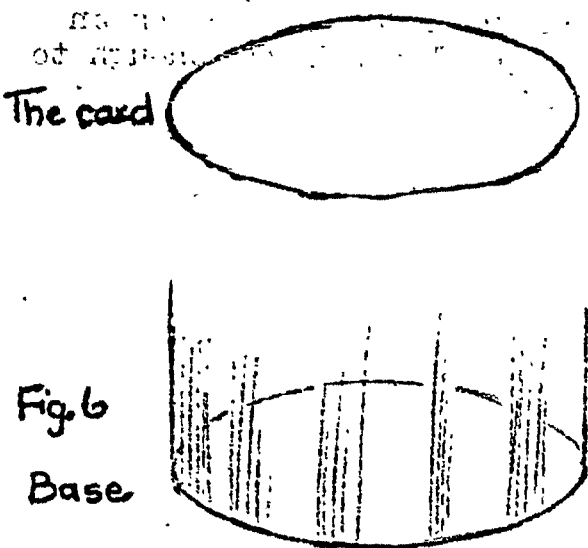

Fig. 6

Base

That is because it is further below the level of your eye. Thus you are looking down on to a larger surface of

If your tin were transparent like glass you would be able to see that the base appeared as a rounder ellipse than the top. But, as you can see only the near side of the base, the point to notice is that it is a deeper curve than the near side of the top.

THESE POINTS ARE VERY IMPORTANT ONES TO NOTICE, SO GO BACK NOW TO THE BEGINNING AND DO NOT CONTINUE UNTIL YOU ARE CERTAIN THAT YOU HAVE GRASPED THEM.

These points are to be noticed in all circular things such as plates and coins, and in such cylindrical things as buckets, drain pipes, jars, tins, round baskets, vases, jugs, cups, bowls etc. Observe as many of these objects as you can.

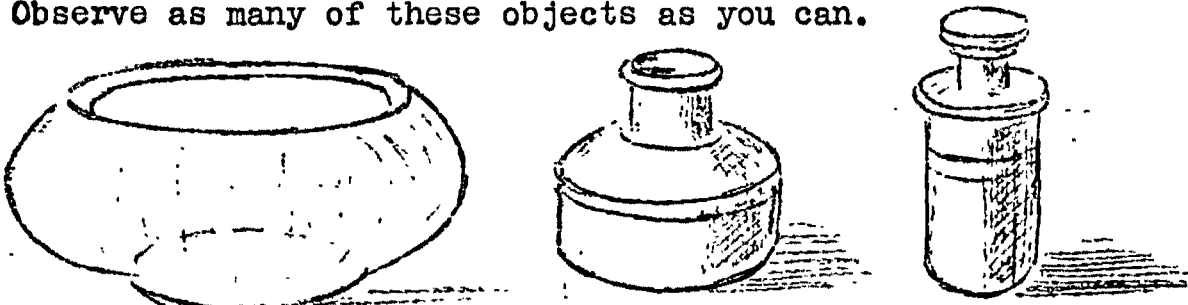

There is an endless variety of objects all about you illustrating these points. Even on my desk at the present moment are four.

Now take your round card and hold it in a horizontal position above the level of your eyes.

Look up to it and it appears thus:-

Fig. 7

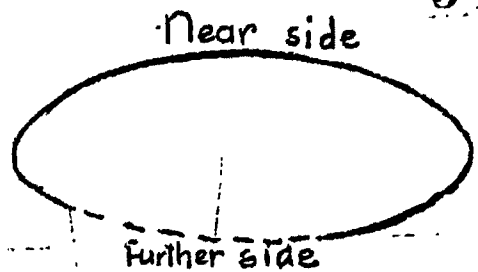

Keeping your card in the same position lower it slowly. Notice that the ellipse narrows as you do so.

Now find a bucket, a billy, or a treacle tin, and hang it on a nail so that the top appears as in figure 7. Of course you will see only the near curve as you cannot see through the tin. Notice that it appears as in Figure 9.

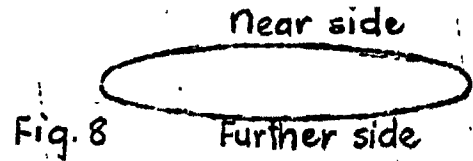

Fig. 8

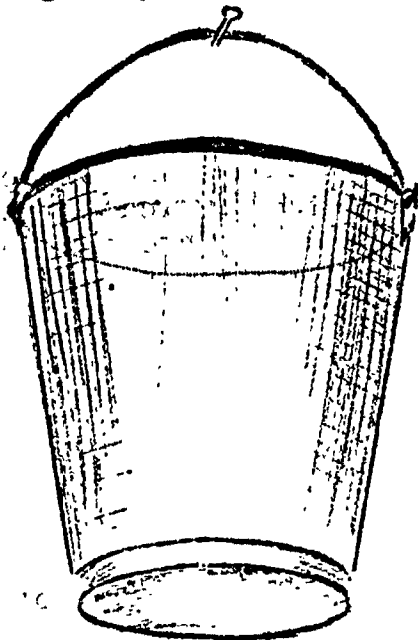
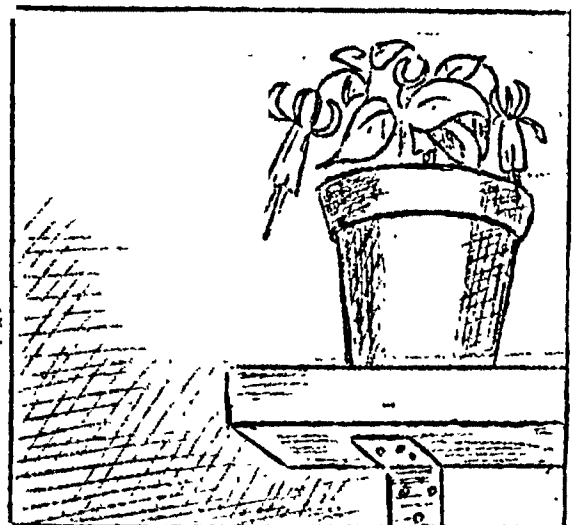
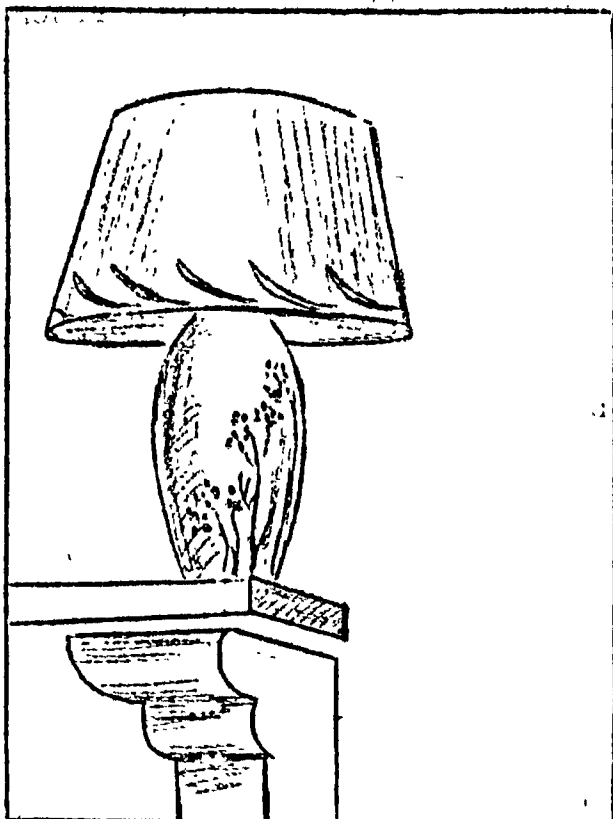

Fig. 9

The dotted line shows where the other side of the top ellipse would be if you could see it. The base will appear as a narrower ellipse as in Figure 8, because you cannot see so far into it.

Generally, when objects such as those mentioned are above eye-level they are standing on shelves and not hanging so you would see only the curve of the top.



In each case the base is hidden by the edge of the shelf.



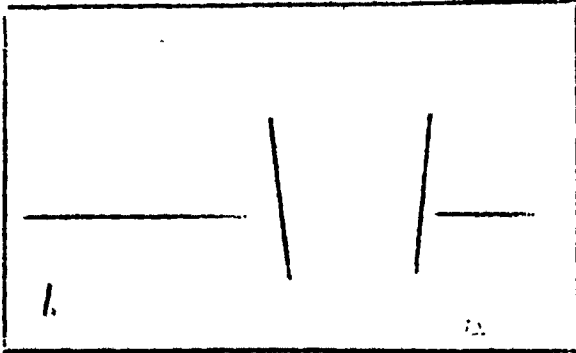

When drawing a cylindrical object such as a jug it is a good plan to first enclose mass of it with side lines. But before doing so you must compare the depth with the width.

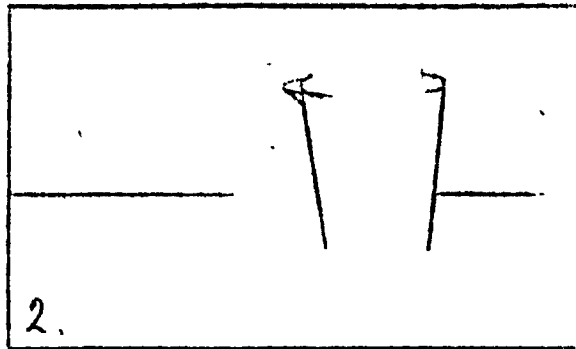

Then draw the curved ends of the top ellipse.

Indicate the spout.

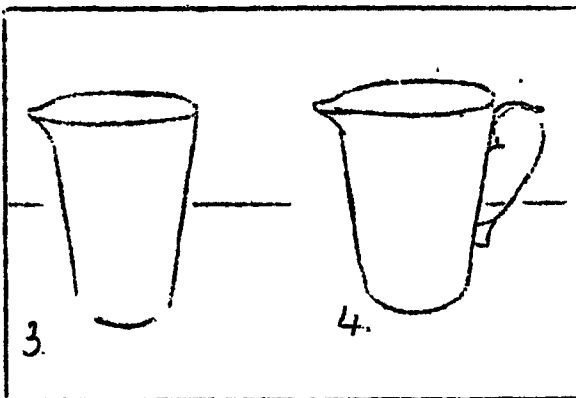

Next feel your way round the ellipse with even sweeps. Then indicate the lowest part of the base curve and join the sides, rounding the corners.

Next mark where the handle comes. Notice how the width of the handle space compares with the length of the handle.

If the proportions are not pleasing the jug will be clumsy in appearance. Notice the turn of the handle.

DRAW ALL THE BLOCKING LINES VERY FAINTLY.

Note carefully the light and shade in your jug. If your jug is white place a sheet of white paper behind it and in comparison your jug will appear quite grey in places.

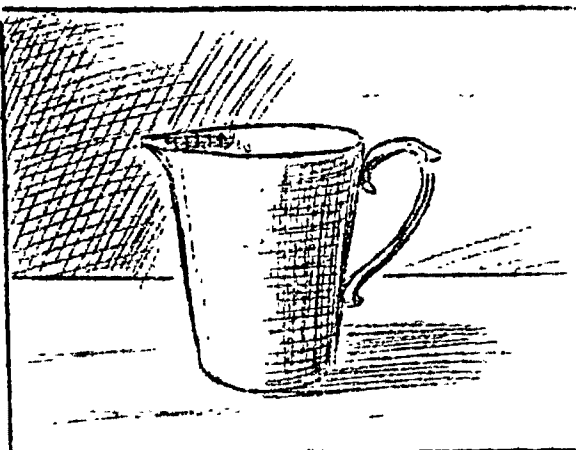

Note where the shadow falls inside the jug.

Direction of light ↓



It is best to lay on the shading with up and down strokes. Where the shading needs to be darker cross hatch, that is, place lines across at an angle. The lines are spread far apart to show clearly how they lie.

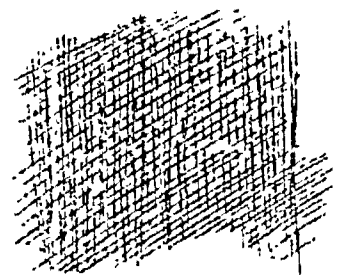

GROUPING.

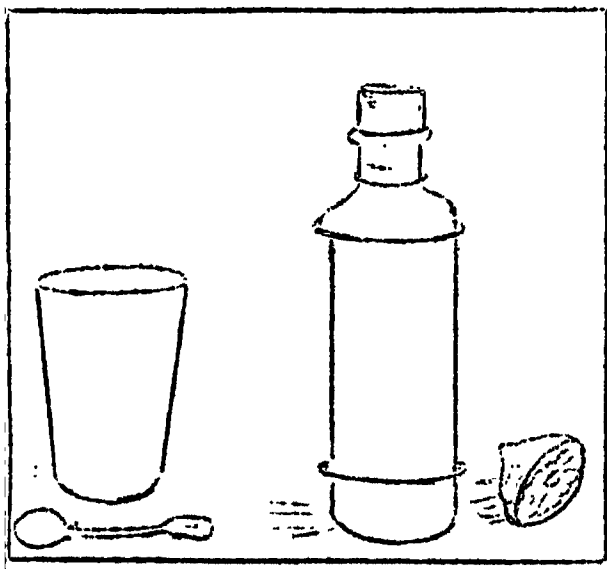

In 2 Note how the overlapping of the thermos and tumbler add to the interest of the group. The indication of a background also makes the drawing more effective.

WORK TO BE SENT IN.

1. Your card with the circular window.
2. Show the four stages necessary in making a drawing of a cup in outline and number them 1, 2, 3, 4.
3. A careful outline drawing of a bucket or tall jar on a shelf, or your tank if it is a cylindrical one.
4. Arrange in a group on a piece of brown paper a cup, a jug, and a vinegar bottle. Try to have the light from a window shining on one side of your group.

Draw and shade carefully with pencil. Put your best work into this.

---

Note: The work of this set will be more or less revision for those of you who have already done the First Year Course, but you will be able to put better work into the exercises now.

---

"The verie essence, and, as it were, springheade and origine of all musicke is the verie pleasaunte sounde which the Trees of the forest do make when they growe."

Trees

In landscape sketching, the study of trees is one of the most important features, and one of the most interesting, too. So we shall begin with the trees and deal with the rest of the landscape later.

Every kind of tree has a distinctive character and to draw trees so that they shall be like trees we must study them from nature. There is always some special characteristic that may be portrayed by pencil or brush so that the first glance enables one to say, "that is a karaka, that is a ngaio, this one is a pine", and so on.

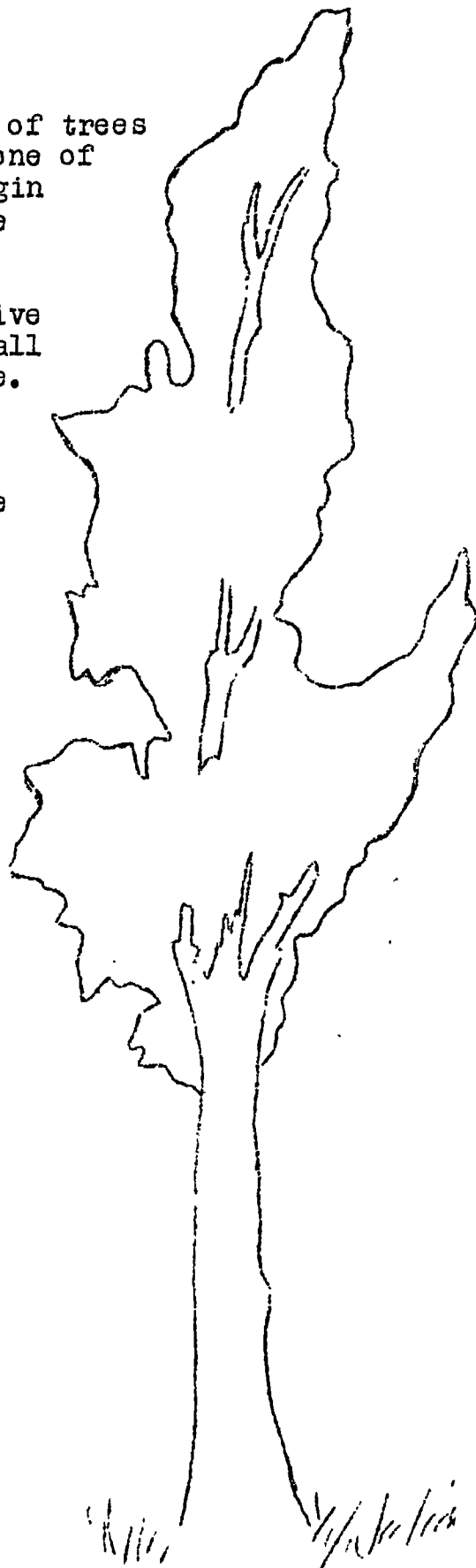

In these two trees notice that in both cases the foliage points upwards, but the visible part of the trunk of one is tall, and of the other short and stumpy. To anyone who knows trees, could the first be anything but a pine, and the other anything but a native honeysuckle? Even in mere outline they are instantly recognisable.



In these trees also the foliage points upwards but they are neither pines nor honeysuckles but obviously poplars - each upward pointing branch of foliage looking almost like a tree itself.

PROPORTIONS.

In observing trees for sketching notice first the general trend of the trunk and main branches. Sketch these in first. You will be surprised to find how few trees stand bolt upright! Watch the proportion of width and height. One way to make sure that you have this correct is to fix the height of your tree and then mark off the height of the visible part of the trunk and the width of the foliage mass at its widest part.



SHADING.

Having decided on the proportions the next thing is to look at the tree with half closed eyes and try to see it as MASSES of LIGHT and DARK. Having decided upon the proportions of your tree lay in your general plan of lumps of dark and lumps of light.

Make each broad mass of shadow throw into prominence a broad mass of light. If your tree is recognisable when you have drawn it in this way you may, if you wish, add a little detail in the light parts by putting in a few paler shadows. But if your tree is not easily recognisable it must lack character so try again.

NEAR BRANCHES.

In sketching trees you will notice that many of the branches are stretching out towards you. These branches with their masses of foliage will appear foreshortened. To draw them as they appear, you need to notice the SHADOWS UNDERNEATH the masses of foliage.



Notice how the dark shadows throw the light part of the foliage into prominence.

NEAR SHADOWS.

Make the shadows that are nearest to you darker in tone than the others, and this will give your tree a rounded appearance making the outer edges of the tree seem further away than the nearer masses.

PEEP HOLES IN THE FOLIAGE.

Whenever you can see little lights or peep holes through the foliage, especially where branches are silhouetted, leave them in your sketch as they add to the "real" appearance of your tree. As one artist expressed it "You want your tree to look as though a bird could fly through it and not as solid as a plum pudding on a pole!" So remember - show the PEEP HOLES.



In this old ngaio, just holding its own on the edge of a tiny stream, notice how some of the branches are silhouetted against the sky. Even a breeze could pass through the foliage.

TRUNKS.

Study the trunks as well as the foliage.

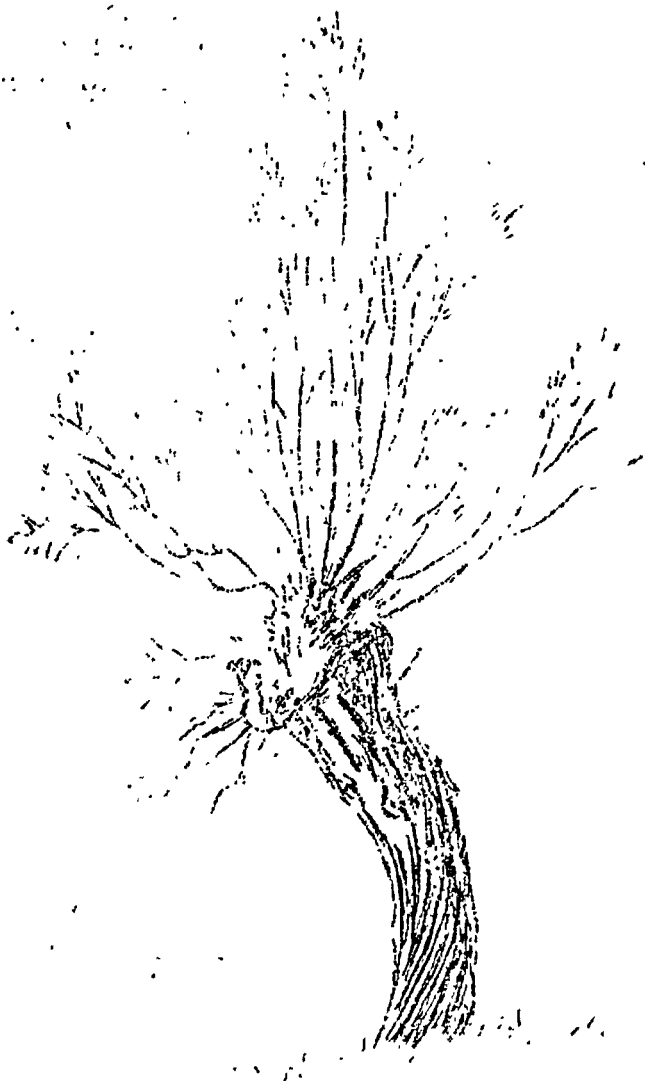

In an old pollard willow the trunk can be sketched in firmly with a series of curved strokes that follow the bend of its weather worn bark, while the long thin leaves and delicate branches should be sketched lightly.



The trunks of the silverbirch and pine tree have very noticeable characteristics. One is smooth and white with dark markings across and the other is scaly and dark with markings up and down.

#### BRANCHES.

Notice the way in which the various trees branch. In the pine tree, above, the branches hang slightly downwards.



In the oak they are somewhat angular.

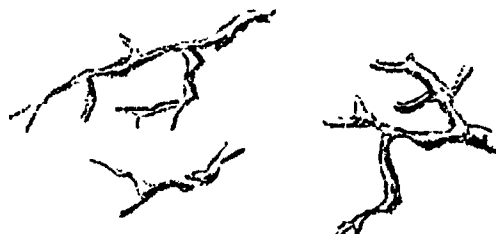

Our native trees have their own characteristic ways of branching and are worth studying.

#### MEDIUMS FOR SKETCHING TREES.

- (1) CHARCOAL. For rapid sketching you would find a stick of charcoal most useful. This may be bought at a shop that deals in artist's requirements, or may be made by charring a thin stick of wood in the oven until it is black right through. Use it as you would use a pencil. Be careful to cover each charcoal sketch with a piece of paper when finished because it smudges badly. If you wish to preserve a charcoal drawing it may be "fixed" by blowing on to it with a diffuser a mixture of

white shellac and methylated spirits which forms a kind of varnish.

- (2) **PENCIL.** Use a hard pencil, H.B., for outlining the light masses and delicate branches, and a dark pencil, 3 B or 4 B, for filling in the heavier shadows. A 2 B or 3 B may be used for the trunk. Be careful when using a 4 B pencil as it is apt to smudge.
- (3) **WATER COLOUR.** Use very light green for the light masses and dark green for the shadows. For the light green mix blue and yellow with water. For the dark green mix a larger quantity of blue with a smaller quantity of yellow and add a little red. Brown may be used for the trunk and branches with darker brown for the parts in shadow. Or you may use grey which is made by mixing blue, red and yellow together. Use more water for a paler grey. When colouring in the foliage, put a wash of the lightest green over the whole foliage mass, remembering to leave the peep holes. When the wash is dry put in the shadows.
- (4) **INDIAN INK.** At this stage it will be best to use a very fine nib for outlining the light parts and to fill in the shadows with solid ink so that you will produce a "black and white" drawing. Later we shall go more fully into the possibilities of Indian ink. Meantime, if you have not already purchased a bottle it will be advisable to do so as soon as possible.

**NOTE:** Whenever you sketch a whole tree indicate in some way that it is growing in the ground and not floating about in mid air. A few strokes for grass are often sufficient to indicate the ground. The sketch will be more interesting if you also suggest a background. Do this very lightly so that the tree will still be the centre of interest. Always show the shadow cast on the ground if there is one.

WORK TO BE SENT IN.

- (1) A sketch of a tree in pencil showing just the masses of light and shade.
- (2) A sketch of a tree in water colour using only two shades of green and two shades of brown or grey.
- (3) A pencil sketch of a branch of your favourite tree.
- (4) A tail piece (that is an illustrated ending) for a poem or story about trees. Make this a silhouette in Indian ink, or fill in with a dark pencil if you have no ink.

See how nicely you can set out your sketches and draw actual trees growing near your home.

Some very interesting work would come in with this set.

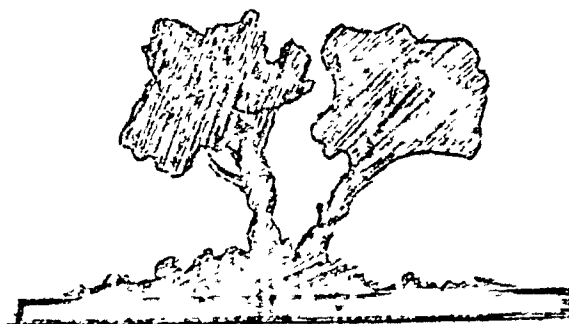



DRAWING



This assignment will deal chiefly with the study of glass-ware and pottery.

In the above drawing of objects, merely the outline is given and there is nothing to indicate whether the objects consist of china, glass or pottery.

From your previous study you have learned that it is the TEXTURE that makes one SURFACE appear different from another. Texture may be smooth or rough, dull or glossy, coarse or fine.

A careful study of the SHAPES of the LIGHTS and SHADOWS on a surface will help you to show the texture of the thing you are drawing.

If YOU HALF CLOSE YOUR EYES when looking for shapes of lights and shadows, the division between light and dark will be more noticeable.

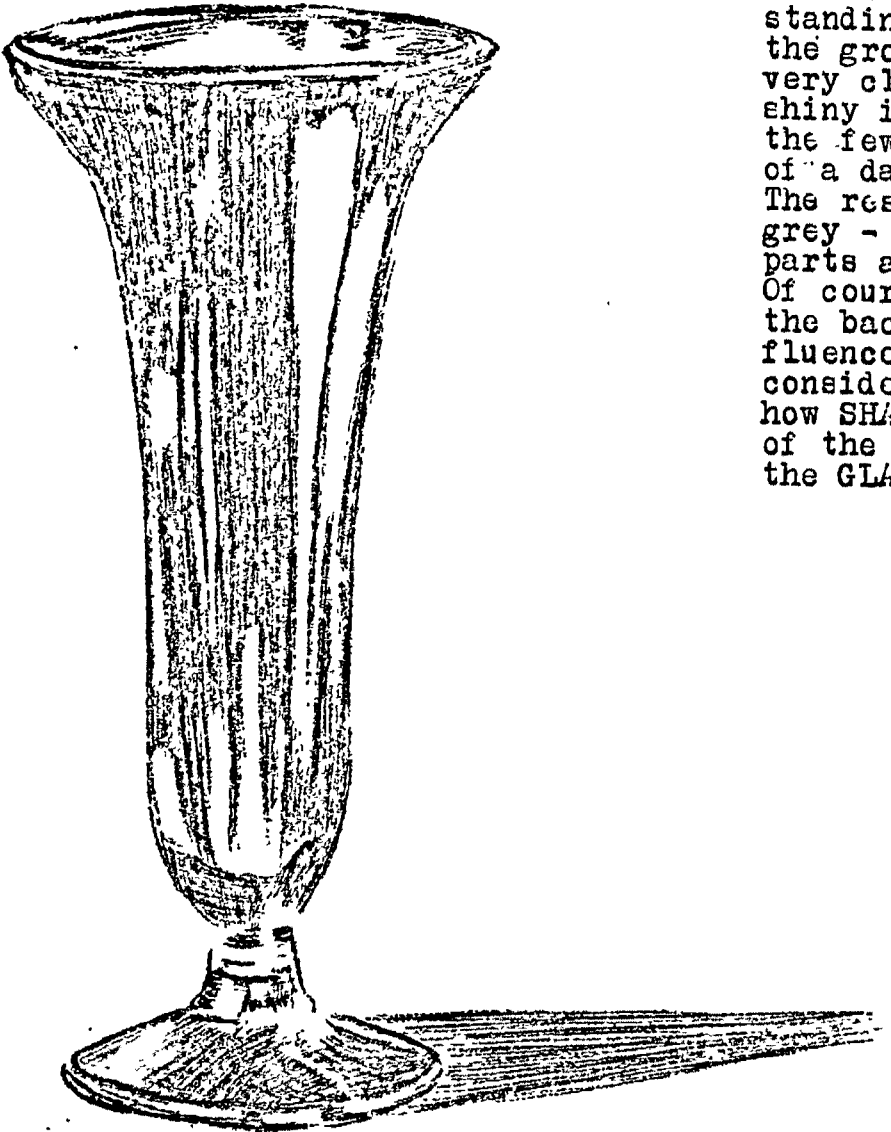

Take this crystal vase standing at the back in the group. It is made of very clear glass yet so shiny is the surface that the few light parts are of a dazzling whiteness. The rest of the vase appears grey - light grey in some parts and dark in others. Of course the colour of the background would influence the appearance considerably. Notice how SHARP are the EDGES of the white LIGHTS in the GLASS.

With the method used in making this illustration it is not possible to show the gradations in shading but find a glass vase and examine it yourself.

In painting a picture of this vase the first step would be to draw a very faint outline in pencil, watching the proportion of length to width. The next step would be to mix a wash for the palest grey colour. When this wash is put on, the edges of the light spots should be left quite clean-cut and the white paper should show through for the lights.

Then a rather darker grey should be mixed and when the first wash is dry graduated washes of this darker grey should be put on where necessary. A few touches of still darker grey may be needed. When you wish to lighten part of a wash do so before the wash is dry, with a clean wet brush squeezed dry between the fingers.

Find a clear glass vase or bottle and place where the light from a window shines on it. Make a study of it with washes of grey paint. As you know, grey colour may be made by mixing blue, red, and yellow with a little water.

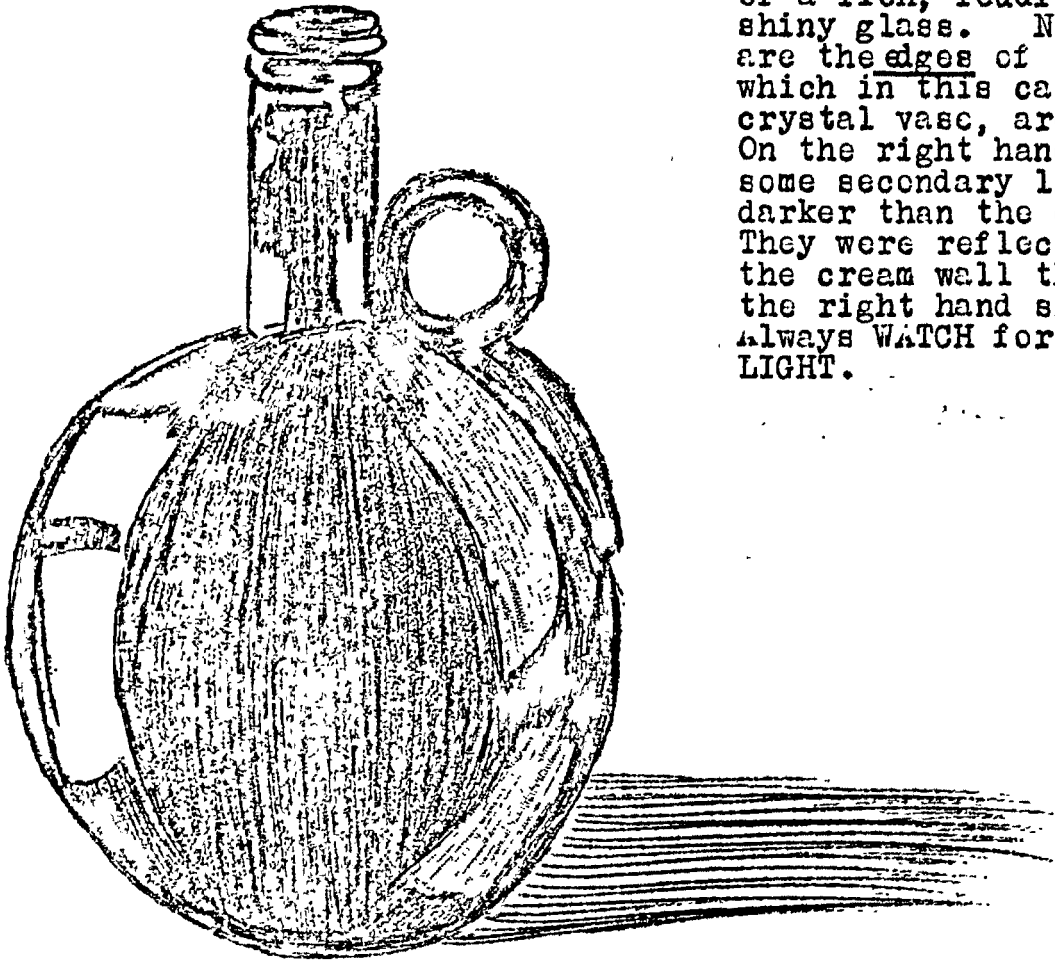

This is a Chinese bottle of a rich, reddish-brown, very shiny glass. Note how sharp are the edges of the lights which in this case, as in the crystal vase, are quite white. On the right hand side are some secondary lights much darker than the others. They were reflected from the cream wall that was on the right hand side. Always WATCH for REFLECTED LIGHT.

To paint a picture of this bottle first make a careful faint pencil outline. Then mix some pale brown colour and put a wash of this over the drawing leaving the white paper showing through for the lights on the left hand side. Make the edges of the lights very sharp. Next put a graduated wash of dark reddish brown leaving the pale wash showing with softened edges for the reflected lights on the right hand side of the bottle.

TO SOFTEN THE EDGES of the reflected lights USE A DAMP CLEAN BRUSH AND GO ROUND THE EDGES WHILE THE WASH IS STILL WET.

Find a coloured bottle, an ordinary green one would do, and make a colour study of it.

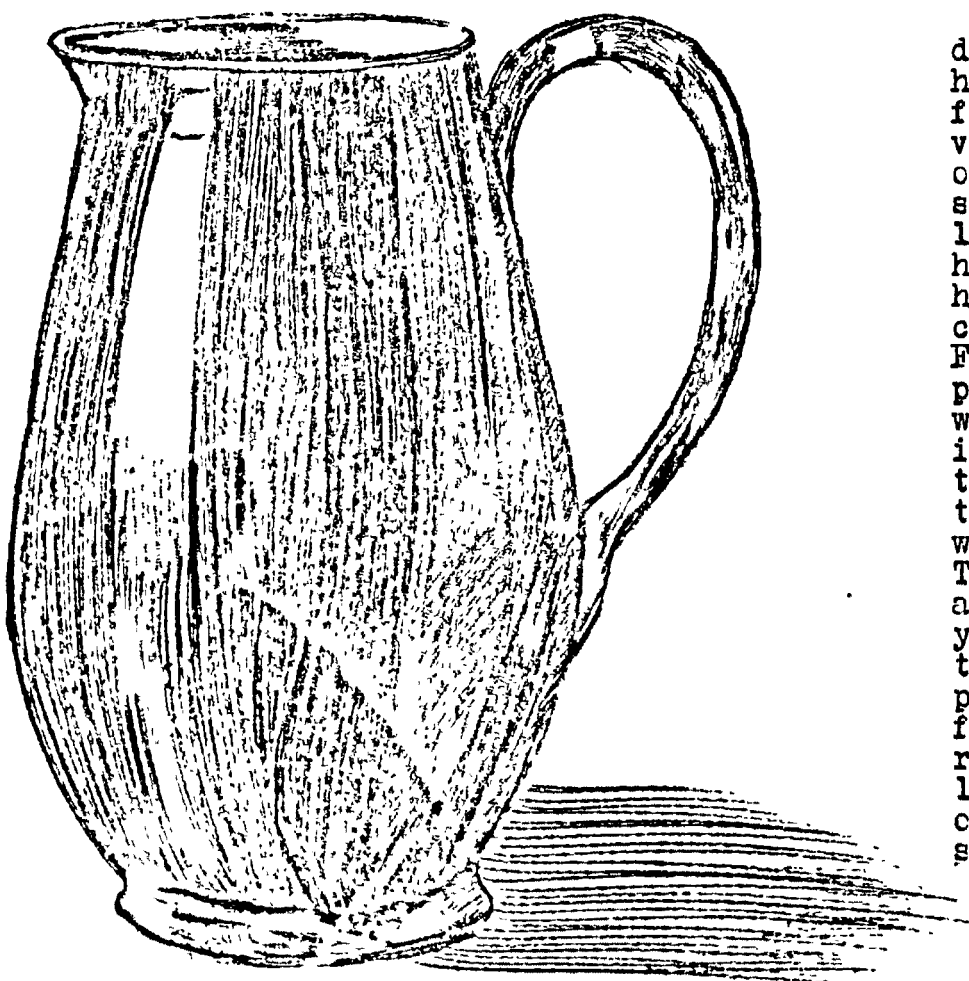

This jug is a dull yellow with a highly glazed surface. There are very decided lights on the left hand side and reflected lights on the right-hand side. The handle is a dark brown colour. First of all put a pale dull yellow wash over the drawing of the jug and take out lights on the left hand side with a clean brush. Then put on a graduated wash of greyish yellow (rather dark), this time leaving the pale wash for the reflected lights on the right hand side and leaving the lights on the left hand side untouched.

The handle is dark brown in colour lighter in some places than in others. For the handle, first cover it with a pale brown wash. When this is dry put on a graduated wash of dark brown leaving the pale wash showing for the lighter parts.

You will probably be able to find a jug with a glazed surface to make a colour study of.



Here is a pale yellow pottery vase with a dull surface which does not catch much light. The lights are not clear cut as in the glass bottle but merge gradually into the darker colour.

In painting a picture of this vase the first step would be to draw a faint pencil outline. Then cover with a flat wash of pale cream. When this is dry, put on a graduated wash of dull yellow leaving the cream colour showing for the lightest spots and softening the edges of the lights with a clean brush. Allow to dry, and then put on a graduated wash of darker greyish yellow leaving the lights showing cream, and leaving also the dull yellow wash showing for the reflected lights on the right hand side. A still darker greyish yellow graduated wash should be added for the darker parts of the handles.

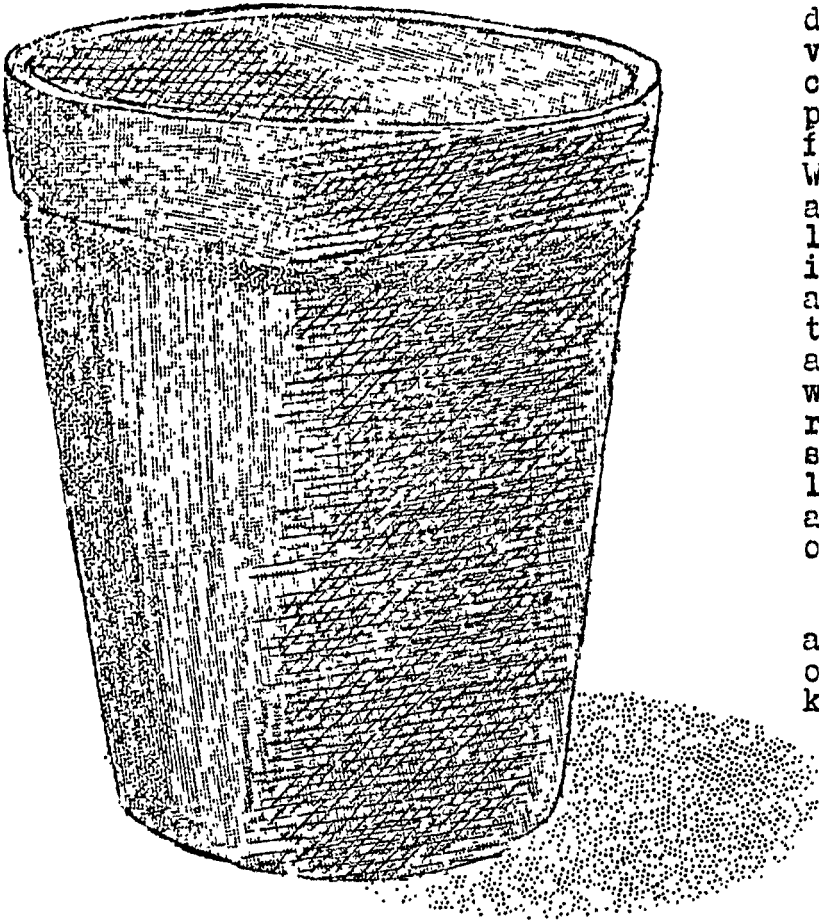

A flower-pot has a very dull surface which catches very little light. To colour a drawing of a flower-pot, first cover it with a flat wash of dull pale red. When that dries, put on a graduated wash of darker greyish red, leaving the first wash showing for the lighter parts and softening the edges of the lights. Allow to dry and then put on a graduated wash of still darker greyish red leaving the second wash showing for the reflected light on the right hand side, and also softening the edges of the lights.

You will probably be able to find a flower-pot, or unglazed crock of some kind to make a study of.

NOTE.- EACH OF THE OBJECTS MENTIONED ABOVE WOULD CAST A SHADOW. THIS SHOULD BE PAINTED IN WITH A PALE GREYISH FLAT WASH WHEN THE FIRST WASH HAS BEEN PUT ON. It may be darkened with further washes later.

STUDIES TO SEND IN:-

1. A painting of a clear glass vase or bottle. Indicate in colour the surface upon which it is standing, and remember to show the CAST SHADOW.
2. A colour study of a vase or jar which has a dull surface. Colour the background with a flat wash and colour the ground also, remembering the cast shadow.

Try to use for the ground and background, colours that harmonise with the colour of the object.

NOTE.- If you have time to do any other colour studies this fortnight I shall be interested to see them.

---

This Assignment is the property of the Education Department. It is to be regarded as confidential, and is to be returned to the Department when asked for.

THIRD YEAR. VF.36

SET 8.

DRAWING.

Secondary Division.

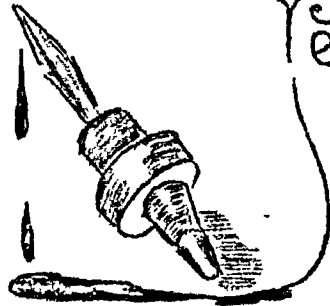



Pen and Ink  
Drawing



For this work you require black Indian ink, fairly fine nibs and paper with a smooth surface. Whatman's "Hot-pressed" paper and Bristol board (a specially prepared card) are most satisfactory to use, but a good quality drawing paper will suffice at present.

In black and white work there are various methods of giving the effect of light and shade. Here are several:-

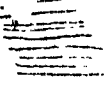
Pale tones

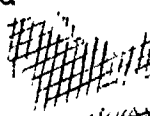
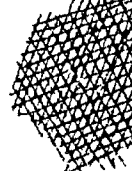
Dark tones

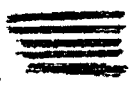
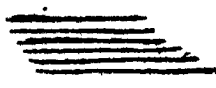
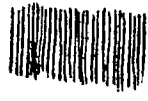
- 1) Thin lines 
- 2) Light pressure 
- 3) Open spaced lines 
- 4) Thin lines crossed 
- 5) Thin lines crossed and recrossed 

- Broad lines 
- Heavy pressure 
- Closely packed lines 
- Heavy lines crossed 
- Heavy lines crossed and recrossed 

GENERALLY, THE DARKER or THICKER THE LINES ARE, THE CLOSER THEY SHOULD BE TOGETHER.



The dark parts may be put in with solid black and the white paper left for the light parts. This is an effective method because of the distinct contrast between black and white; however, much practice is needed before it can be used successfully, because the shape of the shadows must be drawn accurately.



The shading may be done with short broken lines.

The dark parts may be put in with thin parallel lines but this is rather a stiff method of shading.



ON NO ACCOUNT SHOULD THE LINES BE RULED. They should be drawn as parallel as possible by hand. Often, the more rapidly the lines are drawn, the better the result. The hand then seems to maintain its position of regular slope, and the strokes are completed before the hand loses its position.

Here is one method of shading a flat surface.

Draw a series of lines thin or thick, dark or pale, fairly close together and at the natural angle. Draw them as parallel as possible, as long as you comfortably can, and take care to make them end irregularly as in A.

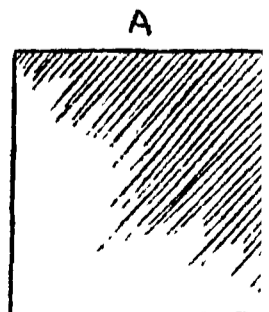

Then add another series as in B, making the strokes nearly or just touch the ends of those in the first series.

Lines may also be drawn vertically and horizontally by this method.

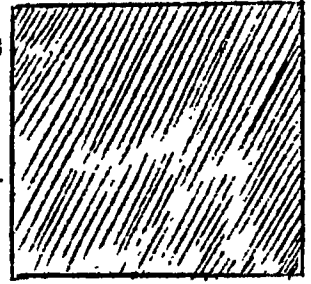

Shade lines are used

- (1) to represent surface character
- (2) to represent shadow pure and simple
- (3) to accentuate the form of the object.

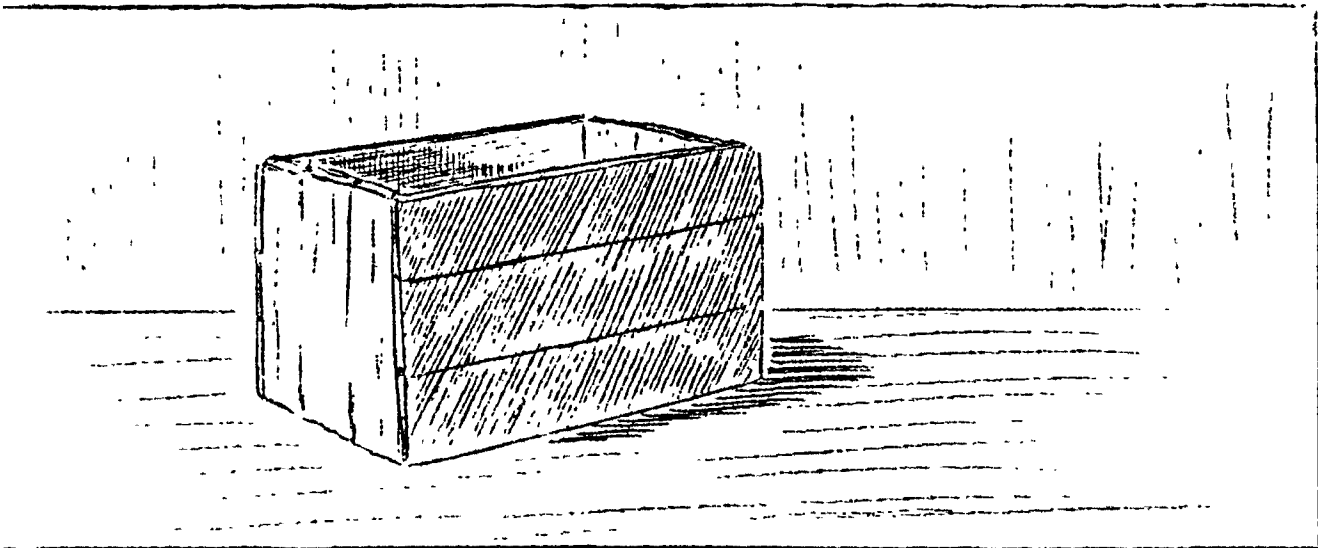

- (1) It is a good plan to let the shade lines express as far as possible the direction of the surface they are upon. In the above sketch of a wooden box it is obvious that the HORIZONTAL lines on the ground suggest the FLATNESS of that surface.

The UPRIGHT lines at the back suggest the UPRIGHT surface of the wall.

- (2) Two cast shadows are shown. The one on the ground is represented by horizontal lines because it lies on a horizontal surface and thus it shows both surface and shadow. The lines are close together and rather heavily drawn to give a deeper tone.

The shadow inside the box is represented by two sets of lines, one running parallel with the top edge of the box (for SHADOW) and the other vertical (for SURFACE) because the back inside surface of the box on which the shadow falls is vertical.

The lines on the ends of the box suggest woodiness.

Note.- The parallel shading on the near surface of the box gives the effect of a dark surface.



(3). To accentuate the form of an object make the shading lines parallel with the edges of the object.

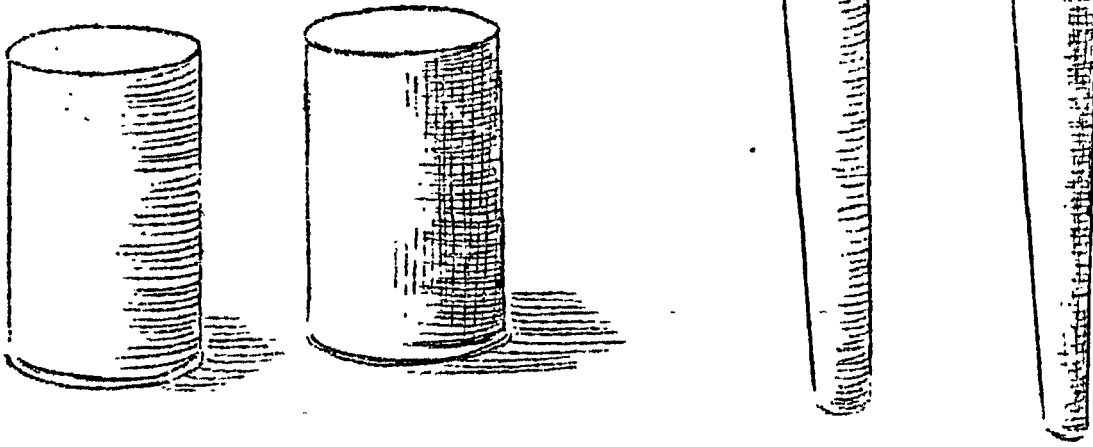

If the surface is rounded, e.g., a tin or a table leg, have curved lines to suggest the rounded nature and a few upright lines to maintain the feeling of uprightness.

This applies to stems of plants, tree trunks, rounded posts, funnels etc.

Note how the shadow inside the tin is drawn. First the lines are drawn parallel with the curve of the top.



To increase the depth of the shadow these lines are crossed with vertical lines.

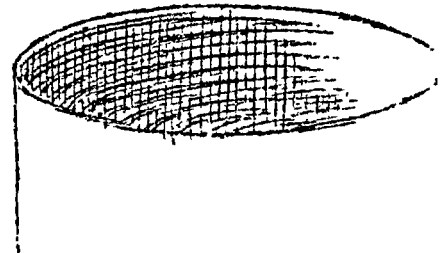

The shading in drawings of cylindrical objects may also be done with two sets of short curved lines crossing at a slightly different angle, but both almost at the "natural angle", that is, the slope at which writing is done.

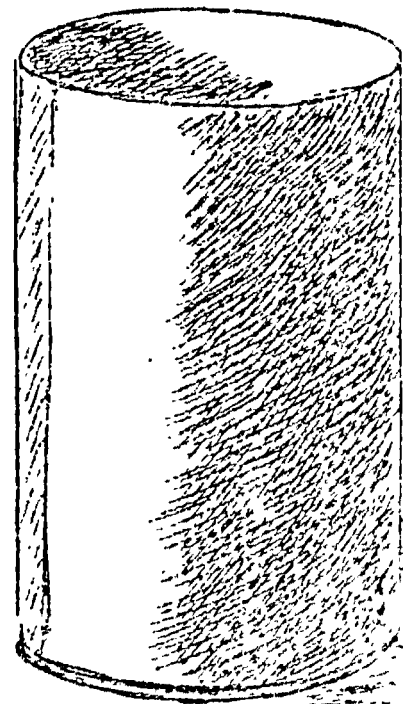

Shading may also be done with dots. This is called STIPPLE.

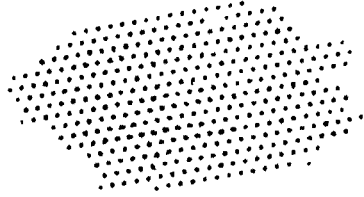

An EVEN TONE may be obtained by placing small dots evenly spaced. For a light tone do not press heavily on your pen. This method is useful in design work for filling in spaces, backgrounds, etc.



A DARKER TONE may be obtained by making larger dots, pressing heavily on the pen and trying to keep the dots nearly round.

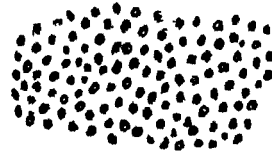

An UNEVEN TONE may be obtained by making large dots in the darker portions and small dots in the lighter parts, OR by making all the dots of uniform size but closer together for the darker parts. The dots may even touch in places.



Another method of shading is by shaded lines. More pressure is applied to the pen in the centre of the line than at the ends. Practice is necessary to perfect this method but it is very useful for representing surfaces such as silk and leather that have soft folds.



Practise the various methods of shading and use, in your drawings, whichever seem most natural to you.

NOTE: Do not use blotting paper on your Indian ink work. It is not necessary as the ink dries very quickly.

(3) To accentuate the form of an object make the shading lines parallel with the edges of the object.

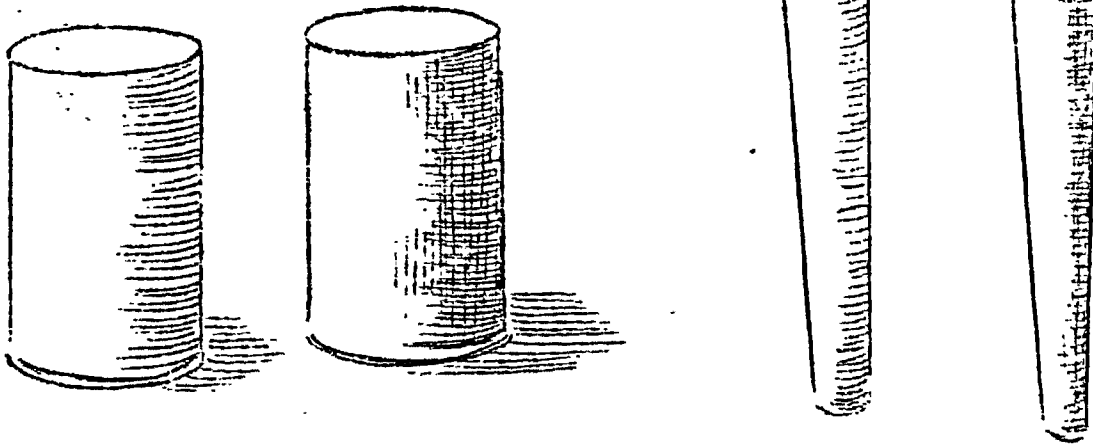

If the surface is rounded, e.g., a tin or a table leg, have curved lines to suggest the rounded nature and a few upright lines to maintain the feeling of uprightness.

This applies to stems of plants, tree trunks, rounded posts, funnels, etc.

Note how the shadow inside the tin is drawn. First the lines are drawn parallel with the curve of the top.



To increase the depth of the shadow these lines are crossed with vertical lines.

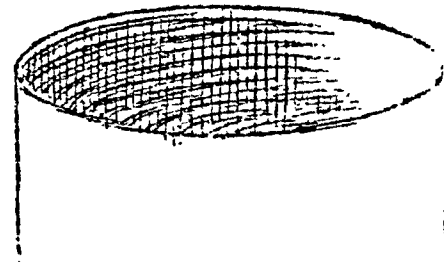

The shading in drawings of cylindrical objects may also be done with two sets of short curved lines crossing at a slightly different angle, but both almost at the "natural angle", that is, the slope at which writing is done.

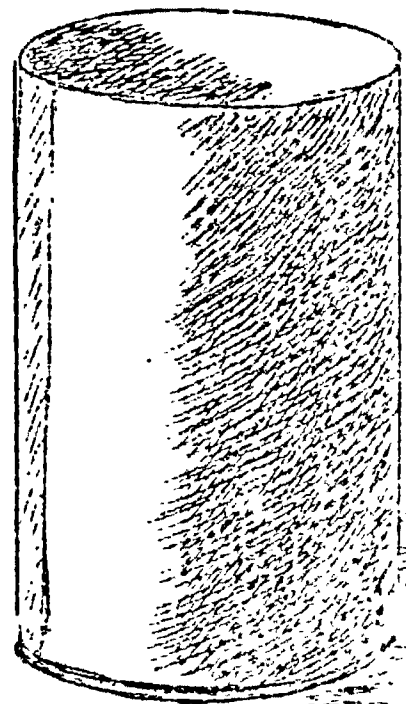

WORK TO SEND IN.

- (1) An ink drawing of a jar or cup shaded with stipple. Show the cast shadow, too. This would be drawn with dots very close together, even touching in places.

For the outline have dotted lines instead of the usual single line.

- (2) Ink drawings of three different twigs. Show buds and study carefully the characteristics of each twig.
- (3) An original illustration in ink for the following poem, or for a poem of your own choice. Print in pencil beneath your picture the lines which you have illustrated.
- (4) A pencil sketch of something from memory.

SHEEP HERDER.

A herder gray,  
Tends his surging band  
Upon a wide blue land,  
Where peace holds sway.

The placid mountains  
Guard his sunlit days,  
While through the silver sage  
The wild wind plays.

And glowing stars give forth  
A friendlier light  
As sheep and herder  
Rest at night.

Jessie Linkletter.

---

Note: Some of the drawing paper supplied by the Correspondence School is not suitable for pen and ink work, as the ink runs on the surface. Test your paper before beginning an ink study.

---

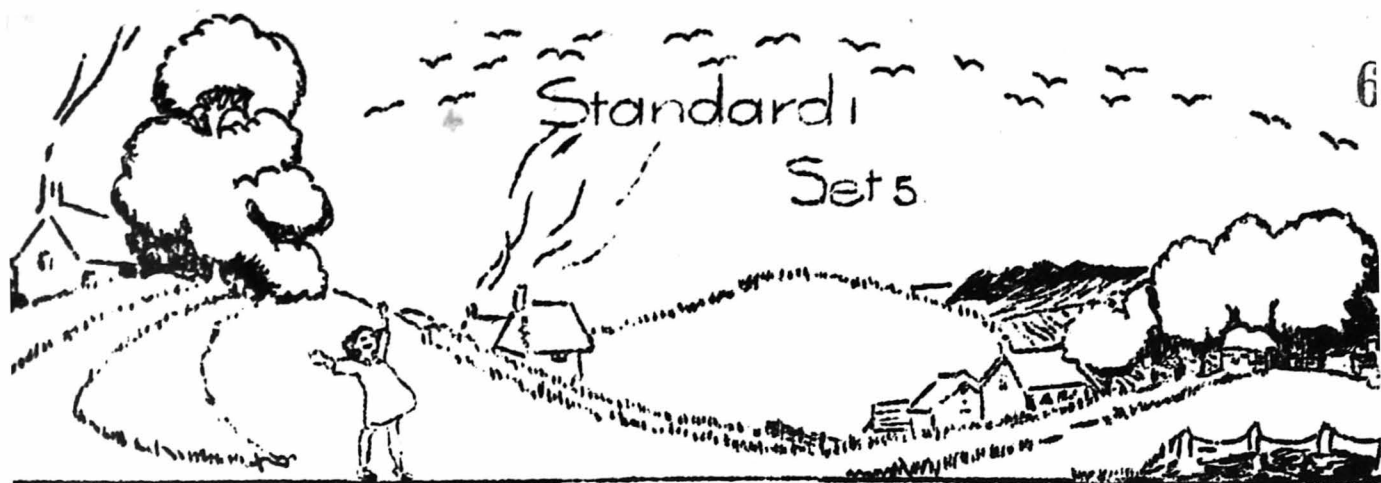

Lesson 1

## The Godwits



What are you doing all flocked on Reingor?  
 What is your hurry—the trees are all gold?  
 Sweeting we gather because we must leave you.  
 April is cold; April is cold.

Oh! we shall miss you, my little kuaka;  
 Where will you go then my wild little one?  
 Over the sea to the country of Russia,  
 Into the sun; into the sun.

We'll nest on the steppes and put on our red kirtles,  
 Teaching our scared little children to fly.  
 Then we stretch wing for the sea and the summer,  
 Forth in July; forth in July.



Where will you be in the windy September?  
 Little kuaka, where will you be?  
 In China the land of the iris and poppy?  
 On a white tree; on a white tree.

Will you forget us, or will you remember?  
 I shall remember wherever I roam.  
 Look for me sweet on the first of December.  
 I shall come home; I shall come home.

Eileen Duggan

Here is a dear little poem for you to learn. If you live near the coast you may have seen the godwits. They stalk about the beaches and cockle banks digging for shell-fish with their long bills.

They are now leaving our shores to fly a thousand miles over the wide ocean. In a little story tell your teachers how you learnt this poem, and what it is about. Make your page pretty by decorating it with godwits cut from black or grey paper, and by drawings of irises and poppies. What pretty pages and lovely stories you will send, Little Friends.

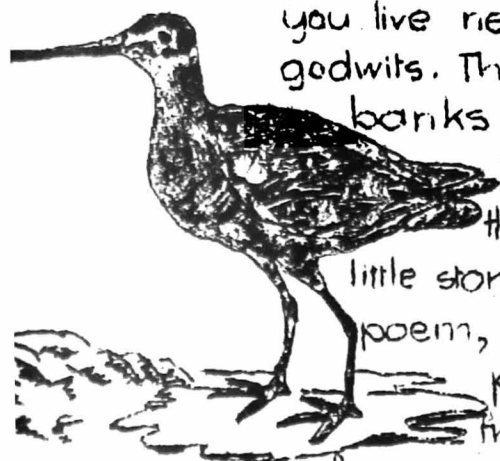

Lesson 2. Reading. The Robin's Worm (February Journal).

looking-glass	itself	real	fright
seemed	window	peck	flew

Cut these words out; say each after Mother and then find them in the reading lesson. When you can recognise each quickly as Mother holds it up begin your reading. Read the story once carefully. Then close your Journal and say it through to Mother in the words of the book as well as you can remember.

On your page print a sentence to tell your teacher how you did the work.

SPEECH TRAINING.

We must try to say our words nicely and clearly, Little Ones. Every day practise the ah sound, opening your mouth well and allowing the jaw to drop. Say this little verse:-

Tra la la, la la la," she sang  
In the laughing weather.

Tell me how you said it and if Mother was pleased.

---

Lesson 3. Spelling.

1. Learn the words on page 23 of de Berry's Spelling Book.
  2. Look at these words: snap, snapped.  
Tell Mother how many p's in snap, and how many there are in snapped. Do the same with lap, strap, nap.
  3. Now ask Mother to dictate twelve words from your spelling. Print these neatly on your page to send in.
- 

Lesson 4.

In the February Journal there is a funny little story called Little Red Hen and Fox. Suppose you pretend to be Little Red Hen and get Mummy or Daddy to be Fox. Have a game doing what they did and in a little story tell me all about the fun you had. Or you may take a story from the April Journal instead.

---

Lesson 5. Mary Lane.

1. Print your name. Notice how each name begins.
  2. Print the name of a little friend.
  3. Print the name of a pet dog, and the name of a cat.
  4. Learn and then print from memory:-  
The name of any person or animal must begin with a capital letter.
- 

Lesson 6.

From the words in brackets choose the right word and print out the sentence in full.

1. One day a ..... flew into a room (frog, robin, emu).
  2. On this table stood a ..... (man, horse, looking-glass).
  3. The robin had a ..... in its bill (bag, worm, wheel).
- 

Lesson 7.

Print one under the other, the words given below. You will find the words that mean the opposite in "Mushrooms", March Journal.

This is how to do it:-

<u>Word</u>	<u>Opposite</u>
Short	Tall

These are the words:- short, round, light, night, slim, fat.

---

Lessons 8 and 9.

Have you a pet hen? Tell me about it or about feeding the fowls. I know you will send in a lovely story.

---

# APRIL

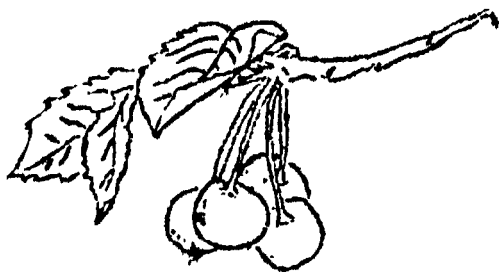

# NATURE STUDY

For your April Nature Study, Little Ones, find a nice juicy apple. Are they now all gathered in or still ripening on the trees?

Cut your apple through the middle and look at it carefully. Do you see the brown egg-shaped pips? These are the seeds. Have you ever wondered why they are hidden away like that?

The apple is formed from the blossom which looks so pretty on the trees in spring. The petals fall off, the pistil in the centre of the flower ripens to form the seed while the calyx or little green part at the back of the petals swells into a tiny apple. Have you seen the small green apple at the beginning of summer? If you tried to eat it you would find it sour and as hard as string for the apple has to have long sunny days to swell and ripen and grow sweet before it is ready. Then it shines and glows with colour and looks so inviting that people and birds simply have to eat it. That, of course, is just what Mother Apple wants. Do you know why? I expect you do when you have looked at the core as we call the ripened pistil. What do you do with this part of the apple? Yes, throw it away and may be it lands in a nice, soft, earthy bed just the place for it to grow. Now you know why Mother Apple puts her seeds in such a delicious wrapper.

Now find some other fruits which have their seeds in a sweet outer layer. I wonder how many you can find to draw and describe on your page?

Set out your nature study neatly on brown pastel paper, making all pages the same size.

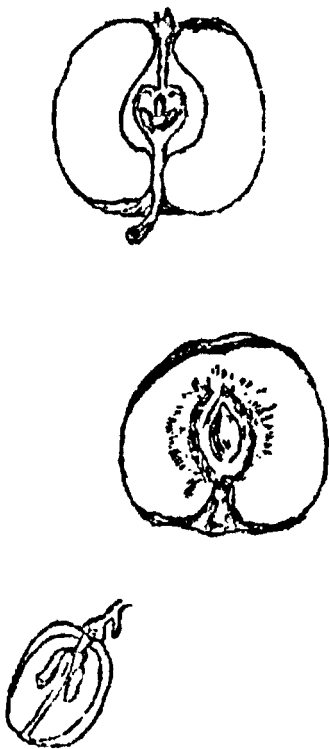
	I cut open an apple ...

DRAWING.

Such splendid drawings of towels came in with your third set that I have been trying to think of something else you use almost as often as you use a towel. I am sure you could not guess what I have thought of so I am going to tell you - a school envelope. Because you handle three blue or green envelopes so often, I am sure you will be able to draw them really well. I will draw a green one which came in by this afternoon's mail.

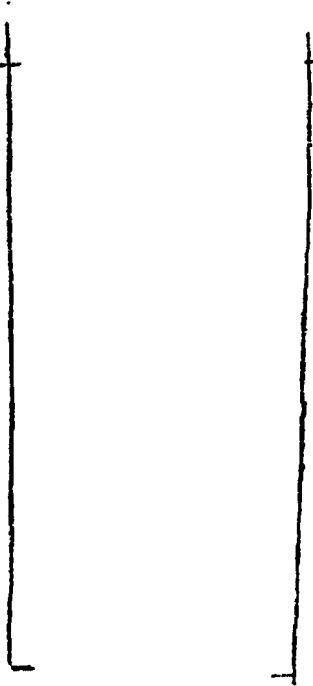

I first look very carefully at my envelope. I notice how very much longer it is than it is wide. I take my green pastel and sketch in the two long sides. If they look the right distance apart for their length I sketch in the two ends numbered 3 and 4 in the diagram. Then I draw the flap which is out, putting in the sketch lines in the order they are numbered. Although I have drawn only seven lines, the shape of the envelope is really there on my paper. I now join up the sketch lines and colour the whole thing in with my dark green pastel.

My drawing is not finished however. I look at the envelope and see that there are the fastenings and the joins of the cardboard to be shown in my drawing. There are certain lines also on the envelope which I must draw. For all these I use my black pastel which I have sharpened so that the lines will not be too thick. The strings hanging loose I show with red pastel.

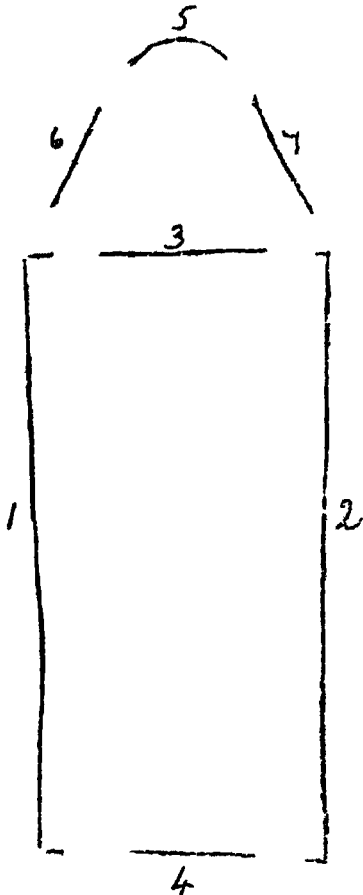

I have drawn the side of the envelope which is address to you as there is not too much on it. Now I would like you to draw a dark blue envelope with that same side up.

If you print your address on it, just as it is on the actual envelope make your printing small and neat.

WORK TO SEND IN:-

1. On a page from your pastel book a fine large pastel drawing of a big blue envelope.
2. A picture to go with lesson 4. Print neatly on the back of your drawing what it is.

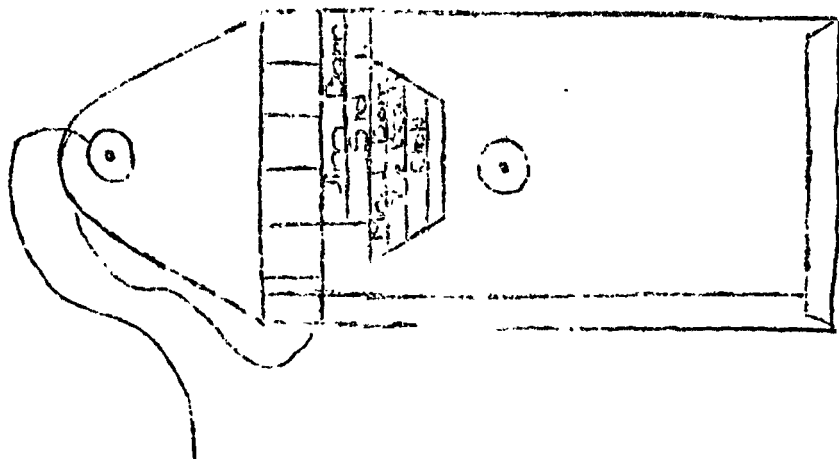



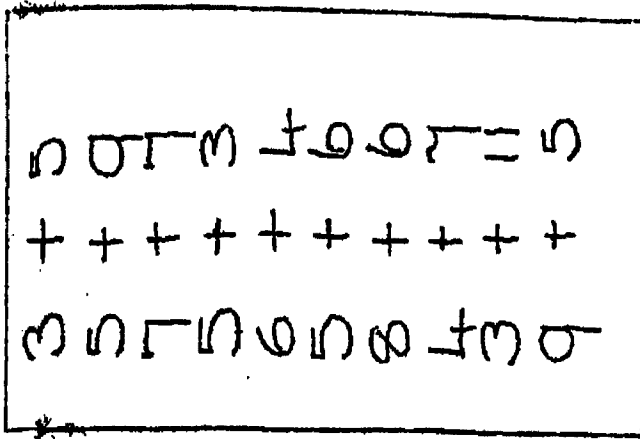

Card 7

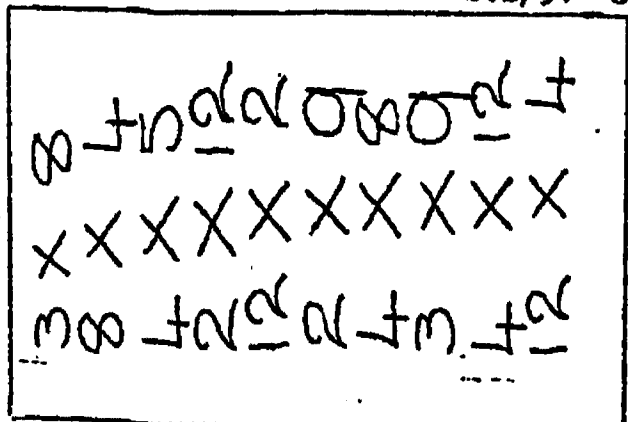

Card 8

Cutout the cards and mount. Do not write answers on card

1st Day: Revise Ex.28. Isn't it easy to add in tens. Try saying this: 3, 13, 23, 33, 43, 53, 63. Now another: 17, 27, 37, 47, 57. Count up in tens for Mother, beginning with 4, 6, 5, 9, and go to 64, 66, 65, 69. Now do this little sum in your head: 35 + 16 (16 is of course 10 + 6). We say 35 + 10 = 45 + 6 = 51.

Do these sums:-

(1) 35 + 10 + 3 =	(2) 46 + 10 + 4 =
(3) 29 + 18 =	(4) 58 + 16 =
(5) 75 + 14 =	(6) 67 + 18 =

2nd Day: Ex.29 and some more like those in the 1st Day's work.

3rd Day: Ex.30 A, B, C.

4th Day: Ex.31 and revise Ex.30.

5th Day: Ex.32 A and B.

6th Day: Here is a little sum: 26 + 53. Put it down this way:  $\begin{array}{r} 26 \\ 53 \\ \hline 79 \end{array}$  T.U. 2 6  
Say 3 + 6 units = 9. Put it in the units. Add the 5 3  
tens and put in the answer as shown. 7 9 Ans.  
Now try these sums putting them down as you have been shown.

(1) 38 + 51 =	(2) 64 + 35 =	(3) 53 + 34 =
(4) 75 + 23 =	(5) 42 + 53 =	

7th Day: Ex.32 C and revise Ex.28 to 32 correcting all your errors.

8th Day: Here is a harder addition sum: T.U. 3  
3 + 9 + 35. Put it down like this:  $\begin{array}{r} 3 \\ 9 \\ 35 \\ \hline 57 \end{array}$  Be sure to put the  
units one under the other as shown. 9  
3, 9 and 5 are units. 3 5  
Now add. The units equal 17 so we 7  
put 7 in the units' place and carry 1  
the one ten. There are 3 tens + 1 = 5. Put 5 in the tens.  
Now do these examples: (1) 9 + 7 + 46 = (2) 5 + 9 + 46 =  
(3) 7 + 39 + 5 = (4) 35 + 3 + 8 =  
(5) 27 + 26 + 9 = and Ex.23.

9th Day: Ex.33. Remember that twenty times 0 = 0. So 20 x 0 + 4 = 4.

10th Day: Work the little test given below, cut out and past on Part B to send in.

- |              |              |             |            |
|--------------|--------------|-------------|------------|
| A.           | B.           | C.          | D.         |
| 1. 16 + 10 = | 1. 35 + 16 = | 1. 6 x 7 =  | 1. 5 x 8 = |
| 2. 49 + 10 = | 2. 24 + 13 = | 2. 5 x 6 =  | 2. 3 x 8 = |
| 3. 37 + 10 = | 3. 47 + 12 = | 3. 6 x 12 = | 3. 8 x 4 = |
| 4. 58 + 10 = | 4. 58 + 18 = | 4. 9 x 6 =  | 4. 4 x 9 = |
| 5. 80 + 10 = | 5. 76 + 14 = | 5. 4 x 6 =  | 5. 7 x 3 = |

Work to send in: Part A: Ex.33. Part B: 8th Day's work and the test for 10th Day.

RECORD CARD

	No. correct	Time		No. correct	Time
1st Day (Card 7)			6th Day (Card 8)		
2nd Day (Card 7)			7th Day (Card 8)		
3rd Day (Ex.30)			8th Day (Ex.25)		
4th Day (Card 7)			9th Day (Card 8)		
5th Day (Ex.32)			10th Day (Test)		

This is how I would like the little people in Standard 1 to set out their writing. Always begin at the top line of a new page and write the heading as I have shown you. You may put a pretty line design, using crayons and a ruler, round the edge of your writing page. In your best writing write me one line of each exercise.

" — " — " — " — " — " — " — " — " — "

*Writing*

*Ann Lee* *Std 1*

1. I wonder who can make the best springs.



2. Begin with an oval and make 3 evenly spaced a's.

*aaaa aaaa aaaa*

Notice where *a* finishes.

3. Begin with an oval and make 6 evenly spaced s's.

*ssssss ssssss*

4. Join a and s.

*as as as as*

5. Join o and s.

*os os os os*

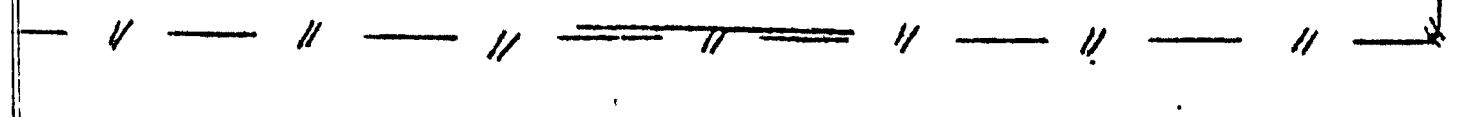

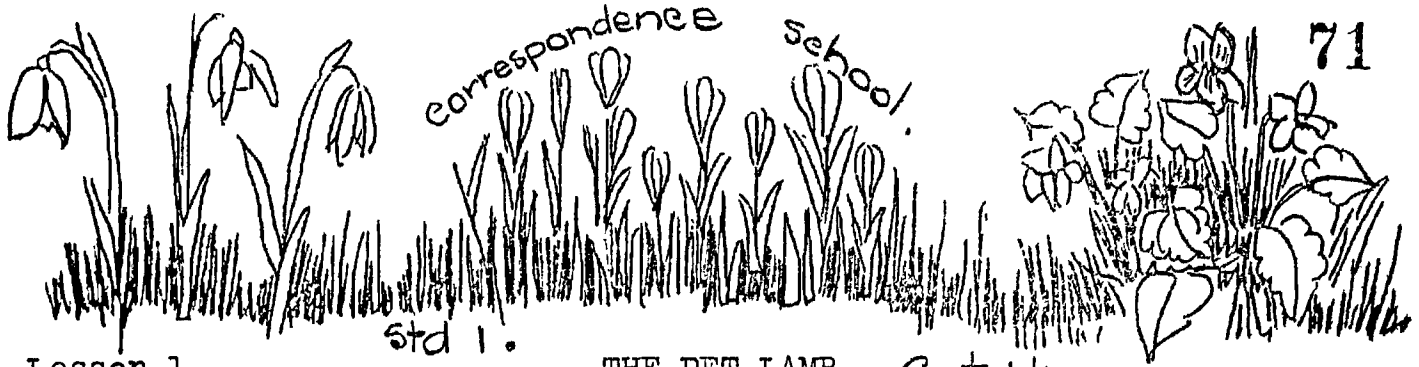

Lesson 1.

Std 1.

THE PET LAMB

Set 14.

The dew was falling fast, the stars began to blink  
 I heard a voice: it said, "Drink, pretty creature, drink!"  
 And, looking o'er the hedge, before me I espied  
 A snow-white mountain lamb, with a maiden at its side. \*

No other sheep was near, the lamb was all alone,  
 And by a slender cord was tethered to a stone;  
 With one knee on the grass did the little maiden kneel,  
 While to that mountain lamb she gave its evening meal. \*

\* The lamb, while from her hand he thus his supper took,  
 Seemed to feast with head and ears; and his tail with  
 pleasure shook.

\* "Drink, pretty creature, drink," she said, in such a tone  
 That I almost received her heart into my own.

\*

\*

\*

- William Wordsworth -

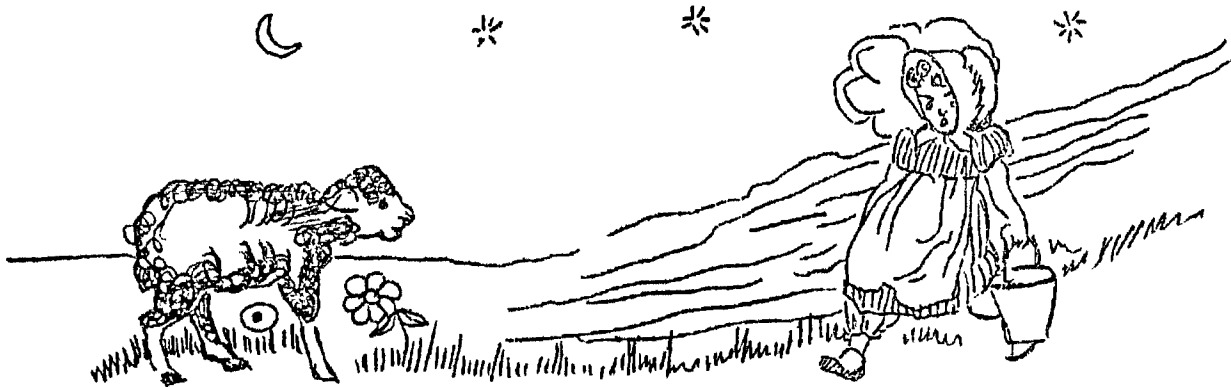

1. Ask Mother to read the poem to you. Listen to it very carefully, Little Ones, and then without looking at it print a line you remember.
2. Now tell the story of what the poet heard and saw, printing it out neatly.
3. Can you tell me the word that has the same sound as blink? Print it out. One that has the same sound as espied? Print it out. The same sound as tone? As kneel? Print these out.
4. Decorate your page neatly by making a margin an inch and a quarter all round. In this margin paste lambs you have cut out from white drawing paper. Colour the background of the margin a smooth green and round the edge of the page put a line design like one of those shown you in Set 8.

Lesson 2. Wink, tied, saw, got, gave, appeared.

From the list above choose a suitable word to put in the space left in each sentence below. Write out the sentence neatly. Above each of the words put in print another meaning much the same and taken from the poem in Lesson 1. Print these words with a coloured pencil.

1. Mickey Mouse ..... to be walking on air.
2. Tom looked across the water and he .... a white ship sailing by.
3. By a long rope a little calf was ..... to the fence.
4. When you wave your hand in front of anyone's eyes, they ..... .
5. The little boy ..... a letter through the post.

Lesson 3. Spelling.

1. Learn all the words on page 31 of your spelling book. Write two sentences. In one use the ninth word from column 1 and in the other the word you found hardest in column 2. Underline the words.

Lesson 4. Reading. Twelve Men of Gotham (July Journal).

1. Read silently the first paragraph of this story. Then close your Journal and repeat it to Mother. Were you able to say it word for word as in the book?
2. Now read the whole story silently, asking Mother to time you. How long did you take?
3. Answer these questions:-
  - (a) Why did they think one was missing? (Begin: They thought.....)
  - (b) Why did the King's man stop to ask the Twelve Men a question?
  - (c) How did the King's man find the twelfth man?
  - (d) What did the Twelve Men ask as they went home?

Speech Training Revision.

Say this little verse over carefully. What is the sound you are practising in it?

"Maa!" said the lambs  
 "Baa!" said their mothers.  
 "So that's where you are!  
 Have you been far?"

Lesson 5.

From the August Journal choose a story or a poem and act it. Ask Mother or Father or big sister to play it with you, and say and do all the things. Then in a good story tell your teacher about it. You might like to write it out in a separate book called "My Play Book". Draw a pretty picture to go with your play.

Lesson 6. Their means belonging to a person.

1. Tony came into the room and said to his sister, "I am going to make a long list of all the things belonging to the Smiths." This is how he began it:- their hats their coats. Now you print (very neatly and carefully) a list in the same way.
2. Write out the sentence given below putting a word that means belonging to them in the space.  
 If you come to tea on Wednesday I shall show you ..... drawings.

Lesson 7.

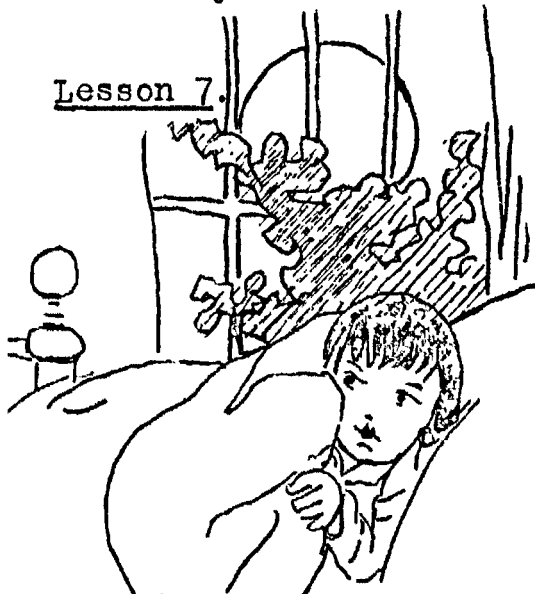

WANDERING JACK

Listen to the song  
 Of Wandering Jack.  
 He carries a bundle  
 On his back.  
 What is inside it?  
 Shall I tell?  
 He carries inside it  
 Dreams to sell.  
 Some cost a penny  
 Some cost a pound  
 But some cost nothing  
 I'll be bound.



Have you ever had a funny dream? Tell me about it. Did Wandering Jack give it to you for nothing?

Lesson 8. Complete these sentences, writing them out neatly.

1. There was once a man who .....
  2. When he saw the horse-shoe he said, .....
  3. He looked at one of the hind-feet and .....
  4. The man was sad because .....
- 

Lesson 9. My Story.

What story would you like to tell your teacher this time? About your doll? Or your pony? Draw a pretty picture to go with your story.

---

Lesson 10.

Learn the little poem given below and then print it ever so neatly and carefully from memory. Make your page look pretty with cut-outs of birds or neatly drawn designs.

SPRING IS COMING



Spring is coming, spring is coming,  
Birdies, build your nest;  
Weave together straw and feather,  
Doing each your best.

Spring is coming, spring is coming,  
Flowers are coming too;  
Pansies, lilies, daffodillies,  
Now are coming through.

Spring is coming, spring is coming,  
All around is fair;  
Shimmer and quiver on the river  
Joy is everywhere.

---



Card 21

56 + ? = 63

23 + 7 =

28 + ? = 33

38 + 4 =

29 + ? = 47

21 - 7 =

26 - 9 =

25 - 9 =

9 + 8 + 7 + 6 - 4 =

18 - 5 - 5 - 5 =

Card 22

8 x 3d = s. d.

4 x 6d =

5 x 2.6 =

9 x 7d =

8 x 12d =

9 x 0 + 6 =

8 x 7 =

9 x 11 =

10 x 11 =

11 x 11 =

WRITING.

Nearly all the Standard 1 children are making v, r, and y wrongly. This is how these letters should be made. I hope that you are all remembering to make narrow letters widely-spaced.

1. An exercise to do at the beginning of every writing lesson this fortnight, counting 1, 2, 3, 4, 5, 6 for each figure 8.



2. Write a line of v's.

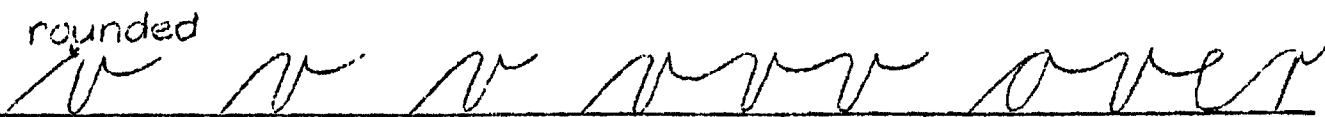

3. Write a line of r's.



4. Write a line of y's.

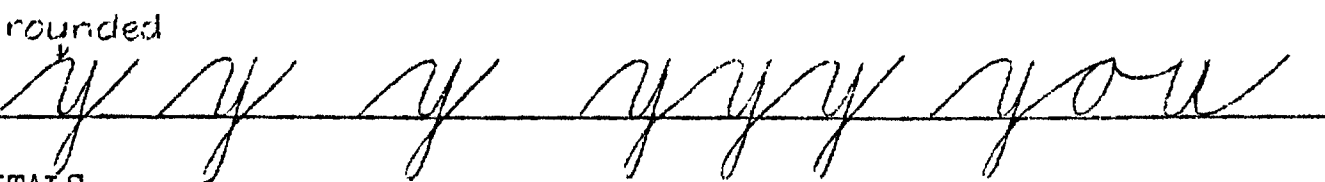

CAPITALS

5. Trace figure 8 three times and then make capital "F".

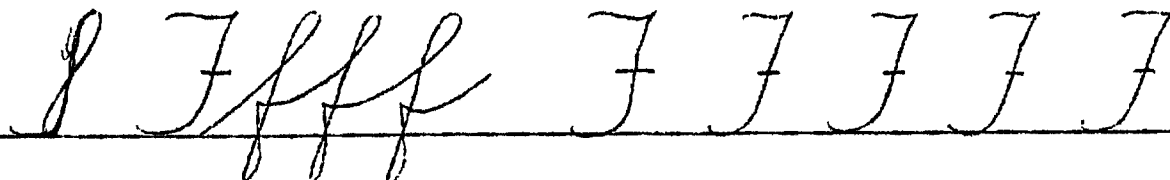

6. Trace the figures three times and then make capital "L".



SEND IN: One line of each exercise.

Also: Look out! Look out!  
Jack Frost is about!



ARITHMETIC.

Tables: Every day revise your 2, 3 and 4 times tables until you know them well. Work at your addition tables each day also.

Written Work: Exercises 65, 66, 67, 68, 69, 70. Work at these exercises until you are able to do all the sums correctly.

Send in: Part A. Ex.67 Nos. 1, 2.      Part B. Ex.65 Nos.18,19,20.  
Ex.69 Nos. 5,6,7.                      Ex.67 Nos. 4, 5.  
Ex.65 Nos. 15,16,17.                      Ex.69 Nos. 8,9,10.

Mental:

1st day: Card 21.

2nd day: Card 21.

3rd day:

- |                        |                               |
|------------------------|-------------------------------|
| 1. $17 + 6 =$          | 6. $5 + 9 + 7 + 6 =$          |
| 2. $3 \times 8 + 5 =$  | 7. $23 \div 3 =$              |
| 3. $32 \div 4 =$       | 8. Nine fours =               |
| 4. 5 threepences =     | 9. $20 - \quad = 8$           |
| 5. 1s. + 2 sixpences = | 10. 1 ft. 11 ins. =      ins. |

4th day: Card 21.

5th day:

- |                                |  |
|--------------------------------|--|
| 1. $36 - \quad = 26$           | 6. $5 + 9 + 4 + ? = 28$                        |
| 2. $15 + 7 =$                  | 7. $4 \times 12 + 6 =$                         |
| 3. $3 \times 9 + 6 =$          | 8. $30 - \quad = 23$                           |
| 4. 8 quarters =                | 9. 32 ins. =      ft.      in.                 |
| 5. 2 shillings - 2 sixpences = | 10. 3lbs.of butter @ 7d. a lb. =<br>s.      d. |

6th day: Card 22.

7th day: Card 22.

8th day:

- |   |                           |
|---|---------------------------|
| 1. $50 - 30 =$  | 6. $13 - 6 =$             |
| 2. $6 + 5 + 4 + 7 =$                                  | 7. $20 \div 3 =$          |
| 3. $\frac{1}{2}$ of 28 =                              | 8. $7 \times 4 + ? = 32$  |
| 4. 3 tens and 4 units =                               | 9. 3 dozen + 11 =         |
| 5. How many apples must I cut up to have 12 quarters? | 10. How many score in 80? |

9th day: Card 22.

10th day:

- |  |  |
|--|--|
| 1. $38 + 7 =$  | 6. $60 \div 9 =$                         |
| 2. $27 - 9 =$  | 7. $7 \times 3 - 3 =$                    |
| 3. $8 \times 4 - 3 =$  | 8. $16 + 10 + 5 =$                       |
| 4. If $\frac{3}{4}$ of an apple is eaten, what part is left? | 9. How many tens in 100?                 |
| 5. How many dozens in 48?                                    | 10. Which is the bigger 6s. or 70 pence? |

MY RECORD CARD

	No.correct	Time		No.correct	Time
1st day (Card 21)	_____	_____	6th day (Card 22)	_____	_____
2nd day (Card 21)	_____	_____	7th day (Card 22)	_____	_____
3rd day	_____	_____	8th day	_____	_____
4th day (Card 21)	_____	_____	9th day (Card 22)	_____	_____
5th day	_____	_____	10th day	_____	_____

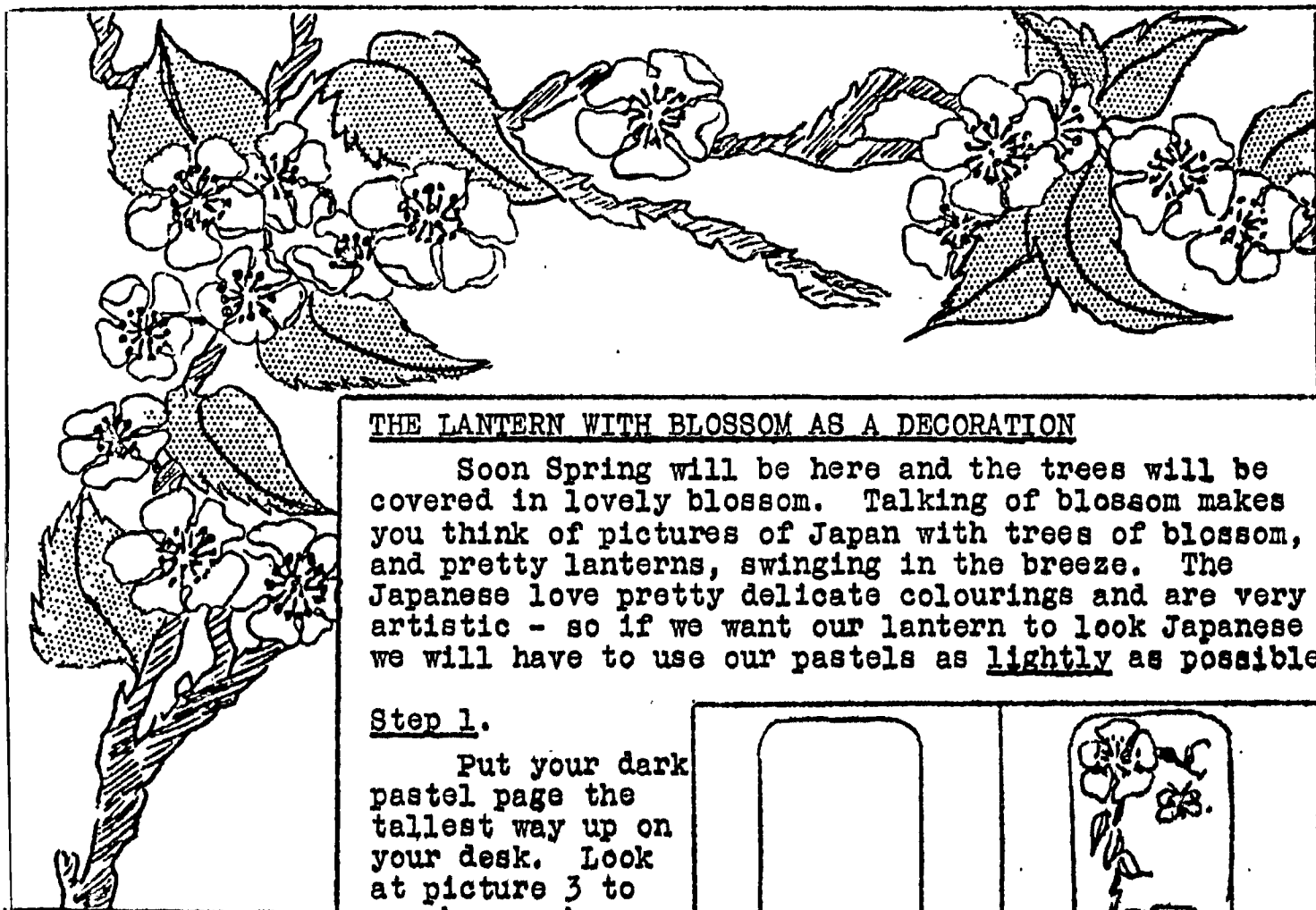

### THE LANTERN WITH BLOSSOM AS A DECORATION

Soon Spring will be here and the trees will be covered in lovely blossom. Talking of blossom makes you think of pictures of Japan with trees of blossom, and pretty lanterns, swinging in the breeze. The Japanese love pretty delicate colourings and are very artistic - so if we want our lantern to look Japanese we will have to use our pastels as lightly as possible.

#### Step 1.

Put your dark pastel page the tallest way up on your desk. Look at picture 3 to see how much room

to leave for the ends, hanger, and tassel; and then draw the shape just as large as ever you can to fit the space. Use for this a brown pastel, or the nearest to the colour of the page, because you do not want it to show, when your drawing is finished.

#### Step 2.

With the same pastel sketch the flower very lightly. Keep the flowers big, and do only the outline. Make the stems curved and artistic.

#### Step 3.

With black pastel draw very carefully the top and bottom. See that the edges of the top are straight above the bottom. Put a little white to show where the light catches the shiny part. With a small piece of yellow pastel lightly colour the lantern in strokes all going across the paper from left to right. Keep the colour even all over the lantern.

Be careful not to colour over the flower you have already sketched. Use red for the blossom, green for stems and leaves and black and white for stamens. The tassel will be done in strokes of red, yellow and black all going downwards, and the hanger will be black.

#### Step 4.

Look at the blossom at the top of the page to see the stamens, and the number and shape of the petals.

Do not forget to practise first on scrap paper.

#### SEND IN:

1. Japanese lantern,
2. A pretty picture to go with the poem in Lesson 1.

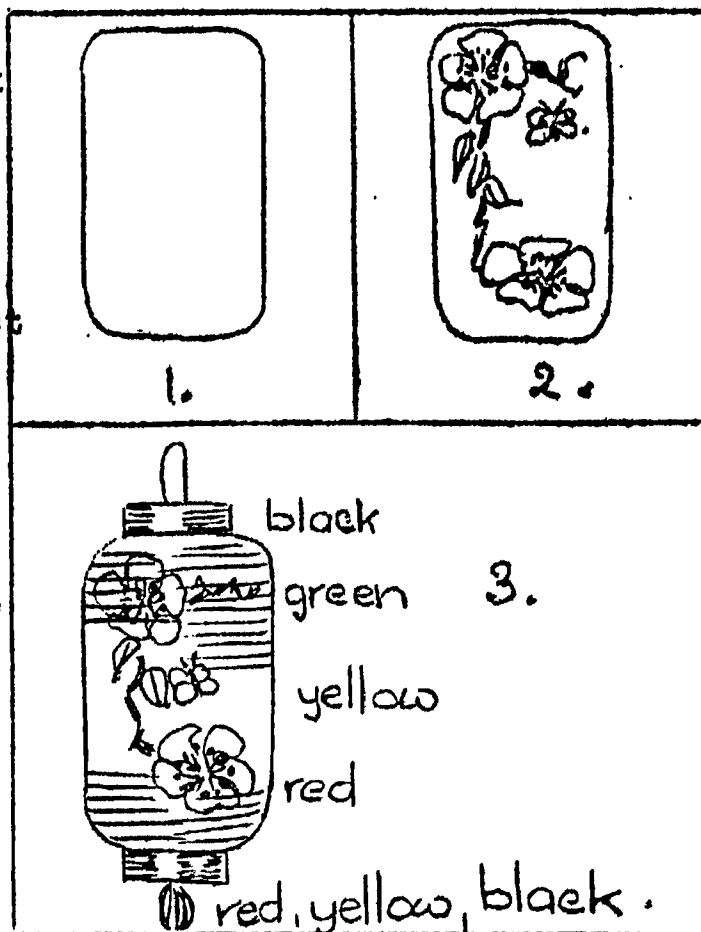





Here is a picture of the way people dressed over a hundred years ago. The men wore suits of velvet with lace ruffles. Over their own hair they wore powdered wigs. Find a picture for your page of people as they dress today.

What You Are to Do:- Cut out letters above and colour; paste at top of your page. Underneath paste on the picture which you have coloured this way:-

First Lady (only part of her shown) rose and white.

The man has a purple suit lined with blue; plum coloured breeches and a white waistcoat flowered in pink. The second lady wears a grey bodice, paniers rose, skirt white, hat grey and yellow. The third lady, grey shawl, green skirt, rose trimmings on skirt and hat. Yellow and white for the little girl, blue and white for her Mother with rose trimmings. The tree in the background light green with dark green shadows. Building and path are a pale yellow.



This is how the children dressed in great-grandfather's time. Cut out the picture; colour neatly and paste on your page. Beside it print a story of how you made these in plasticine. Find a picture of children of today and paste this on also.

Round the edge of your page make a pretty line design in two colours. Use your ruler for this work.



# APRIL

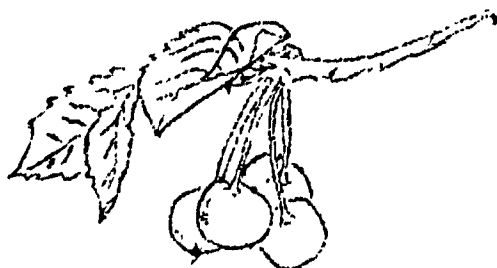

# NATURE STUDY

For your April Nature Study, Little Ones, find a nice juicy apple. Are they now all gathered in or still ripening on the trees?

Cut your apple through the middle and look at it carefully. Do you see the brown egg-shaped pips? These are the seeds. Have you ever wondered why they are hidden away like that?

The apple is formed from the blossom which looks so pretty on the trees in spring. The petals fall off, the pistil in the centre of the flower ripens to form the seed while the calyx or little green part at the back of the petals swells into a tiny apple. Have you seen the small green apple at the beginning of summer? If you tried to eat it you would find it sour and as hard as string for the apple has to have long sunny days to swell and ripen and grow sweet before it is ready. Then it shines and glows with colour and looks so inviting that people and birds simply have to eat it. That, of course, is just what Mother Apple wants. Do you know why? I expect you do when you have looked at the core as we call the ripened pistil. What do you do with this part of the apple? Yes, throw it away and may be it lands in a nice, soft, earthy bed just the place for it to grow. Now you know why Mother Apple puts her seeds in such a delicious wrapper.

Now find some other fruits which have their seeds in a sweet outer layer. I wonder how many you can find to draw and describe on your page?

Set out your nature study neatly on brown pastel paper, making all pages the same size.

	<p>Cut open an apple ..</p>

MY  
BOOK  
LIST  
STDI

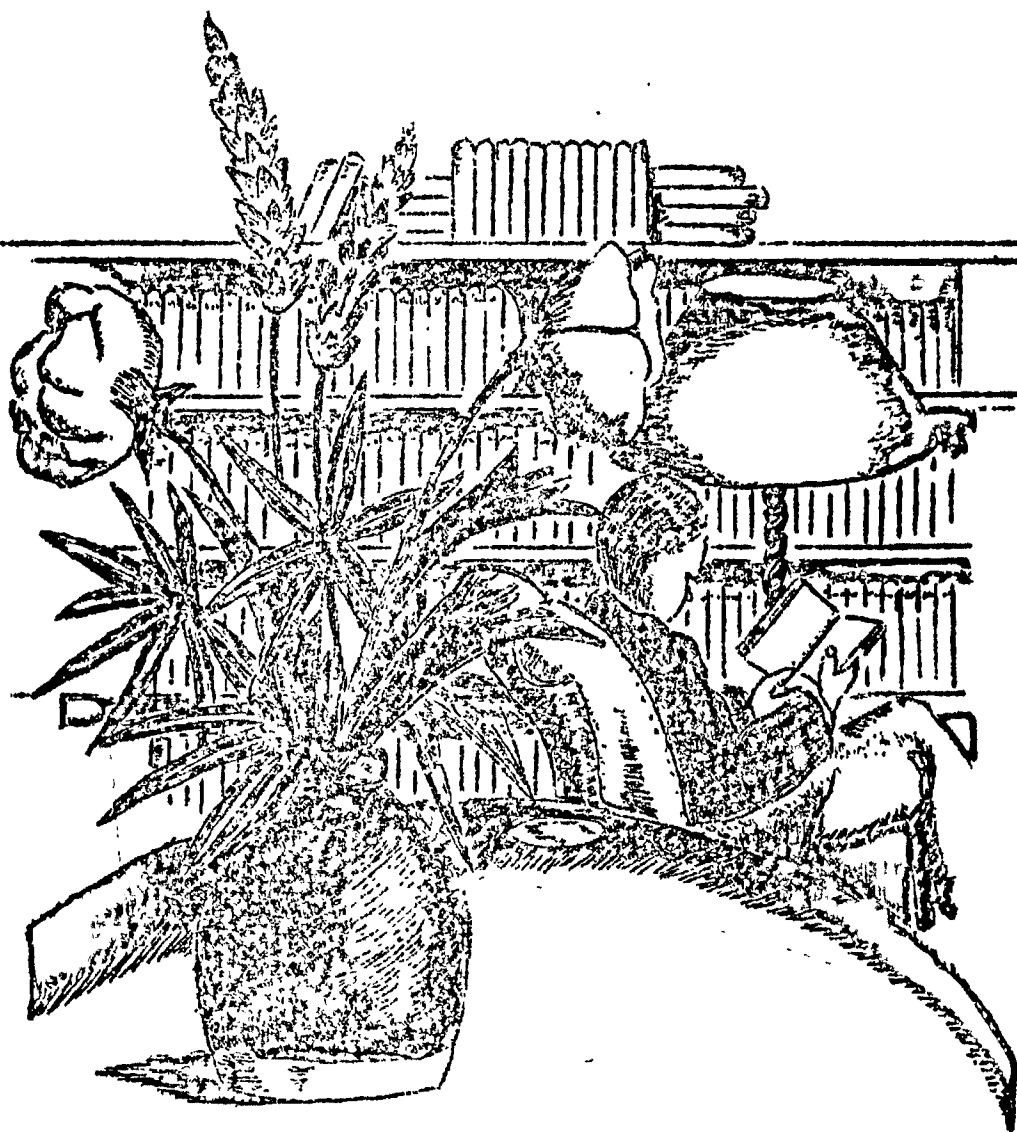

Books, children, books!

Books to carry you off into  
strange lands and fairy  
worlds.

Correspondence School,  
Wellington,  
February, 1936.



Dear little people in Standard One,  
Here is your new list of library books. Yes you really have a library of your own and so you are to take care of it your own little selves. Did you say "But how can we dust and mend the books and see that they are tidy when we are so far away from them?" You can look after the library though and I am giving you a list of "Dont's" to help you take care of it.

Don't touch a book until you are quite sure your hands are clean.

Don't bend or break the cover.

Don't turn down the pages or mark them with a pencil but use a bookmark.

Don't eat or drink while reading.

Don't forget to cover your book.

Now can you remember all these dont's? With each set you will receive a book. When you have covered it, read it as soon as possible and return it with your next set.

You should also send a list chosen from your library catalogue. In it put ever so many names of the books you wish to read during the year, and print your name at the end. You should keep the catalogue carefully and if you colour the pictures it will look pretty hanging on the wall. Put a little mark by the names of the books you have read.

Goodbye little people,  
Yours Sincerely,





- Adventures of Mr. Prickleback.
- " " Buster Bear.
- " " Grandfather Frog.
- " " Old Mr. Toad
- " " Poor Mrs. Quack.
- " " Prickly Porker.
- " " Paddy the Beaver.
- " " Reddy Fox.
- " " Sammy Jay.

## Animals of Storyland.

- Baa-baa and the Wide World.
- Babes of the Wild.
- Bad Child's Book of Beasts.
- Big Bad Wolf.
- Billy Bobtail.
- Blind Man's Dog.
- Brave Dogs.
- Brother Rabbit.
- Bunnikin Brown.

- Cat Book.
- Cassim the Camel.
- Children's Brer Rabbit.
- Cock, Mouse and Little Red Hen.
- Clever Cat.

- Dame Trot.
- Day at the Zoo.
- Deerland.

## Epaminondas and Other Tales.

- Farmyard Party.
- Four Jolly Rabbits.

- Gingerbread Man and Other Tales.
- Grateful Animals.

- Jacko's Day.
- Jumbo of the Jungle.

- Little Betsy Bunny.
- Lion Cubs.

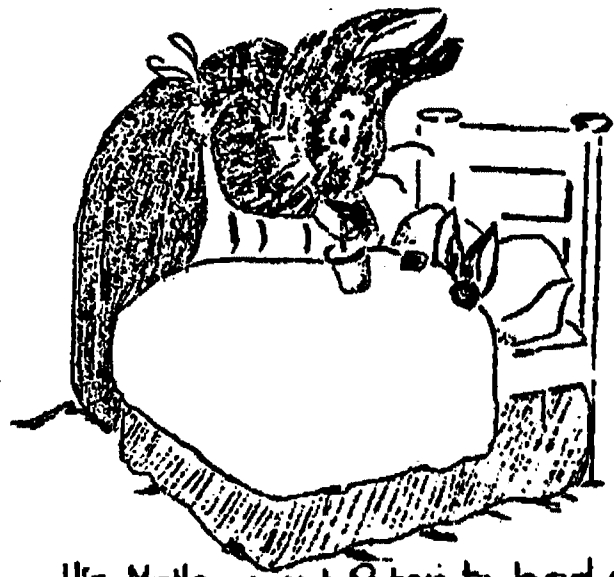

His Mother put Peter to bed and gave him some canomile tea.

- Mrs. Grunt and Her Little Pigs.
- Mr. Mouse's Mistake.
- Mr. Mouse Tries to Help.
- Mr. Prickly Tries to Help.

## Neddy, Story of a Donkey.

- Perfect Zoo.
- Pig Who Became Famous.
- Pete's Elephant and Other Tales.

- School for Frogs.
- Story of Babar.
- Stories about Bears.
- Squirrel who Jumped.

- Tale of Benjamin Bunny.
- " " Peter Rabbit.
- " " Squirrel Nutkin.

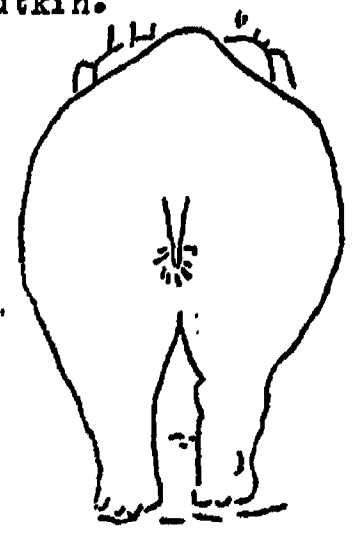

## The Elephant

When people call this beast to mind  
They marvel more and more

At such a little tail behind

So LARGE a trunk before.

From 'A Bad Child's Book of Beasts'.

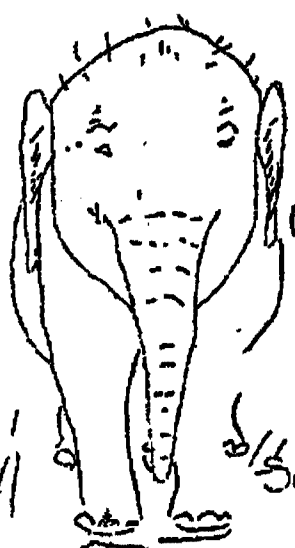

- Tale of Sly Tod.
- Three Bad Pups.
- Three Little Pigs.
- Ugly Duckling.

- Whiskers.
- Wolf and Seven Young Kids.
- Young Bruins.

# Birds, Bees and Insects.

82



Childs' Nature Reader.

Country Holiday.

Cloud-Childrens' Holiday.

Flower-Fairy.

Giants and Pygmies.

Grandfather Starling.

Jacky the Butcher Bird.

Lizzie Limpet.

Lovely Lady.

Nature Stories for Tinies.

Poppy Seeds.

Rainbow.

Rita and the Flowers.

Rose Fairy.

Safe Going.

The Spinners.

# Children of Other Lands.

Ahmed the Arab Boy.

Big Book of Babies.

Boys and Girls and Friendly Beasts.

Cave Dwellers.

Children of Other Lands.

Eskimo Twins.

Gulga.

In King Alfred's Day.

Ito.

Josef.

Kahu, the Maori.

Kanak the Eskimo.

Little Folk Here and There.

Morning Star.

Pieter.

Pictorial New Zealand.

Red Baby.

Strongheart of the Prairie.

Two White Babies.

Waireka.

Wang.

What Toby saw in Australia.

Windmills and Wooden Shoes.



# Tales about Dollies . . .



Doll that would not Grow.

Memoirs of a London Doll.

Enchanted Doll.

Teddy Bear's Birthday Party

Katy Kruse Dolly Book.

# Poems and Plays

Childs' Garden of Verse.

Model Book of Poetry.

Childs' Book of Verse.

New Age Poetry Book.

Childs' Book of Lyrics.

Nursery Numbers.

Fifty Poems.

One Hundred Poems.

Golden Garland.

Oxford Book of Verse.

Land of Poetry.

Poets and Poetry.

Little Gems.

Rhyme book of Flowers.

My Book of Poetry.

Through Golden Gates.

Very Young Verses.

Little Plays.

Seven Little Plays.

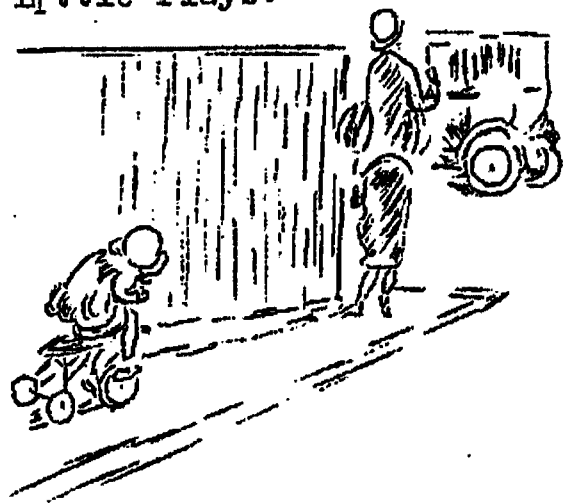

Disobedience

James James

Morrison Morrison

Weatherby George Dupree

Took great

Care of his Mother

Though he was only three

James James

Said to his Mother,

'Mother, he said, said he;  
You must never go down to the end of  
the town, if you don't go down with me

From "Very Young Verses."

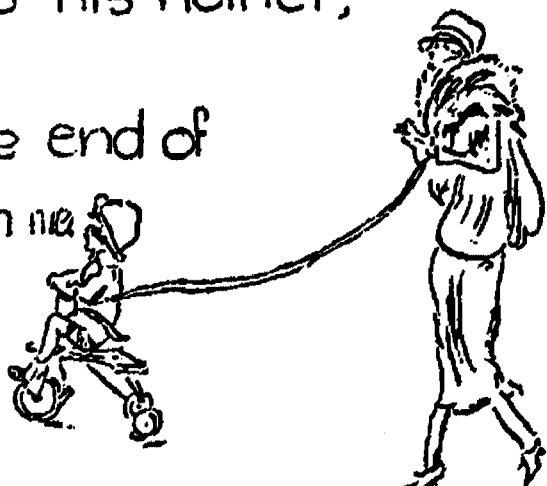

# All Kinds of Stories.

- Aesop's Fables.  
 Aladdin.  
 Ameliaranne and the Green Umbrella.  
     "        "        " Circus.  
     "        "        " Cinema Star.  
     "        "        Keeps Shop.  
     "        "        in Town.
- Betty and the Little Folk.  
 Beauty and the Beast.  
 Bold Robinhood.  
 Bowl of Mist.
- Children's Hiawatha.  
 Jobler.
- Dick Whittington.  
 Dwarfs' Football Match.
- Game of Brownies.  
 Giant's Heart.  
 Golden Key.
- Enchanted Oranges.  
 Eva in Fairyland.  
 Fairyfoot and Merrymaid.  
 Fulk, the Dauntless.
- Happy Days at the Farm.  
 Happy Days in Toyland.  
 Happy Days by the Sea.  
 Happy Days with the Ships.  
 House in the Country.
- Island where Things Come Right.
- Jack and the Beanstalk.  
 Jack's Holiday.  
 Jack the Giant-Killer.  
 Just So Stories.
- Keen-Eye the Tree Boy.
- Land of Sagar and Spice.  
 Little Tin Tea-set.  
 Little Goody Two Shoes.  
 Little Green Shoes.  
 Little Red Riding Hood.
- Magic Duck.  
 Magic Smoke.  
 Magic Plates.  
 Milly-Molly-Mandy Stories.  
 Mrs. Over the Way's Remembrances.
- Old English Stories.  
 Old Trunk.  
 Old Nursery Stories.  
 Old Nurse's Stocking Basket.  
 Once upon a Time.
- Pam's Secret House.  
 Peter Pan.  
 Pied Piper.  
 Princess in the Tower.  
 Princess and the Peasant.  
 Proud Sparrow.  
 Pinkie and the Pixies.
- Queen with the Nose.
- Rainbow Gold.  
 Ride with Robin Hood.  
 Rip Van Winkle.  
 Runaway Bun.
- Shoes of Fortune.  
 Snowdrop.  
 Snow Queen.  
 Snowball .  
 Story of Lady Green Sleeves.  
 Story of Jane.  
 Story of Little Black Bobtail.  
     "        "        "        " Mingo.  
     "        "        "        " Quibba.  
     "        "        "        " Quasha.
- Storyteller.  
 Summer Afternoon.
- Tarry diddle Town.  
 Tailor and the Giants.  
 Tick-tock Tale.  
 Tinker.  
 Three Boys at the Fair.  
 Twins and Tabiffa.
- Unwelcome Guest.
- Water Babies.  
 What Katy Did.  
 What Stella Did.  
 Wide World Wonder Stories.  
 Wonderwings.





FOR THE SUPERVISOR:

With each set of work a book will be sent. This book is primarily for pleasure, the idea being to cultivate a love of reading. It is, therefore, not intended that the story books should be used for class readers or spellers.

There are some children who may find the book chosen rather difficult. In such cases the supervisor should read the story aloud rather than that the child should go painfully stumbling over the words too hard for him; but it is hoped that the greater number of pupils will find the books sent quite within their range. A wish to read often helps a backward reader and encourages him to try for himself. If the story is discontinued at an exciting part, it sometimes happens that the child will read on by himself. The wish to get at the story overcomes many difficulties.

Parents and supervisors are asked to see that the books are returned promptly; that they are treated with care. A book mark should be used, and hands should be clean before a book is touched. It has happened that books have been returned in such a state that it was found impossible to send them out again. When the book is large, a separate envelope or parcel should be used to return it to the Correspondence School, but generally speaking, the books will fit into the blue envelopes in which the sets are put for marking.

When a separate parcel is made, it should be addressed as shown below.

A wise parent will do all in his power to cultivate a love of reading as such a habit leads to the right use of leisure and gives to life one of its chief pleasures.

Address

Primary Correspondence School Library Book  
Special Postage Rates S.I.

The Headmaster,  
Correspondence School,  
Education Department,  
WELLINGTON.

This Assignment is the property of the Education Department. It is to be regarded as confidential, and is to be returned to the Department when asked for.

STANDARD 2.

SET 6.

PRIMARY DIVISION.

ENGLISH:

Lesson 1.TIGER

There is a tiger in our hall -  
He lies so flat and still  
He never seems to move at all,  
But, some time, p'raps he will!

He never turns his head when I  
Come downstairs on tiptoes,  
Nor ever looks as I pass by,  
But every time he knows -

He knows when I come in from play  
And when I go to bed;  
He knows the things I want to say  
And everything I've said.

One day I said: "I'm not afraid  
Of any old dead skin!"  
And though no slightest sound he made,  
I felt that Tiger grin!

Some day when I am grown up tall,  
I'll step on him! You'll see,  
I'll teach that Tiger in our hall  
He's not the boss of me!

- Isabel Ecclestone MacKay -

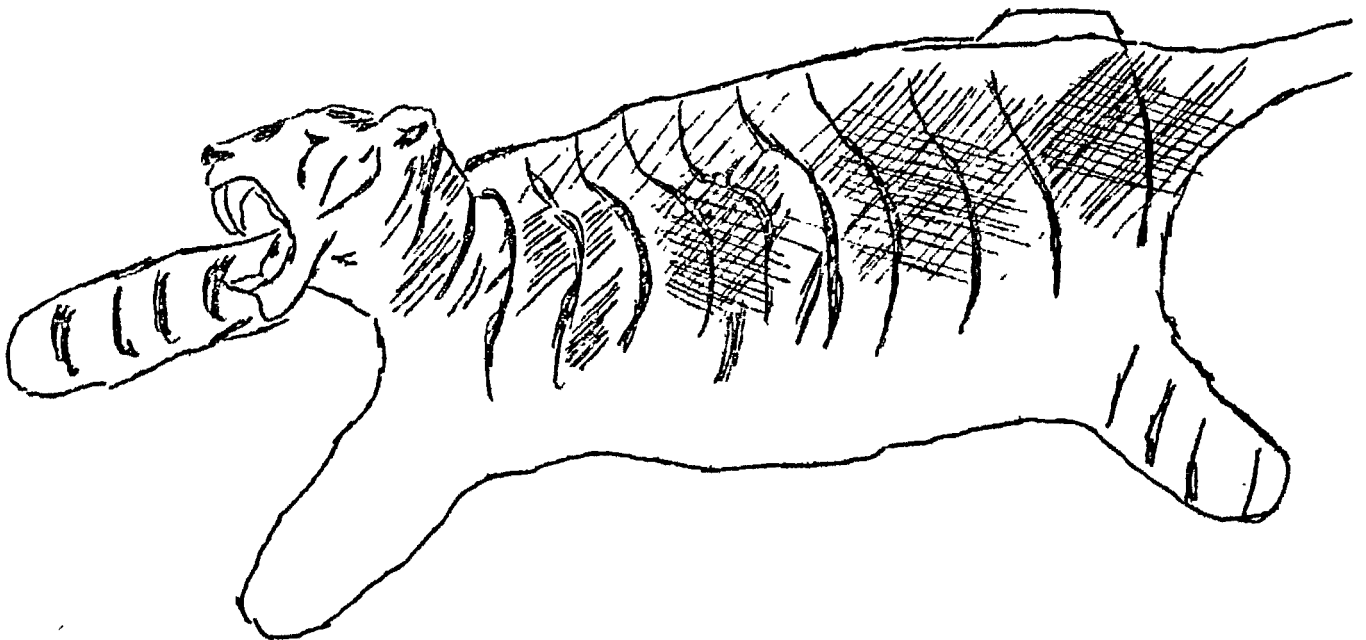
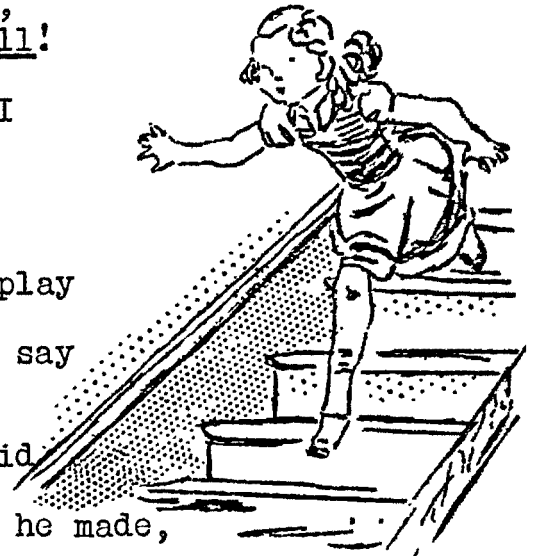

Here is a poem to learn. Print it neatly on your poetry page as you have done in your other sets.

Lesson 2.

-2-

Here is a description of a ship wrecked by a storm.

The ship dashed over the angry sea. The waves rose higher. The ship groaned in the storm. The main-mast snapped. Soon she keeled over and sank.

Close your eyes and try to picture the scene. Describe to mother the ship and her movements - rolling, rocking, plunging. Say something about the height of the waves and the snapping of the mast. Describe the end.

Write for me a description of a storm on land. We had a very bad storm in February this year, do you remember? Tell about the roar of the wind, the lashing of the rain and the rocking and falling of the trees.

Lesson 3.

We should have gone to the picnic. It began to rain.

Here are two sentences which can be made into one sentence by using but.

We should have gone to the picnic but it began to rain.

Join the following pairs of sentences in the same way.

1. Joan and Agnes were going to run races. 1. Agnes hurt her foot.
2. The child tiptoed across the room. 2. Her father heard her.
3. Molly and Dick were going to the Fancy Dress Ball. 3. They were ill
4. The children have gone home. 4. The teacher is still at school.
5. The Rangatira was wrecked. 5. The captain brought her safely into port.

Lesson 4. Colours.

red	green	pale
yellow	brown	golden
blue	white	purple
pink	black	grey.

The ..... grass grows all round.  
 The clouds rolled away and the sky was .....  
 His fleece was as ..... as snow.  
 In winter holly berries are .....  
 He turned ..... with fright.  
 His hair was as ..... as the raven's wing.  
 The ..... daffodils bloom in the spring.  
 The ..... corn was ready for the reaper.  
 Coconut ice is sometimes white and sometimes .....  
 A chestnut has a lovely ..... skin.  
 On wet days the sky is .....  
 The ..... heather grows on the moor.

Lesson 5.

On page 30 of your Journal in the story about the Turnip Mrs Brown asks Mr Brown a question. We read "What kind of seed did you sow?" asked Mrs Brown.

Note very carefully that when we write down a question we always put a question mark (?) after it.

Write for me six questions asking me anything you would like to know about the Correspondence School.

Lesson 6.

In your March Journal there is a story called "The Lion and the Rabbit". Read it through carefully then close your Journal and write the story pretending you are the rabbit.

---

Lesson 7. Spelling.

Each day Mother will give you five words from your Journal to learn and next day you will write them. Make a list of those in which you make mistakes and send it in to me.

---

SPEECH TRAINING.

In this lesson we have to deal with a sound which is made up of two entirely separate vowel sounds; but these two sounds are so pronounced that they cannot be distinguished as two entirely separate sounds

Say air and there.

The part of the word underlined sounds like the e in get + the er in mother. We do not say these sounds quite separately and distinctly, however, but run one into the other.

List of words containing this double sound:-

<u>there</u>	<u>fair</u>	<u>bare</u>	<u>care</u>
<u>wear</u>	<u>air</u>	<u>rare</u>	<u>stair</u>
<u>stare</u>	<u>chair</u>	<u>dare</u>	<u>where</u>
<u>pear</u>	<u>their</u>	<u>fairy</u>	<u>daring.</u>

Verse:-

Mary is a fairy  
 Sleeping in the dairy.  
 Her bed is soft, and feels like silk,  
 But really it is just plain milk;  
 She kicks it here and kicks it there,  
 She kicks it there and everywhere.  
 A very careless little fairy  
 Is fair-haired Mary of the Dairy.  
 But while we sleep and rest and dream,  
 She turns the plain milk into cream.

---

WRITING.

Send in one line of each exercise and also four lines of the poem in Lesson 1. Be careful to make all the downstrokes slope this way

||| | | | | | , and finish e, i, w, at the height of letter o.

Ee

Ii

Uu

Ww

---

Tables: Every day revise your 12 times table.

Card 6

Card 7

1. 5 + 7 =
2. 9 + 5 =
3. 18 + 5 =
4. 5 + 16 =
5. 5 + 3 =
6. 15 + 4 =
7. 5 + 5 =
8. 25 + 5 =
9. 2 + 5 =
10. 5 + 0 =

1. 12 x 3 =
2. 5 x 12 =
3. 12 x 9 =
4. 4 x 12 =
5. 7 x 12 =
6. 12 x 6 =
7. 8 x 12 =
8. 12 x 11 =
9. 12 x 12 =
10. 12 x 0 =

Cut out these two cards and mount them on cardboard. Write the answers on a piece of paper, not on the card.

Mental.

1st day: Work Card 6. Enter the number correct and time taken on your record card.

2nd day: Work Card 6 again. Try to reduce your time.

- 3rd day:
- |                        |   |
|------------------------|---|
| 1. 7 + 19 + 5 =        | 6. 4 dozen and 5 =                            |
| 2. 100 - 5 =           | 7. Write in figures: two hundred and seventy. |
| 3. 12 x 3 + 4          | 8. 4s. - 3 <sup>u</sup> 8d.                   |
| 4. 51 ÷ 12 =           | 9. 7d. + 9d. + 8d. + 4d. = s. d.              |
| 5. $\frac{1}{8}$ of 48 | 10. 2s. ÷ 4 =                                 |

4th day: Work Card 6 again. Time?

5th day: Work Card 7, and record the time taken and number correct.

6th day: Work Card 7 again. Time?

- 7th day:
- |                          |   |
|--------------------------|---|
| 1. 29 + 5 + 8 + 3 =      | 6. 70s. = £ s.                              |
| 2. 7 x 9 + 10 =          | 7. 6 $\frac{1}{2}$ dozen =                  |
| 3. 53 ÷ 9 =              | 8. 5s. - 4 <sup>u</sup> 3d. =               |
| 4. 70 - 35 =             | 9. £2 <sup>u</sup> 12 <sup>u</sup> 0d. = s. |
| 5. $\frac{1}{8}$ of 32 = | 10. Days in 12 weeks =                      |

8th day: Work Card 7 again. Time?

Written Work: Exercises 41, 42, 43, 44, 45 and 46.

What to send in: Part A: 1. Ex.41. B 1, 2, 3, 4, 5.  
2. Ex.43. A.  
3. Ex.46. B 1, 2, 3, 4, 5.

Part B:

<u>Add:</u>	87 96 <u>59</u> —	77 58 <u>46</u> —	53 69 47 <u>64</u> —	58 75 76 <u>67</u> —	67 87 78 <u>59</u> —
<u>Subtract:</u>	194 <u>86</u> —	392 <u>198</u> —	507 <u>156</u> —	500 <u>109</u> —	235 <u>187</u> —
<u>Multiply:</u>	87 <u>6</u> —	78 <u>4</u> —	163 <u>3</u> —	46 <u>7</u> —	140 <u>5</u> —
<u>Divide:</u>	6) <u>870</u> —	7) <u>525</u> —	6) <u>582</u> —	5) <u>805</u> —	4) <u>760</u> —

- (a) Add one hundred and nine, one hundred and nineteen, one hundred and ninety.
- (b) How many half dozens are there in 456?
- (c) What is the difference between 307 and 298?
- (d) How many days are there in 48 weeks?
- (e) Tom has half of 150 marbles and Jim has one-quarter of 200. Which boy has the most?



In the hot land of Malay lives Kromo, a little brown-skinned, black-haired boy with a wide, flat nose, high cheek-bones, and lovely white teeth. For dress he wears a kind of skirt called a sarong, and nothing more. He is barefooted and bare-headed although the sun is so hot that everything is shimmering and quivering with the terrible heat.

Kromo's mother and father live in a little hut built of bamboo and thatched with palm leaves. It is built over the water at a river-mouth, and is raised on wooden stilts about five feet above the surface. It is a queer place to build a house, but nearly all Kromo's people have done the same, so that a little village can be seen perched crazily above the water, with wooden gangways connecting up the houses. On the shore are built a few houses too, raised on stilts, and under the floors of these are kept hens and pigs.

Kromo can hear the swish-swish of the water below his hut when he goes to sleep at night. He can see it too, if he looks down between the cracks in the floor.

In the space underneath the hut are kept the canoes belonging to Kromo's father. He has two. One is a small one for only one person. The other is bigger, and has a sail of coconut matting, that can be put up whenever there is a wind. The head man of the village has a still larger canoe. It has a sort of roof built over the middle of it, thatched with palm leaves to keep out the sun. Kromo's people spend nearly all their time on the sea, for the forest comes so far down to the water that it seems to push them on to it. It is a thick green hot forest, so thick and so moistly hot that the air feels just like the inside of a very hot greenhouse. Tremendous rains come very often and the blazing sun shines down directly after, so that the forest is always kept at a steaming heat. Trees, creepers, ferns and mosses grow enormously fast and enormously thick. Those who cut back the forest must keep it back continually, for no sooner is a part of it cleared than it grows thicker than ever.

Kromo has sometimes been in the forest. He keeps a careful look-out there, when he goes, for tigers and many other wild animals lurk in its depth. Kromo's big brother was once nearly carried off by a tiger but his father bravely rushed at the great beast and killed him with his shark kris (dagger).

When Kromo is hungry he runs up the carved steps of his house to see if anything has been prepared to eat. Perhaps there is rice which is their chief food or perhaps fish or fruit. Sometimes Kromo's little sister Sina, who is only nine, has prepared a meal for him and his father and mother. When Sina is old enough, she will want to have her pretty white teeth filed to points like her mother's. We should think it very ugly, but she thinks it is lovely. Her father's teeth are quite black, though they were once as white as Kromo's. He has chewed betel-nut so much that they have turned a dirty black.

There is no school in Kromo's village. He can neither read nor write, but he can swim and dive well, fish cleverly and hunt animals in the forest. He hopes one day that he will be strong enough to kill all the man-eating tigers which come to his village.

WORK TO SEND IN:- Make a pretty Geography page. In your story tell me who Kromo was, where he lived, and what food he ate. Can you draw the tiger which nearly carried off Kromo's brother?



Let us work with our rulers and sharp pencils this time, and make some designs which can be used as borders. Here are some shapes which are often used in designs.



1. Let us make a border of squares. With your sharp pencil and ruler draw across your paper two lines one inch apart. Mark off the inches with small dots as shown here -



Now join the dots thus -

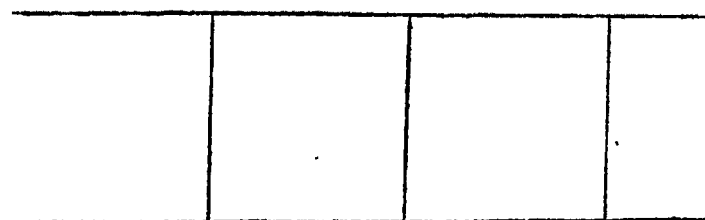

Choose only two colours for colouring in - blue and yellow; green and yellow; red and black, or orange and green. If you choose green and yellow, colour every other square green, and the ones between yellow. Be careful not to go over any of the edges, and let no white paper show through the colour.

2. Now let us make a diamond border. Draw two lines, an inch apart, across your paper just as you did before, and mark off the inches with dots. This time join up the dots in the way shown below, so that the lines cross.

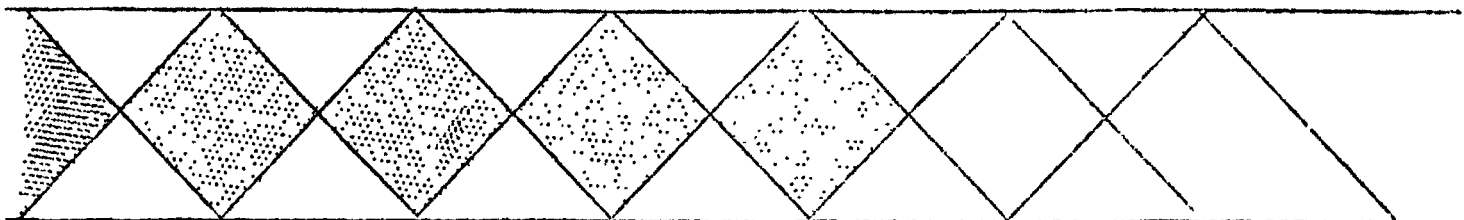

Again choose two pastels for colouring in with. Use the lighter colour for the diamond in the middle and the other colour for the triangles between.

3. A triangle border we can draw very quickly, beginning with a border one inch wide marked off in inches, the lines joined thus -

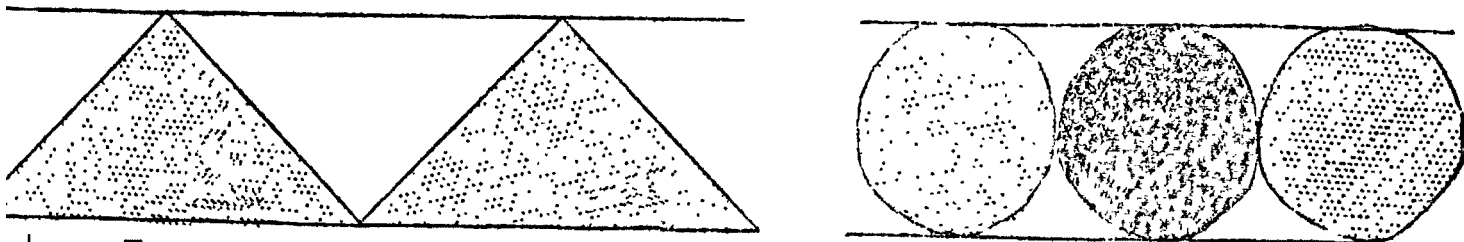

4. For a circle design begin with the inch wide border and, placing a halfpenny between the lines, draw round it. Move the halfpenny along until it is alongside the circle you drew first. Then draw round it again and continue till you have a border of circles. Three colours may be used for this - two different colours for the circles, and a third colour for the background.

#### WORK TO SEND IN:-

1. A pretty border design which could be used round Daddy's handkerchief.
2. Around the first page of your set draw a pretty border.

This Assignment is the property of the Education Department. It is to be regarded as confidential, and is to be returned to the Department when asked for.

PRIMARY DIVISION

STANDARD 2

1936

SET 10

ENGLISH:

Lesson 1.

FIVE EYES

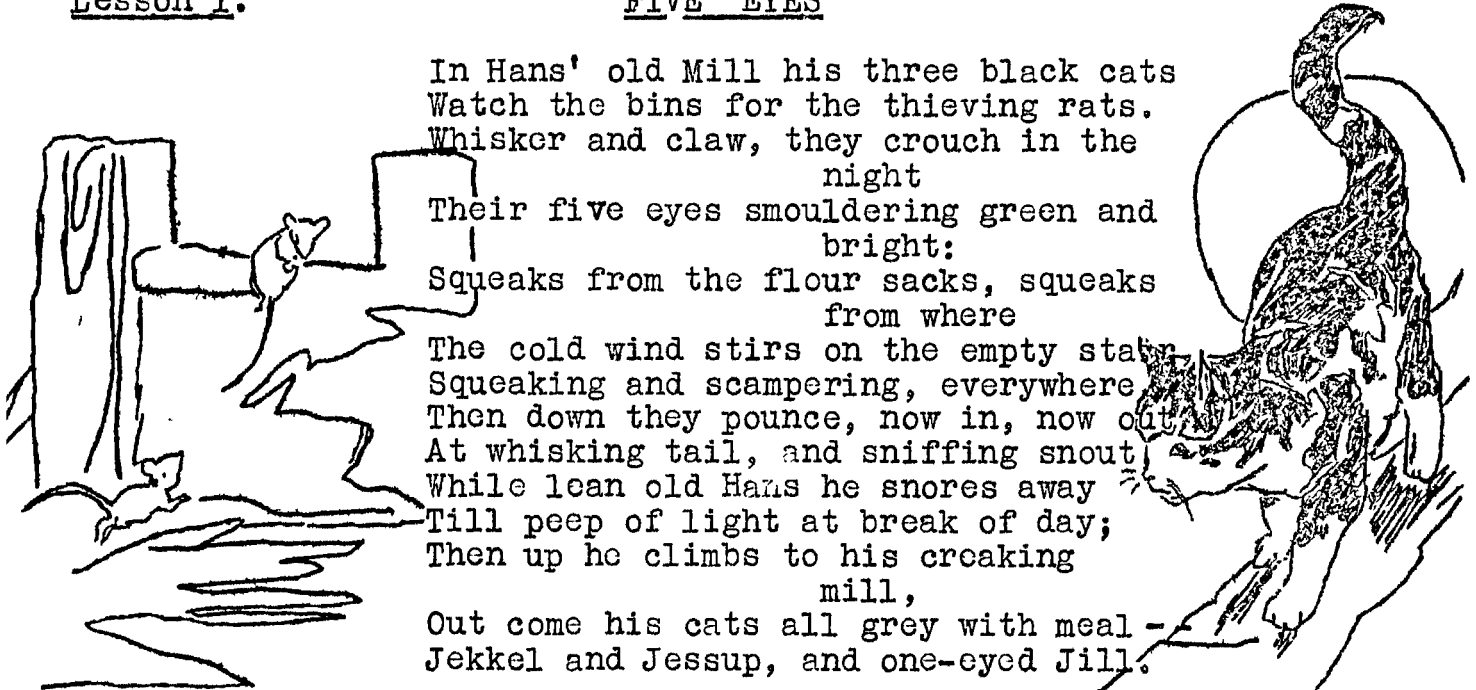

In Hans' old Mill his three black cats  
 Watch the bins for the thieving rats.  
 Whisker and claw, they crouch in the  
 night  
 Their five eyes smouldering green and  
 bright:  
 Squeaks from the flour sacks, squeaks  
 from where  
 The cold wind stirs on the empty stage,  
 Squeaking and scampering, everywhere  
 Then down they pounce, now in, now out,  
 At whisking tail, and sniffing snout,  
 While lean old Hans he snores away  
 Till peep of light at break of day;  
 Then up he climbs to his creaking  
 mill,  
 Out come his cats all grey with meal -  
 Jekkel and Jessup, and one-eyed Jill.

- Walter de la Mare -

Here is another poem for your Poetry Book. I hope you are making all your Poetry pages the same size so that they will make a neat complete book. Decorate your page with a potato-cut border.

Lesson 2.

Fill in the blanks in the following sentences with two, too or to.

- A.
1. There is .... much water in that basin.
  2. The .... girls sang sweetly.
  3. It is never .... late .... mend.
  4. .... boys left early but the others stayed.
  5. The girl is .... ill to go .... school.
- B.
- Fill in the blanks in the following sentences using the words in the side columns.
- |   |   |
|---|---|
| <p>was, were.</p> <p>is, are.</p> <p>is, are.</p> <p>was, were.</p> | <ol style="list-style-type: none"> <li>1. The birds ..... singing in the trees for the shower ..... over.</li> <li>2. Jack and I ..... going to town, but Mary .... going to the farm.</li> <li>3. "..... anyone there?" said the traveller.</li> <li>4. There ..... many people on board the wrecked train but no one ..... hurt.</li> </ol> |
|---|---|

Lesson 3.

Write a story telling me about a game you play by yourself.



Lesson 4.

Here are two sentences we can combine into one by using "because".

The day was wet. We did not go swimming.

We did not go swimming because the day was wet.

Join the following pairs of sentences in the same way.

1. Mary could not go for the mail.  
Her bridle was lost.
2. There was a heavy fog.  
The ship was delayed.
3. The baby cried.  
His toy had been taken from him.

Write three other sentences of your own using because.

Lesson 5.

Each day Mother will give you five words from your Journal to learn and next day you will write them. Make a list of those in which you make mistakes and send them in to me.

Lesson 6.

MIMA

Jemima is my name,  
 But oh, I have another;  
 My father always calls me Meg,  
 And so do Bob and mother;  
 Only my sister, jealous of  
 The strands of my bright hair,  
 "Jemima - Mima - Mima!"  
 Calls, mocking, up the stair.



Read through this poem carefully. I have marked the beats for you. Tap them on the desk with your ruler. Now write a poem like this for me about your own name.

Lesson 7.

The following is a description of the kitchen of a farmhouse. Read it through carefully and notice how the writer uses words which make us see a picture of the room, and the various things in it.

"The floor was well worn red brick, and on the wide hearth burnt a fire of logs. A couple of high-backed couches facing each other on either side of the fire made warm comfortable seats. In the middle of the room stood a long table of plain boards placed on trestles with benches on each side. At one end of it, where an armchair stood pushed back were spread the remains of supper. Rows of spotless plates winked from the shelves of the dresser at the far end of the room, and from the rafters overhead hung hams, bundles of dried herbs, nets of onions and baskets of eggs. The ruddy brick floor smiled up at the smoky ceiling, the plates on the dresser grinned at pots on the shelf and the merry fire-light flickered and played over everything."

- From The Wind in the Willows.

Now I want you to describe for me one room in your house. It need not be a long story.

First of all see that all your up strokes have a big slope.

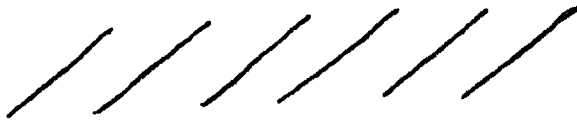

Keep these up strokes all sloping in the same direction.



Start with the oval.



When other letters are joined on watch where the loops come.

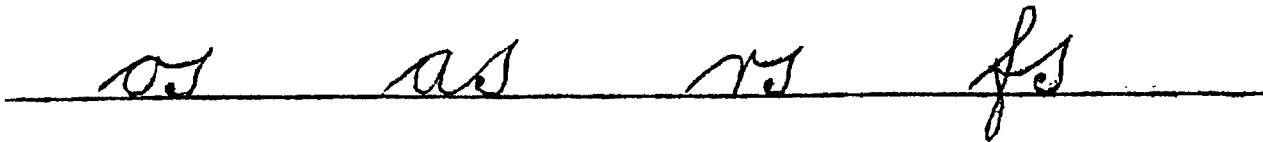

Practise with figure eight.



Notice the loops at the tops of the capitals only.



SEND IN:

Your best half page of exercises, together with the following lines of verse.

SILVER

Slowly, silently, now the moon  
Walks the night in her silver shoon;  
This way and that, she peers and sees  
Silver fruit upon silver trees.



Tables: Revise your 4 and 5 times tables. Mother will question you well on these.

Card 12	
1.	$19 + 9 =$
2.	$9 + 13 =$
3.	$27 + 9 =$
4.	$60 + 9 =$
5.	$31 + 9 =$
6.	$59 + 8 =$
7.	$22 + 9 =$
8.	$19 + 16 =$
9.	$74 + 19 =$
10.	$45 + 39 =$

Use Card 12 for mental work. Do not write answers on the card.

1st day: Work Card 12. Time? Written Work: Ex.66.

2nd day: Work Card 12 again and try to reduce your time.

Written Work: Ex.67, 68.

Send in: Part A: Ex.68. B 1, 2, 3, 4.  
Part B: Ex.68. B 5, 6, 7, 8.

3rd day:

1.  $7 + 9 + 3 + 8 =$
2.  $38 \div 5 =$
3.  $90 - 4 =$
4.  $20 \times 3 + 7 =$
5.  $\frac{1}{4}$  of 20 =

6. 53 pence = s. d.
7. 3s. - 2"9d. =
8. £5"10s. = shillings.
9. 7"4d. = pence.
10. 3s.  $\div$  4 = pence.

Written Work: Ex.69.

Send in: Part A: Ex.69. B 1, 2, 3, 4.  
Part B: Ex.69. B 5, 6, 7, 8.

4th day: Card 12. Time?

Written Work: Ex.70.

Send in: Part A: Ex.70. D 1, 2, 3, 4.  
Part B: Ex.70. D 5, 6, 7, 8.

5th day:

1.  $38 + 16 =$
2.  $53 - 8 =$
3.  $31 \div 4 =$
4.  $5 \times 9 + 3 =$
5.  $\frac{1}{10}$  of 120 =

6. 3 ft. 7 in. = inches.
7. 80 inches = ft. in.
8. 9 in. + 8 in. + 7 in. + 3 in. = ft. in.
9.  $2\frac{1}{2}$  ft. = inches.
10. Feet in 6 yards =

Written Work: Ex. 71, 72.

6th day:

1.  $29 + 17 + 10 =$
2.  $41 \div 7 =$
3.  $20 \times 4 + 10 =$
4.  $50 - 37 =$
5.  $\frac{1}{8}$  of 96 =

- What is required to make
6. 5d. up to 1"2d.
  7. 9d. " " 1"7d.
  8. 3d. " " 1"1d.
  9. 8d. " " 1"7d.
  10. 6d. " " 1"9d.

Written Work: Ex.73.

7th day:

1.  $12 \times 10 + 7 =$
2.  $51 \div 11 =$
3.  $76 - 8 =$
4.  $6 + 8 + 3 + 9 + 7 =$
5.  $\frac{1}{4}$  of 40 =

6. Write in words: 410
7. Write in figures: two hundred and forty-one.
8. Begin at 9 and add sevens till you reach 58.
9. Begin at 5 and add sixes till you reach 47.
10. Begin at 3 and add eights till you reach 59.

Send in: Part A: Ex.74, Nos. 1, 2, 3, 4.  
Part B: Ex.74, Nos. 5, 6, 7, 8.

8th day:

1.  $19 + 7 + 8 + 6 =$
2.  $50 - 7 =$
3.  $76 \div 9 =$
4.  $20 \times 5 + 19 =$
5.  $\frac{1}{8}$  of 64 =

6. 2"3d. = threepences.
7. 11"6d. = sixpences.
8. 12 threepences = shillings.
9. 14 sixpences = shillings.
10. 58 shillings = £ s.

Written Work: Ex.75. Send in: The answers to this day's mental sums.

9th day: Card 12. Time? Written Work: Free time for revision.

Send in: The answers to Card 12.

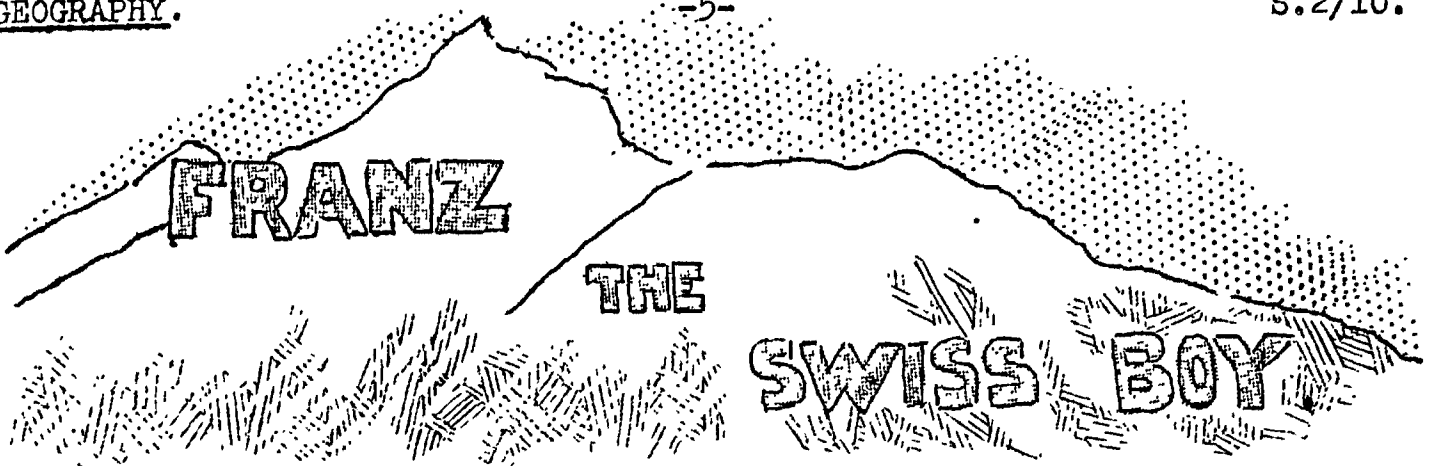

Franz lives in Switzerland. His home is in a tiny village that lies in a deep valley among the high snow-clad mountains. The village street is crooked and narrow, and over its cobblestones the long, narrow wagons drawn by oxen go bump! bump! on their way to the market square, where cheese, butter and vegetables are sold.

The house in which Franz lives is made of wood from the forests which you can see on the hill-side. Its roof is wide with broad eaves, and has heavy stones upon it to keep it safe when strong winds blow. You go upstairs into the house, for the downstairs part of it is a big stable, where Franz's father keeps the cows all the winter.

High above the village rise the big mountains - first the lower grassy slopes, then the thick forests of pine trees, then more grassy slopes, and last of all the white snows and the jagged rocky peaks against the blue of the sky. In summer Franz and his brothers are hardly ever at home. They spend most of their time up on the high grassy slopes with the cows, and stay there milking or making cheese and butter. Up on the high Alps the cows and goats wear bells on their necks, so that they can never get lost.

When the winter draws near the cows must be brought down to the lower grassy slopes and the flat meadows in the valley bottom. Sometimes you may see Franz cutting hay for the winter food of the cows.

Snow falls so heavily on the village in the winter that sledges have to be used instead of wheeled carts. Franz has a fine time ski-ing (pronounced sheeing). His skis (shees) are like long flat strips of wood fastened to his feet, and are polished and smooth underneath. He goes about easily and quickly on these.

Winter is the time for indoor work. Franz carves little men and animals out of the soft pine wood, and during the long dark winter evenings he sits with his brothers making toys to sell to the visitors. His mother and sisters are clever at lace making and, besides that, they make most of the clothes of the family.

Swiss children are dressed like their parents. Franz's sisters have checked skirts, velvet bodices and under-bodices with big white sleeves. Franz has loose trousers which reach below the knees, and a rough woollen skirt, while on his head is a soft felt hat with feathers stuck in at one side. His boots are heavy and well-nailed for climbing.

Visitors come from all parts of the world to Switzerland. Franz's uncle is a famous guide. He can climb up the steepest mountains, and is always ready to take a party of people to the high mountain tops. When he does this he ropes them all together carefully in case one should fall, for it is very dangerous up there among the snow and ice. Everyone carries a stout stick with a pointed end, call an alpenstock. Franz's uncle once got lost when he was crossing the great St Bernard Pass in a snowstorm. He wandered about for hours, and at last fell down, too tired to go any further. He was found by one of the big St Bernard dogs which are kept at a monastery near by on purpose to help lost travellers.

Switzerland is lovely in the spring. The grassy meadows are turned into gardens of flowers. You cannot walk on the grass without crushing down purple or mauve crocuses, or big daisies or other beautiful flowers.

**WORK TO SEND IN:** Make an interesting Swiss page for your Geography book. Print your story about Franz very neatly on pencil lines, which you have ruled across your brown paper page. Head your page neatly, and cut out and paste carefully on your page the picture of Franz given here. Colour him in with your pastels. Perhaps you have some other Swiss pictures you can paste on your page.

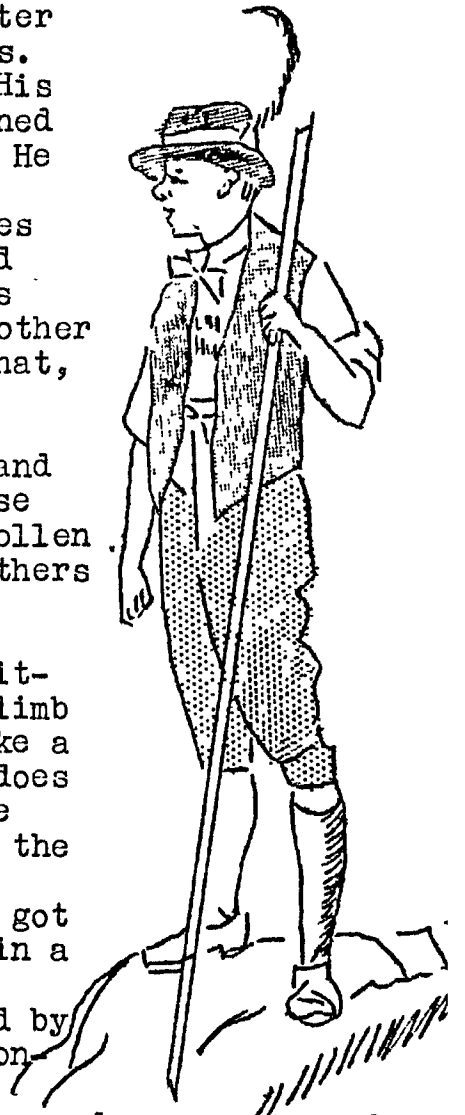

DRAWING.

Let us see if we can draw another winter vegetable, one that is often the cause of many tears - the onion. I am sure Daddy will be able to give you one of those large brown onions that we like with white sauce for our dinner.

Let us place it on a table, with the light falling on it from the right this time. We look carefully at it until we have a very clear picture of it in our minds. Now we are ready to commence drawing. Use half a page from your white drawing book for this lesson instead of the usual brown page from your pastel book.

When drawing our tomato, we rubbed on the page a patch of colour of that shape. But we are going to use a different method of drawing for our onion. We are going to begin by sketching in the shape, using short lines, and placing those which come opposite each other as shown below in diagram 1, so that we can see the onion gradually growing under our pastel.

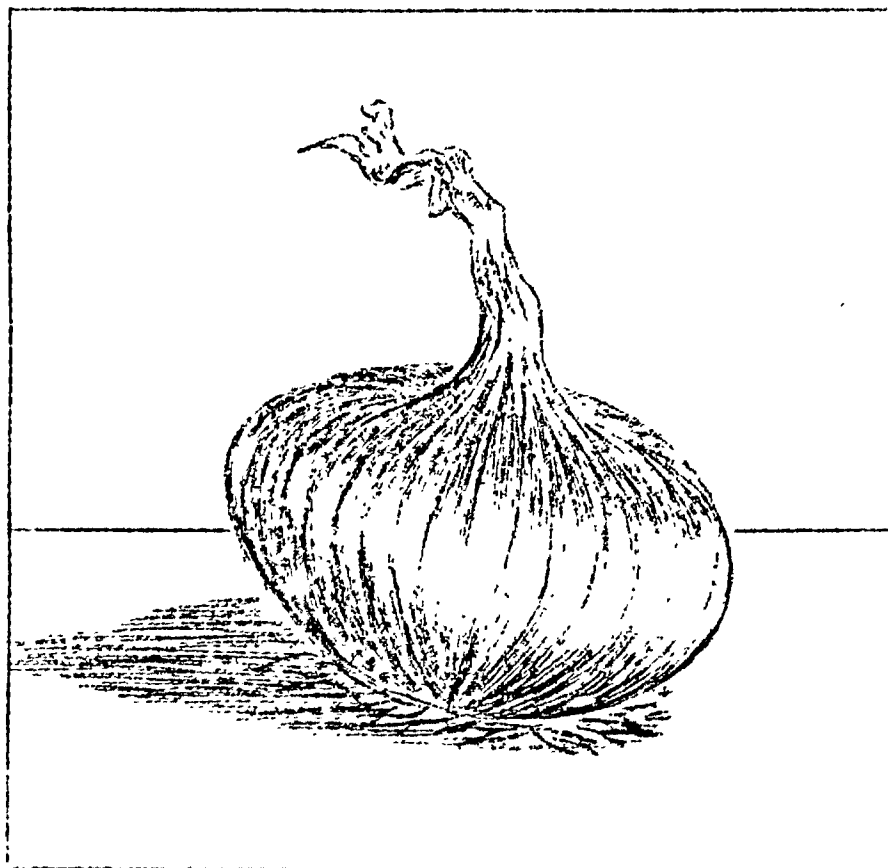

1st step.

Place all the lines in the order they are numbered using your light reddish brown pastel.

2nd step.

Join the broken sketch lines.

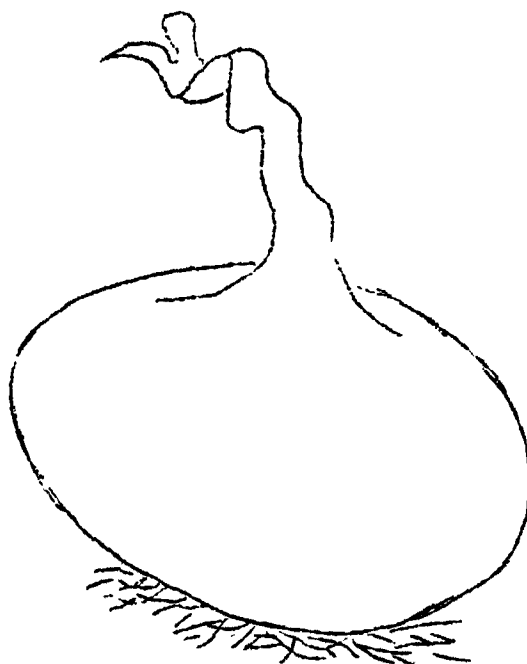
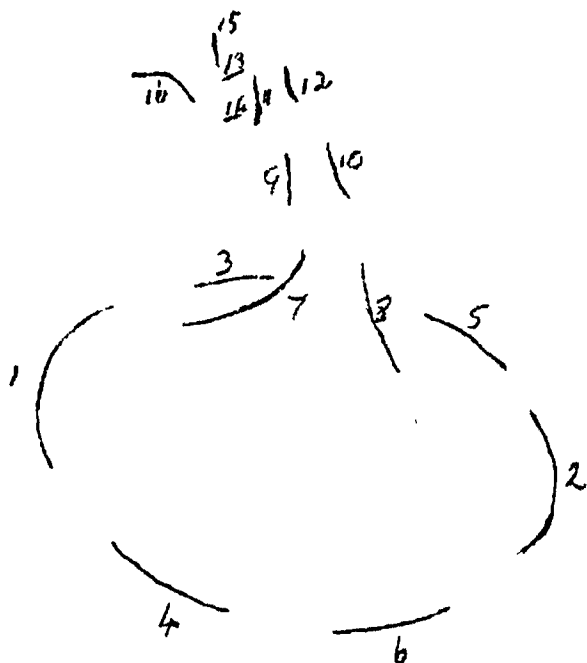

Before we begin colouring our onion let us half close our eyes, and study the light and shade. Take particular notice of the light, because we are going to leave the white paper itself to partly show this. Now, with your reddish brown crayon, begin to colour, using strokes which follow the shape of the actual markings on the onion skin, placing the strokes on the shaded parts closely together, and on the light parts further apart, so that the white paper shows through. Colour in the onion top in the same way. Next, take your dark brown pastel and colour in the darker parts more darkly. Also add the little roots which you notice do not show very much.

...

DRAWING (continued).

Now we must add those touches of colour which brighten the lighter side and darken the deepest shade. Take your yellow pastel and add touches to the very lightest parts of the onion top, and also to the lightest parts of the onion itself. Remember each stroke must be curved to follow the shape of the onion, and still a certain amount of white paper must show through. We darken the deepest shade with a few touches of black, and also make the roots stand out more clearly.

We finally add the cast shadow and so complete our drawing.

WORK TO SEND IN:-

1. A pastel drawing, on white paper, of a large brown onion.

Here are some more ways of cutting potato stamps to make interesting designs.

Flower Forms :-  
Cut out the parts coloured black on spotted

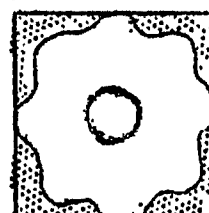
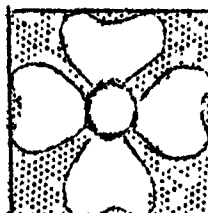
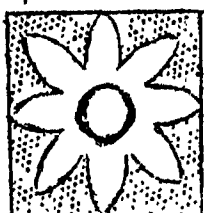
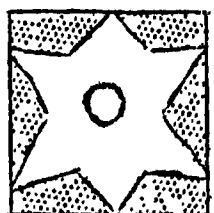

Leaf Forms :-

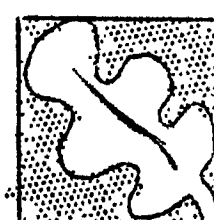

Triangle Patterns :-

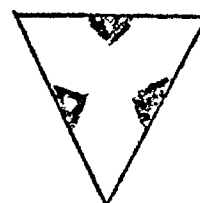
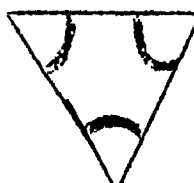
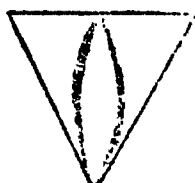
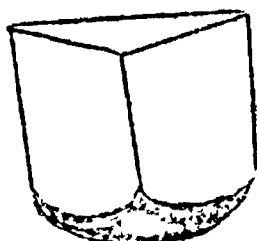

Cut potato into triangle block instead of square

# SEPTEMBER

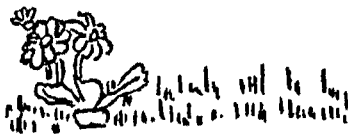

# NATURE STUDY

"The daisy with a golden eye looks up."

Already the little daisy is showing its white frills in the green fields. Have you seen it and played at daisy-chains yet?

It is such a modest little flower and yet looks up at us on its short pinky-green stem with all the beauty of a little star. What other plants have flowers like the daisy? I think you will say quite quickly, the dandelion and the groundsel. They are members of a family which we call compositae. What a grand name for the dear little daisy!

Let us look at the flower first. Take it up and notice that it is not a single flower like the buttercup, but that it is a head of flowers packed tightly together. These flowers or florets are of two kinds. If you take the outer ray florets you will see that they are strap-shaped petals, while the inner disc florets are made up of little tubes. It is these tubes that I want you to study. Notice that inside each one are the stamens and the pistil. In this tube the pollen is shed, and below the disc florets lies the little seed box or ovary.

It is usual for flower heads to have a green ring of sepals below the flower. These we do not find in the daisy. Instead are bracts which protect the little flower when in bud.

Now let us look at the leaf. It is shaped like a spoon, and is toothed. It grows from a root stock, or thickened root, where food is stored for the young plant. From the root grow the leaves and the rootlets.

Although the daisy is a common flower we see now how interesting and wonderful it is. Find one and lift the whole plant carefully. Wash away the soil, and then dry the root, and press the leaves and flowers. Mount the flower, leaf and root on your page at one side and then print neatly beside it the answers to the following questions.

1. How does the flower of the buttercup differ from the daisy head? On your page print a little story about the daisy flower (or use a dandelion if you cannot find a daisy).
2. What is the leaf like? In your story about it, give its shape, size, colour and feel. What other leaves are like it?
3. Tell why the root is so thick. Print a little story about it.
4. Now look at the trees and find if you can, any flowers they may have. Print a story about them on your page.

### Nature Study September.

Your second part of the work is to watch the birds. Draw your bird tray at one side of your page, and beside it print a story of what you have seen. Perhaps the birds are nesting? It will be early for our native birds, many of whom do not nest until October. Watch the busy little builders carefully and tell how each makes its nest. Draw the birds or bird you have seen with with straw or other material for the nest.

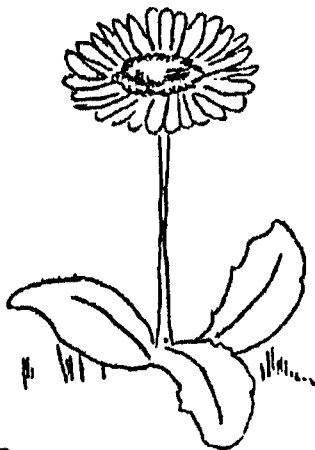

The daisy



Strap-shaped petal



tube petal



Spoon shaped leaf



This Assignment is the property of the Education Department. It is to be regarded as confidential, and is to be returned to the Department when asked for.

PRIMARY DIVISION.

STANDARD 3.

1936.

SET 11.

ENGLISH:

Lesson 1. Page 74.

Be very careful to underline only the pronouns that stand instead of the nouns in black letters, not all the pronouns in the sentence. Send in 1, 2, 3 and 4. Write four more sentences with pronouns in them. Underline the pronouns.

Lesson 2. May Journal, page 60.

Read "The Picture Book" to yourself. Tell me how long it takes you  
Answer these questions:-

1. Do you think it was a cheap book shop that Jeremy went to? Why?
2. What was it Jeremy liked most about the book he bought?
3. Do you think Mary will be pleased when Jeremy gives her his bottle, or would she prefer the book?
4. Write down a list of the words of which you did not know the meaning in this story. Write opposite them the meaning when you find it out.
5. Tell me a story of how you bought a birthday present for someone, and how they liked it.

Lesson 3.

Subjects are missing in these sentences. Place rewrite the sentences with them in.

1. Yesterday ..... walked home from town.
2. .... stands on the top of a high hill.
3. .... talked to us for a few minutes.
4. .... flew across the garden fence.
5. .... swims in the sea.
6. Last night ..... came over to see us.

In these sentences the verbs are missing. Rewrite them in full.

- |                           |                            |
|---------------------------|----------------------------|
| 7. Three blind mice ..... | 10. The blue sea .....     |
| 8. My new gloves .....    | 11. The picture book ..... |
| 9. The inkwell .....      | 12. The new gate .....     |

Lesson 4.

We want you to make something. It may be something for Mother, a swing for baby, a cake for tea, or a waggon for yourself. Tell us how you made it. Don't let us think you know hardly any words except "then".

We shall look forward to your story and hope there will be drawings with it too.

Lesson 5.

Do you know the story of the goose-girl? Here it is in verse, but in case you haven't read the story, you will find it at the end of this set. Tell me which you like best - the poem or the story, and give a reason for your choice.

Do you put all these poems sent you into your Poetry Books? You will be asked to send them in soon. Of course you learn them all too - this one should be very easy to learn.

FALADA

Falada once had shoes of gold,  
And jewelled bridle and burnished bit;  
But now he hangs on an archway old,  
And a little goose-girl goes under it.  
"Falada, Falada, hanging high!"  
He hears the sorrowful goose-girl cry,  
And "Princess, Princess passing by!"  
The faithful Falada makes reply.

. . .



Lesson 5 (continued).

Once she rode through the royal town  
 With broidered gauntlets and shoes of vair;  
 The gilded clasp on her crimson gown  
 Dazzled the people passing there:  
 And Falada neighed and tossed his mane  
 And spurned the stones with his dainty feet,  
 While faces at every window-pane  
 Followed their progress along the street.

But all her splendour is charmed away  
 Her gown is changed to a tattered smock,  
 And every morning at break of day,  
 She drives to the riverside her flock.  
 They've cut off her snow-white palfrey's head,  
 With its gentle eyes and its fairy tongue,  
 And over the City gates instead,  
 Falada's lovely head is hung.

The Princess under the archway herds  
 Her downy brood with their orange beaks,  
 And only Falada hears the words  
 She utters while tears roll down her cheeks.  
 "Falada, Falada, hanging high!"  
 He hears his sorrowing mistress cry,  
 And "Princess, Princess passing by!"  
 The faithful Falada makes reply.

- Elizabeth Fleming -

Draw and send in two pictures, one of the Princess on Falada - and another of her as a goose-girl.

Lesson 6.

- A. Page 80 First revise Lesson 1, Set 9, on page 62.
- B. Write three sentences of your own with a possessive in each of them.

Lesson 7. Page 80.

Lesson 8.

Write a sentence to describe the work of each of these: carpenter, wheelwright, cooper, mason, plumber, glazier, potter, upholsterer, cobbler, miller, janitor, chauffeur.

Lesson 9. Page 82.

Lesson 10. Page 82.

A HOUSE ON WHEELS.

I'd like to be a gipsy man,  
 And drive a dawdling caravan,  
 And light a fire, and fill my can  
 With water from the cressy brook;  
 And then the supper I should cook! -  
 Potatoes in a frying pan  
 Are good for all the gipsy clan.

- M.I.K.Carruthers -

SPEECH TRAINING.

Read "A House on Wheels" out aloud to Mother slowly and clearly. Be sure you say the last letter of each word very distinctly.

Say the words man, pan, clan, and then say the sound "a" by itself. Make it a short "snappy" sound. It is a mistake to drawl it out and say "ma-a-an".

Practise these words: back, bag, bad, bat, and this little verse:-

O what is the matter, what's the matter,  
What is't that ails young Harry Gill,  
That evermore his teeth they chatter,  
Chatter, chatter, chatter still?

SPELLING:

de Berry's book, page 19, lists 17 and 18. Send in Wednesday's lists please, written as Mother called them out to you.

HISTORY.

Read pages 85 to 89 in "Our Nation's Story". This chapter gives you a picture of life in a nobleman's castle during Norman times. Among other classes, life went on very much as it had before. The Norman Knight took the place of the Saxon thane; the people of the villages worked and farmed as before. Life in a village centred round the lord's house. The peasants or villeins, though not slaves were not really free as they could not leave the manor, and if the manor changed hands, they were bought and sold with it. They had to work on their lord's farm, without pay, for one, two, or three days a week. They had to help with haymaking and harvesting, and at stated times, had to pay eggs, or fowl, or honey, or corn to the lord. But this work, and the food they gave the lord, was really the rent for the land the villein had and farmed himself, when he was not working for his lord. Most debts were paid in work, crops, or in military service in those days, as coin was scarce. Even taxes to the king were paid in corn.



Wives of farmers worked very hard. They helped on the land, leading oxen, making hay and reaping corn. They sheared sheep, spun and wove the wool into cloth, and made linen from flax.

But life was not all work. There were many saints or holy days when all made merry. Then there was cock fighting, bull baiting, wrestling and quarter staff on the village green.

Minstrels, acrobats and jugglers went round to amuse the people on such days.

HISTORY (continued).



Everybody also flocked to see the tournaments, where famous knights tried to unhorse each other, fighting with lance and sword. The winner was entitled to claim the loser's horse and armour. There were archery contests at the jousts and prizes were given to the best shots.

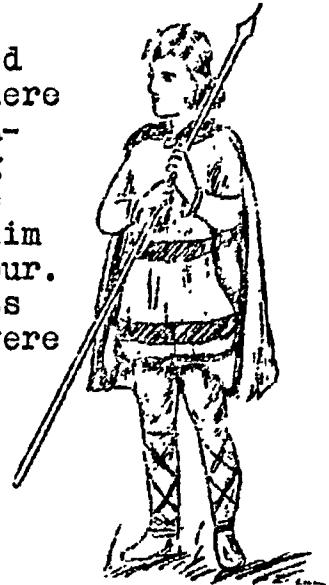

GEOGRAPHY.

1. Continue Records on your moon, shadow and weather charts.
2. Read pages 30-33 in your Human Geography Book, with a map of New Zealand beside you.  
Find the provinces and places mentioned in the chapter.
3. Collect pictures of harvesting, sheepfarming and fruitfarming and put them on some of your brown paper pages.
4. At the back of this set is a blank map of New Zealand. Divide it into provinces and print their names in very neatly. (See page 20) Now trace or draw small diagrams like the following, placing each drawing where you think it most belongs. For instance, the drawing of the Kauri trees will be put in the Auckland Province, because that is where Kauri trees grow.  
The map on page 52 will help you.

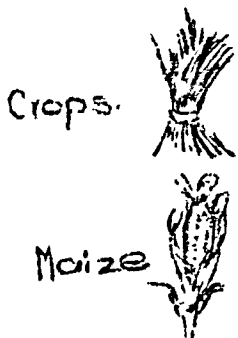

Fruit s.

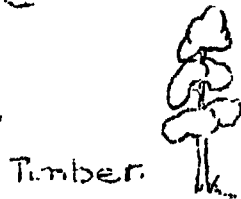

5. Send in your map and your Scrap Book pages.

WRITING.

Pupils are still sending in written work which shows that they have been neglecting their writing exercises. Thick down strokes and heavy lines are a sign that their pens are not travelling smoothly over the paper.

Five minutes daily should be spent in writing exercises. They should be done first thing in the morning upon old scribbling paper. You may use pencil or pen. You may even turn your pen upside down so that you are only pretending to write. The important thing is the movement, the free swinging movement, that you were taught in Lessons 2 and 3. In Lesson 2 you wrote groups of letters like this:-

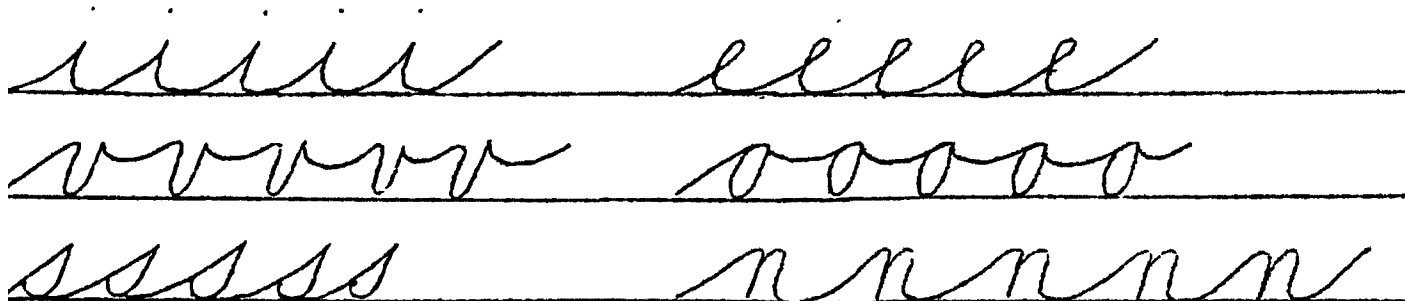

You sang a little song to help you with the swing. Music is important and should always be used in a writing exercise.

Your hand should move as steadily in a writing exercise as your feet would do if you were marching in time to a band.

Revise your writing rules. See that you are sitting properly and holding your pen correctly. Look at the diagram which was sent to you with your first Writing Lesson.

Make up your own exercises, doing groups o, a, e, s (s gives a splendid swing) u, and other letters.

Here is one exercise to send in:

Write the word "sunshine". Make the space between each letter and the next so great that the word takes up a whole line and goes right across the page. Do several lines of this. Then write the words "lilies" and "woodland" in the same manner.

Now choose your own words. Remember, only one word to a line and it must use up the whole line. You will find it almost impossible to press hard on your pen, and it is this heavy pressing on the pen that we want to stop.

---

Nearly every day you will be asked to do some work to be sent in. Be sure to keep your Parts A and B separate, please. Label all sums carefully, too. Try Card 3 (below) every day.

First day: Ex.80.

<u>Send in:</u>	<u>Part A</u>	and	<u>Part B.</u>
	Ex.80 B. <u>Written:</u> 3, 7.		Ex.80 B. <u>Written:</u> 2, 6.

Second day: Ex.81.

Third day: Ex.82. I suppose you can all tell the time, but if you cannot, now is the time to learn.

Fourth day: Ex.83. You will need to study the book very carefully for these sums. Do each step as instructed, and you will not find it difficult. Do all Ex.83 orally, until you are sure of the steps, and then write the answers.

Fifth day: Ex.83.

<u>Send in:</u>	<u>Part A</u>	and	<u>Part B.</u>
	Ex.83. A 3, 5, 7. B 3, 5, 7.		Ex.83. A 2, 4, 8. B 2, 4, 8.

Sixth day: Ex.84.

<u>Send in:</u>	<u>Part A</u>	and	<u>Part B.</u>
	Ex.84. A 3, 5. B 3, 5.		Ex.84. A 2, 4. B 2, 4.

Seventh day: Ex.85.

<u>Send in:</u>	<u>Part A</u>	and	<u>Part B.</u>
	Ex.85. Nos. 5 and 7,		Ex.85. Nos. 2 and 6.

Eighth day: Ex.86.

Ninth day: Ex.86.

<u>Send in:</u>	<u>Part A</u>	and	<u>Part B.</u>
	Ex.86. A 3, 5, 7. B 3, 5, 7.		Ex.86. A 2, 6, 10. B 2, 6, 10.

Tenth day: Ex.87.

<u>Send in:</u>	<u>Part A</u>	and	<u>Part B.</u>
	Ex.87. A 3, 5. B 3, 5.		Ex.87. A 2, 4. B 2, 4.

---

ARITHMETIC.

-7-

Detach this page from your set and send it in.

A. SPEED.

- |                  |                  |
|------------------|------------------|
| 1. 5"3d. ÷ 7 =   | 6. 15"6d. ÷ 6 =  |
| 2. 8"3d. ÷ 9 =   | 7. 16"3d. ÷ 5 =  |
| 3. 13"4d. ÷ 8 =  | 8. 18"8d. ÷ 4 =  |
| 4. 18"4d. ÷ 11 = | 9. 11"5½d. ÷ 5 = |
| 5. 17"6d. ÷ 12 = | 10. 12"3d. ÷ 6 = |

Time: \_\_\_\_\_

3. Copy this: To find the price of a score when the price of one is given:

- Each 1s. becomes £1.  
 Each 6d. becomes 10s.  
 Each 3d. becomes 5s.  
 Each 9d. becomes 15s.

Find the cost of:

- |                                     |                                  |
|-------------------------------------|----------------------------------|
| 1. 1 rubber costs 3d. 20 cost _____ | 9. 20 buns at 3d. each _____     |
| 2. 1 pad costs 6d. 20 cost _____    | 10. 20 papers at 9d. each _____  |
| 3. 1 book costs 9d. 20 cost _____   | 11. 20 stamps at 3d. each _____  |
| 4. 1 ball costs 6d. 20 cost _____   | 12. 20 tops at 6d. each _____    |
| 5. 1 pencil costs 3d. 20 cost _____ | 13. 20 toys at 9d. each _____    |
| 6. 1 ruler costs 6d. 20 cost _____  | 14. 20 purses at 6d. each _____  |
| 7. 1 file costs 9d. 20 cost _____   | 15. 20 glasses at 9d. each _____ |
| 8. 1 orange costs 3d. 20 cost _____ | 16. 20 jars at 3d. each _____    |

3. Find the cost of:

- |   |       |
|---|-------|
| 1. 20 handkerchiefs at 1"6d. each         | _____ |
| 2. 20 bags at 4"6d. each                  | _____ |
| 3. 20 lb. of grapes at 2"6d. a lb.        | _____ |
| 4. 20 hats at 17"3d. each                 | _____ |
| 5. 20 pairs of gloves at 14"3d. a pair    | _____ |
| 6. 1 score of shirts at 15"9d. each       | _____ |
| 7. 1 score of scarves at 12"9d. each      | _____ |
| 8. 1 score of brushes at 14"6d. each      | _____ |
| 9. 1 score of blouses at 19"9d. each      | _____ |
| 0. 1 score of cushions at 17"3d. each     | _____ |
| 1. 20 pairs of stockings at 11"6d. a pair | _____ |
| 2. 1 score of vases at 7"9d. each         | _____ |

Card 3. Time taken:

- 1st day \_\_\_\_\_ 2nd day \_\_\_\_\_ 3rd day \_\_\_\_\_ 4th day \_\_\_\_\_  
 5th day \_\_\_\_\_ 6th day \_\_\_\_\_ 7th day \_\_\_\_\_ 8th day \_\_\_\_\_  
 9th day \_\_\_\_\_ 10th day \_\_\_\_\_

Cut off and mount this card. Remember that no answers are to be written on the card.

Card 3.

- |              |              |              |               |
|--------------|--------------|--------------|---------------|
| 1. 28 + 7 =  | 6. 37 + 6 =  | 11. 38 + 8 = | 16. 19 + 8 =  |
| 2. 35 + 18 = | 7. 26 + 14 = | 12. 48 + 5 = | 17. 25 + 9 =  |
| 3. 29 + 16 = | 8. 25 + 7 =  | 13. 49 + 7 = | 18. 28 + 6 =  |
| 4. 58 + 9 =  | 9. 44 + 7 =  | 14. 83 + 8 = | 19. 27 + 9 =  |
| 5. 46 + 9 =  | 10. 26 + 8 = | 15. 79 + 9 = | 20. 19 + 15 = |

THE GOOSE GIRL.

An old queen, whose husband had been dead some years, had a beautiful daughter. When she grew up, she was betrothed to a prince who lived a great way off; and as time drew near for her to be married, she got ready to set off on her journey to his country. Then the queen, her mother, packed up a great many costly things - jewels, and gold, and silver; trinkets, fine dresses, and, in short, everything that became a royal bride; for she loved her child dearly: and she gave her a waiting-maid to ride with her, and give her into the bridegroom's hands; and each had a horse for the journey. Now the princess's horse was called Falada, and could speak.

When the time came for them to set out, the old queen went into her bed-chamber, and took a little knife, and cut off a lock of her hair, and gave it to her daughter, and said, "Take care of it, dear child; for it is a charm that may be of use to you on the road." Then they took a sorrowful leave of each other, and the princess put the lock of her mother's hair into her bosom, got upon her horse, and set off on her journey to her bridegroom's kingdom. One day, as they were riding along the side of a brook, the princess began to feel very thirsty, and said to her maid, "Pray get down and fetch me some water in my golden cup out of yonder brook, for I want to drink." "Nay," said the maid, "if you are thirsty, get down yourself, and lie down by the water and drink; I shall not be your waiting-maid any longer." Then she was so thirsty that she got down, and knelt over the little brook and drank, for she was frightened, and dared not bring out her golden cup; and then she wept, and said, "Alas! what will become of me?" And the lock of hair answered her, and said,

"Alas! alas! if thy mother knew it,  
Sadly, sadly her heart would rue it."

But the princess was very humble and meek, so she said nothing of her maid's ill behaviour, but got upon her horse again.

Then all rode farther on their journey, till the day grew so warm, and the sun so scorching, that the bride began to feel very thirsty again; and at last when they came to a river she forgot her maid's rude speech, and said, "Pray get down and fetch me some water to drink in my golden cup." But the maid answered her, and even spoke more haughtily than before, "Drink if you will, but I shall not be your waiting-maid." Then the princess was so thirsty that she got off her horse and lay down, and held her head over the running stream, and cried, and said, "What will become of me?" And the lock of hair answered her again,

"Alas! alas! if thy mother knew it,  
Sadly, sadly her heart would rue it."

And as she leaned down to drink, the lock of hair fell from her bosom and floated away with the water, without her seeing it, she was so frightened. But her maid saw it, and was very glad, for she knew the charm, and saw that the poor bride would be in her power, now that she had lost the hair. So when the bride had done, and would have got upon Falada again, the maid said, "I shall ride upon Falada, and you may have my horse instead:" so she was forced to give up her horse, and soon afterwards to take off her royal clothes, and put on her maid's shabby ones.

At last, as they drew near the end of their journey, this treacherous servant threatened to kill her mistress if she ever told anyone what had happened. But Falada saw it all, and marked it well. Then the waiting-maid got upon Falada, and the real bride was set upon the other horse, and they went on in this way till at last they came to the royal court. There was great joy at their coming, and the prince flew to meet them, and lifted the maid from her horse, thinking she was the one who was to be his wife; and she was led upstairs to the royal chamber, but the true princess was told to stay in the court below.

## THE GOOSE-GIRL (continued).

But the old king happened to be looking out of the window, and saw her in the yard below; and as she look very pretty, and too delicate for a waiting-maid, he went into the royal chamber to ask the bride who it was she had brought with her, that was thus left standing in the court below. "I brought her with me for the sake of her company on the road," said she; "pray give the girl some work to do, that she may not be idle." The old king could not for some time think of any work for her to do; but at last he said, "I have a lad who takes care of my geese; she may go and help him." Now the name of this lad, that the real bride was to help in watching the king's geese, was Curdken.

Soon after, the false bride waid to the prince, "Dear husband, pray do me onc piece of kindness." "That I will," said the prince. "Then tell one of your slaughterers to cut off the head of the horse I rode upon, for it was very unruly, and plagued me sadly on the road:" but the truth was, she was very much afraid lest Falada should speak, and tell all she had done to the princess. She carried her point, and the faithful Falada was killed: but when the true princess heard of it, she wept, and begged the man to nail up Falada's head against a large dark gate in the city through which she had to pass every morning and evening, that there she might still see him sometimes. Then the slaughterer said he would do as she wished; cut off the head, and nailed it fast under the dark gate.

Early the next morning, as she and Curdken went out through the gate she said sorrowfully,

"Falada, Falada, there thou art hanging!"  
and the head answered,

"Bride, bride, there thou art ganging!  
Alas! alas! if they mother knew it,  
Sadly, sadly her heart would rue it."

Then they went out of the city, and drove the geese on. And when she came to the meadow, she sat down upon the bank there, and let down her waving locks of hair, which were all of pure silver; and when Curdken saw it glitter in the sun, he ran up, and would have pulled some of the locks out; but she cried,

"Blow, breezes, blow!  
Let Curkden's hat go!  
Blow, breezes, blow!  
Let him after it go!  
O'er hills, dales, and rocks,  
Away be it whirl'd,  
Till the silver locks,  
Are all comb'd and curl'd!"

Then came the wind, so strong that it blew off Curdken's hat; and away it flew over the hills, and he after it; till, by the time he came back, she had done combing and curling her hair, and put it up again safe. Then he was very angry and sulky, and would not speak to her at all; but they watched the geese until it grew dark in the evening, and then drove them homewards.

The next morning, as they were going through the dark gate, the poor girl looked up at Falada's head, and called the same words as the day before, and the head answered her in the same manner. Then she drove on the geese, and sat down again in the meadow, and began to comb out her hair as before; and Curdken ran up to her, and wanted to take hold of it; but she cried out her verse as before so that the wind blew his hat, so that he had to run after it. and when he came back, she had done up her hair again, and all was safe. So they watched the geese till it grew dark.

In the evening, after they came home Curdken went to the old king and said, "I cannot have that strange girl to help me to keep the geese any longer." "Why?" said the king. "Because she does nothing



THE GOOSE-GIRL (continued).

-16-

but tease me all day long." Then the king made him tell all that had passed. And Curdken said, "When we go in the morning through the dark gate with our flock of geese, she weeps, and talks with the head of a horse that hangs upon the wall, and says,

"Falada, Falada, there thou art hanging!"

and the head answers,

"Bride, bride, there thou art ganging!  
Alas! alas! if thy mother knew it,  
Sadly, sadly her heart would rue it."

And Curdken went on telling the king what had happened upon the meadow where the geese fed; and how his hat was blown away, and he was forced to run after it, and leave his flock. But the old king told him to go out again as usual the next day; and when morning came, he placed himself behind the dark gate, and heard how she spoke to Falada, and how Falada answered; and then he went into the field and hid himself in a bush by the meadow's side, and soon saw with his own eyes how they drove the flock of geese, and how, after a little time, she let down her hair that glittered in the sun; and then he heard her say her verse, as Curdken had told him. And soon came a gale of wind, and carried away Curdken's hat, while the girl went on combing and curling her hair. All this the old King saw; so he went home without being seen; and when the little goose-girl came back in the evening, he called her aside, and asked her why she did so; but she burst into tears, and said, "That I must not tell you or any man, or I shall lose my life."

But the old king begged so hard, that she had no peace till she told him all, word for word; and it was very lucky for her that she did so, for the king ordered royal clothes to be put upon her, and gazed on her with wonder, she was so beautiful. Then he called his son, and told him that he had only the false bride, for that she was merely a waiting-maid, while the true one stood by. And the young king rejoiced when he saw her beauty, and heard how meek and patient she had been; and without saying anything, ordered a great feast to be got ready for all his court. The bridegroom sat at the top, with the false princess on one side and the true one on the other; but nobody knew her, for she was quite dazzling to their eyes, and was not at all like the little goose-girl, now that she had her brilliant dress.

When they had eaten and drunk, and were very merry, the old king told all the story, as one that he had once heard of, and asked the true waiting-maid what she thought ought to be done to anyone who would behave thus. "Nothing better," said this false bride, "than that she should be thrown into a cask stuck round with sharp nails, and that two white horses should be put to it, and should drag it from street to street till she is dead." "Thou art she!" said the old king; "and since thou hast judged thyself, it shall be so done to thee." And the young king was married to his true wife, and they reigned over the kingdom in peace and happiness all their lives.

- From Grimm's Fairy Stories -

---

STANDARD 3.DRAWING.SET 11.

You have made designs with your ruler and pencil. This time you are to make one by cutting out a pattern on a potato.

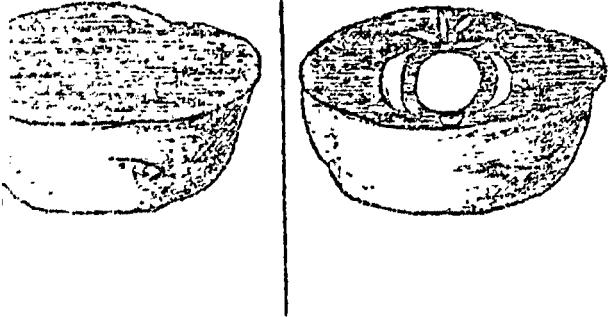

Cut your potato in half, so that a broad surface of white shows. Place this against a piece of blotting paper in order to soak up all the moisture.

It is best to draw your pattern first, so that you will know exactly what you wish to cut on the potato. Lightly trace the pattern on the potato with pencil, and cut away all the back-ground with a sharp knife, leaving the pattern standing out.

Put the ink or paints on the pattern with a brush, and then press the potato on the paper. You may vary the colours in your pattern by washing the surface of the potato each time, before putting on a different colour. The simplest way though, to vary the pattern in your design, is to use two potatoes.

When making a border design, divide it into even parts - so that your design is repeated at regular intervals. In addition to the ordinary line patterns, flowers, berries, or even a rabbit sitting among some green grass could be used as a border design.

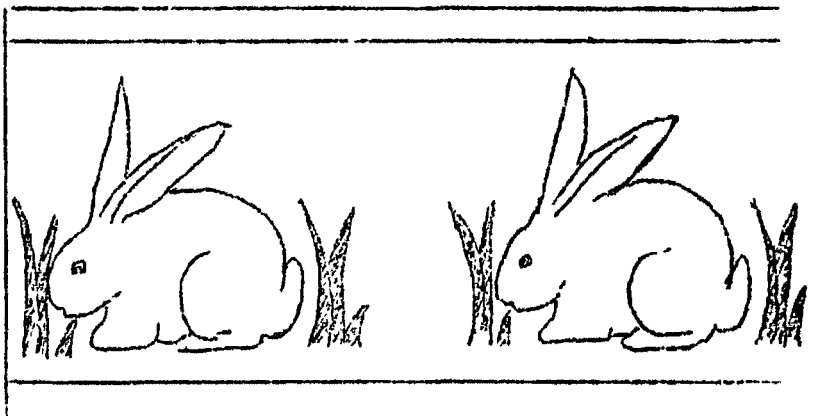
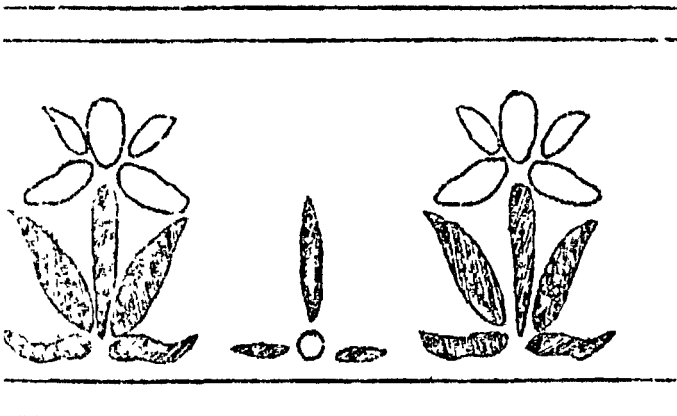

A design suitable for a dress material will need to be an all-over one, so it is best to square your paper. The lines dividing your paper into inch squares should be made very lightly, in order not to interfere with the design.

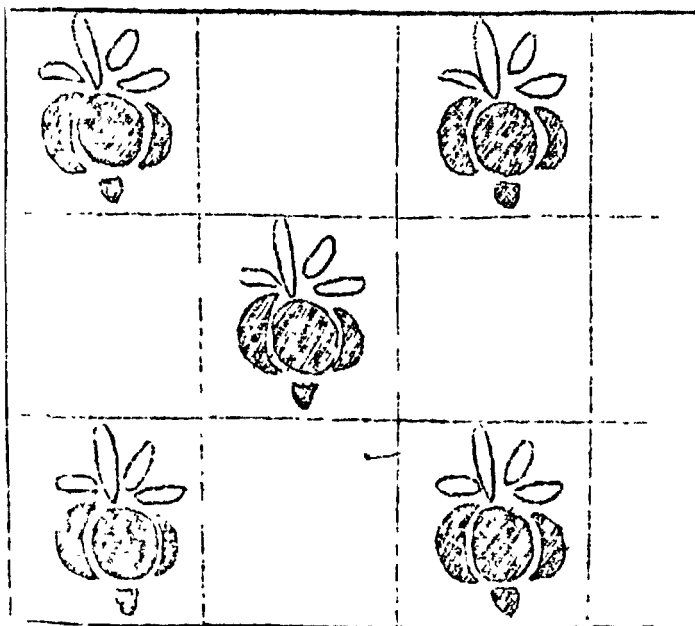

WORK TO SEND IN - using potato prints.

1. A design in a border - two inches by eight inches.
2. A pattern suitable for your little sister's frock in an eight inch square.

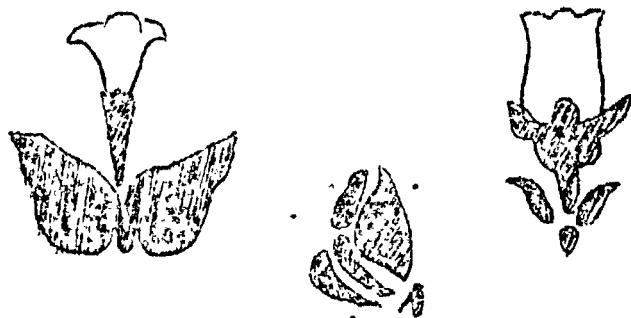

This set of Model Answers is the property of the Education Department.  
It is to be regarded as confidential, and is to be returned to the  
Department when asked for. PRIMARY DIVISION.

STANDARD 3.ENGLISH.SET 11.Lesson 1. Personal Pronouns.

(A pronoun is a word that stands instead of a noun.)

1. When Jason reached the other side of the river, he noticed that he had lost one of his sandals.
  2. The lady said that her name was Juno, and that she was Queen of the Heavens.
  3. The waters of the river were so muddy that you could not see the weeds below them.
  4. Juno is always accompanied by her peacock; she loves it for its gay feathers.
- 

Lesson 6. The Possessive.

- A.
    1. Did you see the queen's jewels?
    2. We have nearly finished papering my doll's house.
    3. Please let me have your family's address.
    4. Have you brought any of John's toys?
    5. My pony's mane is getting very long.
    6. Is that his sister's shop?
    7. The road is a great success, owing to this engineer's skill.
  - B.
    1. I borrowed Jim's bicycle to ride to town.
    2. The dog's collar has a new buckle.
    3. I had a ride in my uncle's car.
-

PART B.			
Ex. 80. B 2.	$\begin{array}{r} 21\frac{26}{32} \\ 32 \overline{)698} \\ \underline{64} \\ 58 \\ \underline{32} \\ 26 \end{array}$ <p>Answer: <u><math>21\frac{26}{32}</math></u></p>	Ex. 80. B 6.	$\begin{array}{r} 15\frac{44}{53} \\ 53 \overline{)839} \\ \underline{53} \\ 309 \\ \underline{265} \\ 44 \end{array}$ <p>Answer: <u><math>15\frac{44}{53}</math></u></p>
Ex. 83. A 2.	$\begin{array}{l} 9\frac{1}{2}d. \\ 4d. \\ \underline{5\frac{1}{2}d.} \end{array}$ <p>Answer: <u><math>5\frac{1}{2}d.</math></u></p>	Ex. 83. A 4.	$\begin{array}{l} 8d. \\ 5\frac{1}{2}d. \\ \underline{2\frac{1}{2}d.} \end{array}$ <p>Answer: <u><math>2\frac{1}{2}d.</math></u></p>
Ex. 83. A 8.	$\begin{array}{l} s. d. \\ 4'' 11 \\ 2'' 7\frac{1}{2} \\ \underline{2'' 3\frac{1}{2}} \end{array}$ <p>Answer: <u><math>2'' 3\frac{1}{2}d.</math></u></p>	Ex. 83. B 2.	$\begin{array}{l} s. d. \\ 12'' 10 \\ 9'' 6\frac{1}{2} \\ \underline{3'' 3\frac{1}{2}} \end{array}$ <p>Answer: <u><math>3'' 3\frac{1}{2}d.</math></u></p>
Ex. 83. B 4.	$\begin{array}{l} s. d. \\ 6'' 5 \\ 3'' 9\frac{1}{2} \\ \underline{2'' 7\frac{1}{2}} \end{array}$ <p>Answer: <u><math>2'' 7\frac{1}{2}d.</math></u></p>	Ex. 83. B 8.	$\begin{array}{l} s. d. \\ 8'' 9 \\ 3'' 5\frac{1}{2} \\ \underline{5'' 3\frac{1}{2}} \end{array}$ <p>Answer: <u><math>5'' 3\frac{1}{2}d.</math></u></p>
Ex. 84. A 2.	$\begin{array}{l} s. d. \\ 16'' 10 \\ 8'' 9\frac{1}{2} \\ \underline{8'' 0\frac{1}{2}} \end{array}$ <p>Answer: <u><math>8'' 0\frac{1}{2}d.</math></u></p>	Ex. 84. A 4.	$\begin{array}{l} s. d. \\ 15'' 10 \\ 9'' 11 \\ \underline{5'' 11} \end{array}$ <p>Answer: <u><math>5'' 11d.</math></u></p>
Ex. 84. B 2.	$\begin{array}{l} s. d. \\ 17'' 5 \\ 3'' 4\frac{1}{2} \\ \underline{14'' 0\frac{1}{2}} \end{array}$ <p>Answer: <u><math>14'' 0\frac{1}{2}d.</math></u></p>	Ex. 84. B 4.	$\begin{array}{l} s. d. \\ 17'' 6 \\ 5'' 8\frac{1}{2} \\ \underline{11'' 9\frac{1}{2}d.} \end{array}$ <p>Answer: <u><math>11'' 9\frac{1}{2}d.</math></u></p>
Ex. 85. 2.	$\begin{array}{l} £ s. d. \\ 1'' 12'' 3 \\ \underline{\phantom{1''} 7} \\ 11'' 5'' 9 \end{array} \quad \begin{array}{l} £4'' 5s. \\ 20 \overline{)87s.} \end{array}$ <p>Answer: <u><math>£11'' 5'' 9d.</math></u></p>	Ex. 85. 6.	$\begin{array}{l} £ s. d. \\ 1'' 9'' 4 \\ \underline{\phantom{1''} 9} \\ 13'' 4'' 0 \end{array} \quad \begin{array}{l} £4'' 4s. \\ 20 \overline{)84s.} \end{array}$ <p>Answer: <u><math>£13'' 4'' 0d.</math></u></p>

PART B. (continued)			
Ex. 86. A 2.	$\begin{array}{r} 8''9d. \\ 2 \overline{)17''6d.} \end{array}$ <p style="text-align: center;"><u>Answer: 8''9d.</u></p>	Ex. 86. A 6.	$\begin{array}{r} 9''3d. \\ 2 \overline{)18''6d.} \end{array}$ <p style="text-align: center;"><u>Answer: 9''3d.</u></p>
Ex. 86. A 10.	$\begin{array}{r} £ 7'' 9s. \\ 2 \overline{)£14''18s.} \end{array}$ <p style="text-align: center;"><u>Answer: £7''9s.</u></p>	Ex. 86. B 2.	$\begin{array}{r} 5'' 3\frac{1}{2}d. \\ 3 \overline{)15''10\frac{1}{2}d.} \end{array}$ <p style="text-align: center;"><u>Answer: 5''3\frac{1}{2}d.</u></p>
Ex. 86. B 6.	$\begin{array}{r} 6''2d. \\ 3 \overline{)18''6d.} \end{array}$ <p style="text-align: center;"><u>Answer: 6''2d.</u></p>	Ex. 86. B 10.	$\begin{array}{r} £ 3''9s. \\ 3 \overline{)£10''7s.} \end{array}$ <p style="text-align: center;"><u>Answer: £3''9s.</u></p>
Ex. 87. A 2.	57,019	Ex. 87. A 4.	22,463
Ex. 87. B 2.	62,408	Ex. 87. B 4.	90,009

This Assignment is the property of the Education Department. It is to be regarded as confidential, and is to be returned to the Department when asked for.

PRIMARY DIVISION.

STANDARD 4.

1936.

SET 8.

SPELLING: de Berry's "Individual Spelling Book".

1st week: Learn list 15, page 33. Revise list 12, page 31.

2nd week: Learn list 16, page 33. Revise list 13, page 32.

ENGLISH: Whitcombe's "Progressive English Course".

Lesson 1.THE KOALA'S PARADISE - A TRAVELLER'S TALE

When you have read this story, which is attached to the back of your Set, you will want to sail to Australia immediately. Who could resist the opportunity of seeing a real live "Teddy"?

WORK TO SEND IN:

1. Sketch a small map of Australia showing the position of Phillip Island, and the other places mentioned in the first paragraph of the story.
2. (a) Phillip Island is a reserve for koalas. What does this mean?  
(b) Have we any similar reserves? If possible, name one.
3. What is a baby koala called?
4. What noises does a koala make?
5. (a) In what way is a koala like a "Teddy"?  
(b) In what way is he different?
6. What does a koala eat?
7. The story is full of vivid words and expressions. Make a list of those that appeal most to you. See if you can use them in Lesson 2 and Lesson 4 below.

Lesson 2.THE TWO RATS

He was a rat, and she was a rat,  
And down in one hole they did dwell.  
And both were as black as a witch's cat,  
And they loved one another well.

He had a tail, and she had a tail,  
Both long, and curling and fine;  
And each said, "Yours is the finest tail  
In the world excepting mine."

We should like you to rewrite this poem so that it tells about two of Australia's native bears - the koalas - that you enjoyed reading about in Lesson 1. You will commence your poem thus:- "He was a bear, and she was a bear." Watch the rhythm of the lines and see that the end words rhyme. Remember also to give your poem a title.

Alongside your poem, it would be a good idea to make a drawing of a koala.

Lesson 3. The Two Parts of a Sentence, page 80.

Answer 2 (a), (b), (c).  
3 (a), (b), (c).

Lesson 4. KOALA AND TEDDY MEET

Imagine that a young traveller has dropped a Teddy Bear on Phillip Island, and write an account of the conversation that would take place when Koala suddenly comes across Teddy lying near the foot of his favourite tree.



Set cut your lesson in the form of a play like "The Whisker" on page 47 of the April Journal. Describe the scene at the beginning and put all directions in brackets.

Lesson 5. Negatives, page 91.

Carefully read the help and instructions. Answer sentences 1 to 6.

Lesson 6. Quotation Marks, page 92.

Answer all the sentences in Groups I and II. You will now be able to show whether you have fully grasped the five rules taught you in Set 7, Lesson 10.

Lesson 7. A Picture Story, page 92. Answer 2.

Lesson 8. Vocabulary Exercise, page 94.

Lesson 9. A Story, page 94. Answer 2.

Lesson 10. Agreement, page 95.

The important word in the subject is a noun or pronoun. This part of the subject is known as the simple subject. Take the following sentence:- The girl entered the room.

The subject is the girl. The simple subject is girl.

Where there is just one word in the subject, then the simple subject and the subject are one and the same thing, e.g.

You entered the room.

In the above sentence you is both the subject and the simple subject.

**NOTE:** When and is used in the subject, then the simple subject consists of two words - nouns or pronouns - as in the following:-

- 1. Joan and Jack are coming. Simple subject: Joan Jack.
- 2. You and Jack are coming. Simple subject: You Jack.

The important word in the predicate is a verb. The verb, therefore, is part of the predicate, except in short sentences where it forms the whole predicate as follows:- She is coming.

Predicate: is coming. Verb: is coming.

**RULE:** The verb always agrees with the simple subject in number. That is, when the simple subject is singular, the verb must be singular, and when the simple subject is plural, the verb must be plural.

Send in answers to the following on page 95:-

- I 1, 3, 5, 7.
- II 2, 4, 6. Think carefully before doing answer 6. . . .

Puk Wudjies

[ "The Puk-Wudjies--- the

little people." Longfellow ]

They live 'neath

the curtain

of fir-woods

and heather."

Use this copy as a railway line and your pencil as a train. Go over the words several times and then copy them on the lines below.

Send in this page.



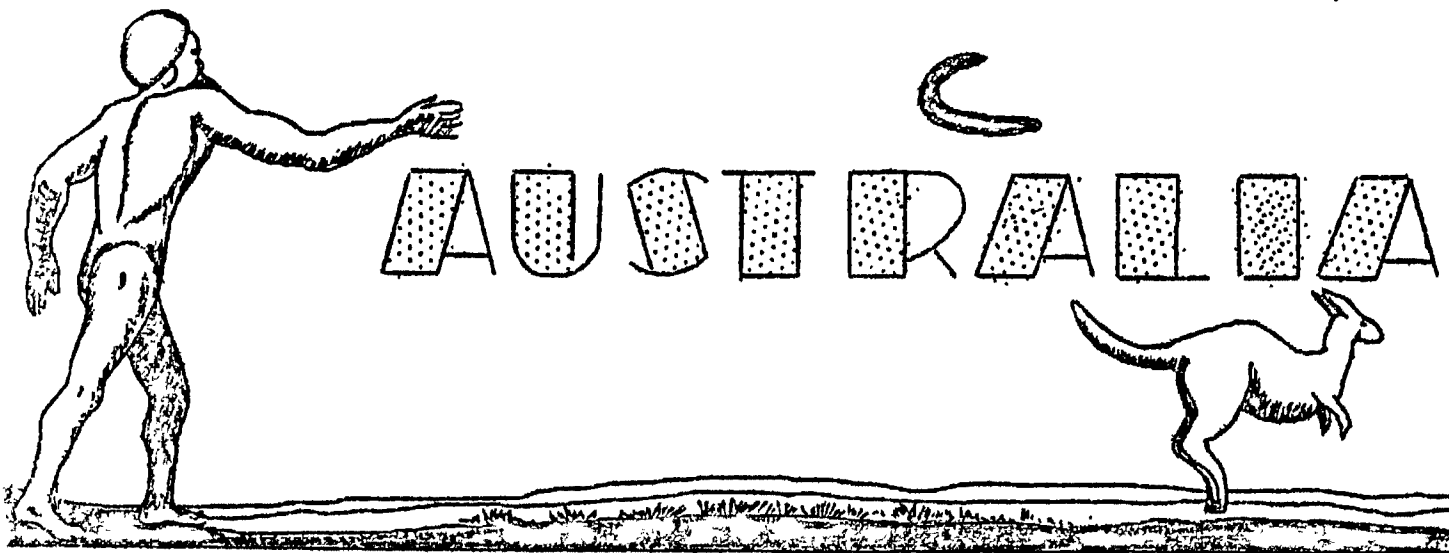

A. As often as possible in the first week read your history book from pages 57 to 67. It tells you of the coming of the first white explorers to Australia.

B. See how much you can find out about the people who lived in Australia before the white man - the aborigines. Start a section on "The Native of Australia" for your scrap book, using pictures or drawings.

You will find that in many ways the Australian blacks were very different from the Maoris. In the first place, they did not live in villages but wandered about from place to place. Their homes were flimsy bark huts called "mia-mias". They would desert these and pass on as soon as they had used all the food in a district. They did not grow crops and most of their food would have seemed very strange to us - lizards, rats, frogs, snakes, fish when they could get them, and many kinds of plants and roots. Generally too they ate their food raw!

They were very clever hunters and I am sure you will be able to find pictures of blacks using boomerangs and spears. In the isolated parts of Australia, particularly in the North-west many blacks still live today in much the same way as they did in the days of Tasman and Dampier. So we find it easy to get information about them - about their tribes, their "corroborees", their "magic" and so on. I wonder how much you will be able to find out?

WORK TO SEND IN.

A. Give brief answers to these questions:-

1. The Spanish captain who first saw Australia was .....
2. .... was the name given by the Dutch to Australia.
3. The Dutch left Australia alone because .....
4. Van Diemen's Land was the name given by ..... to .....
5. .... was the first Englishman to visit Australia.
6. The "Roebuck" was the name of .....
7. Dampier only turned back from Australia when .....
8. Captain Cook landed on the Australian coast at .....
9. .... was the name of Cook's ship.
10. Cook sailed north up the coast till he reached ..... (Trace his course in your atlas.)

B. Write a short paragraph about the Australian blacks.

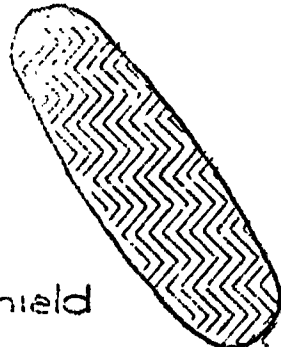

Shield

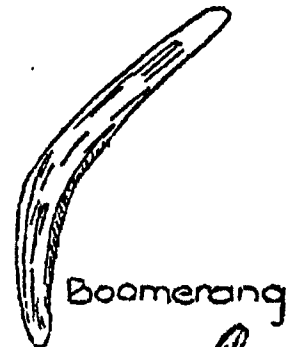

Boomerang

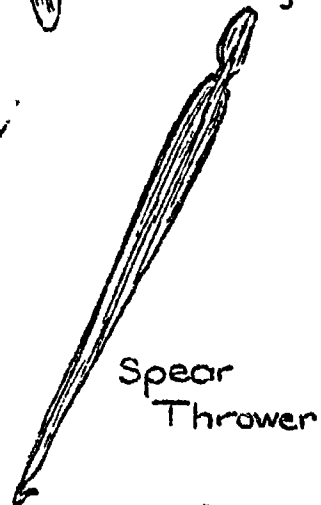

Spear Thrower

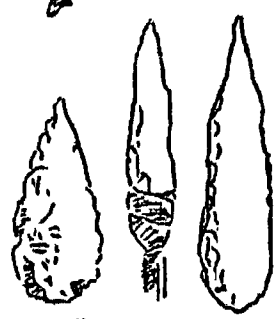

Flints



Making Fire by Friction



Following a Bee for Honey



A Eucalyptus Tree

GEOGRAPHY.

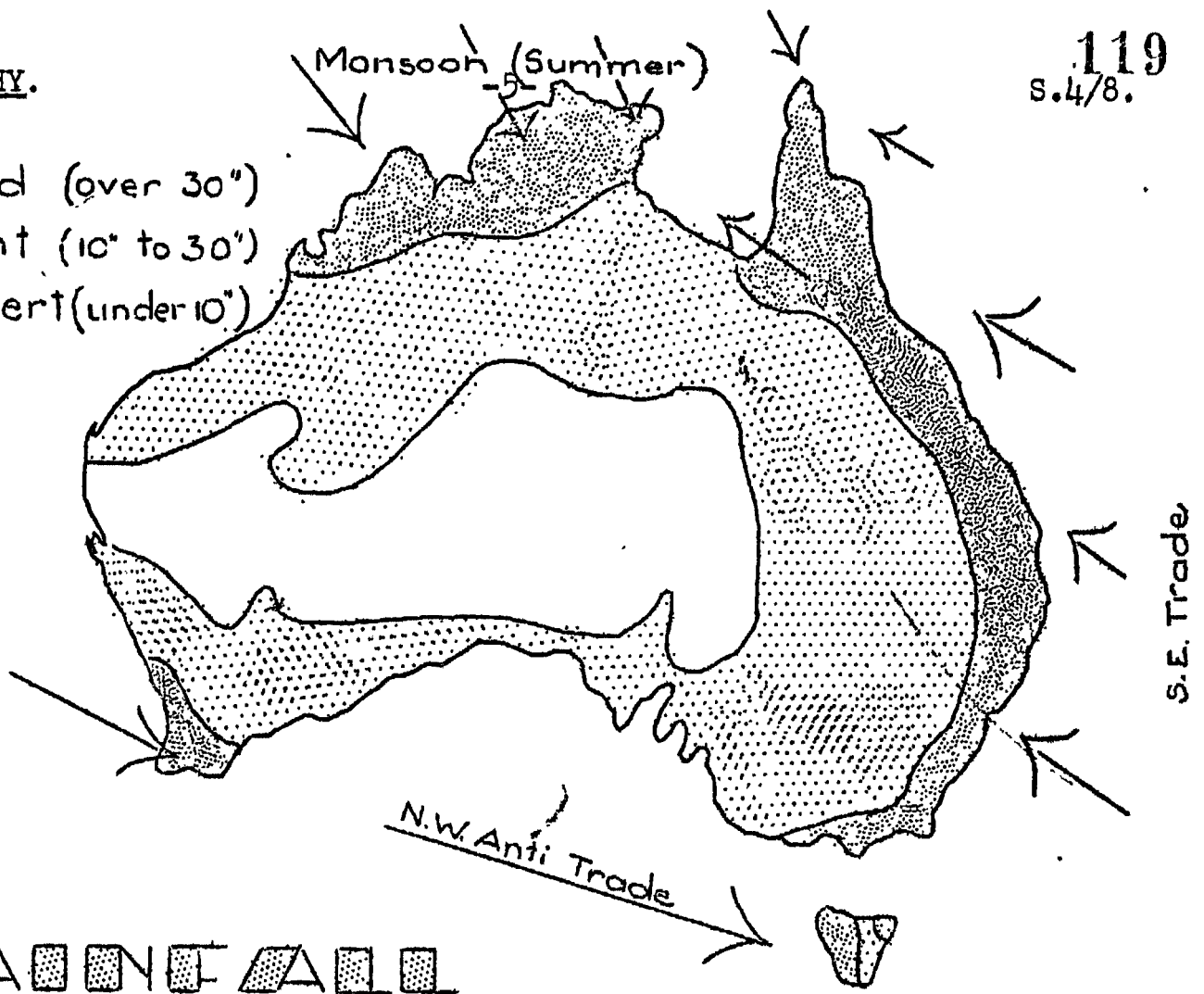
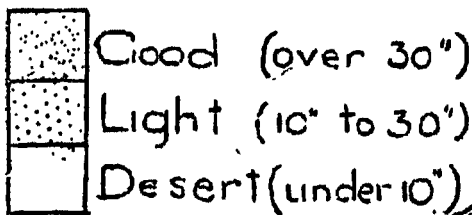

RAINFALL

During the first week:-

- Read Chapters XI and XII as often as possible. While you are doing so make use of your atlas and also of the rainfall map above. You will see from the map how the winds affect the rainfall. Compare Australia's rainfall with that of New Zealand. You will see that by far the greater part of Australia has little or no rain. Chapter XII will show how this makes a difference to the lives and work of the people. You will know, of course, that practically nothing can be grown in the DESERT.
- Begin collecting Australian pictures for your scrap book - particularly pictures connected with the work of the people.

During the second week:- (Send this work in.)

- Make a very neat copy of the rainfall map on this page - make it the same size. With paints, if you have them, colour in the three different parts. I suggest GREEN for the good rainfall area, BLUE for the part with light rainfall, and YELLOW for the desert. Remember to label your map.
- Give brief answers to these questions:-
  - Australia is about ..... times the SIZE of New Zealand.
  - The CLIMATE of Australia is ..... in the north while the southern parts have a climate like .....
  - ..... is the long range of MOUNTAINS running from north to south.
  - Three very important Australian RIVERS are ....., ....., .....
  - Another name for "The DEAD HEART of Australia" is .....
- Answer (in complete sentences) questions 5 and 6 on page 103.

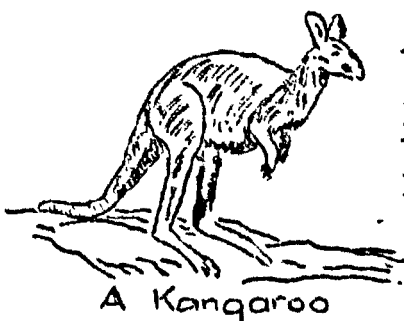

After reading about the dry interior of Australia you will enjoy the little poem - "The Drovers". You will find it at the end of the Koala story.



ARITHMETIC. Whitcombe's "Progressive Arithmetic"

Keep Part A and Part B separate and send in the pages in their right order.

Revise the dozen rule (Set 3, First Day). Then do ten examples from Card II.

FIRST DAY: Revise thoroughly the 1 $\frac{1}{2}$ d. Table and the Halfcrown Table, page 130.

Part A: Revise Set 6, Second Day, and do these sums:-

1. £586"12"3d. ÷ 95
2. A man's income is £464 per year. How much may he spend per week if he wishes to save £100?
3. A crate of 90 bicycles costs £668"5"0d.; what is the cost of each bicycle?

SECOND DAY: Do the last 10 examples from Card II. Revise thoroughly the Parts of a Pound Sterling Table, page 131.

Part B: Ex.46. B 1, 4.

THIRD DAY: Mental: Revise the Score Rule, (Set 3, First Day). Then do Card III.

Part B: Ex.33. B 1 (a), (b), (c); 2 (a), (b), (c).

FOURTH DAY: Read carefully the five examples of the method of multiplying called Practice, on page 31. Here is a clearer way of setting out Example (d):-

$3^{\text{d}}$	= $\frac{1}{6}$ of £1	£	s.	d.	= cost at	£	s.	d.	each	
		128	"	0	"	1	"	0	"	0
		21	"	6	"	"	"	3	"	4
		£149	"	6	"	"	"	1	"	3
				8	"			4	"	

Answer: £149"6"8d.

To find the cost at  $3^{\text{d}}$  each we divide £128 by 6, because the cost at  $\frac{1}{6}$  of £1 each is  $\frac{1}{6}$  of the cost at £1 each. We remind ourselves about this by writing  $3^{\text{d}}$  =  $\frac{1}{6}$  of £1 to the left of the line that shows the

cost at  $3^{\text{d}}$  each. Example (e) could be set out in just the same way but you would have to subtract instead of adding.

Part A: Do the following sums exactly as shown above:-

1. Find the cost of 57 sheep at £1"5"0d. each.
2. What do 48 clocks cost if each costs 18 shillings.

FIFTH DAY: When finding by practice the cost of a number of articles at several pounds each, you must first multiply the cost at £1 by the number of pounds.

Example: Find the value of 35 bicycles at £7"15 each.

	£	s.	d.	= value at	£	s.	d.	each.
	35	"	0	"	1	"	0	"
			7				7	"
	245	"	0	"	"	"	7	"
10s. = $\frac{1}{2}$ of £1	17	"	10	"	"	"	10	"
5s. = $\frac{1}{2}$ of 10s.	8	"	15	"	"	"	5	"
	271	"	5	"	"	"	7	"
			15	"			0	"

Answer: £271"5"0d.

...

FIFTH DAY (contd).

Here the cost at 10s. each is found by dividing £35 by 2, because the cost at 10s. each is half the cost at £1 each. We remind ourselves of this by putting 10s. =  $\frac{1}{2}$  of £1 opposite the line that gives the cost at 10s. each.

To find the cost at 5s. each it is easier to divide £17<sup>10s.</sup> by 2 than to divide £35 by 4, but of course both methods would give the same result. In the example given, the shorter method has been used, so we write 5s. =  $\frac{1}{2}$  of 10s.

Part B: Ex.15. C 1, 2; D 3.

---

SIXTH DAY: Mental: Do all Card II again.

Written: Part B: Ex.24. B 1, 3; C 5. Do these by practice.

---

SEVENTH DAY: Part B: Ex.28. D (written) 3, 9.

---

EIGHTH DAY: Mental: Do Card III again.

Part A: Find by practice the cost of:-

1. 76 bicycles at £6<sup>12</sup>0d. each.
  2. 65 carpet sweepers at £2<sup>14</sup>0d. each.
  3. 47 garden forks at 13<sup>4</sup>d. each.
- 

NINTH DAY: Mental: Do Card II (Set 5).

Part A: Ex.42. A 3, 4, 6, 7.

---

TENTH DAY: Revise 1 $\frac{1}{2}$ d. Table and Halfcrown Table on page 130.

Learn this Table again:-

$$20s. = £1$$

$$16^8d. = £\frac{5}{6}$$

$$13^4d. = £\frac{2}{3}$$

$$10s. = £\frac{2}{4}$$

$$6^8d. = £\frac{1}{3}$$

$$3^4d. = £\frac{1}{6}$$

Do Cards IV and V.

---

Here are four more cards. You already have one you made in Set 5. Add these to your collection.

Cut out your cards and mount them on cardboard. Cut each rule out and paste it on the back and below put the example.

DOZEN RULE. Card II.

1. If 12 cost 7s. what does one cost?
2. If 12 cost 3s. what does one cost?
3. If 12 cost 5s. what does one cost?
4. If 12 cost 14s. what does one cost?
5. If 12 cost 17s. what does one cost?
6. 9s. a dozen. How much for one?
7. 9<sup>6</sup>d. a dozen. How much for one?
8. 2<sup>6</sup>d. a dozen. How much for one?
9. 6<sup>9</sup>d. a dozen. How much for one?
10. 19<sup>3</sup>d. a dozen. How much for one?
11. 8s. for 2 dozen. How much for one?
12. 12s. for 24. How much for one?
13. 30s. for 3 dozen. How much for one?
14. 16<sup>6</sup>d. for 36. How much for one?
15. 48 cost 5s. What does one cost?
16. 60 cost 12<sup>6</sup>d. What does one cost?
17. 24 cost 19s. What does one cost?
18. 72 cost 18s. What does one cost?
19. 17<sup>3</sup>d. ÷ 12
20. 14<sup>9</sup>d. ÷ 12

THE DOZEN RULE.

Any number of shillings divided by 12 gives the same number of pence.

Example -

If 12 things cost 7<sup>6</sup>d. one thing will cost 7<sup>1</sup>/<sub>2</sub>d.

N.B.- Read this aloud several times.

SCORE RULE. Card III.

1. 20 × 1s. =
2. 20 × 3s. =
3. 20 × 4<sup>6</sup>d. =
4. 20 × 6<sup>9</sup>d. =
5. 20 × 2<sup>3</sup>d. =
6. 40 × 5s. =
7. 60 × 5s. =
8. 80 × 5s. =
9. 100 × 5s. =
10. 1 score at 1<sup>6</sup>d. each =
11. 4 score at 1<sup>6</sup>d. each =
12. 40 at 7s. =
13. 40 at 7<sup>9</sup>d. =
14. 6d. × 20 =
15. 3d. × 20 =
16. 4d. × 20 =
17. 2d. × 20 =
18. 2<sup>3</sup>d. × 20 =
19. 22<sup>3</sup>d. × 20 =
20. 18<sup>6</sup>d. × 40 =

SCORE RULE.

Any number of shillings multiplied by 20 gives the same number of pounds.

Examples -

If 1 things costs 1s. 20 cost £1.

If 1 thing costs 3<sup>6</sup>d. 20 cost £3<sup>10</sup>s.

If 1 thing costs 4d. (<sup>1</sup>/<sub>3</sub>s.) 20 cost 6<sup>8</sup>d. (£<sup>1</sup>/<sub>3</sub>)

N.B. - Read this aloud several times.

NEVER WRITE AN ANSWER ON THE CARDS THEMSELVES.

SCORE RULE. Card IV.

1. £1 ÷ 20 =
2. £3 ÷ 20 =
3. £6 ÷ 20 =
4. £6 ÷ 40 =
5. £8 ÷ 40 =
6. £12 ÷ 60 =
7. £2"10s. ÷ 20 =
8. £4"5s. ÷ 20 =
9. £3"15s. ÷ 20 =
10. £2"6"8d. ÷ 20 =
11. £6"3"4d. ÷ 20 =
12. £5"2"6d. ÷ 20 =
13. £4"13"4d. ÷ 20 =
14. £9"16"8d. ÷ 20 =
15. £10"5"0d. ÷ 20 =
16. £10"10"0d. ÷ 40 =
17. £3"15"0d. ÷ 60 =
18. £10 ÷ 80 =
19. 40 cost £2"10s. One costs?
20. 60 cost £22"10s. One costs?

SCORE RULE.

Any number of pounds divided by 20 gives the same number of shillings.

N.B. - To divide by 40, divide by 2 and then 20. Sixty =  $\frac{3}{2} \times 20$ , eighty =  $4 \times 20$ .

Examples -

If 20 things cost £4,  
1 costs 4s.

If 20 things cost £2"5s.  
1 costs 2"3d.

If 20 things cost 3"4d. ( $\frac{1}{6}$  of £1)  
1 costs 2d. ( $\frac{1}{3}$  s.)

N.B. - Read this aloud.

SCORE RULE. Card V.

1.  $1\frac{1}{2}$ d. × 20 =
2.  $4\frac{1}{2}$ d. × 20 =
3.  $7\frac{1}{2}$ d. × 20 =
4.  $10\frac{1}{2}$ d. × 20 =
5.  $4\frac{1}{2}$ d. × 40 =
6.  $1"1\frac{1}{2}$ d. × 40 =
7.  $7"4\frac{1}{2}$ d. × 40 =
8.  $2"4\frac{1}{2}$ d. × 60 =
9.  $12"1\frac{1}{2}$ d. × 40 =
10.  $1\frac{1}{2}$ d. × 80 =
11. 20 cost 2"6d. One costs?
12. 20 cost 7"6d. One costs?
13. 20 cost 10s. One costs?
14. 20 cost 15s. One costs?
15. 20 cost 12"6d. One costs?
16. 20 cost 17"6d. One costs?
17. 40 cost 5s. One costs?
18. 60 cost 15s. One costs?
19. 20 cost £2"2"6d. One costs?
20. 20 cost £5"7"6d. One costs?

RULE.

Any part of a shilling multiplied by 20 gives the same part of a pound.

Examples -

$1\frac{1}{2}$ d. ( $\frac{1}{8}$  of 1s.) × 20 = 2"6d.  
( $\frac{1}{8}$  of £1).

$10\frac{1}{2}$ d. ( $\frac{5}{8}$  of 1s.) × 20 = 12"6d.  
( $\frac{5}{8}$  of £1).

N.B. - Read this aloud.

N.B. Never write an answer on the card itself

THE KOALA'S PARADISE - A TRAVELLER'S TALE



I took a train from Melbourne to Stony Point, a distance of some fifty miles, and then went on by steamer over a strip of channel to Phillip Island. This island faces Tasmania across Bass Strait, but on the day I arrived I was ready to believe it faced the South Pole, so cold it seemed after the heat of the main-land.

Phillip Island is rough country, such as you can imagine if you think of any of the many islands you may know, but you could never imagine the native bears - the \* koalas. The island is a reserve for them. They are allowed to breed, and eat gum tips, their only food, as freely as they like. No one molests them. No one shoots them to make muffs from their thick soft fur. They live

at peace among the three tops, the most enchanting little people that ever drew breath.

Koalas are on view at any hour of the day. To see them, all you need to do is to look up. If your luck is in, you will see half a dozen small grey forms tucked securely into the forks of the trees, peacefully asleep. "The night for living," says the koala, "the day for rest;" and his family have sat so long and so firmly among the branches that they have no tails left.

When you have found your koalas, choose the one you love the best, clap your hands, and shout "Teddy!" Teddy wakes up, rubs the sleep out of his eyes, and turns round slowly to stare down at you in gentle astonishment.

"Bless me!" he says; "here's another of those long-legged bears that grow no fur!"

He keeps his little round eyes fixed on yours, blinking solemnly, and all you can do is wriggle with delight at your discovery that in this grown-up world you have met the most lovable toy of childhood come to life. Here is the very teddy-bear Aunt Alice gave you when you were three. -- Perhaps not the same colour, for koala favours grey or silver or a glossy brown-black, and goes in for white waistcoats; but otherwise, front view, they are twins. The same big bushy ears; the same trusting little face; the same absurd black button of a nose. Side-face, however, koala is slightly different from the teddy-bear you cuddled in your cot. His nose is hooky.

If you waken koala towards evening, he may decide it is time he roused himself and got his breakfast. He gets out of his arm-chair and climbs upwards, slowly and carefully, clasping the boughs with arms and feet and sticking his strong, curved, needle-pointed claws into the bark. He stretches out a hand to a leaf, pulls it gently to that ridiculous nose, and sniffs. No! too mature. He selects another; touches it with the tiniest tip of narrow pink tongue. No-o! a little too tough. He climbs higher. Tries again. Then again. At last! He munches solemnly, keeping even at meal-times, his look of innocent amazement that any tree could be so crammed with surprises as the one he finds himself in at the moment.

If he decides to climb down instead of up, he does so stern first, like a scaman; and if he wants another tree, he scuttles over the ground on his way to it as though he went by clock-work. This happens only at night, so far as I saw. I stayed in a jolly house close to the shore, and nearly always after dusk there would be koalas lumbering about the garden, grunting like pigs. This noise is the only one I ever heard them make. Their other noise I was lucky enough never to hear,

\* Pronounced Kō - ah - la

for Phillip Island is their paradise; but if koala is hurt he will whimper like a baby, his knuckles in his eyes and tears hopping off the end of his poor little nose.

I have met only one more entrancing person than koala, and that is his wife and her baby. I lost my heart to her completely. So would you. She has a pouch for the cub to slip into, but generally she carries him on her back. She always does so when she moves about. He clings on like a burr, looking like a tiny ball of fluff peeping over her shoulder. When she wedges herself into a fork of a tree for her daytime rest she nurses him in her arms, stroking him gently and patting him from time to time, even in her sleep. To see that alone repays a voyage to Australia. It is something no other part of the world can give.



### THE DROVERS

Out across the spinifex, out across the sand,  
 Out across the saltbush to Never Never land,  
 That's the way the drovers go, jogging down the track -  
 That's the way the drovers go. But how do they come back?  
 Back across the saltbush from Never Never land,  
 Back across the spinifex, back across the sand.





STANDARD 4.

DRAWING.

SET 8.

PENCIL. I.

1. Have you ever noticed how many different kinds of stalk junctions there are? Sometimes there is a swelling of the stem at the joint where the leaf stalks grow out, or perhaps little bracket-like leaves help to protect the joint. Choose three twigs showing these stalk junctions, and see how carefully you can draw them. Do not shade them, but show any ridges or marks where the stalks join on to the main stem.

Print the names of the twigs beside your drawing and SEND THEM IN.

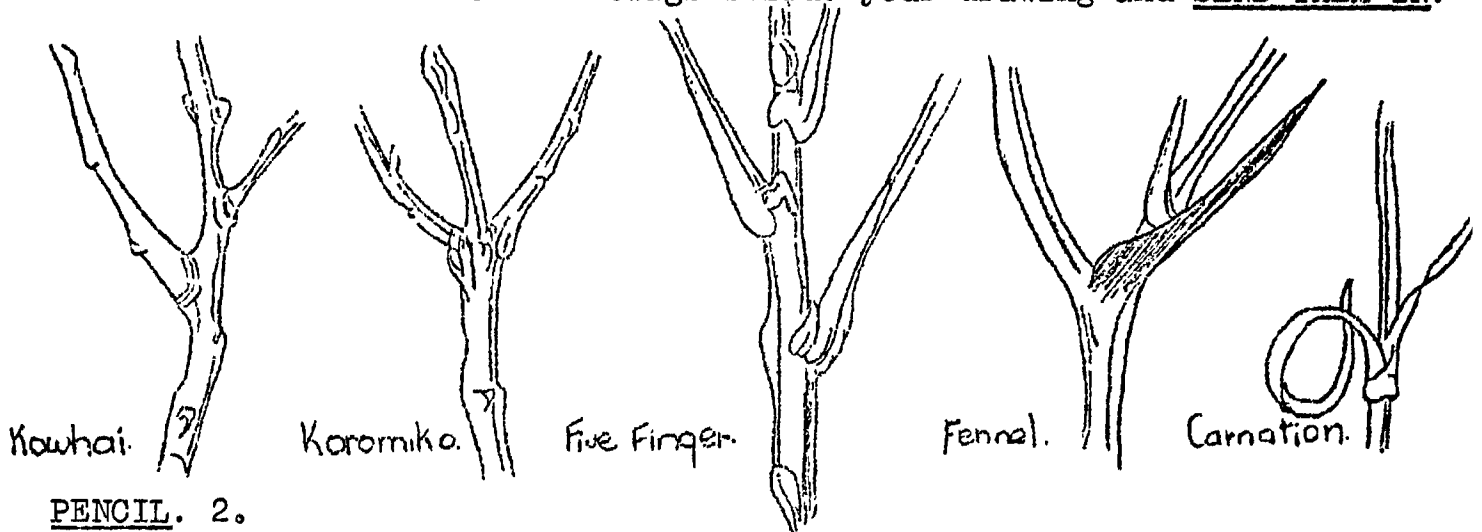
PENCIL. 2.

Choose a spray with two or three leaves on it, and stand it up in front of you, so that the leaves appear fairly flat. Shiny leaves are best, as it is easier to see light and shade on them. Study the spray very carefully for a few moments. Look for these points first:-

1. How the leaf stalks join on to the main stem.
2. The size and position of each leaf.
3. The size of the spaces between the leaves.

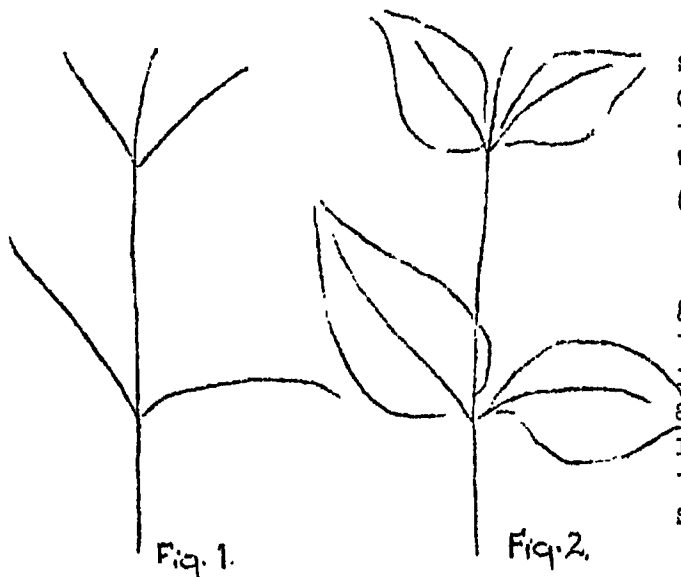

"Place" the stem with the leaf stalks coming from it as in Fig.1. Then draw the leaves themselves, sketching the midrib in lightly first, and "placing" the widest parts of the leaves. (See Fig.2.)

When quite satisfied with the general shape of the spray finish off the outline. The midrib is drawn fairly boldly, but the veins should be added very lightly. Notice how they follow the shape of the leaf towards the tip. Only the important veins should be shown.



To show light and shade draw the edges of the leaves and the stem that are on the light-side with a light line. For the shadow-side use a much firmer line. When showing shadows on the leaves use even slanting lines, but take care not to allow the shading to hide the veins. There will be shadows to be shown on the stems too.

SEND IN YOUR DRAWING.

This Assignment is the property of the Education Department. It is to be regarded as confidential, and is to be returned to the Department when asked for.

PRIMARY DIVISION

STANDARD 4

1936

SET 13

SPELLING: de Berry's "Individual Spelling Book"

1st week: Learn list 24, page 37. Revise list 21, page 36.  
2nd week: Learn list 25, page 38. Revise list 22, page 36.

ENGLISH: Whitcombe's "Progressive English Course".

Lesson 1. Pronouns, pages 139 and 140.

Write out the first two paragraphs. Some of you, who have eyes as sharp as Rag's were, will see that there is one pronoun that stands for both Molly and Rag. If you find this pronoun, write it half in black and half in red.

Lesson 2. July Journal. "An Old-time Teacher and Scholar" and "Uncle Podger Hangs a Picture"

You will enjoy these two amusing stories.

1. You will see that the first one is written in rather old-fashioned language. Why do you think the author did this?
2. This first story too will provide you with some very interesting words and expressions for your collection. Write out the five or six you like best.
3. With the help of your dictionary find out the meaning of these:-  
sonorous, that dire sound, savoury, ventured, by dint of, discouraging upon. Send in words or phrases that could be used instead of these.
4. Write a few sentences telling of something you have seen as funny as Uncle Podger hanging the picture.

Lesson 3. Conjunctions, page 141.

Here are some more interesting joining words which will be useful for you in composition writing.

Do the first six answers orally. Write and send in the last six answers.

Lesson 4.

"A Ghost Story" in your July Journal will give you some ideas for a little story of your own. Tell of some amusing or exciting happening you know about. See how the author of "A Ghost Story" very cleverly made the whole point of his tale come in the last line. I wonder if you can do this too!

Lesson 5. Revision Test, page 142.

Do the first two sentences in each group orally. Write and send in the remaining sentences in each group.

Lesson 6. The Possessive Form of Nouns, page 143.

Send in the fourteen sentences.

Lesson 7. July Journal. "A Safe Home" and the poems.

- A. You will all like the story of the beaver's home not only because of the interesting facts it tells you, but also because of the clear and striking language the author has used. In the third paragraph on page 93 see what a beautiful description is given of a calm scene. Write a similar paragraph describing some scene you know.
- B. Which poem do you like best? Send in an illustration for the one you choose. (If you use pastels remember to cover your work.)

Lesson 8. Vocabulary Exercise - Opposites, page 145.

Say the first five sentences aloud. Write and send in the last five sentences.

Lesson 9. The Looking-Glass

When I look in the looking-glass  
 I'm always sure to see -  
 No matter how I dodge about -  
 Me, looking out at me.

I often wonder as I look,  
 And those strange features spy,  
 If I, in there, think I'm as plain  
 As I, out here, think I.

I wonder what you think about when you look into a mirror! Perhaps you can write a little poem about it too. Or, if you would rather, write a little conversation between yourself and "yourself-in-the-glass".

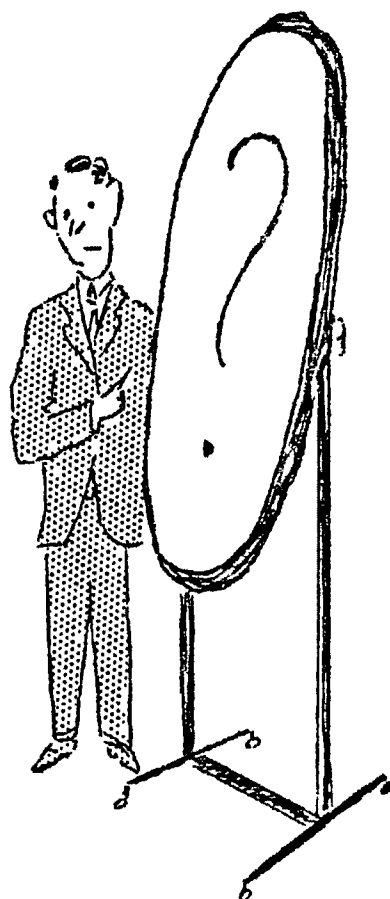

Lesson 10. The Forms of Verbs, page 146.

First do all the sentences orally, then write and send in the last sentence only in each group.

SPEECH AND PRONUNCIATION.

Are you all watching your own speech closely, so as to avoid little carelessnesses that so often slip in unawares?

Garden. Here is a word we often use. But how often do we use it wrongly! Gardin is the pronunciation very commonly given.

Glistening. This is a vivid word which you will find useful if you wish to describe the eye of a cat. The t in this word is not pronounced - a "silent t" it is called. The "en" sound, as in garden, needs care.

Below your Transcription, write out any words you know in which the "e" sound is sometimes carelessly turned to an "i" sound.





ROBIN HOOD

During the first week:-

- A. Read "Our Nation's Story", Chapter 3, (pages 84 to 104) as often as possible. You will like this chapter - it tells how people lived and worked in England eight or nine hundred years ago. Perhaps you have read other stories about the people of these times. For instance, I am sure you all know and love Robin Hood whose picture is at the left.
- B. Collect as many pictures as you can for your scrap book. Label this new section "Life in Early England". Of course you will remember not to cut pictures from good books. Make sketches of pictures like this that you happen to want.

During the second week:-

- A. Send in a list of the missing words in these:-

1. The men who lived "under the greenwood tree" were called .....
2. In Norman times, men who were not free were called .....
3. By "archery" we mean .....
4. .... were the favourite sport in early England.
5. People mostly travelled..... in early England.
6. The "monasteries" were .....
7. .... wrote all the books of the time by hand.
8. .... was the king who ordered the destruction of the monasteries.
9. Today England is a ..... country, but 800 years ago it was an ..... country
10. The people grazed their sheep, pigs and cattle on the .....



WHITE FRIAR

- B. As many of you live on farms I am sure you were specially interested to read the account of the early English farms. Write a page comparing them with ours in New Zealand. Illustrate your answer, if you can, by finding pictures to show the old and the new methods of doing things. A photo of a modern motor lorry, for instance, would make a good partner for the picture of an early English cart below.

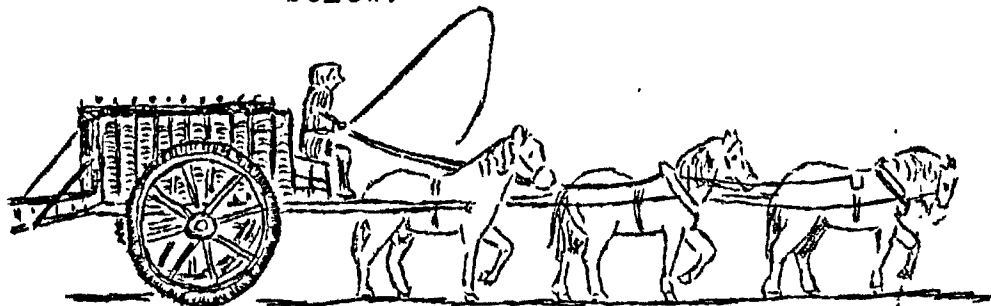

GEOGRAPHY:

-5-

A. Read Chapter XX as often as you can. As you read have your atlas open beside you and find the various places mentioned. When you have finished the chapter you will be interested to read the letter on this page that I have asked a friend from Samoa to write to you. Samoa is of special interest to New Zealanders because we are responsible to the League of Nations for its government and welfare. Perhaps you have seen articles in the newspapers about the way we rule Samoa. Watch out for these!

B. Collect pictures, etc., for a "Pacific Islands" section in your scrap book.

Dear Standard 4,

Everybody likes parties and I'm sure you would all enjoy a Samoan feast. I shall always remember the first one I went to. When we arrived at the village we were welcomed with speeches in Samoan, and invited to drink "kava" out of a drinking bowl made from a polished coconut. Then we were led to the feast, which was spread out on the floor of the "fale". The food was laid on cool banana leaves - whole roasted chickens, crabs and little sucking pigs, taro, yams, baked bananas, coconut cream and every kind of island fruit. We sat on the floor and picked a leg of chicken or a piece of pork in our fingers. Later we were entertained with dancing. First a few girls began to dance the "siva-siva" while the others sang and clapped their hands. The temptation became too strong and some of the older women joined in, then the children and finally the men; each doing his or her own version of the dance. When the farewell speeches had been made we went back to our car which we found had been decorated with chains of leaves and flowers. So we drove away while the Samoans sang a farewell song which begins,

"Tofa mai faleni"

(Good-bye my friends).

Work to send in:

A. Draw a map of the Pacific Islands and mark in the route taken by the "Tofua" in Chapter XX. By using colour make your map really attractive and label the various places in your very neatest print-script. You need not name the smaller islands - just name the groups, Fiji, Tonga, and Samoa. Besides these that are mentioned in the chapter also show Rarotonga and Tahiti.

B. Answer questions 2 and 4 on page 157.

C. Bring your Shadow Record up to date and send it in.

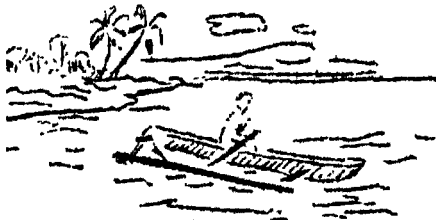

Outrigger canoe



Coconuts

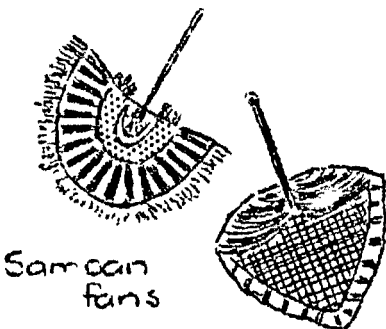

Samoa fans

Kava bowl



Siva-Siva



Pineapple



Native pig



Taro leaves



ARITHMETIC: Whitcombe's "Progressive Arithmetic".

Keep Part A and Part B separate and send in the pages in their right order.

FIRST DAY: Mental: 10 sums at the end of this set.

Special Note: Some pupils, instead of doing the mental sums on the days for which they are set, have been leaving them all till the last day. Do not do that. The mental sums often have something to do with the written sums that follow them; and also if you do them all at once you are so tired when you are half-way through that you make many mistakes. Therefore do the mental sums on the days for which they are set.

Part A: Written: Ex.53. B 1 (c), 2 (c), 3 (c).

---

SECOND DAY: Part B: Ex.53. C 1, 2, 3, 4, 5.

---

THIRD DAY: Part B: Ex.54. A 7, 8, 9, 10; B 2.

---

FOURTH DAY: Mental: 10 sums at the end of this set.

Part A: Problems must be set out fully and clearly. Give a clear statement for each of the following problems, showing how you get your answer, and put in the working column any extra working that you cannot do mentally.

1. If you drank a pint of milk every day for the first six months of the year 1935, how much would it cost at 4d. a quart?
  2. A garden plot is 2ch. 12yd. long and 1ch. 18yd. wide. How many yards of fencing will be required to go round it?
  3. What is left out of £50 after I have paid £4"17"4d. to each of 9 men?
  4. How many more threepences are there in 365 half-crowns than in 437 florins?
- 

FIFTH DAY: Part B: Ex.54 C. Mental and Nos. 1, 3, 4, 5.

---

SIXTH DAY: Mental: 10 sums at the end of this set.

Part A: Written: Ex.54. C 8, 9, 10; D 2, 8.

---

SEVENTH DAY: Part A: Speed Work. Time yourself for these three sums:-

- |                     |                              |
|---------------------|------------------------------|
| 1. £362"14"6d. × 8  | 3. £362"14"6d. - £249"15"9d. |
| 2. £362"14"6d. ÷ 11 |                              |

Problems:

4. Tom has 27"6"9d. and his father has 27 times as much. How much more has the father than Tom?
  5. Express in £ s. d. the difference between 286 florins and 946 threepences.
  6. Add together 276.3, 485.1, 976.8, 287.9, 450.6, and from their sum take 20.2
- 

EIGHTH DAY: Part B: Ex.56, Nos. 5, 6, 7.

In No.6, a table top, a window, or a large window pane will do instead of a blackboard; say what it is you are measuring. In No.7 do all that is asked for and answer all the questions.

---

NINTH DAY: Part B: Ex.65. 1 to 12; C 1, 2, 3.

TENTH DAY: Part A:

1. Construct a square with two-inch sides. On the top side construct an equilateral triangle. Measure to the nearest tenth of an inch the height of the whole figure now formed.
2. Find by practice the cost of 73 bicycles at £5"12"6d. each.
3. How many threepenny exercise books can be bought with the sum of 43 half-crowns and 43 florins?
4. Find the value of 4.7 tons of coal at £3"10s. per ton.

MENTAL ARITHMETIC: Cut off and send in.

FIRST DAY.

Answers.

1. What is the value of three-eighths of £2? \_\_\_\_\_
2. From one-fifth of 95 take one-third of 36. \_\_\_\_\_
3. A boy with 56 marbles loses  $\frac{1}{8}$  of them. How many has he left? \_\_\_\_\_
4. One-third of my money is 5"6d. How much have I? \_\_\_\_\_
5. There are 40 boys in a class. Nineteen-twentieths are present; how many boys are absent? \_\_\_\_\_
6. When I have walked 2 miles I have gone one-sixth of my journey? How far have I yet to go? \_\_\_\_\_
7. Find the cost of  $\frac{3}{8}$  of a yard of cloth at 4s. a yd. \_\_\_\_\_
8.  $\frac{5}{6} + \frac{7}{12}$  \_\_\_\_\_
9. How many inches are there in  $\frac{1}{3}$  of  $\frac{3}{4}$  yard of wire? \_\_\_\_\_
10. A farmer sold seven-tenths of a flock of 500 sheep. How many remained? \_\_\_\_\_

Time taken: \_\_\_\_\_

FOURTH DAY.

Answers.

SIXTH DAY.

Answers.

- |                                |       |                    |       |
|--------------------------------|-------|--------------------|-------|
| 1. 968 - 499                   | _____ | 1. 804 + 968 + 765 | _____ |
| 2. 6s. x 7 $\frac{1}{2}$       | _____ | 2. yd. in 12ch.    | _____ |
| 3. 1b. in $\frac{1}{2}$ ton    | _____ | 3. 387 x 7         | _____ |
| 4. 2,240 ÷ 20                  | _____ | 4. 2 x 3 x 4 x 2   | _____ |
| 5. 750 ÷ 25                    | _____ | 5. 2500 ÷ 50       | _____ |
| 6. 1"3 $\frac{1}{2}$ d. x 9    | _____ | 6. 896 - 489       | _____ |
| 7. 878 x 12                    | _____ | 7. 75,699 ÷ 9      | _____ |
| 8. 31b. 7oz. + 9oz.            | _____ | 8. 489 x 7         | _____ |
| 9. $\frac{7}{8} - \frac{1}{4}$ | _____ | 9. 9 x 5 + 3 ÷ 16  | _____ |
| 10. $\frac{7}{16}$ of £1       | _____ | 10.                | _____ |

Time taken: \_\_\_\_\_

Time taken: \_\_\_\_\_



STANDARD 4.DRAWING.SET 13.1. PASTEL.

Choose a bird for this study. It might be your favourite hen, the rooster, a duck, or even the black-bird on a nearby branch. It would be best however, to choose one that will stand fairly still, so that you can notice the shape of its feet and legs, and the curve of its bill. Roughly plan the shape of the bird with your pastel, sketching the body first, and then adding the head and tail. Fill in the shape with your pastel. You will not be able to show all the feathers, so indicate the main ones in the wings and tail by lines of shading.

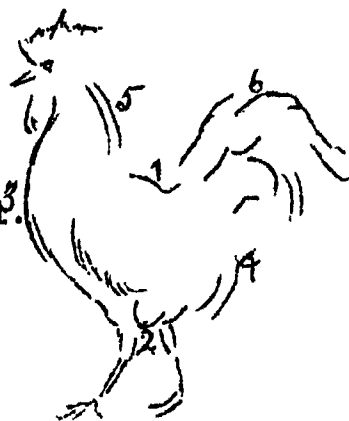

There will be deeper shadows under the wing and on the legs. See how real, and alive you can make your bird appear. Finish off the drawing by indicating what the bird is standing on.

A cast shadow will also need to be shown. A white bird will not show up on white paper. Use your pastel drawing books for this lesson.

SEND IN YOUR DRAWING.2. DESIGN.

In Set 6 you made a design in a square, using a cut-out unit. This time make one in a triangle.

Make a four inch triangle. Compasses will be needed for this lesson.

Step 1.

A ————— B

Rule a 4 inch line.

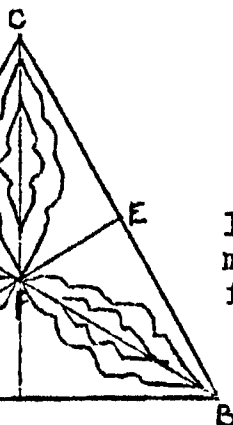

Step 2.

A ————— B

Open your compass to four inches. Place the sharp arm at A. Describe a part of a circle.

Step 3

C  
X

A ————— B

Repeat this, placing the point on B. The two parts will cross at C.

Step 4.

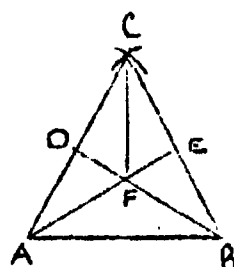

Join up A.C. and B.C. Divide A.C. and B.C. into half at D and E. Join A.E. and B.D, and C.F.

Cut out your motif and arrange it on the three lines as shown in the sketch. A pattern behind these motifs will help your design. Do not use more than four colours.

SEND YOUR DESIGN IN.

FORM I.

1936.

SET 4.

SPELLING: de Berry's Spelling Book.

List 1, page 41, 25 words, to be learnt the first week.  
List 2, page 41, 25 words, to be learnt the second week.

ENGLISH: Whitcombe's "Progressive English Course"

Lesson 1. Conjunctions, pages 43, 44.

A. Do the lesson ORALLY, but send in a list (in correct order) of the conjunctions you supply.

B. Use these in sentences:-

1. neither ..... nor .....
2. either ..... or .....
3. not only ..... but also .....

Lesson 2. Negatives.

A. Note these examples:- lucky, unlucky; opportune, inopportune; defence, defenceless.

Give the NEGATIVE FORM of each of these words:-

- |             |            |              |
|-------------|------------|--------------|
| 1. noise    | 5. thought | 9. daunted   |
| 2. cautious | 6. harm    | 10. capable. |
| 3. welcome  | 7. wounded | 11. use.     |
| 4. help     | 8. happy   | 12. secure.  |

B. Use the first four negatives in sentences. Remember that your sentences should bring out clearly the MEANINGS of the words. Underline the words you use.

Lesson 3. The Two Parts of a Question Sentence, pages 45 and 46.

Do all the numbers in A and B. Remember that it will help you to find the subject if you find the verb first. To find the subject ask yourself "Who or what?" before the verb.

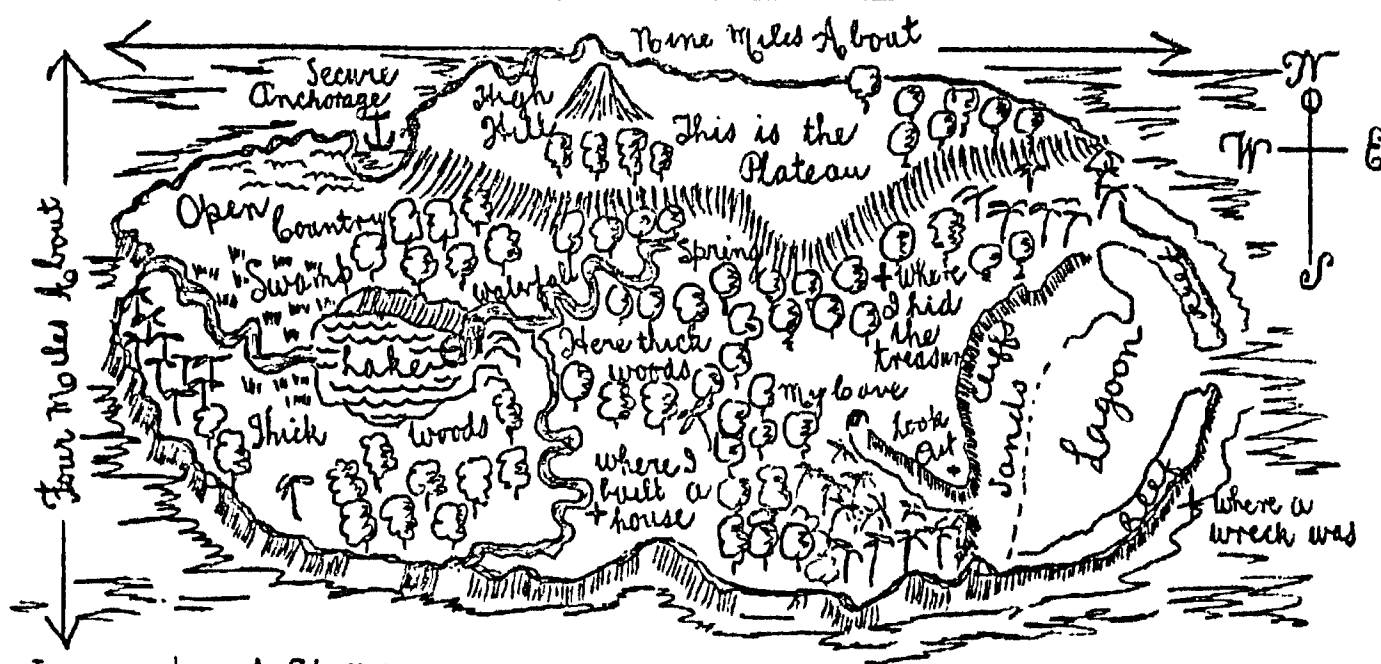

Lesson 4. A Story.

You have been wrecked on an unhabitated island. You find a plan in a cave drawn by a pirate in the year 1600. Here is a copy of the plan. In a story describe your adventures beginning with the wreck, your search for food and shelter, your exploration of the island, the hunt for treasure, waiting for a ship and final rescue. You may add whatever you like to this outline and may draw another plan if this one does not suit your story.

Lesson 5. Clauses.

Study these three sentences:-

- (a) I gave it to the girl.
- (b) I gave it to the girl on the horse.
- (c) I gave it to the girl who was wearing a red hat.

From your previous lessons on phrases you know that "on the horse" is a phrase. But what about the little group of words in (c)? Notice that this group contains a verb so that it cannot be a phrase. We give it the name clause. A CLAUSE is any group of words CONTAINING A VERB. You will see then that the little sentence (a) above is really a clause and that sentence (c) contains two clauses. Notice how the following sentences are divided into clauses. (Verbs are underlined).

1. I found the box where I had left it.
  - (a) I found the box.
  - (b) Where I had left it.
2. As soon as we reached the river, we pitched our camp.
  - (a) We pitched our camp.
  - (b) As soon as we reached the river.
3. Why do you think that the train will be late?
  - (a) Why do you think?
  - (b) That the train will be late.

Notice that in each sentence (a) is able to stand alone without adding anything further. It is really a sentence in itself. (In No.3 you must remember that a question is a complete sentence.) The other clause, however, has to be used with (a) to be properly understood. For this reason (a) is called the PRINCIPAL CLAUSE, while the other is called a SUBORDINATE CLAUSE. A sentence which is made up of one principal clause and one or more subordinate clauses is called a COMPLEX SENTENCE.

A. Answer the following questions:-

1. A complex sentence contains .....
2. Which is the more important. a principal or a subordinate clause?
3. Some sentences have no ..... clauses.
4. Need a principal clause always be first?

B. Make sentences by adding PRINCIPAL clauses to these subordinate clauses:-

5. .... who stood by the door.
6. .... that Dick told us about.
7. While we were waiting .....
8. .... from where I sat.

C. Add SUBORDINATE clauses to these principal clauses.

9. The boy wore a coat .....
10. We did not go to the concert .....
11. .... we played the piano.
12. Where is the house .....

D. In B and C, UNDERLINE all the verbs.

---

Lesson 6. Contractions, page 48, answers 1 to 12.

---

Lesson 7. The Gender (Sex) of Nouns.

As you know, many classes of people and animals can be divided into two groups-- male and female. To show this difference changes are made in the nouns that refer to them. Study these pairs of nouns: heir, heiress; Paul, Pauline, Sometimes an entirely different word is used, c.g. ram, ewe; bull, cow.

A. Give the FEMININE of:- B. Give the MASCULINE of:-

- |          |                 |
|----------|-----------------|
| 1. lion  | 6. mistress     |
| 2. actor | 7. Josephine    |
| 3. duke  | 8. Negress      |
| 4. hero  | 9. maid-servant |
| 5. mayor | 10. shepherdess |

C. Give the OPPOSITE SEX of:-

11. goose
  12. horse
  13. bullock
  14. madam
  15. niece.
- 

Lesson 8. Adverbs, pages 50 and 51.

Write the first eight answers. Do the others orally.

---

Lesson 9. A Beautiful Scene.

It is a good idea to choose some scene that you know well. It will not be necessary to write down a plan for this description, as you have been doing for your other essays. However, before commencing you should think carefully about your scene and you might find it a good idea to write down some striking words or phrases that you intend to use.

---

Lesson 10. Revision Test, page 52.

Write the first ten sentences. Do the others orally. (Ask yourself "Who or what?" before the verb.)

---

WRITING.

Write an extract from your "Journal" ( $\frac{1}{2}$  pad page). Remember! Narrow, well-spaced letters.

---

GEOGRAPHY.

First Day:

- A. REVISION
1. Waterfalls and rapids are formed by wearing away of ..... layers of rock.
  2. The ..... Falls are the highest in the world.
  3. Electricity made by harnessing the power of rivers is called .....
  4. The main electricity supply of Invercargill comes from .....; of Dunedin comes from .....
  5. The names of three breeds of sheep grown in New Zealand are .....
  6. In 1882 a great step forward in the meat trade was made by the discovery of .....
  7. Two important "by-products" of a freezing works are .....
  8. The best dairying lands are found on the ..... country.

GEOGRAPHY (continued).

9. New Zealand's dairying industry has led to her being given the name of the .....
10. The largest city in New Zealand is ..... It is sometimes called the ..... city.

(Send in).

READ Human Geography, Chapter IX, pages 73-78. Study CAREFULLY the maps on pages 74 and 75.

Second Day: COLOUR the Geography Extra Sheet with this set. (Send in)

Third Day: Write answers to any questions on the sheet on a separate piece of paper. (Send in).  
Trace a full size map of New Zealand. Don't forget to go over your outline carefully in ink.

Fourth Day: On your map of New Zealand PRINT in RED INK the main ports (about 20). Beside each PRINT in another colour the six most important EXPORTS of each. The map on page 74 will help but you must revise your other geography to find which of these products is produced in the particular district. (Send in)

HISTORY.

- First Day: A. REVISION. Make a list of the words that fill the blanks in the following:-
1. The Maori Wars were called .....
  2. The first four Governors of New Zealand were .....
  3. General ..... was sent to quell the ..... tribes.
  4. At Orakau the Maori leader was .....
  5. The chief battle in the Tauranga district was .....
  6. Hauhauism began in the ....., ..... districts.
  7. About 1861 gold was discovered in .....; about 1864 in .....
  8. The New Zealand Association founded ..... and .....
  9. Wellington is the capital of New Zealand because of ....., .....
  10. .... farming has made the North Island prosperous.

(Send in)

READ "Our Nation's Story", chapter II, pages 52-60.

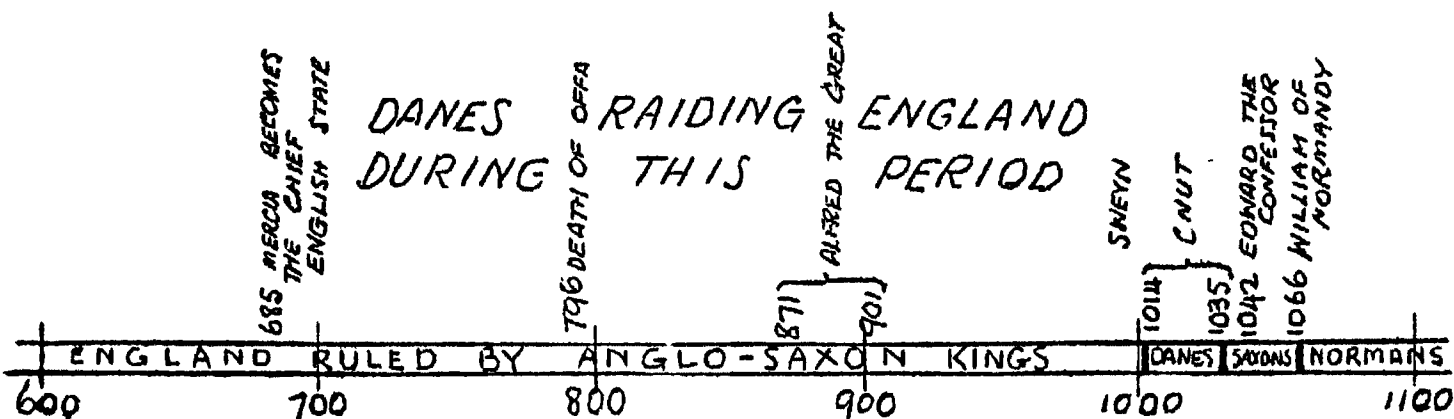

Second Day: Read "Our Nation's Story, Chapter II, pages 52-65.

Third Day: B. Write an account of all you can find out about Alfred the Great. (Send in)

Fourth Day: C. Find out all you can about William I and what he did for England. Write out. (Send in)

ARITHMETIC. Remember to keep Parts A and B entirely separate.

In this set we shall continue to study Fractions. Revise Set 3, so that you know exactly what has already been told you.

1ST DAY: PART B.

- (a) Mental: Card I. Note on the card, and in your set, how long you took.
- (b) Written: Ex.18. A 2 (e).

2ND DAY: PART A.

- (a) Speed: Card V.
- (b) Written: Read page 26. In previous sets we have proved that  $\frac{4}{8} = \frac{1}{2}$ ,  $\frac{3}{9} = \frac{1}{3}$ ,  $\frac{3}{12} = \frac{1}{4}$ , etc. When we say that  $\frac{3}{12} = \frac{1}{4}$  what are we doing? We are dividing the top and bottom lines by the same number. The process is known as canceling. By cancelling, we do not alter the value of a fraction, but simply write it in lower terms.

e.g.  $\frac{16}{32} = \frac{8}{16} = \frac{4}{8} = \frac{2}{4} = \frac{1}{2}$

Remember, that to cancel a fraction the top line (numerator) and the bottom line (denominator) MUST be divided by the same number,

e.g.  $\frac{15}{20} = \frac{15 \div 5}{20 \div 5} = \frac{3}{4}$  (We have divided both the numerator and the denominator by 5.)

Note: Read page 26 carefully and work the first 6 examples of B. Always cancel a fraction, if possible.

e.g.  $\frac{\overset{3}{\cancel{54}}}{\underset{5}{\cancel{90}}} = \frac{3}{5}$  ( $\frac{54 \div 9 \div 2}{90 \div 9 \div 2}$ )

Ex.15. Cancel the fractions in B 1 -B6, and C 1 -C6

3RD DAY: PART A.

- (a) Mental: Cancel the following:-
 

1. $\frac{9}{12}$	3. $\frac{4}{28}$	5. $\frac{5}{15}$	7. $\frac{4}{18}$
2. $\frac{8}{24}$	4. $\frac{6}{9}$	6. $\frac{9}{27}$	8. $\frac{10}{35}$

- (b) Written: Page 26. B 7- B12, C 7- C12

4TH DAY: PART B.

- (a) Mental: Card II. Note time taken on Card and in Set.
- (b) Written: Ex.15. A 1, 2, 15, 16.

5TH DAY: PART B.

- (a) Speed: Card III(a). Add across.
- (b) Written: Read page 21. Ex.12. B 1, 3, 9(a).

6TH DAY:PART B.

- (a) Speed: Card III(b). Add down.  
 (b) Written: Ex.19, B 3; Ex.18, C 7.

7TH DAY:PART A.

- (a) Mental: Card V.  
 (b) Written: Read pages 17, 21 and 27 to learn what multiples and L.C.M. are.

What is the L.C.M.? The letters L.C.M. stand for Least Common Multiple, which is the least number into which two or more numbers will divide evenly.

e.g. Find the L.C.M. of 3, 4, 6.

We have to find the smallest number that can be exactly divided by the three numbers, 3, 4 and 6. Now, 24 is a number into which 3, 4 and 6 will divide, but is 24 the smallest number? No. 12 is the smallest number we can find that can be divided by 3, 4 and 6, so 12 is the Least Common Multiple.

In Ex.17 we see the value of our knowledge of L.C.M.

e.g.  $\frac{1}{3} + \frac{1}{4} + \frac{1}{6}$  How can we do this? We first have to bring one-third, one-quarter and one-sixth to the same denominator, so we find the L.C.M. of 3, 4 and 6. The L.C.M. is 12.

$$\frac{1}{3} = \frac{4}{12}, \quad \frac{1}{4} = \frac{3}{12}, \quad \frac{1}{6} = \frac{2}{12}$$

$$\text{Hence } \frac{1}{3} + \frac{1}{4} + \frac{1}{6} = \frac{4+3+2}{12} = \frac{9}{12} = \frac{3}{4}$$

Sometimes we are not able to find the L.C.M. mentally so here is a good method of finding the L.C.M. of the denominators of fractions.

e.g.  $\frac{1}{4} + \frac{1}{12} + \frac{1}{9}$  We have to find the smallest number into which 4, 12 and 9 will divide evenly.

$$\begin{array}{r} 2)4, 12, 9 \\ \hline 2)2, 6, 9 \\ \hline 3)1, 3, 9 \\ \hline 3)1, 1, 3 \\ \hline 1, 1, 1 \end{array}$$

The L.C.M. of 4, 12 and 9 is  $2 \times 2 \times 3 \times 3 = 36$ . Do you see how it is done? Here is the method: Begin by dividing by 2, if possible, and keep on dividing by 2, line by line, as long as 2 will divide into at least one of the numbers in that line. In the case of a number into which 2 will not divide (see 9 above), write the same number again in the new line. Having divided by 2 as often as possible, divide by 3 similarly, then by 5, 7, 11 etc., if necessary. The L.C.M. is the product of all the numbers by which you divide. In the above example it is  $2 \times 2 \times 3 \times 3$ .

Note: When there are numbers, a smaller one being a factor of a larger one, there is no need to include the factor, as whatever the larger number will divide evenly into, the factor will divide into.

e.g. What 12 will divide evenly into, 6 will divide into, so that, in finding the L.C.M. of 6, 12 and 16, we need not bother about the 6 in finding the L.C.M.

Ex.16. A 1 - 6; Ex.17. A 5, B 8.

8TH DAY:

PART A.

- (a) Speed: Card VI. Time?  
(b) Written: Ex.17. B 1, 3, 5.
- 

9TH DAY:

PART B.

- (a) Mental: Card I.  
(b) Written: Ex.16. B 1, 7, 12; Ex.17. A 6, B 6.
- 

10TH DAY:

PART A.

- (a) Mental: Card II.  
(b) Written: Revise the remarks about Cancelling and L.C.M.  
Ex.15. C 3, 4, 7, 8, 11.  
Ex.16. B 5, 10.  
Ex.17. B 7.
-



4 5

**CHIEF STEAMER ROUTES FROM N. Z.**

From an Atlas fill in names of Ports  
Colour the Suez route, the Panama route and the "All Red" route.

**CHIEF CABLES (FOR NEWS) TO N. Z.**

Fill in names of ports and islands.  
Mark in any radio station you know.

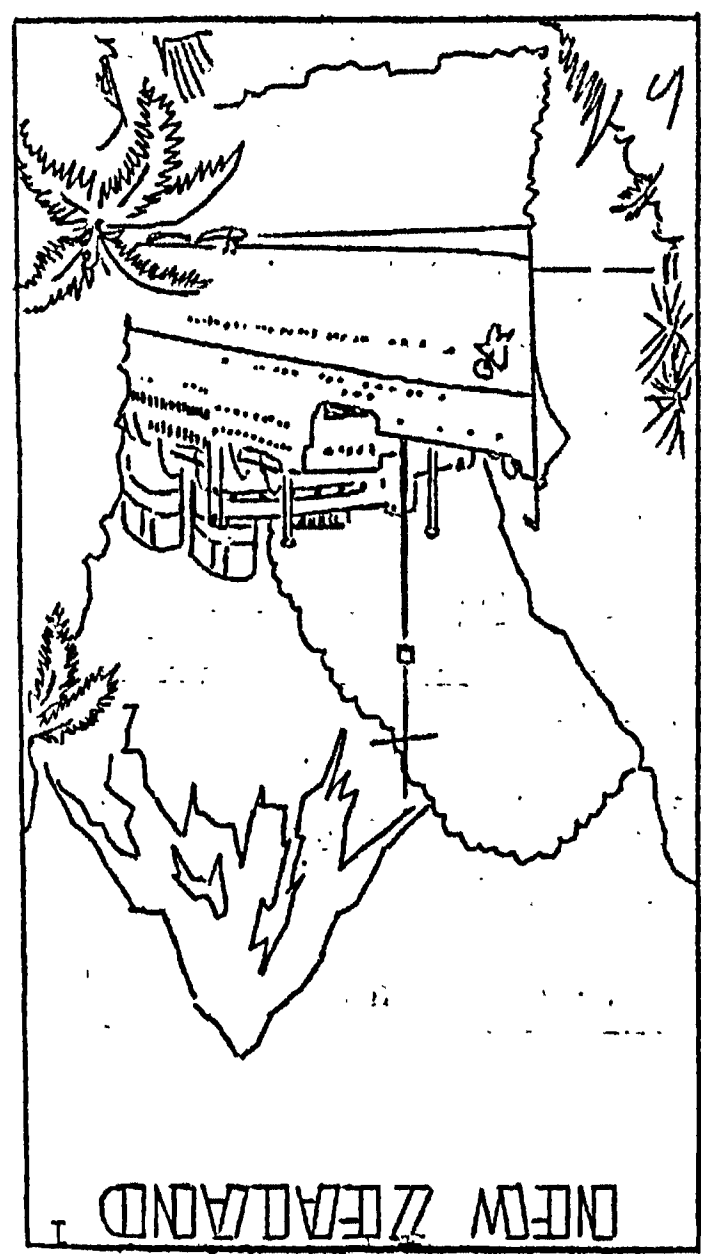

NEW ZEALAND

SEND THIS IN WITH YOUR SET

RECENT NOTES I HAVE MADE FROM THE NEWSPAPERS ABOUT NEW ZEALAND

GEOGRAPHY

**INSTRUCTIONS**

Fold the bottom of this sheet to the top so that pages 4 and 5 are on top. Then fold ACROSS so that 4 and 5 face one another and page 1 or 8 is on top. Cut along the bottom. Colour in all maps and the cover - use water colours or coloured pencils NOT crayons.

**AIRWAYS IN NEW ZEALAND**

For some time isolated parts of N.Z. have been reached by air. The southern west coast district of the South Island has no railway but for some time aeroplanes have been used for the delivery of mails, supplies, as an ambulance service and in tourist traffic from Hokitika to the Fox and Franz Joseph Glaciers. The East Coast of the North Island, also without a railway, has developed a regular daily service from Napier to Gisborne (about 90 miles). In 1934 a service (Cook Strait Airways) linked Wellington, Blenheim and Nelson. Early in 1935 Union Airways began a daily service, Palmerston North, Blenheim, Christchurch and Dunedin (500 miles).

Find out all you can about the propositions to link N.Z. by air with Australia (and so to

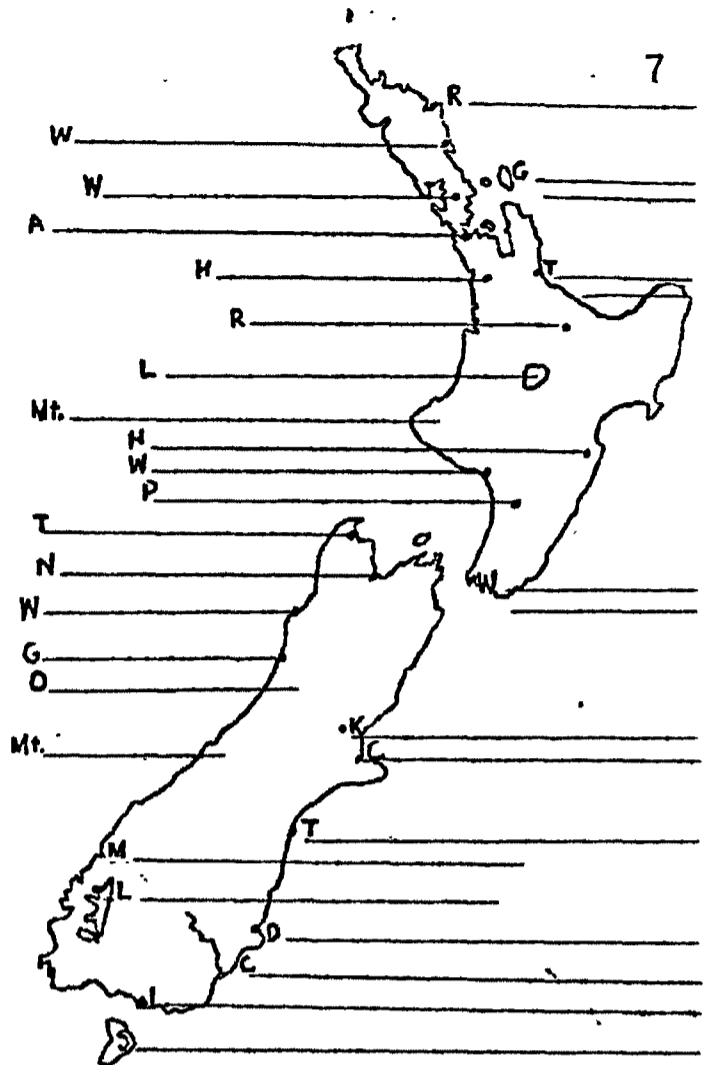

Print in carefully the names of these places and add one thing of interest about each;

for example  
 ROTORUA - hot springs - tourist resort.

England) and across the Pacific to America (along the Kingsford-Smith trails.



NEW ZEALAND AIRWAYS

are most of these to be found? dairying purposes at all - where North Island are not grown for aim. Half the cattle of the 99% of both going to Great Brit- New Zealand's greatest exports - South. Butter and Cheese are North Island compared with the importance of dairying in the yield from the Waikato and the Note the increased butter

THE VARIOUS PROVINCES IN 1934  
 QUANTITY OF DAIRY PRODUCE (IN THOUSANDS OF TONS) EXPORTED FROM

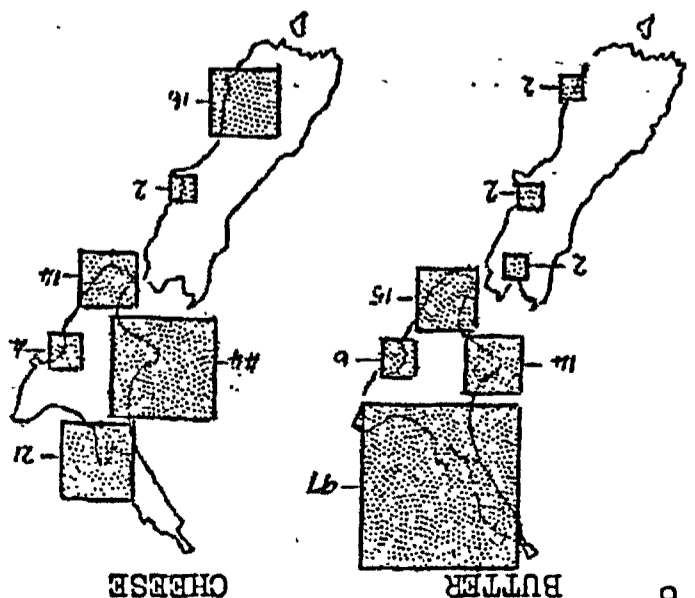

February "Journal".A. "GOD MAKE ME KIND"

This poem is a prayer. Quote the lines which, in your opinion, contain the finest thought.

B. "THE FOREST FIRE"

Make a picture plan of the country in which Kazan and Grey Wolf lived as you imagine it would be. Show the streams and the sand-bar.

Quote the sentence which most thrilled you when reading this story.

C. "POPE GREGORY'S CALENDAR"

Gregory XIII was Pope from 1572 to 1585. (Who was reigning in England at this time? What great event occurred in 1588?) Gregory worked out the calendar as used today.

The Pope is the head of the Roman Catholic Church. His headquarters are at Rome, in Italy, and he lives in the Vatican, a palace quite close to the cathedral of St. Peter's.

Do you know why, in every fourth year, February has an extra day? What do we call such years? Is 1936 one?

D. "THE PRESENT"

- (a) What was the present that Uncle Cavanagh gave the Trevor children?  
(b) Where was the present located?

Form II only.

- (c) Give the author's own words for which the following might be substituted:-

- p. 8. (i) be considered before others;  
p. 9. (ii) available for any purpose I wished;  
(iii) some seemingly reasonable explanation;  
p. 10. (iv) passage-way;  
(v) in small scale;  
(vi) being always at hand to talk to;  
p. 11. (vii) a roundabout way;  
(viii) quick minds;  
(ix) place shut in;  
(x) took possession of.

Note: Pall Mall - A well-known street in London.

Cornish Riviera - The Riviera is a narrow coastal district in the South of France. It has a warm winter climate and is a famous health resort to which people go from all parts of Europe. (Find Monaco, Nice, Cannes on your map of France.) The coast of Cornwall (South of England) also has a winter climate much milder than that of other parts of the British Isles. It is therefore known as the "Cornish Riviera".

E. "BABY" - by Le Gallienne.

Poetry makes an appeal to the reader through:-

- (a) the rhythm or lilt of the lines;  
(b) the sound or music of the words;  
(c) the poet's thoughts, his mind pictures or story.

Note the distinct lilt, or regular swing, of this line.

Blue eyes looking up at me.

READING (continued).

Fs. I&II/4.

The down strokes are placed above the stressed syllables and the horizontal lines above the unstressed syllables.

We might make a rhythm pattern of this line as follows:-

/ - / - / - / -

The second line would be read:-

I wond̄er what yōu reall̄y see  
- / - / - / - /

- (a) Write out the third and fourth lines and show the rhythm pattern.  
(b) In this poem does Le Gallienne give us a mind picture or a story?

F. "HOW'S THAT?" - E. V. Knox.

Is this a "picture" or a "story" poem? There is a stronger and livelier rhythm in these verses than in "Baby".

The M.C.C. - the Marylebone Cricket Club - is the highest authority on cricket. It owns the famous Lord's cricket ground in London. An M.C.C. team toured New Zealand this last summer.

---

POETRY.

What poem or poems have you memorized this year? Give the author's name.

---

This Assignment is the property of the Education Department. It is to be regarded as confidential, and is to be returned to the Department when asked for.

PRIMARY DIVISION

FORM II

1936

SET 13

ENGLISH:Lesson 1. Revise Set 9, Lesson 3.

Just as an adjective describes a noun so does an adjectival clause describe one.

- (a) This is my friend. He lives down the road.  
This is my friend who lives down the road.
- (b) The boy was severely punished. The boy ran away from school.  
The boy who ran away from school was severely punished.

Notice the adjectival clause is placed next to the noun it qualifies.

Join the following, underlining the conjunctions:-

- Henry Wadsworth Longfellow died in the year 1882. He was an American poet.
- At a meeting yesterday the committee passed a unanimous resolution. It was forwarded to the Lord Mayor. He is at present in London.
- Gilbert White wrote a famous book. His name is probably familiar to you. The book deals entirely with natural history and antiquities.

Lesson 2.

- (a) What part of speech introduces a dependent clause?

An adverbial clause adds to a verb. It usually tells us "when", "why", "where" or "how", a thing is done.

The child screamed when she saw the snake. (When)  
He coughed as loudly as he could. (How)

Add adverbial clauses to the following:-

- The boy ran ..... (how?).
- The old man groaned ..... (when?).
- The blackbird chirped ..... (when?).

Sometimes adverbial clauses are separated from the verbs to which they refer.

The boy beat the dog when it killed the chicken.

The adverbial clause is often placed at the beginning of the sentence to vary the style.

When he fell down the boy hurt his knee.

Add adverbial clauses to the following:-

- I ate my lunch ..... (when?).
- The picnickers sat down ..... (where?).
- He picked the chrysanthemums ..... (how?).

Lesson 3. Punctuate the following passage.

N.B. All full stops must be put in and the next sentence must commence with a capital.

the bush certainly has its delights that night however when i got back to the camp i felt so worn out so upset over my narrow escape on the side of the old mine shaft that i felt glad to be leaving at daylight for once i had all the adventure i wanted.

---

Lesson 4. Read "A Mint of Money", page 185 in your July Journal.

This story is written in the form of a play. We are given one scene of the play. Write a short scene taking place between the robbers after they left the old man.

"Dialogue" is the name given to all the words actually SPOKEN in a play by the cast (the actors). All words that are in brackets or in Italics are "Stage Directions". These tell you when someone comes on the stage or what he does. These are NOT spoken and MUST be short. Notice that the dialogue has no inverted commas round it but ALL other punctuation is included. Notice two more things about the dialogue of this play - the number of question sentences used. This is very useful when writing a play because it keeps several people talking and enables some ideas to be repeated.

---

Lesson 5. Give the feminine form of:-

- |            |         |
|------------|---------|
| bullock    | stag    |
| colt       | peacock |
| nephew     | sparrow |
| benefactor | hero    |

Give the masculine form of:-

- |          |       |
|----------|-------|
| bride    | lady  |
| nun      | witch |
| widow    | roe   |
| countess | aunt  |

---

Lesson 6.

Here is a simple sentence:- A tramp walked along the road.

Here is the same sentence with adjectival and adverbial phrases adding to the interest and meaning:

As though suffering much from weariness and hunger a tramp with shirt torn at the shoulders and a pair of old dungarees with patches the knees walked wearily and dejectedly through the dust along the road

Use adjectival and adverbial phrases to add to the following:-

1. The cow is in the corn.
2. The man ate the cake.

---

Lesson 7. Position of "only".

- |                                |  |
|--------------------------------|--|
| Only <u>they</u> own two dogs. | (No one else owns two.)                      |
| They <u>only own</u> two dogs. | (They <u>own</u> but do not use them or keep |
| They own <u>only two</u> dogs. | (Two - no more.)                             |
| They own two <u>dogs</u> only. | (Two dogs - nothing else.)                   |

(a) Show (as above) how the position of "only" changes the sense of the following sentence:-

Our visitor sang a few songs.

(b) Do you think the word "only" is in its correct position in these sentences? If not, rewrite the sentences correctly:-

- (i) Father only gave us sixpence.  
 (ii) We only wanted some tea.  
 (iii) Do you think we should only take sandwiches for lunch?

### Lesson 8. Test.

One word answers. Be sure to number your answers correctly.  
State time taken.

Give plural form:-

- |            |                  |
|------------|------------------|
| 1. knife   | 5. Miss Grey     |
| 2. curio   | 6. woman-servant |
| 3. chief   | 7. appendix      |
| 4. volcano | 8. lord-justice. |

Give correct word:-

9. He was averse ...taking orders from me.  
 10. His knife was different .... mine.  
 11. He parted ..... us with regret.  
 12. He parted ..... his knife.

Write the word required from each sentence:-

13. Participle: Seeing him there I walked towards him.  
 14. Conjunction: As I walked along the river I watched the trout.  
 15. Adverb: He did his work well.  
 16. Complete verb: I may not have been here that day.  
 17. Adverb: I am not going to town.

Give correct word:-

18. None of the boys (has, have) a book.  
 19. Neither of the men (was, were) at work.  
 20. I have (rang, rung) you on the telephone.  
 21. These are (their, there) books.

Use "who" or "whom":-

22. You are the people (who, whom) I saw.  
 23. I asked (who, whom) she meant.  
 24. I saw (who, whom) was there.

Form nouns from these adjectives:-

25. brave.  
 26. great.  
 27. correct.

Give superlative form:-

28. good.  
 29. beautiful.  
 30. little.

Time taken: \_\_\_\_\_

SPELLING: Learn de Berry, Lists 21 and 22.

Get someone to give you two dictation tests - about 5 lines each - from your July Journal each week. Mark them yourself and send in the last one.

At the end of the fortnight rewrite the following, correcting where necessary.. :

obligation	providence	trivial	suspicion
pastoral	physician	vengeance	satisfactory.
perpetual	recompense	economise	
polisy	simplicity	puncture	P.T.O.

Lesson 1. Revise work of assignments 1 and 2.

Answer the following questions:-

1. What industries first brought British traders to New Zealand?
2. Who was the first Resident? When was he appointed?
3. What were three reasons for the Treaty of Waitangi?
4. What gift connected with this treaty was made to New Zealand in 1933? By whom?

Lesson 2.

1. When was the Cook Strait cable laid?
2. When was the Pacific cable opened?
3. When was the Union Steam Ship Company established?
4. When did New Zealand become a Dominion?
5. What important event is connected with flying in New Zealand in 1935?

Lesson 3. Revise Assignments 3, 4 and 5.

1. When and where was the Treaty of Versailles signed?
2. For what reason was the League of Nations formed? Who were the chief movers in its formation?
3. Why were Europeans forced to find a sea route to India?
4. Who first sailed round the Cape? What Indian seaport did he reach?
5. Who were the first European settlers in South Africa? Who followed?

Lesson 4. Revise assignments 6 to 9. Revise Time Charts sent with Se

1. What two nations were at war in Canada and India, during the Seven Years' War?
2. When was the Treaty of Paris signed? What did Britain gain by the treaty?
3. What was happening in America from 1775 to 1783?
4. Who discovered Newfoundland?

GEOGRAPHY.

Lesson 1. China.

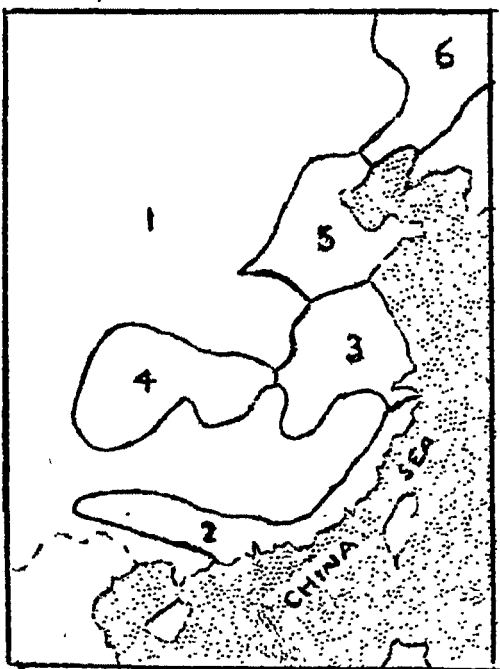

This map shows the five natural divisions of China.

1. Plateaux of Mongolia and Tibet.  
Gobi Desert.  
Southern Mountains.  
Exports: Wool, hides, skins, gold.  
Rich coalfields not extensively worked.
2. The south-eastern coast and the valley of the Si-kiang.  
This part is affected by the monsoons.  
Rice, tea, coffee are grown.
3. Lower basin of Yang-tse-kiang.  
Most densely populated. Climate affected by North-East Trades.  
Wheat, cotton, rice, tea and silk produced.
4. Upper valley of Yang-tse-kiang.  
Silk an important product.

5. Basin of Hwang Ho.  
Climate affected by westerlies.  
Chief products - wheat, peas, beans, millet.

Exercise: Trace above map showing the natural divisions.



Lesson 2. Study pages 134 to 137.

In the map drawn for Lesson 1 mark in all cities named in the passage studied.

---

Lesson 3. Study pages 137 to 140.

The map on page 130 shows Japan's trade routes.

Tokio is now the third largest city in the world. It is nineteen miles from Yokohama. A canal is to be built connecting the two cities, thus making Tokio a seaport. It will take eight years to build and cost about three million pounds.

---

Lesson 4.

See maps of China and Japan enclosed. Trace the map of Japan marking in the chief cities.

---

Lesson 5.

Trace the map of Asia (top map). Print in the names of countries.

Note: Japan has now established a direct shipping trade with New Zealand.

Our trade with Japan is much greater than with China. Our import of ready-made clothing from Japan is steadily increasing. Below is a table showing New Zealand's chief trade with these countries.

<u>Exports</u>		<u>Imports</u>	
<u>China</u>	<u>Japan</u>	<u>China</u>	<u>Japan</u>
Butter	Wool	Tea	Ready-made clothing
Preserved milk.	Butter	Silk	Silk
	Tallow	Fancy goods.	Timber
	Skins		Chinaware
	Kauri gum		Fancy goods.

---

Lesson 6.

In the map below you will notice the large territory of Manchukuo which, within the last few years, has been taken from China by Japan. This province includes the provinces of Manchuria and Jehol and also part of Mongolia. It contains a large Chinese population and deals with a quarter of the Chinese foreign trade.

Japan must import food supplies for her vast population and therefore needs foreign markets for her manufactures so that she may have the money to pay for her imports.

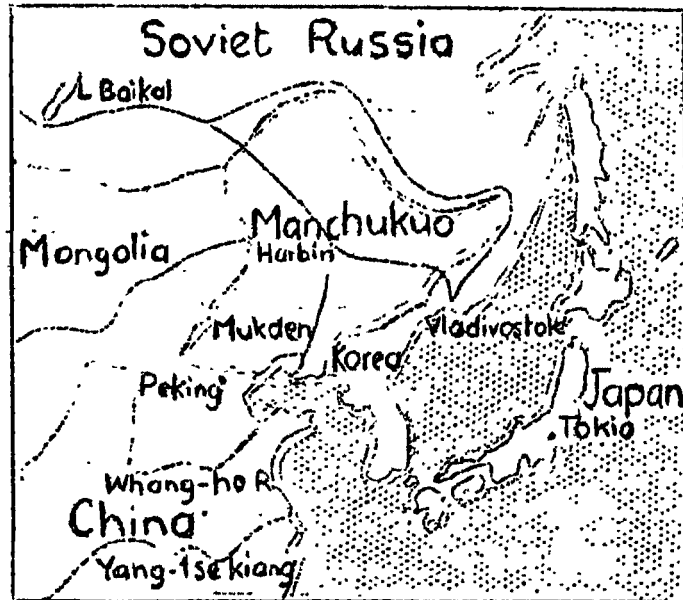
Lesson 6 (continued).

You will see by the map that Japan has now become Russia's neighbour. Russia is afraid that Japan will try to advance into her territory and that she will try to gain control of the four Far-Eastern Railways shown in the map. Note the position of the chief towns of Manchukuo and of Vladivostok, Russia's chief eastern port.

Russia has recently sold her share in the Chinese Eastern Railway to Japan and is taking payment largely in goods. The old system of barter is thus being used.

Answer the following questions:-

1. What three winds affect the climate of China?
2. What British naval base is in China?
3. What are China's three chief rivers?
4. Where is Japan proposing to build an important canal?
5. What is Russia's chief eastern port?
6. What are two important towns in Manchukuo?

ARITHMETIC.1ST DAY:PART A

Mental: Ex.52. Nos. 1 to 10.

Written: Ex.52. A 1, 2, 3.

2ND DAY:PART B

Mental: Ex.52. Nos. 11 to 16.

Written: Ex.52. A 4, 5, 6. Use both methods in No.6.

3RD DAY:

PART A.

Speed: (1) 16mi. 6fur. 7ch. 5yd.  $\times 7$ , (2)  $\times 12$ .  
 (3) 25ton 15cwt. 1qr. 18lb.  $\times 9$ , (4)  $\times 11$ .

Right-angled Triangles, Ex.37, pages 72-74.

The diagram on page 72 gives a right-angled triangle ABC. The right angle is at C. The side AB opposite the right angle, which is also the longest side, is called the hypotenuse. The squared paper shows plainly that the square on BC + the square on AC equals the square on AB. Learn the part printed in heavy type, page 73. Follow the directions-given on page 72.

Written: Ex.37. 4, 5 (1), (2), (6).

Example from No.5.

$$\begin{aligned} 3. \quad a &= 16, \quad b = 20 \\ a^2 + b^2 &= 256 + 400 \\ &= 656 \\ \therefore c^2 &= 656 \\ \therefore c &= \sqrt{656} \end{aligned}$$

$$\begin{array}{r} \sqrt{6,56(25 \cdot 3)} \\ 45 \overline{) 256} \\ \underline{5} \phantom{00} \\ 903 \phantom{00} \\ \underline{3} \phantom{00} \\ 2709 \end{array}$$

Answer: 25.3 units.

4TH DAY:

PART B.

Speed: (1) £67"19"10 $\frac{3}{4}$   $\times 8$ , (2)  $\div 7$   
 (3) 25ac. 7sq.ch. 385sq.yd.  $\times 6$ , (4)  $\times 5$

Written: Ex.52. B 1, 3, 4.

5TH DAY:

PART A.

Mental: Ex.52. Nos.16 to 20.

Written: Ex.52. A 7; B 6, 7, 8.

6TH DAY:

PART B.

Speed: (1) 8cwt. 3qr. 19lb. 8oz.  $\times 11$ , (2)  $\times 9$   
 (3)  $2\frac{7}{10} - 1\frac{9}{10}$ , (4)  $4\frac{3}{5} - 2\frac{4}{5}$ , (5)  $7\frac{7}{8} - 5\frac{5}{16}$

Written: Ex.53. A 1, 2, 3, 4.

7TH DAY:

PART A.

Mental: Express as a decimal:-

(1) £6"7"9 $\frac{1}{4}$ d., (2) £9"17"0 $\frac{1}{2}$ d.  
 (3) £7"10"11 $\frac{1}{2}$ d. (4) £9"3"3 $\frac{1}{2}$ d. (5) £16"8"6 $\frac{1}{2}$ d.

Written:

1. A man whose monthly salary is £27"10"0d. pays £4"8"0d. a month in rent. What percentage of his salary is his rent?
2. A field is 21 ch. long and 20 ch. wide.. What is the length of the diagonal? (See Ex.37. Find square root of the sum of squares on two sides.)
3. A bankrupt who owes me £90 pays a dividend of 4"6d. in the £: what do I lose?

ARITHMETIC (continued).

F.II/13.

8TH DAY:

PART B.

Mental:

- |                                     |  |
|-------------------------------------|--|
| (1) $93 - 6 - 5 - 8 - 5$            | (6) $£6"2"1 \div 5$                          |
| (2) $.06 \times .08$                | (7) Average of 17, 25, 18.                   |
| (3) $2\frac{1}{3}$ times $£3"4"6d.$ | (8) Find area of circle 3ft. in radius       |
| (4) $\sqrt{5\frac{1}{16}}$          | (9) Express $37\frac{1}{2}\%$ as a fraction. |
| (5) H.C.F. of 144 and 168           | (10) Express $17"6d.$ as decimal of £.       |

Written: Ex.53. B 1, 2, 6.

---

9TH DAY:

PART A.

Mental:

- (1) Find selling price of bicycle costing £12 on which  $12\frac{1}{2}\%$  profit is made.
- (2) A house worth £950 is insured at  $10"6d.$  per cent. Find premium.
- (3) Cost of 140 books at  $2"3d.$  each.
- (4) Divide £12 in proportion of 5 to 3.
- (5) How many minutes from  $2:45$  p.m. till  $5:50$  p.m.?

Written:

- (1) A piano costing  $£66"13"4d.$  is sold at a gain of  $17\frac{1}{2}\%$ ; find the selling price.
- (2) 28lb. of tea at 2s. a lb. are mixed with 56lb. at  $2"6d.$  a lb. If the mixture is sold at  $2"11d.$  a lb. what is the gain per cent?
- (3) Find by practice the cost of 11qr. 3bus. 3pecks at  $£2"2"8d.$  per qr.

Remember: 2 gallons = 1 peck.  
4 pecks = 1 bushel.  
8 bushels = 1 quarter.

---

10TH DAY:

PART B.

- Speed:
- (1)  $47.63 \times .12$
  - (2)  $379.645 \times 2.08$
  - (3)  $907.68 \times .887$
  - (4)  $586.971 \div .049$

Written: Ex.54. A 2, 5, 6.

---

I. WORD STUDY (Form II only).

(a) Further roots for your list. Give two more examples of each.

<u>Root</u>	<u>Meaning</u>	<u>Examples</u>
temp(us)	time	temporise (one on page 200.)
pes ped(is)	foot	pedal, pedestrian (one on page 201.)
loc(us) loc -	place	local, location (one on page 200.)

II. READING.

A. "A MINT OF MONEY"

1. What made the robbers think the old man might come back soon? (page 185)
2. How would the robbers be traced? (page 187)
3. In what coin was the money? (page 189)
4. Why was it like this? (page 189)

B. "PAN" (Form II only).

1. What has the author just seen?
2. Who does he say the child is?

In Greek mythology Pan was the god of shepherds and invented the shepherd's pipe which he made from reeds. He had the body of a man and the horns and legs of a goat. If he appeared to travellers he caused terror so we get the word "panic".

C. "LIFE, A QUESTION"

Life ? and wōrth livīng?  
 Yes, wīth eāch pārt of ūs -  
 Hurt of ūs, help of ūs, hope of ūs,  
 heart of ūs,  
 Life is wōrth livīng.

/ - - / -  
 / - - / - -  
 / - - / - - / - - / - -  
 / - - / -

Mark in the rhythm pattern of the remainder of the poem.

This is a poem where there are two syllables marked with a lighter beat. Feel the beat before you mark it.

The rhyme scheme is ABBA. Work out the end rhymes for the whole poem. Notice there are only A and B endings throughout.

D. "DOTHEBOYS HALL"

1. From what novel is this taken?
2. Who was the author?
3. Write the sentence that tells that the boys did not like the treacle, either before or after taking it. (pages 198, 199)
4. What did Mrs Squeers use for a towel? (page 199)
5. Do you think the spelling was good in the school? (page 201)

E. "PICKLED HERRING" (Form II only).

1. Why did the Captain send the fish down to the fo'c'sle? (pages 206-207)
2. Why did Joe and Sam make such haste up to the deck after dropping the plate? (page 208)
3. Do you think the fish was really poisoned?
4. Write the phrase that tells us the sailors were waiting for something to happen. (page 205).
5. Write the words that mean:-
  - angry (page 203).
  - trying to be unobserved (page 203)
  - clever (page 204).
  - pretending to be pious (page 207)

Similes:

Sometimes we say that something is like something else in one respect while in all other respects it is quite different.

The sailor climbed up the rigging like a squirrel.

Here the only similarity is the speed and agility of climbing

The stars are shining like diamonds in the sky.

- (a) What is the point in which stars and diamonds are similar? We call this a Simile (pronounce sim-il-ee).
- (b) Find similes in your July Journal, - one on page 184, two on page 191 and one on page 202. Write three of your own.

III. SPEECH EXERCISES.

Some more words MISSPELT because of FAULTY PRONUNCIATION.

accept (not except)	drawer (not draw)
hydrangea (not hydranger)	remembrance (not rememberance)
peculiar (not peculiar)	victims (not victoms)
properly (not proply)	necessary (not nesary).

The a sound as in "make", "fame", "day", "veil". Say the word "net" - cut off the "n" - say "et". Cut off the "t" and say "e". Repeat this sound very carefully. Follow this sound by the "i" sound as in "i. e-i, e-i, e-i. Be careful not to change into a long "e" sound; "dee" for "day" or holding on to the sound too long. "Dayee", "playee" for "day", "play".

For practice:

"The Dying Aviator"

A handsome young airman lay dying,  
 Chorus: lay dying,  
 And as on the aer'drome he lay,  
 he lay,  
 To the mechanics who around him came sighing,  
 came sighing  
 These last dying words he did say,  
 did say  
 "Take the cylinder out of my kidneys"  
 "of his kidneys"  
 "The connecting rod out of my brain"  
 "of his brain"  
 "The cam box from under my backbone,"  
 "his backbone,"  
 "And assemble the engine again."  
 again."

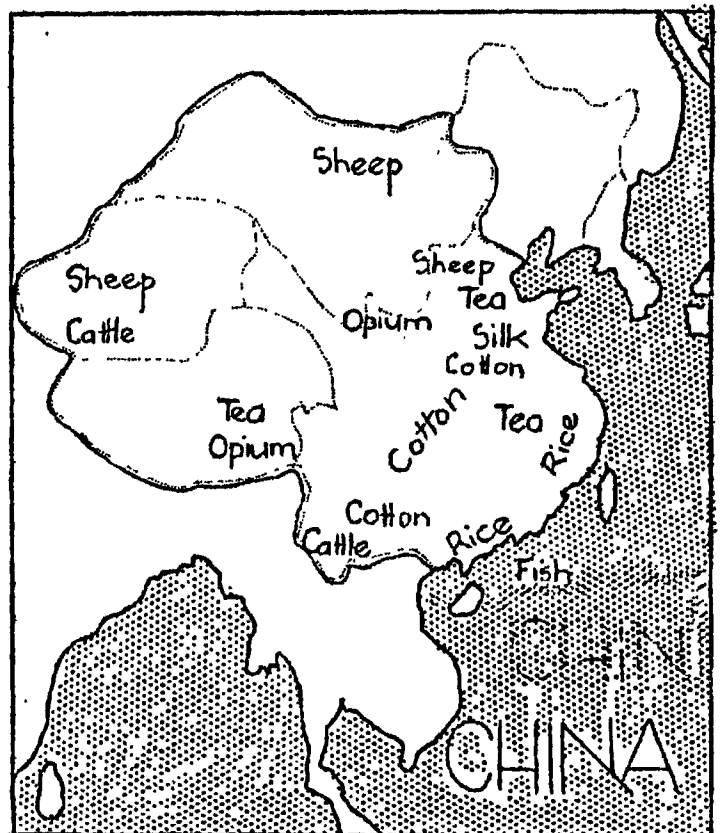
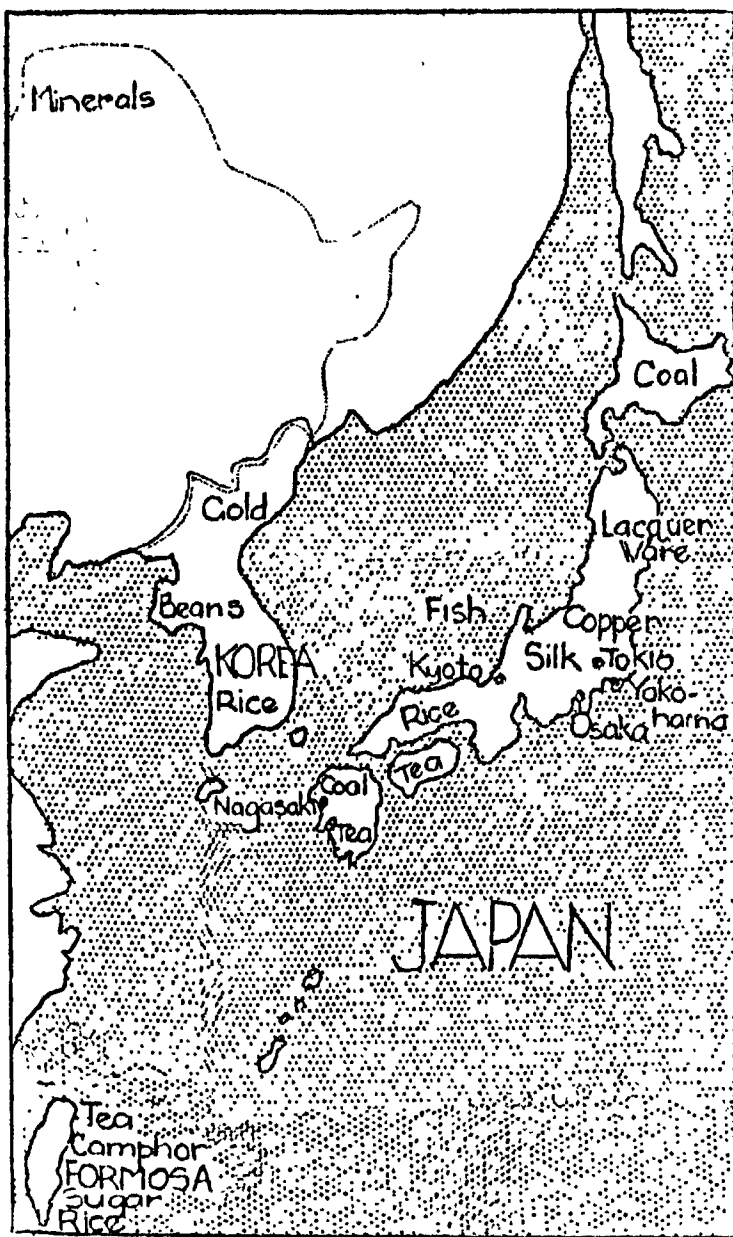
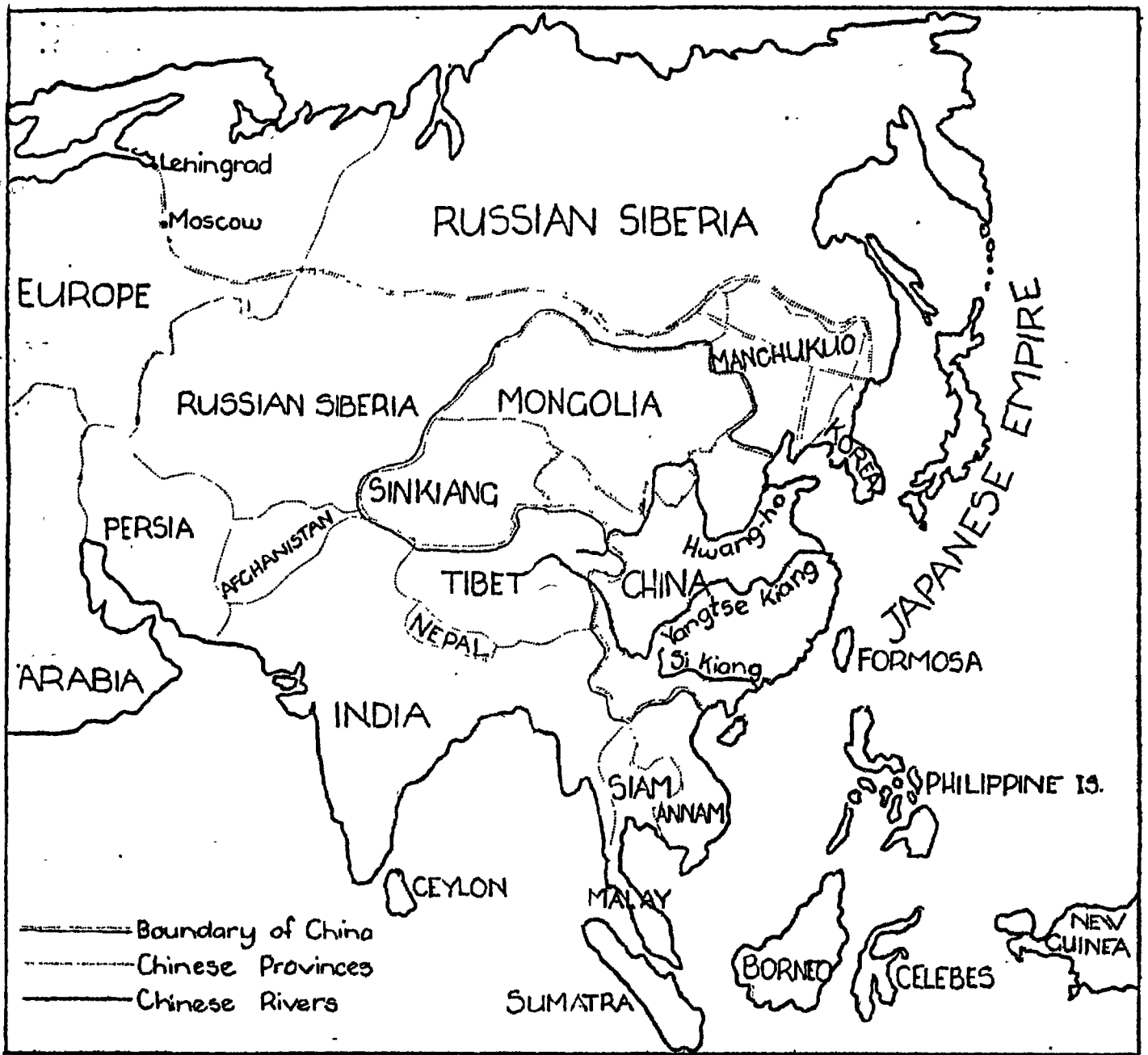

PRODUCTS OF  
JAPAN and CHINA

1. AN ENGLISH HERITAGE, I.

"How Mr. Pickwick went to Dingley Dell," pages 202-211.

Study the whole passage carefully.

2. AN ENGLISH HERITAGE, I, pages 211-213.

See "Work to be sent in."

3. GROUP OF WORDS.Phrases.

In analysing sentences we often come across groups of words which go so closely together that they are equivalent to a single word. For instance, instead of 'the palace of the king' we may say 'the king's palace' or 'the royal palace'; instead of 'the men of Cornwall' we may say 'the Cornish men'. And even when we cannot find a single word which might be substituted for the group of words, we can see that certain groups of words are used like (or are equivalent to or do the work of) a single word.

It is convenient to have a name for such groups of words; and grammarians call them phrases. Phrases are of various kinds. Some phrases are used like adjectives, others like adverbs. They may therefore be names after the part of speech which they resemble. Thus the phrases of the king and of Cornwall are called adjective-phrases, because they are used like adjectives. In the sentence 'The door in the mountain-side shut fast' the group in the mountain-side is used like an adjective; for it indicates the particular door that is meant: it is therefore also an adjective-phrase. But in the sentence 'There it stands to the present day' the group to the present day is used like the adverb 'now', and is therefore called an adverb-phrase. In this instance the adverb-phrase qualifies the verb 'stands'; but in some instances adverb-phrases are used to qualify adjectives or adverbs; for example, in 'The sun is high above the hills' the phrase above the hills qualifies the adjective 'high'; in 'The Falkland Islands lie eastward of Cape Horn' the phrase of Cape Horn qualifies the adverb 'eastward'.

Notice that the word 'phrase' denotes something quite different from the word 'sentence'. A phrase is only a part of a sentence, just as an adjective or an adverb is only part of a sentence.

4. WRITTEN WORK.5. NARRATIVE COMPOSITION:

A few points to note about telling a story, either orally or in writing.

1. Arrange the facts in proper order, so as to lead up to a 'main point' of excitement.
2. Having reached the main point, finish fairly quickly.

The 'graph' of a story is thus:

Main point  
of excitement

ment

Conclusion



3. There should be at least three paragraphs. Five may be necessary in a longer narrative. The crisis should come, as a rule, at the end of the last paragraph but one. The last paragraph is then very short.
4. Conversation can often be introduced with good effect. Remember the idea of 'key-sentences'; remember, too, that we found short sentences best for 'breathless' events.

6. }  
7. } WRITTEN WORK.

8. POETS AND POETRY, JUNIOR BOOK III.

Study the three poems, pages 68-72, and the introduction, pages 64-68.

9. ESSAY-WRITING.

An "Essay" is so named because in it you are expected to make an "attempt," however simple, to express your ideas on a given subject. Your work should be something more than simple "narration" or "description"; it should contain your personal thoughts on the topic you are considering. Thus a descriptive account of a "Soldier" will be largely concerned with his personal appearance, dress, and equipment, but in an essay on "Soldiers" you would be expected to give some of your thoughts about them, thoughts on the attraction of the life, or on its hardships and dangers, and on the need for soldiers and of their value.

"Your ideas, however, must not be put down haphazardly, as they occur. Any piece of composition, whether an essay or an exercise in narration or description, must be a complete whole; that is to say, it must proceed from a definite beginning to a definite end, through successive steps in which the beginning and the end are both kept steadily in view. Evidently to secure this it is necessary that you must think before you write, and must have clearly in mind what you mean to say, both the matter and the order. As in composing a sentence, so in composing an essay, the end should be in view from the beginning; if this is so, the intermediate steps will fall naturally into their place. You must, therefore, make your notes for the matter and order for the essay before you begin to write it."

Thus in an essay on "Butterflies" you may decide to deal with the subject in order to development from egg to caterpillar, to chrysalis, to butterfly, to egg again; or you may begin with the butterfly and give a description of its form, colour, and habits, mentioning egg laying, and so pass to the development of the insect from the egg.

Your personal interest in the subject should be shown, and might appear in a paragraph on the collection of butterflies, together with your thoughts on the beauty of form and colouring; on the interest there is in the study of these insects; on the pleasure derived from country rambles in search of specimens; or you may object to collections and decide to concentrate on the delight to be gained from simply watching butterflies.

For your essay, then, you should make such an introduction as will excite the interest of the reader, then in successive paragraphs discuss your subject in order, leading to some definite conclusion concerning for instance the beauty of butterflies, or to some other point which you intended from the first to reach.

Your general plan may be expressed thus:-

INTRODUCTION:     DISCUSSION:     CONCLUSION.

One sentence or paragraph will be given to the Introduction, one or more paragraphs to the Discussion, according to the number of separate headings in your plan, and one sentence or paragraph to the Conclusion.

10. ORIGINAL COMPOSITION.

Prepare an essay on one of the following:-

- (a) My Hobbies.
- (b) The Sea.
- (c) New Zealand birds.

11. "THE APPROACH TO SHAKESPEARE."

Study pages 57-61 - "King John" and the first selection. Try to read the dialogue between Prince Arthur and Hubert with a friend, aloud.

12. READING.

WORK TO BE SENT IN:-

SECTION A.

1. AN ENGLISH HERITAGE, I, page 211.

Section i, questions 1, 2, 4.

4. AN ENGLISH HERITAGE, I, page 211.

Section i, question 6.

6. and 7. NARRATIVE COMPOSITION.

Weave one of the following into a full narrative.

Supply your own title:-

(a) Napoleon, defeated, on Elba - Discontent and ambition - Decided to return to France - Few followers - Approached large opposing army at Grenoble - Napoleon told followers to remain where they were - He rode on alone towards the hillside held by opposing army - When fairly near Napoleon dismounted - Walked on - Rifles levelled at him - He threw aside coat, crying out: "Where is the man who will shoot his Emperor?" - They were captured by his tremendous courage and personality - Dashed towards him, reswore their allegiance - He went on to Paris and a short period of power.

(b) Robbie Watson - Driver of Dumfries coach - Inexperienced horses took fright - Out of control on steep hillside - Awkward turn at bottom - Gate, leading into field, directly opposite foot of hill - Robbie decided to dash the horses into the gate, hoping to destroy it and save overturning - The impact - Plan successful; passengers, though shocked, were unhurt and grateful.

SECTION B.

2. AN ENGLISH HERITAGE, I, page 212.

Section ii, questions 1, 2, 3, 4.

ASSIGNMENT.

3. PHRASES.

Write out the following, and underline (in black ink) the adjective and adverb-phrases. Rule one line underneath the adjective-phrases, and a double line below the adverb-phrases.

The walk to the field was a muddy one. We crossed a river, which, for some reason, was called 'The Waters of Babylon'. But the bridge across the water had become useless, so we waded through the stream. When we got to the field, we heard the Captain's voice. We arrived at the playing-ground just as the game was beginning.

A Day at Eton

5. AN ENGLISH HERITAGE, I, pages 212, 213.

Section ii, question 8.

Write out the following passage into correct punctuation.

unluckily there was a blunder at the very onset the musicians became flurried master simon was in a fever everything went on lamely until they came to a chorus beginni now let us sing with one accord which seemed to be a signal for parting company all became discord and confusion each shifted for himself and got to the end as well or rather as soon as he could excepting one old chorister in a pair of horn spectacles bestriding and pinching a long sonorous nose who happened to stand a little apart and being wrapt up in his own melody kept on a quavering course wriggling his head ogling his book and winding all up by a nasal solo of at least three bars duration irving

8. POETS AND POETRY, JUNIOR BOOK III.

Write full answers to all the questions on pages 72, 73.

10. ORIGINAL COMPOSITION.

Essay as set. (Begin this answer on a new page).

This Set of Models is the property of the Education Department. It

is to be regarded as confidential, and is to be returned to the

Department when asked for.

MODEL ANSWERS.

---BF. ---35.

FIRST YEAR.

ENGLISH.

SET 11.

SECTION B.

2. 1. He took the children by the hand,  
Tears standing in their eye,  
and bade them straightway follow him  
And look they did not cry;  
And two long miles he led them on,  
While they for food complain,  
'Stay here!', quoth he, 'I'll bring you bread  
When I come back again'.
2. "Now my lads," the colonel went on, addressing the men, "you have all been pressed to serve Her Majesty in accordance with Act of Parliament, and though some of you may not like it, you will soon get over that, and take to it kindly enough. In a newly raised regiment like this one it is necessary to keep a tight hand, but if you behave well, and do your duty, you will not find the life hard. Remember it's no use any of you thinking of deserting; for we have got your names. That will do."
4. AN ENGLISH HERITAGE I, page 154.

SECTION II.

1. Expostulated: Remonstrated with.  
mica: A shining mineral found in granite in thin layers.  
whin: Gorse, or gorse bush.  
burnie: A small stream.  
habitat: The natural home of plant or animal.  
ascertained: Found out after enquiry.  
alternately: (Of two things) occurring one after the other in turn.  
available: Capable of being used; at one's disposal.  
stampede: A disorderly rush of horses, cattle, or people, caused by sudden panic.  
venomous: Poisonous.
2. Adjoining: ad (Latin) to, towards.  
forbiden: for, (depreciatory).  
a-birdnesting: a; on or in.  
impossible: im; not.  
disrobed: dis, apart, not.  
recess: re; back, again.  
deposited: de, down.  
excursion: ex, out of; from.  
conclave: con; with.  
suspended: sub, under.
3. "The disease, if it might be so called, was firmly rooted in him." His love of collecting specimens was so great that it became a ruling passion and was looked upon by others almost as a disease which was incurable.
- "Wha wed gang wi' ye? Ye never come hame.": Who would go with you; you never come home.
- "The boys had fun in skelpin' out the bees.": The boys enjoyed the sport of chasing out the bees.
- "He hasna gotten his sark.": He has not got his shirt.
- "Tom brought it, sorrowfully enough, for he dreaded the issue." Tom brought it (the shirt) unwillingly, for he was afraid of receiving punishment.

5. They were so overcome by the sad news, that they were literally unable to speak.

The patient who had a bad cold was warned not to aggravate it by going out into the cold air.

The idea that all men are equal is preposterous, and need not be considered seriously.

Let us go to the tea-room, and partake of some light refreshments.

The handsomely bound prize books made a splendid show on the table.

The thunder echoed among the rocks with awful sound.

N.B. "Splendid" and "awful" are words which have lost to some extent their original meaning. "Splendid" really means "shining", and "awful" "causing superstitious fear". We now use these words in a more colloquial or conversational sense, as when we say "a splendid idea", "an awful nuisance". This was considered bad writing some years ago, but is now to a certain extent allowed.

8. PATTERN POETRY, JUNIOR BOOK III.

1. "King George's Dalmation" - Descriptive Paragraph.

N.B. A Dalmatian is a large dog of the greyhound type. It has short white hair, covered with small black spots; hence called the "Plum Pudding dog". People of mark in the early days of the last century used to take Dalmatians with them in their carriages.

2. "On the Quay."

The unexpected part of the story is in the last line. The reader would hardly think that the forlorn little middy would one day be the great Lord Nelson.

3. "The Night of Trafalgar."

- (a) The line that describes the giant power of the storm is, "The victors and the vanquished then, the storm it tossed and tore".
- (b) Repeating a word or words, if skilfully done, gives emphasis. The repetition of the words "dark" and "deep" intensifies the darkness of the night, and the depth of the sea.

10. ORIGINAL COMPOSITION.

---

This Assignment is the Property of the Education Department. It is to be regarded as Confidential and is to be returned to the Department when asked for.

BL. 36.

HISTORY.

FIRST YEAR.

SET 14.

SECONDARY DIVISION.

Study Book III, pages 50-53; 61-67; 74-75.

WILLIAM III AND MARY  
1689-1702.

THE TRIUMPH OF PARLIAMENT.



Noble and Lady.

The reign of William and Mary began the period of limited monarchy in England. It discredited the theory of "Divine Right" and marked the triumph of Parliament. These sovereigns consented to rule under certain conditions which were laid down in a document called the Bill of Rights which they had to sign. The chief of these conditions are set out clearly on page 50, and I want you to learn them very carefully.

The history of the beginnings of the national debt is interesting and important. Note that holders of Government bonds could dispose of them to other people. See page 51. In 1694 the Bank of England was founded.

Study the paragraphs on Cabinet government. This is the origin of the present-day cabinet. (Page 52)

N.B. The term "Prime Minister", was first used in George I's reign.

The Act of Settlement, too, is important, on the same page.

As King, William was not a great favourite with the English, for his manner was cold and reserved. He was, however, distinguished for his personal bravery, great-perseverance, and force of will. He succeeded in his endeavours to curb the power of Louis and to protect Protestantism, and he devoted himself to promoting the best interests of England. I shall leave you to read about the war with France and the Spanish Succession, pages 61-65. Note Marlborough's victories and the Treaty of Utrecht, 1713. (Learn the clauses).

Mary died in 1694 and William reigned alone till 1702 when Anne, Mary's younger sister succeeded to the throne.

ANNE 1702-1714.

Queen Anne was very popular with her subjects. Her reign is important for the union of England and Scotland, 1707, and the Great war which was ended by the peace of Utrecht, 1713.

Union of England and Scotland, see page 52.

A Union Bill was passed by both parliaments in 1707 which settled the relations between the two countries down to the present time.

First it was agreed that the two countries should be united under the name of Great Britain, and that after the death of Anne, the succession to the throne should go to the Princess Sophia, and her Protestant descendants. From this date there was to be community of rights and privileges between the two countries. Scotland was to send to the United Parliament sixteen Peers to the House of Lords, and forty-five members to the House of Commons. The Scottish Peers were to elect their own representatives, who should serve only during the one Parliament for which they were elected. The Scots now send 74 members to the House of Commons, owing to the increase in population.

Furthermore, it was enacted that each country should retain its own laws and judges, as well as its own universities and National Church. The King of Great Britain is still required on his succession to take an oath to protect the Church as established in England, and likewise the Presbyterian Church as established in Scotland.

Then it was arranged that equal privileges of trade should be enjoyed, that the same duties should be levied on exports and imports, and that the same coins, weights, and measures should be used in both countries.

The first united Parliament met on October 23rd, 1707. A new standard, on which were blended the flags of both nations, the crosses of St. George and St. Andrew, was adopted as the national flag. It was called the Union Jack, as it was first planned by James I, the Latin name for James being "Jacobus". This union of the two Parliaments marks the close of the long rivalry and much dispute between England and Scotland.

#### LITERATURE:

Queen Anne's reign was an important period in the history of English literature. It was an age when the Great Prose writers lived - Addison and Steele, Defoe and Swift. Addison and Steele wrote essays for the papers which in those days took the place of newspapers. The best known of these papers was the "Spectator" which Addison has made famous. For the "Spectator" he wrote the Coverley Papers which tell of the life and thoughts of Sir Roger de Coverley. Defoe and Swift wrote political pamphlets in this reign, but in the next reign, George I, Defoe wrote the story of "Robinson Crusoe" and Swift, "Gulliver's Travels". Alexander Pope was the best known poet of the reign. He wrote many poems all in the same kind of verse, with each pair of lines rhyming at the end.

Note the dress of the gentleman and lady in this reign on page 66.

Anne died in 1714 without leaving an heir. The nearest heir by birth was her brother, James, the son of James II. But as he was a Roman Catholic, by the Act of Settlement passed in 1701, the Crown passed to the ruler of the German State of Hanover, Prince George. The Tory Party wanted James to succeed, but the Whigs were determined to maintain the Act of Settlement and at once proclaimed George king.

#### WRITTEN WORK.

##### SECTION A.

1. Explain the origin of the National Debt.

2. What did England gain by the Treaty of Utrecht ?
3. State the chief terms of the union between England and Scotland.
4. Make a sketch of Marlborough's route to Blenheim.
5. What changes were made in the currency in William III's reign ?

SECTION B.

1. Parliament granted James II an income for life but William III was granted his income for one year at a time. William III did not like this. Why not ?
2. Explain the origin of Cabinet. Who is Prime Minister in England now ? In New Zealand ?
3. What do you know of the literature in Anne's reign ?
4. (a) Give the dates for the following :-
  - (1) Victory of Blenheim.
  - (2) Establishment of Bank of England.
  - (3) Anne became Queen.
  - (4) Bill of Rights.
  - (5) Act of Union between England and Scotland.
- (b) State chief clauses of the Bill of Rights.

---

FOUR PERIODS PER ASSIGNMENT.

1. Study: Assignment and pages 50 - 53.
  2. Written: Answer A.1, 3, B.1, 2, 3.
  3. Study: Assignment and pages 61 - 67; 74 - 75.
  4. Written: Answer A.2, 4, and 5, and B.4.
-



THE WEST INDIES.

Study text-book, chapter 2.

The West Indies are old colonies which used to be more important than they are at present. At one time they were considered much more important than Canada, because before the Industrial Revolution the colonial products which Britain valued were those which she could not grow herself, such as sugar. The sugar planters of the 16th, 17th and 18th centuries made huge fortunes; but the abolition of slavery in the British Empire raised the costs of sugar-growing in British colonies and Cuba, which is not a British colony, gained the lead in the sugar trade. The growth of the beet-sugar industry in Europe also helped to depress the industry; but there has been some revival in sugar-growing in the last twenty years.

In the 17th century Jamaica was the resort of pirates, who captured and robbed Spanish ships visiting the wealthy Spanish colonies on the mainland of Central America. "It is a very far cry from the early days when Port Royal, in Kingston Harbour, the stronghold of such famous buccaners as Kidd, Blackbeard and Morgan, was the richest city in the world, and bronzed and bearded seamen swaggered about decked out in the finest silks of the Orient and costly jewellery taken from the prizes hoarded at the wharves. The wealth of Jamaica is now neither so fabulous nor so adventurously acquired, but it is nevertheless considerable."

This piracy was carried on without very severe disapproval from the British authorities and Charles II pardoned Morgan and made him governor of Jamaica.

The West Indies have become popular now as tourist resorts. The following is a description of typical West Indian scenery; "It would be impossible to exaggerate the exquisite beauty of the West Indian islands. Cloud-capped mountains covered from base to summit with a wealth of tropical vegetation, valleys densely cultivated with cacao, sugar-cane and fruit trees, surf-bound coasts fringed with graceful coconut palm trees, coral strands whose brilliant whiteness is in pleasing contrast with the indigo blue seas of these low latitudes, form pictures of surprising charm."

Your book does not give a clear enough account of the climate. In winter the east sides of the islands have rain from the Trades, and the west sides are much drier; but in summer the east still gets some rain from the Trades and there are also equatorial rains caused by the sun being practically overhead. Thus summer is a very rainy season and there are many thunderstorms.

QUESTIONS.

1. How did the winds help Columbus on his journeys to America and back to Spain?
2. Give an account of the climate of the West Indies.

or

Imagine yourself one of those who accompanied Columbus on his first voyage. Either write to a friend describing your impressions of the islands on landing or write a diary of the trip paying particular attention to your impressions of what you saw on landing.

3. Describe the physical structure of the West Indies.
  4. Give an account of the relief, climate and products of Jamaica. Illustrate by the three maps in your book. What is the name of the chief port? Would you prefer to live there now or in the 17th century? Give your reasons.
- B.1. What do you know about:
- (a) The Windward Isles?
  - (b) The Leeward Isles?
- What are their products?
2. Describe the changes that have taken place in trade with the West Indies.
  3. Describe the asphalt lake of Trinidad. What other products do we get from Trinidad?
  4. Draw a map showing the West Indies, British Honduras and British Guiana. Put in everything in the map on page 23 of your text-book; but make the map larger.

---

Number of hour periods: 4.

SUGGESTED ORGANISATION OF WORK.

- 1st period: Revise last set returned and do question 4 of section B.
- 2nd period: Study assignment and text-book.
- 3rd period: Do questions 1, 2 and 3 in section A.
- 4th period: Do remainder of questions.
-

This set of Model Answers is the property of the Education Department.

It is to be regarded as confidential, and is to be returned to the Department when asked for. IG.34.

FIRST-YEAR. GEOGRAPHY. SECONDARY DEPARTMENT. SET 11.

1. Map of physical features.

2. Map showing products.

3. The cultivation of the Indo-Gangetic Plain depends chiefly on the water supply. There is a saturated layer of moisture in the ground. This is at the surface in the Ganges Delta, where there is a dense jungle. A short distance away from this jungle are grown things which require a great deal of water - rice, jute, opium, tobacco and indigo. This is the plain of Bengal, one of the most densely populated regions in the world.

The surface of the land rises about a foot a mile and the saturated layer becomes progressively further below the surface of the land and the land becomes drier and drier until at the eastern end of the Indo-Gangetic Plain there is a desert. In the United Provinces the climate and soil are drier than in Bengal, but still damp enough to support a very large population. Some rice is grown, but the chief cereals in this drier part are millet and wheat. A considerable amount of cotton is also grown. Further west in the Punjab wheat is the main crop, though cotton and tobacco are also grown. Here the saturated layer is a considerable distance from the surface and can just be reached by wells. South of the Punjab is the Thar Desert, where farming is impossible. (*The Punjab also has river irrigation*)

4. (a) THE DEKKAN.

On the western edge of the Dekkan the Monsoon brings a good rainfall and there is a forested area with valuable hard woods, such as teak. But over most of the Dekkan the rainfall is insufficient for crops which require a great deal of moisture, such as rice. Wheat and millet are grown where irrigation is possible. The rich, black soil round Bombay is very suitable for cotton, and some tobacco and tea are grown towards the south. However, the greater part of the Dekkan is cattle country.

(b) THE COASTAL PLAIN OF MADRAS.

Round Madras there is a low lying wet plain where the chief crop is rice. Other important crops are cotton, tobacco, oil seeds and indigo.

5. The chief district for tea plantations is Assam in the north east of India. Tea gives the best yields where the temperature is high all the year round and the rainy season is long. It needs a wet climate but grows best on well-drained hill slopes. It is profitable only where there is a large supply of cheap labour, as the leaves have to be picked by hand. Assam is very wet in the long rainy season because one branch of the monsoon crosses the hills and causes heavy rainfall. It has hill slopes, and there is a large supply of cheap labour at hand, as this region is densely populated.

6. (a) Monsoons are like land and sea breezes on a large scale. They are winds which blow from sea to land in summer, and change their direction in winter, blowing from land to sea.

The greatest monsoons are those of Asia. Asia is a large land mass and in summer it becomes very hot, so that there is a low pressure area over the land. The sea does not either gain or lose heat as quickly as the land. Therefore the cool air from the sea blows towards the land, bringing rain. In winter the interior of Asia is extremely cold and forms a high pressure area, from which air flows outwards to the ocean, where the air is warmer and lighter. As this wind has very little change of evaporating moisture as it blows across the land it does not bring rain.

(b) The Indian Monsoon is very important because it supplies rain for growing crops and water for the rivers. Some of the rain also soaks into the ground and forms a saturated layer which is of great use for cultivation. Rice, the chief food of millions of the people of India, is grown in the mud in flooded ground and if the rice crop failed these millions might starve. The Indo-Gangetic Plain is one of the most densely populated areas on the globe.

"This rain-bearing breeze is the most momentous single climatic fact affecting the human race, for it feeds the half of them."

---

Text-book: Loney & Grenville.PROFIT AND LOSS.

It is now necessary to see how the cost price can be found if the selling price and the gain or loss per cent are given. Still bearing in mind that profit and loss are reckoned on the cost price; the rule is:-

$$\begin{aligned} \text{C.P.} + \text{Gain on C.P.} &= \text{S.P.} \\ \text{C.P.} - \text{Loss on C.P.} &= \text{S.P.} \end{aligned}$$

EXAMPLE 1. An article is sold for £21 at a profit of 12% on the C.P. Find the C.P.

$$\text{C.P.} + 12\% \text{ of C.P.} = \text{S.P.}$$

$$112\% \text{ of C.P.} = £21$$

$$100\% \text{ of C.P.} = \frac{£21}{1} \times \frac{100}{112}$$

$$\therefore \text{C.P.} = \frac{£75}{4}$$

$$= £18.15.0$$

EXAMPLE 2. Goods are sold at £510 at a loss of 15%. Find the C.P.

$$\text{C.P.} - \text{loss on C.P.} = \text{S.P.}$$

$$\text{C.P.} - 15\% \text{ of C.P.} = £510$$

$$\therefore 85\% \text{ of C.P.} = £510$$

$$100\% \text{ of C.P.} = \frac{£510}{1} \times \frac{100}{85}$$

$$\therefore \text{C.P.} = £600.$$

SECTION A. Examples LXV, page 112 - No's 8, 9, 10.

SECTION B. Examples LXV, page 112, No's 11, 12, 15.

EXAMPLES LXVI, page 113.

Profit and Loss.

Read through the worked example given below. This method is to be used rather than the method shown in the text-book.

WORKED EXAMPLE. A man sold a field for £138.12s. and by so doing lost 5½% on what it cost him; find what per cent he would have gained had he sold it for £184.5s.

$$\text{S.P.} = \text{£}138.12\text{s.}$$

$$\text{Loss} = 5\frac{1}{2}\%$$

$$\text{C.P.} = 5\frac{1}{2}\% \text{ C.P.} = \text{£}138\frac{3}{5}$$

$$\therefore 94\frac{1}{2}\% \text{ C.P.} = \text{£}138\frac{3}{5}$$

$$100\% \text{ C.P.} = \text{£} \frac{693}{5} \times \frac{100}{1} \times \frac{2}{189}$$

$$\text{C.P.} = \text{£} \frac{440}{3}$$

$$= \text{£}146\frac{2}{3}$$

$$\text{If S.P.} = \text{£}184\frac{1}{4}$$

$$\text{Gain} = \text{£}37\frac{7}{12}$$

$$\text{Gain \%} = \frac{37\frac{7}{12}}{146\frac{2}{3}} \times \frac{100}{1}$$

$$= \frac{41}{12} \times \frac{3}{44} \times \frac{100}{1}$$

$$= \frac{205}{8}$$

$$= 25\frac{5}{8}\%$$

EXAMPLES LXVI, page 113.

SECTION A. Numbers 2-10. SECTION B. Numbers 11, 13, 15, 19, 21, 23, 25.

N.B. Read carefully examples 17 and 22 which are worked out for you.

Period 1. Study the assignment to the end of Example 2. Do Examples LXV, page 112, No's 8, 9, 10. (Section A.)

Period 2. Revise the assignment. Do Examples LXV, page 112, No's 11, 12, 15. (Section B.)

Period 3. Study the rest of the assignment. Do Examples LXVI, page 113, No's 2-5. (Section A.)

Period 4. Do Examples LXVI, page 113; No's 6-10. (Section A.)

Period 5. Do Examples LXVI, page 113, No's 11, 13, 15. (Section B.) Read No's 17 and 22.

Period 6. Revise the whole assignment. Do Examples LXVI, page 113, No's 19, 21, 23, 25.

This Set of Model Answers is the property of the Education Department.

It is to be regarded as confidential, and is to be returned to the

Department when asked for.

FIRST YEAR. VF.36

SET 11.

ARITHMETIC.

Secondary Division.

Page 33.

Examples XVIII.

$$\begin{aligned}
 32. \quad & \left(\frac{7}{8} + \frac{5}{6} + \frac{3}{4}\right) - \left(\frac{6}{7} + \frac{4}{5} + \frac{2}{3}\right) \\
 & = \frac{21 + 20 + 18}{24} - \frac{90 + 84 + 70}{105} \\
 & = \frac{59}{24} - \frac{244}{105} \\
 & = 2\frac{11}{24} - 2\frac{34}{105} \\
 & = \frac{385 - 272}{840} \\
 & = \frac{113}{840}
 \end{aligned}$$

$$24 = 3 \times 8$$

$$105 = 3 \times 35$$

$$\text{L.C.M.} = \begin{array}{l} 3 \times 8 \\ \times 35 \end{array}$$

$$= 840.$$

$$\begin{aligned}
 33. \quad & \left(\frac{3}{2} + \frac{5}{4} + \frac{7}{6}\right) - \left(\frac{4}{3} + \frac{6}{5} + \frac{8}{7}\right) \\
 & = \left(1\frac{1}{2} + 1\frac{1}{4} + 1\frac{1}{6}\right) - \left(1\frac{1}{3} + 1\frac{1}{5} + 1\frac{1}{7}\right) \\
 & = 3 + \frac{6 + 3 + 2}{12} - 3 + \frac{35 + 21 + 15}{105} \\
 & = 3\frac{11}{12} - 3\frac{71}{105} \\
 & = \frac{385 - 284}{420} \\
 & = \frac{101}{420}
 \end{aligned}$$

$$12 = 3 \times 4$$

$$105 = 3 \times 35$$

$$\text{L.C.M.} = \begin{array}{l} 3 \times 4 \\ \times 35 \end{array}$$

$$= 420$$

P.T.O.

EQUATIONS. Revise the explanation of equations and problems given in Sets 1, 2, 3. Study example 1 on page 49. You have already worked several equations in Sets 1, 2, 3 by this method where you have to show all the steps of the working. Now turn to page 50. Study paragraph 43 and the examples worked out on that page. Consider the following equation taken from Ex. VIIb.

$$12 \quad 8x - 12 = x + 2$$

Subtract  $x$  from both sides.

The result is that  $x$  disappears from the right hand side and appears on the left hand side with its sign changed.

$$\begin{array}{l} 8x - x = 12 + 2 \\ \text{Add } 12 \text{ to both sides.} \end{array}$$

The result is that  $-12$  disappears from the left hand side and appears on the right, with its sign changed.

$$\begin{array}{rcl} 8x - x & = & 12 + 2 \\ 7x & = & 14 \\ x & = & 2 \end{array}$$

The following rule is most important.

Any term may be transposed from one side of an equation to another by changing its sign.

To check your answer, put  $x = 2$  in the equation and prove that both sides will come to the same result. Write R.S. for right side, and L.S. for left side.

$$8x - 12 = x + 2$$

when  $x = 2$

$$\begin{array}{rcl} \text{L.S.} & = & 8x - 12 & \text{R.S.} & = & x + 2 \\ & = & 16 - 12 & & = & 2 + 2 \\ & = & 4 & & = & 4 \end{array}$$

As both sides come to 4 when  $x = 2$ , this must be the correct solution of the equation.

$$\begin{array}{rcl} 13. & 2x + 5 & = & 35 - 4x \\ & 2x + 4x & = & 35 - 5 \\ & 6x & = & 30 \\ & x & = & 5 \end{array}$$

CHECK.

$$\begin{array}{rcl} \text{When } x = 5, & \text{L.S.} & = & 2x + 5 & \text{R.S.} & = & 35 - 4x \\ & & = & 10 + 5 & & = & 35 - 20 \\ & & = & 15 & & = & 15 \end{array}$$

$\therefore x = 5$  is the correct solution.



Ex. Vllb, page 49.

SECTION A. Work the odd numbers from No's 1 to 20, omitting No. 1.

SECTION B. Work the even numbers from No's 1 to 20, omitting No. 1.

Check all your answers.

Study the explanation given after No. 20.  
Also study the following:

No. 21.  $\frac{x}{3} = \frac{1}{2}$

Multiply both sides by 6, the L.C.M. of the denominators

$$\begin{aligned} \frac{x}{3} \times 6 &= \frac{1}{2} \times 6 \\ 2x &= 3 \\ x &= \frac{3}{2} = 1\frac{1}{2} \end{aligned}$$

22.  $\frac{2x}{3} = \frac{5}{6}$

Mult. by 6

$$\begin{aligned} 4x &= 5 \\ x &= \frac{5}{4} = 1\frac{1}{4} \end{aligned}$$

Ex. Vllb, No's 23 to 44.

SECTION A. Work the odd numbers.

SECTION B. Work the even numbers.

Ex. Vllc, page 51.

These equations are solved the same way as those in Ex. Vllb.

No. 1 is worked out below.

$$\begin{array}{r} 6x - 18 \\ 6x - 4x + 3x = -8 + 5 + 18 \\ \hline 5x = 15 \\ \hline x = 3 \end{array}$$

Keep your equal signs one under the other in a straight line, do not put equal signs at the side of an equation. In the above equation, all terms containing x are transposed to the left hand side and the other terms to the right: Remember to change the signs when you transpose a term from one side to the other.

Ex. Vllc, page 51.

SECTION A. Work No's 3, 5, 7.

SECTION B. Work No's 2, 4, 6.

When brackets are given remove these first and then solve the equation as above. When there is a minus sign outside the bracket, do not forget to change the signs inside the brackets when you remove the bracket.

$$\begin{aligned} \text{No. 10.} \quad & 3(3x + 1) - (x - 1) = 6(x + 10) \\ & 9x + 3 - x + 1 = 6x + 60 \\ & 9x - x - 6x = 60 - 3 - 1 \\ & 2x = 56 \\ & x = 28 \end{aligned}$$

SECTION A. Work No's 9, 11.

SECTION B. Work No's 8, 12.

Turn to page 56: Study carefully pages 56 and 57 and the examples worked out in paragraph 47.

Ex. VIIa, page 57: No's 1 to 16.

SECTION A. Work the odd No's to No. 15.

SECTION B. Work the even No's to No. 16,

Work these mentally and write down your answers.

Problems, page 66.

You have already solved some problems in Sets 2, 3, 4, 5.

Revise these, then work No's 11 to 14.

Ex. IXa, page 66.

SECTION A. Work No's 11, 13.

SECTION B. Work No's 12, 14.

These problems must be solved by algebraical methods.

---

This set of Model Answers is the property of the Education Department.

It is to be regarded as confidential, and is to be returned to the  
Department when asked for.

IG:33.

FIRST YEAR.ALGEBRA.SECONDARY DEPARTMENT.SET 11.Ex. IVC, page 29.

$$28. \quad \begin{array}{r} x - 3y \\ x - 2y \\ \hline \end{array}$$

$$\begin{array}{r} x^2 - 3xy \\ - 2xy + 6y^2 \\ \hline \end{array}$$

$$\underline{x^2 - 5xy + 6y^2}$$

$$30. \quad \begin{array}{r} x - 5y \\ x + 4y \\ \hline \end{array}$$

$$\begin{array}{r} x^2 - 5xy \\ + 4xy - 20y^2 \\ \hline \end{array}$$

$$\underline{x^2 - xy - 20y^2}$$

$$32. \quad \begin{array}{r} 3x - y \\ 3x - y \\ \hline \end{array}$$

$$\begin{array}{r} 9x^2 - 3xy \\ - 3xy + y^2 \\ \hline \end{array}$$

$$\underline{9x^2 - 6xy + y^2}$$

$$34. \quad \begin{array}{r} 2x - 1 \\ 3x - 4 \\ \hline \end{array}$$

$$\begin{array}{r} 6x^2 - 3x \\ - 8x + 4 \\ \hline \end{array}$$

$$\underline{6x^2 - 11x + 4}$$

$$36. \quad \begin{array}{r} 3x - 7 \\ 5x + 2 \\ \hline \end{array}$$

$$\begin{array}{r} 15x^2 - 35x \\ + 6x - 14 \\ \hline \end{array}$$

$$\underline{15x^2 - 29x - 14}$$

$$38. \quad \begin{array}{r} 5 - 4x \\ 6 + 7x \\ \hline \end{array}$$

$$\begin{array}{r} 30 - 24x \\ + 35x - 28x^2 \\ \hline \end{array}$$

$$\underline{30 + 11x - 28x^2}$$

$$40. \quad \begin{array}{r} 2x - 5 \\ 2x + 5 \\ \hline \end{array}$$

$$\begin{array}{r} 4x^2 - 10x \\ + 10x - 25 \\ \hline \end{array}$$

$$\underline{4x^2 - 25}$$

$$42. \quad \begin{array}{r} 6x - 5 \\ 6x + 5 \\ \hline \end{array}$$

$$\begin{array}{r} 36x^2 - 30x \\ + 30x - 25 \\ \hline \end{array}$$

$$\underline{36x^2 - 25}$$

Ex. IVC, page 30.

$$46. \quad \begin{array}{r} x + a \\ x - b \\ \hline \end{array}$$

$$\begin{array}{r} x^2 + ax \\ - bx - ab \\ \hline \end{array}$$

$$\underline{x^2 + ax - bx - ab}$$

$$50. \quad \begin{array}{r} ax - b \\ ax - b \\ \hline \end{array}$$

$$\begin{array}{r} a^2x^2 - abx \\ - abx + b^2 \\ \hline \end{array}$$

$$\underline{a^2x^2 - 2abx + b^2}$$

Model Answers.

$$52. \frac{p + qx}{p + qx}$$

$$\frac{p^2 + pqx + pqx + q^2x^2}{p^2 + 2pqx + q^2x^2}$$

$$56. \frac{px - q}{px + q}$$

$$\frac{p^2x^2 - pqx + pqx - q^2}{p^2x^2 - q^2}$$

$$60. \frac{3x + 4y}{4x - 5y}$$

$$\frac{12x^2 + 16xy - 15xy - 20y^2}{12x^2 + xy - 20y^2}$$

Ex. IVC, page 80.

$$66. \frac{a^2 - 3b}{a^2 - 5b}$$

$$\frac{a^4 - 3a^2b - 5a^2b + 15b^2}{a^4 - 8a^2b + 15b^2}$$

$$70. \frac{x^2 - p}{x^2 + p}$$

$$\frac{x^4 - px^2 + px^2 - p^2}{x^4 - p^2}$$

$$74. \frac{x^3 - 2}{x^3 + 2}$$

$$\frac{x^6 - 2x^3 + 2x^3 - 4}{x^6 - 4}$$

$$54. \frac{3 - x}{7 + 2x}$$

$$\frac{21 - 7x + 6x - 2x^2}{21 - x - 2x^2}$$

$$58. \frac{cx - d}{cx - d}$$

$$\frac{c^2x^2 - cdx - cdx + d^2}{c^2x^2 - 2cdx + d^2}$$

$$62. \frac{2ax + 3}{3ax + 2}$$

$$\frac{6a^2x^2 + 9ax + 4ax + 6}{6a^2x^2 + 13ax + 6}$$

$$68. \frac{5a^2 - 2b^2}{5a^2 + 2b^2}$$

$$\frac{25a^4 - 10a^2b^2 + 10a^2b^2 - 4b^4}{25a^4 - 4b^4}$$

$$72. \frac{a - b^3}{a - b^3}$$

$$\frac{a^2 - ab^3 - ab^3 + b^6}{a^2 - 2ab^3 + b^6}$$

$$76. \frac{bx^2 + c}{bx^2 - c}$$

$$\frac{b^2x^4 + bcx^2 - bcx^2 - c^2}{b^2x^4 - c^2}$$

Model Answers.

-3-

$$\begin{array}{r}
 78. \quad ax + 1 \\
 \underline{bx - 1} \\
 abx^2 + bx - ax + 1 \\
 \underline{\phantom{abx^2 + bx} - ax + 1} \\
 abx^2 + bx - ax + 1
 \end{array}$$

$$\begin{array}{r}
 84. \quad a + 3b \\
 \underline{2c - 5d} \\
 2ac + 6bc \\
 \phantom{2ac + 6bc} - 5ad - 15bd \\
 \hline
 2ac + 6bc - 5ad - 15bd
 \end{array}$$

$$\begin{array}{r}
 88. \quad x^2 + a^2 \\
 \underline{x + a} \\
 x^3 + a^2x \\
 \phantom{x^3 + a^2x} + ax^2 + a^3 \\
 \hline
 x^3 + a^2x + ax^2 + a^3
 \end{array}$$

$$\begin{array}{r}
 82. \quad a - b \\
 \underline{c - d} \\
 ac - bc \\
 \phantom{ac - bc} - ad + bd \\
 \hline
 ac - bc - ad + bd
 \end{array}$$

$$\begin{array}{r}
 86. \quad ax^2 + bx \\
 \underline{ax + b} \\
 a^2x^3 + abx^2 \\
 \phantom{a^2x^3 + abx^2} + abx^2 + b^2x \\
 \hline
 a^2x^3 + 2abx^2 + b^2x
 \end{array}$$

Revise the work in Set 9 on the angles of a triangle.

Learn the definition of a quadrilateral on page 26.

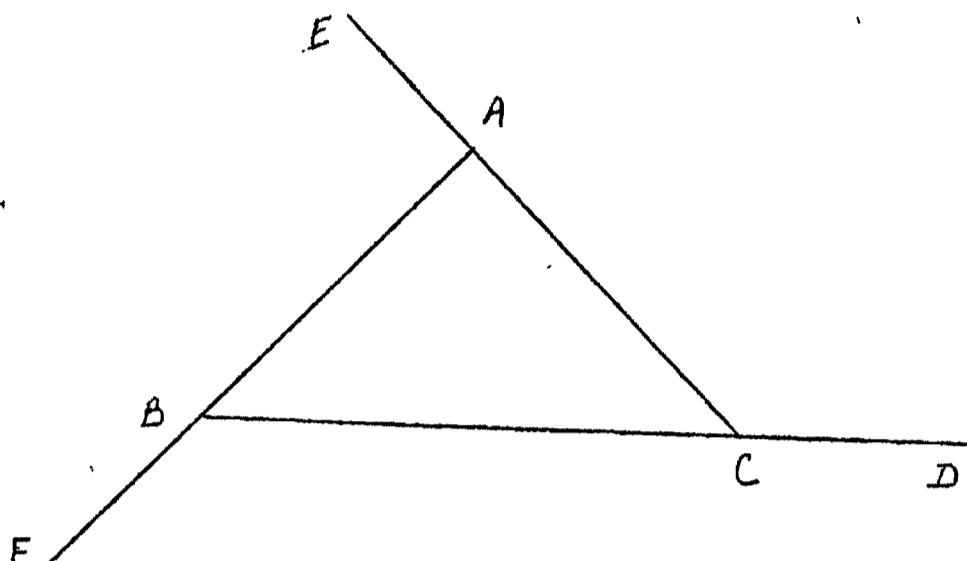

Now consider the above figure.

The sides  $BC$ ,  $CA$ ,  $AB$  of  $\triangle ABC$  are produced so that at each vertex there is an exterior and an interior angle.

At  $C$  the exterior angle is  $\angle ACD$ .

" " interior " "  $\angle ACB$

We call the angles  $ABC$ ,  $BAC$  the interior opposite angles to the exterior angle  $ACD$ .

#### EXERCISE I.

1. What is the exterior angle at  $A$ ? What are the interior opposite angles to it?
2. What is the exterior angle at  $B$ ? What are the interior opposite angles to it?

SECTION A: Do No. 1.

SECTION B: Do No. 2.

#### EXERCISE XII, page 29.

SECTION A: Do No's 1, 3, 6.

SECTION B: Do No's 2, 5, 11.

N.B. In No. 2 (iii) the conclusion is about the exterior angles of a triangle.  
In No. 2 (iv) the conclusion is about the interior angles of a triangle.

Study the following work carefully.

In Theorems 1 to 5 and 8 to 10 you have had to learn some fundamental geometrical facts, which have been deduced from practical examples, but you have not had to prove these statements.

For revision we shall state these eight theorems. The statements should be quite familiar to you now, but make sure you know them, as they have to be used to prove other theorems.

THEOREM 1. (i) When a straight line meets another straight line the adjacent angles so formed are together equal to 2 right angles.

(ii) If two adjacent angles are together equal to two right angles, their exterior arms are in the same straight line.

THEOREM 2. If two straight lines intersect, the vertically opposite angles are equal.

THEOREM 3. If a straight line cuts two other straight lines so that

- (1) the corresponding angles are equal, or
- (2) the alternate angles are equal, or
- (3) two interior angles on the same side of the cutting line are equal to two right angles,

then in each case the two straight lines are parallel.

THEOREM 4. If a straight line cuts two parallel straight lines it makes

- (1) the corresponding angles equal.
- (2) the alternate angles equal.
- (3) two interior angles on the same side of the cutting line equal to two right angles.

THEOREM 5. Straight lines which are parallel to the same straight line are parallel to one another.

THEOREM 8. If two triangles have two sides and the included angle of the one equal to two sides and the included angle of the other then the two triangles are congruent.

THEOREM 9. If two triangles have two angles of the one equal to two angles of the other, and one side of the one equal to the corresponding side of the other, then the two triangles are congruent.

THEOREM 10. If two triangles have three sides of the one equal to three sides of the other then the two triangles are congruent

---

Now Theorem 6 has to be proved and the proof learned. To do this you should first read over the statement of the theorem and draw a figure; then decide what is given and what you are asked to prove. In the general enunciation, or statement, which describes in general terms the purpose of the theorem, the first clause tells us what we are to assume, i.e. what is given. The second clause tells us what it is required to prove. Consider Theorem 6, page 31. From Part (1) of the general enunciation, "If a side of a triangle is produced the exterior angle is equal to the sum of the two interior opposite angles," the first clause indicates what is given, viz., a triangle with one side produced. The second clause states what is to be proved, viz., that the exterior angle is equal to the sum of the two interior opposite angles. What is given and what is to be proved are written down with reference to the figure and below it. The statement of what is given in particular terms with reference to the figure is called the particular enunciation.

Note carefully the two statements in Theorem 6.

Under the figure is written what is given and then what is to be proved. In the fourth line in the text-book the construction is given. It is sometimes necessary to put in some construction in order to prove a theorem. In this one JF is drawn parallel to AB. This should suggest to you that the theorems on parallels may be of use in proving that the sum of the angles of a triangle is equal to two right angles.

Study Fig. 39, page 31. If AB and FC are parallel what angle is equal to the angle FCD? What angle is equal to the angle FCA? Now try to prove the statements (1) and (2). Now read over the proof in the book. When you are sure you understand it draw a figure and letter it differently from the one in the book, and work through the argument on this figure. Theorems must be learned so that you could write ~~them out~~.

A corollary to a theorem is a statement, the truth of which can be readily inferred from the theorem.

Learn the two corollaries given after Theorem 6. Also note a third one. Since the exterior angle of a triangle is equal to the sum of the two interior opposite angles, the exterior angle of a triangle must be greater than either of the interior opposite angles.

Do the following examples. Find the angles by calculation and show how you get your results. Give drawings, naming the given angles, to illustrate the examples.

EXERCISE XIII, page 33.

SECTION A: Do No's 1, 3, 8, 10.

SECTION B: Do No's 2, 4, 6, 9.

PLAN YOUR WORK AS FOLLOWS:-

FIRST WEEK.

Period 1. Revise angles of a triangle Set 9. Learn definition of a quadrilateral. Study work on page 1 of assignment and do Exercise I. Exercise XII, do No's 1, 2, 3.

Period 2. Exercise XII, do No's 5, 6, 11. Revise Theorems 1 to 5 and 8 to 10 stated in assignment. Read over the rest of the assignment and Theorem 6.

SECOND WEEK.

Period 1. Study the work on Theorem 6 again and learn the theorem and 3 corollaries. Exercise XIII, do No's 1, 2, 3.

Period 2. Exercise XIII, do No's 4, 6, 8, 9, 10.



This Set of Model Answers is the property of the Education Department.

It is to be regarded as confidential, and is to be returned to the

Department when asked for.

FIRST YEAR. VF.36

SET 11.

GEOMETRY.

Secondary Division.

Page 80

EXERCISE XXV.

1. (ii)

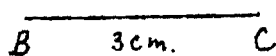

It is impossible to construct the triangle because the sum of the sides a and b is less than side c.

(iv) Angle C =  $180^\circ - (48^\circ + 33^\circ)$

=  $180^\circ - 81^\circ$

=  $99^\circ$

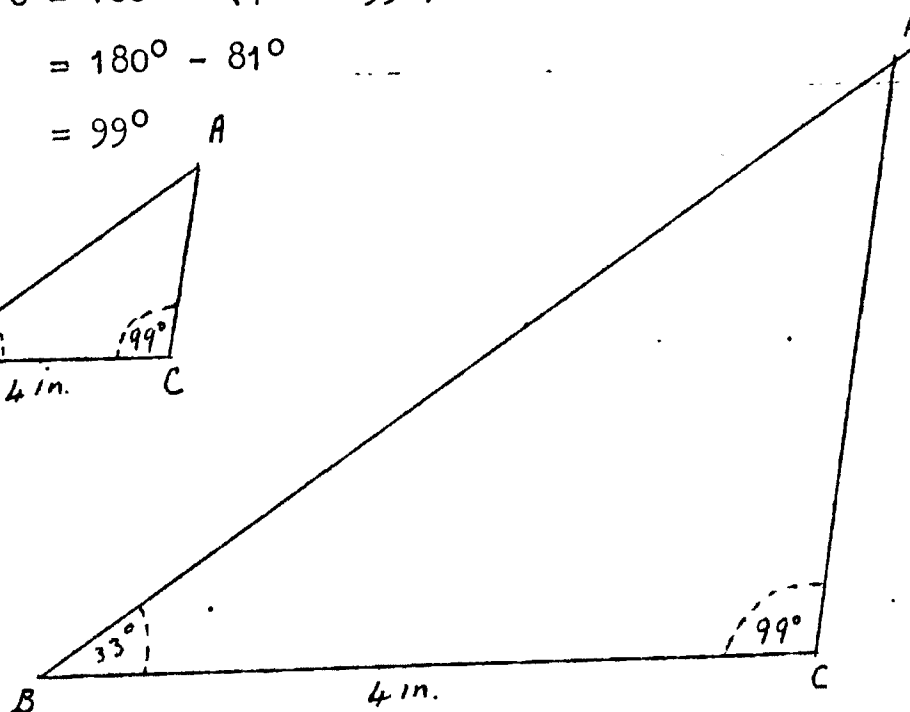
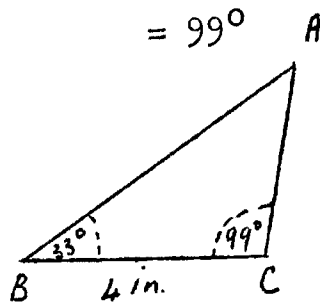

b = 2.95 ins.

(vi)

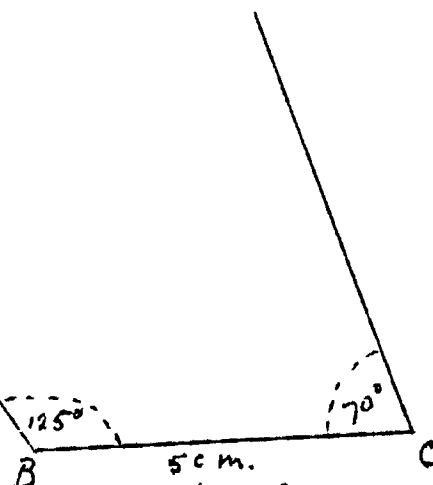

It is impossible to construct the triangle because the sum of the angles B and C is greater than  $180^\circ$ .

(x)

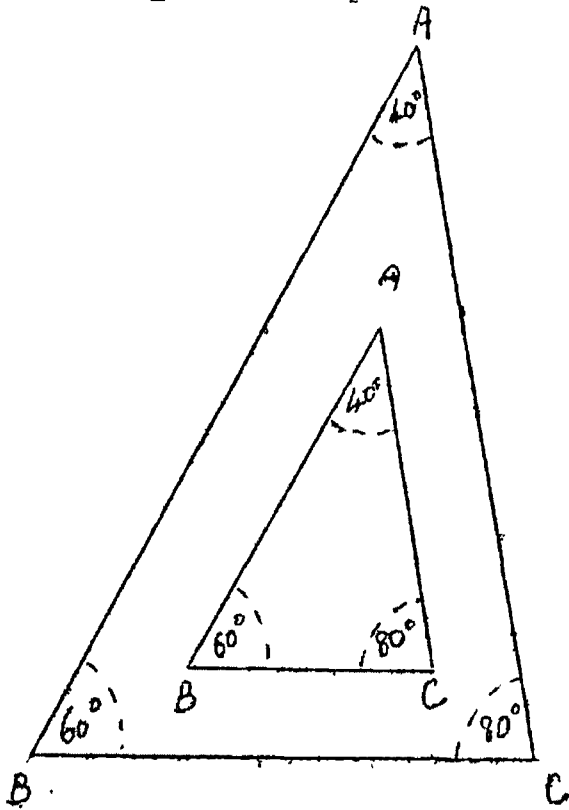
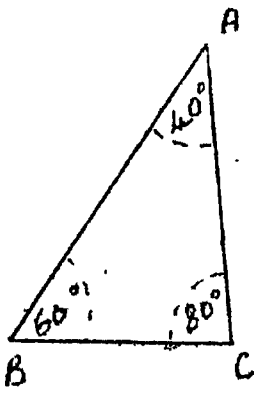

Any number of triangles may be drawn having the given angles, but the size of the triangle is not fixed.

(xii)

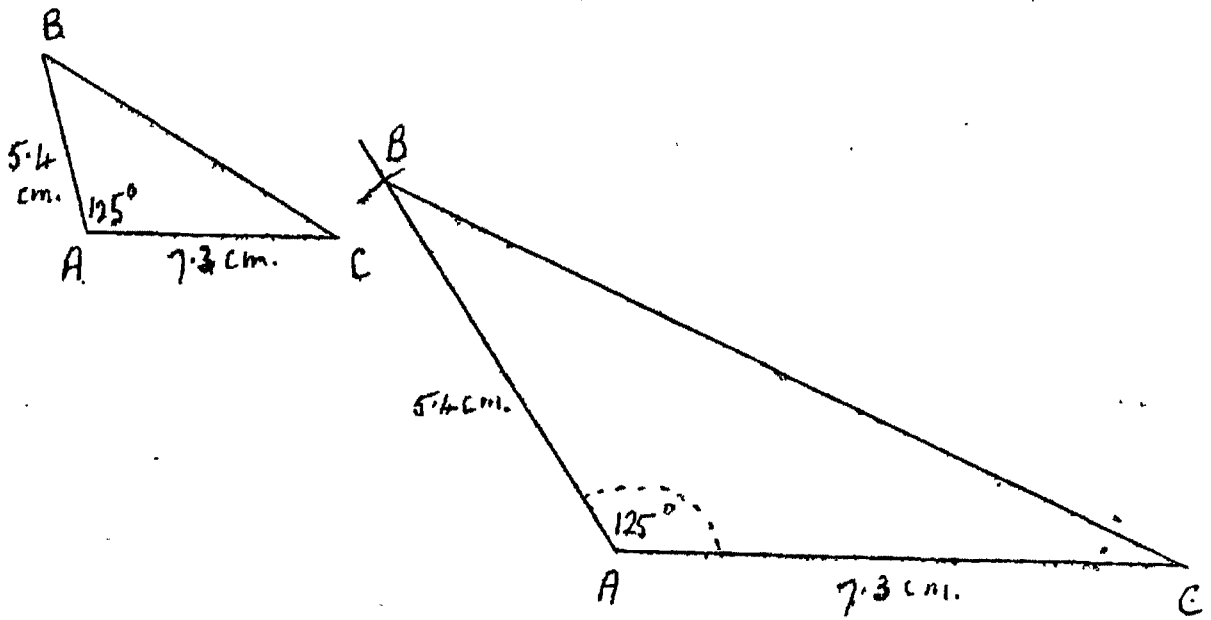

a = 11.4 cm.

EXERCISE I.

(ii)

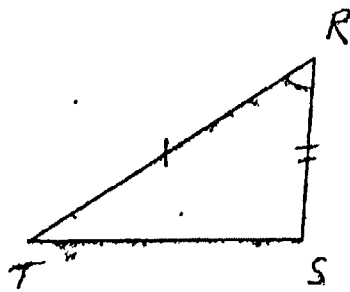
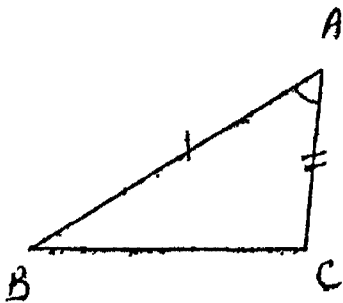

The triangles are congruent because they have 2 sides and the included angle equal.

(iv)

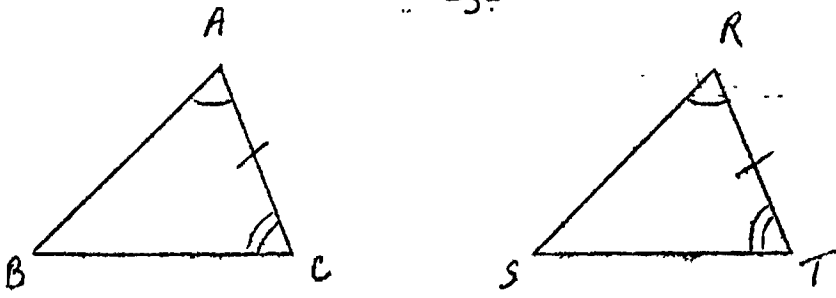

The triangles are congruent because they have one side and two angles equal.

(vi)

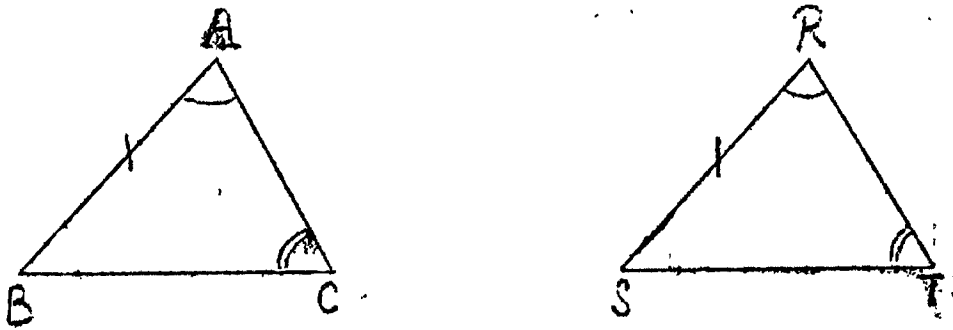

The triangles are congruent because they have one side and two angles equal.

(viii)

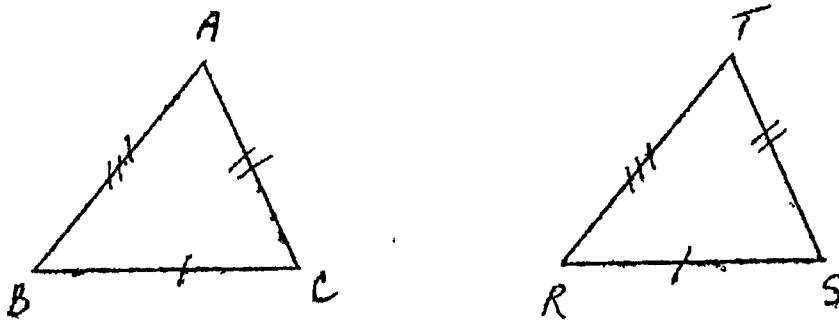

The triangles are congruent because they have three sides equal.

(x)

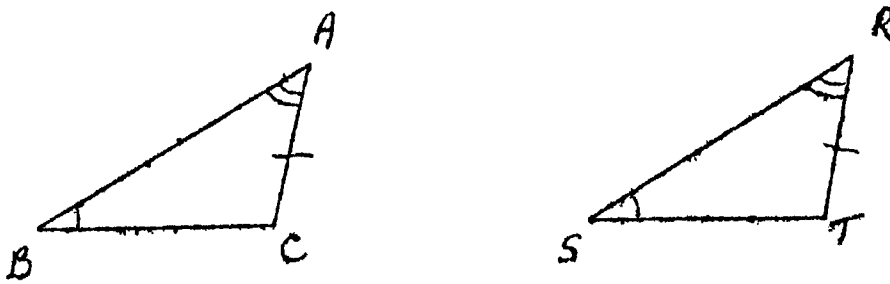

The triangles are congruent because they have one side and two angles equal.

Page 75. EXERCISE XXIV.

3.

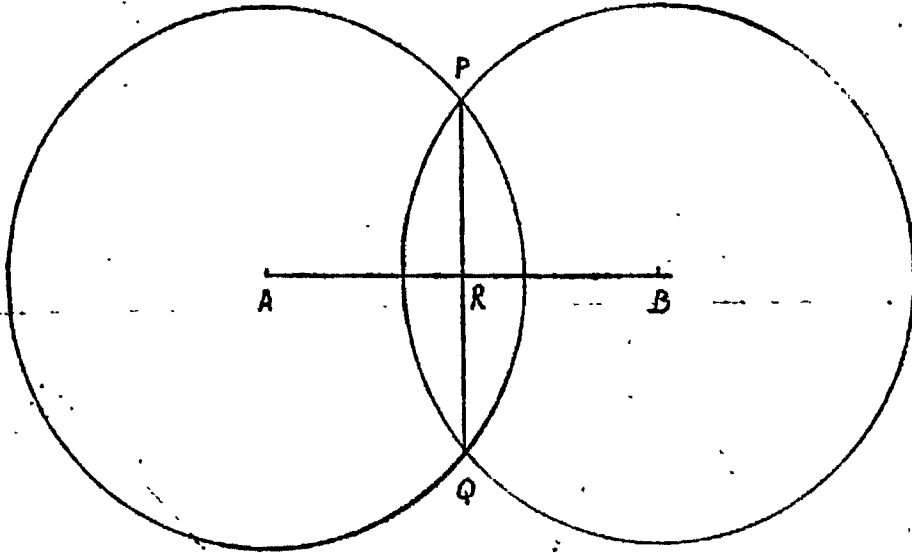

$AR = RB. \quad \angle ARP = 90^\circ$

4.

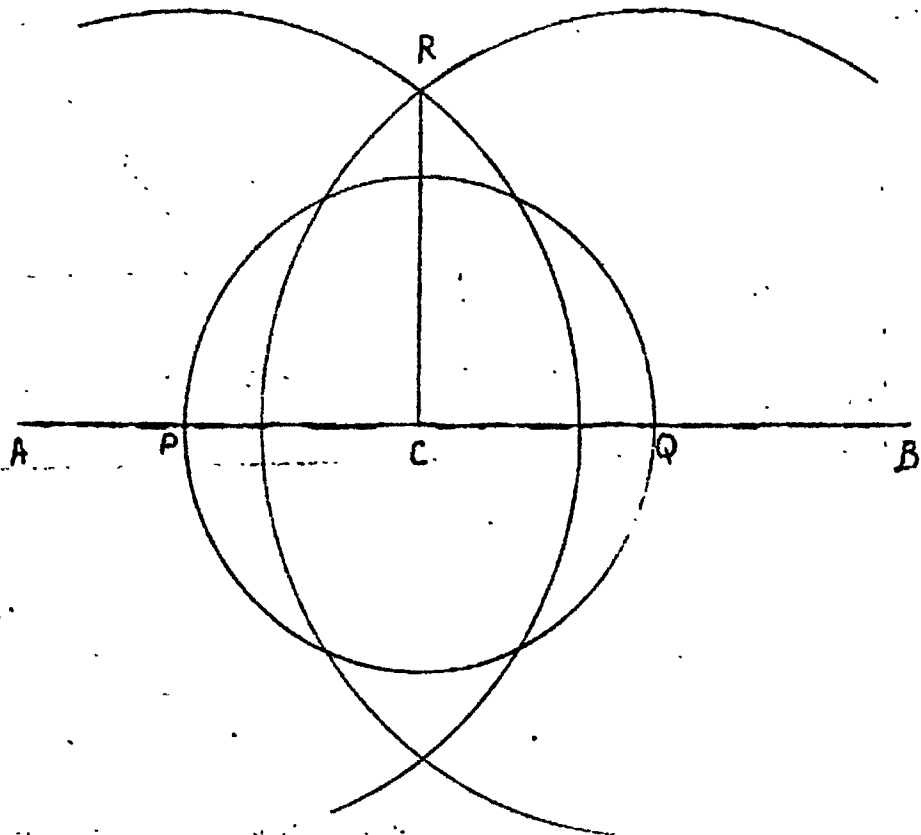

$\angle ACR = 90^\circ$

MATERIALS IN SOILS

Farmers when taking possession of a new farm are anxious to discover exactly how valuable the soil is and what it is suited for. One method is to grow different crops year after year, note the results and thus form a rough estimate of the capabilities of each patch. For many years, however, scientists have been studying the soil in an endeavour to find the Agricultural value of a soil by analysis of its constituents in the laboratory. There are many factors of supreme importance which cannot be considered in the laboratory, such as climatic conditions, previous treatment of the soil, position of the water table etc., and these detract from the value of a laboratory analysis but it is hoped that, as time goes on, a method will be found of valuing a certain soil on analysis by scientific methods. This would obviously be of immense value to farmers.

ORGANIC MATTER.

One of the most important facts to know about a soil is how much organic matter or humus it contains. The word "organic" is derived from a Greek word meaning "work". Organic matter is material which was once part of a living plant or animal, and hence has performed work, at some period. All other material like silicon, aluminium, quartz, is "inorganic". We shall later study the inorganic matter more thoroughly. Let us now consider the all important organic matter.

Organic matter did not enter the soil till living things came to the earth. These first creatures are thought to have resembled bacteria. They lived in the water, and by dying and leaving their remains to be decomposed, left a certain amount of humus. Plants and animals continuing this for millions of years have given us this valuable constituent of soil, which, when decomposed is known as humus and is black in colour. *As life goes on, more organic matter is left.* The humus in the soil forms plant food by the action of bacteria. Plants use this food, grow up and then die, and their remains are quickly broken up again, to humus by bacteria. Thus the plant food is kept constantly circulating from soil to plant (then sometimes to animals) and back to the soil when the plant or animal dies. Organic matter is thus made by the work of plants. This work is not lost for its produce remains to be used again. To do work, energy is used. Energy has two common forms - heat and light. In this case, the plant obtains its energy from the sunlight, and it may by its work, build an immense kauri tree. Can we use this energy again? We do so when we burn wood or coal. New heat and light are thus obtained from the structure built up from soil and air by the power of the sun.

PRODUCING HUMUS.

When the plant decays it gives out in heat the energy it obtained from the sun in building up what is now being destroyed. This decaying refuse is found to be warm and may even burst into flame. This breaking down is done by bacteria, and when plant residues are added to soils, there springs up a vast population of living creatures all drawing on this accumulated store of energy, dying off when it is fully broken down ready for the use of plants.

Humus then, is an intermediate product between two generations of plants. The amount of humus in the soil gives us an idea of the amount of food which will become available for plants, providing that the soil is kept sweet. In an acid soil the bacteria which form the plant food from the humus are not present. *This is one of the reasons why lime is valuable.*

Soils with little or no humus are poor. They are light in colour and their water-holding capacity, aeration, temperature, etc., are not favourable to plants. Thus we may say that humus is what a farmer pays for when he buys land. Let us carry out two experiments with this most important substance.

Experiment A. Examination of Humus.

Dig a trench in your garden to a depth of three feet or more. Note the colour of the different layers of soil.

Measure the depth of each and draw a scale diagram in your practical book in the usual way. You will observe that the top layer of soil, just so far as the living roots go, is darker in colour than the layer below. This dark colour is due to the presence of decayed organic matter, or humus. But to prove this more plainly we must examine several types of soil. We can depend on there being a good deal of humus in decayed leaf-mould, the soil from a plantation or native-bush, and soil from a garden. There is a good deal less in the subsoil, and in soil on which vegetation does not grow well. Why?

Experiment B. Burning Humus.

Take ten grams of each of the above five types of soil. Place them in turn into a clean tin and heat them strongly over a flame, stirring with a long clean nail. First of all it chars, then there is a little sparkling, but not much, finally the soil turns red and does not change any further however much it is heated. Allow to cool and then weigh carefully. A similar experiment is described in Exercise 114. Work out the results individually as shown on page 136, and then tabulate as follows:

	Colour before burning.	Percentage loss on burning.	Colour of Residue
Leaf-mould			
Bush soil			
Garden Soil			
Barren soil			
Subsoil			

ANALYSING SOIL

Take some soil and spread it out on a piece of paper to examine it. It is found to contain bits of twigs and leaves and other plant remains, in different stages of decomposition. Some are large enough to be picked out; others cannot be separated in this way. This is decaying organic matter and the humus of the soil.

In addition there are grains of various sizes. Some are easily seen with the naked eye. Others grade down to a fine powder. It is important to remember that the physical properties of the soil depend largely upon the size of the particles.

Experiment C. Rough Mechanical Analysis into sand, silt and clay.

Apparatus required: Three fruit jars, and a quantity of clay soil.

Fill a fruit jar three-fourths full of water and place in the water about two tablespoonfuls of pulverised soil. Replace the cover and shake vigorously for several

minutes. Let it stand for one minute and then pour the muddy liquid into a second jar. The sediment remaining in the first jar is composed almost entirely of sand. Examine it carefully. Does it look more like sand than the original soil?

When the second jar has been standing five minutes, pour off the muddy liquid again into a third jar. Add more water to the sediment in the second jar, shake vigorously and let stand five minutes, then pour off the water as before. The sediment now remaining is largely silt, whose particles are finer than sand.

Let the water in the third jar stand two hours or longer, then pour off the water. Now you have clay remaining. Note how fine the particles are.

Weigh out and calculate the proportions of coarse sand, fine sand and clay.

A more exact method requiring laboratory apparatus is given in Connell and Hadfield, pages 137-139 (new book pages 139-140).

Note that the lines separating sand from silt, and silt from clay are determined by an International scale agreed on by soil chemists.

Clay is defined as "any material the particles of which are less than 0.002 mm. in diameter".

Silt is "Any material the particles of which are above this but below 0.02 mm. in diameter".

Material varying in diameter between 0.02 and 0.2mm., is known as fine sand.

Material between 0.2 and 2.0 mm. is classed as coarse sand.

These facts should be memorised.

#### PROPERTIES OF SAND, CLAY AND SILT.

The reason for the differences in the sizes of particles is that the materials composing them have different degrees of hardness. The softer materials, oxides of iron, aluminium, and potassium, are quickly worn very fine and are easily dissolved in water. The large particles of sand are composed of quartz and other resistant substances. Some forms of silicon are also very resistant and form much of the fine sand and silt.

#### Experiment D. Sand.

Take some of the sand obtained in Experiment 72, place it on a plate and examine it. Note the following:

1. It does not adhere to the plate and may be collected easily.
2. Most of the grains are large enough to be seen without a magnifying glass or microscope.
3. When moistened and rubbed between the fingers the sand feels hard and gritty.
4. The sand dries quickly.

These are important properties of sand as they are found in sandy soils and distinguish them from clay or loam soils.

Sand particles, being large, do not float in water. If we shake up sand in water the sand sinks, leaving the water entirely clear. Thus running water does not carry sand with it unless it is running very quickly, and the sand lies at the bottom.

Experiment 74. Water-holding Capacity.

Set up exercise 122, page 146 and observe the water-holding capacity of sand in the manner described.

TEXT BOOK.

Study Connell and Hadfield, pages 131-136 and pages 137-140.

CLAY

One of the most noticeable properties of clay in agriculture is its habit of sticking closely together into a hard lump when worked up with water and then allowed to dry. This tendency must be carefully controlled by farming operations.

Experiment F. Clay.

Perform Exercise 112, page 133. (Be careful to use fairly pure clay and to saturate it thoroughly.) Draw the blocks carefully to show the result.

CONCLUSIONS:

You will probably find that shrinkage occurs. What would happen, therefore, if instead of a piece of clay six inches long you had a whole field of clay? Would that shrink also, and if so, what would the field look like? If you get an opportunity of walking over a clay field during a dry summer you will find large cracks, up to two or three inches wide. Sometimes the cracking is so bad that the roots of plants or of trees are torn by it, and even buildings, in some instances, have suffered through their foundations shrinking away. Later we shall study clay more fully.

WORK TO BE SENT IN

1. Practical Book
2. Written Work.

- A.1 The soil on a certain field is found to retain water very easily, and when dried in warm weather it forms into solid lumps with big cracks between. What is the cause of this, and what methods are known for counteracting it?
- A.2 What are organic matter, peat, humus, clay and sand?
- A.3 What is the purpose of a mechanical analysis of a soil? Describe how it is done.
- B.1 Give an account of the probable origin of the dark coloured material in your local soil
- B.2 What is the connection between organic matter, work, and energy?
- B.3 Why do haystacks under some conditions burst into flame?

---

GENERAL SCIENCE

COLOUR

Study Washburne, pages 101-104.

Experiment G. Colours.

Carry out this experiment in a room facing north on a sunny day.

Apparatus: Cut a hole one inch square in a large sheet of brown paper. Pin the paper over the window. The room need not be quite dark but make it as dark as you conveniently can



Method: Fix a piece of red glass over the small hole (one inch square). Red light comes through the glass. This can be seen where the beam of light falls on the floor or wall.

Put a piece of red material in the red beam of light. The material looks red. Put other colours in the beam of light. Blue and green things look nearly black. This is because they do not reflect red light. Purple appears red because it reflects red light. White appears red because it reflects red light.

WRITTEN WORK.

- A. Explain what occurs when a rainbow is seen.
- B. Answer Applications 39, 40 and 41.

SUGGESTED ORGANISATION

- 1st. period Study Assignment (Agriculture) and Connell and Hadfield, chapter IX.
- 2nd period Science (Study Washburne and carry out experiment in Assignment).
- 3rd period Practical work in Agriculture.
- 4th period Write up practical work.
- 5th period Written work, Section A.
- 6th period Written work, Section B.

This Set of Model Answers is the property of the Education Department.  
It is to be regarded as confidential, and is to be returned to the  
Department when asked for.

FIRST YEAR. VF.36

SET 11.

AGRICULTURE.

Secondary Division.

EFFECTS OF POTASH.

Experiments show that in some way potash is essential in the process of carbon assimilation (through which plant food is obtained from the air); when it is deficient the manufacture of carbohydrates, (starch, sugar, cellulose, inulin), is greatly reduced. Since the potato crops is largely starch, potash is valuable for potatoes.

Next to their effect on carbohydrate-making crops, the most striking action of potassic manures is their value in promoting the growth of clover and all leguminous crops. This effect is probably, partly at least, due to stimulation of the nodule bacteria.

It is found that on potash-starved plots the grasses fail, to a large extent, to develop any seed.

Experiments also show that potash makes the plant more resistant to the attacks of fungoid diseases. Note, however, that it seldom needs to be added to N.Z. soils.

- B.2 (a) Sulphate of Potash is obtained from the Stassfurt potash deposits, Germany, and also from Alsace, (France) and Chile (South America).

The manure contains a little over 50 per cent of potash.

In New Zealand potash manures do not always immediately produce increased yields and when used with phosphates they have been found to cause decreased yields. If potash is deficient, however, the manufacture of carbohydrates is greatly reduced and starch making diminished. Potash is especially necessary for clovers and all leguminous crops. It helps to produce seed for grass crops and makes the plant more disease-resistant.

(b) Kainit. This is obtained directly from potash deposits as a crude salt. It contains several salts - sulphate and muriate of potash, sulphate of magnesia, chloride of magnesia, and sodium chloride. The manurial constituent is potash which forms from 12 to 13 per cent.

The manure is used extensively as a top-dressing for pastures, and as a source of potash for mangels as it also supplies common salt which is required by that crop.

- B.3 Superphosphate is an artificial fertiliser made by treatment of rock phosphate with sulphuric acid. Rock phosphate is found in the Pacific, the United States, Canada, Spain, and Algeria. It is ground in a mill to a fine powder, treated in a mixer with the requisite amount of acid, then transferred to a pit till the reaction is complete. Later it is spread out on a floor to dry, and is then ready for use as superphosphate.

Basic slag is a by-product formed in the manufacture of steel. Certain beds of iron ore contain quantities of phosphorus which is an impurity. In 1879 two experimenters, Thomas and Gilchrist, discovered the process by which the phosphorus was extracted by lime to form slag. A few years after-wards other experimenters discovered its manurial value.

A.2 Omitted words:- potash; sulphuric; rock phosphate; superphosphate  
basic slag; heavy, damp; potash.

GENERAL SCIENCE

A.1 An element is one of the ninety fundamental substances of which all matter is composed.

An atom is the smallest particle of an element that can possibly be obtained by ordinary chemical methods.

A molecule of an element is the smallest particle of that element that can exist by itself under ordinary conditions. It may consist of one or more atoms, (e.g. helium, 1; hydrogen, 2; phosphorus, 4; sulphur, 8).

A molecule of a compound is the smallest particle of that compound that can exist. It must consist of at least two atoms (e.g. the molecule of hydrochloric acid), but it may contain more (e.g. the molecule of cane sugar which contains 45 atoms). The atomic theory is the work of John Dalton, whose life is important for science students.

Symbol: To represent one atom of an element, the chemist writes the capital letter which forms the initial of the English or Latin name of the element. Thus H stands for one atom of hydrogen.

Formula: To represent the composition of substances in molecules formulae are used. Thus the formula for one molecule of calcium hydroxide is  $\text{Ca}(\text{OH})_2$ . Two molecules of calcium hydroxide would be written  $2\text{Ca}(\text{OH})_2$ .

A.2                     $\text{H}_2\text{SO}_4$  (i.e., one molecule of sulphuric acid).  
                          $\text{NaCl}$  (i.e., one molecule of common salt).  
                          $\text{CaCO}_3$  (i.e., one molecule of limestone).  
                          $2\text{CaCO}_3$  (Note that "calcium carbonate" is the chemical  
                         name for limestone).

Revise Chapter 6 in the text book. Study carefully the setting out of the documents shown there - the invoice, debit and credit notes, and the statement. When you sell goods to a person you make out an invoice and send it with the goods so that the receiver may check the articles and see exactly what he is charged for each. Invoices are usually bound together in books with two forms for each number so that a copy can be kept. Copies are taken by inserting a sheet of carbon paper between the two forms; the top one or invoice proper is torn out and sent to the customer and the carbon copy is left in the book. It is from these copies that you write up your Sales Journal.

Turn to the example on page 60 of your text book. This shows that Millar and Co., have sold goods to Mr. James Cameron and this invoice would be sent to Cameron with the goods. A copy of it would be left in Millar and Co's invoice book and from this they would make an entry in their Sales Journal as follows:-

Sales Journal.

June 12 Cameron, James 3 12 2.

From the invoices which you receive with the goods you buy, you write up the entries in your purchases journal. Take the same example on page 60. When James Cameron received this invoice he would give it his own number and from it he would make an entry in his Purchases Journal, thus,

Purchases Journal.

June 12 Miller and Co., Ltd. 3 12 2

The Returns Journals are written up from the copies kept of the debit and credit notes. The carbon copies of the debit notes show what goods you have sent back to the sellers and from these you can write up the Returns Outward Journal. The carbon copies of the credit notes show what goods you have received back from the buyers and from these you can write up the Returns Inward Journal.

A Statement is simply a copy of a debtor's account set out in a slightly different form. Look at the example on page 62. This shows that James Cameron owes Miller and Co., £23 8 7. In Miller and Co's books, therefore, there would be an account for James Cameron as follows:-

		<u>Cameron, James.</u>					
June 5	To Goods	12	16 8	June 13	By Cash	10	0 0
12	" "	14	16 3	20	" Returns	2	16 8
19	" "	8	12 4		" Balance	23	8 7
		<u>36</u>	<u>5 3</u>			<u>36</u>	<u>5 3</u>
June 21	To Balance	23	8 7				

Note that in the statement instead of the debit and credit items being shown side by side the debit items are shown first, then the credit ones underneath. The credits are subtracted from the debits to give the balance due.

Study once more how to enter and post from the sub-journals.

Written work for Set 14

Section A:

Write up the Journal Proper, Cash Book, Purchases Journal, Sales P.T.O.

Journal and Ledger for the following transactions. Extract the Trial Balance on 31st January.

On 1st January, 1934, M. Self had Cash in Hand, £125; at Bank £875; Stock (cost price) £1,250; R. Spring owed him £150, he owed Summer & Co., £320.

His transactions during the month were as follows:-

		£	s	d
Jan 5	Sold V. Winter, Goods value	67	10	0
6	Bought of Summer & Co., Goods	240	0	0
6	Received from R. Spring, Cash £144	144	0	0
	Having allowed him as discount	6	0	0
		150	0	0
9	Sold L. May, Goods	75	0	0
9	Paid into Bank, Cash	200	0	0
11	Sold R. Spring, Goods	84	0	0
11	Paid Summer & Co., by Cheque £304	304	0	0
	Having been allowed as discount	16	0	0
		320	0	0
14	R. Spring paid into Bank	64	0	0
16	Sold L. May, Goods	97	10	0
	Received from V. Winter, Cash	50	0	0
18	Cash Sales	108	0	0
18	Received from L. May Cash £115	115	0	0
	Having allowed him as discount	5	0	0
		120	0	0
31	Sold Goods for Cash	187	10	0
31	Sent to Bank, Cash	300	0	0
31	Paid Rent of Warehouse, by Cheque	45	0	0
31	Paid Trade Expenses for the month in Cash	150	0	0

- From the above question make out the statement which would be sent to L. May at the end of the month.
- Make out an invoice for the following items, using the name "J.R. Swinson". Set out the heading correctly, giving other necessary particulars.

13 lb. Tea @ 2/3 per lb.  
 6 lb. Sugar @ 2d per lb.  
 4 lb. Lard @ 8d per lb.  
 6 doz Eggs @ 1/4 per doz.  
 14 lb. Coffee @ 1/1½ per lb.  
 7½ lb. Bacon @ 8d per lb.

Section B:

- Make out a statement to be rendered as on 31st May, 1926, the details being as follows, making up your own heading:-

May 1	Goods Invoice No. 12	4	12	6
5	" " " 21	6	10	0
12	" " " 29	5	2	7
18	Paid Cash	11	0	0
23	Goods Invoice No. 33	6	4	3
26	Returned Goods	2	5	1

- On March 12th, 1929, J. White returned to C. Smith, Ltd., the following goods:-

(1) Overcoat 2 7 6  
 (2) One pair of blankets 2 3 0

Make out a credit note, as on March 16th, 1929, on behalf of C. Smith, Ltd., Drapers, Cuba St., Wellington.

N.B. Use journal paper for questions 2 - 5.

Organization of Work: Number of Periods for Bookkeeping - 6.

1 } Study only. 3 } Write Section A. 6 } Write Section B.  
 2 } 4 }  
 5 }

This Set of Model Answers is the Property of the Education Department. It is to be regarded as Confidential and is to be returned to the Department when asked for. B.L. '35.

BOOKKEEPING.

FIRST YEAR.

SETUP

SECONDARY DEPARTMENT.

Question 1.

			<u>Discount.</u>	<u>Cash</u>	<u>Bank</u>				<u>Discount</u>	<u>Cash</u>	<u>Bank.</u>
Feb. 1.	To Capital			590 0 0		Feb. 1.	By Bank	✓		550 0 0	
	" Cash ✓				550 0 0		" Kern, A		2 11 6		246 17 6
	" Sales ✓			11 4 9		2	" Wages			12 6 6	
2	" Adams, J ✓	4 11 6		92 2 6			" Bank ✓			110 0 0	
	" Cash ✓				110 0 0	5	" Rent				20 0 0
15	" Wells, T ✓	3 15 0			149 18 7		" Stationery			3 5 0	
	" Bank ✓			25 0 0		8	" Purchases ✓			17 2 1	
17	" Sales ✓			14 16 3			" Private Expenses				10 0 0
19	" Winks, T ✓	3 12 0		70 0 0			" Walker, T ✓	18 6			37 14 6
	" Cash ✓				50 0 0	15	" Cash ✓				25 0 0
						17	" Salaries			12 10 0	
							" Purchases ✓			23 17 8	
							" Office Expenses			14 10 0	
						19	" Bank Charge				5 0
							" Bank ✓			50 0 0	
							" Balances			9 12 3	520 1 7
			<u>11 18 6</u>	<u>803 3 6</u>	<u>859 18 7</u>				<u>3 10 0</u>	<u>803 3 6</u>	<u>859 18 7</u>

Summary: Sales 26 1 0

Summary: Purchases 40 19 9

Feb. 20 To Balances 9 12 3 520 1 7

Folio 5

Folio 51

			<u>Discount</u>	<u>Cash</u>	<u>Bank</u>		
Jan 1	To Balances	L1		12 14	7 197 18	6	
2	" Sales	L2		14 17	4		
	" Cash	✓			15 0 0		
3	" Brown, A	L3	2 1 8	17 18	4		
4	" Bank	✓		10 0 0			
	" Interest	L4		5 5 0			
			<hr/>				
		L5	2 1 8	60 15 3	212 18	6	
			<hr/>				
Jan 5	To Balances			35 10	3 141 1 4		

			<u>Discount</u>	<u>Cash</u>	<u>Bank</u>		
Jan 2	By Bank	✓		15 0 0			
	" Cartage	L6		3 6 6			
3	" Rent	L7			20 10 6		
4	" Purchases	L5		6 18 6			
	" Cash	✓			10 0 0		
	" Burns & Co.	L8	1 13 4		16 6 8		
	" Typewriter	L9			25 0 0		
	" Balances			35 10	3141 1 4		
			<hr/>				
			1 13 4	60 15 3	212 18 6		
			<hr/>				

Capital Account.

(1) 173

Jan 1 By Cash

C5 210 13 1

Goods Account.

(2)

Jan 4 To Cash  
" Balance

C5 6 18 6  
7 18 10  
14 17 4

Jan 2 By Cash

C5 14 17 4

14 17 4

Jan 5 By Balance

7 18 10

Brown, A.

(3)

Jan 3 By Cash & Disct.

C5 20 0 0

Interest.

(4)

Jan 4 By Cash

C5 5 5 0

Discount.

(5)

Jan 4 To Debtors

C5 2 1 8  
2 1 8  
8 4

Jan 4 By Creditors  
" Balance

C5 1 13 4  
8 4  
2 1 8

Jan 4 To Balance

Cartage.

(6)

Jan 2 To Cash

C5 3 6 6

Rent.

(7)

Jan 3 To Cash

C5 20 10 6

Burns & Co.

(8)

Jan 4 To Cash & Disct. C5 18 0 0

Typewriter.

(9)

Jan 4 To Cash

C5 25 0 0

Trial Balance.

Discount  
Cartage  
Rent  
Burns & Co.  
Typewriter  
Cash  
Bank

8 4  
3 6 6  
20 10 6  
18 0 0  
25 0 0  
35 10 3  
141 1 4

243 16 11

Capital  
Goods  
Brown  
Interest

210 13 1  
7 18 10  
20 0 0  
5 5 0

243 16 11



Longmans. Text-book.

Revise pages 60, 61, 63, 70, and the notes on verbs given in Set 13.

B1. FIRST CONJUGATION VERBS (continued)

We now come to the Subjunctive Mood which is used much more frequently in Latin than in English.

PRESENT SUBJUNCTIVE is formed by changing the final "-o" of the present indicative into -em, -es, -et, -emus, -etis, -ent.

e.g. laudo, I praise. endings.

laudem, I may praise	-em
laudes, thou mayst praise	-es
laudet, he may praise	-et
laudemus, we may praise	-emus
laudetis, you may praise	-etis
laudent, they may praise	-ent

IMPERFECT SUBJUNCTIVE of any verb is formed from the infinitive by adding -m, -s, -t, -mus, -tis, -nt.

e.g. voco, vocare, to call.

vocarem, I might call	(vocare + m)
vocares, thou mightest call	(vocare + s)
vocaret, he might call	(vocare + t)
vocaremus, we might call	(vocare + mus)
vocaretis, you might call	(vocare + tis)
vocarent, they might call	(vocare + nt)

LEARN the present and imperfect subjunctive of "amo", page 65. Then repeat aloud the same tenses using the verbs given in vocabularies 48-49.

REVISE paragraph 56, page 63 (perfect stem).

PERFECT SUBJUNCTIVE is formed by adding to the perfect stem the following endings:-

-erim, -eris, -erit, -erimus, -eritis, -erint.

PLUPERFECT SUBJUNCTIVE is formed by adding to the perfect stem the following endings:-

-issem, -isses, -isset, -issemus, -issetis, -issent.

These two tenses are clearly set out on page 65.

LEARN them by heart. LEARN also Rules 33 and 34.

WRITTEN WORK:

1. Write out the present and imperfect subjunctive of "libero" and "nuntio", and the perfect and pluperfect subjunctive of "festino" and "aedifico".
2. Exercise 48A, page 66. (First two columns).

A2. USE OF THE SUBJUNCTIVE.

CLAUSES OF PURPOSE. LEARN page 65, paragraph 57.

Further examples:-

We shall fight that the leader may praise us.  
Pugnabimus ut dux nos laudet.

We praise our men that they may not avoid dangers.  
Nostros laudamus ne pericula vitent.

LEARN page 66, paragraph 58.

Frumentum nobis dant ne agros eorum vastemus.  
They give us corn (that we may not lay waste their fields.  
(lest we lay waste their fields.

LEARN page 66, paragraph 59. Rules 35, 36.

Note that the tenses of the verb which refer to present or future events are called primary tenses; those that relate to past events are called historic tenses.

Further examples:-

Pueri arant ut patrem delectent.  
The boys plough that they may delight their father.

Pueri arabant ne pater eos culparet.  
The boys were ploughing lest their father might blame them.

WRITTEN WORK:

- (1) Write out from memory the primary and historic tenses.
- (2) Exercise 48B, page 67.

B3. REVISE Rule 7, page 12. Rule 15b, page 41.

e.g. Galli omnia in castris parabant.  
The Gauls were preparing all things in the camp.

Equites in Galliam festinabunt.  
The horse-soldiers will hasten into Gaul.

LEARN the declension of "domus" (house) which is given in vocabulary 48. Note that "domus" is feminine.

WRITTEN WORK: Exercise 49A, page 67.

B4. REVISE Footnote 3, page 128 (liberi).

Do Exercise 49B, page 67.

B5. THE IMPERATIVE MOOD.

LEARN the whole of page 68. Rule 37 is most important and must be memorized. Section (c) is of special importance, because commands are very frequently given in the second person.

Further Examples:-

(c) Materiam para. Materiam parate.  
Prepare (thou) the timber. Prepare (ye) the timber.

But Ne materiam paraveris (paraveritis).  
Do not prepare the timber.

Remember, then, that for the negative imperative of the second person you must use ne and the perfect subjunctive.

(d) Domum aedificemus.  
Let us build a house.

Ne domum aedificemus.  
Let us not build a house.

Ne liberi in hortis ambulent.  
Let the children not walk in the gardens.

For the imperative of the first and third person, then, you must use the present subjunctive for both affirmative and negative.

LEARN vocabulary 50 and revise the subjunctive, page 65.

WRITTEN WORK: Exercise 50. (Put into Latin). Arrange your work in neat columns.

A6. ORAL WORK: Exercise 50A, page 69.

Make sure that you could do the sentences yourself, before going over the following translation:

1. Give wine to the sick.
2. Show (point out) the place to the spies.
3. Let us adorn the statue with flowers.
4. Do not blame (your) parents.
5. Soldiers, prepare arms.
6. Let the boy not walk in the garden.
7. Plough your fields, farmers.
8. Avoid the evils of war by good plans (counsels).
9. The maidens must adorn the temple with flowers.
10. Do not enter the city by night.

WRITTEN WORK: Exercise 50B, page 69.

REVISE first of all Rule 15, page 41.

e.g. Ne pecuniam improbis demus.  
Let us not give money to wicked men.

7. TRANSLATION

JULIA'S FATHER COMES TO HER RESCUE.

Agricola ad casam venit. Filia parva non est in casa. Tum agricola "Iulia", exclamat, "filia mea, ubi es?" Iterum (again) Iuliam vocat, sed frustra -- nulla est puella. Cena (the dinner) non in mensa parata (prepared) est, nec rosae in mensa sunt. Tum ad oram maritimam festinat et procul (far off) navem albam spectat. Ad nautarum casas festinat. "Cum piratis", inquiunt (they say), "est Iulia tua." Magna est ira agricolae. Galeam et hastam raptat (seizes). Nautae quoque galeas et hastas raptant et cum agricolā ad piratarum navem festinant. Tum agricola piratas vocat: "Ubi", incuit "est filia mea?" Piratae, "Filia tua", inquiunt, "in nave nostra est."

Tum agricola pecuniam multam piratis dat. Piratae Iuliam ad agricolae navem portant.

A8. SECOND CONJUGATION VERBS.

The present infinitive of these verbs ends in -ere.

e.g. moneo, monēre, monui, monitum. (to advise).

PRESENT TENSE.

Change the final -eo, into -es, et, -emus, -etis, -ent.

e.g. habeo, habēre, to have.

	<u>endings.</u>
habeo, I have	-eo
habes, thou hast	-es
habet, he has	-et
habemus, we have	-emus
habetis, you have	-etis
habent, they have	-ent

IMPERFECT TENSE. Change the final -eo into -ebam, -ebas, -ebant, -ebamus, -ebatis, -ebant.

e.g. debeo, debēre, to owe.

	<u>endings.</u>
debebam, I was owing	-ebam
debebas, thou wast owing	-ebas
debebat, he was owing	-ebat
debebamus, we were owing	-ebamus
debebatis, you were owing	-ebatis
debebant, they were owing	-ebant.

FUTURE TENSE.

Change the final -eo into -ebo, -ebis, -ebit, -ebimus, -ebitis, -ebunt.

e.g. praebeo, praebēre, to offer.

	<u>endings.</u>
praebebo, I shall offer	-ebo
praebebis, thou wilt offer	-ebis
praebebit, he will offer	-ebit
praebebimus, we shall offer	-ebimus
praebebitis, you will offer	-ebitis
praebent, they will offer	-ebunt.

LEARN these three tenses of "moneo", page 72.

LEARN vocabulary 51. The four principal parts of each verb must be learnt.

B9. REVISE page 53, Rule 22.

LEARN page 78, Rules 39 and 39a.

e.g. Tibi plus pecuniae debebamus.  
We owed you more money.

Ne eis multum auri dederis. (dederitis).  
Do not give them much gold.

WRITTEN WORK: Exercise 51 (three columns).  
Exercise 51A.

A10. REVISE personal pronouns, pages 54-55. Rule 26, page 56.

e.g. In eis castris erant multi nautae.  
In that camp there werē many sailors.

(Note also the use of the nominative case after the verb "to be", Rules 8 and 12).

WRITTEN WORK: Exercise 51B, page 79.

This set of Model Answers is the property of the Education Department.  
It is to be regarded as confidential, and is to be returned to the  
Department when asked for. FIRST YEAR. NR. 34.

LATIN. Model Answers. Set 11. Secondary Department.

SECTION A.

4. Exercise 37B, page 50.

1. Quis est potentior { quam noster consul.  
nostro consule.
2. Ferrum est utilius { quam aurum.  
auro.
3. Servus interdum fidelior { quam dominus est.  
domino.
4. Turris altissima est in arce.
5. Bellum est tristissimum malorum.
6. Opus est difficilium puero quam puellae.
7. Belgae acriores erant { quam Galli.  
Gallis.
8. Victoriae Caesaris faciliores erant in Gallia quam in Britannia.
9. Iudex Sapientissime, captivo tristissimo veniam da.
10. Quid militi est utilius { quam telum acerrimum.  
telo acerrimo.

As you learnt in Rule 18, page 49, some of the above sentences may be translated in two ways.

Note again that adjectives must agree with their nouns in gender, number, case.

5.

A ROMAN SOLDIER.

War does not please us. We greatly fear it. Wars always terrify us, but the ancient Romans love wars. Neither the Roman warrior nor the Roman boy fears war. Battles and dangers do not terrify them; (but) we do not like long wars.

The fathers often praise their sons, because they fear no danger.

A helmet, sword, shield and javelin are the armour of a Roman soldier.

Many peoples lived in Italy, and wars were frequent.

6. Exercise 48B, page 50.

1. Montes insulae altissimi sunt.
2. Nostri gladios breviores habent.
3. Iter est difficilium hieme quam aestate.
4. Alpes sunt montes altissimi Europae.
5. Aestate itinera sunt facillima.
6. Patientia homines difficillima superant.
7. Omnium animalium ferocissimi sunt leones.
8. Incolae Britanniae naves latiores habebant quam Romani.
9. Romanis Germani erant molestissimi.
10. Oppida antiqua Germanorum altiores turres habebant.
11. Quis fortunam miseriam laudat?

8. Exercise 39 (2) and (3).

(2) melior pars  
meliolem partem  
peior locus  
peiolem locum

plura verba  
plura verba  
optima facta  
optima facta

plurimae arbores  
plurimas arbores  
pessima facta  
pessima facta

minores insulae	maximus numerus	fili nequissimi
minores insulas	maximum numerum	filios nequissimos
plures arbores	plurimi	miles veterrimus
plures arbores	plurimos	militem veterrimum
(3) priora tempora	murum interiorem	vetustiores
prioribus temporibus	muri interioris	vetustioribus
vada superiora	prima nocte	benevolentissimorum
vadorum superiorum	proximā nocte	filio maxime pio

9. Exercise 40, pages 53 - 54.

Viva voce:-

Plurimum pecuniae	plus spei	multum sapientiae
plurimi nautae	plus temporis	multi socii
plurimis nautis	plures flores	multae insulae

Exercise 40A.

1. He overcomes the greater part of the island.
2. The Gauls have a very great number of carts.
3. The old man's plan is better and easier.
4. The worst men (bad men) are feared by all.
5. There was more boldness than wisdom in the leader.
6. The upper fords are better than the lower.
7. In the river are (some) rather small islands.
8. The general makes more (rather many) fires in the camp.
9. He gives very much (a large sum of) money to the best of the soldiers.
10. In the former war he was victor (the conqueror).
11. What is worse than war?
12. On the next night he led the allies into the citadel.
13. In the crossing there was greater loss of baggage-animals than of men.

10. Exercise 40B, page 54.

1. Hostes maximum numerum peditum habent.
2. Proximo anno civitates minores superat.
3. Quid hominibus est melius virtute (quam virtus)?
4. Priore aestate exercitum trans Alpes duxit.
5. Pars superior fluminis ripas altissimas habet.
6. In muro interiore erant multi milites.
7. In nostro duce est plurimum audaciae.
8. Vada inferiora sunt difficiliora.
9. Maior pars hostium est in silvis.
10. In sene erat plus spei quam in filio.

1. Revision of Tenses. Revise the following:-(1) Present tense and imperative, pages 15, 21, 23.

e.g. The little boy is walking in the street.  
= Le petit garçon marche dans la rue.

The children are knocking at the door.  
= Les enfants frappent à la porte.

Revise also Sets 7 and 8.

(2) Imperfect and preterite tenses, page 43, and Set 12.  
Note that the word "did" is often used to translate the French preterite interrogative into English. Thus:-

quittai-je? = did I leave?  
mangea-t-il? = did he eat?

(3) Future tense, page 47, and Set 12.(4) Conditional, page 49, and Set 13.(5) Compound tenses, page 53, and Set 13.Written Work. Section A: Give the French for:-

I was arriving	did she jump?
we have not found	shall we have attacked?
let us knock	was he not visiting?
they are admiring	you are working
will they not explain?	thou wouldst remain
do not shout	would he carry?
did he scold?	I shall not regret
do I walk?	will she forget?

Section B:

1. How are the imperfect and future tenses and the conditional formed?

2. How do you make any verb negative?

2. Conjunctive Personal Pronouns.

Pronouns which stand for the names of persons are called personal pronouns. From your study of verbs you already know the following personal pronouns:-

je	I	(1st person singular)
tu	thou	(2nd person singular)
(il	he	(3rd person singular)
elle	she	
nous	we	(1st person plural)
vous	you	(2nd person plural)
(ils	they	(3rd person plural)
elles		

All the above pronouns are used as the subject of some sentence or clause and are said to be nominative case.

Sometimes personal pronouns are used as the direct object of a verb. For example, "I find him." The subject of the sentence is "I," the verb is "find," the direct object of the verb is the pronoun "him." Such pronouns are said to be in the objective or accusative case. In French the following pronouns

are used for the accusative case:-

me	me	{ 1st person singular,
te	thee	{ 2nd person singular}
le	him, it	{ 3rd person singular}
la	her, it	{ 3rd person singular}
nous	us	{ 1st person plural}
vous	you	{ 2nd person plural}
(les	them (m.)	{ 3rd person plural}
(les	them (f.)	{ 3rd person plural}

The important thing to remember is that these pronouns are always placed before the verb (except in the imperative affirmative). The following examples will make this rule quite clear:-

Charles begged me to go. = Charles me pria d'aller.

Thy mother was seeking thee. = Ta mère te cherchait.

I killed him. = Je le tua. I killed her. = Je la tua.

The children forget us. = Les enfants nous oublient.

We shall save you. = Nous vous sauverons.

I shall visit them. = Je les visiterai.

Notes: (1) Before a vowel me, te, le, la, become m', t', l', l', e.g. He called me. = Il m'appela.

(2) In the interrogative the pronoun object is still placed before the verb, e.g. Did he eat them? = Les mangea-t-il?

(3) In the negative the pronoun object is still placed immediately before the verb, e.g. I shall not forget thee. Do I not visit her?  
Je ne t'oublierai pas. Ne la visité-je pas?

(4) In the compound tenses (see page 53 and Set 13) the pronoun object is placed before the auxiliary "avoir." e.g. He has invited me. Have you forgotten him?  
Il m'a invité. L'avez-vous oublié?

I have not called thee. Have we not sought him?  
Je ne t'ai pas appelé. Ne l'avons-nous pas cherché?

(5) "It" is translated by le when it stands for a masculine noun, by la when it stands for a feminine noun. e.g.

Where is my dinner? I shall eat it.  
Où est mon dîner? Je le mangerai.

Where is the meat. I shall prepare it.  
Où est la viande? Je la préparerai.

Written Work. Section A: Write down the lists of pronouns given on page 55, par. 114, arranging your work in two neatly ruled columns.

Section B: Write down page 55, par. 115-119.

3. Read Lesson 28, page 54. Pay special attention to the conjunctive pronoun objects which are printed in heavy type. You will notice that they are always placed before the verb. Note also that the verbs regarder (to look at) and écouter (to listen to) are transitive verbs in French and require a direct object.

Questions, page 55: Section A: Odd Numbers.

Section B: Even Numbers. All answers in English.



Written Work, page 119, Exercise 28.

Section A: (Do question 1. Note that there are three parts to each question, e.g.

- (a) Il regarde le chien.
- Il regarde la viande.
- Il regarde les os.

In your answers you will substitute pronouns of the 3rd person for the words underlined. Be careful about the position of the pronoun and note that "le" and "la" become l' when the next word begins with a vowel.

Do Question 3. Two answers are required for each question, e.g.

- (a) Il (insert the object, 1st person singular) écoute.
- Il (insert the object, 1st person plural) écoute.

Do Question 7. e.g.

- (a) Je vous prie de brûler les feuilles.

Section B: Do Question 5. e.g.

- (a) He listens to us. = Does he listen to us?
- Il nous écoute. = Nous écoute-t-il?

(Note that the pronoun object still remains before the verb. Revise also page 21, par. 46-47.)

Do Question 8.

- Notes:
- (1) we were watching. See page 43.
  - (2) there was: page 41, par. 84.
  - (3) did he eat: preterite interrogative, page 43.
  - he did not eat: preterite negative.

Conjunctive Personal Pronouns (continued).

Sometimes personal pronouns are used as the indirect object of the verb. For example, in the sentence, "I gave the book to him," the subject is "I," the verb is "gave," the direct object of the verb is "the book." The pronoun "him" is the indirect object and is said to be in the dative case. In French, the following pronouns are used for the dative case.

me	to me	(1st person singular)
te	to thee	(2nd person singular)
{ lui	to him	(3rd person singular)
{ lui	to her	
nous	to us	(1st person plural)
vous	to you	(2nd person plural)
leur	to them	(3rd person plural)

The above pronouns are always placed before the verb.

You will notice that, except for the 3rd person, these pronouns are similar to the pronouns for the direct object.

Examples. I shall bring the letters to her.  
Je lui apporterai les lettres.

We shall not give the beast to them.  
Nous ne leur donnerons pas la bête.

They have not given the money to us.  
Ils ne nous ont pas donné l'argent.

Was he telling the story to me?  
Me racontait-il l'histoire?

Now study the whole of page 57, paying special attention to the notes in par. 121-122.

Written Work.    Section A: Copy down page 57, par. 120, accusative and dative cases only.  
                  Section B: Copy down page 57, par. 121-124.

---

6. Read Lesson 29, page 56.

Questions, page 57:    Section A: Odd Numbers.

Section B: Even Numbers.    Answers in English

---

7. Written Work, Page 121, Exercise 29.

Section A: Do question 5. Be careful about the position of the pronoun objects.

Do question 8.

Notes: 1. are they tying    ) Revise present tense, page 15,  
          they are going        ) and notes to question 5 of Set 7.  
          they are striking)

Section B: Do questions 3 and 6. Before doing 6, revise page 17, paragraph 37.

---

8. Conjunctive Personal Pronouns (continued).

You have learnt that pronoun objects, whether direct or indirect, are placed before the verb. There is one exception to this rule. If the verb is in the imperative affirmative, the pronouns are placed after the verb and are joined to it by a hyphen

Moi and toi are then used instead of me and te. (Revise the imperative, page 15.)

Help me, my children.  
Aidez-moi, mes enfants.

Place it on the table.  
Placez-le sur la table.

Pass the cups to him.  
Passez-lui les tasses.

Give the spoons to them.  
Donnez-leur les cuillers.

Let us invite her.  
Invitons-la.

Let us visit them.  
Visitons-les.

You will notice that all the above examples are affirmative. When the imperative is negative the pronouns are placed before the verb, according to the rules which are given in questions 2 and 5.

Speak to me.  
Parlez-moi.

Do not speak to me.  
Ne me parlez pas.

Let us forget it.  
Oublions-le.

Let us not forget it.  
Ne l'oublions pas.

Note that moi and toi are used for me and te in the imperative affirmative only. In the imperative negative you must use me and te.

Further examples are given on page 59 which should be studied carefully.

Written Work.    Section A: Write out page 59, par. 125.

Section B: Write out page 59, par. 127.

---

Read Lesson 30, page 58.

Written Work.    Section B: Translate Lesson 30 into English.

---

Written Work, page 122, Exercise 30.

Section A: Do questions 3, 4, 6. In question 6 you may omit  
beurre, fromage, sucre. Before you do sentences i, j, k, in  
question 4, make quite sure that you know page 13, par. 27.

Section B: Do questions 1, 7.

---

This Set of Model Answers is the property of the Education Department.  
It is to be regarded as confidential, and is to be returned to the  
Department when asked for. Secondary Department.

FIRST YEAR.FRENCH.MODEL ANSWERS.

JF '34.

SECTION B.

2. Clock diagrams showing the following times:-

4.45 (cinq heures moins un quart).  
 8.21 (huit heures vingt et un).  
 3.35 (quatre heures moins vingt-cinq).

3. Questions, page 37, (even numbers).

2. His big brother is seventeen years old.
4. Clara brings her present at eight o'clock.
6. His mother's present is a five franc piece.
8. The postman arrives at ten past nine.
10. Louis is very proud of his watch.
12. Louis says, "It is half past eleven by my watch."

4. Page 111, Exercise 19, question 2.

(a) Addition.

deux et trois font cinq.  
 deux et quatre font six.  
 sept et huit font quinze.  
 deux et neuf font onze.  
 vingt et trente font cinquante.  
 cinquante et cinquante font cent.  
 quarante et quarante font quatre-vingts.  
 seize et quinze font trente et un.

(b) Soustraction.

Ôtez quatre de six, reste deux.  
 Ôtez quatre de dix, reste six.  
 Ôtez un de huit, reste sept.  
 Ôtez quinze de vingt, reste cinq.  
 Ôtez un de vingt, reste dix-neuf.  
 Ôtez treize de cinquante, reste vingt.  
 Ôtez un de cinquante, reste quarante-neuf.  
 Ôtez neuf de trente, reste vingt et un.

(c) Multiplication.

trois fois quatre font douze.  
 quatre fois quatre font seize.  
 cinq fois quatre font vingt.  
 cinq fois cinq font vingt-cinq.  
 six fois six font trente-six.  
 six fois sept font quarante-deux.  
 sept fois quatre font vingt-huit.  
 dix fois cinq font cinquante.

(d) Division.

dix divisé par cinq donne deux.  
 quinze divisé par trois donne cinq.  
 seize divisé par quatre donne quatre.  
 vingt divisé par deux donne dix.  
 cent divisé par deux donne cinquante.  
 cent divisé par quatre donne vingt-cinq.  
 soixante divisé par trente donne deux.  
 mille divisé par dix donne cent.

4. (Contd.) Exercisc 19, question 3.

Il est dix heures dix.  
Il est deux heures dix.  
Il est trois heures et quart.  
Il est quatre heures et quart.  
Il est deux heures et demie.  
Il est une heure et demie.  
Il est sept heures et demie.  
Il est dix heures moins vingt.  
Il est onze heures moins vingt-cinq.  
Il est midi un.

---

5. Imperfect.

nous étions	était-il?	ils n'étaient pas.
n'étaient-ils pas?	n'étions-nous pas?	n'étais-tu pas?
elle n'était pas	ils étaient	n'était-elle pas?
étais-tu?	tu n'étais pas	nous n'étions pas
n'étais-je pas?	j'étais	je n'étais pas
vous n'étiez pas	étiez-vous?	n'étiez-vous pas?

Preterite.

nous fûmes	fut-il?	ils ne furent pas
ne furent-ils pas?	ne fûmes-nous pas?	ne fus-tu pas?
elle ne fut pas	ils furent	ne fut-elle pas?
fus-tu?	tu ne fus pas	nous ne fûmes pas
ne fus-je pas?	je fus	je ne fus pas
vous ne fûtes pas	fûtes-vous?	ne fûtes-vous pas?

---

7. Page 112, Exercisc 20.

Question 7. Il est temps, etc., is an impersonal expression; such phrases require de with the following infinitive:

- (a) -- de donner de l'eau aux lapins.
- (b) -- de chercher des oeufs dans la basse-cour.
- (c) -- de charger la charrette.
- (d) -- de quitter la ferme.
- (e) -- de monter à la première salle, etc.
- (f) -- de quitter nos travaux.

Question 8.

Vous avez vu un grand homme noir. Il était dans le jardin. Eh bien! Allons au jardin et cherchons la cause de votre épouvante. Regardez (voilà)! Cette chose (cet objet) est la cause de votre épouvante. Qu'est-ce que c'est? C'est un épouvantail. N'importe mais, après cette expérience, ne criez pas "au voleur" avant d'examiner la cause de votre épouvante.

---

8. Imperfect.

nous avions	ils n'avaient pas	avait-elle?
n'avaient-ils pas?	n'avais-tu pas?	n'avions-nous pas?
il n'avait pas	n'avait-elle pas?	ils avaient
avais-tu?	nous n'avions pas	tu n'avais pas
n'avais-je pas?	je n'avais pas	j'avais
vous n'avez pas	n'avez-vous pas?	aviez-vous?

Preterite.

nous eûmes	ils n'eurent pas	eut-elle?
n'eurent-ils pas?	n'eus-tu pas?	n'eûmes-nous pas?
il n'eut pas	n'eut-elle pas?	ils eurent
eus-tu?	nous n'eûmes pas	tu n'eus pas
n'eus-je pas?	je n'eus pas	j'eus
vous n'eûtes pas	n'eûtes-vous pas?	eûtes-vous? P.T.O.

9. Questions, page 41, (even numbers).

2. We had a comrade called Paul Monnier.
4. No we were not afraid of those animals, but it was unpleasant all the same.
6. One day we had a new pupil.
8. We had a geography lesson to prepare.
10. There was a cry.
12. "What is the matter?" cries the master.
14. The master had no difficulty in finding the owner.

10. Page 113, Exercise 21.

Question 5. Completions.

- (a) - parce que j'avais peur du cheval.
- (b) - parce que tu avais peur de la poule.
- (c) - parce qu'il avait peur de la grenouille.
- (d) - parce que nous avons peur du maître.
- (e) - parce que vous aviez peur du monstre.
- (f) - parce qu'ils avaient peur de l'épouvantail.

---

Translation of Question 7.

Il y avait beaucoup de bruit dans la classe aujourd'hui! Nous eûmes un nouvel élève et il avait peur de nous. Mais pourquoi y eut-il beaucoup de bruit? Paul Monnier apporte des bêtes dans la classe, et ce matin une petite grenouille avait sauté sur le livre du nouvel élève. Le pauvre garçon fut tout pâle et tremblant.

Note.- Aujourd'hui may stand first.

---

Study Caradus, pages 227 - 236.  
Rudman, " 81 - 85.

SALTS.

When acids and bases are brought together they combine to form a product which has none of the typical signs of either. This product is a neutral substance called a salt. You will remember that all acids contain hydrogen. Bases, when in solution, all contain a "hydroxyl" group, i.e., a group composed of one atom of hydrogen and one atom of oxygen, OH. It is the hydrogen of the acid and the hydroxyl of the base which give each of them their characteristic properties. Thus when a base neutralises an acid what actually happens is that the hydroxyl of the base unites with the hydrogen of the acid and forms water which is neither acid nor basic but neutral. The rest of the acid then combines with the rest of the base to form a salt.

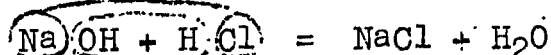

A base may thus be defined as a substance which reacts with an acid to form a salt and water and nothing else.

A salt may be regarded as an acid in which the hydrogen has been replaced by a metal (or metallic radicle like  $\text{NH}_4$ ). The following equations give examples of this. You will notice that the salt is named after both the metal and the acid.

1.  $2\text{HCl} + \text{Ca}(\text{OH})_2 = \text{CaCl}_2 + 2\text{H}_2\text{O}$   
Hydrochloric acid + calcium hydroxide = calcium chloride + water
2.  $\text{H}_2\text{SO}_4 + 2\text{KOH} = \text{K}_2\text{SO}_4 + 2\text{H}_2\text{O}$   
Sulphuric acid + potassium hydroxide = potassium sulphate + water
3.  $\text{HNO}_3 + \text{NH}_4\text{OH} = \text{NH}_4\text{NO}_3 + \text{H}_2\text{O}$   
Nitric acid + ammonia = ammonia nitrate + water
4.  $\text{H}_2\text{SO}_4 + \text{Zn} = \text{ZnSO}_4 + \text{H}_2$   
Sulphuric acid + zinc = zinc sulphate + hydrogen
5.  $2\text{HCl} + \text{CuO} = \text{CuCl}_2 + \text{H}_2\text{O}$   
Hydrochloric acid + cupric oxide = cupric chloride + water
6.  $6\text{HCl} + \text{Al}_2\text{O}_3 = 2\text{AlCl}_3 + 3\text{H}_2\text{O}$   
Hydrochloric acid + aluminium oxide = aluminium chloride + water

Be sure that you remember about valency when studying these equations and take note of how, in equation (1), one calcium atom, which has two valencies, combines with two chlorine atoms which have only one valency

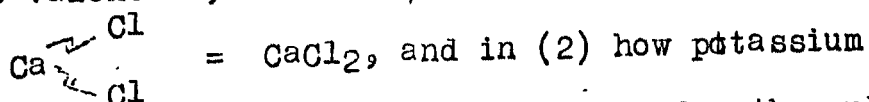

which has one valency has to supply two atoms for the sulphate radicle which has two valencies

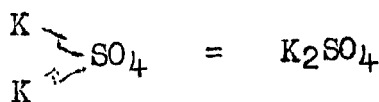

In (4) one zinc atom with two valencies combines with one sulphate radicle also with two valencies

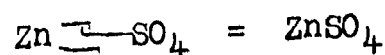

In (6) Aluminium which has three valencies combines with three chlorine atoms with one valency

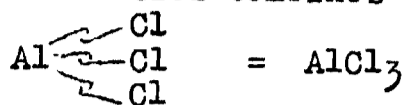

### ACID SALTS.

Sometimes, in the case of acids which have more than one hydrogen atom, only one of the atoms is replaced by a metal thus forming what is called an "acid salt".

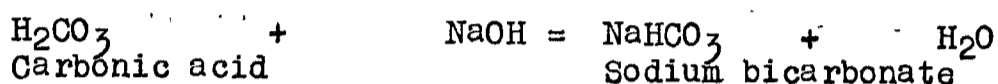
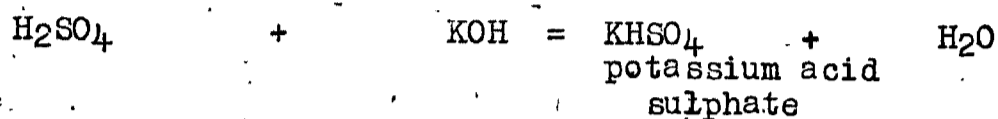

These acid salts can be changed into normal salts by adding another molecule of the base.

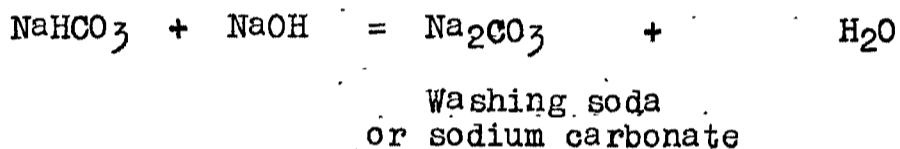
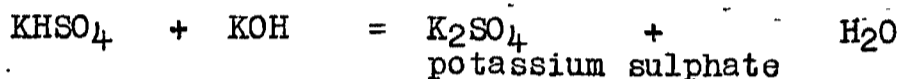

Phosphoric acid, which has three replaceable hydrogen atoms, forms three salts, one normal salt and two acid salts.

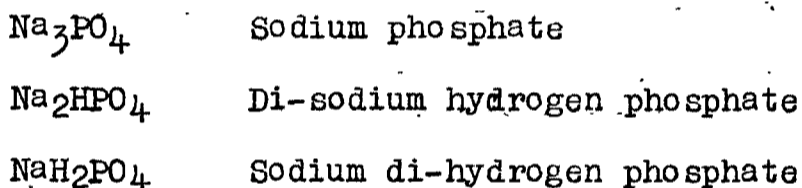

### BASIC SALTS.

There are also salts in which there is excess base called Basic Salts. These are normal salts combined with an extra molecule of basic oxide or hydroxide.

e.g.,  $\text{CuCO}_3 \cdot \text{Cu}(\text{OH})_2$  basic copper carbonate.

### PRACTICAL WORK:

1. Place a piece of litmus paper in a glass beaker containing equal volumes of lemon juice and water. Make up a very dilute solution of caustic soda in water and add very gradually to the lemon juice stirring continuously with a glass rod. At a certain stage the litmus will change colour. This is the point at which the acid is neutralised by the base. If you are very careful and add the alkali drop by drop you may get the exact point when the litmus paper will be neither red nor blue, but mauve. The solution is then quite neutral and contains the salt sodium citrate formed from citric acid and sodium hydroxide.
2. Repeat the procedure in experiment 3, this time adding a solution of equal volumes of vinegar and water to a solution of equal volumes of ammonia and water.
3. Caradus, page 226, Experiment 105 (a). - (Copper sulphate is bluestone.)



Work to be sent in:

1. Practical Book.
2. Written Work.

Section A:

1. How would you define (1) a base (2) a salt? Distinguish between normal and acid salts giving examples of each.
2. Write equations for the action of:-
  - (a) Dilute sulphuric acid on magnesium.
  - (b) Dilute hydrochloric acid on magnesium oxide.
  - (c) Dilute sulphuric acid on washing soda.
  - (d) Dilute nitric acid on caustic soda.
3. Write equations showing the action of (a) nitric acid, (b) hydrochloric acid and (c) sulphuric acid on each of the four common alkalis.

Section B:

1. Describe the four common methods by which salts may be formed, giving an example of each with the chemical equation.
2. Write equations for the action of hydrochloric acid on caustic soda, washing soda, baking soda.
3. Describe the action of concentrated sulphuric acid on copper and give the chemical equation.

This set of Model Answers is the property of the Education Department.

It is to be regarded as confidential, and is to be returned to the

Department when asked for.

IG. 34.

FIRST YEAR.

HOML SCIENCE.

SECONDARY DEPARTMENT.

SET 11.

SECTION B.

1. An oxide is a chemical combination of oxygen with another element.

To obtain an oxide using carbon, place a piece of charcoal in a deflagrating spoon and heat in a bunsen flame until it is red hot, then lower into a jar of oxygen. Here it will burn away brilliantly, combining with the oxygen to form the oxide Carbon-dioxide gas.

CHARACTERISTICS.

1. Will extinguish flame - will not support life.
2. It is heavier than air because it can be poured from the jar into one held beneath it.
3. When tested with litmus it gives an acid reaction.
4. When shaken with lime water it turns the lime water milky.

2. Catalysis is the use, in a chemical reaction, of a substance which will accelerate the reaction without itself undergoing any permanent chemical change.

Example. The use of manganese dioxide when heating potassium chlorate to obtain oxygen.

An Oxidising Agent is a substance which will yield oxygen to another substance.

Examples such as barium peroxide, red lead, potassium chlorate, hydrogen peroxide.

Oxidation is the process of combining chemically with oxygen.

Example. When magnesium ribbon is burned in oxygen forming magnesium oxide the process is one of oxidation.

3. The oxides obtained give the following reaction with litmus:

sulphur	- acid (turns litmus red)
carbon	- acid "
phosphorus	- acid "
iron	- neutral - no effect on litmus
magnesium	- alkaline (turns litmus blue)

---

This Assignment is the property of the Education Department. It is to be regarded as confidential, and is to be returned to the Department when asked for.

FIRST YEAR.

HYGIENE.

SET 14. JMP 36.

Study Lyster, page 196.  
First Aid, pages 121 - 122.

CLOTHING (continued).

Having studied in detail the materials used for clothing we will now turn our attention to the actual garments, their make and fit.

All garments should be light, loose and porous. Heavy, tight-fitting clothes hinder the circulation of the blood and the proper functions of the internal organs and add an unnecessary weight, making one feel cold, tired and uncomfortable. Loose clothes are much warmer than tight ones and two layers of thin light material are much warmer and more comfortable than one thick heavy layer, as air is enclosed between the two thin layers and air is an excellent non-conductor of heat.

Thus garments should be made so that, while fitting comfortably and allowing for free movements of the body and limbs, there is still room for air in between them.

The chief places where undue tightness is to be found in clothing are (a) the hands and feet which are frequently clothed in gloves and shoes which are too tight, and, in the case of shoes, are of the wrong shape,

(b) the waist which is frequently tightly girded by belts, bands and tight elastic,

(c) the legs, which are often marked by the impress of tight garters.

Corsets, stays and hip girdles of all sorts are also undesirable for the following reasons:-

(a) They must be, of necessity, tight, if they are to perform the function for which they are worn, and tight clothes, as we have seen, hinder the circulation and proper functioning of the internal organs and also prevent proper ventilation of the skin.

(b) Corsets are worn for the purposes of (1) Support, and (2) to give a slim appearance and nothing could be more foolish since corsets and all supports of the sort actually increase and even cause a slack figure and the consequent need for support.

The reason for this is as follows:-

If any muscle is not used it will become slack and unable to function properly. For example, if you were to tie up your arm in a sling for a week or two you would have great difficulty in using it. It would be very weak and useless. Or, if you were to lie in bed for some weeks, when you did get up you would hardly be able to stand. In the same way if corsets are continually worn, the abdominal muscles become slack and weak and are unable to hold the internal organs in place. Also the muscles of the spine become weak and the total result is that the individual becomes unable to hold the body in the correct posture. Then if they do try to do without corsets for a few hours their muscles are so unused to it that they get a back-ache, and assert that others may be able to do without corsets but they really need them.

P.T.O.

If the correct posture is maintained from childhood and the right type of food eaten in moderate quantities so that one does not become unduly fat, there would never be any need for corsets, and the health of the nation as a whole would be greatly benefited.

Stockings may be supported either by a light garter which just fits closely enough to keep the stocking up but not so tightly as to leave a mark, or by suspenders attached to a narrow elastic band resting on the hips not worn round the waist.

#### DISTRIBUTION OF CLOTHING

The clothing should be fairly evenly distributed over the body and there should not be more than four layers of it. Also the weight of clothing should be evenly distributed, some garments being hung from the shoulders and some from the hips (not from the waist).

The present day fashions in clothing are not by any means ideal. For example, it is generally conceded that men's clothing is much too heavy and uncomfortable especially for warm weather, the average man's clothing weighing 15 lbs while a woman's clothing weighs only 4 lbs. However, while still keeping outwardly in line with convention we can do much to improve our method of clothing. The following suggested sets of clothing for girls and boys show how to be more healthily clothed than is customary although the necessity for conform to fashion and convention prevents the adoption of ideal garments. Remember that a healthy body fed on proper food and given all the sunshine available is quite capable of maintaining the normal temperature without any clothing.

#### GIRLS' CLOTHING

##### (a) Winter.

1. A singlet of either woven silk or "aertex" cotton material.
2. Bloomers of woven silk, or, for very cold weather, wool with a separate lining of silk or cotton.
3. Silk petticoat if necessary.
4. Warm frock or jumper and skirt, the skirt being attached to a bodice.

Where a brassiere is worn it should support without compression, but it is always better to do without unnatural support.

The modern fashion of wearing silk, artificial silk or cotton stockings is preferable to wearing woollen stockings which cause undue perspiration.

For out-of-doors, a warm coat and hat.

##### (b) Summer.

1. Silk bloomers.
2. Thin silk petticoat.
3. Light frock.

If the petticoat can be dispensed with so much the better. Hats and stockings should be done without as much as possible in order to allow the life-giving sunlight to shine on as much of the body as possible.

BOYS' CLOTHING

(a) Winter

1. Singlet of woven silk or "aertex" cotton material.
2. Cotton or flannel shirt.
3. Coat and shorts of woollen material.  
For out-of-doors a warm overcoat.

(b) Summer

A shirt and shorts of light material is sufficient although a singlet may be worn on cooler days. Caps and stockings are unnecessary.

NIGHT ATTIRE

For both boys and girls pyjamas of some silk or cotton material are suitable. Wool should not be worn. All garments worn during the day should be removed and only the pyjamas worn in bed.

Some authorities consider that the wearing of too many and too tight clothing results in mouth breathing and adenoids in the attempt to lose more heat. It is also thought that the unnatural and continued dampness of the skin brought on by hot, tight woollen garments increases the susceptibility to colds in the head, tuberculosis and rheumatism.

In this connection it is interesting to read what the famous Doctor Rollier has to say about the "School in the Sun", which he started in the Swiss Alps for children suffering from tuberculosis. He says:-

"It must be borne in mind that the majority of children who come to this school in the sun have been treated as delicate for some time and are therefore in no fit state to undergo so sudden a change of environment as the school routine would involve. During the first few weeks of his stay, therefore, the child is given ample rest, and the amount of clothes which is frequently very excessive, is gradually reduced. In a few weeks the newcomer is usually able to live the same life as his school fellows. As health is the most important consideration, school is reduced to two hours a day; lessons being held in the open air with the sun on the children's backs whenever the weather is sufficiently fine. We have had a light folding apparatus constructed, which consists of a desk and chair, fixed at the right distance apart. This apparatus is easily portable and makes it possible for classes to be held in the open air at some distance from the school, the site chosen each day depending on the weather, a sunny sheltered nook being suitable in winter while in hot weather a shady spot in the forest will be chosen. Every afternoon two hours are spent in rest, no talking or reading being allowed."

"We reduce clothes to a minimum so as to expose the body as freely as possible to the sun. For boys, cotton bathing drawers are sufficient while for girls we use a sort of combination garment of white cotton. There is, of course, considerable prejudice against the reduction of clothing to this extent, and even quite small children are not considered "decent" unless they wear more clothes. Personally I do not consider that anything could be more decent than the naked body of a child bronzed by the sun. Nudity soon becomes quite a normal condition and the child rapidly loses his astonishment at it."

## Assignment.

-4-

"By the aid of free exercises in the sun and open air, we are thus able to save many sickly and debilitated children from the ravages of tuberculosis and in many cases we see the bodies of patients, wasted by disease, change into harmoniously developed forms of beauty, worthy of the chisel of Praxiteles."

A picture is shown of a class of young boys sitting in the open air at their little portable desks and dressed only in very short white cotton drawers and snow boots. The ground is covered with snow and the sun is shining on their bare backs.

So you see that while sunshine is absolutely necessary for health, clothing can be done without even in the middle of a snow field!

(It was mentioned earlier in this assignment that proper food was a necessary factor in maintaining the normal temperature of the body when few clothes were worn. Food will be dealt with in detail at a later stage but in the meantime, it may be said that the foods which are necessary for proper health are:-

1. Fruits and vegetables in much larger amounts than is customary, all the fruits and as many of the vegetables as possible to be taken uncooked as cooking spoils much of their food value.
2. Plenty of milk.
3. Whole wheat bread and butter.
4. Some eggs, cheese and nuts.

The above articles should form the main part of the diet and together they contain everything that is necessary for health. Meat is unnecessary and is not advised. If it is taken at all it should be only occasionally and in small amounts.

## INFLUENCE OF COLOUR

Colour plays a more important part in the value of clothing than is generally recognised, and it does this in many ways:-

(a) By its heat absorbing power.

Some colours absorb more light and heat than others. White does not absorb any heat or light, but reflects them so that white is a good colour to wear in hot weather. Black on the other hand absorbs all the heat and light rays and so is very warm and thus more suitable for cold weather. The other colours come in between these two, yellow being next to white, then pink and blue.

Thus light colours are more suitable for summer wear and dark colours for winter.

The following experiment shows how black absorbs more heat than white:- Two pieces of the same kind of material and of the same size, one black and the other white, were put on the surface of the snow while the sun was shining. After a certain time it was noticed that the black material had sunk deeply into the snow while the white had scarcely sunk at all. This was due to the fact that the black had absorbed the heat from the sun and become very hot thus causing the snow under it to melt, while the white had reflected the heat and light rays from the sun and so had remained cool.

(b) The second effect of colour is an aesthetic one, i.e. it appeals to our emotions.

P.T.O.

Some colours give a feeling of cheerfulness, others peace, others are gloomy and depressing and so on. For example, black alone is depressing and should always be worn with something white. Dull browns are also depressing but may be relieved with yellow or orange. White gives an effect of purity. Yellow, orange, scarlet are cheerful and rather aggressive. Green is soft and sympathetic, blue is peaceful, pink and crimson are warm and affectionate, and so on.

The lighter colours should be worn in preference to dull, dark colours. Blue, pink, green and white are all good colours to wear. Black and dull browns and greys should be avoided.

The effect of colour on our feelings is a very real one, although it is not generally recognised.

PRACTICAL WORK

Study your own clothing and food and see if you can increase the amount of time spent in the sunshine. Do what you can to adjust your clothing, food and hours of sunshine to the standard given in the Assignment and state in your practical book what improvements you have made.

WRITTEN WORK

SECTION A:

1. Explain why tight clothes should not be worn, mentioning particularly garters, shoes, belts, and corsets.
2. What do you know of the "School in the Sun"?
3. What are the signs and symptoms of injury to an internal organ?

SECTION B:

1. Give a list of the garments to be worn:  
(a) in winter, and (b) in summer by a girl or boy.  
Give the clothing for your own sex.
2. In what ways does the colour of our clothing affect us?
3. What is the treatment for injury to an internal organ?

ORGANISATION.

- Period I : Study Assignment.  
" II : Study Lyster and First Aid.  
" III : Written Work, Sections A and BI.  
" IV : Written Work, B2 and 3 and Practical Work.
-

CORRESPONDENCE SCHOOLMiddle Division.Introduction toA Wider Range of Studies.

Doubtless you frequently think about what you will do next year; and long for "fresh worlds to conquer". Perhaps you desire to proceed to the work of forms higher than Form II. If so you then will begin the study of new subjects, among which may be French or Latin, Algebra, Geometry, Science or Book-keeping. In that case it will be interesting to have had an introduction to these subjects and perhaps to have tried out some of them.

In any case you will be carrying your education on one step further, whether you continue school work, or whether you work on a farm, or at home or at any other of the varied useful, necessary and interesting work of the Dominion. To all, it is a good thing to widen one's outlook, and these Assignments will certainly do that for you.

Nevertheless the study of them is not compulsory, but optional. It is hoped, however, that you will attempt them, if you can, also that you will find them interesting as giving an introduction to the fascinating territory that lies beyond.



WHO AM I?

I am the foundation of all business.

I am the source of all prosperity.

I am the parent of genius.

I am the salt that gives life its savour.

I have laid the foundation of every fortune.

I can do more to advance youth than his own  
parents, be they never so wealthy.

I must be loved before I can bestow my greatest  
blessings, and achieve my greatest ends.

Loved, I make life sweet, purposeful and fruitful.

All progress springs from me.

I am WORK.

This assignment is the property of the Education Department. It is to be regarded as confidential, and is to be returned to the Department when asked for.

JAD/36

INTRODUCTION TO PRACTICAL GENERAL SCIENCE.

SET 4

I. Air Pressure: In Assignment No. 3 (read it again) you learned that air exerts pressure in every direction. Usually air pressure on one side of everything is balanced by an equal pressure on the other side, so that the effects are not seen. But when the pressure is not balanced, it is often seen to be very great. The pressure of the air is about 15 pounds to every square inch of surface. It is because of this pressure that pumps, fountain pens, siphons, barometers and vacuum cleaners work. Suck some milk through a straw, and think of what happens. Now think about the objects named.

II, There is another property of air you can discover.

A. Experiment 14: Fill a narrow-necked bottle one quarter full of water. Blow hard into the bottle and at once close it with your thumb. Tilt the bottle till the mouth is under water. Then open the mouth slightly. Water will be sent squirting out. After a little practice you will find you can squirt it some distance. When you blow into the bottle the air in the bottle is compressed. As soon as you remove your thumb it springs back to its former size and so drives out the water.

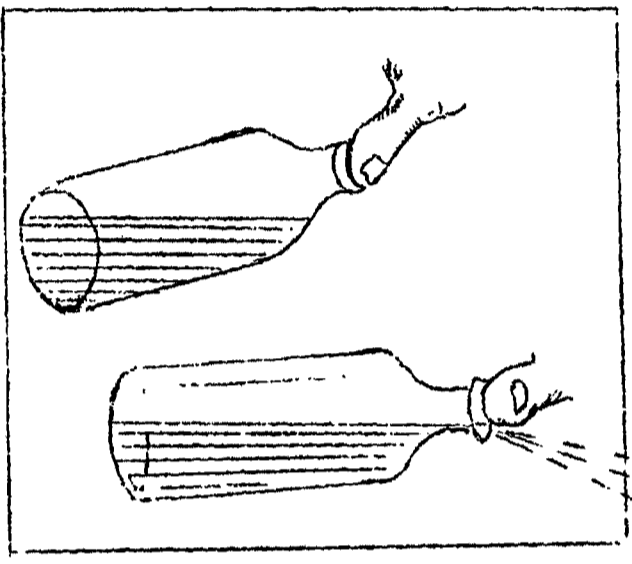

B. Think now of why balls bounce. What makes an air cushion so comfortable? What makes a pop-gun work? Think also of the use of compressed air in cycle and car tyres.

III Air surrounds the earth to a height of about 200 miles. At a height of about 5 miles, however, it gets so thin that men at that height have great difficulty in breathing. (Have you read any stories about the stratosphere?) Mountain climbers also experience the same trouble. You doubtless have read about the recent attempts to climb Mt. Everest, and have wondered why such brave and experienced climbers have so often failed. The failure is due to the scarcity or the rarity of the air at such great heights. We know then that air is necessary for human and animal life.

Now let us try.

C. Experiment 15: Fix two short pieces of candle upright on the bottom of a basin containing a little water (one candle should be longer than the other) Light the candles and place a large jar over them. The candles soon go out. Leave the jar to cool. When the jar is cold you will see that water has risen into it showing that some of the air has been used up. Slip a piece of cardboard over the mouth of the jar, raise it out of the water, and turn it mouth up and leave it still covered. Light a taper or a paper spill, remove the cardboard cover, and put the taper or spill into the jar. The taper goes out at once. It will not burn in the gas that is left in the jar.

There then have been two parts in the air (1) a part that is needed for burning and (2) a part that does not support burning.

Write up your notes: and think about what all this really means.

D. Here are some other questions to think over? Why do we lay the paper and stick loosely when lighting a fire? What is the use of bellows? Why should the dampers of a stove be opened? Why do you tread on a match to put it out? Why is it difficult to burn an old magazine? If your clothes catch fire why should you wrap a rug or a mat tightly round yourself and certainly not run about?

This Assignment is the Property of the Education Department. It is to be regarded as confidential, and is to be returned to the Department when asked for.

JAD/

INTRODUCTION TO BOOK-KEEPING.

SET 4.

I. In the previous assignment we learned about the size of some of the paper used in business. There is another size commonly used. It is called foolscap. This is the size of paper used for this Assignment. Measure it and you will find that it is 8 inches by 13 inches. It is used for official correspondence, for extra long business letters and for reports.

II. The business man buys his paper in packets each holding a ream. The number of sheets in a ream varies. Once it contained 480 sheets, but now-a-days it has become usual to have 500 sheets in a ream.

III. Just as there are different sizes of papers, so there are different sizes of envelopes. In the present we shall consider only three :

- (a) The ordinary commercial envelope. This is oblong - the size varies, but the average size is about  $5\frac{1}{2}$  inches by  $3\frac{1}{2}$  inches. It is the most generally used size.
- (b) The square envelope. This is not really square as you can readily see. Its size is somewhere about  $5\frac{1}{4}$  inches by  $4\frac{1}{2}$  inches. It is used for private correspondence.
- (c) The foolscap envelope. Size 9 inches by 4 inches. This is used for official correspondence.

IV. Now let us consider more particularly the addressing of the envelope. You have studied many envelopes that come to your house and have found out these things about the correct way to address them :-

1. The writing was good and clear.
2. The address began about halfway down the envelope; and about an inch from the left edge - though this latter depended upon the length of the address that was written.
3. The second line began a little to the right of the first line; and each succeeding line still a little further to the right.
4. The name of the town was written a little larger than the rest.

V. Before we leave envelopes we must know how to address the person for whom the letter is intended.

- (a) A man is addressed as Mr.; so also is a youth because Mr. stands equally for Mister or Master.
- (b) A married lady is addressed as Mrs.
- (c) Doctors are addressed as Dr.
- (d) Clergymen may be addressed as Rev. Mr. Jones
- (e) A business firm is addressed as Messrs. (Note the spelling). Whenever the name is a personal one e.g. (e.g. stands for the Latin words "exempli gratia" and means "for instance") Messrs Oates & Johnson Ltd.; or Messrs I. Jones Ltd. but where there is no personal name, the Messrs. is not used. e.g., The Secretary, The Para Rubber Company Limited. is
- (f) A firm of ladies is addressed as Mesdames; but if it/composed of unmarried ladies the term 'Misses' is written e.g. The Misses Hanna and Gee.
- (g) All letters to public bodies such as, Education Boards, Road Boards, etc., are addressed thus:-

The Secretary,  
Kowhai Road Board.

Work to do: Cut out a number of pieces of unlined paper equal in size to the envelopes described in Section III. Practice addressing them, using the correct size envelope for each address and addressing in the seven styles indicated in Section V. Send in only the best one of each kind.

This Assignment is the Property of the Education Department. It is to be regarded as confidential, and is to be returned to the Department when asked for.

JAD/36

INTRODUCTION TO ALGEBRA

SET 4.

I. Still more Symbols: Today I want you to meet another Roman Symbol - D - which was used to represent 500. Now you can express hundreds thus: C = 100; CC = 200; CCC = 300; CCCC = 400; D = 500.

A. (a) Write in Arabic figures the meaning of these Roman numerals :

DL

DX

DV

DC

DCLXV

(b) Write in Roman numerals :-

555

765

768

536

II. Formulae: Here is another formula. Suppose a motor car travels at 25 miles an hour for 5 hours: then the distance covered is 125 miles. We could set this down like this :-

$$\begin{aligned} \text{Distance covered} &= 25 \times 5 \text{ miles} \\ &= 125 \text{ miles.} \end{aligned}$$

Suppose we express this in symbols and try to make a formula. We can do this :-

Let R represent the rate in miles per hour,  
D the distance covered in miles  
T the time taken in hours,

we can express this statement/a formula thus :-

$$D = RT$$

We can also get two other formulae :  $R = \frac{D}{T}$  and  $T = \frac{D}{R}$

B. Express what each of these means :-

$$D = RT, \quad R = \frac{D}{T}, \quad T = \frac{D}{R}$$

Using the above formulae -

(a) Find D, if  $R = 30$  and  $T = 3\frac{1}{2}$

(b) Find R, if  $D = 160$  and  $T = 12$

(c) Find T, if  $D = 354$  and  $R = 56$

III. You will have observed that in Arithmetic there are four simple operations.

- C. (a) What are they?  
(b) What is the answer to the addition operation called?  
(c) What is the answer to the subtraction operation called?  
(d) What is the answer to the multiplication operation called?  
(e) What is the answer to the division operation called?

In Arithmetic you have learned the symbol + (plus) and know that  $12 + 4$  indicates or means the sum of 12 and 4. In the same way  $12 - 4$  (twelve minus four) indicates the difference between 12 and four. So  $12 \times 4$  indicates the product of 12 and 4, and  $12 \div 4$  indicates the quotient of 12 and 4.

D. Similarly indicate the sum, the difference, the product and the quotient of 16 and 2 and a and b.

Work to be done: Work all the sections A, B, C and D.

This Assignment is the Property of the Education Department. It is to be regarded as confidential, and is to be returned to the Department when asked for.

JAD/36

INTRODUCTION TO LATIN

SET 4.

I. In the previous assignments we learned something about the geography of the Roman Empire. We discovered that if we had a map of ancient Europe (Europa Antiqua) the place names would be spelt in Latin. We also read some Latin sentences.

A. Let us pause and learn some of the words we used, and some others:

<u>Latin</u>		<u>English</u>
insula	a noun meaning	an island, or the island
est	a verb meaning	"is", he is, she is or it is
et	a conjunction meaning	and
sunt	a verb meaning	"are" or they are

Just as are is the plural form of the English verb is; so sunt is the plural form of the Latin verb est; and just as an English verb must agree with its subject, so also must a Latin one.

B. Now read these Latin sentences and then translate them:

- (1) Sicilia et Britannia sunt insulae.
- (2) Germania et Gallia non sunt insulae.
- (3) Hispania non est insula.
- (4) Italia non est insula.
- (5) Europa non est insula.

Note (1) that the plural of insula is insulae. Just as you know that the plural of formula is formulae.  
 (2) that "ae" in "insulae" is pronounced with the sound of "a" in the English word "man" very rapidly followed by the "e" sound in "tell"; later this "ae" sound became much like the sound of "ai" in the word "repair".

II. The Romans (Romani) called the people who lived in Britannia, Britanni; in Germania, Germani; in Gallia, Galli.

The Latin verb habitabant means lived or used to live

C. Can you translate these sentences?

- (1) Romani in Italia habitabant.
- (2) Germani in Germania habitabant.
- (3) Britanni in Britannia habitabant.
- (4) Galli in Gallia habitabant.

What do you notice about the order of the words in these sentences? How does it differ from the English order of words.

D. How many English words can you find that are derived from the verb "habito" (the verb habitabant is only one of many forms of the Latin verb habito, (meaning I dwell, or abide, or reside or live).

III. You doubtless have often seen the Latin sentence - Labor omnia vincit - this means: Perseverance overcomes everything.

The verb is vincit (v is pronounced like the w in wall and the c like the c in cat) and means overcomes or conquers: the subject is Labor: and the object is omnia.

Work to do: All sections - A, B, C, D . . .

This Assignment is the Property of the Education Department. It is to be regarded as confidential, and is to be returned to the Department when asked for.

JAD/36

INTRODUCTION TO PRACTICAL GEOMETRY.

SET 4

I. You will remember that in Assignment No. 1 we said "there are two ideas we must be clear upon before we can get far in measurement. These are the ideas of the Line and of the Angle." It is now necessary for us to consider the angle; for unless we understand the angle we will not have clear ideas of direction. The word angle is derived from a Latin word meaning a corner.

II. Here is something to make. Cut two pieces of cardboard each seven inches long by .8 in. wide. (Remember that all geometers must be accurate). Place one piece exactly above the other to see that they fit. Lay both horizontally on a board in front of you. Push a drawing pin through both and into the board half an inch from the left end of the cardboard and .4 in. from each side. You will now find that you are able to turn or rotate each piece of cardboard about the point. Let us now name these pieces. Print the letter 'A' to mark the place where the pin is; and the letters 'B' and 'C' respectively at the other end of each piece. Now keeping AB horizontal rotate AC about A and in the direction shown by the arrow. Stop at the position shown in Fig. 4. We have formed an angle which we call BAC. (Note that the letter A where the lines meet is placed in the middle of the name of the angle BAC). Turn AC still further towards the left and we get the angle BAC' (Fig. 4), which you can clearly see is a bigger angle than BAC. The more turning there is the bigger is the angle. If we continue turning, at last we come back to the original position exactly over AB.

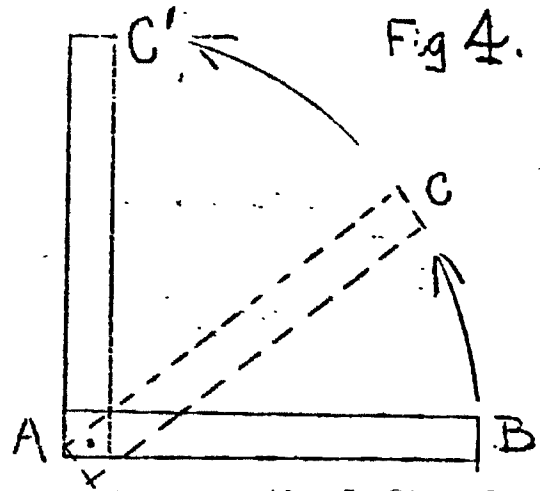

When we have turned AC completely round in this direction we say it has rotated through an angle of one revolution. This complete turn will be our unit of measurement of the size of an angle.

For convenience in dealing with small angles a revolution is divided into four equal parts called right angles. So a right angle is a quarter of a complete turn and AC and AB are said to be perpendicular to each other.

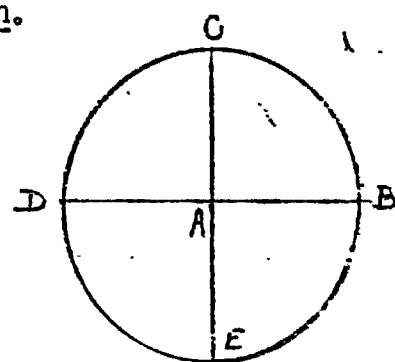

For further convenience in measuring an angle smaller than a right angle a complete revolution is divided up into 360 equal parts called degrees. A right angle therefore contains 90 degrees ( $90^\circ$ ).

The two lines forming an angle are known as the arms of the angle; and the point where they join is called the Vertex. Thus in the angle RST the arms are RS and TS, the point S is called the vertex.

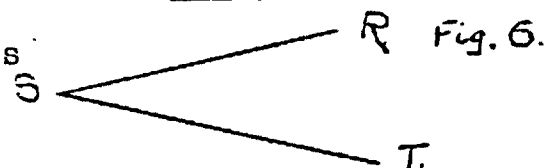

Test your knowledge of the angle with these questions :-

- (a) Name the arms and the vertex of each angle in Fig. 7.
- (b) How many angles are formed at B?
- (c) What makes an angle bigger?
- (d) What effect upon the size of an angle has the length of the arms of an angle?

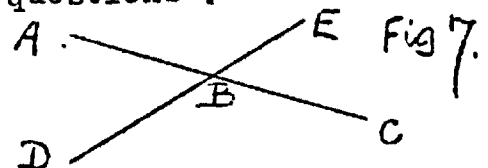

"The lines are fallen unto me in pleasant places; yea,  
I have a goodly heritage."

Psalm XVI. 6.

WORK FOR STUDY.

1. LAWSON AND GUDEX.

"The Sentence" (continued), pages 18 - 22.

2. AN ENGLISH HERITAGE IV.

"How Not to See an Alpine Sunrise" by Mark Twain, from  
"A Tramp Abroad."

3. AN ENGLISH HERITAGE IV.

(a) "A Picture of Old Age" from The Authorised Version of  
the Bible.

(b) "Let Us Now Praise Famous Men" from "The Apocrypha".

4. ANALYSIS.

Lawson and Gudex, pages 269-271.

5. WRITTEN WORK.

6. WRITTEN WORK.

7. POETS AND POETRY, Senior, Book III.

Poems about Larks, pages 28-30.

Study also the Introduction, pages 25-28, and the notes on  
the authors, page 35.

8. "THE TEMPEST".

Act I, Scene 2, lines 1-183.

With this scene we enter the domain of enchantment. The  
scene is for the most part a sketch of the ancient history of  
the wonderful island.

Miranda's opening speech forms a skilful mode of transition  
from the preceding scene. It describes the storm, not as ex-  
perienced at sea, but as witnessed from the land, and suggests  
that, instead of being a natural outbreak of elemental fury, it  
is due to the influence of Prospero's art.

Lines 5-13 give us the key to Miranda's character, in which  
tenderness and simple faith in good are throughout the leading  
notes. Notice her description of the vessel as 'brave' and  
'good', and her instinctive confidence that it carried 'noble  
creatures'.

9. THE ESSAY.

(Notes on the Essay will be given as a supplement, from  
time to time, as opportunity offers).  
Study intensively -

ESSAYS OLD AND NEW.

- (a) The Domestic Young Gentleman.  
(b) A Friend of the Town.

This Assignment is the property of the Education Department. It is to be regarded as confidential, and is to be returned to the Department when asked for.

JAD/3

INTRODUCTION TO FRENCH

SET 4

I. "Bonjour, mon garçon". You can, of course, say that correctly now. (It is a pity that you have not yet met the French word for 'girl', but it will not be long before you learn it).

A. Now let us revise all the French sounds we have so far learned. Practise each well.

<u>Symbol and Sound</u>	<u>French Word</u>	<u>Pronunciation</u>	<u>Meaning</u>
ø (see set 2, A)	mon	m ø	my
	bon	b ø	good
	non	n ø	no
u (see set 2, B)	où	u	where
	jour	ʒur	day
ʒ (see set 2, B)	jour	ʒur	day
	rouge	ruʒ	red
i (see set 3, C)	dis	di	say
	si	si	if
ə (see set 3, C)	le	lə	the
	de	də	of
	je	ʒə	I

II. You will need some more French words, so compile a list in a book. Use three columns as are shown below. Enter all the words you have learned in Sets 1, 2 and 3, and add these :-

<u>B.</u>	<u>French Word</u>	<u>Pronunciation</u>	<u>Meaning</u>
	où	u	where
	le canif	lə kanif	the pocket knife
	le pont	lə pø	the bridge
	est	ɛ	is

We must pause here for we have just met another French sound.

C. Say these English words very carefully:

met                      head                      said

The middle sound of these words is very like the French sound that we represent by the symbol ɛ. Keep your lips well apart.

Practise these words having the ɛ sound:

<u>French Word</u>	<u>Pronunciation</u>	<u>Meaning</u>
est	ɛ	is
elle	ɛl	she
aime	ɛm	loves, or lik

III. D. Here are some interesting sentences. Read each in French:

- (a) Où est le livre?                      Voici le livre.
- (b) Où est le canif?                      Voici le canif.
- (c) Où est le pont?                      Voici le pont.
- (d) Elle aime le livre rouge.
- (e) Elle aime mon livre.
- (f) Je dis, "Où est le livre"?

IV. Translate each sentence into good English.

Note: The mark ` above the letter u in the word 'où', meaning "where?" is called a grave accent. It is very important and must not be omitted. You will learn more about accents in later lessons.

(The word "grave" is pronounced to rhyme with the English word "halve")



10. ESSAY.

Prepare an essay on --

Either "A Defence of Domestic Young Gentlemen",

or "A Friend of the Town".

(Suggestions for the latter are: the doctor, the parson, the schoolmaster, the village storekeeper, the postmistress, the postman, the police sergeant, etc. Make your essay original, and above all of some interest to the reader.)

11. PHONETICS AND SPEECH TRAINING.

The Organs of Speech (continued).

The first point at which speech-modification of the breath takes place is in the larynx. The larynx contains a pair of lips called the vocal chords, which can, if desired, be brought very close together, without entirely closing them, so that they are set in vibration by the air-current and produce musical sound. This sound may vary in pitch according to the rapidity, and in loudness or intensity according to the extent or amplitude of the vibration. This musical modification of the breath is called in the language of Phonetics voice, and speech-sounds consisting of or accompanied by voice are known as voiced. Sounds not so accompanied are called breathed or voiceless.

Were this the only modification possible, human speech would be little more than the song of the bird, a series of musical sounds varying in pitch and intensity. Doubtless a workable form of speech might have been evolved from combination of these sounds, but Providence has seen fit to give us the divine power, not only of expressing ourselves musically, and of thus giving vent to our emotions, but also of uttering words with which we can communicate our best (and also our worst) thoughts to our fellow-men.

In nearly all parts of the mouth we have mobile organs, which can so modify the breath-stream as to give rise to an enormous variety of sounds. Thus the upper and lower lips, meeting together, may for a moment completely block the stream of air coming from the lungs. When the lips are separated the imprisoned air rushes forth with a kind of explosion, and we produce a sound represented in ordinary spelling by the letter p. There are other places at which the breath may be penned-up prior to a sudden release. The sound of the letter t in the word eat is produced by checking the breath with the tip of the tongue pressed (for the English pronunciation of this sound) against the ridge of the upper gums; in the sound represented in writing by k a stoppage of the breath is produced by the meeting of the back of the tongue and the soft palate.

But the making of a complete stoppage is by no means the only way in which we can convert breath into speech. We may do no more than narrow the passage in any given place so as to produce a rubbing of the breath in the narrowed passage, giving rise to audible friction. The blade of the tongue, placed against the teeth-ridge in such a manner as to leave a narrow passage for the breath, produces, according to its position and the degree of narrowing, the sounds of s in sum, sh in shade, of r in ring, or of l in leave.

Certain very flexible organs can be set in violent vibration by the current of breath. Such organs are the lips, the tip of the tongue and the uvula. The sounds formed by vibration of the tongue or of the uvula are amongst the varieties represented in most languages by the letter r. The one produced by the vibration of the tip of the tongue is that which is heard in Scotland, and the uvular variety is the r heard on the banks of the Tyne (known as the Northumbrian "burr"). Amongst the varieties produced by rapid lip vibration are the sounds made by a groom when curry-combing a horse, and the Danish equivalent to woa.

Study "Phonetics Practice Book" (Stewart).

- (a) The table of phonetic symbols, pages 3 - 5.
- (b) Pages 7 - 10.

12. READING.

Make your entries in your Literature Notebooks.

WORK TO BE SENT IN:-

SECTION A.

1. LAWSON AND GUDEX, pages 22-24.

- (a) Exercise on Emphasis, Nos. 1 - 5.
- (b) Loose and Periodic Sentences (A), Nos. 1 - 4.
- (c) Loose and Periodic Sentences (B), Nos. 7 - 11.

2. AN ENGLISH HERITAGE IV, pages 48 - 50.

Section ii, questions 1, 2, 7, 8, 9 and 10.

3. AN ENGLISH HERITAGE IV, page 53.

Questions 1, 3, 4, 5.

4. ANALYSIS.

1. LAWSON AND GUDEX, page 271.

Questions (a), (b) and (c).

2. Give the General Analysis of the following passage:-

'Tis a common proof  
That lowliness is young ambition's ladder  
Whereto the climber-upwards turns his face:  
But when he once attains the utmost round,  
He then unto the ladder turns his back,  
Looks in the clouds, scorning the base degrees  
By which he did ascend.

5. REVISIONAL EXERCISE.

1. Write sentences illustrating the correct use of the following pairs or words:- Credulous, credible; ingenious, ingenuous; irruption, eruption; practicable, practical; reverent, reverend; phenomenon, miracle; legible, eligible.

2. Read the following passages carefully, and describe the scenes which they suggest, quoting any words, phrases, or sentences which appeal to you. Do not paraphrase.

There was a sound of revelry by night,  
And Belgium's Capital had gathered then  
Her Beauty and her Chivalry; and bright  
The lamps shone o'er fair women and brave men;  
A thousand hearts beat happily, and when  
Music arose with its voluptuous swell,  
Soft eyes looked love to eyes which spake again,  
And all went merry as a marriage bell;  
But hush! hark! a deep sound strikes like a rising  
knell.

- Byron.

Questions on the above.

- (1) Of what poem is this a stanza?
- (2) That historical incident is referred to?
- (3) Write a short description of the scene suggested. Do not paraphrase.
- (4) From the above passage select and remark upon...

- (a) A simile.
- (b) an example of synecdoche.
- (c) An example of contrast.
- (d) An example of alliteration.

3. Give figurative expressions or well-known phrases equivalent to the following, adding brief notes in explanation of their full significance. (Example: Things that are damaged should be repaired at once. Figurative expression: "A stitch in time saves nine.")

- (a) A camel. (b) To take precautions when the danger is over. (c) To destroy all means of retiring from an undertaking. (d) Time passes slowly for the impatient. (e) It is a mistake to judge from appearances. (f) Injuries teach people to avoid danger. (g) To exaggerate very much. (h) To try to take both sides in a quarrel.

POETS AND POETRY.

1. Larks by Robert Bridges, questions (1) and (2).
2. Larks by Katherine Hinkson, questions (1), and (2).
3. A Green Cornfield by Christina Rossetti, questions (1) and (2).
4. The Knight's Return by Charles Kingsley, question (2).

10. ESSAY.

Transcribe your finished essay (See Work for Study).

11. PHONETICS AND SPEECH TRAINING.

1. Phonetics Practice Book, page 9 (a), (b), and revise the two verses.
2. Page 10, Words for Practice, and the two verses.
3. Study cards:

3. Study carefully the following words, and their phonetic interpretation.

me	mi	<u>NOTE:</u> The symbol (:)	shows
thee	ði:	that the preceding vowel is	
sea	si:	long. See Stewart, page 5.	
believe	bi:li:v		
key	ki:		
quay	kɪ:		
Phoenix	fɪ'nɪks		
people	pi:pəl		
receive	ri:si:v		
machine	məʃi:n		

NOTE: Be careful to distinguish the long sound of "i" as in "me" [mi:], "sea" [si:], from the short sound [ɪ], as in "in" [ɪn], "it" [ɪt]. The two symbols are quite distinct, as they represent different sounds.

4. Write in phonetic script the following words:- meet, mate, agree, grey, meal, mail, kneel, nail, hill, heal, sit, seen, sane, grit, green.

### SECTION B.

#### 6. REVISION EXERCISES.

1. Write in indirect speech:-

"My dear sir," said Mr. Gilfil with some effort, "you will not suppose that I am not alive to your goodness -- that I am not grateful for your fatherly interest in my happiness; but I fear that Caterina's feelings towards me are not such as to warrant the hope that she would accept a proposal of marriage from me."

"Have you ever asked her?" said Sir Christopher.

"No, sir. But we often know these things too well without asking."

2. Would you make use of the following expressions in a composition? If not, what would you substitute for them?

An unfrequented locality.  
 Extreme felicity.  
 She had seen twenty summers.  
 He met a lot of roughs.  
 He came down on me for this mistake.  
 He did the handsome thing.  
 At the expiration of ten years.  
 I reckon this won't do.  
 The performance was very nice.  
 Mother was wild with me.

3. Combine the following clauses into one complex sentence and then state the grammatical function and name of each clause:-
- (a) The indefatigableness of the country people is well known
  - (b) The country people may be seen in activity all the day all the year.
  - (c) The country people are never idle.
  - (d) They make a good distribution of their labours.
  - (e) Their zeal is praiseworthy in turning to use every circumstance.
  - (f) The circumstance presents itself.
  - (g) Their zeal is praiseworthy in seizing upon every novelty
  - (h) The novelty offers.
4. Give the figurative equivalents for the following expressions (e.g., He ran very fast -- He ran like a hare)
- (a) He worked very hard.
  - (b) He died bravely.
  - (c) He was very rich.
  - (d) He was very proud.
  - (e) He was trustworthy.
5. How would you distinguish a novel from an essay? Name three great novelists of last century, and give two of the chief works of each.

7. "THE TEMPEST".

Tell, in fuller detail than Lamb, either with Shakespeare text before you or from memory, the conversation of Prospero and Miranda in Act I, Scene 2, up to the point where Miranda sleeps. (Do not paraphrase Shakespeare's language, but give the complete sense in your own words).

9. LITERATURE TEST.

1. Say what you know of

- (a) The Field of Blood.
- (b) The Elysian Fields.
- (c) The Hesperian Fields.
- (d) The Field of the Cloth of Gold.
- (e) The Garden of Gethsemane.
- (f) The Hanging Gardens.
- (g) The Garden of Eden.
- (h) Naboth's Vineyard.

2. Mention a novel which is written about a

- (a) Gambler.
- (b) Weaver.
- (c) Convict.
- (d) Highwayman.
- (e) Highland freebooter.
- (f) Doctor.
- (g) Stonemason.
- (h) Bushranger.

NOTE: If you find the set too long, you may omit Sections 7 and 9.

This set of Model Answers is the property of the Education Department.

It is to be regarded as confidential, and is to be returned to the

Department when asked for.

FOURTH YEAR. NR. 35.

ENGLISH. Model Answers. Set 3. Secondary Department.

1. LAWSON AND GUDEX, pages 22-24.

Exercises.

2. AN ENGLISH HERITAGE IV, pages 48-50.

1. See Dictionary.

2.	<u>Noun</u>	<u>Adjective</u>	<u>Adverb</u>
	Breadth	broad	broadly
	miracle	miraculous	miraculously
	melody	melodious	melodiously
	energies	energetic	energetically
	splendour	splendid	splendidly
	impossibility	impossible	impossibly
	stupidity	stupid	stupidly
	universe	universal	universally
	gratitude	grateful	gratefully
	intellect	intellectual	intellectually

7. "To clear out": to decamp.

"Still gently chaffing us": still lightly bantering us;  
still treating us to light banter.

"he pushed ahead": he hurried on.

"our boy had been loading him up": our boy had been de-  
ceiving him.

"we slopped along": we toiled along<sup>a</sup>/muddy path.

"to try to claw up it": to try to climb its precipitous  
face.

"The crusty porter": the irritable porter.

"gawking up at us": gaping up at us.

8. The error lies in -- "it's us". The 'it' refers to 'spectacle', not 'sun', and strictly speaking 'us' should be 'we' in the nominative case. "It's us" may be defended on colloquial grounds. A suitable correction would be "Look here, the sun isn't the spectacle -- we are."

10. Living Languages                      Dead Languages

English	Latin
German	Greek (classical)
French	Anglo-Saxon
Greek (modern)	Hebrew
Spanish	Sanskrit
Italian	
Yiddish	
Chinese	
Māori, etc.	

3. AN ENGLISH HERITAGE IV, page 53.

1. NOTE ON THE "APOCRYPHA".

The Apocrypha proper are those books which are not recognized by Protestants or by the Church of England as of equal

authority with the Old and New Testaments. These are (a) 1 and 2 Esdras (called sometimes 3 and 4 Ezra). 1 Esdras is an ed. of canonical Ezra, and 2 Esdras a 1st cent. apocryphal book with really nothing to do with the other books called by the same name. (b) 1 and 2 Maccabees. 1 Maccabees contains a history of the Jews, 175-135 B.C., and was written in Hebrew about 100 B.C. and translated into Greek; 2 Maccabees an epitome of another work, deals with 176-161 B.C.; written before A.D. 70. (c) Tobit, a didactic narrative; date uncertain, not later than 1st cent. A.D. (d) Judith, a romance, probably of 1st cent. B.C. (e) The Additions to Daniel (Song of the Three Holy Children, History of Susannah, and Bel and the Dragon), probably about 1st cent. B.C. (f) The Additions to Esther, late Greek, found in Greek versions of that book. (g) The Wisdom of Solomon, written in Greek, 1st cent. B.C. (h) Ecclesiasticus, written in Hebrew (original partly preserved), 2nd cent. B.C. translated into Greek. (i) Baruch, composite, written in Greek, latter part 1st cent. A.D., and appended thereto, Epistle of Jeremy and Prayer of Manasse. These are all in the Vulgate of St. Jerome. (j) Some MSS. of the Septuagint also include 3 Maccabees, a pseudo-historical work written about the time of Christ, and 4 Maccabees, written before the destruction of Jerusalem. (A so-called 5 Maccabees is only a compilation.)

There is, besides, a considerable number of Jewish works, many of them apocalypses, some only recently discovered, which are of great importance for Jewish history of immediately pre-Christian times, such as the Book of Enoch, Psalms of Solomon, Assumption of Moses, Ascension of Isaiah, Testaments of the XII Patriarchs, Testament of Abraham, Apocalypse of Baruch, Sibylline Oracles, etc.

- 
3. The men of the Stone Age, who replaced an earlier and more primitive type of mankind, kindled the flame of civilization which has burned steadily and with increasing intensity ever since. They possessed an intelligence very like our own. They hunted and tamed wild animals. They learned the use of weapons of rough and unpolished stone, but the best weapons were as thin as steel blades, and almost as sharp. They learned to draw, in fact astonishingly well. They were by all standards savages, but they were artistic savages. They drew and painted on cliffs and on the walls of caves, on bones and on antlers; they carved little figures. They talked and sang.

Later they learned to sow crops. The discovery of agriculture was to transform the world. They practised a primitive religion; they sacrificed human life.

Thus in the primitive savages of the Stone Age we see the first urge of mankind towards the light. The progress of civilization has been a slow and protracted affair, with many set-backs and failures. But it has gone on, and will continue. That the Stone Age men lived true to the light as they knew it and made a humble beginning is the debt we owe to them.

- 
4. "Such as did bear rule" : Kings and emperors.  
"power.....prophecies" : Prophets, such as Samuel.  
"Leaders of the people.....instructions" : Statesmen, such as King Alfred.  
"Such as found out musical tunes" : Musicians, such as Wagner.  
"and recited verses in writing" : Poets, such as Milton and Tennyson.  
"Rich men.....habitations" : Wealthy philanthropists, such as Rockefeller and Carnegie.

- 
5. Further examples of the above.

4. ANALYSIS.

1. LAYSON AND GUDEX, page 271.

NOUN CLAUSES.

- (a) "that Tea is a liquid not proper for the lower classes of the people," Noun-clause, object of the verb 'admit'.
- (b) "How much more safe," Noun-clause, object of the verb 'tell'  
(If the comma and dash are removed, then the two clauses, beginning with 'where' and 'when' must be taken as Noun-clauses.)
- (c) (i) "Where to find", Noun-clause, object of 'tell'.  
(ii) "That he did not immediately know", Noun-clause, object of 'find'

2. GENERAL ANALYSIS.

- A. "'Tis a common proof", Principal clause.
  - a1. "that lowliness is young ambition's ladder", Noun-clause, subject of "is". (Temporary subject "it".)
  - a2. "Whereto the climber upwards turns his face," Adjective-clause, qualifying "ladder" in a1.
- B. "But he then unto the ladder turns his back", Principal clause, co-ordinate adversative with A.
  - b1. "When he once attains the utmost round," Adverb-clause of time, modifying "turns" in B.
  - b2. "Looks in the clouds, scorning the base degrees", Principal-clause, co-ordinate with B.
  - b3. "By which he did ascend", Adjective-clause, qualifying "degrees" in b2.

---

5. REVISIONAL EXERCISES.

- 1. Illustrative sentences. Use your Dictionary.
- 2. (1) The stanza is from "Childe Harold's Pilgrimage" by Lord Byron.  
(2) The Battle of Waterloo began on 18th June, 1815. The ball on the eve of the battle with its dramatic conclusion is probably an invention of the poet.  
(3) Description of scene.  
(4) Examples of Figures of Speech, as directed.
- 3. (a) The ship of the desert.  
(b) To lock the stable-door after the horse is stolen.  
(c) To burn one's bridges.  
(d) A watched kettle never boils.  
(e) All is not gold, that glitters.  
(f) A burnt child dreads the fire.  
(g) To draw the long bow.  
(h) To run with the hare, and hunt with the hounds.



8. POETS AND POETRY, Senior Book III.

1. Larks.

- (1) sad fields: The fields are contrasted with the joyous heavens.  
mournful mist: Mist over the earth gives an impression of sadness.  
heaven's best azure: The most beautiful blue known. The comparison is a strong one.
- (2) (a) The larks can be heard singing above the fog, but not seen.  
(b) The music of their songs falls upon the earth like gentle rain.

2. Larks.

- (1) The tiny cloud high in the heavens is golden with the glow of sunset. It is, therefore, very beautiful, just as the singing of the lark is beautiful.
- (2) The imagery is that of a flight of stairs, mounting into the heavens.

3. A Green Cornfield.

(1) The Skylark.

- (2) (a) A skylark was to be seen high above the cornfield.  
(b) Not so high, but dancing gaily, as if in harmony with the lark, were white butterflies.

(3) Examples of alliteration.

(4) Late spring or early summer. Give reasons.

4. The Knight's Return. Question (2)

9. LITERATURE TEST.

- (a) Aceldama, the plot of land purchased with the thirty pieces of silver which Judas had received of the High Priest for betraying Christ, and which he threw down in the temple when he found that Christ had been condemned to death. (Matthew xxvii, 5.)
- (b) The abode of the blest in ancient mythology to which those favoured by the gods passed without dying. Believed to lie in one of the Fortunate Islands (the Canaries). (Cf. Valhalla, in Scandinavian mythology.)
- (c) The orchards in which grew the golden apples given by Earth to Juno on her marriage with Jupiter. They were guarded by women called Hesperides.
- (d) A large plain in the north of France where Francis I met Henry VIII of England in 1520, both sides spending enormous sums in their appointments and equipments.
- (e) The scene of Christ's agony before His crucifixion. It was near the foot of Mount Olivet, about half a mile from Jerusalem.

-5-

- (f) At Babylon; one of the seven wonders of the world. They rose in terraces, supported by masonry arches to a height of seventy-five feet, and were irrigated by a reservoir at the top, to which water was raised from the Euphrates by a screw. Tradition ascribes their construction to Queen Semiramis.
- (g) The abode of Adam and Eve at the creation of the world. It was watered by four streams. (Genesis ii, 8 - 14).
- (h) A vineyard close to Ahab's palace in Samaria, and coveted by him. On Naboth's declining to part with it on the ground that it was an inheritance, Queen Jezebel suborned men to accuse Naboth of blasphemy, upon which he was stoned to death, and the property passed to the King. (1 Kings xxi, 1 - 16).
- (a) The Old Curiosity Shop -- Dickens.  
 (b) Silas Marner -- George Eliot.  
 (c) Great Expectations -- Dickens.  
 (d) Paul Clifford -- Lord Lytton.  
 (e) Rob Roy -- Scott.  
 (f) Dr. Jekyll and Mr. Hyde -- R. L. Stevenson.  
 (g) Old Mortality -- Scott.  
 (h) Robbery under Arms -- Boldrewood.

10. ESSAY.

Either (a) or (b).

11. PHONETICS.

4.	meet	mi:t	hill	hi:l
	mate	weɪt	heal	hi:l
	agree	əgri:	sit	sɪt
	grey	greɪ	seen	si:n
	meal	mi:l	sane	seɪn
	mail	meɪl	grit	grɪt
	kneel	ni:l	green	gri:n
	nail	neɪl	heigh	heɪ

OUR RACE AND EMPIRE.

Study Chapter 5. The main general developments traced in this chapter are;

1. The decline of Serfdom dealing especially with the effects of the Black Death and the peasants' Revolt.
2. The progress of Tudor Despotism and its contrast with Stuart Despotism.
3. The successive tyrannies of Charles 1 leading to the Civil War.
4. Events under the Commonwealth and the Protectorate and the reasons for the breakdown of the latter.
5. Development of events from beginning of the reign of Charles II leading to the English Revolution.

You should study the Chapter very carefully, bearing in mind these general divisions. This Chapter, dealing with Constitutional developments, is one of the most important in this course of study.

CONCISE HISTORY.

Study Chapter 7. This is a long Chapter but the necessity of covering the ground in the prescribed time makes it essential that we should study the whole of it in this assignment.

The Matriculation History Notes to be read in conjunction with the Chapter come from Page 52 to the middle of Page 66. In the main this section of the Notes is merely a convenient guide-post to important events. The Chapter is conveniently divided for purposes of study into four main sections and they should cause you little difficulty. Bear in mind two things: (1) Look up doubtful words in your dictionary. (2) Ask questions on any points you cannot understand.

The upheaval of Europe described in this Chapter is especially interesting because it is comparable in some respects to the upheaval that took place almost a century later. The results were also similar.

Of abiding importance because of their far-reaching effects upon the destinies of Europe were the decisions reached at the Congress of Vienna. These decisions and their results should be studied with the utmost care. The general results of the Revolution and the Napoleonic Wars, as summarised in the final section of the Chapter, are also of first importance. Study them very carefully. See Matriculation notes Page 66, and Somervell Pages 439-442.

Books recommended. "Vanity Fair" - Thackeray, "Shirley" - Charlotte Bronte, "Napoleon" - J.Holland Rose.

EXAMINATION TOPICS CONTINUED.

15. Compare the attitude adopted towards Parliament by Henry VIII and Elizabeth on the one hand, with that of James I and Charles I on the other. Select a few typical incidents and comment upon them in detail to illustrate the points you note. Why was Parliament more manageable under the Tudors than under the Stuarts?
16. Give an account of the causes, courses and results of the Peasants' Revolt of 1381.
17. What conditions led to the Barons rising against John? Give the principal provisions of the Great Charter. Did the barons act for themselves or on behalf of the whole nation.
18. What reasons led Edward I to summon the Commons to parliament? Show how the power of the Commons developed during the next two centuries.
18. Could the English Civil War of the Seventeenth Century have been avoided? Discuss this question.
20. Who were the villiengs? Explain the decay of the feudal System.

---

WRITTEN WORK FOR S.E.T. 7. A.

1. Topic 15.
2. Outline the career of Napoleon and express your opinion as to whether he affected Europe for good or ill.

## B.

1. Give an outline of the Peninsular War and indicate its importance in the struggle against Napoleon.
2. Describe the work of the Congress of Vienna.
3. Elizabethan England has been called the "Great Awakening". Discuss this.

UNIVERSITY ENTRANCE AND SCHOOL CERTIFICATE CANDIDATES. Chapt 7. SET 7.

I advise you to learn these Topics very carefully as "Our Race and Empire" does not deal with them. The Tudor period is one of immense importance socially, politically, and ecclesiastically and you should endeavour to read as much as you can about it as well as learn the extracts I am giving you.

BOOKS RECOMMENDED:- "England in Shakespeare's Day" - G.B. Harrison  
"Kenilworth" - Sir. W. Scott.

SOCIAL CHANGES DURING THE 16TH CENTURY.

( adapted from "Industrial History" - Meadows. )

The 16th Century was a period of transition in every department of natural life. A new spirit was expressing itself in the revival of learning, in greater literary activity, in a keener desire for progress and the accumulation of wealth, in religious reforms, and in a general breaking up of the old mediaeval system of things, and in this transition was involved an enormous change in the social conditions of the English Nation.

The selfish and short sighted policy of Henry VIII resulted in the impoverishment of large numbers of the poorer classes, the dissolution of the monasteries, the debasement of the coinage and the confiscation of the gild lands accompanied by a rise in prices all assisted in producing this result, and at the same time the nobility and land owning classes became much more wealthy, and merchants prospered exceedingly.

How This came about.

An important factor in effecting this change was the growing practice of landowners to use their lands for the production of wool. This movement had been proceeding for some time and during the reign of Henry VIII it reached its climax. Everyone thought that the "foot of the sheep would turn sand into gold," and the evil effects of the change were perfectly apparent. Only a few shepherds were needed on land which had formerly employed many labourers, and the resulting vagrancy and unemployment were a source of great concern to the king and his ministers. But their efforts in passing laws to prevent the ill effects of the extension of sheep farming were completely counterbalanced by the action of the king himself in suppressing the Monasteries and handing over a large part of their estates to greedy landlords who meant to derive the greater possible wealth from their land and who had no friendly feeling towards their tenants or labourers.

ENCLOSURES.

Disregarding the rights of the poor to the use of land which had been for centuries at the disposal of the common people, these profit-seekers enclosed the common lands and added them to their sheep farms.

This added greatly to the distress of the poor folk, Landowners too, raised the rents to their tenant-farmers making it almost impossible for them to exist on their farms at all. The smaller tenants who could not resist, were often ruthlessly turned out of their holdings and swelled the ranks of the unemployed.

Henry VIII was not moved by the distress brought about by his actions, but he was concerned with the danger which threatened his Kingdom by the weakening of his powers of defence owing to the depopulation of the country. He caused laws to be passed restricting sheep-farming but they were generally disobeyed.

#### DESPOTIC GOVERNMENT OF HENRY VIII.

The social upheaval of this period was the inevitable result of the despotic government of the King and the selfish ambitions of the new nobility. The greatest misery was of course, experienced during the actual course of the change; when the people had adapted themselves to the new conditions there was less distress, but pauperism became permanently established and provision had to be made for it by legislation.

During the reigns of Edward VI and Mary the condition of the people was extremely wretched. Vagrancy and crime increased, and the government could or would do nothing to amend matters. At length many of the unemployed began to express their feelings by riots and rebellions, e.g. Ket's rebellion in 1549. Nothing was gained, however, the poorer classes being compelled to accept their fate.

#### SOCIAL CHANGES IN THE LATTER HALF OF THE 16th CENTURY.

##### ENGLAND UNDER ELIZABETH.

Changes effected in English life during the latter half of the 16th Century were:-

- (1) People adapted themselves to the economic changes which peace brought about.
- (2) The landowners were rich, and merchants were prosperous.
- (3) Manufactures increased, and the labouring classes were slowly bettering their condition; but there was still much pauperism.
- (4) Little relief was offering for those unable to work.
- (5) Agriculture improved in many respects. Methods of cultivation were altered, high prices of wool declined and the value of corn rose. Arable farming was encouraged.
- (6) Trade increased. The importation of manufactured goods was discouraged, and monopolies were granted with the intention of fostering new industries; but these monopolies were liable to abuse by the Crown, and had to be given up.
- (7) Flemish Protestant refugees brought to England new manufactures which helped to increase Britain's trade and industries.
- (8) Elizabeth reformed the currency, or coinage. This reform was largely responsible for the progress in industry and manufacture.
- (9) A higher standard of comfort prevailed - houses of brick and stone with chimneys and glass windows were built.
- (10) Dress was finer and gayer - new luxuries were continually being introduced from abroad.

England was at this time a much richer and more prosperous nation than it had ever been before, except so far as the poorest class was concerned.

Elizabeth's reign has rightly been called the "Great Awakening". Some of the reasons for this are given above. Let us consider the matter a little further.

We regard Tudor times as pre-eminently the times of cheerfulness, the "good old times" of national memory or imagination. The wealthy flourished and the well-to-do middle class had greatly increased. Old festivals of Christmas, Easter, Whitsuntide, May-day, Michaelmas were kept up. There was high holiday and pleasuring in country towns and villages. With the May-pole began the season of dancing, the favourite dances being the old English country dances. Flowers played a part in many local ceremonies.

Though Elizabeth Loved pageantry and plays, her dignified court was uncomfortably stiff and dull. In the Christmas fortnight, however, all rules were set aside and all games permitted everywhere, Twelfth Night being the final great festivity, when cards might be played, even at Court.

MUSIC held a large place in recreation. The English were naturally fond of singing, piping and bellringing. The lovely songs of the Tudor poets were all meant to be sung and had their own tunes.

FOOD. Beef, mutton and veal were the food of the middle class, venison, hares and partridges were for the gentleman and were often sent as presents. Mediaeval cookery had seldom dealt with the huge joints which were in fashion in the 16th and 17th centuries. The great fireplaces and gigantic spits sometimes shown to us in old places belong to that age.

Elizabeth added satin, silk and brocade to the velvet used by Henry VIII. A cloak was a necessity in those open-air days, when there were as yet no umbrellas. Ladies' dress was of flowing style, stiff round skirts worn with stiff high bodies with ruffs.

The rich materials imported from abroad were used also to improve furniture. Bed hangings and stuffed seats now came into use, though Elizabeth retained the old-fashioned hard benches and stools at Court. Coaches were introduced, but the Queen as a rule rode.

Gardening became an art. The busiest statesman could find time to plan new gardens.

PLAYS. Townsfolk flocked to see plays. For the general public, plays were acted in the court-yard inns where a small stage could be erected. The famous Globe Theatre was built in 1576. Plays were performed by small companies which supported themselves by touring from town to town.

It is often forgotten that three or four generations of Tudor actors and play-writers had flourished and died before Shakespeare was born. The career of Shakespeare himself bears strong testimony to the vigour of intellectual life all over England in this Century.

---

This set of Model Answers is the property of the Education Department.

It is to be regarded as confidential, and is to be returned to the

Department when asked for.

FOURTH YEAR. NR. 32.

HISTORY. Model Answers. Set 4. Secondary Department.

2.

Warren Hastings, for some time Governor of Bengal, became first Governor-General under the new Regulating Act. He rendered two great services to British India, namely, his reforms in the administration and his defence of British interests against the Mahrattas and the French.

As Clive was founder of British sovereignty in Bengal, so the basis of the British administrative system was due to Hastings. He attacked the problem of organising the rural government of Bengal with great zeal and industry. Under his direction English officials were appointed to act as Collectors. They were given limited judicial powers and an attempt was made to organise native police. He simplified Customs duties and other Government charges and strove to repair the damage done by the Great Famine of 1770. The Company's Directors at home did not give him much encouragement while he met with continuous opposition from Philip Francis who was a member of the New Council that had been set up at Calcutta.

It was the aim of Hastings politically not to enlarge the territories of the Company but to safeguard them. The American War of Independence, however, since it involved England in war with France made matters very difficult for Hastings in India.

As soon as the news of the French Declaration of War reached Hastings in 1778 he threw the whole weight of the Bengal power in troops, treasure and credit into the struggle. The French settlements were promptly captured.

Then in 1780 Hyder Ali invaded the Carnatic and ravaged it up to within a few miles of Madras. The arrival of a French fleet was threatening. To take the instant and effective action that was necessary Hastings adopted harsh measures to recover mohies from the Rajah of Benares and from the Princesses of Oudh. With these resources, he was in a position to come to the aid of Madras. The defeat of the French at sea and the sudden death of Hyder ended a very serious crisis. Had it not been for the prompt and energetic action of Hastings at the critical moment, it is very probable that Britain would have lost her hold on India.

But far from Hasting's great work being appreciated in England, enemies had been busy in stirring up trouble against him. They were so successful that Hastings was recalled in 1786 and impeached at the instigation of Burke and Fox, the Whig leaders. The charges laid against him were:

1. Extortion of money from the Rajah of Benares and the Princesses of Oudh.
2. The lending of British troops for the extirpation of a tribe called the Rohillas, and
3. The perversion of justice in securing the execution of a Bengali named Nuncomar.



The trial dragged out for seven years and ended in Hastings acquittal. But the fact that he should have been tried at a instead of being richly rewarded for his splendid work in Br interests does not reflect credit on those concerned.

His trial did, however, result in good if not to Hastings yet to the principles of British administration. For the object of the impeachment, as claimed by those who initiated it, was to assert the principle that native peoples under British rule are entitled to the best government that British rulers can give them.

It was Edward I's ambition to unite Scotland with England. A splendid opportunity appeared in 1286 when the King of Scotland died and left his throne to his granddaughter, the Maid of Norway. Edward was successful in arranging for her betrothal to his son, the Prince of Wales.

On the death of the Maid of Norway, who was heir to the throne, Edward I was asked to decide which of the various claimants had the best right to the throne. The two chief claimants were Robert Bruce and John Balliol. Edward decided in favour of Balliol whom he compelled to do homage for his throne.

Shortly afterwards, however, Balliol quarreled with Edward and entered into an alliance with the King of France. In reply, Edward led an army into Scotland, defeated the Scots at the battle of Dunbar, and annexed the Kingdom. Balliol was deposed and in his place Edward set up an English Council to rule Scotland. English troops were stationed in Scotland to replace Scottish garrisons. As a mark of his triumph over the Scots Edward took back with him to England the ancient stone on which for hundreds of years past the Scottish Kings had been crowned.

To the Scotch, however, the English rule, though strong and efficient, was oppressive and distasteful. They longed to re-establish their own sovereign. They had not to wait long for a leader. In the following year a brave and fierce knight Sir William Wallace, put himself at the head of a Scottish force, drove the English out of Scotland, and plundered and laid waste the English border.

Edward lost no time in leading an army into Scotland to crush this second rebellion. The Scotch were decisively defeated at Falkirk. Some years after the Battle, Wallace was betrayed into Edward's hands and beheaded.

For ten years after this crushing reverse, the Scots remained quiet under English rule. But their enthusiasm for liberty was not dead and only needed a champion who arose in 1306 in the person of Sir Robert Bruce. This Bruce was a grandson of the Bruce who had been a claimant to the throne when the Maid of Norway died. Bruce placed himself at the head of a rebel army who crowned him King of Scotland.

Edward, now old and infirm, still remained resolute to subdue Scotland and at once set out with an army. His strength however, was not equal to the task. He died within sight of the Scottish border.

The only result of all Edward's strenuous efforts was that on his death England and Scotland, far from being united, were further apart than ever.

This set of Model Answers is the property of the Education Department.

It is to be regarded as confidential, and is to be returned to the Department when asked for.

FOURTH YEAR. SSP. 35.

History.

Model Answers. Set.7.

Secondary Department.

Introduction.

After the death of Pitt, Lord Castlereagh was placed in charge of the War Office. The British Army was reorganised and now consisted of 50,000 men provided with adequate supplies and sufficient reserves. In the same year Napoleon attacked Spain and attempted to conquer Portugal. In both countries he encountered unexpected difficulty in the shape of strong national pride.

Napoleon's plans.

He set to work to conquer both Spain and Portugal as he had crushed the rest of Europe. He had to face problems he had not met with elsewhere in Europe. The country was wild and mountainous, there were few roads, and no large supplies of food.

Napoleon thwarted.

Not perturbed, however, Napoleon sent 300,000 troops into the Peninsula. Britain countered this move by sending an army to the help of Portugal. As Britain controlled the sea the French were obliged to bring all their supplies over the Pyrenees. The British, however, had a secure base at Lisbon through which they could bring in unlimited supplies. The presence of the British army at Lisbon made it necessary for the French to leave an army of twice that number to watch it. This complicated the French task of subduing Spain. Moreover, they could not destroy the British army in Portugal because in that country it was the custom to devastate abandoned territory leaving it empty of supplies.

Napoleon's victory at Lisbon.

The campaign in 1809 led to the capture of Lisbon by the French, then subsequent defeat and a temporary peace. It was in this year that Sir Arthur afterwards Lord Wellesley held command in Portugal. He was recalled for allowing the French to escape and had to face a court-martial. Wellesley was soon back in Portugal but for a time Sir John Moore was made Commander-in-chief.

English victory by Sir John Moore.

As Napoleon was making preparations to invade Portugal, Sir John Moore determined to anticipate by attacking him in Spanish Territory. He was surrounded by three French armies but managed to retreat to Corunna where he severely defeated Soult but was himself killed. Napoleon was forced to abandon his plans for conquering the Peninsula.

In the same year Wellesley followed up his victory by clearing the French out of Portugal and invading Spain where he won a decisive victory against the French. The numerical weakness of his forces, however, compelled him to retire to Portugal.

French suffer hardship.

In 1810 occurred the decisive manoeuvres which centred round Torres Vedras. By means of a masterly retreat over country which he devastated during its course, Wellington drew the French after him compelling them to suffer great hardships while his own men lived in comfort from the plentiful supplies obtained at Torres Vedras. Thus, while accomplishing nothing, the French army lost in strength to the extent of 30,000 men.

French reverses.

In 1812 the Russian campaign drew a large number of French troops from Spain. Wellington followed up this weakness by several successes especially the notable victory at Salamanca which forced the French to abandon Southern Spain. A little later he was able to occupy Madrid.

Napoleon withdraws.

Napoleon's position in Europe became so desperate in the following year that he was forced to withdraw his best troops from Spain. After this, Wellington's progress through Spain was rapid. He won a decisive victory at Vittoria in June 1813 and chased the French over the Pyrenees into France.

Result of Peninsula War.

The Peninsula campaign was of paramount importance in the struggle against Napoleon because:-

- (1) It was a serious and constant drain on his military strength and greatly hampered the progress of his activity in Europe.
- (2) Further the superior morale and fighting powers of Wellington's troops and the greatness of his own ability and character as Commander-in-chief played a very important part in destroying the extraordinary prestige which Napoleon's numerous brilliant victories had gained both for himself and his armies.

The Napoleonic Wars came to an end with two groups of treaties signed by the Allied Powers and by France in 1814 and 1815. These treaties only concluded the war and settled the French frontiers. But Europe was so cut about by Napoleon that it was necessary to re-draw the frontiers of European States. This was the task of the Congress of Vienna. The statesmen assembled there had to try to make re-arrangement of Europe that would prevent another great war. At first the powers represented were not able to agree over the division of territory especially with regard to Prussia who was not satisfied with Westphalia which the powers offered to her but wanted in addition the Kingdom of Saxony. Austria considered that this would strengthen Prussia in eastern Germany. She was supported in this view by Britain while Russia supported Prussia.

Talleyrand, the diplomat representing the interests of France, seized on this dispute to win profit for France. He offered to Great Britain and Austria the support of France against the designs of Prussia and Russia in seeking to acquire territory which did not fightfully belong to them. The Saxon King was restored to his throne although Prussia did acquire part of his kingdom. France once again reached the status of a Great Power. At this stage Napoleon returned to Europe. Talleyrand's careful work was undone.

During the Hundred Days Campaign which ensued, the Congress continued to sit and devoted itself to the future of Germany. It was finally decided that the old Roman Empire of 360 states be reduced to a Federation of 39 States. Each state was to remain independent but members of the Federation were to send ambassadors to a Federal Diet which was to discuss affairs common to all Germany. Members of the Federation were not to make alliances with non-German states.

Most of the old States in Italy were restored while Austria gained an increase of territory. Belgium and Holland were joined together in the hope that they would form a solid state to protect the mouths of the Scheldt and the Rhine in North Europe.

Although many of the decisions reached at the Congress of Vienna were satisfactory, some of the territorial arrangements were not because they did not take into account the growing feeling of nationality in the countries concerned. As a result much strife was caused throughout the century in the settlement of territorial disputes. For instance in 1830 Belgium revolted against Holland and after a struggle of several years succeeded in gaining independence.

On the whole England had not gained much from the war; but she had kept her shores from invasion, and she had added to the British Empire three important captures:-

- (1) Ceylon
- (2) Malta } valuable to our navy  
in the Mediterranean.
- (3) Cape Colony, which we had conquered from the Dutch, and which proved to be the beginning of our African Empire.

But as a result of the war, Britain, like every country in Europe, was much poorer; and for more than a generation she was to pay for her victory by poverty among her people, and high prices which made the poverty worse still.

HOW TO IDENTIFY GRASSES.

"I love to come upon a plant which is unknown to me, to identify it with the help of my book, to greet it by name when next it shines beside my path," wrote Henry Rye-croft.

The following fortnight's work aims at enabling you to enjoy the same satisfaction in "greeting by name" the common pasture plants you encounter every day.

It does not require much observation to distinguish certain varieties such as the Ryegrass, on the seed-head of which children play "tinker, tailor..." or the bushy, coarse growth of Cocksfoot or, in Auckland province the flat, aggressive paspalum. On the other hand, it requires closer examination to separate others. But this becomes such a fascinating hobby after a little practice that you will never regret learning the names of the six or seven parts of a grass plant used in identifying it.

Grasses may be identified by seeds as these all have slight differences in size, colour, shape and markings. This, however, requires the use of a microscope, so it is left till your laboratory course. Grasses can also be readily distinguished by inflorescence or seed-head, but this is only obtainable during a few weeks of the year, and not at all under proper pasture management. Identification is therefore, usually carried out by leafage.

IDENTIFICATION BY LEAFAGE.

The characteristics to be examined in identifying a grass by leafage are the leaf-blade, the sheath, the ligule, the ears or auricles, the position of the young leaf in the bud, and also the stolons or rhizomes. The colouration of the leaf stalk at its base, and the presence or absence of hairs on the sheath or blade, are also important with some grasses.

Now obtain any grass plant in order to carry out an examination of its parts. The leaf blades will be found to branch off from the stem at various distances. If you examine the manner in which they are attached you will find that they appear to be supported on the main stalk by the leaf sheath which completely enfolds the stem. This sheath clasps round the stem for nearly the whole distance between the nodes (or "knots") in the stem. The shape of the sheath varies. Sometimes it is compressed with a sharp rib at the back, as in cocksfoot.

Several leaves are often folded together in the sheath.

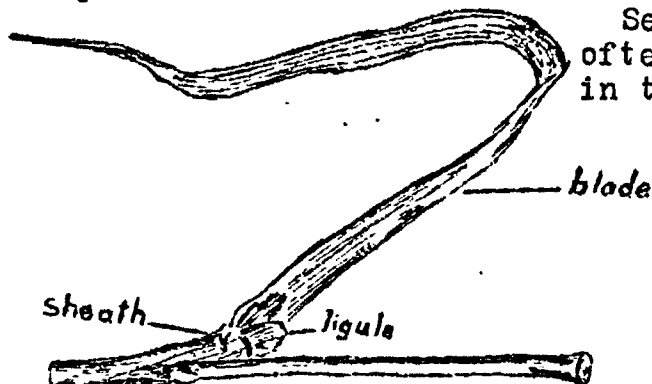

Just where the blade and the sheath join there is frequently found a semi-transparent flap of membrane clasping the stem just as the sheath does. This is the ligule, and it is an important feature as it is very constant in shape for each species. The ligule is practically absent in ryegrass, but quite large in paspalum and prairie grass. It may be short or long, blunt, pointed, square, or ragged. In danthonia grasses (natives of New Zealand) it has a purplish tinge.

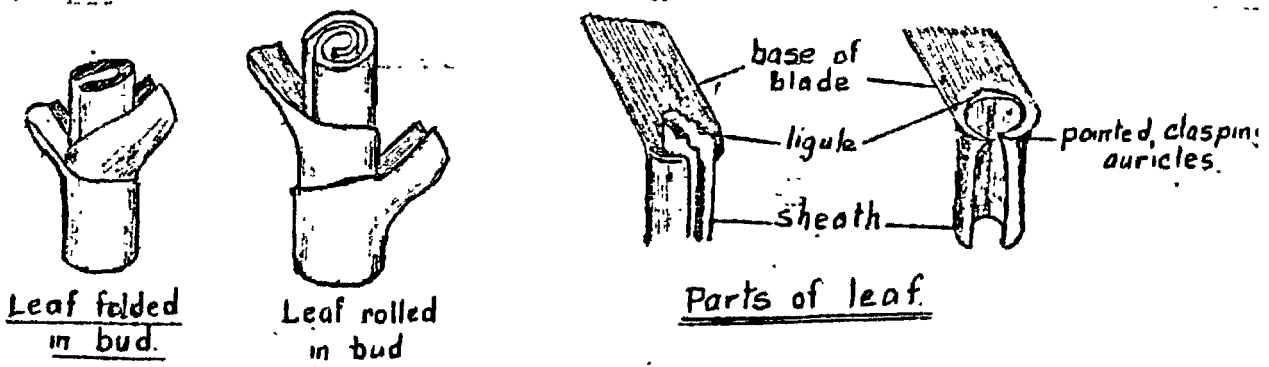

The leaf blade itself varies in shape. In paspalum it is flat and cigar-shaped. In poa, grasses the tip is canoe-shaped. In Chewing's fescue the blade is very long and thin like a pine needle.

The junction of the base of the leaf blade and the top of the sheath is occasionally drawn out on either side into a pair of points which tend to clasp the stems. These are the auricles. They are seen in the ryegrasses and sweet vernal but are absent in Yorkshire fog.

Species may be similar in every characteristic except that one has an underground creeping stem or rhizome. This is found in couch and twitches.

In creeping bent a surface creeping stem or stolon is found.

An additional important identification mark is the presence or absence of hairs. These may be present on the sheath alone or one or both surfaces of the blade.

Some leaves are rolled in the bud while some are folded, as shown in the diagram. This is a useful means of identification.

HOW TO MEMORISE THESE FEATURES.

There is only one way to memorise these facts, namely to select twenty or thirty common grass plants and identify all the parts on them. As a help to this, a "Key" is given below. To use the key it is necessary to dig up a complete plant, wash the roots, and examine all its leaves and stems for the parts referred to. For instance, if we take Perennial Rye: We read Section 1 of the Key - "1. Hairy on leaf ...etc.2". On examining our specimen we find it is hairless so we read the other alternative "Hairless....7." The number 7 here directs you to Section 7. The two alternatives are the presence or absence of rhizomes or stolons. "7.With distinct rhizomes or stolons..8." On examining our plant we find that it has neither. "No rhizomes or stolons...11." Thus we turn to Section 11. From there we get finally to Section 12 and identify it as Perennial Ryegrass.

KEY TO IDENTIFICATION OF GRASSES.

1. Hairy on leaf, or sheath, or both, or only round ligule -2  
Hairless - 7
2. Hairs at least as conspicuous on leaf as on sheath, or chiefly near ligule - 3  
Hairs long and numerous on sheath; much less conspicuous on blade - PRAIRIE GRASS.
3. Hairs long and silky round ligule, shorter or absent elsewhere - 4  
Hairs not chiefly round ligule - 7
4. Ligule very small if present at all - 5  
Ligule quite obvious, with hairs in front of or behind it - 6
5. Thick ring or tuft of hairs round mouth of blade. Blade rather narrow, sometimes hairy. No clasping ears - DANTHONIA.

- Thin ring of hairs; blade broad and light green; distinct though not large clasping ears - MICROLOENA.
6. Very large ligule; hairs long and silky behind it; strong rhizomes; often a few scattered silky hairs on edges of sheathing parts of leaves - PASPALUM.
- Moderate ligule; hairs round mouth of blade; often hairy elsewhere; no rhizomes; taste suggesting smell of hay - SWEET VERNAL.
7. With distinct rhizomes or sometimes stolons - 8  
No rhizomes or stolons 11
8. With clasping ears - LONG TWITCH.  
Without clasping ears - 9
9. Growing almost exclusively in slowly-running water; broad soft blade; compressed sheath - FLOATING SWEET GRASS.  
Growing on dry land 10.
10. Very fine bristle-like blade; rounded shoulder-like ears - CHEWINGS FESCUE.
11. Distinct red colour on underground part of sheath; colour brighter when dead sheaths stripped off. - 12  
No red colouration. - 14
12. Sheath distinctly compressed just below base of leaves - PERENNIAL RYE.  
Sheath just below base of leaves virtually round - 13
13. Upper surface edges of leaves when rubbed downward on lip distinctly cutting - MEADOW FESCUE.  
Leaf only rough, not cutting - ITALIAN RYE.
14. Underground part of sheath with faint but unmistakable colour, both on withered sheaths and on the fresh ones underneath. (Many specimens may need examination to show this.) - CRESTED DOGSTAIL.

This key deals with twelve plants only. We shall pay special attention to prairie grass, chewings fescue, perennial ryegrass, meadow fescue, italian ryegrass, and crested dogstail.

PERENNIAL RYEGRASS (*Lolium perenne*)

The blade and sheath of this grass are hairless. There are neither rhizomes nor stolons. It is a rather small grass, with a distinct red colour on the stem at the base of the sheath, just where it enters the ground. This colour brightens on removing the dead sheath. Just underneath the leaves the sheath is compressed into a distinctly oval shape. (Tested by gently rolling the sheath between the fingers.) The ligule is very short and cut off squarely. The auricles are small and clasping. The upper surface of the blade is distinctly ridged, while the lower side is shiny. A perennial.

For pastoral characters see "Agriculture" page 301.

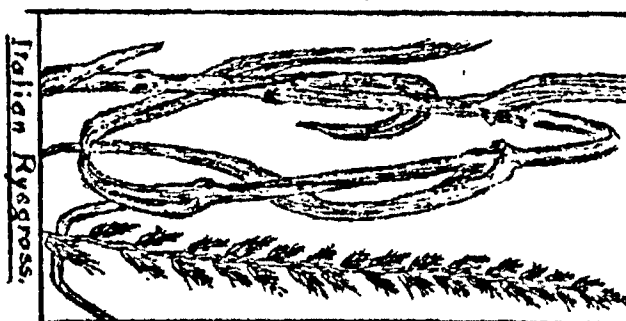
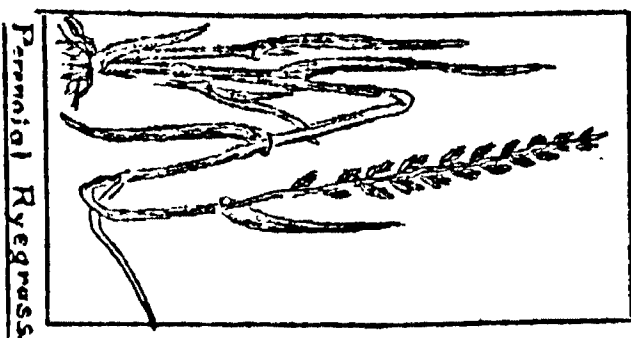

ITALIAN RYEGRASS. (*Lolium italicum*)

This is very similar grass to Perennial Rye, being the same in all characters except that it is an annual, is more strongly-growing, and the sheath, just under the blades is round instead of compressed. In the flowering stage a noticeable difference occurs in that the flowers of Italian Rye have the hair-like projections called awns, which are absent from Perennial.

(See Connell & Hadfield, page 303.)

MEADOW FESCUE. (*Festuca pratensis*)

This is a grass of robust growth with coarse, stiff, and rather pale green leaves. At the base of the sheath is a distinctly red colour. The sheath just below base of blades of leaf is round, but the ears are as in Ryegrass (i.e., Ears small and clasping; ligule very short and cut off squarely). The chief distinguishing character of this grass is the distinct roughness of the upper surface and edges of the blade when it is drawn from tip to base over the tongue or lip. The grass has no rhizomes or stolons and the leaves are rolled in the bud.

(See Connell and Hadfield, page 305.)

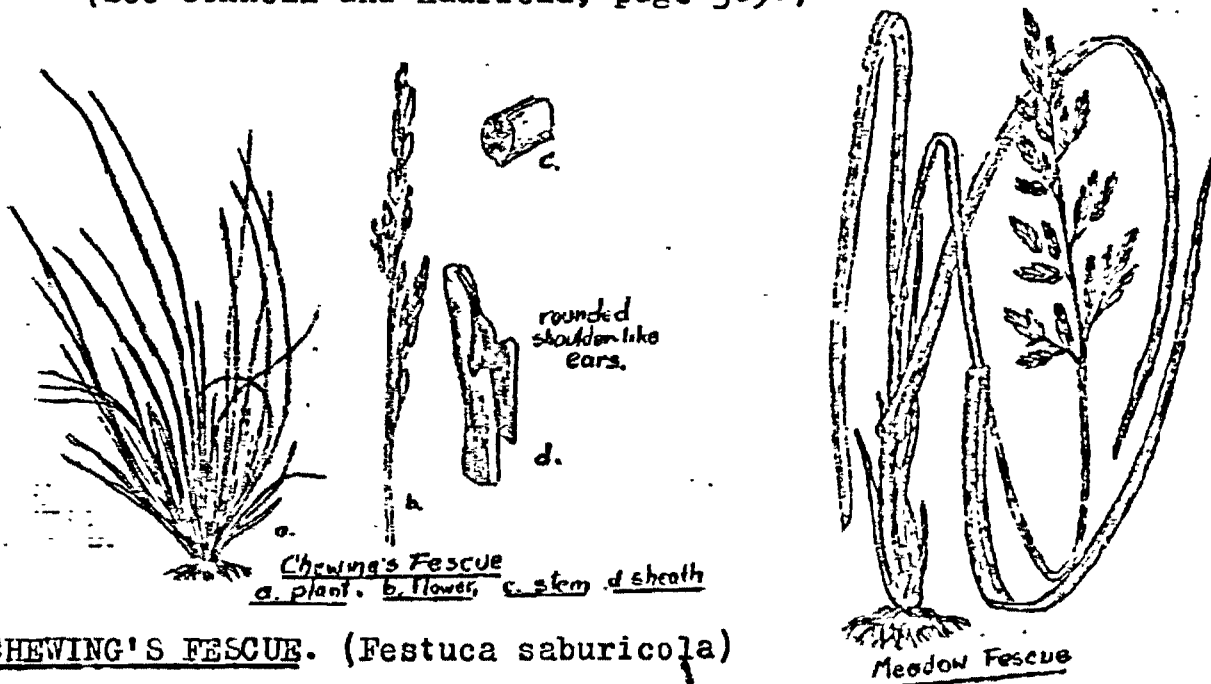

CHEWING'S FESCUE. (*Festuca saburicola*)

This is a New Zealand variety of Festuca, first being grown by a Mr. Chewing at Mossburn, Southland. It is a very tough and resistant but fine and smooth grass, used in the U.S.A. for golf courses and lawns.

The grass has a vigorous growth of stems, forming a very close mat which is difficult to cultivate into a tilth. The leaf-blades are hairless, the auricles are not clasping but of a characteristic rounded, shoulder-like shape. The leaf is narrow and so rounded that it has a hair-like appearance, being long, thin, and bristle-like. It is a very small low-growing grass, its stems being short, though its leaves sometimes exceed 6 inches in length.

PRAIRIE GRASS (*Bromus unioloides*)

This is a very strongly-growing grass with large broad light-green leaves, the blades of which are hairless. The leaves are rolled in the bud and not auricled. The sheath, however, is covered with velvety hairs, and is compressed into an oval shape. The flower head is fairly easily distinguished on the roadsides in early summer. The spikelets are very flat with sharp hard edges, are tightly pressed together, and without the hair-like projections or awns found in the sister plants Barren Brome and Goose Grass.

This plant is well treated in Connell and Hadfield page 311, which should now be studied. Note that the plant produces a great deal of feed in early spring, and even in winter, and is therefore useful at the time Paspalum is dormant.



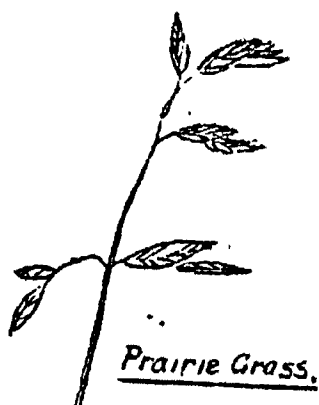

Prairie Grass.

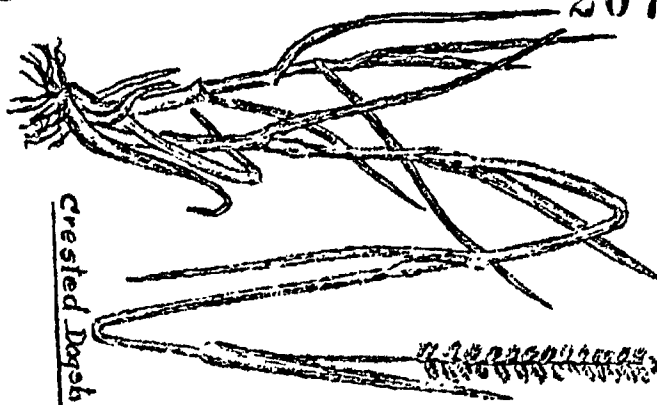

Crested Dogstail

CRESTED DOGSTAIL (Cynosurus cristatus)

This grass is hairless, there are no rhizomes or stolons, and on examination of the base of the sheath, the underground part is seen to have a faint yellow colour, both on the withered sheaths and on the fresh ones underneath (many specimens may need examination to see this.) The leaves are folded in the bud, have no auricles, and the blades are flat or widely V-shaped, several shooting off from the same spot on sheath, sometimes making a fan-like appearance. The stem is rounded.

The grass is very like ryegrass, the yellow colour at base of sheath where Rye is red, is the chief means of distinguishing it. See Connell & Hadfield, page 304.

PRACTICAL WORK FOR SET 4.

As explained above, this is to take the form of practical identification of grasses in the field, using the key supplied. Accounts of 12 of these operations should be placed in your practical book, setting out the steps. Six grasses should be drawn in your practical book or mounted in your plot book, or in an old drawing book (after erasing drawings). In mounting, select complete specimens while the seedhead is about flowering stage and, still quite green, wash soil from the roots, remove dead leaves or stalks and press between two sheets of newspaper putting a heavy weight on top. Leave for 2 or 3 days till quite dry. Mount specimens with strips of paper  $\frac{1}{10}$  inch wide, using gloy or flour paste. Plain varnish smeared over the specimen before mounting greatly improves its appearance. Label parts with strips of paper

WORK TO BE SENT IN.

- 1. PRACTICAL BOOK.
- 2. WRITTEN WORK.

- A.1. Give two means of distinguishing Italian and Perennial Ryegrass, illustrating with drawings.
- A.2. How would you distinguish in the leaf stage - Meadow Fescue and Chewing's Fescue; Perennial Rye and Crested Dogstail?
- A.3. Explain three of the characters you have found most useful and convenient in identifying grasses by leafage giving diagrams. Mention any difficulties you may have experienced in this work.
- B.1. Describe some common grasses having strikingly different growth-habits.
- B.2. Give an account of Chewing's Fescue. What are its chief merits? Name another grass with similar characteristics.
- B.3. What do you know about "strains" of Perennial Ryegrass?

NOTE: General Science will be omitted from this set to enable adequate practical work to be carried out.

ORGANISATION.

- PERIOD I. Page 1 and 2 of notes. PERIOD II. Outdoor work using key.
- PERIOD III. Outdoor work using key.
- PERIOD IV. Finish record of Practical Work.
- PERIOD V.)
- PERIOD VI.) Written work.

This set of Model Answers is the property of the Education Department.

It is to be regarded as confidential, and is to be returned to the Department when asked for.

SECOND YEAR

AGRICULTURE.

SET 1. VF.36.

A.1. (The flower of turnip or rape is the same in structure as the wallflower described in the assignment).

2. The essential parts of a flower are the androecium and gynoecium. They are the parts directly concerned in the process of reproduction or production of seed.

The stamens consist of filaments and anther lobes. The latter have pollen sacs containing pollen grains. When the wall bursts the pollen is set free.

The gynoecium consists of carpels each containing three parts. The ovary or seed case at the base contains undeveloped ovules, which develop into seeds. The stem joining the stigma to the ovary is known as the style.

The gynoecium, after a pollen grain has fallen on the ripe stigma, germinated, grown down to an ovule and fused with it, develops into the seed-case, and each ovule into a seed. It now grows strongly while the other essential parts wither and drop off.

B.1. The way in which the ovule is fertilized by the nucleus of the pollen grain is described in the notes.

Artificial fertilisation is the process by which pollen is artificially transferred by hand from ripe anthers to the ripe stigma of another plant. To prevent ordinary pollination by wind or insects it is necessary to cover the experimental flowers with muslin while they are opening and ripening.

Mention is made of the life and work of Luther Burbank in the notes.

2. The maize, plantain, toi-toi and pine have wind pollinated flowers. They are therefore characterised by long prominent stigmas and anthers, abundance of pollen and absence of prominent perianths. Plants such as the clover, bean and apple have insect pollinated flowers. In order to ensure that they are visited by insects the corolla is large and brightly coloured, and produces nectar. The clover and bean flowers have a special floral mechanism to ensure that pollen is scattered. The bee alights on the two wing petals, pressing them down on to the keel. This is pressed down and the stamens spring out, scattering their pollen over the underside of the bee.

#### GENERAL SCIENCE.

A. A unit is a standard used to measure objects. There are many different systems of units in use, but for scientific purposes, the international metric system is used. This is based on the metre which was calculated as one ten-millionth part of a quadrant of the earth's circumference passing through Paris and the Poles. The systems of units of area, volume and weight were calculated from the linear measurements. Thus the square centimetre is the area of a square of edge one centimetre. The unit of volume is the cubic centimetre, and the unit of weight, the gram, is the weight of a cubic centimetre of water at 4°C.

The advantages of the international system are that the divisions are tenths and the units are interdependent, and not merely arbitrary, as in the various local and national systems.

This Set of Model Answers is the property of the Education Department.

It is to be regarded as confidential, and is to be returned to the Department when asked for.

SECOND YEAR. BF. 35.

AGRICULTURE. MODEL ANSWERS. SET 4. Secondary Department.

A.1. Italian and Perennial Ryegrass may be distinguished by the fact that the former grows more vigorously than the latter. Perennial Rye, however, has the sheath compressed into an oval shape, while Italian has a round sheath. The flower head of

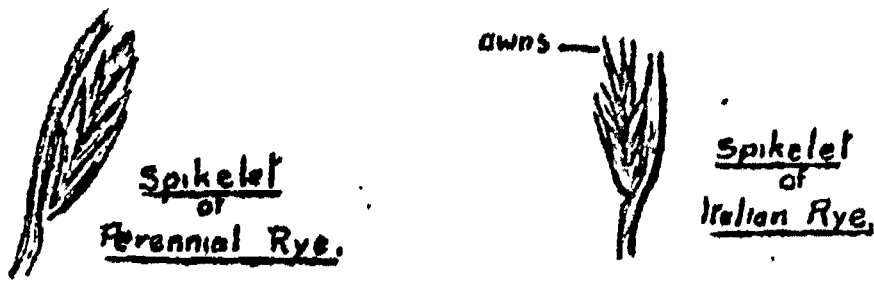

Italian has long awns on the outer glumes which are absent or else very minute on the Perennial Rye. *The leaf of Italian is rolled in the bud, while Perennial is folded.*

A.2. Meadow fescue is a grass of robust growth, with coarse, stiff, pale-green leaves. Chewing's Fescue is very small, low-growing, and narrow leaved. The leaves are rounded and appear somewhat like a pine "needle". When the leaf of meadow fescue is drawn across the lip it is found to have sharp cutting edges.

Crested Dogtail is distinguished by a yellow colour at the base of the leaf sheath while that of the Perennial Rye is reddish.

B.1. A patch of Chewing's Fescue (rarely more than 6 inches high) appears very conspicuous in a cattle pasture of cocksfoot which has been allowed to go to seed, when it reaches a height of about five feet.

Prairie Grass contrasts with Paspalum. The former grows well during the colder weather - even the Winter in some places - while Paspalum is generally dormant. In Summer, however, Paspalum grows vigorously.

B.3. New Zealand agriculturists have found great differences in the ryegrasses grown from seed produced in different parts of New Zealand. This is partly due to farming habits in the various provinces. For instance, in South Canterbury ryegrass is sown specially to be grown for seed, and the paddock is then ploughed up and used for turnips, wheat, etc. Thus South Canterbury seed produces good growth during the first year, but dies out thereafter. In Hawke's Bay, however, the practice is to keep old pastures for the production of ryegrass seed in alternate years. Some pastures thus used are forty or fifty years old, hence perennial plants have become established and good Hawke's Bay seed is truly perennial, and is one of the best types in the world. Though there are none of the usual botanical differences between strains of true and false perennial ryegrass, their seed can be separated with the use of an ultra-violet-ray apparatus.

FLOWER-HEADS OF GRASSES

SECOND YEAR, Set 4 Model Answers.

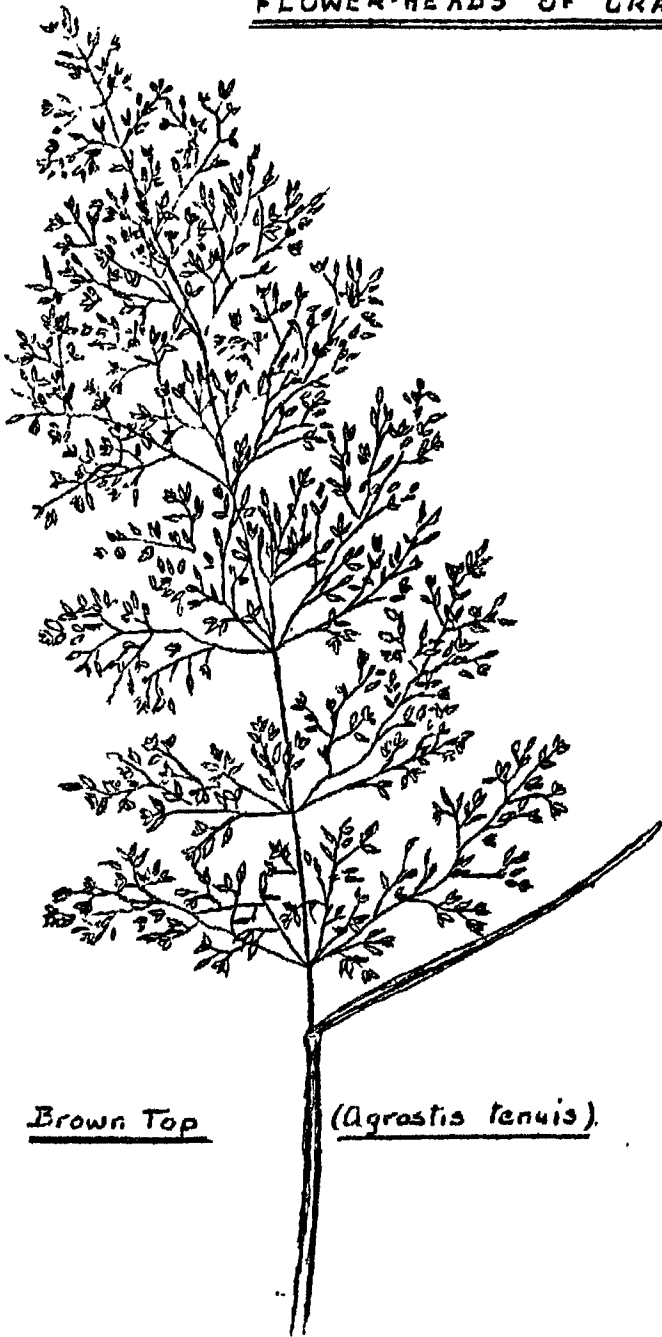

Brown Top

(Agrostis tenuis)



Meadow  
(Alopecurus

Foxtail  
pratensis.)



Crested Dogtail  
(Cynosurus cristatus)

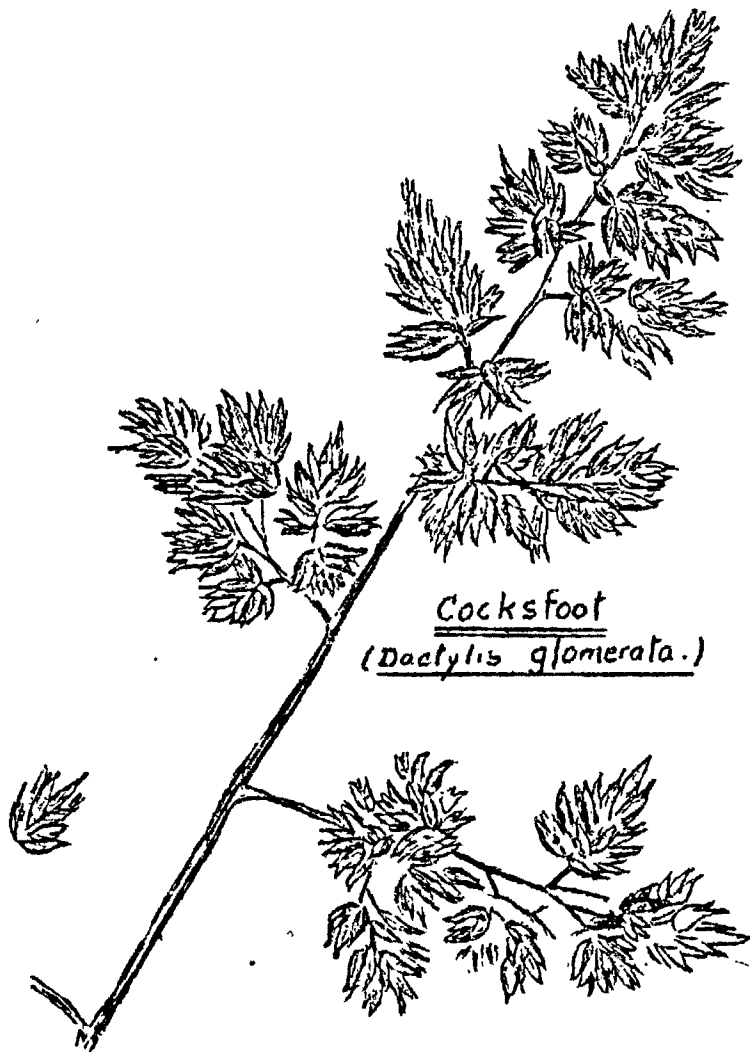

Cocksfoot  
(Dactylis glomerata.)

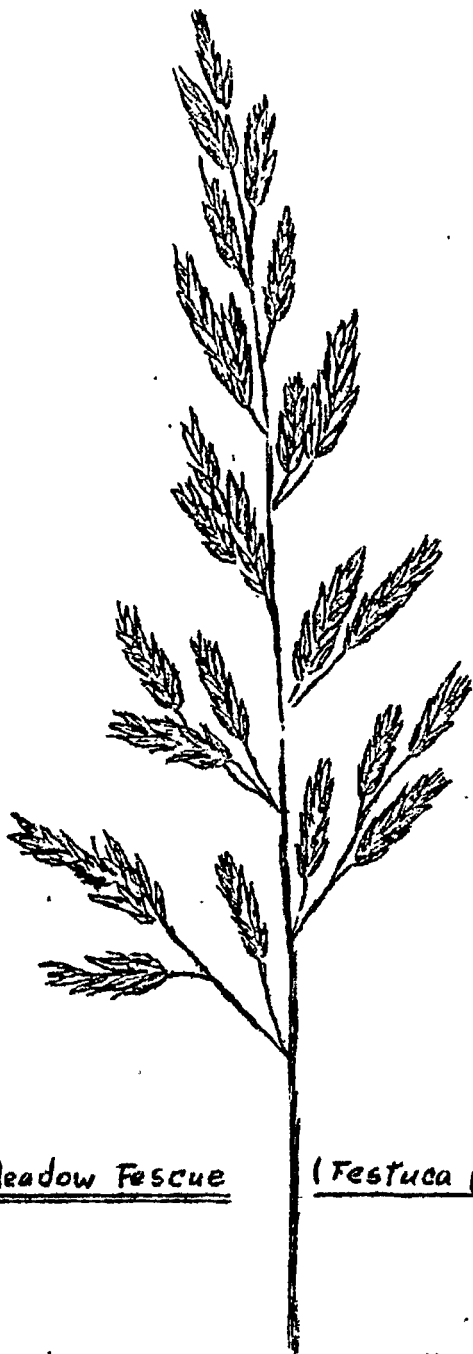

Meadow Fescue (Festuca pratensis.)



Perennial Ryegrass  
(Lolium perenne.)

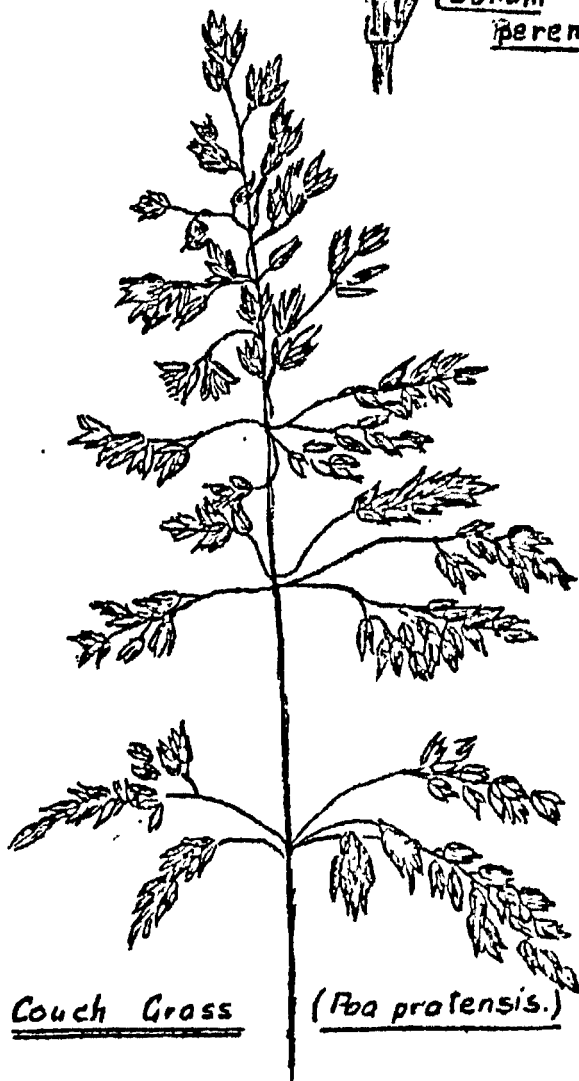

Couch Grass (Poa pratensis.)

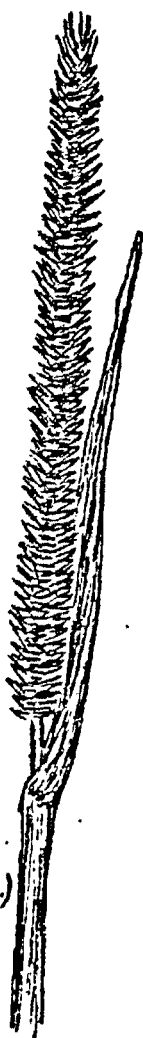

Timothy  
(Phleum pratense.)

SECOND YEAR.

GEOMETRY.

SET 3. NR. 35.

1st week  
Period 1.

Revise Theorem 16 (1) and (2), page 61.

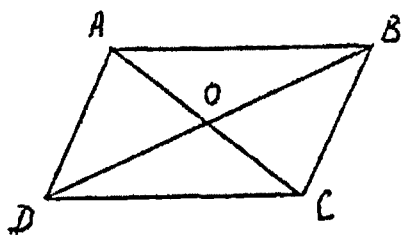

Now draw a parallelogram ABCD and let the diagonals cut at O.

From what you have learnt about parallelograms and parallel lines can you prove the  $\Delta$ 's AOB, DOC congruent? If so name the sides of the triangles that are equal. What can you say about the diagonals of a parallelogram?

Write down your proof and then compare it with the proof of Theorem 17, page 62. Note that instead of one of the pairs of alternate angles used in the book the pair of vertically opposite angles at O ( $\widehat{AOB} = \widehat{COD}$ ) will do. This still gives 2 angles and the corresponding side equal.

Learn the proof of Theorem 17.

Now if the lengths of the diagonals and one side of a parallelogram are given how would you construct the parallelogram?

If you consider the parallelogram ABCD above, and you were given that  $CD = 4$  cm.,  $AC = 6$  cm., and  $BD = 8$  cm. could you find the position of O, the point of intersection of the diagonals?

Having found O, how would you complete the parallelogram? Do the construction, and then study the following and see if your work is correct.

To construct a parallelogram, given one side and the two diagonals.

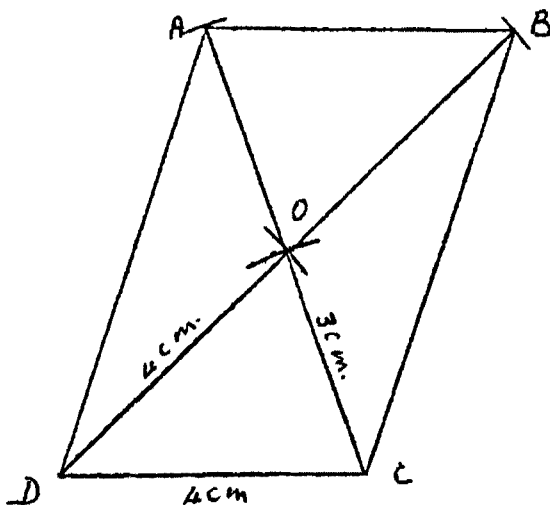

**CONSTRUCTION:** Draw a line CD 4 cm. long.  
Centre C and radius half the diagonal AC draw an arc.  
Centre D and radius half the diagonal BD cut the former arc at O.  
Join CO and DO.  
Produce CO to A making AO equal to CO.  
Produce DO to B making BO equal to DO.  
Join CB, BA, AD.  
ABCD is the required parallelogram.

Period 2.

Revise Theorem 17 and the construction of a parallelogram given one side and the two diagonals.

EXERCISE XXV, pages 80 and 81.

SECTION A: Do No's 2, 3, 4.

SECTION B: Do No's 5, 6, 8.

State your construction in No. 8.

N.B. All these examples except No. 2 are on page 81.

2nd week.  
Period 1.

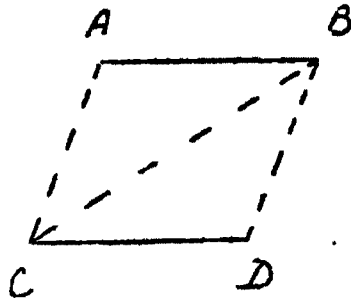

Consider the above figure in which AB and CD are two equal and parallel straight lines. By joining AC, BD, CB the 2  $\Delta$  ABC, DCB are formed. Can you prove them congruent? From this can you deduce that AC and BD are equal and parallel? Write out your attempt, and then compare it with the proof of Theorem 18, page 63. Note that a reason should be given for every statement in the proof. Learn Theorem 18 and note the second method of stating the theorem.

Revise definitions on page 65.

In Exercise XXII, page 65, No. 1, you are asked to prove that the sides of a rhombus are equal. The method of setting out a theoretical example of this kind is the same exactly as the setting out of a theorem. Always remember to put down first what is given and then what you are asked to prove. These should be written below the figure.

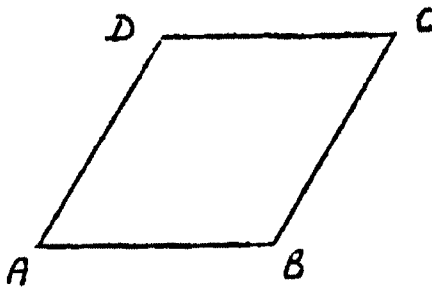

GIVEN: Rhombus ABCD with adjacent sides AB and AD equal.

PROVE:  $AB = BC = CD = DA$ .

PROOF:  $AB = AD$ . Given.

but  $AB = DC$  opposite sides of a parallelogram

and  $AD = BC$  " " " "

$\therefore AB = BC = CD = DA$ .

Q.E.D.

EXERCISE XXII, page 65.

SECTION A: Do No. 2.

SECTION B: Do No. 3.

In No. 3 remember that a rhombus is a parallelogram and the diagonals of a parallelogram bisect one another.

---

Period 2.

Without any further revision of theorems draw a parallelogram PQRS and prove that one diagonal bisects the parallelogram and the two diagonals bisect one another. Send in your work with Section B.

EXERCISE XXII, pages 65, 66.

SECTION A: Do No's 5, 6.

SECTION B: Do No. 7.

---



Period 2.

Revise Theorem 17 and the construction of a parallelogram : given one side and the two digonaals.

EXERCISE XXV, pages 80 and 81.

SECTION A: Do No's 2, 3, 4.

SECTION B: Do No's 5, 6, 8.

State your construction in No. 8.

N.B. All these examples except No. 2 are on page 81.

2nd week.  
Period 1.

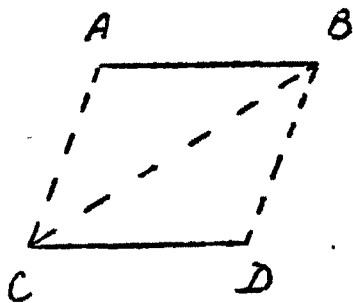

Consider the above figure in which AB and CD are two equal and parallel straight lines. By joining AC, BD, CB the 2  $\Delta$ 's ABC, DCB are formed. Can you prove them congruent? From this can you deduce that AC and BD are equal and parallel? Write out your attempt, and then compare it with the proof of Theorem 18, page 63. Note that a reason should be given for every statement in the proof. Learn Theorem 18 and note the second method of stating the theorem.

Revise definitions on page 65.

In Exercise XXII, page 65, No. 1, you are asked to prove that the sides of a rhombus are equal. The method of setting out a theoretical example of this kind is the same exactly as the setting out of a theorem. Always remember to put down first what is given and then what you are asked to prove. These should be written below the figure.

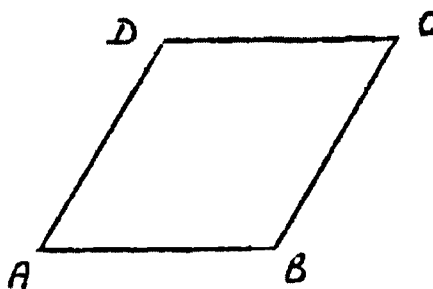

GIVEN: Rhombus ABCD with adjacent sides AB and AD equal.

PROVE:  $AB = BC = CD = DA$ .

PROOF:  $AB = AD$ .

Given.

but  $AB = DC$

opposite sides of a parellelogram.

and  $AD = BC$

" " " "

$\therefore AB = BC = CD = DA$ .

Q.E.D.

P.T.O.

EXERCISE XXII.

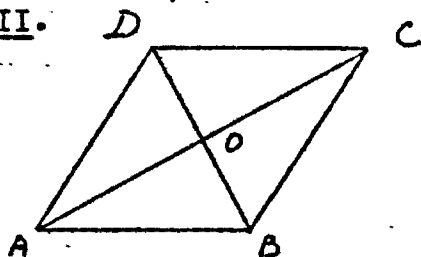

GIVEN: A rhombus ABCD, in which  $AB = AD$ .

PROVE: Diagonals AC and BD cut one another at right angles at O.

PROOF: A rhombus is a parallelogram;  
 $\therefore$  the diagonals AC, BD bisect one another at O.  
 In  $\Delta$ 's ABO, ADO,  
 $OB = OD$ ,  
 AO is common,  
 $AB = AD$ ; Given.  
 $\therefore \Delta$ 's ABO, ADO are congruent (3 sides).  
 $\therefore \angle AOB = \angle AOD$ .  
 These are adjacent angles,  
 $\therefore$  each is a right angle. Q.E.D.

7.

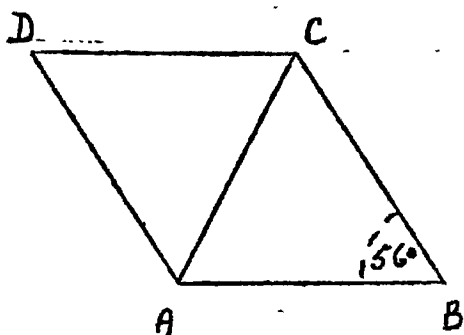

Since ABCD is a parallelogram,

$\therefore B = D = 56^\circ$ .

Since all the sides of a rhombus are equal,

$\Delta$  ACD is isosceles.

$$\begin{aligned} \therefore \angle ACD = \angle DAC &= \frac{1}{2}(180^\circ - 56^\circ) \\ &= \frac{1}{2} \times 124^\circ \\ &= 62^\circ. \end{aligned}$$

Theorems 16 (2) and 17, pages 61, 62.

FOURTH YEAR.

LATIN.

SET 9. NR. 33.

B1. QUIN.

LEARN: NORTH AND HILLARD, page 130, Rule 23, and the examples, especially the important phrases in the middle of the page.

Revise also the Sequence of Tenses, Rule 1, page 2.

Note carefully the use of "quin" only after negatives. Do not use "quin" after a verb of denying, but use the accusative and infinitive.

Remember that the phrase "haud multum abest" (or "afuit") is always impersonal in Latin, (i.e. the subject is it).

e.g. Haud multum abfuit quin interficerer.  
I was not far from being killed.

Note the difference between (1) non potest fieri ut and (2) Non potest fieri quin

e.g. (1) Non potest fieri ut ei credamus.  
It is impossible for us to believe him.

(2) Non fieri potest quin ei credamus.  
It is impossible for us not to believe him.

WRITTEN WORK: NORTH AND HILLARD, Ex. 168.

B2. QUOMINUS.

LEARN: NORTH AND HILLARD, page 132, Rule 24, and examples.

The exceptions to this rule ("prohibeo" and "veto") must be memorised as they are very frequently used. The Infinitive is the better construction to use with these verbs.

You will notice that "quominus" and "quin" are used after exactly the same classes of words, namely, those denoting hindering or preventing.

"Quominus" is not used with verbs of doubting.

The difference between "quominus" and "quin" is that "quin" is used only after a negative, "quominus" chiefly with a positive.

e.g. Nemo est quin intelligat.  
There is no one but perceives (or, all the world perceives).

Perte stetit quominus vinceremus.  
You were the cause of our not winning the day.

WRITTEN WORK: NORTH AND HILLARD, Exercise 170.

A3. REVISE: PRONOUNS AND ADVERBS.

Kennedy, pages 54-55, Par. 102. Learn across the columns.

WRITTEN WORK.

(1) Decline in plural (all genders), the relative pronoun 'qui' (who).

- (2) Decline in singular (all genders), quisque (each) and uterque (each of two).
- (3) Give Latin for -- At some time; -- how great? whence; how often? thither; of what kind? one of two; by some way; so many; how?
- (4) Explain rules of syntax in the following:-

- (a) Crastino die rediit in pugnam.
- (b) Ego et Cicero valemus.
- (c) Pater mihi et mater mortui sunt.
- (d) Rogavi quis esset.
- (e) Venit ut me videret.
- (f) Haec cum audivisset, abiit.
- (g) Quid opus est verbis?
- (h) Ingenio vacat.

A4. QUOMINUS AND QUIN.

WRITTEN WORK: NORTH AND HILLARD, Exercise 172 (1-6), Ex. 174.

B5. OVID. EASY SELECTIONS.

Prepare Selection VIII, "Arion and the Dolphin", lines 21-34.

A6. WRITTEN WORK: Write out a translation of Ovid, Selection VIII, lines 21-34.

B7. REVISE: DEFECTIVE AND IMPERSONAL VERBS.

Kennedy, pages 90-92.

CONSTRUCTIONS WITH IMPERSONAL VERBS.

Kennedy, pages 146-148.

IRREGULAR VERBS, page 102 (quiesco-gemo)

The important point to remember about the defective verbs coepi, memin, odi and novi, is that they are used with present meanings, though they have only perfect stem forms.

WRITTEN WORK:

- (1) Give Latin for -- he shall remember; you hated (plural); about to hate; we shall begin; I may hate; let them remember; do not begin; he might have known; remember (Imperative); they will know. (Use the defective verbs coepi, memin, odi and novi).
- (2) Translate:- (a) I ought to have set out. (b) I ought to set out; (c) I pity your folly. (d) You repeat of your faults. (e) We are ashamed to do this. (f) This is of great importance to me. (g) This is of little importance to Caesar.
- (3) Give (a) The 1st person plural perfect indicative.  
(b) The 3rd person singular imperfect subjunctive.  
(c) The 1st person singular future indicative.  
(d) The supine of -- suesco, arcesso, cupio, quaero, colo, sero, rapio, gemo. (Arrange in columns).

- A8. SIGHT TRANSLATION. Sight translation of both prose and verse is an important part of the Matriculation Examination and requires constant practice. The extracts which will be set from time to time should be done, as far as possible, without reference to text-books or dictionary.

ANDROCLUS AND THE LION.

In circo maximo venationis pugna populo dabatur. Multae ibi erant ferae. Sed praesertim leonum immanitas admirationi fuit, praeterque omnes ceteros unus terrifico fremitu, comisque fluctuantibus, animos oculosque omnium in sese converterat. Introductus erat inter complures alios ad pugnam bestiarum datus servus viri consularis. Ei servo Androclus nomen fuit. Hunc ille leo ubi vidit procul, repente stetit ac deinde sensim atque placide ad hominem accedit. Tum caudam more adulantium canum movet, cruraque et manus, hominis prope iam exanimati metu, lingua leniter demulcet. Homo Androclus inter illa tam atrocis ferae blandimenta amissum animum reciperat, paulatim oculos ad contuendum leonem revertit. Tum quasi mutua recognitio est facta.

VOCABULARY. venatio, -onis, f, hunting.  
immanitas, -atis, f, size.  
coma, ae, f, hair.  
sensim (adv.), gradually.  
adulor, ari, atus sum, to fawn.

- A9. CAESAR'S GALLIC WAR. BOOK V. Study: Chapters XX, XXI, notes, page 67.

WRITTEN WORK: Translate Chapter XX.

- B10. CAESAR'S GALLIC WAR. BOOK V.

WRITTEN WORK: Translate Chapter XXI.

SUPPLEMENTARY NOTES: (to be studied carefully). Now that you have done a number of Latin proses and are gaining some idea from the Model Answers of what constitutes a good prose, the following notes should help to fix clearly in your minds the essentials of Latin prose.

THE ORDER OF WORDS IN LATIN.

It may be assumed that you are all familiar with the elementary principles of Latin order: but even fairly advanced pupils may be reminded of the essential difference in this respect between Latin and English. As a matter of fact, the two languages very seldom correspond. The difference is accounted for by the inflexional character of Latin; the relations of words to each other in a sentence being (in the case of substantives, adjectives, pronouns, and verbs) marked as a rule by inflexion, not by position in the sentence. "A brother loves his sister" may be expressed by frater sororem amat, amat sororem frater, or sororem amat frater. Here the order in Latin is immaterial, except as a matter of emphasis: the right inflexion of each word is essential. But for all this the order of words in the Latin sentence is a very important consideration; and both the ordinary rules and the principal variations from them should be carefully noticed in reading Latin authors. What is the natural order of language? The natural arrangement of a sentence is that which places the different images which its elements represent in the exact order in which we wish them to be conveyed to the mind of the reader or hearer. It is the order of relative importance. If a Roman were walking through a forest, and wished to call his companion's attention to the necessity of caution, and then to explain this by indicating danger from a wild beast, he would say cave leonem; if he wished promptly to call his attention to the presence of a lion, and then to the need of caution, he would say instinctively leonem cave. In English we have not this freedom. We can say "beware of the lion!" but if we wish to use the word lion first, we must substitute an exclamation for the accusative case, and say, "a lion!" take care!" In English we, as a matter of course in ordinary languages, put the subject first; we say "I run", "he saw." But in Latin the unemphasised pronoun, so far as it is expressed at all,

follows the verb: curro is "run I," vidisti "sawest-thou." It does not follow that the English order is the more natural because it is that to which we Englishmen are accustomed.

In English we almost invariably place the object of a transitive verb after verb:

"In the beginning God created the heavens and the earth.

In Latin this is not the rule but the exception. In English the adjective precedes the noun to which it is attached "a good man," "an iron gate." In Latin the general rule is place it after: vir bonus, porta ferrea.

ORDER OF SIMPLE SENTENCES. I. The Subject.

The Subject, if separately expressed, comes as in English in its natural place, i.e. either first or early in the sentence: for it is natural that we should place early the thing or person of which we are about to speak.

But it often yields the first place to words, phrases, clauses, which mark the connection of the sentence with what goes before. Such are pronouns (especially the relative), adverbs, or adverbial expressions, of time and place, ablativ absolute, etc.

Thus -- his de rebus certior factus; quibus rebus cognovisti; eodem fere tempore; dum haec Romae geruntur; post tridie ejus diei; eadem nocte, and innumerable similar expressions, and words or phrases such as itaque, quomobrem, are constantly used as the opening words in a Latin sentence. They are much oftener found there than in English, as Latin seldom omits to express in words the connexion of thought between one sentence and another. (Enim, vero, autem, quoque, quidem -- with of course the enclitics, que, ve, ne, -- cannot be the first words of a clause.)

In English this connexion has more often to be supplied mentally. In any continuous passage of good English prose the sentences are generally detached from each other, as far as their form is concerned; but in Latin they are dovetailed so to speak, into each other by the constant employment of et, qui, quum, enim, itaque, neque, or other connecting words or phrases. Each English sentence will stand by itself apart from its context; but a similar treatment of the successive sentences in a Latin paragraph will give, to any one accustomed to good Latin prose style, the impression of a string of sentences from a "delectus" or exercise-book; the abruptness natural to the one language being uncongenial to the other.

Near the subject, and generally following it, are arranged the accessories of the subject, such as words in apposition with it, or relative or conjunctive clauses which nearly concern it:

"Caesar, qui nondum eorum consilia cognoverat ....."

In English we should probably say, "But though Caesar had not yet ascertained their intentions," and repeat he in the following and main clause. Latin gives greater prominence to the common subject of the subordinate main clause by placing it early.

## II. Predicate.

Here the Latin order differs greatly from English. We place the verbal part of the predicate early; its accessories, such as its nearer and remoter objects, adverbs, and adverbial phrases or clauses, after it.

In Latin this order is exactly reversed; the finite verb is as a rule placed last, all words and phrases which qualify it or depend upon it, such as those mentioned in the last clause, together with supines, gerunds, and dependent infinitives, come before, and lead up to, the final word, the verb, which gives the predicate its full force and meaning and winds up the sentence.

We see the difference in such short English and Latin sentences as

"In the beginning God created the heaven and the earth."  
"They have slain thy prophets with the sword."

The ordinary or grammatical order of such sentences in Latin would be

"Initio (or rerum in initio) Deus caelum et terras creavit."  
"Prophetas tuos ferro occiderunt."

In Latin, therefore, far more than in English, the last place in the sentence is looked on as a place of the utmost importance. The attention is kept suspended till the closing word is reached; and when the verb does not occupy its usual place, that place is sure to be assigned to some emphatic, never to an unimportant or merely accessory word or phrase.

Not only would such conclusions to a sentence as

"Avoid the habits which these men have passed their lives in:"  
"Envy is a vice that clever men are often guilty of,"

which are perhaps undesirable in English, be impossible in Latin, but it may also be said that we rarely see a Latin sentence from which the last word or words can be detached without destroying the grammar, at all events without destroying the life and force of the sentence.

Compare the Latin and English of one of the opening sentences of Caesar already referred to:

"Hi omnes lingua, institutis, moribus, inter se differunt."  
These all (or, as we should say, all of these) differ from each other in language, institutions, habits.

We have at one end the subject, hi omnes, at the other end the most important part of the predicate, the verb, with its most essential qualifying phrase inter se closely attached to it; between these, and in the less prominent part of the sentence, come the less important words of the sentence, viz., those ablative cases which point out the different points in which "all these differ from one another," but the main point of the statement comes last. If you withdraw differunt from the Latin, the sentence ceases to be a sentence; it has no predicate, and becomes meaningless. Remove the last four words from the English, and the sentence, though less clear and precise, retains a perfectly grammatical and intelligible form. It is still a sentence.

This is the most fundamental difference between the order of English and Latin.

One or two important exceptions may be noticed. The very importance of the last place in the sentence sometimes leads to the verb sum, especially in its monosyllabic forms, being banished from it. Latin writers preferred, on rhetorical grounds, to end their sentences with words of some length and force (three-, four-, and even five-syllabled words), rarely with monosyllables or unaccented words.

(a) Hence even when sum is used as a mere auxiliary, though it sometimes ends a sentence in combination with the participle:

"diu acriterque pugnatum est, hostem . . . conspicatus est,

yet it is often separated from the participle and placed between two other words quite out of what seems its natural order:

(qui in fortunae periculis sunt ac varietate versati.

It thus retires into the background and gives additional emphasis to the words which it separates.

(b) When used as a copulative verb it takes the same place as in English, leaving the really important part of the predicate to come last:

"Spes est expectatio boni." Hope is the expectation of good.

This is entirely in accordance with the general principle of Latin order.

(c) When however sum is used in its most emphatic or substantival sense (denoting existence) it is almost always placed, not last, but first in the sentence, thus challenging the attention to the importance of its meaning.

"Est coeleste numen." There is (or, there exists) a heavenly power.

"Sunt ista quae dicis." What you say is true.

But any verb will be made emphatic, i.e. have special attention called to it, by being placed first:

"Tulit hoc graviter Cicero." It need not be said that Cicero felt this deeply.

"Dicebat melius quam scripsit Hortensius." Hortensius was better as a speaker than as a writer.

In such cases the subject when removed from its natural place is generally granted the compensation of being placed last, as above. So

"Malum mihi videtur esse mors;"

(malum is here an emphasised predicate, esse a mere copulative).

The verb is also often placed first in a series of short sentences representing a series of events as rapidly following one another. Such instances are very common:

"Tandem dat Cotta per motus manus; superat sententia Sibi pronuntiatur prima luce ituros; consumitur vigiliis reliqua pars noctis."



This set of Model Answers is the property of the Education Department.

It is to be regarded as confidential, and is to be returned to the

Department when asked for it.

FOURTH YEAR. NR. 33.

LATIN. Model Answers. Set 6. Secondary Department.

1. EXERCISE 112, page 89.

1. Dic mihi, cur illud feceris.
2. Non certiores facti sumus quando novae copiae adventurae sint.
3. Dubium erat num ante noctem adventuri essent.
4. Nesciebamus quo amici nostri abiissent et ubi eos reperi-  
turi essemus.
5. Incertum est num rursus eum visuri simus.
6. Non certior factus sum utrum manere an discedere deberem.
7. Dic mihi unde veneris.
8. Nescio quomodo hoc facere debeam.
9. Audiistine quod dux inierit consilium.
10. Certior factus sum quam fortiter nostri pugnassent.

4. EXERCISE 124, page 96.

Faliscis mos erat liberos magistro committere ut cum eo habitarent. Gerentibus bellum Romanis cum Faliscis magister putabat si liberos obsides dederet (dedidisset) Romanis se placitum esse; itaque insciis civibus de industria illos ad castra Romana ductos duci obtulit; qui tamen rogabat quo consilio liberos qui sibi commissi essent hostibus tradere ausus esset et grave supplicium ei minabatur: deinde liberos jussit sumptis virgis qualibus ipse magister uti solebat ad urbem illum agere.

5. EXERCISE 129, page 101.

1. Me miseret tui doloris.
2. Meae patriae me pudet.
3. Judici placebat captivos interficere.
4. Dixit se mei miserere.
5. Credo te tui sceleris paenitere.
6. Respondit se taedere in urbe habitare.
7. Non cuivis contingit Corinthum adire.
8. Te oportet quid facias scire.
9. Te oportuit hoc tua sponte facere.
10. Liberos deget parentibus parere.
11. Ne talis facti te pudeat.

8. OVID. SELECTION VII.

THE RAVEN'S FALSEHOOD.

By chance Apollo was preparing the annual feast to Jupiter (my story will not make long digressions). "Go, my bird," he said (to the raven). "lest anything should delay the sacred ceremonies, and bring a little water from the running spring!" The raven bore a golden bowl in its claws, and winged on high its airy way. There was growing by the way a fig-tree covered with fruit which was still hard; he tried one (it) with his beak; it was not ready to be picked. Forgetful of his commission, he is said to have sat down beneath the tree, to wait until the figs should slowly become ripe. And then when sated, he seized with his black claws a long water-snake, returned to his master and told a false tale. "This inhabitant of the

running streams is the cause of my delay; this creature guarded the fountains, and delayed my task."

"You are adding falsehood to your fault", said Apollo, "and do you dare to try to deceive a prophetic god with false words?"

But while the juicy fig is hanging on the tree, you will henceforth drink the cool waters of no fountain."

9. CAESAR'S GALLIC WAR.

Chapter XI, lines 1-16.

Caesar returns to the coast .....

When Caesar learned these things, he ordered the legions and the cavalry to be recalled and to halt on their march; he himself returned to the ships. He saw with his own eyes the very things which he had learned from the messengers and the letter, namely that, about forty ships being lost, it seemed possible that the rest could be repaired with great trouble. Accordingly he selected artisans from the legions and ordered others to be summoned from the mainland. He wrote to Labienus that he should construct as many ships as he could, with those legions which were with him.

He himself, although it was laborious labour, still considered it to be most advisable that all the ships should be beached, and joined by one fortification with the camp. In these matters he spent about ten days, not relaxing the labour of the soldiers, even during the night time. When the ships were beached and the camp strongly fortified, he left the same forces as before as a guard for the ships; he himself set out to the same place whence he had returned.

SUBJUNCTIVES.

- viderentur: imperfect subjunctive in a final clause introduced by "ut".
- posset: imperfect subjunctive in a dependent question introduced by "quam".
- instituat: present subjunctive in a final clause introduced by "ut".
- venisset: pluperfect subjunctive because it is a past tense in a clause of time after "cum".

10. CAESAR'S GALLIC WAR. Description of the inhabitants of Britain.

The interior portion of Britain<sup>is</sup> inhabited by those who say that it has been handed down by tradition that they were born in the island itself; the sea-coast by those who, for the sake of plunder and making war, had crossed over from the Belgae (almost all of whom are called by the names of the states from which they came thither) and who, having waged war, remained there and commenced to cultivate the lands. The number of the inhabitants is countless, and their buildings very numerous, in general resembling those of the Gauls; the number of their cattle is great. They use as money either brass, or oblong pieces of iron, ascertained to be of a certain weight. Tin is produced there in the midland districts, iron on the sea-coast; but the supply is very small; they employ imported brass. There is timber of every kind, as in Gaul, except the beech and fir. They do not think it lawful to taste (the flesh of) the hare, the hen, and the goose; they breed them, however, for the sake of amusement and pleasure. The climate is more temperate than in Gaul, the cold being less severe.

This set of Model Answers is the property of the Education Department.

It is to be regarded as confidential, and is to be returned to the Department when asked for.

FOURTH YEAR.

LATIN.

SET 9. JMP 36.

1. EXERCISE 168. Page 131.

1. Non est dubium quin de industria hoc fecerit.
2. Negare non poteram quin nocens essem.
3. Nemo est quin saepe peccet.
4. Ne prohibueris quin proficiscantur.
5. Non possum facere quin ad te scribam.
6. Non dubitabamus quin a nobis illé staret.
7. Non fieri potest ut nocens effugiat.
8. Haud multum abfuit quin fame perirem.
9. Non dubitandum est quin fidem praestaturus sit.
10. Nemo in urbe erat quin aut filium aut fratrem in exercitu haberet.

2. EXERCISE 170. Page 132.

1. Per te stetit quominus exercitus deleretur.
2. Quis te impediabat quominus nobis subvenires?
3. Nive impediti sunt quominus Alpes transirent.
4. Te classem prohibere oportuit navem solvere.
5. Milites deterrere non poteramus quominus (or quin) in hostem impetum facerent.
6. Per nos stetit quominus domus incenderetur.
7. Prohibere eos debemus nos aggredi.
8. Milites non poterant prohiberi in flumen procurrere.
9. Per me credo stetisse quominus vinceremur.
10. Vix iis obstare poteram quominus (or quin) naves incenderent.
11. Recusaverunt quominus urbem relinquerent.

3. (1) See Kennedy, Page 51, Par. 97.

(2) Kennedy, page 51, par. 99. (Quisque is a compound of quis), also page 53, par. 101, foot of page).

(3) Aliquando; quantus unde; quotiens? eo; qualis? alter; aliqua; tot; quam?

- (4) (a) A point of time (time when) is put in the ablative.  
 (b) A composite subject takes a plural verb, in the 1st person plural if the subject contains the 1st person.  
 (c) If the subjects (of a composite subject) are persons of different genders, the adjectives or participles are plural masculine.  
 (d) Subjunctive of an indirect question.  
 (e) "Ut" with the subjunctive is here used to express purpose.  
 (f) With the imperfect and pluperfect tenses "cum" is habitually joined with the subjunctive.  
 (g) Ablative of respect; "What work is to be done in respect of words?" i.e. "What need of words?"  
 (h) Ablative of the thing from which separation takes place or exists.

4. EXERCISE 172 (1-8). Page 133.

1. Nemo est quin sociat hoc fieri oportere.
2. Prohibendi sunt hostes flumen transire.
3. Haud dubium est quin manere debuerint.
4. Loqui dubitabant: nec mihi dubium erat quin irati essent.
5. Haud multum abfuit quin urbs deleretur.
6. Nemo adest quin te mentiri sciat.
7. Per Themistoclem stetit quominus Athenienses Salamina relinquerent.

8. Nemo est quin me pro patria pugnasse sciat

EXERCISE 174. Page 134.

Nemo est quin audierit quam fortiter pontem quo hostes Romanorum se urbem intraturos sperarent Horatius Cocles defendit. Primum cum comitibus duobus, deinde solus omnem in se factum impetum sustinens hostes prohibebat transire: neque dubium est quin saluti reipublicae Romanae fuerit. Indentide aggressi hostes semper magna strage sunt repulsi. Tandem, quod haud multum abesset quin pons ab Romanis rescinderetur, civibus ut rediret exclamantibus, deum fluvii precatus in aquam se projecit. Verentur amici ne submergatur: sed praeter opinionem et suorum et hostium tutus in alteram ripam evadit.

6. OVID, SELECTION VIII.

ARION AND THE DOLPHIN.

Arion, unafraid, said "I do not seek to escape death, but may I be allowed to take up my lyre and play a few strains?". They gave him permission and laughed at the delay. He took a crown, which might become thy tresses, Apollo, and put on a cloak twice dipped in Tyrian purple. The lyre, struck by his thumb, gave forth its well known songs.

Then immediately he leapt, adorned as he was, into the midst of the waves, and the ship, driven on, is sprinkled with the dark blue water. Then --incredible as it may seem (lit. greater than belief)--they say that a dolphin carried him as a new burden on its curved back. Arion, sitting there, held his harp and played as a reward for the dolphin's carrying him and charmed the waters of the sea with his music. The gods approved the kind deed: Jupiter admitted the dolphin to the constellations, and ordered that he should have nine stars.

8. SIGHT TRANSLATION. ANDROCLES AND THE LION.

In the great circus a wild beast hunt was being enacted before the people. There were many animals there, but the size of the lions was particularly a matter of wonder, and one beyond all the others by its terrible roars and waving mane drew the gaze and attention of all the spectators upon it. Among several others the slave of a man who had been consul was brought in, having been given up to fight with the beasts. The name of the slave was Androcles. The lion, when he saw him from a distance suddenly stood still, and then quietly and slowly came up to the man. Then he wagged his tail like a fawning dog, and gently with his tongue licked the feet and legs of the man, who was by this time nearly dead with fear. The man Androcles during these attentions on the part of so terrible an animal recovered the presence of mind he had lost, and gradually turned his eyes to look at the lion. Then as it were a mutual recognition took place.

9. CAESAR'S GALLIC WAR. The submission of the Trinobantes.

Meanwhile the Trinobantes, nearly the most powerful state in those regions, from which the youthful Mandubracius, craving the protection of Caesar, had come to him on the mainland, whose father Imanuentius had held the sovereignty in that state, and had been put to death by Cassivellaunus, but had himself avoid death by flight, sent ambassadors to Caesar; and promised that they would give themselves up to him, and execute his commands. They begged that he would protect Mandubracius from the violence of Cassivellaunus and send him to their state to preside over and hold the chief authority. Caesar ordered from them 40 hostages, and corn for the army, and sent Mandubracius to them. They speedily executed his commands; they sent hostages according to the specified amount, and supplies of corn.

ASSIGNMENT.

223

This Assignment is the property of the Education Department.

It is to be regarded as confidential, and is to be returned to

the Department when asked for.

SECONDARY DIVISION. BF. 36.

FOURTH YEAR.

ALGEBRA.

SET 9.

Text-book: Baker and Bourne.

1st week.

Revise Set 15, 3rd year.

Period 1.

Work the following exercise:

EXERCISE I.

Write down the square of each of the following expressions:

1.  $2ab - 3.$

2.  $1 + 3xy.$

3.  $x - 2y + z.$

4.  $2p - q - r.$

5.  $x^2 - x - 1.$

6.  $2x^2 - x + 1.$

7.  $a - \frac{1}{2}b + \frac{c}{4}.$

8.  $\frac{x}{3} - 3y - \frac{3}{2}.$

SECTION A: Do the odd numbers.

SECTION B: Do the even numbers.

Study the following:-

$$(2x + y)^3 = (2x)^3 + 3(2x)^2y + 3(2x)y^2 + y^3 \\ = 8x^3 + 12x^2y + 6xy^2 + y^3.$$

These cubes are explained in Set 15, 3rd year.

Learn by heart  $(a + b)^3 = (a + b)(a + b)(a + b)$   
 $= a^3 + 3a^2b + 3ab^2 + b^3.$

$$(a - b)^3 = a^3 - 3a^2b + 3ab^2 - b^3.$$

Do not confuse these with  $a^3 - b^3$  and  $a^3 + b^3$ .

Remember  $a^3 + b^3 = (a + b)(a^2 - ab + b^2).$

and  $a^3 - b^3 = (a - b)(a^2 + ab + b^2).$

EXERCISE II.

Write down the cube of each of the following expressions:

1.  $m - n.$

2.  $a - 2b.$

3.  $2c + d.$

4.  $3x + 2y.$

5.  $4x - 1.$

6.  $2ab - 3.$

7.  $p^2 - 3q^2.$

8.  $3x^2 - 2d^3.$

9.  $a - \frac{b}{2}.$

10.  $\frac{c}{3} + 1.$

SECTION A: Do the odd numbers.

SECTION B: Do the even numbers.

Revise Set 16, 3rd year.

P.T.O.

EXERCISE III.

By the use of factors, find the product of:

1.  $2a + b + c, 2a + b - c.$       2.  $a - 3b + 1, a - 3b - 1.$
3.  $1 + a - a^2, 1 - a - a^2.$       4.  $a^2 + 2a + 3, a^2 - 2a - 3.$
5.  $x + y - c + d, x + y + c - d.$       6.  $x - y + a - b, x - y - a + b.$

SECTION A: Do the odd numbers.

SECTION B: Do the even numbers.

1st week.

Study page 2 of Set 16, 3rd year.

Period 2.

Work the following exercise, and put this exercise into SECTION B.

EXERCISE IV.

1. Prove that  $(7x^2 + 4x + 8)^2 - (x^2 - 9x + 13)^2$  is divisible by  $(3x - 1)(2x + 5)$ , and find the quotient.
2. Show that  $(2a + 3b - c)^3 + (3a + 7b + c)^3$  is divisible by  $5(a + 2b)$ .
3. Show that the product of  $2x^2 + x - 6$  and  $6x^2 - 5x + 1$  is divisible by  $3x^2 + 5x - 2$ .
4. Show that  $(x + 1)^2$  exactly divides  $(x^3 + x^2 + 4)^3 - (x^3 - 2x + 3)^3$ .

IDENTITIES.

Turn to page 92 of your text-book.  
Study paragraph 65, also Example 2 on page 93.

Study the following example:

Prove the identity

$$17(5x + 3a)^2 - 2(40x + 27a)(5x + 3a) = 25x^2 - 9a^2.$$

Simplify the left hand side.

$$17(5x + 3a)^2 - 2(40x + 27a)(5x + 3a)$$

Take out the common factor  $(5x + 3a)$ .

$$\begin{aligned}
 \text{The expression} &= (5x + 3a) \{ 17(5x + 3a) - 2(40x + 27a) \} \\
 &= (5x + 3a) \{ 85x + 51a - 80x - 54a \} \\
 &= (5x + 3a)(5x - 3a) \\
 &= 25x^2 - 9a^2 \\
 &= \text{the right hand side.}
 \end{aligned}$$

EXERCISE V.

Prove the following identities:-

1.  $ax(x^2 - a^2) + a^3(x + a) \equiv a(x^3 + a^3).$
2.  $(a + b)^3 - (a - b)^2(a + b) \equiv 4ab(a + b).$
3.  $c^4 - d^4 - (c - d)^3(c + d) \equiv 2cd(c^2 - d^2).$
4.  $(m - n)(m + n)^3 - m^4 + n^4 \equiv 2mn(m^2 - n^2).$
5.  $(x + y)^4 - 3xy(x + y)^2 \equiv (x + y)(x^3 + y^3).$
6.  $3ab(a - b)^2 + (a - b)^4 \equiv (a - b)(a^3 - b^3).$
7.  $b(x^3 + a^3) + ax(x^2 - a^2) + a^3(x + a) \equiv (a + b)(x + a)(x^2 - ax + a^2).$
8.  $(b - c)^3 + (c - a)^3 + (a - b)^3 \equiv 3(b - c)(c - a)(a - b).$

SECTION A: Do the odd numbers.SECTION B: Do the even numbers.2nd week.

Study the following examples:

Period 1.If  $x + y + z = 0$ , prove that  $x^3 + y^3 + z^3 = 3xyz$ .

$$\begin{aligned} x^3 + y^3 + z^3 - 3xyz &= (x + y + z)(x^2 + y^2 + z^2 - xy - xz - yz) \\ &= 0 \quad (\text{second factor}). \\ &= 0. \end{aligned}$$

$$\therefore x^3 + y^3 + z^3 = 3xyz.$$

If  $p = \frac{1}{2}(x + \frac{1}{x})$ ,  $q = \frac{1}{2}(x - \frac{1}{x})$ , find the value, in terms of  $x$ , of  $p^4 - q^4$ , and of  $p^4 - 2p^2q^2 + q^4$ .

In examples like these, make use of factors wherever possible.

$$\begin{aligned} p^4 - q^4 &= (p^2 + q^2)(p^2 - q^2) \\ &= (p^2 + q^2)(p + q)(p - q) \\ &= \left[ \left\{ \frac{1}{2} \left( x + \frac{1}{x} \right) \right\}^2 + \left\{ \frac{1}{2} \left( x - \frac{1}{x} \right) \right\}^2 \right] \left( \frac{x + \frac{1}{x}}{2} + \frac{x - \frac{1}{x}}{2} \right) \left( \frac{x + \frac{1}{x}}{2} - \frac{x - \frac{1}{x}}{2} \right) \\ &= \frac{1}{4} \left( x^2 + 2 + \frac{1}{x^2} + x^2 - 2 + \frac{1}{x^2} \right) \left( \frac{2x}{2} \right) \left( \frac{2}{2x} \right) \\ &= \frac{1}{4} \left( 2x^2 + \frac{2}{x^2} \right) \left( x \times \frac{1}{x} \right) \\ &= \frac{1}{2} \left( x^2 + \frac{1}{x^2} \right). \end{aligned}$$

$$\begin{aligned} p^4 - 2p^2q^2 + q^4 &= (p^2 - q^2)^2 \\ &= (p + q)^2(p - q)^2 \\ &= \left( \frac{x}{2} + \frac{1}{2x} + \frac{x}{2} - \frac{1}{2x} \right)^2 \left( \frac{x}{2} + \frac{1}{2x} - \frac{x}{2} + \frac{1}{2x} \right)^2 \\ &= \left( \frac{2x}{2} \right)^2 \left( \frac{2}{2x} \right)^2 \\ &= x^2 \times \frac{1}{x^2} \\ &= 1. \end{aligned}$$

EXERCISE VI.

1. Given  $(a + b + c) = 0$ , prove that  
 $(a^2 + b^2 + c^2)^2 = 2(a^4 + b^4 + c^4)$ .
2. If  $a = b + c$ , show that  $(a^2 + b^2 + c^2)(b - c) = 2b^3 - 2c^3$ .
3. If  $a^2 - bc = x$ ,  $b^2 - ca = y$ ,  $c^2 - ab = z$ , show that
 

(1)	$bx + cy + az = 0$ .
(II)	$cx + ay + bz = 0$ .
(III)	$ax + by + cz = (a + b + c)(x + y + z)$ .
4. If  $X = b + c - 2a$ ,  $Y = c + a - 2b$ ,  $Z = a + b - 2c$ ,  
 find the value of  $X^3 + Y^3 + Z^3 - 3XYZ$ .
5. If  $2s = a + b + c$ , show that  
 $(s - a)^2 + (s - b)^2 + (s - c)^2 + s^2 = a^2 + b^2 + c^2$ .
6. If  $a + b + c = s$ , prove that  
 $(s - 3a)^3 + (s - 3b)^3 + (s - 3c)^3 - 3(s - 3a)(s - 3b)(s - 3c) = 0$ .
7. If  $a + b + c = 0$ , prove that

$$\frac{1}{b^2 + c^2 - a^2} + \frac{1}{c^2 + a^2 - b^2} + \frac{1}{a^2 + b^2 - c^2} = 0.$$

SECTION A: Do the odd numbers.

SECTION B: Do the even numbers.

2nd week. EXAMPLES XXVI, page 220. (SECTION B)

Period 2. Work numbers 20 and 23.



MODEL ANSWERS.

This Set of Model Answers is the property of the Education Department.

It is to be regarded as confidential, and is to be returned to the

Department when asked for.

SECONDARY DIVISION.

BF. 36.

FOURTH YEAR.

ALGEBRA.

SET 6.

EXERCISE I.

1.  $x^4 + x^2y^2 + y^4$   
 $= x^4 + 2x^2y^2 + y^4 - x^2y^2$   
 $= (x^2 + y^2)^2 - (xy)^2$   
 $= (x^2 + xy + y^2)(x^2 - xy + y^2)$
3.  $a^4 + 4a^2b^2 + 16b^4$   
 $= a^4 + 8a^2b^2 + 16b^4 - 4a^2b^2$   
 $= (a^2 + 4b^2)^2 - (2ab)^2$   
 $= (a^2 - 2ab + 4b^2)(a^2 + 2ab + 4b^2)$
5.  $x^8 + x^4 + 1$   
 $= x^8 + 2x^4 + 1 - x^4$   
 $= (x^4 + 1)^2 - (x^2)^2$   
 $= (x^4 + x^2 + 1)(x^4 - x^2 + 1)$   
 $= (x^4 + 2x^2 + 1 - x^2)(x^4 - x^2 + 1)$   
 $= \left\{ (x^2 + 1)^2 - (x)^2 \right\} (x^4 - x^2 + 1)$   
 $= (x^2 + x + 1)(x^2 - x + 1)(x^4 - x^2 + 1)$
7.  $x^3 + y^3 + z^3 - 3xyz$   
 $= (x+y+z)(x^2+y^2+z^2-xy-yz-zx)$
9.  $a^3 - 1 - c^3 - 3ac$   
 $= (a)^3 + (-1)^3 + (-c)^3 - 3(a)(-1)(-c)$   
 $= (a-1-c)(a^2+1+c^2+a-ca+ac)$
11.  $8x^3 + 27y^3 + z^3 - 18xyz$   
 $= (2x)^3 + (3y)^3 + (z)^3 - 3 \times (2x \times 3y \times z)$   
 $= (2x + 3y + z)(4x^2 + 9y^2 + z^2 - 6xy - 2xz - 3yz)$

EXERCISE II.

1.  $x^3 - 3a^2x + 2a^3$   
 Try  $x = a$   
 The expression  $= a^3 - 3a^2a + 2a^3 = 0$ .  
 $\therefore (x-a)$  is a factor.
- $$\begin{array}{r} x^2 + ax - 2a^2 \\ x-a \overline{) x^3 - 3a^2x + 2a^3} \\ \underline{x^3 - ax^2} \phantom{+ 2a^3} \\ ax^2 - 3a^2x \phantom{+ 2a^3} \\ \underline{ax^2 - a^2x} \phantom{+ 2a^3} \\ -2a^2x + 2a^3 \\ \underline{-2a^2x + 2a^3} \\ 0 \end{array}$$
- $\therefore x^3 - 3a^2x + 2a^3$   
 $= (x-a)(x^2 + ax - 2a^2)$   
 $= (x-a)(x-a)(x+2a)$   
 $= (x-a)^2(x+2a)$
3.  $2x^3 - 9x^2 + 4x + 15$   
 Try  $x = -1$ .  
 The expression  $= -2 - 9 - 4 + 15 = 0$   
 $\therefore (x+1)$  is a factor.
- $$\begin{array}{r} 2x^2 - 11x + 15 \\ x+1 \overline{) 2x^3 - 9x^2 + 4x + 15} \\ \underline{2x^3 + 2x^2} \phantom{+ 4x + 15} \\ -11x^2 + 4x \phantom{+ 15} \\ \underline{-11x^2 - 11x} \phantom{+ 15} \\ 15x + 15 \\ \underline{15x + 15} \\ 0 \end{array}$$
- $\therefore 2x^3 - 9x^2 + 4x + 15$   
 $= (x+1)(2x^2 - 11x + 15)$   
 $= (x+1)(2x-5)(x-3)$

5.  $5x^4 - 4x^3 - 6x^2 + 4x + 1$   
 Try  $x = 1$ ;  
 The expression  
 $= 5 - 4 - 6 + 4 + 1 = 0$   
 $\therefore (x - 1)$  is a factor.

Try  $x = -1$ .  
 The expression  
 $= 5 + 4 - 6 - 4 + 1 = 0$   
 $\therefore (x + 1)$  is a factor.  
 $\therefore (x-1)(x+1)$  are factors.  
 $\therefore x^2 - 1$  is a factor.

$$\begin{array}{r} 5x^2 - 4x - 1 \\ x^2 - 1 \overline{) 5x^4 - 4x^3 - 6x^2 + 4x + 1} \\ \underline{5x^4} \phantom{- 6x^2} + 4x + 1 \\ -4x^3 - x^2 + 4x + 1 \\ \underline{-4x^3} \phantom{+ 4x} + 1 \\ -x^2 + 1 \\ \underline{-x^2} \phantom{+ 1} \\ \phantom{-} + 1 \end{array}$$

$\therefore 5x^4 - 4x^3 - 6x^2 + 4x + 1$   
 $= (x+1)(x-1)(5x^2 - 4x - 1)$   
 $= (x+1)(x-1)(5x + 1)(x - 1)$   
 $= (x-1)^2(x+1)(5x + 1)$

EX. XXXIa, page 249.

3.  $\frac{a-b}{x-c} = \frac{a+b}{x+c}$   
 Multiply by  $(x-c)(x+c)$   
 $(a-b)(x+c) = (a+b)(x-c)$   
 $ax - bx - bc + ac = ax + bx - bc - ac$   
 $ax - ax - bx - bx = bc - ac - bc - ac$   
 $-2bx = -2ac$   
 $x = \frac{ac}{b}$

7.  $x - \frac{ax}{a+b} + a = \frac{a^2}{a-b} - \frac{b^2x}{a^2 - b^2}$

Multiply by  $a^2 - b^2$ .

$$\begin{aligned} x(a^2 - b^2) - ax(a-b) + a(a^2 - b^2) &= a^2(a+b) - b^2x \\ x(a^2 - b^2 - a^2 + ab) + a(a^2 - b^2) &= a(a^2 + ab) - b^2x \\ x(a^2 - b^2 - a^2 + ab + b^2) &= a(a^2 + ab - a^2 + b^2) \\ &= ab(a+b) \\ &= \frac{ab(a+b)}{ab} \\ &= a+b \end{aligned}$$

EX. XXXIc, page 252.

1.  $x^2 - 2ax = 15a^2$   
 $x^2 - 2ax - 15a^2 = 0$   
 $(x - 5a)(x + 3a) = 0$   
 $\therefore x = 5a$  or  $-3a$ .

7.  $x^3 - 4x^2 + 4x - 3$   
 Try  $x = 3$ .  
 The expression  
 $= 27 - 36 + 12 - 3 = 0$   
 $\therefore (x - 3)$  is a factor.

$$\begin{array}{r} x^2 - x + 1 \\ x-3 \overline{) x^3 - 4x^2 + 4x - 3} \\ \underline{x^3 - 3x^2} \phantom{+ 4x} - 3 \\ -x^2 + 4x - 3 \\ \underline{-x^2 + 3x} \phantom{- 3} x - 3 \\ \underline{x - 3} \phantom{- 3} \phantom{- 3} \end{array}$$

$\therefore x^3 - 4x^2 + 4x - 3$   
 $= (x - 3)(x^2 - x + 1)$

5.  $\frac{acx}{b} + \frac{abx}{c} - \frac{1}{abc} = \frac{1}{abc} (1 - b^2c^2x)$

Multiply by  $abc$ .

$$a^2c^2x + a^2b^2x - 1 = 1 - b^2c^2x$$

$$a^2c^2x + a^2b^2x + b^2c^2x = 1 + 1$$

$\therefore x(a^2c^2 + a^2b^2 + b^2c^2) = 2$

$$x = \frac{2}{a^2c^2 + a^2b^2 + b^2c^2}$$

-3-

$$3. \quad bx\left(a - \frac{1}{x}\right) - c\left(a - \frac{1}{x}\right) = 0$$

Remove the brackets,

$$abx - b - ac + \frac{c}{x} = 0$$

Multiply by  $x$ 

$$abx^2 - x(b+ac) + c = 0$$

$$(bx - c)(ax - 1) = 0$$

$$\therefore x = \frac{c}{b} \text{ or } \frac{1}{a}$$

$$5. \quad x^2 - 2ax + a^2 = \frac{1}{a^2}$$

$$(x - a)^2 = \frac{1}{a^2}$$

$$x - a = \pm \frac{1}{a}$$

$$x = a \pm \frac{1}{a}$$

$$= a + \frac{1}{a} \text{ or } a - \frac{1}{a}$$

$$7. \quad \frac{p-x}{p-a} = \frac{p+a}{p+x}$$

Multiply by  $(p-a)(p+x)$ 

$$(p-x)(p+x) = (p+a)(p-a)$$

$$p^2 - x^2 = p^2 - a^2$$

$$p^2 - x^2 - p^2 + a^2 = 0$$

$$-x^2 = -a^2$$

$$\therefore x^2 = a^2$$

$$x = +a \text{ or } -a.$$

This is usually written  $\pm a$ , and is read "plus or minus  $a$ ".

$$\text{So } x = \pm a$$

$$9. \quad abx^2 + 1 = (a+b)x$$

$$abx^2 - (a+b)x + 1 = 0$$

$$(ax - 1)(bx - 1) = 0$$

$$x = \frac{1}{a} \text{ or } \frac{1}{b}$$

EXERCISE III.

1.

$$\begin{aligned} 4x + 3y &= 2 \\ 3y &= 2 - 4x \\ y &= \frac{2 - 4x}{3} \end{aligned}$$

$x =$	-1	-4	2
$y =$	2	6	-2

$$\begin{aligned} x - y &= 4 \\ -y &= 4 - x \\ y &= x - 4 \end{aligned}$$

$x =$	0	1	2
$y =$	-4	-3	-2

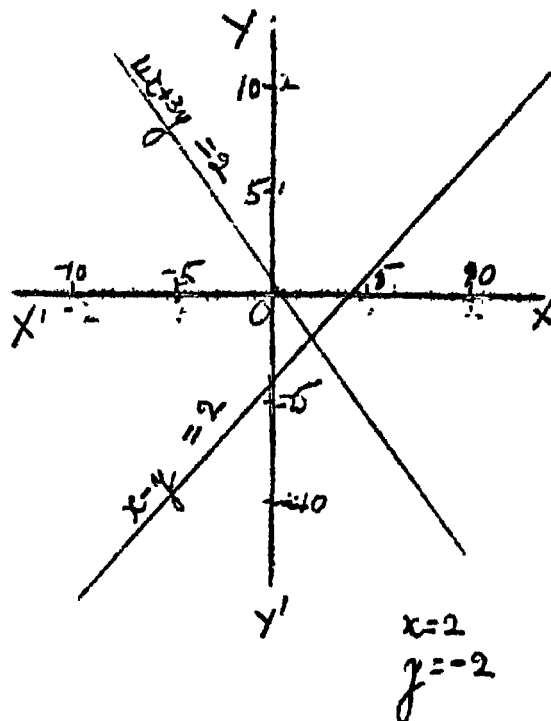

3-

$$2x = 3y + 14$$

$$2x - 14 = 3y$$

$$y = \frac{2x - 14}{3}$$

x =	1	4	7
y =	-4	-2	0

$$3x + y = 10$$

$$y = 10 - 3x$$

x =	0	1	2
y =	10	7	4

$$x + 2y = 0$$

$$2y = -x$$

$$y = -\frac{x}{2}$$

x =	0	2	4
y =	0	-1	-2

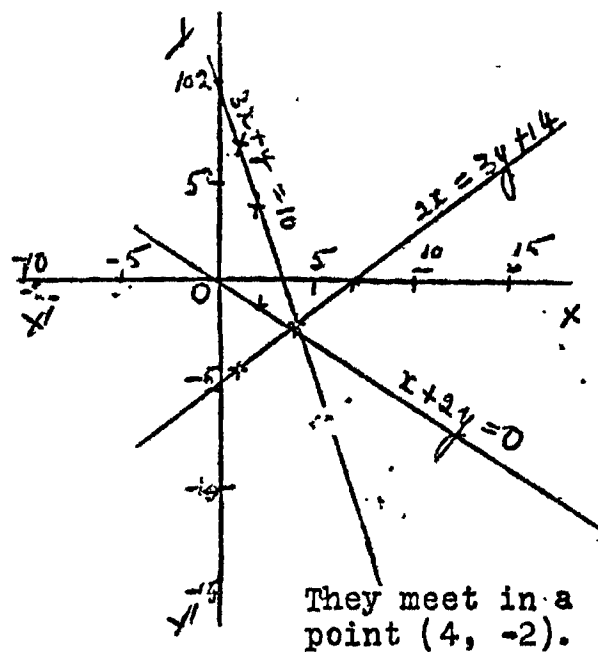

They meet in a point (4, -2).

5-

$$3y - x = 9$$

$$3y = x + 9$$

$$y = \frac{x + 9}{3}$$

x =	0	3	-3
y =	3	4	2

$$x + 7y = 11$$

$$7y = 11 - x$$

$$y = \frac{11 - x}{7}$$

x =	4	11	-3
y =	1	0	2

$$3x + y = 13$$

$$y = 13 - 3x$$

x =	0	1	2
y =	13	10	7

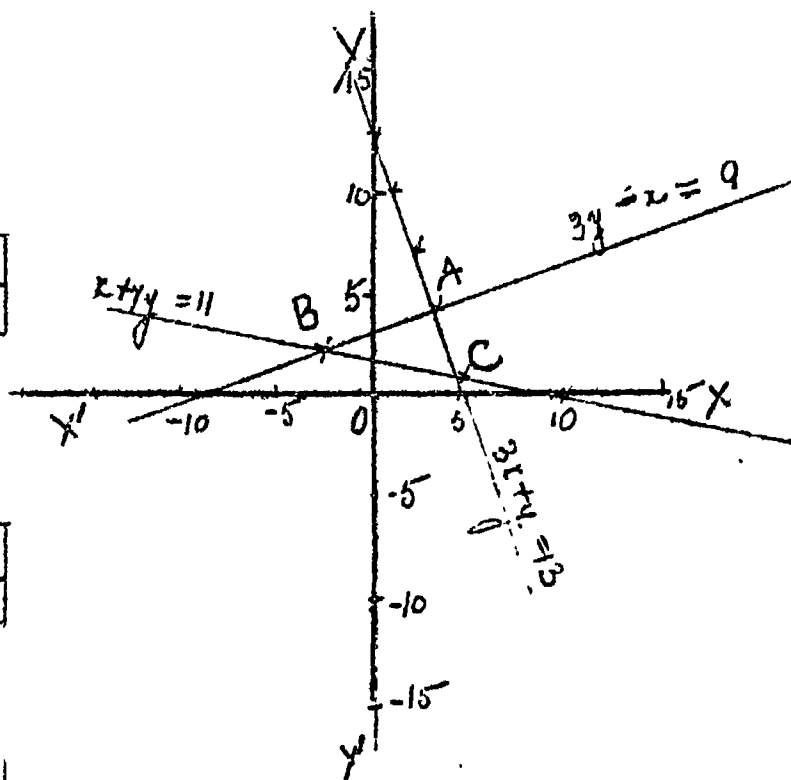

ABC is the triangle,

A is (3, 4.)  
 B is (-3, 2.)  
 C is (4, 1.)

MODEL ANSWERS.

This Set of Model Answers is the property of the Education Department.

It is to be regarded as confidential, and is to be returned to the

Department when asked for.

SECONDARY DIVISION.

BF.

36.

FOURTH YEAR.

ALGEBRA.

SET 9.

EXERCISE I.

$$2. \quad 1 + 6xy + 9x^2y^2. \qquad 4. \quad 4p^2 + q^2 + r^2 - 4pq + 2qr - 4pr.$$

$$6. \quad 4x^4 + x^2 + 1 - 4x^3 + 4x^2 - 2x \\ = 4x^4 - 4x^3 + 5x^2 - 2x + 1.$$

$$8. \quad \frac{x^2}{9} + 9y^2 + \frac{9}{4} - 2xy + 9y - x \\ = \frac{x^2}{9} - 2xy - x + 9y^2 + 9y + \frac{9}{4}$$

EXERCISE II.

$$2. \quad (a - 2b)^3 = a^3 - 3(a)^2 \cdot 2b + 3a(2b)^2 - (2b)^3 \\ = a^3 - 6a^2b + 12ab^2 - 8b^3.$$

$$4. \quad (3x + 2y)^3 = (3x)^3 + 3(3x)^2 \cdot 2y + 3 \cdot 3x(2y)^2 + (2y)^3 \\ = 27x^3 + 54x^2y + 36xy^2 + 8y^3.$$

$$6. \quad (2ab - 3)^3 = (2ab)^3 - 3(2ab)^2 \cdot 3 + 3 \cdot 2ab \cdot 3^2 - (3)^3 \\ = 8a^3b^3 - 36a^2b^2 + 54ab - 27.$$

$$8. \quad (3c^2 - 2d^3)^3 = (3c^2)^3 - 3(3c^2)^2 \cdot 2d^3 + 3 \cdot 3c^2(2d^3)^2 - (2d^3)^3 \\ = 27c^6 - 54c^4d^3 + 36c^2d^6 - 8d^9.$$

$$10. \quad \left(\frac{c}{3} + 1\right)^3 = \left(\frac{c}{3}\right)^3 + 3 \cdot \left(\frac{c}{3}\right)^2 \cdot 1 + 3 \cdot \frac{c}{3} \cdot 1^2 + 1^3 \\ = \frac{c^3}{27} + \frac{c^2}{3} + c + 1.$$

EXERCISE III.

$$2. \quad (a - 3b + 1)(a - 3b - 1) \\ = [(a - 3b) + 1][(a - 3b) - 1] \\ = (a - 3b)^2 - 1^2 \\ = a^2 - 6ab + 9b^2 - 1.$$

$$4. \quad (a^2 + 2a + 3)(a^2 - 2a - 3) \\ = [a^2 + (2a + 3)][a^2 - (2a + 3)] \\ = a^4 - (2a + 3)^2 \\ = a^4 - 4a^2 - 12a - 9.$$

$$6. \quad (x - y + a - b)(x - y - a + b) \\ = [(x - y) + (a - b)][(x - y) - (a - b)] \\ = (x - y)^2 - (a - b)^2 \\ = x^2 - 2xy + y^2 - a^2 + 2ab - b^2.$$

P.T.O.

EXERCISE IV:

$$(7x^2 + 4x + 8)^2 - (x^2 - 9x + 13)^2$$

$$= [(7x^2 + 4x + 8) + (x^2 - 9x + 13)][(7x^2 + 4x + 8) - (x^2 - 9x + 13)]$$

$$= [7x^2 + 4x + 8 + x^2 - 9x + 13][7x^2 + 4x + 8 - x^2 + 9x - 13]$$

$$(8x^2 - 5x + 21)(6x^2 + 13x - 5)$$

$$(8x^2 - 5x + 21)(3x - 1)(2x + 5)$$

∴ the expression is divisible by  $(3x - 1)(2x + 5)$ , and the quotient is  $8x^2 - 5x + 21$ .

$$(2a + 3b - c)^3 + (3a + 7b + c)^3$$

Suppose  $X = 2a + 3b - c$ , and  $Y = 3a + 7b + c$ ; then the expression will be equal to  $X^3 + Y^3$ .

$$X^3 + Y^3 = (X + Y)(X^2 - XY + Y^2).$$

The first factor is  $X + Y$ .

$$X + Y = (2a + 3b - c) + (3a + 7b + c)$$

$$= 2a + 3b - c + 3a + 7b + c$$

$$= 5a + 10b$$

$$= 5(a + 2b).$$

∴ the expression is divisible by  $5(a + 2b)$ .

$$\text{product} = (2x^2 + x - 6)(6x^2 - 5x + 1)$$

$$= (2x - 3)(x + 2)(3x - 1)(2x - 1)$$

$$3x^2 + 5x - 2 = (3x - 1)(x + 2)$$

These are two of the factors of the product.

∴ the product of the two expressions is divisible by  $3x^2 + 5x - 2$ .

$$(x^3 + x^2 + 4)^3 - (x^3 - 2x + 3)^3$$

The expression is the difference of two cubes, and is equal

$$A^3 - B^3 \text{ where } A = (x^3 + x^2 + 4), \text{ and}$$

$$B = (x^3 - 2x + 3)$$

$$A^3 - B^3 = (A - B)(A^2 + AB + B^2).$$

$(A - B)$  is a factor of the expression.

$$A - B = (x^3 + x^2 + 4) - (x^3 - 2x + 3)$$

$$= x^3 + x^2 + 4 - x^3 + 2x - 3$$

$$= x^2 + 2x + 1$$

$$= (x + 1)^2.$$

∴  $(x + 1)^2$  divides the expression exactly.

EXERCISE V.

$$\begin{aligned}
2. & (a+b)^3 - (a-b)^2(a+b) \\
= & (a+b) \left[ (a+b)^2 - (a-b)^2 \right] \\
= & (a+b) \left[ (a+b) + (a-b) \right] \left[ (a+b) - (a-b) \right] \\
= & (a+b)(a+b+a-b)(a+b-a+b) \\
= & (a+b)(2a)(2b) \\
= & 4ab(a+b) \\
= & \text{the right hand side.}
\end{aligned}$$

---

$$\begin{aligned}
4. & (m-n)(m+n)^3 - m^4 + n^4 \\
= & (m-n)(m+n)(m+n)^2 - (m^4 - n^4) \\
= & (m^2 - n^2) \left[ (m+n)^2 - (m^2 + n^2) \right] \\
= & (m^2 - n^2) \left[ m^2 + 2mn + n^2 - m^2 - n^2 \right] \\
= & (m^2 - n^2)(2mn) \\
= & 2mn(m^2 - n^2) \\
= & \text{the right hand side.}
\end{aligned}$$

---

$$\begin{aligned}
6. & 3ab(a-b)^2 + (a-b)^3 \\
= & (a-b)^2 \left[ 3ab + (a-b) \right] \\
= & (a-b)^2 \left[ 3ab + a^2 - 2ab + b^2 \right] \\
= & (a-b)^2 \left[ a^2 + ab + b^2 \right] \\
= & (a-b)(a-b)(a^2 + ab + b^2) \\
= & (a-b)(a^3 - b^3) \\
= & \text{the right hand side.}
\end{aligned}$$

---

$$\begin{aligned}
8. & (b-c)^3 + (c-a)^3 + (a-b)^3 \\
= & b^3 - 3b^2c + 3bc^2 - c^3 + c^3 - 3c^2a + 3a^2c - a^3 + a^3 - 3a^2b \\
& \quad + 3ab^2 - b^3. \\
= & 3a^2c - 3a^2b + 3ab^2 - 3b^2c + 3bc^2 - 3c^2a \\
= & 3 \left[ a^2c - a^2b + ab^2 - ac^2 + b^2c - bc^2 \right] \\
= & 3 \left[ a^2(c-b) + a(b^2 - c^2) - bc(b-c) \right] \\
= & 3(b-c) \left[ -a^2 + a(b+c) - bc \right] \\
= & 3(b-c) \left[ -a^2 + ab + ac - bc \right] \\
= & 3(b-c) \left[ -a(a-b) + c(a-b) \right] \\
= & 3(b-c)(a-b)(c-a) \\
= & \text{the right hand side.}
\end{aligned}$$

---

EXERCISE VI.

2.

$$\begin{aligned}
 & \text{If } a = b + c, \\
 & (a^2 + b^2 + c^2)(b - c) \\
 = & \quad \boxed{(b + c)^2 + b^2 + c^2}(b - c) \\
 = & (b^2 + 2bc + c^2 + b^2 + c^2)(b - c) \\
 = & 2(b^2 + bc + c^2)(b - c) \\
 = & 2(b^3 - c^3) \\
 = & 2b^3 - 2c^3 \\
 = & \text{the right hand side.}
 \end{aligned}$$

---

4.

$$\begin{aligned}
 X &= b + c - 2a, \\
 Y &= c + a - 2b, \\
 Z &= a + b - 2c. \\
 & X^3 + Y^3 + Z^3 - 3XYZ \\
 = & (X + Y + Z)(X^2 + Y^2 + Z^2 - XY - YZ - XZ) \\
 = & (b + c - 2a + c + a - 2b + a + b - 2c)(\text{second factor}) \\
 = & \quad \quad \quad (0)(\text{second factor}) \\
 = & \quad \quad \quad 0,
 \end{aligned}$$

---

6.

$$(s - 3a)^3 + (s - 3b)^3 + (s - 3c)^3 - 3(s - 3a)(s - 3b)(s - 3c)$$

This expression is equal to  $X^3 + Y^3 + Z^3 - 3XYZ$ ,  
 where  $X = (s - 3a)$ ,  $Y = (s - 3b)$ ,  $Z = (s - 3c)$ .

$$\begin{aligned}
 & X^3 + Y^3 + Z^3 - 3XYZ \\
 = & (X + Y + Z)(X^2 + Y^2 + Z^2 - XY - XZ - YZ) \\
 = & (s - 3a + s - 3b + s - 3c)(\text{second factor}) \\
 = & \quad \boxed{3s - 3(a + b + c)}(\text{second factor})
 \end{aligned}$$

but, by hypothesis,  $s = a + b + c$ .

∴ the first factor =  $(3s - 3s) = 0$ .

∴ the product of the two factors is 0, and the whole expression must be equal to 0.

∴  $(s - 3a)^3 + (s - 3b)^3 + (s - 3c)^3 - 3(s - 3a)(s - 3b)(s - 3c) = 0$ .

---



EXAMPLES XXVI.

-5-

$$y = x^2$$

$$5y - 8x - 69 = 0$$

$$y = \frac{8x + 69}{5}$$

x	0	1	2	3	4	5	-1	-2	-3	-4	-5
y=x <sup>2</sup>	0	1	4	9	16	25	1	4	9	16	25

x	2	-3	7
y	17	9	25

From the graph  $x = -3$  or  $4.6$

23.  $2y - 3x - 20 = 0$   
 $2y = 3x + 20$   
 $y = \frac{3x + 20}{2}$

x	2	-4	6
y	13	4	1

From the graph  $x = -2.5$  or  $4$ .

Note: No's 20 and 23 are drawn on the same graph.

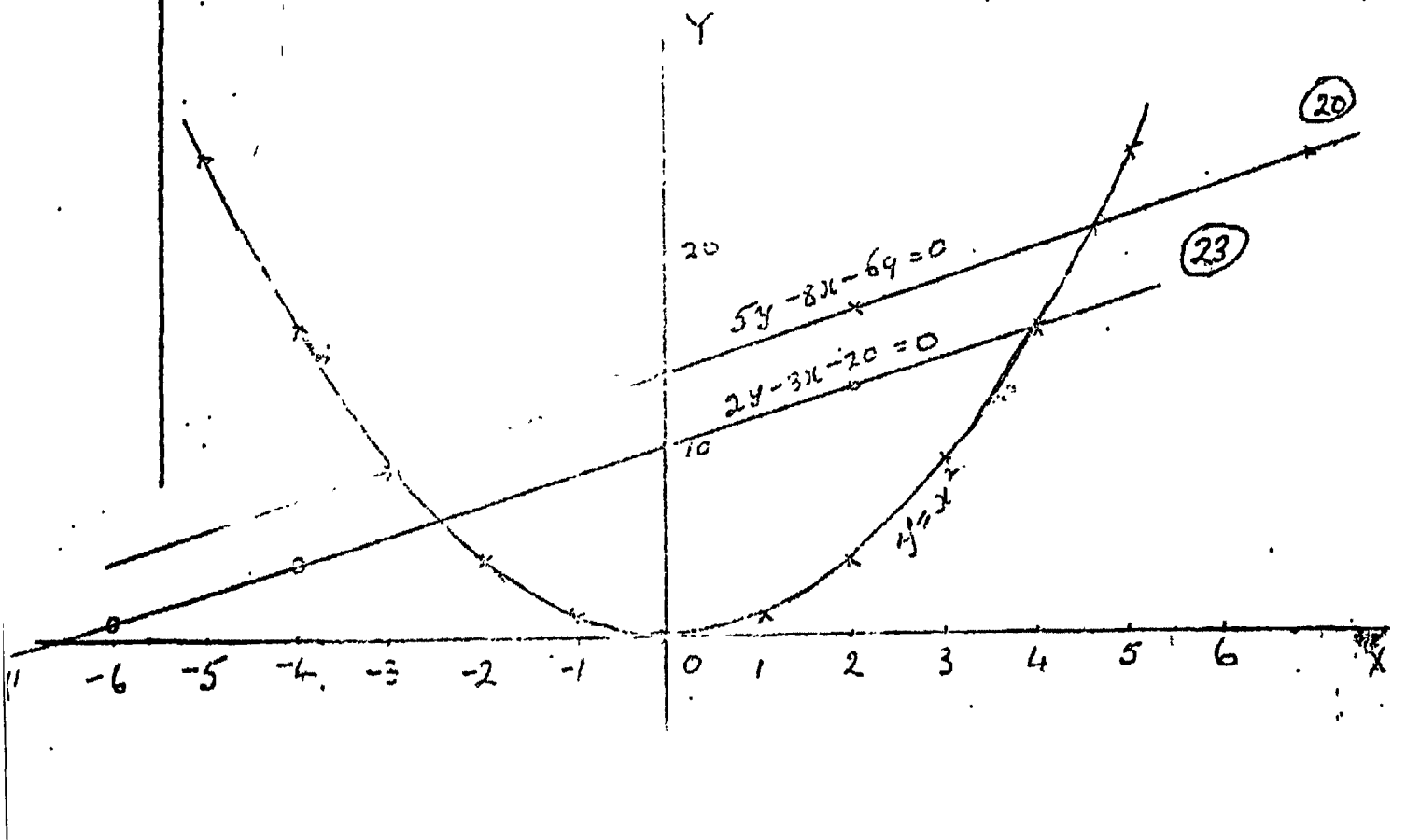

EDUCATION DEPARTMENT.      CORRESPONDENCE SCHOOL.      SECONDARY DEPARTMENT.  
BOOK-KEEPING.                      THIRD YEAR.                      SET 14.                      JF'34.

COLUMNAR CASH BOOK.-

Revise the note on Summarizing on page 37 of your text-book. Note that a summary is made in order to save time in posting and space in the ledger. There is another method by which these advantages can be obtained, and that is by the use of a columnar cash book. Instead of going through the items at the end of the month and picking out and totalling those which have to be posted to the same account and writing the summary at the end, separate columns may be ruled in the cash book for payments and receipts which recur frequently. The items are first entered in the cash or bank column in the usual way, then placed as well in the special column ruled for them. As they are entered in this column a tick should be placed in the folio column to indicate that the separate amounts must not be posted. At the end of the month the analysis columns are totalled and these totals (which really form a summary) are posted to the accounts concerned.

The analysis columns most commonly found in a cash book are as follows:-

Debit Side.      Sundry Debtors, Cash Sales, Bills Receivable.

Credit Side.      Sundry Creditors, Bills Payable, Wages,  
Advertising, Freight and Cartage, Lighting,  
Stationery, Sundries.

Study carefully the following example showing the use of a columnar cash book.

									£.	s.	d
Jan.	1	Cash in hand	..	..	..	..	..	..	12.16.	4	
		Cash at Bank	..	..	..	..	..	..	158.16.	3	
		Paid Wages	..	..	..	..	..	..	12.13.	6	
		Paid Railage	..	..	..	..	..	..	10. 5.	0	
		Cash Sales	..	..	..	..	..	..	25.13.	4	
		Cash Purchases	..	..	..	..	..	..	14. 5.	6	
	4	Cash Sales	..	..	..	..	..	..	16. 9.	11	
		Paid Advertising	..	..	..	..	..	..	1. 6.	6	
	5	Paid Sundry Expenses	..	..	..	..	..	..	4. 3.	2	
		Cash Sales	..	..	..	..	..	..	35.10.	8	
	7	Paid Cartage	..	..	..	..	..	..	2. 5.	6	
		Paid Wages	..	..	..	..	..	..	13. 3.	8	
	9	Received from Thomas	..	..	..	..	..	..	130. 0.	0	
		Cash Purchases	..	..	..	..	..	..	23. 2.	6	
	11	Paid Wests, Ltd.	..	..	..	..	..	..	152.15.	0	
	13	Paid for new Waggon	..	..	..	..	..	..	33.10.	0	
	14	Received from Bannerman	..	..	..	..	..	..	100. 0.	0	
	16	Cash Sales	..	..	..	..	..	..	127.16.	3	
		Cash Purchases	..	..	..	..	..	..	123.16.	6	
	17	Paid Gas A/c.	..	..	..	..	..	..	1. 2.	3	
		Paid Sloan & Co.	..	..	..	..	..	..	11.10.	0	
	27	Received from Stewart	..	..	..	..	..	..	28. 3.	4	
		Paid Wages	..	..	..	..	..	..	12.10.	0	
	31	Cash Purchases	..	..	..	..	..	..	2. 3.	8	
		Paid George Bros.	..	..	..	..	..	..	13.12.	6	

Enter the above items in a cash book containing columns for cash sales, sundry debtors, cash purchases, sundry creditors, and wages. Indicate to what accounts in the ledger the totals of the various columns will be posted.

Receipts were banked daily and all payments were made by cheque.

Date.	Particulars.	Cash Sales.	Sundry Debtors.	Receipts.	Bank.	Date.	Particulars.	Cash Purchases.	Sundry Creditors.	Wages.	Bank.
Jan.1	To Balance			12.16.4	158.16.3	Jan.1	By Wages			12.13.6	12.13.6
	" Cash Sales	25.13.4		25.13.4	38.9.8		" Railage				10.5.0
4	" Cash Sales	16.9.11		16.9.11	16.9.11		" Cash	14.5.6			14.5.6
5	" Cash Sales	35.10.8		35.10.8	35.10.8		" Purchase				
9	" Thomas		130.0.0	130.0.0	130.0.0	4	" Advertis- ing				1.6.6
14	" Bannerman		100.0.0	100.0.0	100.0.0	5	" Sundry Expenses				4.3.2
16	" Cash Sales	127.16.3		127.16.3	127.16.3	7	" Cartage				1.2.5.6
27	" Stewart		28.3.4	28.3.4	28.3.4	9	" Wages			13.3.8	13.3.8
						9	" Cash	23.2.6			23.2.6
							" Purchases				
						11	" Wests Ltd.		152.15.0		152.15.0
						13	" Waggon				33.10.0
						16	" Cash	123.16.6			123.16.6
							" Purchases				
						17	" Gas				1.2.3
						17	" Sloan & Co.		11.10.0		11.10.0
						27	" Wages			12.10.0	12.10.0
						31	" Cash	2.3.8			2.3.8
							" Purchases				
							" George Bros.		13.12.6		13.12.6
							" Balance				203.0.10
		205.10.2	258.3.4		635.6.1			163.8.2	177.17.6	38.7.2	635.6.1

Credit to Sales A/c.      Credit to S/Debtors' Adjustment A/c.

Debit to Purchases A/c      Debit to S/Creditors' Adjustment A/c.      Debit to Wages A/c.

Feb. 1 To Balance

203.0.10

WRITTEN WORK FOR SET 14.

A.1. R. Don keeps three ledgers -- Debtors', Creditors' and Private -- each of which is self-balancing. Enter the following in Cash Book and Journals, post to three ledgers and prepare a Trial Balance from each ledger. Open Accounts for Wages and Salaries, Railways and Cartage, Fuel and Lighting, Discount, Sundry Expenses. Rule columns in the cash book to correspond with these expenses and also for Sundry Debtors and Sundry Creditors, and Cash Sales.

Nov. 1 ASSETS -- Cash £23:16:5, Bank £581:17:11, Stock £2658:14:3, Furniture and Fittings £175:10:0, A. Falconer £25:16:6, R. Sim £163:14:2, W. Mackenzie £18:15:11.

LIABILITIES -- A. Tait £23:14:8, O. Mathias £161:16:2, Bad Debts Reserve £42:14:4, R. Don capital £3420.

	£.	s.	d
1 Bought goods of Tait .. .. .	15	10	6
Cash sales .. .. .	21	13	8
: Paid railage .. .. .		11	6
3 Sold goods to Sim .. .. .	16	3	6
Sold goods to Falconer .. .. .	11	6	3
: Paid wages .. .. .	12	3	6
4 Paid salaries by cheque .. .. .	15	4	3
Paid lighting account .. .. .	2	4	6
5 Returned damaged goods to Tait .. .. .	1	5	7
Paid solicitor's account .. .. .	1	1	0
Cash sales paid to Bank .. .. .	45	15	6
Paid audit fees .. .. .	5	15	6
Received cheque of A. Falconer .. .. .	24	10	9
Discount allowed .. .. .	1	5	9
6 Paid to Bank .. .. .	46	4	5
Paid for new typewriter, cheque .. .. .	21	15	0
Cash Sales .. .. .	17	6	6
7 Paid postages .. .. .	1	10	0
Paid cartage .. .. .	1	3	2
Paid for coal .. .. .	2	5	3
Bought goods of Tait .. .. .	28	1	9
9 Paid sundry expenses .. .. .	2	1	9
Received cash of Sim, discount £4:1:10 .. .. .	159	12	4
11 Cash sales .. .. .	145	17	3
Paid to Bank .. .. .	180	0	0
Paid fire insurance premium, by cheque .. .. .	1	16	6
12 Sold goods to Mackenzie .. .. .	2	1	9
Paid for firewood .. .. .		15	0
14 Paid for repairing typewriters .. .. .	1	2	4
Bought goods of Mathias .. .. .	25	15	0
17 Paid railage by cheque .. .. .	2	15	0
Sold goods to Sim .. .. .	33	12	8
19 Paid Mathias by cheque, discount £6:1:4 .. .. .	155	14	10
Paid for cartage .. .. .	1	3	0
Sim returns goods unsuitable .. .. .	3	13	6
26 Don takes goods for use of his household .. .. .	8	3	8
28 Paid wages by cheque .. .. .	14	5	8
Bought office desk for cash .. .. .	10	10	0
30 Rcnt accrued .. .. .	12	0	0
Don's drawings by cheque .. .. .	17	0	0

A.2. XY & Co. keep a tabulated Cash Book. On the debit side are columns for Debtors A-L, Debtors M-Z, Discount, Bills Receivable, Private Ledger, Receipts and Bank. On the credit side are columns for Bills Payable, Discount, Creditors A-L, Creditors M-Z, Expenses, and Bank. All cash is banked daily and all payments made by cheque.

- (a) From the following write up the Cash Book, rule off, and bring down the balance.
- (b) State to what a/cs the totals of the columns should be posted.

- Feb. 1 Bank Overdraft £1298:3:5, Discounted Bills Receivable £294:6:8, discount £13:1:9.
- 2 Received cheque from Johnston & Co. £14:10:0, discount allowed 7/6. Received cheque from Wilson & Co. £292:14 discount allowed £7:10:6.
4. J. Smith's bill receivable due this day paid to Bank £42:6:8. Paid wages £42:6:8, general expenses £9:10:0, rent £42:6:8.
- 9 Received £500 from W. Brown and paid same into Bank X withdrew £25:10:0 for his own use.
- 10 Received from Blackbell & Co. £20:10:6, and from Incheape & Co. £40:10:9.
- 17 Bill Payable (No. 17) paid, £84:2:7. Wages paid £17:6:8 General Expenses £14:6:9, Petty cheque £6:11:9.
- 20 Paid Sargood's £300:9:6, discount deducted £9:0:6. Paid Harrison's £30:10:6, discount deducted £1:10:0.
- 28 Cash sales £40. J. Williams paid his a/c £2:10:0. Paid wages £17:6:8, Office Cleaning £3:7:6.

(c) On 1st March the pass book is received from the Bank, and it is ascertained from it that cheques for £17:6:8 and £3:7:6 had not been presented for payment, and that the lodgment of Feb. 28th for £42:10:0 was credited by the Bank on March 1st. An amount of 10/- for cheque book and 1/6 for exchange appears in the pass book but not in the cash book. Prepare reconciliation statement.



- Feb. 1 Bank Overdraft £1298:3:5, Discounted Bills Receivable receiving £294:6:8, discount £13:1:9.
- 2 Received cheque from Johnston & Co. £14:10:0, discount allowed 7/6. Received cheque from Wilson & Co. £292:14: discount allowed £7:10:6.
- 4 J. Smith's bill receivable due this day paid to Bank £42:6:8. Paid wages £42:6:8, general expenses £9:10:0, rent £42:6:8.
- 9 Received £500 from J. Brown and paid same into Bank. X withdrew £25:10:0 for his own use.
- 10 Received from Blackball & Co. £20:10:6, and from Inchcape & Co. £40:10:9.
- 17 Bill Payable (No. 17) paid, £84:2:7. Wages paid £17:6:8, General Expenses £14:6:9, Petty cheque £6:11:9.
- 20 Paid Sargood's £300:9:6, discount deducted £9:0:6. Paid Harrison's £30:10:6, discount deducted £1:10:0.
- 28 Cash sales £40. J. Williams paid his a/c £2:10:0. Paid wages £17:6:8, Office Closing £3:7:6.

(c) On 1st March the pass book is received from the Bank, and it is ascertained from it that cheques for £17:6:8 and £3:7:6 had not been presented for payment, and that the lodgment of Feb. 28th for £42:10:0 was credited by the Bank on March 1st. An amount of 10/- for cheque book and 1/6 for exchange appears in the pass book but not in the cash book. Prepare reconciliation statement





Petty Cash A/c

Jan 1	To Balance	4 12 3	Jan 31	By Balance	20 0 0
"	Cheque	15 7 9			
		<u>20 - -</u>			<u>20 - -</u>
		=====			=====
Feb 1	To Balance	20 - -			

S/Debtors Adjustment A/c

Jan 1	To Balance	1030 - -	Jan 23	By Bad Debts	7 10 0
14	" Bill dis-		31	" Bills Rec.	790 19 7
	honoured	320 18 6		" Returns	17 15 -
	" Interest	1 12 1		" Cash & Disc.	554 5 -
31	" Sales	728 6 8		" Balance	710 11 8
14	" Cash (noting exs.)	4 - -			
		<u>£2081 1 3</u>			<u>2081 1 3</u>
		=====			=====
Feb 1	To Balance	710 11 8			

S/Creditors Adjustment A/c

Jan 31	To Bills Pay- able	450 10 -	Jan 1	By Balance	778 - -
"	Returns	40 16 8	31	" Goods	813 - -
"	Cash & Disc.	327 10 -			
"	Balance	<u>772 3 4</u>			
		<u>£1591 - -</u>			<u>£1591 - -</u>
		=====			=====
			Feb 1	By Balance	772 3 4

The other a/cs are simple and straightforward, and it is, therefore, deemed unnecessary to show them in detail.

TRIAL BALANCE. (from Private Ledger.)

Bank	562 3 9	Sales	710 11 8
B/Receivable	322 14 7	S/Creditors	772 3 4
Premises	2750 - -	B/Payable	875 17 6
Purchases	772 3 4	Mortgage	1500 - -
Furniture & Fittings	275 - -	Capital	5000 - -
Rates a/c	16 2 6	Interest	1 12 1
Insurance	11 7 6		
Stock	3250 - -		
Discount	12 11 3		
Petty Cash	20 - -		
S/Debtors	710 11 8		
Salaries and Wages	50 - -		
Bad Debts	7 10 -		
Private Expenses	100 - -		
	<u>£ 8860 4 7</u>		<u>£8860 4 7</u>
	=====		=====

S/Debtors (from Debtors' Ledger). S/Creditors (from Creditors' Ledger).

C. Ray	337 5 -	P. Camp	547 3 4
W. Grove	373 6 8	E. James	225 - -
	<u>710 11 8</u>		<u>772 3 4</u>
	=====		=====

CASH BOOK.

		Discount	Receipts	Bank			Discount	Details	Bank.
Jan 7	To Ray, C.	26 11 9	505 3 3	505 3 3	Jan 1	By Balance			148 15 9
14	" Bills Rec.			545 15 0		" Petty Cash			15 7 9
20	" Bills Rec.	2 7 0		465 18 0	7	" Jones, L.	16 7 6		311 2 6
23	" Boon, H.		22 10 0	22 10 0	14	" Duff (noting exs)			4 0 0
					20	" B/Payable			351 12 6
					31	" Private Expenses			100 0 0
						" Salaries	30 0 0		
						" Wages	20 0 0		50 0 0
						" Balance			562 3 9
		28 18 9		1539 6 3			16 7 6		1539 6 3

SUMMARY:

S/Debtors	554 5 0		
(gross)			
B/Rec. (gross)	1014 0 0		
Feb 1 To Balance		562	9

2. DEBTORS' LEDGER.

<u>Private Ledger Adjustment A/c.</u>							
Jan 23	To	Bad Debts	7 10 -	Jan 1	By	Balance	1030 - -
31	"	B/Rec.	790 19 7	14	"	Bill dis-	
	"	Returns	17 15 -		"	honoured	320 18 6
	"	Cash & Disc.	554 5 -		"	Interest	1 12 1
	"	Balance	710 11 8	31	"	Sales	728 6 8
				14	"	Cash (Not-	
						ing Expenses)	- 4 -
<hr/>							
£2081 1 3				£2081 1 3			
=====				=====			
				Feb 1	By	Balance	710 11 8

CREDITORS' LEDGER.

<u>Private Ledger Adjustment A/c.</u>							
Jan 1	To	Balance	778 - -	Jan 31	By	B/Pay.	450 10 -
31	"	Goods	813 - -		"	Returns	40 16 8
					"	Cash & Disc.	327 10 -
					"	Balance	772 3 4
<hr/>							
£1591 - -				£1591 - -			
=====				=====			
Feb 1	To	Balance	772 3 4				

This Set of Model Answers is the Property of the Education Department.

It is to be regarded as confidential and is to be returned to the

Department when asked for.

Secondary Department. JF'34

BOOK-KEEPING.

MODEL ANSWERS.

THIRD YEAR.

SET 14.

No. 1.			£. s. d	£. s.
Nov. 1	Cash		23.16. 5	
	Bank		581.17.11	
	Stock		2658.14. 3	
	Furniture and Fittings		175.10. 0	
	A. Falconer	25.16. 6		
	R. Sim	163.14. 2		
	W. Mackenzie	18.15.11		
			208. 6. 7	
	To A. Tait	23.14.8		
	O. Mathias	161.16.2		185.10.10
	Bad Debts Reserve			42.14. 4
	Capital			3420. 0. 0
			3648. 5. 2	3648. 5. 2
			=====	=====
Nov.26	Private Expenses		8. 3. 8	
	To Purchases			8. 3. 8
30	Rent		12. 0. 0	
	To Landlord			12. 0. 0

SALES JOURNAL.

Nov. 3	Sim		16. 3. 6	
	Falconer		11. 6. 3	
12	Mackenzie		2. 1. 9	
17	Sim		33.12. 8	
	Sales Credit			63. 4. 2

PURCHASES JOURNAL.

Nov. 1	Tait			15.10. 6
7	Tait			28. 1. 9
14	Mathias			25.15. 0
	Purchases Debit		69. 7. 3	

RETURNS IN JOURNAL.

Nov.19	Sim			3.13. 6
	Sales Debit		3.13. 6	

RETURNS OUT JOURNAL.

Nov. 5	Tait		1. 5. 7	
	Purchases Credit			1. 5. 7

CREDIT.

Date	Particulars.	Wages & Salaries			Railage & Cartage		Fuel & Lighting			Sundry Expenses			Creditors			Discount			Cash			Bank			
Nov. 1	By Railage					11	6														11	6			
3	Wages	12	3	6																12	3	6			
4	Salaries	15	4	3																			15	4	3
	Lighting							2	4	6										2	4	6			
5	Legal Expenses										1	1								1	1				
	Audit Fees										5	15	6							5	15	6			
6	Bank																46			46					
	Typewriter																								
7	Postages										1	10								1	10		21	15	
	Cartage				1	3	2													1	3	2			
	Coal							2	5	3										2	5	3			
9	Sundry Expenses										2	1	9							2	1	9			
11	Bank																			180					
	Fire Insurance										1	16	6										1	16	6
12	Firewood								15												15				
14	Repairs										1	2	4							1	2	4			
17	Railage				2	15																			
19	Mathias													161	16	2	6	14					155	14	10
	Cartage				1	3																			
28	Wages	14	5	8																	1	3			
	Office Desk																			10	10				
30	Private Expenses																								
	Balances																			124	6		625	6	7
		41	13	5	5	12	8	5	4	9	13	7	1	161	16	2	6	14		392	16	11	853	17	10

PRIVATE LEDGER

Furniture & Fittings.

		£. s. d			£. s. d
Nov. 1	To Balance	175.10. 0	Nov. 30	By Balance	207.15. 0
6	" Typewriter -- cash	21.15. 0			
28	" Desk -- cash	10.10. 0			
		<u>207.15. 0</u>			<u>207.15. 0</u>
Dec. 1	To Balance	207.15. 0			

STOCK.

Nov. 1	To Balance	2658.14 3
--------	------------	-----------

PURCHASES.

Nov. 30	To Creditors	69. 7. 3	Nov. 26	By Private Expenses	8. 3. 8
			5	" Tait	1. 5. 7
			30	" Balance	<u>59.18. 0</u>
		<u>69. 7. 3</u>			<u>69. 7. 3</u>
Dec. 1	To Balance	59.18. 0			

SALES.

Nov. 19	To Sim	3.13. 6	Nov. 30	By Debtors	63. 4. 2
30	" Balance	<u>290. 3. 7</u>		" Cash	<u>230.12.11</u>
		<u>293.17. 1</u>	Dec. 1	By Balance	<u>293.17. 1</u>
					<u>290. 3. 7</u>

PRIVATE EXPENSES.

Nov. 26	To Goods	8. 3. 8	Nov. 30	By Balance	25. 3. 8
30	" Cash	<u>17. 0. 0</u>			
		<u>25. 3. 8</u>			<u>25. 3. 8</u>
Dec. 1	To Balance	25. 3. 8			

CAPITAL.

Nov. 1	By Balance	3420. 0. 0
--------	------------	------------

DISCOUNT.

Nov. 30	To Debtors	5. 7. 7	Nov. 30	By Creditors	6. 1. 4
	" Balance	<u>13. 9</u>			<u>6. 1. 4</u>
		<u>6. 1. 4</u>	Dec. 1	By Balance	<u>13. 9</u>

WAGES & SALARIES.

Nov. 30	To Cash	41.13. 5
---------	---------	----------

RAILAGE & CARTAGE.

Nov. 30	To Cash	5.12. 8
---------	---------	---------

FUEL & LIGHTING.

Nov. 30	To Cash	5. 4. 9
---------	---------	---------

RENT.

Nov. 30	To Landlord	12. 0. 0
---------	-------------	----------

SUNDRY EXPENSES.

		£. s. d.		£. s. d.
Nov. 30	To Cash	13. 7. 1		

BAD DEBTS RESERVE.

Nov. 1	By Balance	42.14. 4
--------	------------	----------

SUNDRY DEBTORS' ADJUSTMENT A/C.

Nov. 1	To Balance	208. 6. 7	Nov. 30	By Cash & Discount	189. 10. 8
30	" Sales	63. 4. 2	19	" Returns	3. 13. 6
			30	" Balance	78. 6. 7
		<u>271. 10. 9</u>			<u>271. 10. 9</u>

Dec. 1	To Balance	78. 6. 7
--------	------------	----------

SUNDRY CREDITORS' ADJUSTMENT A/C.

Nov. 30	To Cash & Discount	161. 16. 2	Nov. 1	By Balance	185. 10. 10
5	" Returns	1. 5. 7	30	" Purchases	69. 7. 3
30	" Balance	103. 16. 4		" Rent	12. 0. 0
		<u>266. 18. 1</u>	Dec. 1	By Balance	103. 16. 4
					<u>266. 18. 1</u>

TRIAL BALANCE.

Cash	124. 6. 0	Sales	290. 3. 7
Bank	625. 6. 7	Capital	3420. 0. 0
Furniture	207. 15. 0	Discount	" 13. 9
Stock	2658. 14. 3	S/Creditors	103. 16. 4
Purchases	59. 18. 0	Bad Debts Reserve	42. 14. 4
Private Expenses	25. 3. 8		
Wages & Salaries	41. 13. 5		
Railage & Cartage	5. 12. 8		
Fuel & Lighting	5. 4. 9		
Rent	12. 0. 0		
Sundry Expenses	13. 7. 1		
S/Debtors	78. 6. 7		
	<u>3857. 8. 0</u>		<u>3857. 8. 0</u>

DEBTORS' LEDGER.

A. Falconer.

Nov. 1	To Balance	25. 16. 6	Nov. 5	By Cash & Discount	25. 16. 6
3	" Sales	11. 6. 3			

R. Sim.

Nov. 1	To Balance	163. 14. 2	Nov. 19	By Returns	3. 13. 6
3	" Sales	16. 3. 6	9	" Cash & Discount	163. 14. 2
17	" Sales	33. 12. 8	30	" Balance	46. 2. 8
		<u>213. 10. 4</u>			<u>213. 10. 4</u>
Dec. 1	To Balance	46. 2. 8			

		<u>W. Mackenzie.</u>			
		£. s. d		£. s. d	
Nov. 1	To Balance	18.15.11	Nov. 30	By Balance	20.17.8
12	" Sales	<u>2. 1. 9</u>			
		20.17.8			<u>20.17.8</u>
Dec. 1	To Balance	20.17.8			

PRIVATE LEDGER ADJUSTMENT A/C.

Nov. 19	To Returns	3.13.6	Nov. 1	By Balance	208.6.7
30	" Cash & Discount	189.10.8	30	" Sales	63.4.2
	" Balance	<u>78.6.7</u>			
		271.10.9			<u>271.10.9</u>
			Dec. 1	By Balance	78.6.7

TRIAL BALANCE.

Falconer	11.6.3	Private Ledger Adjust-	78.6.7
Sim	46.2.8	ment A/c.	
Mackenzie	<u>20.17.8</u>		
	78.6.7		<u>78.6.7</u>

CREDITORS' LEDGER.

A. Tait.

Nov. 5	To Returns	1.5.7	Nov. 1	By Balance	23.14.8
30	" Balance	66.1.4		" Purchases	15.10.6
			7	" Purchases	<u>28.1.9</u>
		<u>67.6.11</u>			<u>67.6.11</u>
			Dec. 1	By Balance	66.1.4

O. Mathias.

Nov. 19	To Cash & Discount	<u>161.16.2</u>	Nov. 1	By Balance	<u>161.16.2</u>
			14	" Purchases	25.15.0

Landlord.

Nov. 30	By Rent	12.0.0
---------	---------	--------

PRIVATE LEDGER ADJUSTMENT A/C.

Nov. 1	To Balance	185.10.10	Nov. 5	By Returns	1.5.7
30	" Purchases	69.7.3	30	" Cash & Discount	161.16.2
	" Rent	<u>12.0.0</u>		" Balance	103.16.4
		266.18.1			<u>266.18.1</u>
Dec. 1	To Balance	103.16.4			

TRIAL BALANCE.

Private Ledger Adjust-	103.16.4	Tait	66.1.4
ment A/c.		Mathias	25.15.0
		Landlord	<u>12.0.0</u>
	<u>103.16.4</u>		<u>103.16.4</u>



- 7 =  
DEBIT.

No. 2.

Date	Particulars.	Debtors A-L			Debtors M-Z			Discount			Bills Receivable.			Private Ledger			Receipts			Bank		
Feb. 1	To Bills Receivable							13	1	9	307	8	5							294	6	8
2	" Johnston & Co.	14	17	6					7	6							14	10	0			
	" Wilson & Co.				300	5	3	7	10	6							292	14	9	307	4	9
4	" Bill Receivable										42	6	8							42	6	8
9	" Loan (J. Brown)													500	0	0	500	0	0	500	0	0
10	" Blackball & Co.	20	10	6													20	10	6			
	" Inceape & Co.	40	10	9													40	10	9	61	1	3
28	" Cash Sales													40	0	0	40	0	0			
	" Williams J.				2	10	0										2	10	0	42	10	0
	" Balance																			644	9	4
		75	18	9	302	15	3	20	19	9	349	15	1	540	0	0				1891	18	8
		Credit to Debtors' A-L Adjust-ment A/c in Private Ledger.			Credit to Debtors' M-Z adjust-ment A/c in Private Ledger.			Debit to Discount A/c.			Credit to B/Receiv-able A/c.			Not posted as separate items would be credited to their own special accounts.								

CREDIT.

Date	Particulars.	Bills Payable			Discount			Creditors A-L			Creditors M-Z			Expenses			Bank			
Feb. 1	By Balance																	1298	3	5
4	" Wages												42	6	8			42	6	8
	" General Expenses												9	10	0			9	10	0
	" Rent												42	6	8			42	6	8
99	" Private Expenses X												25	10	0			25	10	0
17	" B/Payable No. 17	84	2	7														84	2	7
	" Wages												17	6	8			17	6	8
	" General Expenses												14	6	9			14	6	9
	" Petty cheque												6	11	9			6	11	9
20	" Sargobd's				9	0	6					309	10	0				300	9	6
	" Harrison's				1	10	0	32	0	6								30	10	6
28	" Wages												17	6	8			17	6	8
	" Office Cleaning												3	7	6			3	7	6
		84	2	7	10	10	6	32	0	6	309	10	0	178	12	8		1891	18	8
	By Balance																	644.	9	.4
		Debit to B/Payable A/c.			Credit to Discount A/c.			Debit to Creditors' A-L Adjust-ment A/c in Private Ledger.			Debit to Creditors' M-Z Adjust-ment A/c in Private Ledger			Not posted, as separate items would be debited to their own special A/cs.						

Note:- The amounts including discount should be entered in the analysis columns, as shown on pages 7 and 8. If this is not done, it would be necessary to analyse the discount total in order to post the amounts to the adjustment a/cs and the Bills a/cs

(c) Reconciliation Statement.

	£.	s.	d
Overdraft as per cash book	644.	9.	4
Less unrepresented cheques	17.6.8		
	<u>3.7.6</u>		
		20.14.	2
		<hr/>	
		623.15.	2
Plus lodgment not credited	42.10.0		
Charge book	10.0		
Exchange	<u>1.6</u>		
		43. 1.	6
		<hr/>	
Overdraft as per Pass Book		666.16.	8
		<hr/> <hr/>	

Study Sutcliffe, pages 129 - 140.  
Cornish, " 20 - 33.

CHLORINE.

HISTORY:

Chlorine was discovered in 1774 by Karl Wilhelm Scheele, a Swede. He called it "dephlogisticated marine acid air" and for a long time chlorine was thought to be a compound, containing oxygen, but in 1810 the English chemist, Sir Humphrey Davy, showed that it was an element.

OCCURRENCE.

This substance does not occur free in nature. When we come to study its properties and find out what an active element it is, we shall not be surprised that, outside the laboratory, it is always found in combination. Its commonest compound, and the one from which it is always manufactured is sodium chloride, NaCl, common salt; and, when we remember what an enormous quantity of salt there is in the oceans, in salt springs and in the solid form of rock salt, we see that chlorine in combination occurs in large quantities. Small quantities of it are found in combination with elements other than sodium such as potassium, magnesium and silver.

PREPARATION:

Chlorine is usually prepared either from hydrochloric acid or from common salt.

In preparing chlorine from hydrochloric acid the hydrogen is removed by causing it to combine either with free oxygen or with oxygen in combination. The usual laboratory method is to use combined oxygen in the form of manganese dioxide. About twenty grams of manganese dioxide are covered with concentrated hydrochloric acid in flask. The apparatus is as given in fig. 43, page 130, Sutcliffe. Shake the contents and heat. Chlorine is given off, dried by being passed through concentrated sulphuric acid and collected in a gas jar. Since chlorine is heavier than air, the air will be displaced from the jar upwards, while the chlorine goes downwards.

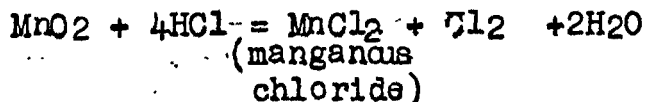

The manganese dioxide in this reaction does not act as a catalytic agent because there is no manganese dioxide left at the end. It is used up, and appears in the manganous chloride and water.

In preparing chlorine from common salt the salt is mixed with manganese dioxide and concentrated sulphuric acid when the following reactions take place. The sulphuric acid acts on the salt forming sodium sulphate and hydrochloric acid.



The sulphuric acid also acts on the manganese dioxide to form manganous sulphate, water and one atom of nascent oxygen. (It is called nascent oxygen because it has just come into existence and has not had time to combine with another atom of oxygen to form a molecule before it combines with some other element in the mixture.)



The nascent oxygen reacts with the hydrochloric acid which has been formed in the mixture, giving water and chlorine.

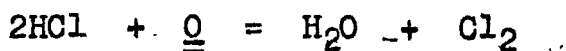

When all these reactions are written in one equation it is as follows:-

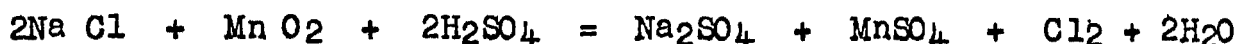

The substances on the left hand side of the equation are those which were put into the flask and those on the right hand side are what was obtained at the end. The hydrochloric acid and oxygen are intermediate products and so do not enter into the final equation.

### PROPERTIES:

Chlorine is a greenish-yellow gas, the name being derived from the Greek, "chloros" meaning "greenish yellow". It has a peculiar suffocating odour and when breathed pure, produces a violent effect on the throat and lungs and may cause death. It is soluble in water and fairly easily liquefied. It is about two and a half times as heavy as air and 35.5 times as heavy as hydrogen, i.e., its density is 35.5.

Chlorine does not combine with oxygen under any ordinary conditions, but it has a strong affinity for hydrogen. A jet of burning hydrogen will continue to burn if passed into a jar of chlorine, hydrochloric acid being produced, the two gases combining in equal volumes. If a mixture of hydrogen and chlorine in equal volumes be prepared it may be kept indefinitely in the dark; but combination takes place slowly in diffused daylight and with explosive violence in strong sunlight.

Chlorine, in the presence of water, has a powerful bleaching and disinfecting action. Strips of coloured cotton, or flowers, introduced dry into chlorine are not much affected but if moist they are rapidly bleached. This is due to the fact that chlorine acts on water combining with the hydrogen and setting free the oxygen.

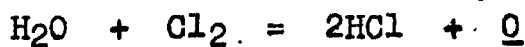

It is this oxygen that does the bleaching, converting the coloured compounds into colourless oxidised products. The disinfecting action of chlorine is explained in a similar way, the germs really being destroyed by the oxygen liberated from the water present. It may be asked why should this oxygen do the bleaching when the oxygen in the air did not destroy the colour of the cotton or flowers? It is because the oxygen is in the nascent state. Since each atom has just been "born" and has not had time to combine with another oxygen atom it is actively searching for another atom to form a molecule with. Thus it is in a more active condition than when it is in the molecular state, as in the air.

Chlorine combines with many metals and also with many non-metals forming chlorides with them, e.g.,

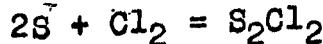
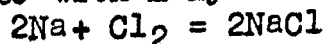

It also reacts with cold sodium or calcium hydroxide to form sodium or calcium hypochlorite.

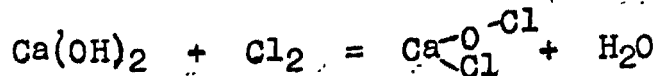
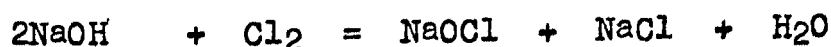

Calcium hypochlorite, or "chloride of lime" gives up its chlorine very readily and so is used as a source of chlorine for bleaching.

Chlorine for industrial purposes is frequently supplied in the liquid form in strong steel cylinders. It is also driven into slaked lime, forming with it a compound chloride of lime, or bleaching powder, which is easily handled and from which the chlorine is easily liberated when wanted. It is used for bleaching cotton, linen, wood pulp, etc., but not for wool or silk as it hardens and destroys them. It is also employed for chlorinating water supplies, in order to destroy any disease germs that they may contain.

---

CARBOHYDRATES:

POLYSACCHARIDES:

STARCH  $(C_6 H_{10} O_5)_n$

OCCURRENCE:

Starch is the form in which most plants store the largest part of their carbohydrate material, and is of great importance as a constituent of many natural foods and as the source of dextrin, maltose, commercial glucose, and many fermentation products. Starch is found stored in the seeds, roots, tubers, bulbs and sometimes in the stems and leaves of plants. It constitutes one half to three fourths of the solid matter of the ordinary cereal grains and at least three fourths of the solid matter of mature potatoes. Unripe apples and bananas contain much starch which is to a large extent changed into sugars as those fruits ripen while, on the other hand, young, tender maize kernels and peas contain sugar which is transformed into starch as these seeds mature.

PROPERTIES:

Unchanged starch occurs in distinct granules, and those formed in different plants vary in size and structure so that in most cases the source of a starch which has not been altered by heat, reagents or ferments can be determined by microscopical examination. The microscopical appearance of starch grains from different sources is shown in Cornish, page 22.

Starch grains are scarcely affected by cold water; on warming they absorb water and swell. Finally, the starch passes into a condition of colloidal dispersion or semi-solution "starch paste". Starch which has been heated in water (either admixed or naturally present with the starch as in a potato) until the granules are ruptured and the material more or less dispersed is very much more rapidly hydrolysed by digestive ferments than is raw starch. This is one of the ways (perhaps one of the most important) in which cooking improves the digestibility of a food. That raw starch may, nevertheless, be quite thoroughly digested is also a well-established fact recently emphasised anew by the work of Langworthy and his collaborators.

On hydrolysis, by means of acid, starch gives glucose as an end product, dextrose and maltose being intermediate products. When brought in contact with saliva, starch is hydrolysed by the enzyme ptyalin with the formation of dextrin and maltose. Starch is coloured intensely blue when treated with iodine. It does not reduce Fehling's solution. Being a colloid starch will not pass through an animal membrane.

DEXTRIN:

The dextrins, of which there are several varieties, are slightly

hydrolysed derivatives of starch. They are more soluble than the starches and the dextrin molecules while very large and complex are probably not over one fifth the size of the starch molecules from which they are derived. Dextrin is a gummy substance and is known as British gum. One of the dextrans, erythrin dextrin gives a red colour with iodine. Their other properties are like those of the starches.

#### CELLULOSE:

Cellulose is the chief constituent of wood and of the walls of plant cells generally. It is practically indigestible in the human body but serves a useful purpose in giving bulk to the food residue, and thus facilitating their passage along the digestive tract. It can be hydrolysed to glucose by boiling with acid.

#### GLYCOGEN:

Glycogen plays much the same part in animals as starch plays in plants and is sometimes called "animal starch". It is a white amorphous powder, odourless and tasteless, which swells up and apparently dissolves in cold water to an opalescent colloidal solution. Water solutions of glycogen are readily precipitated by alcohol. When treated with iodine they give a yellow-brown, red-brown or deep red colour. Hydrolysis of glycogen yields glucose only as an end product. Glycogen does not reduce Fehling's solution.

#### PRACTICAL WORK:

- (a) Prepare thin starch paste in the following manner:-  
Rub a little powdered starch into a paste with cold water, then add boiling water. Stir and boil for a few minutes. Cool.
- (b) Add a few drops of iodine to some of the cold starch paste and note the colour which results. Heat the mixture and observe the effect. Cool. What happens?
- (c) Mix equal quantities of starch paste and Fehling's solution and bring to the boil. Does reduction take place?
- (d) Test some starch paste with litmus paper.
- (e) Cut a small potato across and put a drop of iodine on it. Note colour.
- (f) Make a solution of caustic soda containing a level teaspoonful of caustic soda to 50 ccs water. Unravel a few threads of some cotton material and place in the solution. Note the alteration in appearance.

#### WORK TO BE SENT IN:

- I. Practical book.
- II. Written work.

#### SECTION A:

1. Give the properties and uses of chlorine.
2. Chlorine bromine and iodine form the halogen family. From a consideration of the properties of these elements explain what is meant by the term "chemical family".
3. Explain the bleaching action of chlorine.
4. Name some of the distinguishing properties of starch. Why

should starchy foods be cooked? What is the effect of dry heat on starch?

SECTION B:

1. Distinguish carefully the differences between the preparation from common salt of (a) hydrogen chloride and (b) chlorine.
2. "Chlorine has a strong affinity for non-metals." Describe experiments to illustrate this statement.
3. What happens when chlorine water is kept for a week (a) in the dark, (b) in sunlight?
4. Name the different polysaccharoses and describe the properties and uses of two of them (other than starch).

ORGANISATION:

Period I.	Study assignment on Chlorine. Study Sutcliffe, pages 129-140.
Period II.	Study assignment on Carbohydrates. Study Cornish.
Period III.	Do practical work.
Period IV.	Revise work for study.
Period V.	Written work, Section A.
Period VI.	Written work, Section B.



This Set of Model Answers is the Property of the Education Department.

It is to be regarded as Confidential and is to be returned to the  
Department when asked for. BL. '36.

HOME SCIENCE.

SET 2.

THIRD YEAR.

SECONDARY DEPARTMENT.

SECTION A:

1. Chlorine is a greenish yellow gas with a suffocating odour. It is soluble in water, easily liquified and has a density of 35.5. It has such a strong affinity for hydrogen that it can take it out of combination with other elements. If hydrogen and chlorine gases are mixed and exposed to sunlight they will combine with explosive violence forming hydrogen chloride, HCl, the two gases combining in equal volumes. Chlorine has a strong affinity for many non-metals such as phosphorus and sulphur, and also for many metals. Chlorides are formed in both cases, e.g.,

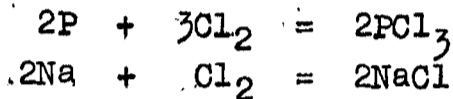

Chlorine reacts with calcium hydroxide to form calcium hypochlorite  $CaOCl_2$ , commonly called chloride of lime.

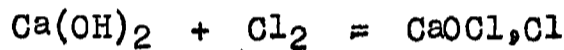

In the presence of water chlorine has a strong bleaching action. Chlorine is used as a bleaching agent and disinfectant for water supplies.

2. A chemical family consists of a group of elements of which the members exhibit very strong resemblances to one another, mainly in their chemical behaviour, although in their physical properties also there are well-marked gradations.

ELEMENT	ATOMIC WEIGHT	VALENCY	STATE	COLOUR	ACTIVITY.
Chlorine	35.5	1	gas	yellow-green	great
Bromine	80	1	liquid	red-brown	medium
Iodine	127	1	solid	grey-black	slight

It may be seen from the above table that as the atomic weight increases the members of the family increase in density and decrease in activity. They all have the same valency.

Chemically, their behaviour is very much alike. They all form similar compounds with hydrogen, e.g.,

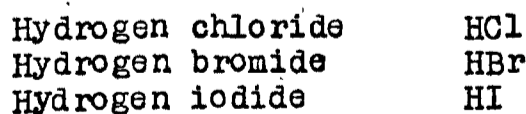

They form similar salts with metals, e.g.,  $HgCl_2$ ,  $HgBr_2$ ,  $HgI_2$ .

With sodium hydroxide they form sodium hypochlorite  $NaOCl$ , sodium hypobromite  $NaOBr$  and sodium hypoiodite,  $NaOI$

3. The great affinity of chlorine for hydrogen causes chlorine to be a powerful bleaching and oxidising agent. Chlorine only bleaches

Model Answers.

- 2 -

when water is present. The chlorine unites with the hydrogen of the water, and the oxygen set free,

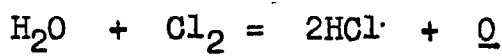

attacks the colouring matter and oxidises it into a colourless compound. Ordinary oxygen will not bleach. Evidently, the oxygen, at the instant it is set free from the water, has properties which it does not possess later. Such oxygen is spoken of as nascent oxygen. Nascent oxygen consists of atoms of oxygen before they have had time to form molecules of oxygen. These atoms are tremendously active seeking for something to form a molecule with. The first thing they meet is the colouring matter of the material to be bleached so they unite with it.

- 
4. (a) On addition of iodine, starch reacts to give a blue colour, which disappears on heating and returns on cooling.
- (b) On boiling with acid, starch is hydrolysed to glucose after which it will reduce Fehling's solution.
- (c) Starch is insoluble in cold water, but forms a colloidal solution in boiling water.
- (d) Starch does not reduce Fehling's solution.
- (e) Under the microscope, starch grains have a characteristic appearance depending on their source.

Starchy foods should be cooked because the moist heat causes the starch grains to swell and burst the cellulose envelopes, thus making it easier for the digestive juices to act on the starch.

When starch is heated dry in a crucible it first turns brown having become dextrinised and then it burns and turns black, carbon being set free and carbon dioxide being formed. Finally all the carbon combines with oxygen from the air and burns off as carbon dioxide.

This Assignment is the property of the Education Department. It is to be regarded as confidential, and is to be returned to the Department when asked for.

SECOND YEAR.

PHYSIOLOGY AND HYGIENE.

SET 6. JMP 36.

Study Lyster, pages 90 - 95.  
" First Aid, pages 147 - 151.

The alimentary or food canal. The oesophagus or gullet, the stomach, the small and large intestine. Their position and structure.

The alimentary canal consists of the tract that the food takes from the time it enters the mouth until its undigested part is expelled by the rectum.

In set 12, First Year Hygiene, is given the structure of the teeth and of the salivary glands of the mouth. Restudy this set. For those who have not taken a First Year course this set is enclosed, and written answers for Section B should accompany this work.

The food is taken into the mouth, broken down by the teeth, acted upon and moistened by the saliva. By muscular contractions it is forced down the pharynx into the gullet or oesophagus. (See diagram of pharynx set 4, sheet 1). The oesophagus descends behind the trachea in front of the vertebral column, and by muscular contractions (peristaltic contractions) carries the food through the diaphragm which it pierces into the upper or cardiac end of the stomach. Passing through the stomach the food is carried to the lower end, the pylorus, when it is taken into the small intestine. The upper part of the small intestine, the duodenum, about ten inches in length, bends upon itself and is fastened by the peritoneum membrane against the wall of the abdomen. The food then passes into the next part of the small intestine, the jejunum, into the ileum, the lowest part of the small intestine. Past the ileo-caecal valve the food is then passed into the large intestine, where its undigested parts are finally expelled by the rectum. During its course the food has passed along a distance of some 30 feet.

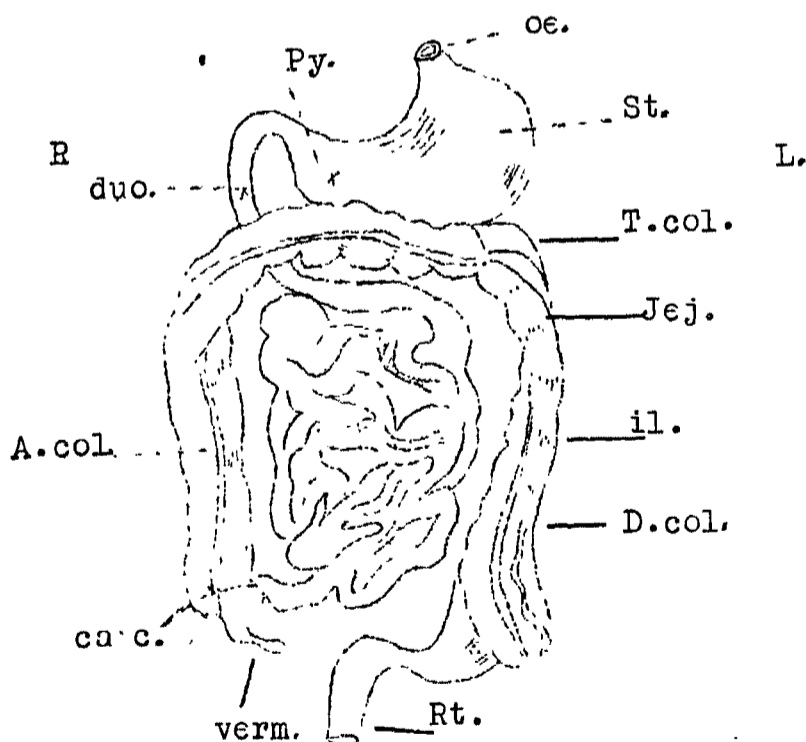

The alimentary canal in the abdomen.

R. right side	dus. duodenum	T.col. transverse colon
L. left side	jej. jejunum	D. col. descending colon
oe. oesophagus	il. ileum	R rectum.
st. stomach	caec. caecum	verm. vermiform appendix
py. pylorus	A.col. ascending colon.	(when inflamed this gives rise to appendicitis).

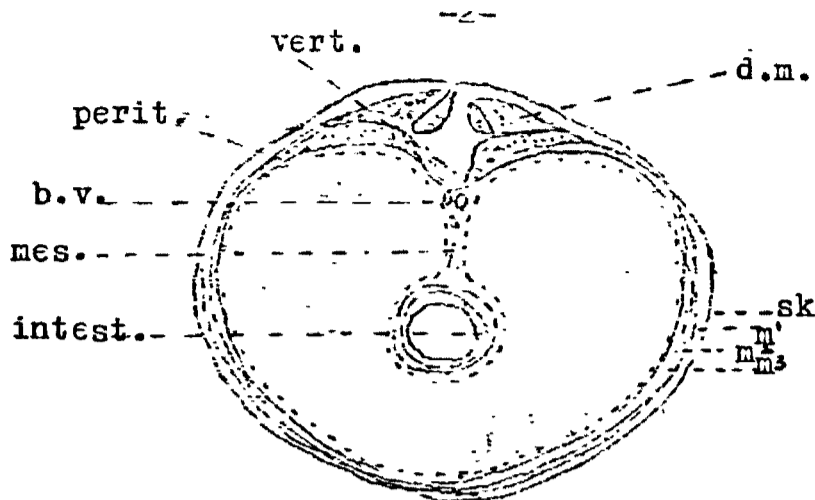

Diagram to show how the wall of the abdomen is made up and how the mesentery supports the intestine.

The body is supposed to be cut across, and the intestine is represented as the section of a straight tube. In reality the space between the intestine and the body wall is filled by the coils of the intestine and by other organs.

- vert. vertebra.
- d.m. muscles of the back.
- sk. skin.
- m<sup>1</sup>, m<sup>2</sup>, m<sup>3</sup>, the three muscle layers.
- perit. peritoneum.
- mes. mesentery.
- intest. intestine.
- b.v. blood-vessels.

#### THE OESOPHAGUS.

The oesophagus is about 10 inches in length. Its walls are composed of four coats:-

- (1) An external or fibrous coat.
- (2) A muscular coat.
- (3) A submucous or areolar coat.
- (4) An internal or mucous coat.

The muscular coat is arranged in an external longitudinal and an internal circular layer. Contraction of these layers produces movement, which propels the bolus of food to the stomach. The areolar coat acts as a padding tissue, and connects the muscular coat to the mucous coat. The mucous coat is disposed in longitudinal folds, which disappear when the tube is distended by the passage of food. It is studded with minute papillae and small glands which secrete mucus to lubricate the canal. No digestion nor absorption of food takes place in the oesophagus. It simply acts as a passage way from the mouth to the stomach. It receives nerve fibres from the vagus nerve system. It is nourished with blood from arteries from (1) the subclavian (2) the thoracic aorta (3) the gastric branch of the celiac artery and (4) a branch of the abdominal aorta.

#### THE STOMACH.

Like the oesophagus the walls of the stomach are formed of four distinct coats:-

- (1) An outer coat is a layer of the peritoneum, which covers the whole surface except along the greater and lesser curvature. It secretes a watery fluid, which lubricates the surface and prevents friction with other organs of the abdomen.
- (2) A muscular coat. This coat is very complex, and consists of three sets of involuntary muscular fibres. The outer set run longitudinally from the cardiac orifice at which the oesophagus enters towards the pylorus, and are continuous with the longitudinal fibres of the oesophagus.

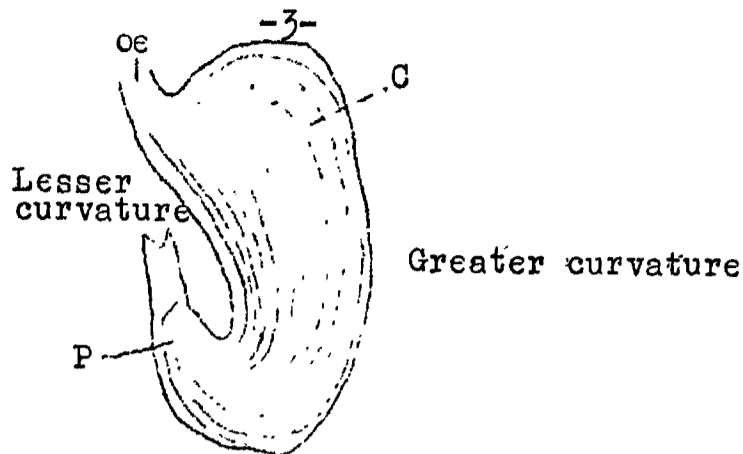
Assignment.

Muscular coat of the stomach.  
External layer of longitudinal fibres.

p. pylorus.  
 c. cardiac end.  
 oe. oesophagus.

The middle set of muscular fibres encircle all parts of the stomach. At the pyloric end they form a circular ring.

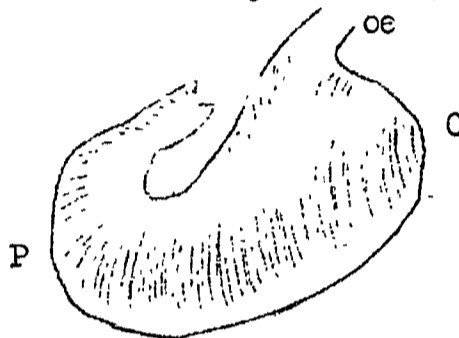

Muscular coat of the stomach.  
Middle layer of circular fibres.

p. pylorus.  
 c. cardiac end.  
 oe. oesophagus.

The inner set consist of oblique fibres. They are continuous with the circular fibres of the oesophagus, and exist chiefly at the cardiac end.

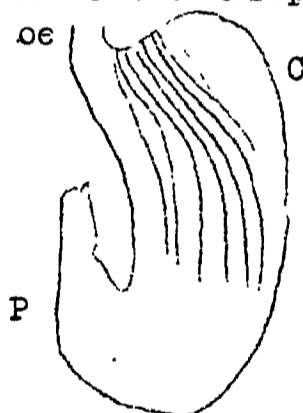

Muscular coat of the stomach.  
Inner layer of oblique fibres.

The cardiac end of the stomach is merely a reservoir for the food, and exerts a constant pressure upon it. It is the pyloric end which undergoes rhythmical movement or peristalsis.

The walls of the stomach are capable of great distension and are able to adapt themselves to the quantity of food contained. The circular muscular fibres at the pyloric end serve to keep it closed, but at certain intervals they relax, and allow the digested food to be ejected into the intestines.

The mucous membrane is smooth, level and soft when the organ is distended, but is drawn up into longitudinal folds when the stomach is empty. Its columnar goblet shaped cells secrete mucus to keep the surface moist. Its thickness is made up of long tubular glands, called gastric glands, which secrete gastric juice.

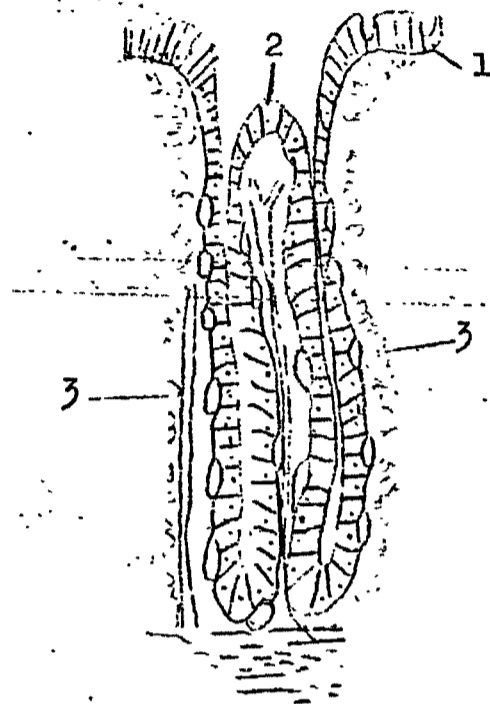

Peptic Gland from the Mucous Membrane of the Stomach.

The gastric or peptic glands consist of three types of cells:

- (1) Columnar goblet, which yield mucus.
- (2) Columnar cells, forming gastric juice.
- (3) Outer parietal cells, which secrete the hydrochloric acid.

When the stomach contains no food, the mucous membrane is very pale in colour, but as food is introduced, the supply of blood increases. The mucous membrane becomes a bright pink, and the secretion of gastric fluid commences.

#### SMALL INTESTINE.

Like the stomach it has also four coats.

- (1) An outer serous coat.
- (2) A muscular coat, composed of:
  - (a) External longitudinal fibres.
  - (b) Internal circular fibres.
- (3) A submucous coat of areolar tissue.
- (4) An inner mucous membrane, lined by columnar epithelium, and consisting of glands.

The mucous membrane of the small intestine is in part drawn up into folds, but to such an extent that they do not disappear when the tube is distended. These folds are called the valvulae conniventes. They serve:-

- (a) To increase the area of the secreting surface.
- (b) To prevent food passing too rapidly through the intestine.
- (c) To assist mixing of food with digestive juices, which pass into the intestines.

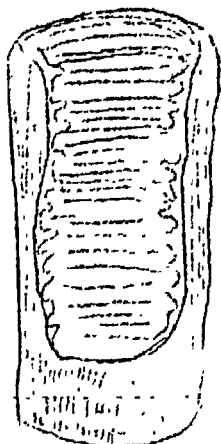

A portion of small intestine laid open to show the folds of the mucous membrane.

The mucous coat consists chiefly of glands, but these vary. Some are tubular and are arranged parallel to each other. They are known as crypts of Lieberkuhn. Others called Peyer's Glands are somewhat globular or ovoid in form, and are distributed singly or in groups (Peyer's Patches). Others again are minutely lobulated, and are so large as to be visible to the naked eye. The small intestine has two movements - Peristalsis, which is a slow onward movement and Segmentation, which consists of a sudden rhythmic subdivision.

The small intestine is about 23ft. in length. For description purposes it is divided into three portions:-

- (1) Duodenum.
- (2) Jejunum.
- (3) Ileum.

The duodenum is 10 inches long and is the shortest and broadest part of the small intestine. It extends from the pyloric end of the stomach to the jejunum.

The jejunum or empty intestine, so called because it is always empty after death, is about 7½ft. long. It ends in the ileum.

The ileum or twisted intestine, so called from its numerous coils, constitutes the remainder of the small intestine. Its junction at right angles with the large intestine, is guarded by a sphincter muscle.

THE LARGE INTESTINE is about 5ft. long. It is divided into four parts:-

- (1) The cecum, a blind pouch at the commencement of the large intestine.
- (2) The vermiform appendix, which when inflamed produces appendicitis. The gangrenous condition which it is subject to is due to its small 3 inch structure not allowing of ready drainage. Its blood supply is limited, and its circulation is easily checked. Its function is not known, but it is thought to act as a small lubricating canal.

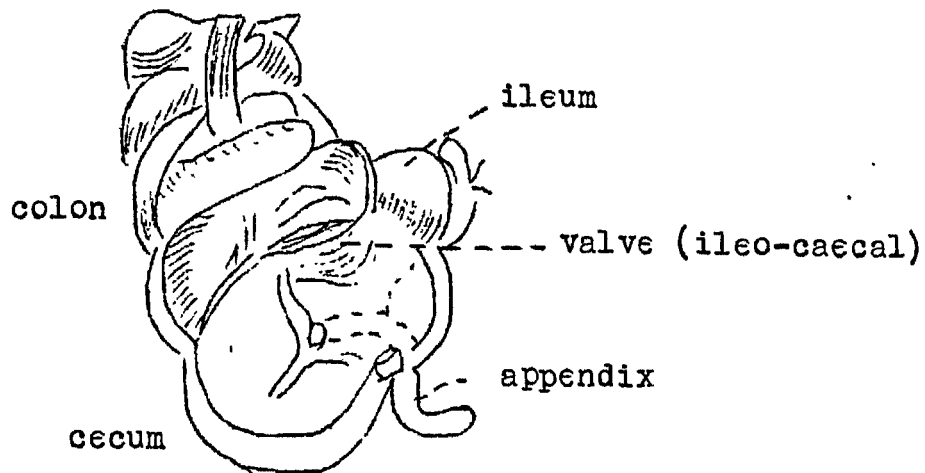

Cavity of the cecum, its front wall  
having been cut away.

THE COLON.

Though one continuous tube, the colon is subdivided into the ascending colon, the transverse or mesial, the descending colon and the sigmoid colon.

The ascending portion ascends on the right side of the abdomen until it reaches the under surface of the liver, where it bends abruptly to the left. It is continued across the abdomen as the transverse colon, until, reaching the left side, it curves beneath the lower end of the spleen, and passes downward as the descending colon. Reaching the ileum of the small intestine it makes a curve like the letter S - hence its name of sigmoid - and finally ends in the rectum.

THE RECTUM is about 5 inches long. It arises near the third sacral vertebra. It descends along the curve of the sacrum and the coccyx and finally bends sharply backward into the anal canal.

THE ANAL CANAL is the terminal portion of the large intestine, and is about 1 to 1½ inches in length. The external aperture called the anus is guarded by an internal and external sphincter (thickening of circular fibres of the muscular coat.)

PRACTICAL WORK.

Write observations clearly in your Practical Book. Draw illustrating diagrams.

- (1) If you are able to obtain a pig's stomach from the butcher, note the glistening peritoneum on the outside. Open it with the scissors and observe the folds into which the lining is thrown.
- (2) If able to obtain a rabbit, examine the contents of the abdomen fully with the aid of diagram on the next page. Cut open the small intestine and note the velvety feel of the villi.



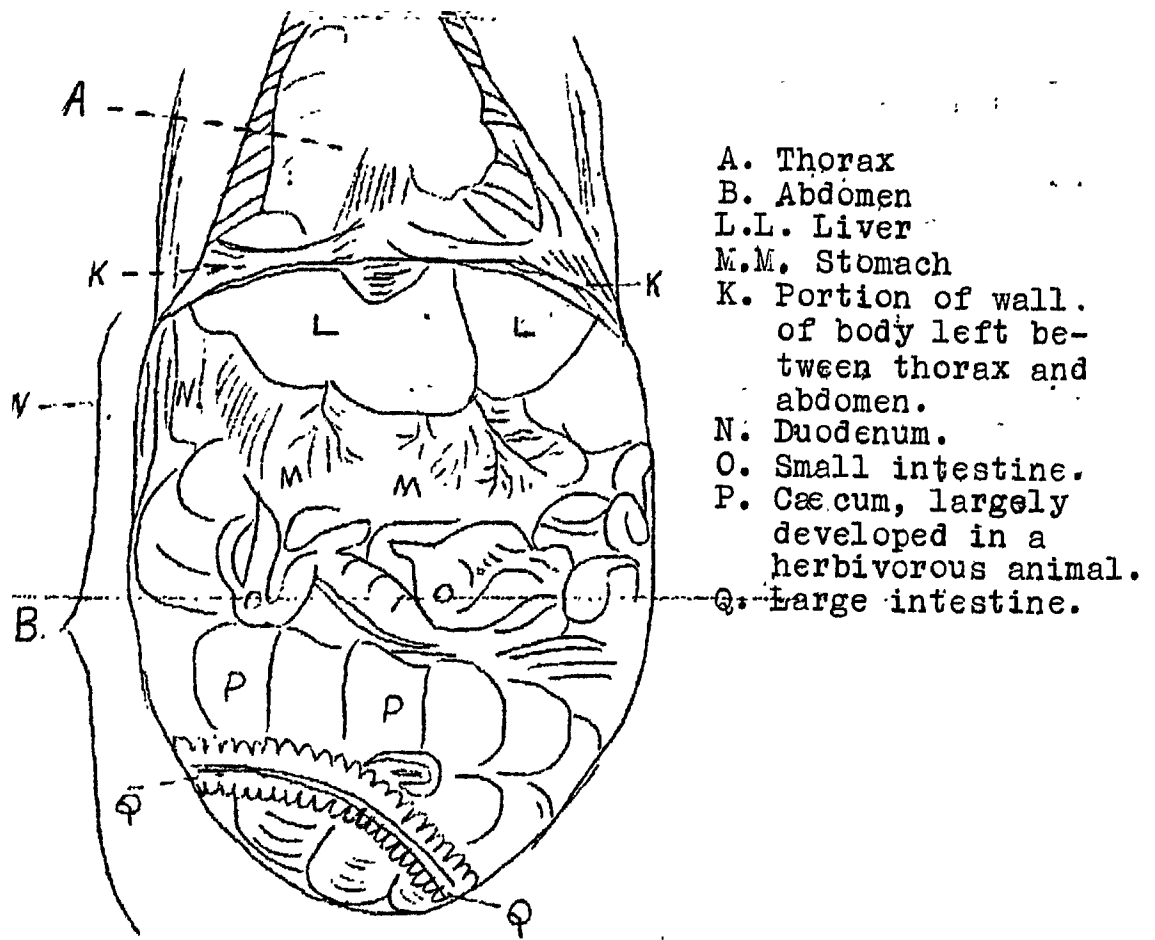

The viscera of a Rabbit.

(3) Examine some tripe obtained from your butcher.

SECTION A.

WRITTEN WORK:-

1. Describe the form, size, position, and structure of the oesophagus.
2. Describe carefully the course of the food from the time it enters the mouth until it reaches the anus (undigested part) of the large intestine. Give all the technical names of the parts of the various organs.
3. Describe the general appearance of the stomach:
  - (a) When the organ is empty.
  - (b) When food is introduced.

How does the cardiac end differ from the pyloric end in regard to the amount of food contained in the stomach.

Draw an illustrative diagram.

4. How does the mucous membrane of the stomach differ from that of the small intestine?

SECTION B.

1. Describe the structure of the walls of the stomach. Give illustrative diagrams.
2. Describe the sectional parts of:
  - (a) The small intestine.
  - (b) The large intestine.
3. Draw a diagram from memory of the abdomen of a rabbit, naming all the organs of the alimentary canal proper.

It is to be regarded as confidential, and returned to the Department when asked for.

SECOND YEAR. PHYSIOLOGY AND HYGIENE. SET 3, VF.36.

SECTION A.

1. The blood is carried by the aorta and its branches to all parts of the body. In the tissues the blood-vessels break up into tiny capillaries whose walls are so thin that they allow of a free exchange between the blood and the fluids which permeate the adjacent tissues. The red corpuscles give up a good deal of their oxygen for the purposes of oxidation. The combination of oxygen and haemoglobin is so loose that oxygen is readily yielded where needed. The reduced red corpuscles become darker in colour, and the blood appears dark crimson or venous "blue". Further the tissues yield to the blood their waste carbonic acid. Filled with venous blood the capillaries unite and unite to form larger vessels or veins. The veins unite in the upper part of the body to form the superior vena cava, and in the lower part to form the inferior vena cava, both of which empty their contents into the right auricle. When the right auricle contracts this venous blood is forced into the right ventricle past the mitral valve. When the right ventricle contracts the blood is forced past the three semilunar valves into the pulmonary artery. The pulmonary artery immediately divides into two, one branch going to each lung. In the lungs the carbon dioxide of the venous blood is breathed out while the oxygen of the air is breathed in. Thus venous blood again becomes bright red arterial blood, and is carried back to the left side of the heart by the four pulmonary veins.

2. RED CORPUSCLES WHITE CORPUSCLES

i. They consist of rounded discs when seen lying flat. When turned upon their sides they are seen to be bi-concave discs.

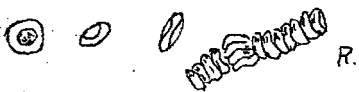

In the field of a drop of blood viewed under the microscope several discs are seen running together to form rouleaux R. The red corpuscles do not contain a nucleus. They are soft, flexible and elastic bodies and readily squeeze through apertures of the tiny capillaries, which are narrower than their own diameter. They readily regain their shape.

i. They are irregular in form and much larger than the red corpuscles. They contain a nucleus. They are seen to be continually changing their form and shape. They consist of a clear jelly-like substance, called protoplasm. They resemble in form, shape and structure the small one-celled animal, the amoeb.

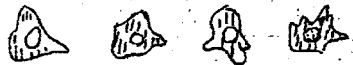

By means of their amoeboid movements they can travel in a direction opposite to the flow of the blood.

ii. There are 500 red corpuscles to every one white corpuscle.

ii. Fewer in number.

iii. The red corpuscles contain a colouring matter, haemoglobin, which has a great affinity for oxygen. The function of the red corpuscles is to obtain oxygen from the air and to yield it up to the tissues. They are often called the oxygen-carriers of the blood.

iii. When a poisonous matter gains access to the blood the white corpuscles by means of their amoeboid movements quickly surround and arrest it. Often many lives of white corpuscles are surrendered in arresting and destroying the harmful foreign body. Pus consists of dead white corpuscles.

3. When blood leaves the body it has the tendency to quickly coagulate or clot. This is due to the elements of fibrin. The fibrin entangles the red and white corpuscles and holds them in the form of a clot. The liquid plasma deprived of its fibrin separates as a pale yellowish liquid known as serum. The clot floats in the liquid serum.

If blood, which is freshly drawn from an animal, be at once beaten by a twig, clotting is prevented. The fibrin is then formed very quickly. It collects upon the twig, and is thus prevented from entangling the corpuscles. The blood thus treated is known as defibrinated blood.

Warming of the blood when drawn from the animal will hasten clotting, while blood reduced to freezing point will be prevented from clotting for a long period. The addition of neutral salts will also prevent clotting.

Haemorrhage in the scalp may be arrested by applying a small firm pad on the bleeding point. This pad should be secured in position by a narrow bandage with its centre laid on the pad. The ends of the bandage should be carried around the head in the most convenient direction and tied tightly and firmly over the pad itself.



This set of Model Answers is the property of the Education Department.

It is to be regarded as confidential, and is to be returned to the

Department when asked for.

SECOND YEAR.

PHYSIOLOGY AND HYGIENE.

SET 6. JMP 36.

1. The oesophagus is the narrowest portion of the alimentary canal. Its length is about 10 inches. It serves as a connecting channel between the mouth and the stomach. Before reaching the latter organ it pierces the partly muscular and partly tendinous diaphragm (the partition wall between the chest and abdomen). Its walls consist of four coats:

- (a) An outer fibrous.
- (b) A muscular coat of outer longitudinal and inner circular fibres.
- (c) A submucous or areolar coat, which contains blood-vessels and nerves.
- (d) A mucous layer of papillae and mucous glands.

2. The food is taken into the mouth, broken down by the teeth, and moistened and acted upon by the saliva. By means of the tongue it is then formed into a bolus, and by muscular contractions of the pharynx is voluntarily forced into the gullet or oesophagus. The food is here forced downwards by the wave-like contraction of the muscular fibres just above it, a relaxation of the fibres just below it. This action is performed by involuntary muscular movement, and receives the name of peristalsis. Having reached the cardiac end of the stomach, the food is here subjected to merely pressure. The gastric juices, however, keep the food revolving around so that all parts may be acted upon. As it is gently pressed towards the pyloric end, rhythmic peristalsis is set up. At intervals the pylorus is relaxed, and food is ejected into the upper part of the small intestine, the duodenum. Here the food is carried along for ten inches, when it passes into the jejunum. Traveling along the jejunum for  $7\frac{1}{2}$  ft. the food then passes into the ileum. Here it has the most winding part in its course, and travels a distance of some 13 feet, when it is forced by a sphincter muscle into the large intestine at a right-angled junction. This orifice by the valvular action of its muscles does not allow the food to be carried back into the small intestine. For  $2\frac{1}{2}$  inches the food passes along what is known as the cecum, and then goes past the vermiform appendix into the ascending colon. Carried transversely across the transverse colon, it then descends in the descending colon into the rectum, and then into the anal canal.

3. When the stomach is empty it is very pale in colour. The fibres of the vagus nerve supplying the organ, control its blood supply. When food is taken into the stomach there is an increased supply of blood to enable the glands to secrete their digestive juice. The cardiac end of the stomach acts as a storehouse for the food taken into it, and simply exerts gentle pressure upon it until it is fully acted upon by the digestive juices. The pyloric end by means of its sphincter muscle discharges the partly digested food into the small intestine.

4. The mucous membrane of the stomach is smooth, soft and level. It is composed of tubular peptic glands, containing goblet cells and parietal cells.

The mucous membrane of the small intestine is thrown into a series of folds which give it a velvety feeling.

The purpose of these folds is to increase the surface area of the digestive secreting glands.

A. Peyer's glands, surrounded by tubular glands.



A small portion of mucous membrane of the small intestine.



2. Aucun and pas un are used alone, in a negative sense, in replies to questions.

Y a-t-il quelque danger ? Aucun.  
Is there any danger ? None.

Reste-t-il quelques marteaux ? Pas un.  
Are there any hammers left ? Not one.

L'un .... l'autre.

1. Autre and un, usually accompanied by the definite article, and united by the conjunctions, et, ou, and ni, are used both as indefinite adjectives and pronouns.

L'une et l'autre armée. L'un et l'autre vous ont aidé.  
Both armies. Both have helped you.

A l'une ou à l'autre gare. L'un ou l'autre viendra.  
At either station. One or the other will come.

Ni à l'une ni à l'autre gare. Ni pour l'un ni pour l'autre.  
At neither station. For neither.

2. They also occur in both genders and numbers as pure pronouns in such sentences as the following.

L'un ne veut pas de maître, et l'autre pas d'égal.  
The one will have no master, the other no equal.

Les uns étudiaient et les autres jouaient.  
Some were studying and others playing.

Ce qui déplaît aux uns plaît aux autres.  
One man's meat is another's poison.

3. In the reciprocal pronoun l'un l'autre (each other, one another) l'un is always the subject, while l'autre is either the object or is governed by a preposition. In the former case the reflexive pronoun must be used with the accompanying verb.

Elles se haïssent l'une l'autre.  
They hate each other.

Ils sont contents l'un de l'autre.  
They are satisfied with each other.

Personne, rien.

1. Personne and rien, originally positive, with the meanings any one and anything, are now more usually negative, with the meanings no one and nothing. In the latter sense they are accompanied by ne, except in answer to a question.

Je n'ai rencontré personne. Rien ne les a retenus.  
I have met no one. Nothing has restrained them.

Qui l'a dit ? Personne. Qu'avez-vous ? Rien.  
Who said so ? No one. What is the matter with you ?  
Nothing.

2. You have learnt that in compound tenses the second part of the negative is placed in between the auxiliary and the past participle. However, personne does not follow this rule and is placed after the past participle.

e.g., Je n'ai vu personne.  
I saw no one.

3. When personne and rien are the subject of the sentence

they are placed before the verb.

e.g., No one has come.  
Personne n'est venu.

Quelque chose, quelqu'un.

1. When the English any one, some one, anything, something, are used with a purely positive force they must be rendered by quelqu'un and quelque chose or, if the word any is very emphatic, by qui que ce soit, quoi que ce soit.
2. quelque chose, something, is a neuter indefinite pronoun, often followed by de and an adjective.

Ils ont appris quelque chose de fâcheux.  
They have had some bad news.

On crie toujours contre quelqu'un ou quelque chose.  
People are always calling out against somebody or something.

3. A similar construction is used after rien.

e.g., Il n'y a rien de plus noble.  
There is nothing nobler.

4. The pronoun quelqu'un, quelqu'une, quelques-uns, quelques-unes: (some one, somebody, any one, anybody, some, any) corresponds to the indefinite adjective quelque. Unlike personne, it has a purely positive meaning.

On crie toujours contre quelqu'un.  
People are always crying out against some one.

Quelqu'une de ces demoiselles.  
One of these young ladies.

Quelques-uns assurent le contraire.  
Some affirm the contrary.

Achetez quelques-unes de ces gravures.  
Buy some of these engravings.

On.

1. On (Latin, homo) (one, people, they, you, we,) is used much more widely than our English pronoun one. It is only used in the nominative case.

quand on parle du loup, on en voit la queue.  
Talk of the devil and his horns will appear.

2. L'on is preferred to on after a vowel sound, especially after et, si, ainsi, eu, où, qui, quoi, in order to avoid hiatus.

Le moment où l'on arrive.  
The moment of arrival.

But on is preferred if immediately followed by le, la, les, lui, or leur.

Si on l'entend.  
not Si l'on l'entend.  
If he is heard.

Written work: page 164, Exercise 18.

Section A: Do question 5 (a) - (g).

Section B: Do question 4. In sentence (e) of question 1 use the singular tout (everything).



3. Read Lesson 18 A, page 40.

Notes:

1. le fabuliste grec: page 79, paragraph 31.
2. av. J.-C. = B.C. (in dates).
3. il avait le corps difforme: page 75, paragraph 18.
4. quoi qu'il en soit. Indefinite expressions like quoi que, etc., take the subjunctive. Note also the difference between quoi que (indefinite pronoun) and quoique (conjunction) = although. Both require the subjunctive.
5. un tel corps: page 96, paragraph 126 note.
6. de les y vendre = to sell them there. Note this use of y meaning there.

Questions, pages 41-42. Answers in French.

Section A: Do the odd numbers in 1-9 orally.

Section B: Give written answers to the even numbers in 2-8.

---

4. Read Lesson 18 B, pages 40-41.

Notes:

1. ne voulut même. The adverb même = even.
2. n'importe quoi = anything; tout = everything.
3. jusque-là = up to then; jusqu'ici = up to now.
4. il ne me reste plus rien à faire = there remains nothing more for me to do. The verb il reste is used impersonally. See page 124, paragraph 201 (d).
5. si je t'achète: page 111, paragraph 155.
6. et non pour son corps: page 138, paragraph 221.
7. plurent au philosophe: to please = plaire à.
8. pardessus le marché = into the bargain.
9. si vous voulez acheter = if you will buy. When will = to be willing, it is not a sign of the future; vouloir must be used.

Questions, page 42. Answers in English.

Section A: Give written answers to the odd numbers in 11-19.

Section B: Do the even numbers orally.

---

5. Read Lesson 18 C, page 42.

Notes:

1. ce qu'il y avait de meilleur = the best there was. See Notes 1, page 97, paragraph 129.
2. lier = to bind, tie; le lien = the bond.
3. la clef (la clé). The f is silent.
4. un organe = an organ, mouthpiece; une orgue = an organ (a musical instrument).

Written work:

Section A: Write out from your text book page 96, Note in paragraph 126.; page 97, paragraph 129, Notes 1 and 2 (b) and (c).

Section B: page 165, Exercise 18, question 3. Note that indefinite pronouns or adjectives must be used. Note also that in sentence (b) acheté should be used instead of achetées.

---

6. Irregular Verbs.

Revise the following verbs which occur in Lesson 18.

1. prendre, prenant, pris, je prends, je pris. See page 130.

As the present participle is prenant the imperfect tense is je prenais, etc.

- 2. croire, croyant, cru, je crois, je crus, page 130. Be careful to distinguish this verb from croître (to grow) which is also given on page 130.
- 3. conduire, conduisant, conduit, je conduis, je conduisis, page 128.
- 4. plaire, plaisant, plu, je plais, je plus, page 130. Note: to please anyone = plaire à quelqu'un.
- 5. dire, disant, dit, je dis, je dis, page 134.
- 6. se plaindre, se plaignant, plaint, je me plains, je me plaignis. All verbs in -aindre, -eindre, -oindre are conjugated like craindre, page 128, but remember that se plaindre is a reflexive verb and therefore requires être instead of avoir in the compound tenses.

e.g., I have complained of it = je m'en suis plaint.  
 I had complained of it = je m'en étais plaint.

- 7. connaître, connaissant, connus, je connais, je connus, page 130. Note that all verbs in -aître have a circumfix accent on the i whenever it is followed by t. e.g., il connaît, je connaîtrai.

The difference between savoir and connaître is explained in Lesson 18 D, page 42. Note that connaître, to know (recognise), is used of persons, places, things. Savoir, to know (by heart) is used chiefly of facts. You should therefore use savoir when que plus a clause follows.

e.g., Je connais cet homme. Je sais qu'il est jeune.  
 I know that man. I know that he is young.

Written work:

Section A: Write out, without English meanings, the perfect and pluperfect tenses of se plaindre.

Section B: Write out in three columns the 1st person plural imperfect, the 3rd person singular present indicative, the 3rd person plural preterite of

dire, croire, plaire, conduire, connaître.

- 7. Phonetics. Revise sounds u and y, page 73. See also Chapter 7, page 28 and Chapter 9, page 32.

Written work:

Section A: Write down the following words and give the phonetic spelling also:-

le troupeau	sur la rue
une plume	qu'il eût
août	le nouveau journal.

8. Contes Mythologiques.

- A. Read Actéon, pages 11-14.

Written work: Section A: Page 99, Actéon. Give answers in French to the odd numbers in A.

- B. Read Phaéton, pages 15-18.

Written work: Section B: Translate into English page 15, second paragraph; page 16, lines 17-30.

As you have a fortnight in which to do this set, you should read Actéon during the first week, and Phaéton during the second week. Do not try to do all the reading at once.

---

9. Prose. Section B: Page 165, Exercise 18, question 10.

Notes:

1. I am sure you will admit: page 95, paragraph 117.
  2. no writer has ever had; Have you ever heard anything finer. Jamais and rien can be used with an affirmative meaning in sentences which contain a negative idea or express doubt, e.g.,  
Si jamais je deviens riche. (If I ever become rich).
  3. I wonder what the guests said; to prove that what is the best; page 94, paragraph 116.
  4. For is not the tongue: page 107, paragraph 141.
  5. old Aesop: page 75, paragraph 13.
  6. to be right = avoir raison,  
to be wrong = avoir tort.
- 

10. Composition: Section A:

Read question 1 again. Imagine that you are the Indian merchant and write a letter to a friend describing the incident. You may use the words given in question 1, but there are two important changes that will have to be made.

1. The 1st person will have to be substituted for the 3rd person.
2. The perfect tense will have to be used instead of the preterite.

Note: In conversation and conversational narrative (including letter-writing) the perfect tense is used instead of the preterite. This very important rule is explained on page 119, paragraph 167. Thus instead of saying je m'arrêtai, j'ouvris, etc., you must say, je me suis arrêté, j'ai ouvert, etc. You will therefore need to revise the perfect tense, page 103, and the perfect tense of reflexive verbs, page 115. Note that the imperfect tense remains unaltered; only the preterite is changed to perfect.

---

This Set of Model Answers is the Property of the Education Department.

It is to be regarded as Confidential and is to be returned to the  
Department when asked for. BL. 36.

FRENCH.                    THIRD YEAR.                    SET 4.                    SECONDARY DEPARTMENT.

SECTION B:

1.                    A Monkey Trick.

An Indian merchant was passing one day through a large forest, and as it was very warm, he stopped to rest towards mid-day under a large tree. He opened a box which contained several dozen cotton caps. He took one of them, put it on his head (literally put it to himself on the head), and went to sleep without delay. When he awoke he found that his box was empty; there remained no longer any of his merchandise! The poor Indian began to lament. Suddenly he raised his eyes and saw in the branches of the tree a troop of monkeys. Each one of them was wearing a cotton cap on his head, and was looking at the merchant curiously. He shook his fist at the thieves. The latter immediately imitated him with grimaces. Then a happy idea came to the Indian. He threw his cotton cap on the ground, and immediately all the monkeys did likewise.

2. Page 164, Exercise 18, question 1.

- (a) Chacun saisit son fardeau.
- (b) Chacune resta chez elle.
- (c) quelques-uns disent qu'il est bossu.
- (d) quelques-unes pleuraient.
- (e) Tout est beau.
- (f) Tous crièrent à la fois.
- (g) L'un pleurait, l'autre criait.
- (h) Les uns pleuraient, les autres criaient.

3. questions, page 41 (2-8).

- 2. Il vivait environ 600 ans av. J.- C.
- 4. Un bossu est un homme qui a une bosse au dos; un bancal est un homme qui a les jambes tordues.
- 6. Ses compagnons se moquèrent de lui parce qu'il se chargea sur l'épaule un gros panier de pain.
- 8. Maintenant il n'eut rien à porter que le panier vide.

5. Page 165, Exercise 18, question 3.

- (a) quelques jours après il fut envoyé à Ephèse.
- (b) Il les aime toutes; il en a acheté quelques-unes.
- (c) Je voudrais avoir une autre maison.
- (d) Il n'a rien à dire.
- (e) Empruntez un livre à un voisin quelconque.
- (f) L'un est fermier, l'autre est charbonnier.
- (g) Ils se moquent l'un de l'autre.
- (h) Achetez quelque chose de bon.
- (i) N'achetez rien de mauvais.
- (j) Tu n'as bon à rien.

6. Irregular Verbs.

<u>Imperfect.</u>	<u>Present.</u>	<u>Preterite.</u>
nous disions	il dit	ils dirent
nous croyions	il croit	ils crurent
nous plaisions	il plaît	ils plurent
nous conduisions	il conduit	ils conduisirent
nous connaissions	il connaît	ils connurent

Note that all verbs in aître have a circumflex accent on the i whenever it is followed by t. Thus il connaît, il connaîtira.

8. Contes Mythologiques, page 15. (second paragraph).

This fiery chariot was drawn by four winged horses, animals so frisky that it was difficult to drive them. But Phoebus was a skilful driver, and once he held the reins in his hand, the horses were forced to obey him. During these daily journeys, Phoebus saw everything that happened on the earth, and he took an interest in men and events.

page 16. (lines 17-30).

But he was very surprised to learn what Phaethon longed for most in the world. It was to drive, once only, his father's chariot from the East to the West! In vain did Phoebus explain to the young man that it was an extraordinarily difficult task, that only a god could accomplish it, that the winged horses would not obey anybody but him; Phaethon refused to listen to reason. His father had promised; he should keep his word.

And one fine morning, Phaethon, proud as a peacock, climbed into the fiery chariot. He took the reins and began his hazardous journey. At first all went well. The horses followed the path traced out for them in the sky.

9. Page 165, Exercice 18, question 10.

Si vous connaissez quelques-unes des Fables d'Esopé je suis sûr que vous admettez que nul (qu'aucun) écrivain n'a jamais eu plus d'esprit. Que pensez-vous de ses réponses aux questions du philosophe? Avez-vous jamais rien enendu de plus beau? Je ne crois pas. Et puis, le dîner de langues, qu'il servit à son maître, fut un chef-d'oeuvre. Je me demande ce que se dirent les hôtes lorsque le cinquième service fut mis sur la table! Et son explication quand son maître le pria de prouver que ce qui est le meilleur est aussi le pire. Vraiment, c'est étonnant. Car la langue n'est-elle pas l'organe du mensonge aussi bien que de la vérité? Oui, le vieil Esopé avait raison!

- A.10. In order to show you how the perfect tense is used in conversation and in conversational narrative, the following account of the incident described in question 1 is written in the first person. Note that all the preterite tenses have been changed to the perfect, while the imperfect tenses remain unaltered.

Model Answers.

- 3 -

A.10. (contd.)

L'autre jour je passais par une grande forêt et comme il faisait très chaud, je me suis arrêté vers midi sous un grand arbre pour me reposer. J'ai ouvert une boîte qui contenait plusieurs douzaines de bonnets de coton. J'en ai pris un, me le suis mis sur la tête et n'ai pas tardé à m'endormir. A mon réveil j'ai trouvé que ma boîte était vide; il ne restait plus rien de ma marchandise! J'ai commencé à me lamenter. Tout à coup, j'ai levé les yeux et j'ai vu dans les branches de l'arbre une troupe de singes. Chacun d'eux portait sur la tête un bonnet de coton, et me regardait curieusement. J'ai menacé les voleurs du poing. Ceux-ci m'ont imité aussitôt avec des grimaces. Il est venu alors une heureuse idée à moi. J'ai jeté mon bonnet de coton à terre et aussitôt tous les singes en ont fait autant.

---

ND YEAR

ARITHMETIC.

SET 4. VF.36.

Text-book, Loney and Grenville.

ST WEEK  
ERIOD 1.

COMPOUND INTEREST.-

Arrangements are sometimes made to leave any interest accruing on a sum of money, with the Principal, to earn in its turn more interest in succeeding years. Thus the Principal continually grows, and the interest becomes greater year by year. Sometimes the interest is added to the Principal every quarter or every half-year. This enables the interest itself to become profit-bearing earlier. Sums of money, allowed to accumulate at Compound Interest, grow in a remarkable manner. Thus a sum of money at 5% S.I. doubles itself in 20 yrs., but at Compound Interest in about 14 yrs.

Examples in which Compound Interest or Amount at Compound Interest are required are worked in decimals. We have a number of steps to perform, each consisting of finding the Simple Interest for 1 yr., and adding it to the principal for that year so as to obtain the principal for the ensuing year. To find one year's interest, we multiply by the rate and shift the decimal point two places to the left. We perform the equivalent of this operation by multiplying by the rate and writing the result two places to the right.

If there are shillings and pence in the principal express these as a decimal of a £, and strike out any figures beyond the 5th place of decimals. Don't write any figures beyond the 5th place. (Revise Decimalisation of Money from last year's work). The result will then be correct to 3 places, so that we can give the amount correct to the nearest penny.

EXAMPLE 1.-

Find the amount of £826.15.7 for 3 years at 4% C.I.

	$£826.15.7 = £826.77916$	
	$£826.77916 = \text{Prin. for 1st yr.}$	
4% of Prin.	<u>33.07116</u> = Int. " " "	15/7
	$859.85032 = \text{Prin. for 2nd yr.}$	
4% of Prin.	<u>34.39401</u> = Int. " " "	= 15 7/12/-
	$894.24433 = \text{Prin. for 3rd yr.}$	
4% of Prin.	<u>35.76977</u> = Int. " " "	= 15.583/-
	$£930.01410 = \text{Amt. at end of 3 yrs.}$	= £.77916
Amount:	$£930.0.3.$	£.014 20 280 12 <u>3.36</u>

EXPLANATION.- To get the first year's interest, we multiplied the first line by the rate, 4, and wrote the result two places to the right. The figures beyond the 5th place were omitted.

Adding the first two columns, we got the amount for the first year. This is the principal for the second year, so we multiply it by 4 and so on, repeating the steps just explained.

When changing the decimal of £1 to shillings and pence, use only the first 3 decimal places, i.e., use £.014. You must, however, correct the 3rd figure if necessary, i.e., if the 4th figure is 5 or over. e.g., £.01453 correct to 3 places is £.015. The 4th and 5th decimals are correcting figures and may not be accurate.

WHEN THE RATE IS PARTLY FRACTIONAL.-

Suppose the rate is  $3\frac{1}{2}\%$ . Then we find the interest in two steps - first multiply the principal by 3 and write the result two places to the right; secondly, to find  $\frac{1}{2}\%$ , divide the principal by 2 and write the result two places to the right.

Suppose the rate is  $4\frac{3}{4}\%$ . Now we must find the rate in 3 steps, multiplying in turn by 4,  $\frac{1}{2}$ ,  $\frac{1}{4}$ . In the last two

steps we can either divide the principal by 2 and then by 4, writing the result two places over to the right in each case, or else, after having found the  $\frac{1}{2}\%$ , divide this result by 2 to get  $\frac{1}{4}\%$ .

EXAMPLE 2.- Find the amount of £826.17.9 for 2 years at  $4\frac{3}{4}\%$  C.I.

	£826.8875	= Prin. for 1st yr.		
4% of Prin.	33.0755	}		
$\frac{1}{2}\%$ of Prin.	4.13443		= Int. for 1st yr.	
$\frac{1}{4}\%$ of Prin.	2.06721			
	866.16464	= Prin. for 2nd yr.	£.307	
4% of Prin.	34.64658	}	20	
$\frac{1}{2}\%$ of Prin.	4.33082		= Int. for 2nd year.	6.140
$\frac{1}{4}\%$ of Prin.	2.16541			12
	£907.30745	= Amt. at end of 2 years.	1.68	

Amount: £907.6.2.

To get line 3 we divided line 1 by 2 and carried the figures two places to the right. To get line 4, we could either divide line 1 by 4 and write the quotient two places to the right, or else divide line 3 by 2.

Note that when we are finding the interest each line of the working is obtained in one step by multiplication or division of a previous line. e.g.  $\frac{3}{4}\%$  is calculated as  $\frac{1}{2}\%$  +  $\frac{1}{4}\%$ . It must not be obtained by dividing by 4 and multiplying by 3.

Do Examples LXXVIII, page 134, no's 18, 20. Section A.

PERIOD 2.

Revise the method of working Compound Interest that you learnt last period. Do Examples LXXVIII, page 134, no's 19, 21. Section B.

PERIOD 3.

In some cases where the percentage is suitable the work can be simplified as follows:-

EXAMPLE 3.

Find the Compound Interest on £1269 for 2 years at  $3\frac{1}{3}\%$  per annum.

	$3\frac{1}{3}\% = \frac{1}{30}$		
	£1269	= Prin. for 1st year.	
$\frac{1}{30}$ Prin.	42.3	= Int. " " "	
	1311.3	= Prin. for 2nd year.	£.01
$\frac{1}{30}$ Prin.	43.71	= Int. " " "	20
	1355.01	= Amt. at end of 2 years.	.20
	1269		12
	£ 86.01	= C.I. for 2 years.	2.4

C.I. = £86.0.2

Note.  $2\frac{1}{2}\% = \frac{1}{40}$ ;  $1\frac{1}{2}\% = \frac{1}{80}$ .

EXAMPLE 4. Find the Compound Interest on £6000 for 2 years at  $3\frac{3}{4}\%$ .

$$3\frac{3}{4}\% = \frac{3}{80} = \frac{2}{80} + \frac{1}{80}$$

$$= \frac{1}{40} + \frac{1}{80} = \frac{1}{40} + \frac{1}{2} \text{ of } \frac{1}{40}$$



$\pounds 6000$  = Prin. for 1st yr.  
 $\frac{1}{40}$  Prin. 150 } = Int. for 1st yr.  
 $\frac{1}{80}$  Prin. 75 )  
 $6225$  = Prin. for 2nd year.

$\frac{1}{40}$  Prin. 155.625 } = Int. " " "  
 $\frac{1}{80}$  Prin. 77.8125 )

$6458.4375$  = Amt. at end of 2 years.

6000

$\pounds 458.4375$  = C.I. for 2 years.

C.I. =  $\pounds 458.8.9$

$\pounds 438$   
 $20$   
 $8.760$   
 $12$   
 $9.12$

TO FIND THE COMPOUND INTEREST WHEN THE INTEREST IS PAYABLE HALF-YEARLY OR QUARTERLY.

Suppose we have to find the Compound Interest on a certain sum for  $2\frac{1}{2}$  years at 5% per annum, interest payable half-yearly. Since the interest on  $\pounds 100$  for 1 year would be  $\pounds 5$ , the interest on  $\pounds 100$  for half a year is  $\pounds 2\frac{1}{2}$  - i.e., the interest is at  $2\frac{1}{2}\%$  per half year. In the above example we would have to work out the interest at  $2\frac{1}{2}\%$  for 5 half-yearly periods. Similarly, if interest is payable quarterly on a sum of money for  $1\frac{1}{4}$  years at 4%, the interest is worked out for 5 quarterly periods at 1% per quarter.

EXAMPLE 5. Find the Compound Interest on  $\pounds 127$  for  $1\frac{1}{2}$  years at  $4\frac{1}{2}\%$  payable half-yearly.

We require the amount at the end of 3 half-yearly periods, at  $2\frac{1}{4}\%$  per half-year.

	$\pounds 127$	= Prin. for 1st $\frac{1}{2}$ year.	
2% Prin.	2.54	} = Int. " " " "	
$\frac{1}{4}\%$ Prin.	.3175		
	<u>129.8575</u>	= Prin. for 2nd $\frac{1}{2}$ year.	
2% Prin.	2.59715	} = Int. " " " "	
$\frac{1}{4}\%$ Prin.	.32464		
	<u>132.77929</u>	= Prin. for 3rd $\frac{1}{2}$ year.	$\pounds 767$
2% Prin.	2.65558	} = Int. " " " "	$20$
$\frac{1}{4}\%$ Prin.	.33195		
	<u><math>\pounds 135.76682</math></u>	= Amount at end of $1\frac{1}{2}$ years.	<u><math>15.340</math></u>
	<u>127</u>		<u><math>12</math></u>
	<u><math>8.767</math></u>	= C.I. for $1\frac{1}{2}$ years.	<u><math>4.08</math></u>

C.I. =  $\pounds 8.15.4$

Do Examples LXXVIII, page 134, no's 22, 24. Section A.

1<sup>ST</sup> WEEK  
PERIOD 1

Revise Examples 2, 3, 4 and 5 in the assignment, together with the explanation of them.

Do Examples LXXVIII, page 134, no's 23, 25. Section B.

PERIOD 2

Do Examples LXXVIII, page 134, no's 26, 28, 30. Section A.

PERIOD 3

Do Examples LXXVIII, page 134, no's 27, 29. Section B.

This set of Model Answers is the property of the Education Department  
 It is to be regarded as confidential, and is to be returned to the  
 Department when asked for.

SECOND YEAR.

ARITHMETIC.

Model answers. Set 1. Secondary Department.

page 126.

EXAMPLES LXXIV.

33.

Interest on £100 for 1 year is £2½

" " £320¾ for 5 years ?

$$\text{S.I.} = \frac{5}{2} \times \frac{1283}{4} \times \frac{1}{100} \times \frac{5}{1}$$

$$= \text{£}40. 1. 10\frac{1}{2}$$

$$\text{Amt.} = \text{£}360. 16. 10\frac{1}{2}$$

$$32) \overset{3}{1283} \\ \underline{960} \\ 323$$

$$\frac{1}{32} = 7\frac{1}{2}d.$$

35.

Interest on £100 for 1 year is £3¾

" " £317½ " 5 mths. " ?

$$\text{S.I.} = \frac{3}{4} \times \frac{793}{5} \times \frac{1}{100} \times \frac{5}{12}$$

$$= \text{£} 4. 19. 1\frac{1}{2}$$

$$\text{Amt.} = \text{£}322. 3. 1\frac{1}{2}$$

$$160) \overset{4}{793} \\ \underline{640} \\ 153$$

$$\frac{1}{160} = 1\frac{1}{2}d.$$

$$153 \times \frac{1}{2} = 76\frac{1}{2}$$

$$229\frac{1}{2}$$

37.

Interest on £100 for 1 year is £6¼

" " £452¾ " 1½ yrs. " ?

$$\text{S.I.} = \frac{5}{4} \times \frac{3619}{8} \times \frac{1}{100} \times \frac{6}{5}$$

$$= \text{£} 33. 18. 6\frac{3}{4}$$

$$\text{Amt.} = \text{£}486. 6. 0\frac{3}{4}$$

$$320) \overset{33}{10857} \\ \underline{960} \\ 1257 \\ \underline{960} \\ 297$$

$$\frac{1}{320} = 3\frac{1}{4}d.$$

$$297 \times \frac{3}{4} \times \frac{1}{4} = 22\frac{1}{2}$$

$$16) \overset{18}{297} \\ \underline{16} \\ 137 \\ \underline{128} \\ 9$$

39.

Interest on £100 for 1 year is £4½

" " £6395½ " 3 yrs. " ?

$$\text{S.I.} = \frac{9}{2} \times \frac{76747}{12} \times \frac{1}{100} \times \frac{3}{1}$$

$$= \text{£}863. 8. 1. \text{ (to the nearest penny)}$$

$$\frac{690723}{100}$$

$$\frac{323}{100} \times \frac{1}{1} = 8\frac{3}{40}$$

$$\frac{3}{40} \times \frac{12}{1} = \frac{36}{40}d.$$

41.

Int. on £100 for 1 year is £2½

" " £625  $\frac{5}{16}$  "  $3\frac{3}{4}$  yrs. " ?

$$S.I. = \frac{5}{2} \times \frac{10005}{16} \times \frac{1}{100} \times \frac{15^3}{4}$$

= £58.12.6 (to the nearest penny)

£58.12. 5
512)30015
2560
4415
4096
.319
20
6380
512
1260
1024
.236
12
2832
2560
.272

5.

Int. on £100 for 1 year is £2½

" " £2834.6875 for 115 days is ?

$$S.I. = \frac{5}{2} \times \frac{2834.6875}{100} \times \frac{115}{365}$$

$$= \frac{2834.6875 \times 23}{2920}$$

= £22.6.7 (to the nearest penny)

June 15 £.328
July 31 20
Aug. 31 6.560
Sept 30 12
Oct. 8 6.720
115 days
28346.875
2.3
56693.750
8504.0625
65197.8125
£22.328
232)6519.78125
584
.679 818
584 584
.957 2241
876 2336
818 5

17.

Int. on £100 for 1 year is £4½

" " £34½ " 72 days " ?

$$S.I. = \left(\frac{9}{2} \times \frac{69}{200} \times \frac{72}{365} \times \frac{20}{1}\right) /-$$

= 6/1

Aug. 21
Sept. 30
Oct. 21
72 days
162
69
972
1458
11178

6/1
1825)11178
10950
.228
12
2736
1825
911

- 3 -

58.

Interest on £100 for 1 year = £4

" " £186½ " 813 days = ?

$$S.I. = £ \left( \frac{4}{1} \times \frac{813}{365} \times \frac{373}{50} \right)$$

$$S.I. = £ \left( \frac{813}{365} \times \frac{746}{1} \right)$$

$$= £16.12.4.$$

June 21  
 July 31  
 Aug. 31  
83 days  
 2 yrs = 730 days  
813 days  
813  
746  
 5691  
 325.2  
48.78  
 365)6064.98(16.616  
365  
 2414  
2190     £.616  
 .2249     20  
2190     12.320  
598     12  
365     384  
2330  
2190  
.140

59.

Interest on £100 for 1 year is £5

" " £1345 " 256 days " ?

$$S.I. = £ \left( \frac{5}{1} \times \frac{1345}{100} \times \frac{256}{365} \right)$$

$$= £47.3.4$$

Jan. 18     269  
 Feb. 29     64  
 Mar. 31     1614  
 Apl. 30     1076  
 May 31     17216  
 June 30  
 July 31  
 Aug. 31  
 Sept 25  
256 days  
£47.167  
 365)17216  
1460  
 2616  
2555  
 ..610  
365  
 2450  
2190  
 .2600  
2555  
 ..45  
£.167  
20  
 3.340  
12  
4.080

This Set of Model Answers is the property of the Education Department.  
It is to be regarded as confidential, and is to be returned to the  
Department when asked for.

SECOND YEAR.

SET 4.

ARITHMETIC.

Model Answers. Secondary Department.

page  
134.  
18.

EXAMPLES LXXVIII.

	£105	= Prin. for 1st year.	
4% Prin.	4.2	} = Int. " " "	£.965
1/2% Prin.	.2625		20
	<u>109.4625</u>	= Prin. for 2nd year.	19.300
4% Prin.	4.37850	} = Int. " " "	12
1/2% Prin.	.27365		3.6
" "	" 114.11465	= Prin. for 3rd year.	
4% Prin.	4.56458	} = Int. " " "	
1/2% Prin.	.28529		
	<u>£ 118.96452</u>	= Amt. at end of 3 years.	
	Amt. = £118. 19. 4.		

20.

	£16000	= Prin. for 1st year.	
2% Prin.	320	} = Int. " " "	£.482
1/2% Prin.	.40		20
	<u>16360.</u>	= Prin. for 2nd year.	9.640
2% Prin.	327.2	} = Int. " " "	12
1/2% Prin.	.40.9		7.680
	<u>16728.1</u>	= Prin. for 3rd year.	
2% Prin.	334.562	} = Int. " " "	
1/2% Prin.	.41.82025		
	<u>17104.48225</u>	= Amt. at end of 3 years.	
	Amt. = £17104. 9. 8.		

22.

	£787.5	= Prin. for 1st year.	
3% Prin.	23.625	} = Int. " " "	£.615
1/2% Prin.	3.9375		20
	<u>815.0625</u>	= Prin. for 2nd year.	12.3000
3% Prin.	24.45187	} = Int. " " "	12
1/2% Prin.	4.07531		3.6
	<u>843.58968</u>	= Prin. for 3rd year.	
3% Prin.	25.30768	} = Int. " " "	
1/2% Prin.	4.21795		
	<u>873.11531</u>	= Amt. at end of 3 years.	
	<u>787.5</u>	= C.I. for 3 years.	
	£ 85.61531		
S.I. on £100 for 1 year =	£ 3 1/2		78.75
" " " £787.5 " 3 yrs =	£ 7/2 x 3/4 x 787.5 / 100		1.05
S.I.	= £ 21 x 787.5 / 200		78.75
	= £1.05 x 78.75		3.9375
	= £82. 13. 9		82.6875
Difference =	£85. 12. 4 - £82. 13. 9		
	= £2. 18. 7		

24. Rate  $2\frac{1}{2}\%$  per half-year.

$\frac{1}{40}$ Prin.	<u>£750</u>	= Prin. for 1st $\frac{1}{2}$ yr.	
	18.75	= Int. " " "	
	768.75	= Prin. for 2nd $\frac{1}{2}$ yr.	
$\frac{1}{40}$ Prin.	<u>19.21875</u>	= Int. for 2nd $\frac{1}{2}$ year.	
	787.96875	= Prin. for 3rd $\frac{1}{2}$ "	
$\frac{1}{40}$ Prin.	<u>19.69922</u>	= Int. for 3rd $\frac{1}{2}$ yr.	17
	807.66797	= Prin. for 4th $\frac{1}{2}$ yr.	<u>2</u>
$\frac{1}{40}$ Prin.	<u>20.19170</u>	= Int. " " "	
	£827.85967	= Amt. at end of 2 yr.	
Amt. = £827.17.2			

26. Rate = 2% per half year.

2% Prin.	<u>£1347.425</u>	= Prin. for 1st $\frac{1}{2}$ yr.	£.
	26.94850	= Int. " " "	<u>9.</u>
2% Prin.	<u>1374.37350</u>	= Prin. for 2nd $\frac{1}{2}$ yr.	
	27.48747	= Int. for " " "	<u>11.</u>
2% Prin.	<u>1401.86097</u>	= Prin. for 3rd $\frac{1}{2}$ yr.	
	28.03721	= Int. " " "	
2% Prin.	<u>£1429.89818</u>	= Prin. for 4th $\frac{1}{2}$ yr.	
	28.59796	= Int. " " "	
	£1458.49614	= Amt. at end of 2 yrs.	
Amt. = £1458.9.11.			

28. Rate = 2% per half year.

2% Prin.	<u>£520.83333</u>	= Prin. for 1st $\frac{1}{2}$ yr.	
	10.41666	= Int. " " "	.7
2% Prin.	<u>531.24999</u>	= Prin. for 2nd $\frac{1}{2}$ yr.	
	10.62499	= Int. " " "	<u>14.2</u>
2% Prin.	<u>541.87498</u>	= Prin. for 3rd $\frac{1}{2}$ yr.	
	10.83749	= Int. " " "	<u>2.8</u>
	£552.71247	= Amt. at end of 1 $\frac{1}{2}$ yrs.	
Amt. £552.14.3			

30. Int. payable yearly.

4% Prin.	<u>£10000</u>	= Prin. for 1st year.	
	400	= Int. " " "	
4% Prin.	<u>10400</u>	= Prin. for 2nd year.	
	416	= Int. " " "	
4% Prin.	<u>10816</u>	= Prin. for 3rd year.	
	432.64	= Int. " " "	
	11248.64	= Amt. at end of 3 yrs.	
	10000		
	£ 1248.64	= C.I. for 3 years.	

- 3 -

Int. payable half-yearly.

	£10000	= Prin. for 1st $\frac{1}{2}$ yr.	£.984
2% Prin.	<u>200</u>	= Int. " " "	20
	10200	= Prin. " 2nd $\frac{1}{2}$ "	<u>19.680</u>
2% Prin.	<u>204</u>	= Int. " " "	12
	10404	= Prin. for 3rd $\frac{1}{2}$ yr.	<u>8.16.</u>
2% Prin.	<u>208.08</u>	= Int. " " "	
	10612.08	= Prin. for 4th "	
2% Prin.	<u>212.2416</u>	= Int. " " "	
	10824.3216	= Prin. for 5th "	
2% Prin.	<u>216.48643</u>	= Int. " " "	
	11040.80803	= Prin. for 6th "	
2% Prin.	<u>220.81616</u>	= Int. " " "	
	11261.62419	= Amt. at end of 3 yrs.	
	<u>10000</u>		
	£ 1261.62419	= C.I. for 3 yrs. (Int. $\frac{1}{2}$ yrly.)	
	<u>1248.64</u>	= C.I. " " (Int. yearly)	
	£ 12.98419	= Difference	

Difference = £12.19. 8