

Dhananjayrao Gadgil Library



GIPE-PUNE-024253

Brought from the Lords, 31 July 1849.

R E P O R T :

Accidents in Coal Mines.

*Ordered, by The House of Commons, to be Printed,
1 August 1849.*

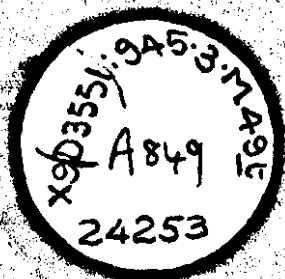

[Price 13 s.]

Under 5 lbs. 4 oz.

JR1

440

~~A202~~

Chairman: The Lord Wharmcliffe.

Brought from the Lords, 31 July 1849.

24253

R E P O R T

FROM THE

SELECT COMMITTEE OF THE HOUSE OF LORDS

APPOINTED TO INQUIRE INTO

The best Means of preventing the Occurrence of
DANGEROUS ACCIDENTS IN COAL MINES;

AND TO REPORT THEREON TO THE HOUSE;

TOGETHER WITH THE

MINUTES OF EVIDENCE,

AND AN

APPENDIX AND INDEX THERETO.

Session 1849.

SERVANTS OF INDIA SOCIETY'S
BRANCH LIBRARY
BOMBAY

*Ordered, by The House of Commons, to be Printed,
1 August 1849.*

X9(D3551):9.15.3.M.13
A849

R E P O R T.

BY THE LORDS COMMITTEES appointed a SELECT COMMITTEE to inquire into the best Means of preventing the occurrence of Dangerous Accidents in COAL MINES, and to report to The House; and to whom Leave was given to report from time to time to The House; and to whom were referred the PETITION of *Goldsworthy Gurney*, praying that Your Lordships will be pleased to institute some Inquiries into the SUBJECT of FIRE DAMP EXPLOSIONS in COAL MINES; the PETITION of *James Mather*, of South Shields, praying that Your Lordships will institute an Inquiry into the Condition of the COAL MINES, in reference to their Lighting, Ventilation by High-Pressure Steam, Plans and Sections, Scientific Education of their Officers, and Government Inspection; the PETITION of the UNDER-GROUND MINERS of the Counties of Durham and Northumberland, whose Names are thereunto subscribed, praying for the examination of some of their body before the said Committee, in relation to their Condition, and exposure in their dangerous Profession; the PETITION of *Richard Brain*, of No. 17, Serle's-place, Carey-street, Civil Engineer, praying that his System of Ventilation in Collieries may have a fair and impartial Investigation and Trial, and that he may be heard in support of his Petition before the said Committee; and the PETITION of *James Godfrey Wilson* and *William Pidding*, of Chelsea, in the County of Middlesex, praying that their Invention for the perfect Combustion of Fuel, and the consequent Abolition of the Smoke Nuisance, may receive the favourable Consideration of this House:—

ORDERED TO REPORT,

THAT the Committee have met, and considered the subject matter to them referred, and also the said Petitions; and have examined several Witnesses in relation thereto; and the Committee having during the short period of the Session which remained from the date of their appointment, felt the necessity of pursuing the inquiry entrusted to them with as little delay as possible, trust it will be found that they have collected much useful evidence upon most branches of the subject to which it has been directed; although they might, perhaps, if the time at their command had been longer, have rendered it in some respects more complete.

The same cause which has somewhat limited the investigation, must likewise prevent any very wide review of the subject in the present Report, and compels the Committee to content itself with little more than a reference, for the most part, to the Evidence which it submits herewith to The House. The necessity for this course, however, is less to be regretted, because the matter therein contained, though in many points new and interesting, presents nothing materially at variance with the results of former inquiries.

Several useful inquiries connected with the subject of accidents in Coal Mines have taken place of late years. To go no farther back than 1835, it may be affirmed that since that period the attention paid to it has received a considerable and effective impulse. The Committee of the House of Commons which sat in that year declined to offer any suggestions of its own, though it placed on record a valuable collection of Evidence, entering largely into the different topics of discussion, scientific as well as practical, which present themselves in connexion with such an inquiry. Since that date various other investigations of the same nature have been conducted by Commissioners under the authority of Government, which will be found among the Papers from time to time presented to Parliament. These consist, first, of the Reports of the Commission for inquiring into the Employment of Children in Mines and Manufactories in 1842; and of the Report of the Midland Mining Commission in the following year; secondly, of the separate Reports of several Special Commissioners charged with the investigation of particular matters or events on certain specified occasions; and, thirdly, of the Annual Reports of Mr. Tremenhèere, the officer appointed under the Act of 5 & 6 Vict., c. 99, for inquiring into the operation of that Act, and into the state of the population of the mining districts; some of which contain the views which he has been led to adopt from his opportunities of observation upon the subject of accidents. Besides these public records, a Committee, voluntarily instituted at South Shields for the same purpose as these inquiries, after the severe calamity at the St. Hilda Colliery, near that place, in the year 1839, published a Report, in 1843, which is distinguished by much research and ability; and these several documents, combined with various private publications, supply altogether an amount of information with reference to accidents in Coal Mines which in some degree supersedes the necessity of any lengthened disquisition of the kind upon the present occasion.

Still it appeared desirable to ascertain, if possible, whether any and what progress had been made during the above period in the knowledge and practice connected with the occurrence of these fatal events; and also whether the time is not arrived at which it may be practicable for the Legislature and the Government to effect some good, with the concurrence of almost all parties concerned, by means of a judicious system of inspection; and by promoting, in whatever manner may seem most effectual, the diffusion of knowledge among the mining population of these Kingdoms.

Keeping these objects in view, the Committee have endeavoured to confine their inquiry, as much as possible, within the limits of practical utility. They have, for the most part, abstained from mere speculative investigations, which, however curious and interesting in themselves, are not very appropriate subjects for the decision of a Parliamentary Committee, and upon which it could scarcely be qualified to arrive at satisfactory conclusions. Upon the same principle, with regard to the many ingenious suggestions and inventions which have been offered to the attention of the Committee, they have declined to undertake an examination of their abstract and intrinsic merits, feeling that no such tribunal as a Committee of the Legislature was properly fitted to perform such a task in a satisfactory manner, or to pronounce an opinion as to the results with any weight or authority. They have, therefore, limited their attention to those cases alone which have been subjected to the test of practical application, and with respect to the actual experience of which, therefore, direct evidence was to be obtained from those whose professional acquirements and experience qualified them to judge of their real value.

Under this reasonable limitation, however, the Committee have had before them several inventions of much interest and merit, which have, to a certain extent, received the ratification afforded by successful use. The plan of Mr. Goldsworthy Gurney, formerly submitted also to the Committee of 1835, for applying the high-pressure Steam-jet to the ventilation of Mines; the Centrifugal Fan, for effecting the same object, invented by Mr. Brunton; the patent Mine Ventilator of Mr. Struvé, acting upon the principle of a powerful air-pump, will be found explained in the evidence, both by the inventors and by those who have brought them into practical operation in each case. The Committee venture to invite attention to those parts of their inquiry, which, together with some collateral investigations connected with the same subject,—especially as to the

the precise action and power of the Steam-jet as a ventilating agent, compared with those of the ordinary furnace hitherto in use,—contain much that deserves consideration. The Committee cannot pretend to pronounce an opinion as to the comparative merits of these contrivances, nor can it venture to declare that the experience of their success is absolutely conclusive in their favour respectively; but they are at least sufficient proofs that there is reasonable hope of attaining greater security by the application of proper means, and that there is a spirit of intelligent energy now awakened with reference to this object, from which the best results may hereafter be expected.

The actual condition of the Coal Mines of this country, as respects ventilation, appears to be widely different, and it is to be feared is, for the most part, seriously defective. In the Northern Counties of England, where the whole science and practice of the subject is more studied and better understood than elsewhere, there are many examples of collieries, some of them upon a gigantic scale, in which the most enlightened attention is paid to the condition of the workings, and to the arrangements for rendering them secure; and, generally speaking, there appear to be but few in those parts where at least the ordinary resources of ventilation are not applied. But in other districts,—in the Midland Counties and in Wales—it is stated that there are many Mines altogether unprovided with anything to aid the mere natural action of the atmosphere. This depends solely upon the difference between the temperature of the air at the surface and that in the Mine; and when the former is high, and therefore nearly approaches to the latter, the ventilation wholly ceases, and the air of the Mine is stagnant—a state of things involving extreme peril, and, even where this is absent, probably serious injury to the health of those employed. There can be no doubt that in these cases considerable improvement might be easily effected, and ought by some means to be secured; and there is strong evidence, from competent authority, that, even in an economical point of view, a safe and healthy condition of a mine may be ultimately the most profitable to the owner. But it should be remarked, that the arrangements under-ground, which are an essential portion of any system of ventilation, are also, in these parts of the country, often very imperfect, in consequence of faulty methods of working. To improve these is a matter of greater difficulty; and it can only be effected by more extended information on the part of those concerned—a consideration which indicates the value of any measures which may tend to direct attention to the principles upon which such operations can be best conducted.

Elliot 3013-3015.
Forster 2711, 2712.
Woodhouse
3895-3906.
3907-3909.
Barber 4216, 4217.
Dobson 4399, 4400.
Dunn 5317, 5369-
5371.
Taylor 6191, 6192.

The Committee cannot quit this part of the inquiry without pointing attention to the evidence they have received respecting the Safety Lamp. The main objections urged against the original invention of Sir H. Davy, are its defective light, and its possible insecurity in a strong current of explosive air. In the evidence of Mr. Biram and Dr. Clanny will be found explanations of two recent modifications of the instrument, for the purpose of obviating those defects, which have been both practically tried, and the latter of which has been extensively approved and adopted by some Managers of Mines. The Committee, for the reasons before stated, do not take upon themselves to express any opinion of their own upon the comparative merits of these inventions, which can be only decided by practical experience; but they have thought themselves bound not altogether to exclude the consideration of so important a branch of the subject.

Though better ventilation, however, appears to be the improvement most generally needed, and most to be aimed at, and though this, together with a vigilant observation of the state of the workings, and a judicious use of the Safety Lamp, will probably reduce the risk from fatal gases, whether explosive or otherwise, to a minimum, it seems to be admitted that there is no hope of wholly excluding all danger from such causes; and, on the other hand, although these classes of accidents give rise to the most extensive calamities, and therefore command most interest, it seems clear that they do not, in fact, entail the greatest destruction of life when compared with the other sources of danger which are of continual occurrence in the working of Coal Mines, but which, involving the loss of few lives only at a time, attract often but little notice. It is difficult to obtain any correct comparison of the amounts in either case both because the data are very incomplete, and because the numbers resulting

from the more extensive calamities vary to so great a degree with the individual circumstances of each event. Sir H. De la Beche (109) asserts that the rate of mortality from explosions has increased since 1835, when the Committee of the House of Commons considered the number of deaths from such accidents in the previous 25 years to have been much under-rated at 2,078;—yet, according to Mr. Dunn (5354), the number of explosions recorded in the Mining Journal for 1844, were only 189 out of a total of 562 colliery accidents of all kinds; and in 1847,—142 out of 462 between April and December. According to Mr. Richardson (3729), the same record gives for 1848—162 explosions out of a total of 466; and in the first half of 1849, to June 30, 184 out of 332. Again, Mr. Taylor (5998) gives 224 out of 439, as the proportion of deaths by explosions in six years ending 1 January 1845 in 55 collieries in the counties of Northumberland and Durham, on the authority of the Registrars' accounts; and Mr. Peace (5009) states, out of 384 underground accidents in the Haigh Colliery in Lancashire, between 1842 and 1849, those by explosions to have been only 25. The proportion of other accidents, out of the whole number, is, therefore, undoubtedly large. These are of various kinds; among the most formidable, and in some districts not the least frequent, are those arising from the breaking of ropes in descending and ascending the shafts, and from drawing the corves or boxes over the upper pulleys. The Committee would particularly point attention to the evidence describing the principle and the successful application of an invention by Mr. Fourdrinier, which seems to promise a valuable protection against this description of danger.

E. N. Fourdrinier
1268, &c.
Jas. Fourdrinier
1926.
Elliot 3073. 3466.
Dunn 5280.

In the evidence of Mr. Swallow, it is stated that a frequent cause of accidents in the Collieries around Bolton in Lancashire, is the existence of what are called "mouthings," or openings of upper workings in the side of a shaft, from which the corves or baskets are to be hooked on to a rope passing down to the entire depth, in which operation a loss of footing or of balance is generally fatal; and it is suggested that this would be in a great degree obviated by fixing a small platform at such mouthings. It is matter for surprise and regret that if so simple a precaution could contribute to prevent the sacrifice of life, those who are mainly responsible for the consequences should omit to adopt it.

Falls of the roof are, in most districts, a still more common form of accident than any of these; and are represented to be, to a considerable extent, unavoidable, from the usual absence of all previous warning. The risk of these occurrences varies much with the mode of working; but there is reason to fear that their probability is often increased by an inadequate supply of timber for the required supports; a deficiency which arises from considerations of expense, and therefore is in many cases difficult of remedy; though this very expense is said to be increased by defective ventilation. But there may be some room to hope, that if the state of such Mines were made more distinctly known, and thereby the responsibility of those on whose neglect it depends were rendered more manifest, some improvement might be effected even in this respect.

Woodhouse 3908.

There is one other cause of fearful catastrophes which must not be left unnoticed, though of more rare occurrence, that of inundations. These arise in all cases from a dangerous approach of the workings to some body of water, such as the sea, or frequently that collected in old and abandoned excavations. There can be no remedy for these but caution where the danger is known, and a correct record of workings, in order to secure that knowledge. One of the suggestions made accordingly with a view to the latter point is, that there should be some registration of coal-workings; and it will be found that one of the Witnesses cites certain cases of this nature as among the strongest practical proofs of the necessity of an inspection.

Dunn 5224 et seq.

In almost all the cases enumerated, it is apparent that one important step would be gained if the actual condition of the several Coal Districts were made more accurately known, and that of the individual Mines brought more distinctly under the notice of some competent authority; and even, it is to be hoped, in some instances of the owners themselves. The Committee, therefore, consider the appointment lately made of Professor Phillips, of York; and Mr. Blackwell, of Dudley, whose instructions from the Secretary of State have already been presented

sented to Parliament, to be judicious as a first advance towards this object ; but a Commission so limited in its organization must be very inadequate to the effectual prosecution of such a task ; and the question remains whether it would not be desirable that Parliament should authorize the establishment of some more comprehensive system, which might tend to promote the same end with greater efficiency. Upon this point there is a striking unanimity in the evidence given during the present inquiry. The Committee believes it may affirm that every Witness, without exception, expressed an opinion more or less favourable to the establishment of a Government inspection. In the Evidence of Messrs. Woodhouse and Peace, which contains information as to two considerable meetings held at Derby and at Wigan respectively,—as well as in that of other Witnesses, derived from their general observation,—it will be found that there is reason to believe that a concurrence in that view prevails among a large portion of the body of colliery owners in those and other districts. But, in considering this subject, the difficult question necessarily arises, as an essential part of it, as to what should be the powers conferred upon any such Inspectors ; and upon this point also the opinions expressed appear to be on the whole remarkably uniform. On all hands it is admitted, that to enable them to discharge their duty effectually, it would be necessary to give them a right to enter and examine Mines, and probably to call for and to inspect working plans ; while at the same time they should not be empowered so to interfere as to take from the owners and managers of such concerns the responsibility which naturally belongs to them, and which it is desirable not only not to withdraw, but rather, if possible, to increase. Some Witnesses, indeed, on behalf of the working miners, seem to wish, in their not unnatural anxiety for greater protection, to carry the powers of an Inspector further, and to think that this might be done even to the length of giving him a power to order and to enforce penalties, without incurring the consequences of a transfer of the responsibility. With every wish to regard in the most favourable light any proposal of theirs for attaining the common object, the Committee cannot but think that this is a mistaken view ; and that interference of this kind, carried beyond a certain point, would result in vexation on the one side, and disappointment on the other, and would tend, both by substituting the responsibility of an Inspector for that of the colliery owner and his agents, and by probably preventing their friendly co-operation, to defeat the very end for which it was designed. An attempt has been made to support such views by the analogy of the Factory Acts ; but it does not appear to your Committee that this analogy can be practically sustained. In so far as the Factory Acts provided an inspection for the protection of women and children from undue labour, the example has been already followed in the case of Mines ; but when it is attempted to draw a comparison between the inspection of a Factory and the inspection of a Mine ; and between the power to order a simple defence against dangerous machinery, and directions for the improvement of ventilation, or as to methods of working collieries, or prescribing the many other changes which may be desirable for their safety ; such a comparison must be held in practice to be untenable. If there were no other reasons against such powers, the cases to be dealt with are too various in their conditions, opinions as to the fittest remedies in each particular instance are occasionally too doubtful, and the difficulty and cost of applying them often too great, to justify the positive enforcement of the views of a Government officer, however competent, against, perhaps, no less experience and knowledge in the properly responsible parties. In addition to this, it would appear to be next to an impossibility that an Inspector should make himself thoroughly acquainted with the working of a large Mine, without the willing assistance of those who manage it ; and, finally, that many remedies and safeguards would require a continued superintendence to render them effectual, which it is clear that no attainable staff of Inspectors employed over the whole mining operations of England, Wales and Scotland, could possibly supply.

Swallow 4382-4385.
5160, 5161.
Atkinson 5544, 5584.
Jude 5755, 5756.
5861-5864.

It will be found, that these and similar reasonings have influenced the decided majority of the Witnesses in recommending that a Government inspection should be invested with no direct powers beyond those of entering and examining Mines, and of investigating plans, so far as may be necessary for judging of their internal condition and arrangements ; and that their duties should then extend to recording and reporting, making suggestions, and communicating information

information to the managers or owners. In this view the Committee concur; and they see no reason for dissenting from the anticipations of several Witnesses, that a Government inspection on such a footing might gradually accomplish essential improvements in the best manner. It is worth while to remark that this appears to have been the case in Belgium, where such a supervision has been established for some years. In the Appendix to Mr. Tremeneere's Report on the Mining Inspection of France and Belgium, presented to Parliament in 1848, there is an account, showing that there has been a decrease from 378 in the deaths and injuries per 1,000 of the population employed between 1835 and 1839, to 268 per 1,000 between 1840 and 1844, an inspection having been in force during the whole of this period, and the system having been more completely organized in the course of the same years; and the same statement shows, that the number of deaths by accidents between 1840 and 1844 had diminished 15 per cent., though the production of coal had increased 20 per cent., and the number of workmen 17 per cent. Moreover, it appears by a Table contained in the same Paper, that of the eight different heads under which mining accidents are there classed, those have sensibly decreased which may be considered as most within the reach of an inspection, while the rest either have continued to increase or exhibit a less distinct result; and from all these data it is not unreasonable to infer, that the system has there, at least, had some beneficial effect in reducing the risk of these calamities. It is true that since in the Continental States the minerals are worked only by concessions from the Government, which in those countries stands in the position of proprietor, a State inspection there affords no strict analogy for a similar arrangement here. But there is evidence to show that both in France and in Belgium the system is found to work without difficulty or vexation, and with the good-will of all concerned; and therefore, although in several respects the circumstances may not be precisely such as to justify us in at once assuming that it forms a precedent on which we could rely in similar arrangements, still it can hardly be deemed unwarrantable to view it as affording a practical ground of hope that they might be established here, under proper modifications, with a like success. At any rate, when it is considered that if, on the one side, the endeavour may involve some objections, and possibly some obstacles, there is, on the other, to be considered the reasonable protection of the lives and limbs, and, it may be added, the health, of a great and valuable portion of the population, exposed at the best to many unavoidable dangers, it cannot be doubted that it is the imperative duty of Parliament and the Executive to adopt, for the purpose of attaining such security as is undoubtedly within the reach of precaution, any steps, whether of the nature of inspection or of direct enactment, consistent with the free pursuits of industry and commerce, with the mutual relations in this country between the Government and private enterprise, and with the due recognition of that responsibility imposed upon the owners and managers of Mines, which it should be the care of all rather to strengthen than impair.

On the inquiry into the sacrifice of 75 lives by explosion at the Darley Main Colliery, near Barnsley, in the beginning of the present year, it was proved that the "Bottom Steward," or "Agent, upon whom devolved the charge of all the under-ground operations, between the monthly visits of the viewer, was, although very careful and zealous in his vocation, a man of too little experience and general knowledge (being unable to read or write) to be able to cope with the emergencies which cannot but frequently occur, and which place in jeopardy the lives of so many human beings, and a large amount of valuable property"—(Report of Mr. Warrington Smyth, presented to both Houses of Parliament, 1849). The Committee did not fail to bear this and similar statements in mind, and to put questions to such of the Witnesses as appeared to have had means of judging as to the connexion between the occurrence of accidents and the measure of instruction among the mining population. There appears to be some difference of opinion upon this point; though none as to the ordinary deficiency of the means of useful education, nor as to the general desire among these classes to obtain it. There can be no doubt that, on general principles, improved education would have a tendency to induce greater caution among the workpeople, and to raise the qualifications of those who, as subordinate agents in the management of a Mine, are charged with the greater part of its effective superintendence. But it does not appear to be the opinion of the practical

practical Witnesses before this Committee that its absence has much perceptible influence upon the liability to accidents. The latter class of persons are stated to be selected from the body of working miners for their steadiness and intelligence, and in the Northumberland and Durham districts, at least, to be required to have a knowledge of reading and writing; though in other parts of the country this is less general. It is represented that they are, for the most part, very competent to the range of duties with which they are charged; although some further instruction, particularly of the special kind connected with mining operations, could not but render them fitter to deal with the unusual and unforeseen circumstances which sometimes occur beyond the routine of their ordinary service, and which may involve the most fatal results. At present there is little of such instruction within the reach of persons engaged in these occupations; and among some of those best qualified to speak upon the point, a want appears to be practically felt of facilities for acquiring it, such as are provided by the Mining Schools and Colleges established in the principal Mining Districts of the Continent, apparently with the most beneficial effects.

Wood 2115.
Taylor 6199.
Swallow 5207-5209.
Atkinson 5621.
Jude 5768-5770.

The Committee finally submit the Evidence they have received to the consideration of The House. They regret that time has not allowed of their calling before them all the Witnesses that they might have wished to summon under other circumstances, especially from North Wales and Scotland. But the former district is believed to be not very different from some of those in the Midland Counties of England, to which the inquiry has extended; and from the latter it is less to be regretted that no information has been directly obtained, since it is understood that with respect to that class of accidents which are the most prominent, and most within the reach of precaution, namely, those by explosion, the Mines of Scotland are comparatively free from danger. They trust, therefore, that these unavoidable omissions will not be considered to show any very material imperfection in their inquiry, and that, on the whole, its results may be such as to contribute something towards the attainment of so important and almost paramount an object as the better protection of the working population employed in that great national branch of industry, the Coal Mines of these Kingdoms.

And the Committee have directed the MINUTES of EVIDENCE taken before them, together with an APPENDIX and INDEX thereto, to be reported to Your Lordships.

26th July 1849.

MINUTES OF EVIDENCE.

(164. 1.)

LIST OF WITNESSES:

| <p style="text-align: center;">Die Jovis, 21^o Junii 1849.</p> <table style="width: 100%; border-collapse: collapse;"> <thead> <tr> <th style="width: 80%;"></th> <th style="text-align: right; font-weight: normal;">PAGE</th> </tr> </thead> <tbody> <tr> <td><i>Sir Henry Thomas De la Beche, C. B.,</i></td> <td style="text-align: right;">-</td> </tr> <tr> <td><i>F. R. S.</i></td> <td style="text-align: right;">- 3</td> </tr> <tr> <td><i>Seymour Tremenhære, Esquire</i></td> <td style="text-align: right;">- 24</td> </tr> </tbody> </table> <p style="text-align: center;">Die Veneris, 22^o Junii 1849.</p> <table style="width: 100%; border-collapse: collapse;"> <tbody> <tr> <td><i>Goldsworthy Gurney, Esquire</i></td> <td style="text-align: right;">- 41</td> </tr> <tr> <td><i>Dr. Lyon Playfair</i></td> <td style="text-align: right;">- 62</td> </tr> </tbody> </table> <p style="text-align: center;">Die Lunæ, 25^o Junii 1849.</p> <table style="width: 100%; border-collapse: collapse;"> <tbody> <tr> <td><i>Seymour Tremenhære, Esquire</i></td> <td style="text-align: right;">- 73</td> </tr> <tr> <td><i>Professor David Thomas Ansted, M. A.,</i></td> <td></td> </tr> <tr> <td><i>F. R. S.</i></td> <td style="text-align: right;">- 73</td> </tr> <tr> <td><i>Neil Arnott, Esquire, M. D.</i></td> <td style="text-align: right;">- 86</td> </tr> <tr> <td><i>James Darlington, Esquire</i></td> <td style="text-align: right;">- 93</td> </tr> </tbody> </table> <p style="text-align: center;">Die Jovis, 28^o Junii 1849.</p> <table style="width: 100%; border-collapse: collapse;"> <tbody> <tr> <td><i>George Whieldon, Esquire</i></td> <td style="text-align: right;">- 107</td> </tr> <tr> <td><i>Henry Hussey Vivian, Esquire</i></td> <td style="text-align: right;">- 115</td> </tr> <tr> <td><i>James Darlington, Esquire</i></td> <td style="text-align: right;">- 127</td> </tr> <tr> <td><i>Mr. Edward Newman Fourdrinier</i></td> <td style="text-align: right;">- 128</td> </tr> <tr> <td><i>Mr. Joseph Fourdrinier</i></td> <td style="text-align: right;">- 132</td> </tr> <tr> <td><i>William Brunton, Esquire</i></td> <td style="text-align: right;">- 133</td> </tr> </tbody> </table> <p style="text-align: center;">Die Veneris, 29^o Junii 1849.</p> <table style="width: 100%; border-collapse: collapse;"> <tbody> <tr> <td><i>William Brunton, Esquire</i></td> <td style="text-align: right;">- 139</td> </tr> <tr> <td><i>John Hutchinson, Esquire, M. D.</i></td> <td style="text-align: right;">- 140</td> </tr> <tr> <td><i>Henry Hussey Vivian, Esquire</i></td> <td style="text-align: right;">- 164</td> </tr> </tbody> </table> <p style="text-align: center;">Die Lunæ, 2^o Julii 1849.</p> <table style="width: 100%; border-collapse: collapse;"> <tbody> <tr> <td><i>Benjamin Biram, Esquire</i></td> <td style="text-align: right;">- 167</td> </tr> <tr> <td><i>Nicholas Wood, Esquire</i></td> <td style="text-align: right;">- 186</td> </tr> </tbody> </table> <p style="text-align: center;">Die Martis, 3^o Julii 1849.</p> <table style="width: 100%; border-collapse: collapse;"> <tbody> <tr> <td><i>Nicholas Wood, Esquire</i></td> <td style="text-align: right;">- 207</td> </tr> <tr> <td><i>Warrington Wilkinson Smyth, Esquire</i></td> <td style="text-align: right;">- 227</td> </tr> </tbody> </table> <p style="text-align: center;">Die Jovis, 5^o Julii 1849.</p> <table style="width: 100%; border-collapse: collapse;"> <tbody> <tr> <td><i>William Price Struvé, Esquire</i></td> <td style="text-align: right;">- 245</td> </tr> <tr> <td><i>Thomas Emerson Forster, Esquire</i></td> <td style="text-align: right;">- 262</td> </tr> </tbody> </table> <p style="text-align: center;">Die Veneris, 6^o Julii 1849.</p> <table style="width: 100%; border-collapse: collapse;"> <tbody> <tr> <td><i>William Price Struvé, Esquire</i></td> <td style="text-align: right;">- 281</td> </tr> <tr> <td><i>George Elliot, Esquire</i></td> <td style="text-align: right;">- 282</td> </tr> </tbody> </table> | | PAGE | <i>Sir Henry Thomas De la Beche, C. B.,</i> | - | <i>F. R. S.</i> | - 3 | <i>Seymour Tremenhære, Esquire</i> | - 24 | <i>Goldsworthy Gurney, Esquire</i> | - 41 | <i>Dr. Lyon Playfair</i> | - 62 | <i>Seymour Tremenhære, Esquire</i> | - 73 | <i>Professor David Thomas Ansted, M. A.,</i> | | <i>F. R. S.</i> | - 73 | <i>Neil Arnott, Esquire, M. D.</i> | - 86 | <i>James Darlington, Esquire</i> | - 93 | <i>George Whieldon, Esquire</i> | - 107 | <i>Henry Hussey Vivian, Esquire</i> | - 115 | <i>James Darlington, Esquire</i> | - 127 | <i>Mr. Edward Newman Fourdrinier</i> | - 128 | <i>Mr. Joseph Fourdrinier</i> | - 132 | <i>William Brunton, Esquire</i> | - 133 | <i>William Brunton, Esquire</i> | - 139 | <i>John Hutchinson, Esquire, M. D.</i> | - 140 | <i>Henry Hussey Vivian, Esquire</i> | - 164 | <i>Benjamin Biram, Esquire</i> | - 167 | <i>Nicholas Wood, Esquire</i> | - 186 | <i>Nicholas Wood, Esquire</i> | - 207 | <i>Warrington Wilkinson Smyth, Esquire</i> | - 227 | <i>William Price Struvé, Esquire</i> | - 245 | <i>Thomas Emerson Forster, Esquire</i> | - 262 | <i>William Price Struvé, Esquire</i> | - 281 | <i>George Elliot, Esquire</i> | - 282 | <p style="text-align: center;">Die Lunæ, 9^o Julii 1849.</p> <table style="width: 100%; border-collapse: collapse;"> <thead> <tr> <th style="width: 80%;"></th> <th style="text-align: right; font-weight: normal;">PAGE</th> </tr> </thead> <tbody> <tr> <td><i>William Keene, Esquire</i></td> <td style="text-align: right;">- 309</td> </tr> <tr> <td><i>Joseph Nadin, Esquire</i></td> <td style="text-align: right;">- 321</td> </tr> <tr> <td><i>George Elliot, Esquire</i></td> <td style="text-align: right;">- 328</td> </tr> </tbody> </table> <p style="text-align: center;">Die Martis, 10^o Julii 1849.</p> <table style="width: 100%; border-collapse: collapse;"> <tbody> <tr> <td><i>James Mather, Esquire</i></td> <td style="text-align: right;">- 333</td> </tr> <tr> <td><i>Joshua Richardson, Esquire</i></td> <td style="text-align: right;">- 355</td> </tr> <tr> <td><i>William Keene, Esquire</i></td> <td style="text-align: right;">- 366</td> </tr> </tbody> </table> <p style="text-align: center;">Die Jovis, 12^o Julii 1849.</p> <table style="width: 100%; border-collapse: collapse;"> <tbody> <tr> <td><i>John Thomas Woodhouse, Esquire</i></td> <td style="text-align: right;">- 369</td> </tr> <tr> <td><i>Edmund Scott Barber, Esquire</i></td> <td style="text-align: right;">- 387</td> </tr> </tbody> </table> <p style="text-align: center;">Die Veneris, 13^o Julii 1849.</p> <table style="width: 100%; border-collapse: collapse;"> <tbody> <tr> <td><i>John Trevor Barkley, Esquire</i></td> <td style="text-align: right;">- 397</td> </tr> <tr> <td><i>Henry Hussey Vivian, Esquire</i></td> <td style="text-align: right;">- 411</td> </tr> <tr> <td><i>Samuel Dobson, Esquire</i></td> <td style="text-align: right;">- 416</td> </tr> </tbody> </table> <p style="text-align: center;">Die Lunæ, 16^o Julii 1849.</p> <table style="width: 100%; border-collapse: collapse;"> <tbody> <tr> <td><i>Benjamin Gibbons, Esquire</i></td> <td style="text-align: right;">- 427</td> </tr> <tr> <td><i>William Reid Clanny, Esquire, M. D.</i></td> <td style="text-align: right;">442</td> </tr> <tr> <td><i>Mr. David Swallow</i></td> <td style="text-align: right;">- 451</td> </tr> </tbody> </table> <p style="text-align: center;">Die Martis, 17^o Julii 1849.</p> <table style="width: 100%; border-collapse: collapse;"> <tbody> <tr> <td><i>William Peace, Esquire</i></td> <td style="text-align: right;">- 467</td> </tr> <tr> <td><i>Mr. David Swallow</i></td> <td style="text-align: right;">- 483</td> </tr> <tr> <td><i>Matthias Dunn, Esquire</i></td> <td style="text-align: right;">- 494</td> </tr> </tbody> </table> <p style="text-align: center;">Die Jovis, 19^o Julii 1849.</p> <table style="width: 100%; border-collapse: collapse;"> <tbody> <tr> <td><i>Matthias Dunn, Esquire</i></td> <td style="text-align: right;">- 501</td> </tr> <tr> <td><i>John Atkinson</i></td> <td style="text-align: right;">- 516</td> </tr> <tr> <td><i>Martin Jude</i></td> <td style="text-align: right;">- 528</td> </tr> <tr> <td><i>Joseph Gott</i></td> <td style="text-align: right;">- 544</td> </tr> </tbody> </table> <p style="text-align: center;">Die Veneris, 20^o Julii 1849.</p> <table style="width: 100%; border-collapse: collapse;"> <tbody> <tr> <td><i>Thomas John Taylor, Esquire</i></td> <td style="text-align: right;">- 551</td> </tr> <tr> <td><i>Joseph Roberts, Esquire</i></td> <td style="text-align: right;">- 575</td> </tr> </tbody> </table> <p style="text-align: center;">Die Lunæ, 23^o Julii 1849.</p> <table style="width: 100%; border-collapse: collapse;"> <tbody> <tr> <td><i>Goldsworthy Gurney, Esquire</i></td> <td style="text-align: right;">- 579</td> </tr> <tr> <td><i>The Reverend Benjamin Morgan Cowie,</i></td> <td></td> </tr> <tr> <td><i>M. A.</i></td> <td style="text-align: right;">- 588</td> </tr> <tr> <td><i>Professor James Hann</i></td> <td style="text-align: right;">- 590</td> </tr> </tbody> </table> | | PAGE | <i>William Keene, Esquire</i> | - 309 | <i>Joseph Nadin, Esquire</i> | - 321 | <i>George Elliot, Esquire</i> | - 328 | <i>James Mather, Esquire</i> | - 333 | <i>Joshua Richardson, Esquire</i> | - 355 | <i>William Keene, Esquire</i> | - 366 | <i>John Thomas Woodhouse, Esquire</i> | - 369 | <i>Edmund Scott Barber, Esquire</i> | - 387 | <i>John Trevor Barkley, Esquire</i> | - 397 | <i>Henry Hussey Vivian, Esquire</i> | - 411 | <i>Samuel Dobson, Esquire</i> | - 416 | <i>Benjamin Gibbons, Esquire</i> | - 427 | <i>William Reid Clanny, Esquire, M. D.</i> | 442 | <i>Mr. David Swallow</i> | - 451 | <i>William Peace, Esquire</i> | - 467 | <i>Mr. David Swallow</i> | - 483 | <i>Matthias Dunn, Esquire</i> | - 494 | <i>Matthias Dunn, Esquire</i> | - 501 | <i>John Atkinson</i> | - 516 | <i>Martin Jude</i> | - 528 | <i>Joseph Gott</i> | - 544 | <i>Thomas John Taylor, Esquire</i> | - 551 | <i>Joseph Roberts, Esquire</i> | - 575 | <i>Goldsworthy Gurney, Esquire</i> | - 579 | <i>The Reverend Benjamin Morgan Cowie,</i> | | <i>M. A.</i> | - 588 | <i>Professor James Hann</i> | - 590 |
|---|-------|------|---|---|-----------------|-----|------------------------------------|------|------------------------------------|------|--------------------------|------|------------------------------------|------|--|--|-----------------|------|------------------------------------|------|----------------------------------|------|---------------------------------|-------|-------------------------------------|-------|----------------------------------|-------|--------------------------------------|-------|-------------------------------|-------|---------------------------------|-------|---------------------------------|-------|--|-------|-------------------------------------|-------|--------------------------------|-------|-------------------------------|-------|-------------------------------|-------|--|-------|--------------------------------------|-------|--|-------|--------------------------------------|-------|-------------------------------|-------|--|--|------|-------------------------------|-------|------------------------------|-------|-------------------------------|-------|------------------------------|-------|-----------------------------------|-------|-------------------------------|-------|---------------------------------------|-------|-------------------------------------|-------|-------------------------------------|-------|-------------------------------------|-------|-------------------------------|-------|----------------------------------|-------|--|-----|--------------------------|-------|-------------------------------|-------|--------------------------|-------|-------------------------------|-------|-------------------------------|-------|----------------------|-------|--------------------|-------|--------------------|-------|------------------------------------|-------|--------------------------------|-------|------------------------------------|-------|--|--|--------------|-------|-----------------------------|-------|
| | PAGE | | | | | | | | | | | | | | | | | | | | | | | | | | | | | | | | | | | | | | | | | | | | | | | | | | | | | | | | | | | | | | | | | | | | | | | | | | | | | | | | | | | | | | | | | | | | | | | | | | | | | | | | | | | | | | | | |
| <i>Sir Henry Thomas De la Beche, C. B.,</i> | - | | | | | | | | | | | | | | | | | | | | | | | | | | | | | | | | | | | | | | | | | | | | | | | | | | | | | | | | | | | | | | | | | | | | | | | | | | | | | | | | | | | | | | | | | | | | | | | | | | | | | | | | | | | | | | | | |
| <i>F. R. S.</i> | - 3 | | | | | | | | | | | | | | | | | | | | | | | | | | | | | | | | | | | | | | | | | | | | | | | | | | | | | | | | | | | | | | | | | | | | | | | | | | | | | | | | | | | | | | | | | | | | | | | | | | | | | | | | | | | | | | | | |
| <i>Seymour Tremenhære, Esquire</i> | - 24 | | | | | | | | | | | | | | | | | | | | | | | | | | | | | | | | | | | | | | | | | | | | | | | | | | | | | | | | | | | | | | | | | | | | | | | | | | | | | | | | | | | | | | | | | | | | | | | | | | | | | | | | | | | | | | | | |
| <i>Goldsworthy Gurney, Esquire</i> | - 41 | | | | | | | | | | | | | | | | | | | | | | | | | | | | | | | | | | | | | | | | | | | | | | | | | | | | | | | | | | | | | | | | | | | | | | | | | | | | | | | | | | | | | | | | | | | | | | | | | | | | | | | | | | | | | | | | |
| <i>Dr. Lyon Playfair</i> | - 62 | | | | | | | | | | | | | | | | | | | | | | | | | | | | | | | | | | | | | | | | | | | | | | | | | | | | | | | | | | | | | | | | | | | | | | | | | | | | | | | | | | | | | | | | | | | | | | | | | | | | | | | | | | | | | | | | |
| <i>Seymour Tremenhære, Esquire</i> | - 73 | | | | | | | | | | | | | | | | | | | | | | | | | | | | | | | | | | | | | | | | | | | | | | | | | | | | | | | | | | | | | | | | | | | | | | | | | | | | | | | | | | | | | | | | | | | | | | | | | | | | | | | | | | | | | | | | |
| <i>Professor David Thomas Ansted, M. A.,</i> | | | | | | | | | | | | | | | | | | | | | | | | | | | | | | | | | | | | | | | | | | | | | | | | | | | | | | | | | | | | | | | | | | | | | | | | | | | | | | | | | | | | | | | | | | | | | | | | | | | | | | | | | | | | | | | | | |
| <i>F. R. S.</i> | - 73 | | | | | | | | | | | | | | | | | | | | | | | | | | | | | | | | | | | | | | | | | | | | | | | | | | | | | | | | | | | | | | | | | | | | | | | | | | | | | | | | | | | | | | | | | | | | | | | | | | | | | | | | | | | | | | | | |
| <i>Neil Arnott, Esquire, M. D.</i> | - 86 | | | | | | | | | | | | | | | | | | | | | | | | | | | | | | | | | | | | | | | | | | | | | | | | | | | | | | | | | | | | | | | | | | | | | | | | | | | | | | | | | | | | | | | | | | | | | | | | | | | | | | | | | | | | | | | | |
| <i>James Darlington, Esquire</i> | - 93 | | | | | | | | | | | | | | | | | | | | | | | | | | | | | | | | | | | | | | | | | | | | | | | | | | | | | | | | | | | | | | | | | | | | | | | | | | | | | | | | | | | | | | | | | | | | | | | | | | | | | | | | | | | | | | | | |
| <i>George Whieldon, Esquire</i> | - 107 | | | | | | | | | | | | | | | | | | | | | | | | | | | | | | | | | | | | | | | | | | | | | | | | | | | | | | | | | | | | | | | | | | | | | | | | | | | | | | | | | | | | | | | | | | | | | | | | | | | | | | | | | | | | | | | | |
| <i>Henry Hussey Vivian, Esquire</i> | - 115 | | | | | | | | | | | | | | | | | | | | | | | | | | | | | | | | | | | | | | | | | | | | | | | | | | | | | | | | | | | | | | | | | | | | | | | | | | | | | | | | | | | | | | | | | | | | | | | | | | | | | | | | | | | | | | | | |
| <i>James Darlington, Esquire</i> | - 127 | | | | | | | | | | | | | | | | | | | | | | | | | | | | | | | | | | | | | | | | | | | | | | | | | | | | | | | | | | | | | | | | | | | | | | | | | | | | | | | | | | | | | | | | | | | | | | | | | | | | | | | | | | | | | | | | |
| <i>Mr. Edward Newman Fourdrinier</i> | - 128 | | | | | | | | | | | | | | | | | | | | | | | | | | | | | | | | | | | | | | | | | | | | | | | | | | | | | | | | | | | | | | | | | | | | | | | | | | | | | | | | | | | | | | | | | | | | | | | | | | | | | | | | | | | | | | | | |
| <i>Mr. Joseph Fourdrinier</i> | - 132 | | | | | | | | | | | | | | | | | | | | | | | | | | | | | | | | | | | | | | | | | | | | | | | | | | | | | | | | | | | | | | | | | | | | | | | | | | | | | | | | | | | | | | | | | | | | | | | | | | | | | | | | | | | | | | | | |
| <i>William Brunton, Esquire</i> | - 133 | | | | | | | | | | | | | | | | | | | | | | | | | | | | | | | | | | | | | | | | | | | | | | | | | | | | | | | | | | | | | | | | | | | | | | | | | | | | | | | | | | | | | | | | | | | | | | | | | | | | | | | | | | | | | | | | |
| <i>William Brunton, Esquire</i> | - 139 | | | | | | | | | | | | | | | | | | | | | | | | | | | | | | | | | | | | | | | | | | | | | | | | | | | | | | | | | | | | | | | | | | | | | | | | | | | | | | | | | | | | | | | | | | | | | | | | | | | | | | | | | | | | | | | | |
| <i>John Hutchinson, Esquire, M. D.</i> | - 140 | | | | | | | | | | | | | | | | | | | | | | | | | | | | | | | | | | | | | | | | | | | | | | | | | | | | | | | | | | | | | | | | | | | | | | | | | | | | | | | | | | | | | | | | | | | | | | | | | | | | | | | | | | | | | | | | |
| <i>Henry Hussey Vivian, Esquire</i> | - 164 | | | | | | | | | | | | | | | | | | | | | | | | | | | | | | | | | | | | | | | | | | | | | | | | | | | | | | | | | | | | | | | | | | | | | | | | | | | | | | | | | | | | | | | | | | | | | | | | | | | | | | | | | | | | | | | | |
| <i>Benjamin Biram, Esquire</i> | - 167 | | | | | | | | | | | | | | | | | | | | | | | | | | | | | | | | | | | | | | | | | | | | | | | | | | | | | | | | | | | | | | | | | | | | | | | | | | | | | | | | | | | | | | | | | | | | | | | | | | | | | | | | | | | | | | | | |
| <i>Nicholas Wood, Esquire</i> | - 186 | | | | | | | | | | | | | | | | | | | | | | | | | | | | | | | | | | | | | | | | | | | | | | | | | | | | | | | | | | | | | | | | | | | | | | | | | | | | | | | | | | | | | | | | | | | | | | | | | | | | | | | | | | | | | | | | |
| <i>Nicholas Wood, Esquire</i> | - 207 | | | | | | | | | | | | | | | | | | | | | | | | | | | | | | | | | | | | | | | | | | | | | | | | | | | | | | | | | | | | | | | | | | | | | | | | | | | | | | | | | | | | | | | | | | | | | | | | | | | | | | | | | | | | | | | | |
| <i>Warrington Wilkinson Smyth, Esquire</i> | - 227 | | | | | | | | | | | | | | | | | | | | | | | | | | | | | | | | | | | | | | | | | | | | | | | | | | | | | | | | | | | | | | | | | | | | | | | | | | | | | | | | | | | | | | | | | | | | | | | | | | | | | | | | | | | | | | | | |
| <i>William Price Struvé, Esquire</i> | - 245 | | | | | | | | | | | | | | | | | | | | | | | | | | | | | | | | | | | | | | | | | | | | | | | | | | | | | | | | | | | | | | | | | | | | | | | | | | | | | | | | | | | | | | | | | | | | | | | | | | | | | | | | | | | | | | | | |
| <i>Thomas Emerson Forster, Esquire</i> | - 262 | | | | | | | | | | | | | | | | | | | | | | | | | | | | | | | | | | | | | | | | | | | | | | | | | | | | | | | | | | | | | | | | | | | | | | | | | | | | | | | | | | | | | | | | | | | | | | | | | | | | | | | | | | | | | | | | |
| <i>William Price Struvé, Esquire</i> | - 281 | | | | | | | | | | | | | | | | | | | | | | | | | | | | | | | | | | | | | | | | | | | | | | | | | | | | | | | | | | | | | | | | | | | | | | | | | | | | | | | | | | | | | | | | | | | | | | | | | | | | | | | | | | | | | | | | |
| <i>George Elliot, Esquire</i> | - 282 | | | | | | | | | | | | | | | | | | | | | | | | | | | | | | | | | | | | | | | | | | | | | | | | | | | | | | | | | | | | | | | | | | | | | | | | | | | | | | | | | | | | | | | | | | | | | | | | | | | | | | | | | | | | | | | | |
| | PAGE | | | | | | | | | | | | | | | | | | | | | | | | | | | | | | | | | | | | | | | | | | | | | | | | | | | | | | | | | | | | | | | | | | | | | | | | | | | | | | | | | | | | | | | | | | | | | | | | | | | | | | | | | | | | | | | | |
| <i>William Keene, Esquire</i> | - 309 | | | | | | | | | | | | | | | | | | | | | | | | | | | | | | | | | | | | | | | | | | | | | | | | | | | | | | | | | | | | | | | | | | | | | | | | | | | | | | | | | | | | | | | | | | | | | | | | | | | | | | | | | | | | | | | | |
| <i>Joseph Nadin, Esquire</i> | - 321 | | | | | | | | | | | | | | | | | | | | | | | | | | | | | | | | | | | | | | | | | | | | | | | | | | | | | | | | | | | | | | | | | | | | | | | | | | | | | | | | | | | | | | | | | | | | | | | | | | | | | | | | | | | | | | | | |
| <i>George Elliot, Esquire</i> | - 328 | | | | | | | | | | | | | | | | | | | | | | | | | | | | | | | | | | | | | | | | | | | | | | | | | | | | | | | | | | | | | | | | | | | | | | | | | | | | | | | | | | | | | | | | | | | | | | | | | | | | | | | | | | | | | | | | |
| <i>James Mather, Esquire</i> | - 333 | | | | | | | | | | | | | | | | | | | | | | | | | | | | | | | | | | | | | | | | | | | | | | | | | | | | | | | | | | | | | | | | | | | | | | | | | | | | | | | | | | | | | | | | | | | | | | | | | | | | | | | | | | | | | | | | |
| <i>Joshua Richardson, Esquire</i> | - 355 | | | | | | | | | | | | | | | | | | | | | | | | | | | | | | | | | | | | | | | | | | | | | | | | | | | | | | | | | | | | | | | | | | | | | | | | | | | | | | | | | | | | | | | | | | | | | | | | | | | | | | | | | | | | | | | | |
| <i>William Keene, Esquire</i> | - 366 | | | | | | | | | | | | | | | | | | | | | | | | | | | | | | | | | | | | | | | | | | | | | | | | | | | | | | | | | | | | | | | | | | | | | | | | | | | | | | | | | | | | | | | | | | | | | | | | | | | | | | | | | | | | | | | | |
| <i>John Thomas Woodhouse, Esquire</i> | - 369 | | | | | | | | | | | | | | | | | | | | | | | | | | | | | | | | | | | | | | | | | | | | | | | | | | | | | | | | | | | | | | | | | | | | | | | | | | | | | | | | | | | | | | | | | | | | | | | | | | | | | | | | | | | | | | | | |
| <i>Edmund Scott Barber, Esquire</i> | - 387 | | | | | | | | | | | | | | | | | | | | | | | | | | | | | | | | | | | | | | | | | | | | | | | | | | | | | | | | | | | | | | | | | | | | | | | | | | | | | | | | | | | | | | | | | | | | | | | | | | | | | | | | | | | | | | | | |
| <i>John Trevor Barkley, Esquire</i> | - 397 | | | | | | | | | | | | | | | | | | | | | | | | | | | | | | | | | | | | | | | | | | | | | | | | | | | | | | | | | | | | | | | | | | | | | | | | | | | | | | | | | | | | | | | | | | | | | | | | | | | | | | | | | | | | | | | | |
| <i>Henry Hussey Vivian, Esquire</i> | - 411 | | | | | | | | | | | | | | | | | | | | | | | | | | | | | | | | | | | | | | | | | | | | | | | | | | | | | | | | | | | | | | | | | | | | | | | | | | | | | | | | | | | | | | | | | | | | | | | | | | | | | | | | | | | | | | | | |
| <i>Samuel Dobson, Esquire</i> | - 416 | | | | | | | | | | | | | | | | | | | | | | | | | | | | | | | | | | | | | | | | | | | | | | | | | | | | | | | | | | | | | | | | | | | | | | | | | | | | | | | | | | | | | | | | | | | | | | | | | | | | | | | | | | | | | | | | |
| <i>Benjamin Gibbons, Esquire</i> | - 427 | | | | | | | | | | | | | | | | | | | | | | | | | | | | | | | | | | | | | | | | | | | | | | | | | | | | | | | | | | | | | | | | | | | | | | | | | | | | | | | | | | | | | | | | | | | | | | | | | | | | | | | | | | | | | | | | |
| <i>William Reid Clanny, Esquire, M. D.</i> | 442 | | | | | | | | | | | | | | | | | | | | | | | | | | | | | | | | | | | | | | | | | | | | | | | | | | | | | | | | | | | | | | | | | | | | | | | | | | | | | | | | | | | | | | | | | | | | | | | | | | | | | | | | | | | | | | | | |
| <i>Mr. David Swallow</i> | - 451 | | | | | | | | | | | | | | | | | | | | | | | | | | | | | | | | | | | | | | | | | | | | | | | | | | | | | | | | | | | | | | | | | | | | | | | | | | | | | | | | | | | | | | | | | | | | | | | | | | | | | | | | | | | | | | | | |
| <i>William Peace, Esquire</i> | - 467 | | | | | | | | | | | | | | | | | | | | | | | | | | | | | | | | | | | | | | | | | | | | | | | | | | | | | | | | | | | | | | | | | | | | | | | | | | | | | | | | | | | | | | | | | | | | | | | | | | | | | | | | | | | | | | | | |
| <i>Mr. David Swallow</i> | - 483 | | | | | | | | | | | | | | | | | | | | | | | | | | | | | | | | | | | | | | | | | | | | | | | | | | | | | | | | | | | | | | | | | | | | | | | | | | | | | | | | | | | | | | | | | | | | | | | | | | | | | | | | | | | | | | | | |
| <i>Matthias Dunn, Esquire</i> | - 494 | | | | | | | | | | | | | | | | | | | | | | | | | | | | | | | | | | | | | | | | | | | | | | | | | | | | | | | | | | | | | | | | | | | | | | | | | | | | | | | | | | | | | | | | | | | | | | | | | | | | | | | | | | | | | | | | |
| <i>Matthias Dunn, Esquire</i> | - 501 | | | | | | | | | | | | | | | | | | | | | | | | | | | | | | | | | | | | | | | | | | | | | | | | | | | | | | | | | | | | | | | | | | | | | | | | | | | | | | | | | | | | | | | | | | | | | | | | | | | | | | | | | | | | | | | | |
| <i>John Atkinson</i> | - 516 | | | | | | | | | | | | | | | | | | | | | | | | | | | | | | | | | | | | | | | | | | | | | | | | | | | | | | | | | | | | | | | | | | | | | | | | | | | | | | | | | | | | | | | | | | | | | | | | | | | | | | | | | | | | | | | | |
| <i>Martin Jude</i> | - 528 | | | | | | | | | | | | | | | | | | | | | | | | | | | | | | | | | | | | | | | | | | | | | | | | | | | | | | | | | | | | | | | | | | | | | | | | | | | | | | | | | | | | | | | | | | | | | | | | | | | | | | | | | | | | | | | | |
| <i>Joseph Gott</i> | - 544 | | | | | | | | | | | | | | | | | | | | | | | | | | | | | | | | | | | | | | | | | | | | | | | | | | | | | | | | | | | | | | | | | | | | | | | | | | | | | | | | | | | | | | | | | | | | | | | | | | | | | | | | | | | | | | | | |
| <i>Thomas John Taylor, Esquire</i> | - 551 | | | | | | | | | | | | | | | | | | | | | | | | | | | | | | | | | | | | | | | | | | | | | | | | | | | | | | | | | | | | | | | | | | | | | | | | | | | | | | | | | | | | | | | | | | | | | | | | | | | | | | | | | | | | | | | | |
| <i>Joseph Roberts, Esquire</i> | - 575 | | | | | | | | | | | | | | | | | | | | | | | | | | | | | | | | | | | | | | | | | | | | | | | | | | | | | | | | | | | | | | | | | | | | | | | | | | | | | | | | | | | | | | | | | | | | | | | | | | | | | | | | | | | | | | | | |
| <i>Goldsworthy Gurney, Esquire</i> | - 579 | | | | | | | | | | | | | | | | | | | | | | | | | | | | | | | | | | | | | | | | | | | | | | | | | | | | | | | | | | | | | | | | | | | | | | | | | | | | | | | | | | | | | | | | | | | | | | | | | | | | | | | | | | | | | | | | |
| <i>The Reverend Benjamin Morgan Cowie,</i> | | | | | | | | | | | | | | | | | | | | | | | | | | | | | | | | | | | | | | | | | | | | | | | | | | | | | | | | | | | | | | | | | | | | | | | | | | | | | | | | | | | | | | | | | | | | | | | | | | | | | | | | | | | | | | | | | |
| <i>M. A.</i> | - 588 | | | | | | | | | | | | | | | | | | | | | | | | | | | | | | | | | | | | | | | | | | | | | | | | | | | | | | | | | | | | | | | | | | | | | | | | | | | | | | | | | | | | | | | | | | | | | | | | | | | | | | | | | | | | | | | | |
| <i>Professor James Hann</i> | - 590 | | | | | | | | | | | | | | | | | | | | | | | | | | | | | | | | | | | | | | | | | | | | | | | | | | | | | | | | | | | | | | | | | | | | | | | | | | | | | | | | | | | | | | | | | | | | | | | | | | | | | | | | | | | | | | | | |

Die Jovis, 21^o Junii 1849.

The LORD WHARNCLIFFE in the Chair.

Sir HENRY THOMAS DE LA BECHE, C.B., F.R.S., is called in, and examined as follows :

Evidence on the
Prevention of
Accidents in
Coal Mines.

Sir H. T.
De la Beche, C.B.,
F.R.S.

21st June 1849.

1. YOU have been for a long time engaged in pursuits connected with the geology and mineralogy of these kingdoms?

I have, about 30 years, or more,

2. And you have turned your attention to the scientific as well as to the practical parts of the subject?

I have.

3. Have you also been employed by the Government upon various inquiries connected with it?

I have in various ways; chiefly as Director-general of the Geological Survey of the United Kingdom, and as Director of the Museum of Practical Geology in London.

4. Will you enumerate to us the different cases of inquiry upon which you have been engaged connected with the subject of Accidents in Coal Mines?

The subject of Accidents in Coal Mines was referred to Dr. Lyon Playfair and myself by Lord Lincoln, in a letter to me, dated the 27th August 1845, in consequence of which we reported somewhat fully on it to Viscount Canning, the successor of the Earl of Lincoln, in June 1846. This Report was accompanied by reports and evidence respecting the explosions at Jarrow Colliery on the 25th August 1845, and at Risca Colliery on the 14th January 1846. To it were also appended Reports by Mr. Warrington Smyth on the explosions at Oldbury and Coppull Collieries on the 17th and 24th November 1846, and by the same gentleman and myself on that of Ardsley Main Colliery on 5th March 1847. These Reports were presented to both Houses. In consequence of our inquiries, we recommended inspection and the other matters which are noticed in the Reports mentioned.

5. Have these inquiries given you very extensive opportunities of obtaining knowledge and experience upon the causes and the incidents of accidents in coal mines?

They have; and not only the inquiries to which your Lordship has just alluded, but also my previous investigations, whether geological or mining; for I have always taken a deep interest in the working of the mines of this country, as also in the means by which explosions in collieries might be guarded against, or at least their present amount be diminished.

6. Will you state in general terms the conclusions at which you have arrived from those inquiries?

My conclusions were, that the different districts in which coal is worked are very differently circumstanced, so that different means, or rather modified means, have to be employed in guarding against accidents in coal mines. It will be obvious (I feel assured that many of your Lordships well know the fact) that a bed which is flat and worked by a pit is differently circumstanced from one which is highly inclined or nearly vertical, and which may be got at through

Sir H. T.
De la Beche, C.B.,
F.R.S.

21st June 1849.

the side of a hill by a level. The various engineering arrangements required are very different, and therefore any general plan which may be very good for one district is not necessarily good for the others. In my opinion, therein consist the discrepancies which have appeared as to what may be good or what may be bad; for persons who have been accustomed to only one district have been too apt to carry their views to others to which they were not applicable; therefore it was that we suggested that properly qualified persons should be appointed to the various districts, who should use considerable discretion in the mode of recommending what should be done in different collieries, not employing compulsory powers, none being given them by which they could act hostilely, but simply by advice. And my general view has been, although I believe not stated there, but derived from subsequent experience, that in the present state of public opinion advice would be preferable to any other mode of proceeding, and that having seen any collieries which were not in a good state of ventilation, and therefore dangerous for the workmen, the Inspectors should advise the parties respecting their condition; thus subsequently, if accidents did happen, the Coroners' Juries would have to decide between the Inspectors and the owners with regard to such accidents, and come to some fair and just conclusions, the result being, it was anticipated, that the public would be extremely benefited, and in a mode consonant with existing English feeling on the subject.

7. With a view to furnishing the means of giving any such advice as that to which you have alluded, did you enter carefully into a consideration of the causes of different accidents?

Certainly.

8. What were the general conclusions at which you were led to arrive?

Imperfect ventilation, and also fool-hardiness on the part of the men engaged; it having been ascertained that in certain mines which were fairly conducted the men were over-daring, and entered into what are commonly called the goafs or wastes when it was dangerous and improper to do so. In the case of Risca, it appeared probable that although there were certain defects of ventilation, that the explosion was attributable to a man having entered improperly into a gob or goaf with a lighted candle. The same thing occurred at Ardsley Main. Very imperfect police, as regards the mine, is to be found in many collieries.

9. Then, in respect of those accidents from explosions, the conclusion to which you were led by that inquiry was, that the principal cause of such accidents was a defective ventilation?

Decidedly.

10. And that that defective ventilation was rendered especially dangerous by the carelessness of the men exposed to the atmosphere which was so generated?

Precisely so.

11. That Report was presented by you to Lord Canning in 1846. Since that time, have you acquired any additional knowledge upon the subject?

Yes; having directed my attention very much to the subject, I certainly have. Notwithstanding that in every district there are usually some well-worked mines, the mass of collieries can scarcely be said to be worked in a satisfactory manner. I speak more particularly as regards ventilation. It sometimes occurs that they have only one shaft, in which case, if there be an explosion cutting off the supply of air at the bottom of the shaft, the whole colliery is, as it were, laid waste, all ventilation being stopped. Sometimes the two shafts, when two are employed, are too near one another, so that when an explosion takes place, throwing the course of air only between them, that amount of air is so small in extent between the two shafts, even assuming that they are not damaged, that the men in the larger portion of the mine must perish by what is commonly called "after damp," or the results of explosion. And I would here remark that the greater proportion of cases of death have been from after-damp, and from inefficient arrangements in the workings, so that the men, after the explosion, had little or no chance of escape. They suffered from suffocation, from what is commonly called after-damp, namely, the products of the explosion, and the nitrogen of the air, which aided in the explosion.

12. What

12. What are the proofs which you think demonstrate that the greater number of lives have been lost by after-damp?

From the mode of finding them, and their being unburnt and uninjured by fire. By very far the largest proportion of cases of death are due to the after-damp. I believe that is generally admitted.

13. Are there any cases in which you have actually found parties in whom life was not extinct after an explosion of this kind, but still whose lives have been lost in consequence of after-damp?

Not actually; but just previously to our investigations at Risca there was a case of that kind, where eleven men so perished in one level. The first man, when picked up, was still breathing, and the next one seemed to have just expired. They all perished from the after-damp.

14. Then from what you have said upon that subject, we may infer, that supposing an efficient system of ventilation were established in the mines, although from some accident an explosion might occasionally occur there, the ventilation, if it could be made efficient immediately after the accident, would save a considerable loss of life?

For the most part the system might be so contrived. If such an explosion takes place in one part of the mine, it does not follow that it should damage the general ventilation. Therefore, if the parties who were not burnt, and were not killed by the explosion, could run to the better ventilated parts of the colliery, their lives would frequently be saved. And I would here remark, that although provision may be made to protect men, and to insure their lives better than at present, yet we must look upon explosions as still likely to occur; and that as lighthouses and harbours of refuge at present are an excellent provision, and prevent a greater loss of life than is now sustained from shipwreck, so whatever efficient arrangements you may make will, though they will not prevent accidents altogether, greatly diminish their number in coal mines.

15. Do you conceive that the most usual causes of the defective ventilation of coal mines are the difficulties of accomplishing it, or the neglect of those who are managers of the concerns?

To a great extent I think it is attributable to the ignorance of the parties, and not to their wilful neglect, because I am aware of many cases where large sums of money have been expended, though uselessly expended, so far as attaining the end required. Neither does defective ventilation so much arise from the conditions of a district, though these, no doubt, exercise considerable influence, since it rarely happens but that in every district there are well-arranged mines. It would appear more to resolve itself into ignorance of what may be accomplished. Unfortunately, there is not that knowledge of what may and has been done that is so desirable. The larger proprietors, who usually have the benefit of the better agents, for the most part have their mines in good condition, but these do not form the mass of collieries.

16. Do you consider, that supposing the attention of coal-owners were properly turned to the subject, they would be able to accomplish efficient ventilation in almost all cases, or are there natural difficulties in the way of the attainment of that object which would prevent it in many instances?

In some instances it would, no doubt, be more difficult than in others; but I consider that it would be attainable in all situations, by proper engineering skill, where it would be reasonable to work.

17. At a very great increase of cost in some cases?

In some cases it might be attended with such increase of cost as, perhaps, not to render the mine worth working at the moment; but still, the hazardous manner in which so many collieries are now worked, and the little care that is taken of the ventilation in them, is very unjustifiable; I have been in situations myself when our lamps have got red hot in a very short time, from bad air. I apprehend that, as a whole, the engineering difficulties are extremely limited as compared with the power of obtaining a general good system of ventilation, always, of course, taking into account the variations that would be needful in different districts, according to circumstances.

18. Some districts being more difficult to ventilate than others?

Certainly.
(164. 1.)

Sir H. T.
De la Beche, C.B.,
F.R.S.

21st June 1849.

Sir H. T.
De la Beche, C.B.,
F.R.S.

21st June 1849.

19. Looking to the circumstance which you have already mentioned, of the inclination of the strata, is it much more difficult to accomplish a proper system of ventilation, and therefore to guard against accidents where the strata are much inclined, than in other cases?

Very frequently it is; but it depends, again, upon the surface of the ground. We must regard not only what may be termed the geological arrangement of the various beds, but the surface of the ground itself, and whether this be hilly, level, or otherwise modified. In many parts of England the coal is, as it is commonly called, won by pit-sinking. Now, in South Wales a very large portion of the coal is got by levels, that is, by driving into the sides of the hills, and pits are not sunk at all, except for ventilation purposes; not unfrequently these levels are too far extended without proper adjustments for good ventilation, such as might be easily made.

20. What is the most usual system of ventilation now in practice?

It varies; but the most usual system of ventilation is by having what are called down-cast and up-cast shafts; that is to say, a contrivance by means of which the air descends one shaft, is drawn through such parts of the colliery as may be thought needful, and then rises out through another shaft; to cause the air to rise out through the latter, it is not uncommon to heat this up-cast shaft by means of a furnace; the air in it is thus rarefied, and, according as it ascends, the fresh air descends the down-cast shaft, and is made to course, as it is termed, through different parts of the mine. Formerly, it used to be made to course in one current through all parts of the mine; but in the more recent and improved systems of ventilation, the air is, as it is termed, split, so that it is directed into various parts of the mine. It is especially necessary that the men, when they are at work, should have a proper course of air before them. To effect this, and other needful objects connected with ventilation, there are various contrivances, such as main and secondary air-ways, and different adjustments of divisions, some temporary, others more permanent, known by various names, such as brattices, and the like, with doors so contrived to open and shut as not to interfere with the course of air, so that currents of air pass in front of the workmen and through the passages, when they are required.

21. Brattices are partitions?

Yes, to direct the air; so that, if noxious gases are emitted from the coal or its associated beds of rock, these noxious gases can be got rid of. In ventilating a colliery, two main objects have to be accomplished—provision of a proper supply of air for the men while working, and the removal of any noxious gases that may be discharged either from old workings or from the coal itself. Coals vary considerably in this respect; some give out no fire-damp, to use the common expression, and others emit a vast abundance of it, and are thence called fiery.

22. Carburetted hydrogen, is it not?

Carburetted hydrogen is the chief gas.

23. According to the results of experiments stated in your Report, the carburetted hydrogen bears a very large proportion to the other constituents?

A very large proportion; in a table given with our Report, it would seem to vary, in the fire-damp in eight seams of coal, from 77 to 98 per cent.

24. However, the scientific fact is, that the carburetted hydrogen alone will not explode, is it not?

Not by itself and without a mixture of air, and that is the thing to be guarded against. We have stated in that Report how the gas comes out from different parts of collieries. We may sometimes regard the discharge of fire-damp as a kind of constant over a long face of coal; in other cases it is more rarely emitted: sometimes it suddenly bursts out, a condition not so easily guarded against: it is occasionally discharged from a fault or dislocation of the beds of rock, and then it may come in large quantities, and not be derived from the coal bed which may be working, but from other coal beds; that is always a case of extreme danger. By pricking a fault, that is to say, by driving the work into a fault, a large volume of fire-damp may be thrown suddenly upon the men working in an otherwise well-ventilated mine, so that if they are working with naked candles there may be an explosion.

25. Like tapping a reservoir, in fact?

Yes,

Yes, just like tapping a reservoir. There is often great difficulty in providing for such cases; for, though the managers should know, generally speaking, the range of the faults running through the country, and where they have reason to expect them, faults may still come in where no previous information would lead the managers to suspect their existence.

Sir H. T.
De la Beche, C.B.,
F.R.S.

21st June 1849.

26. In order to produce the process of ventilation in those cases where you say they have a down-cast and an up-cast shaft, is not the ordinary practice to place a furnace at the bottom of the up-cast shaft?

Yes. Other inventions have, however, been made; two, well deserving consideration, have been recently brought forward in South Wales; one is upon the pump principle, upon a large scale, exhausting the air through the up-cast shaft, so that according to the rate of exhaustion at one shaft, the friction of the air in the colliery being taken into account, is the descent of fresh air at the other: another invention, very recently introduced, is a modification of a fan for driving a blast.

27. The first which you have mentioned was Mr. Struvé's?

Yes; the second was by Mr. Brunton, a well-known engineer. Both plans have been tried, and are stated to have been found effective. Mr. Darlington, who your Lordships may recollect has used the steam jet with success, considering that too much air passed through the furnaces, as usually constructed, of the up-cast shaft, and that consequently more air was converted than was needful into the products of combustion, these pressing down in the shaft, like an invisible cork, has so arranged his furnace work as only to employ fire just sufficient to heat the air passing through into the up-cast shaft, diminishing the products of combustion. By a well-adjusted arrangement of this kind, Mr. Darlington was enabled in one of his mines to produce a very great effect, and to well ventilate a mine which was before by no means so effectually ventilated.

28. Is that the invention with which the name of Mr. Goldsworthy Gurney has been so much connected?

No, that is Mr. Darlington's own, as I understand. It should, however, be mentioned, that of late years great improvements have been made in furnace arrangements in the north of England, and especially with reference to avoiding the passage of too much air through the fire of furnaces. Mr. Goldsworthy Gurney, as your Lordships are aware, has suggested the use of the steam jet; Mr. Darlington employed the steam jet of Mr. Gurney, and is reported to have found it very useful. I believe that not only these but other methods of extracting the foul air and introducing fresh air might be very beneficially employed in collieries in the different districts, and in different cases, according to circumstances.

29. It has been found as a result from those inspections which have been instituted, that one great cause of the danger from explosion is the accumulation of the carburetted hydrogen in certain vacant spaces in old workings?

Yes, to a great extent; precautions are commonly not sufficiently taken regarding their proper ventilation.

30. Do you conceive that by any of these methods it would be possible in extensive collieries to render the ventilation so complete as to reach all parts of the workings at which any accumulation of that kind would become dangerous?

I think they might be employed so as to extend to all parts. Much would depend upon the circumstances under which the noxious gases are discharged; it is sometimes found that these gases can be stopped out very effectually from the actual workings, their discharge from the old workings being prevented; at others it is found very desirable to pass currents of air through certain portions of the old workings, and thus remove these gases; that is a question which would very much depend upon circumstances. At present we have to deal with a large number of works which have been extensively carried on in various ways; their general condition is therefore most varied; it is not like beginning a number of new pits, and laying down a new system for them; it becomes, therefore, very difficult to say to what extent systems of ventilation, however good, might be generally carried out, in the mass of existing collieries, though it may be anticipated that they might be very extensively and beneficially introduced, more effective ventilation being gradually effected.

Sir H. T.
De la Beche, C.B.,
F.R.S.

21st June 1849.

31. You have mentioned the most ordinary mode at present of effecting ventilation, which is by a furnace at the bottom of the up-cast shaft; do you conceive that in average cases that is an efficient instrument of ventilation?

It is found very efficient in many collieries in the north of England and elsewhere, at the present moment, if carefully conducted.

32. Is it a very costly method of ventilation?

Very far from it, if the furnaces, more particularly, were constructed somewhat better than they now commonly are. I would here observe, that if the collieries be taken generally, in most districts some of them will be found well managed as respects ventilation, more particularly as regards the furnace mode of ventilation, especially in the north, where men of great intelligence have been long engaged upon it; at the same time, this method is very ill carried out in numerous localities.

33. Does the operation of that system of furnace, in the position which has been described, produce under difficult circumstances a sufficiently strong current of air upwards to effect the ventilation where it is impeded by obstacles?

I have been in very excellent and extensive collieries, particularly in the north of England, where the ventilation was kept up so strongly that it was needful to guard the candle from being blown out in some of the passages.

34. Have you read the Report which was made by Mr. Tremeneere upon the last accident that occurred at Darley Main Colliery, in Yorkshire?

Yes.

35. Do you recollect that the evidence before the coroner showed that the amount of current produced was very much below what was considered safe as a minimum in that mine?

It was so, I believe; the evidence appeared good upon that point; but I also understand that since that time, they still using the furnace method, a much improved system of ventilation has been brought about.

36. You do not conceive, then, from what you have found in that evidence, that there is anything there to show that a system of ventilation according to the ordinary method would have been, if properly conducted, insufficient for the ventilation of that mine?

Nothing, as far as I can speak, without having visited the locality, and judging merely from the evidence contained in the Report, for I have been in mines perfectly ventilated by that, the furnace system; such mines have, however, been worked from the beginning in an efficient manner, so that everything having been conducted upon good principles the result was effective.

37. Do you suppose that it would be possible to introduce into that ordinary method as strong a current, and as efficient a ventilation, as by the mechanical methods which you have described?

I think if the methods alluded to were carried out to a considerable extent, they might be brought under such control as to be made more effective than the others; when, however, I speak of the furnaces as agents in ventilation, I would more particularly refer to such improvements as are to be found, especially in northern counties, and as Mr. Darlington has suggested and carried out.

38. Your opinion would be, that if the current required was a very strong one, those mechanical contrivances would generally produce more?

The contrivances noticed, no doubt, might be greatly increased in their power, and considerable effects might be produced, so that a larger volume of air might be made to course through the workings than may be now accomplished by means of the furnace method. Such increase of power, supposing the cost not to be regarded, and the application of the contrivances to the works practicable when their power may be so increased, would have many advantages. In the case of a current being so great by the furnace method, as I mentioned just now, as to blow out a candle, it is more than is required if the air is properly split and well conducted.

39. What number of cubic feet per minute would that indicate, do you suppose?

I do not exactly know; and I would here observe that the amount of air which has been supposed to enter collieries, to pass through them and come out, has not

not been commonly obtained by experimental means, which can be altogether relied upon. I need not tell your Lordships, that if they take no account of the friction of all the sides, the air will be very much more retarded than is supposed, when its velocity is only estimated in the central or other parts of shafts or passages where the current of air is more freely flowing. I do not mean to say that the volume of air coming through a colliery may not have been given with sufficient correctness at times, but when I have been shown the mode by which they were calculated, I should doubt the accuracy of a great proportion of the statements made.

Sir H. T.
De la Beche, C.B.,
F.R.S.

21st June 1849.

40. In order to render any system of ventilation effectual, the currents must be guided by arrangements in the passages of the mine, so as to prevent the currents in opposite directions from interfering with them?

That is always done, in an efficient system of ventilation, by the mining engineers; some of the existing contrivances are excellent for distributing the air; the fault too often is, that there is not a sufficiency of it. I am now speaking of well-ventilated mines, because we must guard ourselves from supposing that they would form the mass. It is estimated that 34 or 35 millions of tons of coals are annually raised in this country. The evidence is not very exact as to the one or the other. The amount may even be only 33 millions of tons; be this as it may, it is desirable to estimate how much of that tonnage is obtained from well-ventilated and well-arranged mines, and how much out of mines which are ill conducted. Although the large collieries do contribute, no doubt, a great portion of this amount, still, when we look at the collieries generally, we shall find that a number of minor collieries collectively contribute a still larger quantity. These, for the most part, are very ill managed, and they will be occasionally found close to exceedingly well-regulated collieries, allowing for all the conditions existing in any particular district.

41. You have described the ordinary system of ventilation, and have stated, that there are cases in which, in order to attain the ventilation, they are obliged to divide one shaft; that they have not two shafts, but are obliged to make use of the same shaft for both the down-cast and the up-cast currents?

Yes.

42. Do you consider that ventilation can be made efficient for any extent of workings under those circumstances?

It is a most objectionable mode of working a colliery, for if there be any accident, breaking through the dividing brattices, or by whatever other name the divisions may be known, the ventilation is immediately cut off. When we look at what is done with such shafts, that they are used for the pumps and for the extraction of the coal, as well as for ventilation, it is often a matter of surprise how the latter can be effectively continued. It should, however, be recollected that many beds of coal have been won by a single shaft, at very great cost, so that the cost of another shaft would be very considerable; no doubt this has to be taken into consideration; still, as an engineering mode of work, due reference being made to ventilation, there can be little doubt of its being objectionable, as compared with two shafts distributed in a proper manner.

43. Are not there many cases in which it could be hardly expected that a second shaft would be sunk for the purpose of ventilating the mine? Under those circumstances, do you think that efficient ventilation might be attained, so far as your knowledge upon the subject extends, by these mechanical contrivances, or by other means, even through a single shaft?

The single shaft is objectionable, whether as regards one method or the other. When we consider the liability to accident, since such a shaft is employed, not only for purposes of ventilation, but also for the extraction of the coal, and for the pumps, should they be required, it will be readily seen that in the extraction of the coal there may be accidents which may break through the partition dividing the fresh air going in from the foul air coming out, if they be not properly protected or sufficiently strong.

44. Can you say, under ordinary circumstances, what amount of current of air per minute, stating it in cubic feet, would be necessary, or is it entirely dependent upon the conditions of the mine?

(164. 1.)

B

I am

Sir H. T.
De la Beche, C.B.,
F.R.S.

21st June 1849.

I am not prepared, without looking at figures, which I have not with me at the present moment, to give an answer.

45. What proportion of atmospheric air, mixed with the gas, is necessary to render it perfectly safe?

It must be very dilute. Sir Humphrey Davy showed, that when fire-damp was mixed with five or six volumes of common air, the mixture exploded feebly, and that with seven or eight volumes it exploded with more violence; a mixture of one volume of fire-damp with 14 volumes of common air still exploded; with more common air it ceased to explode.

46. Then the effect of the current must be such as to give the larger quantity of air required?

Yes; it must be in an unexplosive state to conduct it round, the more especially when the men use candles, and they are allowed to use candles very frequently when they should not.

47. You must find the average quantity of gas before you can determine the quantity of air, to make it perfectly safe?

The gas usually oozes out in such minor quantities that a good body of air passing through the colliery is quite sufficient for its removal.

48. The air moving at what rate?

A few feet in a second will be sufficient.

49. The object is to have a current beyond what you would conceive absolutely necessary to render it perfectly secure?

Yes; if it be what is called a fiery colliery, that is to say, where the fire-damp is rather abundant, it will require a large volume of air, and a considerable current of that volume, in order to remove the fire-damp evolved. With regard to the emission of fire-damp, it varies exceedingly in different parts of the same vein of coal; and as I have observed, a flood of the explosive gas may be thrown suddenly upon the men by a sudden burst, or by pricking a fault. It may not appear under the roof of the workings with a certain pressure of the atmosphere, as shown by the barometer; but let that pressure be diminished and it may be found. A working, therefore, which may be very secure, so long as the pressure of the atmosphere is considerable, may be insecure when that pressure becomes less.

50. Are there any other influences besides that of the weight of the atmosphere?

The gas, which is chiefly carburetted hydrogen, may vary in both quantity and purity. Although gases do permeate (in fact explosions would not happen unless they did so permeate), still, the fire-damp will long remain, as a whole, in the higher part of the workings; any given current of air may be sufficient for a time, removing the fire-damp, but the same current may not so readily remove it, should a change in the atmosphere take place, so that the barometer descends, or a larger volume of gas be evolved without such change.

51. So that to convey it safely away it would require the top of the air-courses to be of the same level as the top of the roofing?

Yes; that, however, is not always the case; there are, very frequently, unevennesses which are neglected under ordinary conditions, but which it becomes important to remove when they may form trains of fire-damp. It very often occurs that goafs constitute great reservoirs, holding fire-damp in considerable abundance, and which may be emitted under a change of atmospheric pressure, spreading through the workings, and being connected by the inequalities of the roof, which at the same time prevent the fire-damp from being properly swept away by an air current. It may be noticed with respect to the escape of the foul air at the pit mouth, under the ordinary system of ventilation, by a heated shaft, that this may vary according to the temperature outside at the time, so that differences of temperature which would do well in the winter, may be insufficient in the summer, and so on. A given heat in a shaft, which may be effective so long as there is sufficient cold above, may become inefficient during a very hot day, such as this is; assuming, as is but too often the case, that the draught up the up-cast shaft is but of a feeble kind.

52. Would

52. Would you not regulate that by the thermometer?

You would, if you could; but you have not always the means of increasing the power of the draught which you could wish.

53. Would you not do it by the fire?

Sometimes you could do it by the fire, but very frequently the furnaces are kept up to the full pitch, ineffectual as this may be, under the circumstances supposed.

54. Do you think that when the furnace is kept up in that way, the variations of surface which you have described have a considerable effect upon the amount of current?

Yes; they are found to operate very considerably, but not when the furnaces are really good and efficient, and do give the quantity of heat needed to the air going up. And this is the point; the furnaces are too frequently not what they should be; while some are well constructed, and do their work well, others are ill-constructed, and very often at greater cost than effective furnaces might have been.

55. Is that system, provided it is effectively employed and properly attended to and accurately arranged, in your opinion, sufficient to secure the persons under all circumstances from accident?

As a given shaft and furnace can only produce a given effect, you have to look at the whole range of your workings to see that that shaft is proportioned to them; consequently, an answer would be in the affirmative, provided everything was rightly adjusted, and the shaft was not required to do too much, and there was a full power over all the workings. In that case, and in many parts of the country, you get very good effects; of that there is no doubt, and the proof of it is, that you have such effects produced now in the northern districts, more particularly in the Durham and Northumberland collieries. Probably the Committee will have some gentlemen under examination here from those districts who will give them the needful detail, so that they will be enabled to form a correct opinion as to the efficiency of the furnace system of ventilation. General effectiveness would depend upon the proper adjustment of all parts; a given shaft heated by a given furnace cannot do more than a certain degree of work.

56. Cannot the shaft be proportioned to the quantity of work which it is so to do?

It usually is to a certain extent. It is desirable so to split the workings that there may be a general command of air; and if the works be on a flat piece of coal, or one nearly level, it is much better to apportion the different parts of the colliery, so that too much be not thrown upon one part; that is one of the points to be observed, so that the work expected to be done is capable of being accomplished by the means employed; it is a matter of judgment.

57. One of the branches of the operation that perhaps requires most judgment is making those arrangements in the workings of the pit?

Precisely, to see that the whole is properly adjusted.

58. Whether a given quantum of fire clears a given space of ground under it?

It depends upon the height of the shaft and other circumstances, such as the "drag of the colliery," as it is termed in some localities; that is, the impediments in the way of the air coming through the workings; it is a matter of judgment for each case.

59. Would it not also partly depend upon the dimensions of the workings?

I am assuming that they are all well adjusted. If you give the shaft too much work to do, it is impossible that it can accomplish it.

60. How would you meet this case: supposing that the adjustment was perfect, and the furnace adapted so as to work the thing completely with proper care and attention, and then that the workings were extended further, comprehending a much larger space, how would you correct that?

That could only be corrected by the judgment of whoever had the inspection or charge of the colliery.

61. Supposing you were to inspect it yourself, what means should you take to adapt the draught to the additional work?

(164. 1.)

B 2

I should

Sir H. T.
De la Beche, C.B.,
F.R.S.

21st June 1849.

Sir H. T.
De la Beche, C.B.,
F.R.S.

21st June 1849.

I should see whether there was an opportunity of greater heat, so as to produce a greater quantity of passage of air.

62. Assuming all that to be perfect, so far as it related to the first work, and exactly adapted to it, and that you added more work, what would you do then? I do not think that should ever be permitted.

63. Without another shaft?

No; and then it would be for the judgment of a really qualified person to say whether they were doing a thing which was proper or improper.

64. Would it do to add a second shaft near the former?

They then could have another system of ventilation entirely.

65. Close to it?

They could sink two other shafts, and, of course, obtain the same means as they had had before; there might be nothing to prevent them from doing this.

66. In fact, the up-cast shaft is the chimney by which the foul air is taken out?

Yes.

67. But a very great proportion of the ventilation of the mine depends, not solely upon the up-cast shaft and the furnace, but upon the arrangement of the air-courses below?

Yes.

68. Putting the proper doors to prevent the air spreading uselessly, and by means of brattices and doors and air-courses, always keeping the fresh air close to the parties working the coal?

Yes. It is assumed that they have done all that correctly.

69. In such a case as has been supposed, of extending the working, you might resort to the expedient of cutting off a part of the old work?

It might be done. The workings must be adjusted. It was put to me, that the works were perfect as they were, and did their full work.

70. Perfect in the first instance, *quoad* the work which was then capable of being wrought?

Yes, and then that there was something else done.

71. That you were giving to it a greater power; what means would you resort to for the purpose of increasing your draft in proportion to that power?

If the whole were adjusted, of course you could not increase it any more upon that footing.

72. Could not you widen the shaft?

You might make a bigger shaft, and a larger fire, but that would be an alteration of the then existing conditions.

73. You might make another shaft?

Yes.

74. And another furnace?

Yes.

75. They would not counteract each other in their operation?

No, not with sufficient care, and assuming that a proper amount of fresh air could enter the colliery.

76. You have made it pretty clear that the main source of accidents of this kind is defective ventilation, and that that defective ventilation arises in a great measure from the ignorance or carelessness of parties concerned?

I should say ignorance to a great extent, and I think you will find that borne out by evidence; if you examine gentlemen from the various districts, I think you will find that in some districts they have often great difficulty in obtaining efficient overmen; and I will adduce as an instance the case of the last explosion near Barnsley, the cause of which was inquired into by Mr. Warrington Smyth and Mr. Tremeneere, where there was a man who could neither read nor write, and yet in his hands was the safety of all the men employed in that pit; the viewer only came there periodically. The results of such arrangements and management are before you.

77. Are there any other atmospheric influences, such as electricity, or anything else, which have an effect?

There may be, but these have not engaged much attention as yet. We find the effects of atmospheric pressure as shown by the barometer having the chief influence, not forgetting a damp or dry state of the air, and the force of the winds at different times: there can be no doubt that in many a mine a vast body of fire-damp is thrown out when the atmospheric pressure is much diminished; the evidence upon that head is good.

78. Would you lead one to infer, that a person in charge of a colliery, in order to discharge his duties properly, should be capable of estimating the variations of the barometer?

Certainly; I should say it was an essential thing for him to understand.

79. Such a man as you have alluded to in the Darley Main Colliery would scarcely have been competent to do that?

He may never have heard of a barometer, and certainly he would not be expected to know its principles. That is not an isolated case; I believe we could produce you districts where such men are not so unfrequent as might be supposed; they are appointed sometimes, but not always, with the view of saving expense, since it usually costs less money to have a man of this kind, who may have been a common collier who has behaved well, and therefore deserved promotion. It is too often thought cheaper, which, however, may be doubted, to employ a man of that kind than to employ another more instructed; at the same time, I most fully admit the importance of advancing men for their good services, even to the highest offices, should they be qualified.

80. Would it be a perfect disqualification for an overman not to be able to write? I should consider it a perfect disqualification.

81. That he is not a judge of heat and damp?

If one is to judge of ordinary men, the capability of reading and writing would be of immense importance to them in enabling them to form an opinion; a man who can do neither is barred from the means of obtaining the information of others, except such as may reach him in conversation. Now what may thus reach him in many of those districts we know to be frequently unimportant, and often replete with prejudice; whereas if he had the power of reading and writing, he would always possess the means of more extended information.

82. Would that be needed for a clever practical man for the mine?

It could scarcely but be useful for certain things, and we will suppose that a man is under a good viewer, who tells him to perform certain given duties, and that he does this effectually; I think you will find from experience, if you question them (I have examined a great many), that they have no correct knowledge of the general subject of ventilation, and that though they have a certain practical acquaintance of certain effects arising from the escape and explosion of fire-damp, they have little or no notion of what that gas is; it is immaterial what name they give it, provided they know its properties. I should unhesitatingly say, that when men's lives are, sometimes 100 or more, placed under the charge of one man, that man, at all events, should be sufficiently acquainted with, not only what he is told to do, but also with the circumstances attending conditions that may arise respecting which he has had no instructions.

83. Cannot that man, by long experience in the colliery, be properly qualified to judge of the effect of particular gases, and what is likely to explode?

I have not observed that class of man yet, meaning thereby, a perfectly otherwise uninstructed man. I am well aware that many a man fairly judges of the state of the air by the flame of his lamp or candle; this is no doubt valuable in itself, but to render a man efficient under circumstances affecting the safety of a whole colliery, or of a large part of it, surely something more is required.

84. Assuming that a person of that description may be perfectly competent to discharge his duties, so long as they are confined to the routine of his own experience, as he has been accustomed to them in his district, do you conceive that he can be considered competent to deal with unusual circumstances, or anything that may happen out of his ordinary experience?

Freely admitting that that constitutes education of some kind, I should say un-

Sir H. T.
De la Beche, C.B.,
F.R.S.
21st June 1849.

hesitatingly, taking the subject generally, that such a man was not a competent person; there may be individual men, indeed there are, and have been, whose capacity may enable them to find out such things as may be needed; but looking at the matter generally, I should say that such a man was not a fit party.

85. You would not employ such a man as an overman?

No, answering the question generally; admitting, however, that education is a great deal a matter of experience of some kind or other, that he would be, so far, an educated man with respect to certain things, and that if he possessed very great abilities, he could turn them to account; but an individual case of that kind would not affect the general conclusion.

86. Then you do not think it a perfect disqualification of an overman not to be able to write?

I do, as a general fact; but there may be particular exceptions, no doubt.

87. Would you say that in circumstances which lead to accidents of this sort, it is not sufficient that a man should confine his attention to any one or two particular points; but that there are a great many things to be taken into consideration?

I should say, certainly so.

88. And that, in order to enable a man to do that properly, his mind should be exercised and trained by education sufficiently to give him some powers of reasoning and inquiry?

That is certainly my opinion.

89. And that it is rather in that way that an educated man would generally be a better person to be employed as an overman, than a man who had no education at all?

Certainly; taking the question in its generality, I have not a doubt, in my own mind, about the point.

90. Assuming, then, that it is a fact, that there are, in many cases, very incompetent persons in charge of mines, have you ever turned your attention to the possibility of effecting an improvement in that respect?

I have, because I have been in communication with Government lately upon the subject of accidents by explosions in collieries, and the view taken was much in accordance with a suggestion made in our Report of 1846; namely, that it would be very desirable to have well-qualified persons in the different districts. I do not know that the name "Inspector" is a good one, but a well-qualified person, at all events, who could offer sound advice, after looking to the subject generally, and who could thus aid in protecting the lives of those employed in collieries.

91. You stated that the mass of the collieries are ill-regulated, though the large ones are in a good state; in what part of the country are the mass of those collieries?

They are distributed almost everywhere; I could find some even in the well-worked northern districts.

92. Where are the worst?

Some of the worst, at the present moment, are in South Wales; some of them, I think, are as bad as they can well be. At the same time, there are some excellently managed in that district, and it is one which contributes about six millions of tons of coals per annum. In the chief iron-works, they are, for the most part, well-managed; and others are to be, here and there, found elsewhere. There are ill-conducted mines in Staffordshire, and also many in North Wales, Shropshire and Lancashire; also in Gloucestershire, and in Somersetshire. With respect to some parts of Yorkshire, I need only appeal to the two Barnsley cases. I would likewise include parts of Derbyshire. When we get more northerly, to the Cumberland district, and to Durham and Northumberland, certainly things are greatly improved; but again, in parts of Scotland, they are very defective. I think you will find that even in some parts of Staffordshire, the up-cast and the down-cast shafts are not in a state to produce perfect ventilation, from the want of the proper heat in the up-cast shafts.

93. Do you find that bad arrangements for ventilation generally go together with bad arrangements in working the mines?

No, those arrangements are very unequal. I should, however, call a good arrangement for working the mine that with which the workman can most easily get the coal. If he be in fresh air, he will be better placed, so far as getting coal is concerned.

Sir H. T.
De la Beche, C.B.,
F.R.S.

21st June 1849.

94. In Staffordshire, are not the workings generally over a few acres of ground? They are very extensive in the 10-yard coal.

95. You mentioned police; will you state what you mean by that?

I mean by that, regulations for the conduct of the men, including the arrangements for preventing them from using naked candles in certain localities of the mine where they should not. These are not good so frequently as they should be, and are not sufficiently attended to.

96. How is that to be remedied, by an increased number of overmen?

Yes, an increased number of overmen occasionally would do it. One or two or three, sometimes, would be amply sufficient in a colliery. Very frequently, in many a colliery, after the men go to work, they are not visited again by the overman.

97. Does it partly arise from the ignorance of the overmen?

Yes. It is a common thing, when the men have left, in ill-conducted collieries, that the state of the mine becomes much neglected. Your Lordships are aware that, in some districts, they work continuously, but that is not common. The usual arrangement is a day's work and a night's repose, and then it is not unusual to have a man who goes round before the colliers arrive at their work, and who is considered to see the condition of the workings—the airways, the stalls, and the faces of the work generally. It is usual for him, when he finds anything wrong, to leave some sign, as, for instance, a shovel across a particular place, or something to inform the men going to work that they must not advance further. Sometimes several men may be on this duty. When only one, it depends upon his activity, and his having gone into various places, how far the inspection is properly carried out. Of course, in a case of explosion, we see a mine in its worst possible condition; and it is hardly fair to judge of collieries from what we then find; but you will see, generally speaking, that the arrangement above noticed has not been sufficiently attended to. Evidence is not unfrequent, showing that when men have gone into their stalls, or whatever the face of the work may be called in different districts, that they have found much fire-damp, and that they have proceeded to remove it in a very primitive, but certainly, in one respect, not a bad way. They take off their jackets, and brush away the fire-damp into the more main courses of air. Now it sometimes happens that they never should have gone there at all. We cannot always get at the cause of an explosion; but we know, in many cases of minor explosions, that men going suddenly to their work, and beginning to cut coal, blasts took place, the men being only injured so that they could give a good account of what had happened: The object of the police of a mine is that it should be effectual; that there should be some check upon the parties in charge of different work, to see that they do their duties. In military and similar arrangements there are men to see that the others do their duties; but in the case of numerous collieries, the charge of inspecting the condition of the workings before the men enter the pit, is too frequently left to one or two men, who may or may not go through them in a proper manner; and if they do not happen to leave their shovels across, or make other signs, the men go into places which have been unvisited during the time that they have remained absent from them. With regard to the police of a colliery I would more especially refer to the necessity of having the condition of a mine properly ascertained before the men go down to their work.

98. And that the parties inspecting should have some power of enforcing regulations?

And to ascertain that the others have done their work. These arrangements vary very much in different districts.

99. You do not mean by that to recommend that there should be any power conferred by law?

Not at all.

(164. 1.)

B 4

100. But

Sir H. T.
De la Beche, C.B.,
F.R.S.

21st June 1849.

100. But merely that the owners should take care that there was a more effective police?

That is all; it is absolutely for their own interest.

101. When men have been off working for a day and have come on the next day, have accidents frequently arisen from that?

Very frequently; the case of Risca was one of that kind, a Monday holiday; and although they said that the night fireman, as he was called, and his party had gone round and looked well about, it was quite clear that they had done no such thing; they had just passed along the airways and neglected the stalls. A detailed description of the Risca Colliery, and the circumstances under which the coal was worked in it, will be found in the Report of 1846. It will be seen that the coal-bed worked was curved, so that, after having a moderate dip, it became somewhat highly inclined. To meet this difficulty, a shaft was being constructed to take off the noxious gases at a higher part of the workings.

102. The gas escapes of its own accord?

Yes.

103. Do you recollect the inquiry into the case of the Haswell Colliery?

I was not present at that inquiry.

104. But you are aware of the Report which was made upon it?

Yes.

105. Do you remember a suggestion upon that occasion by Mr. Faraday and Sir Charles Lyell, that the gas might be withdrawn from those goafs or vacant spaces by passages carried up into them and from thence to the shaft, so as to enable the gas to escape, on the same principle, very much, as the opening of that shaft which you have mentioned in the Risca case?

I remember the suggestion very well; it was much objected to at the time by the practical colliers, from the injury to which the invention was supposed liable from being placed as recommended. There was a little pamphlet, I think, published in the north of England upon the subject; it is difficult to arrange ventilation of that kind, when the roof is liable to fall and destroy it.

106. There was an answer by the Committee of Coal Viewers?

I think there was.

107. In short, you do not think that a plan of that kind would be generally applicable?

It might be applied with advantage where the conditions were fitted for it; but, regarded as a general method, there would appear to be others which would be preferable.

108. With regard to the proportion of accidents, you mentioned that the small collieries are generally in a worse state than the large ones; have you any means of judging of the proportion of accidents in them?

The accidents in the smaller collieries are usually unheard of to any extent. It very rarely happens that in them there are more than two or three persons burnt or killed at a time, and this is rarely reported except in the neighbourhood, nor is it usually much thought of there. I may mention, that when we were engaged in that Report to which reference has been made, we applied to the Registrar-General to endeavour to obtain, through him and by means of the coroners, a somewhat detailed account of the needful facts, as we were aware that the case was as before represented. It appeared that the coroners had not kept proper accounts of such accidents, and in very many cases there had been no inquests at all; so that we arrived at no other than a general conclusion, to the effect that, not only looking at the greater number of those collieries as compared with the larger, but also at their general defective state, the accidents in them were collectively very considerable; the accidents in them do not excite the notice which is occasioned by explosions in the larger collieries. Where 70 persons may be swept off, it causes general attention; but it is otherwise where two or three only are killed. A great many are occasionally disabled, who are never heard of, but who go upon the parish; a great many persons go upon the parish, in consequence of injuries that no one ever hears of.

109. It

109. It is stated, in the Report of the Committee of the House of Commons in 1835, that in the course of the 25 years preceding the inquiry, 2,070 persons had perished from colliery explosions, and they considered this number much under-rated; is it not the fact that, during the last 10 years, the rate of loss of life from this cause has not diminished?

On the contrary, it has increased.

110. You would conceive, from the cause which you have stated, that any calculation of that sort must be far below the real amount?

I should think so; we are now on the question of accidents by explosions; but, generally speaking, other colliery accidents are also very numerous.

111. Do you know at all the average population of coal mines?

No; it is a difficult matter to get at; the number might be estimated, but I am not prepared, off-hand, to state any probable number. I am, however, prepared to say, that there are about 34 or 35 millions of tons of coals raised annually in Great Britain and Ireland; not much, as a whole, in Ireland. As an aid to the amount of the coal-mining population, the average number of tons that a man can get in a week might be estimated.

112. That depends upon circumstances?

Upon many circumstances.

113. After what you have stated with respect to the great imperfection of the arrangements in many of these collieries, the want of a better police, and the description of persons who are placed in charge of them, do you conceive that the interference of Government could be applied with any great advantage to the system?

"Interference" I should certainly not like. Your Lordships are aware that I have been lately in communication with Sir George Grey upon this subject; he came to the conclusion that it was not desirable to remove responsibility from the coal workers and coal owners, and that whatever was done by the Government, it should not remove them from the effects of coroners' juries, where, if it were shown before such juries that they were by their arrangements the cause of accidents, or that by their neglect persons had perished, their misdeeds, should there be misdeeds, would be visited upon them. A preliminary investigation was, therefore, first determined upon, in order to ascertain the facts of the subject generally; for that purpose, it was considered that two parties would be sufficient, upon the principle, that by using the same mind over a given area, supposing that mind to be a competent one, you would have the power of useful comparison, and of stating the circumstances better than if a great number of persons were employed. Two gentlemen have been so appointed, who are highly competent persons.

114. Will you say who they are?

One is Professor John Phillips, of York, well known for his attainments, and especially in the north of England, who has been for many years accustomed to investigations of this and similar kinds, and who possesses a mass of other knowledge which is highly valuable in an inquiry of this kind; the other is Mr. Kenyon Blackwell, of Dudley, a practical man of great experience, who has for very many years been acquainted with the practical workings of mines in different parts of the country, who has himself superintended the working of mines, and who has just returned from the United States, where he has been examining their mode of making iron and of working of collieries. I have no doubt that from these gentlemen a very efficient general statement will be forthcoming. What may be further done it would be premature to suppose; but I can imagine that the country might be divided out into a certain number of convenient districts, a proper person appointed to each district, who should be duly qualified to ascertain the state of the workings in his district; that when they should find any defective workings, anything which would risk the men's lives, that they should state the case to the parties working the mines, and point out the remedies, should they have sufficient facts before them to do so. Should an accident subsequently happen, through the neglect of those working the mines, we can hardly suppose that a jury of their countrymen would be so neglectful of their oaths and duties as not to visit any loss of life very severely upon them. At the same time, those working collieries would have a good appeal, inasmuch as they would have the power of showing whether the Inspector's views

*Sir H. T.
De la Beche, C.B.,
F.R.S.*
21st June 1849.

were correct or not. Such is a view which may be taken of the subject, as to what may appear desirable at the present moment; but the preliminary investigation is now ordered, and I have no doubt, as previously stated, that a great amount of valuable information will be obtained, important for legislation, should it be thought desirable to legislate upon this subject.

115. These are Inspectors appointed by the Government?

They are merely investigating, as upon a commission, at the present moment.

116. Are they to inspect the mines in all the districts?

They are to inspect a sufficient number of mines in each district, and ascertain the general facts connected with it.

117. The two together?

No, the two separately, in order to insure quicker action.

118. Will it not be a considerable time before that Report can be completed?

I do not see that. Each possesses a great knowledge of his own districts at present.

119. When were they appointed?

A few days ago.

120. Professor Phillips for the North, of course?

Yes.

121. You are aware that they have received their instructions for the purpose already?

They have.

122. Have the juries in any instances where lives have been lost by explosions, arising out of bad management and so on, found verdicts of manslaughter against any of the parties?

I am not aware; I think there is one case, but I believe Mr. Tremeneere will be better qualified to state that.

123. Have any actions been brought by the relations of parties who have died, to recover compensation for the loss occasioned by negligence?

I am not aware of any.

124. These Inspectors will have no compulsory powers?

None whatever.

125. Their business will be to inquire, in the first instance, and subsequently to diffuse information, and to make any suggestions which they think the nature of the case may require?

At the present moment the object is little beyond a simple investigation. I presume that a Report will be made, and that upon that Report further measures may be taken.

126. Is it likely that any objections will be made by the coal owners to allowing those inspections?

I do not think, from what I know, that any of the larger coal proprietors will make the slightest objection. I should think very much the reverse, because many of their collieries are so well managed that they might be cited as models for management in their various districts.

127. That would lead you to infer that if there were an objection, it arose from the consciousness that the colliery was not well managed?

I would infer that.

128. Do accidents ever happen in coal mines from the want of sufficient supports, from roofs falling in?

Very frequently.

129. There is no legal means of inspection at present with respect to those dangers?

None whatever.

130. Do you think that it would be advisable that that point should be taken into consideration?

The

The instructions which have been alluded to, do contain, I think, words to the effect that the other accidents also shall be looked into.

131. The cases of loss of life from accidents, such as have just been alluded to, are very numerous?

Very.

132. But generally speaking those are cases in which there are only very few lives lost at one time?

Except it is a remarkable case.

133. Is that probably the reason why you hear less of the loss of life from that cause than you do from explosion?

Upon the same principle that you rarely hear of the deaths of two or three persons by explosions beyond the immediate neighbourhood; nor do you, beyond the immediate neighbourhood, usually hear of the serious injuries which have been received, and which have thrown men upon the parishes and upon the resources of their friends.

134. Is it the habit of the proprietors of mines to give compensation in those cases of injury?

In some cases they subscribe very handsomely to them, and I have known cases where they have supported the parties for some time.

135. But it is not a general practice?

I know nothing to the contrary; I have known instances where parties have supported them for a long time and have also subscribed. An explosion in a colliery is a very serious thing to the owner, for not only is the colliery thrown out of work, and the men may not be got down into it even, occasionally, in the proper numbers, for months afterwards, but he may be called upon, in a case of explosion, to expend a considerable sum of money in various ways.

136. Therefore, if any remedial means could be pointed out without too much interference with the persons managing mines, you have every reason to suppose that they would be willing to attend to the suggestions?

I have every reason to suppose that they would attend to them, provided there was nothing compulsory, and that they were merely advised. It would generally resolve itself into this, that in the case of the larger proprietors of mines there would be, for the most part, nothing to be said about them, except that they should be marked out as useful models for the imitation of others; and these would, I think, in the end gladly avail themselves of such statements for their own interests, since nothing can be more adverse to their interests than accidents from explosions in their mines.

137. Are you aware that in the House of Commons there is a Bill pending to provide for the better Ventilation of Mines and Collieries?

I am.

138. Have you seen a copy of that Bill?

I have.

139. Do you see objections to that Bill?

I do. My chief objection is, that it would throw too much responsibility upon officers appointed by Government, and relieve the owners and workers of mines from their responsibility.

140. That is a Bill establishing a very rigorous system of inspection?

A very severe and rigorous one.

141. You do not conceive that it would be possible to carry into execution a system of that kind in the collieries?

I should apprehend not at all in the present feeling of the country.

142. Among other precautions which have been taken in mines with the view of preventing explosions, has been the use of the Davy lamp?

Yes.

143. Is it not the fact that it has been distinctly proved that the Davy lamp is not efficient under all circumstances?

It certainly is not; but, at the same time, it is but justice to the memory of Davy

Sir H. T.
De la Beche, C.B.,
F. R. S.

21st June 1849.

Davy to say, that the cases in which it has not been found efficient were perfectly well known by him, and announced by him at the time. There does not appear to have been any discovery as to its inefficiency under certain conditions not known to Davy, who particularly remarked upon it. I think you will find that we stated this in our Report, because we considered that there was a disposition to run the lamp down, as if something had been discovered which Davy had never contemplated; whereas there would appear no discovery of the kind, and it has been found effectual for those things for which he stated that it would be effectual. At the same time, there are other modifications of lamps which are very good. I think I saw in the newspaper that there was one used in some parts of the north, namely, Clanny's lamp, found whole at the late explosion at Hebburn. This is a fact of importance, as the great objection which used to be made to that lamp was, that the glass surrounding the lower part might be very much heated and be readily broken. There is a Belgian lamp made upon much the same principle, and which is much thought of in Belgium. There are many modifications of lamps. There was one shown me the other day, invented by Mr. Biram, Lord Fitzwilliam's agent, a well-imagined lamp. But all lamps require care; and I have known, as most men do who often go down collieries, that the men will unscrew their lamps when they should not, uncovering the flame in order to obtain a better light. It has even been found that the men have picked the locks, which they have used on lamps, although they go into places where they may meet destruction.

144. What are those exceptions which have been referred to as to the Davy lamp?

In the Davy lamp the danger is, that by means of a strong current of foul air containing the needful fire-damp, the flame may be made to pass the wire gauze, and so communicate with fire-damp outside. You may do this readily, even in laboratories. It has been supposed that, therefore, a current of fire-damp and air coming exceedingly strong against the side of the Davy lamp may have caused some explosions; but this is precisely what Davy himself said it would do.

145. A great heat and a great current?

Yes.

146. Might not that be obviated by something transparent being put in front of it?

There have been various contrivances; there have been transparent materials and metallic shields employed, and a variety of contrivances to prevent it. Shields have been placed inside, which give a reflection at the same time that they stop the draught. Mr. Biram's lamp is contrived to reflect light and prevent the passage of a current of fire-damp through it; when also the air is sufficiently foul, the lamp goes out, and therefore cannot become red-hot; other lamps have been contrived to go out under similar circumstances. With regard to the ordinary Davy, I have myself found it somewhat suddenly become red-hot; it may then become very dangerous.

147. That occurs from the inflammation of the gas inside?

Yes.

148. From the gas inside taking fire?

Yes, and an abundant supply; in such cases you might have an explosion, if great care be not taken.

149. But Davy's lamp will give you notice; the flame will become longer when there is bad air?

Yes; Davy's lamp, if properly used, is a very useful and effective instrument.

150. In general, when it has failed, has it not been from carelessness in using it?

Much more so than anything else, or from bad construction, which is not attributable to Davy's principle. In some collieries very great care is taken in the supply of Davy lamps. In the better managed collieries, if I may use the term police again, the police is so well arranged that the men have no charge of their lamps; they are given out to them when going to work, and they are bound to return them, when they are carefully examined. In some places the men themselves take their lamps home, so that they may or may not use them in good condition;

condition ; in such collieries there is often no provision made when they go down the pits for the examination of the lamps.

151. The result being that any one individual may place in jeopardy the lives of the whole ?

Yes, any drunken fellow, any man in such cases may do so ; a great deal may be accomplished with safety-lamps under proper management.

152. However, is it not the real fact, that neither the Davy lamp nor any other safety-lamp could be so complete as to enable the work-people to continue at work in very dangerous parts of the mine ; the principal object of it would be to prevent the occurrence of sudden accidents ?

They do sometimes work in very foul air with Davy lamps. It has been said that accidents have been more frequent since those protective lamps were introduced than before, since men have run greater risks ; and there is a great deal of truth, no doubt, in that. A variety of safety-lamps have, as above noticed, been constructed, some of a kind which go entirely out when the air gets sufficiently bad, so that the men have to find their way out in the dark ; that is an inconvenience, no doubt, but perhaps it is often the safer thing.

153. Mr. Buddle says, in his Evidence before the Committee of 1835, that there are several collieries at Newcastle which could not be worked without the Davy lamp ?

That is quite certain.

154. And that all the Collieries north of the Tyne are now worked, which would not have been able to have been worked without the Davy lamp ?

There was no person more qualified to judge of that than Mr. Buddle, who was a most excellent and efficient man, and perfectly skilled in colliery workings.

155. After all, perfect ventilation is the great desideratum ?

The great thing is to get perfect ventilation, and to secure it in the best way that you can, according to conditions ; for the most part it might be done.

156. Do you think, from your knowledge of the Davy lamp, and most of the different improvements which have been proposed in it, that it is likely it can ever be made so perfect and effective as to give sufficient light, and at the same time so secure as to be at all a substitute for ventilation ?

Not a substitute for ventilation ; I should think it a very bad thing to allow safety-lamps to be a substitute for good ventilation, since cases might arise where a great destruction of life would take place in consequence ; I have no doubt that many of the lamps now existing are very good in themselves, but that at the same time they should never be substituted for effective ventilation.

157. Is not this foul air bad for the health of the workmen ?

It is probably so, but I am not aware of that ; the men much complain of it on this score. Men were made to breathe pure air, so that where such deleterious mixtures exist it must be wrong ; I have been in much foul air of this kind, without a candle, and felt very unpleasantly.

158. But you may exist for a considerable time in a mixture of carburetted hydrogen gas and common air ?

Yes, so long as you can obtain sufficient oxygen for your breathing, you may do so, but not well.

159. The carburetted hydrogen is not so fatal to life as carbonic acid ?

Certainly not ; but it is nevertheless not a proper ingredient in the air breathed by us.

160. Although a person may exist for a long time in that foul air, a person in the habit of working in it would very soon lose his health and be incapacitated for work ?

Certainly.

161. Your attention has been called to the Report of the House of Commons Committee on Coal Mine Accidents in the year 1835 ?

Yes.

(164. 1.)

c 3

162. You

Sir H. T.
De la Beche, C.B.,
F.R.S.

21st June 1849.

*Sir H. T.
De la Beche, C.B.,
F.R.S.*

21st June 1849.

162. You possibly may remember that Mr. Goldsworthy Gurney was examined by that Committee?

I believe so.

163. In the examination of Mr. Gurney by that Committee, the following question and answer are to be found:—"Will you give the Committee a concise familiar description of the apparatus you would employ in the use of high-pressure steam?—A common boiler furnished with a small tube leading to the shaft and pointing either up or down as you desire the current to be driven, placed in a cylinder the size of which must be governed by the quantity of steam used, or the quantity of current you intend to make; a very small jet of steam at 60 lbs. to the inch, of about the size of a goose-quill, will dislodge 350,000 cubic feet of air in an hour." In a subsequent answer of Mr. Gurney, he says, "A mine of 10 miles might have the whole of the air contained in it, taking the galleries to be five feet square on an average, driven out and filled with fresh air every 15 minutes, let the area of the shafts be the smallest now sunk; such is the singular power of the steam draught." Are you aware that the apparatus there described is now in operation at the Seaton Delaval Colliery?

I do not know it by that name; but I am aware that it is in operation, or has been in operation, at a colliery of which Mr. Darlington has the control.

164. That is in Lancashire?

I think it is.

165. Have you seen the apparatus in operation?

Not in a mine, but otherwise; I am aware of the principle upon which it acts.

166. Have you seen the model exhibited at the Polytechnic Institution?

Not the later one; but I am aware of the principle.

167. Are you inclined to believe, from what you have seen and heard, that the effects of it are such as Mr. Gurney describes in that answer?

I am not prepared to say that I would agree as to the quantities, unless I went carefully into the subject; but I have no doubt that the principle may be employed with very great effect under proper conditions.

168. It is the principle adopted at present in order to obtain a strong draught in the case of certain steam-engines, is it not?

Yes, in the common locomotive; it is one of the means of getting a better draught.

169. In locomotive engines the draught is obtained in the funnel by that very means?

It is one of the means by which the draught is accelerated.

170. You have probably read the Report of the South Shields Committee, in 1842?

Yes.

171. You are aware that they strongly recommend the general adoption of Mr. Gurney's apparatus?

I think I do recollect that there is a recommendation to that effect.

172. Do you conceive that an apparatus like that recommended by Mr. Gurney could be applied without any great cost in most cases?

Respecting the cost, I am not prepared to give an answer; I am quite prepared to say that the principle may often be applied with considerable success; no doubt, like others, it requires fitting circumstances and attention. When one arrangement cannot be made to work well, another often may.

173. Can you describe any conditions or circumstances under which Mr. Gurney's apparatus would not be applicable?

I should consider Mr. Gurney's apparatus applicable under general conditions. So long as the ventilation is produced by a draught of air through the colliery, it would appear as available, under proper adjustment, as other methods producing the same effect. Even as respects South Wales, where a large proportion of coal is got by means of levels, when these require ventilation at the top, a draught of air passing through the working, Mr. Gurney's principle might be applied as well as others.

174. Is that principle easily regulated as to the quantity of draught?
Very easily; a steam jet is very easily regulated.

*Sir H. T.
De la Beche, C.B.,
F.R.S.*

175. Do you know more than one case where Mr. Gurney's apparatus has been applied?

21st June 1849.

I do not.

176. It has been an invention, or has been before the public for 20 years, but has not been applied to the present day; do you know what is the reason?

No, I do not.

177. Would it not produce a current much more strongly than by the ordinary mode?

I conceive you may produce a very powerful current by means of the steam jet.

178. Much more than by a mere furnace, and the draught arising solely from the heat occasioned by the furnace?

The heat is there limited to a certain extent in its power; certainly, by a well-combined system of the steam jet, you may obtain an extent of power.

179. Then it admits of regulation to almost any extent?

I am not aware of how Mr. Gurney now proposes to work his apparatus, but many means readily suggest themselves by which a steam jet may be controlled as to the amount which may be required.

180. So that it is a much more powerful instrument, and subject also to regulation to a great nicety?

I believe it may be regulated with very considerable effect. Dr. Faraday has, I believe, gone largely into the subject of steam jets, and could afford much information upon it.

181. Are you aware that the velocity of the current in the mine in which it has been adopted has been doubled by the application of this system?

I have heard it so stated; I have also heard it stated that at a colliery lately on fire, it was employed to extinguish that fire. A fire-place was so arranged on the surface, that the products of combustion, carbonic acid amongst the rest, were driven down like common air by one of Mr. Gurney's steam jets, another being applied at the other end, to produce the needful current; these gases are stated to have passed into the pit, so that the fire, no longer finding what it required, went out. That was the statement; whether it be true or not, I can easily understand that it might be done.

182. Do you refer to a colliery on fire?

The one that was on fire the other day.

183. That was the mode of extinguishing the fire?

Yes, it was so stated; the principle was a very good one.

184. What is the state of the air below; is it a moist air which circulates through the pit?

I am not at all aware, practically; I never was in a pit where that jet was used.

185. Is not the usual mode of extinguishing fire in coal mines the turning in of water?

Turning in water, or shutting up the pit entirely.

186. Both of which are very expensive?

Yes, and occasioning a great loss to the owner, because in turning in the water great injury may be done to the workings.

187. And neither of them certain?

Neither of them always certain.

188. This would be a much more economical as well as a much more efficient mode?

I can easily understand that, not only by these means, but by others, you may so turn down the products of combustion; and I can understand that they may be employed to put out fires.

*Sir H. T.
De la Beche, C.B.,
F.R.S.*

21st June 1849.

189. You have spoken of other modes; will you describe what other modes you conceive would be equally applicable?

I conceive that Mr. Struve's plan of pumping up might be applied, because if you can pump the air through, the same thing may be accomplished, or if you can get Mr. Brunton's plan to bear, or any other mechanical arrangement made, by which you could suck common air out of a pit, and supply gases only which will not support combustion, you would effect the object desired.

190. But you are not now prepared to explain the relative efficiency of one plan or the other?

I am not.

191. Is not Mr. Gurney's a much more simple arrangement?

It is a very simple arrangement.

192. And much more powerful?

I conceive it can be made powerful by a sufficient amount of apparatus; at the same time, by increasing the power of the mechanical arrangements noticed, a very powerful current of air could be made to pass through a colliery.

193. Do you think that in either of those cases it would be possible to obtain the same power of current at anything like the same cost, as in the case of the steam jet?

I am not prepared to answer that question; I have not gone into the subject of the cost of increasing the current of air of acceleration in collieries, by the different means mentioned. I am presuming that the means do exist, and that acceleration or increased draught could be produced, if required.

The Witness is directed to withdraw.

SEYMOUR TREMENHEERE, Esquire, is called in, and examined as follows:

*S. Tremheere,
Esq.*

194. YOU are Inspector of Mines under the 5th and 6th Victoria, chapter 99, commonly called "Lord Ashley's Act?"

Yes.

195. In the discharge of your duties in that capacity, it is your business to visit mines for the purpose of examining the condition of the population principally?

To visit them externally.

196. It is not your business to examine them underground?

Not at all.

197. However, in the course of your duties, you have been led to very extensive communication with the owners of mines, and to some knowledge of the causes of accidents, or, at least, of the circumstances connected with accidents?

I have, and I have endeavoured, in communicating with various owners and lessees, to understand all these matters relating to the mining population, so far as I have been able to do so.

198. So far as your opportunities have given you the means of judging, what should you say are the most common causes of accidents in coal mines?

I should say that defective ventilation is one of the most prominent causes, but I think that the Returns, as far as they have occasionally been made privately, show that there are many other causes from which very serious accidents occur, such as the falling of roofs, defective machinery for raising the people, and other matters.

199. Apart from any consideration of the physical causes of these accidents, do you think that there are any connected with the management of such concerns and the condition of the people, who are engaged in that management, which lead to the occurrence of such accidents?

The want of proper skill in the managers, mining engineers, &c., I have no doubt, is a very prominent cause of such accidents, entirely apart from physical causes.

200. Your duties not taking you underground, we exclude physical causes, because

because we presume that you have not had an opportunity of examining into them ?

Exactly so.

201. But you think that there is very frequently an incompetency in the parties who have the management ?

No doubt.

202. In so speaking, do you allude to the owners of coal mines, not the proprietors, but the persons who conduct the working of the coal mines, or the overseers ?

Sometimes the lessees conduct them themselves ; in such cases, the previous answer would apply, that there is great incompetence very often shown by them ; but, generally speaking, they are conducted by, what are called in some parts of the country, viewers, in others, agents, and by various other terms, many of whom also show great incompetence.

203. Have you had extensive communication with people in such situations ?
I have.

204. And have you found them in many instances very unfit for the management imposed upon them ?

No doubt.

205. Unfit from a want of education ?

Yes.

206. To what class do the overseers of collieries generally belong ?

A very large proportion of the managers of small mines appear to me to have sprung from the class of working colliers.

207. Are the working colliers generally persons who have received much education in their condition in life ?

Their education, until a few years ago, certainly had been exceedingly neglected ; as a class, they appear to have been below the average of the rest of the population.

208. Is that taking it generally throughout the kingdom ?

I think generally.

209. But of course there is a variation in certain districts, is there not ?

No doubt a great variety in certain districts, because here and there attention has been paid to their education ; schools have been provided by large proprietors or large companies, expressly for their benefit, and in that case, of course, their average intelligence and average condition is superior to that of others.

210. Do you suppose that at this moment any large proportion of the working colliers are able to read and write ?

That proportion is daily increasing, I have no doubt.

211. But do you conceive that there is any large proportion at present who are so far educated ?

I think it may be said that a large proportion can read and write, if you take the whole mass, but if you come to consider different districts that proportion will vary considerably, and will vary probably somewhat in the ratio of the age of the mining districts ; in the more recent districts, such as South Wales especially, where the population has been suddenly collected, and very few opportunities have existed for their education, the ratio of uneducated persons will be very much greater than in some of the other districts where coal has been worked for many years.

212. You state that the greater number of the superintendents or overmen of coal mines are drawn from that class ?

Yes.

213. In the larger mines in Durham and Northumberland and the North, are the viewers, and the persons set over the mines, drawn from the working population ?

The viewers (by that term I understand the mining engineers), are not drawn from that class, but under them are several men in subordinate capacities of authority who have been drawn from that class.

S. Tremenhoe,
Esq.

21st June 1849.

214. Is not the viewer of a mine one of the most intelligent engineers of the country?

No doubt in the north, in Northumberland and Durham, exceedingly so; but there they are, as a class, very superior to that which is found in any other part of the coal-fields of the kingdom.

215. Even the class of viewers in some parts of the country are very inferior to those who have been alluded to in the north of England, are they not?

No doubt.

216. Have you ever turned your attention, in the course of considering this subject, to the possibility of improving the condition of that class of persons in respect of education and intelligence?

I have.

217. Are there any suggestions which you think it would be desirable to make?

Immediately after the inquiry at Barnsley, the other day, several of the owners and managers of mines there suggested to me that it was highly desirable, and their wish, that some system should be set on foot by which the education of the class of managers of mines should be improved; they stated that at present the whole of that district was presided over, as it were, by a committee of colliery lessees for all matters relating to their own interest, and that that committee might be made use of as a means of organizing some system of examination by which the qualifications of these persons might be tested.

218. Have you heard the same desire expressed in other parts of the country?

No doubt. Very recently, in Lanarkshire, where I have always found a most ready desire to benefit by useful suggestions, that opinion has been expressed; and as the district is small, a system of that kind would be very readily brought to bear there. Subsequently, in Northumberland and Durham, I have had communications on the same subject with many of the principal viewers there, and they seem to have taken up the matter with considerable interest, and I think are considering whether something of the kind cannot be carried into effect. In consequence of these communications, I have adverted to the subject in my present annual Report, and have written several paragraphs upon it. I have brought it here. If the Committee wish that I should read that portion to them, I shall be extremely happy. If they will allow me to read it, it will show clearly what my notions are upon the matter.

219. It is desirable that you should do so?

"The Act of Parliament being, I have reason to believe, very fairly attended to in these two counties, namely, Northumberland and Durham, my relations with them, according to my instructions, are confined to what has reference to the welfare of the mining population. In entering upon this subject with several of the leading persons in both counties during my recent visit, I observed somewhat of a feeling of disappointment that the colliers had not taken advantage, to the extent that had been hoped for, of the facilities offered for their own and their children's improvement. It can hardly yet be expected to be otherwise, or that their clannish feelings and suspicious turn of mind should have yet given way to a tone of confidence in their employers, considering how many there must still be among the adults whose early life was passed, as it were, almost entirely in the pits, and whose characters have been formed under the old mode of management. Nevertheless, I am inclined to think, from what I have observed, that one or two simple and easy steps in advance might still be taken on the part of the employers, which would tend to quicken the progress towards a better state of things.

"Although many excellent schoolhouses have been built within the last 10, and especially within the last five years, and many new schools are now in process of being established, I have seen reason to believe, that too low an estimate has still in many instances been formed of the qualifications of a really efficient schoolmaster and schoolmistress, and of the remuneration requisite to secure the services of such. It is obvious that in dealing with a population, a large portion of which has been rendered, by long neglect and their own consequent ignorance, not a little indifferent to the education of their children, it is of the first importance,

importance, in commencing the work of improvement, to place among them really able and zealous teachers, who, in their communications with the parents, would co-operate with the employers and others in removing the lingering prejudices and suspicions, and the common preference for inferior schools; and who would give practical proof to the parents of what good education means, by improving their children not only in the usual rudiments of instruction, but in habits, manners, and tone of mind. The tact and ability to do this can scarcely be expected from any but properly trained masters and mistresses, placed in a position to command respect.

“ But, indeed, the whole question of education in this great and important mineral district deserves a more enlarged consideration than has yet been given to it. It has been estimated that a capital of not less than 10,000,000*l.* is embarked in the coal trade of these two counties, exclusive of that employed in the several new iron works that have already risen into importance. The frequent and serious losses inflicted on these great interests by the ignorance and wilfulness of the colliers and miners in their combinations and strikes, and the burden of no slight addition to their fixed capital imposed on many of the principal works, in consequence of their liability to those untoward occurrences, have already produced a general, though inadequate effort to raise the intelligence of the labouring population. But there is still a wide field comparatively untouched, a judicious dealing with which would give a great stimulus to the whole. The number of collieries in the counties of Northumberland and Durham is about 140; in each of these there are, on an average, perhaps, three subordinate situations of authority and trust filled by men selected from among the most orderly and intelligent of the pitmen, making, on the whole, probably about 400 such situations in the entire district. It is of great importance to the employers that these men (the under-viewers, waste-men, &c.) should not only be thoroughly trustworthy, but should possess a degree of acquirement and intelligence much above the ordinary level. Upon the right discharge of their duties depends, to a considerable extent, the economical working, the discipline, and even the safety of the pits. The higher their qualifications, the greater the chance of their maintaining their authority over the men, and discharging their duties satisfactorily. There is an acknowledged want of men properly qualified for a large portion of these situations, and no means have yet been taken with the special view of supplying this want. Appointments to these situations are said to be generally due to favour, or, in many cases, with a very imperfect security on the part of the employer that the duties will be well performed. It would seem that in a district so compact as this, and where all the employers have, in this respect, a common object, a very little arrangement would be necessary to produce in a few years a number of men as well qualified for the above situations as could be desired. Schools are now numerous throughout the district; wherever they are conducted by sufficiently able masters, inducements might be offered in the shape of ‘exhibitions’ or rewards, of three or four pounds a year for one or two years, to a few of the most advanced and intelligent boys of the highest class in the school, on condition of their passing at the end of each year a certain examination in the ordinary rudiments of education, including a fair acquaintance with arithmetic and with the elements of mechanics. This would induce their parents to allow them to remain at the day-school, which they now almost invariably leave too early, until the age of between 13 and 14. They would then commence work in the pits in the usual course; first, as drawers, &c., and when their strength increased, as hewers. After they had worked a year or two in the latter capacity, encouragement might be afforded them, when about 18 to 20 years of age, to attend a course of lectures, which might be given at Newcastle, on practical mechanics, the elements of chemistry, and the laying out and ventilation of collieries, including the various points connected with their safe and economical working. A contribution of a few pounds a year by each colliery, added to a small sum to be found by each young man himself, (either from his own savings or furnished by his family, both of which would be very practicable with proper forethought), would enable these pupils to suspend their employment in the pits for six months, during which time they would attend the lectures, either availing themselves daily of the various railways which would in most instances enable the young men to continue to live at home, or boarding for that time at Newcastle, or near it. An examination at the end of the course, or shortly

(164. 1.)

D 2

after,

S. Tremenheere,
Esq.

21st June 1849.

S. Tiemenheere,
Esq.

21st June 1849.

after, would be required, to test the amount of attention they had bestowed. They would then return to their employment as pitmen, and without doubt would be in general the most eligible candidates for the situations of trust above referred to, whenever any fall vacant. It is now a common subject of complaint among those employers who have made the greatest sacrifices in money and personal exertion to establish good schools, provide libraries, and encourage evening schools and lectures on useful and entertaining subjects, &c. for the benefit of the pitmen, that the latter do not respond to these efforts, and that the schools are not as well attended as they ought to be; that the children are withdrawn at a very early age; that the circulating libraries are unused, and the other means of information and rational amusement disregarded as soon as the novelty wears off. Considering the present intellectual state of the adult pitmen, and the almost entire want, under present circumstances, of any adequate stimulus to mental exertion (inasmuch as theirs is an unskilled labour, and they appear to have nothing to gain by cultivating their minds), the opening the road of preferment by means of intellectual improvement (coupled, of course, with good moral character) to so large a number as 400, would seem to be a very available means at hand to supply the mental stimulus now wanting. I have discussed this subject with several of the most influential persons connected with the coal trade in both counties, and I believe there is a strong disposition to unite in an effort of this kind. It was, I understand, from want of concert with the coal trade in general, that some similar attempt failed at Durham a few years ago. The cost to each colliery would be inconsiderable, and there can be no doubt that it would be amply repaid, should the effect be to apply a stimulus generally to the working colliers, in favour of a better kind of education than they are now content with, and to furnish a well-qualified set of candidates for all the numerous subordinate offices of trust.

“But the views of many of the leading persons in these counties do not confine themselves to a mode of raising the qualifications for the lower grades of employment. It is satisfactory to be able to say that, notwithstanding the depression of the coal trade of the north during the last four or five years, very liberal discussions have not been wanting as to the means of forwarding the education of the higher class of candidates for employment in the management of these extensive collieries, as ‘viewers,’ mining engineers, &c.; nor have these discussions been confined to Northumberland and Durham, but have been prevalent in Yorkshire, Derbyshire and some other of the mining districts. The approaching completion of the Museum of Practical Geology in Piccadilly (somewhat on the model of the excellent School of Mines in Paris) has led to these considerations; and it appears probable that in many of the mining districts some definite plan will be formed, by which, by means of a small contribution in proportion to the amount of mineral raised by each work, a certain number of young men will be sent up annually to go through the courses of instruction which will be given by the highly qualified officers of that institution, aided by all the scientific and practical appliances which it affords.”

220. The knowledge which you have acquired in the discharge of your duties, has led you to the anticipation that there will probably be some such scheme taken up by the colliery interest in the different parts of the country?

I think so.

221. Those suggestions contemplate altogether efforts made by the parties themselves?

Yes.

222. The greater part of what you have read applies to the localities of Durham and Northumberland?

Yes.

223. Are there any other parts of the country which you can specify in which you have had communications of the same kind with the persons connected with collieries?

I do not think, at present, that I can say that I have had sufficiently distinct communications with gentlemen in other districts to be able to refer to them.

224. Have you taken opportunities of directing attention to the point in the course of your visits in other parts of the country?

Yes.

225. Have

225. Have you found it favourably received ?

I have.

S. Trevellick,
Esq.

226. There is a consciousness upon the part of a large number of the managers of collieries that there is a great deficiency in respect of the competency of their overlookers ?

21st June 1849.

Unquestionably.

227. You are aware that, according to the evidence which has just been given to us by Sir Henry De la Beche, the Government has lately determined to appoint certain Inspectors for the purpose of inquiring and communicating information and advice to the owners of collieries ?

Yes.

228. You were employed last year and the year before by the Government in making certain inquiries into the systems established in France, in Belgium, and in Germany ?

Yes.

229. Are you aware of the circumstances under which the step to which allusion has been made, was taken by the Secretary of State in this country ?

I am.

230. Do you conceive, from the knowledge which you obtained in the course of those inquiries, that the mode in which it is proposed that these Inspectors should undertake their duties is such as is well adapted to the object in view ?

I think, as a preliminary inquiry, it is likely to be of very great use ; at present we are entirely in the dark as to the relative numbers of well-managed and ill-managed mines.

231. The first step, therefore, is to ascertain, by inquiry, what the actual condition of the different mining districts is in that respect ?

Certainly.

232. After having attained that object and secured that information, do you think it desirable that in any step taken by the Government, the officers to which it might confide any such duties, should be armed with compulsory authority or not ?

Undoubtedly, it is my strong opinion that they should be armed with no compulsory authority whatever. To prevent misapprehension, I should like to state a little further what I mean by being armed with no compulsory power ; I think it absolutely essential that the Legislature should enable Inspectors to visit mines, and that they should be protected in so doing, under a penalty, in case of any obstruction.

233. Do you mean any obstruction from the owner ?

From the owner, or the subordinates, or the men.

234. That is, to a degree, a compulsory authority, is it not, as in the case of manufactories ?

Yes ; but I wish to distinguish what I mean by compulsory authority. I think also that every Inspector should be allowed access to the plans of every mine, in order that he may verify the fact whether he has been conducted through the whole of the workings ; so far, and I think no further, would it be necessary to give what may be called a power of inspection, but not a compulsory power in reference to anything to be done in the mine, with a view to its safety, by order or suggestion of the Inspector. The responsibility of placing their mines in a safe condition should be left entirely upon the owners and managers.

235. Supposing that that power were given to the Government Inspectors, do you think that there would not be considerable objection felt upon the part of many persons connected with the collieries to the examination of their workings and of their plans by persons unconnected with them ?

From what I have seen of the mode of conducting the inspection on the Continent, and from conversations with a great number of the persons at the head of the establishments on the Continent for that purpose, I feel quite convinced that no inspection can be satisfactorily conducted unless the Inspector has access to the plans of the mine.

S. Tremehere,
Esq.
21st June 1849.

236. What do you mean exactly by the "plans"?

Every properly conducted mine has, drawn on a plan, the underground workings as they proceed.

237. Where is that kept generally?

They are generally kept—certainly always in all mines of any importance—upon the spot. I distinguish between well-conducted and ill-conducted mines; there are several very small mines in the kingdom where there are no plans, or very insufficient plans.

238. You say that the Inspectors should have a right to inspect the plan of the mine, and that they should have a right to go down the mine and examine personally to any extent which they might think necessary?

Yes.

239. Under a penalty in case of obstruction?

Yes.

240. You state that that is the practice on the Continent?

I do.

241. Are not the mines on the Continent under very different circumstances from those in England?

No doubt.

242. The parties having them are all lessees of the Government?

They are, no doubt.

243. And the Government visit them as the owner in England may visit his tenant, to see what coal he has worked?

Certainly; at the same time it now appears that the public opinion of this country has brought this question of mining inspection to a point where it is necessary to consider it. I understand that it is now under consideration by the Government to legislate upon this question; with that view, probably, I was sent abroad to report upon the management of these things. I went to the different Governments on the Continent, to ascertain the course of legislation on this subject, and its practical working; and it appears that France under Napoleon, and France under constitutional Government, Belgium under constitutional Government, and Germany under its paternal Governments, or whatever they may be called,—all these, although they are virtually proprietors of the mines, have felt that their duty, as proprietors, is to allow an inspection of the mines.

244. How is a proprietor to do otherwise; if I let a man a lease, for my own protection I send people down to that mine three or four times a year to see what he is doing?

Yes.

245. And of course the Government would do the same thing; the Woods and Forests at Dean Forest do the same thing, where they have some coal mines?

Yes; on the Continent they do that, and also they take the additional step of inspecting the mines, with a view, not to their own interests only as proprietors, but to the security of the people.

246. We understand you, then, to mean merely this, that in order to render an inspection effectual, parties should be invested with absolute authority to go down the mine, and that any obstruction should subject the parties obstructing to a penalty?

No doubt; that is my meaning.

247. Whether it is wise or not to do the thing, is one question; but that you say is necessary for an effectual inspection of the mine?

I do not think that any inspection can be effectual without it.

248. At the same time, supposing it were thought desirable to authorize Inspectors to tender advice and to give information, and to apply to be admitted to the examination of mines and of plans, and that in cases where they were refused such opportunities of examination, the responsibility of any accident or of any ill consequences should be thereby entirely thrown upon the owner or manager of the mine, do you think that it would be an improvement upon the present

present system, in which there is no interference on the part of the Government whatever?

It remains to be seen whether this experiment of having appointed two very able gentlemen to go with that view will be successful; whether, in fact, they will be admitted into a great number of mines which it is highly desirable should be inspected.

249. They proceed upon that footing?
They proceed upon that footing.

250. Supposing that in the course of their operations they should find themselves admitted to a considerable number of the best managed mines, and perhaps some others, and that they were enabled thereby to tender useful advice in several cases, and to induce managers to adopt valuable improvements, and to make the condition of their mines more secure; do not you think that even if that were accomplished, it would place those who refused to admit any inspection, and to receive any advice on such subjects, upon rather a more questionable footing than they are, so long as there is no difference in that respect between them and their neighbours?

It would undoubtedly; at the same time as their interests are so greatly at stake in that matter, those who refused would take care to arm themselves with evidence, got up by themselves, to protect themselves in case of any explosion.

251. What mines have you visited upon the Continent; in what countries?
France, Belgium and Germany.

252. Do you think there would be any great objection on the part of the owners of the mines to allow a person appointed by the Government to inspect their mines?

I do not think that any person having a well-managed colliery would have the slightest objection to it; at the same time, I very much doubt whether the inspection of persons, merely voluntarily admitted, will be effectual, and whether they will be admitted into a great many mines into which it is highly desirable that they should be.

253. Your inquiries have been rather of a different nature; but in those inquiries have you ever met with any obstructions from any of the owners of collieries?

It never has fallen to my lot to come into collision with their interests. I have gone on very harmoniously indeed with all the mine owners and managers of the whole kingdom, in carrying into effect this Act of Parliament; there are certain specified things to be done in this Act of Parliament, and as it happens, I have managed to get them done pretty fairly; I may say, with regard to the most important part of it (that of putting an end to the employment of females in mines), almost entirely without any collisions at all, simply by employing a certain number of professional persons in different parts of the kingdom, and, through their instrumentality, effecting the object.

254. Do not you think that the same skilful and good management would enable the Inspectors also to do the underground work?

I think that is a very different matter; when you come to deal with the underground management of the mine, you touch pecuniary interests of a very considerable amount. What I have had to do has been likely to affect mine-owners or managers very slightly indeed in that matter; in fact, it has been more to their advantage than to their disadvantage to get them to do certain things which the Act requires them to do. In other matters, my instructions are to make certain inquiries into the state of the population, and in so doing, I have met with the greatest possible kindness and assistance from everybody; but there again their interests coincide with my duties, and they have, in all respects, favoured my inquiries.

255. Do not you think that their interest would coincide very much with the recommendations made by the Inspector in the other case?

Undoubtedly, their well-understood interests would have induced them, from the first, to obtain the very best possible advice in originally "laying out" their collieries; but it very seldom happens that men of no very high degree

S. Tremenheere,
Esq.
21st June 1849.

of intelligence, as many of those managers of small collieries are, know how to act upon their well-understood interests, and I do not think that we can at all depend upon that as a guide.

256. Are there not cases in which it is possible that their property (for their minerals are their property in those cases) should be so circumstanced as that the inspection of a third party, totally unconnected with their interests, might subject them to inconvenient publicity?

I do not think that it need at all arrive at that. If by "inconvenient publicity" is meant their being liable to have the actual state of their mines exhibited faithfully before a coroner's jury, I think that is quite right; but an Inspector would not be empowered to interfere with any matter relating to their production of coal, or anything of that sort relative to their trade; so that I do not see that they need fear any publicity at all as to those matters arising from that inspection.

257. The question alluded to an inquiry which must be laid open at the same time as the inspection of which you were speaking; namely, an inquiry into the position and the condition of the minerals in the mine, because any well-informed Inspector going through a mine for the purpose of examining its circumstances as regarded ventilation, would have an ample opportunity, of course, of observing the condition and the position of the minerals within that mine; would it not be likely that much jealousy would arise in the minds of many parties with reference to any such inspection of their property?

I really think that no such jealousy would arise to any extent, provided proper care were taken in the appointment of Inspectors. If they were gentlemen unconnected with the particular coal district, unconnected with trade in any way, and not likely to communicate these matters which they would be bound by their position to keep secret, I do not think any jealousy need arise in that respect.

258. That is your opinion?

I think that the only persons whom the Government, with their own sense of responsibility, would appoint, would not be likely to divulge matters which would be improper.

259. However, the Commissioners at present appointed are, in some degree, to test that very question?

Perhaps so.

260. You have stated that there is a want of skill among the lessees of collieries generally?

Not generally. I said in certain districts.

261. Have you ever had charge of a mine?

No, I have never been in a mine at all. I stated that, in some cases, the lessees worked their own mines. I hope I guarded myself from giving that opinion as to the want of skill of many managers of small mines, as a conclusion derived from my own practical knowledge. I should be very sorry to leave a misapprehension on the mind of any Member of the Committee upon that matter. I believe I started by saying, that I had no practical experience in the matter myself. My opinions are formed from communication with a very large number of the owners and managers of mines. My Reports go annually to above 800 persons, with the greatest number of whom I have personally communicated. I also personally communicate with a great many more on matters connected with the state and condition of the mining population, and on those grounds I form my opinion.

262. In communicating with those parties as you would communicate with any other parties in the discharge of such duties as are reposed in you, are you led to conclude that any of them are uneducated persons?

Yes.

263. May not they be very good men underground, though they may not show it above ground?

That certainly is not the impression of the best men in each district. The impression of the educated and intelligent viewers is not that of your Lordship.

264. Is it not the practice to select the overmen from the best workmen, just the same as you select a serjeant or corporal from the best soldiers, in the district?

Yes; but of course there must be a great difference in the capacities of different men, as in the relative nature of their duties.

265. In the countries on the Continent in which you made inquiries, do you think that the circumstances are sufficiently analogous to the case of England to enable you to argue from the one to the other, and to infer that Government inspection, such as is established there, would be likely to have as advantageous effects here?

Quite sufficiently analogous to enable one to arrive at this conclusion, that inasmuch as there are many thousand men employed in very dangerous positions in both countries, and inasmuch as inspection on the Continent has tended to reduce the number of accidents materially, the same duty which on the Continent devolves upon the Governments as proprietors of mines, ought to be laid upon the owners of mineral property in this kingdom, to induce them to do all that they can by admitting inspection to preserve the lives of the people employed by them.

266. Taking those three countries in which your inquiries were altogether conducted, France, Germany, and Belgium, which should you say was in its social and other circumstances most analogous to the case of this country?

With regard to the ownership of mineral property?

267. Yes?

None of them have the least analogy to this country, as regards the ownership of mineral property, inasmuch as all over the Continent the mineral property virtually belongs to the Government, and no man can work a mine without first of all having a grant, called a concession, from the Government; and in making that grant, of course the Government can impose what terms they please upon the owner. Among those terms are these: that the Government engineer shall first of all point out how the area conceded is to be worked, and worked with a view, not only to profit, but also to the preservation of the lives of the people and the preservation of their health; for, by the words of the concession, and also by the decree of Napoleon, in the year 1813, everything is to be done, "*sur les rapports de sûreté et de salubrité*," which the mining engineer thinks necessary; having regard therefore to the health as well as to the safety of the people.

268. Do these inspectors regulate the mine, as well as report upon the mine; is there a double capacity, or are they solely, when making any inspection, to provide against accidents?

In Germany, on the other side of the Rhine, the officers of the Government called mine-masters (Berg-meister), are, in point of fact, the agents of the Government for making marketable the commodity; in Germany, therefore, the lessees really have very little to do with the business portion of their concerns, and the officer of the Government stands in the relation of Inspector and Manager of the mines for the Government. It is not so in Belgium, or in France, or in the Rhine provinces of Germany, because into the Rhine provinces has been introduced the "Code Napoleon," and the whole of the arrangements there are precisely as in France and in Belgium.

269. What do you mean by saying that the lessees have very little to do with it; they pay one-tenth as a dead-rent, do they not?

In Germany, beyond the Rhine, they pay one-tenth of the gross produce.

270. And a fixed rent beyond upon as much as they get?

Yes, in France and in the Rhine provinces of Germany; it is very different in the old provinces of Germany.

271. In all those countries the Government stand in the relation of owner?

Yes.

272. And that places them upon a different footing from what is the case in this country?

Yes; but if the two cases are to be compared, it should be stated in this way; on the Continent the Governments are the owners of mineral property, and they

(164. 1.)

E

submit

S. Tremenheere,
Esq.

21st June 1849.

S. Tremenhoe,
Esq.

21st June 1849.

submit their mines to a system of mining-inspection with an especial reference, among other things, to the safety of the people; in this country, individuals are the owners, and they do not. I beg to refer to my Report on Mining Inspection in France, for a description of the various duties of the Inspectors.

273. Have you inspected any mines in America?

No.

274. Have you any information with respect to the system of mining in America?

None.

275. Have you acquired any information since you made this investigation upon the Continent, on the same subject of inspection; has anything come to your knowledge which you can state to the Committee?

I have talked on the subject with a great many of the most intelligent mining managers of Northumberland, Durham, Yorkshire, Scotland, Derbyshire, Shropshire, South Staffordshire, South Wales, and one or two other districts; I find them universally favourable to a system of inspection; they are impressed with an idea that it is not very creditable to this country that such an immense number of accidents should constantly occur from preventable causes, especially as they have perceived that countries in such different situations as those abroad, some despotically governed, and others under free governments, have extended that protection to their people. And there is unquestionably a very strong feeling among the labouring miners of this country on that matter; they think that they have been neglected, and their lives very needlessly sacrificed, in numbers of cases, from the want of proper precautions; and being men not very much accustomed to take wide views of things, and liable to jump to conclusions rather suddenly, a strong opinion did spring up among them some few years ago, which was embodied in a petition from their delegates, who presented a large petition to Parliament, in favour of very strict measures of inspection, and it is that opinion which has found expression in Parliament in the Bill brought in two years ago, by Mr. Hume, Mr. Thomas Duncombe, Mr. Aglionby and Mr. Bernal. I recognise in the proposed enactments of that Bill the very ideas which I have just referred to.

276. There has been a Bill brought in this Session?

It is, I believe, the same Bill; the Bill was originally brought in in 1847. There was one provision in the former Bill by which a penalty of 100 *l.* was to be imposed upon any manager or owner of mines who did not conform to what was recommended by the Inspector; and this without appeal.

277. That is in the present Bill. Are you aware that a short time ago a public meeting was held at Newcastle, attended by owners and lessees of mines, and by viewers and persons of all classes, at which resolutions were adopted expressing the opinion of the meeting that a system of inspection was necessary, and ought to be enforced by the Legislature?

I am not aware that such a meeting took place.

278. You stated that the most eminent viewers supported the proposition?

Yes.

279. Mr. Nicholas Wood?

Yes, no doubt, most anxious for it; Mr. Hunter, Mr. Forster, Mr. Thomas John Taylor, and others. I think I ought to add, that shortly after the introduction of that Bill in 1847, by those gentlemen who have been mentioned, I was requested by Sir George Grey to go down to Northumberland, to communicate personally with a Committee of Viewers, in order that we might endeavour to arrive at an understanding of what would be a practical measure of mining inspection. I was met on that occasion by a Committee appointed by the Coal Trade, consisting of Mr. Nicholas Wood, Mr. Thomas John Taylor, Mr. Philipson, and others; at all events, they were a Committee appointed by the Coal Trade themselves, and therefore consisted of the most intelligent men; after a few hours' conversation, they being all most favourable to a system of inspection, we did come to an understanding of what would be a measure which, according to their opinion, would work well, without obstruction and without difficulty;

difficulty; a very simple measure. That is a clear proof that the coal owners of the north are not unfavourable to such a system.

*S. Tremenheere,
Esq.*

21st June 1849.

280. What was the result of that communication with the Committee of whom you have spoken?

The result of that communication was, that they all acceded most readily to the heads of a measure which, in my opinion, would have been effectual; and I may now say that, after two years' further experience and consideration of this question, my opinion is, that a measure, precisely analogous in principle to the one then agreed upon, and omitting one or two comparatively unimportant details, would, if embracing the four or five following points, be all that would be requisite: First, power to the Inspector to visit and examine all parts of the mine; secondly, power to inspect plans; thirdly, that an Inspector, on discovering a mine to be in a dangerous state, should draw up a Report, specifying the parts of the mine which he considered dangerous, and the reasons of his opinion; a copy of which Report should be given to the manager. To meet the case of the owner dissenting from the opinion of the Inspector, I thought it necessary that a mode should be defined by which the owner or lessee should have an opportunity of putting his opinion upon record; and therefore, in the fourth place, that the owner or lessee, on dissenting from the opinion of the Inspector, should be required, in conjunction with the Inspector, to nominate a person to give his opinion upon the state of the mine; that that opinion should be given in writing, both to the manager of the mine and also to the Inspector.

281. Upon the principle of an umpire?

Upon the principle of an umpire; there the matter would rest. Supposing the manager to abide by the opinion of the umpire, should it be in his favour, then in case any explosion arose, there would be on record evidence to lay before a coroner's jury, and it would be for them to judge which was right. My difficulty in thinking that a system of voluntary inquiry, such as is now about to commence, will be effectual, is partly this, that I anticipate that before very long the Inspector will come to a mine in which he will see great causes of danger and many causes of complaint. The mine owner may totally differ from the Inspector; he may say, "This is the way in which mines have been managed in this neighbourhood for years, and only a certain number of explosions have occurred." Having had his mine inspected by an officer of the Government, he will be in a very dangerous position if an explosion should occur, unless he can immediately fortify and protect himself by a contrary opinion. Now, as matters stand at present, he will select a certain number of his neighbours, persons probably whose mines are in the same condition as his own; they will inspect his mine, and they will be ready to state before a coroner's jury, in case an accident occurs, that, in their opinion, the mine was not in a dangerous state. This will not be satisfactory to the public, however it may be to a coroner's jury, in case an explosion occurs in such a mine; and I conceive also, that it will place the Inspector in a very awkward position, in a position in which no man discharging such duties ought to be placed, in having his opinion liable to be controverted by persons about whose skill and about whose fairness he knows nothing, and has had no means of ascertaining whether their opinions are likely to be fair and honest. Therefore, I think that before very long it will be found absolutely necessary to define what is to be done in cases in which the Inspector and the manager are in collision on the fact of the danger or safety of the mine.

282. Then a difficulty in the case of the present Inspectors will be, that they have no power given them to inspect a mine in case of an unwillingness on the part of the manager?

That is very true.

283. It is a trial?

Yes; at the same time, there is little doubt that they will be admitted into a great many mines, some of which will be found to be in a dangerous state. The instructions contemplate that fact. The Inspector will find out that such and such things are wrong in the mine, and he is required to state that to the manager.

284. Supposing a case where the Inspector is admitted to the mine, and that he has to observe upon certain circumstances which he has discovered there to the manager, and that the manager then controverts his opinion, and appoints

S. Trremenheere,
Esq.

21st June 1849.

another person to examine, and obtains a contrary opinion, where would be the difference between the position of the Inspector in that case and the position of the Inspector under the system which you have mentioned?

This difference, that in the case which your Lordship has just put, the Inspector would not have had anything to say to the appointment of the umpire; now I consider it to be absolutely necessary to the fairness of the inquiry that the Inspector should be so consulted, otherwise the evidence would be got up in the dark; there would be no guarantee of its being fair, and no security for the Inspector that his opinion would not be controverted before a coroner's jury by persons about whose fairness he had no knowledge.

285. Then under the fourth head of the recommendations of the Northern Coal Trade Committee and yourself, of which you have spoken, you meant the Committee to understand that the owner or lessee dissenting should not have a power of nominating an Inspector of his own independently, but that he and the Inspector together should have the power of naming an umpire?

Yes.

286. Supposing they should not agree, what would be done?

That point arose very soon, and was discussed; they thought it might be left to a Magistrate of the neighbourhood to appoint an umpire; my own opinion is that it would be best to refer it to the Secretary of State to name a person. We saw also that it would be absolutely necessary to define matters of this kind, because who is to pay for this person? These intelligent managers cannot be expected to do the work for nothing; they cannot come from a distance and give up a day or more for the inspection of a mine without remuneration; the thing must be paid for, and it must be provided in the Act of Parliament that half the cost shall be thrown upon the mine owner or manager and half upon the Government; otherwise, if a portion of the cost is not thrown upon the owner, there will be in every case an objection to the opinion of the Inspector.

287. In what year was it that these questions were discussed between you and the Coal Trade Committee; was it previously to your Report in 1847?

I think it was at the beginning of 1848.

288. In your Annual Report of 1847, you entered very largely into the subject of inspection?

I did.

289. Was that in consequence of the communications which you had had with this Committee in the north, or with any other party, or was it in consequence of the suggestions which you had received from the Secretary of State?

No; in my Annual Report of 1847 I inserted a memorandum on the question of Colliery Inspection; that was the first time that I brought it distinctly before the notice of the Government. I did so, because in the course of previous years I had thought it my duty, as a portion of my inquiry into the state of the mining population, to attend to this matter; and I sought, therefore, the opinions of all persons throughout nearly the whole of the mining districts of the kingdom capable of giving me the best information upon the subject; I then embodied it in this sort of memorandum. It was in consequence of this that I was permitted by Sir George Grey to go to the Continent to report to him upon what was doing in France and Belgium.

290. Was it after that Report that you had the communication of which you have spoken with the Committee of the Coal Trade?

It was after my Report on Mining Inspection in France.

291. In these mines in France and Belgium, notwithstanding inspection, there are a great many sufferers by fire-damp, are there not?

No doubt; at the same time, all the evidence which I collected, both published evidence and evidence which I found in the Records of the Councils of Mines in Germany, distinctly proved that the effect of inspection was to reduce the number of accidents, to diminish the liability to accidents, considerably in the case of Belgium. If the Committee will allow me, I will read to them this statement from my Report:—“The Annual Statement published by the Minister of Public Works in Belgium, relative to mines and mining industry, contains, in addition to a variety of valuable statistical information, an account of the accidents in mines for a series of years. At page 82 of this document for 1846, it appears, that

that while the production of coal, between the years 1840 and 1844, has increased 20 per cent., and the number of workmen 17 per cent., the number of killed, by various accidents, has diminished 15 per cent.; and a subsequent table shows, as regards accidents by explosions of gas, that the number of persons killed and wounded has decreased from 378 per 1,000, during the period from 1835 to 1839, to 268 per 1,000 in the period from 1840 to 1844." The care which the Government of Belgium takes in ascertaining the number of accidents, as well as in preventing them, is shown in a table which is annually published, of which this is one:—"The average number of workmen employed in the mines and collieries of Belgium, from 1840 to 1844, was 40,894; during that period there have been 580 persons killed, and 546 wounded (total 1,126) by various accidents; these accidents, arranged in the order of frequency, were as follows: in 1,000 persons killed or wounded, there have been by explosions of gas, between the years 1840 and 1844, 268; between 1835 and 1839, 378; between 1821 and 1840," the whole of the period, "377; by falling in of material, between 1840 and 1844, 259; between 1835 and 1839, 193; between 1821 and 1840, 173."

*S. Tremenheere,
Esq.*

21st June 1849.

292. So that the accidents from that cause were very considerably increased in the latter period?

Yes; but upon the whole, considering the increase of the number, the average has diminished.

293. In the numbers referring to the explosions, the proportion of accidents has decreased materially in the latter period?

Yes.

294. So far as explosions are concerned, there has been a considerable diminution in the latter period?

No doubt.

295. But the accidents from the falling in of the roof appear to have increased considerably in the latter period, do they not?

In the latter period, between 1840 and 1844, there were 259; and in the first period, between 1835 and 1839, there were 193.

296. Therefore, the increase in that case, in the latter period, was very considerable?

Yes.

297. Whereas the decrease in the case of explosions was as considerable the other way?

Yes; then from "Causes not specified, between 1840 and 1844, 152; between 1835 and 1839, 80; and between 1821 and 1840, 67. Divers accidents in the pits between 1840 and 1844, 122; between 1835 and 1839, 105; and between 1821 and 1840, 110. In descending or ascending by cords or chains, between 1840 and 1844, 87; between 1835 and 1839, 122; and between 1821 and 1840, 120. In descending or ascending by ladders, between 1840 and 1844, 45; between 1835 and 1839, 37; and between 1821 and 1840, 40. Blasting, between 1840 and 1844, 35; between 1835 and 1839, 38; and between 1821 and 1840, 42. Inundations, between 1840 and 1844, 32; between 1835 and 1839, 47; and between 1821 and 1840, 71." So that they have, in a tabular form, exactly the facts.

298. Did you ever compare the 40,000 workmen, which is stated as the average number employed in the mines and collieries of Belgium from 1840 to 1844, with 40,000 at Newcastle or Sunderland, or any part of this country, to show the proportion of accidents?

There are no means whatever of making any such comparison. In the first place, nobody knows precisely the number of people employed in that or in any other mining district of this kingdom. In the next place, all the returns of accidents are extremely imperfect; it is the interest of many people to conceal them; coroners do not know them. The fact is, that we have no accurate statistics of any kind; but we ought to have.

299. It is a remarkable circumstance that in the table which you have read, excepting in descending or ascending by cords or chains in almost all the classes of accidents, other than explosion, there has been a considerable increase in the latter period?

Yes.

(164. 1.)

S. Tremenheere,
Esq.

21st June 1849.

300. Whereas the decrease by explosion has been very great ?

Yes ; and I think this is very easily accounted for. The diminution is precisely in those points which would be affected by good inspection, namely in the number of accidents from explosions, from defective machinery, and from inundations, while the increase has arisen from causes more within the power of the men themselves to guard against, as the falling of the roof for want of putting in proper supports, &c ; and this again is the natural result of the great addition of new and, very possibly, inexperienced hands within that period ; the increase in the number of workmen having been, according to the table, 17 per cent.

On the subject of the four heads of a measure, on which I was speaking just now, I would beg to say that they are very nearly what are to be found in the Decree of Napoleon of 1813 ; a Decree which was passed shortly after some very serious accidents had occurred in Belgium, and which induced the French Government at that time to add to the machinery of inspection, and to make it more stringent. In that Decree, at Section 24, I find the following, of which I will read a liberal translation :—“ The proprietors and managers of mines will furnish the mining engineers with all the means of going through the works, and particularly of proceeding to all the points which may require especial superintendence ; they will show the plan both of the interior and the exterior ” of the mine ; “ they will cause them to be accompanied by the managers and underground agents, in order that the latter may give all the information that may be useful in regard to the safety and health of the mine.” “ Ils les feront accompagner par les directeurs et maîtres mineurs, afin que ceux-ci puissent satisfaire à toutes les informations qu’il serait utile de prendre sous les rapports de sûreté et de salubrité.”

301. Who gave the heads of that measure which you have mentioned ; did they proceed from you, or the viewers of the collieries, or were they by agreement ?

The heads were discussed between us. Perhaps I may say, that it was a matter which they had not considered so much as I had ; therefore, as they were not prepared with any measure, and I happened to be, they were good enough to accept, in substance, my ideas upon the matter.

302. We may assume that all the information which you have obtained since the presentation of your Report in 1847 to the Secretary of State, and since your investigations upon the Continent, has tended to strengthen the conclusions at which you arrived upon those occasions ?

No doubt.

303. Are there any further points upon which you wish to give your opinion to the Committee connected with this subject ?

There are a few. I should wish to say something by way of answer to those who have strongly advocated a system of compulsory inspection ; and I know that that opinion is very common in the mining districts, and, as I said before, has found its expression in the Bill now before Parliament.

304. Common upon the part of the working population ?

On the part of the working people. It is strongly impressed upon their minds. I should wish to say, in answer to that, that although on the Continent they have a power of compelling alterations in mines which are considered dangerous, not by the immediate action of the Inspector, but through the legal authorities, the evidence which I collected in Belgium shows very clearly that wherever mines are difficult to manage, and wherever a considerable number of them are in a dangerous state from various causes, there the owners, in consequence of their having an appeal to the local authorities (which it is only fair they should have), do resist, to a considerable extent, the recommendations of the Inspector. I found that at Mons, which is at the extremity of the coal-field of that part of Belgium, and where a great number of the mines are worked on ancient concessions, dating from a period previous to the legislation upon the subject, there are, out of 60 mines in that district, an average of 10 a year which are complained of by the Inspectors as dangerous, the owners of which resist the opinion of the Inspectors, and apply to the local authorities ; and the machinery of the law, which was afforded by Napoleon, in the first instance, as a protection to the mine-owner, is put in force. So that, in point of fact, notwithstanding the compulsory powers given by that law, they do not arrive at making all the mines in every district

district safe ; far from it. I anticipate, therefore, that the power of public opinion in this country, and the fear of a coroner's jury, would, under the system of inspection which I have taken the liberty to point out, produce as good, if not better effects, than are produced on the Continent, by giving the Inspector the power of resorting to a process of law to enforce his recommendation.

S. Tremheere,
Esq.
21st June 1849.

305. In Scotland there is no inquiry by coroner's jury?
No, and it is a great defect.

306. Therefore, so far as this system of inspection applied to Scotland, there would be somewhat of a defect in the machinery of it?

There would be, though not, I think, of a very serious nature, because, if I recollect rightly, the law of Scotland is, that inquiries take place before the Procurator Fiscal in all instances in which any wilful neglect has been shown ; it would therefore be a question whether, when a mine had been reported dangerous by the Inspector, and an explosion took place in that mine, the loss of life did not arise from some wilful neglect.

307. Is there any instance which you know of a verdict for manslaughter having been brought against the owner or the manager of a mine by a coroner's jury, in consequence of death occasioned by negligence?

I am not aware that there is ; I know that there is naturally a very strong feeling in coroners' juries to deal leniently with cases of this kind, and I think that that affords a still stronger argument in favour of inspection ; because when a mine had been inspected and reported upon by an officer of the Government, there would be something definite on record from which no jury could very well escape ; they would be obliged to find a verdict accordingly.

308. They would be obliged to give their verdict according to the information furnished by that evidence?

Yes, unless met by evidence of a contrary nature ; and it is right that there should be a guarantee in the mode of appointing an umpire, that such evidence should have been fairly obtained.

309. By a recent Act of Parliament, where death is occasioned by the negligence of a person, the relations of the party are entitled to an action to recover compensation for the injury which they have sustained by the death?

Yes.

310. Is there any case of an action having been brought by the relations of any party killed from negligence in a mine, against the owner of the mine or the manager?

I have heard of a great many such actions, and I know that in some mining districts the owners are in constant dread of vexatious actions being brought against them by professional men on behalf of persons who have been killed or injured by these accidents ; and I believe that although in some cases they are vexatious actions, yet, upon the whole, the knowledge that the owners are liable to such actions has stimulated them exceedingly to prevent their causes if possible.

311. In Belgium or France have the relatives of any workman destroyed in a mine, any redress against the owner?

I cannot answer that question off-hand, as it is two years since I was there ; but I have a strong impression that they have, according to the Penal Code. I would beg further to make an observation with regard to a question which was put to Sir Henry De la Beche ; namely, if the works were enlarged, how he purposed to provide for the necessary increase of ventilation?

312. Supposing the machinery to be adapted for the complete ventilation of a mine, opened to a certain extent, and to be well-adjusted for that purpose, and supposing the mine to be afterwards extended, what course would you pursue for the purpose of adapting the machinery to the increased extent of the mine?

Cases of that kind will, no doubt, frequently occur, and I would refer your Lordship to the practice of the Continent, as an answer to that question. I think it also strengthens the presumption in favour of inspection. It is generally, I apprehend, from a want of previous foresight that such a question would arise. It arises probably from some defect in the original "laying out" of a colliery ; in the original plan of the mine. On the Continent, that matter is

S. Tremenheere,
Esq.

21st June 1849.

thoroughly considered beforehand by the "Engineer of Mines," as he is called, on behalf of the Government, in conjunction with the owners. Supposing a certain area is conceded, they determine beforehand how the whole of this coal may be got out in the most artistical way, and how, in so doing, they will maintain a thorough ventilation during the period required. I think, therefore, that the difficulty which your Lordship has seen, forms another argument in favour of increasing the intelligence of the mine viewers and managers. I do not think it will be found, that in mines managed by really competent persons, that difficulty would often arise, because they take into consideration beforehand the whole area which is to be ventilated; it would be very likely to arise, supposing the mine to be originally "laid out," as it is called, by persons who had not that sort of capacity.

313. Supposing you could adapt a most powerful mode of ventilation which could be either enlarged or contracted at the will of the owner of the mine, a machinery for ventilation so large as to go much beyond any probable extent of the mine, but that you could in the application so contract it as to adjust it always to the actual state of the mine, would not any inconvenience of that kind be obviated?

I do not think it would, because it resolves itself again into a question of expense; you cannot have a very powerful system of ventilation at work, without having the air-courses of a certain size, which would require so much more expense; I merely speak from the information of others.

314. Though the air-courses may be of the same size, they admit of various degrees of velocity, and cannot you compensate for the want of size by an increase of velocity?

If the velocity were brought beyond a certain point, it would obstruct the working; the candles would be blown out, and it would be inconvenient to the men to work. However, that is a matter which really I ought not to speak upon at all.

The Witness is directed to withdraw.

Ordered,—That this Committee be adjourned till To-morrow,
One o'Clock.

Die Veneris, 22^o Junii 1849.

The LORD WHARNCLIFFE in the Chair.

GOLDSWORTHY GURNEY, Esquire, is called in, and examined
as follows :

Evidence on the
Prevention of
Accidents in
Coal Mines.

G. Gurney, Esq.

22d June 1849.

315. YOU were originally educated for the medical profession ?

I was.

316. You are now a magistrate for the counties of Devon and Cornwall, and live in the West of England ?

I do.

317. Have you turned your attention, for a considerable number of years, to subjects connected with the mining interests of this country ?

For the last 30 years and upwards directly or indirectly connected with the ventilation of mines, more particularly against fire-damp, and other gaseous bodies found in mines.

318. Will you state shortly in what capacities you have had your attention turned to these subjects, and what opportunities you have had of pursuing their study ?

My attention was first drawn to this subject from my chemical pursuits ; I was a lecturer on chemistry in London in 1822, and the subject of fire-damp explosions was often experimentally brought before me : Sir Humphrey Davy's lamp at that time was a subject of considerable interest, and I made a great many experiments in connexion with wire-gauze, and also in relation to the flame of explosive gases generally, and their capability of passing wire-gauze, and the practical conditions under which wire-gauze would pass flame.

319. You then gave evidence upon those subjects before the Committee of 1835 in the House of Commons ?

I did ; but those experiments were more particularly given in 1822, in a work on the " Elements of Chemical Science," which I published at that time.

320. However, you gave evidence before the Committee of the House of Commons in 1835 ?

Upon that subject.

321. Since the period at which that Committee sat, have you still further pursued those investigations ?

I have.

322. Has your study of these subjects led you to any further conclusions or discoveries connected with them ?

The question of safety of the wire-gauze lamp, under certain conditions, having been raised by the experiments I made, and the experiments having been repeated in different parts of the country, I was led to turn my attention to the better ventilation of mines, conceiving that ventilation, in the absence of any other security, was the main stay on which to rest our hopes of safety.

323. In your study of the subject of the ventilation of mines, have you arrived at any conclusions or discoveries of importance which you would wish to lay before this Committee ?

(164. 2.)

F

I have

G. Gurney, Esq.
 22d June 1849.

I have since studied a good many modes of ventilation, more particularly that of the application of high-pressure steam as a motive-power for producing currents of air applicable to the ventilation of coal-mines.

324. You presented your conclusions upon that subject before the Committee, to which allusion has already been made, in the year 1835, did you not?

Yes; I should observe, that in 1824 and 1825 I introduced jets of high-pressure steam as a means of obtaining an artificial draught or blast up the funnel of a locomotive engine; therefore, my attention was more particularly directed to the application of it to mines: in 1835 I suggested it as a means of ventilating mines in the belief of what I conceived at that time, and still conceive, to be the best means of doing it.

325. Will you, as shortly as you can, describe the method by which you propose the application of high-pressure steam to the ventilation of mines, and, in the first instance, place upon record the distinction between high-pressure steam and low-pressure steam in reference to that subject?

The one acts by impulse, or *vis a tergo*; the other acts by rarefaction; low-pressure steam has no momentum of escape; it escapes comparatively slowly into the air; high-pressure steam escapes with considerable force; and when high-pressure steam is allowed to escape through certain sized openings, it drives a volume of air before it, mechanically.

326. To what is that distinction between high-pressure steam and low-pressure steam owing?

The term "high pressure" and the term "low pressure," in practical language, applies, the former to steam at a pressure above that of the atmosphere, and the latter to that below, or equal only to the pressure of the atmosphere. Steam equal to the pressure of the atmosphere is considered to be "low-pressure steam," and steam above the pressure of the atmosphere is said to be "high-pressure steam;" but practically, amongst engineers, it is now scarcely ever called "high-pressure" until it gets to 30lbs. or 40lbs. above the pressure of the atmosphere.

327. On the square inch?

On the square inch. Low-pressure steam has been attempted to be used for the purpose of ventilation; but it has been applied simply as a vehicle for conveying heat to rarefy the column of air in the upcast shaft, not with any view of "momentum," or "*vis a tergo*." Instead of having a fire at the bottom of the upcast shaft, the heat has been carried in the form of steam; thus the heat of steam has been communicated to the column of air in the upcast shaft, and by that means a rarefaction and a lightening of the column has been produced: a certain amount of ventilation has been thus produced; that amount of ventilation is very limited, and is only due to rarefaction; high-pressure steam, on the contrary, if placed at the bottom of an upcast shaft, has the property of conveying warmth to the column in the shaft, and also that of giving the more powerful action of *vis a tergo*, or momentum, by proper arrangement, driving, if I may so express it, the whole column of air up the shaft before it; the column of air in the shaft being thus driven out, a call is immediately made upon the galleries of the mine for a supply to take its place; so that, supposing we have a number of jets, the high-pressure jets force the air in front of them, and thus leave an exhaustion behind; it may be said to act doubly, first, as a force-pump in front, producing compression; and, secondly, by drawing, and causing exhaustion. If it were applied to force air into a mine, it would be applied at the downcast shaft, to force it through, but if applied to exhaust, then in the upcast shaft.

328. If it were applied in both ways, would it offer any additional advantage?

It would afford an extra power if it were wanted; but there is almost an unlimited power on the exhaustion side; we can carry it to an extent almost to produce a vacuum. It has been carried so far as to raise 24 inches of mercury; this, practically, may be said to be a working vacuum for a steam-engine; therefore there is no occasion to complicate the application of it with two forces when one will do. In a recent case, where it was necessary to drive a certain quantity of air through a small area in a mine under special circumstances, both forces were applied; the mine, in this case, was on fire, and we were obliged to make the

the best of the means which we had at hand. Our steam-pipes being limited, and our apparatus altogether being anything but perfect, we applied both powers; in that case, there was a steam-jet acting on one side as an exhausting or pulling power, and there was a steam-jet also acting on the other side as a pushing or compressing power, driving the air down: we had then the two forces operating together; and we obtained a sum sufficiently powerful to overcome the great buoyancy in the downcast shaft, occasioned by hot choke-damp, which, going down the column, offered great resistance: there was a pressure of upwards of a ton against the stopping; but this was a special case.

G. Gurney, Esq.
22d June 1849.

329. Will you explain the process by which you apply this steam-jet to the ventilation of a mine?

The steam is either generated below, by a boiler in the bottom of the mine, or is generated upon the top, as may be thought most advisable; if it is generated below, the steam is applied immediately to a series of jets at proper distances, which are shown in a Report of the South Shields Committee. These are the sections of the shaft—[*showing the same.* *Vide* Appendix, "Section of Upcast Shaft," Letter C. fig. 1]—and the jets are so placed that each may take its proportion of the column to lift it; if there were not that number of jets, the compressed air above would return, to supply the exhaustion below.

Vide Appendix I.
Plan, No. I.

330. That is in existence?

Yes.

331. Where?

At Seaton Delaval, near Newcastle.

332. The process in this instance is to place an apparatus of this kind at the bottom of the upcast shaft, is it not?

Yes.

333. With this number of jets in it supplied from a boiler with high-pressure steam?

Yes; this is the actual drawing of the Seaton Delaval apparatus—[*producing the same.* *See* Appendix]—it was taken from the one in the Report of the South Shields Committee.

Ibid.

334. The apparatus in this case is what we see here, a number of jets supplied with high-pressure steam from a boiler placed near the bottom of the upcast shaft?

Near the bottom of the upcast shaft; the only machinery required is a simple feeding pipe, with a series of small iron jets, smaller than my little finger, with openings through them of about the size of a goose-quill.

335. In this case you have the furnace below?

In this case the steam happened to be below to supply an engine; therefore it was used therein; but in any case where it is desirable to have the steam from above, this represents it—[*showing the same.* *See* Appendix, "Section of upcast Shaft," Letter A, fig. 1.]—Here is the boiler at the surface, and a steam-pipe is carried down the shaft, and communicates with the series of jets; the whole apparatus is a series of jets, nothing more.

Ibid.

336. Of what size are the jets?

About the size of a goose-quill; from an eighth of an inch to a quarter; it depends upon the pressure in the boiler; if you have a pressure of 60 lbs. to the inch, then one-eighth of an inch will do; if you have a lower pressure, it will require the areas to be larger.

337. If you diffused it in a very large space, should you require larger jets?

No.

338. But a greater number of them?

If they are within 18 inches of each other, they will lift the column; if they are further apart, and the resistance of the galleries is great, the air to supply the exhaustion below will go back from above.

339. Have you any case in which the apparatus is fixed in this form?

Yes; there is one case, I think, at Belmont; I am not quite certain.

G. Gurney, Esq.
22d June 1849.

340. Where is that?

That is near Monkwearmouth.

341. The supply is continuous, not intermitting?

The supply is continuous, and the steam is continuous; it produces a constant exhaustion; and the exhaustion is a constant quantity; but whether it would be a more complete or economical mode to supply it by intervals or pulsations, is a question hardly worth while at this time to be mooted, because it is a question only of a few pounds a year expense.

342. Will you tell us what power of ventilation you obtain by the apparatus of which you have spoken?

We obtain any power which we require. The power required in a large mine is considerable, where the galleries are long; we require a force of exhaustion equal to two or three inches of water.

343. To the inch?

Yes.

344. Will you explain the apparatus of the water-gauge?

The water-gauge is an inverted syphon; a bent glass, in which water is placed, and stands at a level in both legs.

345. A bent tube?

A bent glass tube; one leg is passed into the "in-take," as it is called.

346. That is the passage by which the current passes from the downcast shaft?

Yes; and the other end is passed into the exit, the "return;" so that the plus pressure on the one side, and the pressure minus on the other, make a disturbance in the water-level; and if the water-level indicates a disturbance of two inches, it is considered to be a very powerful draught, and, in short, such a power as is required to pass the large mines in the North.

347. The water being depressed at the side of the in-take, and raised on the other side?

Yes, making a pressure of two inches, taking the two sides; so that if you had a water barometer, it would be two inches higher in one shaft than in the other; therefore the water-gauge may be considered as a measure of the power or force of ventilation.

348. In an extensive mine you say that the force of ventilation required might be as much as two inches?

I find, from a series of experiments, which I have made upon the subject, on the difficulty of air passing through tortuous passages and uneven surfaces, that in the ordinary sized mines it takes about six-tenths of water-pressure to a mile.

349. That is to say, six-tenths of an inch?

Yes; if the galleries are a mile in length, you require then a ventilating force equal to six-tenths of the water-gauge; if they are two miles, you require twice that; if three, you require very nearly two inches. I believe there is scarcely any case where more than two inches is required, but in some cases the resistance in the galleries, arising from mechanical causes, too frequently from the trucks and horses passing, and very frequently also from atmospheric interferences, is such, that a larger force than two inches of water is required.

350. With your apparatus, you say that you can obtain a pressure equal to 24 inches of mercury?

Yes; as an experiment it is done every day.

351. Supposing you applied the apparatus so as to obtain a pressure equal to 24 inches of mercury, what power would that give you as estimated in the water-gauge?

Each inch of mercury represents a foot of water in round numbers.

352. That is in weight?

In height and in weight also; a column of a foot is equal to about an inch of mercury; the barometer stands at about 30 inches, and water about 33 feet; so that, in round numbers, you may say an inch of one to a foot of

of the other. Here is a diagram showing the manner in which the air comes in; it represents a jet of steam.

G. Gurney, Esq.

22d June 1849.

353. A single jet?

That is a single jet; as the steam escapes it expands laterally; but you observe that it runs in this direction from its momentum, and as it passes it draws in air with it from all sides, and the air becomes mixed with it, and passes through this, which may represent a cylinder. The fact of the steam drawing in air with it in practice was doubted for a considerable time, and doubted up to almost the last 12 months. I am sorry that I could not get the proper apparatus to show it to the Committee, having no boiler at hand, but I have done the best I can; I have brought some apparatus by which I can show the Committee the principle.—[*The Witness produces the same, and exhibits experiments to the Committee.*]

354. The exhaustion is made in the recesses of the mine?

The exhaustion is made immediately behind the jets, which communicate to the recesses of the mine.

355. If the steam goes through the gallery, and there are recesses, a strong draught up the gallery will exhaust the recesses of foul air?

The steam is not placed in the galleries, but in the upcast shaft: the draught consequent upon the exhaustion by the jets will come on by the most ready channel through the galleries; it has no alternative.

356. When you have produced that violent current of air, its passage will draw the atmosphere from each side?

Yes; it will draw it all through; it will disturb that also in the recesses by its eddies and retrograde action.

357. You produce a vacuum in the shaft, and then all the air goes out of the galleries, of course?

A partial vacuum, an exhaustion; we cannot call it a vacuum; the air runs to supply the exhaustion through the galleries of the mine.

358. The effect of the air rushing through those galleries would be to exhaust whatever accumulation of gases there might be in the recesses?

Yes, it would mix and draw it all out.

359. It would tend to that?

Yes; that exhaustion would again be supplied by fresh air going down the downcast shaft. Now, here is an experiment which goes to prove the fact that the steam carries with it a large portion of air. The air passing from the one bladder to the other, when they are in close connexion, will just fill the second, and no more; but you will observe, that if I drive it in by a jet at a little distance, according to the diagram before us, the quantity of air which fills the one, although at very little momentum, will draw after it enough air to fill the other 20 times; and that is the principle of the high-pressure steam-draught. You will observe in the one case that the jet of air being inserted, gathers no extra quantity, and carries no extra atmosphere with it. With one expiration of my lungs I could not fill this bladder when the pipe was inserted in it; but if I take the jet out to a distance, one charge of my lungs will drive sufficient air before it to fill it several times. That experiment shows that there is a large quantity of air driven in before the jet, and upon that principle it is that the steam-jet is founded. I am sorry the experiments are so rude.

360. You say that by the application of this jet, you can obtain a pressure of 24 inches of mercury to the square inch?

We could do it supposing it to be wanted; but in a mine it is out of the question; such a force as that would pull the mine actually in; two or three inches of water is quite enough for ventilation.

361. A pressure equal to 24 inches of mercury would be equivalent to what, in the water-gauge?

About twenty-four feet of water.

362. Two feet being a very heavy pressure from the current under ordinary circumstances of a mine, that would be very much greater than could by possibility be wanted?

I do not think that, in practice, above six inches would ever be required; I

G. Gurney, Esq.
22d June 1849.

wish to be particular upon that point, lest the idea should possibly arise from what I have said, that such a pressure as 24 inches of mercury would ever be required; this pressure of exhaustion has been shown simply as a matter of experiment, to prove that there is no practical limit to the power of this mighty agent which we have now to deal with: we can cause a current of air to move at the rate of one foot a second, which is hardly sensible, and we can produce a hurricane simply by turning the handle of a stop-cock; in short, any rate of current at pleasure.

363. It is completely under your control?
Perfectly.

364. What is the highest power which you have hitherto applied in practice for mines?

I think we got two feet water-pressure in a late experiment at Manchester; but that was a special case, not for ventilation.

365. That was the case of the extinction of a fire in the mine?
Yes.

366. Mr. Darlington's?
Yes.

367. There you carried it to a pressure of two feet of water?
About two feet.

368. Did it succeed perfectly?
Perfectly.

369. It extinguished the fire?
Yes.

370. It was not extinguished by the current?
No

371. But by the materials which you forced in?
It was extinguished by choke-damp, which was driven in by the agency of high-pressure steam.

372. You forced carbonic acid into the mine by means of this current?
Yes; the buoyancy of air in a shaft is due to its temperature; the greater the temperature, the lighter the column; the Manchester shaft, in this experiment, was 400 feet deep; the temperature was 460 to 480 degrees, because the choke-damp was drawn through a sharp fire; it was made by the fire, consequently we had the buoyancy in the shaft of this temperature to overcome; hence arose the necessity of that strong pressure equal to two feet of water or to two inches of mercury; this force overcame the difficulty.

373. Supposing the air had been at the ordinary temperature, what would have been the force of the current, or what was the actual current when you had overcome the impediment caused by raising the temperature of the air?

If the temperature in the shaft was the ordinary temperature of the atmosphere, there would have been little or no resistance; about 6,000 feet a minute was the quantity which we drove through; it was driven through a cylinder one square foot area, consequently it moved at the rate also of 6,000 feet per minute.

374. Do you know what the temperature of the external air was at the time?
Perhaps about 60.

375. It was not in winter-time?
No; it was on the 29th of April.

376. The current was something more than a mile a minute?
Yes.

377. There is no ascending force from the change of temperature which you cannot easily overcome?
The natural change of temperature is scarcely sensible.

378. In this case, after overcoming the buoyancy of the heated air, you obtained a current of 6,000 feet per minute?
Yes.

379. Would

379. Would that be sufficient in the case of a fiery mine for effective ventilation?

No.

380. What is considered to be a necessary current for the purpose of clearing what is called a fiery mine?

Seventy thousand to eighty thousand cubic feet per minute, a rate of current of about eight feet per second through every gallery, giving a quantity equal to from 70,000 to 80,000 cubic feet per minute.

381. About 12 times as much as what you produced at the mine to which you have referred?

Yes; in this case we had only a single jet and a single cylinder for a special purpose.

382. At each shaft?

At each shaft: with reference to quantity of air for ventilation, Mr. Forster, in a letter of the 11th December, says, that before applying the steam, he had 53,000 cubic feet of air passing through Seaton Delaval Mine per minute; the mine with that amount of ventilation became dangerous; "fire-damp appeared at the goaves, and threatened to render the air-courses explosive;" he applied the steam, as shown in the diagram before us, and immediately the ventilation rose to 79,359.

383. That is a very considerable rate of current, is it not?

It is; it is an increase of about 50 per cent.; it has since been increased to about 100 per cent.

384. One hundred per cent. upon what?

Upon the old ventilation.

385. Upon the 50,000?

Fifty-three thousand; which was from two upcast shafts and two furnaces.

386. When you talk of 100 per cent., you mean 100 per cent. upon that quantity?

Fifty per cent. upon the original quantity; it is now 79,000 up one shaft: if steam were applied to the other, the increase then would be more than 100 per cent. on the whole, it would be about 120 per cent.: the steam-jets were only applied to one shaft, the 53,000 was produced from two shafts and two furnaces, but the 79,000 is produced now from one shaft: the furnaces are put out; and when the furnaces were put out, the amount of ventilation continued nearly the same; it was found that the rarefaction did not assist it much; it was scarcely worth having.

387. Although with the furnaces he had obtained 50,000 feet per minute, yet this state of things occurred?

Yes, with two furnaces: when they obtained more fresh air by the steam-draught, of course the temperature became less in the shaft; the fire-damp was adulterated or diluted below the explosive point: perhaps I need not observe, that it requires a certain proportion of fire-damp to be mixed with air to be explosive. Mr. Forster remarks in his letter, which I hand in, "To myself this experiment affords the greatest gratification; as, before the apparatus was erected, carburetted hydrogen gas was occasionally seen at the edge of the goaves, but since, it has entirely disappeared."

388. Seaton Delaval is considered a very fiery mine, is it not?

It is a very large mine, and occasionally fiery.

389. What are the goaves?

The goaves are the old broken parts of a mine, where the pillars are taken away.

390. Or where the roof falls in?

Yes; any broken part is called a goaf; they are not ventilated, and frequently are filled with carburetted hydrogen; large gasometers fully charged; sometimes they are filled with choke-damp and carbonic acid.

391. You have described to us two different ways of applying the high-pressure steam-jet; which of those two ways do you consider the most applicable to the ventilation of mines?

(164. 2.)

F 4

Either

G. Gurney, Esq.

22d June 1849.

G. Gurney, Esq.

22d June 1849.

Either in the mine, or out of it; it is efficient for all purposes for which ventilation can be wanted; with both there are some points of practical convenience, which a scientific viewer perhaps can judge of better than myself; one inconvenience, like the furnace, of having the steam at the bottom of the shaft is, that the fumes from the fire affect the ropes going up and down, and are also somewhat inconvenient to the men going up and down.

392. What is the effect upon the ropes?

In addition to its chemical action, the effect upon the ropes is, that the temperature is changed as the rope goes in and as it comes out of the shaft; there is a constant change of expansion, if it is a metallic rope, and a partial corrosion and wear and tear upon it; on that account it is better to have the fire entirely out of the way.

393. How is it with a hempen rope?

A hempen rope is damaged very rapidly from changes of wet and dry.

394. They are not used, are they?

Very little; there are many advantages and disadvantages with respect to the two modes of applying the high-pressure system; "much may be said on both sides." It is a matter of very little consequence as far as the principle is concerned; it is a matter entirely of facility and convenience to the manager.

395. You would not say that either method preponderates very greatly over the other in point of advantage?

Very little.

396. Perhaps it may depend upon local circumstances?

Entirely; if the boiler is at the bottom, it would be used there; if the boiler is at the top, which is more frequent, I should advise its being used there. If the exhaustion is made out of the mine, it is self-evident that there must be a stopping of the mouth of a working pit when the cages pass up and down; this is found very easily to be contrived, and I should be very happy to give drawings of the arrangement of it.

397. You have shown us a drawing of the plan by which you apply your principle with a number of jets filling the area of the shaft?

So arranged as to lift the whole column.

398. In that case, do you make the shaft available for other purposes; would it be available for passing the corves up and down?

To allow room for the corves, there are two modes of doing it, one by placing the jets in a "dumb-drift," as it is technically called.

399. That would go in obliquely?

Yes.

Vide Appendix I.
Plan, No. II.

400. Then you would lose some force?

Not a great deal, you would lose some; that is one arrangement [*showing the same on a Diagram.*] The next arrangement is to place the jets in that form by which there will be room for the cage to pass. In case the cages had to pass up and down the shaft, there would be no difficulty in practice.

401. There is no difficulty in practice in so applying it as to enable the colliers to make use of the same shaft?

None whatever; these inner jets [*showing the same*] require strong pressure of steam, and to be pointed in, so as to strike the cage column with greater force.

402. You do not find that the cages descending in that shaft have any effect in interfering with the column of air descending?

No.

403. We have had your explanation of the nature of the apparatus; what is the cost of it?

A few pounds; except the boiler, the cost of it is so trifling, that it need scarcely be considered; Mr. Forster stated at a meeting at Newcastle that it was less than that for furnace ventilation; he said the expense of furnace-bars is greater than the steam-jets; 5 £ will pay for the whole.

404. A single jet?

No, a series of jets.

405. What

405. What sized boiler would there be ?

The boiler should be powerful in proportion to the work it had to do; if it is a large mine with long galleries, difficult tortuous curves, and small sectional areas, you require a more powerful boiler; but if only short passages, one of very small power. As a matter of practice, it is better to have a large boiler to begin with; you need not work it to its full force.

406. What would your lowest boiler be equal to, 40-horse power ?

About 30 to 40; 15-horse power is perhaps enough for all ordinary purposes, but the pressure must be 50 lbs. at least.

407. To produce the same velocity of current, would there be much difference of expense between the present mode by furnace and your mode in an ordinary case ?

Very little.

408. It would be about the same ?

Up to a certain point, after which it would be less.

409. What rapidity of current would prevent the men from working, or expose them to cold and wretchedness ?

A current above eight feet a second, I think, would be inconvenient.

410. Eight feet a second would be how much ?

That would depend upon the sectional area of the gallery; if the area were 50 feet, which is somewhere about the usual sectional area in the north, it would be 400 feet a second.

411. All that you require is the boiler, and one man in attendance to keep up the fire ?

That is all; burning the waste coals and the screenings; the expense in both cases of fuel is about the same; whether the screenings are found at the bottom or the top is a consideration in some mines.

412. What rapidity of current on the average is necessary to secure the safety of the mine ?

Some mines, being more fiery than others, require a greater difference of current; on an average I should imagine eight feet a second through every working.

413. When you say eight feet a second, what exactly do you mean ?

Not eight cubic feet, but eight feet rate or velocity of current per second.

414. Was not that the rate which you mentioned would be inconvenient to the passage of the people up and down ?

No; the question was, what rate of current would be inconvenient to the workmen? I said, that a rate above eight feet would be inconvenient; the inconvenience would be, that it would affect their candles; not to produce cold, for the temperature of mines is generally higher than the atmosphere, and the deeper they are, the warmer they become. In the deep mine at Monk Wearmouth the temperature is always about 80°.

415. What was the first mine at which this principle was applied ?

The Seaton Delaval Mine. There was a mine in Belgium to which the principle was attempted to be applied; but they made the unfortunate blunder of supposing that the steam could be used for no other purpose than that of rarefaction; and they applied it as low-pressure steam; therefore, that was not applying the principle at all; in some cases a single jet has been used, and which would require an immense extra force to fill the expanse of the shaft. Seaton Delaval is the first mine in which the principle has been fairly applied.

416. How long has it been in operation at Seaton Delaval ?

It is stated in Mr. Forster's letter. I wish to add, in referring to Mr. Forster's letter, that this gentleman was a perfect stranger to me; I never saw nor heard of him until I saw this letter—[handing it in].

417. You did not take a patent for your invention ?

I did not.

G. Gurney, Esq.
22d June 1849.

418. You have no pecuniary interest whatever in this invention of yours?
None, whatever.

419. You have no patent?
No.

420. And you have taken no measures to secure the advantage of the invention to yourself?

None whatever; the only interest I have is the common interest of all—to save life, mixed with some feeling of personal merit.

421. If it were universally introduced, it would make no alteration whatever in your pecuniary circumstances?

None whatever. I would wish to observe, that if the Committee refer to the evidence of 1835, they will find that it was given to the public: my second evidence, alone confined to high-pressure steam, was given after the first a considerable time; it arose from one of the Committee stating to me, who is now our Lord Lieutenant, that "I had raised the question of the safety-lamp, and had not suggested any remedy;" this put me somewhat upon my responsibility, "upon my mettle." The principle of "*vis a tergo*," used by me in the locomotive engines on turnpike roads, in which I was then considerably engaged, suggested itself, and I made experiments on a large scale, and saw at once that the same application to produce currents of air was equally favourable to coal-mines.

422. The high-pressure steam-jet is now in universal application in the case of locomotive engines?

It is.

423. For the purpose of producing a draught in the funnel?

For producing a current precisely on the same principle as this, an almost unlimited draught is produced; it is only limited in practice by the quantity of steam; the stronger the steam, the stronger the fire; and the rapidity of the carriage will be as the quantity or intensity of the fire; so that they are kept up together.

424. If you are understood aright, you do not seek by this contrivance to affect at all the chemical constitution of the gases in the galleries, either of the carbonic acid gas, or of the hydrogen gas, but merely by means of this mechanical process to effect a partial vacuum, and so to expel those gases?

Exactly; in addition, I might say, that it does not in any way interfere with the workings; it does not at all change the nature or the present arrangement of the workings of the mine.

425. Your contrivance facilitates, beyond anything which has hitherto been proposed, the introduction of any gases that may be necessary for any purpose?
Certainly.

426. This letter of Mr. Forster states, that his attention was turned to the subject of this apparatus from the evidence given in 1835, and the information obtained by the South Shields Committee in 1839, and that at Seaton Delaval the apparatus was applied in the course of last year?

Yes, it has been daily at work since; it has never stopped an hour from that time to the present. I beg to deliver in this letter from Mr. Forster.

The Witness delivers in the same, which is as follows:

VENTILATION OF COAL MINES.

To the Editor of the Gateshead Observer.

Sir,

Will you have the goodness to insert the following in your widely-circulated paper?

It will be in the recollection of many that Mr. Gurney, the discoverer of the Bude Light, suggested to the Parliamentary Committee which, in 1835, examined into the "Causes of Accidents in Coal-mines," the application of high-pressure steam for procuring an increased force of ventilation; and again, in 1839, when the South Shields Committee, appointed to investigate the causes of accidents, were making their examinations, he more fully detailed the power, safety, cheapness and facility of its application; since that time it does not appear to have been at all noticed by scientific men.

About the middle of this year, whilst in London, I attended a lecture (at the Polytechnic Institution

Institution in Regent-street) on a "jet of steam," in which the lecturer proved, by the experiments he made, the benefits to be derived in ventilation from high-pressure steam; so convinced was I of its utility, that I determined to make the experiment at Seaton Delaval Colliery, and the plan has now been in operation one month, and has far exceeded my expectations.

G. Gurney, Esq.

22d June 1849.

There are four downcast shafts, each eight feet diameter, and, after making allowance for the cage-guides, buntons, &c., the area is 150 superficial feet; the upcasts are two, one of them nine feet diameter, and the other eight feet, giving an area of 113·8 superficial feet: the quantity of air circulating through the mine previous to Gurney's steam apparatus being erected, was 58,058 cubic feet per minute, and since it was set to work, the quantity has been 79,359 cubic feet per minute, which is an increase of nearly 50 per cent.: the apparatus at present is only applied at one of the upcast shafts, and I am pretty confident if another one were erected at the other upcast, a corresponding increase would be the result; a short time, however, will prove this, as one is in course of erection.

To myself this experiment affords the greatest gratification, as, before the apparatus was erected, carburetted hydrogen gas was occasionally seen at the edge of the goaves; but since, it has entirely disappeared, and I entertain sanguine hopes it will not be met with at those points again.

I may be allowed to remark, that the extreme distance of the workings in Delaval Colliery from the shafts, in three districts, exceeds a mile and a quarter, and there is no difficulty with the present means of obtaining a brisk circulation of air.

In working the "whole coal," naked lights are used with perfect safety; but in working the pillars, or what is termed the "broken mine," the Davy lamps are invariably used as a necessary precaution.

I forward you a drawing of the high-pressure steam apparatus as applied at Delaval, *Vide Appendix I. Plan No. I. Fig. 3.* with the necessary references; and I have only further to add, that I claim no credit to myself, except in making the first trial; for it is Mr. Gurney's invention, and to him alone is due the credit; and I should not have troubled you to insert these few remarks, but with the hope that they may be the means of inducing other parties interested in this and other districts to adopt this most useful and cheap mode of ventilating coal-mines.

I beg to remain, sir,

Your obedient servant,

Thomas E. Forster,

7, Ellison-place, Newcastle-on-Tyne,
11 December 1848.

427. What proportion of steam would be required in relation to the diameter of the shaft?

A jet of steam of 50 lbs. to the inch, through an opening of three-sixteenths of an inch diameter, is sufficient to lift two feet sectional area of shaft, so that if the sectional area be 40 feet, it will require 20 jets; 50 feet will require about 25; but all that, is a matter of adjustment and arrangement by the manager. When I give these numbers, I do not give them absolutely, but as an approximation for average workings.

428. It is also in proportion to the area of the galleries of the mine required to be cleared of the foul air: you were understood to say, that the greater the extent of the mine required to be ventilated, the greater the power of exhaustion?

No, it would require just the reverse; the more easily the air passes through, the less power is required to pull it.

429. In many of the mines there are considerable intricacies of working: in those mines there is a greater difficulty of ventilation, is there not?

Yes, considerably; that would not affect the number of jets; that would only affect the pressure of the steam necessary. In your boiler you might have 50 lbs. pressure, and only work at 20 lbs., that is, allow 20 to pass the "throttle," as it is called; then if you required more, you would open the handle larger; you might thus get 30, 40 or 50 lbs.; if you required more ventilation, you would turn on till you got the full amount required.

430. Have you observed that the different states of the temperature of the external air have an effect upon this mode of ventilation?

Not sensibly; the influence of the air upon the weights of the two shafts does not vary to a sensible quantity. If a shaft is 480 feet high, one degree of temperature will give about the weight of a foot of air less in the shaft column, which is somewhere about 535 grains; this is so slight, that the change of temperature of a few degrees does not sensibly affect the force of high-pressure ventilation.

431. Do you find that the state of the barometer affects it?

No.

G. Gurney, Esq.
 22d June. 1849.

432. Is it necessary to place these high-pressure steam-jets at any particular part of the upcast shaft?

No, if the pressure of steam is sufficiently high; this is the great point.

433. Is it desirable to place them near the surface, or near the bottom?

Save the rarefaction, and the little power given out by the heat of the steam in the shape of heat and lightening the column, it does not matter where it is placed; it is not worth consideration.

434. It would be better at the bottom; but it is not worth calculation?

It is not worth calculation; if I had the boiler at the bottom, perhaps I should apply it there; but I should never think of taking a boiler down on purpose: if all fire is out of the mine, you are in a much safer condition than if you have a fire there at all. By carrying a steam-pipe down the shaft, you need not have any fire whatever: furnace-fires, I believe, are sometimes the cause of explosion.

435. What is the effect of furnace ventilation upon the gauge; how does it operate with respect to the gauge?

The furnace ventilation produces a lightening of one column as compared to the other, and the gauge is affected in proportion to the weights respectively of the two columns.

436. Is there any cause of irregularity in the operation?

The visible indication of the water-gauge is no measure of ventilation; it is very deceptive. The force of the upcast shaft is often an indication of the want of ventilation; whereas, to those who do not understand it, it appears to be a proof of a powerful ventilation; it is a seeming paradox: great force of buoyancy indicates a small quantity of air going to the upcast shaft. Suppose a furnace is in full action, giving out its full heat; enough to raise 30,000 cubic feet of air per minute, from 60° up to 120°, and producing an exhaustion equal to eight-tenths on the pressure-gauge; now let us suppose the quantity of air to be increased to 40,000 cubic feet per minute; the temperature will not rise to 120°, since the heat can only raise 30,000 to 120°; consequently, the temperature and the force of buoyancy will be reduced. Let us take it the other way: when a drag, or resistance, from atmospheric changes, or any other cause producing a hanging, requires more force to draw air through; a smaller quantity will pass to the furnace, and the heat being a constant quantity, and all communicated to that smaller quantity of air, will raise it to a higher temperature; it would probably raise it, say to 130° or 140°. It is self-evident the power of buoyancy would be greater; so that whenever the pressure-gauge is higher, it indicates a smaller quantity of air going to the upcast shaft. It is very deceptive, and I believe a variety of accidents, otherwise unaccountable, may be referred to this cause; the paradox of furnace ventilation is, that the more power it appears to possess by the pressure gauge, the less ventilation is going on; and *vice versa*.

437. Nothing of that kind can occur in your system?

No, it being an independent power, the power of *vis a tergo*.

438. It is a partial exhaustion, which is to be supplied by what comes behind? Just so.

439. In your second evidence in 1835, you state, "Perhaps the Committee are aware of the effect of a jet of high-pressure steam made to pass through a chimney or a shaft; if not, I beg to state, that it occasions a most extraordinary and powerful draught, incredible to those who have not seen it; ventilation by it may be carried to an extent that never has been possible to be equalled by rarefaction, the air-pump, centrifugal fan, water-draught, or other mechanical means. We may employ this means, and obtain a draught of any quantity or intensity at pleasure. The same effect would be produced either in an up-shaft or down; I think if the current, instead of being made in the upcast shaft, were made in the down, it would be still better in practice. We know, wherever a partial vacuum is produced, air will run by the shortest and nearest passage to it. From the downcast shaft, therefore, air will go through those galleries only which are most direct, whenever a draught is made, no matter by what means, in the upcast shaft. But if air be in plus, it will percolate through every gallery. The laws of æriform and other fluids are the same; we know, if we draw water through a tube connected with a series, it will run through one or two and not through the rest; but if it is pressed, it will strain through the whole; the blood, for

for instance, from the heart is pressed through every anastomosing vessel; this would not be the case if drawn through. So in mines; if a strong current of air be driven down, instead of being drawn up, we shall have a greater chance of ventilating throughout the whole mine." By that answer, you are of opinion that forcing the jet down the downcast shaft is preferable to making use of it in the upcast shaft?

Yes, I thought so at that time.

440. Are you still of the same opinion, from your further experience, as you were at that time?

No, I do not think so now; I think the upcast is rather the better application; exhaustion is more convenient in practice.

441. Generally speaking, drawing is better than pushing, mechanically?

Yes; particularly when you have an elastic rope.

442. Both may be used?

The use of both may be occasionally applied; if you require double power, you may have it; you must bear in mind this condition, that if you use the compressing force, and push, a certain quantity of steam goes in with the air.

443. That would hardly give you so much force, would it?

Yes, rather more; the force is rather more powerful, plus the quantity of steam in it; it may be about one six-thousandth part, not worth consideration.

444. The only objection to having a very great and excessive force of ventilation is on account of the candles?

Yes.

445. There is no other?

Not that I know of.

446. There is nothing else which affects the workers in the pit?

No.

447. They are not liable to catch cold?

I think not.

448. You never heard any objection made to the strong current of air?

No.

449. Would it affect their eyes by blowing about the particles of dust, and so on?

I think not; I cannot practically speak to that point.

450. Are we to understand that this process of ventilation is continually going on that you are continually making these jets; is it worked every day?

It is going on night and day; it requires no machinery, it is self-acting.

451. What is the consumption of fuel compared with the present mode of furnace ventilation?

The consumption of fuel is less, but in coal-mines that is not much an object, inasmuch as they always burn the waste; sometimes they are very glad to get rid of it, but I believe it is a matter of no moment.

452. Have there been any mistakes committed in the application of your method?

There have; one that of using too low pressure, instead of proper high-pressure steam, which I have already mentioned; another, that of using too few jets, sometimes a single jet, allowing room in the shaft for the compressed air in front to return and fill the exhaustion behind.

453. It is an essential point, that whatever jets there are, should be sufficient to lift the whole column?

Yes; the mistakes which have been made are from using too low a pressure, instead of a powerful high-pressure steam, on the one hand, and, secondly, by not putting in a sufficient number of jets to lift the whole column of air in the shaft; if they are too few, the compressed air in front will run back to the exhaustion behind.

G. Gurney, Esq.
 22d June 1849.

454. There is no advantage in producing rarefaction by low-pressure above that of the present system?

None; on the contrary, more expensive; for you have a boiler and steam to do that which a naked fire would do.

455. Will you describe, shortly and precisely, the case in which you applied your plan to the extinction of a fire in a coal-mine in Lancashire; first of all, what was the condition of the mine when you were applied to, and what was the method which you adopted for extinguishing the fire?

Perhaps I had better "begin at the beginning." I received a letter from Mr. Darlington, stating that one of his mines was on fire; he was a perfect stranger to me; he did not even know my address; his letter was sent to London to a gentleman connected with the press, who passed it on to me to my address in the country. I received his letter, which I am sorry I have not here (if I had thought that this question would be asked I would have brought it with me), stating that a mine of his was on fire; that they had stopped it down; that the fire-damp was escaping in very large quantities from the crevices about the workings, and that the safety-lamp would take fire at a very considerable distance, showing that the fire was then in a state of slow combustion, acting more as a retort, and distilling gas, than an active fire. He asked me if I could suggest some means by which they could draw out the fire-damp without admitting atmospheric air to the mine. Now that, of course, was impossible, on the first view of it; and, secondly, if it could be done, it would be a very dangerous thing to attempt; the atmospheric pressure upon the mine would be sufficient to pull it all in together. But an idea struck me, that I thought would get over the difficulty; the idea, perhaps, more readily struck me than it would have done anybody else, in consequence of my having been engaged in a series of experiments with Sir George Cayley's invention with hot air, with a view of obtaining power for working an engine. In those experiments we had a variety of contrivances for heating air for the purpose: one of those contrivances was that of passing the atmosphere in a close vessel through a burning fire. In those experiments we had occasion to analyse the air after it had passed the fire as it came through, to ascertain that the whole of the oxygen was combined. I found that very little fire would do this, and that, after passing the air through the fire, nothing came through but the nitrogen of the air, and some carbonic acid, formed from the oxygen and the burning material.

Vide Appendix I.
 Plan No. III.

456. In combustible gases?

Yes, extinguishable gases. Therefore, it appeared to me that, if we made a large furnace, and connected with the ash-pit of that furnace, perfectly air-tight, a cylinder, and put the steam-jet in the cylinder, we might draw the air of the atmosphere down through the fire, and drive the nitrogen along the cylinder into the mine; that if the cylinder were projected on to the top of the mine, and carried through the stopping, it would, of necessity, be obliged to go into the mine, and drive out all the contents; we did this; and on the other side, at the same time, we had an exhausting force of steam applied to assist in drawing out the foul air from the mine, aiding the operation at the other end. The parties first considered the thing impracticable altogether; in the first place it was too difficult; and, secondly, they thought it would be attended with immense expense; for, they said, "Where are we to get carbonic acid sufficient to fill the mine; a mine three miles long?" My remark, which Mr. Darlington uses in his account of it, and, perhaps, is one that I may be permitted to use now, being an expressive one, was, that "we could get it from the winds of heaven;" all we had to do was to use the coal lying waste on the "bro," make a fire, and pass the atmosphere through it; it would then be made at the cheapest possible rate; in short, it would cost nothing; a few bushels of waste coal would make all we could require.

457. How do you secure the consumption of the oxygen?

We found, from the experiments that have been alluded to, that a fire 18 inches deep will consume the whole of the oxygen of air as it passed; therefore, I knew it to be so from previous experiment; and carrying out these principles in practice, we succeeded in putting out the fire.

458. Did

458. Did you convince them by your reasoning, or by some experiment?
I convinced them by my reasoning.

G. Gurney, Esq.

22d June 1849.

459. You prevailed upon them to allow you to apply methods?
Yes.

460. Will you describe how you effected the object?
We sent to Wigan, seven or eight miles, and got some gas-tubes for steam-pipes; we got some sheet-iron and made the cylinder, through which the choke-damp was driven.

461. You carried a pipe from your furnace?
Yes, into the downcast shaft.

462. How far down?
Just through the stopping.

463. And the rest of the aperture you made close?
The rest of the aperture we made quite close, air-tight; we had two force jets, the first for the purpose of driving the choke-damp through water; I thought it dangerous to pass it down at a high temperature, knowing that there was carburetted hydrogen, and possibly an explosive mixture in some part of the mine; therefore I passed it through water before it got to this pipe, as it left the furnace.

464. For what purpose?
Simply for the purpose of cooling it, reducing the temperature.

465. Then all you did was to pass common atmospheric air through a fire?
Yes.

466. Thereby withdrawing the oxygen?
Yes.

467. And leaving nothing but carbonic acid and nitrogen?
Exactly.

468. You then passed those by a tube into the shaft?
Yes.

469. And you forced those gases, by means of your jet, down into the mine?
Yes.

470. At the upcast shaft what was your process?
A steam-jet was placed there in a cylinder of the same size, placed into the stopping.

471. Then you had the stopping there also?
Yes; the result was, that the choke-damp was drawn along the gallery.

472. How long was the time that you required to fill the mine and to extinguish the fire?

At the end of about two hours there was a visible change in the appearance at the exit of the upcast shaft.

473. What was the difference which you observed?
I observed a little cloud appear, which I suspected was the choke-damp; I turned off the steam for a moment, and put my nose in it; I soon found that it was so, from the sulphurous smell; some of the farm servants came in at the same time, and said they had smelt it at half-a-mile distance; I then got a safety-lamp, and placed the safety-lamp into it, and found that the lamp was instantly extinguished; it went out as if it had been put into water; by this I was satisfied that the choke-damp had passed through the mine; I kept it on for five or six hours longer, so as to make perfectly certain that the mine would be fully charged: the intelligence from all around that they smelt the "sulphur," as they called it, in all directions, convinced me it was fully charged; it remained about six hours; we then withdrew the furnace fire, and drove fresh air through the mine.

474. By the same means?
By exactly the same means; at the end of two hours and twenty minutes, which I think was the time the cloudy appearance at the exit shaft disappeared,
(164. 2.) and

G. Gurney, Esq.
22d June 1849.

and soon after, on placing a safety-lamp in it, we found that it burned freely; I placed a fire also of charcoal in a chafing-dish in both cases at the exit; in the first case it was extinguished, and in the second it burned very rapidly; as if it were in a furnace draught.

475. That is to say, at the later period?

Yes, when the fresh air had gone through; we then received satisfactory evidence that the choke-damp had been discharged; the men from that moment gained confidence; they were now very anxious to go down the pit; there was a good deal of excitement about the pit, and the men were immediately for taking up the stopping, and going directly down into the workings; we did take up the stopping, as it was necessary to go down the shaft to examine the state of the pumps, which had been standing; I begged Mr. Darlington, as he had influence with the men, to go down to prevent them from entering the mine; fearing that in the recesses of the workings, and the parts out of the current, some choke-damp might still have remained, it being a heavier gas than atmospheric air; therefore, I desired him not to allow them to go into the workings for the night.

476. Did you keep up the jet all this time?

The exhausting jet was kept on all night, but the down jet was discontinued after the stopping was taken away.

477. You kept up the jet of the upcast shaft?

Yes; the men went down the next morning, and passed all through the workings; and found the fire all extinguished.

478. What distance was the fire from the shaft?

I do not know exactly; about 100 yards, I think, or 150.

479. What was the depth of the shaft?

I think it was 390 feet.

480. Was it a single fire, or in different places?

A single fire: if the Committee call Mr. Darlington, he will tell them of another experiment which he has made since, which is rather more satisfactory in some respects; I do not know that an experiment could be more satisfactory than the first was, but the last is more decided as a practical means for putting out standing fires in mines, which are generally built off: in the galleries of the upper levels there was an accumulation of fire-damp; this level was out of the air-course, and therefore could not be removed by the current; he went down, I understand, and got a hole bored into the recess, to allow the fire-damp to escape into the air-courses, and when he bored the hole, the gas escaped, and took fire, and it burnt with a large volume of flame, and set fire to the coals; this was at a very considerable distance from the boiler, and from the downcast shaft; he got the steam-jet down to the spot; he built off the fire, and blew the choke-damp through upon the fire direct, and soon extinguished it: on examination of it afterwards, he found that the coals had been burnt 18 inches deep, and had been coked at that depth. I would remark, that in most of the standing fires in mines they are built off by brick-stopping; it will now be seen that it is very practicable to go down to these stoppings, and drive in these extinguishing gases, and put it out; it is also equally clear, that after you have extinguished it, by steam you can reduce the temperature to 212°, or below the temperature for second ignition; this is essential in putting out a standing fire: in a recent fire, when you extinguish it, there is no magazine of accumulated heat; but in a long-standing fire the magazine of heat is immense; and although you may put out combustion, yet, on the admission of fresh air, it will take fire again; many serious accidents have happened from this cause: a gentleman from Scotland, Mr. Wilson, the well-known proprietor of the hot-air blast for making of iron, has a coal-mine on fire; he told me, about 10 days since, that he admitted water into that mine, which remained there two months; the water was then pumped out, when the fire burnt again as briskly as ever.

481. It goes very deep?

Yes; one reason for it breaking out afresh is, that air is sometimes pent up against the fire; and another reason is, that the great magazine of heat is capable of decomposing water, assisted by pyrites: Mr. Wilson said he filled the mine with water a second time, and allowed it to remain six months; and when

when he pumped it out again, the mine took fire a second time ; he came to me on the subject about ten days ago.

G. Gurney, Esq.

22d June 1849.

482. Where is this ?

In Scotland. He has now gone down to apply the choke-damp ; whether he will succeed or not, I do not know ; if he fails, he will fail in the second process ; not from the first. Such a standing fire requires a long time to cool, out of access of the atmosphere, as well as to be extinguished.

483. How long had the fire in Mr. Darlington's mine been in existence ?

It had been burning about a fortnight.

484. You mentioned at the beginning of your account of that operation that Mr. Darlington was very much alarmed at the probable expense of it ; what was the actual expense which he incurred ?

The actual expense that he incurred I am not prepared to say ; the expense of pipes and steam-jet, and altogether, I should think did not exceed 10*l.*, perhaps not more than 5*l.*, if the gas-pipes were returned.

485. The expense of obtaining the gas was what alarmed him ?

Yes ; he thought that carbonic acid must be obtained by an expensive process from limestone, or something in that way, and that the expense of it would be very great.

486. Then, in point of fact, the expense of the operation must have been very slight ?

Yes ; the expense was very trifling ; I believe the gas-pipes were returned ; they were not injured.

487. Is your process much affected by the depth of the mine and the height of the shafts ?

No ; that does not affect high-pressure ventilation ; no matter what the depth of the shafts are ; if the two columns, the downcast and the upcast, have the same temperature, they will be in a pneumatic balance. In the case of the hot-air furnace ventilation the depth is important.

488. If there were a very large area, say, 2,000 or 3,000 acres, would it then be difficult to apply your process ?

There would be no insurmountable difficulty about it ; it would be a question of time.

489. Of course it is difficult in proportion to the extent ?

I believe, in case a fire had extended over the three miles of galleries, that the quantity of azote and carbonic acid we sent in would have put it out. If you could follow up close to the fire, and brick off, it would be more easily put-out, no doubt. There are certain practical details about this process which are essentially necessary to success.

490. What are those ?

I spoke just now of the force which, in the downcast shaft, we have to contend with, which I should not have anticipated, if my pursuits in life had not been connected so intimately with the subject: this is one; in Mr. Darlington's case, we had upwards of a ton pressure to overcome ; the buoyancy was occasioned from the heat of the column, the temperature being 400 or 500 degrees. There are a variety of other conditions which we have to contend against.

491. In the case which you mention, you overcame it ?

Yes, we did overcome it ; if I could not overcome it in quantity, I could by intensity ; I could do so, no matter what the resistance, by taking longer time. If I had reduced my cylinder to half the size, I should have had four times the power, but then I should have been four times longer about it.

492. You say that that fire had been burning for a fortnight ; supposing that you had not been called in, and extinguished it, what would have been the effect of it, would it have been extended rapidly ?

It would have gone on further ; the fire might not have extended rapidly, but deeply ; the carburetted hydrogen would have been distilled in larger quantities, and then at the opening of the mine they would have had, most likely, a violent explosion. There are explosions arising from the same cause, and some frightful ones. In one case, close to Mr. Darlington's, I am told, an explosion occurred

(164. 2.)

H

by

G. Gurney, Esq.
22d June 1849.

by which they had all their head-gear burnt down; the trams melted in the mine; the flame came up two or three and twenty feet high.

493. But mines have been on fire for years?

Twenty years: a gentleman from America called upon me a few days since, and said, that he had had a mine on fire for 20 years, and that it is on fire still; it is walled up; it is supposed to be hermetically sealed. There is a very slow rate of combustion going on in those cases, as I have previously stated; air is supplied also, I think, by being passed through the same fissures as those through which water percolates; we know that water percolates to great depths; and where water will percolate, air will follow. Water percolates into those seemingly hermetically sealed places, and draws air with it sufficient to keep up combustion at a slow rate. The process used at Mr. Darlington's is given in a letter written by him.

The Witness delivers in the following letter:

A COAL MINE ON FIRE.

To the Editor of "The Times."

Sir,—The following successful result of an experiment made to put out a fire in a coal-mine is so important, that I feel a statement of the particulars will be interesting to your readers. On Monday morning, the 2d instant, one of my coal-mines at Astley was discovered to be on fire, and had spread to such an alarming extent as to prevent all access by the usual shafts. We immediately put out all the fires about the works, and requested the cottagers in the neighbourhood to do the same, for fear of an explosion. The plan of procedure in such cases (which happen more frequently than those unacquainted with collieries suppose), is, first to stop down all openings into the mine, so as to prevent any access to the atmosphere. If after some time the fire is found not extinguished, the only alternative is to fill the mine with water from some source in the neighbourhood. In the absence of a sufficient reservoir of water, the pumps are stopped, and the water allowed to accumulate from the natural drainings, generally an unsatisfactory and slow process. In the former plan, notwithstanding every precaution is taken in sealing the shafts, it is found by experience that air in small quantities will be drawn through the stoppings and fissures of the earth sufficient to keep up a slow rate of combustion for a very long period. We have proof of this in many cases occurring in this neighbourhood. In the extensive collieries worked by Lord Bradford, at Bolton, the mine has been on fire nearly two years. When the fire happened, it was sealed up for some months, but on opening it the fire was still found burning. The pits were again immediately sealed up, and left to remain for twice the former period; on opening the mine at this time the fire burst out as before. It was again closed, and so remains to this day. At the collieries of the Earl of Ellesmere, at Worsley, one of the mines took fire about the same time; it was treated in the same way; it is still on fire, and at this moment his Lordship is about to turn in the Bridgewater Canal. In the Patricroft colliery, the deepest mine in this country, a fire broke out in the upper part of the workings, which baffled every attempt to extinguish it, and is now stopped up, and abandoned. At Mr. Blundell's colliery, at Blackrod, in this district, the pits were opened after being closed some weeks, on account of fire, when a fearful explosion took place, and did considerable mischief to the workings. The fire burned with greater intensity than ever; the flames rose out of the mines, and set fire to the head-gear, and burned so fiercely within the pit, that it actually melted the iron tram-wheels. In this case the River Douglas was eventually turned into the workings, so as to fill them with water. I could mention several other cases in this immediate neighbourhood, to show the importance of the question before us, and the difficulties we have to contend with when these unfortunate accidents occur. In our case we instantly sealed up the mine, yet fire-damp issued from every crevice about the stoppings, and through orifices in the earth, in such quantities, that the safety-lamps would take fire at a considerable distance. In this state of things, I wrote to Mr. Goldsworthy Gurney, whose application of high-pressure steam to ventilation of coal-mines is exciting so much interest, stating the case, and asking if he could point out any plan by high-pressure steam exhaustion, or otherwise, likely to be of service. Mr. Gurney immediately came down, and after well investigating the conditions, in consultation with us, proposed to fill the mine with carbonic acid, azote, or some other extinguishing and incombustible gas. This at first appeared to us impracticable, and the immense quantity required to fill the galleries and lateral workings, together above three miles in length, too expensive, if it were possible to obtain it, to warrant the proposition. He, however, soon set us right. He said nitrogen or azote might be obtained from the winds of heaven, and carbonic acid from the coals lying waste about the pit, assisted by a little charcoal and lime; air would be deprived of its oxygen by being passed through burning charcoal, coke and small coal, and the azote set free. In short, the product of this combustion would be the choke or black damp known in mines. We immediately built a furnace of brickwork four feet square, at a safe distance from the downcast shaft. To the ash-pit, in every other respect made tight, an iron cylinder, 18 inches in diameter, was connected, and made to terminate at an elbow under

under water in a close tank partly filled; with the upper part of this tank, above water, another pipe was connected and carried through the stopping of the downcast pit. A powerful steam-jet was made to work between the furnace and the tank, which drew the air down through the fire, and forced it through the water; a second jet was placed in the cylinder at the top of the downcast shaft, and made to draw the choke-damp from the tank, and force it into the pit. At the other, or upcast shaft, we placed a jet in a cylinder through the stopping, and made to exhaust from the shaft beneath, so as to assist the compressing jets, and draw the choke-damp through the galleries between them. The apparatus thus fitted, as soon as the fire burned up, was set in action. In order to test the effect of the choke-damp, we placed some burning tow, moistened with spirits of turpentine, into it. The flame was as instantly extinguished as if placed in water. It was thus tested in the cylinder as it passed from the ash-pit, before coming to the jet; also in the tank and second cylinder, with similar results. This was conclusive evidence of the perfect formation of the choke-damp. In about two hours after the jets were set in action, fire-damp disappeared from the shaft, and we observed a slight cloudy appearance in the escapeage from the upcast shaft. It had the sulphurous smell of choke-damp, which pervaded the air to a considerable distance. A safety-lamp was now brought and placed in the upper cylinder; it became instantly extinguished, as if put in water. For this purpose the draughts were momentarily shut off. A bright burning fire of charcoal, in a chafing dish, was placed in the escapeage at the cylinder, and was also immediately extinguished. These facts satisfied us that the choke-damp had passed through the mine. The period of its appearance agreed with our calculations. The quantity of choke-damp forced through the mine was about 6,000 cubic feet per minute, and this would fill the galleries in about that time. The choke-damp was allowed to remain for several hours, at the termination of which we were convinced that all fire, however intense, must be extinguished in the mine. The connexion with the furnace was now broken, and fresh air driven through by the same jets. In about two hours the choke-damp disappeared; this was shown by a safety-lamp burning clearly in the escapeage, in the cylinder at the upcast shaft. We regarded the mine now as perfectly safe. With several men I descended the downcast shaft, 890 feet deep, to the tunnel leading to the working. We found all clear. The exhausting jet was kept up, drawing fresh air through the mine all night. The next day several men went down, and passed through the workings, and found all clear and safe. Their report was particularly favourable. In no part of the mine could they perceive any fire, and the action of the single jet in the upcast is described by them as passing a current with greater speed than the furnace (which is pronounced to be the most effectual one in the county) had ever before done in this or any other of the mines of which I am the proprietor. This result has occasioned the greatest interest in our neighbourhood. Never was an experiment more successful: a gigantic power under such complete control, fighting with the elements, and, as it were, compelling them to destroy each other. The application of high-pressure steam to the ventilation of coal-mines may effect a greater protection to life and property; but we regard this application as little inferior to the coal trade, and a triumph of science equal to any of the present day. The steam-jet is now used to ventilate the mine; the galleries are perfectly clear, and the men are working with naked candles. In all the progressive stages of coal-mining, but more particularly of the present time, when we find that, by the ingenuity of scientific developments, it has become one of the most prodigal sources of wealth, not only to the capitalist, but to the labouring artisan, the uncertain value of mineral property has invariably thwarted and repulsed the enterprise of the nation. To-day we may have a remunerative adventure, watched over by the genius of revealed theory and practice; while to-morrow may discover it has become the element of wholesale destruction to life, or a wreck of private hazard and national wealth. This experiment goes far to remove the impending danger, and render those difficulties, which hitherto have been insuperable, easy to be overcome, and at so trifling a cost as to be within the reach of the smallest capitalist. The simplicity of the experiment is only exceeded by its novelty, and the success is unquestionably the most perfect that any single demonstration could possibly have produced. The advantages are more numerous than we can here detail. Supposing an ordinary fire requires the shafts to be sealed for two months, what is the proprietor to do in the meantime, if he cannot reduce the fire to a given space in the mine? His connexions in trade, if not entirely lost, are restricted and broken, his mine injured and consumed, and the working colliers left to starve out the interim. His annual rents, interest of capital, and the more serious disbursements of incidental expenses, fall heavily upon him; whereas the immediate application of our experiment would put the mine in a working condition, with a delay of not more than two days. These facts are brought before the public for the benefit of all classes, being a public remedy for a national loss. To the untiring energy of Mr. Gurney are we indebted for them. He voluntarily tendered his services, and owing to his ability, the mineral property of this kingdom has been insured against the destructive element of fire, and consequently made a safer investment for capital. I may add, the expense of this experiment was trifling compared to the inconvenience, delay, and cost of letting in water to fill the mine, and pumping it out again, being not more than as many pence as the other would have been pounds.—*John Dartington, Astley Collieries, near Manchester, April 30.*

G. Gurney, Esq.

22d June 1849.

494. Have you any personal knowledge of the manner in which the ordinary ventilation of coal mines is managed?

Yes.

(164.2.)

H 2

495. Are

G. Gurney, Esq.
22d June 1849.

495. Are there any improvements which you would suggest in the mode of conducting the ventilation of mines?

I should strongly recommend well-authenticated instruments in which you have confidence; to put the managers in possession of the actual pressures, and the actual amount of currents passing.

496. How would you do that?

For the pressure I should prefer an aneroid; the modification called the "miner's aneroid."

497. The aneroid barometer?

A modification; I used one lately with very satisfactory results; there is a great convenience in it; you can move it about in your pocket from place to place; you can move it to the bottom of the upcast shaft; take the index; then go to the bottom of the downcast, and do the same, no matter the distance; it gives faithfully the amount of drag on the galleries; and although it may not give the exact barometrical measure, yet for showing differential pressure it is correct; I do not think there can be a better instrument; I think it may be used with very considerable advantage. To take the rate or velocity of currents I should use the windmill anemometer, or the disc balance of Sir George Cayley. Those instruments, the windmill anemometer, Sir George Cayley's anemometer, and the "miner's aneroid," the instrument I have formed upon the aneroid principle, would be enough for all practical purposes.

498. They would enable any persons charged with the management of a mine to ascertain the actual pressure at any period?

They would indicate the actual force; and they would also indicate the actual rate of current; and also show exactly the quantity passed in a given time.

499. You think that any one placed in such a post should be in the habit of making such observations?

I think they should be bound to keep a daily record.

500. Are you acquainted with the character of the overlookers in mines, and their competence to discharge the duties?

I know a good deal of them; the overlookers, generally speaking, are very intelligent men.

501. You have not any extensive personal acquaintance with the management of coal-mines, have you?

No; my experience in early life was more in the Cornish copper-mines. With reference to the previous question, an anemometer, self-registering, placed in the extreme workings, with an accurate transcript or record kept of it, ought to be satisfactory evidence of the state of ventilation always going on in a mine.

502. Are not those overlookers generally, the great proportion of them, without education?

They are often uneducated, but very valuable practical men.

503. Would it be of any material advantage that they should read and write?

I would rather not answer that question; I perhaps should not give a very satisfactory answer. I can state the result of the Cornish miners' opinions; a case in point. Sir Charles Lemon very liberally offered to found a school in Cornwall, "a School of Mines," as he called it, and to endow it with 10,000*l.*; but the mine-owners generally opposed it, under the idea that the best men were men of experience, and not men of education.

504. They reckoned the practical knowledge better than the theory?

Yes.

505. You do not concur in that opinion?

I consider practical knowledge very valuable.

506. Would not the principle, that "a little learning is a dangerous thing," apply there?

The principal argument amongst the Cornish men was this: "If you limit our overlookers to men of education, we shall have very few to choose from; the choice

choice is limited; but if we take them from practical men, we have a very large number, and it is practical knowledge which we want."

G. Gurney, Esq.

22d June 1849.

507. That it is to be had cheaper?

No; they say, "If we suppose that men are all born with the same talent, the talent we want is the talent of experience; we should have a larger body to select from."

508. They were of opinion that the time of those men would be employed in reading, and not in practical experience in the mines?

That was their idea; they have a great horror of what are called scientific men.

509. Have any other methods been tried for producing currents in mines besides the steam-jets and the furnaces, for rarefying air; for instance, was the fan ever tried?

Yes, the fan has been tried to a considerable extent, and the blowing cylinders have been used, and also the exhausting cylinders, and several other modifications; but all these contrivances require machinery, which is objectionable: the force of the air to be overcome for ventilation is the same in all cases, and when machinery is used, its friction is an additional expense; it is therefore generally preferred in practice to adopt that which is the most simple, least expense, and most void of anything like complication.

510. And the machine would require superintendence?

Yes, and the machinery wears and tears, and is liable to get into derangement, therefore the more simple the application the better; the great recommendation of the steam-jet and furnace, is their simplicity; the absence of machinery.

511. Have you seen the machinery in operation near Neath?

No; I believe that is by exhausting cylinders.

512. Have you ever attempted to form an estimate of the comparative cost of producing a given amount of vacuum, or a given amount of current by the fan, and by your steam-jet, and the comparative amount of fuel in each case?

Yes; I have not the result of the experiment before me accurately; I can give it in round numbers: the fan requires rather more than double the amount of fuel to produce a given amount of ventilating force, whether you take the force as force of current, or take it in velocity, whatever the measure may be.

513. Did you state in your estimate of expense that it would be 5*l.* for each jet?

No; I said that I thought the cost of the whole apparatus, except the boiler, need not exceed 5*l.*

514. And the boiler would cost how much?

The boiler would cost, in proportion to the horse-power; 5*l.* or 6*l.* a horse.

515. An average boiler in an average mine?

About 5*l.* or 6*l.* a horse, I think, is the cost price.

516. Is the only machinery that you require a small steam-engine to pump for the boiler?

I am glad that I have been asked that question. The boiler does not require a steam-engine to keep it supplied. If the boiler is at the bottom of the shaft, you can keep it supplied by a column of water; but if you have the boiler upon the surface, and have not a column of water, or have not an engine at hand for the purpose, you then can keep it supplied by a self-acting feeder, called "a lock," which I invented about 20 years ago. I shall be very happy to explain it: there is a couple of self-acting valves, which occasions the water to go in of itself; it is in very common use on the Continent and amongst sugar refiners.

517. Will you explain it shortly?

The lock is a vessel containing a quantity of water, connected upon the upper part with the top of the boiler by a valve, and at the under part connected with the bottom of the boiler by another valve or stop-cock; when the boiler requires water, the float in it opens the valves at those two openings, and the water runs into the boiler by its own weight; when the water has passed into the boiler, the float again stops these valves, and admits water on the other side to fill the lock;

G. Gurney, Esq.
22d June 1849.

it is called the "lock feeder;" being somewhat like the lock of a canal, so I gave it that name. This simple contrivance removes the necessity for pumps.

518. But must you not equally have some apparatus by which you supply water to the lock?

No; you will observe that when the water of the lock has run into the boiler, the lock becomes filled with steam; and then, on reversing the valves, they open to the cold-water cistern; the steam condenses, like that in the condenser of a steam-engine; the vacuum fills the lock from any well or cistern at hand; the water runs in of itself.

The Witness is directed to withdraw.

Dr. LYON PLAYFAIR is called in, and examined as follows:

Dr. L. Playfair.

519. YOU have for a long time had your attention turned to the scientific part of this subject, the ventilation of mines?

I was employed by the Government in conjunction with Sir Henry De la Beche to go down to the coal-mine districts, and examine into the subject.

520. Which districts?

Through many of the English districts.

521. Will you enumerate the districts in which you were employed by the Government?

I have been engaged chiefly in the Newcastle district.

522. In what cases?

Generally to examine into the nature of the fire-damp, and to inquire into special cases of accident; I have also seen somewhat of the Staffordshire, the Derbyshire, and other districts during these examinations. Specially, I have examined into some cases of accidents, particularly one in Jarrow, and one in Staffordshire.

523. In the course of those investigations, have you yourself personally examined mines?

I have personally examined mines, and ascertained the condition of the education amongst the mining classes, and also inquired into the expediency of appointing inspectors, as it was one of the instructions which we received, to ascertain generally into the means which might be employed for preventing accidents in mines.

524. Did you find any very great variety in the condition of mines in different parts of the country as respects ventilation?

I found the greatest difference as regards ventilation, partly, of course, from the very various modes in which mines are worked in different localities; but even when they are worked in the same way, there is the greatest difference in the efficiency of ventilation, comparing one mine with another.

525. Should you say that, generally speaking, the larger or the smaller mines are best managed with respect to ventilation?

I am not aware that I can answer that question precisely with regard to their size, but I think that in many of the larger mines which I have seen, very great care and attention is paid to the ventilation.

526. Is the difference between district and district, or between collieries in the same district?

I think there is a difference between collieries in the same district with regard to the efficiency of ventilation.

527. The ordinary mode adopted for effecting the ventilation of mines is the placing a furnace below ground at the bottom of an upcast shaft, is it not?

That is the ordinary mode in the Newcastle coal-field; a furnace is almost always employed there. In other parts of the country, very frequently there is no fire at all placed in the upcast shaft, but the ventilation merely depending upon the circulation of air from the downcast to the upcast shaft.

528. Without

528. Without any artificial method of increasing the ventilation?

In many cases there are artificial means, but there are numerous instances in which furnaces are not employed.

Dr. L. Playfair.

22d June 1849.

529. Where they have no furnace, there is no other artificial method?

No other.

530. In those cases where there was no artificial contrivance for the purpose of effecting ventilation, did you find the ventilation very imperfect?

Under these circumstances I would scarcely say very imperfect, because there was no great requirement for excess in ventilation, fire-damp being of rare occurrence.

531. Do you consider the method of placing a furnace below ground, in order to produce a current through the upcast shaft, an effective mode of ventilating a coal-mine?

I do not think it is the best mode that can be employed for ventilating a coal-mine, and for this reason, that it does not enable the quantities of air entering into the mine to be varied according to special requirements. I will explain my meaning: the quantity of gases or fire-damp issuing from coal into the mine vary very much according to the barometrical pressure; when the state of the barometer is low, there is a considerably greater quantity of gas escaping into the mine than when the pressure is high; there is no means in the furnace ventilation of adjusting the supply of air, for example, of causing a much greater circulation of air when required by particular circumstances; whereas, by a mechanical ventilation, a greater supply of air is commanded in the conditions where it is required.

532. In short, you are in that case enabled to adopt the power of the ventilation to the circumstances which require it?

Exactly so.

533. Could you not increase the heat of the furnace?

You could increase the heat of the furnace, but this is not an exact mode of adjustment, for in doing so, you are not sure of the quantity of air which passes down; there is no means of nicely controlling it; you cannot send a given number of cubic feet of air through the mine by the mere elevation of the temperature at any given time when it is required; in fact, it is not a means by which you can get an exact adaptation to circumstances.

534. Have you ever inspected any of the different contrivances which have been recommended for the purpose of ventilating mines independently of the ordinary furnace?

I have seen the models of some, and the modes in which they are done, and read the accounts of others.

535. Have you seen any in actual application in mines?

No; they are not commonly applied, and therefore there are very few cases in which you can see them.

536. From what you have been able to ascertain from such experimental instances, should you say that there are mechanical means by which a very efficient power can be obtained for the purpose of ventilation?

Certainly, I think so; but I should not wish the answer to imply that such means should be made compulsory, because, in a great many instances, a simple furnace gives a perfectly efficient ventilation to a mine.

537. Wherever the production of noxious gases is not very great, a furnace is sufficient?

A furnace is very often perfectly sufficient.

538. Are we to understand from that, that you allude to those mines where, perhaps, there may not be any fire-damp, as it is commonly called, evolved, and where only the ordinary ventilation is required to keep up a sufficient amount of pure air in the mines for the respiration of the miners and of the people employed?

Exactly so; but in any case I would not insist upon a mechanical ventilation; I would leave that to the intelligence of the viewers and proprietors.

539. In those mines in which you say you have found occasionally that there

(164. 2.)

H 4

was

Dr. L. Playfair.
 22d June 1849.

was no artificial ventilation whatever, should you say that the ventilation was sufficient for the health of the miners, independently of the fact that there was no very large amount of explosive gas?

Sometimes not. I may mention a case: I visited a colliery, not in the Newcastle district, with the permission of the owner, and I was informed that the ventilation was so efficient, although there was not generally a furnace, that no accident had ever occurred there. I arrived on the morning of the day appointed, and I found that the mine was in an unfit state for descent. On inquiring into the reason, I was told that an explosion had taken place about an hour before. This was the case of a mine where it was perfectly correctly stated that no explosion had ever occurred before, there being no great evolution of fire-damp; and yet, under altered circumstances, on one occasion this explosion took place. Therefore, I think that the ventilation in this instance was defective, although it would appear to have answered the purposes before.

540. How long had that mine been in work?

For several years: I do not know how many years; probably 10 or 12.

541. Have you found that the greater number of mines are furnished with two shafts, or are there many which have only one?

There are very many which have only one; some of the great mines in the Newcastle district have only one shaft, divided into two or more compartments; in such a case one compartment may be for pumping out the water; another as the upcast and another as the downcast shaft. Where the extent of workings is large, such a system is excessively injurious. I might instance a case which I specially examined, after a severe accident in Jarrow, where there were two seams worked; one called the Bensham seam, and the other the Low Main; the explosion took place in the Low Main, and the lower part of the brattices or dividing parts of the shaft were so much injured that no fresh air could be introduced into the workings where the explosion had taken place. The consequence of that was, that every person perished, except one man, who happened to be near a staple, which was sunk for the admission of air; every other man was killed, on account of the brattices being broken, and the ventilation being entirely destroyed in the mine.

542. What are those brattices made of?

Sometimes of brick, but generally of wood; one point that can be generally managed is, that the brattices may be made of much greater strength than they usually are. In some parts the brattices are made of strong brickwork, which would resist any ordinary explosion.

543. In a case of that kind, taking a colliery such as you have described, with only one shaft, and that shaft made available for both purposes by brattices, do you think that with extensive workings it is possible so to manage as to give the means of effective ventilation?

I think there might be means of effective ventilation in it, so long as the divisions of the shaft remained entire; but just when it is most required, as in the case of an explosion, the whole means for ventilation becomes destroyed.

544. And there is the additional difficulty, that when an explosion has taken place, you cannot reach the point at which the brattices have been injured?

No; I may mention the case of going down after this explosion; the whole of the brattices between the Low Main seam and the Bensham seam, a considerable distance, were destroyed, and it was impossible to carry on any efficient ventilation: even whilst we were inspecting the mine; the only way in such a case in which we could carry on any ventilation at all to enable us to inspect the mine, was by turning a current of water into the shaft, and forcing the air down it; this is the common method of ventilating a mine temporarily, under such circumstances, in order to rescue those who may be in it.

545. What is your opinion with respect to the application of the power of a steam-jet for the purpose of producing ventilation?

I have never seen it practically tried, but theoretically it appears to me to be a very good plan.

546. It is a power already in use in the case of locomotive engines, is it not?
 Yes.

547. For

547. For producing a powerful draught?

Yes.

Dr. L. Playfair.

22d June 1849.

548. Have you heard the evidence of Mr. Gurney, and the account which he has given of his proposed application of the steam-jet?

I have.

549. Do you conceive that what he has stated to-day holds out a reasonable expectation that it can be so applied with success?

So far as simply hearing it, I would say so; but I do not wish this to be considered as an opinion of mature consideration, because I have not studied the subject.

550. And you have not had any opportunity of seeing it in operation?

I have not.

551. But from your scientific knowledge, would you be able to say whether, by means of a steam-jet of that description, a powerful current can be produced?

I have no doubt that it can.

552. Are you able to state, under the circumstances of a coal-mine, what is the current usually required for proper ventilation?

That must be determined by very many circumstances; it must depend, for example, upon the quantity of foul air which comes into the pit from the evolution of the different gases; if they escape rapidly, a much greater current of air must be made to pass through the workings in order to dilute them; there must be more than 15 times the volume of air mixed with fire-damp to prevent an explosion; therefore the quantity of air must altogether depend upon the conditions of the pit. There is no means of giving any rule, and that is one of the things which renders it advisable to have a mechanical power readily subject to control, and capable of being adapted to the altered circumstances.

553. Do you conceive that in the case of the high-pressure steam-jet there would be the power of adapting it to the circumstances of the case?

Certainly, if the apparatus were of such a nature that you could increase the quantity of jets, and augment the force of steam.

554. Did it appear to you, from the statement made by Mr. Gurney with respect to the power which he was able to obtain by means of steam-jets, arranged as he described, that there was anything inconsistent with your knowledge of the general scientific facts connected with such a subject?

There is nothing inconsistent; but I would rather not give opinions upon a definite plan that I have not studied, so as to make my opinion of value.

555. With respect to other inventions, are you aware of the adaptation of other mechanical methods for effecting ventilation?

There is one plan I may mention, which has come under my attention, of which I have a high opinion, namely, Dr. Arnott's pump, which, I think, under circumstances, might often be found advantageous; but that is a point upon which, I think, the Committee would have better information from the inventor.

556. Are you aware whether it has ever been applied to such purposes?

It has been applied to similar purposes; for example, in ships, and in ventilating large buildings, and under similar circumstances.

557. Are you aware of a method proposed by Mr. Struvè?

I am not aware of its details.

558. There is a method proposed by Mr. Brunton, by the fan; are you acquainted with that process?

I have seen a model of it in operation.

559. Have you found it sufficient in this case?

It causes a great current of air; but I have not seen it in operation.

560. Can you say what amount of current can be attained in a mine without interfering with the working of it, by the extinction of lights, or inconvenience to the workmen?

More than five or six feet in a second might be inconvenient, even when the miner walks with the current: four feet a second has been found so, when a man,

Dr. L. Playfair.
22d June 1849.

with a naked candle, or with a Davy, walks rapidly against the current. There are several circumstances which appear very trivial, but which are of great importance in determining a limit to the rate of a current. Suppose a mine is worked with candles, which the great majority of mines are, a very quick current of air would cause a practical difficulty, which is found to be an exceedingly inconvenient one to the workers, and which frequently prevents the amount of current desirable; that is what is called the sweating of the candles, or the melting and running down of the tallow. Now, such circumstances as those, though trivial in themselves, yet, in the operation of a mine, become great difficulties, especially when taken in conjunction with the more important one, that a rapid current of air may cause a flame to pass through the Davy, and, therefore, there is a practical termination to the rapidity of a current of air.

561. Whatever the power may be, which is supplied in order to produce the ventilation in shafts, that power will be comparatively inefficient, unless the arrangements are well devised below for directing the ventilation?

Precisely so.

562. Have you found, generally, in your inspection of mines that, in that respect, the workings are very deficient?

I have found that the police arrangements of mines, that is, the arrangements for the inspection of the wastes, and of the different parts of the workings, with a view to ascertain their safety before the miners enter, are very deficient. Many of the most important duties, namely, duties involving, for their efficient execution, a knowledge of several collateral sciences, are entrusted to men who, on many occasions, so far from understanding any of the principles which they are carrying into operation, are very often unable to read or write.

563. You have found that they have not understood anything beyond the mere routine business in which they have been occupied?

The mere routine business; and not having that knowledge which enables them to alter their practice to altered conditions.

564. Independently of what you call the police of the mine, looking to the material arrangements and disposition of the different workings, have you found that mines in general are very defective as to the directions in which the currents of air are sent?

No; I think that in general there is great skill shown; I think that the engineering parts of a mine (I am speaking more of the mines of the North and the Newcastle district) are done with great skill and care.

565. Looking to other districts, as you have had experience of others besides the northern districts, should you say that, also, of those of Lancashire and Derbyshire?

Of the Lancashire district I have no experience; in Staffordshire and Derbyshire I do not think that the ventilation is always in a proper state.

566. They are not well arranged?

Not those that I have seen. I should mention that I have not seen above three or four mines in these districts.

567. Should you say that the defects which you observed there in the arrangements of ventilation are such as would require a very considerable expense to make them perfect?

I do not think so; I think that, with proper mechanical means of regulating the quantity of air, they might be easily remedied.

568. And a different arrangement of partitions?

The working there is in a totally different way from that in the North; they cannot be compared. The thickness of the coal is so very different in Staffordshire, that a completely different system is employed; but one thing I would wish to mention, that I believe the supposed efficiency of the mine in all districts is very often a matter of entire conjecture. You are told by the viewers, who are very intelligent men in the Newcastle district, that a certain quantity of air passes down the mine; but when you examine into the scientific evidence, as to whether the opinion of the viewer is correct, you very often find that the quantity of air is very much exaggerated, from attention not being paid to the circumstances of the friction of air through the galleries, and from the wire-drawing of the air through

through the different passages of the mine; therefore, I believe, that when we hear of so many cubic feet of air going down in a second, those statements are very often over-rated.

Dr. L. Playfair.

22d June 1849.

569. Have you among other things paid any attention to the contrivances for lighting mines?

I have.

570. Are there any improvements upon the Davy lamp at the present time that you think render it more secure and more effectual for this purpose?

I have seen several improvements, not upon the Davy lamp, but with a view of giving more light from the Davy lamp; not improvements upon the principle, but improvements in the application of the light.

571. Giving more light, and retaining the same security?

Yes.

572. Which should you say would be most likely to be effectual for that purpose?

I should not like to give an opinion upon any one in particular; there is one which experience has found to be very useful, that is the Belgian lamp; it gives more light, and possesses some points of advantage; the Clanny lamp is a very ingenious one; but both in his and in the Belgian lamp glass is used, and this renders it to some extent objectionable; for example, if the glass got very hot, and a drop of water came from the top of the mine upon the glass, it would be apt to break; however, if you could command the conditions of the glass manufacture, it is a very ingenious and good lamp. There are various other modifications of the lamp, though none of them have yet been sanctioned by the experience to be derived from a very extensive use.

573. Were not those proposals made some time ago?

Except in the case of Biram's lamp, which is, I believe, quite recent.

574. There is one with a double wire?

Yes.

575. Has that succeeded?

I believe they have all succeeded under certain circumstances; but the introduction of glass and those other fragile materials has prevented their practical success.

576. In some of them, namely, Clanny's and others, have they not increased the weight of them very much?

Yes; but in some of the late inventions, this evil has been obviated, and the lamps have been made more portable. I may be allowed to mention, with regard to the use of Davy lamps in mines, that, after considering the subject very attentively, so as to try to devise a plan not injurious to the owners and lessees of mines, and yet giving the guarantee of safety to the workers of mines, I have thought that a proper system might be brought into operation. Such a system might presume, in regard to all districts where explosions have occurred, that all the mines are dangerous. Let the law assume their dangerous state, whether they are so or not, and let the *onus probandi* of their safety be put upon the owners or lessees of those mines; and when they, to the satisfaction of the Inspectors, if those are appointed, show that accidents have not ensued from the use of naked lights, then a license for their use may be given, this license terminating at short periods, but being renewable if the workings are not under altered conditions; it could be thus ascertained whether circumstances rendered it advisable to apply the safety-lamp.

577. By what means could you secure the use either of a safety-lamp, or of any other contrivance?

Simply the great responsibility which would rest with the owners and workers of the mine if an accident took place, and they had not used it.

578. It is not your intention, then, in what you have said, to propose that there should be a constant inspection of mines, in order to see how the working is conducted in that respect?

No, not a vexatious inspection, which would be very unpleasant and unprofitable; a weekly or daily inspection would be quite unnecessary, but it would soon

Dr. L. Playfair.
 22d June 1849.

be ascertained by the Inspector on visiting the district whether the mine was being conducted properly. I think it to be of the first importance in all legislative arrangements for mines that the responsibility for their safety should rest with the owners and lessees, and not be put upon the Government Inspectors. Any enactment that would remove the responsibility from the former, and throw it upon the Government, would produce the most disastrous result.

579. It would not be in the power of any Inspector to ascertain whether the workmen really made use of the Davy lamps in the workings or not ?

It would not be ; but the Inspector in going about would soon hear of infractions of the regulations, at least that was my experience in the mining districts, when I visited them as a kind of Government Mining Inspector. All the delinquencies of not using lamps where they were supposed to be required were very readily stated by the workers themselves, who were very glad to give information, which they supposed might be acted on with a view to their safety. At the same time I am well aware that the owners of pits frequently find a difficulty in inducing the miners to use the safety-lamp, as, from the less light furnished by them, the same amount of work cannot always be performed as with naked candles.

580. Do you consider that the Davy lamps are certainly secure ?

I do not ; but I think that with care they are secure ; I have frequently gone, and I would do so again without any hesitation, into places filled with fire-damp with a Davy lamp, knowing the circumstances which render it secure.

581. Sir Humphrey Davy stated that there were certain circumstances in which it was not applicable ?

Exactly ; he was aware of the circumstances which rendered it unsafe.

582. He was aware of it, and cautioned persons ?

Yes, he did, and actually showed experimentally the conditions under which it might prove unsafe.

583. The principal condition in which it is insecure being that of a current of air ?

A rapid and sudden current of air.

584. You say that you would allow the use of naked candles where it had been ascertained that no inconvenience had arisen from their use ; would not that necessitate a previous use ?

Yes ; or also where the Inspector, from his examination, found that the ventilation was perfectly sufficient, and that no danger was likely to ensue from their use.

585. With respect to the subject of inspection, have you turned your attention to that ?

I have.

586. What is your view with respect to the possibility of any interposition on the part of Government by means of inspection ?

My own experience, so far as it has gone, is, that there would be no objection on the part of the coal districts as a whole ; I might show it in this way : I have been employed by the Government to make inspections of mines, and to report upon certain explosions, whether they were from particular causes or otherwise ; I have never found the slightest obstruction in my inquiries ; so much the contrary, that when I have been in districts making the inquiries for the Report presented to Parliament, I have been invited by the neighbouring coal-owners for many miles round to go and visit their collieries ; they have given the greatest facilities, and I never in one case was refused when I applied to be allowed to descend a mine.

587. You found upon their part a great readiness to consult you with respect to the arrangement of their workings ?

I was not there to give advice ; but I found the greatest readiness to open everything to my inspection, knowing that it was liable to be reported upon.

588. That being the case, upon what footing do you think it desirable that the Government should undertake anything in the way of inspection ?

My opinion is, that it would be advantageous both for the owners and for the workers in the mines.

589. Upon

589. Upon what footing would it be desirable that Government should inspect, that is to say, what kind of inspection do you think it desirable that Government should establish?

Dr. L. Playfair.

22d June 1849.

I think that the inspection should be a compulsory power of inspection; that the Inspector should have the same power of entering into a mine as the Inspector of factories has now of entering into a factory; that he should have power to see the working drawings, and to descend the mine, and see (which is a very important thing) that the working drawings really correspond with the true workings, which is not always the case; that after having done this, he should be able to give his opinion as to whether that mine was worked under conditions favourable to the safety of the mine.

590. Would you recommend that he should have any power of enforcing any arrangement which he thought expedient?

Not the Inspector; I would not give the Inspector more than an inquiring power; the executive power must be in a much higher officer, such as the Secretary of State.

591. Then your view is, that he should have the power of examination, and that he should then be expected to communicate to the coal-owners any observations, or to give any advice which he thought desirable?

He should.

592. And that he should have power to report to the Secretary of State?

That he should have power to report to the Secretary of State; and that the latter should be able to take cognizance of all circumstances affecting the safety or health of the workers in mines.

593. From the result of your communication with the coal-owners, do you apprehend that any power given to Inspectors, such as you propose, of entering their mines for the purpose of examining them, would be looked upon with jealousy?

I have not had much conversation with the coal-owners upon the subject, but I have had very many conversations with the coal-workers upon it. I found a universal feeling amongst the workers that such a system would be a great guarantee to their safety; that it would be a most acceptable measure; and my opinion is that it would be favourable and advantageous to the owners and to the lessees of mines, and in no way injurious to their interests.

594. Do you suppose that there might not be cases in which parties would be extremely unwilling to allow any person so authorized to come and inspect what they considered their property, namely, the minerals underground?

I think that they might frequently have objection if the Inspector were in any way connected with the coal trade, but I do not think there would be an objection if he were an independent officer attached to the Government, without any interests in the coal trade; I think this would be a perfect guarantee of his honourable conduct.

595. The Inspector must come from the coal trade, or he would not be competent to his office?

He must be, at all events, well acquainted with the workings of mines, but he need not necessarily be engaged in the coal trade; the persons appointed as Inspectors would naturally be of very high standing.

596. We all know, from your name and reputation, that you are well received wherever you go; but do you think that the different persons whom Government would select as Inspectors would be equally received and welcome?

They must be of acknowledged probity of character, or they would not be so; I think that if the Inspector were a person upon whom the owners or lessees had been accustomed to look as one of themselves, it would be rather difficult to lay open everything to him.

597. Where are these people to be selected from, because a good man has a high salary as a viewer; we sometimes see Inspectors selected by the Government who have not been successful in their calling. With respect to the working plans, have you ever contemplated the case in which many people are, unfortunately, of disputed boundaries, and that they would be very sorry to show their workings to anybody?

Dr. L. Playfair.
 22d June 1849.

I know that there are such cases, and that in those cases there might be objections, but those are exceptional cases, and only small exceptions, which are not of sufficient importance to prevent any general arrangements for the whole of such an immense interest.

598. Are you aware of the arrangements which have been lately made by the Government for the purpose of introducing inspection?

I am aware of the instructions which have been given.

599. Do you think that those instructions will have the effect of obtaining the necessary means of inquiry?

I think for the necessary means of inquiry they will be quite sufficient. So far as my own experience goes, I have found that inquiry is greatly facilitated and aided by the coal-owners.

600. That being the case, what should you say of a system which left it optional to the coal owners to admit such an inspection, but thereby constituting a line of demarcation between those who were willing to accept advice and permit an examination of their workings, and those who were not?

I think it would entirely fail, for this reason, that those who permitted the inspection would just be those whose mines least required it; and that the mines of those who did not would be in the worst condition, and therefore most in need of it.

601. Let me assume this case, that if I had a mine, I should be very glad to see yourself or Mr. Nicholas Wood, or Mr. Anderson, or any other eminent viewer; but a stranger, coming from London, of whom I had never heard before, I should resist, and be very sorry to have him in my mine, looking at the sort of reports which people sometimes make?

I think that, with the knowledge which the Government would have of that feeling upon the part of coal-owners, they would take great care in the selection of their Inspectors, so as to have them of a class to which such objections would not apply.

602. Have you ever heard the subject of such an inspection discussed by coal-owners?

I do not call to recollection just now that I have.

603. You speak, in fact, almost entirely from the great facility which you yourself have always met with in your inquiries?

I do.

604. Though you would allow a compulsory inspection, you do not wish anything else to be compulsory?

I do not wish the Inspectors to have any other compulsory executive power; I ought to state my opinion, that I do not believe that any inspection, or the recommendations of the Inspectors, or any of the compulsory provisions that may be made by an Act of Parliament, will be successful in preventing accidents, unless there is a means at the same time of improving very much the scientific knowledge of those who have charge of the mines; I do not mean the workmen, although I think they also should receive a proper education; but I more particularly refer to those in charge of the mines, because, if they possessed means of acquiring a knowledge of the collateral sciences (which, to the disgrace of this country, cannot at present be acquired, from there being no institution devoted to mining education, although such establishments exist in other lands, where mining is of less value to the community), I believe that this would be of the utmost importance in causing improvements in mining operations, and enabling those in charge of them to understand those conditions necessary for keeping the mines always in a safe state, and even of working them with a greater economy.

605. Have you visited the mines abroad?

I have visited some of the mines abroad, but that was before my attention was specially directed to the subject.

606. Were they in a higher state of working than ours?

Those that I have seen could not be at all contrasted, as they were worked under totally different conditions.

607. On

607. On what part of the Continent?
In the Rhine Provinces.

Dr. L. Playfair.

22d June 1849.

608. As the mines are very extensive here, what number of Inspectors would you consider necessary to visit them once or twice a year?

That I have not paid attention to; but I might mention also, that, from a calculation which we made upon this subject, in giving in our Report to the Government, a small impost upon coal, which could not be felt, would produce a sufficiently large sum, not merely to pay the expenses of inspection, but to give a very much improved state of education to the workmen in various districts, and to facilitate the establishment of colleges for the head viewers, and those having the more responsible charges. An impost of no more than a farthing a ton upon the coal would produce in England upwards of 33,000*l*.

609. Are you aware that many collieries are now working at a loss, and that a great many are being shut up?

I have been so informed.

610. Then an additional tax would not be very welcome?

A tax is never agreeable; but a farthing a ton is so insignificant in comparison with the value of the coal, and of the advantages to be derived from its application, that it would probably not be met with much objection. Such a tax, whether compulsorily enacted, or, what would be better, voluntarily undertaken by the owners for the improvement of their own districts, would be favourable to all parties, by raising the condition of those employed in the mines, and enabling them to work at a greater profit than they do now.

611. You speak of a farthing a ton as a small sum; do you know of any calculations of one-eighth of a farthing a ton made in the coal trade?

No; there are no means of getting at a very accurate knowledge of the quantity of coal worked in this country; but the lowest calculation gives it at about 31,000,000 of tons per annum, and the higher calculations are much greater than that; but, taking it at 32,000,000, the sum produced would be above 33,000*l*.

612. How do you make that calculation; if you are acquainted with the coal pits, you will know that there is a great difference in calculating the quantity of coal; some of them only calculate the quantity of coal sold, and those coals used for furnaces and ordinary purposes, and given to miners, are not calculated. In your 31,000,000 do you take the coal actually sold, because there are some millions burnt in the steam-engines, and used in other ways upon the spot?

The 31,000,000 is what has been considered the most careful estimate, that of Mr. M'Culloch.

613. Of coal sold?

I will read to the Committee the items. Mr. M'Culloch's estimate was made some years ago, and therefore the amount must have increased. In 1839, Mr. M'Culloch published the following estimate of the total produce in Great Britain: domestic consumption and small manufactures, 18,000,000 tons; employed in iron-making and greater manufactures, railways, steam-boats, &c., 10,575,000; exports to Ireland, 1,000,000; exports to colonies and foreign parts, 1,449,417; making an aggregate of 31,024,417 tons.

614. That does not include the waste?

No.

615. Have you heard or made any calculation of the profits upon the whole coal trade of England this year?

I have not.

616. Have you visited the coal-mines in Ireland?

No.

The Witness is directed to withdraw.

Ordered, That this Committee be adjourned to Monday next,
One o'clock.

Die Lunæ, 25^o Junii 1849.

The LORD WHARNCLIFFE in the Chair.

Evidence on the
Prevention of
Accidents in
Coal Mines.

SEYMOUR TREMENHEERE, Esquire, is called in, and further examined
as follows :

*S. Tremeneere,
Esq.*

25th June 1849.

617. WITH regard to the Inspectors of Mines abroad, are they solely Inspectors as to health, or is this combined with their other duties ?

It is very much combined with their other duties.

618. Then, in fact, it is no more than an Inspector whom I send to a leasehold of mine ?

Your Lordship may request your Inspector to combine both duties, and in your Lordship's mines such inspection may be effectual ; but it is not so in many other coal districts, otherwise we should not hear of so many fatal accidents yearly.

619. Are there officers solely and entirely appointed with salaries to guard against accidents in the mines on the Continent ?

Certainly not solely and entirely for that purpose, but for that and many other purposes. I think, if your Lordship will do me the favour of referring to my Report on France and Belgium, and also on Germany, you will see that I have described precisely the range of their duties.

The Witness is directed to withdraw.

Professor DAVID THOMAS ANSTED, M.A., F.R.S., is called in,
and examined as follows :

*Professor
D. T. Ansted,
M. A., F. R. S.*

620. YOU are Professor of Geology in King's College, London ?
I am.

621. Some few years ago you had an opportunity of bestowing a good deal of attention upon the system of working coal-mines in the North of England ?

Yes.

622. Will you inform the Committee to what district your attention was more particularly directed at that time ?

At that time it was directed entirely to the collieries in the neighbourhood of Newcastle.

623. That was in the year 1845, was it not ?
It was.

624. Newcastle and Durham ?
Newcastle and Durham.

625. In 1846, did you present to the British Association for the advancement of Science, a paper containing the results of your experience at that time on the subject of the working and ventilation of coal-mines in the North of England ?

It was in the middle of the same year 1845 that I made this communication.

626. Since that period, have you devoted any additional attention to the subject ?

Yes, I have been down a good many pits in various parts of the country, and whenever I have had an opportunity, I have visited pits in the Yorkshire Coal
(164. s.) K Field,

*Professor
D. T. Ansted,
M. A., F. R. S.*

25th June 1849.

Field, in the neighbourhood of Nottingham, in some parts of Leicestershire, and in the neighbourhood of Birmingham.

627. And Staffordshire?

And Staffordshire; I have visited collieries in the thick coal there, and also other collieries in the Potteries, and likewise in Flintshire.

628. You have also visited some coal-mines in Belgium?

Yes, and in other parts of Germany, some in the East of Germany; not working the ordinary pit-coal, but beds of lignite; this was in Styria.

629. Have you, in consequence of subsequent investigations, been led to alter the views which you explained when you presented your paper to the British Association?

No; I have seen nothing to induce me to alter any of the opinions which I then expressed.

630. In the course of your inquiries upon the subject in the North of England, to which you have alluded, did you descend a considerable number of the mines in that district?

Yes; I descended a considerable number; I do not know how many; but every day that I was disengaged, I devoted to a coal-mine.

631. Will you state, in the first place, generally, what view your examination induced you to take of the general character of the management of the mines in that district?

My opinion as to the management of the mines that I saw, which were most of them the larger mines, was, that they were as carefully and well managed generally as work of that kind could be. I have been in the habit of seeing mines of other kinds on various scales, and I consider the coal-mines in question to be in very good condition.

632. All coal-mines?

I am speaking now of the coal-mines in the neighbourhood of Newcastle-upon-Tyne; I considered the general management to be good, as far as I was capable of judging.

633. Have you examined any mines where there had been recent accidents?

Yes, I examined two mines; one of them was the Haswell, soon after the great accident at Haswell; and the other was the Killingworth; there had been an accident at Killingworth, by which ten people were killed, during the time I was in the district; and I went down the mine a few days afterwards, almost as soon as anybody could go down with safety.

634. Were both those accidents caused by explosion of the fire-damp?

Both of them.

635. Did you satisfy yourself at that time as to the cause of those accidents?

In the case of the Haswell pit, it was some time after the accident that I visited it, and, although it was quite clear what the general cause of the accident had been, it was too late for any inquiry as to the particular cause; there was no doubt that it was an explosion from a very large quantity of gas; but the Killingworth was an explosion from a smaller quantity of gas given off very quickly. I saw the cause of that very distinctly; it was what is called a "blower" in the North of England, which had come off in a fault some time after the fault had been pricked; it was, I think, more than a fortnight or three weeks after the fault had been found and worked at, that the blower came off; it came off very sharply, between two sets of work; that is, between the time that one set of men were coming out of the mine and another set going in; and a little boy being allowed to proceed before the men with a naked light, the men having a Davy, the accident took place; it was entirely from the carelessness of that boy; he was found in front, and the rest of the people were behind.

636. In order to explain the term which you have used, a "blower" means an opening made into some reservoir of gas, does it not?

A "blower" means a puff of gas, generally coming from a crack or fault, almost invariably producing a communication between two seams of coal.

637. Those

637. Those often occur without any warning?

In this case it occurred without any warning at all; the crack had been seen for some time; it was well known that there was a fault, though of a few inches only, and there was a distinct crevice seen, but no gas came from it until the time of the accident, and nobody could at all understand the immediate cause; when the gas had once begun, it continued to blow for a long time, and when I was in the mine afterwards, it was still blowing, so that I could feel the puff of gas when I put my hand to the crack.

638. There was no peculiarity in the atmosphere indicated by the barometer?

No; there was nothing to account for it at all; there certainly was nothing to account for it beyond a very slight change, which did not attract any notice; there was no storm at the time.

639. How long before you visited the mine had this accident occurred?

This accident happened on the 3d of April, and my visit was on the 16th; the mine had been cleared by that time.

640. In the course of your inquiries at that time, you paid a good deal of attention to the method of working the seams?

Yes.

641. Did you see, in those cases at Haswell and Killingworth, anything that appeared to you very defective in the method by which the workings were conducted?

There was one point which struck me as being, to a certain extent, defective, and it is one that I have mentioned in the account which I read at the meeting of the British Association; it is that in the case of the Haswell accident, there was too much communication between the different panels, or different places where the work is conducted. The works of a mine are conducted in several distinct compartments; each compartment is called a panel; and if those had been completely separated, a very considerable number of the men who were not in the panel in which the accident happened would have been able to get to the surface.

642. But the explosion would have been more violent if it had been more confined, would it not?

No, there is no reason to suppose that there would have been much difference in that respect. There was a certain quantity of gas to explode, and a certain quantity of mischief would have been done by it, but the effect would have been seen rather in the falling of the roof than in anything else.

643. In that case you would have had separate workings, entirely shut off from each other, and a separate ventilation for each?

There is that to a certain extent in every large mine, and it was so, partially, in the Haswell mine; but there was communication between the two panels in several cases.

644. Without doors, or anything to shut them off?

Doors make no difference at all in the case of an accident; I have seen a stopping 36 feet thick blown through.

645. It would be an entirely new working?

It would in that case be a distinct working.

646. There would be another kind of working?

The two parts of the mine or panels would be separated by a very considerable thickness of coal; they leave 60 or 100 yards of coal in those cases.

647. You did not visit that colliery before the accident?

No; my attention was directed to the subject of panels from seeing the workings at that time, and it struck me then as being very evident.

648. Were the partitions or brattices, as they are called, restored at the time when you went there?

Yes.

649. Had the greater number of them been blown out?

Every one, without exception; the whole place is generally cleared by an explosion, even if it is a moderate one.

*Professor
D. T. Ansted,
M. A., F. R. S.*

25th June 1849.

650. As the result of your observation at that time, not only in these cases of accident, but generally in the method of working mines, what is your view as to the possibility of diminishing the frequency of such accidents?

It seemed to me at that time, that if the mines were placed generally under distinct management, and the management was looked after by responsible persons, many of the minor causes of accident would be avoided. In the case of the Haswell mine, I think it is very possible that no inspection would have prevented the accident; and indeed I should not be at all inclined to speak to any probable cause that might have prevented that accident. But though the large and important collieries are well looked after, I fear that many of the smaller ones are in a much worse state, and greatly require attention.

651. Much more than the larger ones?

Yes.

652. You are of opinion that no arrangement could have the effect of entirely securing the workpeople against accidents?

I do not think it possible, so long as coal is to be worked in deep workings, and with anything like economy, that accidents can be prevented. I do think, however, that they might be diminished very much, and that the number of persons who are killed by these accidents might be diminished a good deal.

653. The principal arrangement by which you would hope to diminish their frequency would be by establishing a better superintendence?

I think a little supervision by a public officer is needed, as well as the ordinary superintendence of the viewer.

654. How is the superintendence left, generally speaking, in those large mines?

Entirely to the head viewer and an assistant, or under-viewer; the viewer generally has several mines, and of course a great part of his duty devolves upon his subordinate officer, whoever he may be; under him there are also other men. There are generally a great many persons to look after a mine in the Newcastle district; thus it is the duty of one man to go through the mine every day, before the workmen go into it; he requires to be a man well informed, and tolerably well educated, which he seldom is.

655. It is upon that class of persons that the safety of the mine depends?

To a very great extent.

656. Had you frequent communication with those parties?

Yes; I had an opportunity of speaking to several of them; in fact, I went through the mines generally with people of that kind, although accompanied by a viewer.

657. From your communication with them, should you say that they were competent to the discharge of those responsible duties?

They are generally men who have risen from the ranks; their first employment under ground has been during early boyhood, when they served as trappers (boys employed in shutting and opening doors), and from this they have gradually risen, according to merit; I think that has been generally the history of them.

658. Had you any means of judging what the amount of their education was?

Very little, generally; there is education amongst some of them; but education is certainly not quite so good amongst the colliers as it might be; it is rather deficient.

659. Supposing unexpected circumstances then to occur, involving any difficulty, do you think that those men are competent to take the proper precautions that might be required?

They are competent to a certain extent, but from want of education they are not able so well to judge of what would be the result of unexpected circumstances; so far as the ordinary work of the mine is concerned, I believe they do very well; but no doubt if they were better educated, and taught to think, as well as to do their work, the management would be better when difficulty or danger arose.

660. Are you talking of the viewer or of the overman?

Not of the viewers; the viewers, generally speaking, indeed always, are men of

of education ; they are generally educated very thoroughly for their work, I believe, and lately much more so ; some of them have passed through the colleges in different parts of the country ; in London I have had the sons of viewers at King's College in my own class.

*Professor
D. T. Ansted,
M. A., F. R. S.*

25th June 1849.

661. Many of them are men of high attainments ?

Many of them are exceedingly well informed ; in fact, all the superior viewers, that I have met with, are so.

662. Your observations were confined to the subordinate overlookers, whose duty it is to examine the mines before the workmen enter ?

Yes ; the wastemen and the overmen.

663. Did it occur to you at the time when you were making those observations, that there were any obvious improvements which might be introduced in the existing ventilation of those mines ?

Not exactly ; still, I may observe, that there is one thing which is required to be known with regard to ventilation. I believe there is no distinct knowledge of the extent to which air may be split in a mine. The splitting of the air is a technical name for dividing the current of air, by which means the air that is made to pass down one shaft, and is conveyed along the main workings for a little way, is, part of it, allowed to go along the rest of that line of road, while another part is made to branch off to the right or left, as the case may require. Generally, I believe the viewers are not aware of the extent to which the air may be split. There is no doubt that you may multiply the quantity of air put down the shaft many times, probably not less than three or four times, by splitting under certain circumstances. It is well known that, if air is carried too far, there is great friction ; and splitting the air, although one of the most important parts of ventilation, is one upon which, perhaps, there have been fewest experiments.

664. What is the great object of splitting ?

To multiply the quantity of air put down the shaft.

665. To diffuse it more over the mine, is it not ?

Yes. Perhaps your Lordships will allow me to refer to a note of an experiment which I made upon the subject of splitting the air in one mine. I went into one of the pits that was rather newly started, in which the workings were not very far advanced ; it is one of the mines of which Mr. Wood is viewer ; I went with him, and the notes that I made at the time are these : " In this working, the air at the bottom of the shaft is at once split into three currents, the principal one going into the north district." This is a tracing from the working plan of the mine—[*producing the same*].

*Vide Appendix I.
Plan, No. IV.*

666. What mine is this ?

The Tyne Main ; one on the south side of the Tyne, near Newcastle. " On measuring the air in the usual way, it appeared that 20,000 cubic feet per minute passed along the roley-way into the workings."

667. How was that ascertained ?

By firing a small quantity of gunpowder, and measuring the rate at which the smoke travelled ; that is the usual way.

668. A rough experiment ?

A rough experiment, but enough for practical purposes ; and then, of course, measuring the area of the way. " It appeared that 20,000 cubic feet per minute passed along the roley-way into the workings, moving at the rate of about $4\frac{1}{2}$ miles per hour. In order to see the full effect of splitting the air, we then opened a communication at once to the furnace, by which the air was enabled to travel directly to the upcast shaft. It then appeared that, while the quantity passing along the roley-way was reduced only one-fifth from 20,000 to 16,000, as much as 20,000 feet were passed into the furnace-drift, so that the effect of splitting had been to introduce 16,000 feet of air per minute, in addition to that which before passed into the workings."

669. What do you call the roley-way ?

The roley-way is the main line of road through the mine. There were thus 16,000 feet in addition ; since only 20,000 feet had passed into the mine
(164. s.) before ;

*Professor
D. T. Ansted,
M. A., F. R. S.*

25th June 1849.

before; and now 16,000 feet additional passed into the mine by splitting the air close to the bottom of the shaft.

670. Those were ascertained by the same process ?

Yes ; so that the effect of splitting had been to produce 16,000 cubic feet of air per minute, in addition to that which had been before passed into the workings.

671. Supposing the means of observation were sufficiently correct, the difference would be 16,000 feet ?

Yes ; that was by one split.

672. Do you think that that means of estimating the quantity is sufficiently accurate to enable you to tell that that was really the difference ?

There may have been a variation of 1,000 feet or 2,000, but it could not be much more than that ; there is no way that the air could pass excepting by the way we measured it ; what we observed was probably a minimum result, at any rate.

673. When you had the furnace in action here, and carried the air from the downcast shaft straight to the furnace, what was the moving power in the other case ?

It was also the action of the furnace through the mine.

674. It was a double action, a direct and an indirect ?

Yes.

675. The action of the furnace was the same in both cases, both before and after ?

Yes ; there was still sufficient draught from the furnace to carry up this large extra quantity of air.

676. To what would you attribute that ; would it be that the 20,000 feet being subject to scarcely any friction, being close to the furnace, it would be taken much more readily ?

Yes ; but I think it is quite clear that the draught of the furnace was sufficient to carry up much more air than went to the workings.

677. Then if the draught of the furnace was so powerful, would it not have naturally increased the amount of the current in the first instance ?

Of course ; but there is the friction to be taken into account ; there is a very large friction.

678. If the whole of the current is taken through the passages of the mine, the friction will considerably decrease the amount of it ?

Yes ; the great object of splitting is to avoid the friction of air in the passages ; under the old system the air would be permitted to travel 50 or 60 miles in a large mine ; now you cut it into panels, and perhaps no one current will travel more than two or three miles.

679. Is not the friction a very important element in the question ?

Very important ; and it is important in two ways, because if you carry too much air through all the workings, you do no good ; you make the workings very unmanageable ; it is very inconvenient to have a strong current of air in the principal workings, and may even be injurious.

680. Can you say what amount of current would be practically inconvenient to the working of a mine ?

I think a current of eight miles an hour is very decidedly inconvenient ; four miles an hour is more than is pleasant to meet with ; if you make use of a candle, it blows the flame of the candle too much, and melts the tallow.

681. Do you suppose that these workings, as you saw them, would have been sufficiently ventilated by a current of four miles an hour ?

The current of four miles an hour is in the main passages, but it is quite impossible to keep that up through the workings ; however you manage, the current must be more considerable at its first going in than at its coming out.

682. Then,

682. Then, in point of fact, you are not aware that there are any general suggestions to be made for the improvement of the system of ventilation?

Except that it is very desirable to know how far the air can be split, and under what circumstances the splitting of it may be most effectually and most favourably managed, and that I think is not sufficiently known; I think that, generally speaking, the viewers do not pay sufficient attention to the splitting of the air where it is required; generally they find that they can get air enough to be pleasant by a moderate amount of splitting, and they do not trouble themselves about it beyond that.

683. Do you think that, generally speaking, it is necessary to obtain greater power for the purpose of ventilation than is obtained by the furnace?

For the ordinary working of the mine under ordinary circumstances, I do not think it is.

684. You think that the furnace might be made sufficient?

Certainly; the furnace is quite sufficient for ordinary purposes.

685. Have you observed that the ventilation by the furnace is generally well managed; that the furnace is properly used, and that its full power is obtained?

Yes, in new pits there is a good deal of attention paid to that; it requires to be well set, and that may be rather an expensive thing to manage properly; but when it is once placed, and there is a good communication with the mine, and there are not too many angles about it, I believe that it generally serves very well indeed.

686. Have you ever seen any other system of the kind in operation?

No, I have not seen any other system of ventilation; I have seen the system of no ventilation very frequently.

687. The system of no ventilation, is merely allowing the ordinary defect of the warmth of the mine to operate?

Yes, in some way or other there is always a current of air; but it is constantly changing direction in mines where there is no artificial ventilation.

688. Is there any observation made by the barometer?

No, there is no barometer in the pit. There may be a barometer kept in the engine-house, and there are some observations by the barometer there; I had a series of observations from Mr. Thomas Taylor, which he had kept carefully; they are now published in the Mining Almanack of this year.

689. Do you consider the observation by the barometer an essential point in the management of mines?

The result of the observations made during a great many accidents, and after a great many accidents, was, that there was no change by which you could at all account for the accident; sometimes the barometer would rise, and sometimes it would fall, within a few minutes of the time of the accident.

690. Did you never know a barometer kept in the pit?

No; but there may be in some mines.

691. These observations were made in the engine-house?

The observations that Mr. Taylor made, I think, were made in the engine-house, or close by.

692. Were not you led to conclude that the escape of gas was greater at the time when the barometer was low?

There is no doubt it makes a difference, particularly in those mines where there is a large goaf in which there is much foul air; there it makes a manifest difference; one could tell that by the way in which the viewers have spoken of it; they have said, "There is not much gas to-day; it is a fine day."

693. In a cold atmosphere are the mines less susceptible of explosion?

I do not think the temperature has much to do with it; I do not think that in any of the observations the height of the thermometer has been observed, but accidents have happened in all parts of the year.

*Professor
D. T. Ansted,
M. A., F. R. S.*

25th June 1849.

694. Have you ever considered the question as to whether it would be desirable that Government should attempt to establish anything like an inspection of coal-mines?

I thought at the time when I examined the Newcastle mine, and I expressed it in the paper read at the meeting of the Association, that some superintendence would be very useful, and was absolutely necessary in many cases in those mines.

695. What is your view as to the nature and the limits of that superintendence?

It seemed to me that, beyond seeing that the well-known rules of ventilation were properly carried out, and the best methods of ventilation known in the district adopted, which would no doubt be suggested by an intelligent viewer, beyond justice being done to the viewer, in fact, there could be very little effected. I consider, in short, that a general superintendence of the method proposed by the viewer, supposing him to know his work, and the insisting, if necessary, that his suggestions were carried out properly, would be all that could be done; I think that any general rule with regard to the working of mines is totally out of the question; I am quite satisfied that nothing could be done in that way.

696. Even in the same district?

Even in the same district; each mine must depend upon its own circumstances; every difference requires a particular management.

697. And the use of an Inspector would be to see that the viewers' plans were carried out?

To see that the general principles of ventilation were properly carried out, and, perhaps, to suggest improvements from time to time; this might be useful, because since viewers cannot generally go from one district to another, they do not hear and do not know what is done; some of them, no doubt, know better than anybody else; but it is only the large mines that can afford to have a good viewer; some of the smaller mines are without that kind of superintendence, and they want it much more than the larger ones.

698. At the time when you had communication with the coal-owners in the North, do you think that there would have been any disposition to receive favourably such a proposal?

I believe most of the principal viewers at that time would have received it, and would now; and I believe that they would not object to anything like a reasonable superintendence; they would, however, certainly object to anything like control; anything like an order from an Inspector.

699. Would it be your view, also, that there should not be any authoritative power given to the Commissioners?

I think it very desirable that at first, at any rate, there should be nothing like compulsory power to insist upon any method; in fact, it would be throwing the responsibility of working the mine upon the Inspector, which would be very unreasonable.

700. If the Government have thought fit to commission any well-qualified persons to make inquiries in these districts, and to communicate with the coal-owners, giving them advice and making suggestions, do you think that that is a useful course?

I think it an exceedingly useful course.

701. How far would it be useful or necessary for the Inspector to see the plans of the mine?

Absolutely necessary, and absolutely necessary for him to go down.

702. How would the Inspector see them if it were not compulsory?

I presume that it must be compulsory so far; a compulsory visit at any rate, but not a compulsory measure consequent upon the visit.

703. That is to say, if that power of inspection were not given in a compulsory form, the Inspector must confine his operations entirely to those mines where he was admitted voluntarily?

Yes; no doubt in the course of time this would settle the question, because mines that refused inspection would generally be supposed to be in a bad state; however,

however, as there are generally more workmen than there is work to do, there is no difficulty in getting men who would go on with the works even in the case of mines known to be managed without proper superintendence.

*Professor
D. T. Ansted,
M. A., F. R. S.*

25th June 1849.

704. If the viewer and the Inspector differed, how would it be settled?

I can only suppose that the Inspector would report upon the subject, and then if, after a difference of that kind, an accident happened in the mine, of course the viewer, acting upon his own opinion, and not acting upon any suggestion that might have been made, would be considered culpable.

705. At any rate he would have to justify the opinion which he had given?
Certainly.

706. And the inquiry of a coroner's inquest would at all times be a considerable check?

It would so, no doubt.

707. You have also, as you have told us, examined coal-mines in other districts; you have been to Yorkshire and other districts?

Yes.

708. Have you found a great difference in the system of working in those mines?

The difference in Yorkshire is total; it is quite a different system; the difference consists in not obtaining the coal by a system of galleries at right angles to each other, leaving large pillars for a time, as they do in the North of England, but removing what is called a side of the coal at once.

709. Which should you say, upon general principles, would be the most secure mode of working a colliery with a view to the case of accidents?

I think that in the Newcastle Coal Field (indeed I know it) the long wall method is quite out of the question in most of the mines, since the state of the roof would not admit of it; the long wall method is the best, as far as economy is concerned, where it is available; it might be introduced into some of the Newcastle mines, but not, probably, into many of them; it is much more dangerous, as far as the chances of accident are concerned, when there is much gas.

710. Were there many accidents, during the time that you were acquainted with the mines in the North, from the falling of the roof?

No serious accidents during the time that I was in the district; accidents of that kind do not happen very frequently; they happen from time to time, and are numerous because the whole number of collieries is large; but I know that they are not nearly so numerous in the North of England as they are in the thick coal of Dudley, and those parts; there the accidents from the fall of coal are very serious.

711. Do you think that there are any general regulations which might be adopted for diminishing that class of accidents?

It is very difficult to say; the workings in the Dudley Coal Field are not generally considered to be very perfect, I think; at the same time that it requires a much more practical knowledge of that district than I possess to suggest any improved method.

712. With respect to the ventilation in those other districts, should you say that the ventilation there is as well managed as it is in the Northern districts, generally speaking?

No, I do not think it is; as far as I am acquainted with collieries, I should say that the best ventilation is in the well-managed mines in the North of England, in the Newcastle district.

713. Are the collieries in those other districts, generally, upon a smaller scale than those in the North of England?

Almost always.

714. You told us before that you considered that the largest collieries were generally the best managed?

(164. 3.)

L

I think

*Professor
D. T. Ansted,
M. A., F. R. S.*

25th June 1849.

I think this is the case generally, but there are exceptions; one of the best-managed collieries, in some respects, that I have seen is at Nottingham; it was not a very large one, although one of the larger collieries there.

715. What are the most general defects of the ventilation in those collieries in the Midland districts?

Generally the total neglect of everything like looking after ventilation; there is no principle, generally, of ventilation in the more carelessly managed of them. That is not the case, however, in Yorkshire, where they have their own methods of ventilation; and in some of the Staffordshire mines they have also peculiar systems; providing a separate little channel for the air; that is the case in some of Mr. Gibbons's pits, but generally it is not so.

716. Do they make use of the furnace?

Yes.

717. Wherever there is any ventilation they use that mode?

Yes.

718. Can you say whether the accidents in the Staffordshire district are as frequent as those in the North?

Not from explosions; accidents from that cause are very rare indeed.

719. The coal is not so fiery?

The coal is not so fiery; I do not think the coal sings in the Staffordshire district at all; the thick coal certainly not.

720. And the spaces in the Staffordshire collieries are very different?

The coal is enormously thick there.

721. Therefore a system of ventilation, though desirable in other respects, is not so essential in the Staffordshire districts as in the North?

No.

722. The principal coal in Staffordshire is 30 feet thick?

Yes, the thick coal; the 10 yard seam.

723. Should you say, from what you have seen of collieries, that they are generally provided with two shafts?

There are very few exceptions among well-regulated collieries, I think; there are some exceptions, but they are few.

724. In all the collieries in the North?

In all those that I saw, there were two; I think Jarrow has only one, but I am not quite certain of it.

725. Do you consider that a very essential point in the ventilation of a colliery?

I do; absolutely essential, because when an explosion happens, if it reaches to the pit bottom, it must blow away the separation between the two shafts, and then of course every thing is gone.

726. It destroys ventilation altogether?

Entirely; and the difficulty of getting ventilation into a mine again after that is very great, and there is great additional danger.

727. Is not the making of two shafts such an expense that many collieries could not afford it?

I believe not; I believe there is no instance in which two shafts might not be made with advantage to the workings as well as to the safety of the mine.

728. Is it not a very great cost?

In a few cases the shaft is an enormous expense, but even then it is usual to sink two shafts together. One of the most expensive shafts ever sunk is at Monkwearmouth; there are there a pair of shafts 300 fathoms deep.

729. Would not it require a very large expectation of coal to justify that expense?

It generally happens that those deep collieries are in very large royalties, and, of course, in a very large royalty there is a great result to be obtained, and a large expense can be properly incurred; nobody would think of sinking a shaft
of

of 200 or 300 fathoms in the small royalties commonly taken in the Midland counties.

730. Have you paid much attention to the mode of lighting mines?

Yes; considerable attention.

731. Are you satisfied of the security of the Davy lamp?

I am; I have been myself with a common Davy lamp in atmospheres of every possible degree of explosibility. I have been in an air in which no Davy lamp would remain alight, and in which no flame would live at all; and I have been in atmospheres of every degree of impurity, from that to the open air.

732. You are led, therefore, to conclude, that if properly managed, it is a secure instrument?

I think it is clear from this, that every viewer and every deputy-viewer and overman, every person whose duty it is to go into the worst parts of the mine in the Newcastle coal-field, uses the Davy lamp, and has used it ever since it was invented, and I believe that there has been no instance of an accident when a viewer has been using his Davy. The wasteman, who is the man whose business it is to go into the worst parts of the mine, invariably uses the Davy, and bad accidents never originate with a wasteman; the accidents have all happened in the other parts of the mine.

733. From the result of your inquiry and communication with the persons responsible for the state of the mines, have you come to the conclusion, that in most cases the accidents were caused by the use of some naked light, or by the opening of the lamp?

There is no doubt that in one or two cases, and I believe in the Haswell case, there has been a fall of coal which broke the Davy, and thus produced the accident; and I believe on one occasion there was found a Davy uninjured when an accident had occurred; but I do not think there is any good evidence to prove that there was a passage of the flame of the Davy through the gauze setting fire to the gas outside. I have been in a great many currents of bad air, and seen the Davy used carelessly, and waved about, but I never saw the flame at all in such a state that it could communicate with the outside by passing through the gauze; it can be done, I am aware, with a jet of gas in a laboratory.

734. And by a violent wind?

Yes, I believe you can do it so; I have seen it done, too, by waving the Davy violently through foul air; you can sometimes in that way induce a point of flame to pass through the mesh.

735. With a wind rapidly passing?

Certainly in such a case I should consider it hardly safe, but where it is at all properly managed, you can be sure of it. To avoid any effect of the current of air upon it, there has been a short shield introduced, which serves to reflect the light, and to prevent a current of air from passing through the lamp.

736. Have you ever seen the foul air pass into the lamp and burn?

Yes, that is quite safe.

737. Supposing a current of air passing through the Davy lamp, do you think that there would be no danger?

I believe the only danger is when the flame of the lamp is passed through the gauze by strong pressure, and even then it must be the flame of the lamp itself; the mere flame from an explosion within the lamp lasts too short a time to do any harm.

738. You, yourself, would have no hesitation in relying upon the Davy lamp?

Not the least.

739. Was it not known from the time of Sir Humphrey Davy that it was, under certain conditions, liable to danger?

Yes; Sir Humphrey Davy mentioned, in his little book on the Davy lamp, in what way it ought to be used.

740. Under those conditions you would think it dangerous to expose yourself even with the Davy lamp?

(164. s.)

L 2

I should

*Professor
D. T. Ansted,
M. A., F. R. S.*

25th June 1849.

Professor
 W. T. Ansted,
 L. A., F. R. S.
 15th June 1849.

I should not, of course, play tricks with the Davy lamp in a bad atmosphere; these are things that one would do in a laboratory, where there is no danger of any serious explosion; but in anything like a foul atmosphere, one is careful of it; and in placing the Davy lamp into the upper part of the roof to see the state of the air, one would move the lamp quietly.

741. Supposing a very strong current obtained in the passage of the mine for the purpose of ventilation, would not that cause circumstances which would produce danger in the use of the Davy lamp?

No doubt a current of air would do so, supposing it to be strong enough to pass through the waste of the mine with great strength. I never myself saw anything like a considerable current of air in the waste; in the bad part of the mine the air is generally very slow, not more, perhaps, than a mile in an hour.

742. Do you think, under general circumstances, that that is sufficient to keep the mine clear?

It keeps the waste sufficiently clear for all practical purposes; I have been through all the worst part of the waste of a large mine without meeting any foul air; you can always tell whether the foul air is present by the appearance of the Davy; it alters in colour a little, and the flame lengthens.

743. You say that, so far as you are aware, explosions will not take place more in warm weather than in cold weather?

I am not aware that there is any difference.

744. Do you mean to say that you have ascertained, practically, that they do not, or that you are not aware?

I am perfectly aware of this, that accidents have happened in all states of the weather, and that there have been bad accidents in all temperatures. One of the great accidents has been in July and another in December; the great Haswell accident was in November.

745. Are you aware of any observations with respect to the state of the wind at the time of the accident?

Yes, in the same paper that I had from Mr. Taylor, he mentions the condition of the wind.

746. Accidents take place in different winds?
 In all kinds of winds.

747. Is that as to the current of the wind, whether the wind blows a fresh gale or hard?

No, I do not think that that was mentioned; it was merely as to the direction. I cannot speak quite positively to that, but the observations are on record; I had them published myself in the Mining Journal, in order that they might be referred to; and they have since been copied into the Mining Almanack of this year.

748. What would be the state of the explosion in a mine if the air was going at eight miles an hour in one of the recesses or galleries?

The faster the rate of the current, the more rapidly the blower is mixed with a sufficient quantity of air to render it explosive; it is not explosive until it is diluted; and it must have a certain proportion of atmospheric air to make it explosive.

749. If there is beyond a certain quantity of atmospheric air, it will not explode?

No, if there is more than 12 or 14 times the quantity of air, it is not explosive; therefore, if it could be at once mixed with that large quantity, it would be perfectly safe; but when a current of air comes upon the blower, and mixes with it, it must exist in all degrees of explosibility between that point and the point where it is perfectly secure; and the more air that passes through the mine, the more rapid the current is, the further will be the progress of a dangerous mixture.

750. Do you consider it as quite ascertained what is the lowest amount of inflammable air mixed with atmospheric air which causes explosion?

I think that it is quite established, that 14 times is perfectly safe.

751. Fourteen times the quantity of atmospheric air that there is of inflammable air ?

Yes.

752. What is the least quantity to make it explosive ?

I think it is five times, between five times, or four times it may be, and 14.

753. No current of air through a mine would entirely put an end to explosion ?

I believe not.

754. When you say four times, do you mean four times the weight ?

No, four times the volume.

755. Supposing that in any mine a very efficient current of air is established, and carried by the best system through the workings, so as to diffuse it properly, do you think that, under those circumstances, what is called a fiery mine may be made pretty secure from accidents ?

It may be made perfectly safe for all ordinary circumstances, but it cannot be made safe against the accident of a blower ; nothing, I believe, can secure a mine from that, because a puff of gas may at any time, and at a moment's notice, occur when communication is opened by a crack or fault with another seam of coal.

756. Nothing can save it ?

Nothing can, I believe, prevent it from being highly dangerous.

757. Do you think that such a precaution would prevent the possibility of an escape of gas from the wastes ?

I think it does that ; it may do that to a very great extent, and might do it perfectly, because the quantity of air should always be calculated with reference to the extent of the waste, and the extent of the goaf.

758. But there must be always some danger, in your opinion, from the occurrence of blowers ?

Yes.

759. No precaution of ventilation could counteract that, so far as you know ?

No ; and I believe that the greater the quantity of air passed into the mine, the more the danger is in case of a blower.

760. From what cause ?

From its mixing so much more quickly, and coming so unexpectedly to a distant part of the mine.

761. You do not think it possible, then, to make the current so strong as to overcome anything of that sort ?

I am quite sure not ; it is not within the limits of possibility ; when a blower is very large, nothing can prevent it from being dangerous within a certain distance of the blower.

762. And have you seen blowers discharging as much as that ?

Yes.

763. Can you state what is the largest amount of inflammable gas that you have ever found issuing from a blower ?

It is not easy to estimate anything of that kind ; one is quite in the dark, and does not stay much longer than is necessary.

764. No conceivable velocity of current would be sufficient to dispel and destroy the danger of any such escape of gas ?

No ; it is well known what quantity of gas is given off from a certain area of coal under some circumstances ; evidence was given upon that point by Mr. Buddle before the Committee of the House of Commons " on Accidents in Mines " in 1835, and it is quite enough to refer to one case ; that is the case of the Bensham seam, which is certainly the most fiery seam which is known in any part of the district now.

765. From faults ?

No ; it is one particular seam of coal, and it gives off more gas than any other seam, and the Wallsend pit gives off more gas than any other pit, I believe.

(164. s.)

L 3

766. But

*Professor
D. T. Ansted,
M. A., F. R. S.*

25th June 1849.

Professor
D. T. Ansted,
M. A., F. R. S.
 25th June 1849.

766. But there is not the danger of faults in the Bensham seam?

If it should so happen that a lower seam communicates with that seam by a fault, which is the case sometimes, a very large quantity of gas would probably come off by that fault, and when it was pricked, there would be a very heavy blower.

767. Do you know the fact that it does happen that more than 1,000 feet of gas per minute, at least, is discharged by blowers?

I am unable to state positively the quantity of gas issuing in any case from a single blower.

768. Do you know whether, in the case of mines passing under towns, additional precautions are taken in the way of props?

Yes; that is quite certain to be the case, because any damage done by a mine must be repaid by the mine-owner; in the case of Newcastle, for instance, some of the workings are under the town, and when a crack appears, the mine-owner is called upon to replace the building, so that they are very careful; they generally leave a very large quantity of coal under a town.

769. Then, in point of fact, you do not think that inspection is requisite for that purpose?

No; I think that the interests of the mine-owner are quite enough to make him take care of that in the neighbourhood of towns.

The Witness is directed to withdraw.

N. Arnott, Esq.,
M. D.

NEIL ARNOTT, Esquire, M. D., is called in, and examined as follows:

770. YOU belong to the medical profession?

I do.

771. And you have for a long time devoted your attention to the subject of ventilation in all its forms?

Yes, as a matter of the greatest importance in relation to health and disease.

772. Among other forms of ventilation, you have considered the method in which it should be most effectually applied to the working of mines?

I have.

773. But not having had any personal experience or opportunities of observing the working?

I have never descended into a mine.

774. According to your information upon the subject, what should you say it is that is most deficient in the system of ventilation in mines?

I think up to this time the system of ventilation, not only in mines, but in almost all other cases, has been defective, chiefly because the quantities of air injected or extracted have not been determined and regulated by accurate measure. The whole question of ventilation is in reality a question of comparative quantities or measures, for the object is to ensure that in any place there shall always be present that known proportion of atmospheric air which renders harmless any other gas or aerial matter, such as the breath of men or coal-gas, which, when accumulating beyond certain known proportions, become deleterious or dangerous. Thus it is known that if coal-gas accumulate so as to be a fifteenth part of the air in a place, it renders the whole mass of air inflammable or slightly explosive, as discovered on the approach of a lighted candle; and if before the approach of the candle the proportion of gas be as one to ten of common air, the explosion is as terrible as that of gunpowder. So, again, if human breath accumulate in a place so as to be about one in fifteen of the air present, it begins to be hurtful to persons breathing it again, as shown in the pale countenances and impaired health of those who are much in the house and usually breathe confined air; and if the proportion of breath to air increase much more, the persons die at once of suffocation, as happened lately to 73 persons in a passage-boat in the Irish Channel. But in all such cases it is possible, by maintaining in the place always the due known proportion of atmospheric air, to render the other admixture, even if it be the poisoned breath of

of a patient labouring under infectious fever, perfectly harmless or inert. The means hitherto employed to move air in ventilation have not been such as also either correctly to measure the quantity, or to ensure the passage of the right quantity. For a great chimney-shaft may have fire burning in it uniformly, a fan-wheel may be turning at the same rate, or a steam-jet may be playing as usual, and yet little or no ventilating air may be moving. About 100 years ago, Dr. Desaguilliers and Dr. Hales proposed large bellows and pumps to move the air, and it might have been expected that these would also have measured accurately the work done, but a fault in their construction prevented this in a great degree, and they were found to be so expensive in various ways, chiefly because of the enormous power wasted in working them, that although they had been employed with great advantage in some of the ships in the Navy and in other situations, they gradually fell into disuse. Now that the subject is better understood, and that pumps can be made with the curtain valves, which offer no sensible impediment to the passage of air, we find that the same quantity of air may be moved by about the eightieth part of the force which Dr. Hales had to employ.

*N. Arnott, Esq.,
M. D.*

25th June 1849.

775. Then the principal desideratum, according to what you have stated in your answer, in the usual systems of ventilation, is the power of measuring the quantity of air supplied?

Yes; of measuring the quantity of air, while at the same time a cheap and unfailing means moves along exactly the quantity previously ascertained to be required in the situation; and this, without the need of troublesome superintendence as at present, likely often to be wanting.

776. That is upon the principle that the air which comes into the pit must be pure air, atmospheric air?

Yes.

777. Do you think that there are means attainable of effecting ventilation to any great extent, and without any very great expenditure, and at the same time of accomplishing the admeasurement of the amount of air supplied?

I do. There are various simple and cheap means of accomplishing all these objects. The means, which I think the best for general purposes, is a form of air-pump; persons everywhere are so familiar with the instrument called a pump, consisting of its barrel and piston, that, on seeing it in use, they are at once aware of its purpose, and nearly of the amount of work which it is performing. An apparatus of the kind was put in the Consumption Hospital here about three years ago, when I was consulted as to the best means of securing ventilation in that hospital.

778. That is the Consumption Hospital at Brompton?

Yes. The pump there is a wooden barrel, three feet square, and six feet deep, with a light piston of wood, somewhat less than three feet square, moving loosely up and down in the middle part of the barrel, yet as closely as it can, not to produce wasteful friction. Curtain valves occupy spaces above and below the piston. Two such pumps are connected with the ends of a beam, moving like that of a steam-engine in obedience to a crank. By means of that double pump, 2,000 cubic feet of air have since been measured into that hospital every minute, night and day, in summer and in winter; the air in the winter being warmed to the necessary temperature, so as artificially to maintain always a mild climate. For the purpose of moving the ventilating pump a small steam-engine is used.

779. What is the power of that steam-engine?

One-horse power; but it would do many times the work here required. A smaller engine than of one-horse power costs scarcely less, and is rarely to be found. Before the steam-engine was completed, two men were employed by turns continuously to work the pump night and day; and one of these, to show how easy his work was, used to move the handle round with the fingers and thumb, as if he were holding a pen, and yet was he measuring 2,000 cubic feet of air into the hospital every minute. When the steam-engine was completed, it was so arranged as to be self-regulating; the boiler having a kind of valve applied to it, which admits to the fire a perfectly uniform stream of air under all changes of chimney draught. It matters not, for instance, whether

*N. Arnott, Esq.,
M. D.*
25th June 1849.

the chimney has twice as much, or half as much, force as usual, the same quantity of air always enters; the combustion is always uniform; the production of steam is similarly uniform; and the air-pump, like a pendulum, goes on making its 20 strokes per minute regularly during the whole of the time.

780. And supplying 2,000 cubic feet of air per minute?

Yes.

781. And this has been in operation for three years?

Yes.

782. With perfect success?

With perfect success.

783. The air that is warmed comes in from heated passages?

Yes; in winter it passes through an arrangement of what have been called water-leaves or plates. They are deep narrow troughs of sheet copper, containing each a mass of water, which has the shape and dimensions of a deal board, half an inch thick, eighteen inches deep, and four feet long. They are placed on edge side by side at the distance from one another of half an inch. The water in them is kept warm by circulating constantly from two water-stoves near, and all the air entering the house is caused to rise between the leaves, so that any temperature desired may be given to it. All this heating apparatus, also, is rendered self-regulating, requiring of the attendant only that he put coal into the fire-place once in twelve hours.

784. And it feeds itself?

Yes.

785. What is the cost of that apparatus?

That now described was the first thing of the kind made, and I think the cost of the water-stoves and leaves was about 140*l.*

786. Does that warm the whole hospital?

Yes, the whole of the wards and corridors or passages.

787. What is the number of cubic feet?

Two thousand cubic feet of air per minute are pumped into the hospital; the air, having entered the great distributing shaft, is conveyed by the ramifications of this to all parts of the house, and then, by the action of regulating air-meters or valves placed at the air entrances, every room receives its due proportion of the whole quantity of air entering the hospital as correctly as the patients receive their allowance of food and drink.

788. What is the greatest distance to which the air is conveyed in that apparatus?

It is conveyed in the Consumption Hospital at about 150 feet only; but I may mention that the new Marine Barrack at Woolwich, which is about 700 feet long, has an apparatus of the same kind, which has warmed it now for two winters; the air-pumps there, with pistons of four feet square area and four feet stroke, are adjusted to give 4,000 cubic feet of air per minute as the supply for 1,000 men.

789. What is the power of the engine there?

Two-horses power, I believe, which is much more than is needed; the size was decided upon without consulting me; and the engine has not the advantage of a self-regulating fire for the boiler.

790. And the air-pumps supply 4,000 cubic feet of air per minute?

Yes; with the slow movement of 16 double strokes per minute they supply 4,000 cubic feet; with quicker motion they would give easily 5,000 cubic feet of air per minute, or 6,000.

791. What was the expense of that engine?

It cost, I understood, about 120*l.*; I have no doubt that when many such engines are wanted, they will be sold for less than 100*l.* each.

792. Including what you call the water-leaves?

No, the engine alone.

793. What

793. What would be the expense of the rest of the apparatus?

The 600 feet surface of water-leaves, with the connected stoves for the hospital, cost about 140*l.*; the air-pumps cost about 120*l.*, but would now be made for much less.

*N. Arnott, Esq.,
M. D.*

25th June 1849.

794. What annual expense would the apparatus cost?

The expense of the coal for an engine working with half a horse power would be very little indeed; and as in the hospital the heat which works the steam-engine is afterwards used for the purposes of the house-warming, and would have been required even if there had been no engine, the expense becomes almost nothing.

795. How many years do you suppose the engine would last?

A good engine of the kind required would last, with little repair, for 20 years, even if working through the year, without ceasing by night or by day.

796. Do you conceive that such an apparatus as that would be applicable to the ventilation of a mine?

I have no doubt of the fitness of the pump and engine part of it for the ventilation of mines.

797. How would you apply it?

I may mention, that I have described as yet only one form of pump; there are several others, all simple and cheap; one, for instance, which I have just recommended for the County Hospital at York: its piston has a water-joint, and is moved by the force of descending water instead of by a steam-engine.

798. Has it been in operation?

Not yet; the Rev. William Vernon Harcourt, whose accurate scientific knowledge is aiding the governors of the hospital, has seen the apparatus at the Consumption Hospital here, and has determined to recommend a system of measured mechanical ventilation at York.

799. But the apparatus of which you are now speaking is not in operation at the Consumption Hospital?

Not the water apparatus.

800. How would you propose to apply an apparatus of the kind which is in operation at the hospital for the ventilation of a mine?

It would be necessary to place the air-pump and its small steam-engine in a convenient situation, near the mouth of the pit, and to connect the pump with its work in the most convenient of several obvious ways.

801. How would you convey the air to the parts of the mine which it was desirable to ventilate?

This pump might be employed either to force air into the mine, or to extract air from it, just as fan-wheels, other pumps, heated chimney shafts, or the steam-jet have been employed hitherto; only it acts with much greater certainty, steadiness and convenience, and with clear manifestation to the senses of all the bystanders of what is going on. This modification of air-mover requires no new arrangement of galleries or passages to make it effective. While the action of all the other means is liable to variation and uncertainty, and needs much superintendence, that of the self-regulating pump approaches the exactness of the distributing apparatus of our Coal Gas Companies, which at the end of a year tells every consumer to within a single cubic foot the quantity of gas which he has used, and which he must pay for.

802. Are you able to judge at all, from the experience which you have had of this small apparatus, what amount of supply you could obtain by a powerful engine?

There is no limit to the quantity of air which may be moved: 20,000 or 50,000 cubic feet of air per minute, if necessary, might be supplied as certainly as 2,000 or 4,000.

803. It would be necessary, in order to introduce the air into the mine by such an apparatus as that, to send it through some separate channel, through a large pipe, would it not?

Only from the pump to the shaft, and then it would go down the simple shaft, or up, as the air moves at present. But if it were determined to extract the

*N. Arnott, Esq.,
M. D.*

25th June 1849.

explosive gas nearly unmixed with the air of the galleries from a particular part of the mine where chiefly it were disengaged or accumulated; or if it were intended to send pure air into distinct chambers in the mine, or to supply lanterns in which lights were burning with perfectly pure air from above, as gas is supplied over a town by a gas apparatus; then, for these objects, which in certain cases would be very important, it would be necessary to have tubes from the pump leading into the mine; but I speak, in the first place, of employing this pump merely instead of the other means now in use.

804. And you would propose to attach that apparatus to the ordinary steam-engine of the mine?

Yes, if that were kept at work also during the nights; but in general a small steam-engine to work independently would be preferable; it would be made self-regulating, and would cost very little.

805. There is another apparatus which you spoke of as having been lately recommended by you for the York County Hospital?

Yes; it also is a pump, with a barrel and piston resembling that described in a former answer, but with the edges of the piston turned down so as to dip and move always in water, thus avoiding all wasteful friction, and at the same time producing an air-tight joint, past which a single cubic inch of air cannot escape to waste. The previously described form may be distinguished as the dry barrel and piston pump; this other as the pump with water-joint piston. The latter corresponds much in action with the common gas-holder, for the piston is suspended over pulleys by an equipoise like the gas-holder. The paper in your Lordship's hand—(see Appendix B.)—is the memorandum which I drew up on the subject of ventilating the York Hospital, and it exhibits an outline of this gas-holder pump. A very imperfect form of this gas-holder pump was used in some German mines 100 years ago.

806. By the common gas-holder you mean one of those large cylinders which are made use of at the gas-works?

Yes; they are large cylinders suspended, and nearly counterpoised over pulleys, with the mouth dipping into water, so that when the cylinder by some excess of weight is forced downwards, it compresses the gas within it, and causes this to issue by any passage which is left open from the space below.

807. That is to say, the bottom edge of the cylinder is placed in a receptacle with water, in order to prevent the passage of any air?

Yes; and if there were a closed room over the balanced gas-holder, with valves in the walls, the holder in rising would expel its bulk of air from the room, just as completely as it expelled air from beneath in descending, and it would constitute a large double-acting piston in a barrel. In the drawing of the pump to which I have referred, the water for the piston is shown as contained in a narrow trough, lining part of the wall or barrel instead of filling the whole bottom like a well. Such a pump may be made of any desired magnitude, and it may be worked as shown in the drawing, by water descending from an elevated tank; it may be worked also by a small steam-engine, like the dry pump at the Consumption Hospital; if used at the mouth of a coal-mine, a steam-engine would be the best means of working it. I have recommended for the hospital at York that this pump be worked by the action of water descending from a high tank, filled every day by the Water Company, which water is afterwards to be used for the general purposes of the house.

808. You are understood to say that this apparatus is not actually in operation?

Not actually in operation.

809. Have you tried it upon a small scale?

It is a simple mechanical arrangement already familiar to mechanics in the form used at all our great gas-works, and not requiring further experiment for the elucidation of its qualities.

810. And you would propose by that apparatus to force the air along any passages where it might be desirable, in the same way as gas is supplied for lights?

Exactly

Exactly so. We are perfectly familiar now with the simple gas-apparatus, which, despite the currents of wind and the chimney draughts, and the opening and shutting of doors, delivers with perfect certainty any desired quantity of gas in any room, whether garret or cellar, and which will deliver it certainly over the whole of a town five or more miles in diameter from a central station. The force of an inch or two of water column resting on the top of this cylinder is perfectly sufficient to effect all this; to distribute air over a house much less force is necessary; in a mine, with the galleries in some places very wide, and in others very narrow, a considerably greater force would be required to urge the air along, but a small steam-engine would never fail. It is a great defect in a mine to have any part of the air-channels so narrow as to cause what is called wire-drawing of the air, for much force must be wasted to overcome the obstruction. It is one of the chief advantages of the pump, as compared with other means, that it measures the air passing along so intelligibly to even the ignorant and careless observer, that it keeps all on their guard against possible dangers from unsuspected impediments, &c.: a positive obstruction would stop the pump, but might make no visible change on the action of a chimney, a fan-wheel, or a steam-jet. A powerful and cheap means of moving air is a jet of steam directed through a tube containing air; nearly the whole mechanical force of the steam issuing is applied in that way, but it does not tell the amount of work done by it, and therefore demands additional contrivances for this purpose, and careful superintendence. There are cases in which it might be preferable to other means, and then it would be an advantage to render the generation of steam in the boiler uniform by using such regulating balanced valve for the furnace as is attached to the engine at the Consumption Hospital; an independent anemometer also would be wanted.

*N. Arnott, Esq.,
M. D.*
25th June 1849.

811. You are aware of the ordinary mode of measuring the strength of current supplied by ventilation?

Yes; there are many modes answering more or less accurately, but it is true of them all, that they only measure the air which happens to pass, but do not affect the quantity any more than a rain gauge affects the quantity of rain; they do not of themselves rectify or guard against any irregularity in the action of the air-moving power; they only tell the attendant, when he chooses to consult them, that an irregularity or disturbance does exist; and an unnoticed disturbance may hazard the lives of all the workers in the mine. It must be deemed of the highest importance in every case of mine ventilation to have the most perfect security for unvarying steadiness in the action of the air-moving force.

812. Do not you consider the amount of pressure upon the water-gauge or upon the barometer a sufficient indication of the amount supplied?

It shows only the amount of air-movement going on at the moment of observation; but a uniform fire in a shaft, or a fan-wheel having an unvarying velocity, will move very different quantities of air, according to other accidental circumstances; an attentive watch, therefore, needs to be kept on the indications of the anemometer.

813. Supposing an apparatus established in a mine, and that it gives the pressure of the current at a permanent quantity of about two inches of water in the gauge, do you not consider that to be a measure of the efficiency of the ventilation?

Yes; but the difficulty is by means of such varying efficacy as that of the heated shaft or fan-wheel to maintain the same state of the gauge.

814. It indicates the velocity of the current?

It indicates the velocity of the current at that particular part only, and at the moment of observation.

815. Then the passages being the same, the velocity generally would indicate the amount of ventilation?

Yes; the amount might be calculated from the pressure measured of the moving air, and the area of the passage where the gauge was placed; but if the gauge were carried from one part of the gallery to another, wider or narrower than the first station, a totally new calculation would be required.

816. Supposing the gauge to be fixed as it is in some mines, a fixed water-gauge carried through a partition, with the current passing in opposite directions

*N. Arnott, Esq.,
M.D.*

25th June 1849.

on the opposite sides of that partition, it would, to a certain degree, be an indicator?

It would.

817. In considering any apparatus, such as you have described, there is one point which it is very essential to bear in mind, namely, the impediment caused by friction, is there not?

Yes; the friction of the air in irregular or rough passages is great.

818. Have you made any observations upon that point?

It is because it overcomes the friction of the air, whatever it may be, and any other unforeseen impediment, that a mechanical means like the pump, which cannot fail or disappoint, is so much needed.

819. Supposing that you make use of some well-managed apparatus, such as an efficient furnace or a steam-jet, or any other contrivance of that sort, and that you thereby obtain a strong current; is there any other advantage, do you think, over those methods in an apparatus such as you describe, except the power of more accurately measuring the quantity of air?

The great superiority of the apparatus, as it appears to me, is, that it not only measures the quantity of air passing, and by its visible or audible movement tells all those whose lives depend on its efficiency that it is working steadily, but that it certainly forces through the mine the quantity of air ascertained to be necessary; it is also very cheap.

820. In what respect cheap?

Costing very little to move the air, and very little superintendence.

821. Are you speaking now of the fuel, or the machinery?

The fuel would be little, and the machinery is cheap, to give a certainty of action which is invaluable.

822. You must be aware that at a coal-mine, the quantity of waste coal is so great as not to be an object of any consideration?

Certainly.

823. You would consider it a comparative advantage, in the case of a coal-mine, that an apparatus of this kind might be always attached to the engine which is there already?

Yes; but as the ordinary engine, I believe, does not work at night, it would be well that there should be a little separate engine for the ventilation.

824. Has your principle ever been applied to mines?

Not to mines.

825. In the evidence before the Committee of the House of Commons in 1835 on this subject, there is a reference to an air-pump being used at the Hetton Mine?

I have not seen that evidence. The air-pumps now used for Belgian mines are, I understand, preferred to any other means. Dr. Graham, the Professor of Chemistry at the University College Hospital, mentioned this to me a few days ago.

826. What sized pump would you have?

It would depend upon the quantity of air to be moved, and the speed of oscillation of the pump which it were convenient to allow. With a rapid oscillation, a pump of a small size would answer; with slower oscillation, a larger would be required. A cubical box of 10 feet square contains 1,000 cubic feet of air; that moved up and down, so as to make 10 double strokes in a minute, would give 20,000 cubic feet per minute.

827. In the pump used at the Hetton Colliery, the piston was five feet square?

That would give 125 feet only for each half stroke, if the barrel were as deep as broad.

828. According to the evidence of Mr. George Johnson, he did not think that enough for the situation?

That

That is a small pump. The two pumps at the barrack at Woolwich are each of four feet cube, to send 4,000 feet of air per minute when worked with moderate velocity.

*N. Arnott, Esq.,
M. D.*

25th June 1849.

829. How is it that you propose to measure the velocity of the current; by the anemometer?

The velocity is known at once by the quantity of air sent down, and the area of the shaft or passage along which it moves; but the quantity of air sent down is the important thing to be known, and not the velocity of the current. It is required merely to send in enough air to dilute the gas to the degree ensuring safety.

830. But we are informed, that a current beyond a certain velocity would be attended with very great practical inconvenience in the working of the mine?

Certainly, it might.

831. Would it not, therefore, be important to know the velocity of the current which you send down?

If the current produced by sending down the quantity of pure air required for safety were found anywhere to be inconveniently great, the only remedy would be to widen the passage where the inconvenience was felt.

832. You do not propose to have any anemometer or means of measuring the velocity of the current?

It would not be necessary, in relation to the whole quantity sent down; but wind gauges at various parts of the mine might give useful information as to the distribution of the fresh air in different places.

833. You would propose to regulate the speed of the current according to the practical inconveniences of the case?

The quantity of fresh air required for safety being settled, the passages must be of such dimensions as to allow that amount of air to pass along without inconvenience to the workmen.

834. Are you acquainted with the principle of the steam-jet proposed by Mr. Gurney?

Yes.

835. Is it your opinion that that would be applicable?

I think it an exceedingly good mode of moving air in certain cases, and applicable to the ventilation of mines.

836. You think that the particular advantage which the plan you have now proposed has over that of Mr. Gurney would rather consist in its superior economy?

No; rather that it moves and measures in the required amount of air with a certainty beyond price, and with very little and easy superintendence; yet it is possible to place the steam-jet in circumstances that shall cause it to regulate its own action much more than has yet been done; and I think that in many cases it will be found to be a good mode of moving air in mines.

The Witness is directed to withdraw.

JAMES DARLINGTON, Esquire, is called in, and examined as follows:

J. Darlington, Esq.

837. YOU are the owner of the Astley colliery, near Manchester?

Yes.

838. A short time since a portion of that colliery was on fire, was it not?

It was.

839. How long had it been so?

It was on fire about a fortnight.

840. Do you know how the accident commenced?

We have no knowledge whatever of the cause of the accident.

J. Darlington, Esq.

25th June 1849.

841. Was it an extensive fire?

From the volume of smoke and the heat of the same, it was apparently a very extensive fire.

842. How was the fire discovered in the first instance?

It was discovered about one o'clock on the Monday morning; we were working with a couple of men in the night; those men, on coming to the shaft, found that it was filled with smoke; that the downcast shaft, instead of carrying in pure atmospheric air, was emitting a volume of dense smoke, very hot indeed; it should have been carrying in atmospheric air.

843. Was the furnace in operation at that time?

It was.

844. At the upcast shaft?

Yes.

845. And, notwithstanding that, there was a large issue of heated air from the downcast shaft?

Yes.

846. When did the people leave the pit, before that discovery took place?

The two men made the discovery; they were going down about one o'clock on the Monday morning.

847. How long was that after it had been previously left by the workmen?

The workmen left on the Saturday; they leave about four or five o'clock; we send men down to the furnace two or three times between that and the Monday morning. The men went down to attend to the furnace on the Saturday evening, Sunday morning and Sunday evening, about three o'clock; they discovered nothing whatever up to three o'clock; from which we judge that the fire must have originated some time between Sunday afternoon and Monday morning, about one o'clock.

848. Then on Monday morning it was discovered in the manner which you have described?

Yes.

849. Were you able to examine the mine after having discovered that it was on fire, so as to ascertain to what extent it was so, and in what part of the mine?

We discovered that it was within a very few yards of the downcast shaft, but the density of the smoke prevented us going to the fire; we could discover from the heat of the smoke that came from the downcast shaft that the fire was very near to it.

850. Upon making this discovery, what was the course which you took?

The first thing that we did was to stop down the pits; that was the only resource we had; it was the old principle.

851. There are two shafts?

Yes; the upcast and the downcast.

852. And by stopping down the pit, you mean covering in the shafts?

Yes.

853. By what means did you cover in the shafts, with what materials, and how did you do so?

We used what we call horse trees, or large pieces of timber; we put those across the shaft, and placed strong boards on the top of the large timbers, and then covered that with sand and litter.

854. So as to make it quite tight?

Yes.

855. Having done that, what was the next step which you took?

We were quite undecided for about a week, thinking to let the fire take its own course, and open the shafts in the course of a month; that was our opinion for a few days.

856. Is

856. Is that the course usually taken in such circumstances?

Yes.

J. Darlington, Esq.

25th June 1849.

857. In short, is it the only method which it has been supposed possible to adopt?

There is another course, by water.

858. But that is generally not till after the first method has been tried, is it not?

Water is so very expensive that it is the last resort.

859. And there is the difficulty of pumping it out again?

Yes.

860. It may be very expensive to obtain the water, but even though it is not expensive to obtain it, it is always very expensive to get rid of it?

Very expensive.

861. Then having taken this usual step of stopping the mine altogether, and leaving it for a time, you were under the impression that you could do no more?

That was our impression.

862. What led you ultimately to adopt the course which you took for the purpose of extinguishing the fire?

We knew the consequences of opening the pit too soon, that if we put in atmospheric air, and the fire should then be in existence, as soon as the atmospheric air caught the fire, an explosion of the whole mine would take place; the mine being charged up to the ceilings; therefore it was desirable to remove the inflammable gas that had filled the workings; the inflammable gas was issuing at the stoppings.

863. In spite of the stoppings, the gas was still issuing?

The gas was still issuing at the various crevices, and at the bank, so that we could not stop it down; we apprehended that if we turned the atmospheric air upon the fire, we should have an explosion; that would so seriously damage the colliery, that it might be of very little use afterwards. We have had several explosions in the neighbourhood from this cause, and with the most awful consequences; in fact, a common explosion, attended with loss of life, does very little damage to the colliery, compared with an explosion when the colliery is entirely filled with the inflammable gas; therefore it was desirable to remove the inflammable gas, and we could not put any material into the shaft to take its place except atmospheric air. Under that impression I wrote to Mr. Gurney, stating the case, and asking him if he could assist us in the matter, thereby enabling us to put out the fire, or to approach the fire. If we could remove the inflammable gas, we could approach the fire.

864. Had you had any previous knowledge of Mr. Gurney's invention?

Merely by hearing of him in the public papers, and the reports.

865. What depth was this mine?

About 390 feet.

866. What was the thickness of the seam?

About four feet.

867. So that the passages would be about four feet high?

Yes.

868. You applied to Mr. Gurney?

Yes; he immediately wrote back, inquiring for further particulars respecting the colliery; but before he could receive an answer, he came down to the colliery; in fact, he came down before I had any information that he was coming down. As soon as he arrived, he explained to me the way in which he proposed to take out the inflammable gas, and supply it with something that would not support combustion: the principle which he suggested was carbonic acid gas; this at first appeared to us a very extravagant mode of putting out a fire; but he showed us immediately that he could manufacture the gas at so small an expense that, even if it failed, it would be desirable to try it; still, from the manner in which he explained it, we were quite satisfied afterwards that it would answer the purpose.

J. Darlington, Esq.
 25th June 1849.

pose. By giving us sketches of what he required for manufacturing the gas, we built a furnace, and put pipes into the ash-pit under the furnace; and conveyed the first set of pipes into a water-tank; the air was drawn through the furnace by means of a steam-jet, and passed through the water in the tank; it rose to the top of the water, and was carried by another set of pipes into the downcast shaft, through the stopping. There was a small cylinder of the same size applied to the upcast shaft, and another steam-jet for the purpose of exhausting; the one at the downcast was compressing; the expense of making the gas was very trifling, being made from limestone, and the waste coals about the shaft, and a little charcoal.

869. Will you name what the expenses were; you say trifling?

Very trifling indeed; if we returned the pipes, the whole expense would not be 10%, including coals, and being paid for all the materials; if we kept the pipes to use again, in case of necessity, the expense would not be 20%.

870. Then the result of this was, that you introduced the products of this combustion into the mine?

Yes, we passed the gas into the mine, exhausting at the same time at the upcast shaft.

871. The gas which had been passed through the fire?

The gas which had been passed through the fire and through the water-tank was forced into the mine, and the jet at the upcast shaft was exhausting the meanwhile, assisting the compressing jet. This was passed through the air roads, and eventually found its way to the upcast shaft, from which it issued in a few hours in such a state that it would put out a lamp, or a common fire that was applied in a chafing-dish.

872. How long after you had set the steam-jet to work in the downcast shaft were those appearances observed at the mouth of the upcast shaft?

I should think from two to four hours.

873. When that state of things had occurred, you allowed the operation to continue, did you not, for some time?

The operation continued for about six hours longer, and then a body of atmospheric air was passed through, by means of the same jets, until a lamp would burn in the upcast shaft. There was a compressing jet in the downcast shaft forcing in the carbonic acid gas, and an exhausting jet in the upcast shaft helping it.

874. A steam-jet?

Yes.

875. High-pressure steam?

Yes.

876. What was the pressure?

We had from 30 to 40 lbs. to the inch, perhaps 35 lbs. at the average.

877. Then it appears from your description, that you must have taken altogether, from the commencement to the ultimate clearance of the mine, indicated by the lights burning at the mouth of the upcast shaft, about 12 hours?

About 12 hours; less than that, if anything.

878. When you had satisfied yourselves of the purity of the air which issued from the upcast shaft, did you then enter the mine?

The mine was then entered by the downcast shaft; the jet at the upcast shaft exhausting at the same time, and we could assist it in the downcast shaft by pouring water down from the pumps. The men went down to a small tunnel that there is a little above the coal in the downcast shaft; they entered the mine, and were enabled to get through most of the airways to the upcast shaft.

879. Then you found everything quite clear?

We found everything quite clear.

880. And the fire extinguished?

The fire was extinguished.

881. And

881. And the heat not such as to endanger a renewal of the fire?
There was no danger whatever from the heat.

J. Darlington, Esq.

882. So that the operation was very complete?
It was.

25th June 1849.

883. And you have since been working the mine as usual?
As usual.

884. What kind of burning was it; how deep was the burning of the coal in the mine?

The firecatches the coal on the surface, and runs with the current of air, and will spread over an immense extent of surface very rapidly.

885. What were the appearances which you found on the coal when you inspected it afterwards, where it had been burning?

We found that the fire had brought the roof down, and had charred the edges of the pillars in the mine, and destroyed the even appearance of the roof some distance from the actual seat of the fire.

886. What was the extent of the fire from the appearances?

We have not been able to prove the exact extent of the fire, because the fire extended in several directions; and "on the deep" we have not been able to prove it; we prove it on the rise, where it has connected itself above the levels; but on account of letting the pumps stand for about a fortnight, the downbrow workings below the mouth of the downcast shaft filled with water, and still remain so; those downbrows are now full of water, so that we were only able to see the extent of the fire above the level of the water.

887. The water must have had the effect of extinguishing the fire which had existed in the lower part?

The fire was, to all appearance, above and below the present level of the water.

888. Do you suppose that the accumulation of the water in the lower part of the mine extinguished any part of the fire?

We have not been able to get into the downbrows; if it was at the bottom, probably it might; but the present appearances suggest that it is very near the present level of the water; the mine made such a small quantity of water that it took a considerable time to fill the downbrows.

889. The result was, that after the conclusion of this experiment, the air in the mine was so thoroughly cleared that you were able to recommence working there?

We recommenced immediately.

890. And you continued without any difficulty?

We continued up to the last accident; we have had another of a similar nature.

891. A fire?

Yes, which has been put out by the same means.

892. Will you give a short account of the second accident?

The second accident arose out of the first, from the carelessness of one of the miners; we had instructed him to let off a small portion of inflammable gas in a blind cutting, distilled by the first fire, that was unconnected with the upper air-roads, being above the level of the working air-courses; being lighter than the atmospheric air, it naturally ascended in the dead workings above the high level; we marked him out the point that he was to start from to work down-hill to this lodgment of inflammable gas, and instructed him to bore before him five feet by means of the drill, so that he would always be prepared before he came to the body of the gas, and having some small wooden plugs ready, he could put one into the hole, and there would be security: the man having opened a great many of those places for us before, we considered him quite competent to do it again; he had opened them in our presence, and we were quite satisfied that he could do it. Since the accident we have discovered that he did not bore these holes before him; but in order to make more money, he charged us for boring the holes when they had not been done, for, at the time when we put the fire out, I took the drill and tested it myself; I got the hole bored the distance he ought to have drilled

J. Darlington, Esq. it, and it went through into the inflammable gas; if he had done that, the accident would never have arisen.

25th June 1849.

893. Was he a man that had been long in your service?
He had been some time in our employ.

894. And was supposed to be a very trustworthy man?
We considered him particularly so, on account of his having opened several similar small lodgments in our presence.

895. Had he actually opened the former one?
Yes.

896. Was he in the position of an overlooker?
He was in the position of a pitman, or a common miner.

897. He was not charged with any of the superintendence of the mine?
Not the least.

898. Will you proceed?

Omitting to put the drill-hole before him, and blowing by gunpowder, he came quite suddenly upon the body of gas, and made a hole through, as we now discover, about three inches in diameter; the gas came out so strong through that aperture that it caught fire; he had a lamp and a candle in the place; the lamp-top was discovered off, and the candle and the lamp lying together; we have questioned him respecting the reason of having the top of the lamp off, and he says, that he had been cleaning the lamp; but it is very evident that he had a naked candle as well, and he must have had a candle burning at the time of the accident. The quantity of gas escaping through the aperture was not sufficient to explode the whole of the gas at one particular moment; therefore, it only exploded just as much gas as was contained in the place between his candle and the aperture, and then continued to burn as a common gas-jet; but the immense quantity of gas coming through the aperture made the heat so great that it ignited the coal immediately. About half an hour after the accident occurred, all the men came up the pit.

899. Was there any one hurt at the accident?

The man was a little scorched; I think he had a little of his hair burnt, but that was all; on account of the aperture being so small, it could not do very much damage; the mischief arose from the jet burning: the man left his work immediately, and all the colliers came up. I was just preparing for leaving home at the time; I was going to Ireland; in a couple of hours I should have left. I went down to the pit immediately; and the men hesitated to descend; they thought, of course, that their lives were endangered, and they would not encounter it; but I got the viewer to get into the basket with myself, and proceeded to examine what might be done; the men immediately followed after, and we had plenty of assistance directly; we made brick and sand stoppings; a wall of brick, and three feet of sand, and then a wall of brick again (the sand being very solid between the two), is what we call a brick and sand stopping; those we made on both sides of the fire; taking the air with us, we were enabled to get behind the fire. The worst operation was to make the stopping in front of the fire; we had to face the volume of smoke, and could not get within 150 yards of the fire, being so near the upcast shaft; therefore, we carried on the operation at that distance from the fire, and secured it; it was a very difficult operation; the men could not stand in the smoke above 15 minutes; we had to remove them at those intervals, owing to the suffocating influence of the smoke; but they were soon relieved, and in about half an hour's time they acted as relays again; we had a continual change of men going on, so that in a few hours we had the fire built up on all sides, within a certain space in the mine. Having secured it in that manner, the next operation was to force in the carbonic acid gas; we immediately got a quantity of gas-pipes, conducted the steam from the stationary boilers to the shaft, down the upcast shaft, and along the "inclined level," or slant road, up to the spot where the fire existed. On account of never having carried steam so far before, the first trial was useless, because we found that it took a larger size gas-pipe than we had put in to convey the steam with any force; therefore, a little delay arose in changing the pipes, and putting pipes of a larger bore to the fire.

900. Was

900. Was Mr. Gurney with you all this time?

Mr. Gurney was not; I did it entirely myself; but having spoken with Mr. Gurney on a similar question before he left, I was quite prepared how to act under such circumstances.

J. Darlington, Esq.

25th June 1849.

901. The plan was so simple that you understood it?

The plan was simple. After constructing the steam-pipes in the upcast level, I commenced the manufacture of the carbonic acid gas by the humid process in the lower gallery, making the carbonic acid gas at a lower level than the spot that I was exhausting it at. There was no jet used to put in the carbonic acid gas, for as fast as it was made, the exhausting jet in the upcast shaft pulled it through very readily, and the only difficulty was to supply the jet with the same quantity of air that it was exhausting. In about an hour's time after applying the carbonic acid gas, through the impatience of the viewer and the men, I agreed to open the inclosed part of the mine.

902. To open the part that was built off?

Yes; I went with them, and we were rather too soon; but it was very satisfactory to us that we opened it at the moment we did, because we had positive proof that the fire still existed, although it occupied not more than about five or six inches square. On account of the suffocating influence of the carbonic acid gas—for we had not passed any pure air through it—we could not approach it; we could only get a few yards off; we took the precaution then to pass some atmospheric air through the place built off, and we were enabled, in about three minutes time, to approach the fire; the heat of the mine was so great at that particular point that it again ignited, and spread to two or three yards square; in another five minutes I am satisfied that the fire would have been as great as ever; it was quite evident that the great mass of the fire had only been extinguished a very few minutes, it so readily took fire again; the coke, the roof and the floor were so very hot that you could scarcely bear to touch them with your hand; this would not have been the case if the fire had not been in a very active state up to a very few minutes before. We succeeded in putting out this small remaining spot by two or three pails of water; afterwards we had a full opportunity of examining how it arose, and congratulating ourselves upon our success.

903. How long ago was that last fire?

The fire took place on the 5th of June, and in three days the men were working.

904. In the present month?

Yes.

905. What was the time which it took in cooling?

I was down in the pit during the whole of the operation, which occupied three days and three nights, in getting the apparatus together; we only applied the carbonic acid gas at two o'clock on the Saturday morning, and at five o'clock I had all the men at work.

906. Then, when you talk of three days, you do not mean that that time was occupied in the extinction of the fire, but in the preparatory part?

In the preparatory part; and on account of not putting in a sufficiently large bore of pipes, we had to change them; that was all included in the three days.

907. In short, the failure of your first operations was included in the three days that you have mentioned?

Yes.

908. How was it that you introduced the carbonic acid into the inclosed space?

We introduced the carbonic acid gas at the next lower gallery to the one at which we were exhausting, and we made it by what is termed the humid process. Having an exhausting jet above, it was drawn in by the vacuum caused by the exhausting jet, and being made entirely off from the workings, the carbonic acid gas arising from the operation was drawn on to the fire in the place built off.

J. Darlington, Esq.
25th June 1849.

909. When you had built off this space entirely, in order to confine the fire there, how were you enabled to draw anything off, or to introduce anything; was not it entirely shut off from the rest of the mine?

We had to make a small cutting in the solid coal of about two yards, driving as near as we possibly could to the part built off; then making a large drill hole, and putting a pipe through, and having a lift valve in this pipe, we shut the valve, and consequently could put anything through the valve by opening it; through this valve we drew in the carbonic acid gas.

910. Then you must have had two openings, one to draw in the gas, and the other to take it out?

Yes.

911. Were both those openings at the same point?

One opening was at the lower part of the portion built off, and the other at the extreme rise; we put it in at the bottom, and took it out at the top.

912. How did you produce the carbonic acid gas in that case?

I made it from sulphuric acid and common limestone.

913. That was rather a more expensive process than the other?

The quantity of the gas was little, as compared with the other; the cost of the acid was the chief expense.

914. You had the limestone there?

The limestone is very cheap indeed; we got it at a few shillings a ton.

915. Can you say at all what that operation cost you, independently of the failure of the first attempt?

Does your Lordship refer to the expense of the gas?

916. The whole expense of the extinction of the fire?

The whole expense would be from 10 £. to 15 £.; the expense of manufacturing the gas was not more than 2 £.; yet it cost more than the choke-damp to fill the whole mine in the first fire.

917. Do you include the labour of the men in that?

The labour is not included in that.

918. The expense was useless in the other case, where you put out the fire of the whole mine, compared with this little portion which you built off?

We had the fire so situated there, that we could act upon it more directly.

919. In this case you only made use of one steam-jet at the upcast shaft?

That was all, and in the higher gallery; we applied it as near the point as possible where the accident arose.

920. Is yours what is commonly called a very fiery mine?

One part of the mine produces a considerable quantity of gas.

921. Then, from your experience, you would be inclined to say, that when a mine is on fire, under similar circumstances to yours, the method adopted by Mr. Gurney is a very inexpensive and a very effectual one?

It is a very inexpensive and a very effectual one.

922. How far was this fire from the shaft?

The second fire was about 160 yards.

923. Then you brought the pipes down from the mouth of the pit?

We connected the pipes from the stationary boilers down to the bottom of the shaft.

924. How could you manage the bringing down of the pipes; how did you support them?

We supported them by timber at different intervals.

925. Is not that an expensive process?

The expense of supporting them is very trifling; I should say about half-a-crown would support the whole, from top to bottom.

926. How did you unite the pipes?

We united them as the common street gas-pipes, by screwing them one into the

the other; we had elbows, T joints and taps, and other necessary articles of that kind; they were supplied by the maker of the pipes.

J. Darlington, Esq.
25th June 1849.

927. What was the diameter of the pipes by which you introduced the gas?

We introduced the carbonic acid gas through about four-inch pipes; three and a half to four inches.

928. What was the diameter of the jet?

A quarter of an inch.

929. Was the steam-jet placed within the pipe conveying the gas, or merely near its orifice; the question refers to the first experiment, in which you introduced gas by aid of the steam-jet; in the first operation you introduced the gas by the aid of the steam-jet?

We forced it in by the steam-jets.

930. How was the steam-jet placed, with reference to the pipe conveying the gas?

We had it placed within about three yards of the furnace, and immediately above the elbow that conveyed it into the tank; we put the steam-jet immediately above the elbow going into the tank, and forced the air from the furnace through the water; it rose again above the water, and was carried off to the downcast.

931. There was a steam-jet within the pipe?

Within the pipe.

932. From your experience, should you say that that method of proceeding for extinguishing a fire in a coal-mine would be applicable where a fire has been in existence for some time, and where the heat caused has been very great?

I am satisfied it would, if sufficient time were given it; it would require more time than where it is a recent fire; if it is a recent fire, it would be immediately put out by the application of the carbonic acid gas; but in a fire of old standing it would take a much greater time. From the circumstances of several fires now existing in our neighbourhood, I am satisfied that it would not take one-half the time; in fact, I may say, a tithe of the time that is now occupied when the fire is left to itself.

933. In your first accident, was the carbonic acid gas made as you made it in the second case, with limestone?

It was not; in the first case it was made from charcoal, the waste coal round the pits, and from a little limestone, all these burnt together; a very hot fire, about 18 inches in thickness, was made; the action of the jet drawing the atmospheric air through that fire destroyed the oxygen, and left the nitrogen and carbonic acid gases to be passed into the mine; the limestone supplied the carbonic acid gas: in the second operation it was purely carbonic acid gas.

934. Produced by sulphuric acid and limestone?

Yes.

935. Had you ever used the steam-jet for ventilation, or any other purpose in the mine, or was it new to you?

I had only heard of it by the reports.

936. Have you continued to use it since for ventilation?

On account of putting it up in a very temporary manner, we could not apply that set of pipes to the ventilation of the mine for any long period; we used it to ventilate the whole of the mine, and to make it so that a naked candle would burn with safety; we had only one single jet at this time passing through a foot cylinder; the whole of the top of the upcast shaft was sealed up, except one small cylinder; a single jet inserted therein supplied us with sufficient atmospheric air to put the mine in a condition for the men to descend as soon as we opened the sealing of the upcast shaft.

937. What is the extent of your workings?

Our workings are comparatively new; but I should say that the galleries are from four to six miles already.

938. What is your opinion of the steam-jet which you saw as to the purpose of ventilation?

It was the first application that I had seen of it, and very great prejudice existed

J. Darlington, Esq.
25th June 1849.

existed in the minds of the viewer and of all the men respecting its application; but any one who went down the mine during the action of that single jet must have been convinced that it was a more effectual application than the common furnace, provided a greater number of jets were applied; there was only one single jet, and a foot area was the whole of the surface from which it could escape, and through that single cylinder the current of air was so great as to ventilate the whole mine.

939. Do you know at all the rate of current produced by it in that case?

The rate of current was tested at the time, giving about 6,000 feet a minute.

940. Cubic feet?

Yes.

941. Do you know what was the velocity of the current?

Containing exactly a foot area; of course, every cubic foot that passed through would be a corresponding rate; the cylinder through which we exhausted at the upcast shaft contained exactly a foot area; therefore, if we passed 6,000 feet through, that would be the rate of the current, it being a correct measure.

942. Was it a stronger draught than you obtained from the furnace?

It was not a stronger draught, having only one pipe; if we had had three cylinders, I am satisfied that we should have had a stronger current than with the common furnace.

943. Was that draught with the one jet, which you have mentioned, sufficient for the proper ventilation of the mine?

I should not have been satisfied with the one jet; if I had applied three, I should have had three times the current, and a better ventilation than with the common furnace.

944. What would have been the expense of that current with your mode?

I could not ventilate the mine in that way on account of using the upcast shaft for winning the coals. I was obliged to construct another pipe to descend the shaft about 20 or 30 feet, turning upwards again, and to apply two jets in that way. I had so little power upon the column of air that it did not produce anything more than the single jet at the top; if eight or ten jets were placed round the shaft at that depth, we could have worked the coals and ventilated the mine. We have an excellent furnace in the upcast shaft; we used the steam-jets until such time as the mine was perfectly safe, and are now preparing a tunnel into the shaft, that we may apply it more effectually.

945. Then you intend to make use of the steam-jet for ventilation?

We do.

946. Are you acquainted with other cases of fires in mines?

There are many cases in the district around that I am personally acquainted with.

947. From your experience of this process in your own case, should you be disposed to say that it would be applicable to those cases with which you are acquainted in other mines?

I think it would, without any doubt whatever.

948. And you are not aware of any circumstances which would interfere with its successful application in other instances?

I am not. With your Lordship's permission, I would just notice a fact which I think would induce us to apply the steam ventilation in preference to the furnace when high velocities are at any time required. A furnace fire we cannot at all times depend upon. Supposing a red fire is obtained in the furnace, many parties would think that that was keeping a good fire; we find just the contrary, that the furnace is distilling gas, and not ventilating the mine at all; we must have the flame and the smoke to produce ventilation. On account of the coals used to keep up a very good fire night and day, many parties have their furnace in operation during the day only. I think one of the greatest evils existing at the present time in the Lancashire coal-field is allowing the furnace to be raked, as we call it, during the night; that is, the pits are left, and some wet slack or small-coal is thrown upon the fire. The fire by this means is kept in
until

until early in the morning, but does not produce any ventilation whatever. The fire is stirred up before the men come to work, and some fresh coals are put upon it; then the furnace begins to act again. Now, in the meantime, the shaft may have been standing still, and the ventilation may not have been acting at all; an eddy may have formed in both shafts, and the whole of the gas made in the night may have accumulated in the remote parts of the mine, and made it unfit for the men to go into; they would run great risk of an explosion. Instances of that kind are not uncommon. The steam-jet not requiring any one to attend it, it might be kept going regularly, for having pumping engines working in the night, the boiler would be fired by the same man, and steam taken from it. At the present time, the cost of keeping up furnaces for high velocities is great, by having men day and night to attend to it.

J. Darlington, Esq.
25th June 1849.

949. And the consumption of coal?

Yes; there is a drawback again upon using coals, which I think ought to be taken into account; although it is small slack, and not worth very much, yet there is a royalty rent, a duty paid upon that slack, which I think prevents many furnaces being in full operation, and I think that that has an effect with many of the small proprietors. Any one at all acquainted with Lancashire will know that it is full of small collieries; some of those collieries have no furnace whatever, and I am satisfied that they would have furnaces if they had not to pay the royalty rent; in many cases it is 8*d.* a ton; every ton of coal consumed per day by the furnace, at that rate, would pay a royalty of 12*l.* per year, which is a consideration with the small workers. Many of the workers are miners or under-viewers, who have accumulated a little money, and have opened a shaft themselves.

950. That is the custom in Lancashire?

Yes; a royalty is paid upon coal used for ventilation; if that royalty was removed, I think it would be one of the greatest means, not only of furnishing the small proprietors with a cheap way of ventilating the mines, but at the same time not endanger the lives of the miners for the sake of a little economy.

951. Is that royalty payable to the Duchy?

It is payable to the owners.

952. It is not all the property of the Duchy?

There is very little; in fact, it is very inconsiderable.

953. Is it the usual practice in the mines of Lancashire to have two shafts?

Yes; I know very few instances indeed where one shaft only is used.

954. Are you well acquainted with any workings of mines besides your own?

I know many of the mines in Lancashire; I have had considerable practical experience in that district, and I am acquainted with the local peculiarities of most of the mines; I know little about the mines in any other district.

955. In addition to the question of the furnace, do you think that there are any other points in which the ventilation is deficient, generally speaking, in the mines in Lancashire?

I think it is deficient, inasmuch as sometimes you want a large current of air passing through the mine; the furnace will not do more than a given quantity; because the greater the amount of air which is passed through the mine, the weaker will be the furnace; in passing a larger current of air through the furnace it has not time to heat the extra quantity passing through it, and, therefore, the ventilation is injured; this was first pointed out to me by Mr. Gurney, and I was staggered at so self-evident a fact; it is a thing that ought to suggest itself to every coal proprietor, that the furnace begins to act just reversely after a certain point, but it is little observed: if the ventilation is very slow, the furnace is more powerful; and if the ventilation is very great, the furnace is less powerful, because it begins to go back inversely: the less the current of air passed into the furnace, the hotter the column in the shaft; but the greater the quantity of air passed into the furnace, the cooler the column of air in the shaft, and it is merely by the rarefaction of that shaft that we get any ventilation at all: it is a very striking fact.

956. The heat from the furnace is diffused through a larger quantity of air, and does not heat it so high?

Yes; furnace ventilation seems to be a complete paradox.

(164.s.)

N 4

957. Apart

J. Darlington, Esq.
25th June 1849.

957. Apart from the question as to the furnace, should you say that, in other respects, the ventilation of the Lancashire mines is very defective?

The ventilation is defective in many of the workings, although inflammable gas is not produced; choke-damp is found to exist.

958. In the mode of working are they well or badly worked?

In the larger collieries they are very well worked; in the smaller collieries they are not; in the latter, if four or five men are killed, little is heard of it; but if the same state existed in a larger mine, it would have killed the whole of the men in the pit; in the smaller mine it killed as many as it probably could. The larger collieries would not lay themselves open to such a responsibility.

959. What should you say are the feelings of the coal-owners generally in regard to an inspection by Government?

If it is very gentle and wholesome, I think they would not object to it; but it is the fear of its being arbitrary; if the responsibility were taken from them, I think it would do mischief, and they would reject it on that account.

960. Supposing proper officers were appointed by Government, not to force any rules or to impose any restrictions upon coal-owners, but merely to ask for information, to give competent opinions and suggestions, to communicate information from other parts of the country with respect to the working of mines, to give publicity to all improvements, and to place upon record any defects of working or of arrangement in collieries which exposed the people to accidents; would that, do you think, be an useful course for Government to take?

I think it would, on this account: we find that many grievances only come out after an accident has occurred; a few years ago an accident occurred in our neighbourhood, and two or three men were killed; I believe all that were in the mine were killed; the cause was attributed to there being no furnace in use at the colliery. Now, if some person who had a practical knowledge of mining visited that colliery, and saw that no furnace existed, and yet inflammable gas was in the mine, he might have suggested a furnace, and consequently the lives of those men might have been saved. It was afterwards discovered that no furnace being in the pit the air was very defective, and it got so charged with inflammable gas that it killed the men as they were entering the mine. An Inspector would have been useful in that case; therefore it is desirable if he has not any arbitrary powers.

961. It would be difficult for an Inspector to ascertain the condition of a mine without having the power to inspect it?

He must have the power to see the plans and to inspect the mine, otherwise he would be useless.

962. Do you think that there would be any great jealousy on the part of coal-owners as to an authority of that kind?

I think if care were taken in not giving him any compulsory powers, and allowing all disputes between him and the coal-owners to be decided before a court, such as the bench of magistrates, it could not be reasonably objected to.

963. You do not think the inspection would be a matter of much objection? I think not, provided it were gentle and wholesome.

964. After a little time, do not you think that those Inspectors would assume rather an arbitrary power over the conduct of the mine?

I know, from being in daily communication with many of the mill-owners, that the Inspectors in that case become objectionable; I am not prepared to say whether such a result might not follow.

965. In the case of the Inspectors of Prisons, one comes one half-year and orders directly the contrary from the Inspector of the previous half-year?

There are, no doubt, many very grievous evils existing which would be immediately apparent to the eye of any Inspector, and which might be removed; but still I think the less power an Inspector can have, so that he sees there is no derangement or neglect in the working of the mines, the better.

966. The Factory Inspectors have powers of regulation?
 They have.

967. Therefore,

967. Therefore, if any Inspectors of Collieries were appointed, with nothing more than the mere power of examination, and no power of regulation, they would not be objectionable?

J. Darlington, Esq.
 25th June 1849.

I think the juries then would look upon the proprietor, and treat him as the common law does in France.

968. There is very little done by the coroner's juries, in case of accidents, to impose responsibility upon the owners?

I know that at the present time in the country, they are very little thought of in colliery inquiries: I do not know what they are elsewhere.

969. You have given us one cause of accident, the non-ventilation of mines in consequence of the royalty upon the small coal?

I think the royalty is a grievance, and that if it were removed, the proprietor would then have to pay 1*s.* or 1*s.* 6*d.* a ton on the coals for the colliers getting them; and, therefore, he would have an encouragement to ventilate his workings better than he now does, and would have a good fire in his furnace instead of a small one.

970. Or none at all?

Or none at all.

971. Do not you perceive that there would be a great difficulty with the Inspector in that respect; he would say, "Have a fire in the furnace to ventilate the mine." If the owner had to pay a royalty as in Lancashire, how would you regulate that?

I believe in some districts the royalty is allowed. My suggestion only applies to the furnace, not to the engines winning the coal; the royalty is allowed in both cases in Wales and elsewhere; but in the Lancashire coal-field it is not; and as there is no power to compel the proprietor to have a furnace, if he can do without one, he will.

972. Do you say that you pay a royalty on the coals used in the machinery?

We pay a royalty for all the coals, whatever purpose they are applied to.

973. In the iron concern, no royalty is paid for coals used in machinery?

I believe in some districts it is not; in Lancashire it is just the reverse; and for this and other reasons, where there are many small collieries, a great number of small accidents must occur.

The Witness is directed to withdraw.

Ordered, That this Committee be adjourned to Thursday next
 One o'clock.

Die Jovis, 28° Junii 1849.

The LORD WHARNCLIFFE in the Chair.

Evidence on the
Prevention of
Accidents in
Coal Mines.

G. Whieldon, Esq.

28th June 1849.

GEORGE WHIELDON, Esquire, is called in, and examined as follows:

974. YOU were lately High Sheriff of Warwickshire?

I was.

975. And you are an owner of collieries in that county?

I am.

976. Have you been long in the position of a lessee of a colliery?

Since the year 1826.

977. Whereabout is your colliery situated?

About five miles from Coventry; it is called the Hawksbury colliery.

978. What is the depth of the workings in that colliery?

It varies; but I should say that upon an average the shafts are about 150 yards deep.

979. And the extent of the workings?

Very considerable; I should say, from one end to the other, a mile.

980. Has that colliery been worked for a great length of time?

For a very great length of time; I should say for 60 or 70 or 80 years.

981. Have you some information to give to the Committee with respect to a fire which has lately appeared in that mine?

Fires have occurred recently in two of my shafts. I will begin by stating, that in the solid coal, the unbroken coal, no hydrogen gas whatever is generated; but I believe that carbonic acid gas is generated to a considerable extent.

982. Are you speaking of that particular coal, or of coal generally?

Of the coal generally in Warwickshire. I know the coal of Warwickshire. Mr. Newdigate is near me, and Mr. Dugdale, and two or three other proprietors, and their coal is all of the same quality. I should say that it is the carbonic acid gas principally which exudes from those mines, and not hydrogen gas; there is no explosive gas.

983. Then they are not what are commonly called fiery mines?

They are not, but still they are what are commonly called, according to local phraseology, breeding fires; it is self-combustion. I believe that the fires seldom take place there until the coals have been got; and when the coals have been gotten, the miners leave a considerable quantity of small coal, which is called slack, to support the superincumbent strata; and after that has been lying a considerable time, the fires are ignited in that mass of stuff which is left to support the roof.

984. Will you proceed to explain to the Committee the appearances which you say have shown themselves in your mine lately?

I have two shafts on fire at the present time; the one is what we call an iron-stone shaft, where the coal was got some 50 or 60 years ago, and the iron-stone (which lies under the coals) is now being got. In one of those old coal-pits, a fire broke out, about a fortnight or three weeks ago, and we were obliged to seal or shut up the pit, for the men cannot work in it; that fire originated in the

G. Whieldon, Esq.
28th June 1849.

old gob, or refuse coal and matter, which was left (as I before stated) to support the roof, which, after having laid a considerable time, ignites.

985. Does the word "gob" correspond with the word "goaf," as used in the North of England?

I dare say it does.

986. Is it the requisite space which is left for the support of the roof?

The gob is the rubbish or slack, or small coal, which is left to support the roof.

987. Does it ignite also if it is left above ground?

Yes, if it is loose on the bank; but then, of course, it is exposed to the atmospheric air, which contains a quantity of oxygen and hydrogen. But the great mystery and the difficulty to be accounted for is, how those fires should ignite in the pits where the carbonic or azotic gas is generated; because it does not support, but extinguishes fires; human life, when exposed to it, is soon sacrificed; and that is a very important point. When the miners are at work, if a stream of the azotic or carbonic acid gas exudes from the old refuse slack or gob, as they call it, it puts out their candle; and when the candle will not burn in those gases, human life cannot be supported, but must fall a sacrifice; therefore, that is a fortunate signal for the men to depart and go out of the pit, and they have frequently been brought up exanimate, or almost more dead than alive: but as soon as they are exposed to the atmospheric air, the lungs become properly inflated with it, and they soon come to themselves again.

988. Before going into the process of ignition, will you explain precisely, as far as you are acquainted with it, the conditions under which the present fire has occurred?

It is a very difficult thing to account for it; but I was speaking to one of my agents a few days ago, before I came to town, and he said that a part of the roof, of what is called the gate-road, or gangway, along which the waggons are sent down from the shaft into the workings, broke down, and there exuded an unwholesome air, which is called fire-stink, and the men were driven out.

989. Is that fire-stink sulphuretted hydrogen?

No doubt of it; and that came from what are called breeding fires, immediately above their work. The roof of the gate-road fell in, and then is opened a chasm for a considerable height, perhaps 14 or 15 feet, where a fire was generated; so that we were obliged, after trying various experiments, to seal up the shaft; the men could not go on with the work; and it has remained shut up until this time.

990. Has the fire been actually seen by yourself, or by your workmen?

It has been seen by the workmen, that is, in one shaft; it is in the shaft where we are getting the iron-stone, where no coal has been touched at all; the coal has been exhausted there 50 or 60 years ago.

991. What is the fuel for the fire?

The slack, or small coal, which was left to support the roof 50 or 60 years ago; all the solid coal was exhausted, and came up the shaft, and now the iron-stone is about seven yards below it. Then we were obliged to drive another gate-road below, and the refuse coal, or slack and rubbish, which was left to support the roof, when the coal was being got 40 or 50 or 60 years ago, took fire from self-combustion; and it burnt through the roof of the gate-road, which we drove to get the iron-stone, and down it went. It was a most fortunate thing that the men were not at work when it broke down, because if they had been at work beyond the place where the roof gave way, and fell in, they would have been sealed up. This is all I can state with respect to this particular shaft, which I call the iron-stone pit or shaft. I will now come to another coal pit or shaft, where the fire has ignited, and has stopped the work, at least in one part of it. I will make use of this figure—[pointing to a rough sketch on a piece of paper]—to represent another shaft, with a gate-road, leading to a certain distance, and with another branching out from it. It is rather a curious circumstance, that in one of these gangways, or gate-roads, as they are called, we meet with ignition, and what is called fire-stink, so that a man cannot work in it, but in the other there is no fire at all; we are getting another kind of coal, which is perfectly free from any unpleasant

unpleasant effluvia, or anything of the kind ; but, in the other, the fire has broken out, and has shut us up. That was ignited in the same way, I apprehend, as in the other case, namely, that it took fire of its own accord amongst the rubbish and small coal, which was left when the superincumbent coal was got above it. The coal in Warwickshire lies in four or five distinct veins or seams of coal, one above another ; we first get one out, then we drive another gate-road, and get another seam out, and so on, until we have got the whole ; and last of all we get the iron-stone, which lies under the coal. Now the desideratum would be, if Mr. Gurney, or any other scientific person, could discover a means of extinguishing these fires, by sending down, first of all, similar gas to that which exists in the coal, that is, the carbonic acid gas, to put out these fires, forcing it down by a forcing apparatus, in the same way as forcing-pumps with water ; and after they are extinguished, to force down the atmospheric air, for the purpose of purifying them again, instead of shutting them up two or three years. That would be a very important thing for the public. We are not much exposed to those dangers that exist in most mining districts, our gas not being explosive ; ours is not the hydrogen gas, but (as I stated before) the carbonic acid gas, which will extinguish fire : and the way in which the lives of the men are saved is, by ascertaining whether the works are in a fit state for them to go down, as, by sending down a lighted candle first ; if the candle will burn, the air is wholesome ; and if it will not burn, of course it will not support human life ; because air that will not support ignition will not support human life, and, therefore, if the candle goes out they come up directly, and they do not go down again till the candle will burn. When the atmospheric air is in a particular state, the candle will not burn for four or five days or a week ; when a favourable atmospheric change takes place, the air becomes purer for the underground workings, the candle will burn, and the men go to work again.

G. Whieldon, Esq.

28th June 1849.

992. Is that state of things dependent on the barometer ?

Very much indeed.

993. When the barometer is low, is the danger greater ?

Yes ; the barometer always falls for thunder ; and when it indicates thunder in the air, we know pretty well that the candle will not burn. The great discovery that was made by the late Sir Humphrey Davy of the safety-lamp does not apply to us at all. I received a few years ago a communication from Lord Warwick, which he received from Sir James Graham, and he sent me a copy of a report, and wished me to send my observations upon it ; but I told his Lordship that the remedies recommended in that report of the chemical and scientific persons who were sent down to visit and inspect the mines in the North, did not apply to us in Warwickshire at all, because the gas in those mines in the North was carburetted hydrogen gas, and ours was the carbonic acid gas.

994. But mixed also with sulphuretted hydrogen ?

Yes ; with what is locally called the fire-stink, which is, in fact, the sulphuretted hydrogen.

995. Would it not be important at those times to have some machinery for driving a current of atmospheric air rapidly through the mine ?

That is the very thing that is wanted ; and I was very glad to see in the newspapers, in the "Illustrated London News" particularly, a description of an invention by Mr. Gurney. I immediately directed my attention to it ; and I wrote to Mr. Darlington, whom I have seen this morning.

996. You are at work in a pit, which is now on fire, in a different gallery ?

It is not exactly on fire, but it is the fire-stink ; that is, the sulphuretted hydrogen.

997. But in a pit which is a common shaft to both galleries or gate-roads ?

Yes.

998. You cut off the communication between the two ?

Yes.

999. And you go on working ?

Yes ; we put doors, so that there can be no communication with that part where the sulphuretted hydrogen exudes.

G. Whieldon, Esq.
28th June 1849.

1000. Supposing you could drive atmospheric air through at your will, that would not be necessary at all?

The way in which the pits are ventilated is by having two shafts; there is a constant circulation of air between the two shafts; the cold air or the atmospheric air descends one, and the impure or rarefied and lighter air comes up the other.

1001. Do you use the agency of a furnace at the bottom of the up-shaft for ventilation?

No.

1002. Have you no means of assisting the ventilation?

No; except from the two shafts; taking care that what are called the air-courses are in a proper state; there is one man with a company under him, who is regularly appointed, called "The air-course man and his company," and they attend to all the air-courses; sometimes they extract dirt which has fallen in, and forms an obstruction, when there would not be a proper current of air; there is an under-ground bailiff over the air-course company, and they see that the air-courses are kept open, and if they are properly kept open, there must be a circulation of air.

1003. Then you are satisfied in those mines with the common natural operation of the currents, without any assistance?

Quite so.

1004. In your opinion what is it that creates the current of air?

The cold air will always drive out the warm air.

1005. What creates the current of warm air which produces the current?

It is quite warm down below from the breathing of the men, so that the air becomes rarefied and specifically lighter, and therefore the atmospheric air being much cooler and heavier drives up the warm air.

1006. What is it that causes the current?

I cannot exactly answer that question.

1007. Is it not that there is a difference of level between the bottom of the two shafts?

Not exactly so.

1008. Is there any difference of level?

No.

1009. Are the seams horizontal?

Yes; one pit is deeper than the other.

1010. Up which does the warm air rise; up the deeper or the shallower?

I think up the shallower; that which is called "The Basset-pit."

1011. Therefore the lighter air passes up the shallower shaft and passes out?

I rather think that is the theory; I am not quite clear about it; but we know perfectly well that where there are two shafts open, the atmospheric air will descend one, and drive the rarefied or lighter air up the other; and sometimes cold water is thrown down one shaft to cool the air in it, and a lamp or iron-cradle of fire is sent down the other to rarefy the air in it, so as to make it specifically lighter than the other, and thus cause a current of air through the works.

1012. The fact is that you have no artificial assistance for ventilation?

Not that I am aware of, excepting that we do occasionally use an instrument for sending pure or atmospheric air down the shafts and into the workings underground, when the air becomes too impure for respiration; that instrument is, in vulgar phraseology, called a "Blow-George," which is, in fact, simply a revolving fan, something similar to a "winnowing machine," and is worked by one or two men at a crank windlass; air-pipes or tubes are attached to that machine to conduct the pure air into those parts where the men are at work when they require it; but it would be a great improvement to substitute mechanical power for manual labour where improved ventilation is wanted, and it would no doubt be easily constructed and attached to the engine that works the shaft.

1013. Do

1013. Do you find, generally speaking, that the ordinary action of the currents is sufficient to keep your mine well ventilated?

G. Whieldon, Esq.

Yes; it has been ever since our mine was opened, which is nearly a hundred years, and it is only occasionally that these interruptions take place from the ignition of the old mines.

28th June 1849.

1014. You are pretty constantly obstructed by the fire-stink?

No; only occasionally.

1015. Have there been any accidents of men being killed from an explosion of gas?

No.

1016. You have not lost any men by their staying too long in the bad air?

No; there is always a warning; there is a signal when the candle will not burn; fortunately for us there is that warning; but where there is hydrogen gas, the moment it comes in contact with a candle or lamp an explosion takes place, and the men are killed; but with us there is a warning given, and then they either ring a bell or give a signal, and they are brought up directly; we have lost scarcely any lives.

1017. Within your recollection, has there been a man killed by an explosion?

I have not any distinct recollection of even one, but I am quite sure there have not been more than one or two.

1018. Then the air you employ is sufficient for your purpose?

Quite.

1019. It is sufficient for the purpose of the draughts you now have?

Yes.

1020. But occasionally you have seams which are obliged to be stopped up in consequence of their having bad air in them?

In consequence of these fires; when they occur, we stop them up, in order to extinguish the fires.

1021. Would it not be advantageous to you to be able always to work those seams?

Most assuredly.

1022. What is the heat of your pits below?

It varies considerably.

1023. So that, as you have before stated, machinery by which you could drive atmospheric air constantly through them at your pleasure would enable you to work the mine without any obstruction or difficulty?

It would be a very grand thing if we could do it; except that where these fires take place, the more atmospheric air you send down, the fiercer they would burn.

1024. But then, in the first instance, if you extinguish the fire by sending down air calculated for that purpose, and then filled it with atmospheric air, you would overcome that difficulty?

No doubt.

1025. If there were an efficient system of ventilation, is it not possible that you might prevent the occurrence of these fires?

No.

1026. What leads you to that conclusion?

The fact is, that those fires take place where no current of air could get to them.

1027. That is, you mean that no current of air could get to them in their natural state, except you resort to artificial means?

No, nor with artificial means; the thing is, to send down a powerful stream of carbonic acid gas to extinguish them; we are obliged to shut them up for a considerable time; sometimes for months, and sometimes for years.

1028. Will you explain how it happens that according to your account it would be impossible to pass a stream of air through those parts of the workings?

(164.4.)

G. Whieldon, Esq.

28th June 1849.

Yes; I think I have stated that in the illustration I gave; the coals have been got 50 or 60 years ago, or more than that; and two or three years ago I made use of one old shaft to get the iron-stone out, lying beneath where the coal had been extracted, and after working that iron-stone for a considerable time, say a couple of years, the fire took place above the roof of the gate-road or gangway; no air could get to that; it was perhaps 14 or 15, or 16, or from that to 20 feet above where the gate-road was driven.

1029. Above the working?

Above the working; you could not tell what was going on until it actually broke out; my idea is, that that fire was generated in the old refuse coal or slack, and so on, which had been got many years before, and that by some means or other self-combustion took place; whether it was by the decomposition of pyrites I do not know; most likely it was; and then the fire took place, and dislocated the superincumbent stratum, and down it went into the gate-road.

1030. You are quite satisfied that there could not have been any artificial means to kindle that fire?

I am certain of that.

1031. It could not have arisen from any artificial means?

No.

1032. Was that seam shut up?

The coal had been all got 50 or 60 years ago.

1033. Was it shut up at both ends, or was it open at both ends; it opened into the shaft, did it not?

We are below those workings.

1034. Did the old workings open into the shaft?

No.

1035. Then how did you get to the old workings when they were worked?

I was below them.

1036. How was the coal got from the old workings; was it not got through the same shaft that you are using now?

Yes, by means of the same shaft.

1037. Does not the old working open into the old shaft?

No.

1038. Then how could the coal be brought into that shaft?

It is all stopped up.

1039. After the coal was got out of the seam, and it was no longer of any use to keep it open, you shut it up at both ends?

Yes.

1040. If those stoppages at both ends had been taken away, you might have driven atmospheric air down the shaft, through it, and up the up-shaft?

No.

1041. Why?

They are filled up the whole length.

1042. Then that stuff took fire?

Yes.

1043. Was it in your power to ascertain to what extent the mine was on fire?

No; we cannot get at it.

1044. When you discovered that it was on fire, what steps did you take?

They lighted what is called a lamp to see if they could purify the air; they sent down an iron cradle with a fire in it; then they threw down lime, and they found they could not make any way at all; then they shut it up, and it is sealed up now.

1045. How was it shut up?

By scaffolding it over at the top.

1046. The

G. Whielden, Esq.

28th June 1849.

1046. The shaft is shut up?

Yes.

1047. You did not attempt to build up that point in the working below?

No.

1048. After you had worked out that seam, which subsequently took fire after being filled up with rubbish, what was the object of filling it up?

To prop up the superincumbent strata of the earth, or it would have fallen.

1049. You left pillars from time to time?

No; we put in props, and then threw back what is called the gob, or refuse coal or slack, and so on, and piled it up to the place where they got the solid coal, so as to be a support.

1050. Have you a heap of the small coal at the mouth of the vit on the surface?

Very little.

1051. Have you never had fire above ground?

Yes, the refuse stuff that comes out of the pit sometimes takes fire.

1052. Your pit at present is closed up?

Yes.

1053. From your experience of former accidents of this kind, supposing you had none but the ordinary means of extinguishing fire, how long do you apprehend you would be obliged to keep that pit closed?

It is impossible to say; sometimes a fortnight or three weeks, sometimes three or four months. It has never occurred to me, but I have heard of its being necessary to stop up a pit for two or three years.

1054. You have had fires in your own pits before?

I have.

1055. On those occasions, have you found that you were obliged to shut up your pit for any great length of time?

It has varied. Sometimes a fortnight or three weeks was sufficient, and sometimes it was stopped up for two or three months.

1056. Has it ever been necessary to throw water into your mine to extinguish the fires?

I think, once or twice.

1057. Generally speaking, have you extinguished the fire by merely closing the pit up?

Yes, by keeping the atmospheric air entirely from it.

1058. Then are you of opinion, that if it is possible to make use of some plan like that of Mr. Gurney, for the purpose of introducing carbonic acid gas into the mine, that would be a very great advantage to you in the extinguishing of fires of this description?

I should say that it would be of immense advantage in those mines where explosive gas is generated.

1059. The question refers to your own mine?

I scarcely feel competent to give an opinion; but I should think that if some apparatus were constructed to send down a powerful stream of carbonic acid gas, the fires which are generated there might be extinguished by it; and that afterwards a current of atmospheric air might be similarly driven through it, so as to make it wholesome and fit for men to work in again; I should think so.

1060. You have had a pit on fire which has been extinguished in the course of time, or has ceased to burn?

Yes.

1061. In what time?

I should say sometimes ten days or a fortnight; and I think it has been a month or two, but it has not occurred lately.

1062. When you open these places which have been shut up, has the fire burst out again?

Yes; it has occurred again at perhaps a year or two afterwards.

(164. 4.)

P

1063. A witness

G. Whieldon, Esq.
 28th June 1849.

1063. A witness gave the Committee the other day a description of a fire being shut off, and although the fire was extinguished, the atmospheric air coming on the heated surface, it was ignited again. Have you found that in your experience?

Assuredly.

1064. In the course of time the fire will exhaust itself?
 I should think so.

1065. In such a case, if after letting on the atmospheric air the fire should be restored, would it not be necessary to shut it up again?

If the fire ignites again, you must shut it up again.

1066. At last it will extinguish it entirely?
 Yes.

1067. When it burnt for a fortnight, it was only the slack coal that burnt a fortnight or three weeks?

No, we never have any fires in the solid coal, and that is, I think, an important point; I never knew of any; the fires have always been generated in the refuse stuff which has been left to support the roof.

1068. Has that in any instance communicated with the solid coal?
 Yes, and it has been very serious.

1069. You have stated that you have observed that it is when the barometer is low that there is a want of ventilation; have you ever observed whether the state of the wind, whether there is wind or no wind, affects ventilation?

When the wind is in a certain point, at particular times of the year, it will affect the air in such a manner as to make it unwholesome, so that a candle will not burn, nor can men breathe. I cannot (and perhaps it is not necessary that I should) say exactly what those points are; in that case, I go more by the information I get from my agents; when they come and tell me that such and such pits are not at work, and that the candle will not burn, I have said, "What is the cause?" and they have said, "The wind is in such a point."

1070. Then, in fact, where there is wind, there is a want of ventilation occasionally?

When there is wind in a certain point, and I should say with a humid atmosphere, that is, when there is a density in the atmosphere.

1071. Have you made use of any artificial contrivance, so as to avail yourself of the power of the wind, to produce ventilation under all circumstances; anything similar to what is used in steam-boats?

No, I should be very thankful to avail myself of any invention or discovery that might be made to apply it.

1072. One mode of producing a draught on a smaller scale for rooms, and so on, is a cowl, not turning from the wind, but turning to the wind; would not that answer the purpose to a certain extent?

I should think that it might very likely do so; I think that it would be worth the trial, at all events; it is a very simple thing.

1073. You stated just now, that when the wind was in a particular point the ventilation was less perfect; can you give an idea whether it was from the north or the south?

I think, as far as I recollect, it was from the west.

1074. Is there anything peculiar in the position of your pit; is it sheltered from the westerly wind?

No.

1075. Do you keep any register of the barometer of the winds in your office?

No, I do not.

1076. Can you explain the process by which spontaneous ignition takes place?

No, unless it is the decomposition of pyrites.

1077. Are

1077. Are the iron pyrites very frequent in your coal?

Yes.

1078. You say there is iron-stone below the coal?

Yes.

1079. Are you aware whether the dampness or dryness of the slack or gob makes any difference in its combustible tendency?

I should think that if moisture were applied to it, it would be more liable to ignite.

1080. Have you ever taken any steps to measure the velocity of currents of ventilation between the downcast and the upcast shaft?

No.

The Witness is directed to withdraw.

HENRY HUSSEY VIVIAN, Esquire, is called in, and examined as follows:

H. H. Vivian, Esq.

1081. YOU are connected with the mineral operations in South Wales?

I am.

1082. You have had considerable experience in the management of coal-mines?

I can hardly say that; we have large coal-mines, which have from time to time occupied my attention, and lately considerably.

1083. Have you had any serious accidents in that district?

We have in our district, but in our mines we have had none. When I say none, I believe that in the course of seven or eight years two men have been killed, or something of that kind.

1084. By explosions?

By explosions; we have never had a general explosion, but merely drifts that have been driving where the return air-courses were not holed.

1085. Where, precisely, are your coal-mines situated?

At Swansea, and also about 16 miles from Swansea.

1086. Are they worked at great depths?

Not at great depths; our deepest mine is 72 or 73 fathoms.

1087. What is the thickness of the coal?

The thickness of the coal varies from eight feet to five feet or four feet six inches.

1088. Is it much inclined?

Not there.

1089. Are your underground workings extensive?

They are extensive.

1090. What is the system of ventilation that you make use of for the purpose of keeping your mines clear?

We have little or no gas, and the system of ventilation is simply the natural system which is produced by the heated air of the mine itself; except under certain circumstances, when we use the waterfall.

1091. Will you explain what you mean by the waterfall?

Under ordinary circumstances, when the air is cold, the difference in weight between the ascending column and the descending column is considerable. In summer, when the external air is hot, or when the barometer is low, the difference between the weight of the two columns is lessened, and we then produce an artificial decrease of heat in the descending column by means of water. I believe, also, that it has a mechanical tendency, in driving the air before it.

1092. How do you drive it?

By allowing it to fall through the pumping-pit, which is the downcast pit; it is a simple fall of water down the shaft.

H. H. Vivian, Esq.
 23th June 1849.

1093. You do not spread it?

No, it spreads itself.

1094. Do you find that a convenient mode of effecting ventilation?

It is convenient, but I do not consider that it is sufficient. Our pits are always safe, although we desire to have more ventilation, and we are now adopting another method.

1095. Is it not an inconvenience and expense to be throwing water into the pit, when your principal object is to draw water from it?

Our engines are five times more powerful, perhaps, than is necessary for the duty they have to do, so that the small quantity which we throw in does not affect them; but I do not consider that it is capable of producing a very sufficient current.

1096. What quantity of water do you throw in?

I never measured it.

1097. Do you use a two-inch pipe or a three-inch pipe?

It is not done in that way; it is merely caused to overflow the top of the pump.

1098. When you spoke of some other artificial method to which you thought you should have recourse, had you any particular method in your eye?

I have lately been trying experiments on Mr. Gurney's steam-jet, and we shall, in all probability, adopt that first, at all events.

1099. As a trial?

Yes; there is no absolute necessity for our adopting any artificial method, because our mines are not in a dangerous state; I visited them all myself a short time ago, and tried almost every place, and there was very little foul air to be found.

1100. As far as your experiments have gone, with respect to Mr. Gurney's method, has it proved successful?

I think I should be misleading if I said that my experiments were sufficient; I think that, so far as they have gone, they have proved that very considerable quantities of air may be drawn, but I have never applied them yet to a mine, and I do not know what the resistance of the mine might be. I have some data here which I will submit to your Lordships upon that point.

1101. Upon what point?

On Mr. Gurney's jet; but these have been mere experiments on a boiler. My first experiment was to ascertain the power of the boiler; the experiment was tried with a Cornish tube-boiler 30½ feet long, six feet two inches in diameter; the tube three feet eight inches in diameter all through. I found that this boiler would keep a three-quarter inch square area open, with the safety-valve lifting at 50 lbs. My next experiment was to cause a box to be made, the area of which represented exactly two feet square; on the top of that box I placed a blast-pipe nine inches in diameter and ten feet high; I introduced a gas-pipe immediately under the centre of the blast-pipe, and I screwed jets of different sizes on the top of the gas-pipe. I have here a tabular statement of the result of the experiments which I made before I left home. I was called away from home, and when I heard that your Lordships' Committee was appointed, I immediately wrote home to request our resident chemist, who is a German gentleman, from the Freiberg Academy of Mining, to go on with the experiments, and he has sent me the results. I shall have daily results for a short time, and I will submit them to the Committee; they are very curious. They show that the thing has to be investigated as to the area which each jet is capable of supporting to give the utmost power. These experiments have been tried up to this time with a nine-inch diameter pipe, and a two-inch diameter pipe; singularly, the two-inch diameter pipe registers nearly no effect at all, while the nine-inch diameter pipe registers a high effect under certain circumstances. The one-sixteenth jet registers a power for a boiler of 56,000 cubic feet per minute, at a velocity of 3·2 feet per second; while the three-quarter jet registers a power for the boiler of only 1,415, with a velocity of 23·6. The one-eighth jet registers a velocity of 6·6 feet per second, which would give, when calculated on the whole boiler, a total power of 28,000, being exactly one-half of 56,000: there are four-sixteenth square in one-eighth square,

square, and therefore, of course, the difference. The quarter-inch jet registers a velocity of 9·6 feet per second, which gives a total power for the boiler of 10,000 cubic feet per minute. The probability is, that a maximum will be found for each jet. My object was to find what area of blast-pipe I ought to have to give the greatest efficient power to each jet. There was one very curious thing which I tried; I closed the opening of the box by placing a board before it; when the quarter-inch was on, and I found that I got a water-pressure of one and three-quarter inches, I then placed the anemometer in the box, and it produced a water-pressure of one inch, and a velocity of 11·3 per second against 14·7; so that there was a reduction of velocity from 14·7 to 11·3. In the one case, the whole area of the box was open; in the other case, only one inch was open at the top all the way along, and I had a water-pressure of an inch. I then arranged that a slide should be put in front of the box; but unfortunately they broke the water-gauge, and they have not been able to give me the result.

H. H. Vivian, Esq.

28th June 1849.

1102. Then the result of your investigations on this subject leads you to the conclusion that it would be desirable to make experiments of that mode of ventilation?

It leads me to the conclusion that it is a matter well deserving investigation, and on a practical scale connected with a colliery, because, although by artificial means I produced a drag on my current equal to one inch of water, still I cannot say that this is a real practical result, because it was merely a laboratory experiment.

1103. It was merely an experiment on a small scale?

Yes; at all events not applied to a colliery; and, on the other hand, I am not at all sure that with a nine-inch area blast-pipe, I have the whole efficient power of the boiler; I am led to believe that I have not; I think that by increasing to 18 inches I should get, perhaps, a great deal more; therefore it is hardly giving the thing a fair trial.

1104. Are you aware of the amount of current that you obtain in your mines by the ordinary method you have hitherto adopted of waterfall?

It is not used under ordinary circumstances; when the ventilation is sluggish, the water is thrown down the pit.

1105. You are generally satisfied with the ordinary action of the water in the mine?

Under ordinary circumstances it is sufficient for our mine, although I do not think it desirable to trust to it as sufficient in all mines.

1106. Are you aware what is the utmost amount of current that is obtained by the natural action of the difference of temperature?

That would depend entirely on the depth of the shaft; the power of ventilation by the ordinary action of the atmosphere is precisely the same as the furnace; the two things depend on identically the same principle; both depend on the weight of the air in the two columns.

1107. The principle is the same, but the effect is different?

The one is merely an extension of the other.

1108. Are there no mines in South Wales in which the furnace is used?

I do not know; our own district is the district I have principally visited in Wales.

1109. Then you cannot say what is the greatest amount of current in your own mines, for instance, that you have obtained by the method of ventilation you have hitherto pursued?

I have never measured it with an anemometer; but with a candle it has appeared a very fair current; it would depend entirely on the area of the openings, the distance the air was coursed, and the particular state of the atmosphere at the time.

1110. You cannot say whether it is two or three or four miles an hour?

I have never tried it.

1111. Are these pits under your own management?

They are worked by us, but there is a general head viewer of the whole.

H. H. Vivian, Esq.

28th June 1849.

1112. They are not leased ?

No.

1113. Are your workings in South Wales very contracted in the passages ?

No.

1114. What is the usual height and breadth of the passages of the mine ?

The horse-ways are usually taken down to the height of a horse, and under ordinary circumstances, we take as little of the roof down as we can in the working of coal.

1115. What is the breadth of your working seam ?

It varies from eight feet to four feet six inches.

1116. Does the same seam vary ?

Yes ; we are working exclusively the same seam in the collieries immediately adjoining Swansea.

1117. Does it vary suddenly or by degrees ?

It varies by degrees ; it varies in going to the south ; and, indeed, in the same colliery it varies.

1118. Does it get thicker or thinner to the dip ?

With us it is certainly thinner to the dip, but I do not think that can be taken as an axiom at all ; on the level courses, I have known the same seam vary very considerably ; there is one seam in South Wales which runs as high as 60 feet in some cases, and then again to six feet.

1119. Is that solid coal ?

Yes.

1120. Without any band ?

There are divisions in all thick coal.

1121. Are faults frequent or rare ?

In our immediate district ?

1122. Yes ?

There are, perhaps, 1,000 yards in our colliery nearly free from fault.

1123. Without a trouble ?

Without a trouble ; ours are large faults generally.

1124. Besides the method of ventilation that you have explained, what other steps do you take for the purpose of ascertaining the state of the mine, and of guarding against accidents by precautions ?

There is a very desirable precaution which we take ; it is the duty of the overman every morning to go down the mine some hours before the men go to their work, and to light a candle at the end of each stall where a man is required to work.

1125. What do you call a "stall" ?

A stall is where a man is working coal.

1126. Is it not always the practice that the overman should visit the mine before the men come in ?

I think this is rather more ; he is obliged to light a candle and place it at the end of each stall, so that the candle burning is the proof that he has tried it. We have scarcely any gas ; but if he had any doubt, he would try it with a lamp, and if he found that it was unsafe, he would place a stick across the mouth of the opening.

1127. Do you use the Davy lamp ?

We never work with it ; we have no occasion to do so.

1128. You work with the ordinary candle ?

Yes.

1129. The overman takes a Davy lamp ?

I believe he does. The rule is, that he should light a candle where every man is required to work, and the man when he comes down sees his candle lighted, and he then knows that his place is safe. I mentioned an accident which
happened

happened in one of our collieries. One accident was caused by a man losing his shovel and going with a naked candle about the mine for it; he got into old workings, and blew himself up.

H. H. Vivian, Esq.

28th June 1849.

1130. Was he killed?

Yes; he was cautioned not to go.

1131. Those were abandoned workings?

Those were abandoned workings, which were not particularly attended to at that time.

1132. Then the overman goes down with a naked candle generally, does he?

I am not aware whether he goes with a naked candle; I should fancy that he would take a Davy lamp.

1133. You say that he is bound to light these candles wherever he ascertains it to be safe; he must have some previous mode of ascertaining it to be safe before he lights the candle?

It is pretty well known whether a stall is dangerous or not. The exception is a dangerous stall with us.

1134. Does he know it by the smell?

No doubt he would know it by the smell, and probably he would try it before he went far.

1135. Has there been any accident recently in that district?

Yes; about two or three years ago there was a serious accident near us.

1136. Do you know how that occurred?

From the want of ventilation.

1137. From any want of caution on the part of the work-people, or from unavoidable causes?

I believe the mine was in so unsafe a state that anything would have exploded it.

1138. What mine was that?

A mine called Eaglesbush, to which Mr. Struvé's ventilator was applied.

1139. Do you know it personally?

Yes; I have been underground there.

1140. Was that accident attended with much loss of life?

With considerable loss of life.

1141. There was no artificial ventilation at all?

None whatever; and the mine was conducted generally on an unsafe principle.

1142. There was not even a waterfall?

It was a level colliery worked into the side of a hill.

1143. Are those collieries frequent in South Wales?

Very frequent.

1144. Are they more frequent than those with shafts?

It is difficult to answer that question.

1145. Do you ventilate them by shafts driven down the hill, or how?

They are ventilated by driving up in the hill to the surface, or by a shallow pit to the surface.

1146. From the upper end of the workings?

They would drive on the level course, and then drive up to where the seam crops. It acts in the same way as an upcast shaft.

1147. With respect to the overmen, who, you say, are employed to examine the pits, and on whom, therefore, the responsibility lies of allowing the workmen to go in the pits, what class of men are they?

They are colliers, but they are colliers chosen for their talent, and being careful men.

H. H. Vivian, Esq.
28th June 1849.

1148. In fact, they are mere working colliers?

They are mere working colliers.

1149. Chosen for their steadiness?

Chosen for their steadiness and ability; they are a very intelligent body of men.

1150. What degree of education have they received?

Scarcely any. I do not consider that it is at all necessary in a case of that kind, for it is a more mechanical matter. A man sees whether the candle has a top to it, and by experience he knows whether it is likely to be dangerous or not.

1151. Then do you imagine that no unforeseen circumstances could occur, in which it might be necessary for them to take steps at the moment requiring some greater knowledge of the causes of accidents?

I cannot conceive such a cause with us, at all events.

1152. You think them quite competent for their business?

Decidedly.

1153. And that they are well educated in that sense?

In that sense they are well educated.

1154. The viewer goes every day to look at the colliery?

Yes, the overman, who is a serjeant-major, goes and examines the workings generally.

1155. The overman has to measure the work of the men, and to look after them all day long, and see that they are at their work?

Yes; he is in charge of the colliery to a certain extent.

1156. Are the Committee to understand you to say that the viewer also descends the pit every day?

The head viewer would not descend the pit every day, but there is a resident viewer in most of our collieries, who, in all probability, descends the pit every day.

1157. He is called the under-viewer?

Yes.

1158. From what class of men is that officer drawn?

We have three large collieries; in one of those there is what is called a mine captain in Cornwall; I can hardly tell what amount of education he has, but he is capable of setting up an engine, or taking charge perhaps of the accounts of the men; he is in charge of one pit.

1159. He is a man of superior education to the overman?

Considerably, and of a different class; in another of our pits our head viewer takes the charge and considers himself responsible; another of our pits has not been very long at work, and the head viewer has the charge of that also; he has a son who assists him in many cases.

1160. On the whole, you conceive that the system which you adopt in South Wales for the purpose of superintending the working of your mines is sufficient for the purpose?

I am speaking now of the system we have adopted.

1161. Is the system which you adopt different in any essential particular from that which is generally adopted?

I am not aware of the system which is adopted in the hill districts, where most of the coal is worked.

1162. Are there any suggestions which you could make to the Committee with respect to improvements in the management of mines, as far as South Wales is concerned, your experience not extending to other districts?

I have visited the northern collieries.

1163. On a comparison of the system in the northern collieries with the system in South Wales, are there any circumstances which strike you, which would be improvements in the management of mines?

The northern collieries appear to me to be very efficiently managed; as far as our

our own are concerned, in our immediate district, with the exception of small collieries, they are, as far as I know, efficiently managed.

H. H. Vivian, Esq.

28th June 1849.

1164. By northern collieries, do you mean collieries in the North of England? Yes, in the North of England; the Newcastle district.

1165. Have you ever considered the question of the interposition of Government in the shape of some inspection?

I have.

1166. What is your opinion on that point?

I think it would be very desirable that a body of intelligent men should be appointed to report on districts, and perhaps, under certain circumstances, to give advice to coal-owners; to point out manifest defects, and to show how those defects might be remedied. To give those men any power in the direction of the mines, would be to take the responsibility off the shoulders of those on whom it really ought to rest, and it would also be a measure which I cannot conceive that coal-owners generally could possibly submit to.

1167. What power would you propose to give to the Commissioners?

Simply the power of inspection.

1168. To what extent would you give them the power of inspection as to the right of investigation?

I think it would be quite necessary that they should go down the pits.

1169. That they should have a right to do that?

Yes.

1170. And to see plans?

In both cases an Inspector ought to be honourably, at all events, bound, and perhaps legally bound (like an Income Tax officer), in no case to disclose that which he has ascertained by inspection.

1171. Except to the Government?

I mean to say irrespective of ventilation and safety; that ought to be exposed to the world, I think, most distinctly. In the case of collieries, it frequently happens that ground is very much intermixed, and a piece of ground may be perfectly essential to the mine; if that were known to the person who held the ground, it is very possible one might have to pay a most exorbitant sum for it. By using the map, a thing of that sort is brought plainly under notice; it is seen that the level course is running in a particular direction, that there is a field or a plot of ground which must be had, that the level course will go there, and arrangements are accordingly made for getting it; but if any one had access to the plans, and saw that such would be the case, it is very possible that he himself, directly or indirectly, might make arrangements for that piece of ground, and it might be a very serious difficulty.

1172. Or he might have an interest in that piece of ground?

He might have an interest in that piece of ground, and it might throw very considerable difficulty in the way.

1173. How would you propose to overcome a difficulty of that kind, because it appears to be necessary that the Inspector should have a right to examine the arrangements of the mine so exhibited in a plan?

If the Inspector is not locally connected in any way; if he is merely a Government Inspector, who passes a certain time in perambulating the country, and then goes back to London and makes his report, I do not think such things would be likely to occur, more especially if it was understood that he should not talk of these matters.

1174. Would it be possible to give him such plans as to enable him to judge of the system of ventilation of the air-courses, and of the mode of distribution of working, without giving him a plan actually of the extent of the property?

I think that would hardly be possible; in steep veins, the level course is a very essential feature, and it may turn here or turn there. I have known many instances where it was absolutely essential that a very small plot of ground should be taken.

H. H. Vivian, Esq.
 28th June 1849.

1175. But a mere plan of underground workings, disconnected from the plan of the surface, and without any opportunity of making calculations as to distances, would not enable any one inspecting such a plan to ascertain precisely how it interfered with property on the surface?

Yes; you see that the level course is turning north or south; besides which (I merely put a very simple case) there may be 150 other cases.

1176. Constant disputes arise from carrying water off one colliery and flooding another?

Yes.

1177. Is the coal you work all freehold coal, or is it intermixed with copyhold coal?

I can hardly answer that question; we have a vast number of leases.

1178. Supposing the Inspector were armed merely with a right to enter a mine, and to make a personal examination of the workings, do you think that would be sufficient to enable him to form an opinion as to the management of the mine?

I think it would be perfectly sufficient, on this ground: that it is utterly impossible that a mine can explode unless the air is loaded with gas; if the air is loaded with gas, it ought to be diluted, or the mine is not safe.

1179. Supposing that Commissioners or Inspectors were appointed by Government, having the power of entering mines for the purpose of personal examination, and of making suggestions to the managers of mines, do you conceive, so far as you know, that there would be any great objection felt on the part of that interest to the interference of such officers?

I can only say for myself that I should be glad to have the opinion of any man.

1180. Have you ever heard any opinion expressed by others in South Wales upon that subject?

I have not; I think that great care must be taken in appointing the Inspectors. I do not know a more difficult thing than to pick out a man; because if he is purely a scientific man, in all probability he will not stoop to learn practice, and he will jump to conclusions very rapidly, and frequently his conclusions will have no relation to expense. As a good example of this, I may mention, that one of the greatest men of the day, Professor Faraday, proposed a plan which it was considered by the South Shields Committee would cost from 20,000 *l.* to 30,000 *l.* in one colliery.

1181. Do you know anything of the South Shields Committee?

I have read the book.

1182. You do not know whether or not such a Committee exists?

I was alluding to the printed Report of the South Shields Committee; the proposition was to pipe off the gas, and it was considered that that would cost, besides being impracticable, from 20,000 *l.* to 30,000 *l.* in one colliery.

1183. You have referred to the benefits which would be derived from inspection; what benefit would arise to your mine by inspection?

I hope that our mine is in a safe state; I inspected it myself some little time ago; I went everywhere; I could find no top to the candle, and I hope, therefore, that it is in a safe state.

1184. With respect to those mines which are in a safe state, would it not be a great loss of time to the viewer, the Inspector, and the miners generally, to have their time occupied by Inspectors coming down to go over the mine?

I presume that the visits of Inspectors would not be very frequent.

1185. How many times a year, do you think?

There would probably be some radical defect in a colliery which would make itself apparent; a well-regulated colliery would not be different at any one time.

1186. Supposing a well-regulated colliery like yours, do you not conceive that it might be an advantage, from time to time, to have communication with a person well qualified for the purpose, who had been in the habit of examining other

other mines, and therefore was able to compare the different modes of management, and to make suggestions ?

I can only say that I should be delighted to have such an examination.

H. H. Vivian, Esq.

28th June 1849.

1187. You might sometimes obtain advantage by means of comparison between your mines and others ?

I think so, decidedly.

1188. Then with reference to that large number of mines which are not so well managed, do you not imagine that there would be considerable advantage in the visits of a well-qualified person who was able to judge of the actual condition of those mines from what he had seen elsewhere ?

I think so, decidedly ; you are trifling with that which is very precious, men's lives, and a vast number of men's lives.

1189. In the very instance of your own mines, in which you say that hitherto you have had nothing but a ventilation by a waterfall, which you consider to be rather inefficient, supposing that an Inspector had come to you before you had the means of hearing of any more perfect system of ventilation, do you not conceive that the visit of the Inspector in that case might have been of some advantage to you ?

I think it would have been a great advantage ; I do not think that our collieries are in the position in which I should like to see them, and into which I hope to get them.

1190. Then the visits of the Inspector, in such a case, if they did nothing else, would be likely to draw the attention of managers of mines to useful improvements ?

Decidedly ; but the great difficulty is in selecting a good man ; a scientific man who will stoop to practice, or a practical man who will raise himself to science.

1191. A good practical and scientific man would get better paid elsewhere, probably, than being an Inspector ?

That depends on the salary the Government are prepared to give.

1192. But as far as those parts of the duty are concerned, you would give him nothing more than a right of examining and communicating with the different parties, without any power of interfering by regulations ?

I think so, decidedly ; you ought not to take the onus of the responsibility off the shoulders of the proprietor ; and I think that any system of Government interference, from what I have seen on the Continent, decidedly tends to stop all adventure.

1193. What experience have you had of the collieries on the Continent ?

I have had very little experience of the collieries ; I have been down half a dozen pits in different parts, in Silesia and in Belgium, and in other places ; but I am now principally alluding to mining for ores of different kinds.

1194. Would the owners of mines, generally speaking, be averse to that limited kind of inspection ?

I should consider not.

1195. Supposing that the Government had already taken the step to appoint two well-qualified persons to proceed, in the first instance, to examine the actual condition of different districts, and in the next place to make any suggestions, or give any advice that might occur to them to be useful, should you think that a desirable step ?

I think so, decidedly ; but I cannot too strongly impress the necessity of the choice being a good one, and the difficulty of the choice ; it would be ridiculous to take a north-country viewer to the thick coal in Staffordshire, or to our district ; he would, perhaps, propose things which would be almost impracticable with us.

1196. You have stated that Government interference stops enterprise in sinking for ores on the Continent ?

I have.

H. H. Vivian, Esq.
 28th June 1849.

1197. Generally, all mines belong to the Crown and different States?
 They do.

1198. What is the extent of the power of the Government Inspector? Is there not first of all a dead rent, and are not the mines let on lease?
 I am speaking principally of Saxony.

1199. Does the Government Inspector direct the works?
 He virtually directs the works. The spirit of adventure is entirely at an end.

1200. That is a different species of inspection?
 Yes; it is a much more extended one.

1201. And much more authoritative?
 Yes.

1202. There is an absolute power of interference?
 Yes.

1203. There is the authority of the landlord, and the covenants of the lease?
 Yes.

1204. What is the state of ventilation in the foreign mines that you have visited, in Saxony, for example?

I have never visited the Saxon coal mines, but merely the mines at Freiberg in Saxony.

1205. You have spoken of your experiments on Mr. Gurney's plan; are you aware of any other methods of artificial ventilation which have been proposed?
 I have seen Mr. Struvé's.

1206. You have seen that in operation?
 Yes.

1207. Mr. Struvé's invention is a mechanical ventilation?
 Yes.

1208. Where have you seen that in operation?
 At Eaglesbush colliery.

1209. That is a colliery which you lately mentioned as being particularly liable to accidents?
 It was liable to accidents.

1210. And very ill ventilated?
 Yes, at that time.

1211. How long is it since you saw Mr. Struvé's invention in operation?
 Three or four months ago.

1212. Did you descend into the mine?
 I did.

1213. Did you find the ventilation very complete?
 I think it is hardly a fair mine to make a trial on, because it is a level colliery, as I stated before, which has been worked extensively to the surface.

1214. When you say a level mine, you mean a mine worked on a level?
 Yes, into the side of a hill. It is worked extensively to the surface. There may be, and probably is, very considerable leakage from the sides; so that the total quantity of air which is passed by the machine through the upcast shaft to which it is attached, is not at all the quantity of air which is going through the mine.

1215. Do you know at all what amount of current was obtained by it?
 I did not measure it, but I have heard it stated at above 13,000 feet.

1216. As you went through the workings, did it appear to you that the ventilation was stronger than that to which you had been accustomed in your own mines, which are ventilated merely by a waterfall?

I can hardly say that. I do not think that the mine was under such conditions as would fairly show the ventilation under ground.

1217. Have

1217. Have you been down in that mine before the apparatus was tried?
No; they are now working with naked candles, and before they were working altogether with safety lamps.

H. H. Vivian, Esq.

28th June 1849.

1218. Is it an extensive colliery?
It is not an extensive colliery.

1219. Had explosions taken place in that colliery?
One certainly, and I think two.

1220. How long ago?
Three or four years ago. One subject which I wish particularly to impress upon the Committee, is the extent to which the diameter of the shaft affected the power of ventilation in a mine. I have looked through the evidence which was given before the Parliamentary Committee in 1835, and the South Shields Committee, and I cannot see that that point was sufficiently made at any time; it has been a matter of mere *ipse dixit*; a person being asked whether he considers the shaft sufficient, he answers, that he thinks it is.

1221. Have you made any more precise experiments upon that point?
I have made no experiments; I have made a few calculations, to show the necessary velocity of the air in shafts of different diameters, for different quantities.

1222. What is the result of those calculations?
We will take a seven-foot diameter shaft, to draw 70,000 cubic feet of air per minute; it is necessary that the air should pass at the rate of 30·31 feet per second.

1223. Of length?
Yes; and in a 14-foot diameter shaft the air need only pass at the rate of 7·56 feet per second.

1224. That is less than one-fourth?
About one-fourth.

1225. That is for the same quantity of air?
For the same quantity of air; but the 30 feet would be a very brisk gale, and the other would be a gentle wind.

1226. Is it not very desirable, in the machinery that you establish, to have a mode of adapting it to the accumulation of foul air?
I think it is very desirable.

1227. In a certain proportion, between the foul air and the atmospheric air, that is safe, and in a certain proportion it is dangerous; therefore you would ascertain, in the first place, how rapidly it accumulated, and you would adapt the velocity of the current accordingly?
Certainly.

1228. In fact, a current moving at the rate of 30 feet per second would be too violent for the work-people?
I should think so, decidedly; but the system is now to split the air, and, of course, if you divide the air into different currents; you get a very much less velocity; this is a very desirable system, because the air does not then become loaded, and is not rendered so dangerous.

1229. Is that the system in the collieries in South Wales?
Not at present; a short time ago I sent our head viewer to the North of England, and he visited a number of collieries, and we shall introduce that system.

1230. Supposing that a well-qualified Government Inspector, some years ago, being well acquainted with that system elsewhere, had, upon an examination of the South Wales collieries, suggested the expediency of splitting the air, might not that have been a very useful part of the Inspector's duties?
Decidedly; if it had been carried out, it would have been very useful.

1231. He then would have brought that improvement to the knowledge of the coal managers in South Wales, which might not have come to their knowledge otherwise?

Yes; in some cases, it certainly would not.

H. H. Vivian, Esq.
28th June 1849.

1232. The object is to change the air as completely as you can, and with as little current as possible, is it not?

The object is to pass fresh air to all the miners, where naked candles are in use, and to take the loaded air into other parts of the mine, where it is not brought in contact with naked candles.

1233. You get the fresh air to where the men are working?

Yes; we carry the fresh air to them in all cases.

1234. The result of the calculations you have made seems to show that the difficulty of ventilating properly in a shaft of small diameter is much greater than in a shaft of large diameter?

Yes.

1235. Will you put that table in evidence?

Yes.

The Witness delivers in the following Table:

VELOCITY with which different Bodies of Air must pass through different Areas.

| Diameter of Shaft. | Area of Shaft. | 10,000. | 20,000. | 30,000. | 40,000. | 50,000. | 60,000. | 70,000. | 80,000. | 90,000. | 100,000. |
|--------------------------|----------------------|----------------------------|----------------------------|----------------------------|----------------------------|----------------------------|----------------------------|----------------------------|----------------------------|----------------------------|----------------------------|
| | | Velocity per Second. | Velocity per Second. | Velocity per Second. | Velocity per Second. | Velocity per Second. | Velocity per Second. | Velocity per Second. | Velocity per Second. | Velocity per Second. | Velocity per Second. |
| 3 ft. 6 in. | Sq. ft. 9.62 | 17.2 | 34.4 | 51.6 | 68.8 | 86. | 103.20 | 120.40 | 137.60 | 154.80 | 172.00 |
| 7 - | 38.43 | 4.33 | 8.66 | 12.99 | 17.32 | 21.65 | 25.98 | 30.31 | 34.64 | 38.97 | 43.30 |
| 9 - | 63.61 | 2.62 | 5.24 | 7.86 | 10.48 | 13.10 | 15.72 | 18.34 | 20.96 | 23.58 | 26.20 |
| 10 6 | 86.59 | 1.92 | 3.84 | 5.76 | 7.68 | 9.60 | 11.52 | 13.44 | 15.36 | 17.28 | 19.20 |
| 12 - | 113.10 | 1.62 | 3.24 | 4.86 | 6.48 | 8.10 | 9.72 | 11.34 | 12.96 | 14.58 | 16.20 |
| 14 - | 153.94 | 1.08 | 2.16 | 3.24 | 4.32 | 5.40 | 6.48 | 7.56 | 8.64 | 9.72 | 10.80 |

At from 2.93 to 4.40 feet per second, wind is just perceptible.

| | | |
|------------------|-----|----------------------|
| „ 5.87 to 7.33 | „ „ | gentle and pleasant. |
| „ 14.67 to 22.0 | „ „ | pleasant brisk gale. |
| „ 29.34 to 36.67 | „ „ | a very brisk gale. |
| „ 44.01 to 51.34 | „ „ | high winds. |
| „ 58.68 to 66. | „ „ | very high winds. |
| „ 73.35 | „ „ | a storm or tempest. |
| „ 88. | „ „ | a great storm. |
| „ 117. | „ „ | a hurricane. |

1236. Are the ventilating shafts, in your mine, the same as are ordinarily used for raising coal?

They are; the downcast shaft is the pumping-shaft, and the upcast shaft is the winding-shaft.

1237. You only draw from one shaft?

Yes.

1238. Is it one shaft, or a divided shaft?

Two shafts; there is a distance of 20, or 30, or 40 yards between the pumping and winding pits.

1239. Have you a great deal of water in those pits?

In one we have a considerable quantity.

1240. Have you ever known any instance of spontaneous combustion in the coals in South Wales?

We are not in the habit of gobbing the coal; we bring all the small coal to bank.

1241. Gobbing the coal is heaping up the small coal?

Heaping up the small coal under ground.

1242. Did you ever know that small coal take fire on the surface?

I have known it take fire in vessels frequently, and also after being exposed for a considerable time on the bank.

1243. Does

1243. Does that small coal contain much iron pyrites ?

Yes, in all cases.

H. H. Vivian, Esq.

28th June 1849.

1244. Do you think that there is reason to conclude that the iron pyrites are the cause of the spontaneous combustion ?

Decidedly.

1245. That is generally understood ?

I believe there is no doubt of it.

1246. You have never had any case of that kind under ground ?

It never occurs with us ; we never leave it there.

1247. Have you ever known any case of fire below ground ?

I have seen a very extensive fire in Silesia, on the borders of Poland, below ground.

1248. But none in South Wales ?

No.

1249. There has never been an instance of that in South Wales ?

No.

1250. What means are adopted in the mine in Silesia ?

It has been on fire for a very considerable number of years, I believe 60 or 80 years ; they have driven in the direction of the fire behind it, and they will cut it off by that means. They flood behind, so that it will gradually burn down to water, and they also carry water down upon it ; but it is very extensive.

The Witness is directed to withdraw.

JAMES DARLINGTON, Esquire, is called in, and further examined.

J. Darlington, Esq.

1251. IN your last evidence, you gave an account of your proceedings, in the case of two separate fires which occurred in your coal-pits ?

Yes.

1252. You stated that in the second case you adopted a different mode for extinguishing it, from that which you adopted in the first case ?

Yes.

1253. Will you explain to the Committee the reasons which induced you to depart from the course you adopted in the first fire, and to adopt a different system in the second ?

The first fire was in the air-course ; we could therefore throw the choke-damp easily upon it, making the choke-damp at the surface by means of a furnace. The second fire was out of the air-course, in a dead working ; on account of being above the level, the lightness of the gas made it rise into the dead working ; we could approach it better by confining it, and it was on that account we used a different process.

1254. Was one of the principles on which you acted, that that process enabled you in the case of the second accident to extinguish the fire in that part of the mine separately, while you were making use of the remainder of the mine ?

We could not only make use of the remainder of the mine, but we could approach the fire more directly on account of its being above the air-course.

1255. Therefore, the difference of your proceeding in the second case did not arise from any misgiving as to the successful result of Mr. Gurney's application in the first instance ?

The first experiment is certainly most desirable, if it could be accomplished, being done at much less expense. The choke-damp is manufactured at much less cost than carbonic acid gas, which would be very expensive to fill the whole of the mine ; by the furnace operation it can be made at a very small cost indeed.

1256. So that wherever it is possible to apply the first process, that is the most desirable ?

Yes, but only on account of its cheapness ; it is the cheapness which makes it so desirable.

(164.4.)

q 4

1257. Did

J. Darlington, Esq.
 28th June 1849.

1257. Did Mr. Gurney, on the occasion of these fires, examine by analysis any of the gases?

The two shafts were frequently analysed, and the quantity of the gas was ascertained; it exploded if it contained the carburetted hydrogen; if it was choke-damp it put the light out. The pneumatic trough was used for this purpose.

1258. Have you heard anything about the pit since you were here last?

I heard this morning from the viewer that the pit was in a very favourable state; that everything was going on right, and as well as could be desired.

1259. Upon what footing was it that Mr. Gurney was employed by you? Did he receive any remuneration for the services he rendered you?

He received no remuneration whatever; he was not desired to come down; he saw that a valuable experiment might be given to the public, and that there was a favourable opportunity; this induced him to come down.

1260. And he made no objection to your publishing the particulars of the operation?

None whatever.

1261. The expense was very trifling?

The expense was very trifling.

Vide Appendix I.
Plan No. III.

1262. This is a representation of the process adopted in your first fire prepared by Mr. Gurney—[*exhibiting the same*—]—does that correctly represent the operation as it took place?

It represents the first operation; it has no connexion with the second.

1263. Will you deliver it in to the Committee?

Yes.

The Witness delivers in the same.

The Witness is directed to withdraw.

Mr.
E. N. Fourdrinier.

Mr. EDWARD NEWMAN FOURDRINIER is called in, and examined as follows:

1264. YOU are the son of the inventor of a very ingenious process in paper-making?

I am.

1265. You have lately devoted yourself to the consideration of accidents occurring in mines from the breaking of ropes?

I have.

1266. Will you inform the Committee what led you, in the first instance, to turn your attention more particularly to that subject?

I had seen accounts of many accidents, and, being a little bit of an amateur mechanic, an idea struck me that the load might be arrested in the pit by means of guides.

1267. Having had your attention drawn to this particular subject, did you succeed in devising a method which you thought would be successful for the purpose?

I did.

1268. Will you describe that method?

The method is to require guides down the pit; we first did it in Staffordshire; we put down two chain guides.

1269. In what mode did you attempt to prevent accidents from the breaking of the ropes?

By a cross-bar, reaching to the extent of the guides, which surrounded the guides, and was cut in a shape to appear like a wedge, and inside that cross-bar, at each end, we had two wedges, cut in the same way, tapering on one side, and with the chain concave on the other; these wedges were attached to two levers, each working on a fulcrum. The apparatus was fastened to the cage, in the first instance to the bottom; by lifting up the ends of the levers farthest from the

the

the guides, we threw the wedges down, and the consequence was, that the small taper of the wedges were forced into the large taper of the cross-bar, and the apparatus moved perfectly free and certain.

Mr.
E. N. Fourdrinier.
28th June 1849.

1270. Does it stop the load by attaching itself to the sides of the shaft?
No, merely on guides.

1271. You first had guide-chains, and afterwards you had guide-rods?
The first which we tried above ground was with an iron rod; and the reason of using chain was a communication which we received from a gentleman in South Wales, Mr. Kirkwood, who had seven men killed; to know whether we could arrest or stop the cage on chains, we immediately borrowed some chain from Mr. Sparrow; we put it to the apparatus, and with the same wedges and cross-bar we stopped on chains; and we have it in work in Staffordshire on chains.

1272. Then, in order to bring your invention into operation, besides the ropes which bear the load, you must have guides of some description?
Yes; where there are no guides already.

1273. What do you mean when you say "where there are no guides?"
In some pits they do not work by guides; but in all the large pits in the North of England, where the mines are very deep, and where they work very quickly, they cannot work without guides; and I consider that it is a great advantage to work with guides.

1274. Have they got rods in which the cage slides, in which cage the corve is lowered and brought up?
Yes, and my apparatus is now attached to the top of the cage.

1275. The ordinary guide is merely intended to keep the load in a direct line?
Yes, to prevent its knocking about the pit; I believe it is seen that it is a great advantage, without any reference to my machinery, because it knocks the pit about very much; and I know that when men go down, they first kick on one side of the pit and then on the other, to keep themselves steady. When the rope is in tension, it pulls up these ends—[describing it]—and the moment the rope is disengaged or becomes slack, from breakage, these ends of the levers fly down, and the other ends fly up; then the larger taper of the wedges go into the smaller taper of the cross-bar or shoes, and clip the guides.

1276. Have you practically introduced that apparatus into any colliery?
I have.

1277. Where?
At Usworth, near Newcastle-on-Tyne.

1278. Whose is that?
Elliot and Jonassohn's.

1279. It is applied in the Usworth colliery?
Yes, since the 16th of April last.

1280. Has it been in constant use since that time?
It has.

1281. Have there been any cases in which it has actually prevented accidents?
There were two accidents prevented with a load; and last Monday, I believe, we saved the lives of two men. We had another trial on Monday, and I have a certificate from some gentlemen who had not seen it before, who were very anxious to see it, and I believe we prevented an accident; I was told so by the men. This is a fac-simile of the Usworth cage—[producing a model].

Vide Appendix I.
Plan, No. V.

1282. What is the depth of the mine at Newcastle?
One hundred and seventy fathoms.

1283. How long is the cage in coming out?
I think it comes at the rate of 15 miles an hour.

1284. Can you come up as quick with that machinery as in a pit with a wind-shaft?
Yes; they have a shoe similar to this at the top of the cage, and we take that shoe off, and put mine on.

Mr.
E. N. Fourdrinier.

1285. There is no resistance?

Not the slightest.

28th June 1849.

1286. In point of fact, does it make any alteration in the rapidity of the motion, or can you bring up the cage as quickly, having your addition to the machinery, as before?

Yes; it does not make the slightest difference; they have two cages in each pit, one up and one down, and the kepts at the first seam.

1287. What are the kepts?

A sort of stops on a lever, which is thrown back by the cage passing up, and then falls into its place, and holds the cage while they draw the waggons out; and then it is a boy's or a man's place to pull the lever back, and down it goes again, instead of throwing over bridges, as they do in some parts of Staffordshire. When they come to the first seam, the guides are discontinued on each side; the cage then takes corner guides, or what is called reversing guides, to keep it in a proper position to enter the guides again, which it perhaps would not do; when it got there, the man did not put the kept out sufficiently, but it hung on a little of the kepts. Of course the engineer did not know; he was pulling up the other cage, and a man in it, and he kept lowering down the rope on the cage; she held as long as she could; she dropped all through where there were no guides, until she entered the guides again, when she immediately stopped; and Mr. Elliot told me that it was a hundred to one that as soon as the weight got to that rope, it would have snapped the rope, and down it would have come.

1288. Is Mr. Anderson the viewer of the pit you refer to?

No; Mr. Elliot is the viewer, and the owner.

1289. Has that invention been adopted in many instances?

We have been waiting until we could get it fairly tried in the North of England, and now we are putting one to Mr. Bell's pit, which is the deepest pit, I believe, in the world; it is nearly, or quite, I believe, 1,800 feet.

1290. At Sunderland?

At Monkwearmouth.

1291. It is an apparatus that costs very little, is it not?

The apparatus will cost very little. I said that if some of the principal viewers or owners would meet, I would leave them to say what should be the remuneration. Not only should the saving of life be taken into consideration, but the saving of property, because the rope generally breaks oftener with a load than with the lighter weight of men; and if that is the case, great damage is done to the workings.

1292. Where is your business carried on?

In Staffordshire.

1293. Has there been that meeting of the viewers to which you refer?

No.

1294. Has it been tried anywhere but at Usworth?

It has been tried in South Wales.

1295. Under your own eye?

No, my brother's; and at Hanley, in Staffordshire.

1296. You have yourself seen it?

I have seen it several times tested.

1297. Was it before that time introduced in the North?

It was first introduced in a small pit in the Staffordshire Potteries, but it was not a coal-pit; it was a pit which was merely sunk; it was Mr. Sneyd's pit; and Mr. Brindley, his viewer, thought, as we should want to try experiments, that was a pit to which any gentleman might come, as it did not interfere with their work.

1298. Then, as far as your experience has gone in these cases, your invention has answered all your expectations?

It has never failed when it has been called into action. There is another great desideratum, and that is the action of the springs; it gives the ropes an artificial elasticity, especially a wire rope; it lifts the load at twice instead of directly; we put the springs one-and-a-half or two hundred weight less to carry than the actual

actual weight of the empty cage. When it goes on to the kepts at the top and bottom of the shaft, it goes into action, and the consequence is, that it gives an elasticity to the rope, which it has not in the other instance, and prevents the sudden jerk when taking the lift, which so endangers the ropes.

Mr.
E. N. Fourdrinier.
28th June 1849

1299. Would it not be a great economy in the working of mines, because one of the heaviest expenses is the wear and tear of the baskets and cages in which the coal comes up; have you calculated it in that way?

Yes.

1300. What is the result?

I have not calculated it as far as that.

1301. You say that in the collieries in the North they almost universally make use of these guides?

They do.

1302. Even before the introduction of your method?

Yes.

1303. But in the case of other collieries, where that is not the practice, it would be necessary to introduce guides of some kind?

Yes.

1304. What do you suppose would be the cost of placing two guides of that kind in a shaft?

About 3s. a fathom; that is for chains.

1305. Is that for a single chain, or a double chain?

For a single chain.

1306. So that you must double that?

Yes.

1307. In the case of the Usworth Colliery, has the snatch-block, which is intended to guard against the engine, been introduced?

Not when they are working; the men do not like the look of it at present; and what Mr. Elliot proposed was this: to have two strong balks of timber put across at the top of the "head gear;" to have them sufficiently wide apart for the rope to go through, and to put a bar to the end of the rope, wider than the space between the balks; and he said, "If they choose to do it, let them break the rope, and that will do away with any fear;" the men would have it, that it might be hit when it had no business to be.

1308. Then the breakage of the rope brings the other invention into action?

Yes.

1309. Do you propose lifting it by a chain or a rope?

Either; it makes not the slightest difference.

1310. Which breaks the more seldom, the chain or the rope?

I do not know.

1311. What was the reason for the workmen objecting to this part of the machinery?

Because they had not seen anything of the kind.

1312. There was no objection made to it?

Not at all; I had it on a Monday; we tied a rope to the end of the lever; they fancied that something might hit it; we had a rope tied to it slack, and they pulled us up, and then let it down; as soon as the rope got tight, the lever opened the jaw, and we stopped; Mr. Elliot's brother, Mr. Mather, the Secretary of the South Shields Committee, and Mr. Arkley, were in the cage with me.

1313. Have you tried it several times in your own person?

Twice; and I also saw five men stop; a boy some time back, at Sneed-green, pulled himself off for a joke; and a drunken man, a collier, did the same with the five men in it.

1314. What would be the cost of the apparatus for a mine 100 fathoms deep?

It depends on the width.

1315. A seven or eight feet shaft?

The cost of the apparatus would be from 12l. to 14l.

(164. 4.)

R 2

1316. The

Mr.
E. N. Fourdrinier.
28th June 1849.

1316. The wood-work ?

I do not know ; I have not calculated that.

1317. The paper-making machine was an invention of your father's ?
Yes.

1318. You have a patent for this invention ?
Yes.

1319. It is not open to the public at all ?
No ; and I have also a patent for it in France and Belgium.

1320. Is it in work there ?
No.

1321. It has not been experimented there at all ?
No ; we were anxious to get the thing perfect ; and the Marquis of Londonderry's principal engineer said the other day, that he would defy any man to improve upon it.

1322. Who is he ?
Mr. Thorman.

1323. How soon can you unload it and start it again ?
It does not interfere with unloading at all.

1324. Of course there would still remain the danger to the men of the fragments of broken rope descending upon them ?
The men are inside the cage, and are protected by the top of the cage.

The Witness is directed to withdraw.

Mr. J. Fourdrinier.

Mr. JOSEPH FOURDRINIER is called in, and examined as follows :

1325. YOU are the brother of the last Witness ?
I am.

1326. You have seen this invention in operation in South Wales ?
I have.

1327. How was it applied there ?
To the guides then arranged in the pits.

1328. What were those guides ?
Chains.

1329. Not fixed guides ?
Chains bolted to a balk of timber at the top of the pit, and to one at the bottom.

1330. Were they inserted for the express purpose, or were they there before ?
They were in constant work previously.

1331. Did you find those chain-guides answer equally well with the fixed guides which have been referred to as existing in the North ?
Yes.

1332. Where was the pit ?
Near Swansea.

1333. Belonging to whom ?
To Mr. Kirkwood.

1334. When was it introduced there ?
In May 1848.

1335. Has it been in operation there ever since ?
Yes.

1336. Did you make experiments upon it yourself personally ?
Yes, similar to that which my brother has been describing, in the presence of several influential proprietors in the neighbourhood ; the weight of load and cage being 32 cwt.

1337. Was

1337. Was the basket in a cradle?

A cage, carrying one waggon.

Mr. J. Fourdrinier.

28th June 1849.

1338. These chains were used as guides before the invention was introduced?
Yes.

1339. And you found that the substitution of chains for fixed guides made no difference in the success of the invention?

Not at all; we fitted up the first apparatus with iron rods, and we then took out the iron rods, when Mr. Kirkwood requested us to make the chains do, and we put the chains in without altering the wedges, and they answered equally well.

1340. Are you aware whether it has had the effect of preventing any accidents since it was put up?

I have not heard.

1341. But you actually tried it yourself?

Yes, several times, and it stopped within four inches.

1342. Have you heard from the owner of that colliery, since it was put up, upon the subject?

No.

1343. Was there any objection made on the part of the men to the use of it?

Not at all; they cheered when it was in operation, and they saw the cage disengaged from the rope.

1344. Was the snatch-block also introduced?

They had a similar objection to its use as the men at this pit in the North; they fancied it opened with too much facility.

1345. Then that part of the invention is not in operation?

No.

1346. Your trial of it in South Wales has convinced you that it is perfectly successful for its object?

Yes.

The Witness is directed to withdraw.

WILLIAM BRUNTON, Esquire, is called in, and examined as follows:

W. Brunton, Esq.

1347. YOU have turned your attention to the ventilation of mines?

I have.

1348. Where are you living now?

At Newport in South Wales.

1349. Will you state what is your business, and what induced you to devote yourself to the subject of the ventilation of mines?

In the early part of my life I was in the employ of Boulton & Watt, and for 50 years, as a civil engineer, I have been generally engaged upon the application of machinery to mining operations; and, therefore, I have had opportunities of seeing the mode of ventilation in almost all the districts of England, and in Scotland also.

1350. Was the result of your observations such as to convince you that the system of ventilation in the colliery districts of England was generally defective?

Yes; and that induced me to turn my attention to something which would be a substitute for the furnace now used in collieries.

1351. Will you describe to the Committee what is the plan which you recommend as preferable to the furnace for the purpose of obtaining sufficient ventilation?

This is a drawing of the apparatus—[*exhibiting the same*]—and I have a small model which will further illustrate its operation; this is a drum—[*referring to the drawing*]—(which, in one that I erected for Mr. Powell, is 22 feet in diameter); made of sheet iron; this is the section of it; these upright lines—[*referring to the section*]—are only the interior edges of the radial divisions. This revolving drum is placed upon an air-course which communicates with the upcast shaft, and it stands as it is here represented. This is a circular wall of masonry eight feet diameter inside, concentric with the drum, and reaches to within two inches of the lower part of it. The two-inch space is filled with clay, and is thereby made

*Vide Appendix I.
Plan No. VI.*

W. Brunton, Esq.

28th June 1849.

sufficiently tight, so that when, by the revolving of the drum, a considerable rarefaction is produced, there is no leakage worth speaking of at this part; this is turned round, and in turning, the drum in its revolutions charges the air through the radial openings with that degree of force which is due to the velocity of it, upon the principle of centrifugal force; and in calculating the centrifugal force, I take the medium diameter of the radial compartments; and I find it answers perfectly to theory, that is, the quantity of air discharged is exactly proportionate to the velocity which theory would give it.

1352. Then the air enters these compartments and passes out at the edge?

Yes, as shown by this dart; and that is the plan of it—[pointing to it on the drawing].

1353. It is perfectly level at the top?

It is perfectly level at the top; this shows the top, and this is the bottom; this shows the outside of it, and these are the openings as represented.

1354. And this is a representation of the way the metal comes down to a point?

Yes.

1355. These lines represent in perspective the slope of the lower edge of the radial compartments?

Yes. The model I now produce will exhibit the principle or the construction of it—[producing a model]—this, in actual operation, is turned upside down, and I put it in this way to demonstrate its power; this will show the operation of it, and the air discharged will be always with that degree of force which is due to the velocity with which it is turned.

1356. Is the moving power a steam-engine?

Yes. I am now going, by this model, to show the power of the centrifugal force; the area of this disk or little piston just happens to be the 23d part of a square foot, and this—[showing a weight]—is a 23d part of a pound weight; therefore, if I put this in to the opposite end of the balance and turn the drum until one overcomes the other, we know certainly that the pressure is equal to one pound on the square foot. In the paper I now deliver in is a statement of the size of this model—[the Witness delivers in a printed paper]—and a theoretical statement of its performance; the driving pulley is ten times larger than the little pulley on the spindle of the drum; if I turn the driving pulleys 58 times per minute, I know that necessarily the drum revolves 580 times, and that will be found to be very nearly the velocity with which it raises that weight. I will put in another of equal weight; therefore the pressure on the square foot when these are raised will be two pounds upon the square foot; and it will be found, upon looking at that paper which I have put in, that it is stated, that the velocity of the one is 580, and that the velocity of the other is 830; it is a curious corroboration that the squares of these numbers are just as 1 is to 2.

Vide Appendix C.

1357. Applying that to a shaft, if you left the shaft open and unimpeded, the effect, according to that experiment, would be to throw air in, not only from the mine, but from the open mouth of the shaft, would it not?

This is connected, as will be seen by the drawing, with the upcast shaft, and the upcast shaft is closed at the top.

1358. Then the upcast shaft could not be made use of either as a drawing shaft or as a driving shaft?

It might be made use of in either way.

1359. Not if it were closed at the top?

We do that by this means: on the top of the pit for drawing coal we have a moveable platform, which is raised on the top of the stage when it comes to the top of the pit, and closes again when the stage descends; and while it is up, the top of the pit is closed by the stage.

1360. That would not be an air-tight closing?

The rarefaction produced by this apparatus is so great that if, during the time the stage is at the top, there were a hole as large as a yard square, it would make no difference.

1361. For all practical purposes it is sufficiently air-tight?

Yes—[again showing the model, with the inlet covered with a paper]—it takes scarcely any power at all; the drum is merely a fly-wheel, and has no resistance; but

but the moment the paper covering the inlet of the air is taken off, or any part of it is taken off, the resistance increases, and immensely so when it is all off. There is a table showing the number of revolutions, the centrifugal force, and the rarefaction of so many pounds to the foot, the statical pressure in inches of water, and also in inches of mercury.

W. Brunton, Esq.

28th June 1849.

1362. So that with 200 revolutions per minute, you would get a pressure equal to 9½ inches of water?

Yes; but we have far more rarefaction than is ever to be attained, or than I have ever seen by the furnace. I was in the North in the month of November last, and at the Haswell Colliery, where they have two furnaces; each of the pits is 900 feet, and there I conceive the furnace is at a maximum with regard to power; and I proved to them that all the pressure they had to propel their air, or to draw the air through the whole of that colliery, was under eight pounds on the square foot.

1363. That was the utmost they could attain?

Yes; and that I ascertained by this very instrument—[*producing the same*]—which I applied, and I will now apply it to the model—[*having done so*]—there is absolutely produced by this little model a greater rarefaction than was produced in the Haswell pit at the time I was there, for it was only one inch and a half.

1364. There was only one inch and a half when you saw it?

Only one inch and a half; at Mr. Powell's pit we produced two inches, with 90 revolutions in a minute. I wish to exhibit the capability of this machine as a means of rarefaction; I have seen the most powerful furnaces in England, but I have never seen anything which would produce rarefaction, even one-third part of that which can be produced by it. The machine, of which I have produced a drawing, when I shut the ingress of the air at the foot of the downcast shaft, in less than five minutes the whole of the colliery was rarefied to an amount of very nearly three-tenths of an inch of mercury.

1365. Are the Committee to understand you to say that you put it at the mouth of each shaft?

No.

1366. Then did you rarefy the air by placing it at the mouth of the downcast shaft?

By shutting the doors, to prevent the air going in from the downcast shaft into the colliery.

1367. The apparatus being applied to the upcast shaft?

The apparatus is applied to the upcast shaft; and the peculiarity is that the moment the opening is shut between the downcast shaft and the colliery, the engine, having less resistance, from the air rising up from the colliery, is relieved from its pressure on that account, and all its power is then turned to an increase of rarefaction by increasing the velocity of the drum. It is just like this—[*applying a cover to the air inlet of the model*];—if I take this cover off, and turn the drum of the model in this way, the effect that is now produced is the maximum discharge of air due to the velocity. If I put this cover on again, and shut it all up, so that little air can enter, the maximum effect is in the increase of rarefaction by increase of velocity by the continued application of the same force.

1368. Then this is a model of the apparatus in action at Mr. Powell's?

Yes.

1369. How long has it been in operation at Mr. Powell's?

Four months, I think; Mr. Powell's mine is in Glamorganshire; it is on the Taff Vale Railway, near to what is called Navigation House.

1370. You put it up for Mr. Powell a few months ago?

Yes.

1371. And you applied it to his existing steam-engine?

Yes.

1372. Can you say what was the cost of the apparatus to Mr. Powell?

The cost of the apparatus to Mr. Powell was 100 *l.* I beg to be allowed to say that Mr. Powell put it up as an experiment, because he has many other collieries,

(164. 4.)

R 4

and

W. Brunton, Esq.
 28th June 1849.

and he intends to move it, having now tested its powers. It is upon a colliery where he could have done without it, but he put it there, in order to see that it would answer the purpose, because it would have been a serious thing if, after it had been put up upon a colliery dependent on it for ventilation, a failure had taken place.

1373. Do you conceive that it could be put up wherever it might be wanted for an expenditure of 100 *l.*?

A contract is now going on under my inspection, where the engine and the machinery will be supplied under 150 *l.*, exclusive of the boiler; because there is a boiler already at the pit, and there is no use in putting up two.

1374. In order to produce a pressure, we will say of two inches of water, what is the power withdrawn from the engine for ventilation?

It must be rather a sort of guess; but I am quite sure that I am within the mark when I say three horses power; because the engine that is driving Mr. Powell's machine, and has driven it at 130 revolutions a minute, is not, I conceive, exercising 15 horses power.

1375. Have you a patent for this invention?

No, I have not.

1376. It is used only in one mine?

It is used only in one mine at present; although there is another gentleman, who is so perfectly well satisfied with it, that he is putting up another.

1377. You have an order for another?

Yes.

1378. In the same country?

Yes.

1379. When do you expect to have it in operation?

In six weeks or two months.

1380. Do you think you will be able to furnish that other party with an apparatus of this kind for 100 *l.*?

The machine itself, separate from the engine, which is going to be applied to it, was estimated at 85 *l.*

1381. In that case they require an engine specially for the purpose?

Yes.

1382. Do you consider that generally as a part of the plan, or would you, in most cases, make use of the existing engine of the colliery?

I put always a distinct engine, because it must go on incessantly.

1383. Then that would probably entail an additional expense of 100 *l.*?

When I say under 150 *l.*, I include a steam-engine to drive it, saving the boiler.

1384. But you said that Mr. Powell's was put up for 100 *l.*?

That included neither boiler nor engine.

1385. Nothing but the apparatus itself?

Nothing else.

1386. Then you will not undertake to say that you could furnish a steam-engine sufficient to drive the apparatus also for 50 *l.*?

Yes, I could.

1387. That is exclusive of the boiler?

Yes.

1388. In any other that you may have to put up, you think that you could furnish the apparatus itself for less than 100 *l.*?

The apparatus will be less than 100 *l.* When I speak of the apparatus, I simply include the revolving drum itself. Several, I have no doubt, will be placed immediately on the upcast pit, because there are pits for no other purpose; but where it is necessary to attach an air-course to it, to place the machine at some convenient distance, that will somewhat increase the cost, varying with local circumstances.

1389. But

W. Brunton, Esq.

28th June 1849.

1389. But apart from such sources of expense as that, do you conceive that the apparatus itself, including the small engine that might be necessary to work it, could be furnished for not more than 150 l.?

Yes.

1390. You think you could undertake to do that in most cases?

Yes.

1391. Do you know what is the extent of the working in Mr. Powell's colliery which requires ventilation?

It is a small colliery, and the extent of working I do not suppose is more than three acres.

1392. Have you any suggestions to make as to improvements in directing the currents of air?

Yes; I offer this diagram on account of objections that have been made to an apparatus, either of this or of any other kind, to which the answer has very often been, we do not want to increase the air; we have plenty of air, and if we had an increase of air we should blow the candle out, and should incur a good deal of inconvenience. I want by this paper to show that we have no occasion to increase the air that is passing through the avenues of the colliery beyond what is necessary for safety, but that an increased quantity of rarefaction is absolutely necessary for the purpose of safety; for whilst I have shown what I found at Haswell colliery, viz. $1\frac{1}{2}$ inch of water, I have never been able to obtain in South Wales a rarefaction by the furnace of more than three-tenths and a half of water. I beg leave to read and submit the following statement:

The Figure below may exhibit the essential elements of Ventilating a Coal Mine.

If we suppose A the downcast pit, and B the upcast pit, each having its distinct air-way C and D, and *a b c d e, &c.* to be so many avenues through which the air is conducted from C to D, the following results will take place:—

That upon the amount of rarefaction maintained in D will depend the amount of air passed through.

That to transmit an equal quantity through all the avenues, the apertures must increase in size as they are further from the pits A and B.

That by an undue opening of any of the intermediate avenues, the passage of air (ventilation) of the remote avenues may be stopped.

That the last state of things is more likely to happen when the rarefaction is but only sufficient for the ordinary requirements of the colliery, and not so likely where the rarefaction is powerful even beyond the ordinary requirements; that where such a powerful rarefaction is maintained, the amount of air transmitted through the avenues need not therefore be more than is sufficient for perfect safety (and may be accurately ascertained by a water-gauge upon each avenue), but the languid or stagnated state of the remote avenues would be prevented.

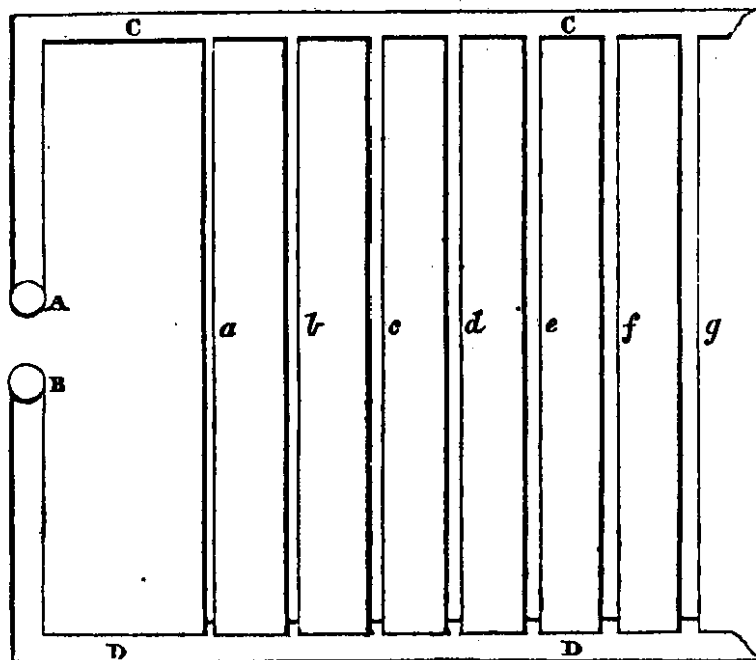

In illustration of this, I may observe, that there are some very good observations by Mr. Stephenson, in his Evidence before the House of Commons, in 1835, at (164. 4.)

W. Branton, Esq.
 28th June 1849.

page 104, in answer to Question 1562. I would further observe, that in South Wales, and I may say in the North also, the only measure they have of the strength of air passing from one place to another is the resistance of the air against the doors, and as felt by their hands. That would be easily and more satisfactorily ascertained by having a bent tube of glass, like that which I have produced, as a water-gauge, which I have used a hundred times for ascertaining the air, or the measure of rarefaction in our copper furnaces.

1393. Are not those in use in mines in certain parts of England?
 Not that I know of.

1394. The Committee have understood that they are in use in the North?
 I can only state that when I used this, it appeared to them in the North of England to be a new thing. I applied it in the Haswell pit, and the expression was, "Well, this is a good thing, but it surprises me very much." I made it in order to settle the point in dispute with regard to the power of the furnace at Haswell, which Mr. Thomas John Taylor calculated to be equal to 15 pounds on the square foot.

1395. Where was this calculation made?
 In Northumberland. He made it out that it was 15 pounds, or thereabout, on the square foot, and I measured it and found that it was under eight. I would recommend that such an instrument (which will not cost 6 *d.*), may be attached to each of these doors, as on the avenues *a b c*, &c., and then the pressure might be ascertained on which the ventilation was depending, because if we suppose that here is a rarefaction such as to take out by the pit B of 1,000 feet a minute, if the needful quantity of air together with the leakage takes 750 of that, or nearly the whole 1,000, before it reaches the middle avenue *d*, then those beyond are so languid that there is in the last, *g*, no current at all. I am perfectly certain, as a practical man, that such gauges would be a great safety, because these openings have doors which are called regulators, and are regulated as to the amount of opening by several men: each of these men has his own notion with regard to how much of the air should pass through these doors.

1396. You have talked about the rarefaction of air; you mean the current of air?

Yes, the drawing power, whereby a current of air is generated.

1397. That is what you meant by rarefaction?

Yes; I wished also to mention the means of subjecting the colliery to rarefaction during the absence of ventilation, and placing the colliery, however extensive, under the same circumstances as if the mercury has fallen three-quarters or five-tenths of an inch.

1398. With what object?

In order to draw out in the absence of the men; and before the men go in to produce a powerful current of air, which shall discharge the carburetted hydrogen.

1399. Do you consider that that exhausting process is a more effectual one than keeping up a sufficient current of pure air through the mine?

I do.

The Witness is directed to withdraw.

Ordered, That this Committee be adjourned till To-morrow,
 One o'clock.

Die Veneris, 29° Junii 1849.

The LORD WHARNCLIFFE in the Chair.

WILLIAM BRUNTON, Esquire, is called in, and further examined as follows :

Evidence on the
Prevention of
Accidents in
Coal Mines.

W. Brunton, Esq.

29th June 1849.

1400. YOU have certain observations which you wish to add to the evidence which you gave yesterday ?

Yes ; in the first place, I am not aware that the character of the machine was spoken to as to its nature ; machines are more or less favourably received as they are simple ; now this is in itself exceedingly simple, as expressed in the printed description of the machine put in. To the drawing which your Lordship saw yesterday, there is a Table annexed of the performance of that machine, which I have copied ; if the Committee will accept of it, it is at their service.

The Witness delivers in the following Table :

Performance of the Ventilator; 22 feet extreme diameter ; mean diameter of the radial trunks, 16 feet.

| Revolution per Minute. | Centrifugal Force. | Pounds on Square Feet. | Inches of Water. | Inches of Mercury. |
|------------------------|--------------------|------------------------|------------------|--------------------|
| 20 | 1.10 | 0.48 | 0.090 | |
| 25 | 1.69 | 0.75 | 0.140 | |
| 30 | 2.45 | 1.08 | 0.201 | |
| 35 | 3.34 | 1.47 | 0.280 | |
| 40 | 4.36 | 1.94 | 0.372 | |
| 50 | 6.80 | 3.03 | 0.580 | |
| 60 | 9.80 | 4.34 | 0.835 | |
| 70 | 13.35 | 5.95 | 1.08 | 0.079 |
| 80 | 17.50 | 7.76 | 1.48 | 0.109 |
| 90 | 22.10 | 9.79 | 1.94 | 0.143 |
| 100 | 27.30 | 12.10 | 2.31 | 0.170 |
| 110 | 33.20 | 14.70 | 2.83 | 0.208 |
| 120 | 39.40 | 17.50 | 3.35 | 0.247 |
| 130 | 46.30 | 20.04 | 3.90 | 0.287 |
| 140 | 53.80 | 25.00 | 4.58 | 0.337 |
| 150 | 61.30 | 27.30 | 5.20 | 0.382 |
| 160 | 70.00 | 31.00 | 5.95 | 0.438 |
| 170 | 78.80 | 35.00 | 6.74 | 0.497 |
| 180 | 88.60 | 39.30 | 7.52 | 0.555 |
| 190 | 98.60 | 43.90 | 8.42 | 0.620 |
| 200 | 110.00 | 48.60 | 9.25 | 0.682 |

1401. Is there any other matter upon which you wish to make any observation ?

Yes ; with respect to the evidence of the late George Stephenson in the year 1835, comprehended in the articles of evidence, 1668 to 1671, relative to the effect of a fall of the barometer upon a blower, producing therefrom a copious out-flow of fire-damp ; and that, on the contrary, during a rise of the barometer, he found the same fissure drawing in air : I have now to observe, that as the state of the atmosphere indicated by the fall of the barometer is the season when the natural discharge of the gases takes place, I propose to anticipate it under
(164. 5.) s 2 those

W. Brunton, Esq.
29th June 1849.

those circumstances. I have now laid before your Lordships the means of rarefying a colliery, or artificially subjecting a colliery to an exhaustion equal to five-tenths of an inch of mercury, producing upon the gases the same effect as a like natural change; and this may be done during the absence of the men and their lights, consequently in perfect safety.

1402. Your operation produces an exhaustion?

Yes; to be followed before the men begin to work by a restoration of the equilibrium by a copious current of fresh air brought in under very powerful circumstances, because, as I said yesterday, I have never yet seen anything like this power of rarefaction possessed by any other means.

1403. How is it that you became convinced that the rarefaction is greater by this means than by any other?

Because I can rarefy to the extent of seven or eight inches of water, and I have never seen that done by any other means.

1404. Which is by increasing the rapidity of the current?

By increasing the velocity of the machine.

1405. What is the effect upon the air, does it increase the velocity of the air?

It increases the velocity of the air, but there may be a powerful rarefaction while there is no great current of air.

1406. Is the rarefaction by heat?

No; the rarefaction, I conceive, to be the power by which a current of air may be generated.

1407. Is the air more rarefied by any process of yours?

Yes, it is rarer. There is one thing that I should wish to impress also upon your Lordships, that when we speak of this rarefaction, connected with my machine, it may convey an idea of a great current of air; now, that is not exactly the case, because in this process of exhaustion we shut the doors which permit the air to enter from the downcast shaft into the colliery; there is then only the air that is in the colliery at the time, and the increment of the gases, which may add to it somewhat to be acted upon; the consequence is, that the machine being relieved from the current and consequent resistance of air going into it, the steam-engine, say a 14-horse engine, the whole of the power of that engine is now transferred to the machine in increasing its velocity, and as it increases the velocity, so it increases the rarefaction, but not in the same ratio, the discharge of air from the pit; because, as I have already said, we have shut the entrance of air from the downcast pit, and the air discharged must be therefore small in proportion to the measure of rarefaction then maintained in the colliery.

1408. The bulk of the air discharged into the machine under those circumstances must be constantly diminishing?

Yes; under these circumstances, possessing the power of thus artificially acting upon a colliery, as well as amply supplying all the ordinary requirements of ventilation, I submit it to your Lordships, to be tested in any manner you may think proper. I have exhausted the colliery upon which the machine stands repeatedly; and as I said yesterday, it has been erected by Mr. Powell, not only for his own satisfaction, but it is ready there to be tested by any gentleman interested in the coal-trade; and I have authority from Mr. Powell to say, that he will be exceedingly glad to give any information, and to afford any facilities to any of the gentlemen who may be desirous of investigating it; it is erected chiefly for that very purpose.

The Witness is directed to withdraw.

JOHN HUTCHINSON, Esquire, M. D., is called in, and examined as follows:

J. Hutchinson, Esq.,
M. D.

1409. YOU are practising in the medical profession, in London?
I am.

1410. And are physician to one of the Insurance Companies?
I am.

1411. Have

1411. Have you for a great length of time devoted your attention to the condition of the coal-mines of this country, more especially in the Northumberland and Durham districts?

I have.

*J. Hutchinson, Esq.,
M. D.*

29th June 1849.

1412. Have you had any extensive practical opportunities of examining those coal-mines?

I have had the means of examining them for about 15 years past; my attention was first drawn to the subject from seeing some of the explosions at the time I commenced the study of medicine in that locality.

1413. Are you connected with those districts?

I am not now connected with them; I was formerly; I am a native of Newcastle.

1414. In the course of those inquiries, you have personally examined a great number of the pits in those districts?

Yes, I have; I suppose I have been not less than 200 or 300 times in the mines for the purpose of examining them.

1415. Will you explain to the Committee what the results of your examination are, as regards the conclusions which you derived from your examination of the causes of accidents in mines?

Perhaps, before I begin that important point, the "cause of accidents," your Lordships will allow me to explain those parts of the art of mining which bear specially and directly upon the question before you, so far as to give you confidence in the facts which I bring forward, and to illustrate the points upon that question.

[The Witness exhibits a series of diagrams, describing to the Committee certain parts in the art of mining, as shaft-brattice, underground-brattice; exploring or main-drifts, or winning headsways; stoppings of deal board, brick, stones and "stowed;" single, double and treble air-coursing; main doors, furnace doors, air-crossings; formation of goaf; construction of the furnace from 1665 to the present period; and ventilation, from the simplest to the more complicated form of scaling or splitting.]

1416. In the district with which you are best acquainted, namely, the Northern District, is it usual for the mines to be furnished with two shafts, or is it a frequent arrangement to conduct the ventilation by means of a partition?

They frequently have a partition, though they have more than one shaft; the partition is considered a regular art of mining; it is not considered a temporary substitute until other shafts are made.

1417. Is it the usual practice for the coal-miners in the North to have two shafts to their mines?

Yes, generally, though they may have a partition shaft, whilst they have several other shafts on the establishment; for instance, I know an establishment (Sheriff Hill colliery) where they have four or five shafts, and yet they have partition shafts.

1418. They have what is called an air-pit, sometimes, have they not?

Yes, sometimes; but this partition is nevertheless called a regular order of mining.

1419. Having entered into the explanations which you have given, will you inform the Committee how, according to your conception, explosions take place in mines, and state the cause of the great loss of life that occurs in those instances?

There are certain accidents which are unavoidable, and there are others which are the result of certain conditions, which may be much improved; but the chief causes of accidents are, too few shafts, narrow shafts, constricted shafts, and badly-constructed furnaces.

1420. All producing imperfect ventilation?

Yes; these are the causes of the accident. The cause of the great loss of life is from weak and imperfect mining arrangements, which, by the explosion,

(164. 5.)

s 3

give

*J. Hutchinson, Esq.,
M. D.*

29th June 1849.

give way, and the air cannot circulate as it should do, and hundreds of men are thus suffocated. If your Lordship will allow me, I will invert the order of the present question, and speak, first, of the cause of the loss of life, and afterwards the cause of the explosion.

1421. Is it your opinion that the principal cause of the loss of life is not the actual explosion, but the consequences of that explosion?

Yes, the consequences of the explosion.

1422. Is that from the after-damp?

It is. The two questions before us at present are, the loss of life and the cause of the explosion. As an illustration (it does not prove the point), Haswell exploded in April 1845; there were 14 burnt, and 81 were suffocated.

1423. Did that appear by the evidence upon the coroner's inquest?

I believe not; I have not been enabled to obtain a sight of the verdict, but the plan which the coroners adopt is to "sit upon" all the bodies in a mass, and pass their verdict either as accidental death from an explosion of hydrogen gas, or something of that kind, as applicable to the whole mass of deaths; they make no distinction between those suffocated and those burnt.

1424. Then how was that fact ascertained of which you spoke in the case of the Haswell colliery?

In explosions you have the marks of fire upon the person. I again have seen men frequently brought out of a mine (it was so in the case of Springwell, which happened 9th May 1833), close from beside the bottom of the shaft, with a perfectly placid and calm expression, without the slightest mark upon their persons of fire or violence, which must have been the effect of suffocation; and it is acknowledged by all the viewers of the North of England, that the greatest mortality is from suffocation; and why it is that we have not come so speedily to the cause of explosion is, perhaps, from these two causes of death being always combined. The public, therefore, justly imagine that the people are all burnt; but the coroner should inquire, "Why are so many killed? True, you have had an explosion, but why have there so many perished?" As a mere illustration upon the points of which I am going to speak, I beg to explain each of these sources of death: First, why these men are suffocated. The weak points in mining are these partitions already described, which the miner terms brattices, doors, stoppings and crossings, and such verging into the main airways. Here is a brattice in a shaft—[pointing to a Diagram]—an explosion happens from a certain quarter, and as is commonly said, the explosion takes the fresh air; in more philosophical and language, it seeks to unite with oxygen gas; the explosion comes with great power and force, breaks this main brattice or partition, which partition is guiding the air; consequently, the air comes down one side of the brattice, passes through this rupture, and returns up the shaft immediately, and never penetrates the mine—[showing the same];—all air below is consequently in stagnation, and in whatever quarter the men are, they have to wade through so many hundreds or thousands of yards in obscure and deranged "ways": lastly, when they come to the bottom of this shaft, it is most probably filled with boards, stones, and an accumulation of other mining instruments, when the rope cannot come down the shaft to extricate them; and here I have known them struggle for life. I illustrate this by a drawing from the case of Springwell colliery, which happened in May 1833, when the brattice was blown away at the bottom of the shaft. I have a very simple illustration here, which might strike your Lordships with the importance of this main brattice in one instant.

[The Witness exhibits an experiment with a candle, over which he places a glass tube 20 inches long, and the candle almost immediately goes out; but on again lighting it, and introducing a division, representing a brattice, down the centre of the tube, the candle continues to burn clearly.]

Another objection to brattice-shafts is, with respect to heating the air from the furnace for the purpose of ventilation; the furnace coming up one side of the brattice-shaft has frequently to be kept at a very low temperature, or what is much more important, they have to reduce the upcast air to a very low temperature; to repair the brattice during this low temperature of the shaft, you expose the mine most favourably to explode. These repairs take place about once a fortnight.

1425. When

1425. When the current is interrupted in that way by the action of the explosion, what is the consequence upon the atmosphere of the mine in which parties are employed, who are not actually killed by the explosion?

They are suffocated from the want of a supply of fresh air. The same answer will apply to the rupture of the other partitions in the mine.

*J. Hutchinson, Esq.,
M. D.*

29th June 1849.

1426. Of any partition upon which the ventilation depends?

Yes, particularly those partitions which separate the "intake" from the return air."

1427. And you conceive that that is the principal cause of the great loss of life in these accidents?

It is, most assuredly.

1428. Do you think that that has been proved by the circumstances of other accidents, besides those which you have mentioned at Haswell and Springwell?

Yes, I believe so.

1429. Have you examined the statistics of accidents, in order to satisfy yourself upon that point?

I have. I have spoken of the effect of a main brattice partition when damaged in losing life. Now, with regard to the underground partitions, which I have described, their effect when ruptured is just the same. I might instance the Wallsend explosion, which happened on the 23d of October 1821, at the commencement of working the Bensham seam.

1430. The Bensham is a very fiery seam?

It is; they had an extensive underground brattice arrangement, and there was a great sacrifice of life; they lost 52 lives. I am not prepared to tell your Lordships how many were suffocated. This Plan, which I now exhibit, came out in the Parliamentary Report of the 4th September 1835; you can easily see there was an extensive arrangement of fragile brattice. Another weak point in mines is dividing the different kinds of air by doors; I think the doors ought to be hung so that they will always fall of themselves by gravitation; as that law never "forgets" to be in operation.

1431. Is not that usually the case with the doors?

Not generally; but with a certain class of door it is the case, a door which they call a man door, a small door for creeping through for the convenience of reaching any particular part of the mine; but generally, in the "mainway doors," it is not the case.

1432. Then, do you think that it would be a great additional security in the working of a mine if the partition for the purpose of ventilation were made stronger?

Yes, I do. In answer to your Lordship's question of making them stronger, I would beg to point out that different partitions vary in their relative value. For instance, if the intake air, Diagram (No. 1), is working towards m & m' , it is guided especially by stoppings b' and B ; but if an explosion should rupture b' at B , the "intake air" immediately passes to the furnace, and thence to the upcast shaft. Now, if you should rupture partition X , the air will supply all the mine, except that little portion c , c , c , &c.; therefore, stoppings vary in their relative value. This is a most important point in the art of mining. The most valuable partition is the shaft-brattice, and other partitions less so, as they verge from thence according to the quality of air circulating in juxtaposition to each other; you may have partitions which are of very small value, as T , V , and X partition, and, therefore, such need not be strong. I will shortly speak of strong partitions.

*Vide Appendix I.
Plan, No. VII.*

1433. Generally speaking, those partitions which are near the downcast current would be the most important?

Perhaps I would rather say, partitions differ in their relative value in strict relation to the difference in the quality of the air which they separate; the greater the difference, the more important the partition.

1434. Separating the commencement and the end of the current?

Yes, the intake from the return air. Another part of the mining arrangement which is also weak is the air-crossings. I have already told your Lordships, that accordingly as the miner increases the extent of compound or splitting ventila-

J. Hutchinson, Esq.,
M. D.

29th June 1849.

Vide Appendix I.
Plan No. VIII.

tion into separate compartments, you have a great liability to different kinds of air crossing each other. I have explained how these air-crossings are made, some with planks of wood, others with brick arches; an explosion happening in quarter *A*, Diagram (No. 2), makes a rupture in the crossing at *c*; then fresh air from *b'* quarter passes up that rupture, and immediately escapes to the upcast shaft. In the explosion at the King Pit, Wreckenton, on the 9th July 1831, I knew three men that died a few yards from a crossing in consequence of such a rupture as I have described; the deal boards were blown up; it was an exceedingly fragile arrangement, when you consider that two kinds of air of very dissimilar composition and course of movement were merely separated by a few planks of wood; consequently the fresh air took this rupture, and escaped quickly to the upcast, and these men perished for want of air.

1435. From suffocation?

Yes; had these boards not risen, they would have lived; they were not killed by the explosion. I may observe that hundreds of lives thus perish by weak points which rupture from the explosion. This viewer, indeed, is nevertheless highly to be commended for his great care and skill—Mr. John Easton, who resides near to Chester-le-Street; the rupture of this crossing happened in a mine under his care; from this circumstance he planned this kind of crossing—[*producing a Diagram*—Diagram (No. 3), to penetrate up into the stone and descend again, so that between your fresh air and your return air you have many feet of solid rock, and thereby your crossing is explosion proof. Mr. John Easton represents a complete crossing for gases of the most dissimilar composition, whether it be carburetted hydrogen on the one side, and oxygen on the other: in the sketch Diagram (No. 3), where *A, A, A*, is the arched channel cut in the solid stone for the “return,” or for an explosive mixture of gases passing away towards the upcast shaft; *B* is the passage for the “intake” on the rolley-way, six feet high and five feet wide; *C, C, C, C*, are pillars of coal, each 10 yards wide; *D, D*, boards four yards wide, from each of which boards the crossing commences, and *X*, becomes the invincible barrier separating the two airs. The same can be effected, says Mr. John Easton, with less stone drifting, by taking away a part of the coal between the points *b* and *b*, on each side of the rolley-way, as may be represented by the dotted lines *a', a'*. This latter crossing is less expensive, and at the same time in proportion less secure; but this security is governed by the quality of the stone through which the excavation is conducted.

Vide Appendix I.
Plan No. IX.

1436. In short, cutting a passage through the solid rock?

Yes; the expense of such a crossing, Mr. John Easton tells me, is about 12*l.* or 15*l.*; perhaps there is no harm in this extra expense, because it might induce some to think well before they made crossings; probably sometimes they are made when they might be avoided. Mr. John Easton has one extensive mine (Pelton colliery) with no crossing in it, although the ventilation is compound or splitting; his object is always to avoid a crossing, and to make one only when it is unavoidable, and then they are made in the rock. The stopping partitions I have described as differing in their relative value may be made as strong nearly as Mr. John Easton's crossings. Every coal-mine should possess certain mainways, communicating between shafts as remote from each other as possible; which mainways should have their lateral “holings” “stowed,” *i. e.*, those communications which were necessary in the first instance (I described as made for ventilation), when the winning-headway was being formed. Let us suppose three ways driven, one centre and two lateral ways; the centre headway can be invulnerably flanked right and left by “stowed stoppings;” this centre way would be a fresh air-course at all times and under all conditions; as long as the shafts remained open, the air would penetrate to the end of this headway, and then “split” right and left to supply the “workings.” This plan is well known (to the viewers) of making three ways instead of two; this would keep the centre way strong, and in some measure avoid a crossing, by splitting the air to supply the districts right and left of the centre headway; therefore three “ways” are to be preferred to two “ways.”

A communication or valuable stopping can be stowed with small coals or “shaft;” but I am disposed to think large stones are better; such stoppings would be explosion proof, like Mr. John Easton's crossing in the roof. In the case of Haswell, had the mainways or any way been so flanked with invulnerable stoppings; after the explosion in question, it would have been impossible for the carbonic acid gas or the after-damp to have passed in such protected ways; therefore,

fore,

fore, wherever the men could possibly enter that mainway, they would have been spared their life. In the instance of Haswell the explosion was supposed to happen there—[*showing the same on the Government Plan accompanying the Report of Messrs. Lyell & Faraday*—here is the place where the air enters.

*J. Hutchinson, Esq.,
M. D.
29th June 1849.*

1437. That is the downcast shaft?

Yes; apparently there are no partitions here which are "stowed," or which are strong partitions and invulnerable; the explosion is supposed to happen at a remote distance from the shaft—[*showing the same*—and the current of air was depending upon a single weak partition to guide it through the whole mine, and this partition seems to be of a very fragile construction; probably common brick or deal boards; consequently by the explosion a derangement takes place; a rupture of all the tested fragile stoppings which guide the air. Hence 81 persons died! whilst only 14 had the marks of fire upon them about this locality; but the 81 were found dead in other localities. You will observe, also, that there are only those two little stoppings near the two shafts separating the "intake" from the return; if those are ruptured, the air comes down here, circulates a few yards, and then immediately passes off by the upcast shaft. Had there been invulnerable ways and a main air-course, some of those 81 men would have probably found life by finding fresh air. I will now conclude this part of the inquiry, the cause of the loss of life, by saying that it is from the rupture of so many weak mining arrangements, as doors and partitions in all forms, that so many men perish after an explosion, and that such partitions flanking mainways, should be preserved explosion proof.

*Vide Appendix I.
Plan, No. X.*

1438. And that, you think, would be one of the greatest protections to human life?

Yes; and that viewers should consider well all the openings immediately round a shaft; the further shafts are apart the better, because the closer they are together, the greater is the liability of your air making a short cut to the upcast, thus laying "dead" the whole ventilation of the mine. In first winning a colliery it is very difficult to avoid weak points. The next remark I make is upon the cause of the accident; why does the accident happen?

1439. You say the mainways should be explosion proof; in the case of different air-pits over an extensive ground, how would it be applicable to a mine under such circumstances?

You may always have a mainway extending between two shafts, with the lateral branchings made explosion proof, that is, strong stoppings which will withstand an explosion; the object is to have as few weak points going into those mainways as possible. I am speaking of mainways; let them be flanked right and left with these invulnerable stoppings, then you will have a fresh air-course maintained at all times; that does not prevent them from having lateral branchings to other parts of the mine.

1440. Your proposition was, that you should make main partitions proof against an explosion?

Yes.

1441. That is particularly applicable to a distinct down and an upcast shaft?

Yes; it is also applicable to all kinds of shafts, bratticed or otherwise.

1442. In a mine where there is an air-pit here—[*pointing to a tracing*—and an air-pit there, and the shaft is out here, where the current of air is going in different directions to the nearest point where the air is drawn from, how would you do in that case?

I should require to examine that plan rather more minutely before I could give, in this case, an answer to your Lordship.

1443. Would the principles which you have been explaining in connexion with the necessity of partitions for the efficient ventilation of mines be at all altered by the multiplication of the number of shafts belonging to a mine?

No; there is no relation between the number of your stoppings and your shafts; you may have 100 shafts, or one shaft, and have your stoppings either many or few, weak or strong.

1444. Supposing that a mine had more than two shafts, and that the ventilation was conducted through several shafts instead of two, as you have
(164. 5.)

J. Hutchinson, Esq.,
M. D.

29th June 1849.

assumed, would that constitute any difference in the argument which you have used with respect to the necessity of strong partitions?

No, I conceive not; of course the greater the number of the shafts, the greater chance you would have of commanding and guiding fresh air into a mine after the force of the explosion was over.

1445. The effect of that would partly be such as you have explained in respect of the subdivision of the workings, would it not?

Yes.

1446. Would you conceive that a mine, having more than two shafts, would have a better chance of protection from the consequences that you have explained than a mine having only two shafts, provided the ventilation was equally well managed in the two?

Yes; the more shafts the better. There is one very important part of the subject which I have omitted: the ventilation may be exceedingly good, but if you constrict the shaft at the top for mechanical advantages, you stop the air; very often there are projections that the men may reach the basket or box which comes up at the pit's mouth, so that your shaft, instead of being circular or semicircular, presents the shape of a parallelogram. I will show your Lordships the shaft of Jarrow colliery in this drawing—[*Witness handed a drawing*—]—which is divided into three parts: there is the downcast, there the upcast, and that upcast is partly railed over with a grating; besides this, two large boxes nearly fill the whole of the upcast shaft; and this third division—[*showing the same*—]—has two pumps, and is not specifically supplying the mine with air; the consequence is, that mine stands upon the list as having exploded seven times, with a sacrifice of 134 lives.—[*Vide Table X, page 152.*]—I went down this mine on 23d December 1845, after the lamentable explosion of the preceding August, when 40 men perished.

1447. What mine are you speaking of?

I am speaking of Jarrow colliery. There was, by way of ventilation in the mine, just the least movement of air, like as if it were a man gently breathing upon you, from the excessively constricted state of the shaft. When I was going towards that mine, I asked a miner "Which is the way to Jarrow colliery?" and he said, "Sir, I do not know of any colliery; but there—[*pointing me in the direction of the colliery*—]—is a butcher's shop;" and that was a man who did not know I was making any inquiries into the state of the mine; it was very distressing to see it, and more so to go into it. To show your Lordships a point which was peculiarly weak in that mine, here was the fire that ventilated the Low Main—[*showing the same*—]—where the explosion happened in 1845; but this furnace was not in that seam which exploded, but it was in the seam above it (the Bentham seam), and the air was guided by a most fragile partition on to the furnace. This partition was so weak, that I dare not stand upon it; likewise it was most favourably placed, either for stone falling down the shaft upon it, or for an explosion to rupture it upwards; upon this was depending the ventilation and lives of all (below) in the "Low Main," the seat of the last explosion.

1448. What was it constructed of?

Wood, so thin that I dare not stand over the shaft across which it stretched; the shaft was about 120 feet deep below this partition; upon this was depending the ventilation of the Low Main seam. Therefore the constriction of shafts, or too few shafts, is another important point, and cause of explosion.

1449. Do the baskets or boxes impede the air much?

Yes; I have observed, when a considerable way in the mine, that when they pass each other at "meetings," there is a distinct oscillation of the mercury in the barometer; and you may sometimes feel it on the drum of the ear; this is remarkably the case when hay is being sent down in large bundles, or when supplying other wants of the mine. There really ought to be more shafts to counteract these effects; I do not like to say so without reason, but such things do seriously affect the ventilation. I will now return to that part of the subject, the cause of explosions; this arises from an inefficient quantity of air sweeping through the pit, either from constriction in main airways, or from the upcast air not being sufficiently heated, or from the effect of solar heat.

1450. Have

1450. Have you observed the causes of accidents much affected by the variations of the atmosphere?

I have. I will, in the first place, show you the result of some experiments I made in December 1845. I beg to hand in a Table of the experiments which I made in certain mines—[*vide* Table A, page 153.]—I examined several mines, 10 in number: I took the temperature of the downcast.

J. Hutchinson, Esq.,
M. D.

29th June 1849.

1451. Where did you take the temperature of the downcast?

At three parts of the shaft, though there is not occasion to take it otherwise than at the earth's surface; because, in reality, the day temperature may be taken as the downcast air temperature.

1452. Are these figures the mean temperature of the downcast?

This is the actual temperature of the day, and consequently of the downcast at "bank," or pit's mouth.

1453. When you were there?

Yes.

1454. At the surface?

At the surface: this was the temperature of the day; this was in winter time.

1455. Was it the same, whether at the top or the bottom of that downcast?

No, you had it a little hotter at the bottom; for instance, at South Heaton the temperature at the surface was 39°; at the bottom of the downcast, 49°; the air gained 10° by falling 1,488 feet. In Gateshead pit, 44° at the surface, and 49° below, by falling 390 feet. At Hebburn, the surface temperature, 40°, and only three degrees more by falling 960 feet. I have not brought these points into account, because there is no occasion to do so, as it would unnecessarily interfere with our question at present.

1456. You give merely the temperature at the surface, for the purpose of ventilation?

Exactly so. On a geological or philosophical point, it is interesting to see how much the air gains by dropping down so many hundred feet; but for our purpose, at this moment, it will do just to speak of the temperature of the day. But not so with the upcast; the upcast was taken at three parts, at the bottom of the shaft, at the centre of the shaft and at the top; the hottest being at the bottom, it being the closest to the furnace; the temperature here given, in the third column, is the mean of those three observations.

1457. Did you find that mean about the middle of the shaft?

Sometimes.

1458. It varied?

Yes; this would depend upon local causes; for instance, a feeder of water running down would cool that part of the shaft. The difference between these two columns of air is expressed in the last column. If there were no difference between them, you would have no ventilation.

1459. In short, the ventilation depends upon the difference of temperature between the two columns?

Yes; this difference of temperature is obtained partly from the earth and partly from the furnace: the heat which the upcast receives from the earth is described in the fifth column; the heat which it receives from the furnace is described in the sixth column. I will show your Lordships the important influence of solar heat upon the ventilation: A, B and C mine had a mean temperature of about 34° F. or 35° F.; that is, on the day which I examined them. It was cold weather.

1460. Was it in the winter?

Yes, in December. The mere heat given by the furnace was, in the case of A and B, 15 degrees, and in the case of C, 2½ degrees. Here is the case of a shaft with a wooden brattice, where they were obliged to reduce the temperature and slacken the furnace, for the sake of repairing this brattice; it was an extensive mine, with extensive goaves, and such a condition was approaching to a most hazardous state of things; but, fortunately for that mine, this condition happened to be on a day when the temperature was 34°; but this mending of the shaft partition and lowering of the furnace would have been done equally the same in summer;

J. Hutchinson, Esq.,
M. D.,
 29th June 1849.

and let us suppose, then, the day temperature to have been 64°, mine C, instead of having a difference of 22°, would have had no difference at all, and an explosion must have followed: this mine had extensive goafs. The ventilation, even in winter, was very feeble, and it was fortunate for that mine it was winter; and perhaps it is fortunate for other mines that the earth does give so much heat to the upcast, as we observe that some furnaces give so little heat to the air.

1461. How near to the furnaces were those temperatures taken?

The return was taken a few yards before it came on to the furnace; then I took the temperature of the return in the shaft; so that the return before it came on to the furnace, plus the difference after it passed the furnace, gave the number of degrees gained by the furnace.

1462. Is not the mode in which you obtain the figures in the fifth column this: that you subtract the natural temperature of the workings from the difference between the mean temperature of the upcast shaft and the actual temperature of the surface?

Yes.

1463. Then the result of that must be, that the figures in the fifth column indicate that portion of the difference between the second and third columns which is derived from the furnace?

Yes.

1464. Therefore it does not indicate the actual heat obtained from the furnace?

The actual heat obtained from the furnace is up to anything; if you go into the furnace, it is white hot; if you go a mile from it, it is otherwise.

1465. You head that column as the furnace-heat; it does not indicate, in fact, the heat derived from the furnace near the heating point?

No, but the heat in the shaft derived from the furnace. Here are two exceedingly beautiful mines, D and E; the temperature of the upcast is respectively 135° and 144°, far above the preceding mines; the difference between the upcast and downcast is 93 and 106 degrees; consequently, the ventilation in those mines was exceedingly good; now, why was it that you had there such a perfect system of ventilation? I will show you: but first allow me, my Lords, before I show you that, to compare D mine with H; these are mines of the same depth exactly; the difference in H is only 35 or 36 degrees F.; in D it is 93 degrees; in H the ventilation is feeble and bad; in D it is exceedingly good, or "very brisk;" the ventilation in H was so feeble that the furnace-room was covered with soot, so that you might write your name on the roof, from the "return" returning again, like smoke down a smoky chimney. The engineer to D and E mines is Mr. John Easton. The whole difference in the ventilation of these mines was due entirely to the construction of the furnace. Mr. John Easton brought all his air on to and close upon the furnace. The mine H which I have spoken of as having feeble ventilation, had a high arch over the furnace, and part of the air escaped through a space in the arch, formed by a false arch, and one-half of the whole return passed into the upcast shaft cold, and never went near the furnace—[*Witness exhibited this on a Diagram*]. The relative size of the arches of the two furnaces is expressed by these drawings: D mine had two furnaces, arch three feet above the fire; H mine, one furnace, arch four feet and a half above the fire; and, moreover, in mine H, as I have already observed, they did not send all the air upon the furnace; thus the temperature of the shaft in mine H may be stated as 35·75, and in D 93 degrees; mine D has a bratticed shaft, but it is made of brick, and hence allows of a greater heat being brought into contact with it than if it were wood, and it seldom needs any repairs. Hundreds of pounds sterling have been saved by this substitution of brick for wood.

[*Witness exhibited a Plan illustrating "return air," being thus split at its termination to escape the furnace in mine H.*]

1466. Were there two approaches, then?—[*Referring to a point in the Diagram.*]

Yes; and a part of the "return" passed into the shaft cold, and the other passed over the high-arched furnace; but not so in mines D and E; consequently you have in D and E a state of ventilation where it is impossible that you can have an explosion

explosion from solar influence, the great cause of explosion, whereas in H mine it is otherwise. J. Hutchinson, Esq.,
M. D.

1467. Where the furnace is properly managed, do you conceive it to be an efficient engine of ventilation?

29th June 1849.

Yes, I do.

1468. Can you say at all what amount of current it is possible to produce in the ordinary workings of a mine at such a depth as you have spoken of with a well-arranged furnace; speaking in general terms, what is the quantity of air that could be passed through the mine?

The quantity depends entirely upon the area of inlets; but I would say that the quantity is almost unlimited, because by a judicious arrangement of the mine, you may have a current so strong as to blow out your lights, which is as strong as you can require it.

1469. Stronger than you can require it?

Yes; in fact, the hurricane which we have on the surface of the earth depends merely upon the action of solar heat; and in a large mine, if you judiciously arrange the application of your heat, you may cause such a degree of rarefaction as to thoroughly sweep your mine, and have as much air as you can bear.

1470. We were proceeding, when you entered upon this explanation, to hear your explanation of the effects of the variation in the temperature of the atmosphere?

I hand you here a Table of the chief explosions since 1800, in combination with the diurnal temperature, showing the influence of day temperature upon the mines—[*vide* Table C., page 154.] The experiments in Table A. were all taken in cold weather, the mean day temperature of 38°. It is clear that, if we suppose a temperature, say of 60° F. instead of 38°, it would tend to equalize the column of the downcast with the upcast, decreasing the difference temperature from a mean of 57 to 35 degrees difference, and as such, materially damage the current of air circulating through the mine. Table C. combines 30 explosions, with the day temperature of their locality for three days, the two days before the explosion and upon the day of explosion.

1471. What is the conclusion which you draw from that?

The conclusion is, that the days of explosions are days of high temperature. On the first of the three days, the mean is 47° F., on the second day it is 49° F.; and on the day of the explosion, the mean temperature is 50° F.

1472. You mean of the natural atmosphere?

Yes.

1473. You mean that, *cæteris paribus*, explosions are much more likely to take place when the temperature of the air is high, than when it is low?

Yes; it will be seen that most of the explosions occur in hot weather.

1474. The conclusions to be drawn from this Table [Paper C.] are, that the greater number of these explosions have happened when the natural temperature of the air was comparatively high?

Yes; from that Table you learn that out of 30 explosions, 19 have occurred with an increasing temperature, with an atmospheric condition favouring the equalization of the temperature of the upcast with the downcast column of air in the mine, which hence is under the influence of solar heat. I would like to show you the combination of these explosions with the barometric pressure which has been taken from time to time in the neighbourhood of Newcastle; the result of which is, that there is a certain relation, but it is feeble compared with the relation between the temperature and explosions—[*vide* Table D., page 154.] You will see a mean decrease merely of $\frac{9}{100}$ ths upon the third day; that is, a decrease of atmospheric pressure. A sudden fall sometimes has taken place, as in the instance of Wallsend, which is 29.93 two days before the explosion, and 29.03 on the day of the explosion, a decrease of atmospheric pressure of nearly one inch of mercury (.90); and, again, Oxclose exploded with a decrease of .78 of an inch. But I hand your Lordships a more striking Table, deduced from these two, C. and D.; this—(Table E., page 155)—is a conjoint matter, of barometric and thermometric differences, in relation to these explosions.

J. Hutchinson, Esq.,
M. D.

29th June 1849.

1475. The barometer and thermometer combined?

Yes; here you have expressed the plus and the minus; that is, the absolute alteration or difference of the barometer and the thermometer, and that gives an explanation almost for every explosion. My experiments in Table A., page 153, were taken when the average of the day was 38°; your Lordships will see here, how strikingly the explosions have taken place with a temperature considerably higher, and in some cases with decreased pressure. Out of 30 explosions, there are 16 which occurred when the day temperature exceeded 50° F.; in seven of these, the barometer was rising, and in nine of them when the mean fall was less than 3 of an inch, showing that a high day temperature was the most disturbing cause of the two. Wherever the temperature is low, we generally find either a sudden rise or a sudden fall in barometrical and thermometrical observations; a low barometric and a high thermometric condition being the most exciting cause for an explosion. At Wallsend the temperature is not very high; it is rather low compared with the other explosions; it is below the average; but the barometer fell almost an inch, and there is a gain of the thermometer of more than three degrees, which would tend to equalize the two shaft currents, while the barometer was falling, liberating a vast abundance of gas from its abode. There are several points for combination here, which are a great deal more interesting to examine in private; but the principle I have stated will be found to run throughout the Tables. In Table B., page 153, I give the day difference of temperature for each month as a guide for the viewer, that he may see the limit of the atmospheric influence upon the differential temperature of his pits, beyond which all mines should have their temperature by furnace heat. I have also combined these explosions with the winds—(*vide* Paper F., page 153.)—there has been no explosion with a north wind since 1800; there has been only one with a north-east wind, and I perceive that there have been a great number of explosions (17) with the wind from the south and west. When I say there has been none with a north wind, perhaps there may have been such a thing as what they call a flushing, or some trifling igniting gas; but not amounting to an explosion, in the general sense of the term.

1476. Not a fatal explosion?

No; all the furnace-men that I have ever asked, and likewise other miners, have always complained of south and south-west winds affecting the ventilation, showing the great influence of solar heat upon the ventilation.

1477. By whom were these directions of the wind registered?

These directions of the wind were registered partly by the Philosophical Society at Newcastle, and the greater number by the late James Losh, Esq., barrister, who used to take meteorological observations every day for years past. There are my own combinations. I examined Mr. Losh's manuscript Tables at the Literary and Philosophical Society at Newcastle-upon-Tyne, and those observations which were conducted after his decease I took from the Philosophical Society, and I believe them to be as correct as such Tables can be taken at this period.

1478. You do not mean that they were registered by the Philosophical Society at the particular localities where the explosions occurred?

No; but these explosions have happened all about Newcastle, so that there would be no material variation in the wind. I do not think you would have a south wind and a north wind so near together at the same time; you may, perhaps, have a slight variation of a few points; but I cannot imagine any appreciable difference of temperature from such variations. In the case of the last accident at Felling colliery, the Committee will see peculiarly that the thermometer was high, and the winds were warm, and the exclamation amongst the men was of the feebleness of the current in the mine.—[*See* Table 2, page 152.]

1479. Is there not this point to be observed upon any return of this kind, that the south and south-west winds being the prevalent winds in these climates, supposing the number of accidents even to be distributed over the different seasons of the year, there must be necessarily a prevalence of those which happen under the westerly and south-westerly winds to a certain extent?

Yes, it may be placed in that light, but still the connexion is strong as I have placed it. I have combined these explosions also with the months—[*vide* Table

Table

Table G., page 153,]—and you will see that the greatest number of accidents have happened between May and September, which are the hottest months of the year.

J. Hutchinson, Esq.,
M. D.

29th June 1849.

1480. There are a great number in November and December?

Yes.

1481. A part of these are taken before 1800?

Yes.

1482. How far back did those observations go?

I am not prepared to answer at this moment; from the commencement of the coal trade at Newcastle, I apprehend.

1483. If you take those since 1800, the number would be in January and February, three; in March and April, four; in May and June, eight; in July and August, seven; in September and October, fourteen; in November and December, nine?

Yes. I have also combined these explosions with the days in the week—[vide Table H., page 152,]—because it has been thought that on certain days, the mine being “idle,” as it is called, the ventilation would be more feeble from inattention; and indeed there seems to be a certain relation. There are but very few explosions on a Sunday; we can imagine that, because there are less lights in the mines on that day. On Monday and Tuesday you get forty-four, including all the accidents, both before and after 1800; on Wednesday and Thursday you have twenty-four, and on the last two days of the week you have twenty-eight.

1484. Friday is a good working day, on which there are twenty; that is as much as Monday, on which the number is nineteen?

Friday is a broken day; generally a “pay-day.”

1485. Saturday is a half-day’s work generally; they go early?

It is almost always entirely an idle day in the mines of Newcastle.

1486. Will you confine yourself to those explosions since 1800; since 1800 it would appear that on a Sunday there have been only two; on a Monday, eight; on a Tuesday, ten; on a Wednesday, two; how comes the number to be so very low, do you suppose, on a Wednesday?

There seems to be very little relation between the days of the week and accidents; therefore I would not suppose, as has been often imagined, that accidents frequently occur from the mere carelessness of the men at the furnace being left alone, and thereby more free from inspection, and, as it were, indolent.

1487. Then you do not conceive that there is much connexion between the days of the week and accidents?

I do not. In order to prevent the influence of the sun (as I believe that solar heat has such a considerable influence upon the under-ground current) damaging the ventilation, I propose that there should be a certain difference of shaft temperature, and, according to the observations which I have made, which I freely allow may be improved by further experience by such a body of intelligent men as the viewers. I propose—[vide Table I.]—to give an opinion of the degree of difference proper to be maintained between the upcast and the downcast shaft.

1488. Have you any record of the hour of the day at which explosions have taken place, whether at noon or at any particular time when the temperature is supposed to be the highest?

Those which I have known have generally happened in the middle of the day or during the afternoon; we very seldom hear of them extremely early in the morning or late at night.

1489. That would rather tend to confirm your conclusions?

Yes; all these meteorological observations are taken at the hours of 9, 3, and 9 on each day. The difference temperature which I propose as adequate to maintain the ventilation is, for shafts 400 feet deep, say 100 degrees.

1490. To be obtained by any means?

By any means; if not 100 degrees of heat, a velocity adequate to that; for shafts of 600 feet, 80 degrees; 900 feet, 60 degrees; 1,200 feet, 50 degrees; and 1,500 feet, 40 degrees: experience may show that this is too high or too low; but from my experiments it seems to be about the measure. This will, by

J. Hutchinson, Esq.,
M. D.
 29th June 1849.

your permission, terminate the part of my observations upon the cause of the accident, from the influence of solar heat upon the temperature between the upcast and the downcast shafts.

The Witness delivers in the following Tables :

2.

EXPLOSION at Felling; 22d June 1847.

| | Barometer. | Temperature. | | Winds. | | | |
|-----------|------------|--------------|---------|-------------|-------------|-------------|-------------------|
| | | Highest. | Lowest. | A. M. 9. | P. M. 3. | P. M. 9. | |
| 1847: | | | | | | | |
| June 20 - | 29.780 | 59.0 | 51.0 | W. by S. | W. by S. | S. W. by S. | cloudy and rainy. |
| „ 21 - | 29.536 | 62.5 | 55.0 | S. W. by W. | W. by S. | W. S. W. | cloudy and fine. |
| „ 22 - | 29.512 | 59.5 | 46.0 | S. W. by S. | S. S. W. | S. W. | fine. |

X.

JARROW MINE, with ONE Shaft.

| | | LIVES. |
|---|---|--------|
| EXPLODED in 1817, September 25 ; there perished - | - | 6 |
| „ 1820, April 28 - | „ | 2 |
| „ 1826, January 17 - | „ | 34 |
| „ 1828, March 15 - | „ | 8 |
| „ 1830, August 3 - | „ | 42 |
| „ 1836, November - | „ | 2 |
| „ 1845, August 21 - | „ | 40 |
| TOTAL - | - | 134 |

I.

TABLE of DIFFERENTIAL TEMPERATURE recommended for Coal Mines of different Depths, ventilated by Furnace.

Shafts of 400 feet deep should exceed the atmospheric temperature by 100 degrees.

| | | |
|---------|---|----|
| „ 600 | - | 80 |
| „ 900 | - | 60 |
| „ 1,200 | - | 50 |
| „ 1,500 | - | 40 |

H.

TABLE of Explosions, in relation to the DAYS of the WEEK.

| | Sunday. | Monday. | Tuesday. | Wednesday. | Thursday. | Friday. | Saturday. |
|---------------|---------|---------|----------|------------|-----------|---------|-----------|
| Before 1800 - | 3 | 11 | 15 | 4 | 9 | 13 | 4 |
| Since 1800 - | 2 | 8 | 10 | 2 | 9 | 7 | 4 |
| TOTAL - | 5 | 19 | 25 | 6 | 18 | 20 | 8 |

G.—TABLE

G.

J. Hutchinson, Esq.,
M. D.

TABLE of Explosions, in relation to the MONTHS, divided into Six Periods.

29th June 1849.

| | January, February. | March, April. | May, June. | July, August. | September, October. | November, December. |
|---------------|-----------------------|------------------|---------------|------------------|------------------------|------------------------|
| Before 1800 - | 3 | 5 | 3 | 1 | 2 | 4 |
| Since 1800 - | 3 | 4 | 8 | 7 | 14 | 9 |
| TOTAL - - | 6 | 9 | 11 | 8 | 16 | 13 |

F.

TABLE of Coal Mine Explosions, in relation to the WIND, since 1800.

| Wind - - | N. | N.E. | E. | S.E. | S. | S.W. | W. | N.W. |
|----------------------|----|------|----|------|----|------|----|------|
| Number of Explosions | 0 | 1 | 1 | 5 | 4 | 8 | 5 | 6 |

B.

TABLE of the Differential Temperature and Mean Temperature for each Month for 1847, Durham. By Rev. R. A. Thompson.

| | Difference. | Temperature. | | Difference. | Temperature. |
|------------|-------------|--------------|-------------|-------------|--------------|
| January - | 23·6 | 34·7 | July - - | 41·2 | 61·5 |
| February - | 33·5 | 35·4 | August - | 40·5 | 56·5 |
| March - | 39·8 | 40·7 | September - | 38·0 | 50·7 |
| April - - | 26·2 | 41·5 | October - | 26·5 | 48·1 |
| May - - | 41·4 | 51·5 | November - | 35·2 | 45·2 |
| June - - | 32·2 | 55·7 | December - | 24·3 | 39·9 |
| MEAN - | 32·7 | 43·2 | MEAN - | 34·3 | 50·3 |

A.

EXPERIMENTS.

TABLE of the DIFFERENTIAL TEMPERATURE in Ten Coal Mines on the Tyne.

| Mines. | Depth of Mine. | Temperature of Downcast or Day. | Temperature of Upcast. | Degrees gained by Earth. | Degrees given by Furnace. | Differential Temperature. | Remarks upon the Ventilation. |
|--------|----------------|---------------------------------|------------------------|--------------------------|---------------------------|---------------------------|---|
| A. | 552 | 35 | 72·8 | 22 | 15·8 | 37·8 | Feeble. |
| B. | 600 | 35 | 70·0 | 20 | 15·0 | 35·0 | Feeble. |
| C. | 690 | 34 | 56·5 | 20 | 2·5 | 22·5 | Very bad indeed. |
| D. | 300 | 42 | 135·0 | 21 | 72·0 | 93·0 | Very brisk indeed. |
| E. | 420 | 38 | 144·0 | 21 | 85·0 | 106·0 | Very brisk indeed. |
| F. | 540 | 40 | 86·5 | 17 | 29·5 | 46·5 | Good. |
| G. | 1,408 | 39 | 78·6 | 30 | 9·6 | 39·6 | Very good. |
| H. | 390 | 44 | 79·75 | 14 | 21·75 | 35·75 | Feeble and bad. |
| I. | 1,170 | 35 | 93·0 | 25 | 33·0 | 58·0 | { - - Feeble in mine, quick in the constricted shaft. |
| J. | 1,290 | 40 | 140·0* | 26 | 74·0 | 100· | Very good. |
| MEAN - | 753 | 38 | 95·6 | 21 | 35·8 | 57·6 | |

* Thermometer at its limit.

C.

TABLE of Explosions, in relation to DAY TEMPERATURE, in the North of England.—Deaths, 982.

| MINES. | — | Killed. | Day Temperature. | | | MINES. | — | Killed. | Day Temperature. | | |
|--------------|-----------|---------|------------------|---------|----------------|------------|-----------|---------|------------------|---------|----------------|
| | | | 1st Day. | 2d Day. | Explosion Day. | | | | 1st Day. | 2d Day. | Explosion Day. |
| Wallsend | December | 13 | 44° | 50° | 54 | Wallsend | October | 52 | 44° | 45° | 47° |
| Hebburn | October | 35 | 38 | 38 | 39 | Rainton | November | 59 | 36 | 40 | 44 |
| Oxclose | November | 38 | 40 | 34 | 43 | Newbottle | November | 11 | 53 | 42 | 40 |
| Killingworth | March | 10 | 41 | 41 | 44 | Lumley | October | 14 | 54 | 53 | 54 |
| Ditto | September | 12 | 57 | 56 | 56 | Fatfield | July | 11 | 53 | 60 | 62 |
| Felling | May | 92 | 49 | 53 | 60 | Jarrow | January | 34 | 20 | 21 | 36 |
| Penshaw | October | 24 | 52 | 49 | 52 | Townley | May | 38 | 56 | 51 | 55 |
| Fatfield | September | 32 | 56 | 57 | 50 | Washington | November | 14 | 44 | 47 | 50 |
| Felling | December | 22 | 40 | 39 | 46 | Jarrow | August | 42 | 60 | 62 | 61 |
| Hebburn | December | 11 | - | 57 | 63 | Springwell | May | 47 | 61 | 60 | 60 |
| Newbottle | June | 57 | 54 | 53 | 58 | Willington | April | 32 | 48 | 49 | 46 |
| Harraton | June | 38 | 60 | 62 | 58 | Wreckenton | April | 28 | 46 | 49 | 49 |
| Rainton | December | 27 | 39 | 39 | 40 | Haswell | September | 95 | 58 | 61 | 37 |
| Sheriff Hill | July | 35 | 61 | 61 | 63 | Jarrow | August | 40 | 54 | 53 | 54 |
| Lambton | October | 13 | 51 | 52 | 58 | Felling | June | 6 | 59 | 62 | 60 |
| | | 459 | 45 | 49 | 52 | | | 523 | 49 | 50 | 50 |

MEAN Day Temperature of the 30 Explosions:

| | | |
|----------|---------|----------------|
| 1st Day. | 2d Day. | Explosion Day. |
| 47°. | 49°. | 50°. |

D.

TABLE of BAROMETRIC PRESSURE at Newcastle-upon-Tyne, in relation to the above 30 Explosions since 1800.

| MINES. | 1st Day. | 2d Day. | Explosion, Day. | MINES. | 1st Day. | 2d Day. | Explosion, Day. |
|--------------|----------|---------|-----------------|------------|----------|---------|-----------------|
| Wallsend | 30-10 | 30-10 | 30-20 | Wallsend | 29-93 | 29-28 | 29-03 |
| Hebburn | 30-23 | 30-25 | 30-21 | Rainton | 29-88 | 29-86 | 29-60 |
| Oxclose | 30-11 | 29-90 | 29-33 | Newbottle | 29-06 | 29-08 | 29-50 |
| Killingworth | 29-79 | 29-90 | 29-95 | Lumley | 29-62 | 29-46 | 29-15 |
| Ditto | 29-18 | 29-53 | 29-53 | Fatfield | 29-61 | 29-80 | 29-68 |
| Felling | 30-10 | 29-90 | 29-83 | Jarrow | 30-25 | 30-33 | 30-25 |
| Penshaw | 29-16 | 29-35 | 29-31 | Townley | 29-70 | 29-76 | 29-78 |
| Fatfield | 30-08 | 29-96 | 30-03 | Washington | 29-49 | 29-62 | 29-48 |
| Felling | 29-25 | 29-63 | 29-76 | Jarrow | 29-33 | 29-15 | 29-40 |
| Hebburn | - | 29-80 | 29-60 | Springwell | 30-16 | 29-81 | 29-62 |
| Newbottle | 29-70 | 29-80 | 29-78 | Willington | 29-74 | 29-64 | 29-63 |
| Harraton | 29-45 | 29-63 | 29-51 | King Pit | 29-58 | 29-45 | 29-19 |
| Rainton | 29-38 | 29-05 | 28-41 | Haswell | 30-11 | 30-03 | 29-89 |
| Sheriff Hill | 29-65 | 29-38 | 29-08 | Jarrow | 29-29 | 29-30 | 29-77 |
| Lambton | 29-53 | 29-68 | 29-60 | Felling | 29-78 | 29-54 | 29-51 |
| MEAN | 29-63 | 29-72 | 29-60 | MEAN | 29-70 | 29-60 | 29-57 |

| 1st Day. | 2d Day. | Explosion Day. |
|----------|---------|----------------|
| 29-63 | 29-72 | 29-60 |
| 29-70 | 29-60 | 29-57 |
| 29-66 | 29-66 | 29-58 |

MEAN Atmospheric Density at the time of 30 Explosions - }

Explosion Day — .08 of an inch.

E.

TABLE OF DIFFERENCE.

Barometric and Thermometric Difference, in relation to Explosions since 1800.

| MINES. | Mean Temp. of three Days. | Difference Bar. | Difference Thermr. | MINES. | Mean Temp. of three Days. | Difference Bar. | Difference Thermr. |
|--------------------|---------------------------|-----------------|--------------------|------------------|---------------------------|-----------------|--------------------|
| Wallsend - - - | 49.1 | + .20 | + 10.7 | Wallsend - - - | 45.4 | - .90 | + 3.3 |
| Hebburn - - - | 38.1 | - .04 | + 1.7 | Rainton - - - | 33.0 | - .28 | + 8.3 |
| Oxclose - - - | 33.3 | - .78 | + 3.0 | Newbottle - - - | 44.9 | + .44 | - 12.3 |
| Killingworth - - - | 42.1 | + .16 | + 3.3 | Lumley - - - | 53.9 | - .47 | - |
| Ditto - - - | 56.2 | + .35 | - 1.4 | Fatfield - - - | 57.1 | - .02 | + 8.6 |
| Felling - - - | 59.8 | - .27 | + 11.0 | Jarrow - - - | 25.4 | - .04 | + 16.6 |
| Penshaw - - - | 50.7 | + .15 | + 1.3 | Townley - - - | 50.0 | + .08 | - 1.5 |
| Fatfield - - - | 54.4 | - .02 | - 6.6 | Washington - - - | 46.7 | - .07 | + 5.6 |
| Felling - - - | 41.5 | + .51 | + 5.0 | Jarrow - - - | 61.3 | + .07 | + 1.3 |
| Hebburn - - - | 40.0 | - .20 | + 6.0 | Springwell - - - | 60.4 | - .53 | - 1.0 |
| Newbottle - - - | 55.2 | - .02 | + 4.6 | Willington - - - | 47.1 | - .11 | - 2.3 |
| Harraton - - - | 59.8 | + .12 | - 3.4 | King Pit - - - | 48.3 | - .39 | + 2.9 |
| Rainton - - - | 39.5 | - .97 | + 0.5 | Haswell - - - | 58.2 | - .22 | - 2.5 |
| Sheriff Hill - - - | 61.6 | - .57 | + 0.2 | Jarrow - - - | 53.7 | + .48 | + 0.6 |
| Lambton - - - | 53.5 | + .07 | + 7.6 | Felling - - - | 57.0 | - .27 | + 0.5 |

| | | | |
|-------------|------|-------------|-------|
| Explosions. | Bar. | Explosions, | Ther. |
| 11 | + | 21 | + |
| 19 | - | 8 | - |

or,
 Out of 50 conditions affecting Explosions,
 11 x 8 = 19 are not favoured by atmospheric influence;
 19 x 21 = 40 are favoured by atmospheric influence.

1491. Did you ever hear of an effect of this kind from the action of the furnace, that in proportion as the current was made more rapid, and thereby a larger quantity of air passed over the furnace, the heat from the furnace being diffused through that much larger quantity of air, did not produce so powerful an effect as it did when the current was not quite so strong?

I cannot say that I have observed that, because I have never seen a furnace, except in mines D and E, constructed on such correct principles as to efficiently warm the air. In all other mines I examined, the furnace was not so efficiently warming the air as in the mines I mention; but it is natural to suppose, that the more air you have to heat with a given quantity of heat, that you get a less effect by the greater diffusion of heat; this is a law in physics. The whole of the matter I have had the honour to speak upon might be summed up in these points—[*producing a Paper.*]

1492. This paper contains a summary of the different points that you would propose as essential, in order to ensure the proper ventilation of mines? Yes, and other causes of the loss of life in coal-mines.

The Witness delivers in the same, which is as follows:

I RECOMMEND the following:—

That Government require, that there shall be maintained a certain difference of temperature at all times between the upcast and downcast air, according to the depth of the mine, and if the ventilation be performed by mechanical means, that there shall be at all times maintained a certain velocity of current, hereafter to be determined.

That the duty of an Inspector shall be to see that this *differential temperature* or velocity of current be maintained at the pit's mouth, and that he be empowered at all times to descend the mine, and to follow the air-course throughout the mine.

That Government recommend the following, for the consideration of the viewer:—

- 1st. More shafts, and a distinct shaft for return air.
- 2d. Avoid brattice shafts; if imperative, use brick instead of wood planks.
- 3d. Keep the shaft free at each extremity; but if constructed for any particular purpose, let there be some compensating opening.
- 4th. Sink shafts as remote as possible from each other.
- 5th. Main drifts for air to be explosion proof.
- 6th. Only make communications into "mainways" where openings are absolutely required.
- 7th. When shafts are close to each other, and one a downcast and another an upcast, there should be no weak or vulnerable communication between them.
- 8th. Study well the communications about the bottom of such shafts.
- 9th. Avoid air-crossings as much as possible, and make them in the solid stone when necessary.

J. Hutchinson, Esq.,

M. D.

29th June 1849.

- 10th. They should be out of the reach of boys and candles.
- 11th. Deal boards and brick walls are no protection against the transfusion of gases.
- 12th. That strong and invulnerable stoppings can be made by "stowing" with large stones or small coals.
- 13th. Weak points in a mine are brattice, stoppings of brick, or wood, doors, and crossings, verging into mainways, or separating air of very dissimilar quality.
- 14th. That coal should not be worked too quickly.
- 15th. That a thermometer and barometer be considered as instruments connected with the ventilation, when maintained by heat, and at hand for daily observation.
- 16th. That the furnace be constructed so as to bring the air as near the fire as possible.
- 17th. That all the air, particularly in shallow mines, pass over the fire, or be otherwise heated.
- 18th. That access to the furnace-room from the fresh air may be as remote as possible.
- 19th. That furnace-doors be hung that they cannot stand open without much force.
- 20th. That all doors be hung so as to fall to of their own accord.
- 21st. That the furnace-man have a means of knowing the relative movement of air, and that there be a check upon him that the draught of air has been kept uniform when the mine is "idle."
- 22d. That printed regulations be circulated amongst the men, containing recommendations and instructions for safety of life in dangerous times.

(*The Witness.*) There is one point which I have here mentioned of great importance, namely, as to the regulations being printed. Here is a very excellent arrangement (I believe first introduced) by Mr. Edward Potter, a printed sheet being given to all his men containing regulations respecting the safety lamp. I think it might be carried out further, and other precautions might be added. I think that this is a very excellent arrangement, and that Mr. Potter deserves great praise for having introduced it to the miners; I believe he is the first man who did so.

The Witness delivers in the same, which is as follows :

ORDERS respecting the Davy Lamps in use at South Hetton Colliery.

1. No workman is allowed to use a Davy lamp in the pillars, working or broken, without its having been previously examined by the overman or deputy, and securely locked.
2. Should any accident happen to the lamps whilst in use, by which either the oil is spilt upon the gauze, or in any other way rendered unsafe, they are to be immediately taken to the out-by side of the Davy door, and not again used till after having been properly examined by the deputy or lamp keeper.
3. The hewers, or any other person to whom a Davy lamp is intrusted, are strictly prohibited from interfering in any way whatever with the lamp beyond the necessary trimming of the wick.
4. Should any hewer, putter, or any person whatever, who is in charge of a Davy lamp, in any case lose his light, he is to take it himself to the out-by side of the Davy door to be relighted, and is not allowed to send it out by another person.
5. It is particularly requested that any person witnessing any improper treatment of the Davy lamp by the boys or others, will give immediate information to the overman in charge of the pit, that proper steps may be taken to guard the lives of the people employed in the mine.
6. Smoking tobacco is not allowed in any part of the mine where Davy lamps are used; and persons found offending against this order are liable to a fine of 10s., or to be taken before a magistrate, at the option of the owners or viewer. The fine to be paid to the informer.
7. No candle to be taken nearer the broken flat than the station fixed by the overman; any one found with a candle within that distance to be fined 10s. The fine to be paid to the informer.
8. No boys putting, either as headsmen or double trams, way cleaners, or others, are under any pretext whatever to carry a lamp during their work. A sufficient number of lamps will be hung along the going roads to prevent the necessity of these boys carrying lamps.

Edw. Potter,
Viewer.

South Hetton Colliery, October 1844.

1493. That was in 1844?
Yes.

1494. Are

1494. Are you aware whether any of the viewers have followed his example, *J. Hutchinson, Esq., M. D.* by issuing similar instructions elsewhere?

It may be so, but I have not heard it stated.

29th June 1849.

1495. In the course of your examination of the different collieries in that district, you had a good deal of intercourse with the persons who are charged with the practical superintendence of the mines?

Yes.

1496. What should you say of the qualifications of those persons for the duties and responsibilities that are imposed upon them; should you say, from your intercourse with them, that they are of sufficient intelligence or education to be able to discharge the duties which are imposed upon them efficiently and properly? The question does not refer to the head-viewers, who are a very superior class of persons, but to the overmen, on whom rests the practical superintendence of the mines?

If we begin with the under-viewer, you have them of various kinds. The viewer of mines A, B and C, could not tell me why air, when heated, ascended: he had the charge of many lives under him.

1497. Will you give the names of those mines?

A, B and C pits are the mines of Sheriff Hill, in the county of Durham; D is Ouston, and E is Pelaw, under Mr. John Easton, whom I have already commended. Cramlington is F; South Hetton is G, under Mr. Potter; Gateshead (I think they call it the Gateshead Park) is H; I is Jarrow; J is Hebburn. In reply to the former question, the men in the mine, the overmen, &c. do not, I am inclined to think, know the elementary branches of physics, and their education is generally not such as to say that they can efficiently discharge their duties, which are out of the common course of work.

1498. Should you consider, from what you have seen of that class of men, that they would be very competent persons to deal with unforeseen circumstances; things that were not in the routine of their employment?

I am afraid not.

1499. They are quite capable of discharging the ordinary duties of a mine, as long as everything goes on in regular method; is that your opinion?

Quite so.

1500. What do you think would be the increased charge to a colliery if those overmen were selected of these higher qualifications, with a knowledge of the currents of air, and so forth?

I am not prepared to answer that question.

1501. Who is the head-viewer of those three collieries which you say are so deficient?

The viewer is now dead; Mr. Patton was his name.

1502. Was he a competent man?

He made this answer to me, when I asked him if he knew the reason why heated air ascended; he said, he thought it was because they lived upon a hill.

1503. Was that the viewer?

Yes, the viewer of the mine already mentioned.

1504. Who issued those instructions which you have handed in?

Mr. Edward Potter.

1505. In your opinion, it would be very desirable that means of superior education should be afforded to the persons connected with coal-mines?

Yes; and I think, from conversations with some of the head-viewers, they are anxious that they should form some society for reading papers or discussing points, or anything of that kind, to disseminate education further amongst miners.

1506. Is this with regard to viewers or overmen?

If amongst viewers, it would spread to overmen, and so on.

1507. Are there schools attached to these collieries, where the children of the colliers are educated?

*J. Hutchinson, Esq.,
M. D.*

29th June 1849.

There are no schools in connexion with the collieries ; if there is a school, it is an accidental affair, and a private matter.

1508. Taking the colliers generally, are they an educated or an uneducated class ?

I should say uneducated.

1509. They can neither read nor write in general ?

I believe many of them cannot.

1510. In what proportion ?

I do not know the proportion.

1511. You would be hardly able to give it, would you ?

No ; except that I have seen formerly, when they had to write their names (I am speaking now from memory), that the prevalence was to make a cross.

1512. In the course of your researches you have paid a good deal of attention to the physical effects of a want of pure air upon the human system ?

Yes.

1513. Without going deeply into the medical part of the subject, will you state to us what you have observed with reference to accidents in coal-mines ?

With reference to the sanitary question, I think that, independently of ventilation as a preventive against explosions, there is considerable deficiency of air for respiration, if you regard the expression of a collier's face, it is so white ; this is an indication of a considerable want of air for the respiration of the miner under ground.

1514. You mean even in a wholesome state of the mine ?

Yes ; I think that, for instance, in a mine of 150 men and 30 horses, and say 180 artificial lights, there should not be less than 2,500 cubic feet of air per minute for vital-chemical purposes alone.

1515. From what do you deduce those figures ?

I have examined some thousands of men on respiration, and have written upon it.

1516. Will you shortly state the reason for which you arrive at that conclusion ?

The conclusion is, that I find men breathe a certain *quantity* per minute, and that they breathe so many *times* in the hour ; and by taking this average, and the average amount of weight of oil and candle that is consumed by their air, thus roughly you may come to this approximation of the amount of air which these men would require for their well-being, and for the combustion of artificial lights.

1517. Those men and the lights ?

Yes ; it is very evident to any one accustomed to the faces of these men, that they have a very blanched look ; and we do not perceive a blanched countenance in those that are on the sea, or that live in the open air ; the aëration in the lungs with the latter is so much better.

1518. Did you ever examine the atmosphere of a mine that was in a proper state of ventilation ?

I have not examined it chemically. It is also important, if possible, that men should not be employed in the " return air ;" if you remain in the return air for half an hour, you soon feel a head-ache, and an indescribable oppression. I have found the return air in a very short time to affect my head, although I am not subject to head-ache. The man that is in the furnace-room is always in the return air. I have seen some very distressing cases of men with bronchial affections, or other lung affections, in the return air, not only bad to breathe, but in a strong draught unduly draining their animal heat ; this is of course highly injurious. I would say that where it is possible, to make a source of relief from such, would be valuable to the miner's life : some men do consider it, and some probably do not consider it. In the instance of mines D and E, which are under Mr. John Easton's care, no men are employed at night, except one man, who has to keep the furnace. Other mines have 20 or 30 men at night-work, as they conceive that they are obliged to keep certain ways open, and to prepare certain works for the morning.

1519. Are

1519. Are those men employed in hewing coal?

No, only in arranging ways and preparing places for work; but Mr. John Easton's observation is, "That night is the proper time for man to sleep, and the day for him to work," and, therefore, there are not any in his mine working at night. Now, I certainly was struck (before I knew that) with the order of his mine. In this colliery of Mr. Easton's, there are 150 men, 30 horses, 100 Davy lamps, 50 candles, and 1,000 acres of mining gallery to keep in order; yet he maintains this discipline. In another mine, which is Hebburn, where there are 160 men and boys, 190 artificial lights, and 16 horses, here the men work at all hours in the 24, and in all days in the seven. Here there was a long channel into the furnace-room, and there was a man who during his working hours was in that channel, which was precisely the same as living in an air tube, with a strong draught blowing upon him; so that for the short time I was there, it made me shudder with cold: that man had a considerable bronchial affection, likewise asthma; and I think I should not like to have been there, though I have not these diseases. This man had formed an arrangement of boards as a screen to preserve him from the draught, but the draught was so strong that the eddy round this protection was almost as bad as being in the draught. Therefore, there are states where the viewer has the means of improving the positions of his men in certain conditions relative to their health. Sometimes viewers do not consider the health of their men so much as perhaps they might do; but I believe these gentlemen are improving considerably in that respect, or I could not have quoted the case of mines D and E.

J. Hutchinson, Esq.,

M. D.

29th June 1849.

1520. What is the general health of colliers and pitmen?

I think their general health is pretty fair; I think, nevertheless, they are disposed more to have affections of the chest; their respiration is certainly affected, for they have high shoulders, and not generally expanded chests.

1521. What is the average longevity of colliers as compared with other persons?

I am not prepared to answer that question. Another point of which I should wish to speak is, the breathing the "foul air" after an explosion. After an accident happens, there is a pressure of people within to escape from the mines; and there is a pressure of people without to go in and help them. The miner rarely considers that the after-damp is a CERTAIN POISON; he considers that it is something which he can resist by some inherent strength, and they go into certain parts to aid their fellow-workmen, and thus they perish. At Sheriff Hill's colliery, many years ago (1819, I believe), there were four brothers who perished; this I mention as an illustration. Fogget was the name of the four men; one died in the explosion; the second brother went in after the first—he died; the third after the second—he died; the fourth after the third, and he died. They *will* rush into this carbonic acid, or "after-damp air," thinking, "I am stronger than you;" but they are sure to perish, for this is nature's law. Several precautions have been proposed, but the great point is to have those things which are most convenient to obtain. The sprinkling of lime in the suspected locality has been spoken of,—that is a very excellent plan, at least it is perfectly philosophical; and also of lime-water,—they always have plenty of lime about a pit, and it may thus be useful. Breathing through bags containing slacked lime and Glauber's salt, in equal parts, have been mentioned; this mixture has a great power of absorbing carbonic acid gas; but such plan is uncertain, for if anything stops the porosity of the bag, then the man's respiration ceases. Sometimes it is of great importance to go a few yards, say 40 yards, "in-by," to try to reach a perishing miner; and a man will enter, and probably he will die before he reaches the spot. I found out, by the observations which I have referred to on respiration, that by the mere process of forcible expiration and inspiration, that is, forcibly emptying your chest of the air, say six times, then give one deep inspiration, you can then hold your breath with the chest full of fresh air three or four times longer than you can in the ordinary state. For instance, the average time for which we can hold our breath is about three-quarters of a minute at the outside; generally under that.

1522. With the lungs full or empty?

Either way; but by inspiration and expiration, cleansing the lungs of old air, that is, emptying out the old air which has been in you, and then receiving fresh air in its place, you will be able to go on with ease for two minutes.

J. Hutchinson, Esq.,

M. D.

29th June 1849.

1523. How do you do that ?

I will be happy to show your Lordships ; it is so simple, and one can accomplish a great deal in two minutes. If any of your Lordships will look at your watch, as soon as I am ready I will strike the table. The most expert pearl-divers never exceed a minute and three quarters under the water ; it is very rarely that two minutes have ever been accomplished under the water.—[*The Witness makes several deep inspirations and expirations, then held his breath for the space of a minute and a half.*]—As I have now been speaking for some time, I have not accomplished the two minutes. At home and before private friends, I have often held my breath for two and a quarter minutes, but just at this moment, I have not carried it out to this extent. However, I do not experience at this moment any inconvenience from this experiment. Now I assure you that this time, though apparently short, is of great value to the miner. I remember a case at one colliery where there was a very small way of perhaps eight or ten yards ; at the end of that, there was a door which had to be opened ; the men were a few yards distance from that door, where there was fresh air, but the air between them and the door was so exceedingly charged with carbonic acid gas, that there were either four or five who died in that space : they took hold hand by hand to go in ; one fell, and the others became confused, until at last they all died. It should be impressed on miners, that this gas IS A POISON, and that they are as sure to die if they breathe it, as that a stone is sure to fall to the ground when not suspended.

1524. In that case, would you have been enabled to reach the door by stopping your breath in that way ?

Yes, certainly ; you might walk round this room with ease in that time, and bring out any person that you could lift conveniently, because the chest is favourably placed for lifting, for it is expanded and fixed. When you take hold of a considerable weight, you always hold your breath to fix the chest for giving a more firm attachment to the great pectoral muscles. Another plan which I would propose is, that of carrying in air ; a bag of four or five feet would last a person with ease half an hour. Such a simple thing as a mask (Figs. 2 & 3, Diagram No. 4.) might be employed with the expired air instantly escaping off into the atmosphere. Sometimes masks have been used with long tubes, but we cannot breathe through a tube of three or four inches in length for any time without feeling inconvenience ; upon the same principle as the partial return of water in the ebb tide is brought back by the flowing tide ; so if we employ a tube of any length, we are always inhaling a part of the previously expelled air ; therefore, the point is to expel it clear out into the atmosphere as soon as possible. Another objection to certain instruments is, that sometimes they make a mask, through which you must inspire by the mouth, and expire by the nose. Now all plans for a miner in time of danger must be such as requires no attention to his respiration, that he cannot breathe wrongly. He has quite enough to do to take care of himself in other ways, and to go after his object. I propose a mask with a valvular arrangement, that he may breathe with either nose or mouth. A mask is used in the drains in Paris, connected to a large bag as a reservoir, a kind of arrangement of this order—[*showing a Diagram of the same*]—a basket containing so many cubic feet of atmosphere. (Fig. 1, Diagram No. 4.)

Vide Appendix I.
Plan No. XI.

1525. How would the air be contained in the basket ?

It is in a bag ; the basket merely keeps it in its place. I propose a mask like Fig. 2, strapped on to the head ; a mask is better than a skull-cap, because the ears are exposed, and hearing is an important sense in time of danger, and the head is kept cooler by a mask ; this to be connected with a bag, as in Fig. 1, which bag may likewise be connected with a lamp. Fig. 3 is a section, showing the arrangement of the valves for directing away the expired air immediately into the ambient atmosphere ; if this is not attended to, I have found the pulse raised, or heart's action, to 160 beats instead of 80 beats per minute ; but even a bladder of pure air, containing 300 or 500 cubic inches of fresh air, or perhaps 1,000 (which would be only a small bladder), in his hand, this supply would serve a man a long time. I press another point, namely, that he should not be dependent upon any tube for his air, COMMUNICATING with " out-by," or at a distance, for such as a tube " following" him, it may be crushed by a stone falling, and he or others in confusion may walk upon it, which would be death to the miner in question ; in fact, anything depending upon people at a distance is uncertain, and therefore bad ; he should have it all with him, only depending upon

upon himself; and I am sure that a bag containing fresh air would be a means of saving many lives after an explosion, from the cases which I have seen; I speak of it because I have seen it. The air-bags should be filled at "bank" WITH BELLOWS, and NOT with any oiled or greased syringe.

J. Hutchinson, Esq.,

M.D.

29th June 1849.

1526. Do not you suppose that in cases of loss of life after an explosion the effect is very rapid, in the same way as that instance which you mentioned a short time ago of the person who wished to reach a door?

Yes.

1527. The loss of life is very rapid?

Sometimes very rapid indeed, or it may be a kind of slow lethargy, which is no less dangerous.

1528. You state that after an explosion the greater number of lives are lost from the after-damp?

Yes.

1529. That the effect of that after-damp is very rapid in destroying life?

Yes.

1530. Then do you think that any contrivance enabling persons to enter the mine a short time after the recurrence of an explosion would enable those persons, in many instances, to save the lives of parties in the mine at the time of the explosion?

Yes, I believe so, because I have seen a man restored who has been brought out with no sign of life, except the sign of warmth, which may exist in a man that has been dead one hour or 12 hours.

1531. How long after the explosion?

This was a man who was not in the explosion, but who went down to help others; I may suppose that since he first began to inspire the foul air, to the time that I saw him, he must have been an hour under an insidious influence.

1532. Would a "respirator" be any protection?

No; it is the QUALITY, not the quantity, of the air upon which we chiefly depend.

1533. In the cases of after-damp, an instantaneous or a more protracted death would be in proportion to the per-centage of the carbonic acid gas in the atmosphere?

Yes.

1534. If it were in a more diluted state, it might produce insensibility?

Yes.

1535. From which a person might recover if brought into the pure atmosphere?

Yes.

1536. But if he remained long in that impure atmosphere, death would ensue?

Yes; the degree to which insensibility may go before you may say that life is hopeless, I do not think can be asserted; it is astonishing how soon some people seem to die, and how hard others seem to die; the same is found in drowning. I would say this, that when a man is brought out, the best treatment is for any one to put his finger down his throat and try if he can make him vomit; I would urge this. Inflation or insufflation of the lungs has been spoken of, by apparatuses like pumps or bellows; but they are generally dangerous. You are perhaps scarcely aware that every one breathing in this room at the present time is resisting a force; I do not mean atmospheric and counterbalanced force, which is mere displacement, but an absolute pressure on one side of his ribs, of about seven or eight inches of mercury upon every superficial square inch of the thorax, from the mere elastic tension of the ribs; our ribs are always tending to collapse, and we are always trying to keep them extended, or resisting that collapse, as we resist the weight of the eye-lids in keeping them open, but which ceases by sleep. When we employ bellows or pumps to inflate the lungs, we use an extreme and unknown force (when we consider the hydrostatic law of pressure of fluids); we have to expand the lungs against the pressure of the ribs; the consequence is, that we rupture the lungs; we cannot introduce, for physiological purposes, the finest injection into the lungs without rupturing them;

*J. Hutchinson, Esq.,
M. D.*
29th June 1849.

I have found that a very little quantity of air produces a rupture; therefore, bellows and pumps, on these grounds, are objectionable for resuscitation, and I would say that such are unsafe instruments in any one's hands. Oxygen gas is also mentioned for resuscitation; I would say that we do not know much of the operation of the oxygen on our system. The only gas which we can breathe with impunity is the atmospheric air, and if we breathe pure oxygen, I am afraid we would do more harm than good. I remember a very strange case of a boy brought out of the canal up at Islington; he was taken into a public-house apparently dead; a man in the tap-room said, "I will restore him;" and he put his mouth to his nostril and inspired all the air out of his chest; consequently, the atmospheric air rushed in by the elasticity of surrounding parts, and thus fresh air was drawn into the lungs. Here there was no danger, because this was a natural agent drawing in the air. The expansion of the ribs acts precisely the same as the expansion of the bellows. The lungs are filled by an external act, by the expansion of the walls of the chest; the bellows are filled in the same way.

1537. And was that boy recovered?

Yes, he recovered. Now, if they had used pumps, which they had gone for, of course, I do not say that anything untoward would have happened, but I am sure they would have applied respiration as it is not applied in nature.

1538. Then, when a man is brought out of a mine in that state, what is the proper course to pursue?

I would first take him into the fresh air; take him out of the way of other people. If you can make him vomit, by means of your finger or an emetic, say a teaspoonfull of mustard and water, do so; if he is past that, pressure on the abdomen. Alternate pressure and relief will tend to move the bottom of the lungs, without any danger, and thus draw air into the chest.

1539. In the atmosphere which destroys life in this manner, we know that a light will not burn; combustion will not take place. In cases where you wish to enter that atmosphere, and to save people in a mine in that state, how would you overcome the difficulty of not being able to carry a light with you?

In reply to this question I would beg to say, that the atmosphere may be so charged with carbonic acid gas as to cause death, and at the same time not to extinguish a candle; therefore, miners should not depend upon their candle as a mark of life and death atmosphere.

1540. Does it require a larger per-centage of carbonic acid gas to extinguish a candle than it does to extinguish life?

It does, and there is a difference between burning gas and burning a candle; I believe a gas-light will burn longer than a candle or in an atmosphere more charged with carbonic acid gas. I mention this because it is a general opinion that if a candle will burn you may live, but I think the contrary now is pretty well known. I have some cases upon this point amongst my papers at home.

1541. How would you overcome the difficulty of not being able to take a light with you into such an atmosphere, your object being, in what you have lately said, to enable persons to enter a mine after an explosion, in order to save the lives of others?

In that case it is possible to take a light in, depending upon the same air that you are yourself depending upon.

1542. Connected, you mean, with the same reservoir of pure air?

Yes, as described in the drawing, Fig. 1, "Air for lamps," (Diagram, No. 4.)

1543. You propose that merely for emergencies, and for use for a short time?

Yes.

1544. You do not represent it as a plan that could be pursued for the purpose of any lengthened use?

Certainly not; only in cases of life after an explosion.

1545. Cases of life and for very short periods?

Yes. I have no plan of how to enter a mine without a light.

1546. Have

*Vide Appendix I.
Plan No. XI.*

1546. Have you ever seen a mine on fire?

No, I have not.

J. Hutchinson, Esq.
M. D.

29th June 1849.

1547. Have you devoted your attention at all to the construction of the Davy lamp?

I have examined the Davy lamp; from the evidence which I have been able to gather, and from my own personal investigation, I have found that the simple lamp, as constructed by Davy, is perfectly safe and efficient in all those circumstances in which Davy intended the lamp should ever be used. This is a common Davy lamp as Davy made it—[*producing the same*]*—*and this is the kind which is extensively used in the North of England. I have had a Davy lamp hot for hours; I do not know how long; two or three, probably; I would say in a red heat at times; and I have tried it in many parts; and if it had not stood the test, I could not have been here now. Several modifications of Davy's lamps are spoken of; but wherever there is an inch, or even one mesh, of gauze connected with a lamp, it is a "Davy lamp," and therefore all other kinds are but modifications. These are modifications—[*producing some lamps*]*—*Upton & Roberts's; but this is extremely heavy—a great objection to a lamp; no man that ever I have seen could carry a lamp of that kind eight hours. That, I believe, is Stephenson's lamp—[*producing the same*]*—*these were made because it was said that you could explode the Davy lamp. It is very true, if you take a piece of wire gauze and put it opposite a jet, and blow upon it, you can cause the flame to pass; but I very much question whether that is ever the case in a mine. These lamps are substitutions to provide against such experimental tests. In this lamp we have a modification, by the double gauze extending over the original gauze for six inches, leaving an inch single opposite the flame; this is proposed by the maker of Davy's lamp; that is, Mr. Newman, of Regent-street; and he says that it is impossible to cause explosion to pass the double gauze under any circumstance; and this double gauze does not obstruct more light, because it comes short of it. The space between the two gauzes is about the eighth of an inch. I am not prepared myself to answer about this; but it certainly seems to me very fair to suppose that this is utterly inexplorable, under all conditions, with the double gauze; that is the most simple thing which I have seen. The objection generally to Davy's lamp is the want of light.

1548. Of course, where the gauze is doubled, it obstructs the light?

Yes; but it will be observed that opposite the flame it is single.

1549. What constitutes the additional safety, the vacuum between the two?

No; the principle of the safety lamp is the cooling power, the gauze cooling the flame down below the point of ignition; then the effect of the double gauze is simply that you cool it twice as much.

1550. Is there not a little vacuum between the two pieces of gauze?

There is a little space there, but no vacuum; that space cannot hold any flame, because of the cooling power of the gauze.

1551. Have you seen the Clanny lamp?

Yes. All the chief viewers that I asked, upon my putting the same question, of the integrity of the simple "Davy," said that they preferred the common Davy to any that they had seen. I particularly hope that this will become known, because an impression has gone abroad that the Davy lamp is a failure. I have seen it stated in France that it is never used now in England, because it is a complete failure.

1552. Do you know what quantity of light passes through the gauze, and what quantity is absorbed?

No, I could not state the proportion; I should guess a loss of 30 per cent. by the gauze. The only original construction that I have seen since Davy's has been the lamp that is in use in Belgium; this is a section of it; the only air that can enter is by these two little tubes, and over those tubes you have your wire gauze; that supplies the flame, and the product passes up here—[*showing the same*]*—*you have a large space open, and consequently you have a lamp not surrounded with wire gauze. The principle of the Davy is, that your flame shall be surrounded by it: the novelty here is, that the chimney shall be open; and it is said to be perfectly safe.

*J. Hutchinson, Esq.,
M. D.*

29th June 1849.

1553. But you do not think that any lamp, however perfect, would be anything like a substitute for ventilation?

No.

1554. The great desideratum is a perfect system of ventilation?

Yes; the absence of that is the cause of the explosion.

1555. The evidence which you have given to us upon the subject of accidents in coal-mines has already been communicated by you, in substance, to the Government?

Yes; it has been submitted to the Home Office, to Sir George Grey.

1556. And your plans were laid before the Secretary of State and Sir Henry De la Beche?

Yes; and I am informed that he reported upon it favourably to Sir George Grey.

.The Witness is directed to withdraw.

H. H. Vivian, Esq.

HENRY HUSSEY VIVIAN, Esquire, is called in, and further examined as follows :

1557. HAVE you bestowed any attention upon the capacity of the water-gauge to indicate the power exerted by the exhausting agent in a mine?

It seems to me that it simply shows the amount of rarefaction required to overcome the resistance caused by the air being drawn beyond its natural velocity, and from the friction of the passages and shafts of the mine, just as a long rope would stretch in proportion to its weight, and to the friction it might be subjected to; such stretching would be no measure of the power attached to and drawing the rope. I think that the experiment shown by Mr. Brunton proves the above to be the true definition of the indication of the water-gauge, for so long as the orifice of the induction-pipe is open, no water-gauge will be produced.

1558. Will you explain what you mean by the induction-pipe?

The induction-pipe is that pipe which is attached to the circular fan.

1559. Through which the draught passes?

Through which the draught enters; but when a piece of paper is laid across the induction-pipe, thereby reducing the opening by which the external air can enter, rarefaction ensues to the extent of the friction produced by the contraction of the orifice, but that it is no measure of the power employed is clear from the fact shown by Mr. Brunton, "that the power then requisite to turn the machine is much less than when the orifice is open;" for this latter cause, I conceive that Mr. Brunton's machine never could produce any great extent of exhaustion. On the other hand, Mr. Struvé's machine would certainly be better calculated to produce exhaustion to a higher degree than any other ventilating agent at present known, for the same reason that although a fan-blast is well known to give more air than a cylinder-blast for the same power, still none but a cylinder-blast can produce the pressure required to drive an iron furnace; the reason I conceive to be, that the air within the cylinder is cut off from the air without, when the motion reverses and the valves close. If Mr. Struvé's machine were applied to an induction-pipe, the more the orifice was closed, the more power would be required to the extent of the strength of the machine. The parties engaged in experiments with the Atmospheric Railway ought to give good evidence on these points; and it would be also very desirable that the laws which govern the resistance of air in collieries should be clearly defined. I am led to these conclusions from the following calculations: I calculated the theoretical power required to draw 13,000 cubic feet of air through the Eaglesbush pit, three feet six diameter, and I find it to be rather less than half a horse-power, while Mr. Struvé's machine is worked by a five horse-power engine, which is fully taxed; this calculation was made by multiplying the square of the velocity in seconds by $\cdot 002288 \times$ the area of the shaft \times the velocity per minute and $\div 33,000$. Now if, as is the fact, five horse-power is required to draw 13,000 cubic feet in this case, and half a horse-power is only required to overcome the resistance of the air as at present stated, then the remaining four and a half horse-power must be required to overcome friction; and if this increases as rapidly as the resistance, then

then the power required to draw such quantities of air as pass through the northern collieries (Haswell, 70,000) may be immense, and the furnaces may represent very high mechanical powers. I throw out these few remarks with a view to show that much remains yet to be learnt as regards the application of mechanical power to ventilation, and that furnaces probably represent much greater mechanical effect than they have credit for. As, however, I urged in my examination, "all depends on the size of the shafts."

H. H. Vivian, Esq.

29th June 1849.

1560. Then your view of the action of any such apparatus as the water-gauge upon a mine is this, that the air extracted by it at the upcast shaft is extracted more rapidly, and to a greater extent within a given time, than is supplied down the downcast shaft by natural causes, otherwise there would be no rarefaction?

Yes; it can be exactly exemplified by a bullet hung on to the end of an Indian-rubber band; if you place the bullet on the table and begin to raise it, the Indian-rubber band will stretch exactly to the extent of the weight of the bullet; so when you begin to draw a column of air, which is elastic in the same way that the Indian-rubber band is elastic, there is a resistance caused by friction and by the natural law of air; the column of air begins to stretch, and stretches to the extent of that resistance; it then becomes lighter, and the water-gauge indicates the difference in the weight of the column within and without, and that I believe to be the whole extent of the water-gauge. I mention this as an important point, because this argument was used in the evidence yesterday: "The furnace of Haswell colliery produced a water-gauge of two inches; the little machine which I show here, produces, as I show you, a water-gauge of two inches; therefore, my little machine is equal to the furnace of Haswell colliery." Now I deny that.

1561. Do you mean that here it is an indication of the actual amount of the current?

No; here it is simply an indication of the amount of friction caused by the contraction of the orifice by laying on a piece of paper; without the paper laid on, you can produce no water-gauge; by means of the paper you cause friction, and you then produce rarefaction: it is an important point, because where mechanical agents are employed, it might appear that they have a further bearing than they really have.

1562. Still, if you place the water-gauge in a point in the mine which gives you the average strength of the current, that is to say, that the distance from the ingress or egress is pretty nearly equal on each side, and that the gauge communicates on each side with the two opposing currents, will it not indicate the power exerted by the current upon the opposite sides of the gauge?

It will indicate the full stretch of the air, and nothing more, just in the same way as the Indian-rubber band, if of equal thickness all over, will stretch equally all over.

1563. Would not that be true, supposing that one side of the gauge were placed in the exhausting current, and the other side were placed in the open atmosphere?

Yes.

1564. But in the case of a gauge placed, as we suppose it, in the partition of a mine, you have one end of the gauge in the exhausting current, and the other end of the gauge in the entering current, which you assume to be in a state of exhaustion also, do you not?

I think that the descending column does not probably begin to stretch, because it is descending with its own weight, and endeavouring to fill the space that the other has left; that is a matter of experiment; but I think it cannot be stated at present what the exact effect of the water-gauge is.

1565. But you would not consider the water-gauge as an unexceptionable test of the strength of a current passing through the passages of a mine?

I think it is little or no test of strength of current; it may be more, or it may be less, in certain cases.

1566. Supposing a mine, under the circumstances which have been explained by Mr. Brunton to-day, in which the apparatus was applied to the upcast shaft, and the downcast shaft was closed, there would be then a powerful process of exhaustion

H. H. Vivian, Esq.

29th June 1849.

exhaustion going on upon the atmosphere of the mine; what do you conceive would then be the effect upon a gauge so placed as to have one of its ends near the upcast current, and the other in the stationary atmosphere of the mine?

I think that if the engine were sufficiently powerful, the water-gauge would not indicate, since the water would be drawn out; complete exhaustion would in time be created if the machine were sufficiently powerful.

1567. In this case, you would create complete exhaustion; but another passage being opened for the air, it would not be necessary for it to pass through the gauge, and therefore it could not by any possibility raise the water in that gauge beyond a certain point?

The gauge will in all cases, I think, distinctly show the amount of rarefaction which is taking place, but I do not think that it is a measure of the power of the engine.

1568. Do you think that it would give the amount of rarefaction which had taken place if there were no downcast current also; which is the case that Mr. Brunton has described to-day of a mine where the downcast shaft was stopped, and the apparatus was in work at the upcast shaft; the process is like that of exhausting a vessel; would the water-gauge in that case give you a measure of the exhaustion?

It is very difficult to theorize on it; but I think it would measure the exhausting power of the engine in that case.

1569. Have you ever had any experience of the aneroid barometer?

No; I intend to take one down with me. My attention was first drawn to the matter of the water-gauge before I left home; I then tried this experiment. I found that I had a certain current passing through a certain area. I then had no indication from the water-gauge, or so trifling, that when I shut the water-gauge on one side, and then opened it, there was just an oscillation; I then, thinking that it depended on the drag which the air had on it, contracted the opening of the box, and I immediately got a water-pressure to any amount that I liked; the more I contracted, the more water-pressure I obtained; I then put the anemometer inside the box, and it still indicated a current as 11 to 14, when free from contraction; this led me first to conceive that the indication of the water-gauge was simply the measure of resistance.

The Witness is directed to withdraw.

Ordered, That this Committee be adjourned to Monday next,
One o'clock.

Die Lunæ, 2^o Julii 1849.

The LORD WHARNCLIFFE in the Chair.

Evidence on the
Prevention of
Accidents in
Coal Mines.

Benjamin Biram,
Esq.

2d July 1849.

BENJAMIN BIRAM, Esquire, is called in, and examined as follows:

1570. YOU are mineral agent and viewer to Lord Fitzwilliam, in the West Riding of Yorkshire?

I am.

1571. Have you been employed in that capacity for a considerable time?

For about 18 years, and for a considerable period before that time under my father.

1572. Therefore you have had very long experience of the colliery business?

Yes.

1573. You are aware that a Parliamentary inquiry took place in the year 1835?

Yes.

1574. Have you ever read that evidence?

I have.

1575. Can you, from your knowledge of the subject, state whether any great advance has been made since the year 1835 in the knowledge of the causes of accidents in mines?

I do not think any material change has taken place in that time; I think people's minds are more alive to the cause of explosions than they were then, probably.

1576. Referring more particularly to the district with which you are acquainted, how should you say that in that district those accidents from explosions generally take place?

Partly from deficient ventilation, I think.

1577. Do you think that the ventilation in that part of the country is generally deficient?

I do not think it is so powerful as it might be if it were well studied; I think the men who are employed in the collieries are in a great measure ignorant of the principles of ventilation.

1578. What is the ordinary method of ventilation in the Yorkshire collieries?

By a furnace at the bottom of the upcast shaft.

1579. Generally placed at the bottom?

It has been tried at the top, but I am quite satisfied that placed at the bottom there is a very considerable advantage over being placed at the top.

1580. Is there any great difference in the construction of those furnaces?

Yes; there is a considerable difference in the construction of them; the drawing which was exhibited here on Friday explains the principle upon which most of them are constructed in that neighbourhood.

1581. The drawing shown by Dr. Hutchinson?

Yes.

1582. He showed a drawing with several descriptions of furnaces; which is the one that is generally used in that part of the country with which you are acquainted?

(164. 6.)

x 4

I can

Benjamin Biram,
Esq.

2d July 1849.

I can scarcely say; the principle is the same, an arch over the fire-place; but there are some in which the arch is at a greater distance from the fire-bars than in others, and both those principles are used in our neighbourhood; I do not know that one is more so than the other.

1583. Are there any cases in which the furnace leaves a considerable space round it through which the air can pass without contact with the fire?

Yes; I fancy myself that there is some advantage in air going along the upcast independently of going over the fire-grate; I fancy that there is a greater bulk of air passing through the mine if there is a facility for its getting up the upcast without its going over a fire-grate; sometimes I have seen, by opening or shutting a door, that the draught is very much increased.

1584. By allowing part of it to pass without going over the fire?

Yes.

1585. Did you ever consider how that could take place?

I think it depends in a great measure upon the size of the air-ways; if the size of the upcast shaft is much larger than the size of the air-ways in the pit, then there is an advantage, by allowing air to go up the shaft sometimes without going over the fire-way; the opening over the grate is sometimes very much contracted, and the heat produced by that grate is often such as to take a greater quantity of air up the shaft than would readily pass over the grate; on that account more air will go up the shaft if a door is opened, admitting air into that shaft without passing over those fire-bars.

1586. So that, according to your experience, it would not be strictly true in all cases that the more completely the entire current of air is made to pass over the furnace, the more perfect is the ventilation?

Not in all cases.

1587. Are you able to say at all to what extent furnaces of that description can be made to carry the force of ventilation?

I think that a furnace properly constructed would be quite sufficient to ventilate any mine that I have seen in our neighbourhood.

1588. To what extent would the workings generally be in those mines?

The workings are often very extensive, but the air-ways are not nearly so long as they are in many of the mines in the North. The system of working is different with us from what it is in the North; the air seldom has to pass a distance of above two or three miles, I should say.

1589. Will you explain shortly the principles upon which that difference depends?

It depends upon the manner of working. The workings in Yorkshire generally are not on the stall-work system which they adopt in the north; they are more on the system of long work with us.

1590. Do not you know that there has been an alteration made lately?

Yes; suppose this to be the downcast shaft (D) [*exhibiting a Drawing*]; there are generally two roads driven, and a communication made; they drive the roads in the first instance, so far as they conveniently can for air.

1591. They drive two parallel roads from the bottom of the shaft?

Yes; as far as they conveniently can, and then they make communications at certain distances, and then the banks (d) are turned out. The levels run generally on the end line of the coal with us, and the boards are then driven out at certain distances.

1592. Up the dip?

Yes, on the rise; then the banks are turned out above those boards.

1593. That is to say, the banks are additional passages in the same direction as the first level along the line of the strata?

Yes; there is generally a pillar (c) of coal left above the counter-level (a), as it is called, sufficient to keep the counter-level good. Another opening is driven here [*showing the same*], and then the coal is begun to be got out in breadths of 20 to 40 yards, varying according to the roof; the air will then come over the bank as it is driven: there are pack-gates made on each side of this road, as the coal is got

Vide Appendix I.
Plan No. XII.

got out, and all the air that is necessary comes immediately in contact with the men as they are working, and would come down this road [*showing the same*]. Those packs are continued as the coal is got out, and the air brought forward.

Benjamin Biram,

Esq.

2d July 1849.

1594. That is to say, the stream passes in immediate contact with the men working in this face?

Yes.

1595. When you say that you proceed with the packs, do you mean that you close up the old passages?

This breadth is generally taken, such that, as the coal is got out, it falls in behind the men, and makes it close up behind them. There are two rows of metal or wooden punches, props, next the face, and occasionally a pack, made of the material which falls from the roof, in the bank as well.

1596. Not of the coal?

Not of the coal, but of the material above the coal; as it falls down, it is made into a wall, and packed up as the work proceeds.

1597. Then the result of that is, that it reduces the ventilation in the different parts of the mine that are worked within a small space?

It reduces the length of the air-way very considerably from the method adopted in the North.

1598. May it be said, then, in that case, that the mine is ventilated in different portions?

Yes; suppose this is the width of your bank, between that and the next bank there is a post of coal left, perhaps, of 20 or 30 yards, and then the same thing occurs again; the coal is got out; the air goes up that and down the road, and up here [*showing the same*] in the same sort of way; when these have gone to any considerable extent, there is a passage made across these pillars of coal, so as to shorten the distance of the air; it takes a shorter course still across the faces; all the current of air in the pit is immediately in contact with the men.

1599. Then in these old workings, as you say, the roof falls in behind the men?

Yes.

1600. As they proceed, the roof falls in?

Yes.

1601. Does that become generally a magazine of foul air?

In my opinion it does not, because it falls in so close that there is no current of fresh air which can mix with it, if there is any fire-damp, which there generally is not, because the fire-damp with us does not come out of the roof, but out of the coal itself; it does not accumulate in that roof, and it falls in a considerable height, even up to the surface; by that means, if there is any fire-damp, it will make its escape out at the surface of the earth, so that we have never had an instance of any explosion from an accumulation in those goaves.

1602. That does not appear to you to be one of the causes of explosions in the Yorkshire collieries?

I think it is the case in some places. In some of the pits round us they work these banks very narrow, not sufficiently wide for the roof to fall in after them, as the coal comes out; in that case, all these galleries are goaves, which appear to me to be exceedingly dangerous. And there is another thing connected with it, instead of making the air-gates up the side of the bank, as we do, they leave the solid pillars of coal between those banks and the air-gate, making communication with the banks at distances of 14 or 15 yards asunder, through which they bring the coal out of these banks.

1603. When you talk of the banks, do you mean the places where the men are working?

The banks are the places where the bulk of the coal is brought out, the wider spaces; those narrow boards are places supported on each side by a pillar of coal that is left. The system of many of the collieries round us, is to bring the coal down these boards. I am confining myself exclusively to the thick coal at present. In many of the collieries they do not leave a road up the side of the bank, by making a pack, as I have been describing, but they drive a board-gate.

(164. 6.)

Y

1604. A board-gate

Benjamin Biram,
Esq.

2d July 1849.

1604. A board-gate, meaning what?

A narrow road of about two to three yards in width.

1605. In what direction, up the dip?

Upon the rise of the coal across the grain of the coal, and, at distances of 14 or 15 yards, make cuttings into the bank: upon the completion of every new cutting, a packing is made across the cutting previously used.

1606. What is a packing?

Stone, loose coal, or anything of that sort, sufficient to turn the air, to keep it confined into the road above.

1607. A complete separation?

In a colliery which I was called in to look at, instead of making these packings air-tight, which it appeared to me plain ought to have been the mode pursued, they had left a small opening in the packing, to allow a small current of air to pass through the bank which is there standing. Now, that appears to me to be just sufficient to make it dangerous; it gives it so much oxygen as to render it explosive, without being sufficient to clear out the inflammable gas.

1608. Therefore you think it would be safer, in that case, if these partitions were entirely closed?

Entirely closed, and confining the air to work round the face of the bank; but I am not an advocate for getting out the coal in such a way as to leave all those openings standing. I think those banks ought to be made of such a width as, if possible, to cause a fall of the roof as soon as the coal is extracted.

1609. Are you able to state the usual velocity of the current produced in your collieries by the furnaces now in use?

I am sorry to say that I cannot exactly state; I tried with the anemometer to ascertain the difference between fixing a furnace at the top of the shaft and fixing one at the bottom, about two years ago.

1610. What anemometer?

My own; we were then in a colliery of very limited extent, getting about 15,000 or 16,000 cubic feet per minute throughout that mine.

1611. Did that appear to you sufficient for the purpose?

It was sufficient there, because we had no inflammable air. I do not think it would be sufficient in a mine highly charged with inflammable gas.

1612. What depth are the pits generally in that part of Yorkshire?

About 90 yards; we are now sinking about 150 yards; they are not deep, any of the pits, in that district.

1613. At that depth it constantly happens that when the roofs fall in, a corresponding depression is seen upon the surface, does it not?

Not always upon the surface; but it often happens that it falls quite to the surface; from 90 to 100 yards it falls up to the surface constantly.

1614. In that case, what in other mines would be a goaf and a reservoir for gas, must be filled up?

Yes; the ground is frequently sufficiently broken as to allow the escape of any gas that might otherwise accumulate in those goaves out at the surface.

1615. Then, according to your description, you conceive that the system of working in these mines by which the different parts are subdivided, and shut off from one another, is rather a security against accidents of this kind?

I think it is of great advantage to confine the air which does circulate through a mine to the face of the works, just where the men are working, and, if possible, so to work the coal as that the roof should fall in behind them, and make close up, so that there may be no accumulation of gases.

1616. You examined the Darley Main Pit after the great accident?

Yes; I was down the pits after the accident, both at the Ardsley Main and the Darley Main.

1617. In those cases did you find that the system of ventilation was such as to account at all for the accidents?

In the Darley Main Colliery, at the time we were in, there was the slightest possible

possible appearance, indeed I may say that there was no appearance whatever, of any inflammable gas being evolved from the measures at the time; the barometer, on the day that we were there, was high, and that might account for no gas issuing from the measures; but there certainly was as little appearance of gas as I could have conceived.

*Benjamin Biram,
Esq.
2d July 1849.*

1618. How long was this after the accident?

About a week, I think.

1619. In short, you would not have considered it, from what you saw, a dangerous mine?

Certainly not.

1620. Was that the case also with the Ardsley Main?

The Ardsley Main I had not so good an opportunity of judging of; I was in it after the accident. There is much more gas given out in the Ardsley Main, I should say, than in the Darley Main Colliery.

1621. They are both in the thick bed, are they not?

Yes, the Ardsley Main Pits are the deepest that we have upon that coal.

1622. Do you know their depth?

Nearly 300 yards.

1623. When you say the thick bed, you mean the 10 feet coal?

What is generally called the Barnsley Bed.

1624. The 10 feet coal?

Nine to 10 feet.

1625. You were examined at the Coroner's Inquest upon that occasion, were you not?

I was.

1626. Do you consider that the evidence given upon that occasion explains the true causes of the accident?

Yes; I think the accident partly arose from the state of the air at the time, there having been a considerable wind the day previous to the accident; and another great cause of the accident I thought was the very bad method of drawing water from the upcast shaft.

1627. Which partly filled the area of the shaft?

Yes, in a great measure, and the water falling down from the tubs into the shaft again, I should say, would have a great tendency to divert the current of the air, and make it draw down, instead of up; we saw them draw up several tubs of water while we were there. Mr. Wood was there with myself, and in a very short space of time a very thick column of smoke which was coming up the upcast disappeared, and the shaft became perfectly clear soon after they began to draw the water; my impression was, that the probability was, that it had become a downcast, instead of an upcast.

1628. You are aware that it is the practice in some districts to make use of a fall of water to create a downward current in the downcast shaft?

We are using that method solely in a new pit at Elsecar at present; there is a very considerable quantity of carburetted hydrogen in the mine, so much so, indeed, as to render a furnace dangerous under present circumstances: the only method we have of ventilating that pit is, by a small stream of water turning down the engine-pit at present; that is not what I should recommend when the pit is carried to any extent; it produces a very great draught for the short space that is already opened.

1629. So that the circumstance that water was continually falling down the upcast shaft in the case of the Darley Main would have been almost a sufficient counteraction to the ventilation?

I think so.

1630. And a sufficient cause for the accident?

We find that this small quantity of water (the size of the tap which we turn down not being above $1\frac{1}{2}$ inch in diameter), by falling a distance of 150 yards, spreads over the whole of the downcast shaft, and produces a very considerable current up the upcast by cooling the air, I suppose.

(164. 6.)

r 2

1631. Was

Benjamin Biram,
Esq.

2d July 1849.

1631. Was there a furnace in the Darley Main pit?

Yes.

1632. In the Ardsley Main also?

Yes.

1633. Were those furnaces efficient for their purpose, do you think?

At the time that I went into the Ardsley Main, the furnace had not been re-lighted after the explosion; but the heat of the strata in the neighbourhood of the furnace was such as to cause a very great draught indeed up the upcast shaft, without any furnace whatever.

1634. What is the usual size of the passage in those mines in that bed; what would be their width?

The air-passages would not exceed 5 feet 6 inches or 6 feet in height, and about 6 or 8 feet in breadth; many of them are much smaller than that.

1635. Among other causes for the accident, you mentioned the action of a powerful wind upon that occasion?

Yes.

1636. Did you ever find the variations of the barometer correspond much with the danger arising in mines?

I believe that a considerable fall in the barometer has a very great effect in causing a discharge of carburetted hydrogen in coal-mines very frequently, on account of the pressure being taken off from the fissures in the coal; any gas which may have accumulated in those fissures, will come out upon the depression of the barometer.

1637. Have you ever made any observations upon the subject of the effect of the pressure of the atmosphere upon the escape of gas?

Not myself particularly; but I know that men employed under me have made those observations, and have observed that when the barometer is low, there is a greater discharge of gas.

1638. You have never yourself done so?

No, I do not do those things myself much, but they are done by the underground men.

1639. Have you received intelligence from them to that effect?

Yes.

1640. Does it seem to be an acknowledged fact among them, that the differences in the weight of the atmosphere have an effect upon the escape of the gas?

It is with some of them; some of them have observed it; but I do not think that the great bulk of that description of people have paid that attention to the subject which they might have done.

1641. You do not mention it as your belief at all that such is the case?

I believe it is the case, and I am persuaded that it is the case; but I do not think that the men generally who have the charge of the ventilation in mines understand it as such; I believe that it has a very great effect myself.

1642. That is to say, most of them have not paid sufficient attention to it?

They have not paid sufficient attention to it.

1643. Is it the practice among the managers of collieries to make use of the barometer at all?

That has not hitherto been the practice generally amongst the managers of collieries; but I believe now that some few viewers are introducing it, and find very great advantage from that introduction.

1644. Do you know the little instrument called the aneroid barometer?

Yes.

1645. Did it ever occur to you to make use of it?

It has occurred to me; I purchased one for that purpose; it is a very nice little instrument, I think; and I should fancy it is sufficiently correct for that application.

1646. If

1646. If it proves to be sensitive in indicating the pressure of the atmosphere, you think that that would be sufficient?

I have noticed it, and it is exceedingly sensitive in indicating the changes of barometric pressure.

*Benjamin Biram,
Esq.*

2d July 1849.

1647. How do you think that the superintendents or managers of mines could advantageously make use of an instrument of that description?

I think it would be a very good thing if those who have the management of mines were required to make daily observations of the height of the barometer and thermometer probably, and the current of air through the mines.

1648. Supposing that they observed a great depression of the barometer, how would the manager of a mine be able to act upon that?

He would act upon it by causing an increased firing at his furnaces, to cause an increased ventilation. A gentleman of my acquaintance, Mr. Woodhouse, in Leicestershire, was telling me the other day that he is getting some barometers made, marked for the purpose of under-ground people.

1649. To use the barometers under-ground?

To use the barometers in the pits; and the way in which he proposed having them marked was, when the barometer was low, instead of "stormy," or anything of that sort, in the way that they are generally marked, to put opposite those points "fire quickly," or "fire slowly," as instructions for the men; I thought it a very good and sensible thing.

1650. And this is about to be adopted by a person of your acquaintance?

Yes, Mr. Woodhouse; he is a coal-viewer in Leicestershire and Derbyshire, a gentleman of very considerable experience, and he is a gentleman whom I should very much recommend to be examined before this Committee.

1651. In case the barometer indicated a lightness of the atmosphere, he would proceed to increase his draught?

Yes, by firing.

1652. Either by firing the furnace, or by any other apparatus?

Yes.

1653. So that he would take greater precautions?

Yes, and he thought that by marking those barometers in that way, it would be an indication to the men when they ought to pay greater attention to the ventilation.

1654. Have you ever seen any other system adopted for ventilation besides the furnace?

I tried a mechanical system of ventilation some years ago in a pit by means of a fan on the screw principle, but I had so small a quantity of power, that I dare not continue it in hot weather. I applied a stream of water falling through about 78 feet; the whole quantity of water that I had was about 10 gallons a minute falling through that distance; it was made to impinge upon the circumference of a wheel, which was four feet in diameter; when the winds were in certain directions it acted exceedingly well, and produced a great draught; but in other situations of the wind it did not seem to be powerful enough to continue the draught up the pit. I am still of opinion that if the principle were properly carried out, it would be as efficient a method of mechanical ventilation as any that I have seen.

1655. There was nothing in the failure of your experiments upon that subject to lead you to the conclusion that it would not be possible to establish a very efficient method of ventilation by means of mechanical contrivances?

No.

1656. The water-power was not sufficient?

The water-power was not sufficient in this case for the purpose required: any person who chooses to calculate the weight of 10 gallons of water falling through 78 feet per minute, will find that the power is very little; but with a fan upon that principle, fixed horizontally in an upcast shaft, a little above the surface of the ground, and worked by a sufficient steam-power, by a shaft coming underneath, I still think that in many cases where it might be dangerous to use a furnace in a pit, a very great draught might be obtained by that mechanical means.

*Benjamin Biram,
Esq.*

2d July 1849.

1657. Are you aware of the contrivance of Mr. Brunton of that description?
I have not seen Mr. Brunton's contrivance.

1658. You have not heard it explained?
No.

1659. Comparing the contrivance which you have mentioned, so far as you are able to form an opinion upon it from the trial which you made, should you say that you would be able to obtain in a pit under the same circumstances a more powerful draught by a contrivance of that sort than you could obtain by the ordinary furnaces?

I would not speak confidently upon that subject. I made a small model to try the experiment. I think the model was about two feet in length, inclosed, except at the ends. I fixed one of my anemometers in one end of this model, and in the other a fan-wheel of similar construction, and of the same diameter (a foot in diameter), which I could turn with considerable velocity, and by that means I succeeded in passing upwards of 1,000 cubic feet per minute through that little machine.

1660. Without the assistance of any furnace?

Without the assistance of any furnace, merely a fan one foot in diameter, made upon the screw principle.

1661. Are you aware of any of the other proposals which have been made for mechanical ventilation?

I have seen Mr. Gurney's plan, as introduced by Mr. Forster in the pits in the North.

1662. Will you state your opinion of that plan?

I am rather favourably inclined towards it; inasmuch as last year in this pit, which I say is now ventilated by a small stream of water going down the down-cast, I tried it by conveying the steam from the engine that draws up the material from the pit down the upcast shaft about 60 yards, and allowing it to escape from a horizontal pipe into that shaft; but I did not try it in the way that Mr. Gurney suggests; he seems to think that it is from the force which high-pressure steam gives, by issuing out of small orifices up the upcast shaft. In the way that I tried it, it would be merely from the heat given out from the steam in the shaft, and from the condensation of that steam causing a degree of vacuum in the shaft in coming up again; there was no mechanical force from the steam; the orifices were too large, and it was only the steam that was used, after it had done its duty in the steam-engine; I conveyed the waste steam down the shaft.

1663. Did you ever see it in Mr. Forster's pit?

I have not seen it at work.

1664. In short, you have never seen it upon that principle?

No; but so far as I have seen it, from having tried it myself, I have a favourable opinion of it. The only objection that I saw to it was this; it increased the draught very much indeed; but there was such a dense vapour coming out of the mouth of the shaft, that it was impossible for the men who were at the top to see where the pit-mouth was; there was a danger of their falling into the pit in putting the corfe into the shaft, or in coming up the shaft there was a danger of being drawn over the pulley-wheel, in consequence of the engine-man not being able to see when the corfe had come to the surface.

1665. Was not that owing to the fact of your having employed low-pressure steam?

Yes, Mr. Gurney said so; I explained to Mr. Gurney the way in which I had applied it, and he said it was from having used low-pressure steam. I have never yet had an opportunity of seeing the effect by using high-pressure steam.

1666. Have you any suggestions which you could make to the Committee which would tend to the improvement of ventilation and the prevention of these accidents?

The subject of ventilation, I think, is pretty well understood; it only wants carrying out; a greater quantity of air should be admitted into most of the mines than at present is admitted, which might be done either by a good furnace or by
mechanical

mechanical means. I am not prepared to say that one contrivance is better than another in this respect.

Benjamin Biram,
Esq.

2d July 1849.

1667. Is there not this advantage in mechanical means, if well adapted to the purpose, that you have the power of regulating them more easily than you have in the case of a furnace?

Probably there may be, but it is a system which has not yet been used.

1668. In the case of the furnace, there must be some difficulty in regulating it according to varying circumstances, must there not?

Yes; but there has not usually been any observation about what the current of air has been which has been passing in the mine, and which is desirable, I think.

1669. You would not be able to say, from a knowledge of the mines in Yorkshire with which you are acquainted, that there was a general rule which would give you the amount of current necessary to be passed through the passages of a mine by any ventilation, in order to make them safe under ordinary circumstances?

No; the circumstances of mines vary so very much, that I do not think anything is to be stated; what would be sufficient for one mine, might not be sufficient for another; those who have the superintendence or management of those mines, must judge from circumstances whether there is sufficient or not, and from the state of the mine whether there is sufficient ventilation.

1670. Do you think that in the arrangement of the workings which you described to us a short time ago, generally speaking, the disposition of the air-passages is as good as it might be for the purpose of accomplishing a complete ventilation?

I think so; we find it answer very well; there is generally a very good current of air where the men are at work.

1671. And, generally speaking, is the system well carried out in those pits?

Yes, with us it is, I think.

1672. To whom is entrusted all that part of the matter?

A person called the bottom steward generally manages the ventilation of the pit.

1673. What class of persons are they?

They are, generally, not very well educated; I think much might be done by a better education of that sort of people; I do not think they understand the nature of currents of air very well.

1674. Are they usually drawn from among the workmen?

Yes, the best workmen.

1675. What is their precise duty with respect to the examination of the mine; do they examine it every day?

They examine it every day; they go round in places where there is explosive air; they go round with the safety-lamp the first thing in the morning, and see whether it is safe.

1676. Before the workmen go down?

Yes.

1677. In case they found the mine in an unsafe state, what would be the duty of the under-ground overseers?

They would warn the men not to go to those places.

1678. They would not allow the men to enter those places?

Certainly not, without lamps.

1679. Do they effectually do their duty in your mines?

I think so; I have no reason to complain of them in that respect.

1680. They are attentive to their duties?

I think so.

1681. Supposing that unforeseen circumstances occurred in any way with respect to the insufficiency of the arrangements for ventilation, or the escape of gas, or any thing of that kind, do you think that they have sufficient knowledge of the subject to enable them to provide for an emergency of that kind?

(164. 6.)

x 4

I think

Benjamin Biram,
Esq.

2d July 1849.

I think that the men employed under me have sufficient knowledge; they seem to be intelligent men.

1682. You think they are quite fit for their duties?
Yes, I think so.

1683. Do you think that they would be rendered at all more competent to meet the difficulties of their duty, if they were better educated?

Yes, I think that many of the men now employed in those situations are very imperfectly educated; they do not understand the subject.

1684. Can many of them read and write?
They generally can read and write, I think.

1685. In your collieries?
I think so.

1686. What branch of education would you recommend?
On the nature of the airs, the proportions to fire, and the effect of a rarefied air.

1687. Some acquaintance with the elements of physics and mechanics?
Yes; some simple knowledge of that sort, I think, would be useful in that description of people.

1688. Is it their business to examine the mine every day?
Yes.

1689. Are they held responsible if the men go down when the atmosphere is unsafe?
Yes.

1690. You have paid some attention to the improvement of the Davy lamp, have you not?

I have. When I went down into the Ardsley Main Colliery, I was struck with the effect of a current of air upon that lamp in passing through the air-doors, strong currents being liable to extinguish it. I thought it possible that the flame might be drawn through the meshes. I believe it is very rarely, if ever, that that has been the case; but I thought that if it could be protected from the currents of air, it would be a great advantage, and that if an increased light could be procured in the lamp, it would be a further advantage.

1691. Is the light that is given by the Davy lamp so imperfect as to render the working very inconvenient to the men who use it?

It is a very small light. I have compared the light given out by the Davy lamp with the light of a common candle, and I find that it is about one-fourth of that emitted from a common pit candle of about 15 or 16 to the pound. I tried several lights; I took a wax candle, such as is used at gentlemen's tables, of about four to the pound; I took that as the standard light; I placed it at one yard distance from a screen; I then compared other lights with this wax candle; I tried the common Davy lamp in comparison with that light and the common pit candle. The common pit candle, as compared with a wax candle of that description, when fresh snuffed, emits about the same quantity of light as this wax candle does. The Davy lamp gives out about one-fourth of that light; that is to say, placing the wax candle at one yard distance from a screen, and throwing the shadow from that candle, and from the other light to be compared with that candle, against the screen, I found that the shadow cast from the Davy lamp at about half the distance from the screen that the wax light was placed, gave about the same depth of shadow; in that case it would be the square of the distance, it would be about one-fourth of the light; I also compared the light given by other candles.

1692. Is not that great defectiveness in the light of the Davy lamp one of the principal causes of the carelessness of the men?

It is one of the greatest reasons why they object to use that light.

1693. It is a constant temptation to them to open the Davy lamp?
It is.

1694. Therefore your attention was directed to the possibility of procuring a stronger light?

A stronger

A stronger light, and protecting that light from the currents of air; I have made several trials; this is the plan which I have last hit upon [*producing a lamp*]; this is a common lamp, upon the ordinary principle, with the wick in the middle, and a reflector placed at the back of it; instead of being screwed under the lamp, as in the plan of the Davy lamp, I put it into the inside of a case; in the back of this case there is a small contrivance, a ball and socket contrivance, for regulating the wick of the lamp; there is a door in front which admits no air, except through the wire gauze at the bottom; as soon as this lamp is put into an explosive atmosphere, the inflammable gas ignites, and burns just within this wire gauze; the consequence of which is, that no further accession of oxygen can get into the body of the lamp, and the wick, unless the lamp is immediately withdrawn, goes out. The only disadvantage which the miner would find would be, that he would lose his light if he went inadvertently into an explosive atmosphere; but if he notices when the flame ignites at the bottom, he will have time to withdraw before losing his light.

Benjamin Biram,
Esq.
2d July 1849.

1695. In that respect, then, it would be a more convenient instrument than those instruments which provide for the immediate extinction of the light the moment that the lamp is filled with inflammable gas?

Yes; there is only the interval of a few seconds before he would lose his light, from the small quantity of oxygen which can be admitted here.

1696. Have you ever made a comparison of the light of this lamp with a common Davy lamp?

With this wire gauze [*producing the same*], this lamp gives the light of an ordinary candle, or about four times that of the Davy lamp; with the tale it gives about four times that of a common candle, which would be 16 times that of the Davy lamp.

1697. Have you ever used it in a mine?

Yes.

1698. Have you found it convenient in point of light?

Yes; it is a most excellent light to work with.

1699. Do the men like it?

The men have not used it much; I have had a good many made; several parties have tried them, and I would rather that other people should speak about it than myself.

1700. How is it as compared with the Davy lamp in point of weight?

It is about the same weight.

1701. Not heavier?

Not heavier than the Davy lamp.

1702. Supposing when this was much heated any pieces fell upon it?

That would not affect it at all.

1703. It would not affect the glass?

No; it does not get hot by having the light in it at all.

1704. It has not yet been made trial of by working colliers?

Not to any extent.

1705. Are you aware whether it has been actually used in an explosive atmosphere?

Yes; I have used it myself in an explosive air in the pit.

1706. Did you use it in such an atmosphere as to observe the fire within the chamber?

Yes; I have tried experiments almost innumerable in a receiver containing gas.

1707. What should you say was the amount of danger consequent upon a man's lamp going out?

There would be no great extent; in general there would be no danger at all.

1708. He would be able to get out?

I should say so.

1709. Excepting he remained in the explosive gases?

They seldom contain such a proportion of carburetted hydrogen as to make it very injurious to a man's health.

(164. 6.)

Z

1710. He

Benjamin Biram,
Esq.

2d July 1849.

1710. He might get into some old workings, and lose himself?
He possibly might, but they generally know what they are about pretty well.

1711. They are pretty well acquainted with the passages generally?
Yes.

1712. Supposing a man was caught in that way, and his light went out, you think that he would in most cases be able to find his way out?

Yes, there is no doubt about that; the probability is, that he would not have far to go.

1713. Your lamp lights only in one direction?
But a man can only look in one direction.

1714. He cannot see the roof?
It only lights in one direction; but he can turn it. I have a spike, which a man can drive into one of the wooden pillars, into the side of the coal, and there is a swivel at the other end, so that when it is fixed, he can readily turn it in which direction he pleases. That is the only objection which I have heard against it, that the man cannot see all round him; but he can turn it.

1715. Have you had any practical experience of it?
Yes, I have tried it myself with the explosive mixture.

1716. How long have the work-people had it in the mines?
It has not been much used.

1717. Have the workmen at all used it in the mines?
Yes.

1718. For how long a time?
They have worked with it for some months. It is an objection which they do make to it, that they cannot see all round them.

1719. The additional light is gained by the concentration produced by the form?

The additional light is gained, in some measure, by the concentration produced by the shape of the reflector, and in some measure by the talc, instead of the wire gauze.

1720. You have also invented an anemometer, of which you have made various trials, have you not?

Yes.

1721. Have you it here?

Yes—[*the Witness produces the same*]. This instrument is constructed upon the principle of a screw; the vanes are each one-twelfth of the segment of a screw of a foot in diameter, and two feet pitch. This represents the plan of one vane of the wheel, showing the distance from one point to the other; the circumference of a wheel a foot in diameter would, of course, be 3.1416 feet; each of these vanes being one-twelfth of the entire screw, the length of the arc would be so many inches. This represents the angle of the end of the vane; the length of the base, from one point to the other, would be 3.1416 inches, and the pitch from this to that [*showing the same*] two inches. Now, if I took a triangular piece of iron, and bent it to the radius of six inches, and applied it to this point, and then upon a pin placed in the centre of this wheel put what I call a radius bar, which would descend freely upon this pin, and made the other end of this radius bar to traverse upon an inclined plane formed by the hypotenuse of this triangle, each part of the under edge of this bar should come in contact with the vane of this wheel; so that the radius bar descending down the inclined plane from this point to that—[*showing the same*]—would descend two inches, and yet touch every part of this vane as it descended, if properly constructed. Now, instead of the radius bar moving in this direction, if the wheel is made to revolve, the radius bar might then be moved in a straight line two inches, while the wheel revolved one-twelfth part of a revolution, and still touched every part of the vane while it was so revolving. This shows that the wind acting upon this wheel, going through in a straight direction, while the wind traverses two inches, each of these vanes recedes, from the impulse of the wind, the distance of one-twelfth of the revolution of this circle, or a distance of 30 degrees; so that while the wind went two inches, its action upon this instrument would cause it

it to revolve 30 degrees; and the angle of every part of these vanes is such, that while the wind went through in a straight line, these would recede and get out of the way of the wind. Now, it is not so easy to show the effect of this in an elastic medium like air, as it is by placing an instrument made upon this construction, with vanes of thin iron made to this angle, through water. By placing an instrument of that sort in a vessel of water in which are floating particles of about the same specific gravity as the water, and moving the instrument through the water in that direction—[*showing the same*]*—*you do not see the slightest variation in those particles of water; but the instrument itself passes through the water, just in the same way as a knife-edge would pass through without disturbing any portion of the surface of the water; so that this instrument would not only measure the velocity of air, but it would also measure the velocity of a stream of water, or the velocity of anything passing through the water.

Benjamin Biram,
Esq.
2d July 1849.

1722. How do you obtain your measurement; from the number of revolutions; have you an index to it?

There is an index here, and this (the wind-wheel) makes one revolution while the wind is passing through a distance of two feet; there is a wheel here of 50 teeth, so that the revolution of this wheel indicates the passage of 100 linear feet through the wheel. There are other wheels here—[*showing another part*]. This first index makes one revolution in 10,000 feet passing through; each of those is subdivided into ten; and that index will pass from the zero point to the one, while 1,000 feet of air are passing through the wheel, and makes one revolution in 10,000 feet. This second wheel passes from zero to 1, while 10,000 feet are passing through, and makes one revolution in 100,000 feet. This—[*showing another part*]*—*passes from zero to 1 in 100,000 feet, and makes one revolution in 1,000,000 feet, so that the instrument registers up to 1,000,000 feet; when 1,000,000 feet have passed through, each of those indices will stand where they do now, and will have to begin again. So that if these instruments were in the hands of people who had the charge of the ventilation of mines, and they were required to make registers of the state of them at different periods, stating the time of day when they made those observations, it would at all times be shown what quantity of the air was passing through the mine; and in case of an explosion in a colliery, where such observations had been kept, it would be a very great satisfaction to those who had the charge of that colliery, if they had testimonials to show that it was not owing to a deficient circulation of air through the mine, as those registers would show.

1723. Have you ever made use of that instrument in a mine?

I have made use of it; but it has been more extensively used by Mr. Woodhouse; he has used it in most of the mines under his charge, and expressed himself very much in favour of it. I attached to this wheel a time-piece, which I have endeavoured to describe in this drawing—[*producing a Drawing*]. This (A) is a plate representing the back of the works of a time-piece; the fusee, or the wheel upon which the chain works on the time-piece, is at this point (B); this would be the axis of that wheel, and it would be prolonged through the back of the time-piece in the way shown here: this (C) is a hollow screw, having eight threads to the inch: this (D) is a cylinder; this low end of the cylinder being supported upon this hollow screw; the other end of the cylinder is supported upon the square axis of this fusee (B): this axis of the fusee passing through this hollow screw being circular till it passes the hollow screw, and then it is square; this part of it passing through this cylinder is square, and there is a square opening in this, the top side of the cylinder to receive the drum: this shows the position of the drum when it is wound up, say on the Monday morning; on the drum there is a registering paper to be fixed: this is one of the registering papers—[*producing the same*]; it is marked with a number of lines; the width of those lines corresponds with the pitch of the screw. This registering paper is fixed upon the drum in this way—[*describing the same*]; so that the dark lines at one end of the registering paper come opposite to the light parts at the other end; as this drum revolves upon its axis, which it does once in 12 hours, it advances one thread of the screw in this direction (the direction of the arrow)—[*showing the same*]. On the surface of this drum the anemometer is placed, and to the wheel which turns this index there is a spiral attachment, which raises a rod having a pricker at the lower end; for every revolution of this wheel this pricker is detached, and falls, making an indentation upon this registering paper; that would be for every 10,000 feet of air having to pass through the wheel: there would be a corresponding prick upon this registering paper. Now, the length of

Vide Appendix I,
Plan No. XIII.

Benjamin Biram,
Esq.
2d July 1849.

this registering paper is divided into 12, representing the hours of the day, and each of those is subdivided into minutes; these parallel lines represent each 10 minutes: this scale on this side—[*showing the same*—]—subdivides those 10 minutes into minutes. Now, as this revolves, supposing it to be put on upon a Monday morning, the pricker would stand over the under side of this dark line which represents the Monday. When it has made one revolution at the end of 12 hours, or Monday at noon, it then comes to this top side of the line, and passes over all this side of that line till the Tuesday morning, and so on till the expiration of the week. On the following Monday morning this paper would be removed, and another put on. This might be conveyed to any person, an inspector, or otherwise, by post, and he would see at one view what had been the rate of the current, or any period which it had taken to pass 10,000 feet of air through the mine, whether any neglect had occurred in consequence of bad ventilation being kept up, or anything else. At the same time, if the superintendent, or the bottom-man of the colliery, or the fireman, were required to notice at certain intervals what was the state of this index, and also the time when he made the observation, it would be a check upon him whether he had attended to this instrument, because if his observation and the time when he said he had noticed it did not correspond with the punctures made upon this paper, it would show that he had not been there when he said he had been there.

1724. It is a self-register?

It is a self-registering anemometer.

1725. Have you taken out a patent for this?

Yes, for the anemometer. This, you see, is exceedingly sensible of the slightest current—[*The Witness walks slowly up and down the room with the anemometer, and it revolves*]. I have had a patent for it for several years; it has not been thought of till lately.

1726. What is the cost of an instrument of this kind?

Five guineas, made by Mr. Davis, of Derby.

1727. You conceive that by the use of that you would be able to ascertain at any time what the actual current passing through the air-passages was?

Yes, I have no doubt about it. Mr. Struvé tells me that he has compared this with the actual measurement of his instrument, which measures the capacity of air, and that he finds it correspond with the greatest minuteness, which I am happy to hear. I think if a system of inspection is pursued, that information of this description, if communicated at regular intervals to the inspectors, might eventually be of very great service in statistical information respecting the effect of the barometrical or thermometrical action of the atmosphere.

1728. Have you ever turned your attention at all to the question of inspection?

I have seen the Bill which has been introduced into the House of Commons, and which, I think, very objectionable in many respects.

1729. Is your objection to it that it interferes too much with the operations of collieries?

I think it would have a very pernicious interference with the working of collieries.

1730. To what extent do you think Government might go in the way of interposition for the purpose of preventing these accidents?

I think they might safely go so far, and with very great advantage, as to inspect collieries, and suggesting improvement, or point out any particular collieries, and, with the addition of information of this sort, as to measuring the velocity of the air in the different mines; if that information were furnished so as to be circulated amongst those having the management of the collieries, they would then see where a more efficient ventilation was carried on in their own neighbourhood, and it would excite a sort of emulation amongst the colliery managers to be as good as their neighbours.

1731. You do not think that any jealousy would be felt on the part of the coal-owners of such an inspection, or an apprehension of a disclosure of the state of the seams, and other circumstances connected with the coal-mines?

I think not; I have spoken to several coal-owners, and they do not seem to think

think so. Going to the extent merely of inspection, and suggesting any alteration that could be made, I do not think that it would be objectionable; still, those who have the management of the collieries should feel that the responsibility rests with them. The Government Inspectors should not take off from the parties who have the management of collieries the responsibility in case of any accident, but if they had suggested any alteration which might be made, and the parties had not attended to that suggestion, of course the responsibility of the person in charge of the colliery would be very much increased.

Benjamin Biram,
Esq.

2d July 1849.

1732. Supposing a suggestion of that sort made by the officer to the manager of a colliery, or the viewer, or whoever it might be to whom he mentioned it, and that he stated objections, how would you then proceed so as to ascertain what amount of responsibility would lie upon the manager?

I think he should be allowed to pursue his course, unless it was exceedingly dangerous, and then perhaps something ought to be done to cause an alteration; but unless there was immediate danger, I think he might be allowed to pursue his course, and in case of any accident, the responsibility would be very heavy against him for not attending to the suggestion which might have been thrown out.

1733. Would not a suggestion be like a command from a Government officer? It might be, to a certain extent.

1734. In case of the Government selecting these people to inspect mines, where are such persons likely to be got to have a thorough knowledge of the practical working?

I cannot say.

1735. It would be a very material point in the question, the persons who might be appointed as Commissioners in such a case, would it not?

Certainly.

1736. Supposing the duty to be entrusted to proper persons, you do not think that there would be any danger of thereby disclosing the state of coal-mines in regard to the depth of the seam, and so forth?

I think not; I heard Mr. Tremenhære speak of the system of supervision in Belgium, and it did not strike me that there was anything objectionable in it.

1737. You would contemplate that the Commissioners should have the power of entering the mine for the purpose of inspection?

Certainly.

1738. You think that essential?

I think that essential; and that they should inspect the levels of the mine, the method of ventilating, and where the stoppings are placed, and things of that description.

1739. You are aware that there is a great difference in the mines on the continent from what we have here, the mine-owners there being the lessees of the government?

I suppose so; but still I do not see any difficulty.

1740. It is only the authority which a landlord has in London now of examining the mines of his lessees?

Perhaps so.

1741. You would see no serious objection to giving the power to the Inspector to examine the mine, for the purpose of reporting its condition?

I think not; I think much good might be effected by it. If the Inspector were a competent, intelligent person, he might communicate his information to persons having the charge of mines in such a way as could give no offence, I think, and many a hint of improvement might be made in a way as if it were not coming from an Inspector. It depends much upon the manner in which the Inspector discharges his duty; it is possible that he might do it in such a way as to be very objectionable; or it might be done in such a way that no one could object to it, I think.

1742. Would there be more difficulty, do you think, in finding proper persons to inspect collieries than has been experienced in finding Inspectors of Factories?

I think not. I think there are plenty of people who are qualified for that office.

Benjamin Biram,
Esq.
2d July 1849.

Besides, the person appointed to be an Inspector would be constantly improving; he would see good methods of working, and so many different collieries, that he must be a simpleton, indeed, unless he improved himself by what he observed in those places.

1743. Have you ever, in your communications with other colliery managers or coal-owners, heard any opinion expressed with respect to the possibility of an interposition of that sort on the part of Government?

I have heard the opinion from several coal proprietors so far as I have mentioned now, that that would not be objectionable; but they are very much alarmed at the Bill which has been brought into the House of Commons.

1744. In your opinion, is that a reasonable alarm?

Yes, I think so. I have just skimmed over the Bill; I have not read it very attentively, but there are many very objectionable points in it, I think.

1745. What should you say would be a reasonable number of visits in the year from an Inspector?

I think the Inspector ought not to visit a colliery at any stated time; he never ought to give notice when he is to be there, but come at irregular periods; five or six times in a year, I should say, would be sufficient.

1746. Do you think it would be necessary for him to come as often as that?

Perhaps not; it would depend upon circumstances: to some collieries it might be necessary to go more frequently, and to others once or twice would be sufficient; it would depend upon circumstances very materially.

1747. What would be the number of collieries multiplied by six?

I cannot say exactly.

1748. If there were an inspection five or six times a year, would not it be a great waste of time for the overlookers and stewards, and other people about the colliery, to be dancing attendance upon this gentleman?

It would only be in particular cases that such an inspection would be necessary; in other cases once a year would be enough; if he once got the plans of a colliery, and knew the system of ventilation, and such things, I do not suppose that such frequent inspection would be necessary.

1749. There are nearly as many accidents from the falling of roofs as from other causes; would you give the Inspectors authority over the general workings of the mines?

If they saw any gross neglect in not taking proper precautions in supporting the roofs, or any gross neglect in using deficient or bad machinery, I think they ought to mention it.

1750. Then, in fact, they would have an inspection over the whole mines, and over the whole workings, if they once got in?

Yes.

1751. But no power of direction?

No.

1752. With respect to those accidents which arise from the falling of the roof, is there anything which you would state to the Committee as expedient to be adopted for the purpose of diminishing that class of accidents?

No; it is a class of accidents which is very infrequent with us; we seldom have any; still I think we have more accidents from that cause than from any other.

1753. Do you think that there are not many lives lost by the falling of the roof?

Very few.

1754. How are the roofs supported in the Yorkshire collieries generally?

By the pillars; by the material which I have explained, and by wooden props or metal pillars; they generally have two rows of metal pillars next the face of the work, and remove the back row as they proceed.

1755. Of cast-iron?

Of cast-iron.

1756. Moveable

1756. Moveable cast-iron pillars?

Yes; they remove them as they go along.

1757. The accidents arising from the falling of the roofs would affect one or two, or a few persons; whereas the accidents arising from explosion, affect a vast number?

It is very seldom that there is more than one person hurt by a fall of any sort; sometimes two; scarcely ever more.

1758. With respect to another class of accidents arising from the breaking of the ropes, are those frequent in the Yorkshire collieries?

I do not recollect a single instance in Lord Fitzwilliam's collieries from that cause.

1759. Do you prefer iron ropes to hempen ones?

I prefer hempen ropes to draw coal with; I like iron ropes for inclined planes, or anything of that sort, very much.

1760. In those accidents from explosions, of which you have had experience in the West Riding, should you say that the greater number of the deaths had occurred from the after-damp, or from the explosion itself?

I should think fully two-thirds from the after-damp.

1761. That is by suffocation?

By suffocation.

1762. Then, if that is the case, do you think that that seems to show that lives might be saved by a good system of ventilation in many cases where the explosion itself could not be actually prevented?

It depends a great deal upon circumstances; there are so many things to be considered.

1763. Should you be prepared to say that in any mine it would be possible, under all circumstances, by any system of ventilation, to make it secure against accidents from explosion?

Certainly not.

1764. It is impossible?

I think so.

1765. Then, assuming that explosions must occur occasionally, do not you think that any such system of ventilation as enabled you to fill the mine with good air immediately after the explosion, might have the effect, in many instances, of saving a great number of lives that are now lost, not by the explosion itself, but by the alteration which takes place in the atmosphere?

Anything which would restore the ventilation of a mine in the shortest time would be the best after an explosion, most certainly.

1766. There might be many cases in which lives would be saved, by introducing good air immediately after an explosion into the mine?

There is no doubt about that.

1767. Can you say at all, from your experience of those accidents at Darley Main and Ardsley Main, what proportion were actually killed by the explosion, and what proportion appeared to have been killed by the after-damp?

No, I cannot say that I know exactly; but in the proportion, certainly, which I have stated, not above one-third by the explosion. Some of them are very much injured by the blast; not actually burnt, but still they have their limbs broken by the force of the current, and others are suffocated.

1768. Those who are killed by the blast would be killed in any case, supposing the explosion to take place?

In the case of an explosion to the same extent, but with a system of good ventilation, the probability is, that there would not be an explosion to that extent.

1769. Do you think that a perfect system of ventilation can be made so far to protect the mine as to confine the explosion to a certain space?

Not at all times, I think; you have sometimes a sudden explosion of gas, which it is impossible to foresee.

Benjamin Biram,
Esq.
2d July 1849.

1770. With respect to the use of candles and lamps, it has been held by some persons well acquainted with the working of mines, that the use of lamps has tended rather to increase the danger from accidents than otherwise, by means of making the men more careless and reckless; are you of that opinion?

The general practice in our neighbourhood is to work with naked candles; but in most of the pits round us there is very little of the fire-damp. In some of the pits in the North it appears that some very great accidents have occurred; one occurred last year, where many lives were lost, and it was said that the ventilation was as perfect as could be immediately before the accident. Now, in that case, in pits which are liable to such a sudden introduction of gas, working with a naked candle is very dangerous; but I think the general state of a mine ought to be such, that it would be actually safe for a man to employ a naked candle; there ought to be sufficient air in the mine generally, that it would not explode in any place where a man has to work.

1771. And you think that that can be accomplished by a proper system?

I think it can be accomplished; and the use of lamps ought to be by the men in case of any sudden or unexpected escape of gas; and where they are subject to those sudden eruptions, they ought to work constantly with lamps.

1772. Then you would not concur in the opinion mentioned just now, and which has been held by some persons experienced in collieries, that lamps ought not to be generally used, inasmuch as they make the men careless, and thereby lead to more accidents than they prevent?

No, I cannot say that I am of that opinion.

1773. Have any of the mines with which you are connected been on fire?

Yes; some years ago one of the pits got on fire.

1774. Did you succeed in extinguishing the fire?

Yes, by turning water in.

1775. Is not that rather an expensive process?

No; fortunately it was so situated, that we had the advantage of a large reservoir of water which supplies the canal, which we could readily turn into the colliery; it was at Elsecar; we have twice had a pit on fire. The other instance was in a situation where we could not get a supply of water.

1776. Even if you do get a supply of water, is not it rather an expensive process to pump it out again?

It depends upon circumstances; we succeeded in getting to work in the course of a week.

1777. How long did it take you from the time when the fire commenced till you got the mine at work again?

Not more than ten days.

1778. Have you heard or read the account of Mr. Darlington, of the extinction of a fire in his mine?

Yes.

1779. Does that appear to you a process well adapted to the purpose?

Yes; there is one thing that struck me, which would appear to require some further experience, and that is, where a fire has got considerable hold in a mine, so as to heat the roof to a very great extent, which one may suppose it would do, or the coal, that it cannot be lowered in so short a period as is said to have taken place, and that upon the re-admission of fresh air it would be liable to ignite again, if it were opened out so soon as it was done there. I do not know whether that would be the fact or not, but it strikes me that it may be.

1780. In the case alluded to, the fire had been of very short duration?

So I heard.

1781. Supposing that after that process had been applied, and the fire extinguished, a continual current of fresh cool air had passed through the mine for some time; do you think that it would have tended to prevent such ignition?

If it were cool fresh air, it would increase the flame; but if it were a cool carbonic acid gas, it would be otherwise.

1782. The-

1782. The question supposes the flame to be extinguished. Supposing the carbonic acid gas had been introduced into the mine, and the flame thereby extinguished for a time, and that you then opened the pit, and carried through a current of cool air to lower the heat; would that prevent ignition again taking place?

If the measures had been cooled down a sufficient time to prevent their re-ignition by the admission of fresh air, it would be prevented certainly; but it appears to me to require more experience than this isolated case can furnish.

1783. Can you state the cost incurred by the fire which you yourself extinguished by water at Elsecar?

No; it was no very serious expense; we set the engine to work night and day, and we were pumping, I think, for about eight days; fortunately, the engine never got out of repair during that time, and we got the fire completely out in that time.

1784. How long had that fire been burning?

A very short time.

1785. In the other case, in which you said that it was difficult to procure water, what means did you apply?

In the other case we made up the pits as air-tight as possible, and kept them made up for, I should say, probably, a fortnight; during that time the air in the pit seemed to be so completely incapable of supporting flame, that, putting a light just within the surface of the ground, it was immediately extinguished, and I thought that by keeping it made up for that time, when we re-opened the pits, we should find the fire extinguished; but, though they had been made up for a fortnight, and, I think, more, but I am not quite certain now of the period, we found, upon the re-admission of fresh air, that it ignited again, though during that time I am certain that no flame could burn.

1786. What did you do; how did you proceed to extinguish it again?

We proceeded by taking the fire-engine into the pit, and making a brattice, taking the fresh air with us, and playing upon the ignited material until the air returned upon the other side of the brattice, and setting some men to remove it.

1787. How long had that fire been burning?

It had not been burning long; we turned it off by closing up all the orifices.

1788. Was it a very extensive fire?

No; but still it ignited again at the expiration of more than a fortnight upon the re-admission of fresh air.

1789. What did it arise from; from a blower?

No; not from a blower certainly, but from the carelessness of some of the men, I take it, in leaving their lights. At the time of the first ignition at Elsecar, it was just at the time when so many stacks were fired in the different parts of the country, and we fancied that some incendiary might have been at work; but we never could have proved, and never had any reason to suspect, anything of the sort of any particular person.

1790. Is it as easy in the collieries of small proprietors to carry out an efficient ventilation, as it is in the collieries of large proprietors?

No, I should fancy not.

1791. The question refers to persons who put down an engine, perhaps, upon the basset of the coal, for the purpose of working 10 or 15 or 20 acres?

If a thin coal is unfortunately very much troubled with the carburetted hydrogen, it is exceedingly troublesome, I think.

1792. But are not those small shallow pits much easier to ventilate than the extensive workings?

A pit may be deep, though not very large.

1793. But a pit which was worked at a great depth would be rather extensive, would it not; it would not be worth while to sink a deep shaft for the purpose of a small working?

There are many pits of considerable depth working a very thin coal with us; the Flockton bed of coal in many places is not above 15 inches thick, and yet in some instances they sink 200 feet deep.

(164. 6.)

A A

1794. Upon

Benjamin Biram,
Esq.
2d July 1849.

Benjamin Biram,
Esq.
2d July 1849.

1794. Upon the basset of the coal a small proprietor works some 10 or 15 or 20 acres?

Yes.

1795. In those cases is there not greater difficulty in ventilation from the confined nature of the work?

No; in consequence of the work being of such limited extent, there is a greater facility of ventilation; the air has not so far to travel.

1796. Are not the galleries of a coal-mine sometimes two or three miles in extent?

The circuit of the air is frequently much more than that.

1797. Supposing a fire to take place at one of the more distant points of one of those galleries, would it not be necessary to fill the whole of the galleries with water to extinguish the fire?

No, I do not think it would be necessary; by cutting off all communication with the air, if you can produce carbonic acid gas, no doubt it will be very beneficial in extinguishing the flame.

1798. And less expensive than introducing water?

Certainly, because it can be so much more readily drawn out again.

1799. With respect to the thin beds, is the ventilation as easy as in the thick beds?

Yes; I do not think there is any great difference.

1800. The ventilation of the thin bed would not be so easy with the same extent of working, would it, because the passages would be smaller?

The passages would be smaller.

1801. Would not that increase the difficulty of ventilating?

I do not think it would much increase the difficulty; they might divide the air more, so that the total number of air-passages might be something like those in the upcast shaft, by splitting the air.

1802. Is not the friction in small passages a very great impediment?

The friction in small passages no doubt would be very much increased, compared with those of greater extent.

1803. In the case of a colliery of very great extent, there is a pit at one end and a pit a mile off, and so on; that is a very different thing from a state of things where the working is of small extent?

I am no advocate for a single shaft; I think there ought to be two independent shafts.

1804. Does it not frequently happen that a single shaft is put down?

It is the case in the North, but not in the Yorkshire collieries; there are two separate shafts.

1805. Not one large one divided?

Very seldom with us; the coal with us is not worked to the depth that it is in the North, and therefore it is not such an object with us.

The Witness is directed to withdraw.

Nicholas Wood,
Esq.

NICHOLAS WOOD, Esquire, is called in, and examined as follows:

1806. YOU are manager for Lord Ravensworth and partners, in the North of England?

I am.

1807. In the neighbourhood of Newcastle?

Near Newcastle.

1808. And the manager of various large collieries in that part?

Yes, the Hetton Colliery, and other collieries.

1809. You have had long experience in the management of collieries, have you not?

It is about 38 years now since I first commenced.

1810. You

1810. You were examined before the Committee of 1835 ?
I was.

Nicholas Wood,
Esq.

2d July 1849.

1811. Since the period of your examination in 1835, have you continued to turn your attention to the subject of accidents in coal-mines, and the method of improving the ventilation, or other modes of preventing accidents ?

Yes, I have ; I have been continually employed in the management of collieries, part of the duty of which is the prevention of accidents.

1812. Do you think that since that period there have been any useful suggestions made, or any improvements adopted, that would tend to diminish the frequency of such accidents ?

I think the ventilation generally has been improved since then, and recently some contrivances have been put forward with the view of improving ventilation.

1813. Have you had experience of any such improvements yourself ?

Yes, I have, partially, in the steam-jet. I do not know that in the evidence of 1835 the question of the power of the furnace was gone into so fully as may be desirable. I have recently made some experiments, with a view of comparing the power of the furnace system of ventilation with that of the steam-jet.

1814. Have you made experiments expressly for that purpose ?
Expressly for that purpose.

1815. Of actual ventilation ?

Yes, of the actual power of the furnace at the Hetton Colliery.

1816. Will you state the general character of the experiments, and the conclusions at which you have arrived ?

The Hetton Colliery is a very extensive colliery.

1817. One of the most extensive in the county of Durham ?

Yes ; there are three distinct windings, as they are called ; at two of them there are two pits, and one at the other. The system of ventilation is by furnaces entirely, and the principal one is at what we call the Lyons Colliery. At that colliery the main upcast shaft is situated ; and there is also a downcast shaft at that colliery, and another at the Eppleton Colliery, which is rather better than a mile from it.

1818. There are two downcasts and one upcast ?

Yes ; the upcast is 14 feet in diameter, and 150 fathoms deep ; one of the downcast shafts 11½ feet, and the other 12 feet ; the former 150 fathoms, and the latter 176 fathoms. There are three furnaces at the bottom of the upcast shaft. I should perhaps rather observe, that there are two or three workable seams of coal in this colliery : the principal one is the Hutton seam ; 12 fathoms above that is the Low Main ; and 28 fathoms above that, or 40 fathoms from the bottom, is the Main Coal. In the Hutton seam there are three furnaces, and in the Main Coal there are two furnaces ; but those in the Main Coal are not at work, so that the ventilation is carried on by the three furnaces in the Hutton seam.

1819. Is the Hutton seam considered a fiery seam ?

Yes ; this Plan (Fig. 1, Plan No. XIV.)—[*producing the same*]—shows the workings and air-courses around the pit and the furnaces. The downcast is the minor pit in two divisions, called the East and West Minor Pits ; and the upcast is called the Blossom Pit—[*showing the same*]. There is another downcast, about a mile from this, at Eppleton, as before observed. The arrows show the direction in which the currents move ; from which it will be seen that the air going down the Minor Pit is carried into the East and West Minor Pits workings in opposite directions, these workings being very extensive. Then the downcast air from the Eppleton Pit goes through the workings of the Eppleton Colliery, and is carried over the furnace A. to the upcast shaft. The air from the East Minor Pit workings returns to the Lyons Colliery, as shown by the arrows, and passes over the furnace A', and up the Blossom upcast Pit. The air from the West Minor pit, after passing through the workings of this colliery, returns, as shown by the arrows, passing over the furnace A'', and so up the Blossom Pit upcast ; so that there are three distinct currents of air which goes into this shaft, after having passed over the three furnaces. (Fig. 2, Plan No. XIV.) is a section of the furnaces. There is also a current of air which passes round the workings of the Low Main seam, (164. 6.)

Vide Appendix I,
Plan No. XIV.,
(Fig. 1.)

Ibid.

Nicholas Wood,
Esq.
2d July 1849.

goes into the upcast 12 fathoms above the Hutton seam of 10,500 cubic feet per minute; and likewise a current of air of about 22,000 cubic feet per minute, which passes around the Main Coal workings, and which also goes into the Blossom Pit upcast.

1820. All three furnaces being of the same size?

Yes; they are 9 feet wide, and the usual length, about 4 feet of grate-bars, with a side air-way on each side, to prevent the coal from being set on fire by the heat of the furnace.

1821. Was this the pit in which you made the experiments with the furnace?
Yes.

1822. Will you explain how you proceeded, and what were the conclusions at which you arrived?

I made the experiments of the velocity of the air with Mr. Biram's anemometer, and also by exploding gunpowder, and ascertaining the velocity of the smoke, which travels at the same rate as the air.

1823. Did the anemometer answer the purpose?

To a certain extent it does; but it is not strictly correct. The air-passages were about 9 feet wide and 6 feet high, the current is not uniform, and it depending very much upon where the instrument is placed whether you get a correct measure of the velocity of the current of air or not: by placing it very carefully, you get a pretty correct measure of it; but the way which I prefer, and by which I corrected the anemometer, was, where there is a long line of drift, by exploding gunpowder, and with a stop-watch ascertaining the velocity of the gunpowder smoke which travels with the air.

1824. You ascertained how long the fumes were in arriving at a certain point?
Yes.

1825. Was there any other cause of inaccuracy in the anemometer, besides the circumstance that it could not be placed in every part of the current at the same time?

If the friction were uniform, there would be no comparative inaccuracy; it is a very useful machine, and sufficiently correct for practical purposes.

1826. By these two methods you measured the quantity of air in a certain time?

Yes.

1827. When these furnaces were in full action, what was the measure that you obtained of the quantity of air?

Perhaps your Lordships will allow me just to go a little into detail; I shall do so with as much brevity as possible. The area of the shaft is 153.93 feet, and the depth of the shaft is 900 feet; the coals used in 24 hours were 160 cwt. for the three furnaces, or 17,920 lbs. The aggregate quantity of air in the different divisions of the mine, produced by the action of these three furnaces, was 168,850 cubic feet per minute; that was the quantity measured before it passed over the furnaces; because after it passes over the furnace, it is heated, and expands, and consequently is of greater bulk, and the velocity is correspondingly increased. I took the temperature of the shaft at 40 fathoms above the bottom of the pit; I could not get it close to the furnace, it was so hot, and there was no place to get it.

1828. You took it at the upper seam?

Yes, 40 fathoms up; there the temperature was 160 degrees. I also took it at the bottom of a door 30 feet from the extreme top, and there the temperature was 125 degrees; taking the average of these two temperatures, which I think would be somewhere about correct, I assume the average temperature at 140 degrees; I think that would be about it, rather under than otherwise. The temperature of the air at the bottom of the pit, in the downcast, was 60 degrees; therefore we have a column of cold air going down the pit at 60 degrees, and a column of heated air coming up at 140 degrees, and the difference between the two is the power of draught of the furnace; it is, in fact, the power employed to produce the current in the mine.

1829. That

1829. That would be about 80 degrees?

That is 80 degrees. Now, the expansion of air by 80 degrees is as 1,000 to 1,169; 80 degrees expands 1,000 parts of air to 1,169; and in calculating the power of a furnace, I have put it into horses' power, as it may be useful in comparing it with the other modes of ventilation. The weight of a column of air, a foot in area and 900 feet in length, at 60 degrees, is 474,300 grains, from the known weight of a cubic foot of air. The weight of 900 feet, at 140 degrees, is 405,700 grains, and the difference is 68,600; that divided by 5,760 grains to a pound, makes 12 lbs. per square foot; therefore, the difference of weight between the downcast column and the upcast column is 12 lbs. per square foot over a surface of 153.93, or in round numbers 154 square feet; that is the effective pressure of the power of the furnace. Taking the expansion of the air, or current, of 168,850 cubic feet per minute, by the additional temperature of 80 degrees, there is a quantity of air per minute going up the shaft of 197,385 cubic feet.

Nicholas Wood,

Esq.

2d July 1849.

1830. That is applying the expansion to the quantity which you had ascertained passing through the workings?

Yes, I ascertained the quantity at the bottom of the shaft, viz. 168,850 cubic inches per minute, and then, by applying the 140 degrees of temperature, which is 80 additional, it is expanded into 197,385 cubic inches per minute.

1831. In short, 168,000 is to the number you have last mentioned as 1,000 is to 1,169?

Yes: then the additional quantity produced by the expansion increases the velocity to 1,280 feet per minute; so that we have a power of furnace equal to 12 lbs. per square foot on an area of 154 square feet, moving 197,385 cubic feet of air at the rate of 1,280 feet per minute; that brought into horses' power, viz. divided by 33,000 lbs. per minute, gives a practical or working effect equal to 71-horse power, which is the power of a furnace under those circumstances. The consumption of coals I stated was 160 cwt. in 24 hours; that is, 746 lbs. per hour, or 10½ lbs. per horse-power per hour. Now I believe that this is the most economical mode of acquiring power.

1832. By means of the furnace?

Yes, by means of heated air, or by the furnace.

1833. What is the conclusion which you come to?

That a working or practical effect of 168,850 cubic feet of air is passed through a very extensive mine, at the rate of 1,097 feet per minute, with a consumption of coals of 746 lbs. per hour, or 12.4 lbs. per minute, which is equal to 10.5 lbs. per horse-power per hour, or above 13,600 cubic feet of air per minute with each pound of coal: I believe the consumption per horse-power of steam-engines in the mines generally is very much beyond that.

1834. The consumption of coals for the furnaces?

Of steam-engines employed in producing a like effect. I was speaking of the most economical mode of acquiring power, which I consider is by means of furnaces.

1835. You consider that as little as could be used for the purpose of obtaining the necessary ventilation?

I think the system of furnaces is the most economical mode of acquiring ventilation; as an instance, we have an under-ground engine at this same pit for the purpose of drawing the coals from the deep workings; and I find that the consumption of coal by that engine is about 15 lbs. per horse-power per hour. There is another 60-horse engine at the Eppleton Pit, the other down-cast, and I find that the consumption of coals by that engine is 13 lbs. per horse-power per hour.

1836. So that the amount of coal consumed in these furnaces is considerably less than in either of those engines?

It is less than the ordinary mode of working steam-engines. I admit that in engines where economy of fuel is a very great object, and with condensing engines, the consumption is reduced to about eight pounds per horse-power. Before I compare the furnace with the steam-jet, I would beg to explain to the Committee the extent of the ventilation of the Hetton Colliery, because the distance which the air travels under-ground is a considerable element in the system of ventilation.

(164. 6.)

▲ ▲ 3

I mentioned

Nicholas Wood,
Esq.
ad July 1849.

I mentioned that there were three currents going from the downcast shafts into the workings, two at Lyons and one at Eppleton, which gives three currents of 56,280 cubic feet per minute each. I will take the Lyons Colliery first; there are two currents there, one going eastward into what we call the east division, or East Minor Pit, and the other going west, into the West Minor Pit; the easternmost division is subdivided into six different currents, so as to ventilate the different parts of the mine.

1837. The air is split into six divisions?

Into six divisions, so as to ventilate the different sections of the workings; the aggregate distance which the air travels is 1,080 chains, which is $13\frac{1}{2}$ miles and 56 chains; but being divided into six divisions, the average distance is about $2\frac{1}{2}$ miles; so that the current, instead of being one continuous current of $13\frac{1}{2}$ miles, is six separate currents of $2\frac{1}{2}$ miles each, and that is very important in ventilation. If there had been only one current travelling 13 miles, it would be quite impossible to get anything like the quantity of air there is in this pit, and, from what I have seen in some places, I find that this has not been attended to, perhaps to the extent to which it ought to have been; I will point out an instance afterwards in the case of the Darley Main, where the quantity of air was much diminished by being confined into a single course of ventilation.

1838. Is it a certain and ascertained fact that, in splitting a current of air, you obtain from the smaller currents which result from that splitting, carried through smaller spaces, a more effectual ventilation than you would from the whole current carried through the whole distance?

Decidedly.

1839. There is no doubt about that?

None whatever.

1840. What does that arise from; does it arise from the friction?

From the friction, resistance or affinity of the air: I have already said there are three currents in this mine, comprising altogether 168,850 cubic feet per minute, which is equal to 56,280 cubic feet for each current. It would not be practicable, without a great diminution of effect, to carry a current of air of 56,280 cubic feet per minute through any part of the workings; neither is it necessary that there should be that quantity in any particular place.

1841. So that there is a gain in quantity by splitting it?

Yes; the resistance of the air would be such, where there were 13 miles, that it would very materially diminish the quantity; and we do not find, except in very extraordinary cases, that we require more than something like 10,000 cubic feet per minute in one current: 10,000 cubic feet of air passing through a district of workings, not very extensive, would be quite sufficient to carry off any quantity of gas that would accumulate, and here we have nearly 60,000 feet divided into six currents, which is 10,000 each.

1842. Is 10,000 cubic feet per minute sufficient for the complete ventilation of a pit like this?

No, only for a district of workings, and in this colliery there are 17 of such districts; and it depends upon the magnitude of the colliery into how many districts it is to be divided.

1843. It is sufficient to ventilate the passages through which that current is passed?

Yes, quite sufficient for a certain extent of workings. The mode in which the gas is generated, is an oozing out in every part of the mine, as described in my evidence in 1835, and it requires to be mixed with about one-tenth or one-twelfth, before it becomes unflammable. A discharge of gas of 1,000 feet per minute would be carried off by a quantity of 10,000 feet per minute of atmospheric air, and we never have anything like that quantity. The great blower at Wallsend Colliery only discharges 120 feet of gas per minute, and this is the largest in the district.

1844. You consider the pit now to be effectually and sufficiently ventilated?

I do. I shall now go on with the description of the west division of the colliery. The aggregate distance which the air travels is rather better than nine and one-third miles, which is divided into four divisions, making an average of about two miles

miles and a quarter. Then from the Eppleton shaft, which is the most extensive part of the mine, the air there is divided into seven divisions: the aggregate distance, travelling from the top of the downcast pit all through the workings and to the upcast again, is very nearly 50 miles, which being divided into seven splits or divisions, the average distance is about seven miles.

Nicholas Wood,
Esq.

2d July 1849.

1845. Each district?

Yes, each district. I should observe, that although each of those currents travels seven miles, they do not travel separately the whole of the seven miles, because they meet together when they come into the main airway before reaching the shaft. The whole air of the pit, viz. 168,850 cubic feet per minute, is divided into sixteen currents of about 11,000 cubic feet per minute each, and those sixteen currents travel from the top of the downcast pit to the top of the upcast pit, those average distances of $4\frac{1}{2}$ miles each.

1846. That would rather diminish the total amount; it would not be quite 70 miles?

It would be about $70\frac{1}{2}$ miles. The greatest distance that one current travels is 732 chains, which is nine miles and about one-tenth.

1847. Is that the greatest extent in the whole pit?

Yes.

1848. That makes about 70 miles altogether?

Yes, it is above 70 miles. I have given the power of the furnace in the shaft itself in the production of a current of air through the workings. In consequence of the distance that the air has to travel through the workings, and the effect of the resistance through the different parts of the mine, we do not get a quantity of air anything like the velocity in the shaft at which the heat of it, and the theoretical power, would give out. If the air were simply to go down one shaft and up another, without friction or resistance, the velocity would be 1,280 feet per minute, which is nearly 22 feet per second.

1849. What would be the greatest velocity which would be consistent with the comfort and convenience of the workmen in carrying on the works of the mine?

The quantity of air which I have observed, is divided in going into the workings into 16 divisions; there is, therefore, no part of the pit where there is anything like such a current. As in the shaft, the velocity in the workings is reduced to from 3 to 5 feet per second. In the shaft you get a very great power of draught and velocity of current, as compared with the velocity in the workings, and this is important, inasmuch as several of the mechanical contrivances for the ventilation of mines are applied to the shaft of the mine; and it is thought by several people that if you apply mechanical force to the shaft, it must produce a similar current throughout all the workings. Now it is not so; in this case we get a velocity of 1,280 feet per minute.

1850. In the shaft?

In the shaft. If we take 71-horse power, and apply that to the pumping out of the air, or use it in any other way to produce a current in the shaft, it will be found that you will not realize that current in the mine. The velocity of the air in the mine varies from 300 to 700 feet per minute, whereas in the shaft it is 1,280 feet per minute. Then the pressure between the one and the other is in the one case 7 lbs. to the square foot, and in the other 21 lbs. per square foot.

1851. Do you consider that as great a velocity in the workings as is consistent with the convenience and comfort of the workmen?

I think that a velocity of something like about five feet per second would be quite sufficient in the workings, which is very much less, about one-fourth of the velocity in the shaft.

1852. This being the power of ventilation exerted by the furnaces in the case of the Hetton Colliery, how did you compare that with the power of the steam-jet which you state you have tried?

I have not had sufficient experience of the steam-jet myself to state positively the precise power which it exhibits.

1853. You were understood to say that in the case of some collieries you had made experiments?

(164. 6.)

A A 4

Yes;

Nicholas Wood,
Esq.

2d July 1849.

Yes; I have in two or three instances, but not to satisfy myself conclusively as to the power of it.

1854. We collect, in the first place, from that answer, that you merely tried it as a matter of curiosity?

No, it was a practical application of it.

1855. You were understood to say that the ventilation effected by the furnaces was quite sufficient for the purposes of the mine?

At the Hetton Colliery; I have not tried the steam-jet at the Hetton Colliery; I have tried it at the North Hetton Colliery, and at a colliery at Norwood; then I have some other experiments which have been given to me by Mr. Elliot, of a neighbouring colliery at Belmont, which I have compared with those that I have made myself.

1856. It was the high-pressure steam-jet which you tried?

Yes.

1857. Can you state what the power is?

In going into the question of the power of the steam-jet, it will perhaps be necessary to explain that it has been tried in two different ways, with a steam-engine at the bottom of the pit, and the steam conveyed from that steam-engine into the shaft at the bottom of the pit where the jet is applied, and with a steam-engine at the top of the pit, and the steam-pipe carried down the shaft, and the jet applied either near the top or near the bottom of the pit. Now, the two cases are essentially different; in the first case, besides the mechanical power of the jet, you have the effect of the heat produced from the coals consumed in the engine-furnace, which acts directly in heating the air in the upcast shaft, and indirectly by the heating powers of the steam proceeding from the jet. The effect of the fire of the steam-engine acts in the same way as the furnace does to create a draught by the expansion of the air, and the steam also acts in a similar manner, by rarefaction, as the furnace does: then we have, in addition to the heating powers of the fire and steam, the mechanical effect of the steam-jet. I shall give some experiments not favourable to the steam-jet, and I give these experiments because I think it is useful to know where a scheme of any kind fails, as well as where it is successful; people will then be able to apply it in the most effectual way. I must also be allowed to observe, that though I think the effect of the steam-jet has been magnified beyond its merits, I am far from being of opinion that it is not useful; on the contrary, I think there are many cases where it may be applied advantageously; but I think that at present there is rather an exaggerated opinion of the power of the jet as compared with the power of the furnace, and I have considered it my duty to make all the inquiries I could as to their comparative merits, to the extent of the information which I have been able to obtain up to this moment.

1858. By the steam-jet, you mean Mr. Gurney's?

Yes; Mr. Gurney's steam-jet: the first place where it was applied at a colliery under my inspection was at the North Hetton Colliery.

1859. Under Mr. Gurney's inspection?

No.

1860. Was that previous to the experiment which was made at Mr. Forster's colliery, the Seaton Delaval Colliery?

I think it was not to its first introduction to Seaton Delaval Colliery, but before Mr. Forster's application of it to the top of the pit.

1861. Can you mention the date of that experiment?

I think it was about six weeks or two months since it was tried, and abandoned.

1862. At North Hetton?

Yes, at North Hetton; we only tried it for a short time, and there it was abandoned. The mode of application was, the steam-pipe from the engine (which was at the surface of the pit) was carried down the pit about 30 feet from the surface; there were 30 jets of steam, of one-eighth of an inch diameter each, and the steam employed was 38 lbs. per square inch; the air, measured by Mr. Biram's anemometer, the same which was used in the experiments at the Hetton Colliery;

Colliery: the results were, previously to the steam-jet being applied, a quantity of air equal to 25,000 cubic feet per minute by the furnace; when the jets were applied, the furnace being still in action, the quantity was increased to 31,000 cubic feet per minute, so that the increase by the jet was 6,000 cubic feet a minute; but when the steam-jets alone were employed without the furnace, the quantity was only 22,000 cubic feet a minute; so that the steam-jet in that case did not give so great an effect as the furnace.

Nicholas Wood,
Esq.
2d July 1849.

1863. And that was with a pressure of 38 lbs. ?

It was.

1864. Thirty feet below the surface ?

Yes; my opinion of the result of this experiment was, that the steam-jets were applied too near the surface.

1865. How far was it from the bottom of the pit ?

That pit is about 90 fathoms deep; the application was about five fathoms down the shaft, or about 85 from the bottom. I think the failure of the jet in this case was, in consequence of its being too near the top of the pit; I think the application of the jet, acting as it does by propelling the air upwards, unless there is a considerable column of air above the jet, produces a sort of counter current, by drawing part of the air down the pit.

1866. To be drawn up again by the jet ?

Yes, to be thrown up again by the jet; it produces a rapid displacement of the air, and the rapidity is such, that the upward current operated upon by the resistance of the mine does not follow the displacement sufficiently quick, so that part of the air required to supply such displacement is supplied from above; therefore, so far as my knowledge goes, I think it is requisite, for the successful application of the steam-jet, that it should be placed near the bottom of the pit, and that in this case it was too near the surface, and therefore failed.

1867. Then you do not consider that experiment conclusive, as showing that it would not produce more than 22,000 feet per minute ?

I do not.

1868. Was it tried under any other circumstances ?

The next application of it was somewhere about the same time (and it is in operation at present), at a small colliery called Norwood Colliery, near Newcastle; the depth of the pit is 60 fathoms to the lowest seam, and to the first seam about 10 fathoms; to the first seam there are two pits, about 10 yards apart, a downcast and an upcast shaft; but between the upper and lower seam there is only one shaft, divided by a brattice or partition, on one side of which is the downcast and on the other side the upcast.

1869. Only a single shaft ?

Only a single shaft from the upper to the lower seam, but a double one from the surface to the upper seam; the jet is carried down from the surface 10 fathoms, down the shaft to the upper seam, and applied there instead of a furnace.

1870. What was the result there ?

The application would be equivalent to carrying a pipe down a shaft ten fathoms, instead of in the former case five fathoms.

1871. It would hardly be equivalent to carrying a pipe down the shaft itself 10 fathoms, as it is impeded by a lateral channel, the distance between the two pits ?

A little; they are near together, and there is not a great deal in that; in this case the furnace, before the application of the steam-jet, produced the effect of 15,750 cubic feet per minute; the furnace was then put out, and the jet applied, and it produced the effect of 28,250 cubic feet per minute; so that in this case the jet produced a greater quantity than the furnace by 12,500 cubic feet per minute.

1872. What was the pressure upon that occasion, the diameter of the jet, and the number of jets ?

There is a three-inch pipe carried down the pit 10 fathoms, and then turned upwards; there are fixed to it six arms, each an inch and-a-half in diameter, each arm having two jets, with a diameter of $\frac{3}{16}$ ths of an inch; therefore there are 12 jets $\frac{3}{16}$ ths of an inch in diameter in the openings, and the pressure of the steam is 30 lbs. per square inch.

(164.6.)

B B

1873. That

*Nicholas Wood,
Esq.*

2d July 1849.

1873. That is eight pounds less than in the last instance ?

Yes.

1874. Then with a pressure in that case of eight pounds less than in the former, and with only 12 jets, instead of 30, at a depth of 10 fathoms instead of five fathoms, you obtained a power of 28,000 cubic feet per minute; whereas in the former instance you obtained only 22,000.

Only 22,000.

1875. Have you thought what was the cause of that increase of the ventilation ?

Yes; the quantity before was about 22,000 cubic feet per minute with the jet; I think that that was, as I stated before, imperfect, on account of the small depth; this is rather deeper.

1876. Just double the depth ?

Yes, and therefore the effect is greater, and it is increased from 22,000 to 28,000: as compared with the furnace, I must observe, however, that the furnace, in this case, is under very disadvantageous circumstances, and only produces a current of 15,000 cubic feet per minute; the furnace is only placed 10 fathoms below the surface, so that you have only a column of heated air equal to 15,000 cubic feet, 60 feet in depth; therefore this experiment ought not to be applied as a general comparison of the two methods, because the steam-jet would, no doubt, be most efficacious, while the furnace is least efficacious, considering the small depth of the shaft.

1877. Then, under these circumstances, you had the furnace and the jet both acting at the same point of the pit, both about 10 fathoms below the surface ?

Yes; the experiments which I have given are by the furnace alone, and by the jet alone; not the furnace and the jet together.

1878. But the furnace and the jet were each acting 10 fathoms below the surface ?

Yes, in this last case; in the other case the furnace was acting at the bottom of the pit, while the jet was acting only five fathoms from the surface.

1879. But in this case they were acting at the same depth ?

Yes.

1880. And under those circumstances the furnace produced only about 15,000 cubic feet, and the jet produced 28,000 ?

Yes.

1881. That would seem to imply, that under similar circumstances, at least as regarded depth, the jet was a more powerful agent than the furnace ?

Applied to a certain depth of shaft, it would appear so. I shall afterwards come to what I consider the mechanical effect of the jet. In this case we have the mechanical effect of the jet and the heat of the steam in the shaft; the two operations operate to produce the effect; we have not the engine fire, but we have the heat of the steam in the shaft, and therefore it is necessary to give the temperature in the shaft. The temperature at the bottom of the staple or pit of 10 fathoms was 56 degrees, and the temperature near the top of the upcast pit was 103 degrees; therefore there was a rarefying power of 47 degrees.

1882. When you say of 56 degrees, was that below the jet ?

Yes, at the bottom of the pit, below the jet; then the steam raised the temperature to 103 degrees; therefore there is the effect of that steam or heat, besides the mechanical effect of the jet. The other experiments which I have are from Mr. Elliott, who, I believe, will be examined; they were made at a neighbouring colliery, Belmont Colliery.

1883. Under your inspection ?

Not under my inspection.

1884. Will you state the general conclusion of those experiments of Mr. Elliott ?

I think that those experiments bear out the result which I have come to in my own mind as regards the steam-jet, compared with the calculation which I will go into with reference to that of the furnace of the Hetton Colliery; these experiments give with the furnace alone 44,000 cubic feet per minute; with the engine alone, and no steam (which would be the effect of the fire), 47,756 cubic feet.

1885. Do

1885. Do you mean the current produced by the engine-fire without the furnace?

Yes.

1886. Then that is greater than the furnace itself?

Yes, the effect depends upon the quantity of coals which are consumed; the furnace is a six-foot furnace; and a six-foot furnace will not consume so large a quantity of coals as a steam-engine fire of 30-horses' power.

1887. It would not be so powerful as the engine-fire?

No. Then steam applied by a pipe of six inches (which would not be as jets, according to Mr. Gurney's principle), in addition to the engine alone, which would represent the effect of the steam and the engine, the quantity was 56,294, and with Mr. Gurney's jet, with the engine-fire and jet alone, it was 59,956, or in round numbers 60,000; and when the furnace was added, in addition to the steam-engine and jets, the quantity was equal to 71,895, or nearly 72,000 cubic feet per minute.

1888. That is in the Belmont case?

In the Belmont case, the depth of the pit being 50 fathoms, and eight feet diameter. Now, in that case we have with the engine alone a quantity of 47,756 feet, the effect depending, of course, entirely upon the quantity of coals burnt. In the Hetton case I gave the quantity of coals which produced a certain effect. The coals in the Belmont case, acting through the intervention of an engine-fire, should, of course, produce a corresponding effect, according to the quantity burnt, which we find here represented by 47,756 cubic feet of air per minute; then we have the effect of the steam not acting as a jet, which produces an additional effect of 8,538 cubic feet per minute; then we have the effect of the jet, which increases the effect to 59,956 cubic feet per minute; therefore, the difference between the engine alone and Mr. Gurney's jets would be about 12,200 cubic feet per minute; and I think that the experiments which I have detailed before will prove something like that effect.

1889. Twelve thousand cubic feet as applicable to the jet alone?

Yes, 12,000 additional. Then, if we have a certain fire, the fire say of a 30 or 40-horse engine, and we apply the steam in the shape of a jet, in the way in which it has been applied hitherto, we get from 12,000 to 15,000 cubic feet per minute additional. In the Norwood case we get 28,000 with the steam and jet, and taking the effect of the steam as equal to the furnace, we have the steam-jet equal to 13,000.

1890. Can you say what the area of the shaft was in the case of the Belmont Colliery?

It was an eight-foot shaft.

1891. And the Hetton 14 feet?

Yes; of course the effect of the jet in all cases will be according to the quantity of steam that is applied to it, and the pressure per square inch of that steam.

1892. What was the pressure in the Belmont case?

I think it was 30 lbs. per square inch.

1893. Was there any priming passed with the steam which would be water mixed with the steam?

That I am not aware of.

1894. Was there any examination as to the pressure of the steam at the jet, as compared with the pressure at the boiler?

No, I believe not.

1895. You are not able to speak to that?

No; I have been extremely anxious, having the charge of so many collieries, to endeavour to find out the merits of this plan, and if my judgment is erroneous, it is, I am sure, not from the want of the wish to get at the truth, but that I cannot make more of the jet than I have explained with the materials I have obtained. I will put the comparison with reference to the Hetton Colliery in another point of view: the consumption of coals of the Hetton furnaces is 746 lbs. of coal per hour, for the three furnaces of nine feet each; that is, 12½ lbs. per minute; that will convert a cubic foot-and-a-half of water into steam every minute; there can

Nicholas Wood,
Esq.
2d July 1849.

be no doubt as to that, because it has been tried so many times over, and it is the established opinion that eight pounds of coal will convert a cubic foot of water into steam; a cubic foot of water produces, in round numbers, 1,700 cubic feet of steam at the temperature of 212 degrees, that is just when it is in a state of steam; a cubic foot-and-a-half of water will produce, therefore, 2,550 cubic feet of steam per minute, which is the whole quantity of steam with those coals that Mr. Gurney would have to deal with, whether it is used at 20, 30, 40 or 50, or whatever pressure per square inch. This is the consumption of coals in the Hetton furnace, producing a current of air equal to 168,850 cubic feet per minute. Now, supposing that the steam is used at 30 lbs. per square inch, the volume of steam then would be reduced from 1,700 to 608, because as the pressure increases, of course the volume of steam decreases; therefore a cubic foot-and-a-half of water would produce 912 cubic feet of steam at 30 lbs. per square inch; supposing, therefore, that the whole of that power is got, we multiply 912 cubic feet by 30 lbs. pressure, and that would give the whole mechanical effect of a cubic foot-and-a-half of water, viz. 27,360 cubic feet per minute. We can get nothing more than that, supposing that the whole effect is obtained; but then that steam has to be expanded from 30 lbs. to the ordinary pressure of the atmosphere; and in this case it would have to operate upon air travelling at the rate of 20 feet a second, and therefore we could not expect to obtain the full effect of the bulk multiplied into the pressure. It would require a very minute calculation to go into the practical effect in that case; but the whole effect of 30 lbs. multiplied by 912, is 27,360 cubic feet per minute; therefore, if the whole effect is obtained, that would be the mechanical effect of the application of the steam-jet with the quantity of coals consumed by the Hetton furnaces as compared with the practical result of a current of air in the workings equal to 168,850 cubic feet per minute, which the application of the same quantity of coals produced by the furnaces. I think the practical result of the steam-jet could not be considered to produce a greater result than 50 or 60 per cent. of the 27,000 cubic feet per minute.

1896. Practically?

Yes, that we could not get a result greater than 50 or 60 per cent., because the steam from the jet expands rapidly, but it does not expand as in an ordinary experiment, with a still atmosphere; the air in an upcast shaft is travelling at the rate of 20 feet a second, and the steam has to expand and act upon a current at that velocity.

1897. Have you seen the steam-jet in operation at the Seaton Delaval Colliery?

I have not.

1898. You have not had the curiosity to examine it?

I was very anxious to do so, but Mr. Forster said it was not ready for examination.

1899. Are you aware that the velocity of the current there has been doubled since the application of the steam-jet?

I do not know that.

1900. Was your attention called to the letter published by Mr. Forster, describing the experiment?

It was.

1901. That experiment was made in November last?

It was.

1902. You state that the experiment in the North Hetton Colliery was made about two months ago?

Yes, those experiments which I have given were made since that at Seaton Delaval.

1903. Did not Mr. Gurney propose to visit your colliery, and direct the experiment himself?

Yes, he did; he was staying with me, and we discussed both the theoretical and practical operation of the steam-jet very seriously.

1904. You did not avail yourself of that offer?

No, I waited for the result of the trial at Seaton Delaval as the test of the effect

effect of the steam-jet in the ventilation of mines; and I believe the trade generally has been waiting with considerable interest to see the effect at that colliery.

*Nicholas Wood,
Esq.*

2d July 1849.

1905. But you tried the experiment at the end of May, or the beginning of June?

I think it might be somewhere about that time.

1906. And you wrote to Mr. Gurney to say that you thought that, partially at least, it had failed?

Yes.

1907. Did you receive a letter from Mr. Gurney in reply, to say that if you had referred to the evidence given by him before the Committee of the House of Commons in 1835, or before the South Shields Committee in 1839 or 1840, you would have found that the failure, under the circumstances under which the experiment was made in your colliery, could not fail to arise?

Mr. Gurney wrote to me to that effect; but I cannot lay my hands upon the part of the evidence that Mr. Gurney alludes to, because I had a very long discussion with Mr. Gurney as to the mode of application of the steam-jet; and certainly, when Mr. Gurney left my house, he had an impression that it might be used near the mouth of the pit, and in fact proposed that it should be done so. I believe that it was tried at the Seaton Delaval Colliery, and did not answer near the mouth of the pit. The preparations were made before Mr. Gurney saw me, to try it at the North Hetton Colliery; and as the preparations were made, I wished to see the experiment, because I thought the experiment of utility, whether it failed or succeeded. It was a mode of application which was not inconsistent with Mr. Gurney's notions at the time that I had the conversation with him. I have stated already that I do not think it is a case which would test the value of the steam-jet. I think the proper application of the steam-jet is at the bottom of the pit. Mr. Gurney and Mr. Forster both stated, that as soon as the experiments were complete at Seaton Delaval Colliery, they would ask some of the viewers to go over to see them. Mr. Forster, I believe, has not been able to make arrangements for that purpose yet; therefore I do not think that its practical effect has been tested in a way satisfactorily or decisively to judge of its utility.

1908. You are waiting, in fact, for the conclusions of that experiment?

Yes.

1909. However, the result of those experiments which you have detailed to us, and of the calculations into which you have entered, is, that you conceive the steam-jet to give an additional power in such cases as those of from 12,000 to 15,000 cubic feet per minute?

Yes, certainly not more than from 12,000 to 20,000; it will depend much upon the quantity of steam used in the jets. The Hetton furnace power is 71 horses; the steam-jet has never been tried in so extensive a way, so that it has not been tested yet; but I think it requires more experiments and greater experience than have hitherto been obtained to justify an application of it in substitution of a ventilation equal to the power of the Hetton Colliery furnaces.

1910. Until it has been further tested?

Until it has been further tested. I think the trade is very much indebted to Mr. Gurney and to Mr. Forster for the experiments at the Seaton Delaval Colliery; any project which will produce an increase of ventilating power in a sound practical shape, must be useful in the prevention of accidents.

1911. You think that a very important object in any steps to be taken with reference to the accidents in collieries?

I think the first object in preventing accidents in mines is to be able to produce a considerable current of air in the mine; but I think it would be an erroneous impression if a conclusion was arrived at that producing a large current of air in the shaft is the only requisite that is to be accomplished in the prevention of accidents. I think accidents generally are occasioned more from not carrying the air properly through the workings after the current is produced, than the ability to produce the requisite quantity of air. I have seen in Yorkshire, and in some other places, very imperfect ventilation, not only in respect of the quantity of air, but in the application of it.

(164. 6.)

B B 3

1912. You

Nicholas Wood,
Esq.

2d July 1849.

1912. You went to examine the Darley Main Pit when the accident happened there last year, did you not?

I did.

1913. Did you find the system of ventilation very imperfect there?

Yes, I found the system very imperfect; it was ventilated by a furnace in the usual way; and a furnace quite sufficient to ventilate that pit in an efficient manner.

1914. What was the principal defect of the system as you observed it there?

In the first place, they were drawing water up the shaft, as Mr. Biram has explained, which, of course, is a very injurious operation; it has a tendency to produce a current the reverse way, by impeding the ascent of the air in the shaft; but, independently of that, the system under-ground was bad. There were two pits; the downcast pit and an engine pit, also a separate upcast shaft, which was upon a considerably higher level than the downcast pits, which, of course, diminishes the column; still, notwithstanding that, there was a very good furnace, and there was sufficient depth of shaft to create quite as efficient a current of air as all the purposes of the mine required; but they were drawing water at the upcast pit, which Mr. Biram explained as being very injurious; but, independently of that, instead of splitting the air into divisions, as we do in the North, it was carried almost in one continuous current from going down the downcast pit, until it went out of the upcast pit; the effect of that was, that there was a much greater power of ventilation in the shafts than there was space in the air-passages in the mine, and, as a consequence, a considerable diminution of effect. I was asked what I would advise the parties to do to increase the ventilation? I said at once that, instead of the air being carried in one current, especially as they had two drifts in all their main roads, one of which was dormant, I should put the air into the two drifts, instead of the one, as the air was going along one of those, and the other was doing nothing. I have since had a letter from the manager, stating, that they have got more than double the quantity of air into the pit in consequence.

1915. By adopting that suggestion?

Yes; and by drawing the water at the downcast instead of the upcast shaft, the air was throttled, as it were, in consequence of its only being in one drift, and there not being adequate area. I give this case as showing that it is not merely necessary for the prevention of accidents that the shaft alone should be filled with air, or capable of producing an adequate current of air, but that the great point is to get it carried round the workings in a proper manner; and I believe, in the majority of instances, the accidents happen, not from the want of ventilation in the shaft, or quantity of air in the mine, but from its not being carried into all the places in a proper manner, so as to carry off the foul air.

1916. You do not consider this so dangerous a bed of coal as you are accustomed to in the North, do you?

No; there was a very small proportion of gas emitted at this colliery.

1917. Whereabouts was the accident in this pit—[*the Witness points out the same*]; in the extremity of the workings?

Near this bank. As Mr. Biram explained, the air came round the face of the banks—[*showing the same*]: the whole of the goaf being dormant, or not supplied with air at all, the system here was to open a small hole, by taking a brick out of the stoppings to let a little air in, which, of course, as Mr. Biram explained, would render the air within the goaf inflammable, if there was any inflammable air there at all.

1918. It made it more dangerous than if there had been the gas alone?

Yes; still I cannot think that if there is gas there of any magnitude produced or accumulating in those goafs, it would have been at all safe to work with candles. I must say that, in that district, they work with candles in places that we should not work in with them in the North; perhaps having more gas, we are more afraid of it, and therefore adopt greater precautions.

1919. You take greater precautions?

Yes. If there was any production of gas so as to fill the goaf, we should at once commence working with lamps, and not use the candles; and we would rather that the goafs were ventilated, than that they should be kept as a magazine of gas,
though

though rendered unflammable by the exclusion of atmospheric air; because, although the atmospheric air, mixing with the stagnant carbonic acid gas in the goafs, renders it inflammable, still I cannot consider it otherwise than as a very hazardous operation to have a magazine of gas which, though not inflammable by the exclusion of atmospheric air, yet by the accidental admixture of a little atmospheric air would render it liable to explode at any time; therefore, I do not think it safe to ventilate or work the mines in such a manner as that such magazines as I have described should exist without any air passing into them to render them inflammable, and to depend upon its exclusion for the safety of the mine. In this case it was supposed that a fault had produced a little gas, and that it had accumulated in the goaf adjoining such fault; and this goaf being at the extremity of the workings, and the air having in this part of the mine two passages to pass along, the one next this goaf being the least direct, the air, of course, would go the nearest way; therefore if there was any deficiency of air, it would be near the goaf adjoining the fault. It had been very windy the day before, and that circumstance, added to the water being drawn at the upcast shaft, diminished the current generally, and the vicinity of the goaf next the fault being the place where there was most gas, and where the current of air was weakest, I believe the inflammable air had come off from the goaf, and been ignited with the candles of the workmen. But it was very extraordinary, though it is a case which sometimes happens, that the men were burnt in this quarter where the gas ignited; between there and the pit they were not burnt; and then again they were burnt in a district of workings much nearer the downcast than where the accident happened.

Nicholas Wood,
Esq.

2d July 1849.

1920. Do you suppose that a second explosion had taken place there?

We supposed so; that the concussion of the first explosion had disturbed the air to such an extent in the distant goafs, which it appears had contained a little inflammable air, and had forced it out upon the candles of the workmen, and produced a second explosion. As the men were burnt very severely in this quarter, that was the conclusion we all came to; but it shows the danger of having such magazines liable to be rendered inflammable at any time.

1921. Generally speaking, in these accidents should you be disposed to say that the greater number of lives are lost by the explosion itself, or by the consequences of the explosion?

By the choke-damp; a man must be very severely burnt who would not be able to walk out to the shaft, if it was not for the effect of the vitiated air; there are few instances where any considerable part of the men are so severely burnt as not to be able to walk out, unless they are knocked about and killed by the direct effect of the explosion; the majority of the persons killed by an explosion are killed by the effect of the choke-damp, which is extremely subtle and deleterious.

1922. Do you conceive that by a well-arranged system of ventilation, and a powerful agent for the purpose of keeping it up, you could render the ventilation of a mine so efficient as at any rate, although not to prevent explosions in all cases, to prevent much of the consequences of the after-damp?

No, I think not; the effect of an explosion is to destroy all the stoppings in the mine, and so to destroy all ventilation where the explosion takes place. I have a model here, which shows the stoppings—[*The Witness produces the same*].

1923. Is that a model of any particular mine?

No; it is one which I sent up to a gentleman in London, who was lecturing some months ago. It was made with the view of producing a current, by the application of a lamp to glass tubes representing shafts, so as to show the ventilation.

[Witness then explained the mode of ventilating a coal-mine, such as shown on the model, by stopping, diverting the current into the proper direction in all the various parts, and at the edges of the pillar working, which was the same model as shown in the drawings of workings given in his evidence in 1835].

1924. Where does the splitting take place?

It is split at the mouth of the shaft, one current going to the right hand, and the other to the left, meeting at the extremity of the supposed workings, and so along one common course down to the upcast shaft.

Nicholas Wood,
Esq.
2d July 1849.

[Witness then showed where the model exhibited the pillars to be taken off, and explained the goaf, and where it is that the accumulation of gas takes place; in the goaf the air passing along its edge, and not going into the goaf, which would become a magazine; and if there is any variation of the atmospheric pressure, or if there is any sudden accumulation of gas, then it is forced or oozes out upon candles of the workmen. Coming to the question, as to any system of ventilation which would save the lives of the men after an explosion, the effect of an explosion is to blow out all those stoppings—[*showing the stoppings on the model*!—every one of them.

1925. And those stoppings cannot be made by any ordinary means strong enough to resist the force of the explosion?

No; I do not think they can; there are parts in all pits where the stoppings are protected by pillars, and where they are entirely stowed up; but in the majority of cases of heavy explosions they have been entirely blown out. The effect of the explosion is to destroy most of the stoppings, and then the air, instead of going round about where the men are working, goes the nearest way to the shaft, and then you have to begin to put those stoppings in, one after another, to take the air to where the men are supposed to be, in order to save their lives.

1926. All ventilation has ceased?

All ventilation at the extremity has ceased.

1927. All ventilation where the stoppings are broken down has ceased?

Just so.

1928. Then, after an explosion for the most part, it becomes absolutely impossible to introduce ventilation into the mine?

Quite; it is a measure of time; deals are got and put up as rapidly as possible, and in those cases the men going down the pit are sometimes lost by venturing to put those stoppings up before the fresh air clears away the after-damp. Sometimes they are only blown down partially, and they are got up before the men are dead; but it is a work of time to replace them, depending on the quantity blown down, and I do not know any system of ventilation which would accomplish the object which your Lordship mentions. In many cases these are stowed, and the general practice is to do so in the main roads, to keep them as firm and strong as possible, with the view, in case of any accident, to get the air into the workings as soon as possible.

1929. With reference to the circumstances under which the experiment which you have detailed was tried at the North Hetton Colliery, will you be so good as to read the first paragraph of that letter in the Report of the South Shields Committee, with which, I believe, you are acquainted?

Yes, I am.

1930. It is a letter from Mr. Gurney, addressed to the Secretary of that Committee; and will you tell the Committee whether it does not appear to you that the circumstances described in that paragraph, and referring to the diagram, are very much the same as those in which the experiment was tried at the North Hetton Colliery?

It does not state here that the jets are to be placed at the bottom of the pit.

1931. Will you just read the paragraph?

“Dear Sir,—It would be more favourable if the steam-jets could be arranged as shown in the drawing I sent you” (that is, at the bottom of the pit); “but they will be sufficiently effective if the steam be passed through a less number, provided each has sufficient power to start a column of air of a diameter that shall extend to and fall into the current produced by the next jet.”

1932. Do not you think that that consequence is pointed out?

I think this state of circumstances might occur, if the jets were not accurately placed, although they were placed at the bottom of the pit, as well as at the top.

1933. Do not you think that the circumstances anticipated and foreseen in that letter are precisely the circumstances under which the experiment was tried at the North Hetton Colliery?

No.

1934. Will

1934. Will you first read the paragraph through, and then give us your opinion upon that point?

"Therefore, as three feet is required in the centre of the shaft for the corfe to pass up and down, the number of jets must be reduced to 10 (fig. 6); the sum of their areas being equal to those of the larger number, it will require the steam to be kept a little higher. If the jets were placed in the diagonal opening, as shown in your sketch A., fig. 7, the exhaustion B. would be almost wholly filled by a return current from C."

*Nicholas Wood,
Esq.*

2d July 1849.

1935. Is not that exactly what happened in the North Hetton Colliery?

No.

1936. Did not you talk of a return current?

Yes, from the top of the pit, but this is a return current from the bottom of the pit.

1937. You have already informed the Committee that you were not prepared to state the pressure at the exits of the jets?

No, I am not.

1938. That the pressure was at the boiler, and not at the exits?

At the boiler.

1939. Might not there have been a considerable difference between the pressure at the boiler and the pressure at the exits?

I think not; I think the area of the jets being so much less than the area of the pipe, the same pressure would take place at the jets as at the boiler. Mr. Elliott will explain this.

1940. The pressure being much increased by the diminution of the orifice?

Yes; if it had gone out of the pipe without any jets, then the pressure would have been less at the end of the pipe; but the jets being of less diameter, of course there is time for the pipe to fill with steam equal to the pressure of the boiler. I think that if I had read this letter very carefully, and considered it, although it is under different circumstances, I should probably have come to the result of what the experiment has given; but it was under different circumstances, and if I had read the letter, I would not have thought it worth while interrupting the experiment.

1941. When you placed these jets in the pit at North Hetton only five fathoms below the mouth of the shaft, how did you contrive to make use of the shaft at the same time?

It was the upcast shaft not in use as a drawing shaft.

1942. Then it would not be possible to make use of the jet under those circumstances, and at the same time to make use of the shaft?

Yes, I think it might; I think it is quite practicable to do so; to place the jet in a shaft, so that it may be made use of, although it would be very much better in a shaft by itself.

1943. Could you, do you think, place the jets in a shaft, so as to enable you to make use of the shaft, unless they were placed below the point of working altogether?

I think they might be placed around the sides where the coals are drawn up.

1944. Would that be sufficient, do you think?

It would not be so effectual as if placed in the proper way.

1945. Have you ever paid attention to any of the other methods proposed for producing an artificial ventilation?

I have seen a model of Mr. Brunton's apparatus.

1946. Did you ever see it in action?

I have not seen it in action; I had a letter from Mr. Brunton, inviting me to go to see it, and I very much regretted that I had not time to do so.

1947. Or Mr. Struvé's?

No, I have not seen it in action.

1948. Nor even a model of it?

I have seen a plan of it; I think I understand the principle of it very well.

Nicholas Wood,
Esq.
2d July 1849.

The difficulty in both those cases is the getting such a quantity of air as you can get by a well-regulated and powerful furnace. There is no doubt that they would be very great improvements, either of them, upon ventilation as carried on in several of the different districts in the country, because in the Darley Main Colliery, for instance, I was told by a person who had been down previously to the accident that the current was about 7,000 cubic feet per minute. Now, either of these machines, I take it, would produce a much more powerful current than that; therefore, it would be an improvement upon the system of ventilation carried on in such collieries; but when it is compared with a powerful furnace, it requires such large machines, that I think it would be a more expensive mode of ventilation than the furnace; there is nothing more simple or cheaper than the furnace, considering that you get a ventilating power of above 13,600 cubic feet of air per minute for each pound of coal.

1949. Still, if you can double by mechanical means the velocity of the current, you would think it a great advantage?

I would; but that is just the doubt I have. I do not see that, practically, either of these machines can produce a current equal to that in the Hetton Colliery; there is certainly nothing like it accomplished up to this time; persons who have used these contrivances will ascertain what extent of current can be produced by their machines, and compare them with the powers of the furnace; the whole question in ventilation being which system will produce the largest current. I take the standard at the Hetton Colliery as being a standard of the power of the furnace.

1950. Being 168,850 cubic feet per minute?

Yes, in the workings, with an average run of four miles and a quarter.

1951. With those three furnaces?

Yes; and I have not yet seen any machine that has yet produced a current equal to the half of it.

1952. With that current of 168,850 cubic feet per minute, what was about the velocity of the current in the workings of the mine?

It was from 500 to 700 feet per minute in some parts of it; in the workings, generally, it would be about from 200 to 300 feet per minute.

1953. A current above that would be inconvenient, would it not?

It would; it is from five to ten feet a second in some places; and from three to five feet per second where the men are working, which is about the ordinary velocity; in the shaft it is 1,280 feet per minute.

1954. With so powerful a current as that, you could not make use of the shaft?

It is too hot to go into the shaft. It has been fitted up in a most efficient manner, and lined in places with fire-brick, and made very complete, with a view of its being a very powerful furnace shaft.

1955. It would be necessary to appropriate the shaft altogether, in case of a ventilation of that power?

It would.

1956. Could you use a shaft through which a current of air was passing at the rate of 1,280 feet per minute, independently of the heat?

Yes.

1957. It would not prevent the corves descending?

No. It is necessary to observe, that you cannot get a current equal to that, unless you have a very deep shaft, and one of large diameter; the practical power of the furnace depends upon the depth of the shaft, and the area, and the heated air.

1958. In your evidence in 1835 you explained a calculation as to the effect of any increase of height in the upcast shaft, did you not?

Yes.

1959. Do you see any reason to alter your conclusions upon that subject?

No; I believe that it is pretty generally admitted to be a correct theorem. Pambourn, in his work on the steam-engine, makes a little difference, deduced from researches by Arago, but not to any practical extent.

1960. With

1960. With respect to the collieries in the northern district, are they generally furnished with two shafts, or are there many in which the ventilation is carried on entirely with one?

*Nicholas Wood,
Esq.*

2d July 1849.

There are some where the ventilation is carried on entirely with one shaft, but generally they are ventilated with separate shafts.

1961. Do you consider it a matter of great importance in the ventilation of a mine to give two shafts?

I do: I think, in order to make the ventilation complete, it is necessary to have two shafts. I think it is very much safer and more complete to have two shafts than one.

1962. It is only a question of expense, is it not?

It is a question of expense; but the expense in the North is very great indeed.

1963. What is the most expensive which you have ever had.

The South Hetton winning, I believe, has been the most expensive winning that has been made in the North.

1964. Is it much more expensive to make two small shafts than one large one?

It depends much upon circumstances; the great obstacle, where these shafts are so very expensive, is in getting through the lime-stone, which contains a vast quantity of water; in some cases the lime-stone is cut through without much expense, whereas by removing the shaft a very little way from it, you come into a place where there is a vast quantity of water. In the case of the Haswell Colliery, the first shaft was obliged to be abandoned, and another commenced at a certain distance, and they got down comparatively easily. At Seaton, near Seabam Harbour, we have sunk a shaft for something like between 50,000*l.* and 60,000*l.*; whereas, I believe, a pit about two miles from that has cost much more than double that sum.

1965. Have you known any instances of collieries on fire?

Yes, I have.

1966. What is the process usually adopted for extinguishing a fire when it occurs in a colliery?

The process generally adopted is to extinguish it with water; I know only one instance in which a fire was extinguished at Killingworth, by throwing the smoke upon the flame; it was in a very dangerous place, in a long drift; at the extremity there was a blower of gas, and the coal got on fire about half-way along it, which set the brattice on fire, and the timber, and the gas accumulating beyond it, would, at a certain period, have exploded; and by way of getting it out as quickly as possible (it was a dangerous experiment) we reversed the air, and threw the smoke back upon the flame, which extinguished it; but, generally, the practice of extinguishing fires in coal-mines is by water, or in case of very large fires, which cannot be extinguished by water, then the shaft is entirely closed up.

1967. The extinguishing a fire by water is a very troublesome and expensive method, is it not?

It depends much upon whether you have water or not, whether it is or is not a troublesome method, and very difficult to carry out.

1968. It does great damage to the pit frequently, does it not, and breaking the sides?

It does; we had a very extensive fire at Killingworth, which took several days to put out.

1969. To pump out the water afterwards must also be expensive?

In this case we poured water upon it; in the Springwell Colliery the pit was shut up several weeks, in consequence of a fire which could not be extinguished by water.

1970. Are you aware of the particulars of an operation which was successfully executed the other day in Lancashire, in the colliery of Mr. Darlington, by Mr. Gurney, for extinguishing a fire, by filling the pit with carbonic acid gas?

Yes.

Nicholas Wood,
Esq.

2d July 1849.

1971. Do you conceive that, from the instances which have come under your observation, that is a process which would be applicable in many cases of fire in mines?

I think in some cases it would be very useful, but I think a simpler application of it might be still more useful; I have, in fact, at present made arrangements, with a view of applying it in a more simple way in the case of small fires; those large fires in the pit always arise out of small ones in the beginning, and the great thing is to have something that you can apply immediately to the fire before it gets to a great extent; which renders necessary the adoption of the mode practised by Mr. Gurney, of shutting up the pit entirely, and throwing in the carbonic acid air.

1972. For how many hours do you remember the pit was shut up?

I do not recollect the number of hours.

1973. Was it for more than a day?

I dare say not; I fancy it would put out a fire in a day, but the whole thing is not merely extinguishing the flame, but getting it cooled down again. In the cases of two fires that I know of, we were able to walk over it: we had no flame, and the great difficulty is in getting it cooled down when it becomes extensive. I think that a machine which might be wheeled about the pit on the same principle as Mr. Gurney employed, and applying the carbonic acid air by a small machine, would be extremely useful.

1974. A machine moveable at the bottom of the pit, for the purpose of injecting the carbonic acid gas?

Yes; a small bellows, the same as a smith's bellows, which is moved about; you could place it in any part of the mine, and, by simply putting up a stopping or two, and closing the fire up, you could force the carbonic acid gas air into any part of the mine immediately; and it would be done at very much less expense, and very much more readily than closing the mine up upon the same principle that Mr. Gurney applied, which I think is a very beautiful mode of extinguishing flame.

1975. Do you know what the cost of that operation was at Mr. Darlington's mine?

No, I do not know the cost.

1976. Should you be surprised to hear that it did not exceed 5*l*.?

No; I think it very likely if all the apparatus was there, that it would cost a very small sum.

1977. The plan you suggest would be, in fact, removing the apparatus that Mr. Gurney made use of in that instance upon the surface, to the bottom of the mine, and to the neighbourhood of the fire?

Yes; Mr. Gurney there employed the steam-jet, to cause a current of vitiated air to circulate through the whole of the mine; all that is wanted in what I propose is, to insulate the fire, which would be readily done by deal stoppings, and then to force in the carbonic acid air, which can be done with a bellows in any part of the mine, and a very small quantity of that air would very soon put out the flame before it got into a large body. In several places it would not be quite so readily applied as it was applied in Mr. Darlington's case. I only mention this as another mode of using the same thing.

1978. For instance, supposing that a mine like the Hetton Colliery was on fire, with workings to the extent of 70 miles under-ground, it would not be easy to fill the whole of that mine with carbonic acid gas; at least it would require some time to do it?

It would be some time before you got the atmospheric air out of it, and in that time the fire might acquire great strength. In one part of the Hetton mine it is a very considerable distance, about a mile and a half from the shaft, and there is no water whatever; and I think that a machine of this kind would be extremely useful in such cases, as it might be wheeled about in any place.

1979. Provided that the fire was taken early enough, you think that it might succeed in extinguishing it easily?

I think it might.

1980. Are

1980. Are you aware that a second operation has been performed by Mr. Darlington of the same description ?

No, I was not aware of that.

1981. You have not heard of the particulars of that ?

No; I was from home, and did not see it.

Nicholas Wood,
Esq.

2d July 1849.

The Witness is directed to withdraw.

Ordered, That this Committee be adjourned till To-morrow,
One o'clock.

Die Martis, 3^o Julii 1849.

The LORD WHARNCLIFFE in the Chair.

NICHOLAS WOOD, Esquire, is called in, and further examined as follows :

Evidence on the
Prevention of
Accidents in
Coal Mines.

Nicholas Wood,
Esq.

3d July 1849.

1982. IS there any matter which you would wish to add to the evidence which you gave yesterday, as to the comparison of the ordinary ventilation by a furnace with that by the steam-jet ?

I have drawn out a more condensed statement of the results of the furnace, but I have not yet made any comparison of that with the steam-jet. I would rather present it as a sort of exposition of the power of the furnace as exhibited in the Hetton Colliery. I have taken the circumstances as proved by the every-day work of the furnaces at the Hetton Colliery ; taking the temperature in the down-cast shaft at 60 degrees, the temperature in the upcast at 140 degrees, and the depth of the shaft at 900 feet, and applying the theorem which is given in my evidence in 1835, which I believe is substantially correct ; under such circumstances that would give a velocity of $37\frac{6}{10}$ ths feet per second. Now I should like to explain that that velocity is applicable only to a case where there is no resistance from the air in the pit or shafts ; it is applicable only to the case of air going down a shaft, and coming up again simply, without traversing through the workings, and without friction ; but that, I should observe, would be a standard, as it were, of comparison with any experiment made with a machine, where that machine was not applied to carry air through any workings ; therefore I give it, in the first place, as a sort of test of comparison with any experiments by machines simply, and without any of the effects of the resistance of the air underground.

1983. Without the friction in the air passages ?

Yes ; the result, supposing the case of the air going simply down the shaft, and returning up again, would give a velocity of $37\frac{6}{10}$ ths feet per second ; applied over the area of the Hetton shaft of 153·93 square feet, it would give a current equal to 347,266 cubic feet per minute ; that would be the quantity of air which a furnace would produce in a shaft 900 feet in length, with an average temperature of 140 degrees against a shaft of the same depth at a temperature of 60 degrees. Then, in carrying this into practice, in this case it is applied to force the air round the workings. Now I find that the quantity of air passing through the workings in this case is 168,850 cubic feet per minute, which is something like half of what the theoretical calculation would give. I find that the average distance which that quantity of air travels in the mine is about $4\frac{1}{2}$ miles ; it is divided into 17 currents, of 10,000 cubic feet each, the maximum distance travelled being $8\frac{1}{2}$ th miles, and the minimum $1\frac{1}{2}$ miles. Now these circumstances reduce the mechanical effect of the power of the furnace in the shaft to a power equal to 21·3 feet per second, measured by 197,000 cubic feet of air passing up the shaft in a minute.

1984. Is the 21·3 feet to 37·6 feet as the 168,850 is to the 347,266 ?

No ; we must take the 197,000. I mentioned that the quantity at the bottom of the pit is 168,000 feet per second, in round numbers ; but when you apply the heat of the furnace to that quantity of air, it is expanded, and it then becomes a quantity of 197,000, in round numbers, which is the quantity passing in the shaft ; the 168,000 is the quantity previously to its passing over the furnace, and the 197,000 is after it has passed over the furnace, and in the shaft ; therefore the 21 feet per second is the velocity in the shaft.

1985. It corresponds to the 197,000 ?

Yes.

(164. 7.)

c c 4

1986. Then

Nicholas Wood,
Esq.

3d July 1849.

1986. Then the proportion is, that the 347,000 is to the 197,000 as the 37 is to the 21, or nearly?

Yes; the practical effect producing in the shaft a velocity of 21·3 feet per second, and in the workings, before the air passes the furnace, the velocity of 13·07 feet per second, applicable to the 168,850. The 197,000 is 21·3 feet per second, and the 168,000 is 13·07 feet per second; that is accomplished in this case with an expenditure of 746 lbs. of coal per hour, or 12½ lbs. of coal per minute, which is equal to 16,000 cubic feet of air per minute passing through the workings for each pound of coal used.

1987. The air, passing through the workings, is measured by the 13·07 feet per second, and not by the 21·3 feet per second?

Yes; the air passing up the shaft is 18,800 cubic feet per minute for 1 lb. of coal, and the theoretical power is equal to 33,000 cubic feet per minute with 1 lb. of coal; that is the theoretical power before it is applied to encounter the long column of air in the workings.

1988. That would be the result of calculation theoretically?

Yes; the practical result up the shaft is 18,800, and the theoretical power is 33,000 cubic feet per lb. of coal?

1989. So that in practice it is reduced to very nearly one-half?

In practice it is reduced to about one-half, about 50 per cent.; and that we find in a very great deal of machinery. The practical result of a very great quantity of machinery is very little more than half the theoretical power: applying this ratio of power to the furnace as a mode of ventilating collieries, we have the theoretical power equal to a velocity of 37·6 feet per second, in the case of a most simple machine, reduced down to 13·07 feet per second by the friction or resistance of the air traversing the working of a most extensive mine; we have then some data by which to test the power of any other application of power to exhaust mines; and the result of that machine, apart from its practical application in a mine, should be compared with the theoretical result of these furnaces.

1990. Some of the elements of this calculation are peculiar to the particular case, and must depend entirely upon the case which is under consideration?

Clearly.

1991. For instance, the amount of air that is passed by any agent of this kind through the workings to the upcast shaft, must depend in a great measure upon the manner in which the mine is worked, and upon the size and length of the air passages?

The moving power depends, in the first place, upon the depth and temperature of the shaft, upon the heat communicated to the upcast shaft by the furnaces; and then the resistance depends upon the length which that air is carried through the workings.

1992. Therefore, although in Hetton you find a practical result of only 13 feet per second, in a mine less deep and with less extensive workings, where the distance to be passed over by the air was of a lower average than 4½ miles, you might have that number raised to a higher point, might not you?

If the length of the shaft and the heat in the shaft were the same, and if the distance which the air travels through the workings be shortened, then there would be a greater effective result, and it would be in the proportion of 37·6 to 13·07.

1993. It might be?

It might be in that proportion: then if the length of shaft was diminished, of course the power of the furnace would be diminished, and there would not be such a quantity of air got.

1994. According to your statement in your former evidence?

Yes; that we find is so in practice, and it is compensated for in practice, because, although the power is less in shafts of less depth, the shafts are more readily sunk, and there the extent of workings is never so great as when applied to a very deep shaft.

The Witness delivers in the following Paper:

POWER.

POWER of FURNACES of the HETTON COLLIERY illustrative of that Power in the Ventilation of Mines.

Nicholas Wood,
Esq.

3d July 1849.

Theorem : $v = 8 \sqrt{\frac{h(t'-t)}{450+t}}$ then $t = 60^\circ$ and $v = 8 \sqrt{\frac{900(140^\circ-60^\circ)}{450+60}} = 37.6$ feet per second.
 $t' = 140$
 $h = 900$

Therefore the ventilating power of the Hetton Colliery upcast pit, independently of effect of resistance of air traversing the workings, is 37.6 feet per second of a current of 153.93 square feet area = 347,266 cubic feet per minute, or 33,000 cubic feet per minute per 1 lb. of coal. This is reduced by the resistance of the air traversing the workings to 21.3 feet per second of the heated air in the shaft, equal to 197,385 cubic feet per minute, or 18,800 cubic feet per minute per 1 lb. of coal; or to 13.07 feet per second in the pit before passing over the furnace, equal to a current of 168,850 cubic feet per minute, with an expenditure of about 12½ lbs. of coal per minute, or 746 lbs. per hour.

The average distance which the current in the mine, viz. 168,850 cubic feet, traverses in the workings is 4½ miles (which is divided into 17 currents, of about 10,000 cubic feet each); the maximum distance travelled being 8½ miles, and the minimum 1½ mile.

The test, therefore, of any improved mode of ventilation, as compared with that of the Hetton Colliery ventilation, will be, that the latter accomplishes a rarefying power equal to 37.6 feet per second on an area of 153.93 square feet in the shaft; the practical effect being the production of a current of air in the workings equal to 168,850 cubic feet of air per minute, traversing an averaging distance of 4½ miles, or subdivisions of air equal to that effect, with an expenditure of coals of 10½ lbs. per minute, or 16,000 cubic feet per minute for each pound of coal.

It will be seen, therefore, that if the air merely passed down the downcast, and up the upcast shafts, without traversing the workings, the effect would be a current of air equal to 37.6 feet per second; but when that current has to traverse an average distance of 4½ miles, the resistance of the air is such as to reduce its velocity to 13.07 feet per second. The distance which the air traverses in a mine is, therefore, an important item in the effect to be produced by any machine.

1995. You stated in your evidence yesterday, that the depth of the upcast shaft at the Hetton Colliery was 900 feet?

Yes.

1996. That the combined power of the three furnaces was equal to 70-horse power?

Seventy-one horse power.

1997. And that it produced a buoyancy of 12 lbs. on the foot?

It produces a practical effect in the mine of 12 lbs. per foot.

1998. What would be the power of the same furnaces, burning the same quantity of fuel, in a shaft of 450 feet, or one-half that depth?

The theoretical power would be as 33 to 37 in round numbers; the theorem which is given in the evidence of 1835 shows this.

1999. Do you mean that the diminution of the depth of the upcast shaft one-half, would only produce a diminished power of 33, as compared to 37?

Yes; that is in accordance with the general power of columns of heated air of different lengths.

2000. Do you feel sure of that?

Yes, I think I am correct. I will, with your Lordships' permission, just look over the figures again, to see that I am correct; and perhaps it is necessary to explain that this calculation is taken from that theorem which was given by me in 1835, and which is the generally received mode of calculating the power of columns of heated air in such cases. I have calculated it according to that, and I think I am correct.

2001. If the steam-jets at the bottom of a shaft of 900 feet produce a power of exhaustion equal to 70-horse power, what would be their power if they were placed at the bottom of a shaft of 450 feet?

That would be rather a difficult calculation.

2002. Do you imagine that the diminution of the depth of the shaft would diminish the power of the steam-jets?

Yes, in this way: I presume that in that case the engine is at the bottom of the pit; the fire from the engine and the heat of the steam produce a very considerable proportion of the effect, the power of both of which depends upon the depth of the shaft. The mechanical power of the jet does not depend upon the depth of the shaft, but upon the power or quantity of steam exerted; so that it is a compound

*Nicholas Wood,
Esq.*

3d July 1849.

pound result, depending certainly more, I think, upon the depth of the shaft than upon the mechanical power of the jets of steam.

2003. But you are not prepared to say what would be the diminution of the power of a steam-jet so placed?

I could go into a calculation, and show it.

2004. Could you tell us if the depth of the pit were diminished again one-half, and taken at 225 feet, what would be the power of the same furnaces placed at the bottom of the shaft?

It would be carrying out just the same calculation; it is about 23·5, as compared with 33 before.

2005. Perhaps you would, at your leisure, make the same calculation with regard to the steam-jet?

I will endeavour to do so.

2006. Can you say what is the pressure indicated by the water-gauge of 12lbs. to the foot buoyancy?

About 2·4 inches.

2007. If this pressure produced a current of air, as you stated in your evidence yesterday, amounting to 500 feet per minute, or 8½ feet per second, what amount of current would the same furnaces give if your upcast shaft was 450 feet deep?

That is a very complicated question. I think I should hardly be able to answer that question. We have a circuit of 50 or 60 miles of air travelling, which affects the question, and it is a very difficult thing to say what current you could produce by a variation in the power of the shaft. I could not satisfactorily answer the question. I endeavoured this morning, in fact, to lay down a sort of rule in such cases; taking the theoretical power, where the air simply goes down one pit and returns up another, at 347,000 cubic feet per minute; then I have a current in practice of 168,000 cubic feet, travelling an average distance of 4½ miles. I find the difference between those two the effect of the various resistances and contingencies. I wanted to try whether I could get any sort of rule by which to calculate the intermediate distances, supposing it shortened to two miles or one mile, what the effect would be; or if the depth was diminished, as your Lordship mentions, what the effect would be; but I found it so complicated that I could not satisfy myself; therefore, I thought it better to give simply this result, which would form a sort of standard by which people connected with mines might deduce practical results from it which might be useful.

2008. Supposing any powerful agent applied to the upcast shaft of a mine, thereby drawing a large mass of air through the workings, what do you conceive to be the effect upon the air in those workings; is it in its ordinary state of density, or is it rarefied by the power exerted upon the current?

The rarefaction by the power of the shaft would not be very much; it would be less dense than it is in the shaft; but in travelling through a mine, there is from the heat of the mine itself, the heat of the workmen, and the natural heat corresponding with the depth, all of which have a tendency to heat the air in the mine; but that, again, we find in practice is diminished very much when it comes near the shaft. It is quite impossible in practice to carry the whole of the air into the extremity of the workings; there are various leakages in the passage from the shaft to the workings, which diminish the quantity of air at the extremity of the workings, which increase the temperature where the workings are; and though it may be of an increased temperature in the working, the accession of the leakages renders it cooler again when we approach the bottom of the pit.

2009. But the effect of any such power upon a current of air must be in some degree to diminish the density of the air; by extending the length over which it is spread, it does not draw the air through the passages precisely in the state in which it enters by the downcast shaft?

No; it is a sort of spring from one end of the pit to the other, the whole length of the circuit, of course occasioned by the friction of the air in all parts of the mine, which is very rough; therefore the density is less than in the downcast shaft.

2010. Have you ever made any experiments to ascertain the extent to which that takes place?

No.

2011. Have you directed your attention at all to the variations of the barometer in mines?

Yes, I have.

2012. At what conclusions have you arrived?

My conclusions in that respect are, that the practical effect is more felt from the increased discharge of inflammable air in a mine, than it is from the effect of the fall of the barometer operating on the ventilating power. It is only during the interval of a change of the barometer that it affects the downcast and upcast shafts; but we find that a fall of the barometer increases the quantity of inflammable air discharged very much; there being a great many instances where, when the barometer is rising, the air passes into crevices or chasms in the mine, visibly so; and of course there are a great many places where the orifices are so small that we do not see it; therefore, I have no doubt that on the rise of the barometer there is a vast quantity of air which passes into the openings, and which, if there is any production of carburetted hydrogen, becomes inflammable air, and which oozes out on a fall of the barometer. I have seen several places where a candle shows a very considerable current of air passing into the cracks and open cavities in the mine, and then oozing out again when the barometer falls. I think the effect of the barometer is more in that way than by its effect on the downcast and the upcast shafts, though of course there is a certain amount of effect due to this also. The mode which we adopt in the North to counteract the effect on the air in the mine by a fall of the barometer, is by placing a sort of windmill or rude anemometer near the furnace, to show the velocity of the current coming to the furnace.

2013. A sort of anemometer?

It is a sort of anemometer, though it does not measure the quantity; it only measures or shows the velocity. The more simple anything is in its application, the more likely it is to be carried out practically; and the furnace-man is instructed that he must keep this machine moving with the same velocity at all times. I think any reference to the barometer, as mentioned by Mr. Biram yesterday, would rather complicate the matter. Here is a machine, a very simple one, which the furnace-man is continually looking at, and his instruction is, that he should so feed the furnace as that he should have the same current at all times; he knows nothing of whether the barometer is rising or falling; but he sees that this machine is slackening, and this is to him an instruction that he is to feed the fire, and so increase the current; that is the mode in which we practically counteract the effect of the fall of the barometer in the mines in the North.

2014. Do you think that a more practicable method than entrusting the observation of the barometer to the overseers of mines?

I think so; I think it is a mode more likely to ensure being carried into effect; and it is quite effectual if the man attends to what the windmill or the anemometer itself points out that he should do.

2015. Are those instruments generally used in the northern mines?

Generally, I think; I have seen cases where they are not used; but generally they are used, and I think they ought to be used in all mines.

2016. Are they tolerably correct?

They are tolerably correct, and quite sufficiently so to answer the purpose.

2017. Have you tried the aneroid barometer?

No, I have not.

2018. Then you do not think that any effectual use could be made of the ordinary barometer in mines for the purpose of guarding against accidents?

I think not; I think a very simple apparatus, showing clearly the velocity of the current, and instructions to the furnace-man that he must feed his furnace so as to produce that velocity of current at all times, is the most practicable and efficacious mode.

2019. In your evidence, in the year 1835, we find this passage: "In all the instances of working a coal-mine with candles, when the ventilation is perfect, the
(164. 7.)

Nicholas Wood,
Esq.
3d July 1849.

explosions are only partial; and it is only where the ventilation generally is deranged by some accident or other that serious accidents occur in working whole coal by candles" ?

Yes.

2020. Do you still consider that that is a well-founded observation ?

In the mines in the North, where the discharge of gas is considerable, and where the coal is worked in the post and stall method,—that is, in the whole mine first, and afterwards taking the pillars off,—I think when the ventilation is complete, and carried out to a proper extent, very few accidents happen. When a fire does take place, it would not be to any extent, provided everything is right; but when heavy accidents have happened in a whole mine, it has generally been where the circulation of air has been defective, or that some interruption has taken place to prevent the proper quantity from passing through the entire workings of the mine.

2021. Then do you think that it would be possible, practically, by a perfect system of ventilation, to arrive at such a point, that, although accidents might not be altogether prevented, they might be confined in almost all cases within narrow limits ?

No; I do not think it possible to arrive at such a state of perfection. I should just mention a case where great difficulties exist in one of the seams in the North, that is, the Bensham seam; it is a seam of coal which discharges a large quantity of gas.

2022. It is considered the most fiery seam of all, is it not ?

It is the most fiery seam in the North; the discharge there is (as it is in most coal-mines), generally, out of the pores of the coal itself; but there are in certain cases accumulations of gas reservoirs, or bags of gas. In working the whole mine, when the miners approach those bags, they burst away, and a very large quantity of gas is often discharged. There is also a thin seam of coal a little way below the Bensham seam, which is also an extremely fiery bed of coal; and on some occasions the force of the gas is such as to burst up the thill, and the gas escapes from the lower bed of coal into the Bensham seam.

2023. The thill is the floor of the mine ?

Yes. Now, in both those cases it is extremely difficult to counteract those escapes or bursts of gas, because they come off so unexpectedly. The pit might be in the most perfect state of ventilation at one moment; an inspector might go down and go through that pit, and report that it was the safest and best ventilated pit in the district, or that he was ever down, and the next moment, almost, an accident might happen, by coming upon or encountering one of those bags or bursts of gas. I believe some of the mines are so much addicted to those escapes of gas, that they are working them now entirely with lamps, even in the whole mine, to guard against any such accidents. There was a very serious accident at the Willington Colliery, and since that, Mr. Johnson, who was examined in 1835, works the colliery now entirely with lamps.

2024. What is the peculiar state of Jarrow; we see that there are frequent accidents there ?

That is the same seam; it is the Bensham seam, and it is an extremely fiery colliery, discharging a vast quantity of gas; and subject to those bursts of gas, not only in the coal itself, but from the floor of the mine, so that it is an extremely difficult colliery to manage, and very liable to accidents.

2025. In seams of that kind, no perfect system of ventilation would confine the accidents within small spaces ?

I think those mines are certainly liable to accidents of considerable magnitude.

2026. Under any circumstances ?

Under any circumstances, and therefore the only way of working such mines with safety would be to work them entirely with lamps.

2027. Is that not the practice ?

That is the practice generally in the North, where the collieries are very subject to these sudden discharges of gas.

2028. But where those very fiery seams are worked with lamps alone; do you consider that the danger is altogether removed ?

I consider

I consider that it is almost altogether removed, unless some accident happens to the lamp, but which is very rare; we have had instances of accidents happening to lamps, and fires occasioned thereby; I believe one at Springwell was occasioned by the breaking of a lamp; other instances have come under my observation, and there are instances of the miners putting their picks through the lamps, and making holes in them.

Nicholas Wood,
Esq.
3d July 1849.

2029. By accident?

By accident, we presume; we have had reports of their doing it wilfully, that is, where the mine was not in a dangerous state; there are certainly several cases where the miners do it, and it is rather an extraordinary thing that in taking those men before magistrates, they say that they cannot take any cognizance of it unless the coal-owner can prove that it has been wilfully done. Now it is quite impossible that any proof of that kind can be given, because no man would do such an act in the presence of another person, and, besides, the pitmen are working alone constantly. Therefore, as the law stands at present, it would appear that the coal-owners are liable to a person putting a pick through the lamp, which might blow up the mine, without any remedy against the man.

2030. What is the usual inducement to the miner to commit such an act?

If it is done wilfully, it would only be done where the man supposed that it was not dangerous, and where he supposed that he was obliged to work with a lamp, when there was no necessity. There are not many instances of its being done, certainly, and one would hardly suppose that it would be done wilfully, though there are instances in which it has been proved to have been so done.

2031. He is induced to do so by the want of a better light, is not he?

Yes.

2032. What is the lamp usually adopted in the North; is it the common Davy lamp?

The common Davy lamp is most generally used; in some of the collieries Stephenson's lamp is used, with a covering of wire gauze.

2033. Did you see the lamp produced yesterday by Mr. Biram?

I did.

2034. What is your opinion of that lamp?

I should not think it a lamp that could be used generally; I do not quite like it myself. I think it is more liable to accident than the Davy lamp; I do not think any lamp with a glass, unless covered by wire gauze, is perfectly safe. I never can bring my mind to believe that any lamp is safe with glass as the only protection.

2035. It is not glass?

Or talc; even with talc, I think it is a sort of substance liable to be broken; and I cannot bring my mind to believe that it is perfectly safe; it is also rather too large a lamp.

2036. Too wide?

Yes. I do not know whether your Lordships are aware, but it was a rule laid down by Sir Humphrey Davy, that a lamp to be perfectly safe, ought only to be of a certain diameter; that is, it should only include within it a certain quantity of flame, he conceiving that the quantity of flame had some effect in the flame passing the gauze; and the size has been instanced as an objection against Stephenson's lamp, which, for the purpose of getting a better light, is of larger diameter; but I have worked with Stephenson's lamp in very fiery places, and I have never had an accident with them.

2037. Did accidents occur formerly from working with the steel mill?

I have known instances where the steel mill has fired the gas; it was only in very peculiar places; it is only where the mill is at work in very good air, and the spark extremely brilliant, and flying from the mill into an explosive mixture.

2038. Previously to Davy's lamp, they worked very generally, did they not, at Newcastle, with the steel mill?

They did, but the miner knew very well where a mill would fire, and where it would not.

Nicholas Wood,
Esq.

3d July 1849.

2039. Are you aware that an opinion has been held by certain practical authorities that the introduction of the Davy lamp, however effectual under certain circumstances, has, upon the whole, tended rather to increase accidents than to diminish them, from the carelessness of the workmen which is produced by it?

There is no doubt that depending upon the Davy lamp as a matter of absolute security, and not upon the ventilation being complete, there may be a little laxity in ventilating a mine, because you are dependent upon the Davy lamp for protection, and not upon ventilation; but I should hardly think that that opinion could be borne out in fact. There is no doubt that collieries are now worked with the Davy lamp that could not be worked previously, and therefore there are a greater number of dangerous collieries, that is, collieries worked in a state where the mine is inflammable, now, than there was formerly; and that would rather account, I think, to me for the greater number of accidents than the want of safety in the Davy lamp. There is no doubt that any accident happening where the Davy lamp is at work is a most serious one, because the mine is generally in a very inflammable state. Therefore it is that I have rather been of opinion that so long as candles can be used with safety it is advisable to use them, so as to ensure a more complete ventilation of the mine; and in a whole mine, where the discharge of gas is not very sudden or considerable, I think candles may be used with perfect safety.

2040. On the whole, then, the opinion which has been quoted from your evidence in 1835 is to be taken with some qualification; you do not mean to say that wherever a mine is properly ventilated, it is safe to work it entirely with candles?

Not in every instance.

2041. The words which you then made use of were: "In all the instances of working a coal-mine with candles, when the ventilation is perfect, the explosions are only partial;" which would lead any one reading it to suppose that your opinion was that all you had to do was to establish an effectual ventilation, and that then you would be able to confine accidents within small limits, even although the mine were worked with candles; you would not be prepared to assert the proposition so broadly?

Not without some qualification; the qualifications being such instances as I have named, although in those instances, if the ventilation was complete, the accident would not be very extensive.

2042. We understand that the instrument called a sympiesometer is used in some mines for the purpose of ascertaining the weight of the atmosphere, and that great difference of opinion prevails with regard to its merits: have you ever seen it, and, if so, will you state your opinion of it?

I have not seen it; I have always relied upon the instrument I have previously explained.

2043. The barometer?

No, the instrument to show the furnace-man when to feed his furnace.

2044. Is it the fact that the power produced by the steam-jet is always a constant quantity, and that the power produced by the furnaces diminishes in proportion to the diminution of the depth of the shaft?

It is so; the power of the steam-jet is a constant quantity, depending upon the quantity of steam used and the pressure of the steam; the power of the furnace depends upon the depth of the shaft, and the heat applied to it.

2045. You gave the Committee yesterday some information with respect to what you found, upon examination, of the Darley Main and Ardsley Main coal-pits in Yorkshire?

Yes.

2046. Have you anything to add to what you communicated to the Committee with respect to that?

The mode of working there is by long wall, taking out a large area, and leaving it in a stagnant state; and I believe that the safety of the mine in that case depends (such is the opinion of the practical people there) upon not allowing any atmospheric air to get into those spaces, that they are left.

2047. But

2047. But we were informed by Mr. Biram that it was the practice to make small openings into those spaces to allow a passage of air?

Yes, in some mines, which he condemned. Mr. Biram, and some other gentlemen whom I met on those occasions, stated that their security depended upon the exclusion of the atmospheric air from the goaves on this ground, that there is always a production of carbonic acid gas, and by excluding the air the carbonic acid gas fills the space; and though there may be a little discharge of inflammable air, yet it is well known that such gas, mixing with carbonic acid gas, is rendered unflammable, and the security depends upon that. Now in the Darley Main they had openings into those goaves. The fact was, it was not a complete system of long wall working; it was rather a system of post and stall method, with bords or banks very wide; for some reasons, about water, or something, they durst not take the coal entirely away. It was a sort of compound system of the long wall and the other, and they let in a portion of the atmospheric air into the goaves to ventilate them. I apprehend that the effect of that was, in the Darley Main, to render the air in the goaves inflammable, where any inflammable air was produced, to prevent, as it were, an accumulation of carbonic acid gas to stifle the other, or render it unflammable.

Nicholas Wood,
Esq.

3d July 1849.

2048. By mixing just the quantity of atmospheric air with the inflammable air?

Yes; that was shown by the second explosion, by the concussion, as previously explained, because it was a place where they had the atmospheric air going in; but in the first explosion of the Darley Main, and in the explosion at the Ardsley Main, in neither of those cases was the atmospheric air put into the goaves; in both these cases the atmosphere might get in, but it was not forced in. Now I beg to express an opinion, that most of the accidents which happen in Yorkshire, and in those places, are owing to that mode of working, depending upon the atmospheric air not getting in, or the inflammable air in those goaves not getting out upon the candles; and I think it is an extremely dangerous mode of working, where there is any discharge of gas; it is always attended with very heavy accidents, and it has always been occasioned, so far as my experience goes, under similar circumstances. In those cases, wherever there is a discharge of inflammable air, I think that those mines ought to be worked with safety-lamps, and I think the system of ventilation in those districts ought to be much more attended to. I found in Mr. Biram's collieries and in Mr. Woodhouse's collieries the system and ventilation extremely good. Some of those pits are ventilated in a most masterly way, and may be considered to be almost perfectly free from accident; but in a great many of the mines in Yorkshire and Lancashire, so far as I have seen or heard, they appear to be very badly ventilated indeed, and very great risks are run where gas at all exists.

2049. Have you generally found the small collieries worse ventilated than the large ones?

They are generally.

2050. Do you think that that arises from any greater difficulty in ventilating a small colliery, or that it is owing to the small coal-owner, perhaps, not taking so much pains?

It is not from any difficulty of being able to ventilate those small collieries, but I have found the persons who have charge of those small collieries generally very ignorant men, badly paid, and of an inferior class; and I do think that it is necessary that some system should be adopted by which a better system could be introduced, either by employing men better educated, or by enforcing some general system of improved ventilation. I think the time has arrived when something of that kind ought to be done.

2051. Would the improvement in the ventilation of those mines, of which you are speaking, consist in passing the air more completely through all the passages, whether in use or not?

The general defect is the want of a sufficient quantity of air in the mine to meet emergencies.

2052. The practice there is to shut up passages which are not wanted?

Yes.

Nicholas Wood,
Esq.

3d July 1849.

2053. And to pass air only through those in which the workings are taking place?
Yes.

2054. The improvement which you would suggest would be, as in the North, that the mine should be divided, and the air split, so as to pass through all those passages, would it not?

It should certainly be done so; the system rather seems to be that of passing the air from the bottom of the downcast direct away to the upcast, without dividing it into currents; the fact being, that the quantity of air is so small by the system of ventilation practised in those shallow mines, that they cannot afford to divide it. Another evil is produced by the long current, in fact, diminishing the quantity of air.

2055. Where are those small mines to which you allude?
In Yorkshire principally.

2056. In the Newcastle neighbourhood are there any small mines?

There are some shallow mines; but the mines are generally deep, and the system at Newcastle is so efficiently enforced, and the shallow mines being in the neighbourhood of mines well and properly ventilated, an example is set them which is generally followed.

2057. Then your observation is confined to Yorkshire?

I think they are mostly in Yorkshire and Lancashire, and Staffordshire and Wales. The mines in Wales are very badly ventilated.

2058. You have examined certain mines in Wales?
I have.

2059. And found the ventilation deficient?
Yes.

2060. From the same kind of cause as in those in Yorkshire?

Generally so; and from a sort of notion that where there is little risk little care is required.

2061. To what do you attribute the system of bad management; to a want of education, or a regard to economy in working on a small scale?

I think it is partly from the want of education.

2062. A want of knowledge?

I am sure we should not, in the North, employ such persons as are employed there to have the charge of the pits; we should consider them not efficient.

2063. Are you speaking of the overlookers?
Yes.

2064. The under-ground stewards?

Yes, and those sort of people. I dare say it is owing, perhaps, to a too rigid enforcement of economy, in some instances; they are paid very small wages, about 3s. a day for the man who has charge of a pit; you cannot get much for that.

2065. There is another class of accidents which are not unfrequent in collieries, and especially in the northern collieries, namely, those arising from the breaking of the machinery, the ropes and so on; have you had any experience of those?

The breakage of ropes is not very frequent in the North; in the whole course of my experience of 38 years, I think I have only had three cases where the ropes have broken, and which have been attended with loss of life. Anything that would diminish the risk is, of course, advisable.

2066. There are accidents of that kind in some collieries, are there not?
There are accidents.

2067. From time to time?
From time to time.

2068. Are you in the habit of working in the North with guides?
We do, almost universally now.

2069. Of what description are those guides?
Generally timber guides.

2070. And

Nicholas Wood,
Esq.

3d July 1849.

2070. And cages?

Yes; cages which slide up and down the guides.

2071. Those are a comparatively recent improvement, are they not?

They are; they have been introduced into the trade within the last 10 or 15 years.

2072. Have they contributed, do you think, much to the safety of the people?

I think they are a much safer method of getting the men and boys up and down the pit than by ropes.

2073. Do they produce a saving of expense also?

Yes.

2074. There is less wear and tear?

There is, both of the shafts and of the baskets, which were used before the guides were introduced.

2075. What are the guides usually made of in the North?

They are made generally of Baltic timber.

2076. Can you say what the expense is of fitting up a guide in a shaft, per 100 feet, or whatever the measure may be?

It would be, I think, about 10*s.* to 12*s.* a fathom, perhaps.

2077. It might be done for 10*s.* a fathom?

Somewhere thereabouts; in some cases there are four instead of two used; say 10*s.* or 12*s.* per fathom.

2078. Have you ever seen any proposals which have been practically made use of for the purpose of diminishing the risk of those accidents?

I have seen Mr. Fourdrinier's mode of doing it.

2079. Where did you see that?

I saw it at the Usworth Colliery; I got one of them to the Hetton Colliery some months ago; I approved of the principle on seeing the contrivance at first; the one that was sent to me was not perfect; it was too heavy, and not a complete one; since that, Mr. Fourdrinier has improved it very much, and it appears to me to be an extremely useful invention.

2080. Have you seen it in action at the Usworth Colliery?

About a week ago I went to see it at that colliery, where I saw it in operation; I saw the rope detached, and it prevented the cage from falling down the shaft.

2081. At what rate does the cage ascend?

About 1,000 feet in a minute; it is now in so simple a state, that I think it might be applied advantageously to prevent such accidents.

2082. Did you also examine a part of the contrivance which is intended to prevent the danger of the cage being drawn over the pulleys?

Yes, I did.

2083. What do you think of that part of it?

I think that is very good also; I do not know whether that is Mr. Fourdrinier's invention; it is a thing which has been used for other purposes for a very long period.

2084. Did it appear to you to be applicable to the object for which it is used in this case?

I thought so, and I think it would be just as safely used, and perhaps it would be more required where the other contrivance was not used, because in case of pulling the cage over the pulley-frame, it is generally attended with the breakage of the rope, and this itself is sometimes attended with the loss of life.

2085. Would it be necessarily attended with the breakage of the rope?

Yes; I should say so, if not provided with this apparatus.

2086. In any other case, the contrivance which detached the weight from the rope would not prevent the accident, because the breaking of the rope at that point over the shaft would be as dangerous a thing as being drawn over the pulley?

(164. 7.)

E E

After

Nicholas Wood,
Esq.

3d July 1849,

After the cage is drawn up beyond the top of the pit, there is a spring-catch interposed, which prevents the cage from going down the pit until it is withdrawn.

2087. Is that the case universally?

Universally, where cages are used. Mr. Fourdrinier's apparatus is a very useful invention, because it detaches the rope at once; I have no doubt that it will be extensively used in the trade.

2088. You think of adopting one at Harton, did not you say?

I ordered one at Harton Colliery; it is more particularly requisite in consequence of the use of wire-ropes, which are rather more liable to break than the hempen ropes.

2089. Are they rather more brittle?

A little more so, I think.

2090. There are other accidents arising from the falling of the roof, which are very frequent in collieries, are there not?

Yes; there are.

2091. Is there any precaution which can be taken against that, without interfering with the necessary mode of working?

No; I do not see any but carefulness on the part of those who have the inspection of that part of the work.

2092. With respect to those persons that you have spoken of, who have the charge of the interior of the mines, from what class are they drawn in the North of England?

The persons who have the general charge of the mines are the viewers; but the under-viewers are the next class of men who go down the pit every day, and who report to the principal viewer. Those are the men to whom the regularity of working and the safety of the mine are more particularly entrusted; they are the persons who are most looked to, for seeing that everything is going right. Their duty is to go down in the pit every day.

2093. Do they go down before the work-people?

No; not before the work-people, but about the same time. There are persons who go down the pit to go through all the working-places before the work-people commence working, to see that all is safe; but they are another class of persons.

2094. What are they called?

They are called the deputies, and they go through the workings to see that everything is right before the men go in, and the overman also goes through a portion of the pit; but the class of persons upon whom most dependence is placed are the under-viewers, and those are rather a superior class of men; they are men who are selected for their intelligence.

2095. From what class?

From the class of overmen generally; they first of all probably commence as workmen; they then are taken as deputies, then overmen, or, in some cases, they may be the sons of overmen, and commence as deputies; they are men who often work up from the lowest grades, up to be overmen, and then they are taken from the class of overmen to become under-viewers. The most intelligent, of course, are selected; and in that way we get a very useful set of men.

2096. The under-viewers, then, are the highest of those three classes which you mention?

Yes.

2097. There are the under-viewers, the overmen and the deputies?

Yes; the under-viewer is the highest, the overman next, and the deputy next.

2098. Then it is the business of the deputy to go through the mine in the morning?

Yes, and the overman.

2099. And the under-viewer, in fact, represents the principal viewer?

He does, in his absence.

*Nicholas Wood,
Esq.*

3d July 1849.

2100. In the practical business of the mine?
Just so.

2101. Taking those under-viewers, are they a well-instructed class of people?
They are generally pretty well instructed.

2102. Have they any knowledge of the physical phenomena of these questions?

No, I do not think they generally have; going to work early in life, they have not very much opportunity of learning, or of attending school so long as to be instructed in the higher branches of education; they attend school only a very short time; but they often afterwards attend schools at night, or after they have done their work.

2103. It is more practical than theoretical knowledge, then?

Almost entirely practical; very little theoretical. The schools in the neighbourhood do not go to any other extent in learning, than merely the common rudiments and ordinary course of learning in colliery districts.

2104. There are no means of obtaining that sort of education for the workmen in mines which you think is important?

No; I think the schools in the North are very deficient in that respect; I mean of a course of education more particularly applicable to mining, and its various ramifications.

2105. And in other districts of the country?

In the other districts, perhaps, it is more so. In the other districts there are not those grades of workmen which we have in the North, and they are therefore almost obliged to select the men who have charge of the pits from the common workmen. We, having the grades of under-viewer, overman and deputy, and so on, have better opportunities of selecting men of intelligence and of experience; but where the mines are more easily worked, and there are not so many grades of persons, the overmen who have charge of the pit are generally not so well educated as in the North.

2106. Do you think it an object of great importance that more means of education should be found for that class of persons?

I do think that it would be attended with very great benefits to the mining interests of the country, not only to the men themselves, but to the coal-owners, if some system of education more particularly adapted to mining were adopted.

2107. Some time ago was not there some movement upon that subject among the coal-owners of the North?

Yes, it was very much talked about. Mr. Tremenhore, who is at the head of the inspection of the mining population, and the Rev. Mr. Allen also, was sent down there by the Government, by the President of the Council, in the late Lord Wharncliffe's time; we went into it with both of these gentlemen, and there was then a sort of system projected, but nothing more, I believe, done about it.

2108. What was the reason that the matter was dropped, are you aware?

I think that it was from the difficulty of carrying it out, and perhaps in some degree the want of means of doing so; but we thought then, and I think so still, that it would be very advisable if a system of schools could be adopted in the mining districts, and if they could be connected with a sort of college, or something of that kind, in London. I have had a good deal of conversation with Sir Henry De la Beche upon the subject, with reference to the Museum of Economic Geology, and I think that something might be established out of that, which, connected with a system of schools in the North, might be of immense advantage to the mining interests. I think the education of the mining population is very sadly neglected, not only in the lower classes of it, but even in the higher. In the viewers, for instance, there is no sort of education particularly adapted for mining instruction; there are no proper colleges; the only places are such as King's, University or Putney Colleges, and the course of education at those places is not exactly adapted for the mining population. The mining interests of the country are so important, in so many respects, that I am of opinion it would be very desirable if some general system of education could be adopted for the improvement of that population.

2109. Do you think that there is a general feeling upon that subject among the parties connected with collieries?

(164. 7.)

E E 2

I think

Nicholas Wood,
Esq.

3d July 1849.

I think there is in the North a feeling of that kind ; I think the coal-owners in the North would promote such a measure, if they saw their way to its being practically carried out.

2110. Do you think it would be possible to obtain the means for anything of that kind by some trifling tax upon coals ?

I suppose they would rather that it was done without a tax ; I have no doubt that the coal-owners would contribute to a certain extent in the promotion of such a scheme, provided it was taken up by the Government, but I think it should be done in connexion with the Government ; and the institution of which Sir Henry De la Beche is at the head affords an excellent opportunity of establishing such a measure.

2111. Have you ever derived any benefit in your mines from the suggestions of men of science ?

Yes, I think we have ; not practical suggestions, because they are not the sort of men from whom we expect to receive those advantages, but from science we certainly have received at times considerable advantages.

2112. From those learned persons who have visited Newcastle, with the exception of Sir Humphrey Davy, have there been any other suggestions of men of science which have facilitated the working of your mines ?

I cannot bring any examples to my mind at this moment, but I think intercommunication between practical men and men of science is always attended with useful results.

2113. You were understood to say that the under-viewer was generally a man who rose from the ranks of the workmen ?

He is so generally.

2114. Is that general ?

That is generally the case, though not universally ; they are sound practical men, practically acquainted with the conducting and ventilating of the mines, and have themselves generally worked at almost every kind of work that they have to superintend.

2115. What is the education of the viewer ?

They are educated generally at a better class of schools ; having more means generally, their parents send them to better schools ; but still I am of opinion that there is a want of the sort of schools in which they should have their sons instructed. Take myself, for instance ; one of my sons is intended to be brought up to be a viewer ; I send him to school in the country ; he gets a great deal of Latin and Greek, and some mathematics ; not a very great deal, for very few of the schools cultivate mathematics to such an extent as they do classics ; and then the only place that you can send him to, perhaps, to complete his education, is either King's University, or the Putney College ; but the system of education at any of those colleges is not precisely such as the mining population require. I think that the mining interests are sufficiently large to support a system of education more adapted for them, and therefore I hope the subject will be taken up by the Government, and by those interested in such a measure. Of course it should not be a system that would be applicable to that branch of engineering alone, but to other classes ; still I think that some system of education is well worth the consideration of the mining interests of the country, which would be more applicable to the mining population or managers of mines.

2116. You mean some institution which should provide the peculiar knowledge which is required for the mining population ?

Yes.

2117. Do you find that the colliers are generally desirous of obtaining education ?

I think they are ; as a proof of it, after they leave their work, they attend the night schools ; they go and work 12 hours in the pit, and then they go a couple of hours to school at night afterwards ; that is a strong proof to me that they are desirous of instruction. In my experience, since I first became acquainted with the coal trade, I think the class of workmen in the North has improved very much indeed in intelligence, and I have always been of opinion, and am still of opinion, that the more you can improve them in education, the better men they are for work ; we always find the most difficulty in strikes and commotions amongst the
workmen

workmen with the most ignorant men ; I am quite sure that if you improve them in education, you will improve them as workmen.

*Nicholas Wood,
Esq.*

3d July 1849.

2118. And do you conceive that if the officers in mines, whom you have been mentioning, were more educated with respect to the causes of all these accidents, they would be better able to guard against their occurrence than they are now ?

I think that an intelligent man is always more to be depended upon than an ignorant man : I think that if they were better educated they would ; as a proof of it, we find that the mines are very much better conducted in the North, where there is a more intelligent class of men conducting them, than they are in the Midland Counties, where they are conducted by less intelligent persons.

2119. Have you ever considered how far it might be desirable for Government to interpose in the management of mines by an inspection ?

Yes, I have ; sometime ago it was brought before the coal-owners in the North by the Government, and Mr. Tremeneere, the Inspector of the mining population, was sent down there to confer with the coal-owners on the subject. We had communications with him, and went into the discussion of a system of Government inspection ; it is an extremely delicate thing to handle ; it is a system of inspection which requires the utmost care how it is to be carried out ; and it is different from the inspection of anything that has been established hitherto.

2120. What is your view as to the footing upon which such an inspection could be established ?

I think it should be a system of inspection which would not interfere with the working of the mines, which would not take off from the existing managers of the mines any of the responsibility of managing them ; and there it is where the difficulty lies. I think a system of a description more with a view of communicating and disseminating information amongst the different mines of the country, than interfering with the management, would be the most beneficial.

2121. How far, in order to discharge those duties properly, do you think it would be necessary for the Inspectors to have a power of examination and inspection ?

I think they should have a complete power of examination and inspection. I think there would be no objection on the part of the coal-owners to have the mines inspected at any time it was thought proper, provided they were inspected by proper people ; but the great risk is in doing so, and not assuming the responsibility ; and that was the difficulty which we found in discussing the question with Mr. Tremeneere. For instance, in a Bill which has been brought into the House of Commons, it is proposed that the Inspector, and also the Sub-Inspector, should go into the mine, and should examine, upon oath, any person concerning anything that such person may choose to give information upon ; and then, if they find anything defective in the mine, or anything wrong, they are to give notice, in writing, to the owner of the colliery, and he is to attend to what they state, under a penalty of I do not know how much. Now, consider for one moment the effect of that. If an Inspector goes into a pit, so complicated as pits are, and objects to any part of the system going on, and gives instructions that it is to be altered, from the moment that he does this he becomes the responsible man ; the persons in charge of the pit then have no responsibility ; they may differ in opinion with the Inspector, but they are obliged to do anything that this person imposes, and, of course, the responsibility then is with the Inspector, and not with the person who has to carry the measure out. That is so serious a matter, that I think any system, founded upon compulsory inspection or direction, would be most injurious. I see in some part of the Bill, also, that the responsibility of that advice is thrown upon the Inspector ; but I am sure that no Inspector would take the office, having the responsibility, and having the mine conducted at his risk by other parties over whom he had no control. In the first place, I think it would be very wrong that the responsibility should be taken from the persons who ought to have it, and who are to conduct the mine ; and I think it is still worse that the Inspector should be saddled with the responsibility, when, after giving those instructions, he has no control over the mode of carrying them out.

2122. He may expend any sum of money he pleases ; in making these alterations there is no limit to expense ?

Certainly ; he may exercise his power in any way ; his instructions may, of

Nicholas Wood,
Esq.
3d July 1849.

course, be so expensive as to render the mine unprofitable. The system proposed in this Bill is such, that I cannot fancy that it can ever pass through the Legislature. The question of responsibility was the great difficulty which we found in going into it, even with all the disposition which there was to arrange a system, and the coal-owners then were very anxious that some system should be carried out; but even with those feelings we had great difficulty in overcoming that part of the scheme.

2123. But you think that it would be possible to appoint Inspectors, who should have a power of entering and examining the ventilation of a mine, but who should have no direct authority beyond that, in the way of ordering alterations or interfering with its management?

I think that a system of inspection might be adopted which, not giving the Inspector directing power, might be useful, and not be objectionable to the trade.

2124. If an Inspector went there, and said, "I am not satisfied with the ventilation of this pit; you must sink a new shaft," how would you deal with that case?

I think that if an Inspector is appointed who has the power to go and order in any way, or alter in any way, the mode of working the colliery, he then takes the responsibility, and then I think the mine-owner ought not to be liable for any accident which happens in the mine after such orders are given. In fact, if a directing power is given to the Inspector immediately he entered the pit, the mine-owner would say, "Now you must tell me whether the system I am pursuing is safe or not;" if he reports that it is safe, then the responsibility, even in this case, in some degree is taken off the shoulders of the mine-owner; if, on the contrary, the Inspector says, "I do not consider it safe, but you must do so and so," then the responsibility of such directions or orders rests with the Inspector. Such directions may be contrary to the opinion of the practical persons carrying it out, and it would be attended to with great reluctance, unless the person giving such instructions is a person of superior knowledge to the persons conducting the mine; therefore no Inspector, who had a directing power, ought to be a man having less experience than the persons whom he has to direct.

2125. Would not it be difficult to find such men as those to combine the two requirements; they must have all the practice of a viewer, to be able to form an opinion?

I think it might be difficult to find such persons; but I think that the system which ought to be adopted, should not give to any person such a power. I think that in some districts of the country it would be extremely useful to have communicated to the managers there the information which exists in the Newcastle district; and again, in the Newcastle district, I think some information might be useful to them from other districts. It should be a system of inspection which would raise the class of workmen or managers above what they are now, in intelligence and practical knowledge, by an intercommunication of ideas and knowledge from one district to another. I think the system should be founded upon that basis, and not upon any interference with the mode of working, except as advice and instruction.

2126. Not any direct interference with the management of the mine?
Yes.

2127. How do you think that the expense of the inspection should be defrayed; at the cost of the Government, or of the coal-owners?

By the expense of Government; I think that was understood when we discussed the subject with Mr. Tremeneere.

2128. Have you seen the Instructions issued by Government to the Commissioners who have been lately appointed to make certain inquiries?

I have.

2129. Do they appear to you to answer the purpose of preliminary inquiry?

I think the queries are very well drawn out; there is nothing that I see objectionable in them; nothing that I think the coal-owners ought to object to answer or to carry out. But there is a part of the Instructions to the Inspectors which I think is a little objectionable.

2130. Will

2130. Will you point out which that is?

It is this part of them: "In case you should be of opinion that, either from defective ventilation or from any other cause, danger is to be apprehended to the lives of the persons employed in any colliery, you will immediately acquaint the managers of the colliery with the opinion you have formed, and with the grounds of it, and suggest such measures as appear to you to be requisite to remove the causes of danger. If your representations should not be attended to, you will forthwith report the case to the Secretary of State." Now, that implies that these two gentlemen are able to form an opinion, and to give an opinion as to the measures which are to be carried on in any colliery, and to direct, in fact, the mode of working; and supposing that they do so, and acquaint the managers of the colliery, and if he refuses to adopt their suggestions, to report the same to the Secretary of State. In giving such an opinion, a very heavy responsibility is placed upon the managers of the colliery, by such a communication, should he not adopt the suggestion; and if he does, and any accident should happen, a very heavy responsibility is placed upon these gentlemen. These two gentlemen are highly respectable and very clever men, and one of them is not a practical miner, and I have some doubts whether they will be able to carry out that part of the instructions either with satisfaction to themselves or to the coal-owners. I have every dependence upon their judgment and discretion, that they would not interfere injuriously in any way; but one cannot but see that such instructions, if carried out by improper persons, might be extremely injurious. It implies that they have a superior knowledge to the persons who are carrying on the mines, and by simply making a statement to the mine-owners it would, of course, throw upon them a very serious responsibility in case any accident happened, and I think that it would be attended with some difficulty in carrying out.

Nicholas Wood,
Esq.

3d July 1849.

2131. Then what duties in that respect would you impose upon any Inspectors appointed by Government?

I think that as a preliminary inspection all these queries are very good, simply reporting, but not to give them a power of directing or expressing an opinion.

2132. Supposing, in consequence of this preliminary inquiry, it should be thought right that Government should appoint permanent Inspectors, in what way could they discharge their duties, consequent upon their examination of a mine? In case they had the power which you propose to give them, to examine a mine, and found it in a state which they thought involved danger, what course would you recommend them that they should take?

I think that the Inspectors who are to give any opinion upon a mine, should be men of sound practical knowledge.

2133. Then, in case such persons were appointed, do you think that it would be right to require them to intimate their opinion to the manager of the mine?

In discussing the matter with Mr. Tremenheere, the system proposed then was, that there should be General Inspectors in London, who should visit the districts at different periods; that there should be under them Sub-Inspectors who should be men of sound practical knowledge; and there was a plan drawn out at that time with which the coal-owners in the North were satisfied, which we supposed would carry out all the objects of an inspection, without any injurious interference with the mines.

2134. Could you supply that document of which you speak?

I could.

2135. You would have no objection to its appearing among the papers of this Committee?

I should have no objection.

The same is handed in, and is, in substance, as follows:

105, Pall Mall, July 14, 1849.

1. Sub-Inspectors to be empowered to inspect, and merely to report the fact of mine being in a dangerous state; specifying the locality, and from what cause.

To leave copy of report in writing with coal-owner or manager, and transmit another to Inspector.

2. Inspector to be empowered to inspect; on receiving notice from Sub-Inspector, forthwith to inquire of owner, &c., whether he admits that the cause of danger mentioned in notice exists, and whether he intends to remove it; if he admits it, owner, on said cause of

*Nicholas Wood,
Esq.*

3d July 1849.

danger being removed, to acquaint Inspector. Inspector, on examining and being satisfied that it is so, to give certificate to owner, stating that in his opinion the said cause of danger is removed.

3. In case of dissenting from opinion of Sub-Inspector or Inspector, owner to name three competent persons, one of whom to be selected by two neighbouring magistrates, of whom one must be the Chairman of Quarter Sessions, if in the county at the time. If Inspector shows reasonable cause to object to all three, the magistrates to name one at their discretion.

The person named, to inspect mine, and state his opinion in writing to owner and Inspector.

Either owner or Inspector dissenting from his opinion, to appeal to Secretary of State, who may appoint any one he may think fit to inspect and report upon the mine in question.

4. Plans to be open to inspection. Penalty for concealing any part of mine, or showing false plans.

If Inspector finds that plans are imperfectly kept, power to compel accurate ones to be made, and submitted to him at stated times yearly.

5. Actions. If accident occurs after notice by Inspector that mine is in a dangerous state, action should be brought by him, or by order of Secretary of State.

6. Action to be brought by Inspector, if Coroner's verdict be to the effect that the death occurred by wilful neglect of owner.

Mr. Tremeneere has a copy of it. He was sent down by Sir George Grey into the North to go into the question.

2136. He told us that he had met a committee in the North?

Yes, a committee, of which I was one.

2137. Do you think that this inspection of mines would very materially diminish the number of accidents, or prevent them altogether?

I have very great doubts of that. I think the public are rather placing more dependence upon the inspection than will be realised by its adoption; but still, looking at the number of accidents which are continually happening, seeing also that several of those accidents have happened where the system of ventilation was very imperfect, and which might not probably have happened had a better system been in operation, I think that the time has arrived when something ought to be done.

2138. Supposing a case like those in Yorkshire, of the Darley Main and the Ardsley Main Collieries, where such a large number of lives were lost in each case, do you think that an Inspector going into those mines, and finding the ventilation as imperfect as you conceive it to have been, would have been able to point out how the danger of such accidents might have been diminished?

I think he might; I think that sound practical men going into those mines, and seeing the state of ventilation in which they were, would have pointed out to the parties a better mode of ventilation, which might possibly have prevented the accidents.

2139. And, generally speaking, the communicating fresh information from quarters in which the management was more perfect, would tend to diminish such cases?

I think so; I think the changing Inspectors from one district to another, so that they could communicate to the different districts the improvements which were going on in others, would have a tendency to disseminate that knowledge and information which would be extremely useful; and I think that that knowledge and information would be useful to the coal-owners and workmen, as well as to the saving of life.

2140. So far as you are acquainted with the feeling of the coal-owners in the North, do you think that there would be any great objection, if proper people were appointed, to that extent of inspection?

I think the coal-owners in the North, or in the Newcastle district, are prepared to co-operate with the Government as to a system of inspection, but I think it should be done by careful and cautious co-operation between the coal-owners and the Government; certainly not by the system which is proposed in this Bill; there are many things in it which are quite impossible to be carried out.

2141. Your objection to the instruction to which you called the attention of the Committee just now, rather arises from your belief that the Inspectors do not possess sufficient practical knowledge, than from the instruction itself, supposing them to be men thoroughly acquainted with the practice of mining?

I think if they had been men of sound practical knowledge, acquainted with all the

the details, intricacies and risks of mining in the North of England, these instructions might not have been so objectionable. There is still the objection of their having a directing power; and therefore, though I have perfect confidence in these gentlemen, that they will not interfere in any way which would be injurious to the mine, I have still an objection to the power imparted to them, for the reasons hereinbefore stated.

*Nicholas Wood,
Esq.*

3d July 1849.

2142. Supposing men practically acquainted with mining to be appointed as Inspectors, you would, in that case, have no objection to their being empowered to make suggestions to the managers of collieries, and, in the event of those suggestions not being adopted, to report their opinion to the Secretary of State?

I should have objections, unless coupled with arrangements to counteract any improper interference. We went into the whole question with Mr. Tremenhare in a more practical mode. The proposition, as far as I recollect at this moment, was, not that they should report to the Secretary of State, but that it should go first of all to the viewer of the colliery; that then it should be dealt with in the particular way which was pointed out in the proposed plan, and that it should ultimately come to be adopted, if it were found, by a reference to practical persons, to be a proper suggestion.

2143. Was not Mr. Blackwell a miner?

Mr. Blackwell, I believe, has had some experience in Wales in mining.

2144. According to your plan, the decision was to rest with the managers themselves, or with parties appointed by them; the adoption or non-adoption of the suggestion of the Inspector was to rest with the owner of the colliery?

It was to a certain extent so; at the same time the increased responsibility of non-adoption of that measure rested with the mine-owner, which would be a sufficient inducement for him to carry it out, if he found that it was a proper measure. Still, the plan proposed gave ample authority to the Inspector to enforce his suggestions, if they were considered by a tribunal of practical men to be advisable. Mr. Blackwell is, I understand, a practical miner. I am still, however, of the same opinion, that the instruction alluded to is not the most advisable way of conducting the inspection, inasmuch as there is no appeal to practical men, in case of difference of opinion between the Inspectors and the mine-owner, in case the latter should be of opinion that the opinions which the Inspector might form was objectionable. The practice of mining is so intricate in so many cases, that even the most intelligent viewers are doubtful, in some cases, which is the proper course to adopt; and I should hesitate very much in going into a district and giving instructions, more especially as it is a mere inspection, without my having any power of seeing whether it is to be carried out agreeably to my instructions or not, and, as I stated before, depending upon other persons to carry it out. I think it would have been better to have made it a simple inspection, to report and obtain answers to all these queries, and not to have given any directing power, in the first instance, until a more mature plan was adopted.

2145. It is rather a suggestive power than a directing power; there is no power to direct anything?

It is a suggestive power, but still the responsibility of not carrying it out would rest with the manager of the mine. Knowing Professor Phillips personally, and Mr. Blackwell from repute, I think they are men who are not likely to make suggestions which would be injurious; but I mention it more particularly, being apprehensive, unless proper arrangements are made as to a system of inspection, that it may produce evils which I am sure it is the object of every one to avoid. I believe Government has done very right in selecting those gentlemen; they could not have got two more respectable men; but I think, as a preliminary measure, it should have been confined simply to reporting, and I think that the information which they will get will be very useful; and when their report is made I think it will be of extreme value, because then the Government and the coal-owners could go practically into the question, and establish a system of inspection satisfactory to all parties.

2146. Of more efficient inspection?

Yes.

2147. You must be aware that if this Bill is carried, those two persons will not be able to inspect a fourth of the mines in England?

(164. 7.)

F F

I think

Nicholas Wood,
Esq.
3d July 1849.

I think it would be very well if those two gentlemen could, during the interval of Parliament, go through the principal parts of the mines of the country, and get answers to those queries. If they could get that information, then, by Spring of next year, it could be all collected, and on a conference or communication with the mine-owners, I think some system might then be established; but I do not think that it is possible to do it by any discussions in Parliament. I think it is so difficult and complicated a question, that it could only be properly done by personal communication between Government and the mine-owners. It is of extreme importance to the country, because any kind of interference with the working of the mines to take any of the responsibility in any way off the coal-owners might increase the danger tenfold, and make it very much worse than it is at present.

2148. Do you think that there would be much objection to such an inspection, on the ground of cases of disputed property and questions of that kind, with respect to the workings?

No; there are no secrets which those Inspectors could communicate; a knowledge of the state of neighbouring collieries, and of the mines, and every thing connected therewith under-ground, is communicated by the workmen to each other to such an extent, that I do not conceive there would be any practical objection to Inspectors going into the mines.

2149. So far as the district with which you are connected is concerned?
Yes.

2150. Supposing a coal-owner had worked 20 or 30 yards into his neighbour's property, the Inspector would not know that; he would not find it out?
No, he would not.

2151. Do you think that there would be any great objection to the Inspectors being able to see plans?

No, I think not; I think the coal-owner would object very much to his plans being handed about; and this Bill is most monstrous in that respect; it stipulates, that there shall be a new set of plans every year; for some 2,000 or 3,000 mines or more, you would want a record office much larger than Somerset House or the Museum to hold the plans. I think the coal-owners would object to the plans being handed about, but I am not quite sure that there would be any real objection to their being deposited in any place where they could be examined by the Inspectors.

2152. There would not be any occasion for that?
I do not think there would be any occasion for it.

2153. Supposing the Inspector had the power of entry, and of requiring to look at the plans for the purpose of examining the method of working, or the system of ventilation, he could do that upon the spot; would there be any serious objection to that?

There would be no practical objection to the Inspector inspecting the plans of the colliery, and I think, for all the purposes for which he would have to be appointed, that would be quite sufficient.

2154. What is there with respect to the plans in the Bill which has been introduced into the House of Commons?

That once in every year a set of plans shall be sent to the Secretary of State; and the most monstrous part of it is, that these three fit persons are to go four times at least in every year down every pit in the country.

2155. Are there ever cases of spontaneous combustion in the northern mines, so far as you are aware?
Not under-ground.

2156. Did you ever know of a case under-ground?
No, I do not recollect any cases under-ground in the neighbourhood of Newcastle.

2157. Anywhere else have you known it?
At Lord Crewe's collieries in Cheshire. I have been in a mine where it has taken place.

2158. Was

2158. Was it proved that there was nobody there ; was it well ascertained ?
It was produced by the decomposition of a bed of shale, which, when placed in heaps, almost always produces spontaneous combustion.

Nicholas Wood,
Esq.
3d July 1849.

2159. What is shale ?

It was, in this case, a peculiar mixture of iron pyrites and other substances, which produce spontaneous combustion ; they give it the name of " Johnny Ardley."

2160. But there is no spontaneous explosion of gas ?

None.

2161. The iron pyrites is the sulphuret of iron, is it not ?

Yes ; small coals mixed with the pyrites, when they are laid down in large heaps, take fire ; but I do not think that under-ground the coals are left in such heaps as to produce spontaneous combustion.

2162. But the heaps on the pit-hills take fire, do not they ?

They do ; but there they are large masses.

2163. You do not think that spontaneous combustion can be the cause of any of the accidents in the northern mines.

I think not ; there is no accident that I recollect which has been occasioned by spontaneous combustion.

2164. Are there any other points upon which you wish to make any observation ?

I think not.

The Witness is directed to withdraw.

WARINGTON WILKINSON SMYTH, Esquire, is called in, and examined *W. W. Smyth, Esq.*
as follows:

2165. YOU are employed in connexion with the Geological Survey ?

I am.

2166. And you have been also commissioned by Government in several cases of accidents in coal-mines to inquire into the circumstances attending them ?

I have.

2167. How long is it since you first turned your attention to the subject of accidents in coal-mines ?

About 10 years. At that time I went over to the Continent, and visited most of the important mines of Europe.

2168. In what parts of Europe, principally did you examine the mines ?

I examined the mines of the Hartz, of Saxony, including the collieries of three different coal-fields there, of Bohemia, of the Eastern Alps, and of Hungary and Transylvania, and occupied some years in obtaining information on the practical details, and examining them under-ground.

2169. Was that before you were employed in the examination of the collieries here, or since ?

Some years before.

2170. Have you made yourself thoroughly acquainted with the systems adopted for ventilation in the coal-mines of this country ?

I have had opportunities of inspecting, under-ground, the collieries of several of our most important districts, including Staffordshire, parts of South Wales, Lancashire, Yorkshire and Shropshire.

2171. You have not been in the North of England ?

No ; the Northumberland and Durham district I do not know under-ground.

2172. Have you found, generally speaking, that in those districts the system of ventilation appears to be very imperfect ?

I would say, that in all those districts there are mines to be found which are worked consistently with all the improvements which have been made in ventilation, and are, generally speaking, very safe ; but in all of them there is a larger proportion in which these improvements have not been carried out, and where the men are every day working at a great risk.

(164. 7.)

F F 2

2173. Should

W. W. Smyth, Esq.
3d July 1849.

2173. Should you say that, generally speaking, it is the larger or the smaller class of collieries in which those circumstances of danger exist?

In most cases the smaller ones.

2174. What is the most common defect which you would say exists in those collieries?

The defects vary so much in different districts, according to the system of working pursued in those districts, that I think it will be necessary to speak of each of them separately. In South Wales there are very many collieries where no artificial system for the production of a current of air is employed; in other cases that current of air will be found to be very insufficient for the extent of the workings under-ground. A third cause of accident there, I think, is, that the air is not sufficiently split or divided into different portions, as it is in the North; and a fourth is, that in cases where an artificial ventilating power is employed, sufficient attention is not paid to carrying the current of air consistently with the natural or spontaneous course which it would take, independently of the artificial agent; and that, consequently, it is at times coursed first up-hill, and then down-hill, up-hill and down-hill again, giving rise to so much friction, that the quantity of air passing through the mine is very materially reduced from what ought to be obtained by the power of the furnace, or other means employed.

2175. In cases where you have found mines in that condition, have you ever conversed with the managers, and suggested to them the expediency of adopting some artificial method for making them more complete?

I have in several cases, and they have always expressed themselves willing, where a thing could be proved to them, to carry it out. I may add, that I have seen the case of a colliery in South Wales which had some years ago the character of a very dangerous work.

2176. Where was that?

It is a colliery belonging to Mr. Charles Smith, of Swansea, where, after numerous accidents had occurred, he employed a gentleman from the North, recommended, I believe, by Mr. Nicholas Wood, to be the viewer of it, and he, by improving the system altogether, by producing a stronger draught, and coursing the air more efficiently, has brought it to be perfectly safe and sweet, as I was able to experience under-ground; and I was informed that no accident had occurred there since.

2177. How long ago is that?

I visited it about two years ago, and he had been there, I think, about 15 years.

2178. Are you aware to what expense he was put in producing that improvement?

I cannot say.

2179. Do you know exactly what was done upon that occasion?

I believe the chief difference was the splitting and coursing the air according to the Newcastle system.

2180. Had he used a furnace for the ventilation of that mine before?

No, I believe not; he was then using a furnace.

2181. But the furnace was introduced in consequence of that recommendation?

I believe it was not used before; upon that point I cannot speak positively. Staffordshire would come as the next district with which I am acquainted; in Staffordshire a very great proportion of the collieries have no artificial means at all of producing circulation. The usual method of extracting the coal there is to sink two shafts at the same level, and within a few feet of each other, and then, just as accident shall determine, the one is allowed to be a downcast, and the other an upcast; but there is no fire made use of, nor exhausting apparatus, nor any artificial means of turning the current in a given direction; so that the necessary consequence is, that sometimes if the external temperature equals the temperature of the air under-ground, there is a perfect stagnation, and at times even the current is apt to be reversed.

2182. Those mines are not what are called fiery mines, to a great extent, are they?

They

They are not very fiery mines, but they are mines in which the coal is sufficiently fiery to occasion a very great number of accidents, so that scarcely a week passes without our seeing an account of some explosion in the thick coal workings; I am speaking particularly of the thick coal of Dudley.

W. W. Smyth, Esq.

3d July 1849.

2183. That is a coal 30 feet thick, is it not?

From 30 to 36 feet thick. Moreover, in most cases, those shafts are so close together, having no partition between them at the surface, that when a strong wind blows, one occasionally sees the return air, or foul air from the upcast shaft, going down the downcast.

2184. When you described the condition of these collieries in Staffordshire, do you mean to apply it to a minority of the whole number, or is it their common condition?

It applies to a very large majority.

2185. In that minority which is properly ventilated, is the usual method of ventilation by the furnace?

I believe that some are ventilated there by the furnace; but I have not been under-ground in any of those which are so ventilated. Mr. Gibbons has lately introduced a furnace with the upcast portion of the shaft bratticed off from the remainder, but of too small dimensions, I think, to be consistent with the most improved methods of ventilation.

2186. Where are his collieries?

His collieries are in the south portion of the Staffordshire coal field, south-west of Dudley. I may also add, that in Staffordshire, the air-headings, or galleries by which the air is carried for the ventilation of the larger workings, are of such extremely small dimensions, that they never can convey a sufficient quantity of air to ventilate those workings when the coal gives off any considerable quantity of fire-damp, or when the barometer is low, or when any other cause makes the colliery particularly dangerous; for instance, they are in general about three feet by two, and in some cases are even narrowed considerably by being carried across the main road-way in a trough of not more than 3 feet by 14 inches; so that the quantity of air conveyed through these is certainly far too small for the general extent of their workings.

2187. In the Staffordshire mines, in that great bed, the workings are very spacious, are they not?

They are very lofty, but the area worked by one pair of shafts is not very great; considerably less than in the pillar workings of Lancashire or Durham, or Northumberland.

2188. Do you think that there is any natural impediment at all to a proper ventilation by artificial means in those collieries?

None at all; I think, in fact, that some of the circumstances are rather favourable to it; the collieries are of moderate depth.

2189. Have you anything to add with respect to the Staffordshire collieries?

I would add one point, that these air-headings or passages driven parallel to the main roads, for the purpose of supplying them with air, are too frequently found to be behind the principal workings; so that from the neglect of the charter master, or man who has the principal charge of the work of extraction, it follows that there is no current of air at all at the extremity or principal part of the workings.

2190. Are there what they call goaves in those collieries, or old workings where the gas accumulates?

There are old workings, the "sides of work," which, when cleared out, are only accessible by one narrow opening; and this is stopped up by a very substantial dam; so that it is supposed, in most cases, that even if fire-damp accumulates in those old workings, none of it is able to find its way out; it of course requires continual and careful examination to see that those dams do not settle, or get otherwise so injured as to leak.

2191. Then, do you conceive that the cause of the numerous accidents which you have mentioned is derived from the existence of those goaves?

I should think not; in one or two cases, I believe, explosions have been attributed to gas having exuded; but in none of the cases which I have seen has there been anything attributable to that cause; they have generally occurred in consequence

W. W. Smyth, Esq.
3d July 1849.

quence of the almost total deficiency of ventilation in the workings where the men were engaged.

2192. In consequence of the employment of no artificial means?

Certainly, for they are thus rendered dangerous at certain seasons.

2193. In those collieries, from your description, may we conclude that they would not require any powerful means of artificial ventilation to make them secure?

Yes; I believe that any one of the various artificial means proposed, properly carried out, and with a very small expenditure of power, would answer the purpose in every way.

2194. Is there anything in the system of management of the mines in Staffordshire which would tend rather to increase the risk of accidents?

I believe that the "butty system," which is generally carried out there, is very prejudicial to the well-being of the colliers.

2195. Will you describe what that system is, and how it operates in that respect?

The butty takes the colliery from the proprietor or lessee, after the execution of certain preparatory works, and undertakes to deliver the coal at the pit-mouth at a certain price per ton.

2196. He is a sub-lessee?

Yes.

2197. What class of persons are they?

He is a man, generally, who has sprung from the rank of the colliers, or very nearly their rank, but possessed of a little capital.

2198. Generally a man of small means?

For the most part.

2199. Therefore not likely to adopt anything that required any additional expense in the working of the mine?

Not in most cases; and I have sometimes found that where he was expected, at his own expense, or at the joint expense of himself and the master, to drive the air-headings, by which alone the principal workings are supplied with air, that these air-ways, so important to the safety of the mine, were behind-hand, entirely from the negligence or sparing of this man, when not kept under proper supervision.

2200. So that the ventilation, in fact, was not carried on through the workings?

It was not. I have seen it as much as 40 or 50 yards behind the working places of the hewers.

2201. What is your experience of the Lancashire collieries?

The Lancashire collieries are worked in most cases on the post and stall system, something like those of the North, although the proportions vary in different pits; and the ventilation is carried on, generally speaking, in the larger collieries upon a very similar system, by means of rarefaction produced by a furnace.

2202. Are the beds in Lancashire for the most part of a dangerous description?

Many of them are very fiery, although I believe none of them so fiery as those of Durham and Northumberland.

2203. What is the system of ventilation most commonly adopted in Lancashire?

The system is the rarefaction of the upcast air by means of a furnace.

2204. Is that very generally adopted?

It is generally adopted in the larger collieries; in some of the smaller ones they trust to the natural ventilation produced by the different levels of the shafts.

2205. Are there many collieries now in the Lancashire district that trust entirely to the natural ventilation?

Towards the hills a great number of them trust entirely to spontaneous ventilation, because they have the advantage of the varying height of the ground, and therefore obtain the moving power produced through the greater part of the year by the different lengths of column in the different shafts.

2206. Are

2206. Are the accidents in the Lancashire collieries frequent?

Compared with the North, or perhaps with Staffordshire, they are not very frequent; but there have been several serious accidents from explosions within the last few years. I was sent down by the Secretary of State to inquire into the circumstances of an explosion in that county, and I believe that that, as well as several others into the particulars of which I have inquired, was partly attributable to false ideas of ventilation, and, amongst other points, more particularly to the impression, that for a given area of colliery it was desirable to have a smaller area of upcast than of downcast shaft.

W. W. Smyth, Esq.

3d July 1849.

2207. Do those false ideas arise from the low education and knowledge of the people?

I think they generally arise from their not understanding the nature of air, and the laws of its motion, and of its expansion by heat.

2208. From their having no scientific knowledge?

I think so; I might instance one case, in which there are two downcast shafts, containing together an area of about 160 square feet, where the upcast is only 38 feet area.

2209. Was there any artificial method of ventilation there?

Yes; there was a furnace.

2210. You are also acquainted with several of the Yorkshire collieries?

I examined immediately after the explosions the two collieries of Ardsley Main and Darley Main, near Barnsley.

2211. How did you find the system of ventilation there, in comparison with those which you have been describing in Staffordshire and Lancashire?

I found that although the system of ventilation might not be amiss, its efficiency was impaired by not carrying it out in a proper manner. At Darley Main, for instance, it was evident at once, and I gave evidence before the coroner's inquest on the subject, that with the same shafts for upcast and downcast which they then had, and the same dimensions of furnace, they might easily pass double the quantity of air, by doubling the area of their air-ways; and having already headings which would have answered that purpose, they might have done so without going to increased expense, excepting a small additional quantity of fuel. Mr. Locke, the viewer there, has since adopted this plan, and has written to Mr. Wood, as that gentleman informs me, to say that double the quantity of air has been obtained. One great cause of the danger there has already been pointed out in the existence of the goaves or gobs, as they call them there; but, I believe, that a better consideration of the subject of ventilation generally would enable them to be rendered less dangerous than they are at present. In the Ardsley Main, for instance, the explosion evidently came from one principal goaf, which abutted on the rise side against a fault. When gas accumulated in this goaf, as it must have done by continual drainage from different parts of the coal, it had no possible escape to the rise, but must accumulate till it could force its way out into the passages of the mine, through which many of the men were passing to and fro, and with naked candles. Now, if on the rise side of this a heading had been driven to carry off the explosive gas as it accumulated, passing behind it, or to the south-west of it, at rather a higher level, but opening into it, and if it then could have been carried to the upcast shaft, it would at once have drained the goaf of all its explosive mixture, and carried it away harmlessly.

2212. Do you conceive that that could have been done without any great additional expense?

I believe that it might have been done; I suggested it to the manager at the time, and he approved of the plan, and thought then of carrying it out. I do not know whether he has done so. This is a plan of the Ardsley Main [*producing the same.*]

2213. Is this the one in which the accident happened last or first?

This is the first; the coal is dipping in this direction towards the south-east, and this is the principal goaf in which the explosion originated [*showing the same*]; the explosive gas accumulating here, draining from all the neighbouring surfaces of coal, had no exit in the direction which it would naturally follow, because it abutted upon the fault, but it must force its way down these different drifts, which

W. W. Smyth, Esq.
3d July 1849.

all opened into the "board gates," or principal passages, where men were allowed to pass and repass with naked candles. The means which I suggested were to have driven a heading at the back, on this fault, at rather a higher level, so as to take the upper part of the goaf; at all events, at a level sufficiently high to prevent any part of the explosive gas finding its way down to the lower workings; and then to have driven it to the upcast shaft at a higher level; the rarefaction caused there would probably soon have drawn off all the dangerous part of the goaf atmosphere.

2214. What distance would they have had to drive that heading?

About 800 feet, I suppose; but unless some such means were taken, it was imperative upon the managers not to allow the passage of naked candles up and down those passages which communicated with the inflammable gas.

2215. Comparing the systems adopted in this country for ventilation with what you saw during your inspection of the collieries on the Continent, how should you say that the comparison stands as respects the condition of the mines in this country?

I must premise that on the Continent I have not had an opportunity of inspecting any of the collieries in the most fiery districts; those which I have seen in the coal beds of Saxony are, generally speaking, not fiery coals, so that the ventilation carried on there is but on a small scale.

2216. Then, in point of fact, you have no experience of the dangerous mines upon the Continent?

Not of the dangerous mines; in Saxony I have been in fiery seams, but where the advantages of natural or spontaneous ventilation were such, that they were able to render them safe by that means alone.

2217. Taking your experience generally of the coal fields in this country, what should you say is the most common cause of the defective ventilation?

I think, to answer that question fully, one ought to consider the question of ventilation under two heads; first, that of developing a draught or current of air through the shafts; and, secondly, a point which is very much more important as regards the present inquiry, the distribution of the air so obtained through the under-ground workings. In the first place, the system of natural ventilation has been applied in many cases, and although safe at certain seasons, it is exceedingly unsafe at others; when the temperature of the surface approaches the temperature of the under-ground workings, there is generally a stagnation of the air current.

2218. There is then no ventilation?

There is not. Considering that the mean annual temperature in London is about 39.5 in the winter, and in Edinburgh 38.5, and in the summer 63 and 58, it is very evident, that in the spring and in the summer there will be many days on which the temperature at the surface will be equal or superior to the temperature of the excavations in shallow pits; and this circumstance must occasion accidents.

2219. Have you ever observed the variations of the barometer in connexion with the condition of mines?

I have not made any series of experiments, but I have remarked upon the occasion of two or three of the accidents, for the investigation of which I have been sent afterwards, that there had been a fall of the barometer immediately preceding the explosion; but I think that the variations of the thermometer seem to be quite as important, for whilst the fall of the barometer allowed the escape of the gas, which was before pent up in the pores of the coal, and in certain of the excavations, the change in the temperature at once so slackened the rate of the ventilating current, that whilst, on the one hand, the quantity of gas was increased, the means for carrying it off became less.

2220. In that case, are you not speaking merely of where the ventilation was left to natural causes; would you say that where there was an artificial system of ventilation?

It is also the case where a fire is employed.

2221. Are the variations of temperature sufficient to affect the action of the furnace?

They are, particularly in shallow pits.

2222. Have

2222. Have you any authority for that conclusion?

In shallow pits, where I have been, passing through the workings, I have found that in winter the air has always been much better than in summer, under the same circumstances, where a fire has been employed.

W. W. Smyth, Esq.

3d July 1849.

2223. Notwithstanding that they were ventilated artificially?

Yes; the same objection will not hold good with mechanical means of ventilation.

2224. You confine your observation, then, to the use of a furnace?

I do; nor will it hold good, I imagine, with the steam-jet, considered as a mechanical agent.

2225. Did you ever hear that opinion expressed by the managers of collieries?

It is generally known by them to be the case.

2226. That the difference in temperature of the atmosphere affects the operation of the furnace?

That it affects it very materially, and diminishes the ventilation. It operates in this manner: that it lessens the difference of temperature between the downcast and the upcast air, and therefore the amount of moving force.

2227. Would it not be too slight to be perceptible?

It would be too slight in the pits, where they have a long column of warm air; but in shallow pits, where the column is very much reduced, the variation is at once perceptible.

2228. Have you ever turned your attention to the method of estimating or measuring the amount of the air passed through the workings of a colliery by the different means of ventilation?

I have on several occasions tried it by the usual means, that of exploding a little gunpowder, or trying the smoke of a candle; but I believe that in most cases the estimate obtained is far too high, inasmuch as the experiment is generally made in the middle of the drift or heading, and the friction against the sides and roof is altogether neglected.

2229. Is it the practice, then, to assume the velocity of the centre of the current as the velocity of the whole?

It is very generally the case.

2230. That you conceive to be a mistake?

That I think is far from giving a true estimate.

2231. Have you any means of arriving at a conclusion as to the amount of that error?

I believe that the laws of the passage of air through cavities so irregular as the workings of a colliery, are so complicated, that the subject has not hitherto been well investigated.

2232. You are not aware of any experimental investigation which would give you an indication?

I am not.

2233. Did you ever try any anemometer, or any instrument of that kind, for the purpose?

I have tried Mr. Biram's anemometer, and I find that it generally gives results somewhat under the results obtained by the other means.

2234. If that instrument were placed in the centre of the current, it would involve the same error, would it not?

It would; whether it is friction, or what the causes are, I am not able to say exactly; but it generally gives the result somewhat lower than the others, and probably, therefore, approximates nearer to the truth.

2235. Somewhat lower than what others?

The firing of gunpowder, or trying it by the smoke of a candle.

2236. Have you examined at all the question of the amount of air that ought to be passed through a certain mine for the purpose of making it secure?

I have only examined it generally in communication with some of the viewers, for it is a subject which depends so entirely upon practical acquaintance with the

W. W. Smyth, Esq.
 3d July 1849.

particular workings in question, that it would be very difficult for a stranger to speak with confidence on the subject. In many cases, which one sees in passing through different districts, the quantity of air is so small as at once to enable even a casual observer to assert that it ought to be doubled or trebled.

2237. Taking the imperfect method, such as it is, of the gunpowder, what kind of current have you found commonly running through those mines which were not well ventilated, but at the same time were in a state of continual working, and supposed to be sufficiently so?

I believe that, taking some of the worst ventilated mines, as many of those in Staffordshire, it is very difficult in the body of the workings to find any motion at all.

2238. You have told us already that you have seen mines in which, from the ventilation being left entirely to natural causes, it was occasionally altogether stopped?

Yes.

2239. The question refers to cases where the ventilation is in ordinary action, without any assistance from the furnace, where the ventilation arising from the difference of temperature above and below is going on in its natural course; what should you say would be, under ordinary circumstances, the utmost amount of the current in such a case?

In such cases, I think in most of the workings, the current varies from one foot to three feet a second; then the system of splitting the air being not sufficiently understood or spread among the miners, the consequence is, that you have that velocity only in one air-way often of small dimensions, and therefore a very small portion circulates through the entire working.

2240. Have you found the managers of the mines that you have visited, generally speaking, turn their attention much to the questions connected with ventilation?

At some of the larger collieries in most of our important districts, I believe the managers, as well as the subordinate overseers, have taken great interest in the subject, and within the last few years have done much to improve it.

2241. But, generally speaking, with respect to the great bulk of managers of collieries, do you think that the principles of ventilation are well understood by them?

I think not by the bulk of them.

2242. Do they appear to you to have turned their attention to questions connected with the best methods of ventilation?

Not sufficiently; the ventilation has been by many entirely overlooked, till a certain part of the mine became so dangerous that something was obliged to be done.

2243. In a great many cases is it not the fact that it has not been thought of at all?

In a great many cases it has been the sort of accidental ventilation which I have spoken of.

2244. In the course of your visits to collieries, have you frequently made suggestions to the managers of collieries with respect to improvements in ventilation?

Only in a few cases, where I have known the manager pretty intimately; because, in general, it appeared to be a matter of some delicacy to find fault with the existing system.

2245. Have you found, generally, much jealousy with respect to any suggestions of that kind?

In most instances, where I have visited the collieries under-ground, it has been merely as a private acquaintance of the owner; so that, under such circumstances, there has been no jealousy exhibited.

2246. Have you ever had any communication with the managers of mines with respect to the expediency of any interference on the part of the Government by means of inspection?

I have spoken with many managers of mines in different districts on that subject, and in most cases they have expressed themselves perfectly willing and desirous that

that such inspection should take place; provided only that it were carried out in a manner which should not interfere in any way with the workings, and that properly qualified persons were appointed. I have also spoken with subordinate agents, and with the men, on the same subject, and I have found a great disposition on their part to hail any movement of the kind with pleasure.

W. W. Smyth, Esq.

3d July 1849.

2247. Have you ever heard any contrary opinion expressed by colliery managers or owners?

I have in several cases; particularly, I think I may add, in Lancashire.

2248. An indisposition to admit of such an inspection?

Yes.

2249. Upon what grounds was the objection made?

I think a great part of the objections were founded on admissions which, if they related to anything that took place at the surface, would excite the indignation of all honest men; generally speaking, they are connected merely with questions of stealing coal over the boundary.

2250. They fear lest inspection should reveal some encroachments below?

Yes; although their objections applied more particularly to the showing of plans, or the sending of plans to any central office.

2251. Is it in many instances that you have met with that sort of objection?

In several instances; I would not say, by any means, in the majority of instances.

2252. You have had some experience in examining coal-mines yourself; do you apprehend that an Inspector, whose sole business it was to enter a mine, or to look at the plans sufficiently to acquaint himself with the methods of ventilation, would have the means of judging as to the extent of any encroachment, or the fact of a coal-worker having exceeded his proper boundaries?

I think he would have no idea of it, unless he were carefully to examine the plan first, and then go under-ground with the object of testing some particular point.

2253. Supposing an Inspector to be appointed by Government, merely armed with the power of requiring admission to the mine, and of seeing the plans so far as might enable him to judge of the methods adopted for coursing the air and splitting the currents, and so on, if he, with the superintendents and managers of the mine, were allowed to examine it, so far as to acquaint himself with those circumstances, do you think that he would have the means of forming any judgment as to the precise interference in any respect of the workings with the property of the parties?

I think that in such case he would not have any means of judging at all of such encroachments.

2254. It would require a more minute and careful investigation?

It would require a more minute investigation; in fact, I think, without instruments, the most practised person would generally fail in detecting anything of the kind.

2255. He must compare the plan with the actual surface?

Yes.

2256. Did you ever make that observation to any of those parties who objected to inspection upon that ground?

I do not think that I ever did.

2257. With respect to the persons charged generally with the practical superintendence of the mine, have you had much communication with them?

I have had a good deal both in the mines under-ground, and in surveying the geology of the surface.

2258. Persons called overlookers, and by names of that kind?

Persons called overlookers, and by various names in various districts.

2259. Have you generally found that they are a class of persons possessing much or little education?

Generally very little; but I have also found them generally a class very desirous of obtaining information, but whose means of acquiring it have been very limited.

W. W. Smyth, Esq.
3d July 1849.

2260. Do you think, from what you have observed of them, that they are parties fully competent to deal with any difficult circumstances in the discharge of their duty?

I scarcely think so. If an unforeseen circumstance occurs, in which they have not previously been practised, they have scarcely sufficient knowledge to cope with the difficulties which it may induce.

2261. Have they, generally speaking, so far as you are able to judge, received any instruction beyond the mere routine practice of their duties?

In very few cases, I should say.

2262. But supposing that the means of proper instruction were placed within their reach, are you of opinion that they are desirous of obtaining it?

I think that nearly all those with whom I have conversed have been people particularly desirous of obtaining information; they have been picked out generally from the workmen, as being the most intelligent and educated, and have shown afterwards also a disposition to obtain knowledge.

2263. Are there any other points upon which you wish to enter?

I have seen several experiments which have been made in Belgium, on the subject of comparing different mechanical means of drawing the air from the upcast shaft with the action of the furnace; and as I have not heard them alluded to in the course of the evidence, I thought it might be worth while to advert to them. In the first place, they tried as an improvement on the furnace system large exhausting pumps, working by means of a piston.

2264. In Belgium?

In Belgium; a very large piston working in a cylinder.

2265. Have you seen it in operation?

I have not.

2266. A sort of air-pump?

A sort of air-pump; and secondly, a cylinder moving in another, filled with water, similar in principle to a machine which has been in use for ventilating the metallic mines in the Hartz for 150 years, and similar in principle also to what Mr. Struvé has applied in Swansea. These two have been carefully compared as to the actual amount of work done with the furnace, and also with the ventilating fan, proposed by Monsieur Combes, the Government engineer, and with the pneumatic screw of Monsieur Motte.

2267. These have been used in different instances, not in the same?

They have been used in the same neighbourhood; they have been tested by several engineers, and the results published in the "Bulletin du Musée de l'Industrie." With respect to the results of the actual power developed, and that brought into effect by these engines, the engineers have not arrived at the same results; but Monsieur Trasenster gives us the result of experiments with the exhausting machine at the mine of L'Espérance in Seraing.

2268. That is the exhausting pump?

Yes; the engine-power was theoretically 33·66-horse power, and the effect was five-eighths of the power developed. The experiments of Monsieur Combes on the same engine have only given about one-third.

2269. That was only about 17-horse power actually exerted by an engine of 33?

Yes; taking the quantity of air extracted with the exhausting machine, where the cylinders were worked in water, the cylinders being 3·66 metres in diameter, the effect found was 82 per cent. by Monsieur Trasenster. A further set of experiments was made by Monsieur Glépin, who is the director of some large collieries near Liege; he found that the exhausting machine, acting in water, produced an effect of 25 to 40 per cent.; that Combes' ventilating-fan produced 25 to 39, and the pneumatic screw 17 to 26; then he tried the steam-jet at the bottom of the upcast, but which I imagine he must have applied more for the purpose of increasing the temperature than anything else, not looking upon it in the light of a mechanical agent.

2270. You do not know of what pressure?

No, it is not stated in the experiments as detailed; he got only a per-centage of 3·5 of useful effect.

2271. Then

2271. Then none of those methods appear, as so applied, to have been very effectual agents of ventilation? *W. W. Smyth, Esq.*

No; they have found that the furnace had always a very great advantage where the shaft was deep, wide and dry, and that in such cases it developed 80 per cent. of the effect which was due to it by theory; whereas in other cases, where the shafts were shallow or wet, it developed only 20 per cent. of the same power.

3d July 1849.

2272. In a furnace of the same power, did they find so much difference as between 80 per cent. and 20?

Yes.

2273. Between a dry shaft and a wet shaft?

Yes.

2274. The size of the shaft must also be taken into consideration?

Yes; the diameters formed an element of the comparison.

2275. And the depth?

Yes; in several of the collieries in that neighbourhood which were closely experimented upon, it was found that the furnace produced not more than 20 to 25 per cent.; they have also calculated the annual expense in fuel, repairs and labour, on these different means of establishing the air current. In the underground furnace, which utilised 80 per cent. of the heat generated, the annual expense was 1,222 francs; in the ventilating fan of Monsieur Combes it was 1,350; in the pneumatic screw of Monsieur Motte, 1,755; in the underground furnace, which utilised 25 per cent. of the heat, it was 4,034 francs, and in the furnace placed at the surface, with a chimney above it, the expense was 15,414 francs. The method of placing a furnace at the surface has been from time to time proposed, and, I believe, carried out in this country; and if a knowledge of such facts as these had only been communicated among the parties who have tried it, it must have led to a better appreciation of the advantages to be derived from placing the furnace only at the bottom of the upcast.

2276. In the 1,222 francs was the furnace at the bottom?

Yes.

2277. So that the difference between the furnace at the bottom and the furnace at the surface, according to those trials in Belgium, would be the difference between 1,222 francs and 15,414 francs?

In the annual expense.

2278. But is it quite certain that the furnaces were of the same power in each case?

Those points were all calculated.

2279. You have found a great difference in the mode in which the furnaces are used, have you not?

A very great difference, both in dimensions and mode of application.

2280. And their efficiency, also, for ventilation must depend very much upon the mode in which they are applied?

Very much indeed. There is a great difference also in the manner in which the return air is brought out, not only as connected with the quantity of air passed, but as to the safety of bringing the return air to the fire. In some cases I have seen that the furnace is fed only with the return air, so that if that air should be mingled with carburetted hydrogen to the explosive point, it would infallibly produce an explosion. It is also very desirable in some cases, as is done, I believe, in all the better-managed collieries in the North, but rarely elsewhere, to feed the fire with a portion of air "sealed" off from the downcast shaft, or "in-take" air current.

2281. In order to keep up the requisite proportion of atmospheric air?

Yes; and I believe that that system might be very much improved, and the furnace made a very much safer thing than it is at present, by means perfectly available, in order to keep up a rarefaction even after an explosion had occurred, if it were still more isolated than it is from the workings, and the return air only carried in above it by a dumb drift, or divided from it by a brick separation sufficient to guard against its firing.

W. W. Smyth, Esq.

3d July 1849.

2282. Do you think that there are many points of that description in the management of the ventilation of collieries which might be the subjects of suggestion in the case of Inspectors well acquainted with the matter?

I have no doubt there are many cases of the kind.

2283. Have you found many cases, in the course of your examination of coal-mines, in which such suggestions might be made with advantage by persons well acquainted with the subject?

I believe, for instance, that if a person well acquainted with the Durham and Northumberland system of coal-working were to visit many of the other districts, he might suggest many useful alterations; and it is possible also that some improvement introduced in the other districts might be found useful there.

2284. Are there any other points upon which you wish to observe?

The furnace, as a means of obtaining a draught, is decidedly very disadvantageous in one point of view beyond a certain limit; if the air is to be heated to a very great degree, the consumption of fuel required advances in a very high ratio.

2285. Did you ever observe an effect which has been mentioned in evidence to the Committee, which appears to produce a sort of paradox, after the furnace has been raised to a certain point, by increasing the rapidity of the current of air through it, and thereby decreasing the proportion of heat supplied to the amount of air which is to receive it?

I have not observed that effect; I have not had the means of experimenting upon it. I have observed that by a similar increase of fuel, a proportionate rapidity of current is not always obtained. I believe one cause of it to be, that the specific heat of the air, when of the standard temperature and elasticity, is inversely proportional to its compression, so that when rarefied, it absorbs its specific heat, and becomes cool; that, no doubt, must be very much against its being rarefied to the proper point by a limited consumption of fuel.

2286. In your examination of the causes of accidents, have you observed that the circumstances of the wind have had much effect upon the occurrence of such accidents?

I have, sometimes, from the current of wind itself, but at other times, as connected with the fall of the barometer, and the difference of temperature commonly attending a change of wind; for instance, it is universally known among colliers that the ventilating current proceeds always with greater rapidity when the wind is in an easterly or a north-easterly direction; but as soon as it changes round suddenly, and frequently, as it does, with a gale of wind, to the south-west, or south or west, there is a fall of the barometer; and this, with the variation in temperature, and the change of wind together, acts prejudicially upon the ventilation.

2287. Looking solely to the direct action of the wind, have you been led to conclude that the force of the wind itself has had the effect of producing circumstances under which these accidents take place?

It no doubt, at the Darley Main and at the Ardsley Main, produced an injurious effect.

2288. That is to say, the strength of the current of wind repressed the current of the upcast shaft?

Yes, and on one occasion it was asserted, I believe with some show of truth, that a portion of the upcast air had been turned down the downcast at the Ardsley Main.

2289. Have you been led to observe that explosions have generally taken place with winds from one quarter rather than from another?

Decidedly so.

2290. More with the south and south-west winds?

Yes; in the first place, in this country we have a greater proportion of days in the year on which the wind is blowing from those quarters, and in the second place the barometer is generally lower when the wind is in those directions than when it is in the opposite quarters, and also the thermometer higher.

2291. Have you any observations to make upon the mode of distributing the air through the workings of a mine?

It is too frequently the case throughout our coal districts, that the advantage of having a number of air-ways, or splitting the air on its exit from the downcast shaft,

shaft, is not properly appreciated. If we take a simple case, that of a single gallery ventilated by a pit at each end, and suppose, as in the case of collieries, that the pit is of small length compared with the workings, and that the area of the pit is also very large compared with the workings, it will be clear that where they are of the same length, taking two galleries of this kind, the volume of air through them will, under similar circumstances of motive power and velocity, be proportional to their sectional areas; so that, if we take a single gallery connecting the two shafts, there will be the same volume of air passing through that gallery as there would be in each of three, if we take the two shafts, and connect them with three galleries of the same dimensions.

W. W. Smyth, Esq.

3d July 1849.

2292. Can it be assumed that the quantity of air passing through two galleries would be proportionate to their area; would it not be the case that if you diminished the area of the passage through which you took the current of air, the current would be diminished in greater proportion even than the diminution of air, in consequence of the amount of friction?

That would be so; but I am only speaking of a case in which the shafts are of a very considerable size, so that they shall be able fully to take down the additional quantity required for two or three galleries besides the first; and in those cases it is found practically that it is very easy to double or treble the quantity, as long as the air-ways are doubled or trebled.

2293. That is to say, that doubling the air-ways of the same size, you would double the quantity of air?

Yes.

2294. Were you rightly understood to state that the quantity of air passed through an air-way would be in proportion to its area?

I would say so, taking the length or extent of these air-ways as very great compared with the shaft, and also their area as very small compared with the area of the shaft.

2295. Supposing between two shafts such as you have described, two different air-ways, one of large dimensions, say six feet square, and the other of very small dimensions, say three feet square, could you assume that the current of air passed through each of those by the same agency would be in proportion to its area?

Independently of friction.

2296. Would not the friction make a very great difference in the amount of air which it was possible to pass through those passages?

It probably would make a considerable difference, but I think it would be almost overlooked in practice in such a case as that assumed, where the velocity in both cases is the same.

2297. Will you proceed with your statement?

In such case I would only observe, that where you have the natural means of creating a draught, it is very easy to increase the area of the current; to double or treble, in many cases, the total quantity of air circulating through the works; but that where a furnace is employed, you would require to use in such case double or treble the quantity of fuel, although the area of the shafts need not be altered. I have seen the importance, in several cases, of a knowledge of that kind being more generally spread, inasmuch as there are many collieries throughout the country which have shafts quite sufficient in their area to take down double or treble the quantity of air which is passing through the workings.

2298. But in which the ventilation is deficient from not giving sufficient power to the furnace?

Exactly so, and from using only one drift or gallery out of two or more, as an air-way.

2299. In such cases, then, there would be nothing more required in the way of expense to the coal-worker than the additional fuel?

Nothing more than a certain quantity of additional fuel; with respect to other accidents different from those of explosion, I believe that something ought to be said of them, for they are exceedingly numerous.

2300. To what class of accidents do you allude?

I am alluding principally to those from the falls of coal, and of the roof; I think that these are questions upon which it is very difficult to gain proper information,
(164. 7.)

W. W. Smyth, Esq.
3d July 1849.

because they depend so entirely upon the methods of working used in the districts to which they apply; but I have seen that these accidents might occasionally be avoided by a greater acquaintance on the part of the men with the principles of mechanics.

2301. Is it not generally arising from carelessness in the people themselves?

Not perhaps so much carelessness as in many cases their want of knowledge. I have been under-ground a great deal in the metallic mines both of the Continent and of England; in Cornwall, and some other counties where the men have occasion to think a great deal for themselves to secure their own safety, they apply timber in various ways to secure the ground in which they are working, and they are thus able to render themselves safe in many cases of danger fully equal to what many of our colliers are undergoing. I have seen rows of timbers put up in many of the collieries in a way which would at once be considered very incompetent to support the weight by the miners accustomed to metallic mines.

2302. Do you think that the people employed in the metal mines are better qualified to deal with those sort of difficulties?

Undoubtedly, from habits of thought being more usual to them, and from their having acquired a better acquaintance with the principles of mechanics; so that when they have to set a piece of timber, or, in fact, any support to a roof, whether it be of stone or timber, they apply it in consistency with sound scientific principles.

2303. Do you think that in the case of the working of collieries, generally speaking, there are any simple means by which the danger from such accidents could be avoided?

I am afraid that there are no simple means.

2304. Would it not entail a great additional expense in the working of a colliery to provide properly against such accidents as those?

There are no simple means, I believe, which could be devised to apply to the majority of cases. In the thick beds in Staffordshire, not a week passes without our hearing of an accident from the falling in of the coal or roof; that arises from the great height of the coal, 30 to 36 feet. Those accidents could perhaps be diminished in number by the method adopted in some of the thick coal in France, by working the coal at twice.

2305. In two stages?

In two stages; working first the upper division of the seam, and allowing all the ground to settle above it, and afterwards working away the other part, perhaps after a lapse of one year or two years, according to the circumstances, the strength of the coal and other particulars. They then find the whole ground so settled that it is like working a fresh seam.

2306. What is the depth of that coal?

I believe it is about 36 feet thick.

2307. Where is that?

At Blanzey.

2308. Whereabouts is that?

I believe in central France. I have not visited the spot, but have seen descriptions of it, and I understand Mr. Gibbons, one of the Staffordshire coal-owners, has commenced working in the same manner, by way of experiment.

2309. Would there not be one great objection to that mode, that it would not all sink equally, and that the upper strata which was got last would be very much broken?

It is no doubt very much broken; and another reason against it is, that the coal, by the present system usual in Staffordshire, can be got much cheaper.

2310. It is got by one working, instead of two?

Yes, and the bringing down of the upper coals is a very cheap operation; one blow sometimes will bring down many tons weight.

2311. Only with considerable danger?

Always attended with considerable danger.

2312. They drive the pick where they see that they can bring down a vast quantity of material, without thinking of the danger which it incurs?

That,

That, no doubt, is one cause; but then, again, there are such vertical joints and horizontal partings through the coal, that in many places you may appear to be standing under a perfectly sound roof, when there is a joint above you which may give way at any time.

W. W. Smyth, Esq.

3d July 1849.

2313. Then, there are no improvements which you think can be introduced to secure the works against such accidents?

I am afraid that no means have been as yet suggested with respect to coal of that height.

2314. With respect to other seams of coal, do you think there is any improvement which it would be possible to introduce into the working of coal-mines, not involving any heavy expense, which should secure the work-people against the falling of the material?

I believe that one of the most efficient methods of working, and one which is liable to the fewest accidents, is the system followed in Shropshire.

2315. What is that?

It is called the working by the long wall; it is efficient, not only as guarding against accidents by falls from the roof, where the men are acquainted with the setting of timber props properly, but it has also the advantage of securing a most efficient and simple system of ventilation. It is only applicable to certain seams of coal, under certain circumstances; but I believe it is applicable in many districts where at present it is almost unknown, or where, at all events, it is not used to the extent to which it might be.

2316. Can you briefly describe that method?

The shafts are sunk at the lower part of the field of coal to be worked, while a level, or pair of drifts, is driven out in each direction, and to the rise of these, commencing from the shafts, they begin to work away the coal in a long line, taking it in a "long wall," from which the term has been derived; and as they go on, they leave from these shafts branching roads through the "gob," either rectangular or angular in their direction, according to circumstances, and leading to the body of coal in this manner—[describing the same]; so that they are continually up to the face of the coal which the men are working. The whole of this is one long fresh face of coal, along which the men are distributed, and the roof in the immediate neighbourhood of it is supported by props in three or four rows, which, as fast as the men advance in this direction, are removed, and placed further forward, whilst the roof behind falls in, and would cut off the communication from thence to the shaft but for the roads which are kept open by walling at the sides.

2317. Of what are those roads made?

All the refuse coal, and the roof which falls in, are packed, and the roof between the road-ways falls down so close, that no room is left for any gas to accumulate and form a dangerous goaf, and, after several years have elapsed, it is found that the space from which the coal, perhaps six feet thick, has been taken away, is often condensed into a few inches, so that there is no possibility of any dangerous reservoir of gas being formed. Then, as another advantage, the air is taken at once from the downcast shaft, in one unbroken stream, right round the face of the working, and comes straight away to the upcast, thus obviating the expense and dangers of doors, stoppings and crossings. The consequence is, that however powerful the gas along this face of coal, it must be removed by so powerful a stream of air.

2318. Is that coal liable to much discharge of gas?

Some of the coals in Shropshire are exceedingly fiery.

2319. Are all the Shropshire beds worked in that manner?

I think all of them.

2320. What is the thickness of those divisions?

They vary from two feet to eight.

2321. Are these passages constructed by the building of a sort of wall as they go on?

As they proceed, certain men being employed to construct the roads.

W. W. Smyth, Esq.

3d July 1849.

2322. What are they covered with?

The natural roof of the coal-seam.

2323. They are built up to the roof?

Yes; the levels and headings or drifts are cut generally only up to the roof of the coal.

2324. Then, supposing the coal falls in large masses by the side, does not it also disturb the galleries?

It forms a heavy weight; but if the walls are built of sufficient thickness, it seldom disturbs them much, and if it does, they cut it away; they employ a number of men to keep the roads always in order.

2325. They get the coal out very perfectly in that way?

There is no waste at all.

2326. Are the props generally strong enough to support the roof?

In most cases; occasionally they are crushed.

2327. What size are the props to support the roof?

The props to support the roof are of ordinary timber, six or eight or ten inches in diameter.

2328. And only one set is required, which is moved forward as the works proceed?

Yes; they are generally in three rows.

2329. Have you at all considered the comparison between iron props and wooden props; their comparative advantage?

I have considered the subject; I think I saw them at Elsecar; Mr. Biram showed them to me there.

2330. Have you been in the colliery at Elsecar?

I have not been in the colliery, but on the surface. I did not hear then whether they had been tried for a sufficient length of time to determine their relative advantage. This mode of working, I believe, is carried out in a few collieries in Wales.

2331. You said that it would apply to certain beds of coal; can you state in what cases it would be inapplicable?

In the first place, where the coal is a very thick one, it would be attended with great difficulty.

2332. Such as the Staffordshire?

Such as the Staffordshire, although it has been tried also by Mr. Gibbons; and where the area of the colliery is very extensive, and the roof is tender, such a mode of working is inapplicable. The Shropshire agents and colliers, however, are so impressed with the value of this mode of working, that they assert they could work it under all circumstances, and that they would not be afraid to take any colliery in Lancashire, or any other district, which is worked by the post and stall method, and work it by this.

2333. In the post and stall method there is a certain waste of coal, is there not?

Always a considerable waste of coal.

2334. With respect to the rapid dips in coal, is the coal in Shropshire horizontal generally, or are there rapid dips?

The dip is in general not very considerable; I believe that favours the system.

2335. How would it be applicable in pits where there is a rapid dip?

It would no doubt be more difficult to carry out that system, although the Shropshire colliers are confident of its value even there.

2336. They have considered that objection, and think that they can overcome it?

They have. I have also been under-ground in one of the principal collieries at Zwickau, in Saxony, where they work the coal in a somewhat similar manner, although the dip is more considerable than in Shropshire, and where it is found to be very successful.

2337. That would be a very secure mode of working; there could rarely be accidents in that mode of working?

There

There would very seldom be accidents; indeed, I believe that the Shropshire district, although most of the coals are fiery, is the most secure from accidents of any in the kingdom.

W. W. Smyth, Esq.

3d July 1849.

2338. How is the coal worked in Belgium generally?

I believe by the post and stall method.

2339. What is the greatest length that you have ever seen in the face of the coal, of one wall of coal?

I have seen in the south of the Shropshire district as much as 180 to 200 yards long; but in Derbyshire Mr. Woodhouse is working in one wall as much as 400 yards.

2340. In a dip up or down, whichever way it lies, would it be worked with equal facility?

I believe whichever way it was, it might be worked with equal facility; but possibly where the dip was very rapid, it would be better worked on the post and stall system.

2341. Are you aware whether those roofs to which you have referred are expensive?

The expense of the roads differs very much, according to the nature of the roof. In some cases, where the roof comes down, and they are obliged to cut into it, it is expensive.

2342. Then there is a good deal of blasting?

If the roof is a stone roof.

2343. It is then necessary to blast the rock?

Yes.

2344. But you were understood to say, that that was not a matter of frequent occurrence?

It was not the case in either of the collieries which I visited; the roofs were generally shale roofs.

2345. They vary?

They vary exceedingly.

2346. Are there any other points which you wish to mention?

There is one point to which I should wish to direct the attention of the Committee. I think it exceedingly desirable that a sufficient and spontaneous circulation of air should be attended to in placing the shafts, by putting the upcast shaft at a considerable distance from the downcast, and on the rise of the coal, inasmuch as after an explosion has occurred, it is generally the case that we find nearly two-thirds of the men have been killed by the effects of the after-damp, and many of them are in positions where, if they had been able to get into a good air-way, they would have been saved. Now it is too frequently the case that the shafts are placed close together, and that a communication between them is at once opened by an explosion, and consequently the air passes down one and up the other, and the whole of the works are laid dead; whereas if there were always a considerable length of air-course maintained, the men would know that by running along the different workings to this principal heading, they would always get air sufficient to sustain life.

2347. And if there was a difference of level, there would usually be some amount of natural ventilation going forward, even although the partitions might have been destroyed?

There always would be a natural ventilation carried on there, and if the furnace-plan should have been in use, the sides of the upcast shaft, supposing the furnace to be put out after the explosion, would retain a sufficient heat always to give the current an inclination in that direction; whilst, if the mechanical means at the surface, or the steam-jet, should be employed, they might be still in action, and still carry on the required current.

2348. Are you aware whether, in Staffordshire, there are very frequent accidents from the breaking of the ropes?

There are many accidents from that cause, arising from the imperfection of the method of raising and lowering the miners and coal.

W. W. Smyth, Esq.

3d July 1849.

2349. Have you ever seen any means adopted there for obviating such accidents?

I have seen Mr. Fourdrinier's apparatus.

2350. In Staffordshire?

Not applied; but I believe that any apparatus of that kind might in many cases be exceedingly useful, because it is too much the practice there to draw both coal and men with single-linked chains, which I think ought never to be permitted.

2351. You mean the ordinary chain?

Yes.

2352. What should it generally be?

Either a flat rope or a flat chain, a chain of three links, where the breakage of one always shows itself. Moreover, they generally draw the men without "guides," so that accidents are exceedingly numerous; as, for instance, where a man strikes against the side of the shaft, or a piece of coal falls out upon a man at the bottom, or any other circumstances of that kind occur, in consequence of the rough mode of effecting these operations.

The Witness is directed to withdraw.

Ordered, That this Committee be adjourned till Thursday next,
One o'clock.

Die Jovis, 5° Julii 1849.

The LORD WHARNCLIFFE in the Chair.

WILLIAM PRICE STRUVÉ, Esquire, is called in, and examined as follows :

Evidence on the
Prevention of
Accidents in
Coal Mines.

W. P. Struvé, Esq.

5th July 1849.

2353. YOU are a mining engineer, and have had a good deal of experience in the mining operations of the West of England ?

I have. I reside at Swansea ; and I am a civil engineer, and coal-viewer, and a member of the Institution of Civil Engineers. I have had experience in mining for the last 15 to 20 years. I am viewer to one of the largest works in South Wales, belonging to the Governor and Company of Copper Miners, and which is now in the hands of the Directors of the Bank of England, for whom I act also. I am likewise viewer to a great number of lessors of collieries, and am very extensively consulted on mining operations.

2354. In the course of your connexion with that branch of business, have you been led to turn your attention very much to the question of the ventilation of mines ?

I have.

2355. Will you be so good as to state to the Committee, in the first place, generally, the conclusions at which you have arrived, from your consideration of that part of the subject ?

I think the ventilation of mines in South Wales (I am particularly alluding to the South Wales coal-field) is, generally speaking, very defective ; there is a very low amount of ventilation in collieries.

2356. What does that arise from principally ?

I think it arises in numerous cases from physical defects in the mines, which are very difficult to remedy, and which I do not think are capable of being remedied, except by mechanical means. In order to illustrate what I mean, I have prepared a series of diagrams, which represent upcast shafts, in order to show that there is a very important element in the ventilation by furnaces, which is the depth of the shafts. This represents a series of eight shafts—[*producing a Diagram*]—from 200 fathoms deep down to 25 fathoms, with an average temperature of 110 degrees in the upcast shaft, the downcast shafts having an uniform average temperature of 60 degrees. The dark green part of the shaft represents the amount of expansion in an upcast shaft of 200 fathoms deep, with an average temperature of 110 degrees ; and it shows how that column of expansion declines till it gets down to a shaft of only 25 fathoms deep. In the first case the amount of expansion is 19 fathoms and $\frac{5}{10}$ ths ; that is, in the 200-fathom shaft.

Vide Appendix I.
Plan, No. XV.

2357. That is to say, the prolongation of the column of air from expansion ?

Yes ; and in the 25-fathom shaft it is only a little more than two fathoms and a half.

2358. That is to say, the same expansion in two columns of those comparative lengths would produce those proportional results ?

Exactly. Alongside of these, I have prepared another set of shafts, of the same depth, in order to show the temperatures which are necessary in each of them, to keep up this amount of expansion ; that is represented by these red colours ; and
(164. 8.) here

W. P. Struvé, Esq.
5th July 1849.

here are the temperatures marked. You may take any shaft you please; here is a shaft of 125 fathoms; the temperature has to be increased from 110 degrees to 140.

2359. In order to maintain the same column of air as is produced by the 110 degrees in the deepest shaft?

Yes; and when you arrive at a 25-fathom shaft, it will be necessary then to have a temperature of 460 degrees. The object of this diagram is to show that the ventilation of shafts is not equal, except under the same circumstances of depth and temperature; that if you have not depth you must make it up by temperature; a temperature which, in many cases, will be impracticable; for instance, a temperature of 460 degrees would be impracticable; it would burn people who went to it, and destroy the shaft; a temperature of 200 degrees would be too great, and that is the average temperature, because the temperature near the furnace would be very much greater than this; a temperature of 193 is a very great temperature; a temperature of 160 is a very great temperature, but still that temperature is made use of occasionally in some of the mines in the North; the upcast shaft of the Haswell Colliery has an average temperature of 160 degrees. I wish to explain that in numerous cases in collieries the upcast shaft is very important; that it is, in fact, the gateway to the colliery, through which the men are admitted, and the horses, into the mine, as well as drawing up the coal.

2360. Is that more frequently the case than with the downcast shaft?

I do not know that I could venture to say that exactly, but in numerous cases it is so; besides which, in many pits there are brattices, and therefore, if you have a high temperature, you destroy your brattices; therefore I have estimated these shafts at 110 degrees, conceiving that to be about the fair average temperature which makes it practicable for such purposes. Now, with reference to calculating the ventilating power of a shaft in this column which is expelled out of the shaft, the velocity which the current will have will be that velocity which a body would acquire in falling through that height; that is the calculation of it.

2361. That is according to the theorem delivered in by Mr. Wood in his evidence in the year 1835?

Very much like it.

2362. That is the recognised mode of calculating the power of that expansion?

Yes; 100 parts of air will expand to 137 $\frac{5}{10}$ ths when you raise it from 32 to 212 degrees, which gives an expansion of 1.480 for every degree of temperature; that is the ground-work of the calculation. There is a formula which I have put; I do not know that it is worth troubling your Lordships with reading it; here is an explanation of it: I wish to draw the attention of your Lordships to this circumstance, particularly in Wales. The nature of our coal-field is, that we have a great many very shallow mines with shallow shafts, and therefore have not the means of having a powerful ventilation by furnaces; the stratification varies from the horizontal up to a rise of 1 in 1, and in some cases the surface of the ground rises in the opposite direction to that in which the stratification dips.

2363. Are the beds in South Wales frequently found at such an inclination as 1 in 1?

All along the south side of the coal-field they are very steep; 1 in 1 would be the extreme, but it would gradually go down from that to the horizontal. This case is a dip of about 30 degrees; the dip of a great many mines in South Wales, where the coal seam dips rapidly, and the ground rises in an opposite direction to the dip of the seam; it then becomes impracticable to sink shafts for the purpose of making a deep winning, because it would be too expensive. The mode adopted, therefore, in many cases, is to follow the seam down by an inclined plane, carrying pumps down, and drawing the coal up. Now the proper thing to do for ventilating a mine of this sort, would be to place the furnace at the deepest part of the mine; but if that were done, it would be necessary to construct a culvert all the way up, which would be very expensive, otherwise the workings would be smothered with smoke; and therefore the plan which is often adopted is to place a furnace and a small chimney at the top of the

the

the crop. Now, nothing can be more unfavourable for ventilation in a case of this sort, because you have a long upcast column below the furnace, which never exceeds the temperature of the mine, and the downcast column in hot weather may therefore be hotter than the upcast column in the mine; and such a ventilation will reverse itself. I can mention one instance of it where it did reverse itself in a colliery near Neath.

W. P. Strucl, Esq.

5th July 1849.

2364. With a furnace?

With two furnaces.

2365. Did it reverse itself in spite of the two furnaces?

Yes. I have a diagram of it, because I thought it would be an interesting illustration of the effect. This—[*producing the same*]—represents a Section of a Colliery at Britton Ferry, belonging to the Neath Abbey Coal Company; it is a vein of coal dipping at an angle of somewhere about 30 degrees; this line represents the surface; this is the upcast column for a length of, I think, about 300 yards. A furnace is placed here—[*showing the same*];—there is then a culvert carried along the surface of the hill, and another furnace is placed here; in last summer this ventilation reversed itself, and drove the men out; now it is easily accounted for. The total vertical height here is 107 fathoms. In order to illustrate it, I have assumed the temperature of the atmosphere to be 82 degrees, which is not extraordinary in very hot weather; the temperature of this upcast column below the furnace 63 degrees, and this culvert, which is heated by the furnace, I suppose to be 100 degrees; that will give a downcast reverse column of expansion of two fathoms and four-tenths. Now this is the dip of many collieries in South Wales; this is a similar dip to the Eaglesbush Colliery, but which is less in degree, to which my apparatus is applied, and which I shall have the honour of describing shortly.

Vide Appendix I.
Plan, No. XVI.

2366. If the temperature obtained from those two furnaces in that culvert was 100 degrees, and the temperature of the upcast column was 63, you would take the average?

You would then have a column of atmosphere at 107 fathoms, of 82 degrees.

2367. The average between the two?

The average between the two; and that will give you a downcast column; that will make the furnaces go downward.

2368. How comes it that with two furnaces the temperature in that culvert was not raised above 100?

I have assumed it to be that, because the furnaces are not very large; and this is all along the surface, a culvert along the side of the hill, and therefore with an extensive surface exposed to the cooling effects of the atmosphere; it was the fact that it was a downcast, and I have assumed the temperature to see if I could account for it.

2369. In order to understand such a phenomenon as that, one must take into calculation the power of those furnaces; we apprehend, from your description, that they must have been inefficient furnaces?

Yes; not very inefficient; with very powerful furnaces you might do it; when a great extent of the upcast column is below the furnace it is a very bad state of things.

2370. The temperature of the upcast column being 63, and the temperature of the downcast in this case being 82, there would remain about 19 degrees to overcome?

Yes, in the wrong direction.

2371. Then, supposing that two powerful furnaces had been applied, they would have had to overcome those 19 degrees before they could have produced the upcast current?

Exactly; but whenever the temperature of the atmosphere increased, it would always go in deduction of the ventilating power of the furnaces. Now that is a circumstance which occurs to every furnace, only the furnace cannot in some cases be overpowered. In the case of such a furnace as we have heard of from Mr. Nicholas Wood of that high temperature, it could not possibly be overcome, but still there would be always a deduction; the downcast column must unquestionably in hot weather be warmer than in cold weather; that is one unfavourable

W. P. Struol, Esq.
5th July 1849.

able circumstance of the case, and it is to be met with in numerous instances; shallow shafts, and also very small shafts.

2372. And highly inclined?

Yes; and a small area for the upcast shaft, which is another very important ingredient in the ventilation of mines. We heard, from Mr. Nicholas Wood, of an area of 150 feet; you will find some of the upcast shafts in Wales not more than three, four or five feet in diameter, sometimes more; I do not mean to say that that is so universally.

2373. Do you suppose that in applying heat to produce a current, you obtain more power in a perpendicular shaft, or in an inclined shaft, like that of which you have been speaking?

I think you get more in a perpendicular shaft; you have very much more surface to the same heat in a longitudinal shaft, and you have more friction.

2374. Do you think that the tendency of the rarefied air to rise would contribute to give more power in a perpendicular shaft than in an inclined shaft?

I think so, on that account, that there would be less surface to heat by the furnace, and less friction and shorter column.

2375. These being the conditions of ventilation in those collieries in Wales, is it your opinion that, generally speaking, the ordinary furnace ventilation is a sufficiently powerful agent to render it effective?

I think, in many cases, the ordinary furnace ventilation is not sufficiently powerful; there are some deep shafts with furnaces. I could mention one colliery, which is a very fiery colliery, belonging to Mr. Thomas Powell, of Aberdare; he has one upcast shaft there; I do not know exactly the depth, but it is a very powerful furnace; he does nothing else but use it for ventilation: then I believe the ventilation in that mine is very good; so I have heard; I have never been in the mine myself. There are exceptions to the rule, but there are numerous cases such as I have mentioned, which I do not think it is possible to remedy except by mechanical means.

2376. Then was it the conclusion at which you had arrived from an examination of these questions respecting ventilation in the collieries in Wales that led you to endeavour to devise some different method of accomplishing ventilation?

It was.

2377. Will you state the mode in which you were led to judge that the ventilation might be better effected?

In considering the principle of ventilation by furnaces, I saw that it was exceedingly limited in many cases where the shafts were shallow, and it led me to consider whether some mechanical plan could not be devised of ventilating mines, which led me to invent the ventilator, for which I have taken out a patent.

2378. Will you be so good as to describe that apparatus to the Committee?

This apparatus, which is a model, represents two pumps; they are two gasometers which move up and down in a case of masonry; the lower portion of this masonry is a tank of water; the water forms the hermetical seal which prevents the air traversing from the inside to the outside of the gasometer.

2379. You do not mean that the whole area of that cylinder is filled with water entirely?

Up to here [*showing the same.*].—There is then a cylinder of masonry coming up through the water, which admits the air to fill this gasometer, as it rises up.

2380. Then the water does not fill the entire area?

No; it fills it, except such a space as would be sufficient to admit the air into the gasometer. These pumps are double pumps; these are the outlet valves, and there are four corresponding inlet valves; you must have an inlet and an outlet valve to a pump. Then this is attached to the shaft of the colliery, and is worked by a steam engine which creates the ventilation. I can take the top of this model off, by which it will be understood a great deal better—[*The Witness does so.*].—Now that is still a pump, but this pump will only draw half the quantity

Vide Appendix I.
Plan, No. XVII.

quantity of air, I having taken off the top. As this ascends, it fills with air from the mine; as it descends, it expels the air that it has received.

W. P. Strucé, Esq.

5th July 1849.

2381. Through this valve?

Yes; it receives a quantity equal to its own bulk in this top case, and when it comes up again, it of course expels it, so that it works both ways; and it is in fact merely a hollow platform, moving in a cylinder of masonry, and in water, with scarcely any friction; the model makes a little noise, but with the machine you can scarcely hear it. The machine which I have erected at Eaglesbush Colliery has two gasometers of 12 feet in diameter each, capable of being worked to a 4-foot or a 6-foot stroke. If they were moved at the rate of 200 feet a minute, the apparatus would discharge 40,000 cubic feet of air per minute; the outside of the apparatus is constructed of masonry; all that you have here is merely a cylinder of masonry; the top is covered with wood; there are two sheives or wheels over the top, and two chains going to the steam-engine, and two cranks in opposite directions on a shaft. Those two gasometers balance each other, and descend by their own weight; in that manner a vertical motion is produced.

2382. Then do you make the upper case of these cylinders air-tight?

It is quite air-tight.

2383. Therefore the piston in rising admits air from the chamber in which it moves?

Yes; as it ascends now, it fills with air from the mine; there is the cylinder.

2384. As it descends, it drives out the current?

Yes, and the top of this chamber fills from the mine.

2385. How is it that that chamber becomes filled with the air as the piston descends?

As this ascends, this chamber fills.

2386. The moveable chamber fills as it ascends?

Yes.

2387. But as it descends, it expels the air which it has received?

Yes, and leaves a vacuum behind it.

2388. Which is filled how?

From this tube—[*showing the tube*].

2389. Filled from another passage?

Yes.

2390. Which communicates with the mine?

Which communicates with the mine.

2391. With a valve opening into the chamber?

Yes; the area of each of these valves is equal to 16 superficial feet in this case, and there are two sets open at the same time; so that there are 32 superficial feet open to receive the air of the mine, and 32 superficial feet open to let the air out of the mine.

2392. So that as they are working together, whilst the one is filling with air from the mine in its interior, the other would be filling from the air of the mine in the exterior chamber?

Exactly. This apparatus is worked by a small engine of 5-horse power, and it is one of those collieries which I just now stated was difficult to ventilate on account of the size of its upcast shaft, and the shallowness of the upcast shaft. I will give the area of the upcast shaft, for it is only 3 feet 6 inches in diameter.

2393. What is the depth?

It is about eight fathoms deep, and descends along the seam of coal about 600 yards, and it would be impossible to ventilate it by furnace: last summer they had a furnace there, and were obliged to desist working several days, the weather was so hot; the air was in a perfect state of stagnation; but since they have had this apparatus that mine is cool; they have abundance of air, and they can work in every one of the stalls without any safety lamp.

(164. 8.)

I I

2394. Is

W. P. Struvé, Esq.

5th July 1849.

2394. Is this apparatus placed over that shaft?

It is placed close to the top of the shaft, not over it; but a culvert is brought to it.

2395. Then the shaft itself is closed in?

Yes, and it drives through this small space of 3 feet 6 inches in diameter 13,500 cubic feet of air per minute; it cannot do more, as the engine is not sufficiently powerful.

2396. What is the extent of the workings of that mine?

Vide Appendix I,
Plan, No. XVIII.

The proprietors were kind enough to lend me their Colliery map, so that I might have an opportunity of explaining the whole thing to your Lordships—*[The Witness produces the same]*.—This is a Colliery, with a vein of coal about five feet thick; it dips to the north at an angle of about 1 in 6 in this direction—*[showing the same]*.—This is an inclined plane through which the coal is drawn up, and is the downcast shaft at present of the colliery. The whole of the vein of coal above here has been worked out; these are all old workings. The air descends this downcast, and then along the level heading of the vein supplying these stalls, which is where they get the coals; it traverses backwards and forwards, and finds its way down this channel, and up along this upcast passage to this point where the apparatus is fixed. The distance which the air travels, as well as I can estimate it, is about a mile and three-quarters.

2397. Does this space of old workings communicate with the passages?

They have had some difficulty in getting the whole body of air which comes out of this pit to traverse the whole of the mine, because the upper portion of the mine through which the upcast air-way passes is all worked out, and they have been to a considerable expense in plastering this air-way, so as to make it air-tight; but in extracting these 13,500 feet of air per minute through this small pit, it creates a rarefaction of about two inches and three-eighths on the average, which is about 12 lbs. per square foot; the same pressure as Mr. Wood stated was in the Hetton Colliery, and which is about a velocity of 24 feet per second. Since this apparatus has been at work, all through this hot summer, they have not lost a single day, and it has enabled them to work a larger quantity of coal, and the result is highly satisfactory to the proprietors.

2398. Can you state, during the recent hot weather, the minimum power which they have obtained from it?

The machine works regularly at about $7\frac{1}{2}$ strokes per minute, as regularly as can be; it is the same all the time; the same quantity of air is passing through, whether it is cold or hot, merely with a difference in the expansion of the air, of course, which would not be much. Then I should like to make some calculations from that, because I think it is important with regard to this invention.

2399. You state that 13,500 cubic feet per minute is what it is now drawing, and that you think that that is the utmost which it is capable of drawing through these passages?

Yes, that is the unit of the power of ventilation of a mine under these circumstances; it does not matter whether it is by this apparatus, or a furnace, or the centrifugal fan; whatever apparatus is placed there must rarefy to that extent in order to pass 13,500 feet through the mine; that is perfectly clear.

2400. Have you had an opportunity of comparing a case like that which you have been describing to the Committee with the workings in the North of England?

I have. The ventilation of the Hetton Colliery is 160,000 cubic feet of air per minute, through an area of 150 superficial feet for the upcast pit. I believe that is as nearly as can be what Mr. Wood stated. The ventilation at Eaglesbush Colliery takes out about 1-12th of the above ventilation, with an engine of 5-horse power; and at the same pressure it will, therefore, require 12 such engines and 12 such sized pits to do the same, or a 60-horse power engine in an area of 115 superficial feet. Now as the upcast pit is 150 superficial feet at the Hetton Colliery, the powers will decrease in the inverse ratio of the squares of the areas of the pits; therefore the power which will be required to drive 160,000 cubic feet of air, when brought by my apparatus through a pit of 150 feet area, will be 31-horse power; 31-horse power will be, therefore, required to take out 160,000 cubic feet through an opening of 150 feet. Now this

this amount of ventilation is more than double the average of the North ; and supposing it were required to pass through such a pit only 80,000 cubic feet per minute, it will only require one-fourth of the above power, namely, about 8-horse power, because the power will decrease as the squares of the quantities. Without going minutely into the calculation of the various sized upcast pits, the performance of the apparatus at the Eaglesbush Colliery, which at present is only developed to the extent of one-third of its capabilities, shows that a 12-horse power engine will provide ample ventilation for most of the collieries in the North of England. It is merely in that sort of general way that I wish to apply it; the element in the question is so much the area of the upcast pit, that that is in fact almost every thing.

W. P. Struvé, Esq.

5th July 1849.

2401. Have you seen your own apparatus since it has been in operation ?

Yes ; I have visited it several times since.

2402. And you have found it performing constant duty to the amount which you have stated ?

Constant duty. On one occasion I tried it with Biram's anemometer, which is a very beautiful instrument, and which was exhibited here a few days ago. I left that anemometer in the main drift which leads to the air-pumps for three hours, and the calculation by the anemometer and by this ventilator was extraordinarily near ; I forget exactly what was the difference, but it was exceedingly slight indeed, which is very interesting.

2403. Is the result to pass the air thoroughly and effectually through all these passages ?

Quite.

2404. Will you inform the Committee what the expense is of an apparatus such as you have placed at Eaglesbush ?

The expense of the whole of this complete, without the steam-engine, is about 300*l.*, and I consider that an ample estimate ; it cost them 300*l.*, and I think if they put it up again it would cost 250*l.* ; but in saying that, I include everything, all the masonry, and all the connexion of drifts with the pit ; I do not mean merely the iron part, but all complete.

2405. Do you suppose that you could undertake, in a case of this sort, to place an apparatus of that description in operation for the sum of 250*l.* ?

I should be incurring a risk ; I would not mind taking a dozen of them at 300*l.*

2406. Is the wear and tear considerable ?

Very slight indeed ; it is merely a platform going up and down in guides ; it is only a repetition of what is in action in every coal-pit in England, of a platform moving up and down in guides, through a space of four or six feet ; it does not touch the sides at all.

2407. Your estimate, of course, assumes that there is a steam-engine, which is not included ?

Yes.

2408. What would be the expense of a fan, which would produce the same amount of ventilation ; have you considered that ?

No, I have not ; the fan is a different principle altogether ; it is centrifugal. I must not say anything against the fan, because Mr. Brunton has already given his evidence upon that subject, but very likely we should differ in our opinion upon it.

2409. Practically, has not the fan in a great degree superseded every other method of introducing air, at low pressure, into furnaces, as being more economical than any other ; more economical, for instance, than an apparatus of that sort ?

The fan is used for small cupolas for melting iron, where they require a large body of air at a low pressure.

2410. But has not the fan practically superseded almost every other method, cylinders, hydraulic machines, and nearly every other in practice, being found more economical ?

I am not aware of them.

(164. a.)

W. P. Struó, Esq.
5th July 1849.

2411. The question refers to whether low-pressure air is required in cupolas ?
 In cupolas it is.

2412. And in practice it has been found more economical ?

I suppose so, since it is used; they require a larger body of air at a low pressure, and they find the fan very convenient for that purpose.

2413. If the fan, as a fact, has been found more economical than every other tried method for introducing air at low pressure into furnaces, why should not it be more economical for taking air out of mines at low pressure ?

Each thing stands upon its own merits, of course.

2414. Have you formed any estimate as to the first cost of a fan of equal power with your machine ?

I have not.

2415. Would not you require a higher pressure in this case than you would in the case of a cupola ?

No, I should think not. I should say with regard to this apparatus, that this is a perfect anemometer, as it were; it is a perfect measurer of the air; if you applied an indicator to it, you might register, of course, from one end of the year to the other, the exact quantity of air taken out of the mine.

2416. By knowing the capacity of the vessels which receive the air ?

Yes.

2417. It would depend upon the rarefaction of the air whether it were more or less according to the temperature, would it not ?

Yes, according to the temperature.

2418. It would vary according to the temperature ?

Yes.

2419. You must reduce it to a standard ?

Yes.

2420. The ordinary variations of temperature would not signify much ?

No.

2421. Supposing your machine were established for the purpose of ventilating a colliery, you could not increase its power beyond what it was originally adapted for ?

No, unless you had power in the engine; you might work it faster; you may apply this in this manner, that you may put an apparatus which would draw more air than you generally require, so as to have a surplus quantity if you should need it, and so as to have the ventilation completely under control; you might put your apparatus to work 40,000 cubic feet of air per minute, but it might be so adapted as to work 60,000, and, upon any occasion where there was a necessity for it, you might get your 60,000.

2422. In the first instance, you would consider the capacity of the mine, and adapt your machine accordingly ?

Yes.

2423. Of course there would be a maximum for the machine; then you could reduce it as much as you thought proper at any time ?

Quite so. I should also observe, that there is great facility in applying this to a pumping engine; there are many pumping engines in collieries which have plenty of power to spare, and it is only to carry it by means of a wire rope, and then you would have ventilation at once in the colliery.

2424. You have stated that at the Eaglesbush Colliery you obtain a pressure of 12 lbs. to the square foot ?

Yes.

2425. Supposing that the passages of that mine had been large, and that, therefore, it had been more favourable for drawing the air from it, what pressure do you think you could have obtained, with that machine, as it is put up at Eaglesbush, and with the engine which works it ?

Supposing another pit were sunk, and another air-passage, double the size of that, you certainly would have very nearly double the quantity of air, as the engine would then work faster.

2426. With

2426. With the same engine?
With the same engine.

W. P. Strutt, Esq.

5th July 1849.

2427. Do you conceive that the engine which is attached to the machine at Eaglesbush, which you say is 5-horse power, is capable of working it to its full power?

Yes, if you make the openings sufficiently large; it all depends upon that; that is part of the machinery in fact, and hereafter they propose bringing up another air-way, and sinking another upcast shaft, and uniting it with the machine.

2428. Supposing a favourable case of application, are you able to say what amount of power you could obtain with an engine of 5-horse power; such an engine as is placed at Eaglesbush Colliery?

On a good sized upcast pit, of something like 50-feet area, I should say the machine might very well work up to from 30,000 to 40,000 cubic feet per minute.

2429. Is that steam-engine applied to any other purpose at the Eaglesbush Colliery?

No other purpose.

2430. In order to obtain the power, which was stated by Mr. Wood as obtained by the three furnaces at the Hetton Colliery, namely, 168,000 cubic feet, you would require a very much larger apparatus than that which is established at Eaglesbush?

Yes; I should say that an apparatus of about 25 feet in diameter would do it.

2431. Then the cost of it would be proportionally larger?
Decidedly.

2432. The diameter in the Eaglesbush apparatus is 12 feet?
Yes, of the machine.

2433. That would enable you, according to the statement upon this paper, to obtain 45,000 cubic feet per minute?

Yes, when these things move at the rate of 200 feet per minute.

2434. You call the diameter of the machine the diameter of the piston?
Yes.

2435. With a diameter of 20 feet, you obtain, according to this table, something more than 125,000 cubic feet of air per minute?

Yes.

2436. That is still under the quantity obtained at Hetton by the three furnaces?

Yes.

2437. Supposing, then, that you were to fit up an apparatus capable of obtaining 168,000 cubic feet, could you say at all what would be the expense of such an apparatus?

I suppose it would be about two 25-feet pumps; I should say so off-hand by looking at that table; with engine and all, I should think it would cost 1,000 *l.* to 1,200 *l.*

2438. What power of engine would be required in that case, do you suppose?

I beg your pardon; I beg to correct myself; I calculate a 30-horse power engine; I should say it would be from 1,500 *l.* to 2,000 *l.*

2439. Including the engine?
Yes.

2440. And taking 25 feet diameter?

Yes; I think we ought not to reckon less than that.

2441. That will be necessary in order to accomplish the ventilation which is obtained in the Hetton Colliery by the three furnaces?

Yes.

W. P. Strucké, Esq.

5th July 1849.

2442. When you say 25 feet diameter, what is the extent to which you drive the piston?

Four feet; it can move six feet.

2443. And how often is the stroke repeated?

With a 4-foot stroke, the machine at Eaglesbush Colliery makes $7\frac{1}{2}$ strokes in a minute.

2444. Supposing a machine were put up of 25 feet diameter, such as you were proposing, would you also increase the length of the stroke?

I should think a 6-foot stroke would be a very proper stroke indeed.

2445. With a 6-foot stroke, how many would you have in a minute?

It may work 200 feet a minute; that apparatus at Eaglesbush only develops itself to one-third of its capabilities, in consequence of the smallness of the shaft; if it is a 6-foot stroke, it may work about 16 strokes a minute.

2446. Supposing there were a piston of 25 feet diameter, and it were elevated at every stroke 6 feet, how many strokes would it make in a minute?

If it were worked at the rate of 200 feet, which it might do, it would be 16 strokes a minute. I should observe here, with regard to that upcast shaft which is alluded to by Mr. Nicholas Wood, that a shaft with such a temperature as that would be useless for men to go through; they could not go through it, nor would such a temperature do in a bratticed pit; it would burn it.

2447. When you speak of that, do you mean the 160 degrees of temperature?

Yes, 160 or 140 would be too high; it would be upwards of 200 near the furnace.

2448. Does that relate to the common mode of furnace?

Yes.

2449. Your evidence relates to the furnace?

Yes. Mr. Buddle, in his evidence in July 1835, before the Select Committee, states the expense of the upcast shaft from the furnace to be, he estimates in some cases, 1,500*l.* per annum from the injury to the upcast shaft.

2450. From the heat?

From the heat; the whole of the tubing of the Haswell pit from that circumstance had to be removed; it was converted into plumbago, carbonate of iron.

2451. Was that supposed to be caused by the heat?

All I wish to imply is, that if the furnace had been removed, that circumstance would not have occurred.

2452. What effect would be produced by Mr. Gurney's steam-jet?

I do not know what the effect of a large quantity of steam would be.

2453. It would not produce the same effect?

I do not know; it has a very decaying effect upon ropes; I have seen that.

2454. Is it your opinion that the smoke alone would produce the effect which you have described to have been produced at the Haswell Colliery, without there being a certain temperature, a certain heat?

I know the furnace has this effect upon a flat chain, that in the upcast pit a flat chain will last only three or four months, whereas in the downcast pit it will last more than 12 months.

2455. That you know from your own experience?

Yes.

2456. What is the effect upon the chain in the upcast shaft?

It corrodes it, and makes it almost rotten.

2457. Can you state at all from what that arises?

I suppose some sort of oxidation goes on, for one thing; it is a chemical combination of the fumes which are thrown up by the furnace, I should think, with water; there are carbonic acid gas and sulphur thrown up.

2458. Would not the agency of water, apart from other causes, be the same in either the upcast or the downcast shaft?

Yes; apart from other causes.

2459. How

2459. How does the smoke pass off in your apparatus from the furnace?
There is no furnace at all.

W. P. Struot, Esq.

5th July 1849.

2460. Is it at the top or bottom of the pit?

At the top of the pit, and therefore there is nothing objectionable in the upcast shaft.

2461. The Eaglesbush Colliery is the only colliery in which it has been practically applied yet?

It is so.

2462. Do you think it equally applicable to coal mines in other parts of England of other descriptions?

To any coal mine; it does not matter what the coal mine is at all.

2463. In addition to the power of ventilation which you obtain by this machine, do we understand you rightly, that you conceive that the absence of heat as an agent is one of the great recommendations of it?

Certainly; and that you can get any amount of rarefaction in the mine; that you may increase or diminish your ventilation as you please, and that it cannot be affected by any change in the atmosphere, either thermometrical or barometrical.

2464. This apparatus is capable of any extension?

Yes.

2465. The only question, therefore, as far as relates to it, would be the expense?

It would be only a commercial question.

2466. With respect to the workings in South Wales, as you have extensive acquaintance with them; can you say whether they are, generally speaking, dangerous mines in respect of explosive gas?

Some of the veins are more fiery than others; this Eaglesbush vein is rather a fiery vein, but not very fiery. If you were to allow this colliery to stand still for 24 hours, all these stalls would fill with fire-damp; in some other cases it would not be so.

2467. Do you think that in a mine worked like that at Eaglesbush, with an apparatus such as yours, it is rendered altogether secure from accident, or would it be still possible that accidents might occur in it?

I should think it would be very difficult for accidents to occur. Your Lordships are aware, perhaps, that an accident did occur in this colliery.

2468. That was before your machine was applied to it?

It was, and it was in consequence of that, that they did apply the machine. On that occasion there was a large accumulation of gas in the old stalls, and the explosion took place in the far end, and that brought the whole of the fire-damp in these stalls in contact with this explosion somehow or other, and they had a second explosion, and it was of a very serious character. Most of the men who died were killed by the after-damp, and numbers of them were found along this level heading, trying to get out, but they were prevented by the waggons on the road; if the waggons had been away, numbers of them would have got out; the ventilation was destroyed. I believe there was no furnace whatever; I believe it was natural ventilation. Now if my apparatus had been there, the same current of air would have continued along this level heading; it would not have been prevented there.

2469. The ventilation would not have been stopped there?

No; and all those men's lives would have been saved.

2470. It did not depend upon any partitions which had been destroyed?

It would in the stalls in forcing the air up and down; but it was along this level heading that the men were destroyed, and it is along that level heading that the air traverses now; so that if an explosion took place here, or even any sudden eruption of carbonic acid gas into the works, still this current of air would sweep it away.

2471. Are most of the mines in South Wales arranged upon a plan similar to this?

(164.8.)

I I 4

Sometimes

W. P. Struvé, Esq.

5th July 1849.

Sometimes the two shafts are together, and sometimes they are a long distance apart. I think it an advantage when they are a long distance apart with an apparatus of this kind, because even supposing that all the stoppings were knocked down, the apparatus still working, there would be a current of air in some direction through the mine, and if anybody got into that current he would be safe.

2472. You think, then, that in the arrangements of a mine, one point of importance is to have the two shafts at a considerable distance from one another?

I think it is an advantage, because with the furnace under-ground, when all these stoppings are blown down, of course the mine beyond the circulation of the air will fill with fire-damp if it is a fiery mine. The furnace then becomes very dangerous under-ground, and very often they are obliged to put it out, and it takes some time to recover the mine; but with this apparatus there will be the same body of air passing through some direction of the mine, and the men would be safe who got into it.

2473. Have you been down any mine during the action of this machine?
I have.

2474. Does it produce a current inconvenient to the working?

No; where the current is concentrated, it is very strong; you could not keep a candle there. There were a number of magistrates of the county and gentlemen of influence who came to visit the operation of the machine. I was anxious that they should see the effect of exploding gunpowder; we put some gunpowder at some distance from the machine, about 400 yards under-ground; we wanted to time it to see its velocity; we had a string, and gave the signal, but the explosion did not take place at the time agreed on beforehand, and we did not know the reason of it. The men, when they came up, told us that they could not get the powder to stand; that it was blown away by the current as soon as it was put on the ground, and that they were obliged to damp it; but as soon as it was exploded, the machine swept it away almost immediately through its valves. They are always obliged to use a lamp; they cannot use a candle in the current; it would almost kill a man if he remained there half-an-hour, it is so cold.

2475. What is the rate of that current?
About 24 feet per second.

2476. What do you consider the greatest velocity of current consistent with the convenient working of the mine?

I think along any of the air-courses a current of about four feet a second is a very nice current; that is a very strong current; it would blow your candle out if you walked against it.

2477. In South Wales, is the system of working what is called the "post and stall system" in the North?

I believe in the North they leave half their coal behind, leaving large pillars. In South Wales, as far as my experience goes, it is rather different; the mode is to turn a stall, and drive that stall up 60 yards, at distances of about 12 yards, leaving a wall of about 8 or 10 yards between each stall; after they have driven up the 60 yards, they then bring back the whole of the pillars to within about 10 yards of the level heading, it being left as a support for that level heading; they proceed in that manner till they get to the extent of their working, and then they pull back all those pillars along that level heading, if that level heading is not required for any ulterior purpose.

2478. So that they get out the whole of the coal?
Very nearly the whole of it.

2479. Do you know the system adopted in Shropshire, called the "long wall system"?

I believe it is used in some parts of Wales, but not generally.

2480. Have you ever seen it in operation?

I have seen it in the Forest of Dean, but not in Wales. I know it is adopted in some parts of Wales.

2481. Do-

2481. Do you conceive it to be applicable in Wales?

In some cases it would do, I suppose, but not in all; it depends upon the circumstances of the roof, and one thing or another.

W. P. Struvé, Esq.

5th July 1849.

2482. Do you think that, where it is applicable, it is an advantageous mode of working coal?

I should think so.

2483. Should you say that it was likely to secure the workpeople against another class of accidents, namely, from the falling of the roof?

I do not know. In well-conducted collieries they generally timber their stall very well. There are some cases I have known where collieries are let out by contract, which I consider a bad system. The colliery proprietor lets it out to some contractors, to work the coal and deliver it at so much per ton. I have seen cases where those contractors, not being men of any capital, have only looked to get as much coal as they possibly could, and have ruined the colliery; they have been sparing of the timber; but where a mine is well conducted by the proprietors themselves, with an under-ground foreman, I have seen some exceedingly well-timbered mines; I think those are sorts of cases of real neglect where any accidents to any extent occur in that way.

2484. Accidents from the falling of the roof?

Yes; I think it is the interest of the mine proprietor to timber his works well, and to make them strong.

2485. And if proper precautions are taken in that way, can those accidents be generally avoided?

Yes, I should think so.

2486. Are there many actually occurring in South Wales?

Occasionally you hear of accidents of that sort; there are many cases of burnings occurring which you never hear of, because unless a man is killed, there is no coroner's inquest.

2487. From what you have told us, we suppose that the accidents from the breaking of ropes are not frequent in Wales; the method by which the coal is obtained is not by deep shafts?

In some cases they are deep shafts; some accidents occur in the breaking of ropes; one very serious accident occurred lately in Mr. Powell's colliery; several men were killed.

2488. Have you ever given any attention to Mr. Fourdrinier's invention for preventing those accidents?

I have not seen it in operation; I have seen his model; I think it very ingenious.

2489. You mentioned that an accident had occurred recently?

At the beginning of last year; there were 22 men killed by an explosion of gas at the Eaglesbush Colliery, I think.

2490. Do you know enough of the history of that colliery to say how frequently those accidents have occurred in the last 20 years?

Several accidents had occurred previously to that accident.

2491. Of a fatal kind?

Of a fatal kind; and it was in consequence of that that the jury requested an Inspector to be sent down; they wrote to Sir George Grey, because so many accidents had occurred.

2492. When was your machinery first put to work?

Last February.

2493. Has there been no accident of any kind since?

None whatever.

2494. No burning?

No burning whatever.

2495. Do they usually work with the Davy lamp?

Since the apparatus has been at work they do not use the Davy lamp in the stalls; before, they were obliged to do it.

(164. 8.)

K K

2496. Generally

W. P. Struot, Esq.
5th July 1849.

2496. Generally speaking, considering the amount of inflammable gas in the mines of Wales, do you consider that a current of 13,500 cubic feet of air would be sufficient to keep those mines in proper ventilation ?

I think not ; it depends upon the quantity of coal you work. I have drawn out a statement of what I think ought to be the proportion of ventilation. I think that the ventilation ought to depend altogether upon the number of men employed in the mine, and I have made out a sort of statement ; if your Lordships will permit me, I will read it.

2497. Why does the ventilation depend upon the number of men ; will you explain that ?

It depends upon the quantity of coal ; you must have so many men to work that coal.

2498. Does not it depend upon the quality of the coal ; the quantity of gas that is extricated ?

No doubt ; and I have divided it under three different heads ; I have given the quantity for a very fiery colliery, for a colliery moderately fiery, and for a colliery with a small amount of fire-damp, and which is the lowest amount of ventilation which ought to exist, in my opinion, in any mine.

The following Paper is delivered in :

ESTIMATE of the Amount of Ventilation, in Cubic Feet per Minute, necessary for the Safety of Coal Mines under different Degrees of Fire-damp ; calculated with reference to the Number of Men employed. It is assumed in this calculation that 80 Men and Boys, on the average, exclusive of Horses, are necessary to be employed in a Mine, in order to obtain 100 tons of coal per day.

| Quantity of Coal worked per Day. | Quantity of Coal worked per Annum. | Number of Men employed under-ground. | A Fiery Colliery, 300 Cubic Feet per Minute per Man. | Moderately Fiery Colliery, 150 Cubic Feet per Minute per Man. | A Colliery, with a Small Amount of Fire-damp, 100 Cubic Feet per Minute; and which is the lowest Amount of Ventilation which ought to exist in any Mine. |
|----------------------------------|------------------------------------|--------------------------------------|--|---|--|
| To 50 tons | 15,000 | 40 | 12,000 | 6,000 | 4,000 |
| To 100 " | 30,000 | 80 | 24,000 | 12,000 | 8,000 |
| To 150 " | 45,000 | 120 | 36,000 | 18,000 | 12,000 |
| To 200 " | 60,000 | 160 | 48,000 | 24,000 | 16,000 |
| To 300 " | 90,000 | 240 | 72,000 | 36,000 | 24,000 |
| To 400 " | 120,000 | 320 | 96,000 | 48,000 | 32,000 |
| To 500 " | 150,000 | 400 | 120,000 | 60,000 | 40,000 |

2499. How does the quantity of coal enter as an element into that calculation ?

The more coal you work, the greater extent of surface, of course, you open for the gas to exude.

2500. What sized machine of your construction would be required for that largest quantity ?

Two 20 feets would do it.

2501. What would be the expense of that ?

I should think, with the engine and all, it would be perhaps from 1,000*l.* to 1,500*l.* ; for a less quantity it would be less.

2502. About what would be the annual expenditure of keeping that machinery in repair ?

The

The pumps themselves create very little wear, for it is nothing but a platform moving in a guide. I should think it would be about 250*l.* a year, working and everything, coal and all.

W. P. Struvel, Esq.

5th July 1849.

2503. And the wear and tear and the injury to the machine?

Yes.

2504. In that case, how often would it require renewing entirely; in 10 years? Possibly so; I do not know exactly.

2505. Once in 10 years?

The airometers once in 10 or 12 years.

2506. And 250*l.* a year to keep it up

Yes.

2507. And from 1,500*l.* to 2,000*l.*, the original cost?

I should think 1,500*l.* would do for two 20 feet for a ventilation of 120,000 cubic feet of air per minute.

2508. What horse power?

I should think it would be about a 15 to 20 horse engine for a ventilation of that kind; it depends upon the size of the pits most completely.

2509. Against that annual expense, are we to understand that you would set the saving caused by the absence of heat as an agent?

Yes, and the certainty of your ventilation, having it completely under control; but for a ventilation of about 50,000 to 60,000 cubic feet per minute, I should think the apparatus would not cost more than 500*l.*

2510. In applying this apparatus to a working shaft, would it not be necessary to make a side passage?

Yes; and the manner in which I do it is represented in this drawing. This represents a shaft through which you raise the coal; it is a shaft with guides; I have two covers which always cover up the pit; the pit is always covered up; when the waggon ascends, the platform upon which the waggon stands enters this tube, which is merely a tube made of timber, coming down about 6 or 7 feet before the top strikes this cover off: so that it is still closed, and they can raise the coal to the shaft without opening it, in fact, practically speaking. When it descends, that cover drops into its place, so that it is impossible for any man to fall into the pit; it is always closed; the rope works through it. With respect to the valves of my apparatus, if you pull one of the valves off when it is at work, it scarcely affects the machine, the body of air is so enormous.

*Vide Appendix I.
Plan, No. XVII.*

2511. Supposing a heavy pressure to be put upon a machine of this kind, tending to exhaust the passages of the mine, would not there be a considerable pressure of the atmosphere upon any opening of this kind?

Of course there would, but there would be only the usual pressure in the mine; for instance, 6 inches of water would be a tremendous pressure; it would give you a hurricane in your mine.

2512. That would not constitute any practical difficulty in raising these coverings?

None whatever.

2513. With respect to the management of the mines in Wales, in point of superintendence, what are the class of men who are employed to superintend the workings of the mines?

In some of the large collieries there is generally a head man, who is rather a superior man, and there are a number of inferior men under him, perhaps men who can scarcely write.

2514. They are taken from the workmen?

Yes; clever practical fellows, some of them very much so.

2515. Is the head man a man of education?

Some education; he can read and write; in some cases not much education; but there are some well-educated men.

W. P. Struvc, Esq.
 5th July 1849.

2516. Are they acquainted at all, do you think, with the principles of the operations which they have to superintend ?

Some of the superior men are, but I should say that there was a deficiency with respect to the inferior men.

2517. Are you of opinion, from your communication with them, that further education would be an advantage to those classes ?

There can be no doubt of it, and I think they would very much appreciate it ; some of them are very intelligent men, naturally so.

2518. Desirous of instruction ?

Very much so indeed.

2519. Have you ever conversed with any of the managers of mines, as to the expediency of some superintendence on the part of Government ?

No, I have not had much conversation, but I do not think it would be objected to, if it were a very moderate inspection, if it did not at all interfere with the management of their mines.

2520. Supposing that Government were to appoint Inspectors or Commissioners, with no power beyond that of inquiring into the condition of the mine, as regards the element of security, and of inspecting plans for that purpose, do you think there would be generally in South Wales much objection felt to any such powers as those ?

I do not think there would. There is a sort of inspection which exists at present on the part of the landlord, and with very stringent covenants, in every lease. For instance, I have a power of going into numerous mines for landlords, under the powers of their leases, to see that they are worked properly, and to inspect their plans, and to take copies of their plans ; still it is not found that that is any practical inconvenience, I think.

2521. It is acquiesced in ?

Yes ; it is always a covenant in a lease.

2522. That is an inspection that no injustice should be done to the landlord, in what is technically called robbing the pit ?

Exactly.

2523. That is an inspection which the lessee could not resist ?

The lessee could not resist it.

2524. Does it stand precisely upon the same footing as an inspection by Government, for the purpose of securing the safety of the workpeople ?

I do not think it does stand exactly upon the same footing.

2525. But would there be any objection to an inspection by Government officers, merely to see the state of the mine and its facility for ventilation, and other circumstances of that nature ?

I should think not.

2526. And to give advice ?

And to give advice. It would have a very good effect in this way : supposing I was an Inspector, and went into a mine and found the ventilation very defective, most probably I should make a representation upon it ; perhaps the proprietor would say that he did not agree with me ; he might say, " I think my mine very well ventilated ;" there is a difference of opinion, and it rests there. Perhaps an explosion takes place, and there is a coroner's inquest ; the Inspector is called upon to say whether he has examined that mine, what was the state of it when he did examine it, and whether he has examined it since, and the state then ; that bears upon the point very materially.

2527. And whether he communicated the result of that inspection to the owner, so as to render him responsible ?

Precisely ; I think that inspection to that degree would be of very great benefit.

2528. And do you imagine that it would also be beneficial in facilitating the communication of knowledge in the different districts ?

I think so, and that it would be appreciated ; in the end the Inspectors would
 of

of course have access to the best information in the country, and very great benefits would result from it, in my opinion.

W. P. Struvé, Esq.

5th July 1849.

2529. Would it have the effect in a very little time of showing what was the best system of ventilation?

Yes; it is wholly a commercial question, I think, with regard to ventilation; I think every colliery manager should do as he pleases, provided he produces ventilation.

2530. Should you say that it was for the interest of the colliery owner to ventilate his mine properly in an economical point of view?

I think so, and I think if one colliery owner had it well done, it would be very readily followed by another.

2531. Do not viewers frequently disagree upon the best mode of ventilation of mines?

Yes; they may do so, but I do not think that viewers can differ as to the amount of ventilation; if two men go into a colliery, and find that there is no ventilation, I do not think there can be a difference of opinion upon that point.

2532. Where a mine is to be ventilated, do not viewers disagree as to the mode of executing it more or less?

Perhaps they may, but then I do not think that that difference of opinion is of much consequence, if there is ventilation created by the plan adopted.

2533. It may make a great difference in point of expense?

Yes, it is merely a commercial question.

2534. Supposing the Inspector were to enter one of those mines of which you have been speaking in South Wales, where the ventilation amounts to nothing, where it is left to nature, and it is sometimes stationary and sometimes reversed, and the Inspector were to report that state of things, and observe upon it to the colliery owner, do you conceive that in that case there could be any difference of opinion between any two Inspectors as to the danger of leaving a mine in that condition?

I should think not.

2535. Are you acquainted with the mode of ventilating mines in Belgium?

I am not; I have been in Belgium, but I have never visited any of the mines.

2536. The Inspector would not prescribe the mode of ventilation; he would merely represent the insufficient ventilation, leaving it to the coal-owner to determine the best mode, according to his view, of producing the necessary ventilation?

I should think so.

2537. Have any applications been made to you to apply your machine to any other mine, except the one you have mentioned?

Yes; I have had some applications, but it is not quite decided on.

2538. Was there an inspection of your apparatus at Eaglesbush Colliery in April last, by several gentlemen connected with the mining interest from the town of Swansea?

There was.

2539. What was the result of that inspection?

That it was highly satisfactory to all those who were present.

2540. Were there scientific men among them?

Several scientific men and practical men.

2541. Was the machinery at work at the time?

It was; and it is so constructed that you can go all through it whilst it is at work; I had it all lighted up with large lamps, so that it could be well seen.

2542. Is there any other point upon which you wish to make any observations to the Committee?

I should say, with reference to the ventilation of mines, there is one point which I should like to observe upon; I have experienced sometimes in mines this sort of circumstance; I have said to the men, "The air is very bad here;

W. P. Struck, Esq.

5th July 1849.

you want better air here, my boys." The reply has been, "If you bring in more air, sir, we shall have an explosion." Now that could only arise from one of two or three circumstances, either that there was such a quantity of carburated hydrogen as was beyond 32 per cent. that it would not explode, or that it was an explosive atmosphere vitiated by carbonic acid gas in small proportion; about 14 per cent. will do it, and 16 per cent. of nitrogen will also vitiate and destroy the explosive quality of an explosive atmosphere. Now, I recollect once being in a mine near Pyle in Glamorganshire; I made the observation to the men that the air was very bad; it was heavy, and a candle did not burn brightly, but still there was no fire-damp. The next morning I was at the place again, but I did not go down; they told me that an explosion had taken place there, and they could not account for it. Now I think it may be accounted for in that way, that the atmosphere of mines is in that state sometimes, and if those proportions become altered by some alteration in the ventilation, you have an explosion without knowing the cause of it.

2543. What inference would you draw from that?

That the mine is not sufficiently ventilated.

2544. You think that an accident from such a cause as that would be obviated by keeping up a continual current?

Nothing but that can do it.

The Witness is directed to withdraw.

T. E. Forster, Esq.

THOMAS EMERSON FORSTER, Esquire, is called in, and examined as follows:

2545. YOU are an extensive viewer of collieries in the counties of Northumberland and Durham?

I am.

2546. You are a manager of certain collieries yourself?

I am.

2547. Have you had long experience in that branch of business?

Thirty years.

2548. Entirely in the northern district?

Yes, except in Lancashire.

2549. And in Lancashire also?

Yes; I have the inspection of a colliery there just now, and have had for the last two years.

2550. From your experience in these matters, how far do you conceive it possible, by any precautions, to diminish the number of accidents occurring in coal mines?

It is only by a good state of ventilation that they can be diminished.

2551. You think there is no other method by which you can proceed, except by improving the ventilation?

That is the only thing.

2552. In consequence of that opinion, have you ever directed your attention very closely to the question of ventilation?

I have.

2553. In what collieries have you pursued your inquiries upon that subject principally?

In the Seaton Delaval Colliery, and the others of which I have the charge in the neighbourhood.

2554. Is the Seaton Delaval Colliery under your management?

Entirely.

2555. Before you introduced any improvements there, what was the condition of the ventilation in the Seaton Delaval Colliery?

The Seaton Delaval Colliery has four downcast shafts, each of eight feet diameter,

diameter, with two upcast shafts, one of them nine feet, and the other eight feet diameter, used exclusively for the upcast. *T. E. Forster, Esq.*

5th July 1849.

2556. The downcast being used for working also ?

For working the coals. The depth of the shafts is 636 feet, with the exception of one of the upcasts, which is only 558 feet.

2557. All the others are of the same depth ?

Yes; the furnace was placed near to the bottom of each of the upcast shafts.

2558. Two furnaces ?

Two furnaces; one at each shaft, 10 feet in width, having 50 square feet of fire surface.

2559. The two ?

Each of them.

2560. And consuming how much fuel in the 24 hours ?

I will mention that afterwards. The distance that the air travelled was in one of the currents two miles and sixth-tenths, and in the other stream two and a half miles.

2561. What were the dimensions ?

They vary very much.

2562. Cannot you give us the average ?

About eight feet by six; 48 or 50 feet area. By that means the greatest quantity of air that I could possibly obtain by the furnaces was 53,058 cubic feet per minute; and in consequence of having to work an immense quantity of the pillars, I found that that was not sufficient; the gas made its appearance at the edge of the goaves. I have brought the plan up, that your Lordships may see it exactly.

2563. All the six shafts were very near together ?

Yes.

2564. What was the extreme distance between any two ?

About 250 yards between the two furnaces.

2565. What would be the greatest distance between the furthest downcast and upcast ?

About 250 or 260 yards. The air descends these shafts in this direction—[*showing the same*]—and returns and comes along to this point—[*the Witness explains the Plan*];—the distance of these shafts from the furthest extremity is about a mile and a quarter. All these black portions are entirely exhausted, and there we have frequently seen the gas making its appearance at the edge of the goaves, having no means of forcing the air into them.

2566. The ventilation does not reach there ?

It cannot reach it.

2567. In the former condition of the colliery, then, there were two furnaces to ventilate the whole of the workings ?

Yes.

2568. Have those pillars been worked backwards; have you taken the pillars away ?

Entirely.

2569. By means of those two furnaces you stated that you obtained a ventilation, at the greatest, of 53,000 cubic feet ?

Of 53,058 cubic feet per minute.

2570. Did that amount of ventilation prove sufficient for the workings of the Seaton Delaval Colliery ?

No, it did not; the gas, as I said before, frequently showed itself in the returns at the edge of the goaves, which is not at all comfortable.

2571. What rapidity of current did you get ?

It varies from 6 feet to 17.

T. E. Forster, Esq.
5th July 1849.

2572. It varies according to the section?

According to the section and the distribution of the air.

2573. What is the utmost rate of current with which you think it is possible to work the mine?

In the workings themselves, I think if we had about eight or nine feet per second it would be quite ample.

2574. Is it possible to work under a current of eight or nine feet?

Yes, I have no doubt of it.

2575. Not with candles?

With candles; the men screen them.

2576. But, practically, it is possible to work under a current of from eight to nine feet per second?

Yes.

2577. Finding these 53,000 cubic feet per minute an insufficient ventilation, what steps did you take for improving it?

Having been up in London, and heard a lecture at the Polytechnic on the steam-jet as applicable to the ventilation of coal-mines, I turned my attention to it, and introduced Mr. Gurney's plan.

2578. How long since is that?

It was in June when I was up here, and I got it fairly into operation in November 1848.

2579. Had you tried any other contrivance before you adopted Mr. Gurney's? No, I had not tried any other plan.

2580. Will you describe the mode in which you applied Mr. Gurney's ventilation?

This is a plan of it—[*producing the same*];—we had an engine near the bottom of the eight feet upcast shaft, for the purpose of hauling the carriages which contained coals from the extremity of the workings, as a matter of economy, to save horses; and having that engine there, I took a pipe from one of the boilers to the bottom of the shaft, about 35 yards from the upcast shaft, and from that I put smaller pipes radiating from the centre, and put my jets into various parts of it, obtaining 25 jets.

2581. How did you fix that apparatus without interfering with the workings of the shaft?

It is exclusively for an upcast shaft.

2582. Then one upcast shaft is exclusively appropriated to ventilation?

There were two at that time.

2583. You stated before that there were two upcast shafts?

Yes.

2584. Was one of those entirely appropriated to ventilation?

Both of them.

2585. Then had you eight jets?

Twenty-five jets; three in each pipe, and one in the centre.

2586. Eight arms, and three jets in each arm?

Yes.

2587. Was this apparatus placed quite at the bottom of the pit?

Just above the furnace drift.

2588. And had you sufficient spare steam from the boiler of your engine to be able to supply what was necessary for those jets, besides the working of the engine?

Quite sufficient; we had two large boilers.

2589. What is the horse-power which you considered requisite to apply to these jets from the boiler?

I could not exactly state that, because the engine is working constantly during the day in doing its ordinary work, and working the steam-jet also.

2590. Were

Viue Appendix I.
Plan, No. I.

2590. Were those boilers from which you derived this steam originally very much larger than was required for the engine? *T. E. Forster, Esq.*

Yes, they were very much.

5th July 1849.

2591. For what reason were they made so much larger?

Because we always like to have plenty of spare power.

2592. Is that usually the case with respect to the boilers and engines of collieries?

Always about our collieries; we generally have a spare boiler.

2593. Do you apprehend that, generally speaking, there would be the same facility of applying any contrivance of this sort by means of the ordinary boilers of the engines?

I should think, in nine cases out of ten, there would.

2594. Will you proceed to describe the operation of the apparatus as you placed it in the Seaton Delaval Colliery?

After the steam-jet was got into operation I obtained 79,359 cubic feet per minute. I think I should also mention that the furnace at the other shaft was still continued; but having taken the air very carefully before the steam-jets were put up, ascending each of the upcast shafts, I then measured the quantity of air after the steam-jets were in operation, and I found that the increase was entirely due to the steam-jets.

2595. How did you measure the quantity of air?

The best mode that we have yet discovered to measure the quantity of air is by exploding a little gunpowder, and taking the time that it is in travelling a certain distance.

2596. And then calculating by the area of the passage?

Yes; there is no friction there. The anemometers are very good things as approximating to the quantity, but they are not correct at all, because they have so much friction.

2597. Did you apply the same mode of measurement to both systems of ventilation?

The same mode.

2598. And from the results of the numbers which you have stated, you obtained an increase of about 26,000 cubic feet by applying the steam-jet?

Yes; I have obtained a larger quantity since that.

2599. How much?

I ought to state that I made several experiments. Mr. Gurney was so good as to come down, at a great expense to himself, to give me all the assistance in his power, and we tried several experiments at the other upcast shaft; but we had not a high-pressure boiler there; it was merely a low-pressure boiler, with which we could not get more than about 15 lbs. to the inch, and which was at the surface; therefore I do not think it would be right to take that as a fair trial.

2600. With respect to the 79,000 cubic feet; with what pressure upon the boiler is it that you obtained that?

Thirty-three pounds; since that I entirely set the furthest upcast shaft aside; I put the furnace out, and closed it up, and I have had nothing but the 25 steam-jets at the bottom of the 8-foot shaft, and have obtained from them alone 85,690 cubic feet per minute.

2601. Then one shaft has been disused as a ventilating shaft?

It is disused at present.

2602. And you obtain from one single shaft, by the aid of these steam-jets, a current of 85,000 cubic feet; whereas the greatest which you obtained with your two furnaces was 53,000?

That is the fact. After having found that we got too large a quantity by the steam-jets alone, and with only one upcast shaft, I thought that I would try the furnace alone at the same upcast shaft, and I ceased the steam-jets and

(164.8.)

L L

lighted

T. E. Forster, Esq.

5th July 1849.

lighted the furnace; the fire was driven hard for two days, and I then measured the quantity of air; it only gave me 48,760 cubic feet per minute.

2603. With one furnace?

With one furnace, which gives an increase of 75 per cent. in favour of the steam-jets.

2604. How long have these steam-jets been in operation?

Since last November.

2605. Do you consider the experiment now to have been complete?

I am perfectly satisfied with it; so satisfied am I, that I am now preparing it for a pit in Lancashire, where it is impossible to place a furnace, the discharge of gas is so immense; the men are working with the lamps, and very frequently the gas discharges so rapidly that it fills the lamps, and they get full of fire.

2606. In that case, where do you intend to place your boiler?

I intend to take the stream down from the boiler on the surface to the bottom of the shaft, and put jets into the furnace drift.

2607. Have you ever tried applying the jets at the surface?

Yes; that was one of the experiments with the low-pressure boiler; it was not so satisfactory.

2608. Have you ever tried the high-pressure boiler at the surface?

No; I have not had an opportunity of trying it.

2609. Applying the low-pressure at the surface would hardly be a fair experiment?

No.

2610. Is it as effectual when you drive it down, as when you drive it upwards?

It is by taking the stream to the bottom of the upcast pit, and putting the jets on, of course.

2611. Have you ever calculated what the expense of your ventilation by the furnaces was?

Yes; perhaps it may be interesting to state that the space in the galleries or excavations through which the currents of air pass in the Seaton Delaval Colliery is 7,249,536 cubic feet.

2612. That is the entire distance?

Yes; those are the entire excavations which this quantity of air has to pass through between going down the pit and ascending.

2613. You have mentioned two currents; one of two miles and six tenths long, and another of two and a half; the other you did not mention?

The other is a very short distance; perhaps about half a mile.

2614. So that the entire distance would be between five and six miles?

No; the entire distance is only two and a half miles, because the current is divided; each current only goes two miles and a half, or two and six-tenths.

2615. The question refers to the aggregate distance; the aggregate distance ventilated would be between five and six miles?

Yes; now the expense of erecting one of those furnaces at the Seaton Delaval Colliery was 212*l.* 10*s.* 6*d.*

2616. Each?

Yes; and the annual cost of working each of them 267*l.* 10*s.*

2617. That is, the wages of the engineer and the consumption of coals?

The wages of the furnace-men and the consumption of coals, and the repairs necessary to the furnace.

2618. What should you state the consumption of coals at?

The consumption of coals in one year is 1,693 tons.

2619. In each or both?

In each furnace.

2620. What

2620. What do you estimate the coals at upon the spot?
Two shillings and three-pence a ton.

T. E. Forster, Esq.

5th July 1849.

2621. That is the refuse coal?
The refuse coal.

2622. Then, in fact, the annual cost of each furnace was 267*l.* 10*s.*, and the interest of 212*l.*?

Yes.

2623. Therefore the whole expense for ventilating was double that amount?

Yes; then my opinion is, that the cost of erecting a boiler, with the necessary apparatus for a steam-jet which would give me a quantity of 85,000 feet of air per minute, is 172*l.* 15*s.*

2624. For the machinery?

The boiler, the pipes and apparatus for the steam-jets, and the cost of working it, is 216*l.* 17*s.* 11*d.*, working, and coal, and every thing about it.

2625. What is the aggregate difference?

It is 56*l.*; that is to say, reckoning one furnace. I see I have put down the summary. It appears from these figures, that a furnace to give 48,760 cubic feet of air per minute will cost in erection 212*l.* 10*s.* 6*d.*, and the annual expense of working it will be 267*l.* 10*s.* A boiler and jets to give 85,690 cubic feet of air per minute through the same workings will cost 172*l.* 15*s.*, and the annual expense of working will be 216*l.* 17*s.* 11*d.*; the quantity of air by the steam-jets being an increase in round numbers of 85,000 over 48,000.

2626. Do you consider that the experience which you have hitherto had of the steam-jets, in comparison with the furnaces which you had there before, enables you to speak with confidence as to the calculation which you have just laid before the Committee?

I can speak with very great confidence; in fact, I believe that the steam-power is unlimited; you can get any amount of ventilation you think proper. I had a letter last night from my under-viewer there; and he says, "I think there really is no limit to the enormous velocities to be obtained by high-pressure steam; every experiment proves some new and interesting fact." Then he goes on to say, "I must not omit to mention, that Mr. Mather, from South Shields, visited the colliery, and he is uplifted to the skies by this astonishing result from one upcast."

2627. Do you keep the apparatus generally at work at a pressure of 33 lbs.?

Yes.

2628. How long have you had it in operation?

Since last November.

2629. And there has been no accident since?

No.

2630. No burning?

No. I forgot to name that after the increased quantity of air was got into the pit, this gas which made its appearance at the edge of the goaves disappeared, and we have never seen any since; we have never seen any gas in that colliery since.

2631. Anywhere?

Nowhere. Still, in working the pillars, I consider it necessary, as a matter of precaution, to work with the safety lamp, because there you cannot get the ventilation so perfect as you wish; and besides, when the roof falls in, it might disturb the gas, and bring it out upon the men's lights.

2632. What is the diameter of your jets?

They are three-eighths of an inch.

2633. How do you regulate it?

We have a cock.

2634. Do you find that the ventilation by this process is entirely under your command?

Entirely; we intend to put up a high-pressure boiler, at the other upcast, just

T. E. Forster, Esq.
 5th July 1849.

to try the quantity that we can obtain at the two upcasts. I believe myself, that I shall obtain double the quantity.

2635. Will it be an advantage to you to obtain in the Seaton Delaval mine twice as much as you are able to obtain from this one shaft?

I do not know that it would be necessary; but still, I think, in carrying the thing out, it ought to be fully proved.

2636. In carrying the steam down from above to the bottom of the shaft, do you find that you lose anything by the condensation of the steam in that distance, as compared with placing the furnace at the bottom?

Very little indeed. I know an instance where the engine is placed at the bank, and the machinery is placed about 500 or 600 yards from the bottom of the shaft, and there they carry the steam down; and the account that I had last week, or the week before, was, that the loss by condensation was scarcely perceptible.

2637. Supposing a case in which the upcast shaft was necessary for the working of the mine, do you think this apparatus applicable in that case?

Quite so.

2638. How should you proceed to apply it in such a case?

I should place it in the furnace drift at the bottom of the pit; I should take the pipe down from the surface, and put it in the furnace drift, and turn the jets into the shaft.

2639. That is to say, you would have a small drift?

There is always a furnace drift.

2640. At present you have only established this apparatus at the Seaton Delaval Colliery?

Only at the Seaton Delaval; I thought it was best to go on by degrees without putting my employers to any expense that was not necessary.

2641. Do you think that there are other collieries under your management to which the steam-jet may be advantageously applied?

Yes; it can not only be advantageously adopted, but I believe it will be absolutely necessary to apply it. For instance, the Percy Main Colliery, of which I have the direction, is working what is called the Bensham seam, the most fiery seam in our district, and although we have a very good current, still we are a very short distance from the shaft; and as we increase the distance, I am quite satisfied that I shall have to apply other power than the furnace. All that I can get in the Percy pit with one furnace is 32,963 feet; but I ought to mention that that is a bratticed shaft, with a partition of wood in the middle of the shaft.

2642. Is that a case in which there is but one shaft for the ventilation of the mine?

Yes; the air descends one side and ascends the other.

2643. There is no other shaft belonging to the mine?

Yes, we have two.

2644. Do you consider it a very essential point for the ventilation of a mine that there should be more than one shaft?

I think it unsafe with only one.

2645. Do you think it also of importance that they should be near together, or at a distance?

I do not think that makes much difference.

2646. Supposing the ventilation below is damaged by an explosion, would not the current be better kept up by two shafts at a considerable distance from one another than by shafts very near?

How are you to obtain that in those deep pits?

2647. Is there any reason which makes it necessary to sink the shafts very close to one another?

Yes.

2648. What

2648. What is that reason?

If you were to sink the shafts at a very great distance in pits which are very deep, and where there is a vast quantity of water, you would require double machinery for raising the water during the time of sinking.

T. E. Forster, Esq.

5th July 1849.

2649. So that shafts are sunk near each other from reasons of economy?

No doubt about it.

2650. From the facility of drying the mine?

Yes.

2651. Are you aware of the evidence that Mr. Wood gave before this Committee of the results of his experiments at Hetton Colliery?

Yes, I heard Mr. Wood give his evidence.

2652. Showing, according to his calculations, that the steam-jet would only supply, in a case such as Hetton, an additional power of from 12,000 to 15,000 cubic feet per minute?

Yes, Mr. Wood stated that; but I have got at Seaton Delaval, with an eight-feet upcast, which is equal to about 50 feet area, 85,690 feet per minute; Mr. Wood, with a shaft of 154 feet area, only gets 168,000. Now, if I had three sets of jets, or 75 jets, applied with 150 feet area, making it somewhat equal to Mr. Wood's shaft, I apprehend that I should get 257,000 cubic feet per minute.

2653. You mean, applying three jets to three separate shafts?

Yes; or if my shaft were the same size as Mr. Wood's, and if I applied three times the number of jets, namely, 75 jets, I have no doubt that I should get 257,000 cubic feet per minute.

2654. Then you would triple your power?

Yes.

2655. In tripling the area of your shaft, you would triple your power?

Of course; Mr. Wood gets a large quantity of air, but it is to ventilate a very large district; it is not one colliery that it ventilates, but three.

2656. There is hardly any limit to what you can do, is there?

I believe not; I believe there is no limit to the steam-jet.

2657. The quantity of air to be passed through a mine would be naturally much greater with the same power if the distance were small, like that at Seaton Delaval, than if it were of such an extent as that at Hetton?

Yes, I think it would.

2658. How many acres do you ventilate?

We ventilate at this time 400 acres.

2659. If you multiply that to the amount of 3,000 or 4,000 acres, the pits being connected one with the other, do you think that one, or two, or three applications of the steam-jet would be required for such a space? you say that the amount of air is almost unlimited?

Yes.

2660. Your colliery, you state, is 400 acres; take one of 3,000?

It is only a matter of the number of jets; all that we have to do is to apply more jets.

2661. And an increased fire?

And an increased fire, of course.

2662. A colliery of that size would extend two or three miles; one portion of the working is three miles from another portion?

Most probably there is a good deal of it in goaf, where the coal has been entirely exhausted and filled up.

2663. In passing through one shaft in that way, would not the rapidity of the current in the shaft be so great as to be inconvenient?

I speak of shafts used exclusively for the upcast.

2664. Supposing that you were obliged to use the same shaft for working, you would not be able to obtain so great a power from the jet?

(164. s.)

L L 3

You

T. E. Forster, Esq.

5th July 1849.

You might obtain such a power as you required for keeping the colliery perfectly safe.

2665. Do you think that, putting the full power that you were speaking of just now in order to obtain such a current as was obtained in Hetton, there would be no inconvenience in working that shaft?

None whatever.

2666. Have you ever made any experiments to ascertain what effect the steam-jet has upon the temperature of the column of air in the upcast shaft?

No, I did not try that.

2667. Is there any great perceptible addition to the temperature, do you think?

I do not think it is very great; I do not think the temperature is increased very much by the steam-jet; the steam dissolves in a very short time.

2668. As the steam condenses, it gives out heat?

Yes, but you must look at the rush of air.

2669. With any volume of steam-jet there must be an equal quantity of cold air?

Yes, it rushes in.

2670. What are the dimensions of the boilers?

The two boilers that I have for working the engine and those steam-jets, are 28 feet long by 6 feet diameter.

2671. Both of the same size?

Both of the same size.

2672. What description of boiler are they?

They are circular boilers.

2673. Cylindrical boilers, rather, you would say?

Yes.

2674. Cylindrical boilers, with round ends?

Yes.

2675. Can you say what horse-power you should consider each of those boilers to represent?

No, I have not gone into that; not having the thing merely for the use of the steam, I did not go into it; I shall try it, certainly, now.

2676. Have you ever calculated at all what sized pipe would be sufficient to exhaust a boiler of these dimensions?

Yes; one boiler 28 feet long by 6 feet diameter is capable of supplying a pipe of three inches diameter, with high-pressure steam continuously.

2677. You had 25 jets of three-eighths of an inch each?

Yes; the main pipe from the jets is only $2\frac{1}{4}$ inches.

2678. That would be three-quarters of an inch less than the diameter of a pipe which you consider to be sufficient to exhaust these boilers?

Yes.

2679. What would be the area of the jets?

The area of the 25 jets is $1\frac{1}{4}$ square inch.

2680. The jets are round, of course, are they not?

Yes.

2681. Are the two boilers connected together?

Yes.

2682. What is the diameter of the cylinder of your engine, and the length of its stroke?

I could not exactly speak to that off-hand; it is called a 40-horse engine.

2683. Is it constantly at work?

Constantly at work in the day-time.

2684. At

T. E. Forster, Esq.

5th July 1849.

2684. At night-time does this ventilation go on?

At night we keep the steam-jets going.

2685. Then, in order to do that, do you keep up the full power of the fires?

No, there is only one of the boilers kept.

2686. Then you never allow the ventilation to cease?

No; the men go down to prepare the coals at two o'clock in the morning, so that it would not be prudent to let it cease at all.

2687. Before you made use of the steam-jets and the boilers, you only kept up the engine furnaces in the day-time?

Only in the day-time.

2688. In calculating the expense of the fuel for the jets, did you calculate only the excess caused by keeping up the fire through the night?

No, I calculated it for the 24 hours.

2689. For day and night?

For day and night.

2690. How did you take it from the whole amount that was required for the engine?

From the quantity that we ascertained is burnt by one boiler of such dimensions.

2691. That was done by calculation; you could not actually separate it?

No, but we know pretty nearly that it takes about three tons of coals for working a boiler of that size for 24 hours.

2692. In the case in Lancashire, to which you say you intend to apply the same process, is that a deep pit?

It is 175 fathoms deep, upwards of 1,000 feet.

2693. In what part of Lancashire is it?

Near Wigan.

2694. What is the extent of the workings there?

It is a seam which they have just got into; about three or four months ago; so that they have not got much from the bottom of the shaft.

2695. Is that an inflammable seam?

Yes, it is the Cannel mine; it is very inflammable; the Cannel mine is particularly fiery.

2696. Are those so which are near the surface?

Those near the surface are not so much so.

2697. What is the area of the shaft there?

It is a 10 feet shaft.

2698. What number of jets do you intend to place there?

Thirty.

2699. Of the same diameter as those at Seaton Delaval?

Yes.

2700. You will then have to place the furnace at the surface, and to carry the jets down to the bottom?

Yes, the boiler at the surface.

2701. Have there been many persons connected with the management of mines who have seen this apparatus in operation at Seaton Delaval?

Not very many yet; I was rather anxious to get the second pit under weigh before I invited them.

2702. When do you expect to have that second pit in operation?

It will be a couple of months yet before I can get the boiler placed, and all the pipes ready.

2703. That has been the cause of the delay in throwing it open to inspection?

Yes.

T. E. Forster, Esq.
5th July 1849.

2704. The information and advice given you by Mr. Gurney were given gratuitously?

Yes, Mr. Gurney has put himself to a very great deal of trouble and expense in coming down to inspect it.

2705. He gets no remuneration for it?

None whatever.

2706. He has no pecuniary interest whatever in it?

None whatever.

2707. He did not require any?

He never required any, and I think the country at large are very much indebted to Mr. Gurney for the trouble and pains which he has taken.

2708. It appears that you are well acquainted with the system of working mines, both in the North and in Lancashire?

Yes.

2709. Is there a great difference between the two?

Not a great difference.

2710. Taking into account the expense of this machinery, still, is it not, commercially considered, advantageous to the workers of mines?

That is my opinion, but I do not think it is more expensive than the furnace.

2711. Considering the interruption which takes place from explosions, and different accidents which have occurred in the mines, is it much more than a balance to any expense that is incurred by any of these modes of ventilation?

Yes; in my opinion, whatever the cost is, it is not a matter of cost; it is a matter of life and death.

2712. Considering it independently of life and death, commercially speaking, as a matter of profit, taking into consideration the interruption occasioned by these explosions, and the fear sometimes of the workmen, upon the whole, does not that more than counterbalance the outlay necessary for the ventilation?

More than ten times over; one accident will cost 4,000*l.* or 5,000*l.*, besides the immense sacrifice of life.

2713. You say that the workings in Lancashire are very much the same as in Northumberland; there is part of Lancashire where the pits are not 10 fathoms deep?

Yes; but I refer to the mode of working.

2714. The mode of getting the coal out?

Yes.

2715. Post and stall?

Yes; the only difference is, that they drive narrow stalls, and we drive wide, excepting in particular situations.

2716. Have you been into many mines in Lancashire?

Not a great many; I have been into one or two.

2717. Have you been in the Shropshire mines?

Never.

2718. Did you hear the description given by one of the witnesses of working the mines in Shropshire?

Yes, the long wall.

2719. Do you think that applicable to the mines with which you are connected?

I think not; it might be in some instances, but I think not in all.

2720. What would be the difficulty?

The difficulty would be, both as to the gas and the roof.

2721. It was supposed to be rather a security against the gas, according to the description?

It may be, but I do not think it is; I have seen it used near to Berwick-upon-Tweed, in the collieries belonging to Greenwich Hospital; there I have seen a whole

whole face 800 yards long; the air goes up one side along the face, and down the other side.

T. E. Forster, Esq.

5th July 1849.

2722. It passes along the whole face of the working?

Yes.

2723. Is there any other part of the working from which gas could issue?

Yes; there are all the roads into it, because they take the coal away as they go along, and they are obliged to make their roads through what we call the goaf.

2724. There is no coal at all in the goaf?

Not the slightest.

2725. Would it be a reservoir for gas?

I have no doubt it would, because they cannot get it ventilated; the roof bends over, and that gives them a great power of getting the coal; after they have curved underneath, they bring it all down; they have no occasion to use any gunpowder; it is the immense weight of superincumbent strata upon it which brings it down.

2726. Your supposition then is, that gas would issue from the coal itself?

There is no doubt of it.

2727. Could that happen with a strong current across the face of the coal?

Perhaps not there, but with us there are little seams above.

2728. Wherever there was another seam close, it would discharge?

Yes, it would so; but to show that I am alive to the thing, I am preparing a district of about a couple of hundred yards in Seaton Delaval, to try the plan, where the seam is thin, only about three feet thick. I have the sanction of my employers to give the thing a trial.

2729. Does it get the coal out more completely than the other mode of working?

Yes, I took a great deal of pains in the colliery near Berwick, and I think there is no doubt that they get seven-eighths of the whole coal.

2730. Which you would be obliged to miss by the other mode of working?

Yes; seven-eighths actually merchantable coal.

2731. And what proportion do you get by your system?

Not more than two-thirds, because there is much of ours refuse, small, which we do not call merchantable coal.

2732. By leaving the pillars, not coming back to take them, can you, to a certainty, secure the roof?

If we leave the pillars and come back to them a certain period afterwards, we allow the roof to fall in.

2733. If you do not go back to them, if you leave the pillars standing, what percentage of coal do you lose by which you can secure the roof; what would be the loss, if you did not take away the pillars?

The loss would be immense, because in many instances, where the depth from the surface is very great, we do not take more than one-third away at the first working, leaving the two-thirds in pillars, to be taken out afterwards.

2734. Would it be necessary to leave two-thirds of the coal in the pillars in order to secure the roof for the general working?

It entirely depends upon the depth from the surface, the weight above; if it was 40 fathoms, or 240 feet, then you would, perhaps, get more than one-half; if it was 600 feet, you would not get more than one-third; it entirely depends upon the weight above.

2735. In all cases there is a very great loss?

Yes.

2736. From your knowledge of the coal mines of Lancashire, should you say that, generally speaking, they are as well managed as the collieries in the North? I should think not.

T. E. Forster, Esq.

5th July 1849.

2737. Is the ventilation as well understood in the collieries in the Lancashire district?

That is scarcely a fair question to me, because the colliery that I refer to we have sent a person from my own neighbourhood to take the management of it, and there we go exactly upon the principle that is carried on in the North.

2738. What should you say with respect to the qualifications of the persons who are entrusted with the immediate superintendence of the workings of the mines in the North of England; are they, do you think, perfectly well qualified for their duties?

I think they are.

2739. Are they generally a class that possess any education besides their mere practical knowledge of the working?

A little; the under-viewers, generally speaking, are very well educated; the overmen are pretty decently educated, but they are always, in every instance, good practical men, and I am not quite sure whether they are not better without a very learned education.

2740. You are not sure, then, that any improvement in their education would be of advantage to them?

No; I think, as far as regards the overmen, the deputies, the waste-men, and all those, if they were highly educated, they would not attend to their duties so well as they do at present.

2741. But supposing them to be so far educated as to have some knowledge of the principles of physics, and of the nature of the phenomena which they have to deal with, do you think that that would be of advantage to them?

I do not think it would; I believe that any one of my men, overmen, or waste-men, if anything were to occur, would know just as well what to do as if he were the most learned man in Europe.

2742. To deal with any unforeseen circumstances?

Yes, and would turn his attention to it in a moment; he would never hesitate or wait for any assistance from any one. The great point is to get them steady, attentive men, and that is the rule which I always make. If a man is not steady I dismiss him immediately; I will not keep a man in any charge that takes drink to excess.

2743. What are the wages of the overmen?

The overmen get 30*s.* a week, their house, their fire-coal, and their garden.

2744. They are promoted from the class of workmen?

Yes.

2745. What can a good workman make in a week?

My workmen at Seaton Delaval are making 4*s.* a day now, and they work 11 days in a fortnight.

2746. Do they, generally speaking, work by the day, or by what is called task-work?

Entirely by the piece.

2747. By measure?

By weight; every tub is weighed that comes out of Seaton Delaval, and we draw 1,000 tons per day of coal.

2748. You have nothing to do with charter-masters?

No; whatever weight a man sends to bank, he gets paid for.

2749. How often do you pay them?

We pay them every fortnight, on the Friday, and that gives them an opportunity of going to market on the Saturday; we do not ask them to work on that day, the market-day.

2750. There must be a certain number of men employed even on the Saturday, the engine-men and furnace-men?

Of course.

2751. How many hours a day do the men work?

The men that get the coal, I am almost ashamed to say, do not work more than about $6\frac{1}{2}$ hours a day.

T. E. Forster, Esq

5th July 1849.

2752. It depends upon the skill of the men; some can work with much greater facility than others, cannot they?

If a man is a very strong man he may do it in four hours, but I take this as an average. My men at Seaton Delaval do not work more than $6\frac{1}{2}$ hours.

2753. Eleven days in a fortnight?

Yes.

2754. Have you any night shifts?

No, we never work night shifts.

2755. Have you established any printed regulations among your men at that colliery?

Yes; I have some regulations here as to the safety lamps.

The Witness delivers in the same, which are as follow :

CAUTION and Instructions respecting the proper Use of the Safety Lamps in the Seaton Delaval Colliery.

1. IN every part of the said colliery, where the pillar-working, or broken, is in operation, stations will be fixed upon by the viewer, where each workman's safety lamp will be examined and securely locked. From those stations, no workman is to take a safety lamp for use in the pillar-working, or broken, without its having been first examined and securely locked by the overman, inspector or deputy. The overman and inspectors to have full power to direct the workmen how to use their safety lamps during the time of working; and it is particularly enjoined that every workman strictly attend to such directions. No lamp to be used on which there is not a tin shield. None but the overman, or similar officer in authority, to be allowed to carry a lamp key.

2. Should any accident happen to a lamp whilst in use, by which the oil is spilt upon the gauze, or it be in any other way rendered unsafe, the light to be immediately extinguished by drawing the wick down within the tube with the picker; such lamp to be directly taken out to the station where the lamps are examined, and not to be again used until after having been properly examined by the overman or some other responsible person—on the in-by side of which station no candles are to be taken.

3. Should any workman using a safety lamp detect, by the usual indications, the appearance or presence of fire-damp, he is first to pull down the wick with the picker as before mentioned, and then to retreat to the lamp station, and give information of the same to the nearest responsible person.

4. Every hewer, putter or other person to whom a safety lamp is entrusted, is hereby strictly prohibited from interfering in any way whatever with the lamp, beyond the necessary trimming of the wick with the picker.

5. Should any hewer, putter, or any other person whatever, in charge of a safety lamp, in any case lose his light, he is to take it himself to the station where the lamps are examined, to be re-lighted, examined and locked by the overman or some other responsible person, before being again used.

6. It is expressly directed that any person witnessing any improper treatment of the safety lamps, by any one, shall give immediate information to the overman then in charge of the pit, so that a recurrence of such conduct may be prevented, by the offending party being brought to justice.

7. Any person found smoking tobacco in any part of the said colliery where the safety lamp is used, will be liable to be fined or taken before a magistrate, at the option of the owners or viewer of the said colliery.

8. No putter, pony-driver, helper-up, wood-leader or other person, is, under any pretext whatever, to carry a lamp during his work; lamps will be hung along the going-road to afford sufficient light for the performance of the work.

9. The hewer that keeps his safety lamp in the best order, for a quarter of a year, will be entitled to a premium of 5s.; and for the second best, 2s. 6d. The putter to be entitled to 2s. 6d. for the same length of time.

Lastly. Any person acting contrary to the above instructions will be liable to a fine of not less than 10s., or to be taken before a magistrate, as the owners or viewer of the said colliery may think proper, in order that the lives of the workmen employed therein may be duly protected. And any person informing against any offending party or parties will, in every case, be handsomely rewarded.

Seaton Delaval Colliery,
2 September 1846.

T. E. Forster,
Viewer.

T. E. Forster, Esq.
5th July 1849.

The Witness.] Perhaps I may mention that at the Seaton Delaval Colliery, where we are working such an immense quantity of pillars, there are 240 safety lamps at work every day.

2756. The common Davy lamps?
The common Davy lamps.

2757. Do you consider that the common Davy lamps are practically the best?

That is my opinion; I have used them all my life, and I have always found them perfectly safe.

2758. You have knowledge of additions to the Davy lamp?
Yes.

2759. But, upon the whole, you do not think them improvements?

No; there is nothing equal to that lamp; I have risked my life a thousand times when the whole of the inside of this cylinder has been on fire, and the gauze as far as there—[*showing the same*—]has been red-hot. By my printed rules, I make a present of 5s. to the man who keeps his lamp in the best order for one quarter of a year, the second man 2s. 6d., and the boys 2s. 6d., and this is one of the prize lamps.

2760. What is the cost of that?
About 7s.

2761. That is a lamp which has been actually kept by a man?
Yes, during the last quarter; the man got 5s. for having it in such good order.

2762. Would any amount of ventilation enable you to work such a mine as the Seaton Delaval Mine without Davy lamps?

No; I should not advise it, because in working the pillars you cannot get the air carried so effectually in, and any fall of the roof might bring down a discharge of gas.

2763. Do you think that ventilation, however perfect, would secure you altogether against accidents?

Certainly not; there will be accidents, however good the ventilation may be. In a case where I happened to be the viewer, I had been in one part of the working where I saw the coal was a little more tender than usual, and I did not like it, and I immediately set the men on with the safety lamp; and in an hour after I had left the mine there was a large quantity of coal rushed over, and a discharge of gas was the consequence, and it fired a lamp 300 yards from it; no power on earth could have prevented that accident if the men had not happened to have been set on with the safety lamp.

2764. Have you ever turned your attention at all to the question of an inspection by Government?

I have thought about it.

2765. How far do you think it would be desirable for Government to establish anything in the nature of an inspection?

I do not think that there would be any harm in it; I think, as far as the viewers in the North are concerned, it would be rather a relief to them.

2766. Supposing that inspection were established, giving authority merely to examine the conditions of a mine and the plans, but without any authority to give directions for the working, do you suppose that there would be any objection to it?

Not the slightest, I think.

2767. Do you think that it would have any beneficial effects?

I think it would.

2768. In what way?

I think it would make the managers and viewers of the collieries more alive to the ventilation, knowing that the Inspector had to come occasionally to see them.

2769. Do

2769. Do you think there would be much jealousy with respect to his examining the mine or the plans? *T. E. Forster, Esq.*

I think not; there are no secrets in the coal trade.

5th July 1849.

2770. Supposing a case in which there might be some disputed question as to the limits of working, or any encroachment underground, do you think that it would be in the power of an Inspector, who was merely allowed the means which were necessary to ascertain how far the mine was in a safe condition, to acquire information with regard to the precise state of the workings in respect of their limits?

I do not think that he would see it if there was an encroachment; but if there was an encroachment, the viewer would take care not to put the workings on to the plan.

2771. Do you imagine that an inspection of the plans or of the mine, such as an Inspector under those circumstances would be able to effect, would give him the means of seeing anything with respect to the limits of the workings?

I think not.

2772. Inspection would very much depend upon the man who was sent to inspect?

No doubt of it.

2773. From your knowledge of certain persons who do not succeed in their trade as viewers, might not it be very disagreeable to some coal owners?

Yes; I must say, that if certain parties were appointed to inspect in my district, I should throw up the whole of my situations, and leave them; I would not hold one.

2774. How would you draw the line between the Inspector making recommendations, and reporting them to the Secretary of State to be carried into effect?

I think, if there was any difference of opinion between the Inspector and the viewer, the viewer should immediately have the power of calling in two other respectable men to see which was right.

2775. To call in other viewers?

Yes; for this reason,—supposing the viewer was right and the Inspector was wrong, if anything was to happen in the course of three or four days, it would be a very serious thing for the viewer of the colliery, because this Inspector might go to the coroner's inquest, and say, "Well, I told this man that this was wrong;" whereas the viewer might be right, and a discharge of gas come suddenly off, and be the cause of the accident; therefore, I think that if there is any difference of opinion between the viewer and the Inspector, there ought to be two other viewers called in to see which was right, or the viewer would never be safe.

2776. In many cases it is not so easy to find viewers to call in at a few days' notice?

..It would require two or three days' notice, certainly.

2777. It would be an expense, on an accident happening in Yorkshire, to send to Newcastle for viewers?

Yes; it should be immediately, the next day.

2778. There is another class of accidents, from the breaking of the ropes; have you had any experience of them at all?

I have been very fortunate in that respect; I never had an accident with a rope breaking but one, or rather it was a chain. My under-viewer and his son were both killed by the breaking of a chain; the cage went down to the bottom.

2779. That is the only accident of the kind that you have ever experienced?

Yes.

2780. Are you aware of the plan which has been proposed by Mr. Fourdrinier for avoiding those accidents?

Yes, I have seen it.

2781. Have you seen it in operation in the North?

No, I have not had an opportunity of seeing it; I shall go next week and see

T. E. Forster, Esq.

5th July 1849.

it; I think it is a very valuable thing: the only difficulty which I have in my mind about it is, that it may lead some of the coal owners to run their ropes too near, calculating that if the ropes should break, this thing would prevent an accident; and if the apparatus was out of order, then it might sacrifice life.

2782. But as long as the apparatus could be depended upon, it would enable them to use their gear still longer than they do now with safety, would it not?

Of course.

2783. Have you ever known anything of the hydraulic engine, which has been used in some cases instead of the steam-engine for collieries?

Yes; the inventor of that engine is in Newcastle now; he resides there, and has a very large establishment.

2784. For what purpose is it used?

For hauling coals down the pit from a distance, the same as my engine which I have at Seaton Delaval.

2785. Is that a more economical power than the steam-engine?

There is no doubt of it; I believe it will be generally adopted in our neighbourhood, where there is spare pumping engine-power, because a quantity of water has to go down to work this engine, and to be lifted again by the pumping-engine. The first one was only got into operation, I believe, last week, or the week before last.

2786. In case, after your inspection of Mr. Fourdrinier's apparatus, as it is at work in the North, you should approve of it, is it your intention to adopt one of them?

Yes; I have already recommended my employers at Percy Main to adopt it; they are going to fit up a shaft there with cages immediately; they have agreed to it.

2787. Are all your collieries worked with guides?

No; Percy Main is not worked with guides. I believe that Percy Main and Felling are the only two collieries not working with guides now.

2788. In the North?

In the North.

2789. Do you consider guides in that way valuable?

Yes; I am putting them in at Felling in that way at present; they are more economical in saving waste and everything.

2790. Are there any other points that occur to you, upon which you wish to make any observations to the Committee?

I think there is one point which I ought to name, and that is, as to the ventilation of collieries where there is no inflammable gas. My opinion is, that there are more lives destroyed in those collieries where no inflammable gas exists, than in the collieries where inflammable gas is.

2791. From what cause should you say?

From the entire want of ventilation. I know some collieries in my own district, where, because they have no inflammable gas, they do not ventilate at all; and I have known more than one or two instances, where the men, after coming out of those pits, have been in such a state that they could not walk home.

2792. The air not being fit for respiration?

Yes; they have been obliged to be carried home on horseback.

2793. Is that from the amount of carbonic acid?

Yes; and when they go to bed and are asleep, they are almost in a state of apoplexy, from the pressure on the brain, I apprehend.

2794. Are there many seams where there is no inflammable gas?

Yes, there are a good many near the crop.

2795. Where there is a discharge of carbonic acid gas, without any carburated hydrogen?

Yes; they sometimes discharge the carbonic acid without any inflammable gas at all.

2796. Are

2796. Are the men able to do a great amount of work under those circumstances? *T. E. Forster, Esq.*

Many of the collieries do a large stroke of work, but it is killing the men.

5th July 1849.

2797. Is there anything else which occurs to you?

I think there is another thing which we have not exactly touched upon, and that is the air-courses. The standard size of the air-course, as given by Mr. Buddle, and which was acted upon for a great number of years, is six feet square, or 36 feet area. Now, my opinion is decidedly, that that is far too small; where there is a single air-course, it never should be under 60 feet area, or 8 by 7½; and I am quite convinced that if that were the case, there is no colliery but what would have a much better ventilation than it has at present.

2798. When you say that, you speak of the main air-course?

Yes, the main returns.

2799. You would not think it necessary to have all the passages of the mine of those dimensions?

No; where you can get two or three it answers the same purpose, but wherever there are main air-courses, they ought not to be less than 60 feet area.

2800. Where you split the air, of course they may be smaller?

Yes; we may put three or four drifts to make it equal to 60 feet, but where there is a main air-course it should not be less than 60 feet.

2801. It would depend in some degree upon the distance the air was to be taken, would not it?

Yes; no doubt the greater the distance, the larger the air-course which is required.

2802. Therefore, that dimension of an air-course which might be safe if the distance were very short, would be unsafe if the distance were greater?

But it will always get less; therefore, I think that in all fiery collieries the standard air-course should not be less, where it is single, than 60 feet area. There was a good deal said the other day also about the accidents by the falling in of the roof; we have not a great many of them in our neighbourhood.

2803. Is there anything that occurs to you in your experience which could be done, in order to prevent such accidents?

There is nothing but putting in a sufficient quantity of timber to support the roof.

2804. It must be a question of expense?

Yes; at the Seaton Delaval Colliery we send down the pit 1,000 props per week.

2805. In small collieries the propping of the roof is probably a very heavy burden, is it not?

There is no doubt that it adds to the expense of producing the coals.

2806. Is the expense the reason why the propping is generally imperfectly done?

There is no question of it, because it tells two ways; there is the expense of the prop, and the expense of the labour in setting it.

2807. Between the imperfect propping which you may have seen in some collieries, and what would be required in order to make the roof secure, would there be any great additional expense, do you think?

No; it would not be a large per-centage; very small. There is another point with respect to coal mines being on fire: I had a case a few years ago at Felling Colliery, where the coal got on fire from the engine that was in the pit, and I worked on for three weeks endeavouring to put it out with water and extinguishing engines, and spent a couple of thousand pounds. I had to close up the pits for six weeks, so as to put the fire out. The atmospheric air in the mine being consumed, of course it became carbonic acid, and it destroyed the fire; but when I went in, the temperature at that point was 150, but it gradually cooled down, after the air went over it, until it came to its natural state. Now if we had had Mr. Gurney at that time, I think we should have been able to have done it in a couple of days at the outside.

T. E. Forster, Esq.
 5th July 1849.

2808. By the process adopted at Mr. Darlington's?
 I think so; I think it is of very great importance.

2809. In the case which you mention, had the fire existed for some time?
 No, it had not been a day; some coals had fallen off the coal-wall against the horizontal chimney of the engine under-ground, and set the coal on fire.

2810. Have you known any cases of fires which have been a long time in existence?

No, I have not.

2811. Then you do not know the difficulty which arises from the great heating of all the substance in the neighbourhood of the fire?

I think this three weeks was a pretty long time.

2812. Was the colliery closed for three weeks?

No; I endeavoured to put the fire out for three weeks.

2813. The fire was burning for three weeks?

Yes; and it got into the old workings and brought down the roof, and there was the great difficulty that we had.

2814. You endeavoured to put it out upon that occasion by throwing water into the mine?

Yes.

2815. You failed in that way, and then closed the shaft up?

Yes, for six weeks.

2816. And it was six weeks before the fire was extinguished?

Yes.

2817. When you let in the atmospheric air again, was there no revival of the fire?

No; the thermometer stood at 150.

2818. When you went in?

Yes, and it gradually cooled down; but it was a long time before it cooled down to the natural temperature.

2819. From what you have learnt of the operation at Mr. Darlington's, your opinion is, that Mr. Gurney's process for extinguishing a fire would be applicable to a case of that description?

Decidedly.

2820. Was there an accident a short time since at the Felling Colliery from the engine-fire?

In June 1847. After the engine had completed the work during the day, the engine-man threw a large quantity of coal on to the fire, and shut down the damper rather too close, and under the boiler it became a retort; it generated gas, which oozed through the damper into the chimney; the fire kindled up, ignited the gas, and an explosion was the consequence at night; there were fortunately very few people in the pit; it killed six, and all the horses in the mine except one; 16 horses we lost; it was a very singular thing.

2821. Were the men and horses that were killed upon that occasion killed by the fire-damp, or by the after-damp?

Three out of the six men were killed by the after-damp; the other three had been killed by the concussion.

2822. From your experience of accidents, should you say that by far the greater proportion were killed by the after-damp or by the fire?

The larger proportion are killed by the after-damp; very much larger.

The Witness is directed to withdraw.

Ordered, That this Committee be adjourned till to To-morrow,
 One o'clock.

Die Veneris, 6° Julii 1849.

The LORD WHARNCLIFFE in the Chair.

WILLIAM PRICE STRUVÉ, Esquire, is called in, and further examined as follows :

Evidence on the
Prevention of
Accidents in
Coal Mines.

W. P. Struvé, Esq.

6th July 1849.

2823. ARE there any additions or corrections to the evidence which you gave yesterday that you wish to place before the Committee ?

Yes ; in re-considering the matter with regard to the cost of the apparatus, I find that I very much overstated it, and I have taken the trouble of going into the detail of the cost of a 25-feet ventilating apparatus, which I make 451*l.* 10*s.*, and which I believe is quite ample to cover it ; the apparatus, when erected, may of course then be worked by any spare power which may happen to be at the colliery, by taking steam out of a boiler, and merely having a cylinder to work it, and that would bring it down to something like 550*l.* to 600*l.* A 16-inch high-pressure engine, with a boiler, would not cost more than 250*l.* ; therefore if the 250*l.* is added to the 450*l.*, that would make only 700*l.* ; and I very much overstated it, I find. I had not considered the subject ; I had only estimated one of 12 feet in diameter, of which I gave the cost at 300*l.*

2824. And an engine of that description would, you think, supply power equal to the furnaces at the Hetton colliery, as described by Mr. Wood ?

Certainly ; an engine of that size would work either 50 or 70 horse power, according to the speed at which you drive the piston, and the pressure of the steam.

2825. It would be sufficient to give a current of 168,000 cubic feet ?

An apparatus of this sort would give 196,000 cubic feet per minute.

2826. Have you any objection to put in the calculation upon which your statement is founded ?

Not at all ; I should wish to go into detail, and I will let it appear upon the evidence with pleasure.

The Witness delivers in the same, which is as follows :

STRUVÉ'S MINE VENTILATOR.

ESTIMATE of the Cost of erecting a double 25-feet Mine Ventilator, capable of passing through a Mine 196,000 Cubic Feet of Air per Minute, when the Pistons move at the rate of 200 Feet per Minute.

| | £. | s. | d. |
|---|--------|----|----|
| Masonry, 460 cubic yards, at 6 <i>s.</i> | 138 | - | - |
| Covers to top-cases of plank, and framing 1,192 superficial feet, at 10 <i>d.</i> | 45 | - | - |
| Two aerometers of wrought-iron plate, 6½ tons, at 22 <i>l.</i> | 143 | - | - |
| Fixing - - - - - | 10 | - | - |
| Four sets of valves - - - - - | 30 | - | - |
| Sheives to work aerometers, and framing - - - - - | 60 | - | - |
| Excavation - - - - - | 25 | - | - |
| | <hr/> | | |
| | £. 451 | 10 | - |

A 16-inch high-pressure cylinder to work horizontal, with boiler, would cost 250*l.*

2827. Is there anything else upon which you wish to observe ?

Nothing.

The Witness is directed to withdraw.

George Elliot, Esq.

6th July 1849.

GEORGE ELLIOT, Esquire, is called in, and examined as follows :

2828. YOU are a colliery owner and viewer in the North of England?
Yes.

2829. At Monkwearmouth ?

At Monkwearmouth and Usworth, and several other places.

2830. Have you been for a long time engaged in that branch of business ?

I went down the pits at a very early age ; I was about nine years old, I dare say, when I went down, and I have been connected with it ever since. I have been officially engaged for the last 14 years.

2831. In the course of your experience of the conduct of mines, have you turned your attention at all to the causes of the various accidents which occur ?

I have ; it has received a great deal of attention from me.

2832. To which class of accidents more particularly ?

In fact, to accidents in whatever shape, but more especially to the subject of ventilation.

2833. Do you conceive that, generally speaking, the ventilation of mines in the North of England is deficient ?

I believe, generally speaking, that we should be in a better condition if we had more atmospheric air introduced into the mines.

2834. Is the defect in the ventilation of the northern mines more, do you think, in the deficiency of the quantity of air introduced, or in the mode of its distribution ?

I am a strong advocate for a large quantity of atmospheric air ; and certainly it is very important to carry out the object of its distribution by its being fairly apportioned.

2835. In which respect do you think that the present systems are usually most defective ?

I think that the greatest improvement would be to get a larger quantity of atmospheric air into the pit. I think the principle of the divisions and subdivisions is very good.

2836. Have you had an opportunity of examining many pits besides those which you manage yourself ?

A great number ; the greater portion of the collieries in Durham.

2837. The ordinary system of ventilation is that by furnaces ?

Yes.

2838. Are the furnaces generally well constructed for their object ?

I am not quite sure that they are so well constructed as they might be.

2839. What is the most usual fault committed in the construction of furnaces ?

I have a notion of my own on the subject, which is, that I would like a larger surface of fire than we generally have ; instead of thickness, I would prefer having surface, so as to allow the atmospheric air to pass more through it, and to present a much larger heating surface than we generally have ; we have them, perhaps, six feet in diameter, and a fire of considerable thickness, 18 inches to two feet thick. I think, by having the furnace larger and thinner, the probability is that we should have a greater amount of heat than by having them so narrow and so thick ; in fact, I am satisfied of it.

2840. Do you recommend passing the whole current of air immediately over the fire ?

I believe it would have a greater rarefying effect to bring it through the fire than over it.

2841. Is it not frequently the case that the air is taken through passages at the side of the furnace ?

Yes, that is frequently so, and it is frequently necessary ; some of our currents are so impregnated with carburetted hydrogen inflammable gas, that it is imprudent to pass them over the fire.

2842. The

2842. The power of ventilation produced by a furnace depends greatly upon the depth of the shaft, does it not? *George Elliot, Esq.*

6th July 1849.

I think that has a great deal to do with it; much might be said upon that subject. I am not quite master of the principle by which I can ascertain exactly the power of the furnace. I have heard a great deal said and written upon the subject; but I cannot get any of the theorems which are laid down to agree with my practice.

2843. Have you examined the mathematical propositions, such as those which were delivered by Mr. Wood to the Committee in 1835?

I have.

2844. And you do not think that they are confirmed by experience?

I do not think they are. You have to make such an allowance for friction, and such deduction, that you completely lose sight of the principles. I do not say the principle is wrong; still it is a very slight guide to you in estimating the power of the furnace.

2845. The ventilating power of the furnace is not a constant quantity?

It varies according to the rarefying influence of the fire.

2846. And according to the depth of the shaft?

And according to the depth of the shaft. I suppose that that increase arises from two causes; the depth of shaft acts like a longer chimney, and gives a much larger rarefying medium between the furnace and the surface; and I have a notion (I do not know whether it is correct or not) that the air requires a momentum by its descent in the downcast.

2847. You think that that ought to be added to the weight of the air in the downcast shaft?

I think that it tends to increase the velocity of the current. I do not think that if you had the same heating power acting horizontally, instead of perpendicularly, the same amount of current would be produced.

2848. Have you ever closely tested that conclusion, with respect to the effect of the depth of the shaft, by actual experience?

I think I have. I am the viewer at Belmont Colliery, which is 50 fathoms deep; I am the viewer at South Peareth Colliery, which is 100 fathoms deep; I am the viewer at Usworth Colliery, which is about 160 fathoms deep; and I am the viewer at Wearmouth Colliery, which is nearly 300 fathoms deep; now in all those cases I find that I can get a larger amount of air by the same furnace in something like the ratio of the depth. I cannot, perhaps, lay it down accurately. I have some experiments which would show it, only I should like to look at them before they are published.

2849. Are the furnaces in those different collieries pretty nearly the same?

Yes; and the temperature of the shaft at a certain height is pretty nearly the same.

2850. Would it be in your power to put upon paper the measurements of the different furnaces in those pits, and the results obtained?

Yes; I believe I could furnish them correctly. I have all the figures; but I should like to go over them again, because these reports are in the hands of every practical man, and I might mislead.

2851. Do you consider that in those pits you have furnaces constructed upon the best principles?

No, I do not think I have; they are deficient in respect of the very principle with which I commenced my observations. I think they are too contracted; it would be better if they were broader and thinner; the same amount of fire, I believe would produce a much larger quantity of heat.

2852. What is the maximum ventilation in cubic feet of air which you get in any one of those cases?

In the Belmont Colliery the maximum is about 51,000-cubic feet per minute.

2853. What is the extent of the workings there; what is the whole distance over which the air has to pass in its different currents?

I should think a mile and a half.

George Elliot, Esq.

6th July 1849.

2854. Not more than that?

I should think not more than a mile and a half.

2855. What is the distance to the extreme point from the bottom of the shaft?

The extreme distance would be scarcely a mile.

2856. And yet there is not more than a mile and a half altogether of workings?

The air of Belmont is peculiarly situated; it is a colliery which is nearly worked out, and there are not the passages and up-and-down coursings that you see in models or on plans; these pillars are all taken away, and there is nothing but goaf; and the duty which the air performs now is merely that it goes into a few places which we have in a certain narrow boundary, and returns again.

2857. What is the depth of the shaft?

Fifty fathoms.

2858. So that that is a very simple case of ventilation?

Yes, it is.

2859. You have only one current of air?

No, we divide it. We have two seams; we have the Hutton and Low Main seam.

2860. On different levels?

Yes; about 100 feet difference between the two levels.

2861. Therefore there are two currents into which these 50,000 cubic feet are distributed?

Yes.

2862. Do you consider that quantity adequate for your purpose?

There it is quite enough for any purpose.

2863. You do not wish for more?

No; I think more would be inconvenient.

2864. Is that the largest current that you have obtained with any of your furnaces?

No; at the Usworth Colliery I find that I have the same quantity with a smaller fire, which I attribute to the greater depth; it is a 7½-foot pit, and the other is an 8-foot pit.

2865. What is the depth?

One hundred and sixty fathoms.

2866. What is the area of the shafts?

The Belmont shaft is eight feet diameter.

2867. And the Usworth?

Seven and a half feet.

2868. Then is it your impression, that the advantage of obtaining the same quantity with a smaller furnace at Usworth is owing to the increased depth of the pit?

I think so.

2869. Are the furnaces quite like one another?

It has been a subject which I have tried over and over again, and I always find that I can get a better current in a deep pit than I can in a shallow pit.

2870. Have you devoted your attention at all to other methods of obtaining ventilation besides the furnace?

I have sometimes ventilated by means of a water-fall; I have poured down a quantity of water from the surface.

2871. In the downcast shaft?

In the downcast shaft.

2872. In conjunction with the furnace?

No; it has been when perhaps we could not get the furnace lighted; when we have had such a quantity of gas that we could not light the furnace.

2873. Have

2873. Have you any case in which the water is in use now as a means of ventilating? *George Elliot, Esq.*

No; at present I have the furnaces in the whole of the collieries for which I am concerned.

6th July 1849.

2874. You would not consider water an efficient mode of ventilating, as a substitute for any better mode?

The furnace is much better than the water.

2875. You would not use it as a permanent method of ventilation?

I do not think I should; unless it was in such a situation that the water could drain itself from the mine.

2876. What amount of current could you obtain from the water-power; do you think you could make it effectual?

I have seen a good current produced from it; the mischief is, that you have to lift it up again with an engine.

2877. And that is very expensive, of course?

That is very expensive.

2878. Is it a large fall of water that you have made use of in such cases?

A three-inch bore; a besom, or something else, is put under it to scatter it: it is only occasionally used.

2879. Have you had any experience of mechanical means of ventilation?

I have applied the steam-jet.

2880. What is your experience of the steam-jet?

I have tried it in several ways.

2881. Where have you tried it?

The first time I ever saw it tried was in 1835, at Urpeth Colliery. I was with my father; it was in a situation just such as I have been describing. There was a great deal of gas under-ground, and the furnace could not be lighted up; and I think my father was sent there to get the colliery put into working condition. He could not get into the mine on account of its explosive condition, and he turned the exhausting steam down the shaft, and he very soon got a ventilation up, and got into the pit, and got his furnace lighted; in the course, I dare say, of two days he succeeded.

2882. Do you know what pressure he had upon that jet?

I cannot speak with certainty on the subject; knowing the engine as I do, and the way it works, I should think he would not have less than from 30 to 40 lbs. on the inch. It was a high-pressure engine.

2883. It would be a high-pressure jet?

Yes, it was exhausting from the steam-pipe.

2884. How did he apply it?

He turned it down into the upcast shaft; he allowed it to exhaust out of the full bore of the exhaust-pipe, instead of allowing it to escape into the air, as we generally see high-pressure engines do.

2885. So that it was a jet of considerable diameter?

Yes, perhaps of eight or nine inches diameter.

2886. What was the size of the boiler which supplied it?

There were two boilers, the engine at work pumping water. There was no cost; it was merely a simple expedient for the moment to get the pit cleared of the gas.

2887. It was merely the waste-pipe of the engine?

The exhaust steam from the engine was applied for that purpose.

2888. What was the depth of that shaft?

I believe it was about 50 fathoms, somewhere thereabouts.

2889. What was the area?

That I cannot be certain of.

2890. How low below the surface was this jet placed?

A very short distance; I do not suppose it was more than 10 feet down.

George Elliot, Esq.

6th July 1849.

2891. Can you say what the extent of the workings in that case was through which the air had to be passed?

The workings were considerable, because I remember being down the pit at the time; I should think about 100 acres.

2892. Was the air taken through the greater part of those 100 acres?

Yes, it must necessarily have been so to have cleared the pit from the gas.

2893. Can you say how long it was before the jet succeeded in clearing the pit after it was first put on?

I think I am within bounds in saying about two days; I am not quite certain on that subject; it was about that time.

2894. Did you go down the pit after it was cleared?

I was down after the furnace was lighted up; of course we applied the furnace as soon as it could be done, and then we got a better ventilation with the furnace.

2895. Better than with the jet?

A great deal; it was merely used for the purpose of putting the pit in such a condition that we could get the furnace lighted.

2896. Do you recollect whether the jet was kept on after the furnace was lighted at all, or was it stopped?

It was kept on for a little time, and then it was discontinued.

2897. The pit having been thus cleared by means of the application of the steam-jet, the furnaces were subsequently found to produce sufficient ventilation to keep the mine clear?

Yes.

2898. It was not necessary again to have recourse to the steam-jet?

The furnace was found to be quite sufficient afterwards, and could be safely applied.

2899. With reference to this particular experiment, was it in consequence of the apprehension of expense, or from what other cause, that you preferred the application of the furnace to that of the steam-jet, which you describe as having been so efficacious?

We get more wind into the pit by means of the furnace than by means of the steam-jet, applied in that manner.

2900. Is that the only instance in which you had experience of the steam-jet?

No; since Mr. Gurney's visit to the North, my attention has been called to it. I saw some experiments made by Mr. Gurney, and thought I would try it. I have applied it in three collieries since that time.

2901. Will you describe the manner in which you have applied it in each of those collieries?

At Belmont Colliery I took exactly the plan that Mr. Forster published in the Gateshead Observer.

2902. Was Mr. Gurney present on either of those occasions?

He was present at Gateshead; he gave a lecture on the subject.

2903. But not when you made the experiment?

Never. This is the plan—[producing the same].

2904. That is the plan of the mode in which Mr. Forster applied it at Seaton Delaval?

Yes, and it was copied from that; I thought I would apply it at Belmont exactly in the same way.

2905. When did you apply it?

I gave the order for the plan to be tried immediately after I heard Mr. Gurney's lecture upon the subject.

2906. That would be in the beginning of this year?

It was in the early part of the present year, I think.

2907. How long has it been in operation?

It has been in operation three or four months or more.

2908. What

Vide Appendix I.
Plan No. I.

2908. What has been your experience of the efficiency of the apparatus during that period? *George Elliot, Esq.*

6th July 1849.

I can give the figures exactly.

2909. In that colliery what was the current previously obtained?

It was 43,770 cubic feet with the furnace before the jets were applied. I may observe, that in this pit we have a steam-engine under-ground as well as a furnace.

2910. Did you extinguish the furnace before you applied the steam-jet?

It has been done both ways. There have been great pains taken with this experiment, and I think this may be regarded as a very fair statement of the result of its application: 43,770 was the amount with the furnace alone, without the steam-engine. I put out the furnace, and then I applied the engine without the furnace.

2911. The engine fires without the furnace?

Yes; there is a furnace and an engine with two boilers under-ground. The first experiment was with the furnace, and the next with the engine without the furnace; with the engine alone it was 47,940 feet, the engine giving an advantage of 4,170 feet over the furnace.

2912. How does the engine operate, merely by means of its fires?

Merely by means of its fires and boilers.

2913. There is no pumping apparatus for the air?

No; it is a stationary engine, which draws the coals from a certain given point under-ground to another.

2914. There is no air-pumping apparatus attached to the engine?

Nothing.

2915. Except what is required for the engine itself?

Yes; nothing in connexion with the ventilation. The jets without the furnace (that is the engine, observe, because the jets are produced from the working of the engine) were 59,485, being an increase over the furnace of 16,000, and over the engine of 12,000 feet.

2916. At the time that the jets were used, was the engine-fire in operation?

Certainly; the engine-fire produced the steam.

2917. The question refers to the engine below, the engine-power which you have been speaking of?

Yes, the engine-fires, the same fires; hence I draw the conclusion, that there is an increase over the furnace of 16,000 feet, and over the engine of 12,000 feet.

2918. How many jets were there; the same number as in Mr. Forster's case?

I think it was 24.

2919. There were 25 in his case; he had eight times three, and one in the centre?

I applied it in the same way; it was made exactly according to that plan.

2920. And the same-sized jets?

The jets were a little larger. I think at Seaton Delaval it was about three-tenths; these jets are something like half an inch.

2921. Is the diameter of the shaft at Belmont the same as at Seaton Delaval?

It is eight feet at Belmont.

2922. You say that you tried the steam-jet in three instances?

Yes, I tried it in three collieries; but there are some more figures connected with the Belmont case, which, perhaps, it might be interesting for the Committee to hear. The engine at rest, not exhausting in connexion with the furnace, gave 62,365. Here is an experiment which I was careful in making, as I thought there had been rather more value put upon the jets than I believed was due to them. I tried the quantity produced by the steam when it was exhausting out of one pipe, and then when it was exhausting through the jets; I stopped the pipe up, and allowed the same to exhaust out of the 24 jets.

George Elliot, Esq.
 6th July 1849.

2923. That is, when it was at rest ?

When it is at rest it may exhaust out of the jets.

2924. When it is at rest, that is the only outlet ?

Yes; the engine exhausting out of a six-inch pipe, as fast as the boilers were generating the steam, or distributing it over 24 or 25 jets; I make only a difference of some 2,500 feet in favour of the jets.

2925. Are you now speaking of the comparison between the case of the engine at rest, which gave 62,000, and the amount obtained by the engine when it was exhausting, and without the jets ?

No; you may either suppose the engine at work or at rest; it is unimportant for this view of the subject; this may be a 6-inch bore or a 9-inch bore, exhausting from two boilers in one current; and here is another experiment where, instead of one, it is exhausting in 25.

2926. When the engine is at rest, the whole exhaustion must take place through the jets, must it ?

It may not be so; in this case the exhaustion was purposely stopped during the experiment, the object of which was to ascertain the heat occasioned by the surface of the boilers and the fires, without permitting the steam to escape. The engine at rest, not exhausting, and the furnace, gave 62,365; those are the two together, but not exhausting.

2927. In the meantime the jets are exhausting; the steam is passing from the jets, is it not ?

No, that is not so. Suppose the safety-valves loaded so as to prevent the exhaustion until the experiment is finished; that being so, the only ventilating power which you have is the surface of the boilers, and the fires under them, together with the furnace in operation; those two powers at work produce a ventilation of 62,365 feet.

2928. Then we understand, in that case, that the jets were not at work either ?

The jets were not at work. The former quantity which I gave was the jets without the furnace power, 59,485; therefore, it will be observed, that there is an increase with the engine and the furnace over the jets of 3,000 feet.

2929. Subsequently to that, you mentioned some other case ?

Yes, the engine exhausting in one column out of one pipe.

2930. And the jets you closed ?

The jets were closed; and the difference between the jets and exhausting all out of one was 2,500 feet.

2931. What was the number of cubic feet in the last case, the engine exhausting in one jet. You say the engine at rest with the furnace gave you 62,000 cubic feet; then you tried again the engine, exhausting through a single pipe, and without the jets; what was the power which you obtained in that case ?

Fifty-six thousand nine hundred and fifty-eight.

2932. Two thousand five hundred would be the additional power due to subdividing the exhausting steam into a number of jets, instead of passing it through one pipe; of what diameter ?

About eight inches.

2933. What was the pressure upon the boiler in those experiments ?

About 35 lbs. on the inch; then I made a final experiment of the jets and the furnace together, and those give a quantity of 71,550 cubic feet per minute.

2934. Was that obtained without any additional expense ?

In our peculiar situation it happened to be so; it did not cost anything, because we had the engine, with boilers and the pipe, and everything by us, so that it was a very ready application just to apply the system, having the boilers already working every day.

2935. Could you supply those 25 jets without any deduction from the power of your engine ?

Yes; there is no deduction; it is merely the steam, after it has done its work, escaping to the atmosphere.

2936. The

2936. The steam which would otherwise be wasted ?
Exactly so.

George Elliot, Esq.

6th July 1849.

2937. It was merely that which you made use of?
Yes.

2938. So that in such case you can apply the jet as a ventilating power without any additional expense, where you have a high-pressure engine?

Yes; in fact, you cannot have a high-pressure engine in such a situation without it having that influence.

2939. If you distribute it into jets you obtain precisely this effect?

You will observe, that there is not so much in the jets; I think I have proved that I only make a difference of some 2,500 feet, which is not a very great deal.

2940. Between 25 small jets and one large one?

Yes. In fact, many times when I have been a mile off from the engine working with the exhaust pipe, I could, at any of the trap-doors, count every stroke the engine made by the propulsion that was given to the air at that distance.

2941. By the natural discharge of the steam in the working of the engine?

Yes; the column of the air seemed to act upon the door with an increased pressure every stroke, so that you could count it; I have done so many times.

2942. Are there any other collieries to which you have applied the steam-jet?

Yes; I have applied it to the South Peareth Colliery, which is about 100 fathoms deep.

2943. In the same way?

Not in the same way; it is at the top of the pit, and applied as I described at Urpeth; only in this case it is divided, but it was not in the case of Urpeth.

2944. How far did you take it down the shaft?

About 36 feet.

2945. That apparatus could not be adopted where you wanted to make any other use of the shaft, could it?

It makes such a steam that there is no seeing yourself at the top of it.

2946. Not only that, but does not it partly fill the pit?

I do not think that that is an insurmountable objection, or that it is necessary to have the pits all at equal distances, or that it is essential to have the jets so mathematically correct as to prevent using the shaft for the purpose of drawing coals. If you get the same amount of jets or the same power of steam at different places, leaving room for the pit, it might still be applied.

2947. You think you could still raise the whole column of air?

I think so; because you can give the jets an inclination just as you like, so as to apply them to the circumstances of the pit in any manner that might be required.

2948. But in giving an inclination to the jets, would not you lose some of the power?

No; I should imagine not. You are dealing with a very small diameter of pit, not more than seven, eight or nine feet, and a very slight inclination would do. Suppose that portion of the shaft was necessary for the purpose of drawing coals, or what it might be, I think you have plenty of room to apply your jets all round here—[*showing the same*—]—and give them such an inclination as to apply them over the shaft.

2949. So that you think that that apparatus might be applied even in a shaft which was used for drawing coals?

I think so; there is no great difficulty in it; it would be disagreeable having the steam about the top of the pit.

2950. What induced you, in the case of the Peareth Colliery, to apply the apparatus at the top, instead of at the bottom?

Because we had not an engine under-ground.

2951. You found it more convenient, therefore?

Yes.

George Elliot, Esq.
6th July 1849.

2952. Have you made any comparison of the effect between the two arrangements?

Yes; it is much better to have it at the bottom of the pit. I do not think it would do for South Peareth without a furnace at the bottom of the pit.

2953. Was there the same pressure upon the boilers in that case?

I think there is rather more pressure at South Peareth than at Belmont.

2954. Is the power of the boilers the same?

There are three boilers.

2955. So that your steam-power was greater at Peareth?

Yes; it was a heavier engine, and more heavily pressed.

2956. Were the jets the same?

No; it was not divided into 24 jets, as I have described; it was divided into three or four.

2957. What was the diameter of those jets?

I do not recollect now, but they were equivalent to the bore of the main-pipe leading from the engine.

2958. What was that bore?

I believe about nine inches.

2959. And you had three or four jets equivalent to that bore?

Yes.

2960. Then they must have been largish jets?

Yes.

2961. Only about four of them?

Only about four.

2962. Did you find that they produced the same power as you found produced from the small jets at the bottom in the case of Belmont?

Not near it.

2963. Can you state at all the extreme power which you obtained by that arrangement at South Peareth?

That is in connexion with the furnace.

2964. You mean the furnace being in action at the same time?

Yes; I tried it both at Usworth and at South Peareth without the furnace, but it would not do at all at the top of the pit.

2965. With the furnace what did you obtain?

With the furnace alone it was 43,240; with the jets and the furnace it was 51,240.

2966. Making a difference of 8,000?

Yes.

2967. Whereas at Belmont you obtained, with the combination of the jets, and the furnace at the bottom of the pit, a power of 71,550; at South Peareth, with the furnace and the jets, the jets being at the top of the pit, you could only obtain 51,240?

Yes.

2968. The power of the steam being greater at South Peareth than at Belmont?

Yes. It is fair to mention here, that I do not attribute all that difference at Belmont to the jet, because you must observe that there are three fires there; there are two fires under the boilers; and supposing there were no boilers, no steam-jets, and nothing of the kind, it is quite certain that those fires would have a certain influence in producing a rarefaction.

2969. Those fires are to be taken in addition to the furnace?

Just so; if the same steam had been taken from the surface at Belmont, instead of having been generated at the bottom of the shaft, you would not have had the same result.

2970. It would appear that the power in the furnace in those two cases was pretty

pretty nearly equal, the amount being 43,770 at Belmont, and at South Peareth 43,240? *George Elliot, Esq.*

Yes; I had not observed that before your Lordship mentioned it, but I see it is about the same. 6th July 1849.

2971. Taking the case of a pit, the shaft of which was much shallower, the power of the steam-jet would have been the same; whereas the power of the furnace would have been much smaller, would it not?

I think the power of the furnace is much greater in a deep shaft; in fact, it is very much in the ratio of the depth.

2972. And is not the power of the steam-jet always the same?

I do not think it is. I place a very great value upon the rarefying influence of the steam, not altogether upon the jet; the value of the jet is made up of two principles, I think; there is the motion which it gives to the air, and I believe the greater portion of it is the rarefying influence which the steam exercises.

2973. Do you mean the rarefaction produced by the condensation of the steam?

No, by the heat of the steam; there is no living in it; the shaft is warmer by the steam than even by a furnace; it may be made so.

2974. Have you made any precise experiments to that effect upon that point?

I think the experiments which are before your Lordships support the view which I am taking.

2975. We have not anything with respect to the temperature of the column of air in the shaft. Have you any particulars with respect to the temperature resulting in each case in the shaft, through which the current of air was passed?

I do not think I have them with me. I can supply them; but I know that the opinion which I have just offered is based upon the fact, that there is an increased temperature from the addition of the steam.

2976. Do not you think that something of the difference which you have mentioned might be due to the mode in which the steam was applied in the two instances, because you have informed us that in the case of Belmont, where you applied it at the bottom, you had 25 jets of small diameter; and at South Peareth, where you applied it near the top, you had only four jets of large diameter?

I have also informed your Lordships of the quantity which I got at the Usworth Colliery, where I only had one pipe; and that is a great deal more, although a shallower pit than South Peareth.

2977. Are you able to tell us what the pressure was at the jets in these particular cases?

I can only tell your Lordships what the pressure of the boiler was whilst they were at work.

2978. But does it necessarily follow that the pressure is the same at the jets as at the boiler?

There may be some little reduction of it between the piston and the exhaust-pipe.

2979. May there not be a very considerable difference; may not the steam in the one case be high-pressure, and in the other case low-pressure?

I cannot see how that can be; the steam proceeding from the piston is exhausting into the atmosphere, after having been compressed at the rate of 35 or 40 lbs. to the inch, or whatever it may be.

2980. But you are not able to state the precise amount of the pressure at the jets?

I am not.

2981. Would not the diameter of the jets make a considerable difference in the pressure?

I should think it would. If you have a current of steam passing from the piston with very great velocity, and then it is contracted altogether by those jets, the probability is, that there will be a greater velocity in passing through those small orifices than in passing through a large one.

2982. Would not that increase the power of the jet?

I should imagine so; but here is the result upon which I place more reliance.

George Elliot, Esq.

6th July 1849.

2983. What was the result at Usworth?

It was a much smaller quantity.

2984. At South Peareth you obtained with the four jets only 51,000 cubic feet; at Belmont, with a larger number of jets of smaller diameter, you obtained 71,000?

Yes.

2985. Therefore you obtained a very considerable increase at Belmont?

Yes; but I called your Lordship's attention to the circumstance, that there were three furnaces at Belmont; there was the ordinary furnace, and the furnaces under the boilers.

2986. But taking the power obtained from the furnace alone in each case, which you state to be a little more than 43,000 feet, they are nearly an equal quantity; therefore you may deduct them from the total power obtained?

The 43,000 is not from the furnaces under the boilers; that 43,000 is produced by a furnace, which is worked without the engine.

2987. Then you would not attribute the whole of that 20,000 cubic feet of difference to the action of the engine-fire in the case of Belmont, would you?

I would not attribute the whole of it.

2988. Would you attribute much of it?

I think it forms a very important part of it; if we had had the same steam escaping with the furnace which was producing the 43,000 feet, and we could suppose the same steam escaping without the fires under the boilers, then I do not think that you would have had so much as 71,000 feet.

2989. You never tested it by experiment?

I think that some of those experiments rather go to prove it; for instance, we have the engine at rest, not exhausting, and the furnace 62,000; therefore, when we bring Mr. Gurney's principle into operation, all other things being equal, instead of that 62,000, we have 71,000; that appears to be about the value of it under those circumstances.

2990. In that case you would argue that there were about 9,000 cubic feet obtained?

Taking that view of it.

2991. But you have not tried jets of the same diameter as those tried in the Seaton Delaval Colliery?

I have not measured those jets; it was to be a perfect model of that machinery, and I believe it would be as near it as possible.

2992. It would appear that the furnace alone in the Belmont Colliery gave 43,000, and the engine at rest with the furnace gave 62,000?

Yes.

2993. Do you apprehend that the whole of that difference, amounting to 19,000 cubic feet per minute, is due to the action of the engine-fires?

Decidedly; what else could it be due to? There is nothing else but the heating surface of the boilers.

2994. Can you be quite sure, in these two experiments, that the power of the furnace was equal in each, there being a difference of 50 per cent.?

When the engine is at work, and the furnace is not at work, there is a certain quantity; with the engine-fires alone there is a larger quantity; the two together do not produce the same quantity as they do separately.

2995. Then the result of it is, that when the jets and the furnace, as you have stated them in the Belmont case, produced 71,000 cubic feet, you must also take into consideration that, in addition to the furnace, there was the engine-fire, which, when tried alone, supplied 48,000 feet?

Yes.

2996. And you have no doubt that the steam applied was what is called high-pressure steam?

I have always considered it so; I do not see what else it could be called; it is passing immediately from a boiler loaded at 35 lbs. on the inch.

2997. Would

2997. Would it depend entirely upon the size of the pipe through which it passed? *George Elliot, Esq.*

There is a rule laid down; it is the ordinary pipe which is considered the proper size for the escape of the steam from the cylinder; the ordinary exhaust-pipe.

6th July 1849.

2998. But in the ordinary way you do not want to retain it as high-pressure steam; it is not necessary to keep it in the form of high-pressure steam; it is allowed to exhaust, and to become low-pressure steam?

You generally find it the better way permitting the steam to get into the atmosphere as soon as possible; the shorter the distance between the atmosphere and the cylinder the better, the more freely it discharges.

2999. Therefore, it is no object in the ordinary case of the discharge of steam from an engine to retain it as high-pressure steam when it has once left the cylinder?

No, I do not think it is; it is an object rather to let it get easily from the cylinder, because if you restrain it at all, you put a friction upon it, and lose your power. I will mention to your Lordships an experiment which I made before I came up, which perhaps will rather bear upon this point. The day I came to London, I went down the Belmont pit. The experiments submitted to your Lordships had been made several times by the resident viewer, Mr. James Croudace, and as I supposed I should have to speak of them, I thought it better to go over all of them myself before I came; on that day I went down, and, in order to get the full benefit of it, I tied down the safety valves for a while, got the steam up, stopped the engine, and raised the steam, so as to allow as much to rush through the pipes, and through those small orifices, as I could possibly generate with the boilers; I kept firing on as hard as possible.

3000. Do you know what pressure you attained?

The common weight was on 35 lbs., and I hung a metal chair upon the boiler, I should say, fully 10 lbs. on the square inch.

3001. At the boiler?

At the boiler.

3002. Then you think it would be about 45 lbs.?

It would be fully 45 lbs. at that time, because I was anxious for a good result; I was trying to see what I could really get out of the thing in that way.

3003. Having confidence in your boilers?

Having full confidence in the boilers, because I had had them examined; I got more than the 71,000 on that occasion; I got about 76,000. I had the full volume that these two boilers could possibly generate passing through those small holes; 76,000 is a tremendous current when it is passing.

3004. Did that current of 76,000 pass in one continued stream through the mine?

We have two seams; it divides and goes into one and into the other; we generally subdivide it.

3005. Then you conceive, that the utmost which you can attain at the Belmont Colliery by means of the jets is 76,000 cubic feet?

Yes.

3006. Have you ever made any calculation as to the relative cost of the two methods, the furnace and the steam-jet?

As to the cost in this case, with us it costs nothing; you have the steam wasting; if I was going to apply it ordinarily in any other situation where I had not that advantage, I think the plan that I should adopt would be to make an ordinary furnace, such a furnace as we daily use, and I would plant a boiler upon the top of it, so that I should have, in the first place, the full benefit of the furnace, as a furnace, which we are all very fond of certainly, and which it is very difficult to supersede, there is no doubt. I should put the boiler upon it, and whatever value there is in Mr. Gurney's plan, I should combine them both, and that with the same fuel that should be at the bottom of the pit.

3007. Then is the impression produced upon your mind by the result of your trials of the steam-jet, upon the whole, favourable to its application in the ventilation of collieries?

(164. 9.)

o o 3

I think

George Elliot, Esq.

6th July 1849.

I think it is; there are many situations in which it would suit. I do not think it will be successful to the exclusion of the furnace; you must have it applied in something like the manner I have been describing.

3008. You must combine it with the furnace?

Yes.

3009. Are there any other points connected with ventilation upon which you would suggest any improved methods?

On that subject I have often been considering; I am a great advocate for plenty of atmospheric air in a pit; that is one thing which is very important.

3010. Having plenty of air going through the pit?

Yes.

3011. That is a question of the power of your agent for ventilation, is it not?

That has a great deal to do with it; but I believe there is something else which has quite as much to do with it.

3012. What is that?

That is to keep your air-courses in your mine of full size; to keep them fully double the area of your shaft, or something like that.

3013. Do you think that can be generally done without increasing too much the expense of working mines?

I believe it is the cheapest way to work mines safely, and have plenty of air in them.

3014. You think that, even in point of economy, it is the interest of colliery owners to go to some expense for the purpose of making their ventilation complete?

Decidedly, I think so; I know that we go to a very great deal; and, I believe, that the collieries in the North go to a very great expense in doing it.

3015. Not merely for the sake of humanity, but of economy?

Yes; as a fair calculation to enter into the subject for producing the coals cheap.

3016. Are the air-passages in the northern mines, in your opinion, generally too small?

I believe that we should have more air if they were larger.

3017. What would be the dimensions which you think it would be desirable to adopt?

That is a difficult thing to say. There is a great deal said about the downcast and the upcast shafts being too small, and so on; my practice generally leads me to think, that the evil is not so much there as in the interior of the mine, because I find by a paper which I have from a gentleman, a friend of mine, that they are passing as much as 94,000 cubic feet of air per minute, by means of the furnace, with a shaft of eight feet diameter.

3018. Where is that?

That is at Haswell. I wrote to the gentleman, and he said that I might make any use of the letter that I liked, if your Lordship thinks proper to look at it.

3019. "Haswell pit is 936 feet deep; area of downcast, 110 square feet; ditto of upcast, 58." What would be the diameter of those two?

About 12 or 13 and 8 feet; I believe the upcast is 8 feet; that is the largest quantity that I have known pass up a pit.

The Witness delivers in the following document:

Haswell Colliery, Durham,

June 27, 1849.

Dear Sir,

I HAVE your letter of the 25th instant, and will endeavour to give you the information required.

| | | | | | | | | | |
|--|-------------------------------|---|---|---|---|---|---|---|------------------|
| Haswell pit is | - | - | - | - | - | - | - | - | 936 feet deep. |
| Area of downcast | - | - | - | - | - | - | - | - | 110 square feet. |
| Area of upcast | - | - | - | - | - | - | - | - | 58 square feet. |
| Mean temperature of upcast is | - | - | - | - | - | - | - | - | 165° |
| Mean temperature of downcast, say | - | - | - | - | - | - | - | - | 62°. |
| Actual quantity of air in circulation is | 94,900 cubic feet per minute. | | | | | | | | |

The

The area of the upcast has been considerably reduced by a lining of fire-brick, which was put in in 1846; notwithstanding, however, we have more air now than ever we had.

George Elliot, Esq.

At the time of the accident the quantity in circulation was - - - 74,228
 At present it is - - - - - 94,400

6th July 1849.

The actual horse-power exerted by our furnaces I calculate as follows:—

| | | |
|--|-----------|------------|
| Specific gravity of air at 62° | - - - - - | 1.228 |
| Therefore 936 feet in height will weigh 1.228 × 936 | - - - | 1149.4 oz. |
| The volume at 32° is | - - - | 480 |
| Ditto - at 62° | - - - | 510 |
| Ditto - at 165° | - - - | 613 |
| And 1149.4 × 510, or weight of column of air 936 high, at 165° | - | 956.2 |
| 613 | - | |
| Ventilating power per square foot | - - - - - | 193.2 |

Equals 12.075 lbs. per square foot; and 12.075 lbs. × 58 area of upcast × 1636.2 velocity per minute in upcast = 1,145,912 lbs., the absolute force of the upcast pit; and this divided by 33,000 lbs. equals 34.7 horses' power.

Without giving any opinion as to any system of ventilation, I can only say, that to produce a greater current of air at Haswell than we have, a greater power than 34.7 horses must be applied. I will try the thermometer in the coal shortly.

Yours very truly,

John Taylor.

Geo. Elliot, Esq.

(The Witness.) I have some other statements respecting Pensher Colliery, which I made in 1835, and which have also been made within the last month. I merely produce these as a proof of the correctness of what I stated, that it depends very much upon the size of the air-courses under-ground for the purposes of ventilation. I was there in 1835; I remember that I took the calculation at that time, and since then my father has had the management of Pensher colliery. I wrote to him; he furnished me with these facts, which I suppose may be used, exactly in a similar way as I have taken them. I recollect taking them with the anemometer (invented by my late brother, Thomas Elliot), standing there in your Lordships' Committee-room, and I find at present that the current of air is less, although the power of the furnace is 10 degrees higher in one pit, and in the other 15; that there is less atmospheric air passing up than there was in 1835; and the reason for that is this, that there is a portion of the goaf, namely, where the coal is all worked away; it is my father's plan to pass a large quantity of air over this goaf, to keep it clean, and by a contraction of his air to force it over this place to keep it well cleansed; the effect of that is to reduce the quantity. These are two cases which are quite an illustration of my view in 1835 and 1849; the same pits. I can give the different temperatures at that time, and at the present time, with the different quantities passing over, thereby establishing that there is no use in having either a hot shaft or a large shaft for the upcast or the downcast pit, unless you have good large air-ways under-ground for the purpose of permitting the air to travel and get out again as soon as possible.

3020. What is the difference in the size of the shafts in those cases?

The one is a 6 1/2-feet shaft, and the other is a 9-feet shaft.

3021. Which are you comparing?

In both cases there is a reduction in the quantity of air now, compared with 1835.

3022. Are you to be understood to say, that the comparison is between two different pits?

Two different pits at two different times. Here is the E pit and the D pit. In 1835, when the mean temperature of the upcast shaft was 135, the quantity produced was, I think, 51,900 feet.

3023. That was in a shaft of what diameter?

Nine feet; the atmosphere at the time was 62 degrees. Now, in 1849, at the same shaft, and with a mean temperature of 10 degrees more, namely, 145, the quantity is about 47,900, about 4,000 feet less.

3024. What was the diameter there?

That was the same pit. I am merely proving that notwithstanding there is an increase of heat in the shaft, and a larger ventilating power with the same area,

George Elliot, Esq.
6th July 1849.

area, yet there is a smaller quantity of air passing up, resulting from the contractions in the interior of the pit.

3025. Those contractions arising from what?

The colliery has been very much worked since then, and there is now a quantity of air forced over the goaf on some old workings, for the purpose of keeping them clean, which operates as a certain amount of friction preventing that quantity of air passing.

3026. Are those passages through the goaf of smaller dimensions than those used for working?

Yes.

3027. What are the dimensions?

We do not make roads through the goaf.

3028. Where are those contracted passages, between the workings and the goaf?

When the air passes through the downcast, its tendency is to get to the upcast to take a direct line, or the shortest distance; if you want it to go round half a mile, you must put in a door or contractor to get it round; if the air is to take a circuitous course, we have to put in the stoppings and doors to take it round; and the further it is taken round, the greater is the friction, and the less is the amount of the current of air which passes.

3029. Then, was the friction in this case caused by the greater length of the air-courses through which the air had to be taken, or by the difference in their dimensions?

It is from this circumstance: there is a goaf of perhaps 50 acres, or a certain amount of goaf where the coal has been worked; the system there practised is to contract the air, and force a quantity of air over this goaf; the air is not permitted to take its course directly to the upcast shaft, but it is so contracted as to press a portion of this air over the old workings, over which there is no regular road, but merely for the purpose of keeping away any gas which might be generated in that large dome, called goaf.

3030. Where is the air contracted; is it at its passing out from the goaf that it is contracted?

The contraction takes place in the goaf, because when the coal is removed the strata bends down, or rushes down, so that there is no thoroughfare through it, and it requires a contraction upon the doors and other passages to force the air through that limited space; if we were to open the doors we could soon restore the quantity of air that we used to have before.

3031. Then there is no free passage through the goaf?

No.

3032. The air would have to pass through the rubbish?

Yes; it would have to pass through the rubbish and broken stones; it is like the refuse of a quarry.

3033. That is the part, then, in which the friction occurs?

Yes; it is not a very common thing to ventilate a goaf in that way; but it is sufficient for the argument to prove in this case, that the air has been lessened in the pit in consequence of those frictions.

3034. Do you know whether that has had the effect of keeping the goaf clear?

I believe it has; I do not believe that there has ever been any instance of any gas being seen in that goaf since the adoption of the above plan.

3035. Did you ever know of that plan being adopted in any other colliery?

I do not think I ever did.

3036. Is there any reason why it should not be more extensively adopted than it is?

I am not sure that it would answer in all cases.

3037. Are there not many cases in which it might be applied?

I believe there are, and very successfully applied.

3038. The

3038. The goaves are generally one of the principal sources of danger in collieries, are they not? *George Elliot, Esq.*

Yes, one of the greatest sources of danger.

6th July 1849.

3039. Therefore any plan which could accomplish the ventilation of the goaves would remove a considerable amount of danger?

Yes, that is a very desirable thing; I do not believe that this is a certain plan in all cases; in this case it has been successful.

3040. And you say that you think there are many cases in which it might be applied?

In similar cases to the present I have no doubt it would answer.

3041. In applying any plan of that sort to the ventilation of goaves, it would be necessary to be able to rely upon a very considerable power of ventilation, would it not?

Yes.

3042. Therefore, if by any of these means, by the combination of the furnace and the steam-jet, or by any mechanical means, you could obtain a high power of ventilation, you would have the means, in such cases, of passing air through the goaves?

I believe that it would be one of the greatest benefits which could be conferred if some means for the purpose of increasing the currents of air could be devised.

3043. Are the mines with which you are connected worked principally with lamps?

Not principally; generally, in the broken parts, in consequence of the goaf which I have been mentioning being more dangerous, and not ventilated, we work the pillars, as we call it, with safety lamps.

3044. Are you in the habit of using the common Davy lamp, or any other?

I have used the common Davy; in fact, I have used the whole of the lamps, I may say; I have five or six of them with me of different sorts.

3045. Are you disposed still to consider the Davy lamp as the most efficient?

The Davy lamp is most deficient in light, that is one great objection. Within the last six or eight months I have had three or four lamp gauzes damaged in the goaf, all of which might have resulted in an accident where the workmen had got their picks into them; they are continually subject to that danger.

3046. Striking the lamps with their pick?

Yes, the light is so very dim that they draw it so near to them in order to enable them to see, that there is a continual risk of their striking their picks into them. It is a subject well worthy of attention. I generally use the Clanny lamp, which has a large thick cylinder of glass half an inch thick; it gives about four times the light of the Davy.

3047. Do you mean that you use it yourself, or use it in the mines?

In the mines; the workmen use it. I have a copy of the Regulations which I have issued with respect to the safety lamps.

The Witness delivers in the same, which is as follows:

REGULATIONS respecting the Safety Lamps in use at the ———.

1.—No workman is allowed to use a safety lamp without its having been first examined by the lamp inspector, and then locked, and again re-examined by the deputy.

2.—Should any accident happen to a lamp whilst in use, by which the oil is spilt upon the gauze, or in any other way rendered unsafe, it is immediately to be taken outbye, to the station fixed upon by the overman (on the inbye side of which candles are not to go), and not again used until after having been properly examined by the deputy.

3.—Any workman using a safety lamp is, immediately on the appearance of fire-damp, to retreat to a pure atmosphere.

4.—The hewers, or any other person to whom the safety lamp is intrusted, are strictly prohibited from interfering in any way whatever with the lamp, beyond the necessary trimming of the wick with the picker, and the lamp is not to be placed within three feet of the side of the goaf, and not nearer the face of the coal than five feet.

5.—Should any hewer, putter, or any person whatever who is in charge of a safety lamp, in any case lose his light, he is to take it himself to the station fixed upon by the overman, to

George Elliot, Esq.
6th July 1849.

be re-lighted, and is not allowed to send it out by any other person; and when re-lighted, it is to be examined and locked by the deputy before being again used.

6.—It is particularly requested that any person witnessing any improper treatment of the safety lamps by the boys or others, will give immediate information to the overman in charge of the pit, in order that proper steps may be taken to guard the lives of the people employed in the mine.

7.—Smoking tobacco is not allowed in any part of the mine, and persons found offending against this order are liable to a fine of 10s., or to be taken before a magistrate, at the option of the owners or viewer. The fine to be paid to the informer.

8.—No candle to be taken nearer to the broken, or pillar-working, than the station fixed by the overman; any one found with a candle within that distance to be fined 10s. The fine to be paid to the informer.

9.—No putters, pony-drivers, or others, are, under any pretext whatever, to carry a lamp during their work. Lamps will be hung along the going roads to afford sufficient light for the performance of the work.

George Elliot, Viewer.

3048. How do the workmen like the Clanny lamp?
They prefer it very much.

3049. They prefer it to the Davy?
Yes, because there is so much more light.

3050. It is heavier?
It is heavier.

3051. Is it in any other respect more objectionable than the Davy lamp?
So far as I am concerned, I prefer it very much to the Davy lamp, on account of its light; and then it is inclosed; so that when you are going against a current of air there is no fear, as in the case of the Davy lamp, of the flame being blown through the mesh of the gauze, because it is inclosed in a cylinder of glass.

3052. Is that glass safe from cracking?
It is not safe altogether from cracking, but it is of such a thickness, and it is so fitted in at each end, that it is like a barrel arch, and if it does crack, we do not discontinue its use because it is cracked; indeed, I sometimes think they are safer after they are cracked, because they are less liable to break; they yield to any little heat or contraction arising from change of temperature after a fracture has taken place.

3053. You do not consider that as an element of danger in the lamp?
No, I do not at all.

3054. Have you ever been in very inflammable atmospheres with it?
Many times.

3055. When the air in the interior of the lamp was inflamed, the interior of the lamp becomes on fire in a very inflammable mixture, does it not?

Yes; as soon as you go into an inflammable mixture, it becomes ignited, and expands.

3056. What is the result of the Clanny lamp in that case?

It perhaps will continue burning for two or three minutes, not much longer, because the carbonic acid deposits itself within the glass, and it extinguishes the light in a very short time, perhaps three minutes. I have often tried it; its superiority is in its light, and in its freeness from the action of the current flowing through it, where you are taking the lamp against a current, or the current is coming against the lamp, or where both are in opposition to each other, if it is an explosive atmosphere. I believe Sir Humphrey Davy was very particular in cautioning the miners at the time he introduced his lamp upon that subject.

3057. And the Clanny lamp is free from that danger?

The Clanny lamp is free from that danger quite. It has occurred to my mind sometimes, whether what I am about to mention might not be a subject worth attention if some reward was offered; it rather floats in my brain that some contrivance might be found out by which the carburetted hydrogen gas might be neutralized or arrested before it reached the flame. I am no chemist, but it merely occurs to my mind that such a thing is worth attention.

3058. Did

3058. Did you ever see a lamp which was produced before the Committee a short time ago by Mr. Biram, as having been tried in the collieries in Yorkshire?

He sent one of them to me a few months ago.

3059. Did you ever try it?

Yes, I tried one of them.

3060. What is your opinion of it?

I think it is objectionable on account of the area; there is too much capacity inside; when it is at the firing point, it goes off with such a puff, such an explosion, that I am afraid of the talc disc which he has in front yielding to it. I do not think that his slide is a good thing; it works with a slide into it.

3061. It gives a large amount of light, does it not?

It gives a large light. I tried it both as to its light and as to its consumption of oil; it gave a greater light, and it consumed less oil than the other lamps.

3062. It throws the light only in one direction?

It throws the light in one direction.

3063. Is that a great inconvenience, practically?

No, I do not know that it is; it is better to have it all round; the Clanny lamp has it all round. I do not think that it is likely to be generally used with us. I will just mention, with your Lordship's permission, before you close the subject of ventilation, a notion which has occurred to my mind in the case of accidents. We generally find, as I think you will have in the evidence of former Witnesses, that a greater number of lives are lost from the choke-damp resulting from the explosion than from the fire. The idea which I am about to suggest has occurred to me from the fact, that at present I have at different collieries pipes taken from a higher level, or from the surface, under-ground, to different points, so that in case of fire, either by explosion or otherwise (as in either case a very great destruction of colliery property ensues), there is a continual head of water to apply to it. Now, having the pipes already laid down in this manner, the idea which occurs to me is this: in the event of an explosion, we have a number of men killed; we have, perhaps, our air-crossings blown out, which very often leads to great mischief, crossings of the air where it passes over itself.

3064. Where the two currents pass in different directions?

Yes. Now an explosion is almost certain to blow out these crossings, and the consequence is, as I before stated, that the air, instead of going round the further workings, goes off to the furnace; the consequence is, that the persons beyond that point are generally suffocated by means of the choke-damp produced by the explosion. Now, having pipes, as I before stated, for the purpose of conveying the water, in case of any fire at any time, it occurred to me, that if a mixture of quick-lime and water (milk of lime) and oxygen gas, in separate vessels, were kept on the surface, either or both could be run down after an explosion, always having them in a large quantity at the top of the pit; they might be run down just as you run water down to extinguish the flame, and thereby not only absorb the deadly poison of the carbonic acid gas, but impart to the residual nitrogen a quantity of oxygen, which would render it fit for respiration.

3065. These pipes, then, are empty, except when you pass water down them?

Yes, and you might have the cock at the top of the pit. I do not give this as a fixed opinion. I merely throw it out as a suggestion worthy of the attention of more scientific people; but it strikes me forcibly it would answer. I know that the other day, only last week, when I was busy sinking a pit (it was a small counterbalance stapple, six feet diameter) at one of our collieries, I found that the men had not been able to get down the pit for two or three days, and the reason was that it was full of this carbonic acid gas, and a light would not live in it; they did not know what to do. I got a shovelfull of quick-lime, and threw it down, and in the course of ten minutes the men were enabled to get to the bottom of the pit, and use their lights as if it were the common atmosphere.

3066. How far did that effect extend?

The place was some 15 or 16 fathoms down, and it was up within five fathoms of the surface.

(164. 9.)

George Elliot, Esq.
6th July 1849.

3067. It was the area of the shaft ?

The area of the shaft for about 10 fathoms.

3068. How far were they able to get down before ?

Merely a few fathoms from the surface.

3069. And the quick-lime cleared the whole of that space ?

Yes. Perhaps something might be found that would have a stronger affinity for carbonic acid gas than lime ; but anything that is capable of absorbing the gas in question would doubtless go a very long way in mitigating the loss of life.

3070. Have you ever considered how it would be possible to have your apparatus in readiness to introduce such an atmosphere immediately upon the occurrence of an explosion ?

I have, in considering this matter. I see no difficulty in having a reservoir of either lime or oxygen. I suppose the lime would have to be excluded from the atmosphere to keep it in a fit state for use ; I believe it is not quite so good when it has been exposed to the air ; but it might be always held in readiness, as you would hold a large tank of any thing, and at any moment's notice it might be turned on, and run down in a few minutes, as also might the oxygen, when kept in a proper vessel.

3071. Is there any other point connected with the ventilation upon which you wish to speak ?

Nothing more strikes me at the moment.

3072. With respect to another class of accidents, have you ever bestowed any attention upon the subject of accidents arising from the breaking of ropes ?

Yes, I have given some attention to that.

3073. Have you introduced any improvements, in order to prevent the occurrence of such accidents ?

I have applied the invention of Mr. Fourdrinier at Usworth Colliery.

3074. When did you apply it ?

In the month of April ; the early part of April, I think.

3075. Is it now in practical operation there ?

Yes ; it has been in practical operation ever since.

3076. Have you seen it tried under circumstances which would have led to an accident ?

Frequently ; it is a place where a great number of the viewers have gone to see it. Mr. Fourdrinier put it on there, and it has been tried very often with very great success indeed ; everybody seemed very much pleased with it who has seen it, and, I think, we must not have any more men killed from the breaking of ropes after this.

3077. It has been sometimes suggested that the adoption of any contrivance like that might render the people who are responsible for that part of the machinery more careless, and that the ropes might be continued in a worse state, and that thereby accidents might occur possibly from Mr. Fourdrinier's apparatus not being in perfect order ; do you think that that is an objection to it ?

I think very likely the ropes would be worn a longer time.

3078. But provided it did not lead to additional danger, it would be rather an economy ?

Yes ; I am not only using it for the sake of economy, but for safety ; the pair of ropes that I put in the pit cost about 650*l.*, and we sometimes have to take them off just because we think they are not good ; very often, long before they are worn out.

3079. Is Mr. Fourdrinier's an apparatus which you think would be at all difficult to keep in thorough and efficient order ?

No ; I cannot see that there is any difficulty, for this reason, that every time it arrives at the top and at the bottom, the springs act so that the man at the bottom of the pit, what we call the onsetter, and the banksman, see the action of the apparatus every time ; it is right before their nose every time it comes up and down the pit, so that I cannot see how it could very well get out of order, unless the party was very careless indeed.

3080. It

3080. It will depend upon the state of the guides, of course?

Yes; the guides, of course, have to do with it; the guides wear, it is true, but they wear uniformly, the same friction being throughout; but assuming that the guides wear half an inch, or an inch, or as much as you like (I suppose half an inch would be as much as they would wear in the course of three or four years), all that would have to be done would be to set the wedge a little nearer, in order to suit it. I do not see any difficulty in that part of it.

George Elliot, Esq.

6th July 1849.

3081. Are your guides of timber or of iron?

Of timber; Memel timber.

3082. Is it universal in the pits in the North to work with guides?

It is not quite universal; I should think there are not more than three or four exceptions in the two counties.

3083. What is the expense of fitting up a shaft with guides, per foot or per yard; have you calculated it?

I think the labour and timber together may be from 10s. to 14s. per fathom.

3084. And is it your opinion that all shafts ought to be furnished with guides independently of Mr. Fourdrinier's apparatus?

I think it is a great improvement having the guides; you have a great saving in the coals; by guides you can work with tubs (wooden boxes) instead of baskets; with baskets we used to lose a great portion of coals through them in the operation of drawing them; the tubs are a very great improvement.

3085. Do you make use of cages also?

Yes, always.

3086. Then your experience of Mr. Fourdrinier's apparatus, as far as it has gone, is that it is quite successful?

Quite successful.

3087. What is the depth of the pit at Usworth?

Somewhere about 1,000 feet.

3088. Do you draw very heavy weights?

We draw somewhere about $2\frac{1}{2}$ tons at a time, at the end of the rope; that is to say, the load at the end of the rope is about $2\frac{1}{2}$ tons.

3089. Having tried it in your pit at Usworth, are you thinking of introducing it anywhere else in the pits with which you are connected?

Yes; I have given Mr. Fourdrinier an order to apply it at South Peareth, and I am going to apply it at Wearmouth; we have not settled about the terms: we want a license, and must have that fixed, and then he may put it on as soon as he likes.

3090. Do you know at all the rate of speed at which you bring up those loads?

At Wearmouth, which is, I think, the deepest colliery in England, namely, about 286 fathoms, we can perform it in about 65 seconds.

3091. Two and a half tons?

It is more than that; there are two tons of coals; at Monkwearmouth we draw from the depth of 286 fathoms a load of coals, two tons weight, in 65 seconds; I will give the actual weight which we raise from that point; I had better give it in the items: 286 fathoms is the depth; the load is two tons of coals at a time; the cage is 24 cwt.; and the four tubs (we draw four tubs at once) are five cwt. each; that is altogether about four tons four cwt. raised from a depth of 286 fathoms in 65 seconds.

3092. That is very nearly one-third of a mile in just over a minute?

Yes.

3093. That would be nearly 20 miles an hour?

Yes; at its maximum speed it is travelling at the rate of 30 miles an hour in the middle of the pit, because it goes slower to begin with. Perhaps it might be interesting to the Committee to know the state of the temperature at that great depth. In the mine I have drilled several holes in the different seams, *Vide Appendix I. Plan No. XIX.*

(164. 9.)

George Elliot, Esq.

6th July 1849.

and inserted thermometers; I have allowed them to remain there a length of time, and I find that in those seams the coal is 82 degrees of Fahrenheit.

3094. At what depth?

At 286 fathoms. I have several facts respecting heat, which might be interesting to the Committee, and the barometrical pressure, how it varies in the same depth.

3095. Have you ever seen a weight of this kind, amounting to four tons, and travelling at the rate of 286 fathoms in 65 seconds, suddenly stopped by the breakage of the rope?

Not in this case. At the Usworth Colliery, where the weight was 2½ tons, I have seen it done over and over again.

3096. And with perfect safety, with Mr. Fourdrinier's apparatus?

Yes; he got upon it at one time when the rope was severed.

3097. Were you ever upon it?

No, I did not like to do it; if I had been the patentee, I dare say I might have done so. I have a brother (John Elliot) who got on it with Mr. Fourdrinier; he has more nerve about him than I have.

3098. Have you ever seen any accidents from drawing over the wheel at the top?

Yes; I regret to say that I have; I had a cousin killed at this very Wearmouth Colliery, in this deep pit, only in January last, from being drawn over the pulley; he was carried over the pulley, and then precipitated to the bottom of the pit.

3099. Do you think that Mr. Fourdrinier's machine would prevent that?

I think it quite impossible for it to have happened if this invention of Mr. Fourdrinier's acted. In the three adjoining collieries, within the last twelve months, I dare say we have had five men killed by that very circumstance; there was one John Elliot at Wearmouth, and a man of the name of Dunbar at our Usworth Colliery, and there were three at Washington.

3100. That was from the inattention of the engine-man?

Yes.

3101. Culpable inattention generally, or was it unavoidable?

We had a long coroner's inquest on the subject, and it is very difficult to convict these men, especially at Wearmouth; it was very gross negligence.

3102. Are those accidents of frequent occurrence in the collieries of the North?

I have known several cases of the sort; perhaps five having lost their lives in the last few months in the three adjoining collieries is more than an average; but it is not an unfrequent occurrence.

3103. You are aware of Mr. Fourdrinier's apparatus for preventing that class of accidents?

Yes, it prevents it, in case either of the breaking of the rope, or drawing over the pulley.

3104. Are you aware of that part of his invention as to drawing over the pulley?

I do not intend to use that part of it; I understood from Mr. Fourdrinier that that is not a part of the patent; I provide for it by this means, so as to render that part of the application quite unnecessary. I carry my frame over in this way—[*showing the same*]; so that it is impossible to carry it over the pulley, because the rope must break, and it is no matter the rope breaking, if the guides are in; and upon that part of it, when so simple a contrivance as this can be effected, I think it is better than applying any nic-nac sort of mechanism to it which requires keeping right.

3105. What was the expense of adapting Mr. Fourdrinier's apparatus?

There is no expense beyond the license; he talks about a license.

3106. Do you mean a payment for the use of it in the first instance, or a continuing payment?

I think

I think his object, from what I understand, is to have so much per annum for it. *George Elliot, Esq.*

6th July 1849.

3107. What is the opinion entertained by the workpeople with respect to that invention; have you ever heard?

It is not very much used yet; at Usworth the men like it very much; indeed, the agent wrote to me the other day to say that they had a subscription, and were going to make Mr. Fourdrinier a silver model of it as a present.

3108. Did not your father invent the self-registering windmill anemometer? My brother did; I have the instrument here.

3109. That is the instrument which you used in making those observations of which you have spoken?

Yes, in making those measurements.

3110. Have you had it in constant use for that purpose?

It has been away for the last ten or dozen years in possession of a gentleman who has been lecturing on it (Mr. Luney, I believe) in Manchester, and in different parts of the world exhibiting it.

3111. Is there anything in the general management of the collieries in the North which you think is capable of improvement, with respect to the persons charged with the inspection of the mines, the ventilating apparatus, and so on?

I do not think that we can do much in that way; for instance, with our overmen and under-viewers, and that sort of thing, in fact, I was one myself. I began, and have been in every department of the colliery, and they are generally selected as being steady, sober, intelligent men.

3112. Do you think that they are generally people of sufficient education to discharge their business effectively and satisfactorily?

Generally speaking, I think they are. With me, to select a man as an overman, is a most important duty; I find it one of the most anxious things to select a proper man for it that I have to do.

3113. The safety of the mine, in a great measure, depends upon his discharge of his duties?

Very much; he has to go down and examine; in fact he is viewer, and all responsibility centres in him for the time being.

3114. Should you have less difficulty in selecting people of that kind, supposing that the general standard of education was higher among that class of persons?

By that class of persons your Lordship means the whole working population?

3115. You draw these men from the working population, do not you?

Entirely.

3116. Do you ever look to the question of education at all in selecting a man for the office of overlooker?

Yes, I have done so. We have viewers who serve an apprenticeship; they are regularly indentured, and pay a premium, perhaps, of 300*l.* or 400*l.* to learn to be viewers; but when they are out of their time, they perhaps are not the persons that you would put exactly into a situation of that kind; they are educated for a higher office, to have merely a general superintendence, and not to be the working men in the matter. The overmen have a great deal to do in keeping the men right and agreeable; they have all their labour to value and keep account of; it must be a man who has been taught and worked at everything with his own hands at the pit; and therefore you must have substantial good men in that capacity.

3117. Do you consider that a certain amount of education is a desirable addition to his practical experience?

You may take this as a measure of their education: these people have all the bills to make out, for instance; they make out all the account of labour, because those below are mostly paid by the piece; those bills have to be made out by the overmen, and inspected by the under-viewer, and then by the chief viewer.

3118. They must be acquainted with writing and arithmetic?

They must understand the rule of three, or they would not be able to manage their office.

George Elliot, Esq.
 6th July 1849.

3119. With reference to their other duties in superintending the mine, and looking after its safety, do you think that it would be any additional qualification in a man that he was to a certain degree acquainted with the causes of danger, and therefore able to judge of unforeseen circumstances?

I am very friendly to education. These men are generally very shrewd, sensible, clever fellows.

3120. Supposing a case like that of a colliery in Yorkshire, where a serious accident happened in the course of last year, and 70 lives were lost, namely, at Darley Main, and where it appeared that the overlooker was a man without any education, being incapable of reading and writing; independently of his steadiness, do you think that that would be an objection to his being employed as an overman in a colliery?

It is an objection, because that is a part of their duty, although, so far as the ventilation is concerned, I do not think I should make much difference.

3121. Do you think that a man, such as has been described, finding unforeseen circumstances upon which he had to exercise judgment, would be as well able to exercise that judgment, being so ignorant as if he had been better educated?

I cannot go quite so far as that; I think not; but it is a rare exception that you have a man in that situation, unless he can write and make out his accounts.

3122. When you say that, you speak of the Northumberland and Durham districts?

Yes; I know that in Lancashire and Cheshire, and places where I have been, they are very different indeed.

3123. Do you think that the class of overlookers in those parts, so far as you have had communication with them, are sufficiently qualified for their duties?

No, I do not think they are. It is no wonder that they have the accidents which they have; they are a very inferior class of officers, generally speaking.

3124. Inferior to what you have in Northumberland and Durham?

Very; in the very point upon which I lay so much stress in the ventilation under-ground, they are very deficient in keeping their air-courses.

3125. Do you think that that arises from ignorance?

Yes, ignorance and a parsimonious feeling.

3126. Have you ever turned in your mind the question of the expediency of an inspection by Government?

Yes, that is a subject which I have also considered, seeing that it was about to come; we do not seem to be very fond of it.

3127. What would be your view of that question?

I should not object to its being done, since I believe that it would have a good effect upon other counties than ours; if it would have the effect of bringing the other places, where we hear of so many frightful accidents, up to the level of our condition, it would tend very much indeed to lessen the loss of human life which we are daily hearing of.

3128. Is it your opinion, then, that Government might, by a judicious system of inspection, effect good in that respect?

I entertain a hope that they would; I think so, if they got some good sound practical men to superintend occasionally.

3129. What would be your view of their powers, supposing such officers were appointed?

That is a very difficult thing to draw out; unless the Inspector was a very competent person, it would not do for him to come to tell such persons as you have had before your Lordships' Committee; it would not do to send anybody; it ought to be some person of sound, competent, practical judgment.

3130. But supposing a competent person appointed, do you think that it would be desirable to give him the power of directing the management of the mine?

No, I do not think that. It would be a great relief to some of the colliery managers if there was anybody to come and divide the responsibility in that manner.

3131. Do

3131. Do you think that it would be undesirable to take that responsibility off the managers of mines? *George Elliot, Esq.*

I think so.

6th July 1849.

3132. Do you think it would be possible for the Inspectors to discharge their duties at all, without the power of examining the pits themselves, and of examining the plans of the collieries?

I think they ought to go down the pit, and they ought to be men that understand the pit when they are down it; in fact, they ought to be pit-men; they ought to be good practical men, and it is of no use sending anybody else.

3133. Suppose they were drawn from the class of viewers, they would be then competent, would they not?

Yes, that is the class of people who alone would be suited for it.

3134. Supposing such a person appointed, what do you think of conferring a power upon him to examine the workings of a pit, and to require to see the plans?

I do not think there could be any objection to that.

3135. You think that it would not be any prejudice to the colliery owners to have an officer appointed with such powers?

I do not know that I should like him to copy my plans; he might come and look at them.

3136. Merely to look at them, so far as to satisfy himself of the state of the ventilation?

Yes, just in the capacity of a check viewer; that is the lessor's viewer, who comes and sees your plans; he has always access to your plans, and talks over the mode in which you work your colliery. If it were in that capacity it would be well enough; but it is a very fine point to make him of any use at all without lessening the responsibility of the manager of the colliery, which is a thing that must not be done under any circumstances, or you will do mischief.

3137. Supposing he was appointed with no powers than those of examining the mine, and of seeing the plans, and with no power of giving any directions to the persons responsible for the state of the mine, or of doing anything more than of suggesting and reporting to some quarter, do you think that that would be objectionable?

With respect to the fact of suggesting, supposing the Inspector comes and suggests to me, "You have too little air in this district of the colliery;" I say, "I am quite sure I have quite enough." Next week, from some other cause, a bag of gas comes off, and we have an explosion, which would not have been prevented by a larger quantity of air; an accident has occurred, and the blame comes upon the colliery owner for not having adopted the Inspector's suggestion; that is one of the difficulties which I see. I have turned it over, and there is a point at which I want to arrive, and I do not know how to get to it. The only conclusion that I come to would be something like this: that supposing an Inspector was appointed by Government, and he was to go down, he ought to be a man that would be tolerably acceptable to the colliery viewers. I suppose, if he went down and looked at the plans and workings, and so on, and suggested, after a conversation with the viewer, that he thought it would be better if he had a little more air in a certain district of his pit, the viewer might say, "No, I think I have quite enough; it will put me to a great deal of expense to do this, and, therefore, I hope you will not press it." The Inspector, being alive to his duty, says, "I cannot let you off in this case, you must have this done;" the viewer says, "I will not;" then comes the difficulty. Now the way that I would provide against that would be this: that the Government should appoint two or three of the most practical colliery viewers in the North, and that they should sit, say three of them as a body, to determine this matter between these two parties; let it be their own act (that is, let it be done in the district by the colliery viewers), so that there shall be no suggestion hanging over the colliery viewer; if there is anything arising at the moment, let it be referred to those parties and put out of the way, not to have a suggestion hanging over, lessening the responsibility, perhaps, of the one party, and increasing the difficulty of the other, but to have it settled by that court at once. Now, I think that that would operate in this manner, that as the ventilation would then be a subject which

George Elliot, Esq.

6th July 1849.

would probably come more before the notice of the viewers, there would be a kind of emulation amongst them always to have as high a statement of ventilation as possible, to look well before the committee, if it were necessary to go there; but I think that, rather than go there, knowing all the viewers as I do in our district, the case would be a very bad one if the colliery viewer did not get the matter in some way conciliated and set right without going before those gentlemen; I think the Inspector would almost be certain to be wrong if they went there. I would merely suggest this idea.

3138. Do you mean, when you talk of this court, that that court should have the power of absolutely directing, or the power of absolutely requiring that the colliery owner should introduce any change; and do you suppose, in the first instance, that the Inspector is to have the power of directing that such and such changes should be made, or merely of advising them?

I am supposing that he has the power of suggesting, and I say, that the fact of suggestion would operate just as painfully upon the sense of responsibility, if a man was alive to his duty, as if it was an order; I could not live under the responsibility of a suggestion.

3139. Then you suggest this court, of which you speak, as a court of appeal for the two parties, in case the suggestion is not accepted?

If it is not agreed to, settle the thing there, and do not let it hang over.

3140. Supposing that tribunal to be composed of three of the most experienced colliery viewers in the district, do you think there would be any objection from those persons being necessarily connected with the same trade in which the party was concerned who had to come before them?

I think not; I think that that is the very place to which any of the colliery viewers would prefer to go. I merely mention this plan as one which I think would meet with the acquiescence of the people in the North, and I think that would be the most competent tribunal.

3141. You do not think that there would be a jealousy of any such tribunal?

No, I think not; my idea is, that it would never have to be appealed to; they would always get the matter put right before they went there.

3142. Do you think that it would be the most desirable to have a person who has been educated and well qualified to judge of the workings of the pit as an Inspector?

Yes; I think that where a person has to come and look after a number of scientific and practical men, he ought to be such.

3143. And you have no great confidence in a person, however great his eminence, from a laboratory in London, or a large town, going down to inspect a mine?

I think it is possible that good might be derived from such parties; in fact, we have evidence that good does result from such visits. We have the case of Sir Humphrey Davy; we have the case of the invention of the wire-rope; we have the case of Mr. Fourdrinier's apparatus: all these things are very valuable, and completely introduced by, as it were, foreigners to the trade; but when you come to consider the practical daily working of the concern, I think that that really does require the experience of men brought up to it, more than of a person merely given to science.

3144. Have you any experience of mines on fire?

Yes, I have a little; not a very great deal.

3145. What process have you usually adopted to extinguish the fire?

We have had water; and sometimes we have extinguished it by closing up the mine, and shutting the air off.

3146. Both those processes are attended with a great deal of trouble and expense?

A very great deal, and a great loss of time.

3147. Has the closing up of the mines been effectual?

Yes; it has been the only course, I think, that has been tried, until Mr. Gurney made that experiment in Lancashire.

3148. It

3148. It has been mentioned here in evidence, that when a fire is closed up, the heat does not exhaust itself, and that the admission of atmospheric air kindles it again ?

I have known a case similar to that for some length of time in North Wales ; there is a great quantity of vitrified rock there, which must be the result of a fire ; a mine that has been on fire many years ; it was near the surface, though.

3149. Have you read the account of the process adopted by Mr. Darlington for the extinction of a fire at his colliery ?

Yes, I have, with very great interest indeed ; and I remember that when I read it, I was so pleased with it, that I wrote to Mr. Gurney, and told him that I thought the Government ought to confer on him the honour of knighthood.

3150. Have you any accidents from the falling of roofs ?

A great number ; there are more lives lost from that than from any other cause.

3151. Have you any accidents from tumbling down pits ?

We have seldom anything of that sort now ; we used to have before these guides were put in.

The Witness is directed to withdraw.

Ordered, That this Committee be adjourned to Monday next,
Half-past Two o'clock.

ADDENDA.

Wearmouth Colliery, Sunderland, 24 July, 1849.

I FIND a mixture of carburetted hydrogen and atmospheric air (in which all the carbon after explosion is converted into carbonic acid), may be supposed to consist of 100 cubic inches of carburetted hydrogen, weighing 17 grains, and 500 cubic inches of atmospheric air weighing 155 grains—altogether, before explosion, 600 cubic inches, weighing 172 grains.

After explosion, about 100 cubic inches of carbonic acid gas, weighing 46 grains, will be produced ; so that, if we assume 1,000 cubic yards of an explosive mixture of the above composition will yield, after explosion, about 170 cubic yards of carbonic acid gas, weighing 171lbs., and as 22lbs. of carbonic acid combines with 28lbs. of quick-lime, therefore, this quantity (171lbs), will require about 220lbs. of quick-lime for its absorption. I should employ, however, at least half a ton of quick-lime for 1,000 cubic yards, as an excess would never do harm.

After an explosion, the nitrogen alone remains unaltered ; hence, it follows, that by the injection of about 160 cubic yards of oxygen, the residual nitrogen would be restored to the state of natural atmospheric air.

George Elliot,
Wearmouth Colliery.

Die Lunæ, 9^o Julii 1849.

The LORD WHARNCLIFFE in the Chair.

WILLIAM KEENE, Esquire, is called in, and examined as follows :

Evidence on the
Prevention of
Accidents in
Coal Mines.

W. Keene, Esq.

9th July 1849.

3152. YOU are a civil engineer ?

I am.

3153. And have been employed in mining operations ?

Many years in France ; I am a Member of the Royal Academy at Bourdeaux.

3154. How long have you had experience of foreign mining ?

I have been working abroad about 20 years in different engineering undertakings ; erecting high-pressure steam-engines, working salt mines, bitumen mines and coal mines.

3155. Are you still so employed ?

Yes ; I have two concessions in France ; I had one granted me personally, and another I have purchased since.

3156. In what part of France ?

In the South of France, near the Western Pyrenees, between Bayonne and Dax, just on the border of the Landes and the Lower Pyrenees.—[*The Witness produces a specimen of coal.*]—The coal that has been opened in that neighbourhood is a six-feet seam ; it is rather light, but it is got very near the surface.

3157. Are both your concessions in that neighbourhood ?

Both.

3158. In what part of Europe have you had the most experience of coal mines ?

In France. I am acquainted with the English coal mines in Lancashire and in the West of England, and also with the Welsh coal mines.

3159. Is this a bituminous coal ?

It is not a very bituminous or caking coal ; it is what is called a dry coal.

3160. What is the depth of this coal ?

One hundred and thirty feet.

3161. And the thickness of the seam ?

Six feet. Here is bitumen in its natural state, from a mine I have worked in the same neighbourhood—[*producing the same*]—this is not fusible at the heat of boiling water, but at a higher temperature, about 220 degrees.

3162. Is this coal liable to any discharge of inflammable gas ?

It is not.

3163. Therefore you are not exposed to accidents of that kind ?

Not from inflammable gas.

3164. In what part of the Continent have you had any experience of coal-mining which was exposed to accidents of that kind ?

I have not anywhere had to contend with inflammable gas, but with choke-damp.

3165. Does the choke-damp exude from the stratum ?

It exudes freely from the roof and the floor of the coal. If the *débris* is heaped

W. Keene, Esq.
 9th July 1849.

up and left in the mine, decomposition ensues; then choke-damp arises, and ultimately spontaneous combustion.

3166. From whence does the spontaneous combustion arise?
 From the pyrites in the roof and in the floor.

3167. How long has this mine been opened?
 It was first commenced in 1830.

3168. Have you had, during the last 19 years, any serious accidents and loss of life?

It has not been working during the 19 years; it was closed for nine years, and after that I became proprietor of the mine. I have had no accident from choke-damp, no loss of life from choke-damp.

3169. What system of ventilation do you adopt there?
 In the first place, natural ventilation, and afterwards I put up a furnace.

3170. Have you two shafts?
 I had but one shaft; I put up a brattice for furnace ventilation.

3171. And you now conduct the ventilation by furnace?
 By furnace; I intend to put up a steam-draught.

3172. The steam-jet?
 The steam-jet.

3173. Have you found your furnace ventilation inefficient, then?
 I contemplated, when I erected the furnace, putting up the steam-jet; I therefore only built a small temporary furnace, looking forward to establishing the steam-jet.

3174. Can you say what power of ventilation you obtained by that furnace?
 Not more than a foot and a half per minute through the workings.

3175. Can you say what quantity?
 About 9,000 feet.

3176. A small amount?
 A very small amount.

3177. That was not sufficient to keep your mine clear?
 In carrying away the refuse from below, that ventilation was sufficient; but if the refuse was left to collect at all, then choke-damp followed, and I should have been obliged to employ a more powerful mode of ventilation.

3178. Do these cases of spontaneous combustion take place frequently?
 Very frequently.

3179. How do you guard against their consequences in the mine?
 By carrying away all the refuse-matter to the surface, and then spontaneous combustion takes place in the heap on the surface.

3180. You have none of that material in the mine?
 None.

3181. Before you went into that part of the country, had you any experience at all of the mines in Belgium or in the North of France?

I know how the mines in Belgium are worked, and I have visited the mines of St. Etienne, which are worked in much the same way as in England, by stalls and pillars.

3182. What they call post and stall?
 Yes.

3183. Are they very near the surface?
 They are near the surface; they are shallow mines.

3184. Are they liable to explosions?
 Not very.

3185. Do you know what system of ventilation is adopted there?
 Furnace ventilation in some cases, and in others natural ventilation is sufficient, there not being much inflammable gas.

3186. Then

3186. Then they are not cases from which information could be derived as to the causes of accidents or the means of preventing them?

Generally, in the mines in the South of France, near Toulouse, at Rive de Gier, and St. Etienne, the coal is not surcharged with gas.

3187. And they are of small extent, are they not?

The late concessions are small, but some of the old concessions are of considerable extent; the concessions now made are comparatively very small.

3188. You have no knowledge of the mining in the North of France, where there is more tendency to explosion?

In Belgium and the North of France I have a general, but not any personal knowledge of the workings.

3189. All the mines in France, whether to the North or to the South, are subject to a system of inspection, are they not?

They are.

3190. Will you describe shortly the manner in which that inspection is carried on as regards the owners of collieries?

We are required to give each of our workmen a book, in which the time of his work, the time that he remains with us, and his conduct, are noted. Once in six months the sub-engineer or the chief engineer pays a visit of inspection.

3191. Is that required by the terms of your concession, or is it by some general law?

It is a general rule; a general bye-law of the mining administration; it is general in the trades in France also, that regular workmen should be given books in which the time of their entry into the service of their employers, their conduct during their stay, and the time and motive for their discharge, are written down.

3192. That must be for the master to certify?

Yes.

3193. You were understood to say that the workman kept the book?

The book is the workman's, but the master writes in it when he enters his service, and the motive of his discharge.

3194. With respect to what may be called the police of the mine, the regulating the working of the mine, what is the system pursued?

We are expected to keep accounts of the extraction and sale of our coals, and plans of the workings.

3195. All the mines in France belong to the State?

To the State; all that is below the surface; open quarries may be worked by the proprietor of the surface; all that is below and worked by mining underground belongs to the State, and is conceded by the State to individuals, and then belongs to them as freehold property.

3196. Do you mean to say that, supposing a man were to find coal at the outcrop, and were to be able to work it on the side of a hill like a quarry, he would then be able to work it on his own account, without any reference to the right of the Government?

No; coal is a mineral; limestone and marbles, sulphate of lime and chalk the not classed as minerals; they can be worked without permission from the Government.

3197. There are certain articles which are classed as the objects of mining which are kept by the Government?

Yes.

3198. Then you are required to keep plans?

We are; they are readily kept; we get paper of this kind—[*producing a piece of paper*]*—this is the only piece that I happen to have by me; this paper is squared by faint printed lines all over the surface, and we take one of the squares to represent one-hundredth or one-fiftieth, and so forth, so that the workings are easily put down day by day, and extended with a pencil by the viewer or the overseer of the mine. We keep up our working plans in that way.*

W. Keene, Esq.
9th July 1849.

3199. By adding the proportionate quantity?

Yes; the scale is already laid down here. When it is agreed upon what one of these squares shall represent upon this paper, the person charged with bringing up the plans daily has no occasion to take any compass for the scale, but, knowing the magnetic direction of the workings, he can represent them, wherever they may be, by pencil-mark upon the paper, to be verified and put in ink afterwards.

3200. Are those plans often inspected by the Government officer?

The Government officer comes round once every six months; I have not had his visits oftener.

3201. Does he come as an Inspector for the owner of the minerals to examine those plans?

No; the State is no longer the owner of the minerals after they have been conceded. If the State had any objection to the administration of the party to whom the concession had been granted, it would be merely personal, it would merely affect that party, but would not affect third persons; if he had any partners who had an interest in that mine, his infringement of the regulations or neglect of them would not affect the rights of his partners in the property. The State never takes back a concession into its own hands irrespectively of the rights of third parties.

3202. Is it then a perpetual lease?

It is a perpetual concession; a freehold that may be mortgaged like other freehold property; but it has this distinction from all other kinds of real property in France, that it cannot be divided as all other property can, under the common law; no part proprietor in a mineral concession in France can oblige its sale, as is the case with all other real property.

3203. It must be kept together as in the concession?

Yes.

3204. If a man dies possessed of only a mine, is it devisable by will to any one of his children?

It is.

3205. Can there be any charge upon it?

A charge may be left upon it.

3206. It may be mortgaged?

Yes; but the property cannot be split up and divided by the mortgagee, as is the case with other property in France.

3207. However, the right by which the State Inspector comes is that of the original owner of the minerals, is it not?

He visits the mine under the authority of the law, and the conditions of the concession; he has a right to see how the parties are working, and report thereon; he would make observations, but he has no right to order.

3208. Is not that right reserved in the concession?

That we shall conform to the regulations which are laid down in the concession.

3209. How is the concession obtained; is a consideration given for it?

None; the person who has discovered a mineral vein is entitled to demand a concession from the Government.

3210. Without a consideration?

Without any consideration. If he can show that he is in a position to work it by himself, or by forming a company, the state will give him a concession.

3211. They then give him a concession, and they include in that concession certain conditions?

They do.

3212. They include a rent in it, do not they?

Very trifling.

3213. If the discovery is made by a person not capable of working the mineral himself, nor of forming a company, what arrangement is then made?

Then

Then, any capitalists who will come forward may obtain the concession; but the Government would take care that a portion of the interest was reserved to the person discovering it, or order him a compensation.

W. Keeve, Esq.

9th July 1849.

3214. Upon what precise footing does the Inspector come; he does not come to examine, as you are understood to say, the mining operations of private individuals merely as an officer of the Government, and for public purposes, but he comes in consequence of certain conditions imposed by the Government in whom the original property of the minerals was vested before they were transferred to these parties?

The Government has the right of making any set of peculiar conditions on conceding the mine.

3215. Comparing an inspection of that kind with the case of this country, in France there is the original property in the minerals, which gives the Government a right to interfere when a concession is granted; in this country there is no such right, except in the private individuals to whom the minerals may happen to belong?

It is so. With respect to the mode of proceeding in obtaining a concession, this is the plan of a concession which was granted to me; and the first step in asking for the concession was the sending in a plan of the limits which I asked to be conceded—[*producing a small plan.*]

*Vide Appendix I.
Plan No XX.*

3216. The *red* lines include your concession?

Yes.

3217. Upon what scale is that map?

One ten-thousandth; it is a very small concession; it is for salt and brine pits. The scale is one mètre to 10,000 mètres.

3218. In addition to inspecting your plans, do these Inspectors interfere in the regulations established for the management of your mine?

They would offer suggestions if they had any observations to make, or any change that they thought desirable in the management, but they have no right to order.

3219. Do they generally descend the mine when they come?

They generally do.

3220. Would they observe upon imperfect ventilation?

They would.

3221. And suggest a mode of improving it?

They would.

3222. But they would not have the power of compelling the adoption of any particular apparatus?

No power whatever.

3223. In your own case, you have already told us that you find your furnace insufficient, and are about to use another power, and that you are much troubled with carbonic acid gas; has the Inspector ever made any remark upon the condition of the mine?

We agreed upon the state of the mine.

3224. But he has remarked it?

He observed that, as I proceeded with the works, I should want greater ventilation. I explained to him the means I proposed to employ to obtain it, and he was satisfied.

3225. Assuming the case of an Inspector remarking upon the defective ventilation of your mine, and suggesting an improved method of ventilating, and that you did not think proper to adopt it, that you differed from him, or did not act upon it, and that an accident subsequently occurred, would any responsibility be cast upon you in that event?

There would; his course of proceeding in such a case, if he thought it urgent, would be to address the mayor of the commune; the mayor would make his report immediately to the préfet or the sub-préfet; the préfet would consult the chief engineer, who would make his report to the Board of Mines; but if the préfet thought necessary, he would take an immediate step in the matter. My

W. Keene, Esq.

9th July 1849.

appeal, if dissatisfied, would be to the Board of Mines, or, in last resort, to the Council of State sitting at Paris.

3226. Not the Council of Mines?

No; the Council of State is superior to the Council of Mines; I hold my concession not from the Council of Mines, but from the Council of State.

3227. Supposing that the matter came before the Council of State in that form, would the Council of State have the right to interfere by positive direction?

They would.

3228. Acting upon the report of the Inspector?

Which had passed through all the degrees of the administration.

3229. And a review of all the facts?

Yes.

3230. Including your counter-statement?

Precisely; I should be heard.

3231. You would be called upon to state your own case?

Certainly.

3232. Have you ever known of any case in which parties have been in that predicament?

I have never known a case; it is very improbable to occur.

3233. For what reason is it improbable that it should occur?

So far as my experience goes of the Inspectors of the Board of Mines, I have found them to be men very well fitted for their employment, and always acting in a very courteous way. I have never had any reason to apprehend any act of oppression, or any attempt to put in force an unreasonable demand.

3234. We are not, of course, speaking of your particular case; we only take it as an illustration?

I reason from my own case and that of others. I have seen a great many around me in a like position, working concessions, and I have never heard a complaint.

3235. And you think that there would be a disposition, generally speaking, on the part of those who have the concessions to adopt the suggestions of the Inspectors?

Yes.

3236. The Inspectors, in your opinion, would make only reasonable suggestions, and there would be a disposition on the part of the persons having concessions to act upon those suggestions?

Exactly so; I have never known any other feeling.

3237. Then you do not think that any jealousy prevails amongst the owners of collieries in France in respect of this inspection?

I do not.

3238. You yourself entertain no objection?

None whatever; on the contrary, I have felt satisfaction at the visit of the Inspector; not that I felt that he took away from me any responsibility.

3239. From what class of persons are those Inspectors drawn?

They have received their education in the School of Mines, having first passed the Polytechnique School.

3240. Where is the School of Mines established?

In Paris; and I think there is a branch in St. Etienne.

3241. The first school is a branch of the Polytechnique, is it not?

I believe not. The pupils of the Polytechnique have the choice of a profession, and some of them choose the mining department, and are then transferred to the School of Mines.

3242. Then when you say that a Mining College is established in Paris, do you mean that that is merely a part of the Polytechnique, or that there is a separate Mining College in Paris?

There is a separate Mining Board.

3243. Which

3243. Which they enter on leaving the Polytechnique School?

I believe so.

W. Keene, Esq.

9th July 1849.

3244. Have any of these visitors of your mines been practical miners themselves?

When they have chosen the mining profession, they are sent to the Mining School and mining districts for instruction.

3245. In order to learn by practice?

Yes, to see all the practice in the mines. They may perhaps occasionally take a pickaxe, but they would not go usually to work there; they are men of superior education; and they endeavour, as far as possible, to make themselves acquainted with the practical part.

3246. They are not persons who have been educated in the mining business?

They are not.

3247. And yet are they considered by the owners of mines perfectly competent to give them advice?

They are considered as men possessing very superior scientific information, directed especially to the practice of mining.

3248. Then, upon the whole, should you say that the inspection in France, established upon that system, works well?

Very well.

3249. And without any vexation to the colliery owners?

None whatever.

3250. Who pays these persons?

The Government.

3251. Can you say what the rate of pay is?

There are many classes. I am not acquainted with their rate of pay; there are the sub-engineer and the chief engineer in each mining district.

3252. Are there many of those?

There are a great many; each department where minerals are worked has its mining engineer.

3253. Does a different man come round to your mine every time?

I have had visits from several; their residence is not very long in any one city; so far as I have observed, they are changed about every three or four or five years.

3254. How often do they visit the mine?

Every six months; about twice a year; they would come oftener if there was anything requiring their presence.

3255. Are they stationed in different districts of the country, or are they sent for the purpose of inspection from Paris?

In the chief cities of each department where there are any mines, there is a mining engineer in chief. There is a resident mining engineer in chief at Bourdeaux, and a sub-engineer at Pau and at Dax.

3256. What mines do they visit, coal mines?

Coal, iron, copper, salt and bitumen mines.

3257. Have you many salt mines in France?

We have many in the South.

3258. Rock salt?

Rock salt.

3259. And in the East also, have you not?

And in the East of France also, in the department of the Jura. I have myself bored and sunk pits down to the rock salt in the South.

3260. With respect to the working population in the collieries in France, what is the degree of education among them?

They read and write, I should say, at most.

W. Keene, Esq.
 9th July 1849.

3261. The greater part of them ?

The greater part of them may be able to read and write, but not more.

3262. As compared with our mining population, are they more or less intelligent, should you say ?

I think they are rather more intelligent.

3263. Rather better educated ?

Rather better educated, which I think arises from the instruction they receive in youth from the priesthood.

3264. Are they as industrious, as hard working ?

They are very industrious men ; they rarely begin work at an early age. Their parents seldom let them go to work till after they have made their first communion, about 12 or 14 years of age ; up to that time they go to the village school, where they learn to read and write.

3265. From your experience of the working population in the mines of France are they apt to be very careless with respect to incurring danger ?

About as other workmen are.

3266. Not less so than in England ?

No ; I have very often found that the more clever the workman, the more reckless he is.

3267. Should you say, then, from your opportunities of comparing the two, that there is not much more security against accidents in France from the education of the people than there is in England ?

Not more.

3268. The practical working of the mine is subject to subordinate officers, is it not--overlookers ?

It is.

3269. Are there parties whose duty it is to inspect the mine daily before the workmen enter ?

The overlookers.

3270. Are the overlookers drawn from the workmen ?

They are ; and occasionally there are lower students than the students in the Polytechnique, who come out of the Mining Schools and are employed as overlookers, who have had more education than the miners generally.

3271. Those would be men not brought up actually to the working business ?

They would be intelligent men, who had found means to quit their working business for study, and had passed a year or two in the public schools.

3272. Is it matter of practice among the working population in France to leave their labour and go to the Mining Schools to obtain education ?

An intelligent man in France is more likely to leave his occupation for a year or two for study than in England.

3273. Being able to compare those overlookers with the officers of the same grade in English collieries, should you say that they were a superior class of persons ?

No, about the same ; they would be very little superior ; it is among the lower class of workmen that I think there is a superiority ; they are more intelligent.

3274. Would your acquaintance with the overlookers of the collieries in England, lead you to say that they were people of anything more than a common education in mining business ?

Yes, superior to the common miner, but not of high education.

3275. Is there anything more than their knowledge of the practical routine ?

A little more ; they have more self-education, and their practical knowledge is very valuable.

3276. In England ?

In England.

3277. Should you say that the same class of persons in the French mines had more, or not more professional education than in England ?

Perhaps they would get a little more scientific education than in England.

3278. The

W. Keene, Esq.
9th July 1849.

3278. The ordinary workmen?
The ordinary workmen in France; but I do not know that to them it is any great advantage.
3279. You do not think it a great advantage?
I do not think it a great advantage to the ordinary workman.
3280. Are you speaking of France, or France and Belgium?
France and Belgium.
3281. Are there many English employed in the mines in France?
There are a few at Decareville, but not at St. Etienne.
3282. Do you know any other place in France where they are employed?
There have been a few Englishmen in the iron mines, in the department of the Landes, employed in the manufacture of plate iron, of which they had better knowledge than French workmen.
3283. Has the present system of inspection in France been in existence for a great length of time?
On its present footing, since the law of 1810.
3284. Before that was there no inspection?
I am not aware of the state of the law previously.
3285. Are you at all aware whether there was any difficulty in establishing the inspection as it now exists originally?
I believe none.
3286. And you never heard any serious objection made to it by any colliery owner in France?
Never.
3287. The Inspectors have a right to inspect in defiance of the owner?
They have.
3288. Is any obstruction ever made to it?
I never saw any; I have generally seen their visits looked forward to with pleasure, and received with pleasure.
3289. Do you think that the visits of the Inspector twice a year give him much means of knowing whether a mine is in a safe state or not?
The plans guide him greatly in his judgment.
3290. Does he come without giving any notice?
We generally know about the time that he arrives; we have frequently some notice of his arrival.
3291. Then a mine may be in a dangerous condition for about five months, and yet sufficiently presentable when he comes?
I do not think that it would be so.
3292. Whether it is likely or not, it might be so, might it not?
I think it would be difficult to put a mine that was in a dangerous state, generally, in a good state in a short period.
3293. Supposing that the ventilation was defective, from the furnace being out of order, or any of the partitions and brattices being removed, or anything of that kind, and thereby the ventilation quite imperfect?
I think it is the interest of the coal owner to keep it up as well as he can.
3294. That is another thing; the question is as to the efficiency of inspection; how far do the visits of the Inspector, only twice a year, give any security that the mine is so managed as to be safe?
If there was any culpable neglect, it would very quickly get to the ears of the Inspector through the ordinary authorities.
3295. Do you find that the workmen ever mention their grievances and complaints to the Inspector?
They would do it rather to the mayor of the commune.
3296. Does an Inspector reside in the district, or what is the rule in that respect?
In the chief town of the department.

W. Keene, Esq.
9th July 1849.

3297. So that he is accessible at all times ?

He is.

3298. If the workmen make complaints to the mayor, that they do not think a certain part of the pit is safe, what does the mayor do ?

The mayor would make his report to the next authority ; to the sub-préfet or préfet.

3299. Do you find practically that they do that much ?

Very rarely ; but they would not, in my opinion, hesitate to do it, if needful.

3300. Is not the choke-damp as fatal as the inflammable gas ?

Yes, it is.

3301. In order to make the ventilation of your mine complete, do not you consider that it would be very necessary to have two shafts ?

No doubt. I intend to sink another shaft.

3302. So as to have a downcast and an upcast shaft, you mean ?

Yes.

3303. What extent is your concession ?

Nearly three square miles.

3304. Do you mean three square miles or three miles square ; do you mean to say that it is three miles in the side of the square ?

No.

3305. But in the aggregate ?

In the aggregate.

3306. Two or three hundred acres ?

Yes, it would be more than that.

3307. Rather more than that ?

Much more than that.

3308. The safety of a mine very much depends upon the size of it ; what number of men have you ?

I have employed about 50 men. Choke-damp is exceedingly difficult to get rid of in a mine, and its effects are very bad upon the health of the workmen.

3309. That could be overcome by sufficient ventilation ?

Yes.

3310. In a mine like yours, the choke-damp might be entirely got rid of by proper ventilation, might it not ?

No doubt of it.

3311. In the case of inflammable gas, it is impossible to be quite secure under all circumstances against danger, is it not ?

Under all circumstances I should believe it would be.

3312. Would not the ventilation be a more complete protection in the case of carbonic acid than in the case of hydrogen gas, from the fact of the carbonic acid all being in the passages, and, therefore, easily taken away ?

Yes ; I conceive that in a fiery mine the ventilation would get rid of it out of all the working passages ; the fire-damp would only remain in the upper part of the goafs of the mine ; the carbonic acid would be at the lower part.

3313. And, therefore, within the reach of the ventilation ?

Yes.

3314. Does the carbonic acid come out in any sudden blowers from the stratum ?

No.

3315. It is constantly exuding ?

It is constantly exuding ; I consider the steam-draught quite needful to get rid of it, and the most powerful means that I could employ for that purpose. I have already had some experience of the use of steam in producing currents, 20 years since.

3316. In

W. Keene, Esq.

9th July 1849.

3316. In what way?

I introduced Mr. Gurney's system 20 years ago, for obtaining a draught by means of high-pressure jets.

3317. How applied?

Applied for locomotion.

3318. Have you determined how you intend to apply it to your present object?

By placing a boiler on the surface, carrying down the steam, and having jets at the bottom of the shaft.

3319. What is the diameter of your shaft?

Six feet by eight; it is not a round shaft.

3320. An elliptical shaft?

Yes.

3321. Have you determined how many jets you will have?

About 15 jets.

3322. Of what diameter?

Three-eighths of an inch.

3323. Is that a shaft of which you will require to make use for other purposes besides ventilation?

No; it would be a separate shaft.

3324. Simply for ventilation?

Simply for ventilation.

3325. Then you will not find it necessary to place your apparatus so as to allow of things passing up and down?

Not at all.

3326. Shall you take your jets to the bottom of the shaft?

To the bottom; I should employ steam at high-pressure, of course. I do not think that low-pressure steam would effect the purpose at all; anything less than 40 lbs. to the inch would be comparatively ineffective.

3327. Has it ever come to your knowledge that, in the visits of the Inspectors, they have been able to suggest information to the owners of collieries as to improvements which they have become acquainted with elsewhere; do you think that colliery owners have come to a knowledge of improvements through the communication with the Inspectors?

They would discuss generally the state of the mine with the owner, and their knowledge enables them to suggest improvements.

3328. That is their practice, is it?

That is their practice.

3329. With the owner or with the workmen?

With the owner, upon the sight of the plan; and they would suggest any improvement that would occur to them from their own practice, or what they had seen elsewhere.

3330. Do you think that a useful process?

I do.

3331. Does anything further occur to you which you wish to state?

Nothing further, except as to what I heard the other day with respect to the employment of steam: from my own experience in the employment of high-pressure steam in procuring a draught, I should say that the employment of steam after passing an engine would be of little or no use.

3332. And would it not be necessary very accurately to measure the pressure, not only at the boiler but at the jets, in order to ascertain the power of the steam?

If the boiler were employed in furnishing steam through the jets only, and the passages were fully adequate, then the pressure could be tolerably well ascertained by the safety valve; but if the steam had first to pass an engine before going to the jets, then it would be impossible to know what pressure was on the jets except by a valve or gauge placed quite close to them.

W. Keene, Esq.
 9th July 1849.

3333. Low-pressure applied in this way would produce no effect?
 No effect whatever.

3334. What wages do your workmen get?
 Thirty sous a day.

3335. Do they work by piece or by time?
 I have found it best to employ them at day wages.

3336. Are they industrious?
 Very industrious.

3337. From what you have seen of the visits of the Inspectors, do you think that, having the means of looking at the plans, and examining the mines, to ascertain whether they were properly worked, they would be able by any such inspection to obtain information with respect to the rights of parties to the minerals which it would be desirable they should not obtain?

I think that their inspection would chiefly go to the mode of working the mine and ventilation for the health of the workmen; they would pay very little attention to my limits; it would be hardly a question that they would entertain unless it was upon special orders from their superior Board.

3338. Do they inspect the plans and workings in such a manner as to enable them, without your being aware of it at the time, to ascertain the particulars with respect to any right of property?

No.

3339. And yet, without making such an examination as would enable them to do that, their investigation is sufficient to enable them to judge of the management of the mine?

Quite sufficient.

3340. Are there any collieries adjoining yours?

There have been workings near me, but they have not come up to my limits.

3341. In the case of contiguous owners, will not it enable them to ascertain how the actual boundaries are?

Such a case would be proceeded in thus:—there would be a complaint from the party who supposed that his neighbour was encroaching upon his ground made to the superior authorities, and the superior authorities would ask from both parties particulars; but the engineer visiting the mine would not enter into that subject unless he was sent down specially charged to do so.

3342. Could not it happen in this way; that a vein was pointing out in a particular direction, and he told it, and the adjoining proprietor might apply for a mine there, and be a rival to you?

Such a case might happen; but I have never seen or heard of any such conduct. I have never seen them disposed to do a private injury, and I never heard any complaint of that nature.

3343. You never heard any jealousy expressed of the visits of the Inspectors upon that ground?

Neyer. I know a case at this moment of two concessions, where I believe they are very near each to the limits of the other, but it is a question which will not be entertained by the Inspector unless he receives direct orders from his superior Board.

3344. Do your workmen use lamps or candles?
 Both.

3345. What lamp do they use?
 What we call a stirrup-lamp.

3346. Is it a safety-lamp?
 No.

3347. They do not use the safety-lamp?
 No; we have no inflammable gas.

3348. You have carbonic acid?
 Yes.

3349. Have

3349. Have you ever seen Mr. Gurney's plan used on the Continent?

It has been used on the Continent for producing draughts in furnace chimneys, the same as I used it there myself 20 years ago.

W. Keene, Esq.

9th July 1849.

3350. Furnace chimneys for what purpose?

Where the draught has been sluggish. I used it to get a stronger draught on board a steam-boat in 1830, to enable me to stem the strong currents of the Garonne.

3351. Did you do it without the waste of your steam in the boiler?

It was more valuable than it cost me to obtain it, more particularly in the getting up of the fire in the first instance. The draught being sluggish, it would be impossible to get up the fire readily. So soon as there was steam enough to put on the jets, they would cause a very powerful draught, and the fire could be got up immediately to a great intensity.

The Witness is directed to withdraw.

JOSEPH NADIN, Esquire, is called in, and examined as follows :

J. Nadin, Esq.

3352. YOU were originally a colliery viewer, were you not?

Yes, I was educated as a colliery viewer.

3353. In what part of the country?

At Newhall, near Burton-upon-Trent, in the county of Stafford. It is in the county of Derby that the collieries lie.

3354. Have you had a great number of years' experience in the management of collieries?

About 35 years. I was employed in gold and silver mining in Peru, Chili and the Plata provinces about five years out of that time. I have been about 30 years in the coal mines; Newhall, Stanton and Hartshorn; my brother and myself are half owners; about 4,000 acres, in conjunction with the Earl of Chesterfield and W. Blake, Esq.

3355. Then you are a colliery owner as well as a viewer?

Yes; I was educated for a viewer.

3356. Are the collieries in that part of the country liable to accidents from explosion?

There is a good deal of fire-damp.

3357. Have there been many accidents there since your acquaintance with them?

There have been a good many altogether.

3358. What is the system of ventilation pursued?

In some cases furnaces, and in others natural ventilation; hanging lamps in the pits in some cases. We have not had an accident in our present bed of coal in our collieries for 80 years, since my father first commenced working. We have not lost a man by fire-damp in them, but we have had many accidents in the neighbourhood.

3359. What is the depth of your pit?

About 120 yards the bed we are now working.

3360. What is the thickness of the coal?

About five yards thick; we only work three yards, the two yards lying uppermost being an inferior coal. We take the works a great length, 200 yards in length; we can take them any length.

3361. You say that your system of ventilation is by furnace and by lamps?

By putting a lamp sometimes in the pit, generally by furnace. We can get a very great deal, the best ventilation, by furnace, better than in any other way.

3362. How do you effect the ventilation by lamps?

Merely by hanging a lamp in the pit on fire, with coal in it, letting it burn in the pit.

J. Nadin, Esq.
9th July 1849.

3363. What do you call a lamp?

It is a large instrument made of iron bars, which can hold a considerable quantity of coals.

3364. In short, it is an open brasier with coals?

Yes.

3365. Do you consider that either of those methods gives you a sufficient ventilation in those mines?

With a furnace seven feet wide, acting up a shaft nine feet in diameter, we have got a current of air of as much as 14 feet in a second near the furnace, in a direct passage to it; I think that is quite sufficient to ventilate a mine, say with 200 men in it.

3366. Do you know what power of ventilation, as measured in cubic feet of air, can be obtained?

About 1,800,000 feet in an hour; I consider that quite sufficient to ventilate a pit of that extent, unless it is excessively fiery.

3367. How many cubic feet per minute would that be?

About 30,000.

3368. What is the extent of your workings?

Where we are at work now, we are about half a mile in from the bottom; we work about 200 yards in length.

3369. Are your air-courses there in one continuous line, or are they split?

They are in one continuous line in the pit in which we are now at work.

3370. Have you two shafts, or one?

We have two shafts.

3371. Are both shafts used for working, or is one entirely for ventilating?

One is used for pumping water and ventilating; the other for turning coal; they were sunk under peculiar circumstances. I had to get through a great quantity of top-water, and to go down on a fault, and have only got two shafts down. I am now pumping the water out, and sinking the other shaft down to put the furnace in. In this case I have not been able to get the furnace in, from only having two shafts, one being used for pumping water. We had to sink down on a fault; we had to get through a great quantity of water, and in doing that, we had to pass down a fault about 14 yards thick. We got thrown off the fault on the bottom, and got a considerable quantity of water at the bottom, and had to put up an engine; it was under peculiar circumstances.

3372. Do you conceive that the 30,000 cubic feet which you say was got per minute was sufficient to make the pit secure?

I think quite so.

3373. Have you any extensive goaves or gobs, waste places?

We carry a clay wall by the side of the off-way; we carry the wall the whole distance along the side of the gobbing, so as to shut it up.

3374. Is that much expense?

No, it is not.

3375. From whence do you take the material in order to make that wall?

We dig clay out of the clay mines above.

3376. Do you mean from the surface?

Yes.

3377. And lower it into the pit for that purpose?

Yes; we have it about half a yard.

3378. What is the height of your passages?

About six feet. The coal is five yards thick in the whole. We leave two yards for the roof; and then there is a portion of earth between the nine feet and the six feet above, and we have to leave a portion of the nine feet between to keep this earth from coming down; about three-quarters of a yard.

3379. So that out of the 15 feet, you take only about six?

Yes.

3380. You

*J. Nadin, Esq.*9th July 1849

3380. You build a wall, then, six feet high?
Yes; the whole of the way along the off-road side.

3381. What is the thickness of that wall?
About a foot thick.

3382. Can you say what the expense is per foot, or per yard, of that wall?
It would be very trifling; it would be perhaps about half a crown a yard.

3383. Does this process altogether prevent the escape of inflammable gas?
Yes, it keeps it entirely, and keeps the material from firing as well from spontaneous combustion; it will fire if that wall is not there.

3384. Is the coal in your part of the country liable to spontaneous combustion?
Very much so.

3385. Is it full of iron pyrites?
Yes, it is considered so.

3386. Has that been the method habitually followed in that part of the country?

It is one which I introduced there. Formerly they only carried the works as far in as they would fire, and then left them off; they would fire in about six months. Since that, I have adopted that plan; but this is not the best method of getting coal; it is best to drive it in to the far end, and come back; but I was forced to begin here, from the failure of another bed of coal.

3387. Supposing you worked it in the way you describe, would it not be equally possible to apply the method which you have spoken of, for the purpose of shutting up the waste parts of the mine?

If we worked it by what we call bringing the coal home again, we should not do so; we should drive right round, and back again, shutting up all behind us. That is by far the best mode of working coals, and should be adopted everywhere.

3388. But supposing you work to the further end, as you say, and then come back again, after having worked out the coal in coming back, do you not leave a goaf?

We leave it behind; it never falls in front; it has not time; you completely throw the stuff back upon it, so that it makes it quite secure behind; there is always fresh small stuff in front, which would fill it up as you come back again, so that you have always one passage for your wind in the whole distance.

3389. Have you had experience of that mode of working?

Yes, I have adopted it before; but I was driven to the course I am now taking by the sudden failure of a bed that we were at work in; we had to commence immediately.

3390. In the case of workings by the method which you have described, have you found that it secures the mine entirely from the inflammable gas from the waste parts?

Yes, the clay wall is a perfect security.

3391. The question does not refer to the clay wall, but to the other method?

The other would be perfectly so, because you have all the solid coal to come back again, and the fresh stuff thrown back completely stops it up.

3392. Is it the usual practice in Staffordshire and Derbyshire, and parts of the country with which you are acquainted, to ventilate by means of furnaces?

In some cases, and some (not a great many) not, and in some they do.

3393. Where they do not ventilate by furnaces, what other method is pursued?

They trust to the currents of the air, just to one shaft drawing against the other. Of course the ventilation is very imperfect.

3394. Is your furnace placed near the bottom of the upcast shaft?

It is.

J. Nadin, Esq.
 9th July 1849.

3395. Do you work with lamps in those pits?

We have them in dangerous places; but we keep such a ventilation as to make it not necessary to go into the works with them; they work with naked candles.

3396. Would you be able to work with naked candles in a pit in that country, where there was nothing but the natural ventilation?

It is dangerous; that is what the accidents arise from; in many cases it is dangerous; in sudden drops of the barometer it becomes dangerous.

3397. The current which you have is quite sufficient for your purpose?
 Quite.

3398. Indeed, as much as you can bear?
 Yes.

3399. Do you think that it is more common or otherwise in the mines of the midland districts to have artificial ventilation?

It is much more common otherwise.

3400. They do without it?
 Yes.

3401. How are your mines overlooked; are there persons charged with the overlooking of the mines?

We have bailiffs; I always go down myself; we have a bailiff as well.

3402. Do you go down every day?

No, not every day; occasionally; we have a bailiff as well, and then we go down occasionally.

3403. Are there persons whose duty it is to go down every day before the men?

Yes, I have a bailiff who always goes down.

3404. It is his business?

It is his business to do nothing else; we call him the overlooker or bailiff; he reports everything to us as he finds the mine. I am there every day myself.

3405. Is he drawn from the class of workmen?

He is.

3406. Supposing that he found, upon entering the mine, that it was in an unsafe state, what course would he take?

He would immediately report to us that it was so. We should keep the men out and examine the airway, and not allow the men to go in unless it was in a proper state. From the airways falling in, of course there are frequent accidents; we are constantly liable to the ways falling in; that by working, what we call home again, would be avoided.

3407. Have you ever paid any attention to the question of a superintendence or inspection by Government?

I have. I was round with a memorial in favour of mining inspection; I have been for some time. I was at a meeting at which the whole of the coal-owners of Derbyshire, Leicestershire and Nottinghamshire were represented.

3408. Where was that meeting?

At Derby. They were meeting, as to business, upon the lines of railroad opening, and I laid a memorial before them in favour of mining schools; I also mentioned the plan to them that I had heard was to be proposed. They said that they should have no objection to Inspectors, provided they had no compulsory power; they made great objection to that. I also laid it before the South Staffordshire coal-owners. I found that there was a meeting of the coal and iron masters, and I met them at Handsworth; and just at that time they had got Mr. Duncombe's Bill, which put them very much out of conceit with the thing altogether.

3409. But they would not object to a right of entrance being given?
 No, provided there was no compulsory power.

3410. Or to a right of inspection of the plans?

No, they would not object to that, but they would object very strongly to a compulsory

pulsory power being given; they were very hot about Mr. Duncombe's Bill. The education matter they seemed very much in favour of; but they were very much irritated respecting Mr. Duncombe's Bill, of which they had then a copy on the table.

J. Nadin, Esq.

9th July 1849.

3411. When they talked of compulsory powers, did they mean to apply that term to powers of directing the mode of working the mine, or did they include in that description powers to make an inspection of the mine, and to look at the plans?

They would not object to that, but not to have compulsory power.

3412. Was it a very general meeting of the coal-owners?

It was; they were all represented at the meeting at Derby, the Leicestershire, Nottinghamshire and Derbyshire coal-owners; they were all either there, or represented.

3413. Was there unanimity upon the point?

I mentioned it, and asked Mr. Jessop, who is one of the principal men, and several more, and they said that they should have no objection to a plan of that sort; and the Staffordshire coal-owners said, that they should object to Inspectors having any compulsory power over them.

3414. Was there any signature of any petition or paper?

I was taking a memorial to get it signed in favour of mining schools and colleges, to be under the direction of Government.

3415. How many signatures did you get?

They would all have signed it, but they had got Mr. Duncombe's Bill at the time.

3416. But did they sign it?

No; they said they would do so if that Bill was withdrawn; they have now the memorial in their hands; I left it with Mr. Grazebrook. They said that they had no objection to sign as to the education part, and to agree with the other; but Mr. Duncombe's Bill had irritated them to such a degree, that they thought it was a sort of trap to get them to assent to that Bill.

3417. The memorial was for the education, generally, of mining operations?

Yes, and the establishment of a college.

3418. Was it with a view to education in mining or the education of miners?

An education in mining, and the other as well.

3419. Uniting the two?

Yes, they were irritated very much at Mr. Duncombe's Bill. I think I should have got them to have signed if it had not been for that. Mr. Smith, Lord Dudley's agent, seemed very favourable to it; and they said that if the Bill was withdrawn, they would have no objection to signing the memorial.

3420. The Bill is withdrawn now?

Yes. I think they would be very much averse to any compulsory power; I think they would oppose it strongly in the Midland districts.

3421. Supposing that the Inspectors had the power to enter mines and to examine the plans, and were then authorized to report upon any dangerous circumstances which they had observed in a mine, should you say, from what you heard on that occasion, that there would be any jealousy of such a commission as that?

No; I think not at all; they seem disposed to support anything of that sort. I think by advice and assistance, a great deal might be done in that way by Inspectors, if they had not the power of compelling; there should be no power of that sort.

3422. From your experience of the mining of those parts of England, should you say that, generally speaking, their mode of management of their ventilation was very defective?

It is so.

3423. Do you think that much might be done by judicious suggestion to diminish the chance of dangerous accidents?

A great deal.

(164. 10.)

J. Nadin, Esq.
9th July 1849.

3424. More especially in what way?

By an improved method of ventilation, and an improved method of working the coal as well.

3425. You are acquainted with other districts besides the neighbourhood of Burton, are you not?

I am, with the Staffordshire and Nottinghamshire; when I was in business I was amongst them all about there.

3426. Are they all worked much upon the same principle?

Yes; generally all those mines, the thin mines; the Staffordshire mines, of course, work upon a different principle; they are the thick coal; there is a difficulty there in ventilating; they do not like very high ventilation, for fear of what they call blowing the gobbing up, making the small coal ignite. That of course might be regulated so as to have enough to ventilate, and not enough to produce that. Of course it is more difficult to ventilate a coal ten yards high than one of six feet; you cannot bring your air round the face as you can in a thin mine.

3427. What are the most extensive workings that you know of in that part of the country?

The Marquis of Hastings' in our immediate neighbourhood, and Mr. Stephenson's and the Company in Leicestershire; Staveley colliery is the largest.

3428. That is in Derbyshire, is it not?

Yes; that is about 300,000 tons a year.

3429. Have you any means of saying what extent of distance in the collieries which you have mentioned it would be necessary to reach by ventilation in order to ventilate the mines completely?

Some of them, the Marquis of Hastings', I should think, are a mile and a half in; and the other, I should say—

3430. Is that a new one?

Yes.

3431. You state that there are some mines in Staffordshire where they cannot apply a furnace for fear of setting the mine on fire?

They are afraid of its firing.

3432. Would the same objection apply to the steam-jet?

The application of the furnace is objectionable, in the first place, as to raising the gas which is in the works, and then as setting the gobbing or small coal on fire; the steam-jet would, of course, not set the gas on fire, but it would have the same effect if you worked it largely in firing the other; but you might regulate it, of course, to a medium between the two, ventilating and not firing the gobbing.

3433. That would be an advantage in the steam-jet over the furnace?

It would.

3434. Have you ever seen the steam-jet in operation anywhere?

I have not; I went to the Polytechnic to look for it.

3435. Did you see it then?

No; I saw Mr. Fourdrinier's apparatus.

3436. Have you had any experience of Mr. Fourdrinier's apparatus for preventing accidents by the breakage of ropes?

From what I have seen, I think it ought to be put into practice. I saw one of the most horrible accidents in a neighbouring colliery to ours; 14 men were thrown down from the top, 217 yards; several men killed, others were dreadfully wounded and lay at the bottom, and some of them died before they could be got up again. It was from the breaking of the main wheel of the shaft. This apparatus would have stopped it.

3437. Do you work with guides in that part of the country?

We do.

3438. What description of guides?

Wooden ones; they are capital things.

3439. Where

3439. Where have you seen Mr. Fourdrinier's apparatus in operation?
I saw it at the Polytechnic.

3440. You have not seen it, practically, in operation?
I have not.

3441. Could you sufficiently judge, by looking at the model, to say whether it would work, practically?

I could not; I could not get near enough to see; but something of that kind I have no doubt would act; it appeared to act remarkably well.

3442. It would answer the purpose?
As far as I could see, I should say it would.

3443. Are there any points in which you think it would be possible to suggest improvements with respect to the Midland collieries, so as to have a greater security against accidents?

Yes; I think in the ventilation and in working the coal as far home again as it is possible to bring it back. I was going by the pit when the great accident happened in Staffordshire, where so many were killed.

3444. Which case do you refer to?
One about three weeks ago, at Dudley.

3445. By explosion?
Yes; I was going by the pit when it took place. I was on the bank when 15 were brought up; eight were dead, and seven apparently were dying; and six were not got out when I came back again at night.

3446. Did you go into the pit afterwards?
No, they seemed jealous about interference. I had the memorial in my hand, and went up to the pit. I asked them if they would allow me to go down, but they seemed jealous; perhaps they thought I should give evidence against them.

3447. Therefore you are not aware what the state of the ventilation was?
No; it appeared at the top of the pit to be very slow.

3448. They had no furnace?
No furnace.

3449. Nothing but the natural ventilation?
Nothing but the natural ventilation.

3450. That is not sufficient to guard against accidents?
It is not.

3451. In your own case, are the two shafts near one another?
Yes, they are close together.

3452. Do you think that a good arrangement?
I do not think it is; by drawing the wind down one when they are close together, the currents of air may be interfered with.

3453. In case of accident, do you think that there is more likelihood of destroying the ventilation altogether below, than if the shafts are at some distance from one another?

I do not think that of very much consequence; I think there should be a little distance between them, perhaps 20 yards.

3454. Supposing that the shafts were at opposite points of an extensive working, and that the partitions were blown out by an explosion, would not the ventilation be much more considerable, even after that, from one shaft to the other, if they were at a distance from one another, than if they were placed close together?

I should say it would.

3455. From your experience of these accidents, should you confirm what has been represented to the Committee, that by far the greater number of deaths, in consequence of an explosion, take place, not from the fire-damp, but from the after-damp?

I am sure I cannot say; many, of course, would be choked by it, provided there was not a good ventilation through the mine.

J. Nadin, Esq.
9th July 1849.

3456. But should you say that the greater number of those lives that have been lost have been lost by the fire-damp, or from the after-damp?

I should say from the fire-damp, the fire itself.

3457. Have you ever examined cases of accident of that kind?

I have seen two or three; I saw this in Staffordshire; they were dreadfully burnt.

3458. Have you ever examined into the proportions of cases that showed marks of fire, and those that did not?

No.

3459. Have you had any accidents in your pit?

We have not had one person killed in the present bed of coal in 80 years, since my father first commenced working; we have been exceedingly lucky.

3460. During the whole of that time have you had furnace ventilation?

No.

3461. For a long time it was natural?

Merely natural ventilation.

3462. How long since was the furnace put up?

I should say just after I first commenced; nearly 30 years ago we had furnaces, and sometimes only with the natural ventilation.

3463. When they have only the natural ventilation, do they ever adopt a mode so as to make the cowl of one of the shafts face the wind?

No, they do not.

3464. Would not that be more effectual?

It would.

3465. In Derbyshire it is constantly used?

It is; I have seen it myself in Derbyshire.

The Witness is directed to withdraw.

George Elliot, Esq.

GEORGE ELLIOT, Esquire, is called in, and further examined as follows:

3466. SINCE you were before the Committee upon the last occasion, have you had intimation of an accident which has lately occurred in your pit at Usworth?

I received a letter on Friday, after my examination here, stating that the rope had broken at the Usworth colliery, and had gone down upon the cage.

3467. At what depth did it break?

In taking the lift; therefore, it was close to the bottom of the pit.

3468. At what depth from the surface?

About 1,000 feet.

3469. Has the cause of the rope breaking been ascertained?

The rope had slipped off the drum; it was too long: I rather attribute it to carelessness; the engineer had fastened it temporarily, so as to take a portion of the slack rope on to the roll, and when he had loosened it off the roll, the clamps which he had put on had not been sufficiently screwed up, and the rope went all down the pit. The value of Mr. Fourdrinier's apparatus in the present case is this: there has been some doubt with respect to his apparatus, in the case of the rope breaking, whether the falling down of the rope upon the cage would not break the cage and carry away the guides, and thereby render the utility of his apparatus ineffective. Now this is a proof of its action in the first place, and of its capability of resistance to pressure on an extreme circumstance like this occurring.

3470. Was it an iron rope or a hempen rope?

An iron rope.

3471. About 200 fathoms of rope?

Yes, about 200 from the drum; it is about 170, and then it takes about 30 more,

3472. Can

3472. Can you say what would be the weight of those 200 fathoms of rope?
I believe it is about 36 or 37 cwt.

George Elliot, Esq.

9th July 1849.

3473. Did that fall upon the cage?

Yes; the lower end of it is down at the cage, and the top end of it is attached to the drum; therefore, it does not fall down like a weight, all at once, but it gradually falls down and coils upon the top of the cage. There has been a fear in the minds of practical men, and a fear which I have had myself, that in a case of this sort, it was doubtful whether the apparatus would be capable of holding the weight of the cage, and also the weight resulting from that descent.

3474. Are you informed what was the actual result with Mr. Fourdrinier's apparatus?

I am informed that the result is, that the cage was not injured.

3475. And that it was arrested immediately?

It did not fall; it stopped.

3476. What number of men were there in that cage?

There were no men.

3477. There were coals in the cage?

Yes; the cage was loaded taking its lift; the rope broke; the cage was arrested, and the rope went down, and it sustained both the load and the rope.

3478. How far from the bottom of the pit did this accident occur?

Very near the bottom of the pit; it must necessarily have been near the bottom of the pit, as the engine was taking its lift of the load. I suppose it was the first stroke or two of the engine.

3479. It stopped instantly?

I infer that it must have stopped immediately, otherwise the cage must have been broken if the cage had fallen.

3480. How far from the bottom did the chain break?

It broke close to the top; indeed, it did not break, it came off.

3481. First it would fall lightly, comparatively?

Yes.

3482. And then there would be a solid mass of iron, and as it became heavier and heavier, the mass of iron would be still more solid?

Yes; its fall would be divided over a period, perhaps, of seven or eight seconds.

3483. Was this a new or an old rope?

This was an old rope.

3484. Was it a rope that you would have used if you had not had Mr. Fourdrinier's apparatus?

It is a rope that is not a very good one. I scarcely can answer that question; we should have examined it very minutely.

3485. Was it a rope that you used for the purpose of taking the men up and down?

Previously to the introduction of Mr. Fourdrinier's apparatus, we did not let the men go down upon that rope; we put the apparatus upon this bad rope, as we called it, and then the men actually preferred to go down upon that rather than go down upon the good rope without it.

3486. What weight was there in that cage, do you suppose, independently of the cage?

I think I have stated in my evidence before, that the weight of the cage and load was about two tons and a half.

3487. It would be about that?

I think so.

3488. Supposing that the rope had broken when that weight was half way up the pit, and that without Mr. Fourdrinier's apparatus the cage had fallen to the bottom of the pit, would it then have been entirely destroyed?

Five or six or ten fathoms would have entirely destroyed it.

George Elliot, Esq.

9th July 1849.

3489. Therefore, even as regards the saving of expense in an accident of that kind, Mr. Fourdrinier's apparatus is an advantage?

Yes. I had a case of that sort at Monkwearmouth about six or eight months ago; the rope broke a short distance above what we call the meetings, half-way in the pit, the cage descending; the rope broke and carried away the other one, and they were thus both broken to pieces.

3490. What would an accident of that kind cost you, from the destruction of the cage with the tubs containing the coal?

I should think that accident cost us nearly 200*l.* The rope went down with it as in this case at Usworth; and a wire rope, when it falls in that manner, is generally rendered useless after it; a hempen rope may be used after a fall of that kind.

3491. However, an accident of that sort would cost you about 200*l.*?

I believe that accident at Wearmouth cost us about 200*l.*

3492. So that the use of Mr. Fourdrinier's apparatus, in the case of the occurrence of any accident of that kind, would save you such a sum?

No; the use of Mr. Fourdrinier's apparatus would not save the value of the rope, because, in the case of Usworth, our rope went down; but there would be the saving of the tubs and cages, which I suppose would be 60*l.* or 70*l.*

3493. Then the 200*l.* included the value of the rope?

Yes.

3494. What is the result of your experience between iron chains and hempen ropes?

We never use chains.

3495. You were understood to say that this was a chain?

No, it is a flat wire rope; we would not use chains at all; they are too uncertain.

3496. Supposing an accident of that kind to occur, is there a great loss of time, besides the expense?

Yes, it may take two or three days; it depends upon circumstances; it may happen to carry away all the guides; I have known it do that.

3497. And probably would?

The probability is that it would; that falling with such a velocity it would carry away the guides.

3498. Therefore, an accident of that kind may put the colliery owner to considerable expense?

It may.

3499. What are the ropes commonly used at Newcastle, hempen or wire?

Hempen ropes have been used until recently; we now find that there is a considerable economy in the use of wire.

3500. Is it flexible?

Very flexible; it is not elastic; it does not stretch, and that is one of the advantages which I believe ought to be mentioned in this invention of Mr. Fourdrinier, that it affords the elasticity of a hempen rope on account of the spring. In taking the load, it relieves the harshness or rigidity of the wire rope, and I believe, on that account, will tend very much to make the ropes wear a longer time.

3501. It prevents the sudden jerk when it reaches the pit?

Yes; and the springs are constructed so as to be about equal to an empty cage; it would not do to have them stronger, or they would not act; and in descending and ascending, as I have often observed, there is a motion; you can feel the action of the springs upon the cage, which reduces the inequality of the motion when the engine is passing the centres.

3502. Are the wire ropes thicker or not so thick as the hempen ones?

Not nearly so thick.

3503. What is their thickness?

They are made of different thicknesses; comparatively with the weight of the same strength of hemp, I think they are not more than 30 or 35 per cent.

3504. Should

3504. Should you say, with reference to this particular accident, from the description which you have had of it, that Mr. Fourdrinier's apparatus, besides saving you the inconvenience of the accident, has also saved you the expense?

George Elliot, Esq.

9th July 1849.

In this particular instance it has been of less utility than almost in any instance that you could suppose, because the load was close to the bottom, and little harm could have resulted from it under any circumstances. My observations are intended rather to prove, that in case the rope breaks at any intermediate point between the bottom and the top, since it will hold the load near the bottom, with all the weight of the rope upon it, it will hold it at any given point higher up.

3505. In considering the saving of expense; first of all, there is the capital employed in constructing the machine, and the interest of that money, and then you must consider the accidents that would have happened without it?

Yes, it is a very simple thing; 10*l.* or 15*l.* or 20*l.* would be the amount of the cost of it.

3506. Then the cost of all the accidents is saved, in fact?

Yes.

The Witness is directed to withdraw.

Ordered, That this Committee be adjourned till To-morrow,
Two o'clock.

Die Martis, 10° Julii 1849.

The LORD WHARNCLIFFE in the Chair.

Evidence on the
Prevention of
Accidents in
Coal Mines.

J. Mather, Esq.

10th July 1849.

JAMES MATHER, Esquire, is called in, and examined as follows :

3507. YOU reside at South Shields ?

I do generally.

3508. In what capacity ?

I am a wine merchant ; I formerly studied medicine.

3509. And you are honorary secretary to a committee formed at South Shields in the year 1839, for the purpose of investigating the causes of accidents in coal mines ?

Yes.

3510. Will you state how that committee is composed, and what led to its appointment ?

In consequence of an explosion which occurred in June 1839, just within the precincts of the town in the St. Hilda Wallsend mine, in which 52 lives were lost. The attention particularly of the inhabitants was called to this matter ; and at a public meeting for the purpose of relieving the widows and orphans, and making provision for them to a certain extent, it was suggested that some inquiry should be made into the causes of these fatal and frequent accidents.

3511. In consequence of that, what steps were taken ?

In consequence of that, a committee was appointed immediately.

3512. At a public meeting ?

At a public meeting ; at least a large committee was appointed, and instructions were given to that committee to appoint several of their own number to make an inquiry.

3513. How was that committee composed ?

At the head of it was the then Member for South Shields, Mr. Ingham ; there were two of the local magistrates of the town, and scientific and medical men, with two or three other influential gentlemen of the town and neighbourhood.

3514. Were they persons well acquainted with the management of mines ?

I should scarcely say so ; in fact, it was a purpose rather not to introduce too strongly practical men of the neighbourhood ; we of course at the moment had no purpose of interfering with the mines at all, but merely to investigate the matter scientifically, and put ourselves in communication with scientific and practical men throughout the Empire : that was the object of it originally.

3515. That committee then proceeded upon its investigation ?

It did.

3516. And reported in the year 1842 ?

Yes.

3517. Has it continued its investigations since the year 1842 ?

Now and then it has made little investigations, but has not continued them.

3518. Has the committee, or have you since that period, arrived at any further conclusions with respect either to the causes of accidents in coal mines, or the means of preventing them ?

J. Mather, Esq.
10th July 1849.

Nothing further; but I think the opinions then expressed have been strongly developed; time has almost confirmed the conclusions at which that committee arrived.

3519. In what respect?

In respect of the ventilation of mines especially.

3520. The Committee pronounced in their Report that they considered the ventilation very generally deficient in coal mines in the North of England?

They have reported so, and the facts are stated. I have facts here, if your Lordships would wish to have them to-day, of the extent of the passages and the rate of ventilation in many of the mines of the North; we find that some of them have such an extent even as 70 miles of passages; at Killingworth pit, of which Mr. Wood has a perfect knowledge, I think it was formerly considerably more than that; nearly 160 miles of passages which had all to be ventilated.

3521. Those are the largest?

They are the largest, of course; these passages or extent of air-ways to be ventilated depend very much upon the depth from the surface; the greater the depth from the surface the fewer are the passages; near the surface they make them more frequent. I find that in a mine within 100 fathoms of the surface, the extent of passage for 100 acres is about 27 miles.

3522. Why is it that the length of the passages depends upon the depth of the mine?

They are obliged, in mines of a great depth, owing to the superincumbent strata, to leave a greater breadth of pillar to sustain the roof.

3523. In proportion to the depth of the mine?

Yes. May I be permitted to give an instance? We will say in a pit 100 fathoms from the surface, we have only a breadth of pillar of nine yards; about 22 yards in one way, and nine in another. In the Monkwearmouth Pit, which is about 300 fathoms, or 1,800 feet down, the pillars are 40 yards by 29 yards; a very great difference; therefore, of course, the passages are at a greater distance from each other, and the number of passages consequently is fewer.

3524. Does that arise from the weight of the superincumbent strata?

They are obliged to do so on this account, that if they were to take out the coal in the same proportion, at 300 fathoms, as they do at 100 fathoms down, then the superincumbent strata would immediately act by its weight, and press down and crush the coal and destroy all the passages.

3525. Is there such a difference in the practical action of the superincumbent strata at 300 fathoms and at 100 fathoms as to produce that different effect?

I quote the practice; they find it so.

3526. Does that paper which you hold in your hand contain other facts of the same description?

It gives three examples, with the mode of arriving at the conclusion.

The Witness delivers in the same, which is as follows:

EXTENT OF PASSAGES IN MINES.

The Extent of Passages in a working of 100 acres, 100 fathoms, 600 feet deep:

| | | | | | | | | | |
|-------------------------------------|---|---|---|---|---|---|---|---|----------|
| Pillars | - | - | - | - | - | - | - | 9 | 5 yards. |
| Breadth of board | - | - | - | - | - | - | - | 5 | " |
| Breadth of wall | - | - | - | - | - | - | - | 2 | " |
| 27 $\frac{3}{4}$ miles of passages. | | | | | | | | | |

Extent of Passages in workings 200 fathoms deep:

| | | | | | | | | | |
|---|---|---|---|---|---|---|---|----|-------------|
| Pillars | - | - | - | - | - | - | - | 15 | × 26 yards. |
| Breadth of board | - | - | - | - | - | - | - | 5 | " |
| Breadth of wall | - | - | - | - | - | - | - | 2 | " |
| 20 miles 1,805 yards in 100 acres of this mine. | | | | | | | | | |

Passages in workings 300 fathoms, 1,800 feet deep:

| | | | | | | | | | |
|---|---|---|---|---|---|---|---|----|-------------|
| Pillars | - | - | - | - | - | - | - | 29 | × 40 yards. |
| Breadth of boards | - | - | - | - | - | - | - | 5 | " |
| Breadth of walls | - | - | - | - | - | - | - | 2 | " |
| 13 miles 1,155 yards passages in 100 acres of a mine of this depth. | | | | | | | | | |

3527. These

3527. These large areas having to be ventilated, do you conceive that the methods in use in the North are sufficient for the purpose of keeping the mines clear of foul air?

Not sufficient.

3528. What is the most usual fault, do you think?

A want of air; a want of power to force the air through all those passages.

3529. The usual mode of ventilation being by furnace?

Yes. I have a statement of the amount of furnace ventilation in the main passages and shafts, and also of the rate of air in the branch air-passages; I have likewise a statement of the quantities of explosive gases that escape. A few instances have occurred, which show the necessity, and may more strongly still confirm the necessity, of a certain proportion of air being required to sweep out those explosive gases, chiefly the light carburetted hydrogen. Here are four or five instances which show its absolute necessity.

J. Mathew, Esq.

10th July 1849.

The Witness delivers in the following Papers:

AMOUNT of FURNACE VENTILATION in the Main Passages and Shafts:

| | Cubic feet per minute. |
|--|------------------------|
| St. Hilda, $\frac{1}{2}$ of 14 feet shaft - - - - - | 30,850 |
| Jarrow, 14 feet shaft, deducting upcast and eng. pit - - - - - | 42,660 |
| Hebburn, 12 feet - - - - - | 45,776 |
| Pensher, 8 feet - - - - - | 50,064 |
| Haswell, 12 feet - - - - - | 74,228 |
| Wallsend - - - - - | 75,976 |
| Seaton Delaval, 8 feet - - - - - | 48,948 |
| Hetton, 14 feet shaft, three furnaces - - - - - | 168,000 |
| Walker, scarcely perceptible ventilation in passages. | |

RATE of AIR in the Branch Air-passages of Mines:

| | Velocity per second. |
|---|-----------------------|
| St. Hilda - - - - - | $1\frac{1}{16}$ foot. |
| Jarrow, West way - - - - - | 1.8 " |
| " South way - - - - - | 1.0 " |
| Pensher, generally a little more than - - - - - | 1.0 " |
| Monkwearmouth - - - - - | .66 " |
| Haswell, at the exploded points - - - - - | .25 " |
| Wallsend - - - - - | 2.55 feet. |

QUANTITY of Escapes of Gas.

| | Cubic feet per minute. |
|--|------------------------|
| In St. Hilda Pit, 14 January 1841, and for five days - - - - - | 1,799 |
| In Jarrow Pit, 2 February 1841, up - - - - - | 4,000 |
| In the water blast in Percy Main, March 1840, 12,686,000 cubic feet of gas in 68 hours, and assumed as - - - - - | 2,618 |

Pressure of $4\frac{1}{2}$ atmosphere:

In Wallsend Pit, from a 6-acre goaf continually burning at the surface - - - - - 52

1 of hydrogen in 8 of air produces the most severe explosions.

1 in 16 and 18, a slight explosion.

It should not, therefore, ever be allowed even in the recesses of mines to approach 1 in 30.

3530. When you speak of the rate of air in the branch air-passages, do you mean the rate at which the air passes through the remote passages of the mine?

Yes.

3531. How were these numbers ascertained?

By measuring the volumes in the principal passages of the mine, and in the ramifications by measuring their passages, and obtaining the rates of the smaller circulation by calculation.

3532. In the air-passages by anemometer?

By measuring in the usual way.

3533. By smoke?

J. Mather, Esq.
 10th July 1849.

By gunpowder smoke; it is the chief way, and there is no other practical way, I am afraid.

3534. Do you consider that a tolerably correct mode of ascertaining the rate of current?

I think it is.

3535. And the amount in the branch passages was ascertained by calculation?

By calculation; by the expansion, for instance, of a 64-foot area into three nineties, where they course the boards up and down three at a time, which make 270 feet area, and from the absolute passage of a certain quantity of air in several instances into dangerous workings of the mines.

3536. Then, in fact, they are obtained by a sort of Rule of Three sum?

Partly by observation, partly by measure. We can trace the air up to a certain point; then it almost becomes impossible to measure it. For instance, in the Haswell explosion we traced it to a certain point. These are calculations given in the evidence as to the Haswell explosion at the time. We traced a column of 4,235 cubic feet per minute into passages, headways of 275 feet area, and into other passages, boards expanded within the headways into 650 feet total area, and by taking the velocities previous to entering those passages, you arrive at the exact rate and supply of air in them, which I have put down there. It is impossible, without a vacuum or the air stagnant in some of those passages, that there could have been anything else; and if the air flowed with a greater rapidity in any of the passages, it would be slower or stagnant in the others; in that instance an explosion occurred with the loss, I think, of 95 people.

3537. The passages to which these calculations apply, of course, are at different and considerable distances from the shaft?

They are at a considerable distance, the extreme distance.

3538. The distance from the bottom of the shaft would make a considerable difference in the rapidity of the circulation of the air through these branch passages, would it not?

It would; but it would still bear the same relative proportion; it was not measured from the shaft bottom; but just previous to entering these branches.

3539. Therefore that would enter as an element into these calculations?

It was not put as an element; but the friction would of course decrease the amount throughout the whole mine.

3540. In order to make the conclusion correct, it ought to have been taken into account?

It ought, if calculating the velocities and quantity of the whole mine. The friction and distance are then important elements. But in cases like this, the calculation can be made with the most exact precision in the manner I have stated.

3541. You have yourself personally inspected a great number of these collieries, have you not?

I have.

3542. With other members of the South Shields committee?

Yes.

3543. Do you consider that the furnaces are generally well constructed for their purpose?

I think they are.

3544. Is there a great difference in their power in different mines?

There is to a certain extent a difference of power, but not a great difference of power.

3545. Is not there a great difference in the amount of current produced?

That depends chiefly upon the area of the passage, and I think not upon the power of the furnace; it seems to approximate very nicely in all points.

3546. Or upon the depth of the shaft?

There is something in the depth of the shaft, certainly as to the extent of the rarefying power.

3547. It

3547. It would appear from the statement which you have handed in, that by far the highest amount of ventilation is in the Hetton Colliery?

Yes.

J. Mather, Esq.

10th July 1849.

3548. That produces, as Mr. Wood told us in his evidence, 168,000 cubic feet per minute?

Yes, it has three furnaces nearly 154 feet sectional area; but if this of Hetton Colliery were reduced to an 8-foot shaft, as in several of the other instances, he would just get about 54,000 cubic feet, and no more, with the present power.

3549. You think that that would be the effect of reducing the shaft from 14 feet to 8?

I have no doubt of it; an 8-foot shaft only gives a 50-feet superficial area; a little more; about a quarter of a foot more; while the Hetton Colliery has upwards of 153, which is three times the amount of superficial area, and less friction.

3550. What leads you to the conclusion that the amount of ventilation depends so directly upon the area of the shaft?

I have found it so in every instance, and the miners in the North commonly adopt that view.

3551. Is it in consequence, do you conceive, of the friction which takes place upon the side of the shaft?

It appears to me that there is also this circumstance, that the furnace is only capable of producing a certain amount of rarefaction, and that it cannot be made to displace that by an increased quantity of rarefied air to produce a greater current. If there were a greater quantity previously rarefied, it would of course pass through more rapidly from the interior of the mine; but if the power of the furnace is limited, and will not sustain it, you can only get in the upcast a limited amount of expansion, and therefore only a limited amount of air.

3552. You mean that the diameter of the shaft does not give sufficient room for the expansion?

Yes; a small diameter only admits of rarefaction to a proportionate amount; the limited power of the furnace doing the rest. This morning I have had a little conversation on that very point; I had been in much doubt on the subject, why the furnace could not operate to produce an illimitable amount of current. I found that there was some check; that there was some particular point at which it always refrained from proceeding further; that 50,000 cubic feet per minute seemed to be somewhere about the greatest quantity that a 50-feet sectional area could pass. Mr. Gurney, this morning, I think, has aided greatly to remove much of that difficulty from my mind. It explains itself, I think, in this way: that if you increase the heat of the air in the upcast shaft to a very great degree, you get rid of it, of course, by the pressure of the air from the interior of the mine; but if the rush of the colder air from the mine be very rapid over the furnace, it will not have time to expand; then, immediately the colder air comes from the interior of the mine, it will decrease to a certain degree the heat of the air in the upcast; the greater the previous heat will be the greater successive cold. Every particle of air that has to pass through the upcast must be heated by the furnace, even if there be 40,000 or 50,000 cubic feet of air in the upcast; whatever passes with great velocity passes without expansion, and acts as a reacting power. Mr. Gurney in such case thinks that this reaction is still more rapidly brought about by cold air from the surface. From this explanation, I think it is in the upcast shaft that the air rises to a certain heat, which is then immediately supplied by the colder air of the mine, and it immediately reacts, checks the velocity, and must wait its turn to be heated and expanded, and so on. If the air in the upcast be greatly heated, the reaction will be the greater, and I think, thus it is that this cause perpetually checks and keeps down the ventilation which you can produce by your furnace operation.

3553. By that theory, is not the very rapidity of the current which you suppose to act as a check produced by the action of the heat, and by the efficiency of that heat upon the rarefaction of the air?

Yes.

3554. Is there any other cause producing the current?

(164.11.)

U U

No

J. Mather, Esq.
 10th July 1849.

No other cause. I am afraid I make myself imperfectly understood. It is a very difficult question. The upcast shaft, of course, produces it by rarefying the air, and making the column of air in the downcast much heavier than that in the upcast.

3555. Or rather making the column of the upcast much lighter than that in the downcast?

Yes, that is more correct; immediately on the rarefaction taking place, the air from the interior of the mine presses into the upcast; the next column of air must be rarefied in its turn, and there is a limit to the supply of heat in the furnace; it is not able immediately to expand and supply that quantity of heat, to bring with sufficient rapidity a perpetual series of volumes of air into the upcast beyond a certain rapidity, and the consequence is, that it cannot proceed; the furnace must have time to do its duty, otherwise the upcast air would continue much more to approximate to the rate of the downcast.

3556. What you mean is, that the furnace, under given circumstances, can only supply sufficient heat to give motion to a certain amount of air, and that beyond that, the heat is insufficient to keep up the same amount of motion?

That is what I mean, and the effects in practice seem to demonstrate that.

3557. Then that tends to show that there is a maximum to the action of any furnace?

I had that opinion previously: that there was a point—what point it was I could not arrive at—but that there was a point evidently in practice, that we could never drive a furnace with an upcast of eight feet area beyond 50,000, or a little upwards of 50,000 cubic feet per minute.

3558. Do you mean that you never could pass that point, even by increasing the heat of the furnace itself?

It appears that the heat of the furnace will not increase it.

3559. How is that satisfactorily accounted for? Supposing a case where a furnace was so heated as to give a current of 50,000 cubic feet per minute, and that, under those circumstances, that was the utmost current which you could obtain, and then, that by the addition of more fuel, or by an improvement in the construction, you obtained a still greater heat; would not that, in the first instance, increase the rapidity of the current which was to pass over the furnace?

If you can more rapidly, by an extent of furnace, touch every atom of that upcast column almost instantaneously, then, I think, it is perfectly possible; but having a limited supply of furnace, you cannot bring it into immediate operation.

3560. The question supposes a case in which the power of the furnace is raised, either by an addition of fuel or by some improvement giving it greater heating power; then, supposing a greater amount of heat to be produced in a given time, would it not necessarily produce a more rapid current of air?

I fancy it would; I have not seen it in practice.

3561. Would it not appear that it must be so from reasoning?

I should say so.

3562. Then, supposing that to be the case, and that this increase of heat has produced greater velocity of current, the very circumstance that the increased velocity of current is produced by the action of the heat must affect the whole column in the upcast shaft, because the impulse given at the lower end of the column in the upcast shaft must necessarily have an effect upon the entire column, must it not?

I think the effect would be this, that you would fill your upcast column immediately with cold air if your upcast column could immediately rarefy it to the same point, but I think there would be a greater danger then; if you increased your heat to a greater extent, you would immediately get a retrograde air; however heated your upcast, even heated to a red heat, it would, if it were a vacuum, produce with the greater velocity an immediate supply of the air from the mine, but the next instant that rapid supply would tend to reduce the heat of the upcast to a very great degree, almost reversing the air by substituting the colder airs of the mine for the former heated and expanded air of the upcast; that seems to me to be the effect of it; there is something like a law there; there is an anomaly in the operation

operation of the furnace that I have never been able to understand; I always thought that it had some given power and no more; I have found it so in practice; I have said, "Why do not you increase your furnaces and produce a greater ventilation?" The answer has been, that they have found generally, on trying it, that their rates have, on the average, in the best arranged mines and the best constructed furnaces, not exactly been alike, but approximating greatly to each other.

J. Mather, Esq.

10th July 1849.

3563. Are those cases in which the air has passed over the fuel of the furnace, or passed through lateral passages?

They pass it generally over the furnace,

3564. Over the fuel?

Over the fuel itself; sometimes a portion of it over the furnace a few yards up, called the dumb-drift, when it is explosive from the deeper part of the mine.

3565. Do not you conceive it possible that this effect may take place when the current is passed immediately over the fuel, that the air in that case is partly consumed, and that that part of it which is consumed is altered in character and made heavier, and that, therefore, in passing up the upcast shaft it acts as it cools towards the top of the shaft rather as a repressing agent, losing its buoyancy in proportion to the extraction of the lighter gases, by passing over the fuel?

It is possible that that effect may be produced to a certain extent. May I give the instances of two pits in two different places? Here is an 8-foot pensher, Lord Londonderry's, giving 50,000 cubic feet per minute.

3566. At its full power?

Yes. Seaton Delaval produces just about 49,000 cubic feet; it is the same area with the best furnace; they have about 50 superficial feet furnace area.

3567. Is the shaft of the same area?

Exactly the same area, and the furnaces. One of those collieries is in the county of Durham, and the other in the county of Northumberland. Those two pits, working under different people, exerted to the utmost (all admitting its necessity), are producing within a few hundred feet the same thing.

3568. And there is no difference except the power of the furnaces?

There may be some minute difference which I cannot detect. There is rather more than 1,000 feet difference in the upcast of those two.

3569. But there is a difference in the power of the furnace, as you are understood?

That I cannot tell.

3570. Is there a difference in the quantity of fuel?

I believe they are nearly about the same; if my memory is to be charged, I know the quantity in Seaton Delaval; I know that they make what they call their 7-foot furnaces; that is, 7 feet wide, and about 6 or 7 in extent beyond.

3571. What element of the case is different in one colliery from the other in those instances: you say that the area of the shafts is the same?

Yes.

3572. And that the quantity of air discharged is the same?

Not quite the same, but within a few hundreds.

3573. You say that the furnaces are of pretty much the same power, as far as you know?

I believe so.

3574. What are the circumstances which are different in those cases, and would lead you to suppose that the power of ventilation ought to be different?

If I might conceive the thing, I would simply fancy that from the extent of the workings in Seaton Delaval, which gave a less amount of air, the friction through the great number of passages in a very extensive mine, about 400 acres, would possibly produce a decreased rate of air in the upcast shaft.

3575. You mean the workings in Seaton Delaval being much more extensive than in Pensher?

Yes.

J. Mather, Esq.
 10th July 1849.

3576. And that, notwithstanding that difference in the extent of the workings, the amount of ventilation is the same; is that your argument?

It is the same, with the exception of a slight difference which may be accounted for, I think, in that way.

3577. You think that that is due to the friction of the passages?

I know no other cause at this moment, and I think that that is probable.

3578. Do not the cases which you quote amount merely to this, that those two cases being in all respects nearly similar, they produce similar results?

They produce similar results, and both are driven, I have no doubt, to the utmost extent; I know it was driven to the utmost extent in Seaton Delaval; and when we visited Pensher, their purpose was to show us the best side of the question; and they have carried it to the utmost extent there also, and I find that the utmost extent is what I state.

3579. Did you ever observe the circumstance of a side current down the upcast shaft when the current was made extremely rapid by the force of the furnace, a current of cool air coming down the sides of the shaft, in order to replace the column of hot air which was rising?

I have not done so.

3580. Have you ever made any inquiry into other methods of ventilation besides the furnace?

The steam-jet ventilation; and I have looked at natural ventilation. I have not examined into it very far, but it was a part of our duty to inquire into it. I found, from answers which were given here yesterday, to my great surprise, that it is still practised in this country: it was exploded 90 years ago in France as a thing totally impracticable.

3581. Are you aware whether in the Northumberland and Durham districts there are any cases of natural ventilation?

None, I believe.

3582. You say that you have examined into the steam-jet; have you seen it in practical operation?

I have.

3583. Where?

At Seaton Delaval.

3584. Did you examine it carefully?

Yes, I did.

3585. In company with any of the committee?

None.

3586. By yourself?

By myself.

3587. What was the result of your examination at Seaton Delaval?

I found the result of air to be about 95,984 cubic feet; I measured the three passages.

3588. A current of 95,000 cubic feet per minute?

Yes.

3589. Do you know what the current was which was supplied by the furnaces?

The supply was 48,948 the day before by the furnace.

3590. Were the furnaces alight when you saw the steam-jet?

No, they were put out.

3591. There is an engine below ground there, is there not?

There is, for drawing coals about 1,200 yards from the face of the works.

3592. Was it from that engine that the jet was carried?

Yes.

3593. And the engine fires were then alight?

Yes.

3594. The heat from the engine fires had some effect in aiding the current, had it not?

I fancy that it would to a certain extent.

3595. The engine was also kept working for the purpose of the pit when the furnace was in action?

It was.

3596. Is it your conclusion, from what you saw there, from your examination of that pressure of the steam-jet, that in that instance it had nearly doubled the strength of the current at Seaton Delaval?

It nearly doubled the strength of the current.

3597. Do you know what pressure was upon it when you were there?

About 35 lbs. to the inch.

3598. And was it considered then as working at its full power; was that as much as the boiler could have given?

I believe it could have given a greater pressure.

3599. What was the current which that 95,000 produced in the passages of the mine?

In one of the main passages we measured a distance of 20 feet.

3600. Twenty feet from the shaft?

No; we laid out a distance of 20 feet in the passage, and it was about 6.66 feet per second in that passage.

3601. How far from the shaft was that?

Perhaps a couple of hundred yards or so.

3602. In one of the main passages?

In one of the chief air-passages; there are three of them.

3603. That would not be a working place?

Not a working place, but they were drawing coals.

3604. That was not where it would be necessary to use candles for working?

No; they were using large naked lights throughout.

3605. But that was a part of the mine where a strong current would be of less inconvenience than it would be in the working parts?

Yes; I do not know any part of the mine where a good current is inconvenient.

3606. We have had evidence that the current may be so strong as to be extremely inconvenient in the working parts of the mine?

I can scarcely conceive it.

3607. If they are working with naked lights, does not it affect the naked lights?

No; they are obliged to have brattices to drive the air up into the face of the works; they have only to put a short brattice, by four or five feet less, and the air will turn short round and disappear in the other passages; I have seen the result of that with the late Mr. Buddle; the working passages are about 15 feet wide.

3608. Generally speaking?

Generally speaking, from 4½ to 5 yards; they run up a brattice, which is a wooden partition through the middle of that, and the air goes up one side and down the other; I speak of the working boards; the ends of the boards, in two or three alternately, are bratticed across to course these passages, with doors for passages; a door was left open on the particular occasion I allude to, and the air was directed into another passage from the face; the consequence was that the air fell short, as it will do at any time you choose to direct it, which will prevent the inconvenience; the air fell short then, and for want of a sufficient supply, there being a considerable amount of gas, the whole place got to a certain extent vitiated. I remember at the time hearing the gas bubble from the coal in the face of the works, so I applied a lighted candle to it, and immediately we had a small explosion; it brushed over our heads and all around us; no one was hurt, fortunately, but a sudden retreat of course was made by us all. The place was put right again speedily; all that was necessary was just to put the brattice right, and the air

J. Mather, Esq.
 10th July 1849.

rushed as usual along the face of the work, and the mine was right again. Had it been allowed to go on for any considerable length of time, I have no doubt that by some accident the accumulated gas would have been ignited, and the people might have got burnt; it would not have killed them, but perhaps it might have produced some slight results.

3609. Do you mean to say that you do not think that any rapidity of current in the passages of the mine can be inconvenient for working?

Yes; in the working passages they can stop the air short of themselves, within eight or ten feet; these brattices are the cause, and the cause alone, of their having any air; they would not have a particle of air up to the face of the works but for those brattices; if they shorten those brattices, the air will disappear suddenly down a return passage, and they may have a dead calm with an 8 or 10 feet current within 8 or 10 or 20 feet of the face where they are at work, and so in any other passage.

3610. Then, when you answered just now that no rapidity of current in the passages would be inconvenient, you did not mean to say that, whatever the force of the current might be, it could not be inconvenient to those working in it?

I mean to say that there is no necessity for their working in it; they can manage it with those brattices so that they may work in a calm place while the air is perfectly sweet around them, the neighbouring current sweeping all impurities away. I think it an error to state that there can be any inconvenience from quantities of air in the mine.

3611. The question did not refer to quantities of air in the mine by any means, because a quantity of air, if it is only split and carried in different directions, is of course very useful to the ventilation of the mine; the only question is as to the rapidity of any one current. Supposing persons are working in a passage where the current is blowing strongly, you might increase the rapidity of the current to a hurricane; you do not mean to say that no rapidity of current could make it inconvenient for persons to work in it?

Certainly not; but your Lordships will remember that I have said that there is no necessity for working in such a passage; that in working the coal, they have it in their power at any time to turn the air from their immediate neighbourhood within a few feet of themselves, so that although it may blow a hurricane within a few feet of them, they can work in perfect safety, convenience and comfort.

3612. But if they turn it entirely off, will it not be dangerous?

They may turn off a portion of it, so as for it not to be dangerous, for the light carburetted hydrogen, being in the same passage, will naturally seek the current, be diluted, and swept away.

3613. Have you ever studied the different methods of arranging the air-passages of mines?

I have not; I have only thought of one thing; I will not interfere to give a practical opinion further than this,—an opinion that the late Mr. George Stephenson, originally himself a practical miner, decidedly gave, and I know its practice to obtain in some of the best mines,—it is to carry a double air-passage to the utmost extent of the works; one a working passage in which part of the air goes, and another passage exclusively for air, and two return passages in the same way. Falls of the roof repeatedly take place in the returns, and without double passages they can never be said to be safe, no matter what the current of air may be in their shafts.

3614. Have not the mines in the North very generally two shafts?

Some of them; some are without two shafts; St. Hilda has only one shaft, and Jarrow has only one shaft.

3615. Are there many with only one shaft?

I hope the number is getting less; there are a few of them.

3616. Do you concur in the statement which has been made by other witnesses, that the having two shafts is a very essential part of the ventilation of a mine?

I certainly do, distinctly.

3617. With respect to the expense of sinking a shaft, we find in the Report of the South Shields committee, that it is stated that there has been great misconception

conception with respect to the expense of sinking shafts for the purpose of ventilation?

Yes.

3618. Are you still satisfied that what was stated in this Report upon that occasion is correct?

I believe so. I think gentlemen coming from other districts will tell you that shafts can be put down upwards of 100 fathoms for 5*l.* or 6*l.* a fathom; 600*l.* and 700*l.* those shafts will cost; but it must be said for the Northumberland and Durham district that they meet with great difficulties in those localities; there are quicksands and much water, sometimes 1,000 gallons a minute. In this very Haswell mine, if my memory serves me correctly, there were about 1,000 gallons a minute from a particular feeder of water, which was obliged to be tubbed back; all that leads to great expenses in the sinking of shafts; you may have those exceptions; but on an average they may be sunk at much less cost.

3619. With reference to your answer about the use of the steam-jet in Seaton Delaval, and the actual ventilation by furnace in the Hetton colliery, supposing the steam-jet to be applied to the Hetton pit, have you ever made any calculation which would enable you to say what you think would be the power of ventilation obtained in the Hetton pit by the steam-jet?

I have; I made that calculation before I came up to town; taking two feet sectional area to each jet, as is done in the Seaton Delaval mine, it would take 77 jets at Hetton, in proportion to the amount at Seaton Delaval.

3620. You mean the area through which the influence of each jet would extend?

Yes; in a similar proportion, the friction being somewhat less, the quantity would be more; but the result would certainly reach 293,945·3748 cubic feet in a minute, nearly 75 per cent. increase.

3621. Did the power obtained at Seaton Delaval by the jets correspond with that calculation?

It did precisely.

3622. Then if the jets were established at Hetton, what is the amount of ventilation that they ought to produce?

That is the amount of ventilation which I think they would produce with 35 lbs. pressure to the inch; if they increased their pressure, of course there would be a proportionate increase.

3623. But they ought to produce that with the same pressure which you found at Seaton Delaval?

Yes. I have also seen it in two manufactories.

3624. Mr. Forster, in his evidence a short time since, stated to the Committee, that the power obtained by the steam-jet at Seaton Delaval amounted to 85,000 cubic feet; you have stated that you found it to be 95,000?

Ninety-five thousand nine hundred and eighty-four in the different passages; I measured each thrice, and there was a corresponding amount in each passage, resulting in this quantity.

3625. To what do you conceive the increased power is due?

I conceive it may have been that a very trifling change would make it in turning the steam-cock. If the tap was turned not fully on, so that the full force of the steam could not be obtained from the boiler, it would go correspondingly at a less degree of pressure into the jet.

3626. You state that you have seen the jet applied in other cases to the purpose of manufactories?

Yes.

3627. Will you describe in what manner?

I have seen the jets applied to two condensing manufactories for the production of soda and alkali.

3628. For the purpose of what?

Of condensing the muriatic acid gas, and for the purpose of giving a ventilating power to the furnace.

J. Mather, Esq.

10th July 1849.

3629. Through what distance of air?

A very short distance from the boiler, a very few yards, eight or ten yards from the boiler.

3630. At what distance did the jet act from the point intended to be ventilated? In one instance, I conceive, about 30 yards.

3631. What was the result in those cases?

The result has been, that they discontinue two large chimneys, one upwards of 200 feet high, and the other about 170 feet, in those two factories.

3632. They obtained a sufficient draught without those chimneys?

Yes; I have the jets here, if your Lordships would like to see them—[*the Witness produces two jets*].—The two factories are worked each with six such jets, which do that which chimneys of the height I have mentioned could not do.

3633. What is the diameter of those jets?

Five-sixteenths of an inch. The parties used to be perpetually paying damages for injury to vegetation, and the neighbours were complaining that it was a most offensive manufacture, so much so, that a very extensive work of that kind was about being destroyed altogether, when the adoption of this plan enabled them to discontinue the use of the chimneys, and destroy the source of injury.

3634. These are larger jets than those used at Seaton Delaval?

Yes, about $\frac{1}{8}$ th of an inch more; that was the most striking fact I have ever seen; six of these jets do instead of a chimney 200 feet high, which cost about 2,000*l*.

3635. What amount of current do they produce?

They produce an enormous current. In the condensation of the gases they pulled the air up 24 feet through a current of water passing down with great velocity; they drew the muriatic acid gas through this shaft, and got it absorbed altogether, and the furnaces were kept infinitely better than with the 200 feet chimney. Then there was this additional result, which may be also observed in the mines, that this ventilating process in south winds is not affected at all; the furnace is invariably affected in south winds. Frequently you have accidents from the want of pressure in the atmosphere, barometric and hygrometric causes; for we know that accidents frequently come about by south winds, accompanied by the circumstances I name, and they also used to affect similarly the furnaces; but on inquiring amongst the people whether such is the case now, they say invariably, that the jet is so steady that they have no back-puffs, as I think they call it, of muriatic acid gas, which was injurious to the health of the men working there; they work as well and as healthily now as in any other manufactory. They have taken a patent (not in justice, I think, to the original inventor) to apply the steam-jet to this particular purpose of condensing acid gases in manufactories with the high-pressure steam-jet through a cone, the very suggestion which was thrown out by Mr. Gurney in 1835. I understand that this operation for the ore-smelting furnaces, if adopted by them, will become of vast importance; that there will then be absolutely supplied by their processes sufficient sulphur, which is now lost, to render it quite unnecessary to have the sulphur of Sicily introduced at all.

3636. You do not think it fair that an invention, the benefit of which was given to the public by the inventor, should be taken advantage of by other parties for their own private gain?

I think not; I think quite the contrary; that if any one is to derive benefit from it, it should be the person whose genius invented, and threw it open to the world. I may name that the parties having this alkali manufactory used to pay considerable sums for damages; the year previous to the adoption of the jet they paid 300*l*, damages for injury to vegetation. The jet has been in operation four years, and they have never paid a farthing damages since, nor has there been a complaint.

3637. In these cases was the steam supplied by the existing boiler of the steam engine, or was there any additional boiler put up for the purpose?

In one instance there was an independent boiler of 10-horse power only.

3638. Put up on purpose to supply this steam?

Yes. In the other instance it was used for other purposes, as for pumping water.

3639. Do

J. Mather, Esq.

10th July 1849.

3639. Do you know what pressure there was in either case?

I think they calculated it at nearly 40 lbs. to the inch.

3640. Are there any points upon which you think it would be possible for Government or Parliament to interfere for the purpose of introducing any improvement into the ventilation of mines?

It is a delicate subject; I am afraid you can scarcely compel a certain system of ventilation; it will be very difficult. But what your Lordships' Committee suggest will do more than has been done for many years; a mere recommendation that your Lordships are satisfied with a certain mode would go far to introduce it generally, leaving all the responsibility upon the parties themselves.

3641. In the Report of the South Shields Committee some words of Mr. George Stephenson are quoted, in which he says, "It does appear to me that an Act of Parliament might be obtained to have power to cause certain regulations to be attended to in the ventilation of mines?" Do you concur in the opinion of Mr. Stephenson, and do you think that there are any points which it would be possible to enforce by Act of Parliament, so as to improve the ventilation of mines?

Mr. Stephenson states in another place, I believe, that two main air-passages, both an ingoing and a returning air-passage, ought invariably to be laid down; and I think if Parliament were so far to interfere, they would do no injustice to the mines at all; they would compel no unnecessary outlay, for the parties would get the mineral for their extra cost. To keep clear these passages at all times would be an important improvement; most of them work only with one, where men and horses are perpetually reducing the area of the passage, and injuring the ventilation of the mine considerably.

3642. What would be the additional expense of making passages of that kind?

I can scarcely say; they would get the coal; it would be no more expense than working the coal out of another district; they would come occasionally to stonework where there would be no produce at all, but the proportionate quantity of stonework would, I think, be trifling.

3643. When you speak upon that subject, you draw your conclusions entirely from your inspection of the coal district with which you are connected?

I do.

3644. You are not aware of the system of working in other parts of the country?

Personally I am not at all.

3645. You would not be prepared to say that a regulation of that kind could or need be enforced in all the mines of the kingdom?

I do not know, but if we require it in the North, where I will venture to say the ventilation is so much superior, and the science applied to the mines so much above what it is in any other part of the mining operations of the kingdom, they must require it elsewhere.

3646. Do not you conceive that a different system of working coal, and of conducting the ventilation, might make a difference in the necessity for those passages?

It might; but when I find that so gross an error as having "too much ventilation" has crept into other districts, which has been exploded for half a century in the North, except amongst the most ignorant viewers, I can scarcely fancy but that that great fundamental error must lead to a variety of others. A large quantity of air, instead of setting fire to the coal, as many of them fancy, from the pyrites and debris, would cool the mine, and remove the explosive gases in sufficient time to keep the mine in perfect health, and free from any risk of explosion or spontaneous combustion.

3647. Where the system of working the coals was altogether different, do you think that the suggestion of two passages would be equally applicable in all cases?

I think so, because they require horses, at least where the coal is of sufficient thickness; and they always have many implements for bringing out the coal in every direction, and therefore they reduce the passages of the mines, wherever they are working, so much that it seems to me absolutely necessary to have two

J. Mather, Esq.
 10th July 1849.

passages, if the air is to be freely admitted. In some districts, such as the Staffordshire, they sink shafts more frequently than they do in the North; they have their shafts, I believe, sometimes to 18 or 20 acres; then there is a possibility, where they have an upcast and a downcast independently in so small a space, that a double passage may not be so necessary; but where there are extensive underground workings, it seems the essential of ventilation; it takes the place of two shafts.

3648. You have stated that the power of the furnace is a constant quantity; are you able to say what the limit of the steam-jets is?

I fancy it is illimitable; in proportion to the pressure which you apply, you get your power.

3649. Can you furnish the Committee with any comparative estimate of the cost of the two modes of ventilation?

I can scarcely do that; but we will take the two instances of Seaton Delaval and Hetton. We have the furnace in one working the engine which is absolutely necessary; we have no other furnace down that shaft; there is no additional expense, except the first cost of the apparatus. In Hetton they have three furnaces: each, I will venture say, consuming two tons of coals in the 24 hours. If one of those furnaces, as at Seaton Delaval, will drive the air with the steam apparatus up this 14 feet shaft, the other two furnaces will be entirely saved to the works. Those two furnaces cannot cost less, at that rate, than 1,000 tons of coal in the year, which are now consumed, and which would be saved, with the attendance and wages of four men: two men each 12 hours, I think, is the arrangement. Those two furnaces, with four men, would then be saved to the working of Hetton, if the steam-jet was adopted, with a greater result.

3650. How much do you conclude that those furnaces consume in Hetton?

About two tons in the 24 hours I know is the average in the other mines; at least that.

3651. Two tons each?

Two tons each. We get at the upcast of Seaton Delaval 21½ miles an hour; while we get at Hetton only 12·39 miles an hour.

3652. Have you any record of observations taken at Seaton Delaval Colliery this year with respect to the pressure of the atmosphere, as measured by the sympiesometer, in the upcast and downcast shafts?

Yes; it was found at the bottom of the downcast that the thermometer stood at 59 degrees, while the barometric pressure was 30·05; in the upcast shaft the thermometer stood at 115 degrees.

3653. In the middle or at the bottom?

At the bottom; the thermometer was 115 degrees, while the barometric pressure was 28·50, making a difference of 1·55 in the pressure, which is a very extraordinary thing; a difference in the pressure on the square inch of three-quarters of an inch, or thereabouts, ·759, and which on the square foot would be about 109 lbs.; this is by the steam-jet. The difference of pressure of the furnace corresponds to a certain extent with its air quantities, and develops something like the power of the furnace. In an experiment by Mr. Stephenson at Killingworth pit, as stated in his evidence previously to the House of Commons, the barometric pressure was about half an inch, ·50; on the square inch it was ·245, giving 35 lbs. ·28 per square foot; the upcast thus producing two-thirds more pressure by the steam-jet than by the furnace, which in this instance shows the relative power of the furnace in another way by the barometric pressure; that develops in a most extraordinary manner, I think, the results of the measured air in the shafts by high-pressure steam and rarefaction.

The Witness delivers in the following Paper:

Observations taken at *Seaton Delaval Colliery* with a Sympiesometer, 4th July 1849. Time when Observations were taken, from 5.30 minutes to 7 o'clock p.m.; Wind South, with Rain.

| LOCALITY. | Thermo- meter. | Barometer. | Difference between Upcast and Downcast. | Rarefaction. | | REMARKS. |
|---|-------------------|----------------|--|---------------------------------|---------------------------------|--|
| | | | | Pressure per Square Inch. | Pressure per Square Foot. | |
| | <i>Degrees.</i> | <i>Inches.</i> | <i>Inches.</i> | <i>Lbs.</i> | <i>Lbs.</i> | |
| On surface at top of downcast | 64° | 29.40 | } | - | - | - - The ventilating power employed in this colliery is 25 jets of high- pressure steam, $\frac{1}{2}$ in. diameter each. |
| Ditto - ditto upcast - | 148° | 29.40 | | | | |
| At bottom of downcast - - | 59° | 30.05 | 1.55 | .759 | 109.3 | <i>in. lbs. in. lbs.</i> 30 : 14.7 :: 1.55 : .759 p' square inch, <i>lbs.</i> × 144 = 109.3 per square foot * |
| Ditto - upcast - - | 115° | 28.50 | | | | |
| In return air-course from E. F. pit. | 60° | 29.85 | | | | |
| Ditto - ditto, from C. D. pit | 61° | 29.90 | | | | |

* The South Shields Committee, in an experiment } D. 56° } This experiment was made 246 yards down; 60 yards from bottom.
in the St. Hilda shafts, 16 February 1842, got } U. 102.

$$\frac{1}{2} .098 \quad 30 : 14.7 :: .20 = .098 \text{ p' square inch. } \times 144 = 14.112 \text{ p' square foot.}$$

Mr. Stephenson, at Killingworth, less than .50 .245 $30 : 14.7 :: .50 = .245 \text{ p' square inch } \times 144 = 35.28 \text{ p' square foot.}$

The Witness. I examined the high-pressure at two other places, as that subject seemed most important. I went to Usworth Colliery to examine, on invitation, Mr. Fourdrinier's apparatus; there was said to be there a high-pressure steam ventilation, and I was told that in the shaft it only produced a difference of some 6,000 or 7,000 cubic feet per minute. I requested permission to see it, which was readily granted me by Mr. Elliot. I went down the shaft, and found that there was quite an exploded application of high-pressure steam.

3654. What was the fault that you observed there?

I observed in the Usworth colliery just the plan which Mr. Buddle tried in 1813 or 1814, if my memory correctly serves me; that was, to bring from the boiler on the surface high-pressure steam, turn it into the upcast, and by its rarefying power expand the air in the upcast, and get an increased ventilation; it was no better than that; this was sent six fathoms from the boiler on the surface down the upcast through a pipe; its open mouth of six inches diameter was turned up on one side of the passage, pulsating once every five seconds with steam, throwing in a jet at that interval. I certainly do not consider that the application of high-pressure steam.

3655. It was not an application of high-pressure steam according to principles which were at all likely to produce the results anticipated by Mr. Gurney?

No; in fact on the contrary; its inefficiency was previously explained, and explained also in Mr. Gurney's letters to the South Shields Committee. This application was attempted likewise in Belgium, but was a failure; there it produced circular currents instead of an upcast movement.

3656. That you think quite sufficient to account for the failure at the Usworth colliery?

Yes. I went to Belmont; there they have applied high-pressure steam, but when I went, the furnace was damped up. They raised the steam at my request; it pulsated there too. They have it to work an engine also, but there is no continuous pipe, that I could observe, to lead from the engine to the high-pressure apparatus, which was in other respects well arranged. But the pulsations of the steam were not enough; too imperfectly intermittent to affect the ventilation in Belmont colliery. The consequence was, that it would not do. I said, "This is an injustice to the apparatus, and it would be unfair, till this alteration is made, to attempt any experiment here." I have no doubt that, as so little will be required to do so, that when Mr. Elliot completes the apparatus and gets a constant power, he will have the best results, such results as they have had at Seaton Delaval.

3657. Have you a reason to believe that that further improvement will be made?

(164. 11.)

x x 2

I think

J. Mather, Esq.

10th July 1849.

I think Mr. Elliot has every desire to improve the mine, and that if that alteration is made, it will succeed.

3658. Do you think that he was aware of the defect in the apparatus as applied when you saw it?

I think not; he had gone two or three hours before I arrived. I saw the other officers of the mine. It was in a conversation which he had had with Mr. Gurney in a journey from Derby to London, that he had become acquainted with the process, and he had adopted it from that conversation; but he was not aware, I think, that Mr. Gurney had pointed out some necessary errors which would have been corrected by referring to the Report of the South Shields Committee.

3659. Did you, upon the spot, point out the defects to his officers?

I had some general conversation with them, but I preferred seeing Mr. Elliot upon the subject; I have no doubt he will make the change; for it is so trifling, that I think it will be readily made.

3660. Have you any knowledge of any accidents by mines being on fire?

I have seen two cases.

3661. Have you seen efforts made to extinguish them?

Yes; I was down the pit in one instance when on fire, and I saw the efforts there.

3662. Was it difficult?

Very much so; the people were defeated in spite of all their exertions; they were driven back, and were obliged to inclose the works, to shut them off by brick stoppings.

3663. That portion of the works?

That portion of the works.

3664. How long were those works shut up, do you know?

I believe a considerable length of time; it is about four years ago.

3665. Where was that?

In the St. Hilda pit.

3666. You mentioned another case?

There was a fire at Seaton Delaval, as to which your Lordships have examined here; I was requested there to see it with a mining viewer; they had shut off the fire for some time previously, and the men refused to work, it appears, until it was examined; a viewer and myself, to satisfy them, examined it, and found the fire extinguished; it had been extinguished by shutting it off, and by its own combustion, by the produce of carbonic acid gas and nitrogen; I have no doubt that that was the cause of the extinction of the fire.

3667. Are those cases, do you think, in which it would be desirable to introduce the steam-jet, for the purpose of sending in carbonic acid gas?

I think so; knowing that one portion of carbonic acid will destroy the combustible power of eight portions of atmospheric air, and that the proportion is one in seven in the case of nitrogen; I think it is more effectual than water.

3668. The South Shields Committee have bestowed much attention upon the different lamps used in mines, have they not?

They have.

3669. There is an examination mentioned in the Report of no less than nine lamps, besides the original Davy lamp?

Yes.

3670. Since that time have there been others invented?

I think there have been several, but they have risen to no mining notoriety that I am aware of; there is one, I believe, spoken of by, the Earl of Fitzwilliam's agent, Mr. Biram; it seems a fair lamp, but I think the principles of it are very much like some of these.

3671. With respect to those lamps which formed the subject of inquiry at the time of the Report of the South Shields Committee, do you still remain of the same opinion as was expressed at that period upon the subject?

I do. There is one thing I may state to your Lordships, that I have exploded the

the Davy lamp through a jet of common gas myself, once in every half hour; the Davy lamp, therefore, being exposed to a jet of gas coming out from the face of the works, or passing a current of 300 feet a minute, which all parties admit will pass the flame, and ignite the surrounding explosive mixture, is dangerous. I have passed the flame myself several times from the Davy lamp, under such circumstances.

J. Mather, Esq.

10th July 1849

3672. In experiments?

Experimentally; therefore the Davy, though an excellent instrument, and which does, of course, immortal honour to its inventor, yet is not to be trusted in the hands always of workmen. I have no doubt that some of the accidents which have occurred in mines have occurred by the use of the Davy lamp; there is nothing that in my mind ever could detach the explosion of Wallsend Pit from the use of the Davy lamp at that time.

3673. The South Shields Committee expressed an opinion principally in favour of the Clanny lamp, and the Mueseler lamp?

Yes; Dr. Clanny, by way of giving more light, since has discarded the gauze, and I think rendered the safety of his lamp much less than it was before. At Belmont, the other day, I made inquiry; that lamp is used there; they have occasionally fractures of the glass. But the principle of the Clanny lamp is no doubt the best of all: this is one of the original lamps that the doctor favoured us with—[*producing the same*]*—*that is not the one which we use at present.

3674. Is that the lamp which was mentioned in the Report of the Committee?

No, another one; it was covered up at the side by a shield, with a glass reflector in the front.

3675. Is not this a very dangerous lamp?

I think so.

3676. Anything would crack that glass?

Yes.—[*The Witness produces another lamp.*]

3677. This is with the gauze inside?

Yes; if you break the glass, you have a Davy lamp in reserve.

3678. Was this Dr. Clanny's original?

Yes.

3679. What was the complaint with respect to the lamp which you first produced?

The men complained of the want of light. The principle of safety is the carburetted hydrogen, being so light on coming into contact with the increased heat, having to descend into the lamp, flies off; it filters, as it were, the air, and leaves the common atmosphere to fall down upon the flame.

3680. Is there no access except through this gauze?

None. This is the last of Clanny's —[*producing the same*]*—*that is the lamp we work with.

3681. It is a good deal heavier than the Davy lamp, is it not?

It is much heavier.

3682. Have you seen it commonly used?

It is used in several mines by some of the officers; they like it better, because it gives a good light; but it is not generally used. The doctor informs me that there are about 1,000 out in the mines; I cannot say myself.

3683. Have you heard any opinion expressed of it by the miners themselves?

They like it on account of its giving a better light than the Davy. Your Lordships will see the thickness of the glass here. Sir Humphrey Davy states a case in which the glass was fractured in Belgium; a piece fell out of the side of the glass; fortunately there was no gas at the time escaping, and no explosion took place; it was a mere naked lamp without gauze. You will see the thickness of the glass in this lamp—[*the Witness shows the same*]*—*there were three fractures which I traced in Belmont mine of that glass.

J. Mather, Esq.
 10th July 1849

3684. There was glass of this sort cracked in Belmont?

Yes; there was one case in which it was cracked nearly all to pieces.

3685. What did that arise from?

It was thought to have been from a blow. In another instance one of the inferior officers of the mine stated, that he had by accident put the lamp on its side, and he thought the flame had come in contact with the glass, for when he took it up, he found a fracture down the side of it; no piece out, but a crack; the glass continued in its original position, and he used the lamp afterwards till he came out of the pit.

3686. Do you consider that an objection to this lamp?

Decidedly. With the wire lamp, the Davy lamp, though it may not be so objectionable in this respect, yet it is more than counterbalanced in another; there is the perpetually recurring possibility of passing the flame, so that at any moment there is a certain degree of danger, if it is in the hands of any careless person.

3687. Upon scientific principles, on the whole, which should you say was the best?

Upon scientific principles, I should certainly say the Clanny and Mueseler lamps.

3688. Which is the Mueseler lamp?

The institution at Manchester got the loan of it, as well as of the anemometer; and they have not done me the favour to return it.

3689. Upon what principle is the Mueseler lamp?

The same as the Clanny; the air is supplied from above; there is no possibility of the carburetted hydrogen passing into the flame.

3690. Is there any glass to the Mueseler lamp?

Yes; it is put in, but the gauze is reserved also. The heated shaft, as you may almost call it, prevents the light carburetted hydrogen, or any other explosive gas, from descending to the flame, and the consequence is, that it is absolutely secure, even from an internal explosion, which the Stephenson lamp and other lamps are exposed to. This lamp is Stephenson's—[producing the same].

3691. Does the Mueseler lamp give much light?

It gives not a greater light; it gives about the light of the Davy, I think. The principle of Stephenson's lamp is to supply the air from below, as in Upton and Roberts' lamp. The consequence is, that they are subject perpetually to slight explosions internally; and if the diameter of these gauzes be great, there is, comparatively speaking, a large body of gas in them; and if there were no glass inside, the probability is that they would explode the external air. They would pass the flame through the gauze; but Stephenson's lamp is preserved against that, because it has a glass inside the gauze, and that prevents the possibility of the passage of the flame. They work with this at the Killingworth or South Moor pits, and some other mines; they prefer it; it gives a pretty good light, I believe.

3692. Does not the glass in some degree tend to diminish the amount of light?

I should think so; it obstructs the passage. There is another lamp, a Belgian lamp; that is Lemielle's lamp, one sent over by the Belgian Government for us to try; it has a glass also, but it is too narrow in the gauze. I think the carbonaceous matter obscures it so much that it is a very imperfect light, and I believe will never be practically used by miners.

3693. Is the light affected by the diameter of the gauze?

I should say so, certainly.

3694. In what way?

Because it requires more gauze for a large cylinder than a small one, a greater quantity of impervious matter, and it obstructs the light more. Sir Humphrey objected to a large gauze principally because it would fill the cylinder with explosive gas, and might pass the flame.

3695. By a large gauze, you mean the diameter of the cylinder?

Yes. Here is Upton and Roberts' lamp, which has been thought the great desideratum

desideratum in working mines. The glass has got broken, and it has become at once a Davy lamp. It passed the atmospheric air through the meshes of gauze, there being a double disc in the bottom for that; and the consequence was that there was no possibility of exploding outwards, as was shown before the House of Commons' Committee. Every lamp produced exploded the gauze except Upton and Roberts'; but the delicacy of it is so great that we could scarcely ever keep it in if there were the slightest gas coming off the works. A little internal explosion immediately takes place from the gas going naturally into the cylinder and it explodes itself out every now and then; it is an extremely safe lamp, and constructed on very scientific principles, but at the same time it will not work.

J. Mather, Esq.

10th July 1849.

3696. What is the objection to it?

That it leaves the pit perpetually in the dark when there is any gas coming off. It explodes itself out by the slightest quantity of carburetted hydrogen passing into the cylinder.

3697. Have you seen Mr. Biram's lamp?

I have not; he sent me a copy of the drawing, but not the lamp; therefore I could scarcely presume to form an opinion of it.

3698. The Davy lamp is still very generally used, is it not?

Yes.

3699. More generally than any other?

More generally than any other; for ordinary purposes it does very well; but I am afraid that it begets explosions sometimes, I have said; it also begets carelessness sometimes, and a confidence which the inventor of the lamp never intended.

3700. In the South Shields Report, it is stated that the committee have reason fear that the introduction of the lamp has led to a great deal of carelessness and recklessness; is that your opinion still?

I can only say that after 20 years' use of the lamp, the explosions were greater than they had been in the previous 20 years.

3701. Does not that partly arise from the fact of their working much more explosive mines than they did before?

It does; chiefly from that, I believe; but of course it brings the mischief immediately around them. They work the pillar working now, which formerly would have been left entirely unworked in the mines, at least in such explosive mines. They now, in confidence of the Davy, go in and work this coal off, which was formerly left to destruction, and they get very properly as much as they can. The consequence is, that it naturally exposes them to a careless man in the mine, or to a current of air, which produces greater facilities of explosion than previous to its adoption.

3702. Still, on the whole, you would not say that it could be recommended that lamps should be discontinued now?

Certainly not; on the contrary, they have been of immense benefit; but I hope the time will come when ventilation will entirely supersede them; they seem to be used in many places instead of ventilation.

3703. Do you conceive that it would be possible to carry the ventilation of mines to such an extent as to render them unnecessary?

I think so; there may be drifts where they may still require lamps; but I think that the general working places are capable of being worked without them.

3704. Suppose the case of working places not far from the edge of a goaf, gas being known to exude from the goaf in certain states of the atmosphere, even supposing the ventilation to be ever so perfect, would not there be always danger in such a case?

If the ventilation were full and extensive, there would be no danger. In the Haswell explosion, within a very short distance of the goaf, they had naked candles; they were working with lamps in the immediate vicinity; but at no great distance, in one of the passages, they were working also with naked candles. Now, instead of the pressure which they had at that mine of Haswell, which was only about 16 feet per minute passing through close upon the edge of the goaf, if they had had what it was in other parts of the mine, I conceive that there would have been no chance of any accident occurring from the gas coming off.

J. Mather, Esq.
 10th July 1849.

3705. Do you think it possible to ventilate the goaves themselves?
 I have seen a goaf ventilated.

3706. Where?

I have seen it ventilated by the pressure of air at Pensher, the Marquis of Londonderry's. There was a pressure of air into one part of the goaf, and it came off into the returns in the other side of the goaf.

3707. Do you know what escape of gas there was?

We tried it in the returns, but there was not much escape of explosive gas; in passing in, the thermometer stood at 63°, and after ranging through the goaf on the other side, it was only about 64°.

3708. And do you think that it would be generally an easy task to ventilate the goaves?

You could not have a coursing of air through the goaves, but you could have a continual pressure of air wherever there was an interstice; of course, being filled with lighter air than the atmospheric, it would be immediately carried away. I do not think you could thoroughly ventilate them, but this pressure of air would, to a certain extent, ventilate them, and render them innocuous. In the Walker pit they also ventilate in that manner to a certain extent; they work there with lamps. The morning that I visited the Walker Pit, there had been some accident to the furnace, some neglect of it, and the pressure of ventilation in the mine was taken off to a certain extent; the consequence was, that the gas came backwards upon the main air-passages, and the mine was filled with foul air. The men were obliged to leave their work; they could not stay in the mine; but they had this matter soon re-arranged. The pressure was put upon the goaves again by increased ventilation, for they had several, and immediately after the men were permitted to return to their work.

3709. Then, in your view of the matter, nothing more is wanted than very efficient ventilation to make mines perfectly secure?

Except in extreme cases; they form exceptions, and not the rule; in almost every case I think it might be done; there are very rare exceptions.

3710. You have never found any disinclination on the part of coal-owners or managers of mines to permit you, though not connected with the business, to inspect the mines?

Certainly not; quite the contrary. The late Mr. Buddle, who was considered the head of the practical viewers of the North, invited me specially to come and visit his mine; and generally I may say that I have served a sort of small apprenticeship to another able viewer in the North, Mr. William Anderson, who is always exceedingly obliging, and has opened his mine to me, and put everything at my disposal, and the disposal of the committee.

3711. And that you found universally?

There were only a few exceptions; not understanding our purposes rightly, I presume they made their slight objections; but generally speaking, it was not so.

3712. So far as your knowledge and experience go, you would say that to anything like a reasonable system of inspection, an inspection not compulsory, there would be no strong objection entertained by the owners and managers of coal mines?

I think not; from conversation with several of them, I think there seems to be a disposition for it; they fancy that it would take a portion of the responsibilities. If your Lordships ask the opinion, I give the opinion of the viewers; they would also be prepared, I believe, to adopt any good suggestions that might be made to them by scientific and practical men, in a spirit of fairness and by competent authority.

3713. From what you have seen in your own inspection of mines, do you think that there are many points in which the opinions and suggestions of competent Inspectors would be useful?

I think exceedingly so; I think a well-regulated and organized inspectorship one of the most important things that could occur to the mines; safer for life, and more advantageous to mining property.

3714. You

3714. You saw the application of Mr. Fourdrinier's invention in order to prevent another class of accidents, namely, those arising from the breaking of ropes?

I had the pleasure of seeing that experiment at Usworth Colliery.

3715. You were in the cage upon one experiment when the rope was cut, were not you?

I was; I felt so assured of its security on seeing it; I think they said that the weight altogether of the four persons in it, with one tub of coals which we retained, would be about 40 cwt. The rope was cut; we were descending with considerable velocity; beneath us we had 1,000 feet; it was necessary to be very particular; we took the inventor with us to secure that, and were arrested in our descent in six or eight inches space, and were perfectly safe.

3716. What were the experiments which were made beforehand to ascertain the safety of such an experiment as that?

The experiments beforehand that were made were made with a weight of 53 cwt., I think; the two tubs were filled with coals, which, with the weight of the cage, I was told, was about 53 cwt. I have no doubt it was that weight; that was worked up and down constantly, and it was invariably successful; that was the cause of our personally putting ourselves in the same situation. There may be a doubt,—I cannot tell myself,—but there may be a doubt, if it was descending with great velocity, whether or not there is the possibility of everything being carried away; but I must do the inventor the justice to say that I do not think it affects the principle of the invention, which I must admit is admirable, and very well adapted for its purpose.

The Witness delivers in the following Papers:

VENTILATION by HIGH-PRESSURE STEAM.—Usworth Colliery, 25 June 1849.

After we had done with the experiments with Fourdrinier's apparatus, having previously been informed that they had one of Gurney's high-pressure steam apparatuses ventilating in the upcast, and that it did not increase the furnace ventilation more than 5,000 or 6,000 feet, and that in an experiment in the heated upcast without the furnace, the supply was about 12,000 cubic feet per minute, and with the steam apparatus little more than 19,000, I requested them to arrange for my going down the upcast to the apparatus.

Before descending, I observed from the course of the steam and from the action of the jets that there were only 12 impulses per minute, or one in five seconds, and that it was not distributed equally in jets.

When I reached the point of the steam operations, about 12 yards down the upcast, I found that the action was merely from the exhausting pipe of the engine boiler on the surface, which had been carried down that distance, and its mouth turned upwards, *recourbée*, as Gonot calls it, and was discharging its steam at the open mouth of the pipe, about six inches diameter, placed against the side of the shaft.

An adoption of a pipe in this mode has been especially pointed out as not only an inefficient but an injurious application of high-pressure steam.

HIGH-PRESSURE STEAM VENTILATION.—Belmont Colliery, 2 July 1849.

Two boilers, 28 x 6, about 50-horse power, for working an underground engine for pumping, jets 8 x 8 = 24, on 8 arms; shaft 8 feet diameter; each jet arranged to make about two feet of air. The fires were damped up when I arrived, about 3 p.m.; examined the jetting apparatus, and then waited till the steam was raised, when without using the pumping gear, we got about 46 strokes or pulsations of steam per minute, fed from the exhausting pipe; internal bore about six inches; 28 inches area.

Area of the 24 jets, three-eighths of an inch each, $1\frac{15}{100}$ inches.

Under the disadvantage of steam, only pulsating not at its power, and with the furnace going, I did not do the apparatus the injustice to take its results.

HIGH-PRESSURE STEAM VENTILATION.—Seaton Delaval Colliery, 3 July 1849.

Arrived unexpectedly a little after 1 one o'clock p.m.; went down about 3 o'clock; depth of shaft about 100 fathoms; found them working the entire mine without any furnace, and only with the steam-jet of eight branches, containing 25 jets or perforations, each $\frac{1}{4}$ of an inch, or the whole $1\frac{227}{1000}$ inches, not $1\frac{1}{4}$ inch area. The steam was produced from one high-pressure boiler, 25 x 6, about 40-horse power, working a long incline of upwards of 1,200, generally drawing upwards of 30 tons, and at the same time ventilating the whole mine of upwards of 400 acres. Pressure about 35 lbs. to the inch. Went to the apparatus at the bottom of the upcast E. I.; pulsating about 30 strokes per minute. In addition, there was a communicating pipe always in full operation from the boiler, which gave a continuous stream of steam through the jet.

J. Mather, Esq.
10th July 1849.

Measured the air, and found it in the south-way area 80 feet; distance measured 20 feet. Time in three experiments, 9 seconds, or an average of seconds 3.

C. D. PIT, WEST-WAY.

| | |
|--|-------------|
| Area - - - - - | 54 feet. |
| Distance measured - - - - - | 60 feet. |
| Time in two experiments, 9 + 8 - - - - - | 8½ seconds. |

ENGINE-WAY, E. I. PIT.

| | |
|-----------------------------|------------|
| Area - - - - - | 78 feet. |
| Distance measured - - - - - | 60 feet. |
| Time - - - - - | 8 seconds. |

| | |
|--|-------------|
| | Cubic feet. |
| South-way - - - - - | 32,000 |
| Engine-way, E. I. Pit - - - - - | 35,100 |
| West-way, C. D. Pit - - - - - | 22,884 |
| Prospect-way and water-ways, 12 feet, and 30 feet area - - - - - | 6,000 |

TOTAL cubic feet per minute - - - - - 95,984

It was stated to me by the resident and assistant viewers, that the circumstances of the mine being exactly similar, the furnace the day before had been tried (possessing 50 square feet of fire, more than the usual size), and had only produced—furnace, 45,948; steam ventilation, 95,984; leaving a balance in favour of the steam ventilation of 47,036, or nearly 100 per cent. with C. D. upcast entirely shut off.

COMPARATIVE VELOCITIES and Powers of Furnace and Steam-jets.

Seaton Delaval area, 50·262, with a steam-jet. Cubic feet per minute, 95,984.

Hetton area, 153·9384, with three furnaces. Cubic feet per minute, 168,000.

The rate in Seaton Delaval upcast by steam-jetting, 1,909½ feet per minute, or a velocity of 21½ miles per hour.

The rate in Hetton upcast by three furnaces, 1,091½ feet per minute, not 13 miles an hour, leaving a velocity in favour of the steam-jet of nearly nine miles an hour; jets for Hetton to produce the same purpose, 50 : 25 :: 154 = 77 jets, or one jet to two feet sectional area.

The Hetton area 153·9384 × 190·95, same rate as at Seaton Delaval = 293,945·3740 cubic feet per minute with steam, or nearly 75 per cent. increase; 50·2656 × 1,091½ rate of Hetton current = 54,856·248 cubic feet per minute.

Actual rate by furnace at Seaton Delaval, 48,948; loss by the Hetton furnace, power of three furnaces, if applied at Seaton Delaval instead of the steam-jet, 41,128 cubic feet per minute. The steam-jet then would, with the same force of 35 lbs. to the inch, produce in the 14 feet upcast, 293,945 cubic feet of air per minute, or nearly 75 per cent., 74·967 more than the three furnaces at present employed, and save nearly 1,000 tons consumption of coals on the two furnaces annually, and the services of four men. It will, as shown, take 77 steam-jets instead of 25, each jet to move a column of air of two feet sectional area. The 77 jets will possess an area of about 3·779, or 3½ inches, which a three-inch pipe from a high-pressure boiler would more than supply, its area being about seven inches. By increased pressure, say 50 or 60 lbs. to the inch, would a greater increased proportion of rate be produced. The actual measurement of these two collieries gives the present steam process as 15 is to 5; and the barometrical experiments formerly at Killingworth Pit and now at Seaton Delaval bear out this proportion in a striking manner.

KILLINGWORTH.—Difference between Upcast and Downcast;

| | | | |
|------------|--------------|----------------|--------|
| Pressure. | | Pressure Inch. | Foot. |
| ·50 ·245. | 30 : 14·7 :: | ·50 = ·245 = | 35·28. |
| 1·55 ·759. | 30 : 14·7 :: | 1·55 = ·759 = | 109·5. |

[See Barometric Observations in Seaton Delaval Colliery, page 347.]

DON ALKALI WORKS, 6 July 1849.

These works condense when in full operation about 43 tons of muriatic acid per week, which were previously nearly all sent into the atmosphere, to the injury of life and destruction of vegetation. In addition to this condensation by the high-pressure jet, there is produced by it a ventilation for six furnaces, which used to be carried through the chimney about 200 feet high. This work employs about 240 men.

All this ventilation and condensation is produced by six jets, ⅝ inch diameter, from one boiler of 10-horse power, about 21 × 6 feet, pressed from 30 to 40 lbs. per inch. (See Section of Process.) The steam, after performing its purpose, is carried through a drain about 30 yards in the yard of the manufactory, and empties its steam upon the surface without

Vide Appendix I.
Plan, No. XXI.

without inconvenience to man or horse. The proprietor of this work paid in 1845, the year previous to the adoption, 300*l.* for damages to vegetation, but since he adopted the steam-jet, not a single complaint nor a demand for damages has been made. The highest ventilating and condensing chimney on the Tyne is about 220 feet high; at Glasgow, Tennant's, upwards of 400, costing nearly 5,000*l.*; those on the Tyne cost each about 2,000*l.* Such expenses will for the future be saved. By the jet the sulphurous acid gases and other fumes injurious to vegetation and life in the neighbourhood of copper furnaces may be condensed. It will not be a more important application to the mines than to the manufactories of the kingdom.

In Dr. Richardson's opinion, the distinguished analytic chemist, if applied in the smelting of copper, it would supply sulphur enough to prevent the importation of a single ton from Sicily.

J. Mather, Esq.

10th July 1849.

MESSRS. SWINBURNE & Co.'s MANUFACTORY.—2 July 1849.

Examined to-day the steam-jets of this manufactory, which work three furnaces with six fires; one jet of five-sixteenths of an inch to each fire. It draws the heavy muriatic gas up through descending columns of water broken by coke 24 feet high, and then jetting any gas that may be left from the condensers into a drain about 2½ feet square, the steam there absorbs it, and at the open mouth of the drain, which is in the manufactory yard, 100 yards in length, the head may be held over the issuing steam without any inconvenience to respiration. I was presented with one of these jets (which was shown to their Lordships) by Messrs. Swinburne, through which this striking process goes on.

The Witness is directed to withdraw.

JOSHUA RICHARDSON, Esquire, is called in, and examined as follows:

J. Richardson, Esq.

3717. YOU are a mining engineer?

I am.

3718. Resident at Neath in South Wales?

Yes.

3719. Have you for a long time been concerned in that description of business?

In Wales for about seven years.

3720. And previously to that anywhere else?

Yes; I was with Mr. Robert Stephenson, as a pupil.

3721. In the North of England?

In the North of England, and during the time of my pupillage with him, we occasionally had colliery as well as civil engineering, generally.

3722. Have you ever turned your attention to the circumstances under which accidents occur in coal mines?

I have.

3723. You have published a work upon that subject, have you not?

I have published one work on Accidents in Mines, another on the Ventilation of Mines, and several other works on kindred subjects.

3724. What do you think would be the most effectual step to be taken for the purpose of guarding against accidents arising from the foulness of air in mines?

Perhaps your Lordship would allow me to observe that explosions do not constitute one-half of the loss of life that does take place in mines. I have here an extract from the Mining Journal; it is the only data which we can obtain of the number of deaths which take place in mines. From that record, it appears that from the 1st of January 1848 to the 30th of last June, 798 lives have been lost.

3725. In a year and a half?

Yes.

3726. Of which by explosions there were about 346?

Yes; the total number being 798. From other causes there have been 452; and if your Lordships will look at the first return, there are some rather curious facts developed; you will find that, in North and South Wales, there were 116 (164.11.)

J. Richardson, Esq.

10th July 1849.

deaths; in Staffordshire, 155 deaths, and in Northumberland and Durham, there were only 38. Now, taking the number of men employed, and the quantity of coal raised, it appears that in the counties where the largest quantity of coal is produced, the fewest accidents really happen.

3727. So far as that one year is concerned?

So far as that year and a half goes.

3728. This part of the document is only for one year?

Yes; the other six months are not drawn out in that way; but I believe it nearly corresponds.

3729. Have you examined sufficiently the records of past accidents to be able to say whether that proportion holds for a series of years between the districts?

I believe it does, as far as I have been able to collect any information on the subject; but there are almost no data. The only source from which information can be derived is the report on the children's commission, and that bears out very much what is stated in the Mining Journal; but it should be borne in mind that that return falls very far short of the real number of accidents. The Mining Journal gives its returns from the local papers; and I know in our district in Wales that many accidents occur which are never noticed in the papers, and there are no returns there from Yorkshire, nor from Gloucestershire, nor from Scotland, nor from Ireland, so that it is very imperfect; but as far as it goes, it proves of use.

The Witness delivers in the following Document:

DEATHS IN MINES.

The following is an Analysis of the Causes of Violent Deaths in Mines, as recorded in the Mining Journal, from the 1st of January to the 31st of December 1848, both inclusive.

| COUNTIES. | By Explosions. | By breakage of Ropes or Chains. | By falling down Shafts. | By falling of Roof, Coal, &c. | By Suffocation. | By Trams or Waggons. | TOTALS. |
|--------------------------|----------------|---------------------------------|-------------------------|-------------------------------|-----------------|----------------------|---------|
| North and South Wales | 43 | 22 | 6 | 39 | 5 | 1 | 116 |
| Lancashire | 24 | 10 | 13 | 9 | - | 3 | 49 |
| Staffordshire | 35 | 28 | 24 | 65 | 3 | - | 155 |
| Cornwall | 7 | 4 | 16 | 8 | - | - | 35 |
| Derbyshire | 2 | - | 1 | 13 | - | - | 26 |
| Durham | 16 | 4 | 1 | 2 | 2 | 6 | 31 |
| Northumberland | 3 | 1 | - | 1 | 2 | - | 7 |
| Shropshire | 2 | 8 | - | 3 | - | - | 13 |
| Cumberland | 30 | 1 | 1 | 1 | 1 | - | 34 |
| TOTALS of Deaths in 1848 | 162 | 78 | 62 | 141 | 13 | 10 | 466 |

Total Number of Violent Deaths in Mines from the 1st of January 1848 to the 30th of June 1849, as recorded in the Mining Journal.

| | 1848. | 1849. | TOTALS. |
|--|-------|-------|---------|
| By explosions | 162 | 184 | 346 |
| By breakage of ropes and chains | 78 | 16 | 93 |
| By falling down shafts | 62 | 37 | 99 |
| By the falling of the roof, coals, &c., on the men | 141 | 80 | 221 |
| By suffocation and drowning | 13 | 3 | 16 |
| By trams or waggons, &c. | 10 | 13 | 23 |
| TOTALS | 466 | 332 | 798 |

DEATHS and BODILY INJURIES in MINES.

The following is an Analysis of the Causes of Deaths and Bodily Injuries inflicted by Accidents in Mines, as recorded in the Mining Journal, from the 1st of January to the 30th of June 1849.

| DATE. | KILLED. | | | | | | | | SEVERELY INJURED. | | | | | |
|--------------|----------------|-------------------------|-------------------------------|---------------------------------|-----------------|----------------|---------|-----------------|-------------------|-------------------------|-------------------------------|-----------------------------|---------|-----------------|
| | By Explosions. | By falling down Shafts. | By falling of Roof, Coal, &c. | By breakage of Ropes or Chains. | By Inundations. | By Trains, &c. | TOTALS. | Monthly TOTALS. | By Explosions. | By falling down Shafts. | By falling of Roof, Coal, &c. | By Trains and other Causes. | TOTALS. | Monthly TOTALS. |
| 1849: | | | | | | | | | | | | | | |
| January - 6 | - | - | 3 | 2 | 2 | 2 | 11 | | | | | | | |
| - 13 | - | - | 1 | 1 | - | - | 2 | | | | 1 | - | 1 | |
| - 20 | - | - | 1 | 5 | - | - | 6 | | | | - | - | - | |
| - 27 | 75 | 2 | 3 | - | - | - | 80 | | 1 | - | 1 | - | 2 | |
| | | | | | | | | 99 | | | | | | 3 |
| February - 3 | - | - | 1 | - | - | 1 | 2 | | | | | | | |
| - 10 | - | - | 1 | - | - | - | 1 | | 2 | - | - | - | 2 | |
| - 17 | 1 | 1 | 2 | - | - | - | 4 | | | | | | | |
| - 24 | 3 | 1 | 3 | 1 | - | - | 8 | | 2 | - | 3 | - | 5 | |
| | | | | | | | | 15 | | | | | | 7 |
| March - 3 | 8 | - | 3 | - | - | - | 11 | | | | | | | |
| - 10 | 12 | - | - | - | - | - | 12 | | 1 | - | 1 | - | 2 | |
| - 17 | - | 4 | 4 | - | - | - | 8 | | 3 | 3 | 3 | - | 9 | |
| - 24 | 1 | 1 | 2 | - | - | - | 4 | | - | 1 | 1 | - | 2 | |
| - 31 | 1 | - | 5 | 2 | - | - | 8 | | - | 7 | - | - | 7 | |
| | | | | | | | | 48 | | | | | | 20 |
| April - 7 | 3 | 1 | 6 | - | - | - | 10 | | 9 | - | 4 | - | 13 | |
| - 14 | 1 | 3 | 2 | - | - | - | 6 | | 7 | - | 1 | - | 8 | |
| - 21 | 1 | - | 4 | - | - | - | 5 | | 4 | - | - | - | 4 | |
| - 28 | 1 | - | 4 | - | - | 1 | 6 | | 3 | 1 | 4 | - | 8 | |
| | | | | | | | | 27 | | | | | | 33 |
| May - 5 | 2 | 2 | 6 | - | - | 2 | 12 | | 1 | - | - | - | 1 | |
| - 12 | - | 3 | 2 | - | - | 3 | 8 | | - | 1 | 2 | 1 | 4 | |
| - 19 | 7 | - | 8 | - | - | 2 | 17 | | 19 | - | 3 | 1 | 23 | |
| - 26 | 1 | 2 | 3 | 7 | - | - | 13 | | 1 | 2 | - | - | 3 | |
| | | | | | | | | 50 | | | | | | 31 |
| June - 2 | - | - | 1 | - | - | - | 1 | | 4 | - | 3 | - | 7 | |
| - 9 | 32 | 3 | 6 | - | 1 | 1 | 43 | | - | 1 | - | - | 1 | |
| - 16 | - | 3 | 1 | 2 | - | - | 6 | | 3 | - | - | - | 3 | |
| - 23 | - | 2 | 2 | - | - | 1 | 5 | | - | 4 | 1 | - | 5 | |
| - 30 | 35 | 2 | 5 | - | - | 1 | 43 | | 19 | - | 3 | - | 22 | |
| | | | | | | | | 98 | | | | | | 38 |
| TOTALS - - | 184 | 37 | 80 | 15 | 3 | 13 | - | 332 | 77 | 22 | 31 | 2 | - | 132 |

3730. The beds of coal in Durham and Northumberland are much more charged with inflammable gas than those in South Wales and Staffordshire, are not they?

-Speaking generally, they are; we have some very fiery veins with us.

3731. As much so as the beds in the North?

Quite as much as some; we have not many; there are one or two which are very fiery.

3732. Even looking to that circumstance, the average of accidents ought to be much larger in the North than in the West, ought it not?

It ought. The greatest number of accidents in South Wales, generally, I have found are from falls of the roof, and not from explosions owing to the nature of the works.

3733. It appears from this return that, in the year 1848, there were in North and South Wales, 43 deaths by explosions; in Staffordshire, 35 by explosions; and in Durham and Northumberland, 19 by explosions?

Yes.

3734. Those numbers, therefore, seem to correspond in some degree with the totals of which mention was made before; the deaths from explosions in the (164. 11.)

J. Richardson, Esq.
 10th July 1849.

North of England appear to be considerably less than those of North and South Wales and of Staffordshire. To what do you attribute that result?

To imperfect ventilation in South Wales.

3735. The system of ventilation in South Wales is very inferior to that in the North?

It is exceedingly imperfect.

3736. Is there much natural ventilation?

A great many mines have natural ventilation.

3737. They depend solely upon the natural ventilation?

In many mines they depend solely upon natural ventilation; in others a kind of imperfect furnace is adopted, but it is a very imperfect one, generally.

3738. Are the furnaces very infrequent?

They are rare.

3739. Are they becoming more common than they were?

Of recent years they have done so; in the last 12 months they have been on the increase.

3740. Where they do exist, do you conceive that they are generally of such a nature as to give sufficient ventilation to the mines?

Not generally; they are generally made too small to be effective. And there is another strong objection to the mode of mining, and that is the very small areas of which the air-ways are constructed; many of the air-ways are not more than eight or ten feet; 16 feet area is about the largest.

3741. When you say 16 feet, what do you mean?

An area four feet by four.

3742. Are you able to say what amount of current is generally considered sufficient in the Welsh mines?

Very little indeed. I think if I stated the general quantity of air entering the mine at 2,000 feet, I should make a very considerable allowance.

3743. You mean 2,000 cubic feet per minute?

Yes.

3744. And what should you think is the amount that is desirable if it could be obtained?

In mines of that description, works of that size, there should be at least 10,000 to 15,000.

3745. Do you think that 10,000 to 15,000 would be sufficient in mines of any extent?

They are not large; the mines are generally small; they are generally driven by level, and when the levels or the cross-headings become very long, it is cheaper to drive another level than to continue the underground works.

3746. There are not many shafts?

Very few shafts in our neighbourhood; in the neighbourhood of Neath.

3747. Have you ever seen any other means applied for the purpose of obtaining ventilation besides the common furnace?

Yes; I have seen Mr. Struvé's machine applied to Eaglesbush colliery.

3748. Is Eaglesbush a dangerous mine?

It was,

3749. Was it very ill ventilated formerly?

It was.

3750. By what means was it ventilated?

It was the natural ventilation.

3751. Nothing but the natural ventilation?

There were two furnaces in the culvert, but the furnaces were not used, nor had they been used, excepting for a few weeks; therefore, although the furnaces were there, yet not being used, it merely was the natural ventilation.

3752. Did

3752. Did an accident take place in that colliery?

Yes; in March of last year.

J. Richardson, Esq

10th July 1849

3753. An explosion?

An explosion, by which 20 lives were lost.

3754. In consequence of that, did the proprietors establish a different system of ventilation?

In consequence of that, and the investigation which took place at the coroner's inquest, they have erected Mr. Struvé's machine.

3755. Have you seen Mr. Struvé's machine in operation there?

I have.

3756. What has been the result obtained at that colliery?

I should perhaps state to your Lordships that I examined the mine immediately after the explosion, at the request of the coroner's jury, accompanying the Government Inspector, Mr. Warrington Smyth, on the inspection; and upon that occasion we found that, taking the quantity of air going into the mine, at the most, it was about 3,000 cubic feet per minute; on examining it after Mr. Struvé's machine was at work, I found that there were about 13,500 feet.

3757. At what power was Mr. Struvé's machine worked at that time, in order to produce that current?

It was driven by a small, rather defective engine, of five-horse power.

3758. Do you know how many strokes it was making?

Seven and a half; it was 12 feet diameter, four feet stroke.

3759. Was that sufficient to place the mine in a perfectly safe state?

I went under ground, and I was astonished at the difference which there was in the state of the air of the mine; the candles burnt clearly and well, and there was no indication whatever of fire-damp. I had formerly found, especially in the further part of the mine, near a fault, that it was so fiery as to be even dangerous to work with the Davy, for the whole of the Davy got so very soon heated and red hot, that it became very dangerous, and they were constantly coming out to cool it; but upon the second occasion I saw not the slightest symptom of fire-damp.

3760. Had you been frequently down that pit before?

Not before I went on the part of the coroner's inquest.

3761. You did not know it before that time?

I had not been down before; I had heard that it was a very fiery pit previously.

3762. Have you had an opportunity of comparing the power and expense of Mr. Struvé's apparatus with the power and expense of the steam-jets?

I have not; I have never had an opportunity of seeing the steam-jet.

3763. You say that you found that very small ventilation, of which you were speaking just now, after an explosion had occurred in the Eaglesbush colliery?

Yes.

3764. Do you suppose that that very feeble amount of current might have been the result of any thing which happened in consequence of the explosion, or was it the ordinary state of the mine to have no more than that ventilation?

The mine was rather in a better state than ordinarily, because the explosion had thrown all the stoppings down, and several falls had taken place in the air-ways; therefore, when we went to examine it, the air-ways had been recently cleared of falls from the roof and other obstructions, and were in a much better state than they ordinarily were; and I think if there had been even 3,000 cubic feet per minute, the explosion would not have taken place. We undoubtedly saw the mine in a better state than it was ordinarily in, from the circumstance of the air-ways being clear; the air-ways were only 16 feet there, which was too small.

3765. Do you know what the distance was through which the air was to be drawn?

One mile and five furlongs. I have a Plan here of the mine as it was on the day of the accident; this Plan was made for the Institution of Civil Engineers.—
[The Witness produces the same, and explains it to the Committee.]

Vide Appendix I.
Plan, No. XXII.

J. Richardson, Esq.
 10th July 1849.

3766. That would appear to be a very imperfect system of ventilation, is it not?
 Yes.

3767. It does not ventilate by any means all the passages of the mine?

Oh, no; a great part of the air is necessarily lost. These are all old workings, and in the direction in which the air comes, it is not tight; there are some curious facts with respect to Mr. Struvé's machine in these old workings, even at this distance from the ventilator. They were formerly in a very dangerous state even to go into them with the Davy, the lamp got so heated; but after the application of Mr. Struvé's apparatus, a man happened accidentally to go there, and he found that the whole of the explosive gas was gone, and that he could now go into places where he could not before with a naked candle.

3768. After Mr. Struvé's apparatus was in operation?

Yes; the entrances of these stalls were closed by dry stone walls, and small coal laid behind them; after being abandoned, they very soon filled with fire-damp, and the mice and rats frequently made holes through; the men were employed to stop those holes; that shows that it was not perfectly tight; that the gas was constantly exuding from these stalls into the head-way. At a recent period they had occasion, in making some alterations in the air-ways, to go into one of these stalls, and they found that, instead of being full of fire as was anticipated, it also was completely clear of fire.

3769. In consequence of the operation of this apparatus?

Yes; that the machine, through the loose stopping, had drawn out the explosive gases, and that good air had been substituted.

3770. Then the effect of the machine, according to your description, is not merely thoroughly to ventilate those passages through which it is directly taken, but to draw the inflammable gas from the collateral spaces?

It does; from what you would call the goaves, in the North.

3771. Did you yourself enter any of those waste spaces?

I have not since Mr. Struvé's machine has been up. The whole of this part is now under water—[*showing the same*—]—so that we cannot get to the lower part.

3772. Even supposing the present apparatus to have all the power that you ascribe to it, in order to maintain this mine properly, would it not be necessary to direct the air-courses in a different manner?

It would, and that they are about doing.

3773. They could not have done that without some artificial ventilation?

No, they could not. There was another circumstance mentioned to me by the men, and also by the proprietors, that since Mr. Struvé's machine has been employed, the men can cut a greater quantity of coal with greater comfort and ease than they could before. Three of the men stated to me that they could now cut three tons as easily as they before could cut two, and that their appetites were better from the improved state of the air.

3774. Of the air that they breathe?

Of the air that they breathe.

3775. They found that it produced that difference in their bodily strength?

In their bodily strength and health, and the proprietors remarked it, stating that they were getting their work done more cheaply in consequence.

3776. Have you had any experience of any other methods of ventilation?

No; excepting the furnace and this apparatus.

3777. You have not seen anything of Mr. Brunton's apparatus, the fan?

I have not.

3778. Carburetted hydrogen is lighter than common air, is it not?

It is. Perhaps your Lordships will allow me to mention that the steam was tried in South Wales by a Mr. Stewart from Newcastle, as early as 1828, and very successfully.

3779. Do you know in what manner it was tried?

I have a letter from Mr. Stewart's son, who is now living, and it is at your Lordships'

Lordships' service; it is dated 21st of January of this year, before this inquiry was anticipated. *J. Richardson, Esq.*

10th July 1849.

The Witness delivers in the same, which is as follows :

Dear Sir,

South Wales Railway, Engineers' Office.

I have put down a few of the particulars respecting the use of high-pressure steam for ventilation, as tried by my father in 1828.

1st. The mine was called the Hendreforgan Colliery, in the parish of Langwick, 16 miles from the port of Swansea, up the Swansea valley, and two miles from the Swansea Canal. The coals were conveyed down in waggons to the canal, over a narrow tram-road, which has since been relaid on the four feet eight-and-a-half inches gauge; the gradients are such that the waggons run down themselves, with a light horse-box attached, in which the horses ride down, and bring up the empty waggons.

2d. There were two shafts sunk to the big vein: 1st. The engine or downcast shaft was 25 fathoms, 12 feet \times 9 feet, with one tier of 12-inch pumps in; all the coals and men passed through this shaft. 2d. The upcast shaft was seven feet six inches in diameter (44 feet area) round 20 feet; the dimensions of the corves in which the coal was drawn were three feet one diameter, and two feet six deep, all iron.

3d. The vein was always very highly charged with gas, and was considered the most difficult and dangerous in the Anthracite district; I think the irregularities of the strata was one great cause, as the adjoining collieries east and west had not one-twentieth of the gas to contend with, but the quality of their coal was inferior. The level course, from the bottom of the downcast shaft, running nearly south, gave us only a very small portion of coal to the rise, which compelled us to drive a pair of drifts in the coal to the deep, nearly 500 yards. We passed through a down-throw fault to the west in going down; we were now compelled to have a stationary engine underground, and old George Stephenson made the engine for us. Before erecting the engine we had a furnace 20 feet from the bottom of the upcast shaft 7 feet \times 6 feet; after erecting the engine and all was ready, we abandoned the furnace, and used the fire under the boiler as a substitute, which, together with the steam from the exhausting-pipe being carried into the flue at the end of the boiler, answered well for a time. We had a dumb-drift always in use, and the return would always explode in the Davy.

The workings increasing in extent, and the water in the deep workings beginning to be troublesome, we had two lifts of slant pumps down above 300 yards. It was determined to sink a shaft in the mine to the brass vein four feet thick, which was reported to be only eight fathoms below the big vein; a place was selected in such a position as that any machinery which might be wanted could be attached to the engine; this shaft was intended for an upcast, after sinking the downcast to the coal; we commenced sinking, and sunk 24 fathoms, struck into a body of coal 10 feet thick (as full of gas as ever you saw an egg full of meat); we drove north and south, got holed round, and had to put in temporary brattice, got the air to work, but still we could not take a candle near the shaft; we soon discovered we had not got the brass vein. About 50 yards each side of the shaft we found the coal only two feet four, the regular thickness of the black vein; this was abandoned, and the gas piped into the dumb-drift; we commenced sinking again, and got the long looked-for at 13 fathoms below the black vein, making the pit 37 fathoms instead of eight.

This vein was of excellent quality, and four feet thick, a clean coal and good roof. The owner, whose patience was nearly exhausted, wished to have the coal to market at once. Machinery had to be got ready; an air-tight brattice partition had to be fixed; we had stemples every four feet, 8 inches \times 5 inches; on these came the 3-inch deal planks, all ploughed and tongued, to make this shaft both an up and downcast; the only difficulty was, that the shaft was only nine feet diameter (63 area), and we found that we would have only two feet four inches from the back of the stemple to the edge of the pit, a space insufficient for the ventilation; as we had two collieries to ventilate, and no increase of communication with the surface when we had only one, the great object now was to increase the ventilation, and that could only be done by increasing the velocity; the quantity of gas discharged was increasing, and the state of the mine daily becoming more dangerous; we had one slight explosion in the brass vein, which damaged the partition very much.

Having observed how the ventilation was increased by the steam from the exhausting-pipe of the engine being carried into the upcast shaft, the height of the dumb-drift, my father proposed trying a constant jet of steam direct from the steam-pipe, conveyed into the upcast shaft at a level with the dumb-drift; the steam was at the pressure of 56 lbs. per inch on the safety valve. In eight days we had got everything ready to try the experiment; and all was quite a secret, for fear of a failure. We had a steam-cock one inch in bore fixed in the steam-pipe between the boiler and the throttle valve, and a pipe two inch bore connected with it, and the upcast shaft at the height of the dumb-drift, which was 40 feet above the furnace at the bottom. The reason for having a cock was, that when the engine was working there would not be required the same quantity, as the exhausting steam would assist. We tried the experiment on a Saturday evening, after all hands had left work, the mine being in a foul state, 26th July 1828. I opened the cock to its full extent, and had only one man, the engine-man, with me. We had no candles, and therefore could not form any idea for some time. My father and the overman were at the dumb-drift

(164. 11.)

Z Z

examining

J. Richardson, Esq.
 10th July 1849.

examining the returns. After two hours' trial they felt satisfied that it would succeed. We all left the mine, with the exception of the engine-man, who came up about 10 o'clock at night, and began to complain of the draught. I examined the mine on the Sunday morning, the 27th, and found it all clean, so that a candle could be safely taken where it exploded in the lamps on the Saturday.

We continued the use of steam until 1833, when the mortgagee took to the concern, and had the under-ground engine brought up and sold. The workings in the upper vein were abandoned, and the downcast shaft sunk to the brass vein; then having the old pit with the brattice taken out of it for the upcast, we had sufficient air even without a furnace. The works were shortly afterwards suspended. There have been two attempts to re-open them by different companies, but they have been finally abandoned since 1840.

The vein dips one in three.

The area of the workings before the steam was applied in 1828, was about 70 acres.

When the works were suspended, 115 acres.

Horse-ways, 7 feet wide, 6 feet high, 42 feet area.

Cross-headings to the full rise, 6 feet \times 6 feet = 36 feet area.

Stalls, about 5 yards wide.

Wind-ways, 5 feet \times 7 feet = 35 feet area.

1822. Quantity of air with the furnace alone, 126,000 cubic feet per hour, 2,100 per minute.

1824. Quantity of air with furnace and the exhausted steam, 172,000 cubic feet per hour, 2,866 per minute.

1828-1833. Quantity of air without furnace, and the steam direct from the boiler, at a pressure of 56 lbs. per inch, 504,000 cubic feet per hour, 8,400 per minute.

The above is what I have got from some old memoranda; I think they are near the truth.

The coal was well known in the London market as Cox's stone coal, and commanded the highest price for Anthracite. The culm was taken as far north as Yarmouth, to burn lime, and stood high, besides what was taken to London, which was no small quantity.

The general working from the pits was about 112 tons per day. We had a number of small veins which only were sold as culm; those I have not included.

I think I have mentioned all particulars; if not, please to let me know. It is a round-about way of coming to the point, but you will see how we were driven to our wit's end for want of air.

I am, sir,

Your obedient servant,

M. G. Stewart.

P.S.—My father was the first person who introduced the use of brattice into the Anthracite district.

21st January 1849.

3780. Can you say what quantity of air was taken down the downcast when Mr. Struvé's machine was put in action?

The quantity of air was going down, I believe, at about five feet a second.

3781. What is the diameter of the shaft?

I do not exactly recollect; it is not a shaft, it is a slope.

3782. What would be the area of the passage?

I should think about six by seven; it would be about 12,600 a minute; but at present they are taking the air down the entrance, and they have not closed the old downcast sufficiently, so that there is a waste of air; a part of the air is wasted in that colliery from the imperfection of the works.

3783. You have stated that the carburetted hydrogen gas emerged from these waste parts into the air-passages?

Into the head-ways.

3784. Or any passages along which the air was taken?

Just so.

3785. How came it that the lighter gas should be pressed from those spaces into these passages?

We

We only know the fact that they were before fiery, and that they are now *J. Richardson, Esq.*
not so.

10th July 1849.

3786. You are not able to explain the mode in which the change took place?
Your Lordship will observe that there is a draught through these parts, in which the hydrogen would, of course, mix with atmospheric air.

3787. Is there a draught through these spaces?

Yes; there is a hole at the top, and the entrance to the stall at the bottom.

3788. Is there an opening at each end?

They are imperfectly stopped.

3789. It passes through the interior?

It has passed through.

3790. There is no opening expressly left for the purpose?

No, certainly not, but there is a sufficient opening for the air as there was for the gas to exude.

3791. Is there sufficient opening for a current of air to be constantly passing through in the existing ventilation?

It has so passed through as to clear it of fire-damp, but there is not a constant current.

3792. In what respects does Mr. Struvé's apparatus differ from an air-pump?

None, essentially; of course it differs from a force-pump; it seems to work with great ease and certainty; the men say that directly it begins in the morning they feel it; immediately the machine ceases they feel it.

3793. Do they work in that mine with lamps or candles?

They did work with lamps; they now work with candles.

3794. Universally with candles?

Universally with candles.

3795. From what you have seen of it, do you consider it safe to work with candles since the apparatus has been put up?

I do; that is when they are in the current of the air; if they are working in a direction where the air is not brought up to them, of course they must use lamps in that case.

3796. In one of your publications upon the subject of accidents in mines, you have expressed a strong opinion upon the expediency of an interposition on the part of Government?

I have.

3797. Do you think that any exercise of authority on the part of Government, in the way of inspection, could be so arranged as to be effectual without exciting great jealousy and objection on the part of those who are concerned in the management of mines?

I think, as far as South Wales is concerned, that it might.

3798. Have you ever heard opinions expressed by colliery owners upon the subject of a Government inspection?

I have, frequently.

3799. Is it your impression, from what you have heard upon that subject, that there would not be much objection felt to such a step?

I believe there would be none, supposing that it was an inspection with moderate powers, not compulsory.

3800. According to your own view of the matter, what would be the powers which you think it would be right to confer upon such Government officers?

At first I should very much doubt the expediency of doing more than merely reporting upon the matter.

3801. What is the extent of the powers that you have recommended to be conferred upon the Inspectors in the work to which allusion has lately been made?

That they should have full power of inspection, and of reporting the state of the mine on that inspection; I think I go no further than that. I do not dis-

(164. 11.)

z z z

tinctly

J. Richardson, Esq.
 20th July 1849.

tinently recollect at this moment; and to have power also to put in operation the existing law as regards open shafts and other circumstances, and where there is immediate danger, of course they must immediately report it; but if your Lordship recollects, I enter into minutiae regarding lamps and falls of the roof, and other circumstances.

3802. Then you would confer upon them a right to examine the mine; would you include in that a right to examine the plans also?

Certainly.

3803. Do you conceive that powers of that kind would be essential to the discharge of such duties as the Inspectors would have to perform?

I do, and it would be also necessary to compel the proprietors of mines to have plans. In South Wales there are many who have not any plans whatever.

3804. Do you think that it would be a proper subject of legislation that they should be compelled to have plans?

I should rather doubt entering into so much minutiae at first; that might be recommended.

3805. In examining a mine, as you would propose that the Inspector should, for the purpose of ascertaining its condition as regarded safety, and in his right to look at the plans of the mine, in order to judge of the ventilation, do you think that he would have the means, without taking measurements and going further into the particulars of the case, of ascertaining what might be the facts with respect to any questions of boundary which might excite the jealousy of colliery owners?

No, I should think not; I do not see that there would be any cause for that jealousy at all.

3806. Having a right to inspect the mines and the plans, what further would you conceive to be the duty of the Inspector?

To report to the Secretary of State or some other authority, and then, in case of an accident occurring, of course that report would be evidence.

3807. Supposing him to make observations upon a mine, and to communicate those to the owner, and that the owner, being a competent person, were to express a different opinion, and to decline to follow his suggestions, what course would the Inspector have to take then?

The Inspector of course, under those circumstances, would have done his duty, having reported, and he must wait events. On the occurrence of an accident, if the Inspector were present at the inquest, which is a part of what I recommend, his report would be produced as evidence against the party. Ultimately, I have no doubt that other measures would be required; but at first I think that the coal-owners would not quietly submit to very stringent measures.

3808. Are you aware that the Government has already appointed Inspectors to examine?

I have heard so.

3809. Have you seen their instructions?

I have seen instructions that have been in the newspapers; I suppose, correct copies.

3810. Do you approve of that as the first step towards the object which you have in view?

I do.

3811. You say that the report of an Inspector of a mine would stand as evidence against the owner hereafter?

I do.

3812. Have you such perfect confidence in any Inspector appointed by Government, that his *ipse dixit* is to go upon the authority of a mere oath or affidavit against the owner of the mine?

In the first place I should presume that the Inspector appointed would be fully competent to his duties.

3813. Have you seen much of Government Inspectors or their reports?

I have seen some very able reports.

3814. On

J. Richardson Esq.
 10th July 1849.

3814. On any business with which you are concerned?

I have seen some reports regarding collieries.

3815. Whose?

I have seen Mr. Warrington Smyth's, which is very much approved of.

3816. On whose collieries; on your own collieries?

No; the Darley Main, I think it was.

3817. Has any Government Inspector been sent to a colliery with which you have been concerned?

No; there has not been occasion.

3818. You have had no opportunity of judging of the justice of their reports?

No, I have not; but will your Lordships allow me to observe, that the mere fact of a defect having been pointed out by the Inspector, and an accident occurring in consequence of that defect not having been remedied, would increase the responsibility of the owner of the mine.

3819. You have stated that a gentleman of the name of Stewart, about the year 1828, made some experiments with high-pressure steam, which were very successful?

He did.

3820. Have you published any account of those experiments?

I have. I must explain that: I only received information (I think the letter is dated on the 21st of January) after I had heard of Mr. Forster, in some works in the North, adopting Mr. Gurney's plan.

3821. Did you happen to see a letter written by a Dr. Vasey, in answer to a statement published by you?

I did.

3822. Do you happen to have a copy of that letter?

I think I have it in town; I have not it with me.

3823. Do you know why, if those experiments which were made in the year 1828, were attended with successful results, they were not persevered in?

They were persevered in for five years.

3824. And why were they ultimately abandoned?

Because the colliery itself was abandoned.

3825. If they were successful in their result, as you describe them to have been, it seems rather remarkable that they were not introduced and adopted in the other collieries in the district?

Yes; but we find coal-owners very slow in adopting those improvements.

3826. You know of no particular reason for their abandonment?

I do not.

3827. You say that you find coal-owners generally very slow in adopting improvements?

There is generally a great prejudice against anything new.

3828. Do you think that the occasional visits of a Government Inspector would tend, in some degree, to diminish that indisposition to introduce improvements?

I do; because I think it very possible that, in conversing with the owners, they would have an opportunity of hearing of the success of new inventions elsewhere, through a party whom they would not suspect of a biassed motive.

3829. You have stated that the accidents in the Welsh coal mines, from the falling of the roof, are the most frequent?

They are very frequent.

3830. Are many lives lost from that cause?

A great many.

3831. Is there any method by which those accidents might be diminished in amount?

(164. 11.)

J. Richardson, Esq.
10th July 1849.

They might be very considerably diminished were the supply of timber sufficient for props.

3832. Is that a question of expense solely?

It is.

3833. Would there be any great additional expense in collieries worked on the Welsh system in providing sufficient props in order to prevent such accidents?

The expense sometimes amounts to a great deal; in some collieries from 1*d.* to 9*d.* I know has been paid, and 1*s.* a ton on the price of the coal; so that there is a great inducement to be very economical, more so than they ought to be, in its use.

3834. Would it be possible for an Inspector, in going through a mine, to form any judgment as to the sufficiency of the supports?

Decidedly.

3835. Any competent person would be able to tell at once whether the supports were sufficient for the purpose?

Easily.

3836. That would be a fair subject for the remarks of the Inspector?

It would.

3837. Have you seen Mr. Fourdrinier's apparatus?

I have not seen it.

3838. There are coal mines in Wales worked by perpendicular shafts, are there not?

There are.

3839. Though a very small proportion of the whole number?

Yes; they are not so numerous as those worked by slopes and levels.

3840. What depth are they?

The deepest in our neighbourhood is 100 fathoms.

3841. In those cases where the mines are worked by perpendicular shafts, have you known any cases of accident by the breaking of the ropes?

Yes, they are very frequent.

3842. Have you ever seen anything of a contrivance for preventing such accidents?

I have heard of one being tried in the neighbourhood of Swansea; I think Mr. Fourdrinier's apparatus.

3843. You have known of its being tried near Swansea?

I have heard of it.

3844. In the pit?

Yes.

3845. But you have not seen it yourself?

I have not seen it.

3846. You have no personal experience of it yourself?

No.

3847. Are there any points upon which you would give us any further information?

There are not.

The Witness is directed to withdraw.

W. Keene, Esq.

WILLIAM KEENE, Esquire, is called in, and examined as follows:

3848. HAVE you any knowledge of some experiments made by Mr. Gurney, in the year 1826, with respect to the power of the steam-jet?

I saw frequently experiments made by Mr. Gurney in 1826, to produce draught by the action of high-pressure steam, exactly in the same way as it is now employed for producing ventilation in the collieries, that is, there were a number of jets of about a quarter to three-eighths of an inch in diameter communicating

municating directly with a high-pressure boiler; the cock being open, the full steam from the boiler was brought upon those jets, and a draught was produced by their action in the chimney shaft.

W. Keene, Esq.
10th July 1849.

3849. In the chimney shaft of a locomotive carriage?

In the chimney shaft of a locomotive, and in the shaft of a factory, the experiment was tried in various ways; I saw those experiments frequently; many other persons saw them at the same time; and I employed the same means myself shortly afterwards for a like purpose abroad.

3850. The steam was applied in that case precisely upon the same principles and in the same manner as it is proposed to be applied now?

Exactly. I made an apparatus myself abroad, applying it exactly in the same way, the steam coming without any impediment, or without any throttling of the cock. It is an essential point of the whole affair that the steam should be brought directly from the boiler with its full pressure, without any throttling or wire-drawing of the cock to the jet; I made an apparatus exactly like it, and found it so very powerful that I was perfectly satisfied.

3851. Where were the experiments of which you speak made?

In the old Ophthalmic Hospital in Albany-street.

3852. Near the Regent's-park?

Yes. The chimney had this very sort of jet, with half a dozen prongs; they were made of about three-eighths gas-pipe, the bore inside not being larger than a quill, and there were several of them placed on the pipe; there were little vertical pipes, half a dozen of them, along this row, and they communicated with the steam-boiler; the whole force of the boiler was let in upon them, and the direct pressure of the steam, at 50 lbs., 60 lbs. or 80 lbs. pressure, admitted into the shaft. I saw many experiments before that time to produce a current which were completely abortive and unsuccessful, by fans and many other attempts, which were quite unsuccessful until the employment of steam-jets.

3853. In those carriages you mean?

In those carriages.

3854. Are you aware whether those experiments of Mr. Gurney were open to the public?

Many persons visited the place daily, and the carriage went out into the road and into the barracks, and was often surrounded by a group of persons. It was understood and known how this draught was procured, because the passage of the steam was heard up the chimney when the carriage was still, and the great draught of the furnace was the occasion of remark by everybody who was around it; they were quite surprised how such a great current could be produced with so small a height of chimney; it was a very remarkable thing, and drew attention from everybody around at that time.

The Witness is directed to withdraw.

Ordered, That this Committee be adjourned to Thursday next,
One o'clock.

Die Jovis, 12^o Julii 1849.

The LORD WHARNCLIFFE in the Chair.

JOHN THOMAS WOODHOUSE, Esquire, is called in, and examined
as follows :

Evidence on the
Prevention of
Accidents in
Coal Mines.

*J. T. Woodhouse,
Esq.*

12th July 1849.

3855. YOU are a colliery viewer, residing in the Midland Counties of England ?
Yes.

3856. In what part of the Midland Counties ?
At Overseal, near to Ashby-de-la-Zouch.

3857. Have you been long employed in colliery viewing ?
I have been employed all my life in colliery viewing, since I was a boy, upwards
of 20 years.

3858. Altogether in that district ?

Yes, in the counties of Leicester, Derby, Stafford, and York, and part of the
central coal-field ; I have made examinations of collieries in the South of England ;
but not so generally as in that district.

3859. In the course of your practice in that capacity, have you turned your
attention to that part of the subject which is connected with the occurrence of
accidents in coal-mines ?

I have.

3860. Will you state to the Committee any conclusions at which you may have
arrived from your experience and observation upon that subject ?

I think that the conclusion at which I have arrived in reference to accidents
from explosions is, that they are from want of a general and better system of
ventilation, and accidents arising from machinery, and from want of more care and
attention in the management of it.

3861. With respect to the first part of your answer, the occurrence of accidents
from explosions, you state that you think the ventilation very deficient ?

In many cases.

3862. Should you say that, generally speaking, of the collieries in the midland
counties ?

Yes, taken generally ; but there are many collieries in the Midland Counties
where they are rapidly improving and making alterations ; the subject has now
become so public and notorious, from many accidents that have occurred, particu-
larly some heavy ones in the county of York, that the coal-owners and the agents
are turning their attention to the subject, and endeavouring to find a remedy for
them.

3863. You think that attention to the subject is much more general than it was ?
I think decidedly so.

3864. And among the colliery owners also ?

Yes, to a certain extent ; but the colliery owners, I think, are not sufficiently
awake at present to the importance of it.

3865. Within your experience, do you think that there is more attention to that
subject among that class of persons than there used to be ?

I think there is ; I think they do not depend so entirely upon the workmen.

3866. In the superintendence of the mine, you mean ?

Yes, they now having a better class of men.

(164.12.)

3 A

3867. As

J. T. Woodhouse,
Esq.
12th July 1849.

3867. As overmen?

As overmen; the collieries in the Midland Counties, since the opening of railways, are increasing in importance and in outlay of capital, and that alone commands more attention to the subject than before.

3868. Which of the districts of the Midland Counties is it in which there is most danger of accidents of that description?

It depends more upon the seam of coal worked than upon the district; the seams of coal are the same throughout the whole length of the district, which we will say extends from the town of Nottingham to the town of Leeds; those are about the North and South boundaries of the Midland coal-field; I am talking of Derbyshire, Yorkshire, and Nottinghamshire.

3869. Exclusive of Staffordshire?

Yes; much depends upon the seam of coal; the heaviest explosions have taken place in what is known at Barnsley as the thick bed, and in other parts of the district as the top hard seam; that is the principal seam of the district.

3870. It is three yards thick, is it not?

Yes, in one part of the county of York it is three yards thick; it runs down to as thin as three feet further South, but it is very variable in thickness.

3871. Do you consider that what is called a fiery seam?

In some places it is very fiery, in others not nearly so much so; that varies also.

3872. In Yorkshire, near Barnsley, would you say that it was not very fiery?

I have only seen two of the larger collieries in Yorkshire; in one of them it is very fiery, and in the other I think not so much so.

3873. Are both those near Barnsley?

One is Ardsley and the other Darley. The Ardsley is a much more fiery colliery than the Darley; I know them, having examined them.

3874. Had you examined them before the accidents took place?

I had not.

3875. Since those accidents took place, have you been able to ascertain sufficiently what the state of the ventilation was at the time, to form an opinion upon it?

Yes; the opinion which I formed at that time was, that the ventilation was in reality insufficient. I should not like to attribute neglect immediately to the parties; I think they acted as well as their information allowed them.

3876. Without any question as to the motives of the parties, the main question is as to the fact of the sufficiency of ventilation?

I think with a more efficient ventilation those accidents would not have occurred.

3877. Do you agree with the evidence which has been before given with respect to the circumstance of deficient ventilation in those cases having arisen partly from the use of the upcast shaft as a drawing-shaft, and water having been frequently thrown down it, and its having been partly filled; were those causes, do you think, which impeded the ventilation?

At Darley Main they doubtless were.

3878. The ventilation, generally speaking, in the Midland Counties, you describe to be defective; is it defective in the insufficiency of the means applied, or is there a total absence of any artificial ventilation?

I do not know any instance where there is a total absence of it, but it is, in fact, from the want of a greater volume of air through the workings.

3879. Is it not the case that there are many of the Midland Counties of England to which there is no artificial ventilation applied at all?

I think there are several: I will take, for instance, the county of Warwick; there are scarcely any artificial means used there; I think in the county of Warwick there is scarcely any artificial ventilation.

3880. Is artificial ventilation, by means of furnaces and otherwise, very common in the counties of Derby, Leicester and Nottingham?

Yes, now it is; it has been introduced within the last 15 years.

3881. Should

3881. Should you say that the majority of collieries in that part of the country are ventilated by furnaces?

The larger ones in the counties of Derby and Nottingham, that is to say, representing the quantity of coal drawn: there are a great many small collieries, where the pits are comparatively shallow, where they do not adopt the artificial ventilation.

*J. T. Woodhouse,
Esq.*

12th July 1849.

3882. Are there any other artificial methods of ventilation applied, besides furnaces, in the collieries with which you are acquainted?

No.

3883. Is the bed of coal at Ashby-de-la-Zouch the same as that worked at Nottingham?

There is a difference; the coal-field itself is entirely distinct; the coal at Ashby-de-la-Zouch, where I am resident, is 13 feet in thickness on the western side of the town of Ashby; on the eastern side it is only six feet in thickness.

3884. And is it an entirely separate bed?

It is supposed to be the same bed, as far as we can identify it; but the features are altogether different. On the Western side (I am now speaking of the collieries of the Marquis of Hastings, the Moira Collieries), there is a very considerable quantity of explosive gas evolved, and there is very great difficulty experienced from spontaneous combustion also. Now, there are neither of those features on the eastern side of Ashby.

3885. And yet it is supposed to be the same bed?

It is supposed to be the same bed geologically.

3886. With respect to the furnaces that are used in that district, are they so constructed, in your opinion, as to be efficient for their purpose?

Of course some of them are efficient for their purpose. There are some collieries where the ventilation is very efficient, and others where it is not so.

3887. Does the deficiency arise usually from a want of power in the furnaces, or from their being improperly placed, or from a defective arrangement of the air-courses below ground?

I should say from a combination of all those circumstances; but the greatest fault, in almost all cases there, is in the airways—want of better management in the air-courses: no matter how powerful the furnace is, or any other means of ventilation, unless the air-courses are kept perfectly clear and open, you cannot, of course, have a good ventilation.

3888. Do you mean in the distribution of the air-courses, or in the size and clearness of the channels?

In both; both in the distribution and in the sectional area.

3889. Are many of the pits of considerable depth in the Midland district?

At Moira they are 175 fathoms, those are the deepest; the pits in Derbyshire run from 50 fathoms to 100 and 120.

3890. What are they in Warwickshire, in the neighbourhood of Birmingham?

Much the same: I am not able to speak much to the Birmingham; that is in the South Staffordshire district; but in Warwickshire they run from 50 to 100 fathoms.

3891. Have they generally two shafts?

Yes.

3892. A downcast and an upcast?

A downcast and an upcast. In some cases now they are doing as much as possible to introduce a distinct shaft for the upcast in Derbyshire.

3893. At present they are used also for other purposes as well as ventilation?

Yes, for drawing as well.

3894. Do you think that very objectionable?

Decidedly.

J. T. Woodhouse,
Esq.
19th July 1849.

3895. It must always interfere with the ventilation?
Always; it is decided economy in every respect to have the upcast pit separate, where it can be practically managed, what we call a dumb-pit.

3896. An air-pit?

An air-pit.

3897. And that practice, you say, is increasing?

It is increasing, certainly.

3898. Are you acquainted with the Report of the South Shields Committee upon accidents in Coal-mines?

I have seen it, but do not recollect any of the particulars.

3899. You do not recollect the portion of it in which they state that they think that great misapprehension has prevailed with respect to the expense of sinking a shaft for the purpose of ventilation, it being stated as much greater than it really ought to be; you are not aware of that?

I am not; but I apprehend that a shaft for purposes of ventilation in the North of England would cost as much as one of the ordinary shafts for drawing, the circumstances being pretty nearly the same; they have the same water and the same sand to encounter, and the same difficulties.

3900. Rock?

Rock and everything else; it is a perfectly parallel proceeding.

3901. Would it be necessary to have it of the same diameter?

Larger, if anything, the upcast being larger.

3902. Is it the practice in the Midland Counties to make the upcast, when it is made, as you call it, a dumb-shaft, of larger dimensions than the drawing-shaft?

Yes; the improvement is so very recent on that subject, four or five years, that there has been scarcely time to carry it out; but where it is done, attention is always paid to that.

3903. In those parts of the country what should you say, under ordinary circumstances, the sinking of a shaft of 100 fathoms would cost?

In the county of Nottingham the sinking of a shaft of 100 fathoms; beginning from the first, would be some 10*l.* to 15*l.* or 20*l.* a fathom.

3904. Boarded or with masonry?

With masonry entirely.

3905. Then about 2,000*l.* would sink a shaft?

Yes; that is, of course, under favourable circumstances; if a quicksand intervened, it would be more expensive; in that part of the country the magnesian lime-stone runs over the coal measures; and sometimes at the bottom of the magnesian lime-stone is a sand similar to that in the North of England; where it happens to be very soft, or yielding much water, it becomes a very expensive process; in those cases, of course, cast-iron tubing is introduced to keep the water out.

3906. But, generally speaking, you stated that you thought it was an economical thing for the colliery to have a separate shaft for ventilation?

Certainly.

3907. You have no doubt of that, notwithstanding the expense which may be incurred in those respects?

Not the least, and for this reason; I imagine that where a colliery is sunk at the expense I have quoted, at a depth of 100 fathoms, it is with the view of working out a very large tract of coal: now, that being so, the more complete the arrangements are for drawing and ventilation, the more economically the pit is worked in every respect.

3908. In what respect do you think that very efficient ventilation is economical?

Not only as a measure of safety, but also of economy in repairs of roads, in the preservation of timber, and in the health of the men generally; there is nothing more easy than to see that in some of the old collieries. In the intake course of the pit the roads are almost universally dry; the timber is without any appearance upon it; but in the return, the roads are damp, and the timber covered with a sort of white mould, which very rapidly decays it, and there is increasing expense continually: I contend that it is strict economy, as well as safety, to have a very strong

strong current of air; there are circumstances where it cannot be done, from other causes, but wherever it can be used, it should. At the Moira Colliery we cannot use a current of air beyond a certain extent, owing to spontaneous combustion; we find that where we force, by furnaces, the air through the workings, it has a tendency to pass through the goaves, and then spontaneous combustion takes place from the pyrites of iron, so that we keep the ventilation as good as it can be consistently with the safety of the pit and of the men.

*J. T. Woodhouse,
Esq.*

12th July 1849.

3909. Do you think that the impression is becoming prevalent, that it is a question of economy for the colliery owner to secure perfect ventilation?

It is becoming more prevalent, I am confident, but I do not think that there is sufficient attention paid to it yet.

3910. In working the mines in that part of England, do you think that the system is such as to admit of perfectly good ventilation?

Perfectly; there is no question of it.

3911. There is nothing that you would think essential to be altered in the system of working coal, for the purpose of admitting proper ventilation?

No, I am not aware of anything.

3912. The method there is what is called the post and stall, is it not?

No, the long-wall system; nothing is so simple.

3913. Is it the same as the Shropshire system?

I am not sure.

3914. It was described to us as being used in Shropshire, namely, working a long wall of coal, and allowing the roof to fall in behind?

Yes, that is the plan.

3915. The passages being covered in as they work the seams?

Yes; in some cases pillars of coal are left on each side to support the road-way to the face or wall; in other cases it is the more usual course in the long-wall system in Nottinghamshire and Derbyshire to make an artificial support by building up packings or pillars with rock, or whatever may be at hand, and allowing the roof to settle gradually upon those packings, and then removing a portion afterwards to make room.

3916. A larger quantity of coal is extracted by that means than by what is called the post and stall system, is it not?

It is; in that case the whole of the coal is hewn; the question of waste there is merely as to how much is thrown behind.

3917. Then the ventilation is a comparatively simple operation, is it not, because it is carried along the entire face of the coal in one line?

Yes, it is very simple indeed; nothing can be more simple.

3918. Then is it in the waste parts which have been left behind, where the roof settles, that the risk of spontaneous combustion takes place?

Yes.

3919. The coal being entirely taken away, from whence do those iron pyrites proceed; do they come from the strata above?

There is a quantity of iron pyrites in the coal, and in the roof, though in very minute portions; there is always a large quantity of coal left in the pit, what we call the refuse or slack, and it is principally in that refuse or slack; because in the long-wall system, where the roof is of coal, or rather broad metal, and what we call pretty tough, it sinks gradually; instead of breaking up in large openings, it sinks all together; therefore it is from the pyrites in the coal itself that the combustion takes place.

3920. Is there also an accumulation of carburetted hydrogen in that part of the mine?

Yes.

3921. Is that entirely shut off from the working where the long wall is?

The effect of the roof sinking so gradually is this (I will take the instance of the Moira Colliery), to completely close it up; the air is prevented from reaching the goaf or waste by walls made artificially of clay, which are carried on each side

J. T. Woodhouse,
Esq.
12th July 1849.

of the road-way; these are built in the night, after the hewers have done work, and the coal is removed; and as the weight comes on, it gradually presses down, and becomes a complete seal.

3922. With respect to that portion of the goaves which is opposite to the long wall of the coal, how is it?

The air sweeps along in a strong current, between the goaf and the face of the works.

3923. The goaf is open to that passage?

Yes, it is completely open; but as the roof follows close after the men, and completely sinks down, there is not much space for it.

3924. But it is not excluded by any wall?

No, no artificial wall.

3925. Then the ventilation would be quite sufficient to take off all the gas which would ordinarily exude from the goaves in that direction?

Yes.

3926. The furnaces in the Midland district are usually placed at the bottom of the shaft, are they not?

They are placed a few feet above the bottom, from 10 to 14 or 15 yards up the shaft.

3927. Have you any furnaces placed on the surface?

There are instances; in the Midland Counties there is every kind of thing that you can imagine.

3928. Are you acquainted at all with the system of management in the Northern district?

Only from going there occasionally.

3929. Can you say whether the system of management is pretty much the same in the Midland district, with regard to the officers, the under-viewers, overmen, deputies, and people of that kind?

In the larger collieries in the Midland Counties they are now introducing the Northern system. For many years the collieries have been on a comparatively very small scale, and they have been managed generally by a man called the ground-bailiff, who is the general superintendent of the whole, the pits being set by contract to butties, and those butties, who are really nothing more than paid agents, do little good for the management of the pits, the ground-bailiff really looking very little after it at all; but since the works have become deeper, and it is necessary to raise a larger quantity, they are adopting the Northern system of the subdivision of labour and the subdivision of management.

3930. You state that the first and best preventive is a larger air-course?

Yes.

3931. What size would you say?

That entirely depends upon the quantity of air which you want to pass through, and then you come to the question of the subdivision of air; I take it that the most perfect way of ventilating is to divide the pit (I am talking now of a large pit) into districts, splitting the air at the bottom of the downcast shaft into as many divisions as necessary, and making as many returns separately, where it can be done, into the upcast shaft.

3932. What height and width should you make those galleries or passages?

In any case you should not have less than four feet square, I mean 16 square feet in area.

3933. Do horses work in your pits below?

Yes.

3934. It would be seven feet high?

Yes, in the waggon-roads; but I am speaking now of the return air-courses.

3935. But in the waggon-roads what would it be?

In the waggon-roads they are from five to seven feet high, and six or seven feet wide, according to circumstances.

3936. You

3936. You have stated that, by having good courses of air, the pits are much drier, and free from mould?

Yes.

3937. Have not you such things as wet pits?

Wet shafts, where they are not properly walled.

3938. Have you not pits where you have to walk up to your ankles in water?

That does occur sometimes.

3939. Do you think that well airing those pits will dry them?

No, I do not mean to say that; but pits never ought to be in that state; no well-managed pits are in that state that you walk up to the ankles in water.

3940. A road is sometimes out of repair, because there are gutters going down to the engine; but there are other places where the water drips through, and is seen on the sides of the roads?

What I mean by the ventilation drying the roads, is carrying off the vapour that arises from the candles and the men, and the heat of the workings.

3941. Rather moisture than positive wet?

Moisture; I do not mean, of course, any feeder of water.

3942. This long-wall system, you say, is general in the Midland Counties?

It is.

3943. Is it so in the Yorkshire collieries, of which you spoke a short time since?

No; in the Yorkshire collieries (I would rather confine my observation to those I have seen); they have been, I believe, for many years working on the system of the post and stall narrow work; but they are gradually lengthening their working, and improving it in that particular.

3944. Are you decidedly of opinion that the long-wall system is a better and safer system of working than the post and stall system?

Where it can be applied; but it cannot be applied everywhere; there are certain conditions and circumstances that prevent its application.

3945. What would be the cases in which it would be inapplicable?

It is inapplicable in a certain structure of the coal and roof of the mine.

3946. Where there is a rapid dip?

Where there is a rapid dip it is not so easy; a rapid dip is against the long-wall system. I take, for instance, the North Staffordshire district, where the dip is very rapid, in some places almost perpendicular; there, of course, they are compelled to work in a series of galleries, cutting off small portions, at a flat rise, up to 1 in 3: the Warwickshire coal is all worked on the long-wall system; there the dip is 1 in 3, or as high as 1 in $2\frac{1}{2}$; there it is perfectly practicable.

3947. You were mentioning some other exceptions?

Yes, the exception in the structure of the coal and in the roof: where the coal is very cubical in structure, and the roof heavy, it is broken in small pieces by the continual pressure. One of the advantages of the long-wall system is this, that where the works are well-managed, it assists materially in hewing the coal, because from the lie of the roof there is a continual pressure upon the face of the mine; and where a seam of coal is very strong, and the roof is well-managed by different packings and arrangements, it becomes a very considerable assistance in the hewing; but where the coal is very cubical, as the North coal is, the Haswell and Hetton coals, I do not think that the long-wall system would be applicable; the continual pressure would knock it all into small pieces.

3948. Is it a safer plan of working as regards the accidents from the falling of the roof?

Yes, I think it is. In the long-wall system the falls from the roof are better understood; and as the roof is always moving but slowly, of course there is every preparation made for an occurrence of the kind, and they are continually on the look-out. When accidents occur in collieries worked on the post and stall system, it frequently happens that a fall takes place without any previous notice whatever, from a fossil or something of that kind in the roof, formed in the shape

J. T. Woodhouse,
Esq.

12th July 1849.

of a cone ; sometimes a large mass will fall out without any notice at all ; in the long-wall system that does not often occur.

3949. Is the pressure such in the goaves sometimes as to destroy the passages ?

Not the air-course passages, with care ; in the waggon-road passages the pressure is such, and particularly if a faulty place occur in the roof, it sometimes altogether chokes up the works ; then, of course, that is cleared out again.

3950. In a well-ventilated mine of the description to which you are accustomed in those districts, what should you say was the rate of current obtained by furnaces ?

The rate of current will run from 8 to 12 or 14 feet a second ; I am talking now of the main upcast.

3951. And the quantity ?

The quantity is from 30,000 to 50,000 feet a minute.

3952. Are there many collieries in which such a power of ventilation as that can be said to be obtained ?

Not many ; not more than five or six, I think.

3953. Do you think that, taking the general character of the collieries in those districts, a ventilation of from 20,000 to 30,000 cubic feet would be necessary to make it sufficient ?

I think so ; I think the collieries, where they have now a less quantity of air, would be very much benefited by an alteration.

3954. So that there are few cases in which 20,000 to 30,000 cubic feet would not be of use to make the ventilation efficient ?

Yes ; I am speaking, of course, of the larger pits ; there are some collieries in the Midland Counties so small as to be raising only 20 to 30 tons a day per pit ; I am speaking now of pits that raise from two to three or four hundred tons per day.

3955. Did you ever observe at all the variations that take place with respect to the pressure of the atmosphere ?

Yes.

3956. The escape of gas is much greater when the pressure of the atmosphere is small, is it not ?

Yes ; as the barometer falls, so you may look for an escape of gas, and particularly in this season of the year—in a hot season.

3957. Do you conceive, then, that it would be a useful practice to keep a watch upon the barometer, with reference to the occurrence of accidents ?

In one of the collieries that I have in charge near Nottingham I have had a barometer recently put in ; a large one, placed in the pit, for the furnace-man always to look at ; I have had it marked with a scale.

3958. What is the scale ?

Instead of having the barometer marked " stormy " and " fair," and so on, I have marked the rate of firing, " fire heavy," " fire moderate," and " fire slow."

3959. How long has that been in operation ?

Not more than six weeks or two month.

3960. Have you reason to know that the fireman has regulated his operations by the barometer which you have put there ?

I have not reason to know that he has, excepting that we have had nothing wrong, and the firemen never leave the pit ; they are relieved in the furnace-drift ; we do not let them change out of the furnace-drift ; they are never away, and there is every inducement to the under-viewer to carry it out ; he has an anemometer, the invention of Mr. Biram, in Yorkshire, which is a very useful instrument, and it is the duty of the under-viewer to use that, and make experiments with it two or three times a week.

3961. Is the fireman in that case a person, do you think, who understands the principle upon which the barometer is applied.

No, I think not ; the fireman is an old collier, whose duty it is to do a certain thing,

thing, without questioning the propriety of it at all; we have made him thoroughly understand the difference of the mercury in the barometer, and we make him fully understand also what a slow fire is, and what a heavy fire is, and all that sort of thing, but he does not understand the principle of the barometer.

*J. T. Woodhouse,
Esq.*

12th July 1849.

3962. Have you tried the aneroid barometer?

I have seen it, but I have not tried it.

3963. Do not you think it is worth making an experiment with?

It is worth making an experiment with, there is no question.

3964. Is it not more sensitive?

I believe it is; but I do not understand it sufficiently to give an opinion upon it. I would not condemn it upon any account; I do not know enough of it; the other is so very simple, that any one of the most moderate understanding can understand the mercury.

3965. Have you remarked whether accidents occur more frequently at any one period of the year than another?

I have noticed that all the accidents of which I have been unfortunately a witness, have been near the Autumn, in August; this time of the year, and a little latter.

3966. And at any particular state of the wind?

The wind being one or two points east of south.

3967. That would rather indicate that it is when the temperature is high?

Yes, and the barometer low; the pit is making gas very fast. We have a case at the Moira Colliery, where we have a dam that acts as a barometer; it is quite accidental, but it is thus: at a place where a certain district, the North district, of the workings is laid off, we have constructed a dam of bricks and mortar, very strong indeed, to keep back the gases; in order to relieve the pressure from behind, we have left at the bottom an opening, a little trough, which forms a sort of inverted syphon with a brick laid across, so that there is about half an inch in depth of water at the brick: now we find when the barometer is very low, and goes down, that the gas boils through this water, and relieves itself; that is a sure test.

3968. Is that very regularly corresponding to the weight of the atmosphere?

It is as clear as the barometer itself; nothing can be more certain than that.

3969. Is there any smell in your pit now?

There is a sharp pungent smell from the carburetted hydrogen; but we have a famous current of air there, and therefore we do not perceive much of it.

3970. But do not you frequently know whether or not the pit is in a bad state by the smell?

Not in the working part; it ought not to be in a state in which you can perceive the smell.

3971. Is it not the case that sometimes a man comes up, and says there is a smell about, and something has been found out, and it has been immediately remedied?

Yes, it is a very common occurrence.

3972. But is that an infallible test upon which you can rely?

I think not; I could test it, for instance, or any one who is a pitman can test it in the same way that we can test the presence of gas with a naked candle; we can test that as clearly as possible almost to the firing point, but that is not a test to be relied upon at all.

3973. In working this barometer of which you speak, where is it placed?

Just at the foot of the furnace drift, where the man goes to fetch his coal, within about 15 yards of the furnace itself.

3974. Would it not be within the operation of the furnace?

It is fixed just outside the airway, off the intake course.

3975. Would not its indications be affected by the power and heat of the draught from the furnace?

No; the thermometer is affected materially, but not the barometer; we try it
(164.12.)

J. T. Woodhouse,
Esq.
12th July 1849.

with a moveable barometer at the same colliery; the under-viewer has a barometer which he carries about with him, on the principle of the mountain barometer, and that, of course, is tried continually with the stationary one, to see how they agree in their action.

3976. Supposing the furnace to be increased very much in strength, and the rapidity of the current to be very much increased, would it not tend in some degree to rarefy the air in the mine?

It would, of course.

3977. Then that will produce an effect upon the barometer?

Yes, so far a slight effect; but I am not prepared to state the measure of that effect.

3978. In order to ascertain precisely the effect of the atmosphere upon the barometer, you must deduct the effect of the furnace?

Yes.

3979. Then you could hardly depend upon it as an indication of the pressure of the atmosphere, in that position, without taking the action of the furnace into consideration, could you?

Your Lordship is quite right; but inasmuch as the safety of the pit does not depend entirely upon the state of the atmosphere, the barometer itself, if noticed by the fireman, is a sure test of the safety; because if it indicate a high state, we are sure that there must be a very heavy current running through: there is either a heavy current running through, or there is an absence of gas, one of the two; we cannot have the pit in a dangerous state, if the barometer be high.

3980. What you mean is, that when the barometer is observed to be high, there must be safety, either from the pressure of the atmosphere, or from the pressure of the current?

Yes, from the quantity of air running through.

3981. Therefore whenever the barometer is observed to be low, there must be either a deficiency in the pressure of the atmosphere, or a deficiency in the current?

Yes.

3982. Did you ever know an explosion with a very strong current running through the pit?

Yes, in that very colliery which I am speaking of, in a current that no candle could be kept in without shelter.

3983. From what did that arise?

From the sudden outburst of gas; the hewers touched some crevice or fissure which gave out a large quantity; we have had two instances of that.

3984. Was the portion of the mine in which that issue of gas took place ventilated by the strong current of which you speak?

Yes.

3985. So that no amount of current would in that case have absolutely secured the mine from the accident?

No; and no amount of current can secure a mine, the quantity of gas coming away sometimes is so heavy.

3986. Have you known any other cases, besides those two which you have mentioned, of explosions when there has been a good current through the pits?

I recollect that we had one heavy explosion at Moira; but that arose from different circumstances; it arose from an error in the under-viewer, who unfortunately lost his life at the time; his instructions were, to open an old working, and, in doing that, he incautiously brought the gas in contact with his light; he changed the current of air, passing it from one point to another, to reach that particular part; there was a very strong current in the pit at the time; that is the only other case that I remember.

3987. However, notwithstanding this occurrence of accidents, with a strong current of air through the mine, would you be disposed to say that they diminished the necessity at all of proper ventilation in order to avoid, as far as possible, the occurrence of accidents?

Certainly

Certainly not; efficient ventilation is absolutely necessary, because it renders the evil less. J. T. Woodhouse,
Esq.

3988. With respect to the consequences of an explosion of that kind, does not thoroughly good ventilation diminish the danger arising from the products of the explosion? 19th July 1849.

Yes, from the after-damp.

3989. Should you say, as has been represented to this Committee by other witnesses, that in almost all explosions by far the greater number of deaths take place from the effect of the after-damp, and not from the burning itself?

I have only witnessed two cases where they have been so; in the collieries under my charge we never lost any men from the after-damp; several from the effect of burning, but never from after-damp; the cases of Ardsley Main and Darley Main are the only two which I know.

3990. In the long-wall system of working, would there be less danger of the ventilation being destroyed by the explosion than upon the other system?

There would; the passages are less numerous; there are less brattices.

3991. And are they less dependent upon partitions?

Yes.

3992. So that if a good ventilation were kept up in a mine upon that system, and an explosion took place, the injury might be very much confined to the actual effects of the explosion?

It would.

3993. You say that the collieries are now being much more commonly furnished with two shafts in the Midland Counties?

It has been the uniform plan in the Midland Counties to have two shafts.

3994. Are they generally placed together or at a distance from one another?

It is very much according to circumstances; circumstances not with reference to ventilation, but merely for convenience of working.

3995. What do you think is the best arrangement for the purpose of ventilation?

The best arrangement for the purpose of ventilation is to have the downcast pit, the working shaft for the ropes, situate on the deepest part of the mine, the upcast shaft being distinct on the rise part of the mine, making all the return air-courses converge towards the upcast shaft, so that the air having once passed through the men and horses, it should never return there, but go off direct to the upcast.

3996. And should you say that it was an advantage to have the two shafts at a considerable distance from each other?

Yes, necessarily so, for that reason.

3997. That would necessarily place them at a distance?

Yes.

3998. Is it usual in the long-wall system of the Midland Counties to subdivide the mine for the purpose of ventilation, or is the ventilation generally conducted in one long course throughout?

It is now becoming the practice to subdivide it.

3999. What they call splitting the air?

The Midland Counties people are now beginning to see the advantage of splitting the air; it has been a long practice to course the air from one end of the workings to the other, but now they are seeing the advantage of splitting it.

4000. What is the greatest distance which you have known the air taken through the passages of the mine in one course?

Under the old system not more than three or four miles.

4001. Three or four miles, in one continuous stream?

Yes.

4002. Should you say that there is an advantage gained in the power of the current by splitting it?

Decidedly so.

J. T. Woodhouse,
Esq.
12th July 1849.

4003. You have never seen any other method of artificial ventilation, besides the furnace?

Not a permanent one; I have seen a temporary artificial ventilation by a water-fall.

4004. You never saw the steam-jet, or the fan, or Mr. Struvé's air-pump?

I have heard a great deal of the steam-jet; but I have only seen it and applied it, not for purposes of ventilation, but merely as an eduction from an underground steam-engine.

4005. From what you have seen of it, should you be disposed to say that it was well calculated to be useful in the ventilation of mines?

I think it will probably be found a very efficient agent; but, without more experience, I will not undertake to say whether it would be more or less so than the furnace. It is very desirable to remove the furnace from the bottom of the shaft, if it can be done with an equal degree of safety and economy, every thing taken into the account. The greatest objection to the furnace is the danger of explosion from a quantity of gas suddenly coming away, and coming upon the flame.

4006. Would not the same objection stand against a fire to keep the steam-boiler at the bottom?

Precisely so, excepting that with the steam-boiler at the bottom you can take an air-course direct from the bottom of the downcast pit to the under side of the boiler, and completely isolate it from any return air in the workings; you can make it completely distinct in that way.

4007. Or you may have the steam-boiler above, and bring the steam from above?

Yes; you then would completely remedy that difficulty; I think it very desirable that it should be fully tested in every possible particular; in fact, every thing of that sort, that regards the condition or safety of the mine, ought to be tried.

4008. Have you known any accidents in the collieries with which you are connected, from the breaking of ropes, the gear, and things of that kind?

Very few, indeed.

4009. What ropes are commonly used in the Midland district?

The flat hempen-rope has been used for many years, and now the flat wire-ropes are coming more into use.

4010. Which do you consider the safest?

I have not sufficiently tried the wire-rope to say; with the present experience, the hempen-rope is the safer rope, because it is better understood, and a deficient place in it is more easily discovered than in the wire-rope; we have not had the wire-rope sufficiently long to test its comparative efficiency.

4011. Do you work the Midland collieries with guides?

Yes.

4012. What description of guides?

Principally wood.

4013. And are almost all the collieries furnished with them?

All the larger collieries are furnished with them; it is merely small ones and old ones where they are working out the old materials, which have not got them, and probably they will be uniformly adopted.

4014. Should not you say that it was also matter of economy?

Decidedly.

4015. A great saving of wear and tear?

Decidedly.

4016. Have you seen the invention of Mr. Fourdrinier for preventing accidents from the breakage of ropes?

I have.

4017. Have you seen it in action?

It was put in action by Mr. Fourdrinier himself at the time, for me to look at.

4018. Where?

*J. T. Woodhouse,
Esq.*
12th July 1849.

4018. Where?
In Staffordshire.

4019. At what colliery?
I do not recollect the name; it was at Sneyd Colliery, I think.

4020. In North Staffordshire?
Yes.

4021. You saw it there in action?
Yes; it was not regularly working; it was put in action then.

4022. Merely experimentally?
Yes.

4023. Did the experiments that you saw answer; were they successful?
Yes; the machine was a square frame, with wedges, and a certain apparatus attached to it; a tub of bricks was put inside, and the thing was detached from the chain, and was caught by the action of the machine.

4024. Immediately?
Yes.

4025. Is it the practice to use what are called cages in drawing the pits?
Yes.

4026. What is the diameter of your pits?
They are as high as 12 feet, and down to seven and six.

4027. And what size are the cages?
The cage is just made sufficiently large to admit the carriage which has to run in it; it is made as small as circumstances will admit of, to avoid weight.

4028. What would usually be the weight of a cage and carriages?
A single corf cage about 6 cwt., and a double corf cage about 9 cwt.; our Moira cages are about 9 cwt.

4029. You have your pits with masonry?
Yes, or walled.

4030. In the North they told us that their cages weighed $2\frac{1}{2}$ tons altogether?
I believe they are very heavy; they draw heavier weights.

4031. Do you work the Midland mines generally with the Davy lamp?
Only for purposes of experiment and trial; we do not consider that a mine ought to be worked, unless it is safe without the Davy.

4032. It is the ordinary practice to work with candles?
Yes.

4033. Are lamps only used by the overmen?
Yes; they are used by the officers in the pit, the wastemen and the men in charge of the air courses, and the under-viewers.

4034. What lamp do you use?
Many kinds of lamp; the general lamp is the ordinary Davy, which we obtain from Newcastle; we have them made there, as being the best of the kind; we have tried several lamps.

4035. Are you liable to explosions in your pits?
We are liable, without a sufficient current of air; but with a sufficient current of air not so.

4036. Have you had explosions in your pits?
Yes, plenty; but no very heavy ones. In the heaviest that I have had we had 18 persons burnt; some of them died.

4037. Then it is not common to use the lamp, except by the officers?
No. There was a case occurred at the Moira Colliery, about six weeks ago, where we put lamps on; we were working at that time along the edge of an old working, and there the gas came out pretty freely; and I immediately put the men on with lamps in that district, and they continued to work with lamps entirely
(164.12.)

*J. T. Woodhouse,
Esq.*

13th July 1849.

until we had passed it. In a case of that kind we should decidedly put them on, but not under ordinary circumstances.

4038. Should you be disposed to say, as some persons have, that the effect of the introduction of the Davy lamp has been rather to increase the risk of accidents than to diminish it, from the carelessness which it induces in the managers and workmen?

Certainly not.

4039. You consider it a great advantage to the working of coal-mines?
Absolutely necessary.

4040. And are you still of opinion that the original Davy lamp is the most serviceable

It is the most simple and most easily kept for ordinary purposes. There are many lamps, which have each of them great merit; there is one invented by Mr. Biram, the gentleman who invented the anemometer, which is a very useful thing.

4041. Have you tried that lamp?
I have.

4042. Do you think that it answers its purpose?
It answers effectually wherever I have tried it.

4043. It is not quite so light and convenient to carry as the Davy lamp?
Not quite so.

4044. And throws the light only in one direction?

It throws the light forward by a powerful reflector at the back; it is very useful in the air-course, being protected from the current of wind; it is a disadvantage of the ordinary Davy, that it is unprotected, and therefore it fills the lamp with smoke and dirt.

4045. Do you see any objection to the use of talc in the front of the lamp?

No, I am not aware of it. I think that any instrument of that sort should be used with great care, and only in the hands of a very careful person; not in the hands of the workmen, who are utterly reckless.

4046. With respect to the state of the education of the workmen, do you think it a matter of great importance that they should be better educated than they are?

I think it a matter of importance that they should be educated, as far as I have seen, for a certain object.

4047. What is that object?

That object is simply to learn sobriety and industry, attention to their duties, and obedience; not in scientific attainment; I do not think that that does them much good.

4048. From your experience, should you say that the risk of accidents is very much increased by the state of the education of the workmen?

I think it is from the moral state of the men; I think that if the men were morally better men, they would carry out their instructions more implicitly, and therefore the risk of accident would in that way be avoided. I am averse entirely to a divided responsibility, or to the safety of the pit being divided between the workmen and the officer.

4049. You think that it should be imposed entirely upon the officer?

That it should be imposed entirely upon the officer, the men implicitly carrying out his orders.

4050. Is not the officer usually drawn from the class of workmen?

Yes.

4051. What should you look for as the qualifications of a person to be selected as an officer of a mine?

He should have more than ordinary intelligence; many of the workmen possess more than ordinary intelligence; he must have sobriety and industry, and he must be able to read and write fairly.

4052. You think that desirable?

Yes, because it is useful in carrying on the works.

4053. For

4053. For the practical discharge of his duties?

Just so.

*J. T. Woodhouse,
Esq.*

4054. Do you generally find a sufficient number of workmen so qualified as to enable you to make a selection of officers?

12th July 1849.

Yes, we fill up the officers from the ranks.

4055. Are there always a sufficient number of men qualified to enable you to make such a selection?

We have always found it so.

4056. What do you mean by the officer, the overman?

Yes.

4057. Not the under-viewer?

Yes; he is a subordinate, and the wasteman too, in fact.

4058. How do the different persons whom you have named stand as regards their rank in the mine; the under-viewer, the wasteman and the overman, which is the highest?

The under-viewer is the highest.

4059. He is the deputy of the principal viewer?

Yes; I will take a case in point, the case of the Staveley Collieries; there we have one resident under-viewer; there are three distinct collieries; they keep only one establishment; in the pit that person has an overman, who takes his orders from him, and in each pit there are wastemen, who take their orders from the overman.

4060. Then the under-viewer is the highest; the overman comes next, and the wasteman third?

Yes.

4061. What is the peculiar business of the wasteman?

To travel the air-courses, and to see that they are kept in order.

4062. That is his special business?

Yes.

4063. And the overman has generally to see that the working of the mine is properly conducted?

Yes, and the economical management of the working, the repairs of roads, and so on.

4064. And he measures the works?

Yes, he measures the works too.

4065. To whom does Staveley belong?

The estate belongs to the Duke of Devonshire; the lessee is Mr. Richard Barrow.

4066. How often does the viewer himself generally inspect a colliery?

It much depends upon the amount of what is necessary, and the time that he has on his hands.

4067. How often does he generally consider it necessary, and generally find it consistent with his own avocations, to visit each colliery?

Sometimes once in a month, once in a fortnight, or once in a week, according to circumstances; a very fiery place is visited very often; a good deal depends upon the quality of the men that the viewer has under him, and the trust which he can repose in them.

4068. But generally once a month?

Yes, at least; in some cases as often as once a week.

4069. Have you ever given any consideration to the question of a Government inspection?

Yes.

4070. What is your opinion upon it?

I think that a Government inspection, under certain modifications, would be useful.

J. T. Woodhouse,
Esq.
12th July 1849.

4071. What would be your view of the proper powers to be conferred upon a Government Inspector?

The power should be that of visiting at all reasonable times the different collieries, and reporting upon their state and condition.

4072. And inspecting plans?

And inspecting all the working plans, and giving advice and assistance as far as may be; not interfering with the commercial part of the thing at all.

4073. You would give him no authority to direct the practical management of the mine?

No, certainly not.

4074. You would confine his powers to those of examination of the pit and the workings?

Yes.

4075. Do you conceive that if such a power as that were given and were exercised by Inspectors, they would have the means, having access to the workings and to the plans, for the purpose of judging of the state of ventilation of a mine, and matters of that kind, of obtaining such information as might be prejudicial to the colliery owners with respect to questions of property?

Undoubtedly, the very inspection of the plans and the view of the colliery would lead to an amount of information that might be exercised prejudicially, because a man could not go into the matter without understanding the relative bearings of it.

4076. You think, then, that such an inspection as that would give the party the means of judging of such questions?

Yes, I think so.

4077. Without going more closely into the matter than would be necessary for the purposes of judging of the arrangement of ventilation?

Yes; I think, for instance, that if an Inspector were fully conversant with the working plans and position of the colliery of A., and also of the colliery of B., which was next door, and in rivalry, it, of course, would give him information which, improperly used, would be prejudicial.

4078. What do you think would be the effect of any objection upon that score; do you think that it would lead colliery owners to be very averse to admitting the officers?

In some cases I think it would; I do not attach much importance to it; I think that if the Inspector is a man of sufficient respectability, and sufficiently paid to place him above any advantage which he could possibly derive from conveying information improperly, there would be no danger or risk.

4079. Do you think that there would be no very strong jealousy felt of an Inspector upon that ground among colliery owners?

There might be in the earlier stage of the inquiry; but the thing once established, I think there would be confidence ultimately placed, because it would be proved that, in fact, there was not that risk or danger.

4080. In order to obtain any information of consequence upon questions of limits of property, and so on, would it not be necessary that the Inspectors should be acquainted with measurements and details of that kind to a greater extent than would be at all required in order to enable them to judge of the state of a mine?

No, I do not think it would.

4081. You think that they could tell, merely from an inspection of two mines in the immediate neighbourhood of one another, whether there was any question of that kind interfered with?

Yes; the colliery plans are all laid down to a scale, and a man who is accustomed to the inspection of colliery plans knows at a glance relative distances, and all those things.

4082. Is it universal for the collieries in the Midland districts to be provided with plans?

It is general, not universal.

4083. Have

4083. Have you ever communicated with colliery owners upon the question of a Government inspection? *J. T. Woodhouse, Esq.*

I have talked with them about it.

12th July 1849.

4084. And should you say that, generally speaking, there was a disposition to admit of it upon the footing which you have described?

There are some colliery owners who are perfectly indifferent about it, and others are averse; some say, "We will not have this sort of interference; we do not know what it will lead to;" and others say, "We have nothing to apprehend from a Government inspection."

4085. Are some desirous of it?

I think here and there one; not many; they are more indifferent to it, I think.

4086. Are those who object strongly to it numerous, do you think?

I am not prepared to say that; it is principally, I think, amongst the smaller men. The objection raised by many is this, that it is unfair; the question arises, how the Inspectors are to be paid, and in course of conversation I have said, "I have no means of knowing how they will be paid, but probably by some very small tax upon coal;" then they say, "If that be so, that is very unfair, because it is wrong that those collieries which are free from explosive gases and danger, should be taxed for those that are not so;" and it is very difficult to draw the line.

4087. Is that the objection which you have heard generally made to it?

Generally.

4088. Not an objection on the score of interference?

No, they do not appear to have hit upon that point; I think it is more for that reason; it is merely a question of pocket.

4089. You state that the small collieries object to it?

I think they are the most numerous who object to it.

4090. They would be the persons that probably would have recommended to them increased ventilation, and so forth?

Precisely so; no doubt they would.

4091. They are the parties who most need inspection?

They are.

4092. Then that would probably lead to shutting up those small collieries?

I am not prepared to say that; because I think that the collieries managed under a good system of ventilation would be managed in reality (it would be found) more economically than those are which are badly ventilated.

4093. Looking to the small collieries that you mentioned just now, which furnish 40 or 50 tons of coals a day, any increased expense would fall heavily upon them, would it not?

An increased immediate outlay would fall heavily upon them; but it is quite possible to improve them very materially indeed without any increased outlay, and I think the advantages would be almost commensurate.

4094. If you shut up those, it would be for the benefit of the larger collieries?

No doubt of it.

4095. If you inflict an increased expenditure upon the smaller collieries, the larger collieries will profit by it?

No doubt, by every colliery that is shut up.

4096. But do you think it likely, supposing it was considered necessary that those smaller collieries should be improved in ventilation, that to attain that object such an expense would be requisite as to make it necessary to shut them up?

I think certainly not; I think the expense is very trifling; it would be done in this way, simply by compelling the men to carry out their contract; for instance, in the smaller collieries the work is all let by contract; a man contracts to hew the coal, to make the air-ways under ground, to keep all the roads in repair, and to land his coal at bank for a certain amount per ton; he contracts to keep everything in order; but he does not keep everything in order; he does not

J. T. Woodhouse, do what he contracts to do, and what he is paid to do, and therefore the thing
Esq. gets bad.

12th July 1849.

4097. Have those collieries upcast and downcast shafts?
Decidedly so.

4098. Have most of those small collieries two shafts?
I believe all of them; I do not know any instances where they have not two shafts.

4099. You stated that some of the parties who had coals not of an explosive character objected to inspection?
Yes.

4100. Does it ever happen that a mine which is generally not of an explosive character becomes, by getting into a fresh seam of coal, more explosive?

No, generally the contrary; after a seam is once opened, and the gas has escaped to a certain extent, it becomes less explosive; of course there are circumstances which arise totally unexpected; a strong feeder of gas may occur at a fault or break, or something of that kind.

4101. You may now and then get into a vein of coal where there would be more gas given off, may you not?
Yes.

4102. Supposing the inspection of mines to be placed upon the same footing as the inspection of factories, which is paid for by the general revenue of the country; do you think that there would be then much objection felt on the part of the colliery owners to the interference of Government, merely upon the ground of interference?

I think not; many parties would object to it, because they would consider it in the light of some undefined difficulty or evil coming upon them; they do not know what, and therefore they object to everything.

4103. Supposing such Inspectors to be appointed by Government, should you say that there are many points in which the observations of an Inspector and his suggestions, the information which he might communicate from his knowledge of other districts, and matters of that kind, would be a material advantage to those who are interested in the management of collieries?

I think so.

4104. Supposing the case of one of the small collieries which have been spoken of, and that the Inspector, upon entering that colliery, found that there was nothing but the natural ventilation, which was extremely defective; that there was scarcely any current of air passing through the mine; that the wood-work was decaying very fast, and that various other injuries were occurring, of which you have spoken, to the passages of the mine, and other matters included within it, do you think that the Inspector, by suggesting a different mode of working the mine, or of managing it, might conduce ultimately to the pecuniary profit of the owner?

Decidedly so.

4105. Are there many cases within your knowledge to which you think such an observation might apply?

Yes, undoubtedly, many of them.

4106. What class of men do you anticipate being made Inspectors?

I am not prepared to state; I have seen one or two gentlemen who have been sent down by Government, that are very competent men; I do not know any beyond those.

4107. Who are they?

I saw at Darley Main two gentlemen who were sent down that were strangers to me.

4108. Mr. Warrington Smyth?

Mr. Warrington Smyth; that description of man is exceedingly competent; he has made himself very much so, and seems to understand ventilation very well, and has a great deal of sound common sense. The great thing for Government Inspectors, I think, if they are not practical men, would be to avoid theory as much as possible, and to reduce everything to common sense.

4109. Is

4109. Is there any other point which occurs to you upon which you can give information to the Committee?

No, I am not aware of any.

4110. Have you ever made any observations upon the effect of a furnace in full operation upon the current of air passing through it when it has been raised to a certain point of heat?

Yes; the observations which I have made are these, that in some cases where you warm the air in the upcast pit by firing to a certain point, you reach the maximum current through the furnace; but by turning a portion of the cold air into the upcast pit without passing through the furnace (cooling the upcast), you simultaneously get an increased amount of current.

4111. That is to say, that you may raise the heat of the furnace to such a point as rather to diminish its power of ventilation?

To a point where the power of ventilation ceases, provided the current be wholly taken through the furnace; but if you divide the current, and take a part of it through the upcast pit without going through the furnace, although the air in the shaft be cooled, the effect is materially increased.

4112. Have you ever considered what is the explanation of that phenomenon?

No, I have not; at least, I am not sufficiently conversant with the subject chemically to understand it, or to explain it; I know that that is the practical effect.

4113. Assuming that your fire is four feet in width and one foot in depth, if you made that fire six feet wide and of greater depth, is it from the greater increase of the heat of the fire?

No, I mean this: supposing that the fire is four feet in width and one foot in thickness of coal, with a certain sectional area of furnace, and I fire up to a certain point, as high, in fact, as the furnace will admit of, I find that by making an increased fire, I cannot get any increase in the current; but by passing a part of the current into the upcast pit, keeping the fire the same, I get a material increase upon the whole; it has the effect of reducing the temperature of the upcast pit, but getting a material increase upon the whole. I have tried it in several instances; but I have not sufficient data that I should like to lay before your Lordships; I know that that is the practical effect, and I know it to this extent, that we have reduced some of the pits to the extent of 30 or 40 degrees of temperature.

4114. By this same process of passing a portion of the air independently of the furnace?

Yes, simply by dividing the current, and passing it wide of the furnace; I can only speak to the practical effect.

4115. Did you ever find out what was the maximum heat?

No.

The Witness is directed to withdraw.

EDMUND SCOTT BARBER, Esquire, is called in, and examined as follows:

E. S. Barber, Esq.

4116. YOU are a Civil Engineer, residing at Newport, in Monmouthshire?
I am.

4117. Have you been engaged in that business for any great length of time?

On my own account about 15 years; I was formerly an assistant to Mr. Brunel for some years.

4118. Have you any large mining concerns under your superintendence?

I am engaged as mining engineer and agent to Sir Charles Morgan, who has very extensive mineral properties in Monmouthshire, Glamorganshire, and in Breconshire; I receive his mineral rents, and survey all the collieries and workings.

4119. And you are well acquainted with the mining operations of that district?
I am.

E. S. Barber, Esq.
 12th July 1849.

4120. What is the character of the coal in South Wales as regards the liability to accidents from explosions?

The principal house-coal, which is called the Mynyddysllwyn vein, and which is the principal supply for the shipping of Cardiff and Newport, is free from fire-damp; it is a red-ash coal.

4121. Is that the bed most commonly worked in South Wales?

In that district; it does not extend westward of the Taff Valley.

4122. Are there other beds which are more liable to accidents than that?

The whole of the steam-coal, the white-ash series, contains more or less fire-damp.

4123. In which of those two seams are the largest collieries of South Wales?

Mr. Powell's Duffryn Colliery, on the upper four-feet seam, is one of the largest; there are several of very nearly the same extent in the Aberdare district; Mr. Russell's Risca Colliery, on the black vein, in the Monmouthshire district, supplies more coal from one pit than any other; that is a fiery vein.

4124. So that there are some large collieries in each vein?

Yes; there are also a good many sale collieries attached to the ironworks.

4125. Do you think that, speaking generally, the collieries, whether in one or other of these beds, are properly provided with ventilation?

I think there is a very great deficiency of ventilation in all of them.

4126. What is the most common system adopted there?

The furnace, almost entirely.

4127. Is the furnace very common, or are there many cases in which the ventilation is left entirely to the natural operation of the atmosphere?

Many.

4128. Should you say that that was the majority or the minority?

The minority now, I think.

4129. Are there any of the large collieries which are left entirely to natural ventilation?

None on the white-ash seams; they would not admit of it.

4130. Those are the fiery seams?

Yes. On the Mynyddysllwyn vein the men frequently, when the wind is at the opposite point to the direction of the level, are obliged to leave work in consequence of the choke-damp; it is a very common occurrence.

4131. In that bed which is not charged with the fire-damp is there much choke-damp?

A good deal.

4132. The existence of choke-damp, to any great extent, would render ventilation as necessary in those mines as the fire-damp, would it not?

Quite so, and the ventilation is more neglected, from the confidence which has been created in the minds of parties that no explosion can possibly take place.

4133. You are speaking of the bed which is least explosive?

Yes, the red-ash coal, where there is no fire-damp; when I say none, Mr. Powell's Colliery, where Mr. Brunton's machine is erected, is the only instance of fire-damp being found in that vein; but that pit is situated between two large faults, and the coal has never been worked in that dyke between those faults before; that is the Gallygaer Colliery.

4134. You have seen the apparatus of Mr. Brunton in operation at that colliery, have you not?

I have.

4135. Do you think that an improvement upon the furnace?

I think the principle is simple and good, and that it is a great improvement upon the furnace.

4136. Do you consider it to have been altogether successful in its application to that mine?

The

The circumstances under which it is tried there are not favourable for testing its merits to their full extent; for instance, the engine is a condensing engine; Mr. Powell applied the first engine that came to hand, a spare engine, and that is ill adapted for high velocities; the windways in that colliery also present very objectionable obstructions to the free passage of the air; in one case the aperture is only about 18 inches square, and in another about two feet by three.

E. S. Barber, Esq.

12th July 1849.

4137. Was that colliery ventilated by a furnace before Mr. Brunton's apparatus was applied to it?

Yes.

4138. Were you acquainted with the mine before the change was made?

Yes, I frequently surveyed it; they work some of Sir Charles Morgan's coal in the neighbourhood of the mine.

4139. Do you know what was the greatest amount of current obtained by the furnace?

I never tested it by the water-gauge, and therefore cannot say; a very sluggish ventilation.

4140. You cannot speak, then, to the difference of cubic feet which has been obtained by the application of the machine?

I cannot; I cannot draw the comparison.

4141. Do you know what the apparatus has effected, measured in cubic feet of air?

Eighteen thousand.

4142. Is that at its utmost power?

No, that is under the circumstances which I have mentioned; if the windways generally were of a larger size, and there were no obstruction, a very much larger quantity would be passed through the mine.

4143. Do you know with what power of engine those 18,000 cubic feet were obtained?

It is difficult to calculate; the engine is a condensing engine; I have the dimensions of the engine, about 8 or 10-horse power, I think.

4144. And you do not know whether it is worked up to its full power in order to obtain that ventilation of 18,000 cubic feet?

The engine is ill-adapted for working the machine; an 8-horse high-pressure engine would work Mr. Brunton's machine much more effectively than a 12-horse condensing engine.

4145. Did you ever know it give more than 18,000 cubic feet?

By closing the upcast aperture, we produced 4.20 inches on the water-gauge, which is equivalent to about 24½ lbs. on the foot; that is very much more, something like 40,000; that showed the effect of the rarefaction divested of the connexion with the coal-workings.

4146. From your having been well acquainted with this colliery, and having examined it since the application of this apparatus, should you say that the ventilation in the pit now is quite sufficient for all purposes?

Quite so.

4147. Have you observed whether any accumulations of gas have taken place since that apparatus has been put there?

I do not think they have worked it continuously, in consequence of their being very short of water there; the other day we were obliged to condense with the hot water from the other engine, so that, of course, that was another unfavourable circumstance to test the machine.

4148. Then a high-pressure engine would, in fact, be cheaper, as well as more efficient?

Also cheaper.

4149. Is the machine kept constantly going, day and night?

For the reason I have explained, they have not used it constantly.

4150. In the system by which the mines are worked in that part of the country, are there any large wastes left?

Very extensive.

E. S. Barber, Esq.
 12th July 1849.

4151. Called goaves?

Yes.

4152. Are those generally the most dangerous parts of the mine?

They are accumulations of hydrogen, which are, of course, like so many reservoirs of gas.

4153. Would it be possible, by any system of ventilation, to clear those goaves of inflammable gas?

I think it ought to be done to the greatest extent possible; I think they ought not, as at present, to wall up all the stalls and apertures on the main headings, so as to cause this great accumulation.

4154. Do you think that it could be practically done?

I think that it could, to a very much greater extent than is done at present.

4155. Is it the practice in those collieries to work with lamps, or candles?

With candles.

4156. Universally with candles?

Almost universally, except in driving headings in advance of the windway, and there they use the lamp.

4157. Do you consider that a safe practice, or would it be better if they worked with the lamp?

The men cannot see with the lamp; they object to the lamp very much; I think the ventilation of a mine ought to be such that a man could work with a candle with safety.

4158. Do you think that practically it would be possible so to secure the state of the mine by proper ventilation as to make it safe to work with a candle?

I think so.

4159. Are the mines in South Wales generally provided with two shafts?

Generally two shafts.

4160. Many of these pits are worked by galleries, levels from the hill, are they not?

A great many.

4161. And with no perpendicular shaft?

None for working; generally a short distance from the level mouth they have an air-shaft.

4162. Used for purposes of ventilation alone?

Yes.

4163. Does the pressure of the atmosphere exert a sensible influence upon the escape of gas in those mines?

It does.

4164. Is it generally understood that when the barometer is low, the mine is in a more dangerous state?

Invariably so.

4165. Is there any use of the barometer in those mines?

I have never seen one applied in South Wales.

4166. Do you think it desirable that it should be more extensively used?

I think so.

4167. Supposing such a plan as that which has been described by the last witness, of a barometer adapted especially to mining purposes, with a scale indicating how the ventilation was to be regulated, according to the condition of the barometer, do you think that that would be a useful improvement?

I think it would be very valuable.

4168. And would the persons charged with the firing of the furnaces, where they exist in South Wales, be people to whom the observation of the barometer might be trusted for that purpose?

I question it, in South Wales.

4169. Are they generally a very uneducated class?

They

They are generally uneducated ; they have good natural intelligence ; they are very sharp, active men, who make useful agents. *E. S. Barber, Esq.*

12th July 1849.

4170. But it would be a comparatively simple operation ; do you think that they might not be entrusted with the duty of just watching whether the barometer was at such a point as for them to fire more or less ?

I think with a little tuition they might be brought to understand it.

4171. Are those persons generally able to read ?

The overmen can read always.

4172. Can the persons charged with the firing of the furnaces ?

I should think most of them can.

4173. In the occurrence of accidents, have you been led to the conclusion, from what you have observed, that the greater number of the deaths which take place from explosions occur from the after-damp, or from the effects of the explosion itself ?

From the after-damp, those that have occurred in South Wales.

4174. Would it be possible, by any system of ventilation applied to the method of working in South Wales, to make a mine tolerably secure, after an explosion has taken place, from the effects of the after-damp ?

I have never given that point my particular attention ; it would be attended with difficulty.

4175. Supposing it to be true that the greater number of the deaths are caused by the change produced in the atmosphere after the explosion, would it not be a matter of great importance, if possible, so to regulate the ventilation as to confine the effects of the explosion to the actual violence of it ?

It would.

4176. You never considered whether that would be possible in the mines as they are worked in South Wales ?

I have thought of the subject generally ; but I have never hit upon any plan that I could suggest as feasible.

4177. Are the downcast and upcast shafts generally near one another in the Welsh mines, or at a distance ?

Close together generally.

4178. So that in case the stoppings and arrangements for ventilation below were destroyed, the entire ventilation would probably be destroyed ?

Frequently.

4179. Do you think that a defect in those arrangements, and that it would be better to have the shafts at a distance ?

It is more economical for the coal-worker, on account of his engines, to have them close together ; but for the safety of the men, and preservation of the ventilation, I think it better that the shafts should be further apart.

4180. But, supposing that the power applied to the upcast shaft did not depend upon the machinery required at the downcast shaft, it would not then be more economical ?

It would not be.

4181. Supposing the case of a furnace placed at the bottom of the pit, would there be any economy in placing the shaft for that furnace near the downcast shaft, or would it not be equally economical if that shaft were at a distance from the downcast ?

It would, provided the pit were not used for winding or pumping.

4182. Do not you think it a matter of importance that the upcast shaft should be kept entirely for ventilation, and not used for working ?

I think so ; the water passing down the shaft is very objectionable.

4183. It tends to counteract the ventilation ?

It does so ; it decreases rarefaction.

4184. What is your opinion with respect to the economy of Mr. Brunton's invention, as far as you have seen it ?

I think it very simple and very inexpensive.

E. S. Barber, Esq.

12th July 1849.

4185. Do you know what it cost at the colliery where it is applied?

I do not know the precise sum; somewhere about 100*l*. I have understood.

4186. Do you think it as cheap as a furnace ventilation, with the same power?
I think it is cheaper.

4187. Can you say what is the extent of those workings?
They are not very extensive.

4188. You cannot say what distance the current of air has to travel below ground?

No, I cannot.

4189. Can you speak to the velocity of the current in the workings of that mine where Mr. Brunton's machine is in full action?

I think the maximum was 70 feet per second.

4190. Would not that be a greater velocity than would be consistent with the working?

Decidedly.

4191. It was merely an experiment?

It was merely for the sake of experiment; Mr. Dobson, Mr. Clive's mineral agent, was with me.

4192. It was done to show what current could be produced by the machine?
Yes.

4193. How did you measure the 70 feet per second?

We tested the velocity of the air through the air-courses.

4194. By what?

By flashing gunpowder; we had no anemometer at hand, and it is generally the practical way that is adopted; we saw the flash, and we had our watches, and noted the seconds; that was the result.

4195. Were you standing in that current?

Yes.

4196. Was it a very powerful gust?

Very, indeed.

4197. Too strong for practical working?

Yes; the air would require to be split, if applied with so strong a current as that; it merely showed the capabilities of the machine.

4198. Do you know what pressure the water-gauge gave in the workings?

In the workings we had two-and-a-half inches on the horse-road; but there was a great deal of leakage under and around the door where we applied the water-gauge.

4199. The 4.20 inches, with the water-gauge, equal to a pressure of 24½ lbs. on the foot, is the full power of the machine under the circumstances in which it is applied there?

That is the power of the machine disconnected from the workings, as it is applied there.

4200. Would you say that that was the power of the machine if it had been worked by a high-pressure engine to its full power?

No; I think the velocity would be increased; the rarefaction increases as the squares of the velocities.

4201. Then so far as you have had any experience of it in that case, you would say that it is an efficient agent for the ventilation of a mine?

I consider it so.

4202. And that so far as that instance is concerned, it is applied with economy?

Yes.

4203. Are the accidents from the falling of the roof very common in South Wales?

Very common.

4204. Have

4204. Have you ever thought of any mode of obviating them?
 Nothing but the ordinary precautions of not driving the stalls too wide, and supporting the roof by timber where necessary.

E. S. Barber, Esq.

12th July 1849.

4205. Are the workings generally faulty in those respects?
 In many instances the top is bad, very tender.

4206. Then it would require more timber?
 Yes.

4207. Are all your collieries worked on the post and stall system?
 We have none worked on the long-wall system.

4208. Have you ever heard that system described, or have you seen it?
 I have seen it.

4209. Should you say that it was applicable to the Welsh coal-field?
 No; I should think the present system is better.

4210. In what respect?
 Many of our veins are steep, and I do not think it is applicable; we should not get so much coal out of the ground as by the present mode; the coal is now abstracted very clean.

4211. Do you take the whole coal out, in the South Wales workings?
 Yes, nearly so.

4212. The preventing of accidents from the fall of the roof by more timber is a question of expense, is it not?
 Entirely a question of cost.

4213. Taking the small collieries in South Wales, are you of opinion that they would generally bear an increased expense for the purpose of securing the work-people against accidents of that kind?

The per-centage would be the same on the whole, I should imagine, according to the extent of working, supposing all the other circumstances to be the same.

4214. But there would be no extent of workings corresponding with the increased use of timber in those mines, would there?

They draw a great deal of the timber out as the pillars are drawn back; they do not leave a great deal of timber under-ground in South Wales permanently.

4215. Then should you say that in most of those collieries in which there is a deficient supply of timber for that purpose, it might be increased without seriously diminishing the profit of the colliery?

Decidedly; it bears but a small proportion to the cost of working a colliery; we generally put it down, in the worst instances, at one penny a ton upon the cost of the coal.

4216. Have you ever observed that where the collieries are worst ventilated, the timber used for that purpose decays most rapidly?

Yes, I have.

4217. Therefore in that point of view ventilation would be economical?
 It tends to preserve the timber.

4218. Do accidents from explosions happen for the most part, according to your observation, from the carelessness of the work-people, as much as from the defective state of the mines?

Yes; I think the cases which have occurred in South Wales have been very clearly traced to the carelessness of the men, particularly the last explosion at Mr. Russell's colliery, where there were 47 killed. There a man had worked round a large stump of coal, and his lamp was found blown up into a portion of the small coal which was thrown back there, and the man was also blown a considerable distance, that being very clear evidence that the explosion took place at that spot.

4219. In that case he was working with a lamp, was he?

He had a lamp, and it is supposed that he must have lifted the top off his lamp.

E. S. Barber, Esq.

12th July 1849.

4220. Then is it the practice to make the workmen work with lamps whenever there is danger apprehended?

They have taken lamps into that colliery ever since the first explosion took place there, but they do not use them as a general thing.

4221. Where they do not work with lamps, in what way does the carelessness of the men expose them to danger?

They are very apt to go with a candle where they ought to use a lamp.

4222. Have you ever considered the question of a Government inspection?

I have thought it would be very desirable on many grounds; we have numerous accidents from the breakage of ropes and chains. I think a periodical inspection of such things would be very advantageous, testing the ropes periodically, submitting them to heavier strains and more sudden jerks than the usual circumstances under which they are worked.

4223. Have you ever seen a contrivance of Mr. Fourdrinier for preventing those accidents?

I never saw it until I saw the model this morning; I am aware that it is applied in a colliery in South Wales, the Waun Cae Gerwen Colliery.

4224. Where the shafts are perpendicular in South Wales, do they generally work with guides?

Always; I do not know an exception; generally rods, sometimes chains.

4225. You did not see Mr. Fourdrinier's apparatus in operation in the instance of which you have spoken?

No, I did not; it was not in operation when I passed the pit.

4226. Supposing that Government were to determine to establish an inspection, upon what footing do you think that it ought to be placed?

It is a very difficult question, in consequence of the fear that parties would have lest such an officer should divulge the state of the workings to rival parties in the trade. I think that a registry of all mine-plans in each district ought to be made, for the purpose of preventing the tapping of water, for instance, in which many lives have been lost from not knowing the extent of the past workings of an adjoining mine; and I think that such an officer ought to be sworn to secrecy, and that the maps ought to be submitted to him without prejudice. He should have a power, I think, of stopping the workings, in a certain direction, when they approached too near to be safe; too near to the workings of another colliery to the rise which probably might contain water. Then, again, he must also see the mine without prejudice, with regard to trespasses, which are of frequent occurrence in our district.

4227. Would they be the cause of much jealousy on the part of the colliery owners, if any person were sent to inspect their mines?

No doubt there would; but still, as the law now stands, if a man can hide a trespass for six years, nothing can be recovered; he pleads the statute. This inspection would prevent the evil being done.

4228. What degree of examination would enable an Inspector to speak to any question of that kind?

The mere production of the map frequently shows a trespass. I have seen maps accidentally where I have observed trespasses that I should not otherwise have known.

4229. And you have been able to detect them without entering into detailed measurements at all?

Merely from their own surveys.

4230. Such things are frequent, are they?

They are, I am sorry to say; I think the appointment of a Government Inspector would be the means of preventing them, and that the landowner, and also the colliery proprietor would feel the benefit of it, for we make them pay the smart, of course, when they do trespass.

4231. Then you would consider it a matter of necessity that any Inspector appointed should have the right of entering a mine, and of examining the plans?

Yes; and I think that he ought to be invested with power to enter on the application

cation of any landowner whose property adjoined, or was in proximity to any colliery or mine; for instance, the lessee of a colliery may take a large tract of any landed proprietor, and a small freeholder has perhaps a small property in the middle of this large property; he has no means of going down, unless he files a bill of discovery, which perhaps costs him the value of his coal. I know several cases where the coal has been worked out, and the party has never had an opportunity of arriving at a knowledge of it: the late Sir William Follett held, that we had no power in a case of that kind to recover; that the statute debarred us.

E. S. Barber, Esq.

12th July 1849.

4232. Do you think that it would be desirable, in any inspection established for the purpose of securing the safe condition of the mines, to mix up the question of individual rights between the parties?

I think it would be much more beneficial to the district if the party were so appointed, that on the application of a landowner, he might be empowered to make a survey, and if the party complaining were in the wrong, he would have to pay the costs of the survey.

4233. Do you think that it would be advisable to confer a power of that kind upon an Inspector whose appointment was with the view of securing the safety of the mine?

I do not see how you could prevent the drowning of a colliery without investing the Government officer with some such power; he must be a man, of course, who is independent, and not subject to local influence.

4234. Have you ever heard any opinions expressed by the colliery owners in South Wales upon the subject of inspection?

I have not heard many express their opinions upon it.

4235. You would not be able to speak to the general feeling among that class with respect to any such proposal?

No; I have not spoken to them much upon the subject; I act principally for the freeholders; I have very little to do with the tenants, except furnishing them with copies of surveys, or matters of that kind.

4236. Is it not felony to trespass upon your neighbour's mine?

It is held to be so now, I believe; it was not so at the time of the case to which I refer.

4237. Supposing, however, Inspectors to be appointed with a power such as you recommend, of investigating mines and plans, should you think it desirable to confer upon them any directing power as to the management of the mine?

I do not think they ought to go into the details; they might make any suggestions which might occur to them, and of course their recommendations would be attended to by all the coal-workers.

4238. And according to your experience, should you say that there are many points in which the suggestions of such a person, well qualified and well acquainted with other districts, would be of value with a view to improving the management of collieries?

Yes, I think so.

4239. You have seen no other method of artificial ventilation at work besides this of Mr. Brunton?

There is a fan applied at the Abercrave Level, in the Swansea Valley, for driving air into the level.

4240. Something of the same kind as Mr. Brunton's?

No, of small diameter; Mr. Brunton's is of large diameter.

The Witness is directed to withdraw.

Ordered, That this Committee be adjourned till To-morrow,
half-past Two o'clock.

Die Veneris, 13^o Julii 1849.

The LORD WHARNCLIFFE in the Chair.

Evidence on the
Prevention of
Accidents in
Coal Mines.

JOHN TREVOR BARKLEY, Esquire, is called in, and examined as follows :

J. T. Barkley, Esq-

13th July 1849.

4241. YOU are a Mining Engineer ?
I am.

4242. How long have you been engaged in that pursuit ?
I was engaged for five years as a Mining Engineer ; subsequently I have been employed as a Civil Engineer, under the late Mr. George Stephenson and Mr. James A. Longridge.

4243. With what mining districts are you most particularly acquainted ?
I am most particularly acquainted with the Northern districts, Durham and Northumberland ; I have been connected with a considerable number of collieries in that coal-field.

4244. Were you connected with those collieries in the capacity of an Engineer ?
In the capacity of a Mining Engineer or Viewer. I was a pupil of a most eminent Mining Engineer at the time, and in that capacity was connected with them ; subsequent to the termination of my pupilage, I remained under that gentleman for a short period.

4245. Have you turned your attention especially to the subject of accidents occurring in coal-mines ?

Yes, I have been engaged in other colliery districts ; I have had opportunities of conversing with many colliery managers, and becoming acquainted with the practice of their several districts. From information so acquired, I am convinced of the great disparity existing in the different districts, and even in adjoining collieries of the same district, with reference to the means adopted to protect life ; and some few months since, having read the accounts of accidents that had occurred in various coal-fields, through, I believed, the insufficiency of those means, I was led to consider whether the publication of some practical work, descriptive of the arrangements and ventilation deemed best in the dangerous collieries of the North, might not be the means of diffusing some more general knowledge among the miners in other and less protected, because less naturally fiery, districts. When I came to enter on the subject in detail, and more particularly to prepare the diagrams necessary for its elucidation, I came to the conclusion, that even in the North a considerable improvement might be made in the details of the precautionary arrangement.

4246. Will you explain in what respect you think the system of ventilation in the North faulty, and how it would be improved in the manner you have alluded to ?

I think the principle is perfectly correct, namely, the division of the air and mine into main districts, and their subsequent subdivision ; but I think that in the detail of that arrangement there is great want of additional precaution in rendering the separation effective, more particularly on the occurrence of an accident.

4247. The present plan is to take the main stream of air down the downcast shaft, and when it has entered the mine, to subdivide it into several portions, which portions are taken round limited divisions of the workings ?

(164. 13.)

3 D 3

That

J. T. Barkley, Esq.
 13th July 1849.

*Vide Appendix I.,
 Plan No. XXIII.*

That is the principle ; it is in the performance that the error arises. If your Lordships will permit me to produce the plan I have prepared, I will attempt to explain how I propose that those divisions should be made so as to render them independent of each other ; and I have also brought the plans published of the collieries of Haswell and Darley Main, where accidents have occurred, and where the excessive loss of life after the explosion might have been prevented by this method, at least in my opinion. I have also the working plan of Killingworth Colliery, as produced before the Committee of the Lower House in 1835, in order to show in what the difference consists ; the principle I advocate is the same ; the variation is in detail solely. I think that the means of regulating the air and an uniformity of arrangements are much required, and I think that by the means which I have proposed it may be very simply effected. I am not in the habit of offering explanation, and may, perhaps, have a difficulty in so doing—*[The Witness produces a Plan]*. This represents the plan of a supposititious coal-field ; the blue colour is intended to represent the intake of the air, it being so termed until it leaves the last working place ; it is then coloured yellow, and is considered as the return air ; two shafts of equal diameter (15 feet) are shown as penetrating the supposed seam. We will first assume the motive power of ventilation to be determined, reserving that subject for after-consideration. The air is divided into two currents at the bottom of the shaft, and at the point A is again divided into two volumes, one portion ventilating the north main division of the mine, and the other the east ; on the southern side a similar division takes place. Now, the object sought is to keep all those divisions totally separate, so that any accident originating in one of them should be confined entirely to that locality. Round the shaft I leave very strong barrier pillars of unwrought coal, as is the practice in opening new collieries now in the North. The galleries surrounding those barrier pillars likewise are prepared for the main returns. We take the northern division of the air from A. At the first intersection it is spanned by the crossing conveying the return of the eastern workings to the up-cast, and at the next intersection a similar crossing of a moiety of its own column is shown. Up to this point, these divisions are termed shaft-walls in colliery working.

4248. You mean those blocks of coal ?

Generally so, but the galleries more particularly. The blocks are called the shaft-barrier pillars.

4249. Being blocks of coal between the main passages close to the shaft ?

Yes ; they are left very large on purpose to support the shaft. Being the last portion of the mine worked, it is very necessary to leave them strong, to preserve them from being in any way crushed by the incumbent strata ; formerly they were frequently so ; and when that occurred, the area of their walls or surrounding galleries was reduced, the return of the air was interrupted, and a great degree of danger consequently ensued. To return : the air continues in one undivided column, it being left to the discretion of the mining engineer to determine at what distance in the exploring drift he will commence the main workings by the first subdivision of the district. At that point, B, I divide the air, continuing the main portion in the exploring drifts, the remainder passing into the first east panel, or first working portion of the mine. Now the custom in the North of England, and in other districts, is, to connect each gallery of these panels with the next return gallery of the main exploring drifts ; I connect it with those drifts, but at two points, one being the intake connexion, the other the return.

4250. On the present system is it usual to make it cross in more places ?

Usually the galleries, meeting the intersection C, D, would be continued as shown by the lines dotted red. In this panel the principal portion of the coal is shown as worked off totally. We will, therefore, proceed to the next or first west subdivision E ; there we find the same system exactly pursued. A portion of the main current is again diverted, and passes under the west main return, and, on joining the panel, it passes likewise beneath the return of its own separate division. Then, in the usual way obtaining in the North, I proceed to ventilate this district ; it is advisable not to confine the intake of the air to a single gallery further than is unavoidable ; therefore we allow a portion of the air to pass into a gallery south of the main intake of the panel, uniting with that current at the last intersection, and it is confined to that intersecting gallery as the principal directing

directing passage, being carried up to the places where the men work by means of brattices, and is prevented passing directly east to the return by wooden stoppings; all other stoppings marked black being formed by a brick wall, closely backed by several yards of coal.

J. T. Barkley, Esq.

13th July 1849.

4251. Do you mean of solid coal?

I mean of dust or foul coal, which, being unsaleable, is left in the mine.

4252. Coal placed there to strengthen the stopping?

Yes; it is the usual practice now to drive what are called stow-boards to contain the rubbish produced in working the exploring drifts, while in the other workings it is left on one side of the gallery: now the drift intersection stoppings, and those on either side of each main panel intake, I would have backed, as I before said, in order to render them infinitely stronger than at present.

4253. Do you think that that would render them strong enough to resist a moderate explosion?

I think that 14 tons of coal, faced by a well-built wall, presenting an opposing area of but 30 square feet, would resist an exceedingly violent explosion. I have witnessed the effects of explosions, one of extreme and most unusual violence, but I have never seen anything they effected which would occasion material injury to the stopping I have described.

4254. Have you seen any mines after explosions?

Yes. The principal damage in a mine after an explosion is caused by the fall of the roof; where but little timber is found necessary for its support, an explosion effects comparatively little injury; but where the roof is supported at every yard by props, when those props are swept out by the concussion and reaction of the air, the roof falls, and great damage is inflicted on the working plant, and a great outlay is necessary to restore the galleries to working order.

4255. Is it not generally the case, that after an explosion almost all the stoppings of a mine are blown out?

Yes, but in many districts, and in some collieries of every district, the stoppings are generally defective, referring them to the unbacked wall as the standard; such was the case, if I remember rightly, at Darley Main, and was so stated in evidence.

4256. That wall alone?

Yes, that is the nature of the stopping, as at present generally considered perfect.

4257. Is there nothing added to strengthen it?

In few instances; and when added, it is often with the view of removing the refuse out of the way; nor is it compactly placed, as it is not intended to give additional strength to the usual wall; the intersection is merely used in place of a stow-board.

4258. What do you call a stow-board?

They are short galleries driven to put the waste portion of the coal into, or the stone frequently removed in forming the rolley-ways in passing through faults in the strata. I return to the current passing through the intersection adjoining the working face of the west panel: adjoining, I have introduced a slight dislocation of the seam as marked pink, not sufficiently large to interrupt the working; and I have shown here, but more fully in the next west panel, the method of passing it, and the way in which it is usual to resume the old form of working afterwards. The air is now confined to the last north gallery, through which the whole current passes, with the exception of the small scale penetrating through each of the wooden bratticed stoppings before alluded to, and which is all that is required to ventilate these galleries, where very little exudation from the coal is at that time taking place, owing to the unwrought pillars in the immediate proximity being left of a sufficient size to resist the incumbent pressure; on leaving, it is conveyed by the pillar or broken working to the return, skirting, as it proceeds, the whole exposed portion of the goaf, and resuming at every intersection the portion it before permitted to escape during its course through the face gallery. I have now, though hardly intelligibly I fear, followed the ventilating current through the working portion of this district; and, before pursuing the inquiry into the system adopted for its return, I will attempt to explain the nature of a goaf, or of that chasm left after the removal of the coal. A very common impression exists among unprofessional men, that the goaf can be ventilated; that it is possible

J. T. Barkley, Esq.
 13th July 1849.

to direct or force air through it; I believe firmly that it is utterly impossible to do so. Again, it was supposed that though it was impossible perfectly to ventilate it, yet, by connecting it immediately with the main return, a certain portion of atmospheric air did percolate, and remove a considerable moiety of the gas generated. I will explain why this belief is erroneous; that it arises from a misconception of its nature, and neglect of due consideration of its size. In the limited extent of this plan, in this panel it is about four acres.

4259. And very frequently in those mines of the North are they of great extent?

Very great extent indeed; it is imagined that the goaf is a concave basin; that as it increases in circumference, so it increases at the height of the crown. Now, the goaf is not of that form, nor do subsequent workings affect it after the roof has once fallen; this is proved by the indications found in the seams worked immediately above the goaf, and within the range of its influence; we find there dislocations of the strata, small faults, occurring at irregular intervals, which are not met with in higher or lower veins, and are consequently produced by the subsidence of the intervening measures. From this we deduce the chaotic nature of the goaf itself; that it consists of numerous interstices of varying dimensions, closed entirely or partially from one another, but similar in general irregularity. In these cells the gas generates, issuing from a thousand jets in the inferior coal, left frequently unworked at the top or bottom of the seam, or otherwise penetrating from the small seams usually lying in the immediate vicinity, but now connected by the fissures formed in the general disruption consequent on the removal of the coal. Thus, the goaf becomes a huge gasometer, and the attempt to effect its ventilation, by forcing air through its extent, must be perfectly impracticable, and, moreover, must be injurious.

4260. Why do you think that?

Because otherwise we can confine its outlet to a defined and limited line, which is not extended in proportion to the augmentation of the goaf area. Across that line (the line marked blue) I know that whatever exudes must pass to reach the working portion of the mine. By the other system we have it constantly liable to evolve at every connexion with the main return; by referring to the dotted red lines this will be understood. When the pressure of the barometer is heavy, the gas is pent up, and confined by the density of the atmospheric current; but when the pressure is reduced, it escapes in a greater degree. Now, by limiting the escape to one defined portion, where the decreased density can be counteracted by increased velocity, readily and effectually applied, the danger is rendered infinitely less than it would otherwise be were the escape permitted to take place at other points removed from constant inspection, and much less easily subjected to additional ventilation. This argument is also applicable to the case of gas ejected by the fall of a large area of roof; when, as sometimes occurs, acres of coal are removed before the subsidence of the roof takes place. Your Lordships will likewise notice, that the intake air is not only confined to the blue line marked as surrounding the goaf, but that it penetrates its boundary, sweeping by the extreme edge of the standing coal (a sufficient channel is always left by the support that coal affords), and thus a perpetual current is kept up, in addition to the main draught conveyed by the nearest converging gallery. This principle is the system of panel ventilation that usually exists now in the North of England, in the new collieries of that district, perhaps in South Durham more especially. I should explain, that the pillar working is discontinued at two pillars' distance from the main intake of the panel; those are removed at a subsequent period, when the further advance of the panel is abandoned, as is shown in the drawing of the first east panel. In that case the air is divided at the last intersection, and forced by the goaf boundary; thence it returns on either side, till it again unites before joining the main return. The other districts denote various degrees of advancement, and one, the second west panel, is represented with only the working and intersecting galleries removed, and also the system of arrangement adopted to effect the ventilation, but requires no special explanation. Between each panel, and between the panels and the drifts, such space of coal is left as the nature of the coal and incumbent strata may demand to permit of its after easy removal; the said panels being also turned from the main drifts at equal distances, but at varying points on either side, so as to effect what in masonry is termed breaking the joint, and which is intended to act as a

safeguard

safeguard in this instance by rendering the communication less facile. I now address myself to the details connected with the return air. The last intake division occurs at the last intersection of the drifts, and immediately commences to return in two columns; resuming at the returns F, G, H, I, J and K, its former volume, and after the total east portion has crossed the arch over the centre exploring drift at the intersection of the shaft walls, the whole current traversing the north main division, unites in a single column, and passes at once to the upcast shaft. In the panel returns the system pursued would be as follows: I take the return air of panel E; it crosses the intake at the point shown, and thence at an abrupt angle passes to the gallery leading to the main return; in this gallery a regulator is placed; similar regulators are also placed in the other district returns, as at F, G, H, I, K; by these regulators the admission of the proper proportions to each district is accomplished, and the additional volume required by an increased exudation directed to the affected district. Opposite each panel return in the stopping of the main return, a similar regulator, but of smaller dimensions (about 1' 6" square), is inserted, by which a current of pure air can be passed directly to join the south return, and purify it previous to means being taken to remove the danger by stimulated ventilation. I specify the size of these last-named regulators, as they should permit, when necessary, of the passage of a man. I would use three different sized regulators, termed the shaft-wall or main-return regulators, the panel-return and exploring-drift regulators. But a similar scale of areas, as far as the dimensions would allow, should be marked on each: the main regulators would allot the proportions to each general division of the mine, the panel-return regulators to the subdivisions, and the drift regulators would admit clean air when the returns were foul. By these means the internal arrangements for ventilation would be completed. Nor in advocating this do I forget that no system can be justified which obtains not the greatest quantity of coal per acre at the least expense per ton, and that to effect this and security combined, must be the great object which we desire to attain; and I further believe that no two of these advantages can be secured without the possession of the other. I continue the explanation of the plan: each main return, as you perceive, is kept totally separate and distinct from the one on the opposite side, the only possible communication between the two being at the crossings L and M; of course there is, besides, a communication at the last intersection of the exploring drifts.

J. T. Barkley, Esq.

13th July 1849.

4261. Where the intake air is divided?

Where the last of the drift intake air is divided. The crossings L and M span the centre drift; on the top or crown a door is fixed, which, when opened, connects the main returns: in either return, south of the crossing, a door is suspended by a hinge; the said door being kept open by a support beneath, which when removed, allows it to fall; it then, after a short pendulous motion, remains at rest, and closes the return. Now, when this is the case, by opening the door on the adjoining crossing, the current is diverted into the opposite return, and passes with it to the shaft. I suppose the west door closed and the diversion made into the east return; it is desirable to convey that current to the upcast, without permitting a junction with the remaining portion of that division air. This is effected at once by closing main regulator O and opening P; and with each return of each main division the same can be done. I will explain the reason why this is so very necessary; it is because when we increase the quantity of air admitted to the mine, we wish to carry it all to the point where an accident has occurred, or its presence is required from other causes, and not to decrease at the same time the volume of air passing through the other parts. When no accident has occurred, this is simply effected without the diversion of any portion; but when that is lamentably the case, the diversion of the portion on the affected side of the exploring drifts lying beyond the panel injured is necessary for the retention of ventilation, and as offering a means of escape to the men. The goaf of panel E is the most dangerous place where an accident can occur. We will suppose that an accident has occurred in that goaf: and it here becomes necessary to explain, that the impression that carburetted hydrogen explodes with the rapidity of and in a manner similar to an electric flash, is erroneous, except in cases where, owing to great negligence, it is permitted to accumulate in an active form. I will attempt to explain the rationale of an ordinary explosion in connexion with a goaf. Mr. George Stephenson once related to me the aspect of an explosion he witnessed

J. T. Barkley, Esq.
 13th July 1849.

nessed at Killingworth Colliery, in 1806. Mr. Stephenson was a most excellent authority in those matters. He mentioned what I now allude to in his evidence before the Committee of the other House. He told me that, when at Killingworth in that year, he saw an explosion take place, he saw it come to bank, to use the usual expression. For a quarter of an hour the shaft emitted a dense black smoke. Now the propulsion caused by the expansion of the atoms in combustion must have been continued for that period to have produced that effect; as the instant the fire goes out a vacuum is formed. The carburetted hydrogen combined with the oxygen of the atmosphere in a state of incandescence would dissipate as steam; and the moment the vacuum is formed, the air rushes in, and therefore would cut off any emission from the shaft, and thus the duration of the explosion is ascertained.

4262. Was there an opinion to that effect stated in Mr. Stephenson's evidence?

No; it is the simple deduction from what Mr. Stephenson stated that he saw. Mr. Buddle likewise was present at an accident which occurred at the Row Pit, Harraton Colliery; he said that on that occasion the blowing-out lasted for about five minutes, and formed in a large black canopy over the pit; suddenly the stalk, which was of the diameter of the shaft, was withdrawn, and it floated away; the stalk was cut off immediately the combustion ceased, and on the formation of the vacuum, when the air rushed in. It is very evident, on a little consideration, that this must be the case when the explosion is connected with a goaf, such as I have described it to exist; it elucidates what I said on that subject; the gas there confined is very pure; but carburetted hydrogen without its proper admixture of atmospheric air will not ignite; it requires a proportion of oxygen; but that oxygen is only to be found in the current at the goaf boundary; in that current, then, the combustion arises, and it immediately passes with extreme rapidity by the exposed line, but with less eagerness in the return direction, not acquiring the oxygen so rapidly from the departing stream; it repels the intake also, but by this act is also checked; then retires; the atmosphere follows to the partial vacuum; mingles with a fresh portion of hydrogen, which has been withdrawn by the same means from the goaf interstices; another explosion or more eager ignition ensues, and the same process is repeated; the force of repulsion and the extension of the flame being in opposition to the advancing ventilation.

4263. Is that the observation of working people in the pits?

Yes, it is a common remark, and is always expected; of course a proportion of power is directed towards the return; but, meeting with no resistance, it causes less injury, nor does the flame extend in that direction. Now, supposing that goaf to be connected with the main return by the red dotted lines; the gas there evolving would ignite, and, passing in the manner I assert, would communicate, under ordinary circumstances, with the goaf of the adjoining panel, supposing a similarity of form in that also.

4264. That would depend entirely upon the quality of the air in the passages between the two, would it not?

Your Lordship thinks that if the main return air was not previously of an explosive nature, it would prevent the passage of the flame; I think that supposition is hardly correct. I would instance the jet of a common fire; as first seen, it is a black pitchy vapour, passing off in the general draught, but immediately on ignition, projecting itself into the pure current of the atmosphere. I allude in this evidence more especially to an explosion in connexion with a goaf, as in working the whole coal, in my opinion, no great accident can, without some want of skill on the engineer's part, or negligence on the part of the under officials, take place.

4265. The carburetted hydrogen could not pass in opposition to the current of fresh air; the explosion may take that course if the carburetted hydrogen is mixed in proper proportions for combustion, but the carburetted hydrogen cannot pass against the current for the purpose of gaining the proportions?

In practice, something very similar occurs.

4266. The fire may pass against the current?

It is the fire I have stated that passes against the current.

4267. In order to admit of that, is not this necessary, that the current itself up which the fire passes should be in a condition to explode?

Not

Not by any means ; take the accident at Haswell Colliery as an example ; there are the two goaves ; those two goaves were connected ; a pure current intervened, yet the connexion was effected.

J. T. Barkley, Esq.

13th July 1849.

4268. Must not there be some other explanation of it ; is it not impossible that the lighter air should pass upwards against the current of the heavier air ?

It is by the propulsion or repulsion of the air, and the continuous explosion : the carburetted hydrogen in the expansion of combustion opposes the main current of the air ; it repels that current, and repelling, pursues, conveying the jet of flame much beyond the boundaries to which the explosive mixture was confined. If you take any small blower which you can ignite without danger, you will see the explosion spread over a very much larger area than was before impure ; you may advance a candle, without producing any change, for some distance ; further on it effects ignition, and the flame immediately passes into the previously unexplosive mixture.

4269. That seems to be assuming the question that it was not explosive before ?

We try it by applying flame ; if it could explode, it would explode then.

4270. Assuming that you are correct in that, will you proceed with your explanation ?

The flame would pass against the current, fluctuating as described, till the combustion ceased, consequent on the dissipation of the hydrogen ; while the air repelled would rush through each gallery with extreme violence, but being confined to abrupt angles would lose power at every turn ; and by two galleries alone finding access to the panel intake, and then divided and opposed by powerful stoppings and the solid coal would reach with diminished force the main intake, and again opposed divide. The power propelling the return is met near J by a right-angle, but, destroying that regulator, divides in the main return, having sufficient power also to eject the drift regulator, and, passing through the aperture thus formed, to join the repelled intake air in the centre drift. I have described no crossing as destroyed, and I see no necessity for their being so by the air passing with whatever rapidity it may between their abutments ; but crossings are generally built rather lower than the usual passages in the mine, because it is inconvenient to take down a greater height of roof, and, consequently, an opposing area is offered to the violence of the stream : I think that by building them in a more cautious manner their destruction might be avoided in a great degree.

4271. Do you know the plan which has been adopted by Mr. Elliot in order to obviate accidents of that kind, namely, making a passage through the coal itself ?

I understand it to be by carrying the return over in a tunnel ; it is a very excellent plan, but it cannot be adopted in all mines, by reason of the deficient height of the seam.

4272. It might be taken through the superincumbent rock ?

Yes ; I can see no objection to it, and a most excellent result ; if that were not done, I think that if care were taken in building the walls, so as to build them perfectly flush with the side of the passages, it would have a somewhat similar effect. Now, if when the blast arrives in the centre drift, the current is sufficiently strong to destroy the east stoppings, the whole of that division must be cut off ; I do not believe that it could without negligence in the erection of the stoppings do so ; if the colliery was exceedingly fiery, these panels could not perhaps be commenced so immediately in the neighbourhood of the shaft as shown here ; but in most, indeed in all collieries, with the exception of six or seven in Durham, and three or four in South Northumberland, it could be done. Ordinarily, by the destruction of the stoppings, all the panels beyond the site of the accident would be cut off by the carbonic acid gas evolved ; as here shown, the east side remains uninjured, and by the adaptation of the power secured by the swing-door and dumb crossing, the separation of the other panels is effected, and the men's escape secured. The swing-door, as I said previously, is supported from beneath ; the reversed current passing along the return, removes that support, and the door falls.

4273. A sort of valve ?

Yes ; the men working in the next division of the mine are aware an accident

J. T. Barkley, Esq.
13th July 1849.

has occurred; they hurry into the return, and come down as far as that door, pass over the dumb crossing from the west side (leaving its door open), and from thence proceed directly to the shaft.

4274. Then the result is, that the principal object of the plan, as you have explained it, is, in the first place, that there should be a more complete subdivision of the mine for the purpose of ventilation?

Yes.

4275. And, in the next place, that there should be of two passages kept for the return air, one always free, if possible, after an accident?

Yes, and when any division of the mine is foul, the power of directing the additional current procured to that division without delay, and with great certainty. In the usual system of arrangement, and when rarefaction is adopted as the motive power, we are obliged to check the current of air passing through other divisions on purpose to throw the excess of air so gained into the division where it is required; of course by doing so we are liable to render the other divisions foul also, if the air is not in excess previously.

4276. You say that in the new pits opened in the North there has been much more attention paid to the subdivision upon the principle which you have been explaining?

Yes, very much greater attention has been paid in the North; but in some coal-fields, with barely the exception of a single colliery, no precautions, and hardly any ventilation, is enforced; in other districts, one colliery may be fitted with every known means, and others, in the immediate vicinity, be grossly in want of the most ordinary requirements.

4277. Does this plan, which you have drawn out here, correspond in general principles with the method adopted in those new collieries?

In general principles; but uniformity in the arrangements is not insisted upon in so great a degree, nor is the regulating system so defined, or the non-connexion of the divisions and subdivisions so thoroughly obtained.

4278. And it is an essential part of your plan that there should not be more than two passages from the main channels into each subdivision of the mine?

Never more than two.

4279. In the present plan of working, they have passages at each of those compartments?

At every other one, as the dotted red line is intended to represent, it being usual to leave large pillars to support and protect the exploring drifts. I must now show how it is possible to direct and control the volume passing into each division and district; to do this more simply, suppose the diagram No. 1, on the general plan, to represent at D the main intake of an air division, W the upcast shaft while the connexions denote panels provided with regulators, situated at various distances. I show the quantity of air in the first place to be 40,000 cubic feet, which, at 8,000 to each division, will give 5 as a certain number. By the anemometer we adjust the velocity to the area of each regulator, so as to effect an equal supply to each panel: then to first intersection the velocity is as 5, to the next as 5-1, one-fifth portion of the volume being lost; and the same is repeated till the air before the final return is as 5-4, or one; but, resuming its velocity on the resumption of its volume, it joins the upcast with the velocity represented by 5. In No. 2, I exemplify the method of directing an additional current of 8,000 feet to the third panel, without affecting the quantities ventilating the other districts, and also without having recourse to the anemometer to regulate the consequent reduction and expansion of the regulating areas.

4280. You do not mean after an explosion, but under ordinary circumstances?

Under ordinary circumstances, or after an explosion, if the diversion I before described was accomplished, when the shaft wall regulator of the injured division would be the agent employed—[*The Witness explains the same upon the Plan*].

4281. Is there any other plan of regulating doors of that description?

Regulating slides or doors are adopted, but not on this principle; the quantity of air admitted by them being left (without being calculated) to the discretion of the proper

proper official. In diagram No. 3, a more complicated dispersion of the increased volume is represented, and the consequent variation of area in the regulators, which are thus found; the additional number of feet that would pass through each regulator, if permitted, is discovered, and is then referred to the number of feet then passing, and thus the increase or decrease of area is determined. Nos. 4 and 5, represent the downcast shaft, and the four divisions of the mine, with regulators supposed to be situated in the shaft-walls: the process now alluded to is again repeated, and the additional volume directed to the proper main division, where it is subdivided by a similar calculation. Thus, by using the anemometer to regulate the original areas, and with a scale marked on each regulator, the subsequent changes may be calculated, and the necessary orders given with the utmost promptitude and correctness, without leaving anything solely to the judgment or discretion of the official charged with the execution.

J. T. Barkley, Esq.

13th July 1849.

4282. Those regulating doors, as you call them, would be a sort of sliding partitions?

Yes, sliding from the bottom towards the top in a well-fitted frame; and by attention a complete classification of proportionate areas and distances might be compiled, and these be again referred to the pressure on the steam-jet, where that motive power is adopted. The fault in the east workings of the mine is supposed to be too great to admit of its being penetrated by the panel C; and the exploring drifts turned in a north-east and south-west direction from the east main channel on the further side, are intended to show how the form and principle of working may be resumed, when, as is usually the case, the cleavage requires that the working galleries should be driven at a certain angle, to prevent waste of coal, while the dumb drift and double crossings (coloured sienna) are necessary to allow of the diversion of the air, when other districts of the new drifts are commenced. I would explain also, that every main district or sub-district is provided with a separate return, up to the immediate neighbourhood of the upcast, in case any accident or necessity should arise.

4283. In short, you would consider it a matter of great importance in all plans for the ventilation of a mine, that there should be as much isolation as possible of the different parts of the mine?

Certainly, as much as possible.

4284. Is not there an additional advantage gained by splitting the air and subdividing it very much, namely, that the force of the ventilation is rendered greater with a given power by that means, than by keeping it in one current?

Yes; it expands when kept in one current from the heat of the men, and is loaded with the impurities, arising in working, and much of its power is destroyed; the air is, of course, much purer when conveyed but a limited distance; indeed, every advantage is gained by the subdivision of the air; and none of the most dangerous and fiery mines, such as are alone found in the Northern field, could be worked with the degree of safety they now are but for that principle.

4285. Do you think that a plan such as you have been describing would be applicable to all the different beds with which you are acquainted in the North of England?

It would be applicable as differing but in the minutia of detail from the present system; and more, I think it would be applicable to any system of working that obtains elsewhere. In the long-wall system, where they remove the whole face of coal at one operation, I see no difficulty to oppose its introduction, or why that removal should not be made in regular divisions.

4286. The long-wall system seems to be upon a different principle altogether, namely, having, all the workings in one continued line, and passing the ventilation entirely along that line without any subdivisions, having one single channel merely for the passage of the air?

That line being, in fact, similar to an extension of the face of our broken workings. Now, I speak confidently, when I say that no excuse could be offered for the introduction of such a system (where any gas whatever is generated) unprotected by divisions of the mine, and the necessary divisions of the air.

4287. It would appear, according to the descriptions of the long-wall system, that the remainder of the mine is left without any coal, and that therefore it is not necessary to ventilate it?

(164. 13.)

3 E 3

Yes,

J. T. Barkley, Esq.

13th July 1849.

Yes, in the long-wall system ; the working face is the goaf boundary in all cases, and if an accident occurs in any part of that line, when no divisions are opposed, all the men in the mine must be infallibly destroyed. If gas exists, it is in the goaf it will be found, and at its verge the men work ; the deduction is obvious.

4288. As it has been described to the Committee, one of the advantages of the long-wall system is, that it makes the ventilation so extremely simple, confining it to one single passage along the workings ?

If you confine the air to one single passage along the workings, and interrupt it at any one point, all the men beyond the interruption must be killed ; and in the long-wall your Lordship describes, the possibility of escaping by the return must be most doubtful.

4289. But does it not make the occurrence of an accident much less likely, because the ventilation is so complete ?

In most long-wall districts but little gas evolves, and a single current is alone required to permit of the works being continued ; but almost invariably in such cases, unless the mine is most limited, the ventilation is most oppressive and unhealthy, from the nature of the unexplosive gas generated in the place of fire-damp ; but where carburetted hydrogen is found in any quantity, a certain separation and division is attempted, with skill and effect in some cases, but, generally, in a most imperfect and slovenly manner ; and I wish to say, that when fire-damp does exist, the use of the unprotected candle in the immediate proximity to a large goaf, where the sudden fall of a portion of the roof, or an alteration in the density of the atmosphere, may bring the flame and gas into direct contact, is most culpable and wicked.

4290. Have you seen the system adopted in the Midland Counties at all ?

I have not ; I have been in North Wales, Somersetshire, Lancashire, and Cumberland, besides the great Northern field.

4291. Have you seen it in operation in the North ?

In Lancashire, in the neighbourhood of Bury.

4292. Have you there seen the long-wall system pursued ?

Three or four years ago I was with a friend of mine ; he was surveying ; the system was as I have related, and little gas was generated. The gentleman I accompanied had been educated in the North ; he spoke favourably of the system generally, but strongly reprehended the vicious arrangements too often applied.

4293. Is it adopted anywhere in the North of England, so far as you know ?

No, I do not know any colliery in the North of England where it is adopted ; it was attempted to be introduced ; but where the incumbent strata is very oppressive, and the roof does not fall readily on the removal of the coal, the face is so much crushed, that when obtained, the coal is so very inferior in size as to reduce its value greatly ; where these difficulties are not met with, I believe the system to be good.

4294. It would only be possible to apply a system like the one which you have been describing to a colliery recently opened ?

To a colliery recently opened more perfectly.

4295. You could not apply it to a colliery already in existence ?

In the continuation of that colliery you could, and where already explored, in a great measure, by the introduction of the backed stopping.

4296. Supposing you were working a long face of coal, frequently interrupted by dykes and throws, it would stand rather in the way of your system, would it not ?

I think I answer that by the east workings. There is a large intersecting dyke, as I before explained ; we pass through it by means of three exploring drifts, and resume the working form immediately ; three exploring drifts should be always used, instead of two ; in most new collieries that is the number adopted.

4297. Supposing, instead of these two dykes in this extent of workings, you had the frequent intersection of dykes, which often happens, would not it create great difficulty ?

It

It would not create more difficulty than is met with in the ordinary workings of the North now; we work now on the same principle as these panels. The exploring drifts are always advanced, and thence their name, and by that means we know where the lines of dyke extend.

J. T. Barkley, Esq.

13th July 1849

4298. With regard to the expense of a system like this, would it be great?

The expense would not be more than is at present incurred; the number of doors is reduced as much as possible, and great advantage gained by the reduction. The only additional expense is in the stowing at the back of the stoppings, and yet the small coals might just as well be placed there as in the usual board, at the cost of a very slight inconvenience.

4299. Which is waste?

Yes.

4300. And this, you think, might be put into the stoppings?

Yes, to strengthen them.

4301. That seems so obvious an arrangement, that one should imagine there must be some reason for not doing it; what is the reason for making these stow-boards, and not placing the rubbish in the stoppings?

In all mining hitherto in the North of England principal attention has always been directed to keeping up a good ventilation; and a good ventilation is equally kept up by a 9-inch stopping as by a 12-feet one; but I recommend, in addition, precautionary arrangements to preserve life after an accident has occurred.

4302. But it is well known, that in the case of an accident all the ordinary stoppings are blown out?

Yes, but they are not backed in any way.

4303. Must it not have been an object with the viewers of mines to take any step which was likely to obviate such a consequence as that?

I must explain: in the first place, it is inconvenient, in some measure, to have to retain rails in an intersection after the next is completed, for until then no stowing can be commenced; and, moreover, the coal obtained from the stow-boards is generally of an excellent size, and renders the sample of coals from the narrow work or drifts an average one; and again, the backing of the stopping would rarely afford the space required.

4304. You would take these main passages, then, in the same direction as the principal passages of the mine are taken now?

Exactly in the same way, that way being first determined as the best. I have shown the divisions here at right-angles to each other; that they should be so is by no means necessary.

4305. You propose in this plan that there should be four different main divisions?

Yes.

4306. You suppose the main passages in each division to be according to the different points of the compass; could that ever happen in the working of a mine?

It would very seldom; not more frequently than in any other.

4307. Could you take one set of main passages along the dip or rise, and another along the strike?

In the North country working we are obliged often, in deep collieries, to work as much to the dip as to the rise.

4308. When you take two lines at right-angles, the one is to the dip or rise, and the other is in what they call the strike of the stratum, along the horizontal stratum?

Yes. When I laid this plan out, I supposed that we sunk at the lowest level of the colliery boundary, that the north was to the rise, and that the east and west galleries were, as nearly as possible, on the level; if the rise of the colliery proved to be in another direction, the general form would be the same.

4309. Supposing you had sunk your pit, as this is supposed to be sunk, at the lowest point, and you drove your level upon the rise; would it be possible to drive a main drift here at the lowest point?

Yes; I have shown as if one had been commenced at B.

J. T. Barkley, Esq.
 13th July 1849.

4310. But you would not be able to make your main passage in this direction, would you?

Yes, perfectly well.

4311. Would it not be difficult, on account of the water at the lowest part?

If you have dip workings, that is, workings below the shaft level, and water is found in them, you must remove it by mechanical means.

4312. The object of the plan is to subdivide all the different parts of the mine, so as to confine the consequence of any accident to one of those subdivisions?

Yes.

4313. Have you had experience of accidents occurring in coal-mines?

Yes.

4314. In most cases should you say that the mortality from those accidents occurs from the effects of the after-damp, or from the burning?

The majority of deaths occur from the effects of the after-damp.

4315. And the fatality of the after-damp arises, in a great measure, from the destruction of the ventilation, does it not?

It arises, in a great measure, from the destruction of the ventilation, which precludes its being carried off. I will submit to your consideration a plan I have devised for preserving life in those portions of the mine thus affected, and where no access to the shaft or uninjured district offers, and where death is occasioned by the action of the choke-damp or carbonic acid gas, generated in the combustion of the hydrogen. The means I propose is a refuge-chamber, placed in the main intake of each panel, and supplied by artificial means with respirable air.

4316. How would you manage such a chamber as you speak of?

If you refer to the evidence taken before the Committee of the House of Commons in 1835, Mr. Roberts, of the then firm of Upton & Roberts, lamp-makers, was examined; he was inventor of a hood, termed "Roberts' Safety Hood;" it was to be used in sewers, where carbonic acid gas abounded, and likewise in mines, for the purpose, as he said, of removing the bodies before the ventilation could be restored after an explosion. The principle of it was this: the carbonic acid gas was passed through lime-water (cream of lime), or chloride of lime, or other preparation having the same quality; in so doing, the foul or destructive portion was precipitated, and the oxygen set free, affording the agent necessary for the support of life. Mr. Pereira, in his evidence, affirmed the soundness of the principle. Roberts was thus enabled to remain a considerable time where no light would burn, and where no unprotected person could remain for two minutes; the application being this, the vapour inhaled was passed through the composition, and after respiration ejected by a separate valve; a sponge was soaked in the composition, and the air was passed repeatedly through that sponge.

4317. How would you apply that to the case of the refuge-chamber of which you speak?

I would erect a small air-tight compartment in each panel, sheltered, by its position, from the action of an explosion, and of the dimensions, say 8 feet by 12 feet, and 6 feet high; the entrance to it would be by means of double or treble doors, suspended by hinges, and fitted closely, to exclude the atmosphere. The men having passed to the interior, would eject the air, by means of a force-pump, into the foul air in the outer drift.

4318. By what force-pump do you mean?

By using a common air-pump in the inside.

4319. You mean when the men had reached it?

Yes.

4320. How would you let in the pure atmospheric air in that chamber?

I would conduct the bad air, (in pressing in to fill the partial vacuum formed by the action of the pump,) through a composition, as described. The carbonic acid would precipitate and form chalk, while the oxygen would alone enter, and, by supplying

supplying the necessary ingredient, would prolong the inmates' existence for a sufficient period to permit of their being rescued.

J. T. Barkley, Esq.

13th July 1849.

4321. You would, in fact, filter the air into that chamber?

Yes.

4322. Then would you keep a constant current through that material into that chamber?

Certainly I would, when used for its special purpose.

4323. If an accident occurred, would not it be affected?

It would be perfectly tight; it might be ventilated or aired every day.

4324. You would place those ingredients of which you speak there, but would not pass the current through it continually?

No, that would be useless; we know that very many cases have happened in which, after an accident has occurred, the unfortunate men have lived a considerable time in the mine before eventually succumbing to the deleterious vapour. When the great accident occurred in 1835 at Wallsend, where there were, if I remember rightly, 105 persons destroyed, a man was discovered very near the shaft; he was an overman, and had collected all the lads under his charge, and driven them before him several hundred yards; they were so found dead, and it was supposed, from their position, that he had been conducting them as I have stated. At St. Hilda 19 men were also cut off when within a short distance of the shaft. Again at Haswell the position of many of the bodies proved that life and the power of locomotion had been for some time retained. I need adduce no further instances; every collier's experience will at once recall similar melancholy proofs, and there is reason to believe that many others remain alive after the explosion who remain without leaving the galleries or places in which they work: as to do so when no refuge offers may but be the means of accelerating their impending fate, and thus, in perfect darkness, and paralysed by the consciousness of their hopeless state, they await the merciful lethargy and certain death.

4325. What kind of apparatus would you place in this chamber in order to enable them to obtain the fresh air?

I am not prepared to answer that question decidedly; in the course of a few days I shall be able to do so, I trust, in a satisfactory manner, when I have consulted with others on the subject. What I proposed to myself was a perfectly tight oblong trough, extending the length of the chamber, filled with saturated sponge, and of a sufficient depth to hold the required quantity of the preparation, and perforated from the outer side by numerous pipes, leading to the lower portion of the trough, and likewise on the inner side by simple holes above the level of the liquid. A partial vacuum is formed by the air expelled, then the natural specific gravity of the carbonic acid being also greater than the purified atmosphere in the chamber, that gas would press down the pipes into the sponge, and, passing upwards through its pores, escape above the level in a purified condition, leaving its noxious proportions in the precipitate of the solution. This would be a continuous process, until the men could be otherwise saved, and would preserve life. I think with the power procured by the steam-jet, and the directive power exercised over the surplus quantity, but little time would suffice to reach the men. Unless the accident was something very terrible indeed, and great inattention had been customary in the conduct of the arrangements; by the system of detail I advise, and with the assistance derived from the instantaneous increase of volume produced by additional pressure on the jet, I believe that assistance could be rendered in an hour, or little more. With respect to the question of motive-power, I may say that I have carefully considered the methods proposed, having that object in view; my bias was in favour of rarefaction, produced by one or more powerful furnaces; but, on mature deliberation, I have convinced myself fully of the infinite superiority of the steam-jet. I do not know Mr. Gurney personally, but I consider the energy and knowledge he has brought to bear on this subject worthy of high commendation. I went to see the application of his principle at Seaton Delaval; the necessary arrangement unfortunately was not then completed, and I was informed by Mr. Forster that it would not be perfected for some time, and, being engaged elsewhere, I was obliged to leave without seeing it in operation.

J. T. Barkley, Esq.

13th July 1849.

4326. When was that ?

In April, I think, or the beginning of May. Its power is practically illimitable; but while so powerful, it is capable of the most minute regulation. Suppose the barometer indicates a fall; at once, and in proportion, the power is augmented by the comparative number of pounds' pressure, and, by a careful attention to that warning instrument, a total independence of atmospheric changes may be achieved; that is to say, when the density is less effective, the velocity of the volume is stimulated in a counteracting degree. It is, moreover, simple and economic.

4327. Have you ever seen any apparatus in action besides the furnaces ?

No; I speak as admitting the power assumed by their advocates, I may say as proved in the case of the jet.

4328. Is there anything with respect to furnaces which you would recommend as an improvement, having considered that subject ?

I would always recommend the application of two furnaces of corresponding area with the shaft, thus extending the surface of return current exposed to the action of the fire, and acquiring greater power.

4329. For what reason is that ?

The power is in proportion to the degrees of heat in the upcast in excess of the downcast volume, and is also in direct relation to the depth; the furnace moreover varies with the position of the fire, and requires, where bituminous coal is burnt, to be constantly cleansed, which is effected more easily when two furnaces are used. The defects of the furnace are these, the impossibility of increasing the volume traversing the mine in any great or immediate degree, should the necessity arise. The injury it produces by the corroding action of the smoke on the metallic tubing of the shafts rendering renewal necessary, and producing a considerable degree of danger, and, lastly, the imperfect means it offers of careful regulation and adjustment.

4330. Is it the practice in the North to have two furnaces ?

It is the practice in the North generally in the new collieries. I have a letter with a description of a pneumatic machine by Mr. Struvé. By his specification, it appears, that its power is great; but I should be exceedingly reluctant to allow any mine under my charge to be dependent for ventilation on the perfection of a machine, whatever the power or facility it might afford; in Mr. Struvé's invention great ingenuity is apparent.

4331. Have you ever paid attention to the question of the different lamps ?

I have not, particularly; I have used the Davy lamp upon all possible occasions, and in the most explosive proportions. I believe myself that it is as safe as it is possible for any lamp to be. The Davy lamp I consider given into our hands to denote the danger present, and to warn us to remove it by ventilation, not to supersede that ventilation, as is but too often attempted.

4332. You prefer it to all other lamps ?

I prefer it to all; it is superior in form, and in the light it emits, and in the warning given by the elongation of the flame; I speak in regard to lamps surrounded with other than the usual gauze, not of mere modifications of the original.

4333. Is there any other point upon which you would wish to observe ?

I think that it would be a great improvement if an organized code of detailed instructions were printed, and affixed in some prominent place at each colliery, comprising plain general injunctions, and a detail of the ordinary duties of each description of workman.

4334. Is not that usual among the best-managed collieries ?

Among the best-managed collieries it is generally the case in regard to the use of the Davy lamp. Mentioning the Davy lamp, I would say that I am strongly opposed myself to its being placed in the hands of boys, or any irregular workman having anything to do with the lamp; it is not by any means necessary in actual working that they should. At South Hetton Colliery and Murton Colliery, in Durham, the Davy lamps are hung where necessary to give light to the boys passing with the tubs and ponies; they are hung by the deputies, who alone attend to them, under the direction of the overman.

4335. Do

4335. Do you think that that is a better plan than entrusting them to their own management?

J. T. Barkley, Esq.

13th July 1849.

Yes; nor would I allow any man to take a lamp unless it had been previously examined by the overman, and it was properly locked. I think by introducing a little tact in the management, the men might be rendered very much more cautious; I think if the managers of mines would permit the men to have some voice in the punishment of others convicted of wilful carelessness, this end would be in some measure obtained. I knew a man who opened his lamp in a most dangerous situation; he had been a deputy before, and had retained a key after he had been reduced to a common workman, and with that key he opened the lamp; we punished him by imprisonment. If I had thought as now, I should have laid that matter before the men, and requested them to prosecute the man themselves, and a little explanation of the nature of the crime would at once influence them to do so. I think by such means you might produce a feeling of *esprit de corps* among the common workmen, and that they would pride themselves on the caution and supervision they exercised. I know no class of labourer more generally intelligent, however rude they may appear. I would likewise attend to all complaints of negligence on the part of the officials, when such negligence involved the security of life; I would carefully and gravely investigate the charge, and, if proved, would instantly dismiss the offending person, but would, on the other hand, turn away the man laying the information, if I found it to be ungrounded or malicious. I believe that conduct of this description would operate most beneficially. I offer the Committee the plan alluded to in evidence.

The Witness is directed to withdraw.

HENRY HUSSEY VIVIAN, Esquire, is called in, and further examined as follows:

H. H. Vivian, Esq.

4336. SINCE your last evidence, have you had an opportunity of pursuing your inquiries into the most efficient mode of applying the steam-jet?

The experiments which I then alluded to as in course of trial at our works at Hafod, near Swansea, have been since conducted by Mr. Herrmann, of the Mining Academy at Freiberg, in Saxony, and I now lay before the Committee the result.

4337. Will you explain to the Committee what the results are at which you have arrived?

The principal object which I had in causing these experiments to be made, was to ascertain the size which the blast-pipe ought to be, as compared to that of the jet.

4338. In order to produce the greatest power of ventilation?

In order to obtain the most efficient means of applying the steam, by ascertaining the greatest effective force which each jet can exercise in different blast-pipes; and I conceive that, by multiplying the area of a blast-pipe so determined, the aggregate area due to a certain number of jets might be ascertained.

4339. In fact, it amounts to an inquiry as to the area within which the jet exerts its power under certain given conditions?

Under certain given conditions; the results are exceedingly curious; as I stated before, the box to which the blast-pipe was applied was in all cases two square feet area.

4340. What do you mean by the box?

These experiments have not been made in a colliery. A long box was constructed, to which the blast-pipe was applied, a pipe such as you see on a locomotive engine; that box was constructed of the size of Biram's anemometer, with which all these experiments have been tried, in order that no differences as to the velocities of currents in the different parts of the box might cause error in the observation.

4341. Then the blast-pipe was the passage through which the air was to be drawn from the box?

The blast-pipe was the pipe into which the jet was projected.

H. H. Vivian, Esq.

13th July 1849.

4342. And through which it drew the air from the interior of the box?

Yes, the box representing the colliery in all cases; it was tried with the mouth of the box completely open.

4343. The mouth opposite to the blast-pipe?

The mouth opposite to the blast-pipe where the air entered, in which case no water-pressure was produced. To the mouth of the box slides were fitted, which were shut, so that the water-gauge indicated the greatest exhaustion in each case; the slides were then opened until the water-gauge stood at two inches, until it stood at one-and-a-half inch, and until it stood at an inch.

4344. Where was the water-gauge placed?

The water-gauge was attached to the side of the box, so that it prevented distinctly the rarefaction of the air in the box: the anemometer was placed in all cases in the box; two slides were fitted to the box; the two slides met in the centre, so that the passage was always left in the centre to give the air a power of expanding itself more evenly in the box.

4345. When you talk of the two slides, you mean the open end of which you spoke before?

Yes; the open end was fitted with two slides.

4346. A sort of double slide?

A sort of double-sliding door.

4347. Then you used jets of different sizes?

We used jets varying from one-sixteenth of an inch up to three-fourths of an inch square, in all cases.

4348. By three-fourths of an inch square, you mean the area of the jet?

It was three-fourths of an inch square.

4349. You are not talking of the diameter of the jet?

No; it was a square jet in all cases. In the former part of my evidence I stated that we had a boiler 30 $\frac{1}{2}$ feet long, keeping the safety valve at 50 lbs, with a jet of three-fourths of an inch open; therefore the power of the boiler is represented by that which is contained in a three-fourths of an inch jet. The result is, that with a jet one-sixteenth of an inch square, the greatest exhaustion produced was half an inch, and that, I think, is hardly to be relied on.

4350. With the doors closed it produced half an inch?

Yes. The greatest exhaustion produced by the one-eighth of an inch jet was two inches; the greatest exhaustion produced by the quarter of an inch jet was six inches; the other jets produced an exhaustion which the water-gauge was not capable of indicating as the water was drawn out of it. Our next experiment was with the passage so contracted as to cause a two-inch water-gauge, which, I believe, is considered to be the water-gauge represented by the ordinary drag on collieries. I believe it has been found that two inches is usually the difference between the outgoing and incoming air.

4351. Those were the reverse experiments; in the first instance you closed the passage, and obtained the highest amount of exhaustion?

Yes.

4352. Now, instead of closing the passage, you open it sufficiently to produce always the same exhaustion?

Yes, and to produce such an exhaustion as represents the drag on collieries.

4353. Assuming that to be two inches?

Assuming that to be two inches; I find that in all cases there is one particular diameter of blast-pipe which produces the greatest effect with each particular jet.

4354. What was the length of the blast-pipes?

We find a length of 10 feet to be best; we tried 5 feet, 10 feet, and 20 feet; the $\frac{1}{4}$ th jet produces the greatest effect with a 4-inch diameter blast-pipe; the $\frac{1}{2}$ th-inch jet with a 6-inch diameter blast-pipe; the $\frac{3}{4}$ ths-inch jet with an 11-inch diameter blast-pipe; the $\frac{1}{2}$ -inch jet with a 15-inch diameter blast-pipe; the $\frac{3}{4}$ ths-inch

$\frac{3}{4}$ th-inch jet with a 16-inch diameter blast-pipe; and the $\frac{1}{2}$ th-inch jet with a 17-inch diameter blast-pipe.

H. H. Vivian, Esq.

13th July 1849.

4355. Can you ascertain from those numbers at what ratio the size of the blast-pipe ought to increase as regards the area of the jet?

Some of the concluding experiments only reached me this morning, and I have not had time to calculate them.

4356. Do they appear to you to observe any law?

In all probability they would; I have not made the calculation; according to this, with $1\frac{1}{2}$ -inch pressure, the amount of air drawn by the $\frac{1}{4}$ th-inch jet acting in a 4-inch blast-pipe, would be equal to 35,856 cubic feet per minute; the $\frac{1}{2}$ th-inch jet, acting in a 6-inch blast-pipe, would produce 21,816; with the $\frac{3}{4}$ th-inch jet, in its corresponding blast-pipe, 18,240; the $1\frac{1}{2}$ -inch jet, 13,543; the $2\frac{1}{2}$ -inch jet, 9,158; and the $3\frac{1}{2}$ -inch jet, 7,200; that is reducing those figures to the total capability of the boiler under those circumstances.

4357. What was the highest amount that you obtained?

The highest amount was obtained by the $\frac{1}{4}$ th-inch jet in a 4-inch blast-pipe, with $1\frac{1}{2}$ -inch pressure, which was equal to 35,856 cubic feet.

4358. What was the pressure?

Fifty pounds in all cases; in Mr. Forster's case he had two boilers, which were connected together, and at times every engine is at rest; therefore it is highly probable, at all events, that at certain times the whole force of those two boilers was acting on his jets. The above results would assign to two boilers a power of 70,000 cubic feet, besides the rarefaction produced by the heat of the boiler-fires under-ground; but it is highly important in all cases to observe a distinct law in the size of the blast-pipe, into which each particular jet is driven: the height of the pipe appears to have little or no influence on the effect produced.

4359. Do you mean the length of pipe beyond the jet?

The length of pipe beyond the jet; the 5-foot pipe gave 5.8 feet per second velocity, the 10-foot pipe gave 5.5, and the 20-foot pipe, 4.9; in another case the 5-foot pipe gave 5.8, the 10-foot pipe 6.3, and the 20-foot pipe, 5.6; so that there was a very trifling difference, the aggregate being rather in favour of the 10-foot pipe above the jet.

4360. That would hardly hold good if you diminished the length of the pipe very much, so as to bring the opening of the pipe very near the jet?

We diminished it to 5 feet.

4361. But supposing it was diminished below 5 feet, you do not suppose that it would hold good then?

I should hardly think so.

4362. Did you try it below 5 feet?

There were some experiments made at 2 feet; but the results were so unsatisfactory that I did not think they were worth while producing: having these data, it would be exceedingly easy to apply the steam to any colliery; it would be only necessary to construct a sheet-iron pipe 10 feet high, of a certain diameter, and to connect it with the upcast shaft, to close the upcast and downcast shafts, and you have then an immense exhaustion on your colliery; it might be done at times when the colliery was not working, namely, at night, or at times when the engines were not winding, presuming the winding-pit to be the upcast-pit; but in all cases I should conceive that the pumping-pit would be the better upcast-pit, provided no water were allowed to fall down. Exhaustion is a very important matter; supposing steam is capable of producing, on a large area, such as exists in a colliery, an equal exhaustion over the whole, that exhaustion may be made equal to half an inch of mercury, or two inches of mercury; you would then get the gas, which is retained by the pressure of the air on it, to exude from all the pores of the coal and goaf to a most enormous extent; and it seems to me that when the men are withdrawn from the colliery in the evening on leaving work, and when the engines are no longer winding coal, the whole of the surplus steam (the steam left in the boiler) might be applied to exhaust the colliery, when the engine has ceased working.

H. H. Vixian, Esq.

13th July 1849.

4363. Closing the downcast shaft?

By closing the downcast shaft, you might produce a very powerful exhaustion over the whole of your colliery; and it seems to me that in all probability the colliery would be left entirely free from gas during the whole of the next day, because, I believe, that the pressure of air at the bottom of a colliery is equal to two inches of mercury in some cases; I am speaking now of Monkwearmouth pit, for instance, or if you take it at 900 feet, it would be equal, perhaps, to an inch of mercury; the gas is confined by the pressure of the air in the colliery. Now if you can relieve the gas from that pressure, it at once exudes from all the pores of the coal, and would be some time gathering strength again sufficient to overcome the pressure of the air, and to mingle with it.

4364. Upon the same principle as the exudation which takes place when the barometer falls?

Exactly on the same principle; and having withdrawn all your lights, I think you might clear your colliery for the next day almost entirely, so as to be completely free from gas; and if you can do so by means of steam, you might, when your engine ceases work, shut your upcast pit, attach the steam to it, and bring a most powerful exhausting effect upon the colliery.

4365. The result of those experiments of which you speak has been to satisfy your mind of the great power of the steam-jet as a ventilating agent?

I think so. I am very doubtful of experiments made on a small scale at all times; but I felt it very desirable to ascertain the most efficient mode of applying steam. I could get no information as to what sized blast-pipe my jet ought to be driven into, and I thought it very desirable to determine that point in the first instance. There is one point which I wish to correct in my former evidence: I stated that candles were lit at the end of each stall, where a man was required to work: I find that that is not the fact; that that plan has been discontinued as inconvenient; but that the firemen visit the stalls every morning two hours before the workmen come to them, and then place a strong stick across the mouth of the stall, in case any danger is apprehended.

4366. So as to warn the men not to work?

Yes.

The Witness delivers in the following Tables:

IN the experiments from which the following Tables are derived, the velocity of the current was measured in all cases by Biram's anemometer, the air-passage being as nearly as possible the size of the anemometer, $17'' \times 17'' = 2$ square feet: by this means nearly the whole of the air passed through the machine, and the false results arising from the varying velocity of the current in different parts of the air-passage were avoided. The greatest exhaustion was ascertained by closing the mouth of the air-passage entirely, and attaching a water-gauge to it. The respective water-gauges of 2, $1\frac{1}{2}$ and 1 inches, were produced by partially opening the mouth of the air-passage, until each degree of rarefaction was produced. The steam was always kept blowing off at 50 lbs.; the blast-pipes were in all cases round, and ten feet high; the jets were all square, and were placed one inch from the bottom of the blast-pipe for the smaller pipes, and $2\frac{1}{2}$ inches for those above five inches diameter. The effect produced is in all cases given in lineal feet per second. The number of cubic feet of air drawn in each experiment may be calculated by multiplying the numbers given by the area of the air-passage (two square feet), and the product by 60; and the power of a boiler may be estimated by multiplying the numbers so obtained by the number of jets which the boiler may be capable of maintaining. It may be useful here to repeat, that a Cornish tube boiler, $30\frac{1}{2}$ feet long, of the best construction, was found capable of affording steam for a $\frac{3}{4}$ -inch square jet, with the steam blowing off at 50 lbs.; it would therefore be equal to 36 eighth-inch jets. It may be proper also to remark, that in these experiments the large jets acted under a great disadvantage from the small area of the air-passage, and that it is by no means proved that the results to be obtained from the use of large jets must be worse than those to be obtained from small jets, if the area of the air-passage be correspondingly increased. The principal object with which these experiments were undertaken, was the determining of the proportions to be observed between the blast-pipe and jet to produce the best result. From the shortness of the time within which these experiments could be made, it was impossible to investigate the causes of discrepancies which may be observed.

RESULTS of EXPERIMENTS on the Effect produced by different Jets in different Blast Pipes, showing the Velocity of the Current in Lineal Feet per Second, when the Orifice of the Air-passage was open and when it was partially closed, so as to produce a Rarefaction equal to 2, 1½ and 1 Inches of Water, together with the greatest Exhaustion produced in each case.

| DIAMETER of BLAST PIPE - { | 2 Inches. | 3 Inches. | 4 Inches. | 5 Inches. | 6 Inches. | 7 Inches. | 8 Inches. | 9 Inches. | 11 Inches. | 12 Inches. | 15 Inches. | 16 Inches. | 17 Inches. | 19 Inches. |
|----------------------------|-----------|-----------|-----------|-----------|-----------|-----------|-----------|-----------|------------|------------|------------|------------|------------|------------|
| 1/6-inch Jet. | | | | | | | | | | | | | | |
| Open - - - - - Velocity | nil | 0.6 | 1.1 | 1.6 | 2.1 | 2.4 | 3.1 | 3.2 | not tried | not tried | not tried | 6.5 | - | 5.8 |
| Greatest Exhaustion - - - | - | ¼ in. | ½ in. | ¾ in. | - | ½ in. | - | - | - | - | - | - | - | - |
| 1/3-inch Jet. | | | | | | | | | | | | | | |
| Open - - - - - Velocity | 0.2 | 1.6 | 2.5 | 3.3 | 4.5 | 5.3 | 6.2 | 6.6 | not tried | not tried | not tried | 11.1 | - | 10.5 |
| 1½-inch Water-gauge - - - | - | 4 | 8.3 | nil. | - | - | - | - | - | - | - | - | - | - |
| 1-inch - ditto - - - - - | 2.6 | 6.6 | 9.7 | - | - | - | - | - | - | - | - | - | - | - |
| Greatest Exhaustion - - - | 1½ in. | 2 in. | 1½ in. | - | ¾ in. | - | - | - | - | - | - | - | - | - |
| 1/2-inch Jet. | | | | | | | | | | | | | | |
| Open - - - - - Velocity | 0.9 | 2.9 | 4.4 | 6.2 | 10.5 | 8.8 | 10.5 | 9.6 | not tried | not tried | not tried | 19. | - | 20. |
| 2-inches Water-gauge - - - | 5. | 10. | 14.5 | 17.6 | 19.5 | nil. | - | - | - | - | - | - | - | - |
| 1½-inch - ditto - - - - - | 5.1 | 10.3 | 16. | 20. | 20.2 | 19.8 | 19.6 | nil. | - | - | - | - | - | - |
| 1-inch - ditto - - - - - | 5.1 | 11.3 | 13. | 20.3 | 19.8 | 20.6 | 17.6 | nil. | - | - | - | - | - | - |
| Greatest Exhaustion - - - | ¾ in. | 4½ in. | 6 in. | 5½ in. | 3½ in. | 3 in. | 2 in. | 1½ in. | - | - | - | ½ in. | - | ¼ in. |
| 5/8-inch Jet. | | | | | | | | | | | | | | |
| Open - - - - - Velocity | 1.3 | 4.6 | 6.2 | 10.2 | 11.9 | 15.1 | 18.1 | 15.1 | not tried | not tried | not tried | 33.3 | - | 31.3 |
| 2-inches Water-gauge - - - | - | - | 23.6 | - | 29. | - | 39.6 | 27.3 | 12. | nil. | - | - | - | - |
| 1½-inch - ditto - - - - - | - | - | 22.9 | - | 27.8 | - | 35.6 | 34.2 | 38. | 28.3 | - | - | - | - |
| 1-inch - ditto - - - - - | - | - | 21.3 | - | 27.2 | - | 32.3 | 35.7 | 39.3 | 40.6 | - | 7.0 | - | - |
| Greatest Exhaustion - - - | - | - | - | - | 6½ in. | - | 3½ in. | 2½ in. | 2½ in. | 1½ in. | - | 1½ in. | - | ½ in. |
| 1-inch Jet. | | | | | | | | | | | | | | |
| Open - - - - - Velocity | 1.4 | 5.5 | 7.7 | 12.4 | 15.1 | 18.6 | 21.6 | 19.6 | not tried | not tried | not tried | 41.6 | - | 39.6 |
| 2-inches Water-gauge - - - | - | - | 25.0 | - | 30.6 | - | 42.6 | - | - | - | - | - | - | - |
| 1½-inch - ditto - - - - - | - | - | 23.6 | - | 29.4 | - | 34.5 | - | - | - | 51.3 | 33.6 | - | - |
| 1-inch - ditto - - - - - | - | - | 21. | - | 31.6 | - | 38.0 | - | - | - | 55.6 | 43.9 | - | 14.6 |
| Greatest Exhaustion - - - | - | - | - | - | - | - | - | - | - | - | 2 in. | 1½ in. | - | 1 in. |
| 1 1/8-inch Jet. | | | | | | | | | | | | | | |
| Open - - - - - Velocity | 1.2 | 6.3 | 8.3 | 12.7 | 16.5 | 21.3 | 25.4 | 21.5 | not tried | not tried | not tried | 58.3 | - | 42.3 |
| 2-inches Water-gauge - - - | - | - | 28.1 | - | 36.6 | - | 42.6 | - | - | - | - | 40.0 | - | nil. |
| 1½-inch - ditto - - - - - | - | - | 24.9 | - | 36.1 | - | 41.0 | - | - | - | - | 53.0 | - | 44.6 |
| 1-inch - ditto - - - - - | - | - | 24.0 | - | 31.6 | - | 40.4 | - | - | - | - | 53.0 | 62. | 47.0 |
| Greatest Exhaustion - - - | - | - | - | - | - | - | - | - | - | - | - | 2½ in. | 1 in. | 1½ in. |
| 1 1/4-inch Jet. | | | | | | | | | | | | | | |
| Open - - - - - Velocity | 0.8 | 5.5 | 8.9 | 13.3 | 17.2 | 21.9 | 26.5 | 23.5 | not tried | not tried | not tried | blown away | - | 47.3 |
| 2-inches Water-gauge - - - | - | - | 24.9 | - | 41.0 | - | 45.6 | - | - | - | - | 47.5 | - | - |
| 1½-inch - ditto - - - - - | - | - | 28.8 | - | 38.0 | - | 42.3 | - | - | - | - | 59.6 | 60. | 53.3 |
| 1-inch - ditto - - - - - | - | - | 26.0 | - | 34.1 | - | 40.1 | - | - | - | - | 58.3 | 63.3 | 58.6 |
| Greatest Exhaustion - - - | - | - | - | - | - | - | - | - | - | - | - | 2½ in. | 2 in. | 2 in. |

EXPERIMENTS made with a view of ascertaining whether the Height of the Blast Pipe influences the Effect produced.

| JET - - - - - { | 1/8 Inch. | 1/4 Inch. | 1/2 Inch. | 3/4 Inch. | 1 Inch. | 1 1/4 Inch. | 1 1/2 Inch. |
|---------------------|--------------------------------|-----------|-----------|-----------|---------|-------------|-------------|
| 3-inch Blast Pipe { | 5 feet high - - - - - Velocity | 0.4 | 1.5 | 3.1 | 4.3 | 5.3 | 5.8 |
| | 10 ditto - - - - - " - | 0.6 | 1.6 | 2.9 | 4.6 | 5.5 | 6.3 |
| | 20 ditto - - - - - " - | nil. | 1.1 | 2.5 | 2.8 | 4.3 | 5.6 |
| 3-inch Blast Pipe { | 5 feet high - - - - - Velocity | 2.8 | 5.8 | 9.7 | 15.6 | 19.2 | 19.4 |
| | 10 ditto - - - - - " - | 3.1 | 6.2 | 10.5 | 18.1 | 21.8 | 25.4 |
| | 20 ditto - - - - - " - | 2.7 | 6.1 | 10.1 | 16.9 | 17.8 | 22.5 |

The Witness is directed to withdraw.

S. Dobson, Esq.

13th July 1849.

SAMUEL DOBSON, Esquire, is called in, and examined as follows:

4367. YOU are a Mineral Agent and Engineer in South Wales?

Yes.

4368. Have you any large collieries under your superintendence?

I have no collieries under my management; but, as the Honourable Mr. Clive's mineral agent, I am in the habit of frequently examining several extensive collieries and mines.

4369. Have you been for a long time engaged in that occupation?

I served a pupilage in the mines of the North of England; but I have only been about 10 months in South Wales.

4370. Have you been long engaged in it in the North of England?

Yes, I have been connected with collieries for about seven years.

4371. In the course of your experience in that business have you turned your attention to the causes of accidents and the means of preventing them?

Yes, I have paid some attention to that subject.

4372. With respect to accidents arising from explosions, what appears to you to be the most common cause of such occurrences?

I should say neglect.

4373. Upon the part of the managers, or of the work-people?

Both on the part of the work-people and on the part of managers.

4374. Is it your opinion that in most collieries the arrangements for working the mine are responsible for the accident, or not?

In many mines the arrangements are bad, and many accidents, no doubt, occur in consequence; in others, accidents take place from neglecting to carry out the arrangements of the colliery.

4375. In what part of the arrangements do you generally find that the danger of accidents is most prevalent?

In South Wales, I think, the danger of such accidents as are most prevalent arises from the defective way in which the air is distributed under-ground, thus allowing of partial accumulations of gas; such, for instance, as in the cavities of the roof, and in the stalls and headings, where no regular current of air is passing.

4376. Do you think that an efficient system of ventilation would, for the most part, secure mines against accidents of that description?

No; I do not think that ventilation alone would render such mines perfectly safe under all circumstances: I do not think that any practicable amount of ventilation would secure the mines of some districts from accidents.

4377. Not altogether?

Not altogether.

4378. But do you think that the risk of accidents might be very much diminished by good ventilation?

I think that the risk of accidents would be very much diminished by the adopting of a judicious system of distributing the air under-ground. This subject, in my opinion, requires more attention than any other.

4379. Do you think that a matter of greater importance than the apparatus which is made use of for the purpose of effecting ventilation?

Yes; I think the mode of distributing the air under-ground of the greatest importance.

4380. In saying that, do you apply that remark principally to the Welsh coal-field with which you are now acquainted?

Yes, more particularly to the Welsh coal-field than to any other; the arrangements for conducting and distributing the air under-ground in the North of England are very superior to those of South Wales, and, perhaps, to those of any other district.

4381. Should

4381. Should you say that the system of ventilation in South Wales is generally defective?

Yes, I think it is, generally speaking, very bad.

4382. In what respect do you think it most so?

I have prepared a plan showing the present mode of working, and upon which is laid down a mode of ventilating much practised in some districts of South Wales—[*The Witness produces the same*]. Perhaps it will be as well to describe the mode of working in the first place, and the mode of ventilating afterwards. It is customary to drive a level heading and a wind-road, which are marked A and B, from the bottom of the pit, where the seam of coal is sunk to or from the surface, when it crops out. This heading and wind-way are driven in a water-level direction.

S. Dobson, Esq.

13th July 1849.

Vide Appendix I.
Plan, No. XXIV.
Diagram (No. 1.)

4383. Are they driven along the line of the strata?

Yes; from these headings cross-headings are turned to the rise, and sometimes to the dip, but very seldom to the dip, the inclination of the strata being so great as to render the cost of leading the coals from dip-workings so great, that workings to the dip of the water-level are seldom made, except under peculiar circumstances. These cross-headings are driven at an angle of about 75 degrees to the level heading; they are driven at that angle, instead of at a right-angle, for the purpose of lessening the inclination, thereby rendering the transit of the coals from the workings to the level heading easier. These cross-headings are turned at distances apart of from 70 yards to 120 yards, according to the nature of the roof and the weight of the superincumbent strata, and from them stalls are turned, which are driven in both directions, when the roof is good, and when the headings are turned 120 yards apart, but only in one direction when the headings are turned about 70 yards apart. Those stalls, when turned in both directions, are driven until they hole into each other; but when only turned in one direction, they are driven to within eight or nine yards of the adjoining heading, and then stopped; the stalls are driven about six yards wide, and the thickness of the pillars left varies from five to six yards; a portion of these pillars is taken out by what is called "robbing." The system of taking out the pillars is shown upon the plan at F, and consists of the taking of as much coal from the sides of the pillar as can be gotten, until the pillar is rendered so weak as to make it no longer safe for the workmen to pursue the getting of the coal there, and the remainder is lost. As regards the ventilation, the air is brought in by the wind-way, and carried around each cross-heading, ventilating, in its course, the stalls. The stalls are ventilated by driving wind-ways through the pillars, which are left behind as found necessary, the last wind-way being closed up with rubbish of the mine as soon as the innermost one is holed. The air, after ventilating the first heading, is brought into the next one, and so on throughout; there is no splitting carried on in this system at all.

4384. The same current passes through each of the headings successively, does it?

Yes, the current is continuous. After it has passed around the whole of the workings, it passes to the upcast shaft, along the main-way, the main-way being made the return.

4385. Do you consider that a very imperfect mode of ventilating?

Yes, I think it is a very imperfect mode of ventilating.

4386. And do not you think that by that means you lose some of the power of ventilation which you might obtain by splitting?

Yes, I think a great amount of power is lost; for when the current of air is continuous, the distance which it has to travel is very great, and the resistance of the mine, in consequence, much greater than it would be if the system of splitting were practised; so that the same motive-power applied to ventilate a mine, where the current is continuous, would not be nearly so effective, as regards quantity of air, as it would be were the system of splitting practised.

4387. So that whatever improvements were introduced in the ventilating agent for mines, there would be still a very great defect in the distribution of the air-passages below ground?

Yes, a very great defect.

S. Dobson, Esq.

13th July 1849.

4388. Unless an alteration was effected in those respects ?

Yes.

4389. The ordinary agent of ventilation in South Wales is the furnace, is it not?

Yes.

4390. Where there is any ?

Where there is any; but if your Lordships will allow me, I wish to state, that the system of ventilating, which I have just explained, is the worst practised in South Wales; and my object in laying it down upon this diagram, was for the purpose of drawing attention to the fact, that such a system continues to be practised in that country: it will be easily seen that the system is very bad. The mere fact of returning the air along the main-way, after it has passed around the whole of the headings and stalls, to be there exposed to the naked lights of the hauliers and others is bad; and after the current has passed around the stalls in each heading, it sweeps along the edge of its goaf, carrying with it whatever impurities it collects there into the adjoining heading to be there carried around the stalls; so that it is really very bad; but, notwithstanding that, many of the collieries continue to be ventilated upon this principle. At some of the collieries attached to iron-works, however, and in some of the better conducted sale collieries, there is a different system adopted; splitting is practised to some extent, and there is more attention paid to the working generally.

4391. Many of the mines in South Wales are left entirely to natural ventilation, are they not, without any artificial assistance ?

Yes, many of them are: the usual mode is to ventilate with the furnace.

4392. But there are many that are not even ventilated with the furnace, are there not ?

Yes, many.

4393. That are left to the ventilation of the atmosphere, without any furnace or other apparatus ?

Yes; there are some ventilated by natural means; for instance, by erecting a stack over the upcast shaft.

4394. That is to say, there is no ventilation, except the natural action of the atmosphere, by the difference of temperature in the two shafts ?

Yes. This is a diagram—[*producing the same*]*—*which I have prepared, showing some modifications and improvements which, in my opinion, might be adopted with advantage in the working of the mines of South Wales. I do not think that the principle of working practised in South Wales is by any means ill-adapted to the working of the coal-seams of that country; but I think that it might be very much modified by the introduction of improvements from other districts.

*Vide Appendix I.
Plan, No. XXV.
Diagram (No. 2.)*

4395. Do you think that this plan of working the coal might be still pursued consistently with a better system of ventilation ?

Yes, if it were modified. The great difference between the system of South Wales and the other districts, is the driving of stalls without holing them into the adjoining heading, so that each heading with its stalls is, in point of fact, a different district; it is a district of itself.

4396. Would not that make it still more easy to subdivide and split the air ?

Yes, which I will endeavour to explain; I think that the first great improvement which might be effected, would be the driving of double drifts, both for the level-headings and for the cross-headings, in addition to the water-level drifts. It is customary now, as will be seen from Diagram (No. 1,) to drive, as it were, double drifts; but the second drift, which is called the wind-way, is only made by holding through from one stall to another. There is very little attention paid to the driving of those wind-ways; they consider that if they get the air-way through, that is quite sufficient. Now I think it of great importance that as much attention should be paid to the driving of the wind-way as to the main-ways, and that, instead of opening the wind-way from one stall to another, that the cross-headings and the level-headings should be driven, and made use of as exploring drifts, as in the North of England.

4397. So as to be continuous passages ?

Yes; and to be kept before the other workings. After that, I think the leaving of thicker pillars a matter of great importance: instead of leaving the pillars five

or

or six yards in thickness, I think they ought to be left from 12 to 15 yards or more, according to the nature of the roof, and the weight of the superincumbent strata. Now, by leaving the pillars of this thickness, the taking of them out would be made a distinct operation: at the face of the stall an opening would be made from one stall to another, and the taking out of the pillar proceeded with towards the heading; two or three rows of timber would always be kept behind the workmen; the last row of timber would always be drawn out as soon as the front row was added, thus allowing the roof to fall, as shown upon this diagram. This system is not at all different from the present mode of working in South Wales, because they do hole the pillars through at present for air. It will be observed, that when this cross-heading is finished, it will have its pillars left: now, those pillars could be very easily taken out in the same way, as explained in speaking of the stall pillars: two or three rows of timber are kept standing, and the last ones drawn out as the work proceeds: by the present mode of working, these pillars are left, and taken out afterwards, in a similar manner to that just described; but it is all by the system of "robbing;" the pillars are left so thin, and, in consequence, become so crushed, that they get out what they can with safety, and leave the remainder: now, there is not only a great waste of coal by leaving the pillars so thin, the coal becoming so much crushed, as to produce in working scarcely anything but small; but the workmen, in pursuing the system of "robbing," are much exposed to accidents from falls from the roof, and so on.

S. Dobson, Esq.

13th July 1849.

4398. And would this plan render a good system of ventilation easy?

The system of ventilation would be this: the air would be brought in along the main-way, and at each cross-heading it would be split, so that each cross-heading with its stalls, would have a separate current of air for itself: so much would be split off here [*showing the same*], and carried round the workings; it would bear up to the face of the heading, thence around the face of the stalls, and afterwards ventilate the edge of the goaf of each heading, after which, it would be carried over the main-way by a crossing into the return drift, where it would join the return current from the other headings, and be conducted to the upcast shaft. Now, upon this part of the diagram, which is coloured red, is shown a different system of ventilating the stalls, *i. e.* by the use of brattices. The use of brattices for ventilating, is not by any means general in South Wales; they are sometimes applied, for instance, in driving headings, or other narrow work. By this system of working which I have explained, brattices might be applied very easily, in fact even better than in the North of England; in the North of England they require board-end doors, but by this plan they could be applied without any additional doors. The current of air, as laid down upon the diagram, ventilates the stalls, and then the edge of the goaf, after which it is carried into the return drift, as before explained. Now, this plan of ventilation, as will be observed from the diagram, is much more perfect than the system of making openings through the stalls, because by that system there must always be a part of these stalls without any current of air passing in them.

4399. Do you conceive that there would be any difference in the expense of working a mine upon this plan, or upon another?

I think that this plan would not be more expensive; on the contrary, I think it will be of very great benefit to both the person who works the coal-mines, and to the person to whom the mineral belongs; because a very much greater proportion of merchantable coal would be got out by this system, in consequence of the pillars being left of such a thickness as to prevent their becoming crushed; and if a greater proportion of large coal was got out, it is quite plain that the person who works the mine, as well as the owner of the mineral, would benefit by it, because he has got a certain amount of narrow work to drive for a given extent of coal-field, and his object is to get as much large coal out for his narrow work as possible.

4400. You think, in fact, that this would be a much more profitable way of working?

I think decidedly so. Many people would object to this plan of ventilating, because they would consider that the use of brattices was more expensive than the present mode of ventilating; but I think it could be easily shown that ventilating with brattices would be less expensive than the mode of driving wind-ways through the stalls, when the pillars were left thicker, especially when there is taken into

S. Dobson, Esq.
 13th July 1849.

account the saving of large and merchantable coal, by not having these wind-way driven; because it must be recollected that very nearly all the coal got out of them is small coal.

4401. You say that many collieries in South Wales are ventilated by furnaces
 Yes.

4402. Do you consider the furnace an efficient agent of ventilation; does it do its work properly, so far as you have seen it; generally speaking, have you found furnaces efficient for their purpose in South Wales?

The mines of South Wales are very ill adapted for the application of the furnace as a means of obtaining a motive power.

4403. Because there are very few perpendicular shafts?

Not only on that account; even where there are perpendicular shafts they are, in many instances, of so small a depth, that the furnace is almost ineffective, because the power of the furnace depends upon the depth of the shaft.

4404. Did you ever see any other means used in place of a furnace for the purpose of effecting ventilation in South Wales?

I have seen Mr. Brunton's machine, which is erected at Gelly Gaer Colliery, belonging to Mr. Powell.

4405. Have you seen it in action?
 Yes.

4406. Have you examined it at all?
 I have.

4407. What is your opinion with respect to the action of that machine?
 I think it is a much more powerful means of ventilating than the furnace.

4408. Have you ever made any accurate observations as to its power?

Yes, the first day that the machine was tried I was there, and took some part in making some experiments with it; I expected to have made some further experiments during this last week, under much more favourable circumstances than those under which the first were made, and went to the colliery for that purpose; however, I found that the air-courses had not been altered at all, and, more than that, there was not sufficient water for condensing the steam from the small engine that was working it, the engine being a condensing engine; therefore the experiments could not be made with any degree of satisfaction.

4409. Therefore the engine was not working under favourable circumstances?

Not at all. I think it only right to the inventor to state, that the machine is very badly made; I believe he had to make it out of old materials, and it is not by any means perfect.

4410. Will you state the result of the experiments which you say you made upon that occasion?

When the machine was revolving at 48 revolutions per minute, there were .55 of an inch of water got.

4411. Do you mean in the water-gauge?

Yes; which is equal to a pressure of 2.860 lbs. per square foot; at 93 revolutions there was 2.10 inches of water, which is equal to 10.936 lbs.; and at 99 revolutions there was 2.50 inches of water, which is equal to 13.020 lbs. per square foot. When the current of air was cut off from the pit, and the door which is in the drift or tunnel leading to the machine was closed, the machine was driven at 132 revolutions per minute; this was under very unfavourable circumstances; the steam from the small engine was blowing through the condenser; however, the water-gauge during that experiment gave 4.20 inches of water, which is equal to 21.873 lbs. per square foot.

4412. Of exhaustion?
 Yes.

4413. Do you know what amount of current you obtained at that time?

On the first trial we measured the air in a 6-foot drift, and found that it was passing at the following rate. This is a paragraph which appeared in the local newspapers at the time, and the statements found in it are perfectly correct. In this

this 6-foot drift it was found that 18,000 cubic feet were travelling through it. In the first place, before getting into this area of 36 feet, the air had to pass through a drift in some places only about three feet broad and two feet high, making an area of six feet; after passing through the part which was 36 feet area, it had then to pass through a place where a man could merely crush himself through, which had not an area of above four feet; so that under these circumstances the velocity of the air, both in the first and second small places, must have been very great indeed.

S. Dobson, Esq.

13th July 1849.

4414. Therefore the current was considerably impeded by those places?

The resistance must have been very great, from the passage of 18,000 cubic feet of air per minute through such small openings as those just mentioned. I should mention, that the air, in the first place, was travelling at 32 feet per second, and, in the second place, it was travelling at 70 feet per second.

The Witness delivers in the following document :

William Brunton's New Colliery Ventilator.

At Gelly Gaer Colliery a ventilator, upon an entirely new construction, invented by Mr. Brunton, has been erected under his superintendence for the special purpose of testing its power of rarefaction.

On Friday the 4th instant, Thomas Powell, Esq., of the Gaer, proprietor of the colliery, together with several practical and scientific gentlemen, attended to see the machine put to work, and to ascertain its capability. The experiments were recorded and calculated by Mr. Samuel Dobson, mineral agent to the Honourable R. H. Clive, M. P.; Mr. E. Scott Barber, mineral agent to Sir Charles Morgan, Bart. The experiments were also witnessed by Jonathan Worthington, Esq., proprietor of the Llancaiach Colliery; W. S. Cartwright, Esq., proprietor of the Waterloo and Tophill Collieries; John Calvert, Esq., proprietor of Collieries in the Rhondda Valley; Messrs. James and Hughes, of the Uskside Iron-works; Mr. Enoch Williams, Mr. Oliver, and several mining agents.

The machine is applied to the top of the upcast pit by a short tunnel or air-course, and is driven by a steam-engine. By the principles of this machine the air is subjected to the influence of centrifugal force, whereby any degree of rarefaction necessary to the complete ventilation of a colliery may be attained with the greatest economy of power.

The rarefaction produced was indicated by a water-gauge, and being carefully noted and compared with the velocity of the machine, was found most satisfactorily to correspond with theoretical deductions.

The rarefaction maintained in the upcast pit being equal to $2\frac{1}{2}$ inches of water, or 13 lbs. on the square foot, of course produced a strong current through the workings of the colliery, one of the air-ways of which, 20 yards long, has a mean area of only $9\frac{1}{2}$ superficial feet; yet such was the power of the machine, that 18,000 cubic feet per minute were propelled through this passage, at a velocity of 32 feet per second, and afterwards, in its way to the upcast pit, through an opening of only four superficial feet area, at a velocity of 70 feet per second, exhibiting a degree of rarefaction and power of propulsion (the chief objects of the experiment) to the entire satisfaction of all the gentlemen present.

The quantity of air was measured carefully in its passage through one of the levels six feet square, where it travelled 20 yards in seven seconds.

The mechanism of the machine is of the most simple and integral character, has no valves or separate moving parts, had no attrition, and all the friction is resolved into a foot pivot, moving in oil; when at rest, offers no impediment to the air ascending from the pit; liable to no derangement, and is very inexpensive; in short, it is a simple mechanical implement, whereby any degree of rarefaction necessary to ventilation is rendered certain, regular, and, under visible inspection, being subject to the law of central forces, which is as fixed and determinate as that by which a stone falls to the earth.

On the following day a very important experiment was made by stopping the influx of air from the downcast shaft, and in less than five minutes the whole of the colliery was thus artificially subjected to a rarefaction equal to, and in its effect upon the gas in the coal corresponding with, a sudden fall of the barometrical column of about 2-10ths of an inch of mercury, and this may be greatly increased.

To this capability of drawing off at pleasure the carburetted hydrogen from the goaves and fissures during the absence of the workmen and their lights, and the re-introduction of fresh air before the men resume their work, when the colliery will be found in a state of extraordinary purity of atmosphere, the inventor looks with great confidence as the most effectual means of preventing fire-damps, and also of promoting the health of the workmen. Mr. Calvert, a large coal proprietor, one of the gentlemen present, was so satisfied with the utility of the machine, having been under-ground during its operation, that he has since given Mr. Brunton an order for one to be fixed at his colliery immediately. We congratulate our enterprising neighbour, Mr. Powell, on being the first to introduce so valuable an invention, the adoption of which, we trust, will be the means of saving the lives of many of our colliers.

S. Dobson, Esq.

13th July 1849.

4415. Do you know what quantity of air was passing through these passages at the time when you made the experiment ; did you ascertain the number of cubic feet per minute ?

Yes ; there were 18,000 cubic feet per minute passing through.

4416. Do you know what had been previously produced by the furnace ?

It was ventilated by a water-fall. At the time the 18,000 cubic feet was passing through the mine, the machine was making between 90 and 100 revolutions per minute, perhaps I might say 94 or 95 revolutions per minute.

4417. That would be about $1\frac{1}{2}$ revolution in a second ?

Yes. Although there was a water-pressure shown at that time of about $2\frac{2}{10}$ ths of an inch by the water-gauge in the drift, upon the surface leading to the machine, there was only a water-pressure shown of about $1\frac{1}{2}$ inch by the underground water-gauge. This was owing to the machine getting its air from the top of the upcast pit, which was so imperfectly covered in as to allow air to pass down it to such an extent as to cause the difference between $2\frac{2}{10}$ ths and $1\frac{1}{2}$ inches of water. If the whole of the power had been applied, of course the amount would have been greater.

4418. Do you know what power there was in action at the engine when there were 132 revolutions in a minute ?

The engine is an engine of 18 inches cylinder, and 4 feet 6 inches stroke, and the pressure of the steam was about 30 lbs. upon the square inch ; but the engine is a condensing engine ; therefore it cannot be considered that that steam was anything like so effective as it would have been had the engine been a high-pressure one.

4419. Do you think, from what you saw of the machine at that time, that it could have been made to revolve very much more rapidly with safety ?

I should say that the machine might be driven with safety up to 150 revolutions per minute.

4420. You attained 132 ?

Yes ; at 150 revolutions per minute there would be $27\frac{2}{10}$ ths lbs. upon the square foot got.

4421. Did you go into the mine during the time that this apparatus was in action ?

Yes, I did, when it was driven at 132.

4422. Was the current very strong ?

Yes. I did not measure the air at that time, because I considered it perfectly useless to make any experiments upon the current of air under-ground, seeing the unfavourable circumstances under which the machine was applied ; but at that time I observed some water standing against one of the main doors, upon the horse-way. This door was not quite close at the bottom, and the current was forcing its way through the water, which it was bringing up from the bottom of the door in a shower.

4423. Can you form any opinion as to the probable expense of applying an apparatus of that kind to a colliery ?

I should think the expense would be very trifling indeed. Does your Lordship mean the cost of working it, or the cost of applying it in the first instance ?

4424. The cost of the apparatus in the first instance ?

I really do not know the cost of it, but I should think it very trifling ; the inventor may, perhaps, be better able to speak as to the cost of it ; but I should think that 100% would cover every expense necessary in the first instance, exclusive of the power to drive it.

4425. So far as you have been able to judge of it, do you think it an apparatus which could be put up by the owner of a colliery for the purpose of effecting good ventilation ?

Yes. I think it might be applied in some collieries with considerable advantage. I think it is the most simple means of ventilating by machinery that I am aware of. I think the machine itself is much less liable to accident than any other machine of the kind.

4426. Are

4426. Are you aware whether any one else is about to apply it?

I believe Mr. Calvert, a coal-owner, in Glamorgan, is going to apply it; indeed I believe that one is now being made for him.

S. Dobson, Esq.

13th July 1849.

4427. Is the current now produced by this apparatus, sufficient for the purpose of ventilating this particular colliery?

Yes, when the machine is driven at 132 revolutions per minute; it is upwards of twice the power that can be got by the furnace.

4428. Is that as much as is desirable?*

I should think quite sufficient.

4429. Is it sufficient to keep the mine in a safe state?

I should think quite sufficient.

4430. Supposing a greater quantity were required for more extensive workings, could an additional quantity be easily produced by this apparatus; could the velocity of the current be increased, I will not say indefinitely, but to a great extent?

I should not like to say that the machine might be driven with safety for any length of time to upwards of 150 revolutions per minute; it might be for a short time, but not to continue at a greater velocity.

4431. Then you believe the power to be limited?

Yes; the power would be limited as far as that goes; but it must be recollected, that when the machine is making 150 revolutions per minute, there are $27\frac{9}{10}$ ths lbs. pressure upon the square foot, and the furnaces in the best regulated districts do not produce a motive power of more than from 5 lbs. to 10 lbs. on the square foot; in fact, to apply the furnace under the best circumstances, that is to say, if you have an upcast shaft of 400 yards in depth, with a mean temperature of 120 degrees, while the temperature of the atmosphere is about 60 degrees, you will only get 10 lbs. upon the square foot, or $1\frac{9}{10}$ ths inch of water.

4432. You are of opinion that, in order to give the experiment a fair operation, you ought to have a high-pressure engine, which you could not command at the time when you saw it?

Yes; I think if the machine was made in a better way, which it is quite capable of being, and a high-pressure engine applied to drive it, if ever it was found necessary to do so, it might be driven with safety up to 150 revolutions per minute; but I think it would always be found that the machine, when driven at 100 revolutions per minute, which would give a pressure of upwards of 13 lbs. upon the square foot, would be quite sufficient for all purposes of ventilation under ordinary circumstances. Perhaps it might, in case of emergency, be necessary to increase the velocity of the machine, which could be easily done.

4433. Do you know what the water-gauge was in the workings?

At the time of the experiment, when the water-gauge was about 2.20 upon the surface (I speak from memory), I think it was about $1\frac{1}{2}$ inch in the workings; the difference was lost by not having the upcast shaft properly covered in; the machine was drawing a portion of the air from the surface.

4434. It was drawing some down from the surface?

Yes.

4435. Would it not be partly caused by those impediments of which you spoke a short time ago?

No; I think the pressure in the mine would have been the same under all those circumstances. I think it is perfectly obvious, that if all the means of getting air had been cut off, except through the workings of the mine, the pressure would have been the same in the mine as it was in the drift or tunnel leading to the machine.

4436. Have you any means of saying whether the machine, as you saw it, is capable of so exhausting the colliery, as to place it in the same circumstances as if the barometer had fallen $\frac{5}{10}$ ths of an inch of mercury?

I think if the air was cut off, and a proper engine applied to drive the machine, it might be driven up to 180 revolutions per minute; because the more the mine became exhausted under these circumstances, the more easily would the machine

S. Dobson, Esq.
13th July 1849.

be driven, as then the resistance from the air passing through it would be very much lessened; 180 revolutions would produce a rarefaction equal to about $\frac{5}{10}$ ths of an inch of mercury.

4437. Supposing that that were done in the absence of the men, and the colliery supplied again with fresh air, would the workmen, on resuming their work, be placed in the same circumstances as if the barometer were rising?

Yes, precisely the same; because if the mine was exhausted when the workmen were out of it, so soon as the fresh air was admitted, the explosive gas would be driven back into the goaf and into crevices, which is the case when the barometer is rising; the effect, I think, would be the same in that case.

4438. By the natural pressure of the atmosphere?

Yes.

4439. In short, what you saw of the machine would leave no doubt upon your mind that it might be so applied as to secure thoroughly effectual ventilation in the Welsh mines?

I think there is no doubt but that mines might be effectually ventilated with it.

4440. Do you think, considering what you have already said of the difficulty of applying furnace ventilation to shallow mines, such as those in Wales, that the application of some apparatus of this kind would be a more desirable mode of accomplishing the ventilation than the mode generally used?

Yes, I think it would in those cases, where a sufficient power of ventilation cannot be got by the furnace, for the reasons which I have already explained.

4441. And it might be applied with economy to mines?

Yes, I think it might; because I think the machine could be worked at as small an expense as the furnace, if not smaller.

4442. Have you ever turned your attention to the subject of an inspection by Government?

Yes, I have paid some attention to that subject.

4443. Do you think that such an inspection might be made efficient?

Yes, I think it might be made very useful in such a district as South Wales.

4444. Upon what footing do you think it could be best established?

That is a question to which I am scarcely prepared to give a direct answer.

4445. What powers do you think the Inspectors should have, and what should be their duties?

I think that an Inspector for such a district as South Wales ought to be a person who understands the different systems of mining for coal at present practised in this country; and he ought to have the power to examine the mines and the maps of the workings when he desired to do so, and to make suggestions to the coal-owners as to the way in which they ought to work and ventilate their mines.

4446. In order to enable him to discharge those duties properly, would it not be necessary for him to have the right to examine mines and plans?

I should think decidedly so.

4447. Do you think that there would be any objection to his having such a power conferred upon him?

No, I do not know that there would be any objection; he would be placed in a very similar position to the mineral agent of an estate; the mineral agent of an estate has the power to examine the workings, the plans, and the account-books, when he likes to do so.

4448. And he would have the means at any time of finding out anything wrong in the workings of the mine quite as easily as the Inspector would?

Yes, decidedly.

4449. Therefore do you think that there would be any great cause for jealousy on the part of the colliery owners if such a power were conferred upon a well-qualified officer by the Government?

I think they would be very glad to listen to a practical person, if they knew him

him to be so ; but I question very much whether they would like to be interfered with by a person unless he understood his profession perfectly.

S. Dobson, Esq.

13th July 1849.

4450. Supposing him to be a well-qualified man, have you any reason to suppose, from your communication with the colliery owners, that there would be a disposition to receive favourably the visits of an Inspector under those circumstances ?

Yes, I think there would ; I think they would like well enough to see a person who would make suggestions for improving their mode of working, and would be glad to carry out such suggestions, if they were convinced of the utility of them, and found the expense of doing so not too great.

4451. Supposing he had no authoritative power to direct any alteration in the management of the mine, and that, with the sole exception of his having power to see the plans and to examine the mine itself, he should have no power of controlling their operations, do you think that they would, generally speaking, be pleased to receive suggestions from him, and to communicate with him ?

The great difficulty in carrying out mere suggestions would be that no one would feel himself called upon to carry them out.

4452. Supposing that an Inspector having the power of examining a mine did so, and then, having seen the mine, expressed to the colliery owner a strong opinion that his mine was in a dangerous state, and that he ought to take certain steps for the purpose of securing the people from risk, do not you think that there would be then, to a certain degree, an inducement to the owner of the colliery to attend to his suggestion ?

Yes, I think so, if the Inspector showed him that his colliery was in a worse state than other collieries in the district ; but if it was not found that his colliery was in a worse state than those of his neighbours, I do not think that he would feel himself called upon to put his colliery in a different position from those of other people, more especially if to do so would cause great expense.

4453. Supposing the Inspector made his observations to those whose collieries are generally found in a defective state, do you think that there would not be a disposition generally to attend to his suggestions involving the safety of the mines ?

Yes ; I think it quite natural to suppose that they would endeavour to make their mines as safe as those of their neighbours.

4453.* Are you aware, from any communications which you may have had with the owners of collieries in South Wales, whether they would be disposed to receive an Inspector upon that footing generally ?

The coal-owners of South Wales are not desirous at all of having an Inspector amongst them ; I have heard some of them speak upon the subject.

4454. But you yourself would see no objection ?

I do not see any objection at all to Inspectors being appointed to the mines ; provided they had only the power of making suggestions, I think they would do good.

The Witness is directed to withdraw.

Ordered, That this Committee be adjourned to Monday next,
Half-past One o'clock.

Die Lunæ, 16^o Julii 1849.

The LORD WHARNCLIFFE in the Chair.

Evidence on the
Prevention of
Accidents in
Coal Mines.

B. Gibbons, Esq.

16th July 1849.

BENJAMIN GIBBONS, Esquire, is called in, and examined as follows:

4455. YOU are a colliery owner in the Midland Counties?
I am.

4456. In the neighbourhood of Dudley?
Yes, near Kingswinford.

4457. Is it long that you have been engaged in those operations?
Fifty years.

4458. In the course of your experience you have turned your attention very much to the question of the ventilation of mines?
Constantly.

4459. And you have published upon the subject, have you not?
I have published a small pamphlet in consequence of a tremendous accident that happened; it was published rather in haste, or I might have improved it, probably.

4460. How long since was that?
It is dated 16th December 1846.

4461. How many collieries have you under your management?
I am at present only working one colliery field in the thick coal, drawing about 100,000 tons per annum of large and small. I have several collieries. I have several pits in the thin coal mines on which ironstone and thin coal are got; but I am only working two pairs of pits in the Staffordshire thick coal, which is there 8 yards or 24 feet coal.

4462. What depth are those mines?
A hundred and forty yards, more or less.

4463. Are the workings extensive under-ground?
Very.

4464. They have been worked for some time, have they?
Yes.

4465. Are those pits of a dangerous description?
Unless properly ventilated, they would be.

4466. The seams are what are called fiery?
Yes; perhaps not to the extent which is found in some districts, but they would be termed so in our district.

4467. In what manner are they ventilated?
By means of a separate air-passage, which is distinct from the working shafts, upon the plan which I recommended.

4468. By furnace?
I use a furnace occasionally, but I now have in use Mr. Gurney's plan of steam, which is peculiarly adapted for the separate air chimney which I use.

B. Gibbons, Esq.

16th July 1849.

4469. Since when have you adopted the steam-jet?
Only recently, within this fortnight.

4470. Up to that time did you ventilate the mine entirely with furnaces?
Only occasionally; frequently with none.

4471. Leaving it to the natural ventilation?
Yes, which is the manner in which the Staffordshire mines are generally ventilated.

4472. Under that system did you find your mine very insufficiently ventilated?
No; I found it perfectly well ventilated, but I was satisfied that the use of high-pressure steam would increase the power of ventilation to any required extent, and I therefore adopted it.

4473. If you found it perfectly well ventilated before, what was the inducement to make the change?

The inducement was simply that it gave me an increased power of ventilation if I should require it, and for the purpose, in fact, of ascertaining the soundness of the principle.

4474. Did you conceive that the mine was properly ventilated when left to the natural action of the atmosphere?

No; at a certain period, during very hot weather, I occasionally used the furnace which was attached.

4475. What was the power of that furnace?
A very small one indeed.

4476. Can you say what power of current you obtained by it?
I can hardly state that distinctly.

4477. What would be the length of the air-passages through which you had to carry the ventilation?

I am afraid in some of these particulars I may be at a loss to answer precisely. My principle is to take all the air into the mine along the working roads and face of the workings, and take it out again by heads driven as near to the top of the coal as possible; so that any gas that is evolved from the coal may go off in an undiluted state, and travel along the air-passage back to the chimney, which discharges it into the atmosphere.

4478. How is this air-passage situated of which you speak?
At the back of the working shaft.

4479. Can you say what was the velocity of the current produced by the natural ventilation, under ordinary circumstances?

No; we can judge when we have a sufficiency; we can tell at once when we have a sufficiency of current. I do not think that in the Staffordshire mines the rapidity of the current has been much attended to. I believe that the rapidity of my currents through the working roads would be from three to four feet a second; not more than that.

4480. And the quantity?

The quantity would be no more than would be discharged by an air-way two feet square for each separate shaft.

4481. Have you calculated what that would amount to in cubic feet per minute?

Not sufficiently to state; I have tried it, certainly.

4482. Can you state nearly?

I should take a great latitude, and say from 5,000 to 10,000 feet is as much as we require.

4483. Not more than 10,000?
No.

4484. Are you speaking now of the current produced by the steam-jet, or by natural ventilation?

By natural ventilation.

4485. Under

4485. Under your former system?

Yes; I could now increase it nearly one-half, if I required to do so.

B. Gibbons, Esq.

16th July 1849.

4486. Is it usual, in the district with which you are acquainted, to have a separate air-passage, in order to carry off the gas from the mine?

Yes.

4487. Where is that air-passage usually placed?

That air-passage is driven at the middle of the coal.

4488. In the middle of the thickness?

Yes.

4489. Of what dimensions, generally speaking, is that air-passage?

It is generally driven about 4 feet by 3, but it is very variable; it is more regulated by the nature of the coal, having to make convenient room for the men to work in.

4490. And that is kept entirely separate from the working passages?

Entirely separate from the working passages.

4491. Have you made any alteration in the position of that air-passage in the case of your mines?

A very material one; my air descends the shaft, travels along the working road and face of the workings, and ascends in the excavations of the coal into the air-passage, which is as near to the top of the coal as the nature of the coal will allow. In the sinking of the pit, there is a channel cut out, which is bricked and separated from the shaft; the air then travels along the air-head, and comes in at the back of the shaft to the chimney. I have one 90 feet high with a fire-place, and another about 35 feet high, which may be used during very hot weather, or at times when there is a want of air; but in the winter time we scarcely or ever use it.

4492. Then the advantage gained by that arrangement is, that the air-passage, departing from the upper portion of the seam of coal, takes off all the light gas that is collected there?

Yes; without having any necessity for a current of air to force it, it will go off entirely by its own lightness.

4493. Under that arrangement you make use of the same shaft, for the downcast shaft and the upcast shaft, do not you?

No, it is the downcast shaft always; it only is a single shaft; other parties are under the necessity by their mode of using two shafts, because by one the air descends, and by the other ascends.

4494. Is not the upcast passage here taken off from the downcast shaft?

Yes; but it is separate from it.

4495. But it is the same sinking?

The same sinking; it is done at the same period.

4496. Do you make the original shaft of larger dimensions, in order to allow of your taking that?

No, it is cut out in the sinking with very great facility, according to this plan — [producing the same].

*Vide Appendix I.
Plan. No. XXVI.*

4497. Then that small ventilating shaft is an addition to the ordinary shaft of the mine?

Certainly. Then I would just mention that by the common means, the ascent and descent of the skips or corfs, or by whatever name they may be called, in which the coal or material is drawn, are very frequently keeping the air in the upcast shaft in a state of disturbance, creating eddies in the air, and interrupting the free passage of the air; whereas by the principle which I have adopted, this is used for the air-passage alone, and is free from all interruption, so that the current of air which descends travels into the work, ascends and discharges all the foul vapours of the mine at the top of this chimney, without ever having been disturbed at all; it is closed from the air.

4498. How long have you had that apparatus in operation?

I have had it 30 years, — not in the same complete state in which it is now, but I have used it for 30 years; almost all my shafts are so; I have 16 or 18 of them.

B. Gibbons, Esq.
 16th July 1849.

4499. Was the sinking of that ventilating shaft attended with any considerable additional expense ?

No; I have stated the particulars in my pamphlet: the sinking cost me, I think, about 5s. a yard, and the bricks are not expensive.

4500. And have you found the result of that, during your long experience of it, quite satisfactory ?

Perfectly.

4501. Have you had any explosions in that mine since you made use of that arrangement ?

When I came to carry out this plan upon a system, I had one explosion by placing a candle in the gas passage, before the system of ventilation was completed. I prosecuted the man at Stafford. It was the result either of extreme ignorance, or of malice, as we suspected; but the difficulty of proving malice is so great, that the jury did not convict him. We have had one other, but it arose from a cause which never, in my opinion, can be obviated by any kind of ventilation; it was by the fall of the roof, bringing down gas with it.

4502. A sudden influx of gas, from the falling of the roof ?

Yes; a roof sometimes before it falls will crack and sink some distance above the coal; then any gas which is lighter than the atmosphere will immediately rise; that cannot be prevented by any plan of ventilation, that I know of.

4503. No ventilation could affect it ?

In my opinion, not by any means. In this case it did not cause any further disaster in the pit; but from a mere accident, the man was passing at the time and this roof fell, and just brought gas enough to fire; they were ignorant of it in the greatest part of the pit.

4504. Was there any great damage done ?

One man died in consequence of it, and two others were burnt in some degree near to the spot; a man 20 yards off was not aware of it.

4505. In the other case, was there any extensive damage done ?

Not that I am aware of, either in the pit or workings.

4506. Then you have had no explosion which would test the question whether that partition would stand a violent shock ?

In the instance that I mention, before the plan of ventilation was carried out, the explosion would have been sufficient to have destroyed it; but it is impossible that it could; it passes at the back of the shaft, and consequently the circle of the shaft opposes its being driven in.

4507. It acts as an arch ?

Yes; it cannot be driven in, and if there were any doubt with respect to sinking it in this oblong form, it could be sunk entirely circular with equal facility, so that any explosion in the inside would only tend to bind it; the circle would be bound by the ground in such a manner that it could not possibly give way.

4508. Then you would not think that the objections which apply to partitioning off the shaft with what are called brattices, for the purpose of using one shaft both for working and for ventilation, would be applicable to a case like that ?

Certainly not; I have had experience of it for 30 years, and never had a derangement take place in it; and if that is not considered sufficient, I would make it circular, and then it would be admitted by everybody to be impossible.

4509. Can you state what that adds to the expense of your shaft ?

I can, because it is stated in my pamphlet; I state that the expense of cutting the channel, which only contains four superficial feet in that instance (but which I recommend 3 by 2), does not amount, at the present high rate of wages, to more than 5s. or 6s. a yard; then there are the bricks to line it with, but those are not much; when the shaft is bricked, that is done; they are not stated, but I can state it.

4510. That would bear what proportion to the sinking of the shaft itself ?

About one fifth or one-sixth part of sinking the shaft.

4511. So

4511. So that in any question arising between the sinking of two separate shafts, and the sinking of a shaft so arranged for the purpose of ventilation, there could be no question as to expense?

None.

4512. Did you ever examine the discharge of gas which took place through that ventilating shaft, the amount that was discharged?

No; because what passes from the mines and comes off in its pure undiluted state is mixed with the air which has passed through the mines; it goes off by its own levity, and therefore that would be uncertain, and I never made any experiments to ascertain the quantity of gas carried off from the mine.

4513. Taking the arrangement as it has been described by you, a passage passing at the upper edge of the seam of coal, and supposing the workings to be carried forward, so as to leave considerable spaces beyond the spot from which this passage first commenced, how would you carry forward the ventilation?

We always begin by driving our working roads to the extremity of the mine to which we intend to get, so that this air-head is cut shorter as you get back; there is no occasion to extend it.

4514. You drive the workings to the extremity?

To the very extremity.

4515. And then bring them back?

Yes; so that this head which drains the working part, and communicating with the air chimney, always remains untouched till these collieries are excavated: this air-head is not disturbed; as you cut it back, the air-head still remains always open in the top of the workings.

4516. Then would the further extremity of the workings always be upon the rise of the coal?

It depends upon the nature of the mine; sometimes it is upon the rise, and sometimes upon the dip; to begin in the dip is the true principle.

4517. You should work upon the dip?

Yes.

4518. Supposing it were taken the other way, would this arrangement serve the purpose of carrying off gas?

Better, I think, than any other method.

4519. Supposing there was at all a rapid dip in the bed of coal, and the passage was taken from the upper end of the working, would it be easy to make the lighter gas descend along that line?

It never will descend, except by mechanical means.

4520. Then would you ventilate in that case by mechanical means?

I must do it, but it is a mode of working which I may state is rather supposition than a thing that would actually occur. If ever you have your air-head below the level of your vent to drain your gas, the gas will not pass along except it is driven out by mechanical means, such as by a violent current of air or some other contrivance.

4521. Take the reverse case; supposing you began at the dip of the pit, and carried this air-passage upwards to the shaft, then all that collected at the lower end of that passage would pass along it to the shaft?

Unquestionably.

4522. Supposing there was an issue of gas not quite at the end of that air-passage, but at some intermediate point, how would it be taken off?

It would pass off by its own levity, which is one of the great objects of that plan; it would pass off by its own levity, without any impulse at all.

4523. How would it reach the air-passage?

These openings all open into the air-passage. This is the working road—[*showing the same*—and for the purpose of driving this air-head, you will observe that there are perpendicular openings into the working road.

4524. At certain distances?

Yes; every 12 or 15 yards.

B. Gibbons, Esq.

16th July 1849.

4525. So that those act, as a kind of subordinate shaft to drain the gas into the main air-passage?

Certainly; and I would just explain this, that these are most important in draining the coal, because gas never passes through our thick coal vertically. It always passes through certain partings of the coal; it passes horizontally from the different partings, but never vertically through the coal.

4526. It passes through those openings?

Yes; I compare it to draining a bog; it is a similar thing; you make main-drains and cross cuts into it.

4527. Having made use of this system for some time (with the aid of a furnace occasionally), you have now substituted the action of steam?

I have.

4528. What experience have you had of that?

Very little; it has been done only for a month; but I can state the increased velocity of the passage of air in the upper air-way, because I have got that.

4529. Will you describe, first of all, the mode in which it is applied?

I carry the steam from the boiler of the engine, because I strongly object to mechanical means (depending upon the care of workmen, when it can be avoided) in a mine.

4530. The boiler is at the top?

The boiler of the engine is on the surface, and that boiler is always at work so long as men are down; therefore it cannot be neglected; it does not depend upon the care of men to furnish steam, as would be the case if you had a separate boiler, which is my great objection; if you use mechanical means, and (through carelessness) the men omit to attend to those mechanical means, accidents may occur at any period; but when you close your chimney entirely from the air, and take your steam from the boiler of the engine, you have nearly a positive certainty that so long as the men are down in the pit, and the engine is at work, you have a supply of steam; therefore it no longer depends upon the care of workmen.

4531. What number of jets have you?

I have carried an inch-and-a-half pipe from the top of the engine-boiler, which is very near to the chimney, and supplied with steam of not more than 6 lbs. or 8 lbs. to the inch; and it is upon that that I shall make the statement of the increased velocity. The other is 30 lbs. to the inch; and in this case I carry some four-inch pipes all the way from the boiler to the side of the chimney, which stands at a considerable distance from the boiler. I open a small aperture under the boiler, adjoining to the boiler fire, by which the ventilating chimney constantly draws a small portion of hot air along the outside of the pipes, to prevent the condensation of the steam; it keeps the outside of the pipe as hot as the inside; it is supplied by the boiler fire; it is a very small space; a current of hot air constantly passes along it. At the side of the chimney there is a pipe inserted. I took an inch-and-a-half pipe and doubled it down, so as to represent what you see in the oblong slit of an organ pipe; I found that that would answer the purpose perfectly well.

4532. That is the jet?

That is the jet.

4533. A simple opening?

A simple opening just beaten down to an oblong passage, like the slit of an organ pipe, about three-sixteenths of an inch wide: there is a cock to regulate the admission of the steam.

4534. What is the pressure at the jet?

The pressure at the jet is the same as at the boiler, because the pipes are kept hot by those means, without any condensation of steam.

4535. And there is no obstruction to the passage of the steam from the boiler to the jet?

Not at all; the four-inch pipe is much larger than the jet; therefore, the steam is at its full density.

4536. Then

4536. Then your jet is applied at the bottom of the chimney ?

Yes.

4537. And the chimney, in fact, constitutes the blast-pipe ?

Yes ; by this plan you will see that it is connected with this air-head, which passes from the working ; this air-head is connected with this air-passage ; it then goes into the chimney, which is closed from the air entirely, and the pipe comes here— [showing the same].

B. Gibbons, Esq.

16th July 1849.

*Vide Appendix I.
Plan, No. XXVII.*

4538. Do you intend, by any mark which you have made upon this diagram, to show that the steam-jet was placed at that point in the shaft ?

It is immaterial where it is placed ; in the chimney it is placed near the bottom.

4539. You were understood to say, that you carried it in a sort of drain ?

I carried it by four-inch pipes inclosed in a small brick sough ; it may be 130 or 140 feet from the boiler to the chimney.

4540. What is the height of the chimney in that case ?

In this case, the chimney is 90 feet high, and in the other not above 35. I found it do in both very well.

4541. It is an oblong jet ?

Yes ; just like the slit of an organ pipe.

4542. Have you examined what power of ventilation you have obtained by this jet since you have applied it ?

From coming so suddenly away, a letter having miscarried, I was obliged to leave yesterday, not wishing to be absent to-day, and I could bring no documents with me except putting this book in my pocket ; but I can so far state as this, that with low-pressure steam of about 8lbs. to the inch, an anemometer being placed in this air-head, the velocity of its revolution before the steam was put on was in eight minutes 1,000.

4543. Without the furnace ?

Perhaps there might be a small quantity of fire used at that moment ; I cannot positively say ; when the steam was put on, the revolutions of the anemometer increased in the same space of time, viz. eight minutes, to 1,600.

4544. Did you ascertain at all what quantity of air was passing through the passage at that time ?

Not sufficiently near to put it upon evidence. The revolutions of the anemometer in an air-way four feet by three feet would give it very nearly.

4545. By calculation ?

Yes. The anemometer is one foot in diameter, and that would be sufficient data for any scientific man.

4546. What anemometer did you use ?

I do not remember the name ; it is a very good one, one which I had from Derby.

4547. Is it Mr. Biram's ?

I think it is Biram's anemometer ; I am pretty positive it is.

4548. This experiment of which you speak, then, was performed with low-pressure steam ?

Yes.

4549. Have you ascertained what it is by high-pressure ?

I have not yet ascertained that. I only know that it has increased the current of air quite as much as we can conveniently work with. It is desirable to regulate the air in our mines ; it is very often an inconvenience to have too much, because our mines have great deposits of small coal or slack coal, causing spontaneous combustion : our object, therefore, is to work, under those circumstances, with as little air as possible, otherwise you would quicken the spontaneous combustion that does take place from the slack and small and broken coal which there is in the mine.

4550. The iron pyrites ?

Yes, where pyrites are mixed with the coal ; but where not, it is very often necessary to lessen the quantity of air.

B. Gibbons, Esq.
 16th July 1849.

4551. Is spontaneous combustion frequent in the mines of Staffordshire?

Always; every side of work, say 90 yards by 50, is obliged to be surrounded with a solid wall of coal, and every aperture is obliged to be stopped closely up, so as to prevent that combustion taking place; that wall is always kept in, and we are obliged to make the doorways or openings into it air-tight with brick and mortar; one of those excavations cannot be made larger, unless you draw your coal very quickly.

4552. Have you ever seen the steam-jet in action as high-pressure steam?
 Never.

4553. You have never seen it anywhere excepting at your own pits?
 I have never seen it; it was from reading the results in other places that I was induced to try it.

4554. You say that you made use of the boiler simply attached to your steam-engine?

Yes, in both instances.

4555. Were you able to supply steam enough without interfering with your working?

Yes; the quantity was small.

4556. Can you say what power you abstracted from the boiler?

No; but it was of no inconvenience; our fuel is of such little importance that we make no calculation of that sort.

4557. Is your boiler high-pressure?

One low and one high.

4558. From which is the steam brought?

From both.

4559. Not in the same place from both?

No, they are separate, at a considerable distance from each other, about 300 yards.

4560. Did you find any difference in convenience between the two?

None whatever; there is no question that the high-pressure steam would increase the quantity of air passed very materially, but we find that with the low-pressure steam we have an ample supply.

4561. You find in that case that the pressure of 8 lbs. to the inch is sufficient to ventilate the mine completely?

Amplly sufficient.

4562. Have you been into the pit often since the jet was applied?

No; but my viewer who manages the work is there, and he is every day in the pit; he spends a great part of his time in it.

4563. Does he consider the ventilation in the workings better than it was before?

Certainly, better in one sense, that is, that there is a greater quantity of air passing through; but it was sufficient before; it was only to ascertain the soundness of the principle that I applied it; it was not from the necessity of increasing the ventilation, but under certain circumstances it might be wanted.

4564. Taking the ventilation which is in action under the steam-jet there applied, and that which you had before, do you think that the present plan is sufficiently preferable to the other to induce you to continue it?

Most certainly, using a separate air-shaft, of whatever dimensions the mine may require, whether one of seven feet diameter, or one of two feet square, such as I use.

4565. You intend, therefore, to retain the steam ventilation?

Certainly.

4566. And not to revert to the furnace?

Certainly not; it is a most convenient and economical mode of procuring that additional draught, which you can always command if you want it.

4567. Do

B. Gibbons, Esq.

16th July 1849.

4567. Do you consider the ventilation in that district bad, generally?
I would rather not give an opinion, if your Lordship would excuse me.

4568. Do you know the works of Mr. Williams, Mr. Forster, and all those parties?

Yes; Mr. Forster and I have adjoining works.

4569. You think that the general ventilation of the Staffordshire coal may be improved?

I think it may; I think the book which I have written is the best expression of my opinion.

4570. We observe that in your pamphlet you state, that you protest *in limine* against all artificial modes?

Yes, I do.

4571. Do you adhere to so broad a proposition?

It was written in rather too much haste, because you will find that the context acknowledges that I recommend the occasional use of the furnace; as far as natural ventilation can be carried with certainty, I would always adopt it, and therefore I would use no greater artificial means than was indispensably necessary; but I think that my opinion is very much modified now from the adoption of the high-pressure steam of Mr. Gurney.

4572. Which does not require the attention that other mechanical means do?

No increased attention at all; it is like using the natural means of ventilation.

4573. The necessity of that attention was your principal objection to artificial modes?

It was.

4574. Is it one of the advantages of the steam ventilation, that you have it more completely under command than the ventilation by furnace?

Certainly, because now there is no opening at all to the outward air. When there was a furnace, though the aperture was so regulated as not materially to impede the ventilation or diminish the draught of the chimney, yet to a certain extent it did so; but that is now at an end, as there is no opening for the external air to get in; therefore it compels all to pass through the mine.

4575. Is there any one in charge of this jet, or is it left to act entirely by itself?

It does not need any one; as soon as the steam is up (and the men cannot go to work until it is), the steam begins to discharge into the chimney.

4576. What proportion does the jet bear to the area of the chimney?

The chimney is $2\frac{1}{2}$ feet by 5; $12\frac{1}{2}$ feet square; $12\frac{1}{2}$ superficial feet.

4577. Near the base where the jet is introduced?

At the base; all the way up it is the same; it is perpendicular.

4578. Had you ever occasion to observe, in the case of that jet which you describe, any reverse current in the chimney?

I should think it is impossible. I do not understand exactly what is meant by the observation.

4579. Supposing a single jet, such as you describe, were placed in the midst of a large shaft, is it not intelligible that it would produce not only an upcast immediately above it, but that it would produce a downcast at the sides to supply the current of air?

That would not happen if the chimney was closed.

4580. Would it not depend upon the size of the shaft?

No; I do not see how it possibly could; that must have been in an open shaft. It could not be, I think, in a closed shaft with a ventilating chimney. If you find any inconvenience of that sort in the chimney which I have mentioned, you may regulate it to the mode of the best action, either by a damper or in any mode which you think proper.

4581. When the air-passage is properly arranged in the mine, is it your practice to keep it entirely to itself?

Entirely.

(164. 14.)

3 1 2

4582. You

B. Gibbons, Esq.

16th July 1849.

4582. You think that very essential?

I consider it indispensable. I have laid down what I call the principles; I do not profess to say that the mode of practice in certain cases is not necessarily different, in some respects, from that which is suited to my own case; still these general principles would, if properly regulated, I should say, apply to any mine whatever: those are the principles upon which I conceive the most perfect ventilation can be effected.

4583. The principles which you state in your publication to be essential in the ventilation of mines are these: "First, that the air-head shall always open into the highest (practicable) part of the mines which are being gotten; secondly, that the air-head shall be a continuous communication from the workings to an air chimney of sufficient dimensions; thirdly, that the air-head shall not in any part of its course be depressed below the level of its opening into the workings; fourthly, that the air chimney, however formed (whether by a separate shaft, or in the manner I recommend), shall never be used for any other purpose than the passage of the current of air from the workings to the surface; fifthly, that the top of the air chimney shall be always closed from the external air, and shall be connected with a ventilating chimney, with a furnace or jet of steam to be used, when required, of sufficient power"—you state now, instead of a "furnace," with a jet of high-pressure steam?

With a jet of high-pressure steam.

4584. Do you conceive that the strict observance of those five conditions is indispensable to efficient ventilation?

I do, as far as practicable, and the nature of the mines will admit, but which, of course, I do not presume to say can invariably be done to the full extent; but as far as the mine allows, in my opinion they ought to be adopted.

4585. When you state as the fifth condition, "that the top of the air chimney shall be always closed from the external air, and shall be connected with a ventilating chimney of sufficient power," will you describe precisely what it is that you mean to enjoin in that condition?

The top of the air chimney is at the top of the shaft, and that must be closed.

4586. What you call the air chimney there, is the lateral shaft that you describe as being made at the same time as the main shaft?

Yes.

4587. The ventilating chimney being above the surface?

Yes.

4588. The air chimney being the lateral shaft from the surface down to the workings?

Yes.

4589. Do you conceive that the plan which you have explained of an air chimney saves expense in the sinking of shafts?

Yes, greatly; I must have two shafts if I do not make that.

4590. Can you state at all, in general terms, what would be the difference of expense to you, between sinking 100 fathoms in the mode which you describe here, and sinking two shafts?

Yes; supposing the shaft to be represented by 1, the addition of the air chimney, of the dimensions which I have given, would add about one-fifth or one-sixth.

4591. Then the two shafts would cost 2?

Yes.

4592. So that it is opposing 1½th against 2?

Yes.

4593. In point of fact, it is dividing a part of the shaft off?

Yes.

4594. Then the result of that is, that you would save five-sixths of the expense of the second shaft?

Yes; and further than that, unless you had three shafts, that is, unless you substituted another shaft for this air chimney, I should not consider the plan of ventilation practicable; if you did not make use of this, I should consider it necessary then to have a third shaft, solely for the purpose of ventilation.

4595. Supposing

4595. Supposing you had two shafts, of which you used only the downcast shaft for working, the upcast shaft being used entirely for ventilation, what should you say?

It would be the same thing as an air chimney, but then you lose a shaft.

4596. That is the usual arrangement?

If you appropriated the shaft solely for ventilation, it would come within what I think right.

4597. Do you know many collieries in which one shaft only is used?

Never before I adopted it.

4598. Have you known it since?

Yes, in my neighbourhood, in some instances, it has been copied, I know; there is one very near to me.

4599. Do you know whether it is successful in those instances?

Perfectly.

4600. But it has not been adopted, so far as you know, in any other district?

No; I am not aware of the fact; they say that it was invented 150 years ago; if so, why did nobody make use of it? Somebody published a letter, stating that it was to be found in the French King's Library.

4601. But you are not aware of any instances in your district before you adopted this system?

I am not; not of using the one shaft for working the mines.

4602. But have you not known of cases where there has been one shaft for the mine, and divided by what they call a brattice?

No, we never do that; it is the Newcastle mode; but we think it more economical to sink two than to sink a large shaft; that has been the universal practice with us, and we consider it a good deal more economical.

4603. Supposing, instead of the 30 feet coal which you have to deal with here, you had only a thin seam, say five or six feet thick, how would you then proceed with respect to the air-passage which you take through the coal?

The thin seams with us furnish so little gas comparatively, that we find it sufficient to carry the air as high as we can; we do not find that it requires more.

4604. Supposing a case like those in the North of the coal being some five or six feet thick at the thickest, and extremely full of gas, what course do you think it would be best to adopt?

I can say nothing more than carrying the air-headings as high as practicable.

4605. Would you think it, then, worth while to carry the air-headings above the coal, and through the top?

I would only limit myself, if your Lordship pleases, to the word "practicable"; I would leave them to judge; I only speak of the principle.

4606. The air-heading in this case is taken entirely through the coal?

Yes.

4607. Therefore whatever working there is in making the air-heading, coal is obtained at the same time?

Yes. Perhaps I may be permitted to say, that I am now getting this coal in a different manner from what I did; I am now getting the whole of the coal throughout, and so is Mr. Forster; we are both of us excavating the whole of the coal; we take the top 12 feet off first; I carry this air-head in the top half; we begin our working half way up; our coal is only 24 feet there, and we take 12 feet before us; I carry a head, but I drive the top head in that case to the outside, together with the working road, which working road would be represented in the middle of the coal; when we have brought back from the extremity the top of the coal, we then begin at the bottom; this air-head is destroyed by the operation of getting the top part, but the interstices formed by the breaking of the mine-down (getting the whole out as we do) are quite sufficient always to allow a passage for all the gas in the bottom part of the workings to pass along through these interstices, and empty itself into the upper chimney, without any further heading.

4608. It would then empty itself first into a large open space?

No; merely into the interstices, which are very large.

B. Gibbons, Esq.

16th July 1849.

4609. The air-heading is destroyed?

Yes, of course; but this air-chimney is not destroyed; we always leave a solid portion of coal for the support of the shaft, therefore the mouth of this is always open; and I find that the interstices or crevices formed by the abstraction of the coal, and the coal breaking and leaving large apertures between, are amply sufficient. I find no new head necessary for the lower 12 feet; I find this sufficient always to keep the lower 12 feet perfectly clear of gas.

4610. Without any distinct air-passage?

Yes; it is not necessary; the passages are, in fact, of much larger capacity than the original air-passage; but this part of the air-passage remaining as far as here —[*showing the same*]—entire, all the light gases rise up, and the air with the light gases; all the light gases from the lower part of the coal rise in an undiluted state, and drain off into the air-chimney.

4611. And do you find that, notwithstanding those openings nearer to the up-cast shaft, the draught is not damaged at the more remote points?

Not the least. Perhaps I may explain why it is not damaged; when I come to drive the working road, there is still a body of solid coal to the outside of the workings, because this working road is only six feet high, so that six feet of solid coal lies between it and this part which has been abstracted, and forms a complete preventive to any of the air passing till it gets to the extremity again. There is a solid table of coal six feet thick, which prevents the air being abstracted by the upper workings, because it remains solid to the outside workings, and then you bring back the lower part.

4612. Then that portion which is left behind you in coming back becomes a waste, does it not?

Yes.

4613. Does that fill with gas at all?

Not at all with inflammable gas; it fills with carbonic or other heavy gases if you work deep; the heavier gases descend by their own gravity and fill that part, more or less; it is full of carbonic or other heavy gases, but not with inflammable gas; there is no vital air remaining in those parts; they require no kind of ventilation.

4614. Do you work in those mines with lamps?

No; we work them with candles; we examine the mines constantly with lamps. I never allow the men to go down till they have been examined, but you may almost call it unnecessary.

4615. Are they examined every morning?

Every morning; we never allow the men to go in till they are thoroughly examined.

4616. Has it ever happened since you have had that method of ventilation which you have described, that upon examination the mine has been found unfit for working with a candle?

Never, that I know of, unless there was some opening that required to be made for the purpose of communicating with the air-head; probably we might not have the air-head sufficiently advanced; then it always is necessary to carry it forward, and till it is secured, we work with lamps till there is an opening made into this air-head. If we had got the road a little too forward, there would probably be gas in the farther part; then we should not allow any work to be done, except with a lamp, until we had an opening to allow the gas to escape.

4617. What lamp do you generally use?

Dr. Clanny's; I find that very effective.

4618. Do you use that which Dr. Clanny has most recently invented?

If he has made any improvements upon them within two years, we do not.

4619. Since the year 1835, in which he was examined before the Committee of the House of Commons?

I have had mine since that time. I have never had occasion to complain of them at all, and have tried them under the most dangerous circumstances that lamps ever ought to be tried under, for the express purpose of seeing whether they are safe.

4620. Have

4620. Have you tried the common Davy lamp ?

Yes.

4621. Do you think Dr. Clanny's superior ?

I think so. I have abandoned the Davy lamp entirely, or nearly so ; but there is a vast variety of opinion upon that subject. I can only speak from my own experience.

4622. Have you ever, in the course of your consideration of these subjects, turned your attention to the question of an inspection by Government ?

Yes ; I have thought of it a great deal ; I allude to that in my book ; perhaps I should express myself best by reading a passage out of it : " It has upon various occasions lately been suggested, that the interference of Government is desirable ; but I entirely dissent from this opinion. Any interference in the power of Government could not be efficacious, and must be a constant source of vexation and interruption in the working of the mines. Such interference is contrary to every sound principle ; and we have sufficient evidence to prove that the arbitrary interference exercised by the continental Governments, has been in the highest degree detrimental. It is self-evident that the workings of a pit, which must be controlled and varied by the different changes that take place in the natural formations of the mines, such as the slips, faults, rises and falls constantly occurring in the thick coal,—it is evident that these and many others cannot be brought under any compulsory code of regulations. I do not contend that if a safe system of ventilation can be pointed out, it should not be enforced ; it ought to be, and it will be, if it is once proved that it can be, and this will be done by the humanity and the good sense of the proprietors, the mine surveyors and the charter masters ; and if neglected by them, it will be compelled by the voice of the public and the workmen. These means will be found infinitely more effectual, and far less objectionable, than any interference of the Government ;" that is, I mean, a compulsory set of regulations.

4623. Do you mean those remarks of yours to apply solely to the case of Inspectors armed with the powers of directing the management of mines, or would you equally apply them to the case of Inspectors, merely commissioned to inquire and to point out defects, and to make suggestions of improvements ?

Certainly to the former, not to the latter ; no man would promote that more than I would.

4624. Should you think that there was any objection to the interference of Government upon that footing, namely, appointing Inspectors, with a power to examine mines and inspect plans, and the systems of ventilation, and thereupon to make any suggestions, being well-qualified persons, and to communicate information ?

None ; I am a great advocate for communicating information, which I think is the proper preliminary step where information can be afforded ; otherwise, if it is not communicated, I think no measures adopted by the Government will ever be found effectual. I think that information should be extended as much as possible, by those means which are thought most effectual for the end, to the different persons who are employed in the management of mines ; they should have their minds enlightened upon the subject, either by meetings with well-qualified Inspectors, or by lectures, or in some way or other, before any operations of the Government can have any other effect than that of vexation ; and I believe that by freeing the mine-viewer and the mine-lessee proportionately from responsibility, the first effect (I do not know what the ultimate one might be) would be to make the mine much more liable to accidents than at present.

4625. You do not intend your objections, of course, to apply to the case where the Inspector is merely invested with the power of examination ?

Certainly not ; I would give every facility and every information in my power to the Inspector, under those circumstances.

4626. Do you think that much jealousy would be entertained, so far as you know, among the managers and owners of mines, at the visits of the Inspector, who was authorized to make such inquiries ?

I think it would depend upon the manner in which it was conducted. I think, if information could be given in some public manner ; if they were convened together, and lectures were given as one mode by which to acquire information,

B. Gibbons, Esq.
 16th July 1849.

the Inspectors would be welcomed generally by everybody. I am sure they would be by the proprietors. We are not so much masters of the way in which the mine-viewers might consider it, because, in point of fact, anything that interfered with their old modes of action would, in the first instance, no doubt, occasion some jealousy; but the proprietors would put it down, I am convinced.

4627. When you speak of the proprietors, you do not mean the freehold owner of the minerals, but the colliery owners?

Yes, the workers of the coal mines.

4628. Looking to the feelings of the colliery owners rather than to those of the viewers, do you think that there would be any jealousy as to the consequences of an inspection by a party unconnected with them into the state of their workings?

I can only say there ought not, nor can I conceive that the proprietors of the mines in my part of the country would any of them have an objection; so far from objecting to it, I point out especially in my pamphlet what I consider a great disgrace to us as not having had long ago.

4629. That is with respect to a mining college?

Certainly; I think that a great disgrace.

4630. Do you think it desirable that some steps should be taken for communicating more ample information to the miners?

I do; I think it indispensable; I think that without that preliminary knowledge, any legislation must fail of its object.

4631. That was your opinion at the time when you wrote this publication?

Certainly; I express it.

4632. With respect to accidents in the collieries of Staffordshire from the falling of the roof, are you of opinion that there are any means by which that danger might be diminished?

I am afraid not; I see no prospect of preventing it. Of course there are mines worked unskilfully, that is, they are worked of extraordinary widths for the purpose of saving coal; there are solitary cases of that kind, but I do not think it is the general practice, and I do not think that much could be done in diminishing the amount of accidents resulting from that cause.

4633. You are not aware of anything defective in the system of working in the Midland Counties that leads to those accidents?

No, I am not; they generally arise from circumstances which no foresight can prevent. They arise from a rottenness of the coal, which is not seen until perhaps it gives way and falls. There no doubt is carelessness, but by what possible means it can be obviated I cannot say; their own safety, in fact, you would think the strongest motive for care. I do not know what you can do further.

4634. Is there generally sufficient care taken in providing props?

I think now there is, because every proprietor would be held responsible. The coroner's juries of our county would hold the proprietor responsible if he did not provide sufficient timber for props.

4635. Are such accidents frequent in the Staffordshire mines?

There is a good deal of it, and always will be, when you consider that there are 20 feet high of coal hanging over a man's head, and that a piece drops out without the slightest notice; how it is possible to prevent it I do not know; I do not think it is.

4636. There is another class of accidents arising from falling down pits, through the breaking of ropes; have you ever directed your attention at all to the means of preventing those?

They are very rare in well-regulated collieries; I have never met with such a thing.

4637. Do you work with guides?

No, we work without guides. We work entirely with chains, which consist of three chains connected together, any one of which is sufficiently strong; and I consider them far safer than any rope.

4638. Do-

4638. Do you mean merely the chains conveying the coals, or do you mean chain guides?

We have no guides at all.

4639. Do you find it convenient to work without guides?

With our thick coal we cannot use guides.

4640. Why?

The coal comes down in such large masses, that it is occasionally as much as will come up the shaft. There is no room for guides, and it is exceedingly inconvenient in landing. The guides have been tried; Mr. Forster tried them in two or three instances, but he was obliged to give them up.

4641. Is that common in the collieries in your district?

Yes; I do not know of any guides being used, except in some of the Wolverhampton mines; the thin mines; none in the thick coal, that I am aware of.

4642. What weight do you raise at a time?

Twenty-five cwt. frequently; this is an ordinary load.

4643. That is not more than they raise in the northern mines?

We often have more, but that is about our average loading; 1 ton to 25 cwt.

4644. Guides, you say, have been tried?

They have; I had an opinion that guides would answer, but we meet with no accidents.

4645. From what cause is the practical inconvenience of guides?

From the large masses of coal which would be very likely to catch the guides and pull them down the pits. When we have a layer of these large coals, we put an iron ring on, and lay another layer, and we can pile them up as high as we wish, and draw them up the pit; I have seen them draw two tons as steadily as possible; the engine man, if he pays any attention, can draw 20 of them, and the coal shall never touch either side of the shaft; it shall not touch the brickwork at all.

4646. Have you any cases of men being drawn over the pulley?

If it was so, we should think it necessary to prosecute the engineer, and to have the opinion of a jury whether there was culpable negligence or not.

4647. Culpable negligence on the part of the engineer?

Yes.

4648. But such cases have happened, have they not?

It has been done, but in such cases we have always prosecuted.

4649. In the case of the thick coal of Staffordshire, you would not confirm the evidence which we have received, that, generally speaking, it is a very economical arrangement to have guides, in order to prevent the wear and tear of the cages or skips, or whatever they are, in passing up and down the shafts?

I have shafts that have been worked for 30 years, and they are very good yet; that is all I can say about wear and tear; I can only oppose a fact to an opinion.

4650. Have you not had many accidents in raising the coal without guides?

No, we do not hear of such cases, except from negligence.

4651. Do you think that, generally speaking, the amount of education among the persons concerned in the management of coal mines is defective?

I hardly dare say yes; I might think so, perhaps; I think it would be perhaps better to say, that any additional information would be useful; I think the owners of mines in this country could not owe a greater boon to the Government than if the means of extending knowledge in the most effectual manner were given to them by some educational district establishments.

4652. Have you ever seen any other method of mechanical ventilation in use excepting the steam-jet?

No, I cannot say that I have, sufficiently to form an opinion; there is a mechanical means recommended by Mr. Struvé, which I have never seen in actual use, but which I believe is found a very effective method; but then I have

B. Gibbons, Esq.
16th July 1849.

a decided objection to all mechanical means, which require any degree of necessary and constant care ; therefore, perhaps, I have gone a little too far in objecting to them altogether.

4653. Is there anything besides the matter of ventilation which you would think of great importance for the purpose of preventing the occurrence of these accidents ?

No ; I think the first step is to extend information, and then I think, when that has been done, the proprietors would attend to any recommendations that might be made by the Inspectors, and enforce their regulations as they might think proper ; but until that information is extended, I do not think that it would be in their power to do it. The Inspectors who are appointed now by the Government will be of infinite service, as they will derive a great body of information, and I think that you will have a foundation by which you can judge of the most effective means of extending that information to those upon whose care we necessarily must depend to carry through an improvement of the system.

The Witness is directed to withdraw.

W. R. Clanny, Esq.,
M. D.

WILLIAM REID CLANNY, Esquire, M. D., is called in, and examined as follows :

4654. YOU reside at Sunderland ?

Yes.

4655. You have turned your attention for a long time past to the best method of obtaining light in mines ?

I have.

4656. You were examined before the Committee of the House of Commons in 1835 ?

I was.

4657. And you have still continued your study of that subject ?

I have.

4658. Since your examination in the year 1835, are there any subsequent conclusions at which you have arrived with respect to the best form of lamps for mines ?

I have bestowed a great deal of attention upon the subject ; and following up the inquiry as to the safety with which the pits might be lighted, I have at all times, from the very commencement, been satisfied that the safety-lamp in use could not, under any circumstances, be safe, though generally it might be used.

4659. You mean that it could not, under any circumstances, be absolutely safe ?

That, under every circumstance, it could not be absolutely safe, to my certain knowledge.

4660. A certain improved lamp of yours was extensively in use at the time that the inquiry took place in 1835, was it not ?

It was not in extensive use.

4661. Had it been then recently introduced ?

It was employed a good deal in Lord Londonderry's mines, but hardly in any other.

4662. Since that period, has it been more generally used ?

It has not been used generally ; but that with steam, for which I received the gold medal of the Society of Arts, has been a good deal used in mines.

4663. When did you receive it ?

In the year 1817 I received the large silver medal and the large gold medal for the steam safety-lamp.

4664. Was not that the lamp which was mentioned by you in your evidence of 1835 ?

They are mentioned ; I could mention no others than those two. I forget the exact date ; in 1841 or 1842 or 1843, I performed a series of experiments in one of the rooms of the infirmary to which I was senior physician : we had an explosive atmosphere with the common coal gas.

4665. You

4665. You made an experimental explosive atmosphere for the purpose?

Yes, with the house surgeon. It was certainly a very hazardous one for him, for it nearly cost him his life; he was inclined to be consumptive, and I had to get him out of the room as soon as I could, such was the power of the gas: it was not proper for myself.

*W.R. Clanny, Esq.,
M.D.*

16th July 1849.

4666. What was the object of that experiment?

That there might be had a safe lamp, which was not then the case with that in use.

4667. What lamp did you use?

The one shown here the other day by my friend, Mr. Mather, with a top of wire-gauze and a cylinder of glass below. I first used lenses, and they answered very well, but they threw the light to such a distance, that I was compelled to have made glass cylinders for the express purpose.

4668. Then, upon this occasion, your object was to test some additional improvement which you had made in the lamp which you had previously contrived?

To prove that it would be perfectly safe in an atmosphere with coal gas, containing a greater portion of carbon than that of the light fire-damp of the coal mines.

4669. The lamp which you used upon that occasion, as you are understood now, was the last improved form of the lamp?

Decidedly.

4670. That is a lamp with a thick glass cylinder below the gauze, is it not?

Yes. The point is this, that heretofore atmospheric air, or atmospheric air containing fire-damp, was admitted below the light; but in this improved safety-lamp it descends to the flame, being considerably above where the flame is burnt.

4671. Is there no opening for the gas below?

None whatever.

4672. So that it is entirely fed through the gauze above?

Entirely so.

4673. Has that lamp been generally used?

I think near to 1,000 of them have been employed; one individual has made 353, and they have been used in the most explosive of mines.

4674. Have you yourself been into mines with them?

I have not; I had enough of that formerly, and I knew very well that viewers understood the matter much better than I did. This is a sketch of the lamp—[producing the same].

4675. Is not there an objection stated to the use of glass in this manner, that it is liable, under certain circumstances, to be fractured very easily?

It has not yet come to my knowledge that any one of them has been fractured by common use; but even where they may be fractured, I think their safety is augmented, for the lamp is shut in on all sides. I think it is safer after a fracture takes place. This is in respect to expansion of glass by heat, as the glass is hemmed in by the frame.

4676. Have you ever made any experiment upon that point?

I have frequently; but more especially Mr. Elliot, who has been here and examined before your Lordships, tried this lamp determinately. He kept it first at the angle of 45, when lighted; he then laid it upon its side, and struck it repeatedly, but he could not break it; at last he did make a fracture, by a blow of a stick, but that fracture was so insignificant, that I believe it was used afterwards in the mine without any detriment or accident occurring. No accident has yet occurred in any of those mines where these lamps have been used.

4677. These are the number of lamps made by one manufacturer?

By one individual, Mr. Mills, of Newcastle; as also by others, whose names I do not recollect.

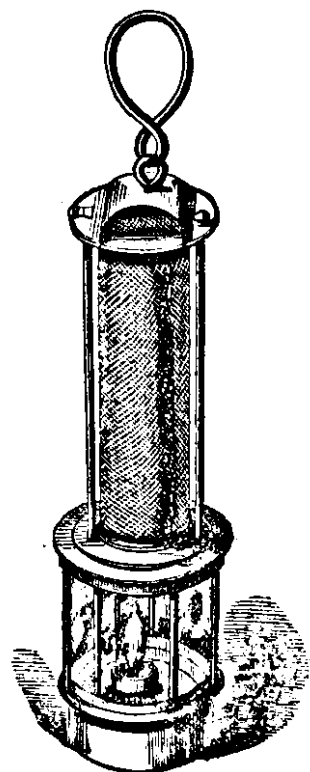

W. R. Clanny, Esq.,
M. D.

16th July 1849.

4678. For these different pits?
Yes.

The Witness delivers in the same, which is as follows:

NUMBER of the CLANNY SAFETY LAMPS made by me from 1843 to 1849—J. MILLS.

| NAMES OF COLLIERIES. | 1843. | 1844. | 1845. | 1846. | 1847. | 1848. | 1849. | TOTAL. |
|--|-------|-------|-------|-------|-------|-------|-------|--------|
| Mountain & Sons - - - - | 7 | 17 | 8 | 5 | - | - | - | 37 |
| BY ORDER. | | | | | | | | |
| Wearmouth Colliery - - - - | - | - | - | 37 | - | 18 | - | 55 |
| South Pearith - - - - - | - | - | - | - | 58 | 1 | 1 | 60 |
| R. G. Heathcote, Stoke-on-Trent - | - | - | - | - | - | - | 26 | 26 |
| G. W. Chambers, Holmes Colliery, Rotherham. | - | - | - | - | 14 | 12 | - | 26 |
| Mapplebeck & Low, Birmingham - | - | - | - | - | 14 | - | - | 14 |
| Rhymey Iron Company - - - - | - | - | - | 12 | - | - | - | 12 |
| Belmont Colliery - - - - - | - | - | - | 12 | - | - | - | 12 |
| Walker Colliery - - - - - | - | 1 | - | - | 7 | - | - | 8 |
| Johnson, Worthington & Co., St. Helen's. | - | - | - | - | - | 6 | - | 6 |
| Blackley Hurst Colliery, Lancashire | - | - | - | - | - | 6 | - | 6 |
| Patricroft Colliery - - - - - | - | - | - | 6 | - | - | - | 6 |
| Colebrook Dale Company, Shropshire | - | - | - | - | 6 | - | - | 6 |
| Thomas Proctor, for a Colliery un- known. | - | - | - | - | 6 | - | - | 6 |
| Threupthuart Colliery, Whitehaven - | - | - | - | - | - | - | 4 | 4 |
| Usworth Colliery - - - - - | - | - | - | - | 4 | - | - | 4 |
| Walbottle Colliery - - - - - | - | - | - | - | 1 | - | 3 | 4 |
| Felling Colliery - - - - - | - | - | - | - | 12 | - | - | 12 |
| Jarrow Colliery - - - - - | - | - | - | - | - | 3 | - | 3 |
| Gas Company - - - - - | - | - | - | - | - | 2 | - | 2 |
| G. M'Dormott, Esq. - - - - - | - | - | - | - | 24 | - | - | 24 |
| Gosforth Colliery - - - - - | - | - | - | - | - | - | - | 2 |
| Dr. Clanny and sundry parties un- known. | - | - | - | - | - | - | - | 18 |
| | | | | | | | | 353 |

MANUFACTURERS in Newcastle and Gateshead.

| | |
|-----------------------------------|----|
| Messrs. Abbott, Gateshead - - - - | 24 |
| Mr. Watson, Newcastle - - - - - | 12 |
| Mr. Cail, Newcastle - - - - - | 72 |
| Mr. Ross, here - - - - - | 12 |

In London, &c., and in other towns not now remembered.

The Witness. I have a list of a few of the pits in which these lamps have been used, with very satisfactory reports of the parties' own accord sent to me.

The Witness delivers in the following Paper:

| | |
|----------------------------|------------------|
| 2 Wellington - - - - - | Northumberland. |
| 3 Walker - - - - - | ditto. |
| 4 Wallsend - - - - - | ditto. |
| 5 Sidghill - - - - - | ditto. |
| 6 Gosforth - - - - - | ditto. |
| 7 Coxlodge - - - - - | ditto. |
| 8 Heaton - - - - - | ditto. |
| 16 Patricroft - - - - - | near Manchester. |
| 9 Monkwearmouth - - - - - | Durham. |
| 10 Thornley - - - - - | ditto. |
| 11 Wingate - - - - - | ditto. |
| 12 Belmont - - - - - | ditto. |
| 13 Jarrow - - - - - | ditto. |
| 14 South Pearith - - - - - | ditto. |
| 15 Pelton - - - - - | ditto. |

| | | | | | | | |
|----|----------------------|---|---|---|---|---|-----------------------|
| 17 | Oxclose | - | - | - | - | - | Durham. |
| | Rhymney | - | - | - | - | - | Wales. |
| | Mostyn | - | - | - | - | - | Flintshire. |
| | Coalbrookdale | - | - | - | - | - | Shropshire. |
| | Risca | - | - | - | - | - | Moumonthshire. |
| | Broadsfield | - | - | - | - | - | Staffordshire. |
| | Newcastle-under-Lyne | - | - | - | - | - | ditto. |
| | The Colliery | - | - | - | - | - | Newcastle-under-Lyne. |
| 18 | South Moor Colliery | - | - | - | - | - | Durham. |
| 19 | Shield Row Colliery | - | - | - | - | - | ditto. |
| | Craghead Colliery | - | - | - | - | - | ditto. |
| | Holmside Colliery | - | - | - | - | - | ditto. |
| 22 | Burnhope Colliery | - | - | - | - | - | ditto. |
| | Pensher. | | | | | | |

Also, Geo. Wilton Chambers, Esq., Clough House.

W. R. Clanny, Esq.,
M. D.
16th July 1849.

4679. What does your lamp weigh ?

I think it is about two pounds, not more.

4680. What does the common Davy lamp weigh ?

Considerably less.

4681. In Mr. Buddle's evidence, he lays great stress upon the weight of the lamp ?

Yes, but it has not been complained of to me at all; I never heard it complained of; Mr. Buddle commanded everything in his lifetime, in respect to Sir H. Davy; he had peculiar views, and was not my friend, by any means.

4682. What is the advantage of this lamp as compared with your own former lamp ?

The former lamp was a very peculiar one; above the flame, I placed a small boiler for water, and the air ascended by a tube, as it were up a chimney, and passed over a volume of steam extricated by the flame of the oil-lamp itself, which thereby rendered it in a peculiar manner safe, more so than perhaps any other, for the flame stands with safety in fire-damp when mixed with steam.

4683. Does the steam neutralize its explosive character ?

It is a singular fact that I could never make it explode in that way, and I thought it perfectly safe; but it was inconvenient: the pitmen used it principally in Lord Londonderry's mine, the lamp being on a large scale with a great quantity of steam; and they used no other lamp, because the air was so foul in other respects; however, it was laid aside a long while ago.

4684. Is the effect of the steam to neutralize the explosive character of the air ?

Decidedly.

4685. In what way does it do so ?

There is no mode of explaining it further than this, that water in the form of steam allows it to stand in that way; it does not alter the nature of the water; it is water still, expanded to the 212th degree; it is a point which I followed up very closely; but afterwards, I turned my attention another way, so as to do without steam altogether.

4686. You did not understand how it acted in preventing the explosion ?

This gas requires twice its volume of oxygen for complete combustion,—hence the value of steam in diluting the atmosphere within a safety-lamp of this description. In the first instance, fire-damp is extinguished by being diluted with steam, and soon afterwards the flame of the oil-lamp dies out. With respect to explosions, here is the rationale of an explosion in a coalpit, which I drew up on purpose—[*producing a paper.*]

4687. Are these the results of experiments tried as you have stated in the infirmary ?

The results of experiments and of calculations accordingly.

4688. Upon the occasion of which you have spoken ?

Yes; they have been followed up in this form.

*W.R. Clanny, Esq.,
M. D.*

16th July 1849.

4689. An artificial explosive atmosphere having been made for the purpose ?
For the purpose ; these are the calculations.

4690. Then it would appear from this, that the most explosive mixture is one portion of fire-damp to seven or eight volumes of air ?

That is the case with respect to the inflammable gas of coal mines, but the olefiant gas has double the quantity of carbon to the hydrogen, and the consequence is, that it is very dangerous ; though it is the opinion of my friend, Mr. Goldsworthy Gurney, that it is to be found in some of the mines ; and also of a very distinguished foreigner, Professor Bischoff ; but I have not found it to be the case in our mines.

4691. Has there been any instance of an accident where your lamps have been used ?

Never, that I could hear of. After many explosions I have visited the coal mines in order to publish the particulars. The other day an explosion occurred in a mine belonging to a friend of mine, who is also a viewer, Mr. Easton, but there the explosion was caused by a naked candle. I have been in the habit of visiting many of the pits after explosions, and making special inquiry for 30 years, and he told me how it was ; they had only my improved safety-lamps in the mine ; they were using one where they thought it was dangerous ; but a poor man at a distance, who was using a naked candle, caused the explosion, and the man using my safety-lamp was blown up a small staple, as it is called, and the lamp with him, which lamp was afterwards found in a perfect state. The lamp was used afterwards in the most dangerous parts, to explore the mine, and in perfect safety.

4692. In your opinion, supposing the glass to get very much heated, and then water to fall upon it, which is said generally to lead to the fracture of the glass, you do not conceive that, with the form of lamp which you recommend, there would be any danger ?

No ; the heat of the glass is never above 120 or 130 degrees, and you may lay your hand close to it during the whole time that combustion is going on, whether there be fire-damp with the air or not.

4693. Is that at the time the upper part of the lamp is full of inflammable gas ?

Yes ; you may keep your hand close by it all the time ; the upper part of the lamp gets heated at the top of the cylinder ; the wire gauze is heated, but not so much so as in the common Davy, because the atmospheric air is very much expanded, especially with the fire-damp, as it descends to supply the oil-lamp flame.

4694. In the ordinary Davy, supposing the atmosphere to be very explosive, the interior of the lamp becomes filled with flame, does it not ?

Always.

4695. Supposing the same circumstances with your lamp, what happens ?

I think that will be explained if your Lordship will take the trouble of looking at the paper which I now produce. These are different results in different inflammable atmospheres.

The Witness delivers in the following Paper :

FIRE-DAMP OF COAL MINES.

W. R. Clanny, Esq.,
M. D.
16th July 1849.

THE following were the results of experiments in explosive atmospheres, which were intended to be similar in quality to the different descriptions of fire-damp which are usually found in the coal mines of the counties of Northumberland and Durham. In the above-mentioned atmospheres my improved safety-lamp was tested, very determinately, several years ago:—

1. With one volume of fire-damp to three of atmospheric air, no explosion occurred.
2. With one volume of fire-damp to five or six times its volume of atmospheric air, a slight explosion took place.
3. With one portion of fire-damp to seven or eight volumes of air, a violent explosion occurred.
4. With one portion of fire-damp to fourteen times its volume of air, a slight flash took place.
5. When the proportion was exceeded fifteen times its volume of air, it was observed that the flame of the oil-lamp in the improved safety-lamp became enlarged, and the cylinder was filled with a transparent blue flame, and soon afterwards both flames died out very quietly.

The glass cylinder is never above 130 degrees Fah., and at all times the hand may be kept against it without inconvenience. This safety-lamp gives at least four times as much light as the Davy, and by it five or six pitmen may carry on their work. Thus it is that, though this improved safety-lamp be in some degree more expensive than the Davy, be it remembered that the saving of lamp-oil will, in a short time, compensate such coal owners as may be inclined to use my improved safety-lamp.

| Atmospheric Air before combustion. | | After explosion | Fire-damp. Elementary Mixture before combustion. | |
|---|--------------|------------------|--|------------|
| Atoms. | Weight. | | Weight. | Atoms. |
| Oxygen 1 | Oxygen 8 | Carbonic acid 22 | Carbon 6 | Carbon 1 |
| Oxygen 1 | Oxygen 8 | | Hydrogen 1 | Hydrogen 1 |
| Oxygen 1 | Oxygen 8 | Steam 9 | Carburetted Hydrogen 8 | |
| Oxygen 1 | Oxygen 8 | Steam 9 | | |
| Nitrogen 8 | Nitrogen 112 | Nitrogen - 112 | Hydrogen 1 | Hydrogen 1 |
| Mixture before combustion, Atmospheric Air - 144 Carburetted Hydrogen 8 | | 152 | Fire-damp 8 | |
| | | Choke-damp 152 | | |

A few remarks are here needful, in order to explain the phenomena of an explosion of fire-damp in a coal mine, and which will be readily understood upon examining the accompanying simple diagram. Let the third column represent the equivalents of the atmospheric air in a coal mine, and the fifth column show the equivalents of fire-damp. When these gases come into contact, they, generally speaking, mix by what is designated diffusion of gases. If a light or flame of any description be applied to this mixture, an explosion must of course take place, after which we shall now find that a noxious atmosphere will be instantly generated, which is designated choke-damp by the coal-miners, and in which no animal can live. Hence the cruel death of the pitman, should he not be blown to atoms, or be so severely burnt by the explosion as to cause immediate death.

*W.R. Clanny, Esq.,
M. D.*

16th July 1849.

4696. Supposing your lamp to be in such an atmosphere as fills the common Davy lamp with blue flame, what is the condition of your lamp in that case?

It burns steadily for some little time, and gradually dies out, the flame of the oil-lamp first, and the blue flame afterwards; first, oil-lamp flame goes out, and then the other or blue flame in the gauze cylinder follows very quietly; there is no explosion.

4697. Does the interior flame in that case fill the space within the glass cylinder?

It does, to a certain extent, but not very much so; because the meshes of the Davy lamp are 784 to the square inch, and these lamps which I recommend occasionally, are 1,296; that therefore adds to the safety beyond all comparison: but say about 1,000 meshes to the square inch will suit admirably; and I think that would be a very proper proportion; it would give no light through such meshes; indeed it could not be expected, but would be bright through the glass cylinder.

4698. Can you state what is the proportionate difference of light, according to any measure, between your lamp and the common Davy lamp?

I measured according to Romford's plan, and I measured in different ways of reading, as to strength of light; and I think, as nearly as I can calculate, the light of the improved safety-lamp is about four or five times greater than that of the Davy.

4699. So that there would be a proportionate absence of temptation to the workmen to take the top off the lamp to procure more light?

They never had occasion so to do. In visiting the mines and inquiring among them, I sometimes say, as a stranger, "What sort of lamp is this; do you ever unscrew the gauze cylinder from the oil-lamp?" "No; I never unscrew it; there is no occasion to unscrew it;" but they are locked for all that; the light is so perfect, that there is no occasion to unscrew the top to give more light.

4700. Is the light diminished by the smallness of the meshes of the gauze?

It may be, in some degree, when we use a considerable increase of numbers of meshes to the square inch, but of this I am not certain.

4701. When you increase the number of meshes to the square inch, do you diminish the diameter of the wire?

There is always an accumulation of soot, and that soot has the effect of diminishing, to a certain extent, the ingress of atmospheric air.

4702. Is the diameter of the wire of which the lamp is composed smaller when you increase the number of meshes?

I believe such is the case.

4703. You diminish the spaces, but you retain the same description of wire?

Finer wire is needed.

4704. You make use of the same wire for constructing the gauze as in the Davy lamp?

The wire is necessarily finer.

4705. Increasing the number of meshes?

The wires are necessarily finer in texture.

4706. The inevitable consequence of that must be, that so far as that part of the lamp is concerned, it would obstruct the light, would it not?

It never does so in my safety-lamp, for the glass always stands clear; the soot accumulates at the top in a small degree; there is a curious fact, that after a certain period, say half an hour or an hour, the soot accumulates at the top, but the wire cylinder is perfectly clear immediately above the glass cylinder.

4707. How do you account for that?

That the heated air ascends, and it is of course part of the soot is precipitated upon the wire at the top of the safety-lamp.

4708. Then does that, after it has taken place for a certain time, interfere with the efficiency of the lamp?

It has never been complained of yet to me in any instance. I have had no complaints against these lamps whatever, but every commendation.

4709. Do

4709. Do you consider the common Davy lamp, under ordinary circumstances, a useful instrument? *W.R. Clanny, Esq., M.D.*

I think it may be used under many circumstances; but the men complain of the light being so insignificant, that as they are compelled to send up good coals, and require a proper light to hew them, they often run risks by unscrewing the cylinder, unknown to the superintendents, and hence arise many fatal accidents or explosions.

16th July 1849.

4710. What is the difference of cost between your lamp and the common Davy?

Just double; but the expenditure of oil is very much diminished by using my lamps; that the pitmen have found out themselves, and told me of it; and that in my safety-lamp, in a very short time, they saved the difference of price of this lamp in the purchase of oil.

4711. Have you a patent for your lamp?

No, I never thought of such a thing for a moment.

4712. Your lamps are used in Lord Londonderry's pit?

Yes; it is one of the best ventilated pits in the North of England; a remarkably clever man has the deputy-management there. He is Mr. Elliot's father, who was lately examined by your Lordships. I had him summoned in the year 1835, and he gave about the best evidence that we had. When he came out, I was proceeding on the street with Mr. Buddle and Mr. Pease, and Mr. Buddle said, "What do you mean by this, Mr. Elliot? You have spoken of a ventilation at the rate of ten miles an hour; do you ever effect such a current? I never heard of more than three or four miles." "Yes, I do frequently," said Mr. Elliot, "and hence the safety by so rapid a current; and another consequence is the preservation of the timber and the materials of the mine, by reason of the pureness of the air."

4713. Supposing that the lamp was exposed to the action of a rapid current, which renders the Davy lamp unsafe, would not the same danger attach to your lamp?

No; for it continues to burn, because the air penetrates on all sides of the gauze cylinder, and the top of the glass stands much above the top of the flame.

4714. You are understood to state, that the upper part of your lamp, which is gauze of rather smaller meshes than the common Davy lamp, becomes filled with flame in a very inflammable atmosphere?

It is merely the usual sort of inflamed gaseous substance, and from it there is no mischief whatever by reason of the fine gauze; it cannot get through the meshes to the surrounding atmosphere.

4715. Is it not the same sort of flame as fills the Davy lamp?

Precisely. In my opinion, it is carbonic oxide.

4716. Supposing a rapid current to pass against the Davy lamp in that state, is there not always a danger of the fire passing through?

The current always passes exactly upon the flame in the Davy, except it be shielded at the side on which the current strikes.

4717. Does the danger in that case arise from the action of the current upon the flame itself of the lamp, or upon the burning portion of the atmosphere above the flame?

Decidedly upon the flame itself in the Davy.

4718. Only upon the flame itself?

Altogether that is the case.

4719. Would it not have the same effect upon the burning atmosphere in the upper part of the gauze?

It cannot, in the improved safety-lamp; because the blue flame only burns about a second or two after the oil-lamp flame becomes extinguished.

4720. In an atmosphere of that kind, the gauze of the Davy lamp is apt to get red hot, is it not?

Yes; it gets red hot, and it is very dangerous then, because it allows the flame to pass into the fire-damp atmosphere.

*W.R. Clanny, Esq.,
M. D.*
16th July 1849.

4721. With your lamp, might not that happen ?

No, it does not happen, because the air is so expanded in its descent, and the glass cylinder is always so cool, comparatively speaking, that there is no chance of such taking place.

4722. You stated, that Lord Londonderry's mine was one of the best ventilated mines ; would Jarrow be capable of being as well ventilated ?

I am not very well satisfied about that.

4723. Could you make a fiery mine sufficiently ventilated to prevent accident ?

The men cannot live unless they have pure air ; they require wholesome atmospheric air to breathe ; they may live, perhaps, after their lamp goes out ; but I think the men should have good ventilation for the sake of their health.

4724. Do you think the Jarrow mine capable of being well ventilated ?

I do not know what Mr. Goldsworthy Gurney may do ; as I have great expectations on that plan.

4725. Have you examined that mine yourself ?

I have not been down it.

4726. Would you venture to say that any system of ventilation could be introduced which should secure a mine altogether from accident ?

Not at present ; it will take some time before that can be accomplished.

4727. You do not think it would be possible, under any circumstances, to make the ventilation so perfectly effective as to secure a mine, in all cases, from explosion ?

I am afraid not.

4728. The ventilation might be very much improved, and the risk of accident very much diminished ?

Decidedly so.

4729. How many hours would the oil burn in the lamp you have described ?

Fourteen hours.

4730. A short time since you stated, that the wire used for making the gauze in your lamp is of the same size as that of the Davy lamp ; are you satisfied, upon recollection, that that is so ?

I do not recollect exactly that particular point. The same man made nearly six hundred of them ; they were manufactured by the same wire-weaver ; I think they are of the same size ; I am not sure ; but perhaps smaller.

4731. Will you state what the cost of that lamp was ?

Fourteen shillings ; I believe it might be made for less, if they had sufficiently numerous orders ; say 12s.

4732. Are you able to state whether that lamp is coming more generally into use ?

Daily into extensive use.

4733. Have you any concise description of your lamp, which you would consider to be correct ?

I have. The following was drawn up by Mr. Alexander Kirkaldy of his own accord, and published by him.

The same is read, as follows :

FIRE-DAMP IN COAL MINES.

A MEETING of the Society of Arts was held last week ; BENJAMIN ROCHE, Esquire, in the Chair.—A Paper was read from Mr. Eginton on ventilation and fire-damp in coal mines. After describing the nature and causes of fire-damp, and its explosive properties when brought in contact with the atmosphere, Mr. Eginton proceeded to say, that when the roof fell in, in a coal mine, a large disengagement of the gases was thereby occasioned, and that there the Davy lamp, which had been so greatly praised and extensively used, was of very questionable use ; and although the accidents which occurred where the Davy lamp was used, were ascribed to the carelessness of the men, such was not the case ; and those accidents were attributable to the defects of the Davy lamp, which had, in his opinion, been unworthily called a safety-lamp. He stated, that ventilation was the most rational way to prevent explosions of fire-damp. He then pointed out the best methods of ventilation, and illustrated his plan by a display of diagrams.

The

The "Clanny" or the safety-lamp invented by Dr. Clanny, differs but little in form from the "Davy," yet it is a curious fact that the inconveniences attending the latter are, happily, obviated in the "Clanny" lamp; and although the number of meshes in this amount to the astonishing number of 1,296 to the square inch, through which air for combustion passes, yet such is the fineness of its texture, that the light is no ways obscured by it. It should also be observed, that the air passes downwards (the reverse of the other) in safety through the meshes, and immediately afterwards within the whole depth of a very thick and well-annealed glass cylinder. By this discovery in the "Clanny" lamp, the atmospheric air, when mixed with fire-damp at the exploding point, is rendered completely innocuous, being greatly expanded in volume, and passes off in safety, whilst it gives a much more preferable light. It burns much longer than the other; besides, when the flame is extinguished, the blue flame of fire-damp in the whole cylinder instantly disappears in the most quiescent manner, at the same time readily indicating to the miner the nature and extent of fire-damp contained at the moment in the atmosphere of the mine. From the flame of the lamp being surrounded by the glass cylinder, no blower or unmixed fire-damp, or yet of strong currents of fire-damp, however explosive and dangerous they may be, can come in direct contact with the flame of this lamp, nor can the pitman unscrew it, (being locked) to draw the flame for the purpose of lighting his pipe: this alone would give it a preference over all other lamps used for the purpose. Its light is sufficient for the pitman's purpose in hewing, as well as for separating the argillaceous schistus, &c. &c. from the good coal. There have been persons whose shallow experience in mining have found fault with the glass cylinder, but without a shadow of truth, for the scientific viewer looks at it, next to the wire gauze, as the *ne plus ultra* of discovery; and it is a well-known fact that this lamp has been in daily use for a number of years in many of the most dangerous coal mines without a single accident occurring.

*W. R. Clanny, Esq.,
M. D.
16th July 1849.*

The Witness is directed to withdraw.

Mr. DAVID SWALLOW is called in, and examined as follows:

Mr. David Swallow.

4734. I BELIEVE you live at Bolton in Lancashire?

I do.

4735. Have you been practically engaged in the working of mines for some time?

For 16 years.

4736. As a miner?

Yes.

4737. In what capacity have you been employed?

I went into the pits first at eight years of age; I was only then, of course, a helper; when I became 17 years of age, I started working as a collier; I worked for seven years with a pick as a collier.

4738. How long is it since you last worked?

Six years, the 7th day of last September.

4739. During all that time, have you been in the Lancashire coal-field?

No; I have been a good part of the time in the Lancashire coal-field; I have been, in fact, in all the principal coal-fields in England.

4740. Have you worked any where except in Lancashire?

Yes, I worked partly in Yorkshire; I worked for Mr. Charlesworth near Wakefield, and for the Stanley Coal Company; that was the last coal-pit I worked at.

4741. You have not worked in the mines in Scotland, have you?

I have been in Scotland since 1842, but I never worked in the mines there.

4742. In the course of your employment in mines, have you had any experience of explosions?

Yes, I have seen several explosions; I have been burned slightly myself.

4743. Will you describe to the Committee how that happened?

The explosion happened in this way: a man was looking behind him in the colliery which we then worked in; we had merely a clay roof; the roof was very soft, and we had to leave some coal to put props under, to keep the roof up; sometimes when this coal fell, the men would pick it out; the man just turned round to look and see what it was, and it lighted from his candle. We were not far out of the air-course, so that the explosion was only slight; it burned him a little.

(164. 14.)

3 L 2

I fell

Mr. David Swallow. I fell down ; and the workings being something like five feet high, the fire made for the roof, and I being at the bottom, it only slightly burned me.
 16th July 1849.

4744. Did you suffer at all from the gas after the explosion ?
 No.

4745. Was that mine properly ventilated ?
 Yes, it was as well ventilated, or perhaps better than most in the neighbourhood.

4746. Was that in Lancashire ?
 No ; the one I am speaking of now was in Yorkshire ; it was Messrs. Fernandes, Dunn & Co.'s pit then.

4747. What was the system of ventilation adopted there ?
 A furnace.

4748. Is that generally adopted in Lancashire ?
 Yes, generally, where there is any system of ventilation ; but there are other systems of ventilation in Lancashire also.

4749. What other systems of ventilation are there ?
 There is the fan system in operation in several collieries.

4750. Do you know where ?
 The fan system is in operation at one colliery near Rainford, near St. Helen's.

4751. Did you ever work in that pit ?
 No, the pit has only been sunk within the last three or four years.

4752. Have you ever been employed in pits, which were ventilated by means of that sort ?
 No ; I believe it has been invented since 1842 ; I was not aware of it previously to 1842.

4753. Do you know by whom it was invented ?
 It was invented by some one at Leeds, I forget his name ; I have seen it in operation at Pickley Green, West Leigh.

4754. Have you had any experience yourself of any ventilation, except by means of a furnace ?
 Not any practical experience ; I have not worked in any mine which has been ventilated by any other means.

4755. Have you found in the different mines in which you have been employed any great difference in the ventilation ?
 Yes ; a great deal of difference.

4756. Some are much better ventilated than others, are they ?
 Yes ; I have worked in a coal mine belonging to the Byerly Iron Company, near Bradford, where they had no regular system of ventilation.

4757. Was that a dangerous bed of coal ?
 It was not dangerous from fire-damp, though there was fire-damp ; and it was a very fortunate circumstance that I was not burnt ; I was working in a certain place, and after leaving it, I went and worked in another. A person went and worked in the same place that I had been in before, and was burnt within a week afterwards, but we had never seen anything but black damp.

4758. In that case, the absence of ventilation was no fault of the colliery owners ?
 All pits ought to be ventilated ; the health of the men requires it ; the black damp always abounds in pits where fire-damp does not exist.

4759. Have you found great difference in your health in those mines which have been well ventilated, and those which have not ?
 Yes ; I left the mine principally on account of that.

4760. Have you been in any mine where the ventilation has been so strong as to be inconvenient ?
 No.

4761. Do

4761. Do you suppose that if a very powerful ventilation were put upon a mine, and a strong draught caused through its passages, it would be inconvenient? *Mr. David Swallow.*

No.

16th July 1849.

4762. Under no circumstances?

No.

4763. Supposing a hurricane were blowing through the passages, would not that be inconvenient?

I cannot conceive the idea of more air being admitted into a coal mine than is really necessary.

4764. Supposing not only a great quantity to be introduced, but that the air introduced was moved with great force and rapidity, do not you think it might then be an inconvenience?

If it were blowing a hurricane it might; I do not think coal mines require that quantity of air; but they require, certainly, a very large quantity.

4765. Have you been in the habit of working with naked candles or lamps?

I have worked with both.

4766. Which do you think the safest system, under ordinary circumstances?

Under ordinary circumstances I should prefer working with a candle; I do not approve of working with lamps at all.

4767. Why not?

In the first place, it gives such very little light that the collier cannot see his work properly; he has to work more in the dark than anything else, and that subjects him to great danger. He cannot see about the place; when he is undermining or cutting his coal, he cannot observe it as he ought to do.

4768. Supposing the lamp gave as much light as a candle, you would not feel an objection to it?

I should certainly feel an objection to it, because I could not place it in the same position as I can a candle; I can place a candle so as to throw a light upon any part that I want. Supposing I am cutting coal in an end, I cannot fix my lamp at all times so that it will throw a light upon the piece of coal I am cutting; but I can fix a candle upon anything which is close at hand, so as to throw a light on the piece of coal I am working on.

4769. What would be the effect upon a naked candle of a very rapid current of air?

It would make it sweale very fast.

4770. That would be an inconvenience?

Yes; but it would be one that I could prevent.

4771. How would you prevent it?

We generally have a piece of wood, what we call a cricket, for it to stand upon, with a bottom to it, which will rear it up, and protect the candle from the wind.

4772. Is that sufficient in a strong draught?

It is sufficient. I have never yet been in any pit where the current would blow the board away; if a current is going straight forward, it will not blow round the board; if it is just at the corner, it would require to have another side to the board.

4773. Your inclination would be to use the candle generally, rather than the lamp?

Yes.

4774. Is there any other reason for which you prefer it, except the additional light it gives?

The lamp is very inconvenient, and particularly to draw with; for the boys, in waggoning or drawing, it is very inconvenient.

4775. Do not you think that the use of the lamp is safer than the use of the naked candle?

It is, where there is fire-damp and no ventilation; if an explosion takes place where you have a lamp in your hand, it will fill the lamp, and I should then know to extinguish my lamp as soon as it was possible, and to make my way out of

Mr. David Swallow.
16th July 1849.

the place; if I had had a candle in my hand, it would have lighted the whole of the gas, and I should have been burnt.

4776. Do you think any ventilation could render a mine perfectly secure against the possibility of an explosion?

Yes, I do, in general.

4777. Perfectly secure?

I do not exactly think it could be made perfectly secure under all circumstances; but from those terrible explosions, I believe it possibly might. I believe a mine may be so ventilated as that if an explosion does take place, it will be only local, and will produce very little injury.

4778. You did not mean, by your previous answer, to point out any mode of ventilation which could protect the miners altogether from the possibility of explosion?

No, not under every circumstance.

4779. In what way do you think the explosion might be made merely local; by subdividing the mine?

The way mines are generally worked, particularly when they are opening out new mines, is this: that each man has a place to himself; he will drive 10 or 12 or 20 yards, just as the case may be, in a narrow place, 4 or 5 or 6 feet wide, according to the working of the colliery; while that man is 10 or 12 yards out of the air, it is possible a fire may occur in that man's place, if it is not sufficiently bratticed; but if there is a sufficient current of air coming up to the last opening, that ventilates all the other parts of the works, would cut the fire off, and be kept from the other men's places; it will only burn the man who fires it.

4780. Supposing an explosion to take place and to destroy those brattices, is not there the danger of its communicating to other parts of the mine?

Not if there is a sufficient current of air passing through the last opening. When all the pit is foul, one man lights it up in his place, and it runs from place to place; it is lit up all over the pit, and that causes those terrible explosions.

4781. Do the explosions run up against the air, or with it?

That depends upon circumstances; sometimes it will run with it, and sometimes it will run up against it.

4782. Do you think it possible for inflammable air to pass up against a strong current of wind?

No, it cannot. As respects the explosion I am speaking of, the fire stood just the same as a wall; a strong current of air was blowing up; as soon as it met with the current of air, it bubbled up and stood there, and never went any further until it exploded.

4783. Did you see the fire stand in that way?

Yes, I saw it stand, built up in the same position just like a wall.

4784. That would be just in the place where the pure air joined the inflammable air?

Yes; we were close to the air-course; if there had not been a strong air-course there, we should have been burnt; there was a goaf close to the air-course of about 250 yards, and it would have lighted all the sulphur in that goaf, but the strong current of air cut it completely off.

4785. Have you ever had any experience of the lamp described by the last Witness?

No, I never saw it, with the exception of once before.

4786. Have you been in the habit of always working with a common Davy lamp?

Yes, when I worked with any.

4787. What is the difference in the amount of light between a common Davy lamp and a candle?

I should think about 1 to 20; a common pit candle would give 20 times as much light as a common Davy lamp.

4788. Have

4788. Have you ever seen steam ventilation in action ?

No.

Mr. David Swallow.

16th July 1849.

4789. Have you ever tried the effect of a candle and of a Davy lamp against a wall ?

I have tried it against a coal face.

4790. And you think the proportion is what you have stated ?

Yes, as respects the usefulness of working with it, and the amount of light it will give to a collier to work with.

4791. Have you ever observed the effect of the pressure of the atmosphere upon the escape of gas ?

Yes, very much.

4792. Is that very obvious to those who are employed in a mine ?

Yes, I have observed that particularly ; and there is a common expression in many parts, that when the bean is in bloom, there is more danger than at any other time.

4793. What do you take that to mean ?

I did not understand what it meant till I took notice of the facts. At that time there was generally a great deal of calm weather ; the wind was very calm ; the air was stagnant ; and I found it was the same about the 21st of March and about the beginning of autumn ; the air, just as the sun is crossing the equinox, is very bad indeed ; sometimes it is liable to strong hurricanes ; at other times it is completely stagnant.

4794. Does your experience confirm that saying ?

Yes.

4795. Have you known more danger at those periods than at other times ?

Yes.

4796. Did you ever observe the variations of the barometer ?

I never saw one in the bottom of a pit.

4797. Do you think it would be desirable that barometers should be more generally adopted in pits ?

Yes, I think it is very desirable that they should be used in pits.

4798. You have no doubt, from your own observation, that the heaviness or lightness of the air has an effect upon the atmosphere of the pit ?

I have not the least doubt of it.

4799. Supposing a barometer were to be introduced, as has been proposed, with a scale adapted to the ventilation of a pit, and not having any reference to the state of the weather, simply directed the fireman to regulate the furnace according to the height of the barometer, do you think that would be a good arrangement ?

Yes ; it would be something like what a man has in his locomotive engine ; he has a kind of barometer by which he can tell when the steam is at a certain pressure.

4800. Supposing a barometer with a scale something like this, at one point " fire heavily," and at another, " fire moderately," do you think that would be a useful instrument ?

I do not exactly understand how that could affect the firing ; the barometer only gives the weight of the atmosphere, therefore it would not test the current through the mine ; that must be tested by some other instrument.

4801. It would be for the purpose of showing what the state of the atmosphere was, and therefore what the condition of the mine was as to danger ; supposing the barometer stands high, the atmosphere is then heavy ?

Yes.

4802. Supposing the barometer to stand high, and the atmosphere to be heavy, the escape of gas in the mine is less than usual ?

Yes ; when the atmosphere is heavy, it is less.

4803. Supposing the barometer to fall, it shows that the atmosphere is light, and that there is an escape of gas ?

Yes.

(164. 14.)

3 L 4

4804. Supposing

Mr. David Swallow.
 16th July 1849.

4804. Supposing the scale of which I speak were so arranged, would not it be a direction to the man in charge of the furnace to increase the power of the furnace when the atmosphere was light, that is to say, when the barometer was low, in order to make the current stronger, and when the barometer was high, and, therefore, the atmosphere was heavy, he might relax the power of the furnace?

As regards relaxation, I do not agree with relaxation at all; I do not think that any relaxation in the furnace system is necessary; I do not think you can pass too much air through a colliery by a furnace; I have never seen it in the most favourable weather.

4805. You think there should be as much air passed as possible at all times?

Yes; if the barometer falls, that is an indication of danger, and the person who has charge of the barometer immediately ought to give warning to the parties who are in charge of the pit, that they may examine it immediately, and see whether there is immediate danger or not.

4806. What are the partitions generally made of in the mines in which you have worked?

The partitions are pillars of coal which are left.

4807. Besides the pillars of coal, there are other stoppings, are not there?

They are generally built with brick and mortar.

4808. Regularly built?

Yes, regularly built.

4809. In case of accidents, are they generally destroyed?

Generally, if it is a severe accident; in the explosions I was speaking of just now, they were not destroyed.

4810. Supposing that it were possible, by subdividing the mine, to confine accidents within a small space, do you think that would prevent the destruction of the partitions?

I do not think it would; I believe it would rather have a tendency to destroy them. If in the case just referred to, the air of the pit had been split into five different parts, I do not think there would have been sufficient current to have prevented that fire crossing the air-course, and lighting up the other gas in the goaf.

4811. Are not you aware that you may get a much larger power of ventilation from a certain current by dividing it, than by taking it in one body through a mine?

Perhaps there might be more air, taking it as a whole; but for useful purposes, I do not think it would be better.

4812. What is the greatest extent of workings which you have ever seen in a colliery underground?

Sometimes about 2,000 yards from the shaft; but that is a rare circumstance.

4813. Supposing that you heard of a colliery in which the workings were altogether above 70 miles, you would think it a very large concern?

I should not like working in it; I should not work in it if I could get work any where else.

4814. Perhaps you were not before aware that there is at least one colliery with respect to which that is the fact?

I am aware of it by report, though not by practical experience.

4815. Would it be reasonable, or would it be possible, to apply the same system of ventilation to collieries such as this to which I am now alluding, and collieries such as you have been accustomed to, in Lancashire and Yorkshire?

No system of ventilation, that I am acquainted with, could safely ventilate a mine of that extent.

4816. Have you ever considered the bearing of the question of Government inspection?

I have.

4817. Is there a great anxiety on the part of the workpeople in the districts of which you have spoken for the interference of Government for their protection?

Very great.

4818. You

4818. You are aware of a Bill brought into the House of Commons this year by Mr. Duncombe, Mr. Aglionby and Mr. Hume?

Mr. David Swallow.

Yes; I took part in the preparation of that Bill.

16th July 1849.

4819. You have constant communication with the workpeople, have not you?

Yes; I am employed by the workpeople, as agent, to attend to those matters.

4820. Have you made it your business to turn your attention very much to questions connected with ventilation?

Yes.

4821. Is it your opinion that it would be right for the Government to establish Inspectors to take upon themselves the direction of the working of coal mines?

No, not the direction of the working of coal mines.

4822. Among the clauses of this Bill, are there not several which confer upon the Inspectors a power of that kind?

Not that I am aware of.

4823. In the second clause of the Bill it was proposed that Inspectors should be appointed to examine and inspect collieries, and the works, buildings, machinery, and all the parts belonging to a colliery, and that if the Inspector found anything objectionable, dangerous or defective, so as to threaten or tend to the bodily injury of any persons employed in working the mine, he was to give notice to the owner of the mine or colliery, and direct the said owner to alter, repair or improve the said mine, works or machinery, or to do or perform such matter or thing connected with and relating to the said works or machinery, as to the said Inspector should seem proper and advisable; and if the said owner did not, within a reasonable time, obey the same, he was to forfeit the sum of 100 l.; do not you think that amounts to a very extensive power of direction to be vested in the Inspector?

This is the way I understand that: that if the Inspector finds the colliery, or any part of the colliery, not properly ventilated or attended to, such as the ropes being bad, there not being sufficient props, or the trap-doors being defective, it should be the duty of that Inspector to give notice of those defects, and point out the evil; but the Inspector is not to have the power of ordering any particular way of remedying the evil. Supposing he finds a colliery is fiery, he points out the danger which exists, but he does not tell the master that he must adopt either steam ventilation, fan ventilation, or furnace ventilation. We propose leaving that with the masters and the managers. We do not think that it would be wise to recommend any one particular system, but to leave the management of the colliery entirely with the masters; but where the Inspectors find there is danger, they are to point it out; and if the owners do not remedy it by some means, they are to summon them before a magistrate.

4824. Does not this clause empower the Inspector to direct the owner to perform such works as to the said Inspector shall seem proper and advisable; are not those the words of the clause?

Yes.

4825. Do not they necessarily imply, that the Inspector should form his opinion as to what was proper and advisable, and should distinctly give his directions thereupon to the owner?

No; I do not understand them to mean that.

4826. Was not that the intention of the framers of the clause?

No; our intention was to give notice of the danger, and point it out, and if after a certain time it was not remedied, then the Inspector must examine it and report, or obtain a summons from a magistrate; if it was not altered according to the Inspector's opinion, he must report.

4827. Supposing those words really to mean that the Inspector, under such clause, would have the power of entering a mine, and forming an opinion as to what the mine required, and giving positive directions to the owner, rendering the owner subject to a penalty of 100 l. if he did not follow the directions of the Inspector; that would not be what you meant in drawing up that clause?

No.

Mr. David Swallow.

16th July 1849.

4828. Do you think any such power as that would be desirable to be conferred upon any Inspector?

I do not think it would be desirable that the Inspector should have the power of directing the owner of any colliery to work as he thought proper.

4829. Supposing a power were given to the Government to appoint an Inspector, who should have the power of examining a mine at all times, and of inspecting the plans, and making any recommendations to the owner of the colliery which he might think the state of the mine required; would that be nearer your intention in drawing up this clause?

No; that would not be nearer our intention. What the colliers generally want is some one to point out the danger; and if the masters do not remove it, then subject them to a penalty; but give them the option to remove it.

4830. How would you reconcile giving the Inspector the power of pointing out the danger, and requiring that it should be removed, and yet not giving the Inspector a directing power over the owner of the colliery?

In all cases, if there is danger it ought to be removed.

4831. Supposing the Inspector to visit a colliery, and to find something which in his opinion was objectionable, and to make a remark upon it; and supposing that the owner of the colliery, being a man of intelligence and experience, differed from the Inspector, and refused to make the alteration; in case an accident occurred afterwards, upon whom would the responsibility lie?

Upon the master.

4832. Supposing, on the other hand, a difference of that kind took place, and that the Inspector's advice was followed, and then an accident occurred, upon whom would the responsibility lie?

An Inspector, properly qualified, would give directions for no alterations but those that were necessary.

4833. Do you feel so confident that persons could be appointed as Inspectors, who should be quite infallible upon such points, so as to be able to say exactly what is right, and to direct the managers of collieries at all times, by a power such as has been suggested?

I believe Government inspection is carried on with great advantage in foreign countries.

4834. Do you know the difference which attaches to the case of foreign coal mines and the coal mines of this country, with respect to the right of the Government to interfere?

I understand that all the minerals generally belong to the various Governments.

4835. Is that so here?

It is not.

4836. Does not that constitute a very material difference between the two cases?

It constitutes a material difference so far as owning the mineral goes, but it constitutes no difference so far as the safety and ventilation of the mine is concerned.

4837. Does not it make this essential difference, that the owner of the minerals has a right upon his own account to an inspection, independent of any public object?

And he ought to have inspection.

4838. Does not the owner of the minerals in this country exercise the right of inspection?

Yes.

4839. Does it quite follow, that because the Government of those countries has always exercised the right of inspection, it would have found it equally possible to exercise such right, if it had not been the owner of the minerals?

I think the inspection of mines in this country should be a similar inspection to the factory inspection. Inspectors with the power of the Factory Inspectors, are what the men generally want.

4840. The

4840. The Factory Inspectors are appointed to examine factories, and to see that certain provisions of the law with regard to the regulations of factories are strictly observed, principally as to the hours of work and the ages of the work-people ?

Mr. David Swallow.

16th July 1849.

Yes ; and if there is any factory not properly ventilated, or any dangerous machinery, they give orders that it shall be properly secured.

4841. Do they give any orders with respect to the alteration of machinery ?

No.

4842. All their power in that case is limited to this, that where they find that machinery is exposed, they may require that it shall be shielded ?

Yes.

4843. Is not that a very simple direction ?

Yes.

4844. Might not it be applied to any case without difficulty ?

Yes.

4845. Are you sure that they inspect the machinery ?

I believe they do ; I have never seen them, not being a factory workman ; but being in the midst of them, and associating with factory people, I have heard them speak about the Inspector coming into the factory. I have seen reports occasionally in the newspapers of factory masters being summoned before the magistrates for having machinery exposed, and not boxing it up after sufficient notice.

4846. Do you think, with respect to the ventilation of mines, there is so much certainty with respect to the best arrangement of the workings as to enable any one man to come and express a positive opinion, and direct the owner of the colliery to adopt his opinion ?

I do not think that that would be right.

4847. Supposing an Inspector, in going through the workings of a mine, were to find that certain partitions in his opinion were required ; that the air ought to be taken in a different direction ; and from a cursory inspection, which must be all he would have an opportunity of exercising, were to adopt that opinion, and express it to the manager of the colliery ; do you think his opinion upon that point would be more trustworthy than that of persons who were in the constant habit of inspecting the mine ?

Undoubtedly it would.

4848. Do you think a man visiting extensive works, and, perhaps, passing a few hours in them, would be able to speak with more confidence as to the necessities of that mine than persons who are continually accustomed to it ?

I do not think a mine can be inspected in a few hours ; I do not think that kind of inspection sufficient.

4849. What do you think should be the duty of an Inspector ?

I think the Inspector's duty would be to examine the ropes and machinery of the colliery, to descend the mines, and examine them very minutely.

4850. What do you call examining them very minutely ?

He should pay attention to the force of air, the stoppings and the quantity of air passing through the workings, and how the mine was conducted ; in what condition the goafs were ; whether they were well ventilated or not ; whether there was a sufficient quantity of props. There are many things which he would find it necessary to direct his attention to, such as using gunpowder in a pit where it is very fiery.

4851. Have you known any explosions occur from the use of gunpowder ?

I have.

4852. In how many cases ?

The first case that I recollect must be about 20 years ago ; I had only been working in the pit a very few years ; I recollect it was some time about September. A cousin of my father, Matthew Ramsden, was sinking a pit for Messrs. Charlesworth, called the "Orchard Pit ;" it was evening, if I mistake not ; it was on the Monday evening he had lighted the shot at the bottom of the pit. Sometimes when

Mr. David Swallow.

16th July 1849.

the pits are a good depth they will light them, so that the blast will go off before they get to the top. As soon as he had lighted the match he ordered them to wind him up: the shot went off while they were doing so; that lighted the gas that was in the pit, and burnt him dreadfully; it blew the head-gearing off, and the gin down, and the horse also; he died very soon after. In another case, a man that was working with him a few years after, was also sinking a pit for Messrs. Charlesworth. In the first case, Matthew Ramsden, I believe, was not aware that there was any fire-damp in the pit; in sinking the second pit, they were; and it is customary, when they are sinking pits with fire-damp in them, that they fire a shot, not by lighting it at the bottom, but they attach a rope from the top of the pit to the bottom, and have a red-hot ring at the top and run it down, so as to put the ring properly round the top of the blast. When we draw the spindle out of the shot, we fill this up with powder, and put powder round the hole, fasten it at the top of the pit, and drop the red-hot ring down; as soon as the ring touches the powder, it explodes, and then the blast goes off. This man was standing at the top, putting the ring on and watching it, and it exploded, and blew the head-gear up, and blew the gin down; it blew him up into the air; he fell down into the pit again, and was killed at the bottom of the pit.

4853. For what object was the blast?

To blast the stone at the bottom of the pit. On the 28th of June 1847, an explosion took place at Kirkless colliery, near Wigan; I think there were 13, if not more, lost in consequence of it; that occurred by the firing of a shot. It has been the general opinion among colliers that fire-damp will not light by the explosion of powder.

4854. Supposing the coal to require that method of working, how would you propose to work it without gunpowder?

Coal can be worked very well without gunpowder.

4855. In all cases?

Yes.

4856. Are you prepared to say that there is no coal in this country which requires the force of a blast of gunpowder?

I am prepared to say that there is no coal which cannot be worked without gunpowder.

4857. Have you had sufficient experience of the different kinds of coal to be able to state that?

I think I have.

4858. Have you ever worked in South Wales?

No, I have not; I am not speaking of Wales, but only of England.

4859. Where coal is very hard, it is generally found necessary to work with gunpowder, is not it?

Yes.

4860. In what way would you work it without gunpowder?

When I had holed my coals, and cut them, I would drive them down with hammers and wedges.

4861. Do you think you could do that at such cost as would enable you to work the colliery profitably?

I do not think I could get as much coal.

4862. Would not that increase the cost of working the coal very much?

I think very little.

4863. Do not you think, if proper ventilation were established in a mine, gunpowder might be used with safety?

I do not wish gunpowder to be prohibited, except where it was found necessary to work with a safety-lamp; where it is found necessary to work with a safety-lamp, gunpowder ought to be prohibited.

4864. It may be necessary to work with a safety-lamp in one part of a mine, and not in others?

Gunpowder should not be used in the parts where the safety-lamp is used.

4865. How

Mr. David Swallow.

16th July 1849.

4865. How would you define that in an Act of Parliament?

I would state that wherever it is found necessary to work with a safety-lamp, gunpowder should not be used.

4866. Who should be the judge of where it was necessary so to work?

The managers generally are the judges.

4867. Then it must be left to the managers?

Yes.

4868. Do you conceive that a Government Inspector could be constantly in the mine to see how the case really stood?

He could not.

4869. By the third clause of this Bill the Inspectors are required to visit, enter and examine every mine and colliery within their respective districts four times at least every year; how long do you think it would take them to examine one large mine thoroughly?

I should think one of those with 70 or 80 miles of passage in them would take about a week.

4870. How many mines could an Inspector take under his charge if he were to visit each of them four times a year?

I should propose having four Inspectors, and let them have a few Sub-inspectors.

4871. Do you think that four head Inspectors, and a few Sub-inspectors, would be able to examine every colliery in this kingdom four times a year?

Yes.

4872. By a few Inspectors, how many do you mean?

According to necessity; some circuits will require more than others.

4873. Are you aware how many collieries there are in this country?

No; I have no notion of how many different pits there are, nor how many firms.

4874. Taking the different districts of Northumberland and Durham, Cumberland, Lancashire and Yorkshire, Shropshire and Staffordshire, Derbyshire, Nottinghamshire, Cheshire, Leicestershire, Warwickshire and Worcestershire, all South Wales and North Wales, and all Scotland, do not you think there must be a very large number of collieries to be inspected?

There is a very large number of collieries; but I think at a very little more cost than the cost of the factory inspection, it might be done.

4875. What is the cost of the factory inspection?

I believe something like 13,000*l*.

4876. Take the case of a large factory, and compare it with a large colliery, which do you think would take the longest time to inspect?

A colliery.

4877. A much longer time, or not?

A great deal longer time, I have not the least doubt. A small colliery would take a longer time to examine than a large factory.

4878. Would it be possible for one man to get through anything like the same amount of colliery inspection that is got through by the factory Inspector?

I think there are not the same number of collieries that there are factories.

4879. There must be a very large number in the districts which have been mentioned?

There is a very large number; but I think there are more factories in Lancashire than there are coal-pits.

4880. It is your opinion that four head Inspectors, with a few Sub-inspectors, would be sufficient efficiently to examine all those collieries four times a year?

Yes, I think so.

4881. And to write 1,000 reports?

Every colliery would not require a separate report.

Mr. David Swallow.
 16th July 1849.

4882. Supposing the Inspector to have examined a colliery, we will say in January, and not to be expected again for some time, upon whom would the responsibility of the management of that colliery remain in the meantime?

With the manager.

4883. Then it is impossible to relieve the manager of the responsibility?
 Quite impossible.

4884. Do not you think, in that case, it would be better to leave the entire responsibility upon the manager, after proper warning, than to take the responsibility off his shoulders, and place it upon those of the Inspector?

I would not take it off his shoulders at all; I would try to put it more on.

4885. Supposing an Inspector examined a colliery, and took it upon himself to give certain directions, and the colliery owner, in spite of his own difference of opinion, adopted those regulations, where would the responsibility lie?

Of course it would lie with the owner still.

4886. If he followed the directions of the Inspector?

He might suggest, but not to have the power of giving any positive directions what should be adopted.

4887. Suppose the colliery owner differed altogether, in his view of the question, from the Inspector, and adopted the directions of the Inspector, merely in consequence of the power conferred upon him by the Act of Parliament; do you think the responsibility would lie upon the manager?

No, of course it would not lie upon the manager, it would lie upon the owner.

4888. Would it not lie upon the Inspector who gave the direction?

I do not think it would be his duty to give any specific directions as to any mode or system to be pursued; the only directions he ought to give would be, where he saw evident danger, to point out the danger; but he should give no specific directions as to how it should be remedied, only suggest remedies.

4889. Do you think all those cases are so simple and clear as to enable one man to say that he is quite confident he must be right, and another must be wrong?

In that case, I would propose that where the owner or manager thought he was quite correct, he should have the power of calling in an arbitrator or arbitrators, one to be called in by the master, and the other by the Inspector; as in the case of the Factory Act, if the arbitrators gave a decision against the owner of the factory, he should pay the expense. If the Inspector's opinion is wrong, and it is given in favour of the manager, or the master, the expense should be paid out of the funds of the colliery inspection.

4890. Supposing an Inspector were to enter a mine, and were to find there a ventilation of the amount of 20,000 cubic feet per minute, and he were to declare to the owner his opinion, that that was not a sufficient ventilation, and the owner, on the contrary, differing from him, said, that from long experience he was quite satisfied that 20,000 cubic feet per minute was sufficient ventilation for the mine; do you think the owner should be bound to increase his ventilation to 30,000 or 40,000 cubic feet, at the direction of the Inspector?

Yes; I think he ought to be compelled to do it.

4891. At whatever cost to himself, though he was satisfied it was unnecessary, and although no accidents, arising from the want of ventilation, had occurred in his mine?

The expense of ventilating a colliery cannot be great.

4892. It may involve expense, the amount of which it is impossible to say; do you think it would be right for an Inspector to have the power of imposing upon an owner a large expense by the expression of such an opinion, without being able to prove that the owner was wrong in his opinion?

No; I think the owner ought to have a fair chance of proving that he is right by an arbitration.

4893. Do you think it would be desirable, in every case of this kind, to have an arbitration upon such questions?

Yes, if the owner objects to introducing the quantity of air required.

4894. And

4894. And that power you would confer upon the Sub-inspectors, appointed under the chief Inspector?

Yes.

Mr. David Swallow.

16th July, 1849.

4895. Persons of the same class as the Inspectors of Factories?

Yes.

4896. Who do you propose should arbitrate in a case of difference of opinion? The coal-master should choose one, and the Inspector the other arbitrator.

4897. And if they disagree?

Then the two arbitrators should mutually choose one, or an umpire should be chosen mutually by the parties.

4898. At the expense of the owner?

Yes; supposing that the case goes against him.

4899. Supposing the arbitrators determine in his favour?

Then it must be paid out of the funds provided for the inspection.

4900. Is there a very prevalent feeling among the workpeople, that an Inspector, with such powers as those, would be a desirable thing?

Yes, a very strong opinion.

4901. Supposing an inspection of that kind were established; what do you think would be the feeling among the colliery owners upon it?

I believe that, with some, the feeling would be very much against it; others appear to care nothing at all about it.

4902. Can you name any colliery owner who ever expressed an opinion in favour of a system of inspection such as you have described?

No.

4903. Supposing an inspection were appointed in direct opposition to the feelings and wishes of all the colliery owners, do you think it would be easy to execute that inspection?

I do not think it would be so very easy at first.

4904. Is it as easy, do you think, for an Inspector to gain access to a mine, for the purpose of examination, as it is for an Inspector to obtain admission to a factory?

Of course it is, if they are armed with the same powers.

4905. Do you think it practically as easy for an Inspector to obtain admission to a mine, as it is to require that the door of a factory shall be opened?

Yes, if he is armed with the same authority.

4906. Supposing a colliery owner to be extremely unwilling to admit him, and gave him no facility whatever for entering the mine, how would he be able to accomplish it?

If the mine be a working mine, there are always facilities.

4907. Provided the manager chooses to afford them?

There must be always facilities of entering a mine which is working; if it is not working, it does not want inspecting.

4908. Supposing the colliery owner, or the person managing a colliery, were very hostile to the visits of the Inspector, do not you think he could put difficulties in the way of his seeing the mine?

Yes; but not difficulties which could not be overcome.

4909. Would not they be much greater difficulties than the owner of a factory could interpose?

I believe they have had great difficulties to contend with.

4910. Do not you think that the difficulty of inspecting mines would be still greater?

No, I do not think so.

4911. You think it would be as easy to gain access to a mine as to walk through the different floors of a factory, and see how many people are employed, and ascertain their age?

It is not such easy work, but I do think that the difficulties might be overcome.

Mr. David Swallow.

16th July 1849.

4912. You compare the case with that of the factory inspection; do not you think that the difficulties are greater than in the case of the factory inspection?

I do not think they are much greater.

4913. Do you think that a man could come to a colliery where he was ill received, be let down into that colliery, go over all its workings, examine all its air-passages and the whole system of ventilation, and inspect every part of its working, and that that could be done by the Inspector, in spite of the disinclination of the people concerned in the mine, as easily as an Inspector could come to a factory, ask that the doors should be opened, walk through the different floors, and ask the workpeople their ages?

It could not be done so easily.

4914. In the case of Factory Inspectors, is it their business to look into the manner in which the machinery is applied, and the particular description of machinery which is employed?

I believe they direct their attention to that subject; but I am not aware that it is necessary for them to observe what kind of machinery is used.

4915. If they saw any machinery which was dangerous, would they have the power of compelling its alteration?

Yes, they would have the power of giving the master notice of the danger of the machinery, and if he did not box it up, he would be liable to be taken before the magistrates and fined.

4916. The only thing that the Inspector is empowered to require is, that the machinery shall be protected?

Yes.

4917. Not that it shall be altered?

No.

4918. He has no right to inspect the machinery?

No.

4919. All he has to do is to inspect the exposure of the workpeople, and to see that they do not work over hours?

Yes.

4920. Is not there an inspection already established with respect to mines for a part of that purpose?

I believe there is.

4921. With respect to the ages at which children are to be allowed to work in the mines?

Yes.

4922. Therefore the only part of the factory inspection which would remain to be imitated in mines, is that which gives the Inspector the power of ordering that machinery should be boxed off?

Yes.

4923. Do you think that that is not a power of a very different description from giving the Inspector the right to go into a mine, and give directions as to the different arrangements of the passages and workings in the mine?

I think I have been rather misunderstood. My decided opinion is that the Inspectors should not give any specific directions how the mine should be worked; I mean that they should not direct that the mine should be worked either on the long wall system or on the post and stall system, or that it should be ventilated by the furnace or by the fan or by steam; if they found deficient ventilation, or that the roofs were not sufficiently propped, they should point out the danger, and if that danger were not remedied, they should have the power of summoning the master or manager before a magistrate.

4924. It has been represented to the Committee, that there is great danger in certain modes of working mines; the working of some of the mines in Yorkshire is said to be very dangerous; supposing the Inspector were to visit those mines, do you think he should not have the power of giving directions with respect to the working of those mines?

No.

4925. Then

4925. Then he would not remove the danger ?

Of course he would not remove the danger ; he would make the master liable to a penalty.

Mr. David Swallow.

16th July 1849.

4926. How would he do that if he could give no directions ?

He would give directions in certain cases ; supposing there were a trap-door that was bad, if that trap-door were not repaired, or a new one put up in its place, then of course the master would be liable to a fine, or supposing there was not sufficient air introduced into the mine.

4927. Supposing that the system upon which the air was passed through certain parts of the mine was, in the opinion of the Inspector, dangerous, would he have the power then of giving directions to the owner to alter those air-courses and adopt a different system ?

Not specific directions.

The Witness is directed to withdraw.

Ordered, That this Committee be adjourned till To-morrow,
One o'clock.

Die Martis, 17^o Julii 1849.

The LORD WHARNCLIFFE in the Chair.

Evidence on the
Prevention of
Accidents in
Coal Mines.

WILLIAM PEACE, Esquire, is called in, and examined as follows:

W. Peace, Esq.

17th July 1849.

4928. YOU are an agent to collieries at Wigan, are you not?

I am; I am the principal agent of the Earl of Crawford and Balcarres, who is one of the principal coal-workers and owners in Lancashire; besides that, I practise as a regular colliery viewer.

4929. Have you had long experience in that business?

About 20 years.

4930. Has your experience been confined altogether to the Lancashire district?

No, I was extensively connected with the Yorkshire collieries before I went to Lancashire; I have had the management of Lord Balcarres's collieries for 17 years, besides practising as a viewer in various parts of the Kingdom; I am also acquainted with the South Wales coal-field, and the North Wales coal-field, and to some extent with the Northumberland and Durham coal-fields.

4931. Have you ever turned your attention to the subject of the occurrence of accidents in coal-mines?

I have frequently; in fact it has been my constant subject of consideration.

4932. Will you state at what general conclusions you have arrived upon that subject?

The general conclusion to which I have come with respect to accidents in the North, I mean Durham and Northumberland, is this; I am now speaking particularly with respect to accidents resulting from explosions. So far as I have been able to form an opinion, from my inspection of the collieries, I think there are an insufficient number of air-pits or upcast shafts for the large extent of mines which are there opened at the respective collieries; the system of working there is to lay open an immense field of coal, and to keep that field of coal so opened in a kind of honeycomb state, with drifts, perforating it in every direction, all which require to be ventilated; consequently the air has to travel an immense distance, and is subject to great friction in its course; it requires great power to cause that current, and that power is very often insufficient to keep up a current of sufficient rapidity to clear off the gases as they are evolved from the coal.

4933. Does that defect prevail equally in Lancashire?

No, the coal-field of Lancashire differs altogether from that of Northumberland in this respect; in the coal-fields of Durham and Northumberland we find immense fields of coal almost undisturbed by faults or dislocations; whereas in Lancashire and Yorkshire the very reverse obtains; for example, in Lancashire, the entire coal field of North Lancashire is intersected with main dislocations, at distances varying from 500 to 1,000 yards, running parallel to each other in the direction of north-west and south-east; those dislocations raise or depress the strata according to the side from which you view them, from 600 yards down to 200 yards; I should say upon the average 300 yards; this divides the country into belts.

4934. You mean that 300 yards is the extent of the dislocation?

Yes, those main faults which divide the country into belts we look at as the principal geological features of the country; those belts are again subdivided by smaller

W. Peace, Esq.

17th July 1849.

smaller faults, varying in size from 70 yards to five or six feet or one foot; to such an extent do those dislocations prevail, that I should say upon an average 100 yards cannot be perforated in any mine in Lancashire without meeting with one of them.

4935. Does this frequent occurrence of faults, in the Lancashire coal-beds make the system of ventilation more complicated and difficult?

No, rather the reverse, because it prevents such a large field of coal being worked to one or two pits; we are obliged to have considerably more pits to work any particular seam of coal than would be the case, provided the seam were undislocated for a very large extent; we should then endeavour to save ourselves the trouble and expense of opening more pits than were absolutely necessary; whereas now we are obliged to sink the pits in consequence of the dislocations; consequently there is a less extent of mine to be ventilated by a given number of pits.

4936. The opposite state of things in the North leads, in your opinion, to too small a number of upcast shafts?

Yes, and downcast also, too few shafts are sunk to afford ventilation to the mine. I went through the Fenwell Colliery, which at that time had an air-course about 60 miles along; the top of the candle, which we always have recourse to to view the state of the air previously to its access to the upcast shaft, was, to the best of my recollection, an inch and a half long.

4937. Was the mine at the time in course of working?

It was in course of working. Two or three years subsequently an accident occurred involving the destruction of about 90 people.

4938. When you observed this appearance near the upcast shaft, was there then a strong power of ventilation at work?

A strong power, but not sufficiently strong.

4939. By a furnace?

Yes.

4940. In Lancashire, what is the largest extent of coal-field worked by two shafts?

I should say, speaking, of course, roughly, that the extent of mine worked by two shafts, the upcast and the downcast, in Lancashire did not in any case exceed 100 Cheshire acres, that is, 200 statute acres; in the majority of cases I should think the average quantity worked by any two shafts would not exceed from 20 to 30 statute acres.

4941. Are the distances through which the air has to travel very great?

No; the system of working mines is different altogether in Lancashire to that which prevails in Northumberland and Durham; there it is usual to work out an enormous extent of coal-field in drifts, leaving pillars to support the roof through that entire extent; whereas with us, we get a certain number of drifts, and bring back the pillars immediately. I have brought a model to explain to your Lordships the system adopted by us—[*producing the same*]. Here is a mine partially got out and partially worked; that is a model of the workings carried on by us; that was the state of them in the year 1845; we are now approaching a finish; we have never had any accident there.

4942. How long have you been working there?

It is now nearly exhausted; it has been worked about 15 years.

4943. Do you attribute your freedom from accidents to the perfect system of ventilation adopted?

Yes, we have no other cause to which to attribute our freedom from accidents; this was one of the most fiery mines.

4944. The ventilation in that mine is conducted by what means?

By means of a furnace.

4945. One furnace?

Only one.

4946. Where

4946. Where is that placed?

It is placed at the higher part of the workings; it is shown by this aperture—
[pointing to the model].

W. Peace, Esq.

17th July 1849.

4947. At the bottom or the top of the shaft?

At the bottom of the shaft.

4948. That shaft not being a working shaft?

Not being a working shaft.

4949. What is the diameter of that shaft?

Nine feet.

4950. What is the depth?

Ninety yards.

4951. What is the width of that furnace?

The width of the furnace is six feet, and ten feet long.

4952. Does the whole of the air pass over the furnace?

Not entirely over; some passes underneath and some passes through small passages by the side of the brick-work; those passages are only about 18 inches wide.

4953. What is the object of sending part of it through those passages?

To keep the brick-work cool; to prevent the coal taking fire.

4954. What amount of ventilation can you obtain from that furnace?

A current of eight miles per hour; about 18,000 cubic feet of air per minute. It passed 100 yards in half a minute, according to the actual notes last taken, or about three yards and one-third in a second.

4955. Do you consider that to be quite sufficient to keep the mine properly ventilated?

Perfectly sufficient.

4956. What distance has the air to travel in that case?

At the present time it is much less than it has been on previous occasions; I should say eight or nine miles is the utmost extent.

4957. Does it travel that distance in one continuous stream?

No, in two streams; one stream down each downcast shaft; about seven miles in one case, and about three miles in the other.

4958. That is the only division made in the current of air?

That is the only division.

4959. Is not it your practice in the ventilation of mines in Lancashire to split the air?

We do so occasionally; if we had only one downcast pit instead of two, we should split the air; as it is, we have two downcast pits, so that we do not split the air.

4960. When you spoke of the whole distance over which the air had to travel, did you mean the whole distance travelled by both currents, or by one of the two?

By both.

4961. Generally speaking, should you say that the ventilation of the mines in Lancashire was deficient?

No; so far as I am aware, the ventilation of the mines is not insufficient; on the contrary, in the large collieries I have inspected, the greatest care has been taken, quite obviously, in order to prevent accidents.

4962. There are many of the smaller collieries of which the same cannot be said, are there not?

There are a great many small collieries at which the same care is not used.

4963. Is it almost universal among those collieries to have two shafts?

In small collieries there are a great many shafts generally; in small collieries the mines are very near the surface; they are, therefore, accessible by adventurers with small means, in many cases totally unacquainted previously with the
(164. 15.)

W. Peace, Esq.
17th July 1849.

working of mines; they work them, being ignorant of the consequences, in a manner which is censurable.

4964. Do you think it is essential that there should be two shafts in all cases for the ventilation of a mine?

In almost all cases I should say it is desirable to have two shafts for ventilating a mine.

4965. And one specially reserved for ventilation?

It is desirable in all cases to have one reserved for ventilation.

4966. Should you not say that it is very objectionable to have the upcast shaft used as a working shaft also?

It is objectionable undoubtedly.

4967. Are those small collieries generally furnished with furnaces?

Yes, they are, generally.

4968. Are there any mines in the district with which you are acquainted which depend entirely on the ordinary atmospheric ventilation, without any artificial means?

I do not know; but I know that some mines are naturally so free from gases, either carbonic acid gas or hydrogen, that very small furnaces are used, called fire-pans, which are let half-way down the pit, and fed from the top.

4969. Are there collieries for which such a plan is sufficient?

There are some.

4970. But in a seam of coal which produces much coal, I suppose that could never be sufficient ventilation?

Never; the deepest pits we work in the collieries under my own immediate superintendence are 240 yards; there are pits much deeper in Lancashire.

4971. Have you ever seen any other method of ventilation in operation besides the furnace?

Yes, I have seen attempts made to ventilate mines by means of a fan.

4972. In what cases?

Only in one case that came immediately under my own knowledge, which was in Mr. Thompson's pit, on Brim-Moss; they were afraid to resort again to the furnace, an explosion having taken place, and the mine remaining full of gas, and they resorted to the fan; but the result was not satisfactory.

4973. In what respect did it fail?

The current of air produced was very insufficient to clear the atmosphere in the mine from the gaseous matter.

4974. Whose fan apparatus was that?

It did not differ materially from the ordinary fan; to the best of my recollection it was six feet in diameter; it was endeavoured to force the air down the pit by the centrifugal force of the fan.

4975. In that case the current produced was not sufficient?

It was not.

4976. Was it greater than had been produced by the furnace?

No, I do not believe it was; I had not been in the mine before; I was called in after the accident had occurred; I found the mine in a rather dangerous state, so much so as to render the use of a lamp very insecure; shortly afterwards the pit was stopped.

4977. Notwithstanding the application of the fan apparatus?

Yes; besides that, I have been told by a person who carried on the experiment, that at Oldham a fan of nine feet in diameter was employed in the same manner. John Evans, of Oldham, informed me of it, who is a colliery viewer of considerable experience; he told me that the experiment had been carried on under his direction; it exhausted the entire power of an engine, I believe of about 30-horse power, and he said that the effect of it was very unsatisfactory.

4978. Have you ever seen the fan apparatus applied to the upcast shaft, for the purpose of driving the air out of the pit?

No.

4979. You

4979. You are not aware of an application of that kind by Mr. Brunton, in South Wales?

No.

4980. Have you ever seen anything of the steam-jet?

No.

4981. Your experience of artificial modes of ventilation is confined to the furnace, and those particular instances of fan ventilation?

Yes; I am not aware that there are more than two or three instances in which the steam-jet has been applied; I was told by Mr. Johnston, of St. Helen's, that a short time since he had tried the experiment; that is the only instance, I believe, in which it has been tried in Lancashire, and he has suspended it; he worked it in connexion with a furnace then existing at the bottom of the upcast shaft; the effect was, that the current of air was increased about 50 per cent.; but there was one very serious objection which caused him to suspend its operation, temporarily at all events, which was this: the pit had been previously used for a long time as an upcast furnace pit; the sides, consequently, had become very dry, in consequence of the heated air continually ascending; on the application of the steam-jet the steam became condensed on the sides of the pit, and produced small streams running down the sides, and this produced what the miners called the swelting of the sides, that is, the soft strata rapidly absorbed the water, and expanded, and fell off down to the pit's bottom, and caused a great accumulation of debris, which would have stopped up the pit had it gone on.

4982. Do you know how it was applied in that case, with respect to the distance from the surface, and so on?

It was 10 yards from the surface.

4983. And do you know how many jets were applied?

No.

4984. What was the diameter of the shaft?

Nine feet.

4985. Had Mr. Johnston more than one jet?

A considerable number.

4986. What was the diameter of the jets?

He had them surrounded by a square funnel; the bottom of the funnel was about a foot square, widening up to about two feet square at the top; he said the object of applying each jet at the bottom of a square funnel was to increase the power of the jet; he had the tops of the funnels made to approach within a little distance of each other, so that the area of the pit would be occupied by square funnels, about two feet square at the top, with a jet of steam at the bottom of the funnel, which was only a foot square.

4987. That was the plan upon which it was tried?

Yes.

4988. Do you know what was the pressure?

About 30 lbs. upon the inch.

4989. The jets were not playing freely in the area of the pit, but were confined to those tubes?

To the bottom of those funnels.

4990. Independently of the objection you have stated with respect to the action upon the sides of the pit, he informed you that he had obtained an increase of 50 per cent. of power?

Yes, using the furnace at the same time; he continued the use of his furnace also.

4991. And the two together gave him an increase of 50 per cent.?

Yes, one-half more than he had before.

4992. The pressure at the boiler was 30 lbs. upon the inch?

Yes.

4993. You cannot tell what the pressure was at the jet?

No, and whatever the pressure might be, it would not prevent its condensation; if the same quantity of steam were emitted, the pressure would be of very little consequence; because whatever the pressure were, if a smaller quantity in proportion

W. Peace, Esq.
 17th July 1849.

tion were emitted, the condensation would be the same, because the quantity coming into contact with the cold air would be the same.

4994. Is the superintendence of the mines below ground in the Lancashire district quite efficient for its purpose?

I should say so; the system of superintendence is this: I speak now with immediate reference to our own colliery, where we have at the present time about 1,200 people employed daily under-ground; I have an under-looker upon whom I can depend, who sends me a daily report; he has charge of from one to three coal-pits; under him again are what we call firemen, who are deputy under-lookers; each of those firemen's time and attention is exclusively confined to one pit.

4995. Are they persons derived from the class of workmen?

They are all derived from the class of workmen.

4996. Do you issue printed regulations for the guidance of the workpeople in your colliery?

We issue verbal and written regulations, not printed ones.

4997. Is it usual to establish the same system of superintendence as that which you have described in the collieries of Lancashire?

Yes, that is the system, I believe.

4998. Are there any regulations with respect to the use of lamps or candles?

In many cases it is usual (for example, it is so in fiery mines) to make the use of the lamp compulsory upon all the workmen; it is necessary, however, in order that they should use the lamps with effect, that we should lock them; but notwithstanding this locking, and notwithstanding we have a person whose duty it is to see every lamp locked, the men are so negligent and contumacious, in fact, that they will possess themselves of keys clandestinely, by which they open those lamps at improper times and in improper places, thus jeopardizing their own lives, and those of the other people in the pit, for the purpose of lighting their gunpowder, which they take down contrary to orders, or lighting their pipes.

4999. Have you known many instances of that sort?

Yes, I have seen them do that before my own face, when I have been down in the most dangerous of our mines; after perambulating nearly the entire workings, I recollect one instance in particular, in which a man close to an open goaf came and sat down upon a heap of slack close to where I was standing, and took off his lamp top; the under-looker and fireman were close beside me; but he took off the lamp-top, and filled his pipe with tobacco while I was there.

5000. Were there any indications of gas there?

Yes, the gas might have been driven out at any instant from the goaf behind us; I permitted him to finish his pipe and depart, and then I made what remarks I thought necessary to the under-looker; it was very possible that the roof might have fallen, and forced back a quantity of air from the old working, which it is impossible to ventilate.

5001. Do you use the common Davy lamp?

Yes.

5002. Do you think that the best lamp?

I do.

5003. Are you acquainted with the others?

Yes, I know almost all of those that have been put forward.

5004. Is not the common temptation to the men to take off the top of the lamp that they have not sufficient light?

Yes; and another reason is, that if they upset their lamp, and put it out, it is a long way for them to travel back to the pit bottom to get another light; in order to save themselves that trouble, they will have recourse to any means of getting their lamp-tops off; it is no unusual thing for me to find the lamps unlocked when I go down; I generally go once a week, or oftener, as the case may require.

5005. Do you never work in the mines with naked candles?

No, except close to the pit in the mine previously referred to, and shown on the model.

5006. Do you use gunpowder?

Not in any case where we use the lamp.

5007. Do

5007. Do you think it is possible always very clearly and decidedly to tell where it is safe to use gunpowder, and where it is not?

Yes, without difficulty.

W. Peace, Esq.

17th July 1849.

5008. Have you ever observed the effect of the difference of the weight of the atmosphere upon the escape of gas?

I have never found that it has made any difference in our mines, which are properly ventilated.

5009. By artificial means? ..

Yes; I have brought a list of accidents, of which we have kept a record for about eight years; those accidents show that they have occurred at every time of the year; they are classified, showing the year, the number of men employed under-ground, the number of accidents under-ground, and those above-ground; the nature of the accident, with the man's name, and the surgeon who attended him, and how much the surgeon's bill was.

The same is delivered in, and is as follows:

ACCIDENTS at Haigh Colliery, in the County of Lancaster, from 1842 to 1849 inclusive.

| Years ending 30 June | Working on Surface. | Workers Under-ground. | Total Workers. | Accidents Under-ground. | | Accidents on Surface. | | TOTAL Recovered. | TOTAL Died. | Number of preceding Accidents caused by Explosions. | Proportion of Accidents, caused by Explosions, to Workers Under-ground employed Daily during the Year. |
|----------------------|---------------------|-----------------------|----------------|-------------------------|----------------|-----------------------|-------|------------------|-------------|---|--|
| | | | | Recovered. | Died. | Recovered. | Died. | | | | |
| 1842 | 281 | 734 | 1,015 | 50 | - - | 4 | 2 | 54 | 2 | — | |
| 1843 | 308 | 729 | 1,037 | 58 | 3 | 6 | - - | 64 | 1 in 507½ | — | |
| 1844 | 319 | 708 | 1,117 | 38 | 3 | 2 | 2 | 40 | 3 | 4 | |
| 1845 | 305 | 902 | 1,207 | 43 | 2 | 3 | 1 | 46 | 5 | — | |
| 1846 | 320 | 898 | 1,218 | 47 | 5 | 8 | - - | 55 | 1 in 223½ | — | |
| 1847 | 328 | 987 | 1,315 | 42 | 3 | 6 | 3 | 48 | 1 in 412½ | 3 | |
| 1848 | 325 | 1,127 | 1,452 | 37 | 5 | 6 | 1 | 43 | 1 in 243½ | 11 | |
| 1849 | 326 | 1,046 | 1,372 | 44 | 4 | 7 | 1 | 51 | 1 in 214½ | 7 | |
| TOTAL - | 2,512 | 7,221 | 9,733 | 359 | 25 | 42 | 10 | 401 | 6 | 25 | 1 in 289 |
| Average 8 Years | 314 | 902 | 1,216 | 45 | 3½ 1 in 289 | 5½ | 1½ | 50½ | 4½ | 3½ | |

ACCIDENTS at Haigh Colliery, from 1 July 1848 to 30 June 1849.

| | | |
|---|-------------------|-------|
| Average number of colliers and drawers employed daily this year | - - - - | 951 |
| Ditto - ditto of labourers under-ground - ditto - ditto | - - - - | 95 |
| Total Average number of workers under-ground - ditto | - - - - | 1,046 |
| Total number of accidents under-ground this year | - - - - | 48 |
| Persons injured | - - - - | 44 |
| Persons killed | - - - - | 4 |
| Average number of persons employed on surface this year | - - - - | 320 |
| Total number of accidents on surface this year | - - - - | 8 |
| Persons injured | - - - - | 7 |
| Persons killed | - - - - | 1 |
| Average number of persons employed daily this year, under-ground and on surface | - - - - | 1,372 |
| Total injured both under-ground and on the surface this year | - 36, or 1 in 24½ | |
| Total recovered - ditto - ditto - ditto - ditto | - 51 | |
| Total killed - ditto - ditto - ditto - ditto | - 5, or 1 in 274½ | |

ACCIDENTS at Haigh Colliery, from 1 July 1848 to 30 June 1849—continued.

| Date. | Recovered. | Died. | Pit. | Nature of Accident. | Under-ground. | | Surface. | | Surgeon. | Charges. |
|----------|---------------------|------------------|----------------|--|---------------|-------|------------|-------|----------|--------------------|
| | | | | | Recovered. | Died. | Recovered. | Died. | | |
| 1848: | | | | | | | | | | |
| July 6 | Thos. Naylor | - | Aberdeen | Hurt by buzzard falling | 1 | - | - | - | Daglish | £. s. d. 2 13 6 |
| " 7 | - | Thos. Hartcliffe | - | - ditto - ditto | - | 1 | - | - | - | - |
| " 24 | - | John Walkden | William Pit | Rope broke, and he was knocked into the dip-hole. | - | 1 | - | - | - | - |
| Aug. 12 | Jas. Bamber | - | Aberdeen | Foot hurt by the buzzard falling | 1 | - | - | - | Hawett | - 18 6 |
| " 18 | Saml. Haddock | - | - | Knee hurt by falling when going down brow with a basket. | 1 | - | - | - | Fisher | 1 2 - |
| " 19 | Jas. Prescott | - | - | Head hurt against pillar | 1 | - | - | - | Daglish | - 19 6 |
| " 31 | Hd. Gorton | - | Arley Pits | Hurt | 1 | - | - | - | Hawett | - 18 - |
| Sept. 10 | Chr. Sautors | - | Bridge Pit | Head hurt by catching it against the roof | 1 | - | - | - | Fisher | 1 14 - |
| " 11 | Wm. Ball | - | Patchcroft | Hurt by buzzard falling | 1 | - | - | - | - | 3 10 - |
| " 11 | - | John Grayson | - | - ditto - ditto | - | 1 | - | - | - | - |
| " 15 | Allan Parr | - | Wall Hoy | Finger crushed with a rail | 1 | - | - | - | Daglish | - 7 6 |
| " 29 | Thos. Pilkington | - | Brinks Incline | Leg hurt; caught between two railway waggons. | - | - | 1 | - | Hawett | 3 19 4 |
| Oct. 3 | Hy. Milling Wack | - | Wagon Road | Leg broken by falling (in a fit) from a plank when wheeling coal. | - | - | 1 | - | Fisher | 2 10 6 |
| " 5 | Ab. Preston | - | Smithy | Hand hurt by being caught between chain and pump stocks. | - | - | 1 | - | Daglish | - 6 - |
| " 10 | Josh. Smethurst | - | Patchcroft | Thigh broken by buzzard falling | 1 | - | - | - | Hawett | 4 3 - |
| " 19 | John Seldon | - | - | - | 1 | - | - | - | Daglish | - 9 - |
| " 21 | Scholfield | - | - | - | 1 | - | - | - | - | - 6 - |
| " 24 | John Baron | - | Yard Pit | Leg caught between tram and wall | 1 | - | - | - | - | 2 12 - |
| Nov. 10 | Sam. Melling, B. | - | Morris Lane | Arm hurt by lifting at a basket of slack | 1 | - | - | - | Fisher | - 9 - |
| " 18 | John Houghton | - | - | - | 1 | - | - | - | - | - 2 6 |
| " 25 | Sam. Collier | - | No. 4 | Hand hurt by roof falling | 1 | - | - | - | Hawett | - 6 - |
| " 27 | Peter Harrison | - | - | Thumb - ditto | 1 | - | - | - | Daglish | - 3 - |
| Dec. 1 | - | Peter Hart | - | Killed by red waggons at No. 4 | - | - | - | 1 | Fisher | - 3 - |
| " 11 | Wm. Derbyshire | - | Yard Pit | Leg broken by roof falling | 1 | - | - | - | Hawett | 18 6 6 |
| " 20 | John Hough | - | Wood's Pit | Hurt by a tram | 1 | - | - | - | Daglish | 1 3 6 |
| 1849: | | | | | | | | | | |
| Jan. 2 | Wm. Alker | - | Aberdeen | Arm broken by a windlass | - | - | 1 | - | Fisher | 1 - - |
| " 23 | John Holland | - | Patchcroft | Hurt by buzzard falling | 1 | - | - | - | Hawett | - 18 - |
| Feb. 10 | Peter Cunliffe | - | Yard Pit | Fingers broken by roof falling | 1 | - | - | - | Daglish | - 5 6 |
| " 13 | - | Thos. Newton | Aberdeen | Killed by buzzard falling | - | 1 | - | - | - | - |
| " 19 | John Jolley | - | Wood's Pit | Hand much hurt; caught between the tub and the side of the road. | 1 | - | - | - | Fisher | - 3 - |
| " 19 | Wm. Collier | - | Yard Pit | Much hurt by the coals falling upon him | 1 | - | - | - | Hawett | 3 18 - |
| " 21 | Robt. Taberner | - | Wagon Road | Thigh broken by waggons on spring incline. | - | - | 1 | - | Daglish | 6 8 - |
| " 21 | John Aspinall | - | Wood's Pit | Knee slightly hurt by a basket; abscess formed. | 1 | - | - | - | - | 4 6 6 |
| Mar. 6 | Thos. Benson | - | - | Hurt by roof falling | 1 | - | - | - | Fisher | - 8 - |
| " 15 | Wm. Moore | - | Yard Pit | Hand cut by ditto | 1 | - | - | - | Hawett | - 10 6 |
| " 15 | John Prescott | - | No. 4 | Back hurt by a stone, and afterwards a prop falling upon him. | 1 | - | - | - | Fisher | - 10 - |
| " 16 | John Anderton's Boy | - | Aberdeen | Hand hurt by coal falling upon it | 1 | - | - | - | Daglish | - 3 6 |
| " 19 | Rachel Pennington | - | Wagon Road | Ankle broken, and thigh badly cut; run over by blue waggons. | - | - | 1 | - | Hawett | 26 5 2 |
| " 22 | John Eckersley | - | Wall Hey | Foot hurt by cannel falling | 1 | - | - | - | Fisher | 4 8 6 |
| " 23 | Alex. Shepherd | - | No. 3 | Hand hurt by coal falling | 1 | - | - | - | Daglish | - 4 - |
| " 28 | John Wright | - | No. 4 | Hand hurt; caught between basket and roof. | 1 | - | - | - | - | - 3 6 |
| " 31 | Wm. Irving | - | Brock Mill | Hurt by coal falling | 1 | - | - | - | Fisher | - 14 6 |
| " 31 | Jas. Rothwell | - | New Wash | Finger crushed; caught between the roof and a basket. | 1 | - | - | - | Daglish | - 4 6 |
| " 31 | John Gorton | - | Arley Pits | Foot hurt by stone falling from the roof | 1 | - | - | - | Hawett | - 7 - |
| April 16 | Wm. Timm | - | Yard Pit | Hand cut when repairing a basket | 1 | - | - | - | Fisher | - 1 - |
| " 30 | Hy. Banks | - | Bridge Pit | Foot hurt by coal falling | 1 | - | - | - | Daglish | - 3 - |
| May 6 | John Scott | - | Arley Pits | Banksman | - | - | 1 | - | - | - 1 6 |
| " 15 | John Fishwick | - | William Pit | Finger hurt by stone falling from the roof | 1 | - | - | - | Hawett | - 1 - |
| " 16 | Robt. Lane | - | Wood's Pit | Hurt by - ditto - ditto | 1 | - | - | - | Fisher | - 4 6 |
| " 24 | Brooks | - | Patchcroft | Hurt by buzzard falling | 1 | - | - | - | Hawett | 7 7 7 |
| " 24 | Brooks | - | " | - ditto - ditto | 1 | - | - | - | - ditto | 7 - 7 |
| " 24 | Josh. Parkinson | - | " | - ditto - ditto | 1 | - | - | - | Fisher | 2 16 6 |
| " 25 | Thos. Parkinson | - | Arley | Hurt by tub when driving horse | 1 | - | - | - | - | - 7 6 |
| " 25 | Wm. Seddon | - | - | - | 1 | - | - | - | Daglish | - 4 - |
| June 15 | Geo. Valentine | - | William Pit | Head cut and thumb cut off; engineman was winding instead of lowering. | 1 | - | - | - | - | 5 1 - |
| " 25 | John Holland | - | - | - | - | - | - | - | Hawett | - 6 - |
| " 27 | Wm. Riding | - | Arley | Hurt by buzzard falling | 1 | - | - | - | Daglish | - 4 - |
| | | | | | 44 | 4 | 7 | 1 | | |

5010. To how many collieries does that apply?

To the whole of Lord Balcarres's coal-field at Haigh; there have been, upon the average, about 900 people employed under-ground there, and 300 on the top; the whole number of accidents resulting from explosions, is one accident in 289 work-people in the course of the year; if 289 people work in the year in our pits one accident occurs.

W. Pence, Esq.

17th July 1849.

5011. How do you define an accident; do you mean a fatal accident?

No, any accident whatever; there are 45 recoveries per annum, and 3½th die.

5012. Have you any statement with respect to the months of the year in which they occurred?

Yes.

ACCIDENTS by EXPLOSIONS at *Haigh* Colliery, in the County of *Lancaster*, arranged according to the Dates of their Occurrence, between 30 June 1841 and 30 June 1849; the average Number of Workers under-ground during the entire Period being 902.

| Number of Accidents. | Dates of Occurrence. | Number of Persons Burnt. | Recovered. | Died. |
|----------------------|----------------------|--------------------------|------------|---------|
| 1 - | 22 June - 1844 | - 1 - | - 1 - | - none. |
| 2 - | 29 Aug. - " | - 2 - | - 2 - | - none. |
| 3 - | 11 Sept. - " | - 1 - | - 1 - | - none. |
| 4 - | 11 Dec. - 1846 | - 3 - | - none - | - 3 |
| 5 - | 31 March - 1847 | - 1 - | - 1 - | - none. |
| 6 - | 27 April - " | - 3 - | - 2 - | - 1 |
| 7 - | 28 May - " | - 1 - | - 1 - | - none. |
| 8 - | 21 June - " | - 1 - | - 1 - | - none. |
| 9 - | 6 Nov. - " | - 1 - | - 1 - | - none. |
| 10 - | 12 Nov. - " | - 1 - | - 1 - | - none. |
| 11 - | 6 Dec. - " | - 3 - | - 2 - | - 1 |
| 12 - | 27 March - 1848 | - 2 - | - 1 - | - 1 |
| 13 - | 13 June - " | - 2 - | - 2 - | - none. |
| 14 - | 9 July - " | - 2 - | - none - | - 2 |
| 15 - | 26 Oct. - " | - 1 - | - 1 - | - none. |
| TOTAL - - - | | - 25 - | - 17 - | - 8 |

5013. Where the artificial ventilation is efficient, the differences in the atmosphere which you have observed do not affect the occurrence of accidents?

No.

5014. Supposing there is not an artificial system of ventilation, have you observed that the variations in the atmosphere render the mines more or less dangerous?

I have not.

5015. Do you think there is any authority for that opinion?

I am aware that it is believed a low state of the barometer gives rise to a more copious evolution of gases.

5016. Do you see any reason to doubt that?

I have never suffered from it, in my own observation; sometimes in high winds the eddies in the atmosphere have interfered with the operation of our furnace.

5017. Have you found them seriously affect the action of the furnaces?

Not to a dangerous extent; but to an apparent extent.

5018. Not to a sufficient extent to neutralize the ventilation?

No.

5019. You think no ventilation which is properly established ought to be liable to serious inconvenience from such a cause?

My experience would lead me to that conclusion.

5020. Have you ever observed the barometer in mines?

No, I have not.

5021. Have you seen much of accidents occurring from the breaking of ropes and machinery?

(164. 15.)

W. Peace, Esq.
 17th July 1849.

We have not had one single accident from the breaking of ropes at the Haigh Colliery during my superintendence of it, which is 17 years, and we have had 50 ropes going continually during that time.

5022. What ropes have you used?

We have used all sorts, principally hemp; we are now using both hemp and iron; we have used Chinese grass-rope.

5023. Which do you think the best from your experience?

The best ropes we ever had were the Manilla hemp-ropes.

5024. Do you consider hemp-ropes better than those made of iron-wire?

I consider hempen ropes less liable to accidents, at present, in their present state; but recently an improvement has been introduced, which I think will remove the great objection to the use of iron ropes. The objection to the use of iron ropes is this, that, being almost destitute of practical elasticity, a sudden motion of the engine upon the rope, causing the rope to move with a heavy weight at the bottom, breaks the rope. That has occurred in several instances in Lancashire to my knowledge, and it has occurred with us to this extent, that we have been obliged in our inclined plane ropes, where we have used iron ropes, to put what are called tail ropes, that is a piece of hemp rope, to each end, for the purpose of having the proper degree of elasticity. Now the original inventor, Mr. Newall, has invented a contrivance, which I think will remove that difficulty; it is the application of an India-rubber spring to each terminus of the rope, to give elasticity to it; that appears to me to be calculated to remove a very serious objection to the iron ropes.

5025. Do you use guides?

We do, in almost every instance.

5026. Have you seen Mr. Fourdrinier's machine?

Yes.

5027. Do you consider that applicable to your purposes?

I consider it perfectly useless, because sufficient care ought to be taken, and would be taken by every prudent superintendent of a mine, that his ropes are in a proper state, and he will take care that they are removed as soon as dangerous, or before they are dangerous. With regard to Mr. Fourdrinier's invention, the trial of which I went to see, at his request, in the Potteries, it is liable to this, as I call it, a capital objection; supposing the rope is liable to break, that is when it becomes a good deal worn, which is the only case in which Mr. Fourdrinier's invention will be of any benefit at all—(I will suppose a pit 500 yards deep)—Mr. Fourdrinier's invention cannot be used without the use of guide-ropes; it is entirely dependent upon the guide-ropes: in the case of a descending rope, we will suppose that the pit is 500 yards deep, and that the rope breaks after it has descended 300 yards; the 300 yards of rope comes upon the basket descending, containing anybody or not, as the case may be; and however safe Mr. Fourdrinier's invention might be to stop the cage by itself, or even containing half a ton weight, I consider it impossible that any invention of that kind, or any reasonable guides which we could put in, could resist the impetus of a falling mass of rope 300 yards long and 5 inches broad.

5028. Supposing evidence has been given of an accident which took place in a very deep pit in the North, in which precisely the circumstances which you have described occurred, excepting that the rope, instead of being 300 yards, was 200 fathoms long, and that the whole of that 200 fathoms fell upon the cage without disturbing Mr. Fourdrinier's apparatus; should not you say that that was a proof of the value of it?

I should say that I should have been very sorry to be in the cage at the time.

5029. That having occurred, is it not a proof that it may act under such circumstances?

It is a proof that it has acted in one such circumstance.

5030. You say that it is useless, because every manager of a coal-pit would keep his ropes in proper condition; can you undertake to say that that has been so, in every case?

I should say that the instances in which it would be successful would be about in the proportion of those of people who die by lightning; and I do not think if

if there were an apparatus invented to keep persons perfectly safe from strokes of lightning, they would always carry it about in their pockets.

W. Peace, Esq.

17th July 1849.

5031. Supposing it were easily applied, and at a small cost, if accidents of that kind have frequently occurred, do you think it would be quite useless to apply an apparatus which rendered the operation of descending and ascending the pit quite secure?

Yes. There is another reason why I should think it would be useless; it would get out of order; things of that kind require to be constantly used.

5032. What reason have you for saying that it would get out of order?

The atmosphere in a pit is continually loaded with coal-dust; the pit itself is continually penetrated in all directions by dropping water; all the iron-work gets completely rusty; the interstices of every part of the iron which does not move, become choked with coal-dust, so that you would have to use such an instrument very often in order to keep it clean and effective.

5033. Can you show how such causes would have the effect of neutralizing the usefulness of Mr. Fourdrinier's apparatus?

Mr. Fourdrinier's plan acts by the removal of the weight from the centre of the lifting part; the removal of that weight causes it to collapse, and brings a kind of wedge between the guide-ropes or the conductors, as the case may be, and so stops the descent of the cage. The rods permitting the descent of those wedges between the conductors and the guides, if anything of that sort were to accumulate, it would prevent Mr. Fourdrinier's apparatus from acting.

5034. Are you aware that the cage cannot go to the bottom without the invention being tested?

It would not in that case.

5035. There is nothing very delicate in the machinery, is there?

There is not.

5036. Therefore the mere accumulation of dust is not likely to interfere with it much?

It is my opinion that it would prevent its operation.

5037. Is there anything in the use of the rope which makes the rope chafe in any particular part?

The rope chafes in the pulley and at what we call the verticals.

5038. If it chafes in any particular part, are you obliged to renew the whole rope, or do you splice it?

We renew the whole rope.

5039. That is done at considerable cost?

There is no doubt it is.

5040. Therefore the use of Mr. Fourdrinier's plan would be economical?

It would jeopardize life; in my opinion, it would cause people to run their ropes longer than they do now.

5041. Supposing they could run their ropes longer than they do now, with the certainty that no accident would occur in the fracture of the rope, would not that be an advantage?

I do not think that the plan would remove the risk of accident.

5042. Are you aware that the apparatus is brought into action every time that the rope is slackened?

Perfectly.

5043. Would not that keep it in continual action?

No, it is never in action unless the rope is absolutely slackened.

5044. Would not it be slackened every time the cage went down?

It does not follow that every time the rope is slackened the wedge rises into its place.

5045. It follows that the arm of which you have spoken comes into action immediately?

No; it would only allow it to come into operation if there were no obstruction.

W. Peace, Esq.
 17th July 1849.

5046. Its coming into operation every time it was drawn up and down would prevent there being an obstruction, would not it?

It would be necessary that it should be cleaned; we are obliged to clean the parts of our steam-engines which are constantly used.

5047. Do you find yourselves obliged to clean the pullies of the gear over the pit-head?

We are not obliged to take off the tops, because they are constantly in very rapid motion; but this apparatus of Mr. Fourdrinier would come into operation at the top and bottom of a pit; we will suppose it descends a considerable distance, and comes up again; it is in a state of quiescence during the remaining part of the time; there is no part of the motion in Mr. Fourdrinier's plan which gives it a tendency to clean itself, or to remove any obstruction that I can see.

5048. Is not there an arm to which the wedges are attached?

Yes.

5049. Which moves upon a pivot?

Yes.

5050. Would not the arm move every time the apparatus went up and down?

Yes, and so would the shunt of a railway; but unless you clean the interstices between the shunt and the railway, the shunt would become incapable of closing sufficiently close.

5051. From the accumulation of dust in the hinge of the shunt?

It is in the long flat part I am alluding to, between the rod and the place where the hinge operates. I expressed my opinion very clearly to Mr. Fourdrinier at the time I went to see his apparatus; and I offered to Mr. Fourdrinier, if he chose, to try his apparatus at any of our pits he might select, and if I found it work well at the end of the year, I said I would not object to pay him the patent right for it; he objected to letting me try it for a year. We have not in our pits, during the 17 years I have superintended them, had any accident from the breakage of a rope.

5052. Can you practically say that it is the case with all managers of collieries, that they are as careful about their ropes as you state yourself to have been?

In many cases they are.

5053. Are you not aware that accidents from the breakage of ropes, and from the drawing over of pullies, and matters of that kind, are events of constant occurrence?

Accidents from the drawing over of pullies would not be prevented by Mr. Fourdrinier's apparatus.

5054. Are you aware that he looks to that as one of the great objects of his apparatus?

If it brought the men against the pulleys at the top it would kill them, for instance.

5055. Supposing he affixes an apparatus by which to break the rope in case of there being any danger of the men being drawn over the pulleys?

That danger has been prevented many years ago, independently of Mr. Fourdrinier's plan; it may be made an adjunct to his plan.

5056. Supposing that the apparatus were so disposed, you must have some means of stopping the weight in that case?

Yes; accidents are of such rare occurrence, that any apparatus of that sort for the prevention of accidents in case of pulleying, would, in my opinion, in 99 cases out of 100, be found inoperative when an accident really occurred.

5057. That is your conviction from general principles?

Yes, from what I know of the working of the pits.

5058. Should you say, from your experience of the different coal districts in England, not looking merely to the best-managed mines, but taking an average, that accidents are extremely rare from those causes?

Yes, in proportion to the number of people employed, they are exceedingly rare.

5059. Have

5059. Have you any facts with respect to the number of accidents in proportion to the number of people employed?

No; I speak from general impression, caused by my attention being directed to accidents in mines whenever they came under my notice. With respect to collieries under more imperfect management, the machinery would be more liable to injury than otherwise.

5060. Have you ever turned your attention to the question of an inspection by Government?

Yes.

5061. You were in the chair at a meeting which was held some little time since, were not you?

I was, at Wigan; I believe a copy of those resolutions was sent to your Lordships.

5062. Have you a copy of the resolutions passed at that meeting?

I have not with me.

5063. The result of that meeting was the declaration of a desire for inspection, was not it?

It was that we have no objection to inspection.

5064. Was the meeting composed of colliery owners?

Colliery owners and superintendents of collieries, exclusively.

5065. Was the decision of that meeting unanimous?

With one exception; there was but one dissentient in about 15.

5066. Is it your opinion, individually, that it would be desirable to have the inspection of Government?

Speaking as the manager of extensive collieries, I should feel that a Government Inspector, properly qualified and disinterested, coming to inspect our colliery, would relieve me, to some extent, of the responsibility of managing it, because, if an accident should occur after such an inspection should have been made, it would necessarily remove from me the odium of having maintained the mines in an improper and ill-ventilated state, the Government having expressed its satisfaction with it.

5067. Do you contemplate the Inspector coming with such a power as to authorize him to direct the way of working and managing your mine?

No; that would entirely exonerate the coal-owner from every responsibility; I should say I should feel quite averse to answer for the mode of operation of another person; my own I could depend on, but I could not answer for the success or failure of a system forced on me by another person.

5068. Are the Committee to understand, that you think the great advantage of an inspection is to relieve you from responsibility?

No, the advantage, in my opinion, resulting from the inspection, would be this: it would operate as a spur to the colliery managers and colliery owners to maintain their mines in a state of good ventilation and good order.

5069. Would it do that if it relieved them from responsibility?

No, but it would operate in that manner by rendering them liable to the censure of the Inspector, and to the censure of the public also, if the result of that inspection were made public.

5070. You stated that you thought the great advantage of such an inspection would be to relieve you from all responsibility in the management of your mines?

Yes, I am now speaking of my own mines; on the occurrence of accidents we are always obnoxious to the censure of the public; they are always ready to come to hasty conclusions, and say that the accident was in a great measure owing to the improper state of the ventilation. If a Government Inspector existed, and he had previously to such accident seen the mine, and pronounced it to be satisfactory, we should avoid that odium.

5071. You mean that it would be satisfactory to you to have the confirmation of a favourable opinion from the Inspector, in case of any occurrence of that sort taking place?

Precisely so.

W. Peace, Esq.

17th July 1849.

5072. You would not recommend such an inspection as should relieve the colliery owners from the responsibilities attached to them for the management of their mines, would you ?

No ; I should say that that would be objectionable in the highest degree ; it would be impossible for the Government, unless they took the management of the collieries entirely into their own hands, to assume such a responsibility ; in that case, unless the Government appointed a corps of sufficient strength and ability to manage the collieries, the coal-masters would say, or those who were careless about the condition of their mines would say, " It is not our business at all ; we will get as much coal as we can ; but the responsibility as to the safety of the men rests entirely with the Government officer."

5073. What power should you, with your view of the matter, wish to be conferred upon the Inspectors ?

I think powers very similar to those contained in clause 3 of Mr. Wyld's Bill ; I do not think they would be objected to by the coal-owners as a body, and I think they would have a very beneficial tendency.

5074. Those powers being what ?

Those powers being, to enable the Inspector appointed by Government to descend the mines, and examine the state of the ventilation, and the state of the ropes and machinery, and, if he found anything objectionable in the condition of any of them, to give notice of such a fact to the owner of the mine, and to suggest what he conceived to be the necessary alterations.

5075. Among the resolutions of the meeting of which you have spoken, there was an opinion expressed in favour of Mr. Wyld's Bill, was not there ?

Of some parts of it ; there were objections to other parts of it ; there were objections to the part of it which rendered it compulsory upon the owners of mines to send every year complete plans of their collieries and machinery.

5076. In the fourth clause of Mr. Wyld's Bill, it is proposed that the Inspectors shall be authorized to examine every mine and colliery as often as they think necessary during the working of the same ; and the works, buildings, and machinery belonging thereto ; and to make inquiry into the state and condition of the mine and colliery, and the ventilation, and the mode of working of such mine, and lighting it, and into all matters connected with, or relating to, the safety of the mine : the Inspectors are to be authorized to examine, upon oath, the persons concerned in any matter or thing relating to the mine ; and if they find or observe any part of the mine or colliery, works, buildings, machinery, air-courses, air-doors, water-ways, drains, pits, levels, shafts, or other matters or things in or connected with the said mine or colliery, or the mode of working or lighting, to be dangerous or defective, they are to give notice to the owner in writing, or his agent, and suggest to the owner or manager to alter, repair or improve the mines, works or machinery, or to do or perform such matter or thing connected with or relating to such mines, works or machinery, as the said Inspector may consider to be necessary ; do you think provisions of that kind would be unacceptable to the colliery owners in Lancashire ?

I do not think they would.

5077. That assumes that you think there would be no jealousy with respect to a power of inspection on the part of Government officers ?

No ; but if that should be so, we conceive it would be necessary that proper and disinterested persons should be appointed Inspectors ; it would be very unpalatable that a coal-owner should have his mine inspected by the brother or son of a neighbouring coal proprietor, who might be a competitor for mines then in the market ; also, we must be protected from unqualified persons being appointed by a provision that no other person should be appointed than one who had had the previous management of a colliery for a certain period of time, say 10 years, so that no impracticable schemes should be forced upon us ; schemes which might be suggested by otherwise very able men, but which, to a working miner, would be obviously impracticable.

5078. From your knowledge of the business, do you think it would be difficult to find proper persons to appoint as Inspectors ?

I do not think it would ; perhaps a sufficient number might not be found immediately.

5079. You

5079. You would give the Inspector power to examine and to suggest, but no further power?

No further power.

5080. Do you think it would be possible to introduce into an Act of Parliament any enactment respecting certain points of regulation, such as the amount of ventilation to be employed, or a prohibition against working the mine without some method of artificial ventilation?

No; I think the existence of an inspection would go a very great way towards insuring that, and especially when taken in connexion with the obvious interest of every mine-owner, for the preservation of his own property, to maintain his mines in a proper state; in dangerous mines it is well known men will not work for the same wages as in mines which are safer.

5081. With respect to the use of candles and gunpowder in mines, would it be possible to introduce into an Act a positive prohibition against such modes of proceeding in any dangerous atmosphere?

In that case you would have to establish a tribunal, which should have the power of pronouncing whether the atmosphere was safe or not, and the same mine might have an atmosphere, under a proper system of ventilation, perfectly safe, and under an improper or neglected one, altogether the reverse: I have to observe, that I view the introduction of the safety-lamp into a pit with very great jealousy; it appears to me, from what I have seen of its use, that the exclusive use of the safety-lamp creates a certain false security on the part of the men using it, leading very frequently to great loss of life; the mines in Lancashire and Yorkshire which I have seen are all capable of being rendered, by a proper system of ventilation, perfectly safe for the use of the candle,—I mean as regards the general state of the air in any mine. It is impossible, in opening out a mine, to guard against the occurrence of what we call blowers suddenly filling up the mine to such an extent with explosive gas, as to render that locality explosive; and, to guard against that, we order the exclusive use of the lamp in the collieries, because they are liable, one day out of 50, to the occurrence of one of those blowers; in that case, the possession of a safety-lamp insures them against danger, while the people in the main roads, who do not approach the men so at work, use candles or open lamps without any danger.

5082. Should you have been disposed to prohibit the use of gunpowder in coal-mines?

Only in cases where candles could not be used with impunity; there I should prohibit the use of gunpowder. The use of lamps and gunpowder are altogether irreconcilable.

5083. How could any additional regulation be established with reference to points like those?

The most efficient cure for the improper use of safety-lamps, and the most certain way of keeping their tops on, in my opinion, is this, that the coal-owners should have the means of punishing men for disregard of their orders. We very frequently find men, in defiance of all our orders, and all the care we take to see them enforced, disobeying them, either by pulling the lamp-tops off, or by being possessed of keys, or of gunpowder, or of tobacco, and leaving doors open, and things of that kind; we find them very difficult to manage, and till we have the means of taking them before a magistrate, and punishing them, it will be impossible to do more than is already done for the protection of life by means of safety-lamps.

5084. Do you consider it would be possible for the Government Inspectors to examine mines so frequently as to be able to offer any additional security against the occurrence of accidents from causes like those?

I think there would be a general effect produced upon all the owners of a district liable to the visit of an Inspector; they would all endeavour to vie with each other in having their mines in such a state as to gain the approbation of the Inspector: that appears to me to be the principal beneficial effect that would result.

5085. Was the meeting to which you have alluded very fully attended?

It was so for Wigan, with the short notice they had.

W. Peace, Esq.

17th July 1849.

5086. There were 15 present, you say?

Yes.

5087. How many coal-owners are there in the district?

I should say one-half of the coal-owners of the district and their representatives attended.

5088. You said you thought that a person should not be an Inspector, unless he had had 10 years' experience in coal-mines; what should you say to a person being sent down who was an eminent chemical professor?

He might know nothing about mining; in the case of the recent explosion in the North, two of the ablest scientific men in the world were sent down to make a report, and they suggested a thing which every practical miner pronounced at once to be altogether useless and inoperative; that was, the having large pipes at the upper part of the workings, to draw off the foul air.

5089. You do not think that the visit of those professors would be satisfactory to the miners?

Not only not satisfactory, but, speaking with great humility, I should say useless. I might as well attempt to dim the light of the sun, as to dim their reputation as geologists and chemists; but as miners, I should say they were altogether disqualified.

5090. Should not any person appointed to an office of that sort possess some more qualifications than a mere knowledge of the practice of mining?

Most mining engineers at the present day have an acquaintance both with chemistry and geology to a great extent.

5091. In order to make the Inspector efficient, ought he not to be a scientific man, as well as a practical man?

Yes; he ought to be regularly educated as a mining engineer.

5092. Is there any other point upon which you have any observations to make to the Committee?

It has been suggested in both the measures presented to The House of Commons, that complete copies of the plans should be sent up to London; that is almost impossible; in fact, it is more than the owner of the mine requires from his lessee; he only requires that a plan should be presented to him of the surface, and that the workings of each successive year should be laid down upon it.

5093. Are there plans kept of all the mines in Lancashire?

I should say so.

5094. Even of the small ones?

Yes; at present I should think so.

5095. So far as you know, are they tolerably correct plans?

I think they are.

5096. They would be sufficient to enable the Inspector to judge of the workings and the air-courses?

I should say they are sufficient in ninety-nine cases out of a hundred in Lancashire.

5097. With regard to the subject of Inspectors, have you anything more to say, as to their qualifications?

The coal-proprietors in the neighbourhood of Wigan are of opinion, that the Inspectors and Sub-inspectors should be prohibited from acting professionally as colliery viewers; the reason of that is sufficiently obvious, and they think that they should also be compelled actually to go into the mines, and not to take evidence of the state of the mines exclusively from other people, but that they should be compelled to go into any mine, and inspect it for themselves, prior to giving notice to the master.

5098. Prior to making any report?

Yes, or suggesting to the owner of the mine any alteration: also, we think that the machinery should not be subject to inspection; for instance, the pumping engine or the apparatus above ground; we think the power of suggestion would be so unlimited, and be applicable to such an amount of detail, that an Inspector, if he chose to be troublesome, might put a coal-owner to an inconceivable amount of

of

of expense and trouble, without going down the pits, or inquiring at all into the main objects which he ought to inquire into.

W. Peace, Esq.

17th July 1849.

5099. You do not mean to say by that, that he should not have the power of inspecting the condition of the ropes, and other matters involving the safety of the people?

No; he should have the power with respect to all matters involving the safety of the people.

5100. Would not the proper line to draw be, that he should have no power of examining any matters which had merely relation to the general management of the mine, but only into such as affected its safety?

That is our feeling.

The Witness is directed to withdraw.

Mr. DAVID SWALLOW is called in, and further examined as follows:

Mr. D. Swallow.

5101. IN the course of your examination yesterday, you stated that you thought the provision in the third clause of this Bill, requiring the Inspectors to visit, enter and examine every mine and colliery in their district four times at least in every year, would not be difficult of execution?

I do not think it would.

5102. It appears, from the manner in which that question was answered on the last occasion, that you meant to apply that observation to the whole number of principal Inspectors and Sub-inspectors?

Yes.

5103. Does not it appear by the third clause, that what the Bill is intended to provide for is, not that the whole number of Inspectors and Sub-inspectors should perform that duty, but that there being three Chief Inspectors to be appointed, those three Chief Inspectors should each of them visit all the mines and collieries in their respective districts four times in each year?

It is intended that the Sub-inspectors should visit the collieries, and that the head Inspectors should superintend them, and see that they do their duty.

5104. The first clause says, that three fit persons shall be appointed as Inspectors, and the third clause says, that such Inspectors shall and they are hereby required to visit, enter and examine every mine or colliery within their respective districts four times at least every year?

That is intended to apply to the Sub-inspectors.

5105. The Sub-inspectors are appointed afterwards; but the first clause of the Bill appoints three fit persons as Inspectors; and the third clause requires that the Inspectors should visit, enter and examine every mine and colliery within their districts four times every year?

It is impossible that the three Inspectors could do that; they could not examine a tenth part of them.

5106. The Inspectors have the power to which allusion was made in your last examination, of giving directions, and of subjecting the colliery owner to a penalty, if he does not attend to those directions; is it the case that the Sub-inspectors are to have the same power?

We should propose that the Sub-inspector should report to the head Inspector, and lay the case before him.

5107. By the fourth clause of the Bill is not it provided that the Sub-inspectors should only have the power of visiting and examining?

Yes, and reporting to the head Inspector.

5108. It would not be in their power to give any direction?

No.

5109. Therefore, all inspection for the purpose of giving directions must be performed by the Chief Inspector?

It must be under his control and sanction.

Mr. D. Swallow.
17th July 1849.

5110. The eighth clause proposes that within two months after the passing of the Act, and once in every year afterwards, every owner of a mine and colliery should send up to the office of the Inspectors in London a variety of particulars, including his name and address, the name of the mine, the number of persons employed, the mode in which the mine is worked, the name of the firm, and together with those particulars a map or plan accurately drawn and delineated of the colliery, works and machinery, showing all the different and several works, air courses, air-holes, water-ways, drains, pits, levels, shafts and other matters and things in and connected with such mine or colliery. Do you think it would be possible to require the transmission of such particulars as those every year from every colliery owner in the Kingdom to an office in London?

Yes, it might be done quite easily.

5111. Do you think the owners have generally information so extensive as that at hand, and perfectly accurate, so as to be able to send it up to an office here?

I do not think they have generally now; but I believe if Inspectors were appointed, they would put them in such a way that they would have that information.

5112. What do you think would be the expense to a colliery owner of being obliged to furnish such particulars as those every year?

The only thing that would be required beyond what is now required would be an extra plan of the colliery.

5113. What would be the great advantage of a regulation, for instance, requiring the name of the firm to be given?

The great advantage would be, that not knowing at present who the firm is, sometimes it is very difficult, if any party wishes to institute legal proceedings, to ascertain who is the real proprietor.

5114. Do you think that would be better ascertained by their sending up information of that kind to London, than by leaving it to the Inspector in the country to obtain the information there?

I do not know that it would make much difference whether the plans were registered in London or in the various districts.

5115. Supposing that the Inspector appointed by Government to examine mines had the power of demanding to see the plans of the collieries upon the spot, would not that be quite as effectual a security as sending up copies of plans to an office in London?

No.

5116. In what respect would it not?

The plans ought to be registered for several reasons; the first is, that a great many mines in many parts of the country have been worked where no regular plans have been kept; upon that account there has been a great deal of capital lost in various places in sinking pits where coal has been expected, but where the coal has been worked out some time previous. In the second place, it has been known that men have been working, for anything they knew, to solid coal, and they have all at once fallen upon old works; sometimes, perhaps, they have been full of water, and a number of people have been drowned; on other occasions explosions have been caused; sometimes the men have driven into black damp, and have been suffocated; I look upon it as a national loss that we have not proper registered plans of all mineral workings.

5117. Supposing copies of such plans were sent to some place within the district, would not that be a much more effectual method of providing for the difficulty than sending them up to an office in London?

I think it would do equally as well.

5118. Would it be necessary to send up plans to the office in London, showing the different workings, air-courses, air-holes, water-ways, drains, pits, levels, shafts, and other matters and things connected with the mine?

I think so.

5119. And also the accounts of all accidents taking place?

If they were not lodged in the centre of the district they must come to London; but the reason why that should be required is that there is no proper register now
of

of the various accidents which occur in mines; we have no authentic data as to the proportion of deaths which happen to the number of people employed; all those things might be very easily attended to with a proper form, which should be filled up and signed by the manager of the colliery; by that means the Government of the country would be able to ascertain the real number of accidents which do occur; that was the intention of that part of the clause; it was inserted with the view of ascertaining the real number of accidents which do occur.

Mr. D. Swallow.

17th July 1849.

5120. With regard to plans, would not it answer all the purposes which you have described, if the owner or manager of the colliery were required to keep accurate plans upon the premises, and the Government Inspector had a power of examining those plans from time to time?

It might answer for the present time, but circumstances might change by some means or other. The Railways are taking the trade of some collieries away, and transferring it to others. There may be changes in trade, or there may be inundations, so that a colliery may be drowned out; a colliery may be partly worked out, and pits may be filled up. There is the land, and in 200 years the owner of that estate may set to work again, not knowing but that it is all full of mineral underneath, when perhaps three-fourths of it may be worked out. Having registered plans in London, he could ascertain how much mineral there was in the estate, and he could tell whether it was got, or whether it was not got.

5121. Supposing a person in the Lancashire district about to open a pit was anxious to ascertain whether there were any old workings in the neighbourhood, would not it be much better for him to refer to plans nearer his own locality, than to have to refer to plans in London?

I believe coal-owners and managers are very jealous of showing one another their plans.

5122. Is not there some ground for that jealousy?

Undoubtedly there is: supposing I were the owner of a colliery, or had an interest in a colliery, and my neighbour was wishing to open another colliery on the next estate to it, I am sure I should not give him any more facilities in opening that mine than I could help.

5123. Do not you think that is a reasonable jealousy as far as it goes?

It is so.

5124. Would not there be the same jealousy on the part of a factory owner as to permitting his neighbour to inspect all the parts of his factory?

The factory owners are equally jealous.

5125. Will you explain to the Committee how you think a return to an office in London of the number of persons employed, the mode in which the mine is worked, the name of the firm, and a map or plan of the mine, showing all its working and air-courses, &c., would give you the means of ascertaining how many accidents had occurred?

In another part of the Bill there are clauses which provide that in the case of any accident happening, so that a person cannot return to his work before a certain time, the next day the manager of the colliery must send a written paper to the nearest Sub-inspector, showing the nature of the accident, so that by knowing the total number of persons employed in each colliery, and the number of accidents which happened in it, the fact would be very soon ascertained.

5126. You think it is necessary to have all those minute Returns, together with the provisions of the subsequent clause requiring notice to be given of an accident, to enable you to judge of the number of accidents which occur?

To ascertain the real number.

5127. Would not the Inspector be able to ascertain it without such Returns?

No.

5128. Do not you think it a matter of great importance that a proper selection should be made of persons to fill the offices of Inspector and Sub-inspector?

Yes, I think they ought to be very carefully selected.

5129. Should not they be persons very well qualified in various respects?

Yes; not only in point of knowledge and science, but I think the head Inspectors particularly ought to be men of the greatest attainments in science, men who

Mr. D. Swallow.
 17th July 1849.

are eminent for a knowledge of science; I think that only the very highest men in science ought to be appointed as head Inspectors.

5130. You are aware of the qualification required in the 27th clause of this Bill for the Inspectors?

For Sub-inspectors.

5131. "And be it enacted, That no person or persons shall be eligible to be appointed as Inspector or Sub-inspector who shall not have had at least ten years of practical experience in the working of mines or collieries, and who is not possessed of sufficient amount of education to report on the various accidents which may happen in their respective districts from time to time;" what amount of education do you think necessary for that purpose?

I think there has been a mistake in the printing of the Bill in that particular; that clause had no reference at all to the Inspectors, but only to the Sub-inspectors.

5132. Take it as applying to the Sub-inspector, he is the officer whose more particular business it would be to be constantly upon the spot, and inspecting the mines?

Of course he is required to be more a practical miner.

5133. Would it not be necessary that the person who is to judge of the condition of the mines, and their state of ventilation, should be something more than a practical miner?

Yes, it is necessary.

5134. What amount of education do you think those words imply, "a sufficient amount of education to report upon the various accidents"?

If a man is not sufficiently educated when he goes into the pit, and he finds certain gases, and so on, if he cannot give a proper statement to the head Inspector, and either analyze the gas, or get it analyzed, and give a statement of the result, he would not be a proper person for a Sub-inspector, in my opinion.

5135. According to your view of the matter, there would be many persons who might be capable of reporting upon an accident who would not be possessed of such an amount of knowledge as that to which you have alluded?

He might be able to make some report, but not a proper report.

5136. How will the words of this clause secure that a proper person shall be appointed as Sub-inspector?

He ought to have practical experience, as well as other qualifications.

5137. The words here are, that he shall have a sufficient amount of education to report upon the various accidents; could those words, describing the qualification, secure to you a proper appointment of Sub-inspectors?

We mean by those words that the Sub-inspectors should be men of practical experience, as well as of scientific education.

5138. In fact, you think they ought to have a much higher qualification than possessing merely a sufficient amount of education to enable them to report upon an accident?

Yes.

5139. In the 28th clause there is this provision: "That whereas the practice of using gunpowder in collieries and mines where carburetted hydrogen or fire-damp, as it is termed, exists, is attended with much danger, and from which cause many distressing and dreadful accidents frequently happen; be it therefore enacted, That from and after the passing of this Act no gunpowder shall be used in blasting or getting of coal in any colliery, mine or working, where it is unsafe to work by or with naked lights or candles;" and that any proprietor allowing or suffering persons to use gunpowder in such case shall, for every offence, forfeit a sum not exceeding 20*l.*, nor less than 5*l.* Are there not other offences of the same kind to which penalties of that nature might be as justly applied as the use of gunpowder by the colliery owner?

That clause, as I understand, has reference to nothing else than the use of gunpowder.

5140. Is there any clause in this Bill imposing similar penalties upon other acts which are liable to lead to accidents?

I do

I do not recollect that there is, except at the instance of the Sub-inspector or the head Inspector.

Mr. D. Swallow.

17th July 1849.

5141. Does not your experience lead you to the same conclusion as that which has been stated by almost every other person acquainted with the working of mines, that accidents continually happen from the carelessness and the recklessness of the workpeople?

In some instances they may so happen.

5142. Do you think they are the majority or the minority of cases?

I believe they are the minority of cases.

5143. Do you think there are very few cases in which they happen from that cause?

I do not think they are very few; I think the men are careless and negligent in many cases.

5144. Is there a provision in this Bill imposing a penalty upon persons who take off the tops of their lamps, or who use naked candles, where it is dangerous to do so?

There is not in this Bill, but there are such provisions.

5145. Are there provisions which would reach misconduct of that kind?

Yes.

5146. Where?

In the common law. At the last Liverpool Assizes one man was committed from St. Helen's under such circumstances.

5147. Would not the same provisions of the common law apply quite as much to the explosion of gunpowder as to the lighting of a candle?

No.

5148. What leads you to express that opinion?

My knowledge goes so far as this, that I have never heard tell of it; I have never known of any person being sent to gaol for using gunpowder in a coal-mine; I have known persons sent to trial for taking off their lamp-tops.

5149. When an accident has happened?

No, when an accident has not happened.

5150. Under what Act of Parliament can that be done?

I do not know the Act, but it is quite common in Lancashire now.

5151. Do you mean that there is a provision now in existence which enables colliery owners to punish workmen for taking off the tops of their lamps, or working with candles?

The magistrates can punish them, by sending them for a month or two months to gaol, or sending them for trial to the Assizes. The last case of the kind I remember was at the last Liverpool Assizes, a man was committed from a colliery at St. Helen's; there was no bill found against him, and consequently he was not put upon his trial, but he was put in gaol till the Assizes. I have known other men brought before the magistrates, and very often they have got off by means of employing the best legal talent, and after most strenuous efforts, and it has, in some instances, almost ruined the poor men in expenses.

5152. Do you think the power of the present law, with respect to the use of candles in mines, is so efficient for the purpose of preventing such offences as to justify your leaving out altogether any provision on the subject from this Bill, while you put in a provision for the purpose of imposing heavy penalties on a party in the case of his using gunpowder?

I am not prepared to give an opinion upon the Act under which it is done, not having seen it; but knowing that men have been committed under the circumstances I mention, I take for granted that no magistrate would commit a man without a law for it; therefore I made no particular inquiry upon the subject; but the man's name and address, if necessary, I can furnish to the Committee.

5153. Supposing the law to be at all uncertain at present, would not it be just to put into a Bill of this description a clause imposing penalties upon such offences as those which have been described upon the part of the workmen, when

Mr. D. Swallow.
17th July 1849.

you put in a clause inflicting such penalties upon the owner for the use of gunpowder?

Our reason for not putting in a clause to that effect was from thinking that there was one which was sufficient already. If after inquiry it were proved that the law was not sufficient under present circumstances, I should think it would be very desirable to put one in to that effect.

5154. In the 39th clause of this Bill I find it enacted, that if any person shall suffer any bodily injury in consequence of any neglect on the part of the owner of the mine in obeying the notice of the Inspector or Sub-inspector, a penalty of not less than 10*l.*, and not more than 100*l.*, shall be inflicted. In the first place, with respect to that provision, do you think it would be just to impose penalties of that kind upon the owner of a colliery for injury occurring in consequence of neglect, without requiring proof of whether the neglect was wilful on the part of the owner or not?

I do not think it would be right to inflict any penalty, unless it was proved that the neglect was wilful.

5155. Do those words require any such proof?

If they neglect to obey the orders of the Inspector, it must be wilful and intentional.

5156. Does that follow?

I think so.

5157. Supposing the owner misunderstood the directions of the Inspector?

If he misunderstood his directions, that would be alleged by him in the way of explanation, and no doubt would be taken into account by the magistrate before whom the case was heard.

5158. Supposing the owner of the mine to have given the best orders he could to his under-viewers, or to the officers under him, and it was ascertained afterwards that those orders were not executed, would that be a wilful neglect?

It would be a wilful neglect on the part of the person to whom the orders had been given.

5159. But the penalty imposed by this clause attaches only to the owner of the mine or colliery?

There is another clause in the Bill, I think, which is somewhat similar to the clauses contained in Lord Ashley's Act. The master is first held responsible by that Act for employing women or children in the way which is there prohibited; but if the master can prove that it has been done without his knowledge and consent, he is acquitted, and the party who is really guilty is rendered liable to the penalty. I think the manager ought to be liable where the neglect has been his.

5160. Do you think it would be a just provision that the manager should be subjected to a penalty of 100*l.* for neglecting to obey the directions of the Sub-inspector, even against his own convictions?

Yes, I do.

5161. Supposing that directions of that kind were given by a Sub-inspector, and they were followed, and an accident subsequently occurred, upon whom would the responsibility lie?

The responsibility would then lie undoubtedly upon the Sub-inspector.

5162. Do you think it desirable that the responsibility in such a case should be taken from the party on whom it would justly appear to rest, and should be placed upon the Sub-inspector, who can only visit the mine occasionally?

If the Sub-inspector were a man qualified for his business, he would not direct any particular step to be taken. That is not the intention nor the object of having Inspectors. They are not to point out the remedies which are to be applied. When the expression "directing" is used, it is only in this sense, that where a place is found to be in a dangerous condition, the Inspectors would direct that that place should be ventilated.

5163. Who is to decide upon whether it is in a dangerous condition or not?

Of course the Inspector will be able to tell whether it is fired at his lamp, or not: he could readily tell whether the place required ventilation or not.

5164. Supposing

5164. Supposing there was a question as to the arrangement of the air-passages, which the Sub-inspector, being a man capable of reporting upon the subject, thought was of a dangerous description, and he remarked upon it to the owner, but the owner, being a well-qualified and well-informed man, was of a different opinion, do you think it would be right to give the Sub-inspector the power of directing the owner to take certain steps contrary to the opinion of such an owner?

Mr. D. Swallow.

17th July 1849.

In that case I would give to the colliery master the same privilege as the factory owners have by the 43d clause of the 7th & 8th Victoria, chapter 15.

5165. That applies simply to the boxing of machinery, does not it?

Not exactly to the boxing of machinery, but to shielding the workmen from danger of any kind.

5166. Will you look to that clause, and say whether there is any power conferred by it on the Inspector, except a power to give notice to the owner of the factory, who is thereupon required to fence the machinery?

The 42d and 43d clauses will be found to bear upon each other.

5167. They relate to unguarded machinery?

They do.

5168. The purport of those clauses is, that the Inspector shall have the power, if he sees the machinery to be dangerous, of requiring the owner to fence it. Is there any interference with the nature of the machinery which may be used by the owner?

The clauses refer likewise to an escape of steam taking place, or to the work being wetted, or the place of work not being ventilated, and so on; and the law requires that the Sub-inspector shall give notice to the owner of the factory so many days before he can take any proceedings at law against him. If the owner of the factory thinks the Inspector is wrong, and that his mill is in a proper condition, he has the power of calling in arbitrators. No proceedings can be taken against the owner of a factory without giving him so many days' notice.

5169. Do you think that the power which is conferred by the provisions of the Factory Act, of requiring the factory owner to place a wooden box round dangerous machinery, can be compared with the difficulty which there would be in determining what system of ventilation shall be pursued in a colliery, or what system of working is best for the safety of the persons in the mine?

Yes, I think they can be compared.

5170. Do you think that a person who would be qualified to determine the one would be equally qualified to determine the other?

I do not think he would; I do not think that the man who would be qualified to inspect the factory, would be qualified to go and inspect a colliery; but I think a properly educated man, who had been brought up to the business, would be perfectly qualified, where he saw danger existing, to point out the evil, leaving the onus with the manager or the master of adopting some remedy.

5171. Are you aware that among persons of the greatest experience in the management of coal-mines and persons of the highest education there is considerable difference of opinion as to the best mode of working a colliery?

I am aware of that.

5172. Do you consider that it would be right to give to any one person in the capacity of a Sub-inspector a power of determining for the owner of the colliery what is the proper mode of working?

There are not so many opinions as regards the general principles connected with the working and management of a colliery; they are more connected with the details.

5173. Does not the quality of the ventilation depend altogether upon the details?
No, not altogether.

5174. Not upon the splitting of the air-courses, upon the brattices, and so on?

I do not think that they are of any good; I do not think that brattices are useful.

Mr. D. Swallow.
 17th July 1849.

5175. If there have been most experienced miners before this Committee, people of the highest education and intelligence, who have been a long time engaged in mining, who think them of great importance, you would undertake to think them all wrong?

I would adhere to my own opinion, which experience had taught me to be true, while I respected theirs.

5176. Supposing a person holding your opinion were appointed a Sub-inspector, and went to a mine, and gave directions in accordance with the opinions which you have expressed, do you think it would be right to subject those parties to a penalty of 100*l.* for not obeying such directions?

Yes.

5177. Have you known many accidents occur from the work-people falling down the pits?

Yes, and there are a great many accidents occur from other causes.

5178. From what causes?

One of the principal causes, I believe, is from having what we call mouthings in the side of the pit; drawing the coals from one seam above another, without proper protection.

5179. You mean having openings from seams in the side of the shaft, as well as at the bottom?

Yes, working the mines two or three seams at a time, and having no regular landing at those seams, so that the tubs can go from the top of the pit to the bottom; they have to catch them, and draw them in; wherever there is a seam worked, they ought to have a regular landing.

5180. Is it the practice in Lancashire generally to have mouthings without any landings?

It is not practised in Lancashire generally; but particularly about Bolton, I believe, it is more practised than anywhere else.

5181. What causes the accident in those cases?

When the boys are catching at the tubs sometimes they overbalance themselves, and fall down; sometimes when a tub is going off, it drags them down.

5182. How would a platform prevent such an accident?

Because the tub would alight upon it, and they would have nothing to do but to take it off the hooks, and draw it into the mine.

5183. They would still have to direct the tub on to the stage?

Yes; but they would just be as safe as being at the bottom of the pit for that matter.

5184. Would not it be necessary for them to go to the edge of the platform?

No; for the tub would be between them and the edge of the platform; but the end of the platform should be railed off.

5185. Could that be easily done in most mines?

Yes.

5186. At no great expense?

At no great expense; some mines are already beginning to adopt the plan. The Government Inspector is already doing much good; the report is getting about with respect to certain appointments which have been made, and the very name of the thing is doing good.

5187. Do you know of any accidents occurring from the breaking of ropes?

I think that is not so common an occurrence; I have heard of accidents, but they are principally from falling down, or from falls of dirt, from the want of proper props in the pit. The collieries about Bolton and round that neighbourhood are not properly supplied with props; in fact there are many collieries round that neighbourhood where they have no regular system of ventilation at all.

5188. What are those collieries?

I can mention the names of a few of them; there is Radcliffe Bridge; a lamp is hung in the pit occasionally, and I have here a list of the accidents in that pit; the first was in 1828; there are about 20 men and 20 boys employed in that colliery,

colliery, and this is a list of the accidents which have occurred, amounting to 16.

Mr. D. Swallow.

17th July 1849.

The same is delivered in, and is as follows:

RADCLIFFE BRIDGE COLLIERY.

(No regular Ventilation at all of any sort.)

| DATE. | NAME. | CAUSE. |
|------------------------|------------------------|--------------------------|
| 26 December 1828 - - - | Thomas Garbert - - - | Fell down pit. |
| " - " - - - | An old man - - - | Caught on the scaffold. |
| " - " - - - | William Fletcher - - - | Fell down pit. |
| " - 1830 - - - | Isaac Hurst - - - | Explosion. |
| " - 1832 - - - | James Grundy - - - | Fall of dirt. |
| " - 1833 - - - | John Hollows - - - | Explosion. |
| " - " - - - | Robert Hughes - - - | - |
| " - 1836 - - - | Wm. Lomax - - - | Explosion. |
| " - " - - - | Wm. Seddon - - - | - ditto. |
| " - " - - - | William Heap - - - | Fall of dirt. |
| " - " - - - | Squire Taylor - - - | - ditto. |
| " - " - - - | John Lord - - - | Waggon falling down pit. |
| " - " - - - | Thomas Raynor - - - | Fell down pit. |
| 26 December 1845 - - - | John Lomax - - - | Explosion. |
| " - " - - - | Peter Valentine - - - | - ditto. |
| 26 July - 1848 - - - | Wm. Lever - - - | Fell down pit. |

5189. This would seem to show, that, in spite of the defective ventilation, out of 16 accidents which have occurred, only six have occurred from explosion?

Yes.

5190. Would that seem to show that the great source of accident at that pit was the state of ventilation?

No; but it shows if that pit had been properly ventilated, there would have been no explosions at all, at least it shows that to any person acquainted with the system of ventilation, because there is not much fire in the pits; if they can work it at times without any ventilation at all, they can, of course, work better with good ventilation. What I mean by occasionally having a lamp hung up in the pit is, that when the men are suffocated by black damp, so that they cannot work any longer, they will hang the lamp up for a day or two. In April 1848, Daniel Gidman was burnt to death by an explosion, when he was working; then, on the 25th of June following, a man was suffocated by black damp, within a short distance of the same place where the other man was burnt to death, but yet there is no regular system of ventilation. So at other collieries; the men, when they cannot work any longer, will hang the lamp in the pit; and if they complain, "Why is not the regular fire kept up?" they will get an answer like this, "Oh, you must beat the fire yourselves, for it is for your own benefit." In fact, I only know about three or four collieries which have a good system of ventilation. There is a master who employs, I should think, about 200 colliers, who has no furnace at all.

5191. What is the depth of his pit?

There are none of them very deep; I should think the deepest is about 120 yards.

5192. Can you speak, from your own knowledge, of there being a great number of pits which have no proper system of ventilation?

Yes; bad ventilation is not the exception, in fact it is the rule; good ventilation is the exception.

5193. That is the case in the neighbourhood of Bolton?

Yes.

5194. Is there anything else which you wish to lay before the Committee?

The falling down of pits, and so on, appears to be a very prominent feature. Another evil is, falling from the top of the pits. I think it would be very necessary that the banksman should be compelled to be there when the men and boys descend the pit; I always found it was very useful; in well-regulated collieries it is the case, and that there are very few persons who fall down the pit. When

Mr. D. Swallow.
 17th July 1849.

colliers are descending the pit in the morning, if they are rather late, it is very common for them to make a rush to the tub, and, perhaps, there is fighting amongst them, and they go down in a very disorderly and dangerous manner. If a banksman were put in charge of the pit, to see that proper order was kept, and to hand the boys into the tub, and so on, I think it would be a very great means of preserving life.

5195. Have you ever known a coroner's inquest held upon cases of that kind?
 Yes.

5196. Have there never been any verdicts given against managers of pits who did not see that proper precautions were taken?

No; it is always "accidental death;" it is generally argued, that the person's own safety ought to induce him to mind what he is doing.

5197. I suppose it is the fact, that such accidents generally occur from the person's own carelessness?

Yes; but I think there ought to be a kind of police regulation about the matter; a banksman could come an hour sooner to his work; the colliers generally go down an hour and a-half or two hours before they begin winding the coals; it would not be so very easy for him to come and see that order was kept upon the pit's bank while the men were descending.

5198. Supposing such regulations were laid down, and were no better observed than the regulations which are laid down with respect to the not taking the tops off the lamps, to whom would the responsibility attach?

I think the man who took the top off his lamp ought to be sent to gaol, and I think the man who does not inform of him there and then is as bad as he. If I were in a dangerous mine, where I thought my life was in danger, and I saw a man taking his lamp-top off, I should either take means to escape as quickly as possible, or try to prevent him, and I should inform against him to the master. There is one observation I wish to make: I do not think it is advisable to entrust young children with the trap-doors; and another thing is, that of the persons that are lost by those explosions, the greater number are not burnt, but they are generally destroyed by the after-damp; I think in that case extra trap-doors might be so constructed as that the ventilation might be very easily put in operation again, and the great majority of lives which are now lost through the after-damp might be saved.

5199. Have you thought of any plan by which you could keep up the ventilation when all the stoppings are destroyed by an explosion?

Yes; what I should propose is, over every stopping there should be a door put into the top at the back of the stopping, and let this door be lifted up, so that the blast could not possibly catch hold of it; then, when the stopping was blown out, the door might be let down, and so they might ventilate two or three hundred or two or three thousand yards in a very short time.

5200. Who should let the door down?

Of course the persons who are going in search of the men; they could do it very quickly.

5201. How could they reach the door?

They could always reach it from one stopping to another: when I turned the door down in one stopping, it would turn the air through the next; then I should have only from this door to the next to go in the foul air; when I turn that down, it brings the fresh air up to that point.

5202. When a mine is full of that sort of gas, do you think it is possible to pass from one stopping to another?

Yes, I have frequently gone as long distances as would be required in this case.

5203. Have you ever seen cases in which it is impossible for a man to walk a few yards?

No.

5204. You are not aware that such cases exist?

I have never heard of such cases. The great majority of lives which are lost by

by explosion are not lost from the men being burnt to death, but from the after-damp.

Mr. D. Swallow.

17th July 1849.

5205. The difficulty in such cases is to keep up a ventilation, in consequence of the destruction of the stoppings?

Yes; and that is the remedy which I should propose, which would be no great expense, because if the door was not wanted, it could be removed to another place when the pit was finished.

5206. Have you turned your attention at all to the state of education among the mining population?

I have; I find, generally speaking, that the means of education are very limited.

5207. Do you mean schools?

Yes; and the means of education within the colliers' reach are generally very limited; there are a few honourable exceptions; for instance, the Earl of Ellesmere has provided excellent schools upon his estates, and many other gentlemen have provided schools. It has often been observed that public opinion is sufficiently operative upon the coal-owners, but it is not with the great majority of the coal-owners.

5208. Do you think that an improved education would lead to a smaller number of accidents?

Yes, I believe it would have a tendency to decrease the accidents. I believe when a collier pulls the top of his lamp off, it is through ignorance. I do not think that any man would knowingly expose himself to danger. I believe that colliers, generally speaking, do not know the use of the Davy lamp, and do not know the danger of the abuse of it; they have no knowledge of the nature of the gases by which they are surrounded, and, generally speaking, they have no conception of the importance of ventilation.

5209. Do you think they are sufficiently acquainted with it to know the extreme danger of opening their lamp when they are surrounded by a foul atmosphere?

I do not believe they are sufficiently acquainted with the consequences.

5210. Not living, as they do, among constant accidents of this kind?

I do not think they are. It is looked at in this way: where one man happens to meet with an accident, it is considered a sort of misfortune or bad luck; the man says, "I have carried it on so long," or "I have worked with a lamp red-hot." If I say to him, "It is not safe to work in the place after the lamp fires; I should either extinguish it, or leave the place as soon as I could," they would say, "I durst work in a place with a lamp red-hot for six hours." They do not understand the nature of the lamp and the nature of the gases by which they are surrounded.

5211. Therefore you are led to the conclusion, that if they were better educated, they would be more careful?

Yes; they would be more able to reflect and think upon the consequences.

5212. Are they, generally speaking, able to read and write?

No, they are not.

5213. That is to say, in your neighbourhood?

Yes, in our neighbourhood; I should think not more than 1 in 20 could read and write.

5214. Is the proportion of those who can do so increasing?

I believe that the rising generation are somewhat better than the old colliers; I know that from going about with petitions, or assisting in getting up petitions. If you see a collier's petition, there are very few handwritings to it.

5215. Is there any difficulty in finding men to act as viewers and under-lookers?

I do not think there is any difficulty in finding good, well-qualified and intelligent men.

5216. Sufficiently educated for the purpose?

Yes, for under-lookers. In reference to machinery, there is some part of the machinery

Mr. D. Swallow.
17th July 1849.

machinery which it is necessary should be inspected. In many collieries they pump water with the same engine that they wind the men up and down with. Here is a case of accident to Robert Taylor from the engine slipping out of gear. It is very common in many collieries, when they have given up winding coal, that they just slip the winding part out of gear; then they pump without that incumbrance during the night, and they just push it in when the men are going down; and sometimes it is not properly secured, and the men are precipitated from the top to the bottom of the pit. In such cases the machinery ought to be under the inspection of the Inspector.

The Witness is directed to withdraw.

M. Dunn, Esq.

MATTHIAS DUNN, Esquire, is called in, and examined as follows:

5217. YOU are a Colliery Viewer in the North of England, are you not?
I am.

5218. At Newcastle?
Yes, Newcastle-upon-Tyne.

5219. Have you had long experience of the working of collieries?
I have.

5220. Have you bestowed considerable attention upon the subject of the occurrence of accidents in coal-mines?
I have bestowed a good deal of attention upon it.

5221. Do you think that the present state of the mines, in the districts with which you are acquainted, is such as to give rise to more accidents than might occur under a different system of management?

I have long been of opinion that the interference of Parliament would be a very advantageous measure. I advocated that interference in a little work upon the coal trade, which I published in the year 1843, intituled, "View of the Coal Trade, &c.," which I will give. In the year 1847 I was introduced to the Society of Engineers by Mr. Robert Stephenson, whilst a paper was being read upon the subject of accidents in collieries, and I was requested to speak upon it. I there also advocated the interference of Government. Since then, I have also published a little work, intituled, "The Winning and Working of Collieries," in which I have again advocated it. I bring into the present consideration the Reports of the Government Commissioners, after many of the great explosions, in all of which they appear to me to wind up with the opinion (and in which opinion I perfectly concur) that legislation, carried out under practical Inspectors, is desirable.

Vide Appendix G.

5222. To what length do you think it would be possible for legislation to go as respects providing for the safety of coal-mines?

I would advocate, in the beginning of legislation, that you should have as few enactments as possible. The Bill introduced by Mr. Wyld, in my opinion, far exceeded that of Mr. Duncombe, in respect that it was much more simple. After providing for the appointment of proper Inspectors, and a sufficient number of them in the first instance, I should advise the enactments to be as few and as simple as possible.

5223. Are you acquainted with Mr. Wyld's Bill?
I have read the Bill.

5224. Should you say that that Bill was well adapted to its object?

To a considerable extent I think it is. I can mention to the Committee three or four very extraordinary cases, in which the appointment of Inspectors would have saved life and property to a great amount. I have here—[*producing the same*]—a map of the Workington Colliery, in Cumberland; I had the management of it up to within ten months of the deplorable accident which took place in that colliery in the year 1837; the accident was caused by robbing a portion of the pillars underneath the Irish Sea; the pillars were quite adequate to support the roof, although the workings were advancing towards the bottom of the sea; there was at that period abundance of space between the bottom of the sea and the leading

leading workings, but in one part they most injudiciously took away some of the pillars; a crash took place, and down came the sea. The most remarkable circumstance belonging to it is, that some months before this event I had several communications from that quarter, and I submitted those communications to a friend of the proprietor, resident in Newcastle; he communicated with him upon the subject, and advised him to have the matter well investigated, for if the representations he had seen were correct, a calamity would happen. The proprietor did examine into it, but he continued to place confidence in the representations of the person who was managing the work; and he returned an answer, thanking his friend for his interference, but that he was quite satisfied all was going on well. The impending danger, however, was the common discourse of the town and neighbourhood, inasmuch as there had been several warnings, by falls of stones and spouts of water, that the thing would happen. I had my own forebodings, for I knew the colliery; I knew that if the representations that were given to me were correct (and in which I had perfect confidence), nothing else could happen than did happen. If, then, there had been an Inspector in the district to whom I could have communicated that correspondence, most undoubtedly he would have felt it his duty to go and examine into all the circumstances of the case; in which case the entire colliery, with all its stock, and the lives of 36 people, would have been saved. A singular thing, also, is connected with it, that there never could be an inquest upon the circumstances of this inundation, because there was never a body obtained, and there never will be, from the extensive fracture of the strata that took place.

M. Dunn, Esq.

17th July 1849.

Vide Appendix F.

5225. Would you have given the Inspectors, when they came, the power of directing that the works in that part of the mine should be abandoned?

That is a subject which I speak of with great deference. I know if the Inspector understood his duty properly, and his attention had been called to it, he would have made a strong protest upon the carrying on of those works in the manner in which they were doing; and it is for your Lordships to consider how far (under such pressing circumstances as I have described) it would be prudent or proper to give such power. I have advocated, to a certain extent, that a power should be given for a temporary suspension of certain parts of works, till a disputed opinion between the owner of the works and the Inspector was brought before some proper tribunal, which tribunal should examine into all the circumstances of the case, and decide the case upon its merits.

5226. Do you think that that case was so clear, that the Inspector would have been able to pronounce with confidence upon it?

Yes; the salt water was filtering into the colliery by means of heavy falls.

5227. Was the person in charge of that colliery a person of much experience?

He was experienced to a certain extent; in fact, he was brought there by myself; but his experience was more for a secondary situation; unfortunately for the proprietor, he gave the whole charge of the colliery into his hands.

5228. Was he a man of great education?

No; he was qualified for an overman. I can mention another case of the same kind. This is a letter, dated February the 22d, 1844, from a person describing the state of the Landshipping Colliery in South Wales (but which colliery I never saw), where 40 persons were drowned. He says, "Just as the tide broke into the workings, it blew up the roof in several places into the river, and some props out of the roads were also blown up, and seen floating in the tide; but men's bodies, I expect, will lie still here until the sound of the trumpet at the great day of the resurrection." He gives a sketch of the workings; and he says, there were 20 yards of sand and only four feet of metal between the bottom of the sand and the roof of the coal. They were working in that position, and so immense was the fracture, that the very timber of the colliery floated up into the river. That is another case in which the Inspector, if his attention had been called to the working, undoubtedly would have prevented that sad affair.

5229. You are not acquainted personally with that case?

No. I never saw the colliery; but I know this person very well. I wrote to him to ascertain the particulars, and this is his letter in reply to me.

5230. You have no means yourself of saying that this was a case in which the Inspector could have spoken confidently?

M. Dunn, Esq.
17th July 1849.

If that description be correct, that there was only four feet of rock between the sand and the top of the coal, it was most undoubtedly a most imprudent thing to continue so to work underneath a river.

5231. Can you mention any other case of the same kind?

This—[*producing the same*]—is a sketch of the drowning up of Sir John Hanmer's Colliery upon the River Dee. This is an extensive old colliery, which was well known to every one to be drowned. These were workings of the Eatons, who worked an intermediate piece of coal between the drowned colliery and Sir John Hanmer's Colliery. There was warning given in this case by spoutings of water for a considerable number of weeks before the thing happened. They did not, however, take alarm till upon a Sunday evening a communication took place with this immense mass of water, and in the course of a few hours every thing in Sir John Hanmer's Colliery was drowned up to the level of the River Dee. If it had been in the day-time, most undoubtedly life would have been lost, as the colliery workings were in the deep. That also was an act of imprudence. I cannot call it wilful, for their own colliery shared in the ruin; but persons having a due regard to their own interest, and that of their neighbours, as well as the saving of life, would not have continued working in that position.

5232. Those three are all cases of the inundation of water; are you equally confident that the appointment of an Inspector could be serviceable in preventing accidents from explosions?

Yes.

5233. Are you acquainted with any instances in which it is clear that the appointment of an Inspector would have been of use in that respect?

Yes. There was a colliery in North Wales, with a single shaft, 9 feet in diameter, 60 fathoms deep; it only begun to work about four or five years ago, and was ventilated not by the usual application of a brattice, but by a wooden box, 14 inches square, and a fan blast upon the top of the wooden box; the seam is nearly 6 feet thick, lying at an angle of 30 degrees. This colliery got fiery, and could not go on without danger, for I had letters to the effect that the pit was getting into a very bad state, and so on. The engineer one day went to the top of the boxes to do something, and the air was in so inflammable a state, that an explosion took place upon the top of the box, and extended throughout the workings. That happened twice afterwards, although they replaced that box with two boxes; still the two boxes were only an area of about 8 or 9 feet, whereas the area of the shaft was nearly 70 feet; therefore the one bore no practical proportion to the other. I therefore submit, that if any one in the district had been entitled to interfere, that state of things would not have been permitted to go on; two persons' lives were eventually lost, and several others had very narrow escapes.

5234. With respect to the power which the Inspector should have, to what extent do you think power should be given to him?

Being well aware of the strong feeling which prevails upon this part of the subject in the first commencement of legislation, I certainly would not advocate much power being given beyond the power of suggestion and of formal protest, for the purpose of calling serious attention to the various matters.

5235. There should be a power of examination in the first instance?

Of course.

5236. Are you of opinion that the interference of an Inspector, with power of that kind, enabling him to examine, and then to make suggestions, would be effective for the purpose of introducing any great improvement in the working of mines?

I have no doubt it would be so, provided the Inspectors were duly qualified, so as to give them a proper confidence in their own judgment; and with respect to safety, suppose that a set of workings were going on under circumstances of manifest danger, it will be for your Lordships to determine whether the Inspector is to have any power of suspending the working of that part of the colliery until he had brought the case before some board of appeal, it might be neighbouring Viewers or neighbouring Inspectors. If there were chief Inspectors appointed by Government, it might not be objectionable to bring a subject of that sort before two of them.

them. We must suppose that such persons would be masters of the subject, and entirely disinterested; therefore, if a question of that sort were brought before them, that they would deal with it according to the best of their judgment.

M. Dunn, Esq.

17th July 1849.

5237. There is no doubt whatever as to the expediency of appointing Inspectors, with the power of inquiry, at any rate?

I have no doubt that it would produce a great deal of good in the saving of life if this measure were adopted, by transplanting the improvements which prevail in the districts most advanced to those districts where the science is behind hand.

5238. How far would it be possible for an Inspector to make himself acquainted with the system of ventilation?

I think the chief thing that the Inspector could look to would be the general principles upon which the mine was arranged and conducted. The Inspector could not be expected to go into all the minutiae of the internal working, except when called on especially to do so. Suppose the workmen in a particular colliery had reason to think that the colliery was dangerous, then I think the Inspector would be bound to go and personally inspect those parts which were complained of, having first received the complaint in writing; upon which, he would found his inquiries, and exercise the power entrusted to him by Parliament.

5239. Does your acquaintance extend more to the Northern districts of Northumberland and Durham than to other districts?

No; I think I have general experience over most of the coal districts, with the exception of South Wales.

5240. In which district do you think the arrangements are most effective as respects ventilation?

Decidedly in the North of England. I would wish to explain a curious subject with respect to the Staffordshire ventilation; for whilst in one part of the world we are striving to produce greater ventilation, the Staffordshire people think it of advantage to restrain it within certain bounds.

5241. You have stated, that in the Northern districts the ventilation is most effective; in which districts do you consider it most defective?

I think Staffordshire is possibly the most defective, although the number of pits exceeds, I believe, that of any other district in proportion to the mining area.

5242. The coal there is not so fiery as it is in the North of England, is it?

No, but it is exceedingly thick; the principal seam is 30 feet. I have here an authenticated plan of the workings of a colliery which has just exploded in Staffordshire, and where nearly 20 people have been killed; the air-head is only 3 feet 6 by 2 feet 6, to ventilate a seam of 30 feet high; even the gate-road or horse-road is 12 feet square; the gate-road is at the bottom of the mine. The difficulty of ventilation in this case is obvious, for the ventilating current does not go higher than 12 feet; whereas the seam is actually worked 30 feet high; this forms, therefore, an immense dome, containing stagnant air and gases.

5243. Wherever old coal is worked out, the portion of the space above the level of the air-course must be filled with gas?

Undoubtedly; from the mode in which a colliery is worked, it accumulates a vast quantity of rubbish, small coal, and pyrites, to the amount of seven or eight feet in thickness, at the bottom of the working; this mass generates a great deal of heat, whilst it evolves the gases; therefore they allege that, according to their principle of working, if they were to apply any active ventilation, it would blow up that mass into a fire sooner than otherwise, for it invariably takes fire under their own fashion.

5244. In that case a very active ventilation would produce some danger?

Yes: this is a communication dated the 15th of July, from a friend of mine, a mining agent in Staffordshire, who has sent me this plan; he goes into the results with respect to the ventilation there. He says, "It is beyond human ingenuity to keep a side of work perfectly free from gas; you may ventilate it by an air-heading of what dimensions you please, or by gaitwading, and gas shall lodge in places, such as the holes of cutting, or the place where a drop of coals were last cut from; but the moment the band (rope) commences work, the whole air of the side of work is agitated, and mixes with the gas, and is so carried off by

M. Dunn, Esq.
 17th July 1849.

the intake air-head. How can it be expected that a side of work should be kept perfectly clear at all times? not but that any great accumulation may be prevented; but the moment our great skips, of perhaps 60 to 70 feet sectional area, have done running, and in spite of a good current of air running its whole length, and taken off at the highest place, it will collect in every pot-hole and cutting that is above the level of the intake head, but which is almost momentarily carried off in the morning by a little application of the (poor) colliers' waistcoats. I would wager that if you Northern viewers had the management of a bit of our thick coal, you would have it all of a shine before four months had gone over your head. About three weeks ago I had a side of work that on the Saturday night was as cool as could be wished (would only have taken another three weeks to complete it), and by a little alteration in the air that I ordered to be made on the previous Wednesday for the safety of the men, it was all up with it on the Monday morning; and such was the rapidity of combustion, that it was with the greatest difficulty that the whole of the pit's company could master it, and complete the dam, engaging near half the men to carry the other half away into the fresh air. This was a work of only 48 hours." He says, "I have known sides of work extended near double its originally intended size by gauging the air, and so limiting the quantity simply to what would be actually demanded by the men, horses and candles." I submit that in this there is a great anomaly; in one part of the country we are striving for the advantage of greater ventilation, whilst the people of Staffordshire say expressly there ought only to be what is demanded for "the men, horses and candles."

5245. Where there is a great liability to spontaneous combustion, how do you conceive the ventilation ought to be regulated?

That is a very difficult question to answer; I have an idea that it would be both to the interest of the owner of the mine and the safety of the people, if the colliery were worked in twice; they work it in once; they work first the lower part, and then take down the remaining coal. I have had a great deal of reflection upon the subject, and I think that the latter mode would be the more profitable for the owner, and safer for the people; both as regards ventilation and falls of coal and stone, by which many are killed.

5246. Should there be any difference in the ventilation where there was this liability to combustion?

Yes; in that case it might be ventilated in detail as the North country collieries are. If a certain thickness of coal were mined over in the first instance, and the pillars taken out, then the new works might begin at the bottom of the mine, taking down the coal resting between, which would, in my opinion, lead to a better method of working.

5247. How would you avoid the danger of passing a rapid current over those materials which you have spoken of?

They do not use close tubs in Staffordshire, but skips, which consist of square frames upon sledge feet, upon which the coals are built to the extent of 28 or 30 cwt. It is not convenient to get small coal out by those means, consequently the small coal is chiefly buried in the mine. By the North country method of working, the coal in certain departments would be kept clear of refuse; and if tubs were used, it could be conveniently brought out of the mine, and so the danger of this breeding fire would be avoided.

5248. The fire arises from that small coal, does it?

From the small coal, pyrites and rubbish; they work it by sledges, and the passage of the sledges, and the trampling of the horses going over it, tends to hasten the combustion.

5249. Is there any other cause you can assign for that combustion, except the decomposition of the pyrites?

No.

5250. Supposing there were any system adopted, by which they got that refuse out of the mine, that cause of accidents would be removed?

Yes, owing to this extraordinary mode of working, there is an immense loss of coal; I am told that they do not get above one-third of this valuable mine to market; a great deal of the top coal is left which they cannot remove in any way, as well as the small coal, ribs and pillars.

5251. Does

5251. Does the air upon that part of the coal which is trodden on accelerate or diminish the combustion?

The general opinion is, that the more active the air, the more speedy the combustion; combustion is a matter of course; it always happens, but quicker where the air is active.

M. Dunn, Esq.

17th July 1849.

5252. There are two stages to it; there is one when the coal is loose, and the other when it is trodden on?

Yes, it is the trodden part which fires; it distils the gases, and the air operates upon it; I examined one of those collieries lately, and I took a thermometer with me; upon the surface it was 49, at the bottom of the pit it was 52, and in the workings it was 70, though the workings were not above 150 yards from the bottom of the pit; that showed that combustion was progressing. In the Seaton Delaval pit, between the bottom of the pit, which is 95 fathoms deep, and of the return air-course, after having travelled a mile and upwards into the workings and back again, the difference of the thermometer was only between 59 and 62, being an increased temperature of only three degrees, whereas in the other case there was an increased temperature from 52 to 70.

5253. Seaton Delaval Mine is ventilated by a jet, is it not?

It is ventilated by a jet and an under-ground engine.

5254. Have you ever turned your attention to the question under what circumstances the combustion takes place in cases such as you have described?

Only in this respect; that the universal mode of ventilating the Staffordshire Collieries is from the bottom, and therefore there is necessarily a dome which cannot be ventilated at all; I attribute the freedom from explosions in Staffordshire in a great measure to those gases which are evolved by this lower mass of rubbish counteracting the inflammable air, which would otherwise explode.

5255. Are you of opinion that the colliery managers in Staffordshire, who think that ventilation rather increases the danger of spontaneous combustion, are right in their belief?

I have not had sufficient experience in the Staffordshire Collieries as to answer that question fully; I only know, from the mode in which ventilation is carried on, that they cannot ventilate the interior of the Staffordshire Collieries properly.

The Witness is directed to withdraw.

Ordered, That this Committee be adjourned to Thursday next,
One o'clock.

Die Jovis, 19° Julii 1849.

The LORD WHARNCLIFFE in the Chair.

MATTHIAS DUNN, Esquire, is called in, and further examined
as follows :

Evidence on the
Prevention of
Accidents in
Coal Mines.

M. Dunn, Esq.

19th July 1849.

5256. WHEN you were last before the Committee, you quoted the instance of the catastrophe at Workington as an illustration of the utility of inspection?

Yes.

5257. Have you any means of showing that upon that occasion there was ample warning of the probable occurrence of that accident?

I think I have; this is a letter dated the 10th of April 1837, wherein this passage occurs: "Lady pit is now, and has been for some time, going double shift, and from accounts, they are making very rough work among the pillars, and are, I am told, now splitting pillars to the very rise of the Union; this, for a certainty, will lead to something very serious, after a piece."

5258. When did the accident take place?

I will come to the accident by and by.

5259. From whom is that letter?

It is a letter from Mr. Bowness, who had formerly had the management of the colliery, and knew the colliery well.

5260. Is it addressed to you?

To me.

5261. Did you then forward that to Mr. Curwen?

I will state by and by the course which I took. I quitted the management of the colliery on the 31st of December previous. The next letter is on the 24th of April; he says, "The Camperdown coal is now working into very little compass, and they are only leaving it very weak, and from the manner they are pulling out the pillars, both in Union and Lady pits, one may expect soon a general creep, and which will, for a certainty, lead to very serious results."

5262. That was to you, also?

That was to me, also. On the 2d of June 1837, the same person writes to me, "They are still making free with the pillars at Lady and Union pits, which will tell a tale some day, when they don't expect it." I was quite satisfied that if these representations were correct, some calamity would happen. I took those letters to Mr. Humble Lamb, of Newcastle, who had been instrumental in my going to Workington, and laid them before him, and begged him to interfere in the matter, as I was sure an accident would happen. He wrote to Mr. Curwen, and I hold in my hand a copy of Mr. Curwen's letter to Mr. Lamb; it is as follows: "I hasten to thank you for your very friendly letter. I am certain you acted in the kindest manner in recommending Mr. Dunn. Most of his suggestions were very valuable, but at his last visit——" he describes a difference between this person and me; then he goes on to say—"The working of the colliery will be plain and easy enough. I am not aware I could do more than follow up my present intentions, but I am not the less obliged to you for the kind intent you express for me, and the friendship to us in your letter." I wrote to Mr. Bowness to say that I had taken this step; that I had submitted these letters to Mr. Lamb. Another letter is dated 24th July 1837: "At Lady and Union pits they con-

M. Dunn, Esq.
 19th July 1849.

tinue pulling out the pillars." "The water is now rising." It is just a continuation of the process going on. Then comes a letter of the 31st July 1837, from Mrs. Curwen to myself; she says, "You will be surprised to see a letter from me, if the fatal tidings which I am about to communicate have not reached you ere this does."

5263. When did the accident occur?

Here is a letter from Mr. Bowness, stating that the accident happened on the 28th of July. Mrs. Curwen goes on to say, "Alas! your worst predictions of Coxen have come to pass, and by his self-willed obstinacy and ignorance he has ruined, not only the colliery, but the whole town of Workington;" and so on; and she begged me to go up, which I did immediately. Now, that is a case which I put very strongly before your Lordships, to show that if any person had been authorized to have interfered, the colliery would have been saved, as well as the lives of the people.

5264. Supposing that an inspection had been established upon the system generally recommended, namely, that there should be no positive power of directing upon the part of the Inspector, but merely that he should be authorized to examine the state of the colliery, and to report upon it to some authority, and, at the same time, to enter a protest as to its condition, do you think that that would have been sufficient to guard against that accident?

I submit these facts before your Lordships for your consideration, because everything was done in this case to induce the owner to have the matter fully examined into.

5265. But merely by private parties?
 Through his personal friend.

5266. By persons who had no right to interfere?

Of course not; I could not interfere; Mr. Lamb did interfere, as far as he could.

5267. Looking to this particular case, it never was accurately ascertained how the accident happened; whether it was the fall of the pillars, or working the coal to the rise.

There is no reason to doubt, I think, that it was in consequence of taking away the pillars. There were about 25 fathoms between the extreme rise workings and the bottom of the sea.

5268. However, nobody has been down the pit to prove it?
 No.

5269. The fact of the warning having been given of danger from a certain cause was sufficient?

Yes. I hold in my hand, also, some similar correspondence relative to an explosion at a colliery on the River Dee, where the colliery was ventilated by a box 14 inches square.

5270. Will you show the warnings in that case?

I will give two or three short extracts relative to that case. The party says, "I want to sink a new air-pit before the weather comes so warm that we shall be overpowered with sulphur; for a fine day or two makes a great change with us in the works, and I have hopes they will give way to me, and do away with the blowing machine."

5271. What was the blowing machine?

The blowing machine was a fan machine, placed upon the top of a set of boxes, 14 inches square; this was the only means of ventilating a nine-foot pit, with a seam six feet thick, as I described before, at an angle of above 30 degrees, and at the depth of 60 fathoms.

5272. What date is that?

The 1st of April 1848.

5273. Is that from the manager of the mine?

Yes.

5274. To yourself?

To myself. The next letter is the 23d of April 1848: "I am driving up for
 a new

a new air-pit, for we are nearly overpowered in some places with fire-damp." The next letter is the 24th of June: "I am sorry to inform you that we had a sad accident here on Tuesday night last; one of the men took his candle down into one of the wickets, and it took fire, and set the coal on fire in the lower coal, and then set the coal on fire in the two yards, and four men in the pit, and it flamed and burnt very hard till six o'clock in the morning, and we then got two men out quite free from fire or accident, but the other was quite dead for hours previous, and I was then obliged to fill up the pit 17 feet, to smother the lower seam, before I could get the other two men out, and during that operation the pit exploded several times. The pit is still made up, and the two men are down, and we think to open it to-morrow evening, if all is well. I will write you further particulars."

M. Dunn, Esq.

19th July 1849.

5275. Then in that case there was also a sufficient warning?

Yes. There was another explosion described as follows: "Owing to the unfortunate explosion, we have opened the pit, and put the fan to work, and the colliery exploded at half-past nine last night; so we have not got the two men out yet." That was a second explosion which took place. Another letter is of the 12th of July, saying that the colliery is still shut up, and we cannot get on. The means used were well known to myself as being quite inadequate to ventilate the colliery.

5276. There was sufficient warning, in that instance, to have enabled the managers of the mine to have avoided that accident in case they had attended to it?

Undoubtedly.

5277. You have already stated that you consider the principal cause of the occurrence of these accidents from explosion to be deficiencies of ventilation?

Yes, that is one; but I believe that it does not amount to an equal quantity of the general accidents.

5278. The question refers to explosions alone; the principal cause of the accidents from explosion is a deficiency of ventilation?

Yes.

5279. What is the most common form in which that deficiency of ventilation shows itself, do you think, judging of the average of cases in the different districts with which you are acquainted?

I will take the liberty of reading a few extracts as to various collieries, chiefly throughout Lancashire, showing that there is very little artificial ventilation applied in any of them. This is in the neighbourhood of Mold, in North Wales: "The only mode of airing is by a wooden box, 10 inches square; in consequence the air is past breathing, although little inflammable air. The end of the box is taken into the engine chimney." This is with regard to another colliery in North Wales: "The air-pit for this colliery is alongside of Dingle pit, only three feet diameter." Another is a colliery close to Wigan, which afterwards exploded, and killed several people: "No air-course; a sail is put up to throw air down, but the pit is so foul that everybody works with Davy's, which are badly attended to, so that there is every chance of burnings taking place here." Here is one of Lord Balcarres' collieries; this is May 1843: "No artificial ventilation, but everything exceedingly rude and unimproved." This is a considerable colliery in Lancashire, near Newton Ashton colliery; the remark is, "In ordinary they have eight pits working; no furnace is used, but common ordinary fire-lamps."

5280. Those fire-lamps being cradles holding burning coals?

Yes. The next is a colliery near Stockport, Poynden and Worth: "Have much inflammable air; carry the air through the works with brick stoppings, but have no furnace; engine-pit, the downcast; the old goaves fill with inflammable air, and are liable constantly to ooze out upon the men; have frequently people burnt." I did not examine the under-ground department of this colliery; it is from the intelligence of the manager. This is near St. Helen's, Cowley Hill colliery: "A good deal of foulness here, and bad ventilation, so much so, that constant burns are the result; work much with lamps badly attended to." Perhaps I need not go through any more. Among the rest occurs a colliery in Belgium, which I examined.

M. Dunn, Esq.
 19th July 1849.

5281. Have you examined the collieries near Bolton ?

There is one which I will give near Bolton ; Rose-hall, near Bolton : " very rude and unimproved."

5282. Were any of the collieries worked well in Lancashire ?

I should think, in point of ventilation, considerably inferior to what they ought to be.

5283. Did you see Lord Ellesmere's collieries ?

I have not been down any of Lord Ellesmere's collieries. I will just particularize one more colliery, as it is one of the most important and one of the most dangerous collieries in that part of the country, and of which I had the management nearly two years ; it was the Dukinfield colliery, in Cheshire, south of Manchester ; I can give many particulars with respect to it, but the chief one which I wish to show is that there were nearly 170 feet of area in the downcast, and the only upcast was less than 20 feet of area ; therefore it could not but be a very ill-ventilated colliery.

5284. Do you think that quite sufficient to prevent ventilation ?

That alone is sufficient to characterise it as an ill-ventilated colliery ; in fact, I reversed one of the pits, and turned it from a downcast to an upcast, which made all the difference in the general state of the ventilation.

5285. Did you bring it into a proper state of ventilation ?

It was vastly improved.

5286. How long ago is that ?

In September 1845.

5287. Do you know what its present state is ?

It continues in the state in which I then put it, but I do not know internally the present state of the colliery.

5288. You do not know whether there has been any accident from explosion ?

There have been several accidents since ; but previously to that there were very serious accidents ; it is one of the most onerous collieries in the country, for the seam lies at an angle of 45 degrees, and they are working the coal 200 fathoms deep ; it is one of the most important collieries in the district.

5289. Was there any artificial ventilation at the time you were there at the top of the small shaft which you speak of ?

They had an underground engine at the bottom of the pit, therefore the boiler-fires of that engine acted as the ventilating power.

5290. Was that at the bottom of the small ventilating shaft ?

Yes ; I put a ventilating lamp into the upcast pit, which was added to this, and which caused all the increase.

5291. Are the most common causes of deficiency, then, in the ventilation, the want of an apparatus, and the want of sufficient shafts ?

No ; I do not think there is a great want of sufficient shafts generally ; through Lancashire the shafts are more abundant than they are in the North of England, I would say.

5292. But the most common defect is the deficiency in ventilating apparatus ?

The most common defect is the deficiency of the ventilating principle of good furnaces and ample columns of air.

5293. Have you remarked, in the course of your experience, that there is a good deal of imperfection in the way in which the air-courses are managed and the brattices placed ?

I do not think that they use brattices generally in Lancashire ; they often use canvass as doors, for instance.

5294. Nothing more ?

They frequently do ; but I am speaking of many of the collieries which are so deficient.

5295. Does that render the ventilation more imperfect than if they had brattices ?

It shows that they have not the full complement of ventilation, otherwise a piece

piece of canvass hung from the roof would not turn the air ; but if the air is very weak, then it suffices, perhaps, to check it in some degree.

M. Dunn, Esq.

19th July 1849.

5296. It never could be made use of as a stopping where there was sufficient ventilation ?

No ; I might mention, that Mr. Anderson and I viewed a very extensive colliery in Scotland about six weeks ago ; they are using canvass instead of doors there at this moment.

5297. The Scotch mines are not very fiery ?

There is no fire in them, but there is choke-damp.

5298. Should you say that the defect which you have remarked with respect to the colliery at Dukinfield is common, namely, having a very undue proportion between the shafts ?

I could not exactly answer that question fully ; but I dare say it prevails in other parts as well as there ; for instance, at Seaton Delaval there are four downcasts for one upcast ; and there are several other collieries in the northern districts as well as other places where the proportion between upcast and downcast lies the wrong way.

5299. Do you think that it would not be possible to have good ventilation with the upcast shaft smaller than the downcast ?

I think it decidedly better to have the upcast shaft larger.

5300. Are you acquainted with Mr. Gibbons' system ?

I have considered it a good deal, and I believe written upon it ; I think it is completely contrary to all principle of either philosophy or practice.

5301. Have you ever inspected his mines ?

No ; I have never inspected his mines, but I have seen and heard and read a great deal of the particulars.

5302. You have never been in the pits in which it is used ?

No ; I never was in Mr. Gibbons' pits.

5303. Have you seen his work upon the subject ?

No ; except just cursorily in the hands of another person ; I never read it with much attention.

5304. Then from what source is your knowledge derived of his system ?

The source from which I derive my knowledge is some controversies that were passing in the Mining Journal, in which the sizes of the air-courses and so on were given, and the arguments were raised as to whether this was not a superior system to the ordinary system in Staffordshire.

5305. You are aware that a part of his system is to bring this air-shaft and these passages below ground from the highest level of the seam, so as to enable the light gas to pass off constantly and continuously ?

Yes ; but his system is entirely deficient, inasmuch as his upcast area is totally out of all character with the downcast shafts.

5306. You think it would be inadequate for the purpose ?

Perfectly inadequate, I should say.

5307. Would not that depend very much upon the area to be ventilated below ground ?

It would ; but still to have a competent ventilation, you must have a competent shaft.

5308. Whatever the size of the downcast shaft might be, supposing there were two pits, one with very extensive workings, and the other with very limited workings, might it not be possible to have the pit with limited workings properly ventilated by a small upcast shaft, the other requiring a very large one ?

I consider that it requires very extraordinary means to make an area of four or five feet ventilate a 30 feet seam, except they go upon the principle of having a very small quantity of ventilation ; besides, Mr. Gibbons had no other means except a small fire at the bottom of his ventilating chimney.

5309. With respect to the arrangement of mines underground, do you think that, generally speaking, the mode in which the air is conducted is defective ?

I think they have arrived at great practical perfection in the North of England ;

M. Dunn, Esq.
 19th July 1849.

I think that almost everything is done there in a general sense which could be desired to be done, but I think that in many other parts there is a great defect.

5310. In what direction do you think the fault generally lies?

I will mention one circumstance, which happens to be familiar to myself, in the collieries at Moston, for instance; they are extended about 1,200 or 1,400 yards underneath the River Dee; the only stoppings that they put in are stowings of rubbish; therefore, however good the ventilation, and however ample the short current of air may be about the bottom of the shafts, before it arrives at the extremity it is scarcely visible at all.

5311. It leaks through those stoppings?

It leaks through; it requires to be forced, and especially where the distance is considerable; the more considerable the distance the greater the leakage.

5312. Is that a common practice?

It is very common, I dare say, in many parts of the Midland districts; in the North of England it is universally the case to put in brick stoppings, and very often the principal ones are stowed and supported in anticipation of some violence to derange them.

5313. Where a large area is to be ventilated, is it not in the North of England now considered very desirable to split the air?

Yes; it is absolutely necessary to split the air.

5314. Is that splitting of the air a system generally adopted in other districts?

I dare say it is in some degree, but not so methodically by far as in the North of England.

5315. Do you conceive that such defects as those might be easily remedied by the owners of mines without incurring any very ruinous expense?

In many cases they could; but it often happens that the mines are left to the management of persons who are just accustomed to the locality in which they have been bred and brought up, and who have not seen, perhaps, the better practice in other parts of the country; therefore, it does not occur to them to go out of the regular beaten track.

5316. But supposing that an Inspector were authorized to visit them occasionally, and by that means they were to become acquainted with better systems, and to hear suggestions upon the subject from him, do you think that it would be possible for them to act upon such suggestions without any great difficulty, or without any very great expense in those cases?

In many cases it would be their interest to act upon them; for instance, in the case in North Wales, where, instead of the ordinary brattice across, they introduce a box; the result of that is explosion; therefore, eventually, the colliery lessee would be vastly benefited if any constraining power could compel him to do that in the first instance which his interest afterwards prompts him to do, namely, to get another pit.

5317. Generally speaking, do you consider improved arrangements for the prevention of accidents matter of economy, as well as of humanity?

Indeed I do; I think the better a colliery is ventilated, the more economically it can be worked.

5318. With respect to the goaves of collieries, are not they almost always one of the most dangerous elements in a colliery?

Of course; they get filled either with inflammable air or with the choke-damp, as the case may be, and except that is carried off by good practice and by intelligent conduct, it often leads to explosion.

5319. Do you think there is any method known by which in all cases it would be possible either to ventilate or to shut off those spaces?

No; they are very difficult to shut off, and they are equally difficult to ventilate. I could advert, perhaps, very strongly to the labours of Messrs. Lyell and Faraday, after the explosion at Haswell. They made some suggestions with respect to pipes for carrying off these accumulations in the goaves; but their suggestions were considered both by viewers and by the coal-owners, who instituted a committee (indeed Mr. Taylor was one), as well as the colliers, to be totally inapplicable, and entirely impracticable.

5320. That

5320. That they would be too expensive to bring into action ?

Not only too expensive, but that it was not practicable ; that they were quite mistaken as to the results of what they proposed to have done.

5321. Do you think that there is any method by which those goaves might be rendered safer than they are ?

No ; I am aware of no method except a good sweeping air-course along the side of them, and conveying the adulterated air by separate passages to the upcast shaft.

5322. You would not attempt to ventilate the goaves themselves ?

You cannot ventilate them, for they are not accessible. After you get out a few acres of pillars, the strata is entirely broken down, and there is no access to them ; you can therefore only get round about them ; if they produce inflammable air, you must carry that inflammable air off by some means.

5323. And it would not be possible to wall them off ?

You cannot wall them off where they happen in a numerous set of workings ; they do practise that in Staffordshire by stowing them up with rubbish upon the damming system, which I have described before ; but it often leads to explosions, because if the gas goes on accumulating and oozes out from those dams, which it often does, into the air-course, it leads to adulteration of the air before it gets into the workings.

5324. And does it not blow out the stoppings ?

It does not blow out the stoppings ; but as it swells in the part walled off, it oozes out into the air-course.

5325. Then the only method, in your opinion, of dealing with that part of the danger is to take a strong ventilating current along the edge of the goaf ?

Yes, and if the air is so far adulterated, which it generally is, to convey that air through passages not entered into by the workmen's candles.

5326. With respect to the persons who have charge of these mines, are they generally, do you think, capable of effectively superintending them ?

In the North of England, I think, generally speaking, it is so ; I think it is not so in other parts.

5327. Do you think that they generally understand the principles of ventilation ?

Yes ; I dare say in the North of England they generally do very well.

5328. With respect to the colliery owners, have they, do you think, generally paid much attention to the principles on which the ventilation ought to be conducted ?

I think it is left chiefly to the viewers, of course. As far as I can judge, there is no lack of anything that can be suggested, so as to prevent any damage or any loss of life.

5329. So far as the North is concerned ?

I speak particularly of the North.

5330. That would not be so in other districts ?

It would not. For instance, the breaking of ropes and the accidents in shafts are particularly few in the North ; you scarcely ever hear of anybody's life being lost by the breaking of a rope or a chain ; indeed, there are no chains used.

5331. Are there, generally speaking, good plans to the mines ?

Yes, throughout the North it is universal.

5332. And in other districts too, so far as you know ?

Of late years I dare say they are very much better than formerly, of course. Generally speaking, they have plans in almost all collieries now.

5333. Are all the new workings in these plans entered pretty constantly and regularly ; are they kept up so as to be a correct representation of the actual state of the mine ?

(164. 16.)

M. Dunn, Esq.

19th July 1849.

Yes, in the North particularly, and generally speaking, I dare say over all the country now, for the landlords have an interest in it.

5334. They never fall into arrear?

In Lancashire they enter them up every six months; and throughout the North, I should say, oftener; and in other districts I dare say something like it.

5335. With respect to the systems of ventilation generally in use, the most common of all is the furnace, is it not?

Yes.

5336. Have you seen any other artificial apparatus for ventilation in use? I have seen the fan-blast, which I have spoken of before.

5337. In use?

In use; and in the Dukinfield colliery they use portable fan machines underground, working with three-inch pipes to ventilate the rise workings.

5338. How are they moved?

They are carried by the workmen from place to place.

5339. Are they moved by hand?

They are carried about by the men.

5340. How is the fan worked?

It works within a little chamber; it is turned by a handle, and there is a pipe from it leading up into the working to be ventilated.

5341. Is it merely worked by the hand?

Merely worked by the hand.

5342. It must be a very feeble engine, must it not?

Very feeble.

5343. Have you ever seen any of the large mechanical fans attached to steam-engines?

Yes; when I was at Hebburn colliery some years ago, Mr. Buddle introduced the air-pump worked by the engine. I think it was about four feet square, and it was applied because the return air was in such a state that the ordinary furnace could not be used.

5344. How long did that continue in use?

It continued in use not very long, a few months.

5345. Was it found not to answer?

It answered to a certain extent, but it was so very unstable that it was quite inferior to the furnace. He also tried a discharge of steam so far down the shaft by an ordinary pipe; and another thing that he adopted was, a hot cylinder; that was heating a cylinder by turning a flame round about it, and the air from the mine passed within the heated cylinder. Those were all devices used when the ordinary furnace could not be applied.

5346. Have you ever seen Mr. Gurney's proposal of the steam-jet applied?

Yes; I have seen it at Seaton Delaval.

5347. Did you examine it closely at Seaton Delaval?

Yes, I examined it.

5348. What was the impression upon your mind with respect to the trial of it at Seaton Delaval?

It is exceedingly difficult to judge from a cursory visit, such as mine was, along with several other professional persons, amongst whom was my Lord Lonsdale's agent, Mr. Anderson, for we saw it working in connexion with two boilers 25 or 26 feet long and 6 feet diameter, driving a 40-horse engine; therefore the hot flame and the discharge of steam from these boilers heated the shaft up to a very considerable temperature, and along with which there was working also the steam-jet; when we went into the hot chimney to get to the bottom of the shaft, they were obliged to stop off the hot air from the flues to let us get in, and then we saw the apparatus, how it was arranged, and so on.

5349. Did it appear to you that the current produced by that apparatus was very strong?

I could not possibly say to what extent it would increase the current; my impression is, that it would increase the current, but to what extent it is impossible to say, for the reasons which I have assigned. I believe Mr. Taylor, who was there that day, but who has since examined the subject more minutely, will perhaps give better information upon it than I can do.

5350. Did you go through the workings upon that occasion?

No; we saw the amounts of air that were going into the workings, and the amounts that were coming out of the workings; and we went into another pit altogether from those, where a new apparatus, according to Mr. Gurney's arrangements, is fitted up, but that is not at work yet; a boiler is intended to be situated upon the top of the pit, but it is not set to work; therefore we could not see it otherwise than in conjunction with what I have described before.

5351. There was no furnace at work at the same time, was there?

No.

5352. Nothing but the engine fires?

Nothing but the engine fires.

5353. Did the current appear to you to be very strong?

Yes, there was a strong current; Mr. Taylor measured it; therefore he will be able to give your Lordships better information.

5354. With respect to other accidents, have you any suggestions?

Here is a list showing the accidents, which I have taken from the "Mining Journal" entirely; I can give them for three years. In the first, ending in 1845, there were by water, 17; by falls of stone and coal, 138; by explosions, 189; by shaft accidents, 105; by sundries, 113: total, 562. I will give another year, with your Lordships' permission, the year 1848, which is perhaps more correct still: 6 from water; 151 from falls of stone and coal; 225 explosions; 100 shaft accidents; 88 sundries: total, 570. This year, I believe, as far as it has gone, the accidents are more numerous than they were in those years. In 1847, from 17th April to 31st December, there were 8 from water; 125 from falls of stone and coal; 142 explosions; 88 shaft accidents; and sundries, 99: total, 462.

5355. Does it appear from that, that except with respect to the accidents from water, there is any great difference in the amount of accidents from the other causes?

No; I should think the causes are operating pretty generally.

5356. When you speak of the number of accidents, do you mean the number of lives lost?

Yes, deaths; there is no notice taken of persons who are lamed.

5357. Most of the accidents from explosion would involve the destruction of number of lives at once?

Yes.

5358. The other accidents would, generally speaking, involve the loss of only one or two lives, with the exception of those from water?

Yes; perhaps they would be a good while in dying, and there would not be a coroner's inquest.

5359. Do you believe that to be a complete return?

I do not know that it is accurate; I would not vouch for its entire accuracy.

5360. Does it not omit many accidents which have occurred, and of which they have no knowledge?

I have no doubt it does.

5361. It is an approximation?

Yes, merely that; it shows the proportions from each cause; that is the utility of it, I think.

5362. With respect to accidents from the fall of stone from the roof, do you think there are any means which would enable colliery owners to guard against them?

M. Dunn, Esq.
 19th July 1849.

A very great proportion of those arise in Staffordshire in working the thick coal, quite out of all proportion to any other part of the kingdom, and that again brings into consideration the principle of working.

5363. Is not that a description of accident which sometimes occurs without any notice whatever?

Yes; it often occurs in other parts of the country; but in no sort of proportion to Staffordshire.

5364. Are you of opinion that it would be easy so to modify the working in Staffordshire as to make the number of those accidents less?

I give an opinion upon that subject with great deference, because the general feeling in Staffordshire is in favour of the present mode of working; therefore any opinion given to the contrary would, of course, be viewed with considerable diffidence.

5365. But you have been frequently in the habit of inspecting collieries in that district?

Yes; I have inspected collieries myself, and given great consideration to the subject, and discussed it with professional persons; but there are not many professional persons in the North of England who have seen much of Staffordshire working.

5366. In what manner do you think it possible to work those mines so as to render the danger in that respect less than it is?

I think by working them at twice.

5367. By working the upper portion of the seam first?

Yes, taking a certain portion of the most valuable coal, because it would be the most perfectly gotten, and having it entirely worked out according to the North country system; the whole strata would then be settled down a stage; then, by the next process, I would have it worked also in the North country fashion, taking all away; the intermediate coal between the two might form the roof of the second working; a great portion of that, I should submit, would be procured also, and it would be large coal.

5368. You would have a portion of the coal in the intermediate stratum?

As a roof for the second working.

5369. Is not that the mode in which they work some of the thick coal in France?

I never saw the thick coal in France. There are two or three other advantages which appear by this system. In the first place, the small coal in that case would be clean and marketable, and would be removed out of the mine with a similar apparatus to what the North country collieries have; therefore the danger and difficulty of ventilation would be removed.

5370. Would it be possible to leave such an intermediate stratum of coal as to be strong enough to support the roof subsiding after the first layer of coal was taken away?

Yes; because, by the second process of working, the pillars are first left, and, in taking away those pillars, the upper stratum of coal would then be gotten more or less.

5371. You do not think that that would be a more expensive mode of working than the present?

No; I am of opinion that the mine would give a great deal more produce by those means, and that, taking all things into consideration, it would be worked just as cheaply, or more cheaply.

5372. With respect to accidents in the shafts, what is the most common form in which, according to your experience, those accidents occur?

Several accidents happen by the breaking of chains and ropes; several happen, again, by the ships going against the sides of the shaft; and several accidents happen by the disconnexion of the machinery. Throughout many of the districts, the rope-wheel is connected by cogs or teeth with the crank axle, and those are apt to get disconnected; I have known accidents happen in that way. Many accidents happen, again, from women and boys falling down whilst

whilst manœuvring the machinery upon the top of the shafts; numbers of people fall down the shafts throughout Staffordshire and those parts.

M. Dunn, Esq.

19th July 1849.

5373. Do those accidents arise principally from their own carelessness, or from any defect in the arrangements?

I think, generally, from a defect in the arrangements; for instance, the thing happens very seldom indeed in the North of England.

5374. It is the usual practice in the North of England to work with guides, is it not?

It is becoming now the general practice.

5375. Is that the case in most other parts of England, do you know?

No; they have very long had guides of chains and of iron throughout the Yorkshire districts; in fact, they had guides in Yorkshire and Lancashire before they were used in the North; but I do not think the wooden guides, such as are now the most estimable in the North, are much in practice in other districts.

5376. But are other guides, chain or iron, generally used?

In many cases they are.

5377. In the Lancashire and Yorkshire districts, are guides of that kind generally in use?

They are frequently in use, but not generally, I should say.

5378. And in Staffordshire?

In Staffordshire very seldom; scarcely at all.

5379. In South Wales?

I do not know much of South Wales.

5380. You have seen the apparatus of Mr. Fourdrinier in the North, have you not?

I have.

5381. At Mr. Elliot's pits?

Yes.

5382. Did you see enough of it to be able to judge of its efficacy?

Yes; I attended there about two months ago.

5383. At Usworth colliery?

At Usworth colliery.

5384. And you saw it in operation?

I did, and was so satisfied with it, that I myself drew up a minute, and it was signed by the gentlemen present.

5385. Do you think that it would be a valid objection to that apparatus, that it was likely to get out of order by constant working?

No; I do not think there is much to get out of order about it; there is only a single pair of springs belonging to it; it can be very easily kept in order.

5386. It has been suggested that it would be likely to get clogged, and therefore not to work when it was wanted?

I do not think there is anything in that at all.

5387. You do not think that the dirt and dust of the mine, or the moisture rusting the apparatus, would be likely to impede it?

No; it is constantly seen; the banksman sees it every time it comes up the pit.

5388. And every time it comes up and goes down to the full length of the rope, is it not brought into play necessarily?

Yes; one advantage belonging to it is, that the rope takes its draught gradually; the springs are first raised, which take up a certain proportion of the load, and then the remaining proportion is taken by the other chains; there are six chains; two work the springs, and the other four carry the load.

5389. You think, therefore, that it might be safely trusted to be effective if it were in common use?

(164.16.)

M. Dunn, Esq.
 19th July 1849.

I have not the least doubt of it. I have a very recent case here, where life has been lost which would have been saved by it. The cage was drawn over the pulley; this was at Bilston in Staffordshire; it is stated to have been accidental, through the negligence of the engineer; the carriage was drawn over the pulley; one of the men jumped out and saved himself; but the other was killed by falling down the shaft. Now Mr. Fourdrinier's apparatus is contrived in this way, that before it reaches the pulley, there is a disengaging apparatus upon the same principle as the pile-driver, and, therefore, it cannot get over the pulley; it disengages itself from the rope, and the apparatus immediately takes effect. In the case just mentioned, if that machine had been in operation, that life would have been saved.

5390. Are you aware that great objection was expressed to that part of the apparatus by the men at the pit where it was adopted?

No; I conclude quite the reverse; many of them were about the pit at the time, but they might have an objection till it was tested.

5391. Merely with respect to that part of it, not the apparatus in general, but the disengaging part, to prevent the drawing over the pulley?

No, I am not aware of that.

5392. Are you not aware that Mr. Fourdrinier has since altered his plan in that respect, and that he proposes now, that there should be a strong stopper put, in order to prevent the cage from rising to the pulley, and therefore to break the rope, and so to avoid an accident by those means?

I was not aware that that was suggested, but that, perhaps, would be equally effective.

5393. But the objection made to it was, that perhaps it would be too easily disengaged?

Perhaps that would be an improvement; it would break the rope or the chain; but then, if the apparatus was good, it would bring the cage up.

5394. With respect to lamps, have you generally been in the habit of using the common Davy lamp, or what lamp do you make use of?

Speaking from general impression, the Davy lamp, taking it all in all, is the most simple and the most convenient. Dr. Clanny's lamp, I have no doubt, possesses every principle of safety, and gives a most excellent light; and the only drawback at all to it is, that it depends upon glass.

5395. You do not think that the thickness of the glass, in that case, constitutes sufficient security?

I am afraid the glass would be subject not only to breakage, but to heats and colds.

5396. Have you seen Mr. Biram's lamp?

I have seen it, but I have not paid much attention to it; I had the idea that it was rather complex and expensive.

5397. You are, in some degree, acquainted with the system of mining on the Continent, are you not?

Yes; I examined some of the Belgian mines.

5398. The Belgian mines are in many cases rather liable to accidents from explosion?

Yes; they are ill-ventilated, from what I saw.

5399. Are they deep?

Yes; I was down some mines 180 fathoms.

5400. Whereabouts are those?

Very near to Mons, at a place called Produit; Produit mine I examined.

5401. Did you go down into several mines?

Yes, I went into these mines, and I got an order from the secretary of one of the great companies, with the privilege of going to the premises and putting any question I liked to their managers; I saw their systems, and took down all the particulars.

5402. Were those considered well-managed mines in that district?

I suppose

I suppose they would consider them so; I considered that they were very inferior. I also examined the Grand Hornu; that was a crack mine, I would call it.

M. Dunn, Esq.

19th July 1849.

5403. They were the principal mines of the district?
Yes, they were two of the principal mines.

5404. Were the workings extensive?
Yes; the one is 340 metres, and the other is 320 deep.

5405. In depth?
In depth.

5406. A metre is a little more than a yard, is it not?
A metre is three feet four. These are the minutes which I took on the occasion—
[*producing the same.*]

5407. Are those collieries furnished with two shafts?
Yes.

5408. Those are the collieries that send the principal part of the coal to Paris, are they not?

The Grand Hornu was a very extensive and valuable colliery; they told me that at one time they made 30,000 *l.* or 40,000 *l.* a year; those coals are sent to Paris by the canals.

5409. Is the upcast used for other purposes besides ventilation?

The upcast of one of those was a ventilating machine, which I have not yet described; it was a spiral, worked by a steam-engine.

5410. And did it appear to you to be effective?

By no means so effective as our ventilation; the ventilation in these mines is very defective, in my opinion; the workings are exceedingly hot.

5411. Did you see the mines at Valenciennes?

No, I did not; they are deeper still. The Minister of Public Works offered me an introduction to any of those in Belgium, but I had no especial object, therefore I contented myself with seeing those which I have mentioned; they were the deepest and most difficult, and, as I was led to understand, the most important.

5412. Had they any furnaces underground?
I think, hardly.

5413. You did not see any?

I did not see any; but I know that the mine was exceedingly hot; I had not a thermometer with me, but it was unbearably hot, and you had to creep along the roads; the whole place was in a species of crush.

5414. Did you go through them with a lamp, or with a candle?

I forget whether they had lamps or candles; we had lamps, and I think we had candles too.

5415. You did not see any indication of inflammable air?

No; I did not see any inflammable air, but the ventilation was exceedingly weak, and the air excessively hot.

5416. Do you know whether accidents are of frequent occurrence in those mines?

Yes; they have had heavy explosions.

5417. Do they use the Davy lamp?

Yes. There is also a lamp which I have brought with me from the Continent, Mueseler's lamp, very similar to Dr. Clanny's present lamp.

5418. But you do not think it preferable to the Davy?

No; for the reasons I have mentioned, I think Davy's, for general use, is the best.

5419. Mueseler's was a lamp with glass in it?

Yes.

M. Dunn, Esq.
19th July 1849.

5420. Are the two shafts in those mines placed near together generally?

Yes; they generally have a ladder-shaft attached to the coal-shaft, and this ladder-shaft every body is made to go down; there was an order of the Government to that effect; it was by special favour that I could get down by the cuffat, as they call it; I did not like to trust myself to the ladders.

5421. Do they use the upcast shafts for other purposes besides ventilation?

I dare say sometimes they may, but I cannot exactly answer that, for I did not see many of the mines.

5422. The men have to go up and down by the ladder?

Yes; there is an order of Government to that effect, I believe.

5423. Did you see or hear anything of the system of inspection there?

I was introduced to some of the Inspectors, and had a good deal of discussion with them; indeed I had a present made to me of the yearly Report, containing all the subjects which the Inspectors take under their care, which I shall be very glad to exhibit if your Lordships have not seen it; as I think I left one at the Engineers' Society, I should wish much that your Lordships should see it; it is the Government Report, containing all the mining statistics which those Inspectors take cognizance of.

5424. What is the title of it?

I forget.

5425. It is a Report by the Inspectors to the Government?

Yes; it is an official Report from the Inspectors, and issued by the Government.

5426. Did you converse at all with the owners of those collieries upon the subject of inspection?

Not upon the subject of inspection. I had a great deal of conversation with respect to all the subjects of working, and the cost of working, and a very remarkable thing is, the extraordinary number of people that they require in those mines, as compared with what we do in England for raising a certain quantity, which I attribute to the ill mode of working; there is a continual movement going on with respect to the inefficiency of the pillars, and so on.

5427. So that there is nothing to be learnt by the colliery managers of this country for the purpose of improving their ventilation in those mines which you saw there?

No; notwithstanding the Government education, they are nothing like such good colliers, in that district as the colliery viewers in Northumberland and Durham.

5428. Did the Inspectors with whom you conversed there appear to be well acquainted with the subject?

I had not much opportunity of going into the minutiae; of course, they seemed well-educated men.

5429. Did you find any Englishmen as managers there?

No, I did not see any.

5430. Are there any other points upon which you would wish to speak?

The only subject which I should wish to speak upon is the subject of inspection. I believe that the principal fear in the coal districts, I would say both amongst the workmen and the colliery owners, is, that in case of an Act of Parliament being passed, and Inspectors appointed, those Inspectors would not be real practical persons; that they might happen to be theoretical gentlemen, who would not, in the first place, perfectly comprehend the usage and the present amount of the science of colliering, and therefore might either be not effective, or might take a wrong view of matters.

5431. The success, therefore, of an inspection would depend very much upon the persons who were appointed?

I think it would altogether so.

5432. Faraday and Lyell's Report gave dissatisfaction, did it not?

It was not approved of, either by coal owners, colliery viewers, or the working people.

5433. What

5433. What class of men would you recommend as Inspectors?

I do not know any class so estimable as colliery viewers; an educated colliery viewer, I think, is the best Inspector, because he knows the working parts as well as enough of science, probably, to carry out the object of inspection. This is a paper of which I took the liberty of forwarding a copy to Sir George Grey in August 1847; it was not printed for circulation. I believe there were not above five or six copies disposed of. It first describes the causes of accidents, and the deficiencies of other districts, as compared with the North of England.

M. Dunn, Esq.

19th July 1849.

5434. You state in the 7th page of this paper, with respect to the powers with which an Inspector should be invested, that you think they should be "almost limited to the suspension of such parts of a work as are satisfactorily made out to be in a dangerous state, with certain fines for refusing such information as might be demanded by the Inspector." Do you mean by that, that you would give to the Inspector himself the power of ordering the suspension of such parts of the work?

I submit that opinion with great deference, and I think that I would not attempt it, in the first instance; in the first act of legislation I would not recommend that it should be adopted; but from the cases which I have produced before your Lordships, I leave you to judge how far, in extreme cases, it would be applicable.

5435. Would it not be necessary to give any such power as that, with very great caution, to parties who were not actually responsible for the condition of the mine?

Of course it would, and I would rather suggest that the first legislation should be without it.

5436. Will you deliver this paper in to the Committee?

The Witness delivers in the same—(*vide* Appendix H.)

5437. Have you a diagram showing the different systems of working coal in different districts?

Yes.

5438. With a paper referring to it?*

Yes.

* This Paper is embodied with the Plan.

5439. Will you deliver them in to the Committee?

The Witness delivers in the same—(*vide* Appendix I.)

Vide Appendix I. Plan, No. XXVIII.

5440. Are these different systems, in your opinion, equally applicable to the different beds of coal which are worked in various parts of the country?

It entirely belongs to the discretion of the manager; one person would work the coal by long wall, and another person would work it by pillar and stall; that is entirely at the option of the manager.

5441. Do you think that he could exercise the option in all cases; are there no natural obstacles to applying the system in one case, or in a different one?

Yes; where the roof is exceedingly bad, as it is in some cases, the pillar system could not be adopted; where the roof is so exceedingly friable and loose that it would not stand up between pillar and pillar, where timber would not keep it up, it would not be practicable to work with pillar and stall.

5442. In that case, what is the best mode of working?

The only way is by long wall in that case. There is a tramway up each of these spaces, and to guard that tramway against a certain depression, it is necessary to put a loose wall on each side, either of stone or coal, and the waste occurs where it often requires coal.

5443. Otherwise, by the long wall system, they extract the whole coal from the mine as they go on; do not they?

Yes.

5444. Should not you say that, upon the whole, that was the most effective mode of working?

(164. 16.)

M. Dunn, Esq.
19th July 1849.

I do not know ; everything depends upon the state of the roof, and other accompanying circumstances.

5445. The northern system of working does not extract all the coal, does it ?
It extracts all the coal in the second stage, but not in the first stage.

5446. Do you obtain it all ultimately ?

They obtain in many cases nine-tenths ; eight-tenths I would say, generally speaking ; but I have known nine-tenths got.

5447. Is that so by the pillar and stall system ?

Yes.

5448. Which of these systems do you think most favourable to an efficient mode of ventilation ?

The pillar and stall, because by the long wall mode of working, a goaf is made, and the whole roads lead through the goaf, as it is called ; therefore, if gas is made in that goaf, it will not be practicable to work by long wall.

5449. But the whole coal being extracted from the goaf, is it likely that inflammable air would collect there ?

Yes, inflammable air frequently collects in the goaves.

5450. In the goaves where the coal is not altogether taken away ?

Yes, and where the coal is taken away, it either fills with choke-damp, or with inflammable gas.

5451. Does not the long wall afford the simplest system of ventilation, carrying one continuous stream along the face of the workings ?

The air travels into fewer passages ; but I have known the long wall for weeks together, that you could not get access to it for choke-damp.

The Witness is directed to withdraw.

John Atkinson.

JOHN ATKINSON is called in, and examined as follows :

5452. YOU are a miner from the North of England ?

Yes, from Jarrow colliery.

5453. That is in the county of Durham, is it not ?

Yes.

5454. Have you been long employed there ?

The last eight years.

5455. Did you enter the mine at an early age ?

I think I was about nine years of age when I entered the mine, but that is 34 years ago.

5456. You began at Jarrow at that time ?

Yes.

5457. Then you have been in other mines between that time and your last coming to Jarrow ?

Yes.

5458. In any other district besides the northern district ?

No.

5459. In the course of your experience as a miner, have you seen anything of the causes of accidents from explosion ?

Yes ; I have seen a sudden discharge of gas take place.

5460. Have you ever, yourself, had experience of an explosion in a pit ?

Yes ; at Hetton colliery there were only three men got out ; there were 22 lost ; and I was one of the three.

5461. How long since is that ?

I think about 11 or 12 years ago ; 12 years, I should think.

5462. At

5462. At that time, what was the system of ventilation in the Hetton pit?
Such as it is now, I think.

John Atkinson.

19th July 1849.

5463. Three furnaces?

Yes; there are eight pits connected with each other at Hetton, and I should think there were three upcasts at that time, and five downcasts.

5464. As Mr. Nicholas Wood described it to this Committee a short time since, there appear to be three furnaces; was it so when you were there?

Yes; there was nothing more; there were just three furnaces when I was there.

5465. In the case of Jarrow, how is the ventilation carried on?

Under the same system as it is at Hetton.

5466. Then you have furnaces there too, have you not?

Yes.

5467. In the case of Hetton, was it usual to have a strong current passing through the workings?

There was not so much inflammatory gas at Hetton as I have seen at other collieries, and I think the ventilation was not kept so good near to the face of the workings there as I have seen at Jarrow.

5468. Was the Hetton what is commonly termed a fiery mine?

Not so much as injurious to the health; another sort of gas.

5469. Another sort of gas, and not the inflammable gas?

Yes.

5470. Is not that worked in what is called a fiery seam of coal?

Yes; the Wallsend seam is where the most inflammable gas is, but this gas generally is what we call bad air; it injured the men's health very much.

5471. But it did not explode like the common inflammable gas?

No.

5472. Is it what is called the choke-damp?

We used to call it bad air, and we generally call it bad air.

5473. It is not the same thing as what is called choke-damp, then?

I think not; it is rather a peculiar kind of gas.

5474. How do you know it to be a peculiar kind of gas?

In working the coal, after you get in the pit you find a peculiar smell.

5475. An offensive smell?

Yes; something like the smell of French polish.

5476. Then that was not considered a very dangerous atmosphere for explosions?

Not for explosions; but it was very offensive to health.

5477. And that was the most common gas in the Hetton Colliery?

It was.

5478. In the Jarrow there was a great deal of explosive gas, was there not?

A very great deal.

5479. How was the ventilation there?

Just in the usual manner that it has been these last 20 years, I should think.

5480. Is there, generally speaking, a powerful current of air through the workings of the Jarrow?

There is only one pit.

5481. Is there only one shaft?

Three shafts, partitioned.

5482. Each of them partitioned?

One pit and three shafts partitioned; three shafts in this one pit.

John Atkinson.
 19th July 1849.

5483. That is to say, one shaft divided into three?
 Yes.

5484. Is that the only shaft which there is to the Jarrow colliery?
 The only one, except when we get about 120 fathoms down, there is another.

5485. A lateral shaft?
 It is what we call an oval stappel.

5486. What is that; is there a passage from the side of the other shaft?
 There is a seam lies there, and after you go 20 yards from the main shaft, there is an oval stappel, the same as the other shaft, which goes down to the other seam.

5487. Does that pass into the same beds as the main shaft goes into?
 The same beds.

5488. What is the use of it; for ventilation?
 Yes.

5489. Is it used for anything but ventilation?
 No.

5490. Is there a furnace at the bottom of that oval stappel?
 There are two furnaces at the bottom of the main shaft.

5491. Not of the other?
 No; there are two furnaces.

5492. And there are three divisions of this shaft by brattices?
 Yes; but there are several small seams, which are not worked yet; one in particular below the seam that we are working; that has discharged a great deal of gas at times.

5493. Have you ever known any explosion in the Jarrow colliery?
 Yes, I was there when the last one was.

5494. When was that?
 Nearly four years ago.

5495. Were you in the pit at the time?
 I was up the pit.

5496. Upon that occasion, were the brattices in the main shaft at all injured?
 Towards the bottom they were.

5497. So as to destroy the system of ventilation?
 Yes; there were some men killed by the chok e-damp, in consequence of the ventilation being stopped.

5498. Is it generally considered that a system, such as that of Jarrow, with only one shaft divided by brattices, is a dangerous one for the mine?

It would be much better if there was another; but I would be very content with it where it is now, if we continued with lamps.

5499. Are you not allowed to work with lamps there?
 All with lamps; no candles have been allowed to go down ever since the last explosion.

5500. What do you mean, then, by continuing with lamps?
 I think we are safe with the lamps.

5501. You mean that, as long as you could work with lamps, you would be satisfied with the ventilation?
 Yes, just as we are now.

5502. Do you look upon it now as a perfectly safe mine?
 I would trust myself in it; if there were 20 pits, I would not like to go with a candle any more after the last explosion.

5503. But do you think that, even with lamps, a system of that kind is a desirable system of ventilation?

I would be more content, I think, with respect to the discharges from the little seams that are not workable, that the lamps would be safer.

5504. Now

*John Atkinson.*19th July 1849.

5504. Now there are nothing but lamps used?
Nothing but lamps.

5505. You do not believe the air to be unwholesome to breathe?
Not there; there is none of this curious kind of gas that affects the health there; I never knew it on the Tyne; that is in the northern division.

5506. There is nothing there but the common explosive gas?
I think not.

5507. And that is not so injurious to health?
Not so injurious to health as the other.

5508. Where you are, do you use the common Davy?
Yes.

5509. Have you ever used the Clanny lamp?
Yes; I think there is one in the colliery, but it is near the shaft; it shows a good light, but I am not much acquainted with it.

5510. Do you look upon the Davy lamp as very deficient in light?
I have seen it very often tried; it is very deficient in light, but when we get accustomed to it, we think nothing of it now; I have seen it very much tested with gas; I have seen it hundreds of times, I should think, full of fire.

5511. Do you feel perfect confidence with the Davy lamp?
I have every reason for it; there has nothing happened with the Davy lamp where I have been.

5512. Have you ever had it in positions where there was a strong current of air passing through it?
Yes; I have had it in all positions, I think.

5513. And do you look upon it as a perfectly safe instrument?
Yes, I do; but I do not think that every man thinks that; I have been mostly accustomed to it; I have not the least fear to go where I like when I have the Davy lamp with me.

5514. Have you had it red-hot?
The part which takes red-hot is the top of the lower gauze; I have seen that red-hot, I should say, scores of times; but I do not think there is any other part which will take red-hot.

5515. When that happens, does it become dangerous?
Yes; it has an awful appearance, but still there has never nothing happened where I have been with this lamp.

5516. Is that the only lamp that you have ever tried?
The only one.

5517. In your experience, has it not been commonly the case that workmen have opened their lamps in order to get at the flame for one reason or another, either to get more light or to light their pipes, or for other objects of that sort?

That is not allowed where we are, not in Jarrow.

5518. Is it effectually prevented?
There is no man allowed to take a pipe down a pit; if he is caught with a pipe any where about him, he is fined; we have a rule to that effect.

5519. Have you ever known men punished for offences of that kind?
Yes, I have known men punished for that at Hetton colliery.

• 5520. And at Jarrow?
I have never known a case of that kind at Jarrow, I think, not lately, but 24 or 25 years ago it used to be so.

5521. Are the lamps all locked?
Yes.

5522. Are there any regulations issued by the owners of the Jarrow colliery for the observance of the men?

John Atkinson.
 19th July 1849.

Yes; there is a man at the bottom of the shaft who oils the lamp and puts it all right, and trims it for the hewer; that is locked, and it comes to one of us; I am a deputy; it comes through our hands.

5523. Are there any printed regulations?

No; there are no printed regulations; it comes through our hands before it goes to the workings.

5524. Did you ever know the case of a man having a private key of his own in order to enable him to open the lamp?

I think not there.

5525. Have you known such cases elsewhere?

I think I once knew one man that had opened his lamp with a nail; he had a guinea stopped off him for it.

5526. Are the colliery owners more strict upon those subjects now than they used to be, do you think?

Yes, I think so.

5527. And are the regulations better observed generally by the men?

Yes; since this last explosion there have been more pains taken in Jarrow with the lamps, and things have been better looked after.

5528. In your experience, should you say that, generally speaking, the management of mines in the North has improved as regards the precautions against accidents?

Yes; at our colliery it has.

5529. It has improved?

Yes.

5530. In what respect do you think the improvement is most perceptible?

The air-courses of our colliery have been improved very much since that.

5531. When the ventilation is at its highest point, and the current of air very strong, is there any practical inconvenience in working in that current?

Not where I am; not in the part of the mine that I am in. I have not been in the other part lately, but I have never heard any complaints. In the part where I am in, we are exploring, and if the brattice be attended to and the ventilation of the works be attended to next the workings, I have not the least doubt that we can get on very well where we are, but not if there is any neglect; I believe there has been neglect in some collieries.

5532. Have you ever been where the ventilation was so very strong, and the current of air so violent, as to make it inconvenient to work in it?

I have seen it in Jarrow colliery rather inconvenient with a candle, that is, it causes it to burn and waste away; we have had a deal or something for a shelter to keep off the air.

5533. But if you worked with a lamp, you felt no inconvenience from that?

Never; the gauze is a kind of shelter for it.

5534. Do you think that there is need of further precautions to be taken, in order to guard the people working in mines from accidents of this kind?

I would like to see Inspectors employed.

5535. Authorized, by Government?

By Government, to inspect the collieries.

5536. What do you think should be the duties of Inspectors, supposing that Government appointed them?

I think it would be their duty to go and inspect the colliery, not to give any notice whatever; as the supervisor visits the exciseman, not to give any notice whatever when he is coming; that would cause each colliery to be very particular in keeping the partition at the face of the workings. We put the board four yards wide where the man is hewing; we put the partition there and take the air. In some parts there has been a fault in that, and I have heard the men state, that there has been no partition at all, as far as 30 yards.

5537. Has

5537. Has that been frequently the case within your knowledge?
I never knew it to be the case in Jarrow colliery, but in Hebburn colliery the men told me so both before the last misfortune and since.

John Atkinson.

19th July 1849.

5538. Was that known to the viewer of the colliery?
Some seem to say that he is down every day.

5539. Must he have been acquainted with the state of the brattices in that case?

Most likely he would be acquainted with it.

5540. Have you known a brattice left in that state without any steps being taken to put it right for any length of time?

I have known no further than common report.

5541. Not of your own knowledge?

Not of my own knowledge; the men often told us this.

5542. Supposing that an Inspector, authorized by Government, were to examine a mine, and to find that there was a defect of this kind, what is your view as to the duty that he should be called upon to discharge with respect to it?

I think it would be better if there was a severe fine; he would have rules to go by, that is, if he found any defaulter with respect to the air-way, next the face especially; if there were Sub-inspectors going in to examine this place, that is, practical working men; as for men that had never been in a pit before, I could deceive them; I would not care who it was, I could deceive them every day if I were in the same situation that I am now, as deputy, putting in this partition and such like; I could hang it one day and take it away the next.

5543. The Inspector could only come occasionally?

It would not answer to keep him constantly attending upon one colliery; but if he was coming unawares to any colliery, and there was a man guilty of this neglect, it would be the means of catching him, and the Inspector would know if there had been negligence taking place.

5544. Would you give the Inspector or the Sub-inspector the power himself of inflicting a fine in such case?

Yes, I think so; it could not be done otherwise with any satisfaction.

5545. Do you think it would be right to authorize a person unconnected with the colliery, such as you describe, to come into it, and, upon a mere conclusion of his own, to determine that the viewer and the managers of the colliery were wrong, and to inflict a fine upon them, without any trial or any examination?

There ought to be an examination in some cases.

5546. The viewers of collieries, generally, are persons very well acquainted with their business, are they not?

Yes.

5547. Then, supposing that an Inspector of this kind were to visit the colliery, and to express an opinion at variance with that of the viewer, do you think it would be fair to assume that the Inspector must always be right?

It would be right to have a trial, and to let the working men come in; to bring them forward; the men that were working in this place; either party could bring them forward as a witness, either the viewer or the Inspector.

5548. Supposing that to be the duty of the Inspector, how many Inspectors do you think it would be necessary to have for executing it throughout England; have you ever thought upon that subject?

Throughout England I cannot tell.

5549. How long would it take the Inspector to make himself thoroughly acquainted with the arrangements of such a colliery as Hetton or Jarrow?

Hetton is a very large colliery; I should think the largest colliery almost in England; it would take two or three Inspectors a long time going through that colliery.

5550. And whenever they visited it in order to see that there were no such things as that which you have spoken of, they would have to go very completely over it, would they not?

Yes.

(164. 16.)

3 U

5551. Then

John Atkinson.

19th July 1849.

5551. Then it would be almost the business of one Inspector to examine Hetton alone, would it not?

It would almost take one in such a colliery as that.

5552. Then, if you imposed duties of that kind upon Government Inspectors, when you consider the number of districts in England, the North, the West and the Midland districts, and Wales, do not you think it would be almost impossible to appoint Inspectors enough to discharge their duties properly?

The number of pits in each county could be ascertained, and that would be the best way of coming at it. There are pits, I believe, in the county of Durham, in the southern part, where there is no inflammable gas at all.

5553. Where there is no inflammable gas, are there not other causes of danger?

I was once working at a colliery, Cockfield Fell, I think, in the county of Durham; it was very shallow; it was not above 10 fathoms deep; there was no system of ventilation there whatever.

5554. No furnace?

There was no furnace.

5555. Nothing at all?

No; we used powder; and after this powder was begun to be set off, after the men fired what we call the shots, we could hardly see our candle.

5556. The smoke remained?

The smoke of the powder used to stand. There was no system whatever of ventilation there.

5557. There was no inflammable air?

There was no inflammable air.

5558. Was there much of the choke-damp there?

I was only a very short time there, five days, I believe; that was the very reason that sent me away, but it is a great while since now.

5559. The calling together of such a number of people as you propose, and the holding of a trial upon a case of this kind, would be a proceeding that would require some time; would it not?

Yes, I should think it would.

5560. And supposing that an Inspector had a great number of mines to look over, would it not be very difficult for him to hold many such inquiries as that?

It would be very difficult in some cases.

5561. Do you think, in questions arising with respect to the ventilation of mines, that the principles of ventilation are so completely understood and known in all cases, that no reasonable difference could arise between two people well acquainted with the subject?

I do not exactly understand the question.

5562. Are the principles of the ventilation of mines so well understood that two people, well acquainted with the subject, might not reasonably differ in many cases?

I think they cannot far reasonably differ, two acquainted with the ventilation.

5563. You think all such questions are so plain that two people could not differ upon them?

No; I mean a man that is bred and brought up to it, or two men of that kind. I have known men differ that have come from Lancashire, and such parts as that, to the county of Durham; they have been quite upon another system there.

5564. Are you prepared to say that those persons in the county of Durham, or Northumberland, who are best acquainted with the subject, do not differ upon certain points respecting the management of a mine?

I think the Inspectors should belong to the county that they have to inspect in.

5565. Looking

5565. Looking no further than those counties, should you be prepared to say that two viewers belonging to that district might not differ upon certain questions respecting the management of a mine?

Yes, in some cases they might.

5566. In that case, would it not be rather doubtful whether a power should be given to a Government Inspector to determine upon his own opinion in opposition to that of the viewer?

Such as that might be settled by arbitration.

5567. An arbitration would incur some expense, would it not?

Yes; I should think it would.

5568. Would you, in all cases of doubt of that kind, throw the entire expense of the arbitration upon the owner?

I do not think it would be altogether fair for the owner to pay all the expense; each party might pay a part.

5569. Whom do you call each party; do you call the Government Inspector himself one?

Yes.

5570. That is to say, the Government?

Those that are to blame ought to pay.

5571. But who was to blame could only be ascertained after the trial, could it?

Certainly.

5572. Have you ever had any reason to know how the owners of collieries would be disposed to receive a Government Inspector; how they would like him to come?

I cannot tell how they would receive them; I should think they would like better to be without them.

5573. Supposing that the Government inspection were of such a character as to make the colliery owners very hostile to it, do not you think that there would be a great difficulty in the Inspector discharging his duty properly?

Yes.

5574. Would not the colliery owner have great opportunities of preventing the Inspector from gaining a real knowledge of the state of the mine if he chose?

If there were a set of pitmen Inspectors, that had been there about the work all their lives, they could not stop them very well.

5575. Suppose the Inspector had a right to enter the mine, would it not be necessary for him to have some assistance besides the merely being let down into the mine in order to enable him to ascertain its condition properly?

Yes; they will always have to be beholden to one of the agents in the colliery.

5576. Supposing that the colliery owner and his agents were all very much opposed to the visit of the Inspector, how would the Inspector be able to come at a real knowledge of the state of the mine?

There would be a difficulty there, without there were rules drawn up.

5577. Then, if there was a difficulty there, do not you think it very essential, if possible, that the inspection, at any rate at first, should be of such a description as not to make the colliery owners and their agents very much opposed to it, to get them to assist it rather than to oppose it?

● In some collieries I do not think it would suit very well.

5578. What would not suit?

They might as well stay away, and let the collieries be as they are.

5579. As what?

To let the masters have anything to do with the inspection.

5580. Without letting them have anything to do with the inspection, supposing Government were to appoint Inspectors, with no power absolutely to
(164. 16.)

John Atkinson.
 19th July 1849.

control the colliery owners, but still with a right to come and examine, would they not be more likely to assist in an inspection of that kind than if they were subjected to the control of the Inspectors?

Yes; it would be very well for them to come and be friendly with each other, to have no disagreeables.

5581. Would not you say it would be better that they should be friendly with each other, if possible, than that the Inspector should come in such a manner as to excite the opposition of the colliery owner?

Certainly it would be much better.

5582. Supposing that a Government Inspector were to be appointed, with the power of visiting a mine, and going all over its workings, for the purpose of making himself acquainted with its arrangements, and with the power also of asking to see the plans of the mine; and also with directions to give his advice, to make his suggestions, and to object to any parts that he thought very defective, but without the right to give any positive directions; what should you say to that?

I think the coal-owner that has his colliery right, or the agents that have the colliery right, would not object to that; he would be very willing to offer the plan to any Inspector if he has his mine right; he would have more satisfaction in doing it.

5583. Do not you think that an Inspector, with those powers, might do a great deal of good?

Yes.

5584. Without having the power to give any positive directions, or to inflict any penalties himself with respect to the management of the mine?

He might do to advise the owner; as for compelling him, I do not know how that would answer; at least, the owner's system should be exposed if it was not good.

5585. It would be exposed by any report of the Inspector, would it not; supposing the Inspector were required to report upon the condition of the mine?

Yes; that would be the best way, I think.

5586. Supposing the Inspector visited a mine in the manner I have described, and made his remarks upon any defects in the arrangements that exposed the people to danger, and the owner neglected to follow his advice, or to make any alteration, and after that an accident occurred, would not the responsibility be increased as regarded the owner of the mine?

So I think it ought to be.

5587. The very circumstance of his having had this matter pointed out to him by the Inspector would increase his responsibility, would it not?

Yes; but where the defect is, is bad to find out after an explosion.

5588. But, supposing that beforehand the Inspector had discovered a defect, and had told the owner that the colliery was in a dangerous state, would not that lead to a very natural inference, that the explosion arose from that cause?

Yes, certainly it would.

5589. And would not it also throw an additional responsibility upon the owner?

Yes, I should think so.

5590. Do not you think that that would operate as a considerable check upon owners in the management of their mines?

Yes, it would, I think.

5591. Do you think that it would be a great improvement upon the present total absence of inspection?

Yes; certainly it would.

5592. From your knowledge of the district, derived either from your own experience or from your communication with other people, should you say that there are many collieries in the Northern district that are very defective in their arrangements for ventilation?

I cannot

I cannot say; I have not had much to do with any colliery; I have had nothing to do with any colliery that is in the district of Newcastle these last eight years, except just the colliery I am at—Jarrow. I cannot say that I took so much notice of the ventilation before the last accident.

John Atkinson.
19th July 1849.

5593. Are there any points besides ventilation upon which you would wish to make any remarks to the Committee?

There are other points besides the ventilation; with respect to men going down.

5594. What have you to say to that?

We are very well situated ourselves in that way; we have very strong ropes, and such like; but in some collieries I have heard it complained of.

5595. Are they apt to work the ropes too long?

In some collieries they are; but I never knew a rope to break at Jarrow; that is, with men upon it.

5596. You never knew an accident of that kind?

Not of that kind; the wire rope broke two or three times, when it was first put on there, but it was drawing coals in the pit, where the men did not ride.

5597. At Hetton did you ever know of such an accident?

No; I cannot say at Hetton either; but I have heard tell of it at other collieries. The Inspector should interfere, I think, as to the number of men riding at one time.

5598. His interference upon that subject could only be quite occasional, could it?

According to the depth of the pit.

5599. Supposing him to be absent, how would he have any control over the number of men going up or down the pit?

There is a difficulty there; there might be a man appointed by the master to see every man out, and to be at the shaft when the first of the men arrive, after the pit is done, and to see that no man rides there improperly.

5600. The Inspector might impress upon the master the necessity of having some person to look after that?

Yes.

5601. Supposing he did so, and the master neglected his directions, or that the person appointed to that duty did not properly execute it, would the Inspector be able to do anything more?

In such cases I think it would take good effect if they were reported to the public, and advertised, or anything like that.

5602. But the Inspector could only visit the colliery occasionally, could he?

Yes; at such a place as Hetton, it would take one constantly; always upon the spot.

5603. Should you say that those accidents from the breaking of ropes are frequent in the North?

No; I do not think they are; I have heard of other collieries where they ride very heavy.

5604. In both Hetton and Jarrow they work with guides, do not they; the cages go up and down with guides?

Yes.

5605. Should you think well of any contrivance that had the effect of stopping the cage, in case of the breakage of the rope, on those guides?

I think it is a great improvement, the cage.

5606. Have you seen or heard anything of the contrivance which has been lately applied at Usworth colliery by Mr. Elliot, the invention of Mr. Fourdrinier?

No.

5607. In case of the occurrence of any accident, is it easy to obtain medical assistance?

There is generally a doctor kept for every colliery.

John Atkinson.
 19th July 1849.

5608. Is there any hospital within an easy distance?

No, not except the Newcastle Infirmary. I have known cases that have gone beyond the colliery doctor that have had to go to the infirmary.

5609. Have not many of the collieries with which you are acquainted formed a club amongst themselves, for the purpose of providing medical assistance in case of accidents?

Not for medical assistance.

5610. Surgical assistance?

No; the colliery generally finds a surgeon with us.

5611. For all cases of illness, or merely cases of accident?

Accident, not illness. Then we have sick clubs amongst ourselves, to help us to subsist in time of inability of working.

5612. With reference to these accidents from the breaking of the ropes, have you any suggestion which you would wish to make besides that of the propriety of the colliery owner appointing some person to look to the manner in which the men go up and down?

No, I have no other suggestion concerning that.

5613. Are there any other accidents of any description upon which you would wish to make any observations?

I think not.

5614. What is the state, so far as you know, of the education of the mining people in the North?

Where I am, at Jarrow, there is a school that any man may set his children to; I believe it is only 2*d.* a week for each child.

5615. Is it kept by the owner?

I think it is kept by the parish; it is called the National School; I do not think there are many scholars go there; I do not think the parents are exactly satisfied with the educating of them.

5616. Do you think that, generally speaking, the workpeople are anxious for more education in the North?

In some parts of the neighbourhood where we are. My children go to school, and I know of none that neglect it where I live.

5617. Do you think that if they were better educated, generally, they would be more careful in the mines, and that there would be less danger of accidents?

Yes; it would have a good effect. There are some men that are working who are hardly fit to be trusted by themselves; a few that I could mention very ignorant men amongst us.

5618. Should you be anxious, for the sake of the safety of the mines, that the people should be better educated?

Yes; I would like to see every youth get education.

5619. You have heard, I dare say, of what are called Mechanics' Institutes in the large towns among the manufacturing population?

I have heard tell of such.

5620. You have nothing of that kind in the neighbourhood of the colliery?

No.

5621. Where lectures are given on gases, and so forth?

We have nothing of that kind about the colliery.

5622. In those collieries in which you have been employed, are most of the working colliers able to read, do you suppose?

A part of them can read.

5623. Not the greatest part?

No, I think not.

5624. According to the best opinion you can form, what proportion of working colliers should you say are able to read?

I should say not much above one-third of the hewers will be able to read, and few of them will be able to write or cipher.

5625. Have

5625. Have any of them expressed to you a wish to be better informed, to have more education?

Yes.

5626. They have so?

They never had the privilege when they were young.

5627. Have you ever been an overman or deputy?

I am a deputy now.

5628. Have you been deputy long?

These last three years and a half, I should think.

5629. Should you say that the class of persons to whom you belong, namely, deputies, are, generally speaking, persons of any education?

Yes; a man cannot be a deputy unless he has some education.

5630. What education must he have in order to be a deputy?

So as to be able to take down men's names, and such like.

5631. He must be able to write?

Yes.

5632. And he must be able to do accounts?

Yes.

5633. Do you find that many of the men who learned to read or write as children, from want of practice, lose the knowledge which they have acquired?

Yes; I have lost part of mine for want of practice; I have never gone to school since I was ten years of age.

5634. Do they generally go into the pits as early as they can?

I think there is a law that they cannot go in before they are ten years.

5635. But do they generally go in as soon as they are allowed?

I think they go in at ten.

5636. Do you think that too early; do you think it better for them to remain at school a little longer, so as to get better grounded in their education?

I think it answers very well as it is. I have one boy who goes to school every night after he comes out of the pit.

5637. He is not too tired after coming from the pit?

No; he is better situated than most.

5638. Are there any Sunday schools in your part of the world?

Yes.

5639. Do any of the colliers' children go to school on a Sunday?

Yes, some; some neglect it.

5640. Do any of the grown-up people go to learn on a Sunday; are there any Sunday schools for grown-up people?

No, unless they be teachers; some go to teach; they teach to read; and the while they are teaching they learn a little themselves, perhaps.

5641. Should you say that the Act of Parliament passed a few years ago, for the purpose of regulating the age of the children entering the mine, for keeping women out of the mine, and so forth, has been of advantage to the mining population?

Yes, it certainly has; I have seen them begin at five or six years of age, with a string tied to them for fear of losing them.

5642. You do not approve of women going down pits?

There are no women where we are.

5643. Have you ever heard any thing of the Government inspection for that purpose; did you ever see the Inspector?

No.

5644. Is it the practice in the mines in the North to entrust the door-ways to children in the mines?

Yes; but there are men passing and repassing who have charge to look after those

John Atkinson.
 19th July 1849.

those doors; if anything happens the deputy is sent for, and such like; if he is not there, he is sent for, or searched for.

5645. Do you think that there is proper precaution taken as to the doors? Particularly there, since the last misfortune.

5646. You are speaking of Jarrow?
 Yes.

5647. Generally speaking, have you any means of saying whether that part of the arrangement is properly looked after?
 It is properly looked after there.

5648. You cannot speak of any other place?
 No.

5649. Is there anything more which you wish to say yourself?
 No, I think not.

The Witness is directed to withdraw.

Martin Jude.

MARTIN JUDE is called in, and examined as follows:

5650. ARE you a miner in the North of England?

I am not working at present, and have not been for six or seven years; I have been in a little business; I have retired from it.

5651. You went into the mine as a boy, did you not?
 I did, at eight years of age.

5652. How long did you work in the mines?
 I have worked in the mines about 34 years.

5653. In what mines have you worked?
 I commenced at Wallsend.

5654. In Northumberland?
 Yes.

5655. Did you stay all your time at Wallsend, or did you work in other collieries?
 Probably about eight or nine years.

5656. After that, where did you go?
 I went to Heworth colliery.

5657. And after that?
 I went to Washington.

5658. Where is that?
 In Durham, not far from Heworth.

5659. Did you stay there till the end?
 The next I was at was Walker colliery, in Northumberland.

5660. Did you go to another?
 I have been in one more, St. Lawrence, since that.

5661. So that you have had experience of a good number of collieries?
 Yes.

5662. Since you left the mining employment, have you been down any pits at all?
 No, I have not.

5663. You cannot speak, then, to their actual condition at the present day?
 I cannot, excepting what I have been informed by other parties. I have been in connexion with miners a long time. Since I left the mines they chose me to be the leading man amongst them, as treasurer, and I was obliged to leave on that account, and I have been in connexion with them in that capacity for a long time, and they wished me to come to represent them, and to state their convictions to the Committee; I would rather that one of themselves had come.

5664. From

Martin Jude.
 19th July 1849.

5664. From what you have ascertained upon the subject by communication with others, should you say that the condition of the mines at the present day is better than that to which you were accustomed formerly, as regards the danger of accidents?

I think not.

5665. You think they are not improved?

Not at all.

5666. Is not there more attention paid to ventilation now than there used to be?

There is more attention paid, I think, to get larger currents of air down; but they still work to the verge of danger. I went only a fortnight ago to various collieries to ascertain from the parties the state of the ventilation at the following collieries: at Hetton colliery, at Washington colliery, at Usworth colliery, and at Seaton Delaval colliery, and Walker colliery, and Wallsend, and they informed me there that they were working in a very bad atmosphere in the face of the workings, notwithstanding that great quantities of air got down the shafts.

5667. What does that arise from?

From the want of conducting the air.

5668. Should you say, from your experience, that it is a very common fault that the air is not properly conducted?

It is, indeed.

5669. What do you think is the principal defect?

I think, in the first place, it is from the want of proper and sufficient parties to do the work. Economy is the order of the day with them: there are too few parties as deputies, and as wastemen, and as overmen.

5670. Supposing that there were wastemen and overmen enough, in what respects do you think it requisite to alter the system observed in collieries generally?

To send the currents of air to the face of the workings by brattices, by stoppings being properly put up, and doors.

5671. In your opinion, the currents are not taken far enough into the workings?

They are not.

5672. They are brought back short of the parts where they should be taken?

They are taken faintly in, instead of strongly in.

5673. Is it not very much the practice now to, what they call, split the air; to subdivide the air?

It is.

5674. Do not you consider that that is a desirable plan?

I think it is desirable if not carried too far; and I think it has been carried too far...

5675. What do you think is the cause of the weakness of the current; supposing that the air was taken to the face of the workings completely, would the current, do you think, be strong enough for the purpose of ventilation, in the cases where you have said that it is deficient?

No; in some cases they require a stronger current, a larger current.

5676. Is there any other mode, do you think, of guarding against accidents of that kind but by passing a strong current through the mine?

I think it is the safest, and the most to be relied on.

5677. Are there any points in the methods of working which you think ought to be altered, for the purpose of making them safer?

I should prefer having it as it was formerly, to have the pillars worked on the far side of the royalty, instead of being worked as they are, at almost the commencement.

5678. To go to the further point to begin?

Yes.

Martin Jude.
 19th July 1849.

5679. At present the coal is worked partly forward, and then backward, is it not?

In back workings, following up the whole coal; the pillars are taken away, and reservoirs of gas are formed in every part of the mine.

5680. Are not the most dangerous parts of the mine always the further parts, where there are the wastes; what they call the goaves?

Yes.

5681. Would not those equally exist in the manner of which you speak?

They would indeed.

5682. Therefore the danger arising from those would be the same, would it not?

Not exactly so; the current of air could sweep them off cleaner than having to pass through so many places where the air is split.

5683. You think that if the other air-passages were more simple, they would be able to carry the current round there better?

Yes.

5684. Have you been in mines when they were in a dangerous state?

I have. I have been into the Wallsend colliery, where I have worked with the carbonic acid gas, that has made me fall down, and I have had to be dragged out by the agent.

5685. After an explosion?

No; just working in it as it was present in the workings.

5686. Have you ever been in a pit when an explosion actually took place?

Yes; at Wallsend colliery, previously to the invention of the Davy lamp, we were frequently leaving work from slight explosions; they were working in the pillar-workings; we had steel mills and candles.

5687. Is that reckoned a fiery mine?

It was; it is worked out now; that was the Wallsend High Main.

5688. That was the original Wallsend?

Yes.

5689. Was that a fiery seam?

It was not a very fiery seam, excepting from the pent-up gases, with the creep or thrust.

5690. Was the system of ventilation in use in the Wallsend colliery at that time as good as is generally adopted now, do you think?

There was much more attention paid to it; there were eight or ten wastemen, and they were at certain distances; they watched the candle, and could tell when it was near the point of danger by practice; they were there night and day watching it, and though the flame has been going up the furnace frequently when I have been there working, yet it was always kept below the point of danger by those men watching.

5691. Yet you say there were frequent accidents?

Frequent, but always slight; never any great explosion to carry away lots of people at once.

5692. Do you attribute that entirely to watching?

I do.

5693. What were the means of ventilation at that time?

Simply coursing the air, and so on.

5694. Was there any furnace?

Yes, taking the whole of the column through the whole of the workings, not splitting it at all at that time.

5695. Were there two shafts?

Only one shaft then.

5696. Only one shaft, with a brattice?

With a brattice, a partition.

5697. Do

5697. Do you think that by splitting the air, and subdividing the mine, it is possible to confine the effects of an explosion within small parts of the mine?

I believe it was intended, but it has not been found to answer in practice. There have been greater quantities of people carried off at once since the splitting of the air and district working was brought into practice than before, when the air was coursed.

Martin Jude.

19th July 1849.

5698. To what should you attribute that?

To the presence of a greater quantity of gas in these goaves, and when once an explosion takes place, it generally connects itself with all those goaves, the same as was sworn to in the evidence at the Haswell inquest, where it was said that one goaf was in connexion with another, and the fire had gone from one to another, and increased the explosion.

5699. But why should the splitting of the air and the subdividing of the mine increase that danger?

Each portion of the mine has its quantity measured out to it, and can have no more, whatever may arise.

5700. Supposing it to be proved that by splitting the air you can obtain a larger amount of ventilation upon the whole than you can by taking the air in one current round a great distance, would not the ventilation thereby be improved?

Yes.

5701. You are not aware whether that has been ascertained by experiment?

It has been done so up to a certain distance, but they increase the distance now further than they did when they did not split the air; they work at greater distances, and under increased danger.

5702. Are not you aware of the fact that, with a given amount of current down a downcast shaft, you can pass a larger quantity of air through a mine by splitting it, than you can by keeping it in one current through a great number of passages?

I cannot say that, indeed.

5703. You do not think so?

No.

5704. You should be surprised if it were ascertained by experiment to be so?

My opinion is that the upcast shaft being of a certain diameter, and the downcast also of that diameter, there cannot be an increased air further than filling the shaft, both the upcast and downcast.

5705. Are not you aware that the friction in passing a large body of air through passages without splitting it is very great?

Yes, there is that drawback upon it.

5706. Then supposing you have a large current to pass through a great number of passages, such as at Hetton, should not you suppose that that must cause a great obstruction of the current?

Yes, there is no doubt of it.

5707. And a greater obstruction in proportion to the amount of air passing?

Yes.

5708. Should you consider the want of sufficient superintendence to be the principal cause of the dangerous state of mines?

There wants first, I think, larger main air-ways, double air-ways instead of single; in many collieries they are only single; I do not know any where they are double; I think they should be double air-ways, and the column of air increased so as to give a certain amount to each man as they do now; but it is so faint that they get it in a stagnant state, and I think it should be so increased as to give every man a good proportion of cool air.

5709. Do you think that in very extensive collieries without more than one shaft it would be possible to accomplish that?

Not with one shaft only.

5710. Take the case of the Jarrow colliery, of which we heard from the last Witness, which is a very extensive colliery, and has only one shaft, divided by
(164. 16.)

3 x 2

brattices

Martin Jude.

19th July 1849.

brattices into three, do you think that it would be possible in such a case to establish such a system of ventilation as would effect what you say ought to be accomplished?

I think it could not.

5711. Then how would you proceed to improve ventilation in a case like that supposing that you had the power to do so?

I would make it imperative that a certain quantity of air should be afforded to each man.

5712. How would you ascertain that?

By the thermometer; by the heat and the presence of a brattice; each man can tell when it is warm, and he is working in a state injurious to health.

5713. But each man could not tell the amount of air passing, could he?

No; I could tell myself; I have ascertained each day whether there has been an increase or decrease of air given; sometimes from a door being hung, there would be nice cool air; but previously to that it would be warm and unpleasant, and you could not work so well.

5714. Supposing it were made imperative to have a certain quantity, it would be necessary, would it not, to ascertain that quantity?

Yes.

5715. How would you do that in the case of a large number of men working in a colliery?

I think it is capable of being done; that the area of each part and passage could be ascertained from the height of the seam, and the quantity of men that was likely to be employed as a general staff: some collieries have 300; some 400; some 200; and some 100.

5716. Then you would take it in the whole?

Yes.

5717. By a calculation of the quantity of air brought down, and the number of men in the pit, you would ascertain the quantity allotted to each?

Yes.

5718. That would not give you the quantity which each man had, but only the average quantity supplied to the whole number?

There would be an approximation.

5719. One man might have a great deal more than another, practically, and another a great deal less, might not he?

Quite so.

5720. Then you could not secure the same quantity for each man?

You could, as nearly as possible.

5721. Supposing that a smaller number of men was in the pit at any particular time from any particular cause, and therefore a smaller amount of ventilation was sufficient, and that number of men was increased, would you increase the ventilation in proportion?

Yes.

5722. But supposing that a system was established by which a full amount of ventilation was secured for all times in the mine, would not that be a better method of doing it than varying the ventilation according to the number of men?

Quite so; I am only for having it varied by increasing the quantity as they increase the area of the workings.

5723. Do you know whether it has ever been the practice for the men to observe the different states of the atmosphere as regards the condition of the mine?

I have done so myself.

5724. Have you become convinced that the pressure of the atmosphere, or its lightness, has an effect upon the causes of danger?

Yes, a great deal.

5725. There

5725. There is a greater escape of gas, is there?
There is indeed.

Martin Jude.
19th July 1849,

5726. Have you ever known a barometer used for testing the condition of a mine?

Never, when I was down the pit.

5727. Is there any particular season of the year at which accidents occur more than at others?

Frequently in September and August and July.

5728. You think they are more frequent at that time than at others?

Yes.

5729. Have you observed whether they occur at any particular state of the wind?

Generally from the south-west wind.

5730. Should you say the same of the early part of the summer, and the end of the spring?

Yes; when I was working at Backworth colliery it affected the blowers much more in the spring; we had more west wind prevailing.

5731. Should you say that accidents were more frequent about that time; about April or May?

Yes; and in the summer season, especially in the south-west winds, blowers give out very much.

5732. Have you ever had any experience of any mode of ventilation besides the furnace?

No. I have been to Seaton Delaval where Mr. Gurney's apparatus has been introduced.

5733. You have not seen it, have you?

I have not. Two of the working men who were selected to be sent up have been down, with the permission of Mr. Forster, to see it; their names were sent up with a number of others for the Committee to send for.

5734. Do you know what their report was upon it?

They seemed to approve of it very much.

5735. Did they go down into the workings?

They are working there regularly, and though they state to me that there is an increased quantity of air in the main passages, the people derive no benefit in the workings; they are working with the lamp still, and that only proves what I say, that it wants direction, so as to ensure its being carried through the workings.

5736. Do you mean that there is no greater current of air through the workings than there was?

There is no greater current than there was previously to it.

5737. Because it is not properly distributed?

Just that.

5738. Do you look upon it that that is the fault of the viewer of the mine, or is it the neglect of the persons who have to watch over the working of the mine?

Sometimes both; the viewer sometimes prescribes the quantity of brattice to be sent down, and when the deputies have not sufficient quantum, they cannot put it up; sometimes it is the fault of the deputies.

5739. Are the brattices very insufficient, generally?

Generally very much neglected in putting up; loosely and slovenly put up; some of them fall down before the board gets up to the pillars.

5740. Do you think there might be an improvement in that respect?

I think more attention would be paid to that if there were more men employed in that way; as it is, a man just tacks them up in any way to get through, and they are frequently imperfectly put up.

Martin Jude.
 19th July 1849.

5741. We understand that the workpeople are very anxious that there should be some inspection established by Government?

Yes; they are indeed.

5742. Do you look upon it, yourself, that that would be a great additional security to them?

I think it would.

5743. Did you ever consider at all in what manner an inspection of that kind ought to be established?

By a general supervision of the mines, and having parties to visit at intervals, and at short intervals too, I think.

5744. Do you consider that it would be a matter of considerable difficulty for an Inspector to make himself thoroughly acquainted with the workings of a large mine?

If he had had no practical experience of it before, it would be a matter of difficulty.

5745. Supposing that you yourself, having had practical experience, had to make yourself acquainted with all the workings of the Hetton mine with which you are not acquainted, would it not be a matter of considerable difficulty?

No; I think not of great difficulty to go through a large portion of the works; being well acquainted with the air-ways, and where to look for danger, I could soon go to find it.

5746. Without having known the mine before?

Yes.

5747. There are great distances to go, are not there?

Great distances.

5748. It would take a long time, would it not, to go over a mine like that?

Yes, it would take a man a week.

5749. Then if the Inspector had many such cases as that to inspect, he would find his time fully occupied, would not he; how many could he inspect in a year?

I think that the chief difficulty would be in the first beginning; that as the thing was established, the mines would be kept in a more perfect state of ventilation, and hence less visiting would be required, and fewer Inspectors needed.

5750. A good deal would depend, would it not, upon the facilities afforded to the Inspector by the persons connected with the mine?

Indeed it would depend upon that.

5751. Therefore it would be very desirable to make the inspection such as should be received in a friendly spirit by the managers of the mines?

Yes.

5752. What powers do you think ought to be given to the Inspectors, bearing that point in view?

I think they should have the power, when they see a dangerous place, to call in question the utility of working that place.

5753. How should they do that?

By apprising the master of it.

5754. And by requiring him to make an alteration?

Yes.

5755. Do you think that in so doing the Inspector ought to have the power of ordering the master to do so upon his own authority, or should he merely point out to him the danger, and make him responsible for altering it?

I think he should just point out the danger, and require it to be done.

5756. And leave upon the master the responsibility of not doing it?

Entirely.

5757. You would give the Inspectors a right to examine the mines?

Yes.

5758. And

Martin Jude.

19th July 1849.

5758. And to see the plans ?

Yes.

5759. Do you think that that would be necessary ?

I think it would, indeed.

5760. Should you think that, supposing Inspectors were appointed with those powers, well-qualified persons, and to make suggestions with respect to the danger of mines, those suggestions would be generally attended to by the owners of mines ?

I think they would generally be.

5761. Do not you think that it would be very desirable, in whatever was done with respect to Government inspection, that the responsibility of managing the mines should be left with the owners of the mines ?

I do ; I think it should be so.

5762. And you would not think it desirable that Inspectors should be appointed with such powers of interference as would make them responsible for managing the mines ?

No ; I would like to have them responsible for not attending to their duty.

5763. But not for the arrangements of the mine ?

No.

5764. You would be glad, then, to see Inspectors appointed, on the part of Government, with the power of examining mines, and making themselves acquainted with the conditions of the mines, and with directions to remark upon anything that was wrong in a mine to the owner, and to report upon those circumstances ?

Yes.

5765. Are the persons to whom the practical superintendence of the mine is committed, such as overmen and deputies, generally, do you think, well qualified for their office ?

Not generally so.

5766. Does much of the safety of the mine depend upon them ?

A great deal.

5767. Do you think that there would be any mode of raising their qualifications ?

There wants a great deal of that.

5768. Are the means of education generally deficient ?

Very deficient.

5769. To what should you look, principally, as a means of improving that class of persons ?

I think that there might be schools established higher than the common schools that are now in the collieries, and that schoolmasters might be properly brought from these Normal schools of the Government, and that there should be facilities given in every shape and way, to give them education by regular Mechanics' Institutes of some kind, and such as that.

5770. To give them mining information ?

Yes ; and scientific instruction.

5771. Are you of opinion that, supposing that was done, and that those persons were better instructed on those points, they would be better fitted to execute the duties which they have to discharge ?

I do.

5772. And that it would contribute to the safety of the mines ?

Yes ; it is frequently indeed that the ignorance and the obstinacy consequent upon it risk many people's lives.

5773. Independently of the case of the overmen and the deputies, is that the case also with the workpeople ?

Much more so.

Martin Jude.
19th July 1849.

5774. Have you known many cases of danger occurring from the ignorance of the workpeople?

No; I have been very apprehensive, at many times, of danger arising from ignorance and obstinacy on the part of the workpeople, and also on the part of the overmen and deputies.

5775. You have known cases where the men have wilfully opened their lamps, have not you?

No; I cannot say that I have; I am glad to think that that is rather exaggerated.

5776. Do you think that it is not frequent that men make use of naked candles, or open their lamps in dangerous positions?

I think not; I worked with a lamp for a long time at Walker colliery, and have hardly heard of anything of that kind being done; I have worked six or seven years in Walker colliery with nothing but Davy lamps.

5777. Are they not much tempted to do so from the deficiency of light in the Davy lamp?

There is a great deal of temptation in that respect, inasmuch as they are obliged to have the coals well cleaned, and the light is very deficient for doing it.

5778. But your observation would not lead you to say that that was of frequent occurrence?

Not very frequent.

5779. If a mine could be so well ventilated as to enable the workmen to use candles, of course that would be a great advantage?

A great advantage indeed.

5780. Have you worked much with the Davy lamp?

I think I have worked with it six or seven years.

5781. Have you ever worked with any other?

No.

5782. Are you quite satisfied of the efficacy of the Davy lamp?

No, I am not; I always felt alarmed when I saw the lamp explode, and frequently inclosed it in my jacket, and made away with it to where there was more air.

5783. You would not feel so much confidence in it, then, as the last Witness, Atkinson?

I do not.

5784. Have you ever seen it red-hot?

I have worked with it when it was near to that point, but I have generally got it down before that.

5785. At any rate, neither the Davy lamp, nor any other lamp, is a substitute for a proper ventilation?

I think it is not; it should not be allowed if it could be helped.

5786. The ventilation depends entirely upon the partitions, does it not?

Just so; and the stoppings and doors.

5787. Are the doors properly guarded, generally?

No; they have a system now in the North country of having fly-doors substituted, which is a mockery.

5788. What is that?

A door on hinges, which has no stanchion, and it flies backwards and forwards.

5789. A swinging door?

A swinging door, and each man with his tub pushes it this way and that way, and it is some time before it gets to its centre of rest; it is hardly ever at its centre from the frequent passage to and fro, and it is making the men complain very much from the want of continued air; the air is unsteady, and not continued, and they are very apt to be knocked down by the tubs going against them.

5790. In that case, is the man who was put to attend to the door dispensed with?

Yes.

Martin Jude.

19th July 1849.

5791. In that case, the door is left to act by itself entirely?
Entirely so.

5792. Is that lately introduced?

It has been introduced within late years; 10 or 12 years.

5793. Before you left the mines?

Before I left the mines.

5794. Generally speaking, are the persons to whom the doors are entrusted, even where they are not swing doors, fit for that duty?

I should say not, being mere boys.

5795. They are generally the youngest boys that are admitted, are not they?
The very youngest.

5796. Have you ever known many accidents from falling down shafts?

They are not very frequent in the North country; there have been rare occasions of parties getting down when the banksmen have not been present, when the men have had to go down; there is a sort of rushing with the young boys and thoughtless lads to get down first, and there have been one or two instances where they have thrown themselves down, which have come to my knowledge.

5797. How do you think that that could be best prevented?

Only by the banksmen or the proper men of that sort being there to prevent them.

5798. That must be rather a matter of arrangement for the mine owner?

Yes, they generally do so in the North; the banksmen generally put them on in that way; but in some cases it has not been so.

5799. And are the banksmen generally attentive to their duty, or are they too apt to be neglectful of it?

They are generally attentive.

5800. Are there any other points connected with the subject which you wish to observe upon?

There is, as to examining the mine before the men go to work.

5801. Is it the custom to examine the pit properly before the men are allowed to enter it in the morning?

It is a partial custom; it is partially observed, and I think it should be imperative.

5802. It should be required in all cases?

Yes.

5803. Where it is done, how is it generally performed?

By the overman going down, and the deputies, before the men.

5804. Has he to go over all the workings?

Yes; it is done among the parties. The overman will take one district, and the deputies, if there are two or three or more of them, will take each a separate district.

5805. Is that not done in many collieries in the North?

It is done in many.

5806. But not in all?

Not in all.

5807. Do you think that the proportion between the up and the downcast shafts is generally ill observed?

It is; we frequently have the upcast the least.

5808. When you say that, do you mean to apply that observation to cases where there are separate shafts, or merely where the shaft is bratticed off and divided?

In each case it is equally the same. In Jarrow colliery there are three different

Martin Jude.
 9th July 1849.

shafts with partitions, and two of them are downcast and one up; one-third is upcast and two-thirds downcast, and in some collieries we have three or more pits, and have one upcast and the rest downcast. I think a greater body of air would be got into operation if they made the upcast larger.

5809. Would it be possible to make the stoppings and brattices of a mine more secure than they are without very much increasing the expense of the working?

A very little increase of expense will make that perfect.

5810. How would you propose to do it?

The brattices should be kept in a sufficient stock on the colliery, instead of having to make them when there is a necessity for them; some collieries have no stock on hand for brattices; and if there were a stock on hand, it would cost no more in the end, and they would be always ready.

5811. Of wood?

Yes.

5812. Do you think that the wooden partitions are sufficiently strong to make a mine secure?

I think they are.

5813. In case of an explosion, are they not all blown out?

The stoppings should not be of wood at all.

5814. They are constantly of wood, are not they?

Many of them are; stoppings are sometimes of wood, but they should not be so.

5815. How are they made in the best cases?

With brick and lime.

5816. A regular wall?

A regular wall.

5817. And stone?

Sometimes stone, when they can get them.

5818. Are the plans and sections generally deficient, or well executed?

There might be a continual supplying of those plans and sections to a certain office, in order to avoid coming into contact with other wastes.

5819. You think there ought to be some place of registry?

I do, indeed.

5820. Do you know any cases in which old workings have been unexpectedly opened?

Yes, one or two, particularly Heaton, in May 1815, and Oaklegate.

5821. Was there any danger?

No accident of late has happened at Oaklegate, but it was very dangerous; very nearly so.

5822. Do you think that anything might be done to obviate the consequences of the stoppings being blown away, in case of an explosion?

I had a personal observation of that in the Wallsend colliery. There was a door hung up at the roof, and kept suspended there; there was a short prop of wood, and when an explosion happened, it was expected to be driven out, and if the regular door was carried away by the explosion, this would fall down, and keep the ventilation good. I was in that pit when it fired, and it so happened that the regular door was carried away, and this prop was driven out by the explosion, by the force of the wind; the door fell down, and kept the ventilation good, and all within that door saved their lives by it.

5823. So that that contrivance was quite successful in that instance?

It was.

5824. Is that method adopted in any other collieries?

I think it is not; I never saw it in any other place.

5825. Whose

5825. Whose invention was it?

Mr. Buddle's.

5826. Is it still in operation there?

I believe not.

5827. Do you know at all why it has been discontinued?

I am sure I cannot say; I was surprised that I could not hear of anybody carrying it out when I was inquiring.

5828. In your case it seems to have saved your life?

It did, and several other parties that were with me at the time. I was working in a pit at another time—this is as to deputies and overmen being insufficient—the gas came off suddenly, in greater quantity than usual; the brattice was about 12 or 4 feet back from the face, and I was working with a candle; we were working with candles then; and observing that the candle was influenced by what I thought some extraneous matter, I took it up, and went back to observe if there was a current of air coming up there; it was very faint, and I went back to the broad end, out of the way, into the main air-course. I sent for the overman; he came, and said, that he had ordered the deputy to hang a door at the broad end two days previously; the deputy had neglected to do so; his excuse was, that he had not time; he had so much to do; the overman went up the board; he had a Davy lamp, and 18 feet from the face of the work; the Davy lamp was filled two feet from the bottom of the seam; there was a mass of gas that would have killed me, and others. All that was swept away in one-half hour, when the door was hung up, and I went and worked with a candle, as usual.

5829. An accident occurring in that case would have occurred entirely from the negligence of the overman?

Yes, or the deputy; he had given his orders; it was between the two; the other said that he had not had time.

5830. In that case, no question of ventilation and no inspection would have secured the mine against the accident, provided the overman had not done his duty?

Just so.

5831. Is there anything else upon which you wish to observe?

The principal thing is, that the main current of air should be increased, if the owners and viewers would just take that view of it, without competing with each other in trying to work the collieries cheaper than each other for the purpose of gain (I suppose) to the owners; but which, I think, in the long run is not a real gain, but more generally a loss to them.

5832. You think that the security from explosion is a question of economy?

Entirely so.

5833. It would be profitable to the owner to secure his mine against accidents, even at a little expense?

Yes; I think they could be generally avoided, if it was not for this false economy.

5834. That false economy is not observed in the largest and best mines, generally speaking, is it?

The largest and best are liable to it; they save a few shillings for brattices, and doors, and stoppings, and the wastemen being fewer. The collieries have a less staff of officers now, though they are much more extensive than that they had formerly.

5835. Should you say, from what you know of the state of the districts at present, that the larger collieries are the best managed or not?

No, I think not. I should like to observe that miners complain as much and as justly of the want of proper ventilation in collieries where no inflammable gas exists; but where carbonic acid gas prevails to a great extent, the health is injured so much by it. I have worked in a colliery where the Davy lamp was burning 20 yards from the place of work, and had to be kept alight by a boy set purposely by the master to twirl it round, and that is the case at the present day at that same colliery, the Walker colliery.

Martin Jude.

9th July 1849.

5836. Therefore, you would say that although the danger of explosion may be prevented, the danger to health cannot be prevented?

It can, by the proper conducting of the air.

5837. But as long as the air remains in that state, the health of the workmen must suffer?

It must indeed; it suffers materially. Many workmen would rather work exposed to the danger of fiery collieries, than in those where they are exposed to the carbonic acid gas, because, though it sweeps numbers away, they enjoy better health for the time, and they expect not to be killed by an explosion. I may mention that I have also inquired two or three times at Monk Wearmouth colliery, and at Usworth colliery, where the men are working with Dr. Clanny's lamp, as to the utility of it, or the superiority of it, and they give it a superior character as to affording them light.

5838. Do they approve of it in other respects?

They say that in all respects it affords them a better light, and I asked them, was the principle of safety the same, and they said, yes, as far as they knew.

5839. Do they complain of the weight of it?

Only in slight instances.

5840. Do they mention instances in which the glass has been broken?

Not one, that I heard of.

5841. Should you say that the weight of a lamp is a matter of great importance?

No, I think it is not, if it is not too heavy.

5842. You know the Clanny lamp, do not you?

I have only seen it lately.

5843. Have you held it in your hand?

Yes.

5844. Should you say that it was inconveniently heavy for the workmen?

I think not.

5845. Is the glass any objection, do you think?

I would not say the glass was not objectionable, so far as the probability of its being touched with water when heated.

5846. But you have not heard of any such case in the mines in which it has been employed?

I have not.

5847. And the light which it gives is a great advantage, is it not?

A great advantage, and I think, if it is equally safe, it might be regularly worked with, instead of the Davy being employed where there is an expected danger, and the men have a better light.

5848. Would it not diminish any temptation which the men might have to open the lamp?

Yes; that is what I mean.

5849. Have you ever known any cases where the lamp has been broken by the miner's pick?

Yes; accidentally.

5850. Do you think that that is an accident which is very likely to occur often?

No; it is a very rare case indeed; I was at Walker's colliery six or seven years, and I only knew of one case or two where it was accidentally hit with a pick.

5851. A workman may generally avoid that, may he?

Yes. I would just say as to the inspection of mines, I believe that the great body of coal owners and colliery owners would not object to a general inspection; no doubt there are some who would object to it.

5852. Who would object to any inspection?

To any inspection; and I think it should be imperative that their collieries should

should be inspected by a Government Inspector. This is a copy of the Petition which was presented to the House of Commons from the mines of the North.

Martin Jude
19th July 1849.

The Witness delivers in the same, which is as follows :

PETITION TO PARLIAMENT.

To the Right Honourable the Lords Spiritual and Temporal, in Parliament assembled.

The PETITION of the Colliers and Miners of Northumberland and Durham ;

Humbly sheweth,

That your petitioners are from day to day exposed to imminent dangers while following their employment, and that a great number of the friends and relatives of your petitioners have been killed and otherwise deprived of life by explosions of fire-damp and other calamities incident to coal-mines; and that upwards of 300 miners have met violent deaths during the first months of this present year.

That your petitioners have learnt with great satisfaction that your Lordships have recently revised and passed a Bill, called the "Passenger Act," which very properly provides that all owners of ships, &c. conveying passengers to the United States, or the British Colonies, shall so construct and fit up such vessels with a view to provide a sufficiency of light and air, that passengers shall not in their berths be exposed to the injurious effects of a vitiated and unhealthy atmosphere; that penalties are also imposed upon such owners of ships not complying with the terms and conditions of such enactment.

That your petitioners (irrespective of being exposed to those fearful accidents which instantaneously deprive them of life) are also obliged, when following their employment, to work in a very vitiated and unwholesome atmosphere, with manifest injury to their constitutions, and derangement of their general health.

That your petitioners are desirous of representing to your Lordships that the appointment of properly qualified Inspectors of Mines (such Inspectors being practical miners), who shall visit the pits at short intervals, and be empowered to enforce a system of healthy ventilation of mines, would in a very material degree be beneficial to the health of your petitioners, and considerably lessen the dangers to which they are exposed.

That your petitioners would respectfully submit to your Lordships that sufficient evidence has been given by the Reports of Sir H. De la Beche, and other Commissioners appointed by the Government, to inquire into the causes of accidents in coal mines, together with the continued frequency of such accidents, as to enable and justify your Lordships to legislate thereon; your petitioners would, therefore, implore your Lordships, before this Session of Parliament closes, to provide, by some enactment, a proper protection to the lives and health of your petitioners.

And your petitioners will ever pray.

The Witness.] The miners are getting up a petition now for the purpose of impressing these views upon the Legislature.

5853. In this petition it is stated, that the petitioners desire that Inspectors should be appointed, "and be empowered to enforce a system of healthy ventilation of mines"?

Yes.

5854. What is precisely meant by the expression "to enforce a system of healthy ventilation"?

That if, when passing through the mines, they should find a man working in a dormant or stagnant atmosphere, they should consider that not a healthy ventilation.

5855. But how should they be empowered to enforce it?

By calling upon the owner of the colliery to give him more air.

5856. Does it mean that the Inspectors should be invested with the power of directing the owners to take certain steps, and of subjecting them to penalties if they did not?

It would mean this: that if the Inspector found that the establishment had not sufficient brattices and doors to convey a sufficient quantity of wholesome air to those men, he should order it to be done.

5857. That the Inspector should order it?

Yes; that he should communicate to the master the necessity of some more air being conveyed to that man by some known means, some of the regular practical means of getting air up.

Martin Jude.

19th July 1843

that could see that they should merely communicate and recommend the master to that than upon any other order him?

5883. Do you have recom^y you think that there would be no difficulty in a course like that? of the b^y the generality of collieries; in some particular case there would be I th^y difficulty.

5860. Supposing a case in which there was a difference of opinion between the Inspector and the viewer, the viewer being a very competent person, would there be no difficulty in giving the Inspector the power to decide the question and to impose a penalty?

It would come to this: if the Inspector saw that this place was much more neglected than the ordinary workings of the pit, that while the others were well and healthily ventilated by means of brattices and doors, &c., this particular district had not those means, he could easily name it; and as soon as he named it, it would be upon the part of the viewer to do so, and he would naturally feel it his duty to do so.

5861. Supposing that the viewer denied the fact, or disputed the cause of it? Then, I think, he should be obliged to do it by some means.

5862. That the Inspector should have the power of enforcing his own opinion in spite of that of the viewer?

Yes.

5863. Do you think that that would be a proper course to take?

I think it would.

5864. Would you be always sure that the Inspector was in the right, and the viewer in the wrong?

Yes.

5865. Would not that rather be an arbitrary proceeding?

Yes; but I am afraid that we could not get it done otherwise. Sometimes people are very obstinate in their own opinions, and I find that the Legislature have carried out that principle in the Passengers' Act; it is imperative there to afford each passenger a sufficient quantity of air and light, otherwise they, the ship-owners, are subjected to a penalty; and it is only to the evil-doers that these things apply. The good people would naturally act upon the suggestions of the Inspector, but there are some bad people who would not do so, and therefore I think it should be enforced upon those bad people.

5866. In the case of the Passengers' Act, it is at the option of the ship-owner whether he will bring it into that particular employment or not?

Quite so.

5867. That is not so with the owner of a mine?

He is not compelled to have it in that form.

5868. But the owner of a passenger-ship has notice beforehand that those are the regulations to which he must submit if he enters that trade?

Yes.

5869. Is it so with respect to those who have their mines already opened?

No; but I think the regular principle of the establishment is conducting air; they intend to have air; they form the establishment upon the general principle of getting air, but they are too apt to work it to the verge of danger to save money; the Inspector would merely have to attend to say when the verge of danger was approached, and to see that it was not carried any further.

5870. But the question of difficulty arises in the case of a difference of opinion between the Inspector and the owner of a mine or his viewer; it might be a case of doubt, supposing there was a real doubt as to the question on which the Inspector interfered; would it be right to enforce the opinion of the Inspector, in spite of the opinion of those who were much better acquainted with the state of the mine?

As far as carrying air in the common established way, it would be right for the Inspector to enforce its being done; but any new improvement that he might suggest, I think he should have no right to enforce.

5871. Do

5871. Do you think it proper to assume that the current of air upon all in the right, in a question like that?

I think he would, indeed.

5872. Have not you stated that you think it essential to the suiting a mine? system of inspection, that the colliery owners should be willing themselves such a system should be adopted?

Quite so.

5873. And that they might obstruct the movements of the Inspectors, so as, in point of fact, to render it almost impossible for them thoroughly to inspect the mines, or at least to render it very difficult for them to do so?

They could put many difficulties in the way.

5874. Then, if that be essential to a system of inspection, do you think it would be desirable to attempt to introduce such a system as you have now spoken of; at all events, in the first instance, do not you think that the colliery owners would be reluctant to arm an Inspector with the arbitrary powers of which you have spoken?

I think a great number of colliery owners would not object to it; if they were highly sensible of the responsibility upon themselves, they would not do so; but, as I have said before, I think there are some who would object; some are obstinate parties, who would not be controlled, without some power by legislation to enforce them.

5875. But do you think there are any considerable number of colliery owners who would be disposed to give their assent to such an inspection as that which you have now spoken of?

I think there are very few indeed who would dissent.

5876. Is it not the fact, that at all the meetings of colliery owners which have taken place on this subject, a pretty general opinion has been expressed that the system of inspection ought to be limited to a power of examination and of suggestion?

Yes; I think they have been led to adopt that from the impression that the Inspectors would not be practical men; that they would be men unacquainted with the thing, who might lead them into great expenses, by obliging them to comply with some new inventions or some crude ideas of their own, such as Messrs. Faraday and Lyell were supposed to have recommended.

5877. What security do you propose to take, that the Inspectors should be men perfectly competent to discharge such duties as you have described?

Well knowing their character, would be a guide, I think, in the district.

5878. Would you leave it to the Government to make the selection?

I should think it would be necessary to do that.

5879. If the Government were to be deceived in their estimate of a man's qualifications, and to appoint a person not thoroughly qualified, would it not, in that case, be a great hardship upon the colliery owners to be obliged to bow to his decision?

Yes.

5880. Would the colliery owners prefer having the appointment from some colliery viewers, who were totally unconnected with the mines that they went to see?

I cannot say, indeed.

5881. Instead of employing professors and that description of people, if the Inspectors were appointed from among colliery viewers at large?

I think they would prefer the latter; that they would prefer having the Inspectors from practical men who had been several years in the business, and understood the whole rationale of it.

5882. And would the workmen be satisfied, do you think, with the Inspectors being chosen from that class?

The workmen anticipate that the Inspectors should be practical men, and the Sub-inspectors some of their own body; some of the best-educated men, men

Joseph Gott.

19th July 1849.

Martin Judd.

19th July 1849.

that could see that they should have justice done ; they would depend more upon that than upon any of parties that were strangers to the district.

5883. Do you feel quite confident in an inspection such as that which you have recommended, that there would be no objection on the part of the owners of these collieries ?

I think the greater part of them would not object ; there may be some more or less, as I have said, and we can expect that to be the case.

5884. The evidence before this Committee is rather that the colliery owners would object to such a power as that ; should you be disposed to say that that does not represent the common feeling of the colliery owners ?

I should think they could not fairly object, as far as my own opinion goes ; I have no means of knowing their real opinions upon it ; that is my own opinion as to the probable course they would take.

5885. Supposing it has been represented to this Committee in evidence that the owners of collieries generally would be very well disposed towards an inspection with a right of inquiry and examination, but that they would object to anything like a power of directing on the part of the Inspector, do not you think that that would be rather a reason against going quite so far ?

I think that with the colliery owners it would only lead to having a compulsory power or directing power, that where the regular quantity of air should not be got up to each man's working, each owner should really make it so ; and that is what the men want ; they want to have a sufficient quantity of healthy air to work in, both where it is dangerous and explosive and otherwise ; and I believe that if they have that enforced and ensured, that is all the inspection that they want.

The Witness is directed to withdraw.

Joseph Gott.

JOSEPH GOTT is called in, and examined as follows :

5886. YOU are an overman in a colliery near Wakefield ?
Yes.

5887. Criggleston colliery ?
Yes.

5888. Before that time were you employed in Lancashire ?
Yes.

5889. In whose collieries in Lancashire ?
Mr. Livesey's.

5890. Near Oldham ?
Yes, about four miles from Oldham.

5891. Have you been accustomed to employment in collieries from your youth ?
Yes ; never anything else.

5892. Have you paid much attention to the management of collieries as regards the danger of accidents ?
Yes ; I believe never anybody more so.

5893. Have you ever had any experience of accidents in those collieries in which you have been employed ?

Never much of accidents ; we have only lost three men in about 32 years.

5894. Where was that ?

One at Criggleston and two at Smithson colliery ; the last man stripped himself ; he had a lamp to work with, and he got through ; he fired it ; there were never any misfortunes where I was, further than the men being burnt.

5895. To what do you attribute your having had no accidents ?
Always a good strong current of air.

5896. That you always thought a very essential point, did you ?
Yes.

5897. How

5897. How have you managed to secure a good current of air upon all occasions?

We always keep good roads.

5898. Do you look upon that as the most essential point in ventilating a mine?
Yes; I think it the main thing, the completely keeping a good air-road.

5899. How have you managed to keep a good air-road at all times?

I have always been there every day, and attended to it after the manner of a gardener pulling up weeds; when he sees one growing, pulling it up, and keeping them down.

5900. By personal attention of your own?

Yes.

5901. Are you in the pit every day?

Yes, I have not been to-day; when I am at work I have been every day.

5902. When you are in the pit do you inspect all the stoppings?

Yes, we do them gradually as we go on.

5903. Upon what system do you manage the air-courses; is it by splitting the air?

I believe I was the first that split the air in Yorkshire; I am much given to splitting the air; but it depends upon circumstances. Supposing this bottle is a pit, and you knock four holes in it, one every way, and keep it supplied with water, it will fill them all; but in case you take your air for such a distance, and get it on a bad road, where you have little room for it, and after that you split it, there will be no advantage by splitting; but if you know how to split it, it is better split than not split.

5904. Then, in your opinion, it ought to be split where the current is strongest?

Yes, just the same as a gentleman who has his pocket full of money; if he has many shillings he may do good with it, but if he has only sixpence he cannot do much good by dividing it.

5905. It is to the circumstance of your managing ventilation in that way that you principally attribute the absence from accidents in the mines where you have been employed?

Yes.

5906. Have you ever had any means of ventilating the mines except the furnace?

No; I never stood in need of them in any way.

5907. But you have had furnaces in your mines?

Yes.

5908. And you have found them always quite sufficient?

Quite sufficient, if they only know how to do it; it is only men who are bothered in their mind, who keep trying this and trying that, and trying a hundred things.

5909. Is there a furnace at the Criggleston mine?

Yes.

5910. More than one?

Yes; we have two, but they very seldom keep more than one in.

5911. You find one sufficient?

Yes, entirely.

5912. Did you ever ascertain the amount of current which you have at the Criggleston colliery?

No, I never bothered with it; I have always plenty, and to spare.

5913. What is the extent of the workings in the Criggleston mine.

About 900 yards from the shaft.

5914. And what is the depth of your shaft?

One hundred and five yards.

Joseph Gott.

19th July 1849.

Joseph Gott.

19th July 1849.

5915. And 900 yards is the distance from the shaft?

Yes, to our further place.

5916. But that does not measure the distance which the air has to travel?

No; it goes up and down many miles backwards and forwards.

5917. Can you tell how far the air has to travel in one stream?

No, I do not know that I can exactly; I never took any notice.

5918. Do you know how many acres the workings extend over?

Four or five and twenty; I do not exactly know.

5919. Was it the same system of working at Mr. Livesey's collieries, in Lancashire.

Yes.

5920. What they call the pillar and stall system?

I do not know what they call it; we reckon to get nearly the whole coal; we do not leave much.

5921. When you say you have very few accidents, you do not mean to say that you have none?

No; we have sometimes had a man slightly burnt, but we have only lost three lives.

5922. Have you seen any other collieries besides those in which you have been employed?

Yes, many.

5923. Do you think that the system which you have pursued in these collieries would be applicable to all others which you have seen?

Yes, I think so; a good air will suit every colliery.

5924. Do you think that, generally speaking, those which you have seen are well ventilated?

I have seen some that have been in a middling way, and some—no matter.

5925. Generally speaking, should you say that the collieries in Lancashire and Yorkshire are well ventilated?

In some parts of Lancashire they are not well ventilated.

5926. And in Yorkshire?

We have different sorts; it just depends upon the manager.

5927. From your knowledge, what should you say is generally the case?

I have seen bad ventilation in many places; I have worked at different collieries.

5928. Is it more usual, or not, to have a furnace?

There is a certain quantity of air that will go by nature, and all that you want over and above, you have to push it to pull away.

5929. Is it more common, or not, to have a furnace?

Whenever we have too little, we are forced to have a furnace.

5930. You say that you have seen many other collieries besides those in which you have been employed?

Yes.

5931. Should you say that, generally speaking, furnaces are employed in those collieries?

Some have a fire of some description, not exactly a furnace; it depends upon the manager; sometimes he will want to do something better than anybody else, and he will do it worse, as it happens.

5932. Do you think that some method of ventilating like that is essential to supply a mine with air?

The furnace is the first thing you can have for air; I think so.

5933. You would not think it safe to leave the mine without any furnace, or some means for ventilation?

It is the same as sailing a ship without the men in it, going without a furnace.

5934. Supposing

5934. Supposing it to be the practice in many parts of England to leave the mines to nothing but the natural action of the atmosphere, you would not think that safe?

Joseph Gott.
19th July 1849

No; it would be just like sending a ship to sea without having proper men to work her; it is only going by nature.

5935. Have you seen any other mode of artificial ventilation?

I have seen bad pits that have been very badly ventilated; with a furnace they may pull away as hard as they can, but in case the air-roads are not kept sufficient, the furnace will be of no use; but if you have a furnace and air-roads, as you ought to have, you will have a good air.

5936. Have you ever seen any other method of ventilating?

No; and I believe I never shall do, and no man else; they must have either the furnace or something to the same purpose.

5937. Have you seen Mr. Struvé's plan, or Mr. Gurney's plan, or a variety of other plans that there are for ventilating mines?

If he ventilates it with steam or any other plan, he must have a furnace.

5938. You are only asked whether you have seen it?

No; if he has his steam, he is forced to have a furnace to raise that steam, but I do not think it a good plan at all having steam upon the pit top, because most of the pits have plenty of water in them, and if you set your fire at the bottom of the pit, then your steam will be at the bottom, and it will vent away.

5939. You say that you are frequently, yourself, in the pit?

Yes, regularly.

5940. Every day?

Every day, or nearly.

5941. Do you remain down in the pit?

Not long; two or three hours or so.

5942. Do you go down in the morning before the men come?

When the pit is in danger, I do.

5943. Are there other parties who go down before you?

No; not if the pit be in any danger.

5944. How do you ascertain whether there is any danger?

We know when the pit is in danger as well as you know anything.

5945. Not without going down into it, can you?

No; you know how you left it the night before.

5946. When it has been left the night before in a condition that makes it likely to be dangerous, you go down in the morning, do you?

Yes; if ever there be any danger, I always go down first.

5947. You have other men under you as deputies, have not you?

Yes; there is one that runs about, and so forth.

5948. There is only one besides yourself who superintends the pit?

That is all.

5949. And you do not want any more?

No.

5950. How many men are employed at that pit?

About 40 or 50; there have been 60 or 70; we are slack now.

5951. And you find one man, besides yourself, sufficient to keep them in order?

Yes; the men do not want an Inspector from Government; they do not cry out for one.

5952. What is your own opinion upon that subject?

I do not think there would be any harm in it at all; supposing you could only pick some clever men for the purpose.

Joseph Gott.
 19th July 1849.

5953. Supposing that Inspectors with experience and knowledge were directed to come and make inquiries in the different pits, and to point out any defects that they found in them, do you think that that would be useful?

Yes, I think it would; supposing a man of judgment went down a pit, and after that he advised with the man who was manager of the colliery, and in case he saw anything amiss he should say to him that he thought he could mend it; supposing I went down with another man and saw his pit in a bad state, I would not blaze it about, and tell all the men so and so; I would take him on one side and advise with him, and tell him that I thought I could be a helpmate to him, and tell him the way, and in case he was anything of a man he would listen to me, and if not, he would hardly be fit for his situation.

5954. From what you have known of managers of collieries, should you say they would be generally disposed to listen to a suggestion of that kind?

I think they would.

5955. Do you think, from what you have seen of collieries, it would be possible for any Inspector, or person examining the mine in that way, to point out improvements that could be effected by the colliery owner, without any great difficulty or expense?

To be sure; I should never wish to throw a gentleman into an expensive way of doing it; in many cases they could do it without any expense at all.

5956. Do you think that, generally speaking, the faults in ventilation could be remedied without great expense?

I think they can.

5957. What do you think is generally the fault in ventilation; is it the want of proper brattices?

Different men have different notions of taking their air at starting, and in case they start badly they never get into a right train, because if they start badly their judgment is bad to begin with; and if a man has bad judgment when he begins he cannot be expected to go on well.

5958. The principal fault in the ventilation of mines, so far as you have seen, is in the way the air is taken?

Yes; when they begin at first.

5959. Do the men in your mine work with lamps?

Very seldom with lamps.

5960. You think it clear enough to enable them to work with candles, do you?

Yes.

5961. At all times?

Not at all times; sometimes when we are driving two places together, or want to drive rather farther than we ought to do, we take lamps to drive for a day or two, and after that we work with candles again.

5962. Yours is not what is termed a fiery seam, is it?

I have had to do with as fiery collieries as any in England.

5963. The one which you have now?

Yes; when I was in Lancashire, there was not a more fiery colliery in England.

5964. Did you pay any attention to the circumstances of the accident at Darley Main?

Yes.

5965. What is your opinion of the causes of that accident?

I did not see the pit, and for that reason I cannot say exactly what it was.

5966. Did not you see the pit afterwards?

No.

5967. Did not you go to the inquest?

My master wrote to the coroner to let me go, and he never answered back again.

5968. You

5968. You did not go?
No, he did not allow it.

Joseph Gott.
19th July 1849.

5969. You are not acquainted, in fact, with the circumstances of it?

I know the workings. I made some plans of it from what I heard from the men. I did not think it was my duty to bring them, for this reason, that I could not pretend to say, "I will make you do this, or I will make you do that;" anything that could be mended, I think it might be done without force. In case a man, who is the manager of a colliery, knows his own faults, and another would advise him, and he saw that he could lend him a helping hand, I think he would gladly take it, because you may depend upon it that the man who is manager has his life at stake the same as the men who are with him; he runs the same risk as they do.

5970. Was the pit at Criggleston, at which you are employed, always ventilated in the same way in which it is now?

Yes; I was at the beginning of it.

5971. Were you there at the first sinking of the shaft?

It was just down when I was there; but I was at the ventilating of it at the beginning.

5972. It was never worked before you were there?

No.

5973. And did you give directions for the system of ventilation?

Yes; at first when I went to Criggleston there were not many doors; there was a sheet at the bottom of the door. I bid one of my men pull it off, and he did so; when I went afterwards it was put on again; so I did not say anything to him, and the third time I went I ordered him to pull the door down, and he did so. I fancied it was better down than up, so that there is that difference in people's fancy.

5974. Such differences might arise, even with people acquainted with the matter?

Yes; there is many a man who has been accustomed to do things in a certain way, and he very seldom thinks of any other way than he has been accustomed to; he and his father and grandfather have done them after that manner; if there were no better mechanics than there are among colliers, machinery would never have been brought to the perfection that it has.

5975. Then you think that it would not be proper to give any man a right to enforce his own opinion, in questions of that kind, against the wish of the manager of the colliery?

I think it would not. I think it might be done a deal better without, because, for one reason, it is a strange thing to think of, supposing that I was a coal-owner, if I could not have as good faith in my own body of men as in a stranger. It is only fancy, I think, that has come into some one's head, because, without a doubt, you would not have the best men in England, in case you made choice of them; you cannot have all the best; it would be a pity if all the best men were out of situations; you should try and pick clever men out of those who are in situations.

5976. Are there any other accidents besides explosions that you have had any experience in?

Not much.

5977. Do the ropes ever break in that part of the country?

No; they have never broken where I was with men on; in case we have bad ropes, we always give orders to the banksman, until such time as the rope gets changed, to let no man go up and down with it; men are very cautious; they will never go down with a bad rope; they would sometimes, when they are hasty come out with one.

5978. You mean the banksman whose duty it is always to see the men go down?

Yes; he is always there when the men go down and up.

Joseph Gott.
19th July 1849.

5979. Does he regulate the way in which they get into the baskets to go down?

No; the baskets come up; they are all right when they come up, and they step in; he always stands by, and if he saw anything dangerous he would speak.

5980. Does he prevent anything like a rush to the baskets, or people getting in improperly?

No.

5981. Is not that part of his business?

In case he saw more wishing to get in than ought to do, he would say, "stand back."

5982. That would be his duty?

Yes.

5983. Have you known any accidents from people getting imprudently and improperly into the baskets?

No, never.

5984. Can many of your workmen read and write?

Yes; some of them can; a good many of them.

5985. Not the greater part of them?

No; I do not think so; it is hardly that; just as it happens; there are Sunday schools for the younger ones.

5986. Do you think that there is much cause of danger from the want of education, and from the ignorance among the workpeople?

They have nothing at all to do, in a manner of speaking, because if the foreman is a man who understands his business, he is standing for them there, and if he thinks it not altogether safe he knows where it is.

5987. With respect to using lights in improper places, what do you say?

I never knew a man that I have had to do with, do anything contrary to orders; I always found my men to be men that are to be trusted where it is in danger. I do not consider that a pit is fit to work in at all, where there is nothing but lamps; that pit is not ventilated as it ought to be, and in case the man who is manager cannot ventilate it better than to have a lamp, he is not fit for his situation.

5988. In case there is a strong current of air, is not there an inconvenience in working with candles?

Blowing the candles out?

5989. Yes?

They can prevent that in some way or other.

5990. By shields?

Yes; the men are not working in the regular air-way; they are working out a little, and in case it be bratticed, or anything of that, they can keep the brattice a little further off them.

5991. Supposing there is a sudden blow of gas upon them?

If there is a sudden blow of gas, that is not air; that is foul air; they are aware of such things as those; when those come they would have a lamp then, because all collieries have lamps now, either more or less.

5992. Is there anything else which you wish to say to the Committee?

No, I do not think that I can say anything. As to all that is past, you are quite aware of it; talking about what is past is all nonsense, and what is to come I cannot exactly tell.

The Witness is directed to withdraw.

Ordered, That this Committee be adjourned till To-morrow,
Two o'clock.

Die Veneris, 20° Julii 1849.

The LORD WHARNCLIFFE in the Chair.

THOMAS JOHN TAYLOR, Esquire, is called in, and examined
as follows :

Evidence on the
Prevention of
Accidents in
Coal Mines.

T. J. Taylor, Esq.

20th July 1849.

5993. YOU are a Viewer in the North of England ?

Yes.

5994. You are manager of the collieries of the Duke of Northumberland ?
I am Mining Agent to the Duke of Northumberland.

5995. Have you been for a long time engaged in that occupation ?
As a Viewer during the last 25 years.

5996. In the course of your experience, have you paid close attention to the subject of accidents occurring in coal-mines ?

I have. I have taken a good deal of trouble in investigating the nature of those accidents, and have prepared several documents bearing upon them, more particularly as to the statistics of the accidents, with a view to distinguish how and to what extent they occurred. One of these documents I shall be glad to lay before your Lordships ; I drew it up, for my own satisfaction, with great care ; it comprises the returns from 55 collieries in Durham and Northumberland, and is taken principally from the registered accounts of the different districts, checked by local information.

5997. What do you speak of when you speak of the registered accounts of the different districts ?

The accounts kept by the public Registrars of the districts.

5998. You mean the registers of deaths ?

Exactly. This is an account of the fatal accidents which have occurred in 55 collieries of Northumberland and Durham, during a period of six years, ending January 1st, 1845. I have here given a list of the different collieries. I will state the general result. At those 55 collieries there were killed by explosion 224, being 51 per cent. of the whole ; from falls of stone and coal, 96, being 21 $\frac{2}{10}$ ths per cent. Killed in shaft, namely, by ropes breaking, 3 ; by being drawn over pulleys, 3 ; and by other causes, 58 ; total, 64 ; being 14 $\frac{2}{10}$ ths per cent. Killed by underground waggons, 36, being 8 $\frac{2}{10}$ ths per cent. Drowned 3, being $\frac{7}{10}$ ths per cent. Various accidents 16, being 3 $\frac{6}{10}$ ths per cent. Total, 439 killed. The particular cause of death is specified under each head : the head of " Various Accidents," includes a number not easily classed, on account of their anomalous character ; one person was killed, for example, by being wrapped with the rope round an incline wheel, and this, and other accidents of a similarly irregular kind, not previously specified, are entered here. All the accidents enumerated have happened under-ground, or in the shafts. The statement does not include the casualties among the persons who work above-ground ; there are a number of waggon-men and other parties employed at the surface who are not, of course, liable to the casualties that happen among the pitmen ; those I have kept out. The persons employed above ground have accidents occasionally from waggons passing over them, and other causes.

5999. Sometimes they fall down the pits, do not they ?

Yes. I may, however, explain, that the banksmen, the men who take the coals immediately out of the pit, are included in the return.

6000. When you give the 224 accidents from explosion, you mean that to specify each particular death caused by explosion ?

I do. I include the single cases, as well as those more numerous ones which occasionally occur.

T. J. Taylor, Esq.
20th July 1849.

6001. But the proportion of 224 to the entire number is no indication of the number of accidents, but the number of deaths caused by accident?

The number of deaths caused by accident, not the number of accidents. The return shows the fatal cases that occurred during those six years.

6002. Then this statement would not show that of 439 fatal accidents occurring, 224 were from explosion, but merely that there were 224 deaths caused by explosion out of that number of deaths?

The account comprises the total number of fatal accidents that occurred at 55 collieries during six years, and shows that 224 of those deaths were caused by explosion.

6003. For instance, in explosions one accident will cause a great number of deaths?

Exactly.

6004. Those would be included as separate deaths in that document?

Yes; sometimes it happens that only one man is killed by an explosion, or sometimes two men or three men are so killed; sometimes, unfortunately, the number is very much greater; but all are included in the total of 224. The above aggregate of 439 persons killed in six years is at the rate of 73 per annum. I estimate that there were 9,500 persons employed under-ground at the 55 collieries, enumerated on the average of the six years. On these grounds, the fatal accidents are 1 in 130 per annum; and, assuming the entire number of persons employed under-ground in the trade during the same period to have been 21,000, this makes the total casualties of the collieries in Durham and Northumberland 161 per annum, including men and boys.

The Witness delivers in the following Paper:

ACCOUNT of the FATAL ACCIDENTS which have occurred in the following 55 Collieries of Northumberland and Durham, during a Period of Six Years, ending 1 January 1845.

| | | |
|----------------------------|------------------|-----------------------|
| Burradon and Killingworth. | Burdon Main. | Copley Butterknowle. |
| Backworth. | Whitley. | Copy Crooks. |
| Cramlington. | South Hetton. | Whitworth. |
| Seghill. | Dalton. | Bowdon Close. |
| Hartley. | Haswell. | Byers Green. |
| Earsden. | Shotton. | Westerton. |
| Seaton Delaval. | Thornley. | West Auckland. |
| Holywell. | Kelloe. | Leasing Thorne. |
| East Holywell. | Wingate Grange. | Woodfield. |
| West Cramlington. | Castle Eden. | Engine Pit, Lynesack. |
| Cowpen Colliery. | South Wingate. | Oaks, near Evenwood. |
| Wideopen and Fawdon. | Adelades. | Hetton. |
| Bigges Main. | Etherley. | Painshaw. |
| Byker Hill. | St. Helen's. | Renton. |
| Walker. | Black Boy. | Newbottle. |
| Seaton Burn. | Butterknowle. | North Hetton. |
| Wallsend. | Woodhouse Close. | South Shields. |
| Wellington. | Witton Park. | |
| Percy Main. | Eldon. | |

Note.—A few of the collieries have been in operation during a part only of the six years, but this does not at all materially affect the general result.

| | Number Killed. | |
|---|----------------|------------------------|
| Explosion - - - - - | 224 | 51.0 per cent. |
| Falls of stone and coal - - - - - | 96 | 21.9 " |
| Killed in shaft; namely— | | |
| Rope breaking - - - - - | 3 | } 64 - - - 14.6 " |
| Drawn over pulleys - - - - - | 3 | |
| Other causes; principally falling out of roofs and cages down the pit - - - - - | 58 | |
| Under-ground waggons - - - - - | 36 | 8.2 " |
| Drowned - - - - - | 3 | 0.7 " |
| Various accidents - - - - - | 16 | 3.6 " |
| TOTAL - - - - - | 439 | 100.0 per cent. |

6005. Have

6005. Have your researches extended farther back than these six years at all? Not with the same degree of minuteness.

T. J. Taylor, Esq.

20th July 1849.

6006. You would not be prepared to say whether the proportion has increased of late years, as compared with former?

There have been more fiery mines opened out of late years than existed formerly; so that, upon the whole, I should say the proportion of explosions has been rather upon the increase than otherwise.

6007. Should you say that there is more precaution taken now than there was in former times?

Certainly, especially as regards ventilation.

6008. Has there been much progress made in the science of ventilation in the Northern district?

Yes, a good deal. This may be the more easily explained to your Lordships on account of the late Mr. Buddle having put upon record, in the year 1814, his own standard of ventilation at that time. In his letter, addressed to the Sunderland Committee for the Prevention of Accidents in Mines, he states as follows: "The standard air-course of atmospheric air which I employ in the ventilation of the collieries under my care, abounding in inflammable gas, moves through an aperture from 30 to 40 feet in area, with a velocity of three feet per second, which equals from 5,400 to 7,200 cubic feet, or from 525 to 700 hogsheads per minute." At that period, therefore, the average current which Mr. Buddle states as his standard was about 6,000 cubic feet. Now it is in evidence before your Lordships, that at present we have, in many cases, from 50,000 to 100,000 cubic feet per minute, and even upwards, in circulation, so that in reality we have improved our ventilation in the proportions stated.

6009. Were those mines, of which Mr. Buddle spoke at that time, mines with very extensive workings?

Yes. I may explain, that at the time in question there was only a single air-current in mines; the plan of splitting the air has been devised since that period, and is, in point of fact, the source of the great improvement which has been made in ventilation.

6010. Do you consider that a very essential part of the proper arrangements of a mine?

Yes, most important. It has two direct effects; in the first place, by increasing the aggregate area of the air-channels, the resistance to the current is diminished to a very great extent; and, secondly, the run of each current of air is shortened, and has, therefore, much less work to do than it had formerly.

6011. Is it clearly proved that, supposing two cases in which the power of ventilation was the same, and the distance to be traversed the same, and that in one case the current of air was taken continuously in one stream the whole distance, and in the other case it was split up into several streams, the gain in the latter case would be greater with the same power than in the former?

Decidedly; the aggregate quantity of air is very much increased by increasing the number of channels. I have frequently tried the effect of shutting off certain parts of the mine, and then ascertaining the quantity of air in circulation with the same ventilating power at work as before. In one case I found that with about half the extent of mine shut off, the quantity of air was reduced to four-sevenths, in consequence of its restriction to a smaller number of channels. On a general view of the improvements in ventilation during the last 35 years, it may be stated, that we have shortened the distance of the runs to about one-sixth or one-eighth, as compared to what they used to be; while the aggregate area through which the air has to move in its under-ground channels has been increased from 30 or 40 feet, which was Mr. Buddle's standard in the same proportion of six to eight times that extent; we have also improved the furnaces, by making them larger than formerly.

6012. What do you think has been the economical result as respects the furnaces, comparing it with the increased consumption of fuel which must take place, of course, in a much larger furnace?

I may explain, that the coal which we use for the ventilating furnaces is of that description which is not, in point of fact, saleable; it is the small coal and slack
(164.17.)

T. J. Taylor, Esq.
20th July 1849.

produced in working the large coal; and, therefore, the cost of the article cannot really be considered as being anything at all; the quantity used is generally from two to three tons per day per furnace, in some cases greater, in others less.

6013. In those collieries with which you are connected are there in all cases two shafts?

Yes.

6014. Do you consider that as a very essential point in a colliery?
I consider the colliery safer with two distinct shafts.

6015. Are your upcast shafts used for other purposes than those of ventilation?

Yes, also for drawing coals.

6016. Does not that interfere with the operation?

Practically, not so much as may be supposed; the shafts form a very small part of the whole extent of channels, and through their area are contracted by the cage-jet; when the space thus contracted at a single point is taken into the general average of the whole area of the air-channels, it does not make a very material alteration. With a view to test this principle, I have contracted the area of a shaft at one point to a third part, without finding a very sensible difference in the quantity of air passing.

6017. In what way?

As I have said, only at one point, by putting in a cradle a moveable scaffold, on which persons stand when work is done in the shaft; if the contracted space is more extended, then the resistance is greatly increased.

6018. Then your argument would not apply to a case of a small air-shaft?

Certainly not; the general principle clearly is, that the larger the shafts the better.

6019. What is the least amount of current with which you should be satisfied in any of those pits which you have under your management?

That would depend upon the requirements of the mine; for example, in a mine which yields no fire-damp, with 120 or 130 persons employed in it, I should say that a current of 20,000 to 30,000 cubic feet per minute might be a fair quantity, being properly conveyed up to the face of the workings, and made to sweep those districts where the people are employed; but in a fiery mine I should require very much more than the quantity named.

6020. Assuming that the mines in the North are properly furnished with furnaces capable of producing a sufficient current of ventilation, should you say that, generally speaking, they are arranged in the best manner below ground, so as to make that ventilation effective?

There are many circumstances to be considered; it happens sometimes in laying out a mine, that there is a good deal of difficulty experienced; a shaft may, for example, be sunk in the neighbourhood of dykes, and if only two or three places are put through those dykes, the air current is more confined than would be the case if it could be divided nearer the bottom of the shaft. Generally speaking, however, the principle of splitting the air is carried to a very great extent in the North of England.

6021. Do you think it possible by any method of arrangement to ventilate the goaves or wastes of a mine?

The goaves are to be viewed as detached parts of the mine; they are not approached except with safety lamps; the men who remove the pillars in fiery mines work with safety-lamps, and no naked light is allowed to come near them; the air that passes into the goaves reaches them after traversing the regular working districts of the mine, or sometimes in a distinct current appropriated to the goaves, and in leaving the goaves passes away into the return, where it does not again come into contact with naked lights; so that in reality the present arrangement in regard to the goaves may be considered to render them as safe as other portions of the mine, one great proof of which is, that in point of fact the great pit explosions have, with very few exceptions indeed, taken place not where there were goaves, but in the whole mine.

6022. In the case of the Haswell explosion, was not it supposed to have taken place close to the goaf? *T. J. Taylor, Esq.*

20th July 1849.

There is a difference of opinion about the cause of that explosion; after investigating the subject very closely, I really could not make up my mind as to where the explosion originated; the safety-lamps found in the broken were some of them twisted and bent by the effects of the explosion, but not injured in such a way as to lead to the supposition that they might have caused the accident, assuming any of them to have been injured before it took place.

6023. The immediate neighbourhood of the edge of the goaf is almost always the most dangerous part of a mine, is it not?

It is; but I have mentioned to your Lordships that the product of the goaf falls into the return, where it comes no longer in contact with naked lights.

6024. In bringing back the workings, so as to take the pillars, you must keep close to the edge of the goaf, must not you?

Yes.

6025. In those cases there must be great precautions adopted?

In consequence of the extra danger, safety-lamps are always used in fiery mines when the pillars are taken off; in mines not containing fire-damp, this precaution is, of course, unnecessary.

6026. Do you think that there is any possible arrangement by which more ventilation might be applied to the goaf than is now usual?

As a general rule, all the air that there is in the district passes ultimately over the goaf. I do not see, unless we get more air into the mine generally, that we shall get more into the goaf; the goaves at present are swept as far as is practicable by the air current, which cannot indeed pass freely through them, because heavy falls and subsidences of the roof take place, and bar up the passage; but it sweeps round the edge of the goaf, and has the effect in many cases of keeping the goaf remarkably free from fire-damp. I examined the goaves of the mine that your Lordship has just alluded to about a couple of months after the Haswell explosion, when an answer was to be written to the report of Messrs. Lyell and Faraday on the subject. I went to the upper edge of these goaves, where the gas, if any exist, will naturally be found; yet in that situation I found no gas, on trying it with a safety-lamp; and on further trial with a water-bottle and stop-cock fitted up for the purpose, and thrust up into the goaf, I still found no gas; in this particular case the air-current was effective enough to sweep the gas away.

6027. Is there not the greatest difference in the different states of the atmosphere?

That has been alleged as a cause, and I think it in many cases of consequence; if there is a lodgment of gas, for example, in a goaf, that body of gas is operated upon by the state of the barometer; if the barometer falls, a portion of the gas comes off by the enlargement of its volume; if the barometer rises, then the gas is compressed into smaller bounds, and ceases to issue; there are also some blowers that are affected in the same manner.

6028. Are your firemen in the habit of watching the variations of the barometer at all?

There is generally a barometer in the colliery office, and the viewer and the under-viewer consult the barometer frequently.

6029. And do they give directions accordingly to the firemen?

Not exactly that; common fluctuations are not noticed; but particular cases have occurred, where the viewer of the colliery, when the barometer fell suddenly, has given directions for the pitmen not to go to work.

6030. Have you ever observed whether these accidents occur more frequently at one period of the year than another?

I can produce a list, showing at what seasons, and in what states of the barometer, many of those accidents have occurred. So much has been said about the connexion of pit explosions with the state of the barometer, that, to test the

T. J. Taylor, Esq.
20th July 1849.

matter, I took out, with considerable pains and trouble, the great accidents that have occurred in Durham and Northumberland during the last 45 years, and I compared those accidents with the state of the barometer. I took the state of the barometer the day before the accident, the day of the accident, and the day after the accident, to show whether it was steady, rising or falling, at the time the accident took place; that account I have here, and will state the general results. The explosions enumerated are the principal ones which have occurred in our district during the last 45 years, and the result is this: it appears, first, that of 25 great explosions which have happened as described, 13 have occurred when the barometer was either steady or rising, and 12 when it was falling; and of the cases put down as falling, some may be regarded as stationary, the fall not having exceeded one-twentieth of an inch. Secondly, that the average heights of all the days of explosion are just about the average heights of the barometer in our district, or, we may safely state, something higher than the average; and, notwithstanding the numerous occasions during 45 years, when the barometer must have fallen below 29 inches, only one of these explosions has occurred when it was under that height, while several have happened when it was above 30 inches, and a considerable majority when it was above 29½ inches.

6031. How were those circumstances ascertained; how did you procure the observations?

I got them principally from a register, kept near to Newcastle, by Mr. Losh; partly, also, from the Register of the Newcastle Philosophical Institution, and from other sources on which I could rely.

6032. So that in all cases the barometer was on the surface?

Yes; the fluctuations are relatively the same in mines as on the surface, but they are something greater in amount, by reason of the greater atmospheric pressure.

6033. The barometer would stand permanently higher at the bottom of a shaft?

Yes, in our deepest mines about an inch and a half higher.

6034. And these are observations which have been regularly registered?

Yes; I have no doubt of the accuracy of the observations. From the list it is evident that the explosions enumerated are not to be explained by referring to the state of the barometer, since an equal quantity seems to have occurred when the barometer was steady or rising, as when it was falling. I have extended this list to a greater number of explosions, and the complete list contains 65 cases, the analysis of which is as follows: first, cases accompanied by a falling barometer, 33; secondly, cases accompanied by a state of the barometer either steady or rising, 32; and of those under the first head, there are four in which the fall of the barometer did not exceed one-twentieth of an inch, and 11 more in which it did not exceed one-tenth of an inch. The inference from the more extended list is, therefore, the same as from the shorter one.

The Witness delivers in the following Paper :

LIST of Great Pit Explosions during the last 45 Years.

The Barometric Observation nearest the Time of the Explosion is given in each Case, together with a Comparison of it with one the Day before and the Day after, to show whether the Glass was in a rising, steady or falling state at the time of Explosion.

| Date. | COLLIERIES. | Killed. | BAROMETRIC OBSERVATIONS. | | | Wind. | Weather. |
|---------------|------------------------|---------|--------------------------|-------------------|----------------------|----------|-------------------|
| | | | Day before Explosion. | Day of Explosion. | Day after Explosion. | | |
| 21 Oct. 1805 | Hebburn | 35 | 30.25 | 30.20 | 30.15 | N. | fair. |
| 29 Nov. 1805 | Oxclose | 38 | 29.90 | 29.40 | 29.03 | E. | fair. |
| 25 May 1812 | Felling | 92 | 29.90 | 29.85 | 29.80 | W. | fair. |
| 10 Oct. 1812 | Harrington Mill Pit | 24 | 29.35 | 29.35 | 29.30 | S. E. | fair. |
| 28 Sept. 1813 | Hall Pit, Fatfield | 32 | 29.95 | 30.05 | 30.20 | E. | fair. |
| 24 Dec. 1813 | Felling | 22 | 29.70 | 29.85 | 29.90 | S. E. | fair. |
| 2 June 1815 | Success Pit, Newbottle | 57 | 29.80 | 29.80 | 29.70 | W. | fair. |
| 30 June 1817 | Row Pit, Hanaton | 38 | 29.65 | 29.50 | 29.35 | S. W. | rain. |
| 18 Dec. 1817 | Plain Pit, Rainton | 27 | 29.20 | 28.40 | 28.70 | S. E. | fair. |
| 19 July 1819 | Sheriff Hill | 35 | 29.40 | 29.50 | 29.10 | S. | fair. |
| 23 Oct. 1821 | Wallsend | 52 | 28.90 | 29.00 | 29.25 | S. | fair. |
| 3 Nov. 1823 | Plain Pit, Rainton | 59 | 29.90 | 29.60 | 29.40 | S. E. | fair. |
| 17 Jan. 1826 | Jarrow | 84 | 30.35 | 30.25 | 29.95 | S. W. | fair. |
| 30 May 1826 | Townley | 38 | 29.75 | 29.75 | 29.65 | N. E. | fair. |
| 3 Aug. 1830 | Jarrow | 42 | 29.10 | 29.40 | 29.00 | N. W. | fair. |
| 9 May 1833 | Springwell | 47 | 29.85 | 29.60 | 29.75 | W. | fair (night wet). |
| 18 June 1835 | Wallsend | 102 | 30.00 | 30.11 | 30.10 | | |
| 28 Jun. 1836 | Downs Pit, Hetton | 22 | 29.91 | 29.62 | 29.34 | | |
| 6 Dec. 1837 | Springwell | 30 | 30.37 | 30.12 | 29.80 | | |
| 29 June 1839 | St. Hilda | 51 | 28.89 | 29.68 | 29.95 | | |
| 19 Apr. 1841 | Biggs Pit, Willington | 32 | 29.65 | 29.65 | 29.62 | W. | fair. |
| 6 Apr. 1843 | King Pit, Wreckington | 28 | 29.29 | 29.44 | 29.58 | W. N. W. | fair. |
| 28 Sept. 1844 | Haswell | 95 | 30.012 | 29.852 | 30.122 | W. N. W. | showery. |
| 21 Aug. 1845 | Jarrow | 39 | 29.47 | 29.81 | 30.05 | N. W. | fair. |
| 5 June 1849 | Hebburn | 31 | 29.90 | 29.88 | 30.08 | N. E. | dull. |

6035. The variations would differ in some degree with the amount of gas escaping from the coal, would they not?

Yes, to a certain extent; but the state of the barometer more particularly tells at less depths from the surface, where the fire-damp is not found in so concentrated a state; in shallow mines it affects more materially the discharge of fire-damp and also of carbonic acid gas. On the fall of the barometer, I have heard blowers begin to hiss and howl in a mine, so that it was possible to tell at once, without consulting the barometer, that the pressure of the atmosphere had diminished; but this occurs principally in mines where the fire-damp is not capable of assuming so high a tension as in deep mines, where it seems to possess a power of overcoming the mere variations of the barometrical atmosphere.

6036. Then should you say that in shallow mines the observation of the barometer would be a useful practice?

Yes, I should say so; for example, I have the management of a little colliery not far from my own residence, where there is no fire-damp, but where a great quantity of carbonic acid gas is discharged from the fissures of the roof; and after the glass has been high for some time, more particularly if a sudden fall takes place, I have sometimes had occasion to send word to the under-viewer to be upon the look out, knowing that there would be a great deal of "stithe" or carbonic acid gas discharged into the mine at that time.

6037. It has been suggested to the Committee that firemen might be provided with a barometer, upon which, instead of the ordinary words, might be marked "fire heavily," or "fire moderately," according to the state of the barometer; does it appear to you that such a plan would be desirable?

I am not averse at all to the adopting of any plan that may be useful; but I really must be permitted to say, that I do not think the one alluded to would be of much service: your Lordships perceive what the general result is of the comparison made with the state of the barometer.

T. J. Taylor, Esq.

20th July 1849.

6038. The facts to which you have alluded apply principally to deep mines, do they not?

The list given applies, of course, to all the mines in which the explosions occurred; but, generally speaking, deep mines are those most infested with fire-damp.

6039. Can you state what is the shallowest of those mines to which that statement would apply?

I should say, on looking over the list, between 50 and 60 fathoms.

6040. Do you look upon it, that, generally speaking, in such mines as those in the North, the furnace ventilation is sufficient for its purpose, if it is properly managed?

It is sufficient to procure a very good ventilation in the mine; that it is not sufficient to guard against explosion, is too evident from the results.

6041. Should you say that there is any hope of being able to apply any system which would secure a mine altogether from explosion?

I apprehend not; my own opinion is, that the extended use of the safety-lamp is calculated to be of more benefit than other proposed remedies. I do not mean to press this as the general opinion; but I have been led to entertain it from the investigations which I have made into the subject, and must candidly state my belief that the extension of the use of the safety-lamp is what we have principally to look to for the prevention of explosions.

6042. With respect to the safety-lamp, which do you most approve of, the common Davy lamp?

There have been several very useful and ingenious lamps invented; but I feel called upon to state, that I have the most perfect confidence in the security of the Davy lamp, and I formed this opinion on the experience of so many years in our own district. I believe that the viewers of the North of England will concur in this statement without one exception. One, for example, to whom I spoke before leaving, said to me, "If their Lordships ask concerning the safety of the Davy lamp, you may state that we have taken off 1,000 acres of pillars during the last 30 years, and used nothing but Davy lamps all that time, without one accident happening." The colliery alluded to is Walker Colliery.

6043. But there are conditions under which Sir Humphrey Davy himself admitted that there was danger in the use of his lamp, are there not?

Yes; but these are not cases of practical occurrence; nor have other experiments on the subject had a sufficiently practical bearing, but are open on this ground to substantial objections; the common street gas was, for instance, used in those experiments; yet this is not the fire-damp of coal-mines, but (in considerable portion at least) a much more inflammable gas; the fire-damp of mines is light carburetted hydrogen, containing, it appears, from recent experiments, a little olefiant gas, but in so small a quantity as not sensibly to affect the qualities of the mixture; and as the light carburetted hydrogen is understood to be the least inflammable of the gaseous compounds of carbon and hydrogen, a lamp that may be safe when exposed to the fire-damp of mines, may not be so in the case of the heavy carburetted hydrogen gases, or in pure hydrogen gas.

6044. What is the difference between the light carburetted hydrogen, of which you speak, and the gas of the streets?

One contains a larger proportion of carbon; the fire-damp contains the least, and is much the lightest gas of the two.

6045. Is not the Davy-lamp certainly exposed to danger in a strong current?

In a current of mixed coal-gas, or street-gas the flame has been made to communicate.

6046. Should you say not of the common explosive gas?

I should say not.

6047. Have you ever made any experiments upon that subject?

Practically I have, by trying the Davy lamp under-ground in the fire-damp of mines, by waving it backwards and forwards, and by walking about in a foul part amongst the mixture.

6048. When

T. J. Taylor, Esq.
 20th July 1849.

cracked in that way ; it sometimes happens, when the glass gets very hot, and a little water comes upon it, that it cracks directly ; there was no water, however, near this lamp : if there had been water suddenly poured upon it, I am afraid that the glass, instead of the effect being confined to what is now seen, and which is not sufficient to cause explosion, might very likely have been not merely cracked, but broken.

6062. You think it would have fallen to pieces ?
 I think so.

6063. This appears to be just as firm as if it were not cracked ?
 Yes, it is remarkably firm ; it may be a matter of speculation whether it would not be better to have it in that state to begin with ; it might prevent its cracking again if it were so.

6064. Was it by the heat ?
 By the mere action of the heat ; the thick glass is very liable to crack, because with the flame acting on the inside, the interior of the glass gets into a greater state of expansion than the outside ; it is just upon the same principle that a tumbler of thick glass is more liable to crack when you pour hot water into it than one of thin glass.

6065. Do you think talc as objectionable as glass ?
 It is not so brittle ; I do not know whether talc could be had in sufficient quantity.

6066. It is practically applied in the case of Mr. Biram's lamp, is it not ?
 Yes ; I have seen a lamp with talc in it ; it is not liable to the same objection as glass ; it is not so brittle ; but neither is it so transparent as glass.

6067. The light from a lamp of the description of Dr. Clanny's is very good, is it not ?
 Yes, it is very good.

6068. You have given some attention to another mode of ventilating besides the furnace, namely, the steam-jet, have you not ?
 Yes ; I have been at Seaton Delaval ; once I met Mr. Dunn and several other gentlemen there, and I afterwards returned to inquire more particularly into the subject. On the last occasion I went down the pit to try some experiments, and these experiments I have put down in writing.

6069. Will you explain to the Committee the mode in which you instituted those experiments, and what was the result of them ?
 There are four downcast shafts at Seaton Delaval ; they are each eight feet in diameter, and there is one upcast.

6070. That is eight feet too ?
 Eight feet also in diameter. There are, likewise, two other shafts ; but at present they are shut off from the general ventilation, so that they do not concern this question. First of all, when I went to the colliery on the 15th, I found that the jets which had been put in at the bottom of the upcast shaft were at work, and that the engine which stands at the bottom of the same shaft, the under-ground engine, for the purpose of getting the coals from the inner districts of the mine, was not at work at that time, so that the jets were doing the work of ventilating the mine, along with the heat that arose from the firing of the steam-boilers.

6071. The ventilating-furnace was not in operation ?
 No ; there were two fires underneath the steam-boilers.

6072. For the purpose of heating the boilers ?
 Yes, for the purpose of raising the steam. I ascertained first of all the temperature of the upcast shaft, and found it to be 151 degrees, which is a very considerable temperature ; there are, indeed, few upcast pits in the trade that have a higher temperature ; the Haswell temperature just now is 163, which is higher, but there are not many other pits with so high a temperature.

6073. Is that the average or the heat at the bottom ?
 The heat half-way down ; I have generally found that the heat half-way down is very nearly the mean temperature of the shaft. I had tried the heat two days before,

before, when the engine and jets were both on, and I found it to be 147, which is a little lower; the inference I drew from this circumstance was, that as much coal was being used at the time of the experiments as when both engine and jets were on, the temperature of the shaft being the same, and the volume of air, as was afterwards found, not very materially different. After ascertaining the temperature of the shaft, I went down the pit, and measured the air-currents that were passing; after collecting them together, the aggregate result was 77,455 cubic feet per minute. Now, assuming that the same quantity of coal was used during the time the jets were on, as was used for both engine and jets, the grounds of which I have stated, this quantity was 20½ lbs. of coal per minute, which gives 3,778 cubic feet per minute per lb. of coal. Now when the furnace only was on, the quantity of air is stated to have been 48,948. I had no opportunity of trying this, but got the information from the officers of the mine; and as 7½ lbs. of coal were consumed per minute by the furnace, this gives 6,526 cubic feet per minute per lb. of coal, which is a better result with the furnace than with the jets.

T. J. Taylor, Esq.

20th July 1840.

6074. So far as respects the power obtained from the coal, it would appear to be nearly double?

It is as 3,700 is to 6,500. Then I went further with the experiment; the jets were stopped entirely, and the steam being turned off, escaped into the ordinary flue of the furnace through the usual escape-pipe of the engine.

6075. Can you say how long it was after you shut off the steam that you tried the velocity of the current?

Immediately afterwards; on trial being made, the velocity of the air-current was found to be not sensibly different from its velocity during the operation of the jets.

6076. Would not the momentum be continued for a considerable time?

That is a question of rather a complicated character, and one which, in the present state of our knowledge, it would be very difficult to answer definitely. I believe, however, that the velocity of the air would keep it in motion a certain time, though not to the same extent as before the withdrawal of the power.

6077. Since it appears that there was a current of 77,455 cubic feet in action from the jets and the boiler fires, and the experiment of which you speak was made immediately upon the removal of the jets, would not it be likely that the momentum of a current, such as you have stated, would continue sometime after the cause which produced it was removed?

I do not think it would; I do not mean to assert my opinion very strongly, but my argument is founded upon the great resistance which the air current has to encounter in the mine; that resistance is very considerable, and I think it would at once have operated as a check, after the shutting of the jets.

6078. Was the whole steam delivered in the passage in which you tried the air?

It was delivered into the furnace flue through a four-inch pipe.

6079. Are you aware, from observation, that after a furnace is extinguished, the momentum generated by its action in the current of air still continues for a considerable time?

I am not aware that the momentum continues long; the current does continue, but I ascribe its continuance to the circumstance that the heat continues in the shaft.

6080. After a powerful ventilating furnace has been in action some time, there must be a considerable accumulation of heat?

Yes, a very great accumulation.

6081. Therefore, you would attribute the continuance of the current to the action of that heat?

Yes.

6082. How long is it after the furnace is first lit before the action of it is felt?

Presently, as soon as the air gets heated in the shaft. The first air, in point of fact, that passes over the furnace is warmed, and that warmth produces a

(164. 17.)

4 B

rarefied

T. J. Taylor, Esq. rarefied column ; the action is the same as in lighting a common fire ; as soon as the air feels the first heat, the current begins to pass up the chimney.
 20th July 1849.

6083. Have you ever seen lead melted in the upcast shaft ?

Yes ; I have melted lead myself in an upcast shaft, at the bottom.

6084. At what heat ?

About 620°, I think ; I do not recollect exactly, but I think that is the temperature of melted lead.

6085. Are you acquainted with the colliery immediately adjoining the Seaton Delaval, namely, Seghill ?

Yes.

6086. Can you give us any information as to the ventilation of that colliery ?

Yes, I have some particulars of it.

6087. Has it sufficient ventilation ?

The colliery is well ventilated.

6088. Can you say what is the amount of velocity of the current ?

Yes, I have the particulars here, as procured by me a few days ago : Seghill Colliery, Minutes on Ventilation, July 17, 1849. The downcast shaft is 11½ feet in diameter ; the upcast shaft is 9 feet in diameter ; the temperature of the upcast pit at the bottom is 130, and at meetings, that is half-way up the shaft, 122. There are stated to be five currents of air, and that the mean distance run by each is two miles ; the quantity of air in each run is also stated ; the gross quantity of air is 42,708 cubic feet per minute, and the aggregate sectional areas are 188 feet.

6089. Is the consumption of coal given in that paper ?

Yes ; the coals consumed in 24 hours by one furnace seven feet in breadth, with a fire surface of 35 square feet, are 60 cwts., or $4\frac{1}{10}$ ths lbs. per minute ; the quantity of air per minute per pound of coal is therefore 9,087 cubic feet.

6090. That is with the furnace alone ?

With the furnace alone by the combustion of 60 cwts. of coal in the 24 hours.

6091. In the Seaton Delaval case, where the jets were extinguished, the steam was still allowed to escape from the boilers ?

Yes.

6092. Where did that steam escape ?

It escaped from the safety-valve by the waste-pipe ; that waste-pipe was a 4-inch pipe communicating with the furnace flue, and entered the flue nearly at right angles, but with a very slight inclination towards the pit.

6093. Therefore the escape of the steam into that furnace flue in its ordinary way from the boilers would tend so far to raise the temperature of the air in that flue ?

Decidedly, and also in the shaft.

6094. Then how do you allow for that in the comparison which you made just now between the jets when they were in action, and the current remaining after the jets were extinguished ?

I found the current the same after the jets were extinguished as before ; there was no sensible difference between the two.

6095. It was measured in the same passage in both cases ?

Yes.

6096. Was it in the same passage that the jets played in ?

No ; it was in a different part of the mine, not far from the bottom of the downcast shafts.

6097. Did you make that comparison only immediately after the jets were extinguished ?

Immediately after the jets were extinguished.

6098. Not at a later period at all ?

Not at a later period.

6099. And you are unable to say how long the momentum would continue?

T. J. Taylor, Esq.

I cannot; I am not aware, in fact, that there have been any experiments made upon such a subject?

20th July 1849.

6100. When you state that you measured the current of air in a different part of the mine, you mean in a different part of the mine from the point at which the jets were in action?

Yes, quite at a distance from it.

6101. Was it at the bottom of the downcast shaft that you made those measurements?

Not very far from the bottom of the downcast shaft.

6102. And in both cases at the same point?

At the same point precisely.

6103. So that the measurements which you took were those of the intake current of air?

Exactly.

6104. Did you ascertain when the jet was applied, and produced a current of 77,455 cubic feet, what amount of coals was consumed in the course of an hour?

I judged of that from the temperature of the shaft.

6105. That was a matter of calculation?

That was a matter of calculation; I concluded as the volume of air was very nearly the same, and the temperature of the shaft a little higher than it was before, that the same quantity of coals was used.

6106. Was any statement made to you as to the amount of fuel?

Yes, that there were eight tubs in 12 hours used in the ordinary way for the jets only.

6107. Eight tubs in 12 hours would be how much per minute?

When the engine and jets are both on, the consumption of coal is at the rate of 20½ lbs. per minute; with the jets only, the consumption was stated at the rate of 7½ lbs. per minute. Though the consumption for the steam-jets only is given at 7½ lbs. per minute, yet it must be inferred, on the grounds I have stated, that during the experiment of the 15th, as much coal was being consumed as is customarily used for both engine and jets.

6108. Do you know at all upon what grounds the statement was made that it was only 7½ lbs.?

It was given to me as the account that had been kept by the persons who fired the engine; the experiments made, must, I may remark, go for what they are worth; I have not the least wish to oppose Mr. Gurney's plan, and shall be glad to see it further tested at the same colliery.

The Witness delivers in the following Paper:

15 July 1849.

Account of Trials with Steam Ventilation at Seaton Delaval Colliery.

| | |
|--|-------|
| Temperature of air at the surface - - - - - | 62½° |
| Temperature of air at the bottom of downcast pit - - - - - | 62½° |
| <hr/> | |
| Sympiesometer at bottom of downcast - - - - - | 30.55 |
| Ditto - - ditto in return near upcast - - - - - | 30.45 |
| <hr/> | |
| Difference - - - - - | 0.10 |
| <hr/> | |

Temperature of upcast shaft at 53 fathoms from surface, being half way down 151°
 Temperature of upcast shaft observed on the 13th instant, when under-ground engine was going, and jets on - - - - - 147°

There are four downcast pits, each eight feet in diameter, and 50½ square feet area, but, allowing for slides and fittings in the shafts, the joint area is 179 square feet.

One upcast pit, eight feet in diameter, 50½ feet area, at the bottom of which are 25 jets of steam, each one-fourth of an inch in diameter, the joint area being 1.23 square inch: there are also four other jets, being those first made use of.

There is also an engine-pit and a former upcast pit, neither of which is connected with the present general ventilation. The latter is to be fitted up with 26 steam-jets in the furnace-

T. J. Taylor, Esq.
20th July 1849.

drift, each three-eighths of an inch in diameter, equal to .11 area each, and joint area 2.86 square inches. The steam is to be supplied from a boiler, at the surface, 30 feet long by six feet in diameter.

In C D pit there are two air currents, one of $2\frac{1}{2}$ miles, with four-fifths of that pit's air, and one of $1\frac{1}{2}$ mile, with one-fifth of that pit's air; mean area about 38 square feet.

In E F pit there is one current $2\frac{1}{2}$ miles long; mean area 40 feet. There are also two other currents, one to the South Way $\frac{3}{4}$ ths mile and 36 feet area, and one to the Prospect Way $\frac{3}{4}$ ths mile and 30 feet area. A part of the South Way air passes to the under-ground engine by a very short run, not more than four chains to the shaft. The mean length of air channels is, therefore, $1\frac{1}{2}$ mile, and the aggregate area is 182 square feet. I exclude the engine air, as having so short a run as not to be worth noticing.

The following are the quantities of coal stated to be used :

First. On the 30th June the steam-jets and engine fires were laid off work, and the furnace was lighted until the 2d July : the coals consumed by the furnace were at the rate of 96 cwts. in 24 hours, equal to four cwts. an hour, and $7\frac{1}{2}$ lbs. per minute.

Second. When the furnace is off, and the engine and steam-jets are at work, 132 cwts. are used in 12 hours by engine and jets jointly, and by the jets only 48 cwts. are stated to be used during the remaining 12 hours ; so that when the engine and jets are both on, the consumption is at the rate of $20\frac{1}{2}$ lbs. per minute ; but, with the jets only, the consumption is at the rate of $7\frac{1}{2}$ lbs. per minute.

Third. Though the consumption for the steam-jets only is given at $7\frac{1}{2}$ lbs. per minute, yet it must be inferred, that during the experiment of the 15th as much coal was being consumed as is used for both engine and jets. The proof of this is, that the temperature of the upcast shaft was four degrees higher on the 15th than on the 13th, though on the 13th both engine and jets were in operation. This circumstance, together with the large quantity of steam issuing from the waste-pipe (four inches diameter) into the flue during the time of the experiment, must be held sufficient to show that at least the same quantity of fuel was being used as is consumed by both engine and jets ; that is to say, a quantity of $20\frac{1}{2}$ lbs. per minute.

The steam worked with was 33 lbs. per square inch.

The following shows the quantity of air in circulation on the 15th :

1. Engine plane :

| | Sq. Ft. | Cubic Feet per Minute. |
|---|---------|------------------------|
| Mean area - - - - - | 68.02 | |
| Mean velocity feet per second - - - - - | 6.50 | |
| Quantity - - - - - | | 26,473 |

2. West Way :

| | | |
|---|------|--------|
| Mean area - - - - - | 53.3 | |
| Mean velocity feet per second - - - - - | 7.0 | |
| Quantity - - - - - | | 22,574 |

3. Prospect Way :

| | | |
|---|------|-------|
| Mean area, square feet - - - - - | 37.0 | |
| Mean velocity feet per second - - - - - | 1.5 | |
| Quantity - - - - - | | 3,249 |

4. South Way, engine and stables :

| | | |
|---|------|--------|
| Mean area, square feet - - - - - | 60.0 | |
| Mean velocity feet per second - - - - - | 5.0 | |
| Quantity - - - - - | | 18,000 |

5. Water Level Way :

| | | |
|---|------|-------|
| Mean area, square feet - - - - - | 34.8 | |
| Mean velocity feet per second - - - - - | 3.43 | |
| Quantity - - - - - | | 7,159 |

77,455

As $20\frac{1}{2}$ lbs. of coal are consumed per minute, this gives, for the above quantity of 77,455 cubic feet, 3,778 cubic feet per minute per pound of coal.

When the furnace only was on, the quantity of air is stated to have been 48,948 cubic feet per minute, with $7\frac{1}{2}$ lbs. of coal, being 6,526 cubic feet per minute per pound of coal.

In corroboration of the foregoing statement, it must be added, that the jets were stopped, and, on trial being made, the velocity of the air-current was found to be not sensibly different from its velocity during the operation of the jets.

During the closing of the jets the steam escaped by the waste-pipe into the furnace-flue, as already mentioned.

6109. The result of your examination upon that occasion would be, that although the jets produced a much larger current than the furnace alone, the consumption of fuel in proportion to the amount of current was greater?

So I inferred from my experiments.

6110. Can

6110. Can you say what the highest temperature is that you have known in an upcast shaft? *T. J. Taylor, Esq.*

The highest temperature that I have had an opportunity of observing at the bottom of the shaft has been when I have melted lead; but that was a case where the furnace-flue and the engine-flue (for there were both an under-ground engine and a furnace—I am speaking of the old shaft at Earsdon Colliery) were both joined together at the shaft, and the heat was consequently very intense; but the medium temperature of the same pit half way up was not more than 152°.

20th July 1849.

6111. Generally speaking, you find that the temperature half way up the shaft is about the medium?

Very nearly; I had it tried at Haswell by intervals, and found that the half-shaft temperature was very nearly the medium temperature of the pit.

6112. In the first experiment at Seaton Delaval in which the jets were in action, but without the furnace, what caused the very great increase in the consumption of coal over that which took place when the furnace alone was in action; it appears that in the first instance there were 20½ lbs. per minute consumed, and in the second case there were only 7½?

I conclude that the rate at which the engine-boilers were being fired at the time was the cause.

6113. Were the engine-fires very much larger than the ventilating furnace?

No; but the fires are very brisk, and consume a great quantity of fuel.

6114. Should you say, from what you saw of those fires, and their appearance, that it was probable that there would be a difference of nearly two-thirds in the amount of coal consumed in a given time by the two fires?

The coals consumed by the furnace were at the rate of 7½ lbs. per minute; and when the furnace was off, and the engine and steam-jets both on, 132 cwts. were used in 12 hours, which is at the rate of 20½ lbs. per minute.

6115. Was the steam for the jets merely the escape of steam from the engine?

No; the arrangement for the jets is an express one.

6116. Are there separate fires for the purpose of supplying the jets?

No; the jets are from the engine-boilers, but supplied by a separate pipe; the original jets were worked with the exhaust steam of the engine; but the jets more recently fitted are worked by steam direct from the boiler.

6117. The only fires in the second case were the fires heating the boilers?

Exactly; there was no furnace-fire.

6118. You have calculated the whole consumption of fuel for the general purposes of the steam-engine?

Yes; I have stated my reasons for doing so.

6119. Would there be no reason to suspect some error in a disproportion like that between 7½ lbs. and 20½ lbs. per minute?

That is what is stated here. When the engine and jets are both on, the consumption is at the rate of 20½ lbs. per minute. The particulars were given to me by the officers of the colliery; 132 cwts. are stated to be used in 12 hours by both engine and jets, and by the jets only 48 cwts. are stated to be used during the remaining 12 hours; so that when the engine and jets are both on, the consumption is at the rate of 20½ lbs. per minute; but with the jets only the consumption is at the rate of 7½ lbs. per minute.

6120. According to the facts which you have given, if correct, it is quite clear that the power obtained by a certain weight of fuel is much greater in the case of a furnace alone than of the jets?

So it would appear.

6121. But it appears to be a very large disproportion?

I may observe, that the quantity of fuel which I have taken there is, of course, assumed; I assumed it from the circumstance of the temperature and the volume of air in the upcast shaft being the same. I do not put this in as a conclusive statement, but I think it is, on the whole, best to put it upon record. A boiler is being put up at another pit at Seaton Delaval, from which a pipe will be

F. J. Taylor, Esq. conveyed down to the bottom of the shaft, and the steam-jets will be fitted up there; that arrangement will try the matter conclusively.
 20th July 1849.

6122. Supposing two given fires of a certain size, the one merely used as a furnace to heat a current of air passing over it, the other used to generate steam; besides heating whatever current of air must necessarily pass over it, would not there necessarily be a considerable absorption of heat in the latter case, by the very act of generating the steam, which would pass off in the current of air in the other case?

Yes, a good deal of the heat that is absorbed by the steam becomes latent.

6123. That, then, would in itself account in some degree for obtaining only the same temperature in the shaft in the case where the engine-fires were in action as in the case where you had the furnace in action?

Yes, that would account partly for it, part of the heat being still latent.

6124. Part of the heat is absorbed by the steam?

Yes.

6125. Whereas, in the other case, all that is generated would pass off?

Yes, without waste; a great advantage possessed by the furnace is the simplicity of its application; as no machinery or apparatus is interposed, there is no waste by friction, a property which the steam-jets do not possess.

6126. The problem would be to ascertain whether the amount of mechanical ventilation obtained by the force of the jet was sufficient to counterbalance the loss of heat by the consumption of a portion of it in generating the steam itself?

Yes; the direct experiment is to be tried at Seaton Delaval, and I do not state my opinion as at all conclusive upon the subject until the result of that experiment is known; the entire matter is yet in embryo, and there cannot be a definitive opinion given about it until further trial is made.

6127. You were there upon two occasions, were you not?

Yes.

6128. Are these the results of experiments upon the last occasion?

Upon the last occasion.

6129. On the first occasion that you went, did they resemble these at all?

I did not try any experiments upon the first occasion when I was there; I merely went to see some parties who were there.

6130. One fact, at least, seems to have been ascertained, namely, that with the jets in action, and the engine-fires together, a current of 77,000 feet per minute was obtained; do you know at all whether it would have been possible to obtain that same current from the furnaces alone?

So far as the experiment goes, it certainly would, because we have here, by the consumption of a pound of coal by the furnace, a certain duty performed, and by the consumption of a pound of coal by the engine and the jets a less duty is performed; therefore the inference is, that if the furnaces had been applied to the duty, quite as great an effect, and even a greater effect, according to the proportions put down, would have been produced.

6131. Do you conceive that you would have had the power of raising the furnace to so high a point as to furnish that current?

Probably there would have been two furnaces in that case; it is very possible to raise a temperature of 151 in a shaft with a couple of furnaces.

6132. But with this furnace as it stood there, you would not have been able to raise the consumption of coal from 7½ lbs. to 20½ lbs. a minute?

No, not as matters stood; the same ventilation would not have been got with one furnace as with the engine-fires and the jets.

6133. Are the furnace-fires larger than the engine-fires?

A good deal larger; but there is not the same briskness of current.

6134. Was there any jet to generate the current for feeding the fire?

None.

6135. Do you know what the pressure was?

Thirty-three pounds to the square inch; that, I think, is the highest pressure which can just now be attained; the weight of the safety-valve will not go higher.

T. J. Taylor, Esq.

20th July 1849.

6136. Was that more than had been usually put upon the engine?

It is not higher than it is common to employ in high-pressure engines, which, in our district, are usually worked from 25 lbs. to 35 lbs.

6137. On the occasion when you made these observations at Seaton Delaval, were they using the engine at the time?

They were not.

6138. Would it be possible for them to obtain the power, of which you have spoken, from the steam jets in that case, and at the same time to work with their engine?

Not without additional fuel.

6139. Then the additional fuel would not be applicable to those boilers?

No; it requires so much more fuel; part of the fuel would then be required in working the engine, and part in working the jets; there is an additional expenditure of steam.

6140. Do you consider, then, that in that case it would be necessary to have a boiler expressly for the jets themselves?

Yes; I think it will be necessary to have a separate boiler.

6141. Were you in the workings during the time that the jets were in action?

I was not; I was not further than about 300 yards from the shaft; I went only so far as was necessary to ascertain the aggregate quantity of air passing through the mine.

6142. Have you ever seen any other mode adopted for obtaining a powerful ventilation?

The only mechanical means now employed in the North is of a very trifling description; we use a little fanner sometimes for driving air through air-boxes, but it is so trifling an apparatus as to be hardly worth mentioning; the various methods in use have been superseded, by common consent, as it were, by the furnace, which may now be considered as the only ventilating power of our district.

6143. Are the furnaces kept up day and night?

Yes.

6144. Is not there this objection to the furnace, in some cases where there is a considerable discharge of gas, that the foul air passing over the furnace at the end of its course, if it should be much mixed would incur some risk even then of explosion?

There was a risk of this nature in former times, when only a single current of air circulated in the mine, and became loaded with its gaseous products; but now the various runs on their return to the shaft are so much mixed with other airs, that there is very little fear of an explosion at the furnace.

6145. Have you had any acquaintance at all with any other districts besides the North?

I have examined mines in Lancashire and in South Wales, but principally in Durham and Northumberland.

6146. Do you find the systems very inferior there in respect of ventilation?

Yes, I should say that they are.

6147. Is less attention paid to the subject?

Less attention is paid to the subject; their system is less perfect than ours.

6148. Have you met with many cases where there was no artificial ventilation at all?

Yes, I have met with many cases.

6149. Should you say that there were any cases in which a mine at all

(164. 17.)

4 B 4.

liable

T. J. Taylor, Esq. liable to a discharge of gas, could be properly ventilated without some artificial apparatus?

20th July 1849.

I should say not.

6150. Have you ever paid any attention to the question of an inspection by Government?

I have; I have had occasion to give some attention to the subject, partly in consequence of my connexion with the Coal Trade Committee in the North of England, the subject having been discussed in that Committee.

6151. What is the opinion entertained there with respect to such a proposal?

The subject is of a difficult and delicate character, and the interests concerned are of great magnitude, the capital embarked in the coal trade of the United Kingdom being, by a probable estimate, about 30 millions. On the entire matter a great difference of opinion prevails; but the coal-owners of Northumberland and Durham would not, I believe, as a body, object to a system of inspection, provided it were not of a compulsory character.

6152. Do you think that, supposing Inspectors were appointed with a right to examine the state of the mines, and to look at the plans, in order to ascertain their internal arrangements, there would be much objection felt to that?

I do not think there would; of course it must be understood that the Inspector would not make use of the information procured by him in that manner, for any other purpose than the strict and legitimate one of his own occupation.

6153. But there would be an objection to his having any power to direct? Decidedly an objection.

6154. Do you think that that is the general view of the matter among the coal-owners?

I think it is, so far as I have had an opportunity of ascertaining their sentiments.

6155. Do you conceive that, supposing well-qualified persons were appointed for that purpose, they might effect good by communicating with the colliery owners in different parts of the country?

Yes; I think they might be of service, more particularly in other districts; I do not know that they would be of much service in our district.

6156. In those districts where there has been least attention paid to the proper management of mines?

Yes; I think that men who are conversant with the best practical systems in operation might be of service in particular districts of the Kingdom.

6157. Would such a system of inspection give satisfaction generally to the working men?

I think it would; they seem anxious to have such a system established.

6158. Do you issue any printed regulations in the collieries which you manage?

With respect to the safety lamps, there are printed regulations; as regards other matters, printed regulations are not issued.

6159. Do you enforce the observance of those regulations very strictly? Very strictly as regards the safety lamps.

6160. By what means are they enforced, by penalties? By penalties, and by legal prosecutions.

6161. Do you think it would be easy to get a sufficient number of practical men, in whose judgment you could confide, to survey the numerous collieries throughout the Kingdom?

I do not doubt that many competent men would be glad to accept of such situations, and do not know that there would be much difficulty in finding suitable parties; I do not think there would.

6162. Do you conceive that it would be necessary, in order to enable a man to discharge his duty properly as an Inspector of mines, that he should have been for a very long time in charge of collieries?

I think

I think he should be thoroughly conversant with the systems of working and conducting mines now in use. *T. J. Taylor, Esq.*

20th July 1849.

6163. Supposing that Inspectors were appointed without the concurrence of the owners of collieries, and rather against their consent, would it be in their power very much to impede and to neutralize the exercise of their duties?

It would certainly be in the power of owners of collieries to throw obstacles in the way if they thought fit.

6164. The question supposes the case of Inspectors being appointed in opposition to the wishes, and with powers rather offensive to the colliery owners?

Yes; I think that they might throw great impediments in the way of the proper performance of the Inspectors' duties.

6165. Should you say that it would be possible for them to perform their duty in such a case, if the owners of collieries were determined to place impediments in their way?

I conceive that it would be scarcely possible for them to do so.

6166. Supposing, that although entrance were given to the mine, facilities were not given of going over it, would it be possible for the Inspector rightly to discharge his duty?

No; unless the owners of collieries go heartily into the matter, I do not think that much good is to be done.

6167. What is the general condition of the education of the miners in the North?

The state of education is better than it was; schools are very generally established in the neighbourhood of collieries, and there is a general improvement in point of education, as well as in the habits of the mining population of our district.

6168. Looking to the causes of accidents, do you think that improved education would have any effect in diminishing the dangers which are incurred by the workpeople?

Whatever contributes to render men more intelligent, I conceive, would have that tendency.

6169. In your opinion, would it be desirable to give them some elementary knowledge of mechanics and chemistry, and so forth, bearing upon their own pursuits?

Yes; I think it would be useful to give them a knowledge of these subjects; such a knowledge as bears upon their own occupation.

6170. Have they such facilities at present?

They have not.

6171. Do not the Mechanics' Institutes give them to them?

The colliery population is scattered in pit villages throughout the country, and not generally within reach of Mechanics' Institutes.

6172. Is not there one in every town?

In Newcastle there are several excellent institutions; but the mining population is not generally, as I have said, within reach of those institutions; their condition is, however, so much improved, that the pitmen may now be fairly considered an intelligent, as they are certainly a very deserving body of men.

6173. And desirous of instruction, are they not?

Much more so than formerly.

6174. They are generally men in good health, are they not?

Yes; the medical men who attend them state that their health is unusually good, and cite as a proof of this, the facility with which the wounds and bruises received in their occupation are healed.

6175. Are they not liable to pulmonary complaints?

No; pulmonary complaints are remarkably rare among them.

6176. As to the time that the survey of a pit would take, what staff would be necessary to survey all the pits in England, do you think?

That would be a very extensive operation; of course the time required in each particular case would depend upon the extent to which the workings had been carried.

T. J. Taylor, Esq.

20th July 1849.

6177. A man would not undertake more than one large mine in a day, would he?
The question concerns the number of Inspectors; if we attempted to calculate the Inspectors or Sub-inspectors for the Northumberland and Durham Coal-field only, there are about 120 collieries in that district, and more than that number of pits, because there are in particular cases two or three pits at one colliery; assuming that there are 150 pits, and supposing an Inspector or Sub-inspector to go down a pit twice a week, having on other days to move about and to attend to his plans and office-work, then for one man it would take 75 weeks to go down the 150 pits; for two men it would take 38 weeks; for four men 19 weeks; and for eight men about 9½ weeks; so that eight Inspectors or Sub-inspectors might be able to visit each mine in our district every two or three months.

6178. Do you think that the colliery owners would agree to Sub-inspectors?
I assume them to be competent and respectable men.

6179. To the Inspectors themselves they might have no objection, but a Sub-inspector is of a different class?
I have put the Inspectors and Sub-inspectors into one class.

6180. In Cumberland there are about 40 pits, producing about a million of tons of coal in a year; how long would that take inspecting; how many men would be required?

According to the proportion which I have mentioned, namely, eight men for Durham and Northumberland, it would be two for Cumberland; that is about the same proportion.

6181. What class of men do you think would be the most fit for the office?
They should be, I apprehend, men who are conversant with the practical details of mining?

6182. Would you take them from colliery viewers?
It might be necessary; I should say that the colliery viewer would be the fittest man to inspect coal-mines. I should say that the Inspector ought to be taken from that class of men, who knows the subject best practically; and I apprehend that to be thoroughly conversant with the practice is of more consequence than to have a merely scientific man. I think good may be done by communicating the information of one district to another by men acquainted with and competent to appreciate the systems of working and ventilation in use.

6183. It is generally said, that the smaller collieries are in the worst state as to ventilation; is that your opinion?
Yes, it is frequently the case.

6184. Would the expenses be great to put those small collieries into a better state of working?

In some cases they might, so far as it depends upon providing an artificial means of ventilation; a furnace, for example, that is not a very expensive addition.

6185. But supposing a colliery where there was no furnace, and that the atmosphere of that colliery was in a dangerous state, supposing the lives of a great number of people to be periled every day, would not that be a sufficient reason for some interference, in order to induce the proprietor to take the ordinary steps for the efficient security of a mine?

Yes, supposing the case to exist.

6186. If increased expenses were to come upon the small pits, do you think that any of them would be shut up?

I very much fear so, especially at the present time, when the trade is so depressed.

6187. It is only by great economy that those little ones exist?

It is, and they cannot bear additional expenses; speaking generally of the coal-trade just now, it is a profitless adventure.

6188. In those districts?

In our districts.

6189. Then

6189. Then is it your opinion, that if much alteration were required in the pits now, it would be impossible to effect it, in consequence of the state of the trade?

T. J. Taylor, Esq
20th July 1849.

I think so; additional cost must, as far as possible, be avoided; the trade is extremely sensitive of any additional expense.

6190. Should you say that the placing a mine in a state where great security can be attained against the occurrence of accidents is a considerable saving?

Such cases may be; there may be a false economy in not doing certain things, and under the existing system great pains is taken on this account; for instance, it was given in evidence yesterday, that so much care is taken at Jarrow Colliery, that no naked light is allowed to go beneath the shaft.

6191. Is not an accident a considerable expense to the owner of a mine?

It is; and besides the direct expense, it injures the character of the mine, and operates in raising the wages that have to be paid to the workmen.

6192. Therefore colliery owners have a direct interest in preventing accidents to the utmost of their power?

Decidedly.

6193. And it might be worth while in many cases to incur some little additional expense, such as that of a furnace, in order to render the system secure, if they could feel that that was the result?

Yes, in those cases where the defects are very great.

6194. There is another description of accidents which you mentioned among those that you enumerated at the beginning of your evidence, namely, accidents from falling down the shafts; have you known many cases of that kind?

Yes, there are many cases of men falling down the shaft, and being killed in the shaft; formerly several were killed by falling out of the loops; that is not so frequent now, on account of the general adoption of slides and cages; there are also many cases of deaths in sinking pits, or pits being sunk down to the coal.

6195. Any by the breaking of the ropes?

Exceedingly few; at the 55 collieries to which I have referred, there were only three in six years.

6196. Do the men stand at the bottom of the shaft to load the cage?

Yes; the onsetter is at the bottom of the shaft for this purpose.

6197. Are they not in danger of any coals or things that might fall down?

Yes; but they know the danger, and are on their guard against it; they do not stand quite under the bottom of the shaft.

6198. Do you know an invention which has lately been introduced into some of the collieries in the North by Mr. Fourdrinier?

Yes; I have not seen it in actual operation; Mr. Fourdrinier brought a model, which I saw.

6199. You did not see it in action at Mr. Elliot's colliery?

No, I have not seen it in action.

6200. Do you think well of it?

Yes; I think it is calculated to be useful; but, as I said just now, there are not a great number of men lost in our district by the breaking of ropes.

6201. Have any of the mines with which you are connected been on fire?

Yes, Whitley Colliery was on fire in the year 1839.

6202. What means have you generally adopted for the extinction of the fire?

We shut the district off entirely by closing it with solid stoppings. In the case mentioned, the stoppings were of stone four or five feet thick, and perfectly air-tight; in this state the mine was allowed to remain eight or nine weeks, and then opened out, when the fire was found to be entirely extinguished.

6203. Are you aware that the high-pressure steam-jet has been applied with that object?

I am.

T. J. Taylor, Esq.
 20th July 1849.

6204. Are you acquainted with the circumstances of that case?

No.

6205. You did not witness the experiment?

No.

6206. You would consider that a very useful application of the steam?

Yes.

6207. And that it is likely to be attended with a great saving of expense as compared with the other modes of extinguishing fires?

Yes; speaking generally, we have not fires of this description in our district so frequently as in some other parts of the Kingdom, where the coal-beds are associated with a good deal of pyritous shale, which decomposes, and in some cases produces heat enough to set the coal on fire.

6208. Have you ever examined the different seasons of the year at which accidents occur?

Yes.

6209. Have you made out any statement upon the subject?

Yes, I have prepared a diagram, which I now produce.

6210. What is the result of that diagram; is it that they appear to have occurred more in any particular parts of the year than in others?

In the month of June particularly; and then, after diminishing in July and August, in an increasing degree from September to October and November; then again diminishing to January, till they are at a minimum in February.

6211. For how many years is that diagram?

It comprises the principal explosions during the last 40 years.

Vide Appendix I.
 Plan, No. XXIX.

The Witness delivers in the same.

6212. Are there any other statements which you would wish to make?

I have drawn up a list of accidents of the ordinary character, purposely taken from those collieries which are not troubled with fire-damp; 317 accidents are enumerated in the list, none of which were attended with fatal consequences.

6213. In what period?

In four years; 227 of those accidents happened to the officers and men, and 90 to the lads. The nature of the accidents was as follows: accidents to officers and men by falls of stone and coal, 168; by pick-wounds, 16; sprains and lifting coal, &c., 15; other causes, 28; total, 227. The accidents to lads were, by under-ground waggons, 17; trams, 48; by falls of stone and coal, 12; by other causes, 13; total, 90. The list is, as I have said, taken purposely from collieries not containing fire-damp, in order to show the nature of ordinary accidents. The men lost $13\frac{1}{2}$ days on the average by each accident, and the lads $12\frac{1}{2}$ days by each accident. The days lost by men were 1 in 51, and by lads 1 in 152. The average time lost by each man in a year is 5 days out of 250 working days, and by each lad is $1\frac{1}{4}$ day out of 250 working days.

6214. When there is an accident in the pit, do the men go out for that day?

On the occurrence of a fatal accident they generally do, but not in an accident of otherwise than a fatal character.

6215. In the arrangements of a mine, is not one very essential point to keep the doors properly watched?

It is.

6216. Do you think there is much fault in the manner in which that duty is generally observed?

I do not think there is; the doors are kept by boys generally.

6217. Do you think that those boys are competent to such duty?

I think they are; your Lordships are aware that we cannot now take boys of less than 10 years of age into mines; the pit-lads are very sharp, intelligent fellows, and they do this sort of duty very well; we have no reason to complain of them.

6218. An old man would go to sleep ; a boy plays sometimes ?

Yes.

6219. Looking to the cause of accidents, especially from explosions, do you think they are generally owing to the carelessness of the work-people, or to unavoidable causes ?

I should say very often to unavoidable causes.

6220. Have you known many cases, in which they have been owing to the carelessness of the workpeople ?

I do not think I have ; I may say that, generally speaking, there is great obscurity as to the immediate cause of explosions ; the direct evidence being destroyed, the mine much shattered, and the ventilating apparatus blown out, there is often very great difficulty in discovering what the cause of the explosion was ; of those cases, therefore, we know little ; but there are others where explosions have taken place from sudden issues of gas in very great quantity, and against accidents of this nature I confess myself unable to suggest a remedy, except the use of the safety lamp.

6221. In many cases might not they be avoided by a very efficient system of ventilation ?

The difficulty would be to fix upon a standard of ventilation that is calculated to meet the cases under consideration : is it to be four feet in a second, or five feet in a second, or six feet in a second ? I fear that the highest of these would still be very inadequate.

6222. Does not that depend upon the nature of the mine ?

A sudden issue of gas may take place in any fiery mine. My own well-considered conviction is, that most of the great explosions of the Durham and Northumberland collieries have been owing to sudden issues of gas.

6223. Is not one great cause of the fatality of these accidents the state of the mine after the explosion has taken place ?

Yes, from the after-damp.

6224. Do not you think that there might be some method of mitigating the consequences of that ?

I have often thought of this part of the subject : the great object is to get fresh air thrown in as soon as possible, the district of explosion being at first quite unapproachable ; and it may be remarked, that the after-damp spreads itself much beyond the limits of the explosion, its volume being very considerable. With the mine in this state, and the ventilating apparatus destroyed, we have no means at present in use to remove the fire-damp, excepting the gradual operation of replacing the stoppings that have been blown out, and I confess that I do not see my way to the adoption of any more expeditious process.

6225. Do you know anything of the arrangement mentioned by one of the witnesses yesterday, of a door that fell from the effects of the explosion, in case of the regular door being blown away ?

I think Mr. Buddle made an arrangement of that description at Wallsend. There was a prop put underneath a swing-door, and it was expected that if an explosion blew out the prop, the door would fall down, and be a substitute for a stopping, or for another door. Mr. Buddle did use that apparatus for a short time, but discontinued it.

6226. Do you know why he discontinued it ?

I do not know that he found it actually ineffective, but I presume that he thought it not worth while persevering in the use of it.

6227. One of the witnesses yesterday stated, that he considered that his life had been saved by it ?

That is a very strong case. In a partial explosion it might be that an apparatus of the kind under consideration might answer the purpose ; but in really powerful explosions I conceive it would be quite ineffective.

6228. Anything that closed the passages which had been laid open by the destruction of the stoppings would be of value, would it not ?

Yes, if such an object can be attained ; but I cannot think that the use of the swing-door, which was given up by Mr. Buddle himself, would go far towards it.

T. J. Taylor, Esq.
20th July 1849.

6229. You are not aware of the grounds upon which he discontinued it?
 I do not know those grounds.

6230. Is there anything else which you wish to state?

At the Haswell explosion I made a particular list of the sufferers, and of the manner in which they were killed: that list I now beg to hand in.

The Witness delivers in the same, which is as follows:

ANALYSIS of the Persons killed by the Haswell Explosion of September 1844.

| | Burnt Fatally. | Killed by Concussion. | Killed by After-damp. | TOTAL. |
|---------------------|-------------------|--------------------------|--------------------------|--------|
| Meadows Way - - - | 6 | 6 | 28 | 40 |
| High Brockley - - - | 6 | 6 | 13 | 25 |
| Low Brockley - - - | none | none | 30 | 30 |
| | 12 | 12 | 71 | 95 |

Killed by after-damp, three-fourths. Killed by the direct action of the blast, one-fourth.

6231. Therefore anything that would just keep up a sufficient partition to turn the current of air, might save a great many lives?

Yes, if it were practicable to do so. Of course it would be still better to go back to the source of the mischief, and stop it there, by preventing explosion, if possible.

6232. Do you think that there are any points connected with the working of mines which it would be possible to make the subject of direct legislative enactment and restriction?

I do not think so. Such enactments would constitute, in my mind, an unfair and unreasonable interference with the management of mines, and might have a tendency to retard the progress of improvement, by fixing it at a certain standard.

6233. Any particular acts which it would be possible to make legislative offences, and to attach penalties to them, as in other offences?

I do not think so. I may say, that my private opinion is not favourable to the appointment of Inspectors, more especially as regards the Northumberland and Durham Coal Districts; but I defer a good deal to the opinion of other parties, without, however, being convinced that the appointment would be productive of much benefit.

6234. Do not you think it would be of any service in regard to those collieries that are less well managed?

It might be in some particular cases; but I think that more is to be expected from the general progress of knowledge on the subject, and the proper education of the managers of mines, than from the appointment of Inspectors.

6235. Are not you of opinion that Inspectors, properly qualified, might contribute to that advancement?

No doubt they might advance it a little more rapidly.

6236. Bringing the interests in the different districts more into communication?

Yes, bringing them into communication, and acquainting the parties with each other's mode of working and ventilation, might be of service in some districts; but in ours I do not think there is very much good to be done by it.

The Witness is directed to withdraw.

JOSEPH ROBERTS, Esquire, is called in, and examined as follows :

J. Roberts, Esq.

20th July 1849

6237. YOU are a colliery owner ?

I am a colliery proprietor in the Dean Forest.

6238. Are not you a colliery owner as well as a proprietor of coals ?

I am.

6239. On the Crown lands ?

On the Crown lands of the Dean Forest.

6240. Have you a lease from the Crown ?

It is not a lease ; I have purchased the mines ; they are subject to a galeage rent payable to the Crown ; they are not leased from the Crown.

6241. Are they what are called fiery seams of coal ?

There have been no cases of ignitable gas. Whether fire-damp may exist amongst the gases which we are subject to, I cannot say ; but there has never been any instance where it has ignited.

6242. At what depth are those mines generally worked ?

The depths vary very much ; the deepest shafts that we have in the Forest do not exceed 300 yards.

6243. And what is the thickness of the seams ?

They vary very much also ; the thickest seam of coal, which is called " The Coleford High Delf Vein," is in the thickest places, where it is found about six feet, or from that to seven feet thick, and down to about four feet, which is the thinnest ; that is the thickest vein which we have in the Forest ; we do not work it by pillars as in the North.

6244. In what manner do you work it ?

We work it with timber ; we clear away the whole of the coal.

6245. Is that upon what they call in some counties the Long Wall system ?

No, it is not ; it is a system which is applicable to thin veins only, similar to the other coal-mines in Gloucestershire.

6246. Do you work it as you go forward ?

No ; we work it out, and bring back the coal, and in some instances draw the timber.

6247. Do you work any very great extent of the field beyond the shaft ?

Yes ; we work a mile or a mile-and-a-half out from the bottom of the shaft, where the allotment extends as far, and with sufficient ventilation.

6248. Have the mines in that country generally one or two shafts ?

Oftentimes two, but not generally.

6249. More usually one ?

More usually two, those collieries that are worked by shaft ; but in the Forest of Dean a great quantity of coal may be worked by level.

6250. Without any perpendicular shaft ?

Without any perpendicular shaft.

6251. Is that the more common method ?

It is not the more common method ; there is a greater quantity of coal being raised at the present time by shaft than by level.

6252. Whereabouts are your pits in the Dean Forest ; are they near Mr. Protheroe's works ?

I have two collieries which I purchased of Mr. Protheroe ; I have also one near to his Park End Collieries.

6253. Are accidents frequent in your collieries ?

Not frequent, I am glad to say ; they arise more from casualties connected with the surface than from those underneath ; we have very few accidents underground from the black damp.

6254. And no explosions ?

No explosions at all.

J. Roberts, Esq.

20th July 1849.

6255. Have you any system of ventilation ?

We have no artificial system of ventilation at all ; we rely upon the free action of the atmosphere for ventilation, which we find to be very defective, and which is the cause of the mines not being worked in that regular manner that they otherwise might be.

6256. All that you have to contend with there in the way of gas is the carbonic acid ?

It is.

6257. Does that come out in great quantities generally ?

When the air is bad, of course we are subject to it, which sometimes prevents the working of the mines altogether.

6258. Does the air of the mines often become so bad as to prevent the working of them ?

Not often ; in the winter season we can work tolerably regular.

6259. Is it in sufficient quantities to injure the health of the miners, without absolutely preventing their working the coal ?

I do not think it exists in that degree to injure their health ; for when it does, they cannot work at all ; therefore they are not subject to its influence.

6260. Have there been many cases, within your knowledge, in which lives have been lost ?

There were three lives lost through suffocation in one of the collieries which I now have, but before I was the owner of it.

6261. Are such accidents common ?

I cannot say that they are common ; casualties have occurred through boilers bursting, ropes and chains breaking, negligence, and causes of that description.

6262. The question refers to accidents arising from the gas from the want of ventilation ?

They are not common ; for when the mines are not in a workable state, of course the men are not in the mines to experience accidents.

6263. Have you ever been in other districts where ventilation is practised and attended to ?

I have not been in any district where ventilation is practised ; I have heard that in districts where the fire-damp exists, there is a system suggested and in use for preventing the effects of the fire-damp, and for removing it.

6264. Is there much attention now being given to the question of ventilating mines in the West of England ?

There are a few gentlemen in the Forest who, I believe, are desirous of understanding the principle of ventilation, with the view of causing the mines to be more regularly worked, and therefore of causing employment to be cheaper ; we are paying very high wages there on account of the mines not being worked regularly ; the miners are only partially employed, and if we got them into a state in which we could work them in a regular manner, we consider that it would be beneficial to the coal-owners, and in every respect.

6265. From what you know of the owners of collieries in that district, should you say that they would be at all favourably disposed to an inspection on the part of Government ?

I think many would ; for my own part, I think I can answer for myself and several others ; I think that a system of inspection, under proper management, would be a very good thing, and attended with very beneficial results.

6266. In what respect do you think it would be an improvement ?

I think were collieries subject to a proper inspection, and accidents rendered less prevalent, it would so far inspire the confidence of the working classes, that there would be a more plentiful supply of miners at fair wages ; we are giving as high as 4s. a day to coal-cutters ; a much higher price than I think the coal-cutters in the North get, or in Wales.

6267. Are those the common workmen who have 4s. a day ?

Yes ; I have given myself 4s., and never less than 3s. 6d. to coal-cutters.

6268. Is that in consequence of the frequent interruptions?

That is in consequence of the employment not being regular, and there not being a sufficient supply of good coal-miners in the district; men seem indisposed to turn their attention to that description of work, from the employment not being regular, and partly from the accidents which happen.

J. Roberts, Esq.

20th July 1849.

6269. If you are impressed with the notion that it would be beneficial, and you would get wages so much cheaper in the mine if the arrangements were in a perfect state, why do you not employ some one yourself to do it in your own mine?

For my own part I am only recently engaged in coal-mining, and I have had no accidents occur in my collieries, excepting one man having some rock fall upon him which broke his collar-bone; that is the only accident that has occurred in either of my collieries, and I have done all in my power to prevent accidents.

6270. Your mines being in a more perfect state than your neighbours', you do not find that the men come more readily to you than to your neighbours?

I think I may say that they come quite as readily, owing to so few accidents happening.

6271. What have you done in your pits?

I have had all in my power done to prevent accidents, and I think the men prefer coming and working for me, even though it were for less wages. I have heard some of them express their opinions to that effect; they prefer working where the air is good for less money than where the air is bad.

6272. Does the carbonic acid in those mines occur suddenly?

It occurs generally as the wind shifts.

6273. And does it then drive all the people out of the pit?

Yes; they generally retreat upon finding the candles burn dimly; that is the first symptom of the existence of the carbonic acid.

6274. You have done nothing yourself in order to introduce a better system of ventilation, have you?

I am desirous of ascertaining the best and most improved method of so doing, as I open my mines.

6275. Before you undertake to make any attempt?

Yes, having two mines now to open, which will require a system of ventilation.

6276. You are going to open some fresh ones?

Yes.

6277. Do you think that you would get a better supply of labour, if the labourers were satisfied with a system of inspection?

I think it would insure their confidence, and cause more labourers to turn miners, and to adopt that means of livelihood; a great many of them about the country I have endeavoured to employ on the surface, and several have ultimately gone under-ground and become miners; in several instances that has been the case; there seems to be a great timidity on the part of the labourers about the country to turn their attention to mining, owing to the accidents and the irregularity of the labour.

6278. Are there any accidents in that district from the breaking of ropes, and matters of that kind?

We have sometimes had accidents, I am sorry to say, on account of the breakage of ropes.

6279. Do you work the collieries in those districts with guides?

In some instances; the more recent shafts that have been sunk and are put to work have guides.

6280. And cages?

And cages, which we consider is an improvement.

6281. Have you ever had any information with respect to a contrivance of Mr. Fourdrinier, for preventing accidents in those cases from the breakage of ropes?

J. Roberts, Esq.
20th July 1849.

I have heard, by way of discussion, that there is a plan to prevent accidents by the breakage of ropes, but none has been introduced yet into the Forest, that I am aware of.

6282. If an inspection were adopted, what class of persons would you suggest as the most proper persons for Inspectors?

I would respectfully suggest that an Inspector should be appointed for each coal district, who should periodically inspect and report the state and condition of the engine power and ventilation of each colliery within his district. A person of practical experience, as well as scientific attainments, I consider best qualified to inspect and report upon the state and condition of the steam-engines, and the condition of the workings below.

6283. Is there any other point upon which you wish to observe?

I would remark, that I consider the plan of Mr. G. Gurney for ventilating coal-mines the most preferable system that has yet come beneath my notice; from its simplicity of application, cheapness and general utility, I consider it preferable to the furnace system.

The Witness is directed to withdraw.

Ordered, That this Committee be adjourned to Monday next,
Two o'clock.

Die Lunæ, 23^o Julii 1849.

The LORD WHARNCLIFFE in the Chair.

GOLDSWORTHY GURNEY, Esquire, is called in, and further examined as follows:

Evidence on the
Prevention of
Accidents in
Coal Mines.

G. Gurney, Esq.

23d July 1849.

6284. SINCE your last examination, have you received any further communications upon the subject of the application of the steam-jet to the ventilation of collieries?

I have received many: it appears from them important to put more clearly before the Committee the plan of applying it out of a working shaft; I believe it to be important as connected with the subject generally, but more particularly so as connected with those mines in which small capitals are engaged, and where it is desirable to produce ventilation by the cheapest means possible. There are a great number of small mines wanting ventilation, in which they have boilers near the top of the shaft; therefore, at a few pounds expense, by applying a few pipes to a small external chimney or shaft built for the purpose, as shown in this drawing, they might apply ventilation at a very trifling expense. One of the objections in applying the steam-jets out of the upcast shaft arises from the necessity of keeping the upper end of the shaft sealed; because it is evident whenever an exhaustion is made, air will run into it by the shortest passage; instead of coming through the workings, it will go down at the pit's mouth, unless cut off.

6285. Supposing the steam-jet to be placed in a side passage?

Yes; the steam-jets B, [Diagram No. (1)] in this case are placed on one side, communicating by a dumb drift, C, with the upcast shaft K; the pit's mouth is covered by a light cover, H, with a hole through it for a chain to pass; there is an inverted trunk, E, made to descend a few feet into the pit, like an inverted neck of a bottle; the cage G, as it comes up, first enters into the inverted trunk at the bottom, and stops it.

*Vide Appendix I.
Plan, No. XXX.*

6286. Or rather, you would say, the neck of the bottle?

Yes, into the inverted neck; the cage forms a stopper on entering the neck of the trunk; and when it has passed into it, the air-cover opens by a knot in the chain, as shown in the drawing, and will be lifted up out of the way when the corf comes to the stage; the cover does not open until the neck of the trunk is completely stopped, and is deposited before the cage leaves it on descending; consequently, whatever position it may be in, there will never be a communication between the external air and the exhaustion going on by the jets at the side. On reference to the scale of the drawing, it will be seen that the area of the exhaust-chimney or shaft A, is less than that of the upcast shaft K, or the dumb drift C. This smaller area is found in practice no objection, if short. In the first place, it reduces the expense and size of the chimney; secondly, it reduces the necessity for a larger number of jets; and, thirdly, it enables us to lift the column more effectually. I find, from experience, that a narrow area, when of short distance, makes little or no difference in the amount of ventilation; the amount is made up in increased velocity; the cylinder or chimney A, by the side of the pit, will be seen by the scale to be about 2½ feet in diameter, and to contain only seven jets, of three-eighths of an inch diameter; the plan M, by the side, shows their arrangement; the exit part of those jets are placed below the contracted part of the side-shaft; being in a larger area, the exhaustion is more easily
(164. 18.)

G. Gurney, Esq.
23d July 1849.

supplied from the upcast shaft. The steam-pipe *a, a*, goes in at the side, and supplies these jets from any convenient place in which the boiler may happen to be.

6287. Would not there be considerable practical difficulty in such an application of the principle, in any case where guides were not in use, in consequence of the narrow passage at the upper end of the shaft?

No; if guides were in use, the trunk E would form a part of the guides; if there were no guides in use it would not affect the question

6288. In the case of a rope or chain working without guides, the motion of the cage, or corf, or whatever it may be, is very unsteady in the shaft, is it not?

In the lower part.

6289. It is said to hit the sides, and occasion a great wear and tear?

If it should do so towards the top, it could be very easily steadied into the trunk; the hole through the cover would steady and guide it into the inverted neck.

6290. Scarcely any of the small collieries have guides?

I believe not; guides are not necessary to this arrangement; I believe the cage would fall in readily without difficulty; this is a simple and cheap mode of application of steam ventilation; 3 *l.* or 4 *l.* applies it at once to a colliery. I should observe in regard to the question of rarefaction from heat, if the steam be at the bottom of the pit, that it is not of much importance; although my opinion, I believe, is contrary to many of the owners, I still retain it; the heat of the steam is not of much comparative value; I do not think in practice it will be found worth much trouble; in support of this opinion, I refer to an experiment, to show what it really is. It will also serve to explain away a remark made by one of the witnesses, "that the experiment was a failure," because the object of it was not known. The experiment alluded to was an experiment made at Seaton Delaval, expressly to determine this point, and not for ventilation; my sole object in making the experiment was to ascertain what quantity of ventilation would be produced by a given quantity of steam out of the pit; and what quantity of ventilation could be produced by the same steam at the bottom. The steam was only about 15 lbs. to the inch, and therefore in favour of rarefaction; it was taken from a low-pressure boiler for working a condensing engine. The quantity of ventilation produced by the jets, out of the pit, was 27,000 per minute; the quantity of ventilation produced by the same jets, at the bottom of the pit, was 33,000, making a difference of 6,000 upon 33,000.

6291. With precisely the same power in both cases?

The same steam, same boiler, the same power; 6,000 was due to rarefaction from the heat of the steam; it must be observed that that proportion would remain the same under any increased amount of ventilation; for if the amount of air was increased, the temperature would be reduced by quantity, consequently the proportion of 6 on 33 would run through a larger quantity; if we raised it up to 60,000, or even 90,000, we should get no more than this proportion of 6 to 33 due to temperature, because a larger quantity of air going through the upcast shaft, an exact proportion of heat would be required to raise its temperature; this experiment shows 6,000 only to be the difference due even at this low pressure of steam; I do not think even here the extra quantity is of so much value as the convenience of working the steam-jets, in many cases, out of the pit; taking all the practical considerations into account, taking the wear and tear of ropes, injury to the tubing and the sides of the pit from change of temperature, and a variety of other circumstances, it is certainly desirable, in many cases, to have the exhaustion out of the pit altogether.

6292. Do not you find in experiments of that kind, where the shafts are of considerable depth, that some power is lost by carrying the steam that distance?

The condensation in the conveying-pipe amounts to very little, hardly worth notice; it should be borne in mind that where the boiler is out of the pit, we lose this heat also, which adds to the rarefaction in the upcast shaft; but the comparative value of the whole are questions for practical men. I was anxious that the fact which I have stated of 27,000 and 33,000 should be put in evidence; and that in this experiment the pressure of the steam was only 15 lbs., that

that being thus applied under the most favourable circumstances for rarefying power at the bottom.

G. Gurney, Esq.

23d July 1849.

6293. Are you speaking of steam carried from the same boiler on the surface to the bottom of the shaft?

Yes; the same jets were also used.

6294. Did you make any experiments to ascertain whether, in that case, the steam escaping from the jet at the bottom of the shaft was precisely the same in pressure and power as the steam escaping from the jet at the top of the shaft?

Yes, so far as we could judge, it was the same: the pipe going down to the bottom was very large, so that there was no throttling or wire-drawing of the steam; and the condensation by passing down was very little, and taken off by itself; the pipe was surrounded by sawdust; I believe that in both cases the pressure was nearly the same; the small area in the plan given in is the only seeming objection to it; but the evidence of my own experiments, and those brought before this Committee, which I have been favoured to hear, settles this question. Mr. Vivian's experiments are to the point; Mr. Vivian through a small pipe passed a very large quantity of air without loss; therefore, through short distances the size of the area is not of much consequence. Before leaving the question of rarefaction, I beg to call the attention of the Committee to a fact or two standing in evidence. The facts to which I would call the attention of your Lordships is from that of Mr. Darlington's fire, where the air was driven down against rarefaction, a column of hot air at 400 degrees, to the experiments made by Mr. Vivian and others; in all it has been shown that nothing whatever could be due to rarefaction.

6295. In Mr. Darlington's case, the downcast current was aided by the process in another shaft?

Yes; but in the downcast the current had to be driven down against a column of 400 degrees of temperature. In the chemical works alluded to by Mr. Mather there is no rarefaction; it is driven downwards.

6296. Was there any upcast current?

No; in the smelting of iron also, lately introduced, there can be nothing due to rarefaction; it is driven horizontally. All facts go to show that there is no assistance from rarefaction; at best it is a small assistance; I do not think, after a few years' practice, it will be thought worth consideration.

6297. Is there any other process connected with the ventilation of coal-mine workings to which you think the steam-jet could be advantageously applied?

I think it could be very advantageously applied to ventilating sinking shafts; a small jet at the end of a pipe, placed at the commencement of the working, and producing an exhaustion at the top, would draw air from the bottom as a matter of course; as the shaft is sunk, the pipe might be lengthened by a piece put on.

6298. That is Dr. Potts' plan?

Yes; adding lengths of cylinders, sinking in sand.

6299. Dr. Potts has an iron column, and exhausts the air at the top, in consequence of which, it goes down and the stuff rises; then he adds another piece?

Just so, for sinking shafts in sand, but this is for ventilation; as the pit is sunk, we put on a pipe for ventilation, the jet being here—[*showing the same*]; consequently the exhaustion produced draws from below; as the men sink the pit, they put on a piece of pipe at the lower end; and so they go on till they get to the depth of the pit. That is a very simple application, and inexpensive; common stove tubing is sufficient for the purpose; fresh air of sufficient quantity is supplied from above, and the foul air taken out at the bottom; it is worth attention, as saving the expense of brattice.

6300. How is the ventilation effected now in sinking shafts?

By bratticing; a brattice is made down the shaft; heat is placed on one side, which rarefies an ascending column, and the air falls on the other side, on the common principle of the up and downcast system of ventilation. It is self-

G. Gurney, Esq.
23d July 1849.

evident that this mode of jet would be effective in cutting horizontal drifts, which they require in Ireland.

6301. And in South Wales?

Yes; you cannot ventilate the horizontal drifts or tunnels by a furnace.

6302. Could you apply your principle to the making of drifts through what they call in mines dykes, a great mass of stone of 500 or 600 feet, or in making a drift where you know that there is a bed of coal from one mine to another?

Yes; if we have to drive a horizontal adit or a horizontal drift from the side of a hill into a bed of coal, this plan of ventilation will do; it is very simple and efficacious; it is self-evident that the principle of the jet will draw horizontally exactly the same as it draws perpendicularly; it is self-evident also that the same principle applies to the cutting of tunnels in railways, as well as in driving mining levels; instead of sinking shafts for ventilation at a very great expense, they might use the jet; railway engineers should know of this simple application.

6303. Are you aware of an opinion which has prevailed, that the introduction of atmospheric air in the case of spontaneous combustion in coal-mines rather tends to increase the progress of the combustion than otherwise?

I am of opinion that plenty of atmospheric air, by ventilation, would prevent spontaneous combustion ever arriving at such a stage as to endanger a fire; decomposition goes on rapidly in close places. I would call attention of the Committee to a fact familiar to all, namely, the spontaneous combustion of a common haystack; if you stack hay too early, it heats, and ultimately takes fire; the heating does not take place in the external part where it is exposed to the air, but in that part which is excluded from the air—the interior. If the same hay be put into a close house, it takes fire in a less length of time. A cornstack bears the same remark; wet straw, litter, &c. The fire at Plymouth Dockyard took place from spontaneous combustion, in consequence of the material being in a close place; if it had been in an open place, it would not have happened.

6304. What substance was that?

Tow and oil.

6305. In the dockyard?

In the dockyard; vegetable and mineral decomposition are the same; I believe, therefore, that if those mines which are subject to what are called "breeding fires," or spontaneous combustion, were better ventilated, they would never arrive at that point; whenever an increase of temperature was observed taking place in any part of the slack or waste, if it was turned over and exposed to cool air, a fire would be prevented; my opinion is contrary to many viewers, but I have no doubt I am supported by facts and proper reasoning. "Combustion" is a term likely to mislead; they do not look at the first steps; the slowest possible chemical action going on where there is a change of temperature, strictly speaking, is combustion; but not so in common language; eremacausis, or decay, is the first stage of spontaneous combustion; the second would be called "incandescence;" the next "ignition," then "combustion," commonly so called; the next state would be that of "inflammation." The first stages or processes of decomposition are produced in a mine independent of atmosphere; the mineral sulphurets only require water; they go on quite independently and more rapidly out of the atmosphere; for when the atmosphere is freely admitted, it prevents the temperature rising; but when the state of ignition has arrived, air fans combustion, and inflammation takes place; they now for the first time see it, and know the reason why the presence of the atmosphere is supposed to occasion the fire; the fire was in existence before.

6306. You would, then, be of opinion, that when the combustion has reached one of the latter stages of that process, the admission of atmospheric air would rather tend to feed it?

Yes, certainly.

6307. But in the earlier stages it takes place wholly independently of the atmosphere?

Yes; the first steps are favoured by the absence of air, and, consequently, increase of temperature.

6308. How

6308. How do you account for the spontaneous combustion of banks, when you state that fresh air will prevent spontaneous combustion?

On exactly the same principle; it takes place inside, not out. If you take the example of a haystack: lay it open to the air, it stops decomposition; let it lie together, it takes fire.

6309. Those deposits at the pits' mouth are constantly on fire?

Yes, because they lie covered up in beds, and so in a mine. On the continent it is a very general practice to turn these heaps in a mine, as a matter of prevention. The Inspector orders it to be pulled over; if he puts in a thermometer, and finds the temperature rising, he says, "It is time to turn this; give it air;" they do so, and keep the temperature down. The way to prevent a haystack or a cornstack taking fire is to pull it to pieces; decomposition certainly goes on more favourably when the atmosphere is excluded than when it is present; mineral, particularly coal, and vegetable decomposition are closely allied; if air be excluded, temperature rises.

6310. Up to a certain point?

Yes, up to the point of active combustion.

6311. Have you any further observations to make with respect to the action of a furnace upon the current in an upcast shaft?

I have, in my former evidence, called attention to the fact, that it frequently happens in furnace ventilation, the force of exhaustion and the amount of ventilation are in an inverse ratio with each other; this seeming contradiction we here called "the furnace paradox." There is another point hitherto, I believe, unnoticed connected with this system of far greater importance, namely, its capricious limit. It is well known, that whenever attempts have been made to get a larger amount of ventilation in coal-mines than is usually obtained, by increasing the heat, the size of the furnace, or otherwise, singular as the fact may be, they have never succeeded; there seems to be a sort of magic quantity or uniform maximum, in spite of every modification, which runs through the whole; the quantities of air drawn through the mines by the best arranged furnaces are so nearly alike, that the coincidence is clearly not accidental, but evidently governed by some law of pneumatics not yet sufficiently examined; these quantities seem to be in exact proportion to the areas of their respective upcast shafts—about a thousand cubic feet per minute to one foot sectional area of the shaft. Jarrow has an upcast shaft of 50 feet area, and passes 50,000 cubic feet of air per minute; St. Hilda, 30 feet shaft, and passes 30,000 cubic feet of air per minute; Felling, 48 feet shaft, passes 42,000 cubic feet per minute; Seaton Delaval, 50 feet shaft, and before the steam-jet was applied passed 50,000 cubic feet per minute; Percy Main, 44 feet shaft, passes 35,000. I could mention many others; there are some of the collieries near Newcastle, and it will be observed their proportional numbers are nearly equal; there are mines which, from smaller galleries, or longer and tortuous turnings, do not pass so much air: Dowdon, 201 feet shaft, passes only 130,000; Haswell, 109 feet shaft, passes 74,000; Scaghill, 70 feet area, passes 42,000 only: there is but one case on record where the amount of ventilation exceeds a thousand cubic feet per minute to the foot area of the shaft, and that case is the one given in evidence by Mr. Wood, at Hetton; the shaft is 154 feet area, and the ventilation is stated to be 168,000 per minute; this may be considered as the extreme limit; for it was obtained by three furnaces, driven as hard as they could be driven; the proportion, it will be observed, is very little above the others notwithstanding, 14 on 154. In many of the above cases the furnaces have been increased in size, and the intensity of fire also; but no more ventilation has followed. Viewers are anxious to increase their ventilation; they try all feasible means with the furnace, but cannot do it. On looking carefully into the subject, and fairly regarding all the conditions found in mines, the explanation does not seem very difficult; it opens views of the greatest importance to coal-mine safety. The heat of the furnace, by the rarefaction of air in the upcast shaft, produces a partial vacuum at the base; this partial vacuum, or exhaustion, is open to the atmosphere by two channels, one directly down the upcast shaft, the other by the galleries going to the downcast shaft; and it is evident that air can come in to fill it by either passage; but as it can come more readily along the galleries than down against the buoyant column of hot air, it comes that way in preference; this, however, it

G. Gurney, Esq.

23d July 1849.

Vide Appendix I.
Plan, No. XXXI.

does up to a certain point, and no more; for when the resistance is increased by the speed (which it will be as the squares of its velocity), up to a force, equal to the force of buoyancy in the upcast shaft, the maximum power is produced; and any extra vacuum, or exhaustion from inward heat, or otherwise, becomes supplied down the shaft. Let us suppose an exhaustion to be produced by rarefaction in the shaft A by the furnace B, [Diagram No. (2)] equal to two inches on the water-gauge, which we will represent by (2 a); the air, being at rest, and in a state of pneumatic balance in the shafts and galleries, at first comes on without opposition through the latter passage (2), and supplies the exhaustion (2 a); its velocity goes on increasing until its resistance exactly balances this force of (2 a), when it ceases to increase, and ventilation proceeds no further; this is the limit; for if a stronger force than (2 a) be made by rarefaction over the furnace, air to fill the extra vacuum will come down the shaft, as shown by the arrows, and destroy it; because, from well-known laws, the long line of air through the galleries cannot be increased in speed, or started suddenly; and long before a sensible increase can take place, the extra exhaustion will be supplied by the other way. No matter to what extent rarefaction is now carried, all extra supply comes down the shaft, and the more easily, as the descending column becomes more perfectly formed. Suppose the power by the furnace be raised to 4, the quantity (2) will still come through the galleries, but no more; the other proportion will come down the shaft, as shown by the arrows (b, b, b); if it be raised to a power of 6, the quantity (2) will still come on by the galleries, but the extra quantity of 4 will descend through the shaft, and so on to higher powers; (2) then is the limit, no matter what increase of fire or furnace is used. I have said that the resistance of air in motion increases as the squares of its velocity; this of itself would sufficiently account for this maximum; but there is another condition which fixes it more effectually. Air is light, and because it is so, we naturally suppose it may easily be stopped, or set in motion; it is only light comparatively; the long line of air, the elastic rope, through the galleries of a coal-mine, is of considerable weight, about five to six tons per mile, which in 20 miles of passages would amount to upwards of 100 tons; this moving weight, or train of air of 100 tons, could no more be stopped or increased in motion suddenly, than could be a railway train of equal weight, moving at the same speed; consequently the resistance (2) by the galleries is a constant quantity; practically it cannot be altered, and, in connexion with the subject, must never be lost sight of; the descending column, when once established, forms a natural brattice, as it were, in the shaft, and facilitates the descent by its weight; in short, it soon balances the downcast shaft, and it is self-evident, if carried on long enough, would stop ventilation altogether; no doubt this is sometimes the case, and may cause the accumulation of fire-damp, and consequent explosion, particularly if assisted by a change of wind and other atmospheric influence; a feather weight will turn the balance. This formation of the natural brattice, if I am right in my reasoning, is of the highest importance, and cannot be too carefully looked to.

6312. But do not you think it true, that, under circumstances like these, you could increase the upcast current to a certain degree by rarefying the air in the passages of the mine?

No. Rarefying the air in the passages of the mine, supposing they are horizontal, would have no power one way or the other; it would act as much in favour of the downcast as in favour of the upcast.

6313. Would not there be thereby an additional quantity of air supplied to the furnace from those passages?

The weight of the air would be changed a little by alteration of temperature.

6314. Supposing a given quantity of air filling the passages of the mine, and that in a certain state of the furnace it was in equilibrium by the resistance in those passages, and therefore there was no action, and you increased the heat of the furnace until an action took place in the upcast shaft, would not the first effect of that be to produce some rarefaction upon the quantity of air in the passages of the mine?

The air in the passages of the mine goes on towards the furnace. The heat of the furnace cannot affect air in the passages, except by radiation.

6315. Do

6315. Do not you think that the additional power put upon the elastic rope of air at this point would produce some rarefaction in the substance of the air upon which it acted?

A little, some way back; but it would be very little.

6316. If, instead of increasing the heat suddenly, you increased it by slow degrees, till you got it to a very high temperature, what would be the effect?

You get to the point where the resistance of the galleries and the rarefaction came to a balance; that balance is found to be about two inches of water-pressure; it seldom exceeds it. I have put the numbers in the diagram, because the disturbance of the water-level is generally found somewhere about that in working. When up to this point the action goes steadily on; but the moment you attempt to get beyond it, air comes down the other way.

6317. What is the law of resistance when it comes in this way in reference to velocity?

The velocity would increase the resistance as the squares; that itself would afford a very considerable opposition. When we take the other law into consideration, it will be as the weight multiplied into motion; you can no more start a train of air suddenly than you can start a railway train of equal weight. I believe this to be a very important question. I believe the rationale is founded in truth; and I have no doubt that ventilation in many cases is very seriously affected, if not occasionally stopped, particularly when we know that external interference of weather frequently assists such predisposed retrograde currents—high wind, for instance. The power of air coming into this column, would influence it much; you get an oscillation of the air. We know that nothing is more capricious than smoky chimnies; an upcast shaft is nothing more on a larger scale; that which will affect one, will affect the other.

6318. Then that is a serious and formidable objection to the mode of ventilating by heat?

It explains the limit which has been observed in all cases; the evidence which has been given bears it out.

6319. Is it founded upon a true principle?

Yes, I believe so. I have here a letter of Mr. Donnison, which he wrote, having no connexion with this subject; he never heard of it. He says, "I have burnt three or four times the quantity of coals, and can get the temperature no higher. This fact by the present view is explained."

6320. Have you ever made any experiments to ascertain this by practical examination?

I have.

6321. By increasing the fire and the head, you increase the rapidity of this column?

Decidedly.

6322. And, therefore, you increase the mixture of the cold air with the hot air?

Yes, and get a mean; you increase the weight of the down-set, and you get it cool from top to bottom; it becomes as heavy as the downcast. The division between them forms a natural brattice. I beg to introduce an experiment—[*showing an experiment*]*—that your Lordships may see the theory is true. You can show the principle always by a simple lamp-glass. The air going into this glass in the present instance is throttled, so as to represent (2). It does not amount to two inches of water, certainly; but we have a throttled action at the bottom. The consequence is, that you will find a column descending on one side, and another ascending on the other; it is ascending over the furnace, and descending on the other side—[the Witness exhibits an experiment with a lamp-glass, and a lighted candle at the bottom of it on one side]. The same experiment is here on a larger scale—[the Witness exhibits another experiment]. There can be no doubt of the theory from the fact before us. A column of air is seen going up, and another is seen coming down in the same shaft. If the furnace was in the centre, you would find the current would descend round, the sides making a cylinder. The point of the descending current depends upon the part of least buoyancy or resistance. The resistance of air in a mine is an*

G. Gurney, Esq.
23d July 1849.

inseparable condition. This is the great point which we must never lose sight of; resistance of the galleries is an inseparable condition; it varies in different mines from an inch to two inches of water; but is never absent.

6323. In all these cases the bottom of the shaft was closed?

Partially. Here is a more open one—[*the Witness exhibits an experiment accordingly*]. I come to this question, perhaps, in the light of a prejudiced witness, advocating a system of ventilation different from the furnace; but I hope the Committee will not consider that my evidence has been unfairly prejudiced by any feeling of that kind. I have no pecuniary interest. I have considered our question one of life and death; and, therefore, I have felt it imperative to give this evidence; I might otherwise, perhaps, have hesitated. The great object which we have in view rides over every objection arising from a feeling of that sort.

6324. The inference, then, from your statement, and from the experiments which you have shown is, that so far as furnace ventilation is considered, it must be taken as only effective below a certain limit?

Up to a given point.

6325. That point depending upon the area of the shaft and the extent of the workings, or upon what elements?

Upon the amount of buoyancy, as compared to the resistance of the air coming through the galleries.

6326. The resistance caused either by the extent through which it passes, or the confined area of the passages?

Yes; hence the reason why there is a variation in the amount of ventilation in some of the mines which I have named; I repeat the striking fact, that in every case the amount has never exceeded 1,000 cubic feet per minute to a foot area, and rarefaction can do no more; at Seaton Delaval it is now 95,000.

6327. To what area?

Fifty feet area. Your Lordships will observe, with regard to the jet arrangement, and which accounts for this quantity, that if air attempts to come down to fill the extra exhaustion or partial vacuum, it is stopped by a jet ready to meet it, to drive it up again. I mention this here also to explain the results of mistakes which have been made by some in the application of the steam-jet; namely, that of leaving some part open, not acting on the whole column, by which means the air can descend somewhere from above, and supply the exhaustion below, producing what is technically called "the flower-pot." Hence also the necessity of the condition which I have stated in the correspondence with the South Shields Committee, of lifting the whole column.

6328. Supposing the jets to be applied, would not some point exist at which the resistance of the air drawn very rapidly through the passages of the mine would be sufficient to counterbalance the force of the jets also?

It would, if they were not properly applied; a return air would form a down current to supply exhaustion below; this is one of the advantages in the drawing that I have placed before the Committee this morning; the area is so reduced that there is no possibility for air to return.

6329. Is the jet in that drawing level with the surface?

The jets are below in the base of the shaft, because it is desirable that the exhaustion should have a free access. I do not know that I have any other observation to make upon this point of the furnace limit; but I should be glad if the eminent mathematical gentlemen who are present might be asked some questions upon it.

6330. Are you acquainted with the experiments which Mr. Taylor stated to the Committee he had made at Seaton Delaval, of the effect of the steam-jet as applied there?

Mr. Taylor informed me a few days since of the experiment, and the result: if there is any truth in the reasoning I have just gone into, it could not of necessity be due to rarefaction; no such quantity could be so produced: the first thing which struck me was, that the amount of ventilation was only 77,000 per minute, instead of 95,000, the ordinary working point; I found upon inquiry that he had

had made the experiment upon a Sunday, when the men were not at work, and the power was not working at its full speed; I also observed to him he had left out a most important element in his calculation; on cutting off the steam, he immediately measured the quantity passing through the drift; he did not take into account the existing *vis inertiae*, the momentum of the moving train of air; there must have been an acting power equal to 48,000 or 50,000, arising from rarefaction of the furnaces, aiding the existing inertia of the moving mass; consequently there was an inertial force of 77,000, acted on by 48,000 not calculated; I find the weight of air in motion at Seaton Delaval drift and galleries amounts to nearly 120 tons.

G. Gurney, Esq.

23d July 1849.

6331. In the entire length of the passages?

In motion through the various galleries; all of which is in motion towards the upcast shaft.

6332. Taking the whole length of the passages?

Yes.

6333. What is the whole length of the passages?

About 20 miles; in round numbers the weight of air in those drifts is about six tons per mile at 60°, as nearly as can be: now here we have a train of 120 tons of air moving, not in an open space (for if it had been, it might easily have been turned aside), but confined, as it were, in a tunnel, within walls, pressing onward by the laws of momentum; 120 tons of air can no more be suddenly stopped by turning off the steam-jets in Seaton Delaval mine, than can 120 tons in a railway train, by turning off the steam from the engine; there is a momentum accumulated, and that momentum will go on for a considerable time; if Mr. Taylor had waited until the momentum had ceased, he would have found that it would have fallen back to the normal quantity of 48,000; but taking it immediately after, and forgetting the important element of momentum, I think he came to an erroneous conclusion; fearing the mistake, I wrote to Mr. Donnison, Mr. Forster's assistant, at Seaton Delaval, stating that I thought the experiment was not fairly made, in consequence of time not being allowed, or correction made, for momentum of the air, and desired him to repeat the experiment, and give time for the momentum to cease. This is his letter, which I received in answer this morning; it is a private letter, but I believe I may read it, and hand it in:—"Dear Sir; I received your letter duly, and have had the experiment you named made over again; we turned off the steam, and kept up the same heat in the shaft, and, after allowing time for the existing momentum of the air to decrease, measured the amount of air going into the pits, and found it to be within a hundred feet of my first experiment, viz. 53,000 cubic feet per minute."

6334. He does not say what time he allowed?

No; he says, "time for the existing momentum to stop." I have a former letter, in which he says "that he waited from the Sunday to the Thursday, and then it fell back to 48,000." Mr. Taylor's experiment seems to have been made upon the Sunday, and three days after they found it 48,000.

6335. He does not mean that he turned off the jets at that time, and kept the furnace in action for three days, and allowed three days for the subsidence of the momentum?

That I cannot say; I will read the remainder of his letter. He goes on to observe, "With the steam on, we have reached in six measurements 95,000 cubic feet as a maximum, and 77,000 as a minimum quantity, the mean being 86,000 cubic feet per minute." In another part of his letter he incidentally mentions that in many experiments he has never been able to raise the column of air above 150°; you will observe the explanation of this fact is connected with the furnace limit. The ascending current, on being pushed by heat, brings down so much cool air by the descending one, that the mean temperature is fixed, as well as the amount of ventilation. One is a measure of the other; air will come down, not up, exactly in proportion to the extra heat applied, and the general temperature be the measure of (2a) in the diagram; this column is very hot; this is cool--[showing the same]. I think Mr. Taylor told me he had seen lead melted in an upcast shaft; that temperature, it is evident, was not the general temperature of the upcast shaft, but the temperature at the bottom of the ascending column.

G. Gurney, Esq.
 23d July 1849.

6336. That temperature was taken near to the furnace?
 Near to the furnace; it is rather a singular fact that the limit of temperature, which Mr. Donnison sends me incidentally to-day, should agree with the limit of furnace ventilation; it seems to confirm the present view of the subject.

The Witness is directed to withdraw.

The Rev.
B. M. Cowie, M.A.

The Reverend BENJAMIN MORGAN COWIE, M.A., is called in, and examined as follows:

6337. ARE you connected with the College of Civil Engineers at Putney?
 I am Principal of that College.

6338. Have you been made acquainted with the proposal of Mr. Gurney; for the application of a high-pressure steam-jet for ventilation?
 I have.

6339. Have you considered the statements that he has made with respect to the relation between the power of a steam-jet so applied, and the power of a furnace?
 I have.

6340. Do you conceive that the circumstance which he states, with respect to the action of a furnace, indicating that there is a point beyond which the power of the furnace cannot be carried, is correct, on scientific principles?

I believe it is; the action of the furnace is by creating a vacuum, which will be supplied by the surrounding air in the easiest way possible; if, therefore, the air down the shaft will come more easily than the air through the galleries, it will come that way; now, the resistance to the air moving in the galleries will increase with the velocity; it will, therefore, increase up to a certain point, and, after that, the vacuum will more easily be supplied from the top of the shaft than from the galleries, and this will indicate the maximum power of the furnace.

6341. Supposing the power of the furnace to be increased from a given point, do you apprehend that the first effect upon the stream of air in the passages of the colliery, would be to communicate an additional momentum to the whole, or to produce a certain rarefaction in that quantity of air which at the time filled the passages?

Certainly not to give an increased momentum to the whole at once; it will begin by rarefying the air at the mouth of the gallery, and only, I should fancy, by radiation; not by any other power; merely the radiating power of the furnace; not to any great extent by the vacuum there. I think the vacuum which the increased heat may cause, will be, in the first instance, supplied from the top; but, by the radiation of the furnace along the gallery, no doubt the beginning of the column will be somewhat rarefied.

6342. Do not you think that that rarefaction might be somewhat increased by the force employed at that end of the stream of air?

I should think to a very small extent.

6343. Supposing that stream to be kept at the maximum point of power, and the furnace then to be extinguished, do you conceive that the effect would be immediately to put a stop to the motion of the air through those passages?

Certainly not; the motion of the air will continue for a considerable time after the furnace is suddenly stopped.

6344. Do you think that there are any means of estimating the length of time during which the action of that momentum would continue?

I should not trust to any theoretical means of doing so; I should distrust any means that I know, of calculating beforehand how long it would take. The difficulty arises from the great uncertainty in the value of the constant, and co-efficients of the retarding forces.

6345. Then, supposing that certain experiments had been made at the Seaton Delaval Colliery, for the purpose of ascertaining the power obtained by the steam-jet,

steam-jet, and that in one of those experiments it had been tried in conjunction with the furnace, and that then the jets had been withdrawn and the furnace continued alone, and the experiment tried immediately after the withdrawal of the jets, do you think that the conditions of that experiment would be such as to justify a comparison as to the difference of power between the jet and the furnace?

The Rev.
B. M. Cowie, M.A.

23d July 1849.

I think not, if tried immediately afterwards; because the motion of the column of air would be due partly to the furnace and partly to the steam, even after the steam was cut off. The steam-jet, I apprehend (I have not read any particulars of the experiment), was applied while the furnace was in action. The effect produced was due to the joint action of the steam-jet and the furnace; when the steam-jet was cut off, the action due was only to the furnace; but the effect produced belonged to the previous action of the jet, as well as the action of the furnace.

6346. Should you say that there are any scientific means by which you could, *a priori*, show that, supposing the power of a furnace to be raised to a certain point, and thereby the difficulty of supplying air to the furnace through the air-passages to become greatly increased, a downward current would take place in order to supply the vacuum caused by the furnace?

I think, by general reasoning on the principles of hydrostatics, it might be shown, but I do not think that any formulæ in existence would accurately give the means of distinguishing the boundaries of the ascending and descending currents, or say how much air would come down the shaft. We could show, by reasoning on general principles, that there would be such a return current; but as to actual quantities and amounts, the state of the science of hydrostatics is not such as to allow one to place confidence in results obtained from calculation.

6347. Do you think that there are any means of arriving at an approximation?

I should prefer an experiment in all cases; the science of pneumatics altogether is at present, I consider, experimental, not depending on mathematical facts.

6348. Have you ever seen the steam-jet applied for the purpose of ventilation?

I have not; but we have received at the Metropolitan Commission of Sewers, of which I am a member, a notice of motion from, I think, Lord Ebrington, in which he has proposed, that it should be applied to ventilate the sewers of London, and I have no doubt we shall try it there; from all that I have heard, I think we ought to make a trial of it; and we have also evidence to show the effect of the furnace ventilation.

6349. Supposing the action to which you have just alluded to take place in a case where the resistance in the passages of a mine was too great to allow a sufficient supply to pass over the furnace when raised to a certain point, and supposing that a steam-jet were substituted in place of the furnace, do you apprehend that the same effect would take place with respect to the jet, as takes place with respect to the furnace?

I should be doubtful in giving a decided opinion upon that point; but, on general grounds, I should expect more from the jet than from the furnace, for this reason, the furnace acts by tending to produce a vacuum, the steam by the sudden emission of a compressed gas; the one is a rarefaction of the air, and the other is a filling up the space with compressed gas: now, there is no limit to the power which we can get by compressing a fluid, but there is a limit of 14 lbs. to the inch to the power of the vacuum; in such a case, there is no doubt the compression is the one which will produce most power of the two. This subject has received a good deal of consideration lately, in connexion with the attempts made for atmospheric railways, where it was clearly shown that there was a limit to the power which you could obtain by exhaustion before a piston, but that, combining the exhaustion with the compressed air behind the piston, there was no limit whatever to the power that might be obtained. Now, the high-pressure steam appears to me (it would hardly be an exact comparison) to be using a compressed gas as the motive power, instead of using the exhausting power, which is parallel to the case of the furnace vacuum. I should expect, on the whole, more from

*The Rev.
B. M. Cowie, M.A.*

23d July 1849.

the steam-jet than from the furnace; but as to the amount of gain, I think that that must be concluded from experiment.

6350. Is not the effect of the steam-jet to produce a vacuum behind it?

Not to produce a vacuum into which air is to rush from *all* sides, but to produce a vacuum in one direction only; to send the steam up the shaft; to fill the shaft: we cannot say to fill the shaft with a more solid matter, but with a more dense gas, which shall fill the shaft, and thus prevent the air from coming down, so that all the power shall be expended in drawing from the gallery.

6351. Did you hear Mr. Gurney's explanation of the diagram, which he put in, illustrating the case to which allusion has just been made?

I have not the slightest doubt that Mr. Gurney's explanation of this case is the correct one. Of course I am not well acquainted, personally, with the statistics of the mines with respect to ventilation; I do not know whether these things do actually occur, except from hearing of them here; but supposing the data to be assumed correctly, I have not the slightest doubt that this is the true explanation; as to the power of the steam, I decline giving any opinion; I think it is a matter for experiment.

The Witness is directed to withdraw.

Professor J. Hann.

Professor JAMES HANN is called in, and examined as follows:

6352. YOU are a Mathematical Master in King's College School?

I am.

6353. You were formerly accustomed to mining operations?

Yes; the first situation I ever held was that of an "Above-bank Trapper."

6354. Where was that?

At Hebburn Colliery; the pit was in a very critical state; it was an upcast shaft, and they had trap-doors to open when the banksmen went out with either stones or coals, whichever happened to be taken away, and these trap-doors had then to be shut again immediately for fear of any of the currents disturbing the ventilation.

6355. Have you heard what has been stated by Mr. Gurney with respect to the effect of a furnace and a steam-jet as applied for ventilation?

I have, and fully concur in everything which he states. If your Lordships will allow me, I will give you an extract from Combes, which goes to verify, I think, Mr. Gurney's views completely. The title of the work is, "Combes on the Ventilation of Mines." I will read a translation of it. After giving a complete investigation of this matter, he gives the following Table. In the first column we have the temperature of the air in the upcast shaft, in degrees, centigrade; these could be easily put into Fahrenheit if we wanted them, but that is not necessary for the present purpose. The second column contains the numbers proportional to the mass of air which flows out in an unit of time, or the activity of the circulation; then in the third column there are the numbers proportional to the quantities of combustible matter or fuel burnt.

| Température de l'Air ascendant en -Degrés centigrades. | Nombres proportionnels à la Masse d'Air qui sort dans l'Unité de Temps ou à l'activité de la Cir- culation. | Nombres proportionnels aux Quantités des Combustibles brûlés. |
|--|--|---|
| 30 - - | - - 43 - - | - - 43 |
| 40 - - | - - 51 - - | - - 102 |
| 50 - - | - - 58 - - | - - 174 |
| 60 - - | - - 64 - - | - - 256 |
| 100 - - | - - 79 - - | - - 632 |

He (Mr. Combes) says: "Now, we observe that the numbers in the second column of the Table increase slowly, and much more slowly as the temperature is elevated, whilst the numbers in the third column increase very rapidly, following a law much more rapid as the temperature is elevated. Thus, in progressing from a temperature of 30 to 100 degrees, we do not double the mass of air which flows through in an unit of time; but it is necessary to augment the expense of combustion in the ratio of 43 to 632, or 1 to 15 nearly. In working out the application of the formula to temperatures above 100 degrees, we find that the activity of the circulation progresses more slowly, whilst the expense of combustion continues to increase much more rapidly than the temperature. It follows from thence, first, that the air furnaces are so much more disadvantageous with respect to economy, as the temperature that is necessary to be communicated to the current of ascending air, to allow of sufficient circulation, is raised higher; secondly, that to augment in any considerable manner the activity of the ventilation, it is necessary to carry the temperature of the column of warm air to a very high degree, and beyond a limit sufficiently low; every increase of temperature will only give place to an insignificant increase in the circulation; it is, besides, evident that the more the temperature is elevated, the more the cause of loss of heat, so that in practical application the disadvantage of air-furnaces at high temperatures is yet greater than would appear from the preceding discussion." He refers to the discussion which he has given: "Lastly, if the temperature of the heated air exceed 40 or 50 degrees centigrade, it becomes almost impossible to use the upcast shaft for the extraction of minerals, or for any other purpose whatever. We conclude from what has gone before, that when a temperature of 40 or 50 degrees centigrade is insufficient to produce the circulation of air necessary, the means that we use will be of little power and very slightly efficacious as a remedy, as we seek to increase the temperature of the column of warm air in giving more activity of combustion upon the air-furnace." If your Lordships will look at this Table, you will see how the temperature increases, and also how the combustion increases, and, above a certain limit, by using a greater quantity of coal, you scarcely increase the temperature at all. The results in this Table seem to be a singular confirmation of Mr. Gurney's views.

Professor J. Hann.

23d July 1849.

6356. This Table gives, in the first column, the temperature of the ascending air?

Yes.

6357. Then it gives the number proportional to the mass of air which passes in a given time?

Yes, up the upcast shaft.

6358. Or the activity of the circulation?

Yes.

6359. And then, lastly, the numbers proportional to the quantity of fuel consumed?

Yes, in the last column is the expense; so you see that by increasing the quantity of fuel, your temperature is very little higher, scarcely any.

6360. That whereas with the number of 43 representing the consumption of fuel you obtain a temperature in the ascending air of 30 degrees centigrade, with 632 to represent the amount of fuel you only get 100 degrees?

Yes, just so.

6361. Increasing the temperature two-thirds, whilst the consumption of fuel is increased 12 times or more?

Yes, as 1 to 13, or 1 to 15, Combes makes it.

6362. Does not the velocity of a current depend partly upon the depth of the shaft?

Certainly, for the power of the ventilation; the deeper the shaft, the greater is the power of ventilation.

6363. Then supposing a certain rate of current to be produced by a furnace placed at the bottom of a shaft 900 feet deep, what rate of current would be produced by the same furnace at the bottom of a shaft 450 feet deep?

Professor J. Hann.
23d July 1849.

There would be a wonderful difference. The question was once put to me by a viewer, and I made it out to be in the proportion of 17.6 to 25; but I think in almost all practical cases it will be found that the one is only about half the other.

6364. To what would you attribute this seeming paradox in the production of heat from a given amount of fuel?

It is a confirmation as it were of what has gone before; the only thing to account for it is, what Mr. Gurney has explained, I think, very satisfactorily.

6365. Do you know under what circumstances those results were obtained?

They were obtained from a long calculation, where he assumes the resistances to be the same for aeriform fluids as for liquids.

6366. Suppose the air was inclosed, and no current of fresh air could come in, what would be the effect of increased combustion?

I should not like to give an opinion upon this subject at present.

6367. It would not produce the same effect as is produced by an open current of air?

No, I think not; but this seems to be quite a different question altogether from that of ventilation; I think it is more a question for a chemist than for me. In the case of ventilation, I have gone through it carefully, and I consider that everything I have met with worthy of notice is a confirmation of the theory which has now been expounded by Mr. Gurney, and what I have already explained myself.

6368. That with a certain resistance in the passages of a mine, if the furnace is raised beyond a certain point, there follows a downcast current in the upcast shaft?

Yes; all this is due to the force necessary to move a mass of matter from one velocity up to another; and, consequently, the weight of the air in the workings cannot be so moved in an instant; all the friction against the sides of the mine, and other resistances, have to be overcome before it can arrive at the increased velocity required; from, perhaps, three feet per second to five feet will make about 3-horse power difference.

6369. Looking at the experiment which has been described as having been tried by Mr. Taylor at Seaton Delaval, in which he examined the power of the steam-jets combined with the furnace, and subsequently withdrew the steam-jets, and left the furnace alone, do you think that, taking an observation immediately after that change had been made, he would obtain a proper indication of the force due to the steam-jets, by ascertaining the difference in the amount of power in the two cases?

Certainly not; the thing just amounts to what I think was observed by Mr. Gurney some time ago, and by Mr. Cowie. I am entirely of the same opinion as Mr. Cowie upon that subject: it is quite clear that if you cut off the steam when a railway train is running, the train still goes on. Now, it is a well-known principle in mechanics, that the accumulated work in the train is equal to half the *vis viva*,* therefore the train will go on with the work accumulated in it, until this *vis viva* is destroyed. If we move the train from a state of rest, it goes on gradually increasing, until the resistance becomes equal to the accelerating force; then the motion becomes uniform; after that every new accession of velocity is destroyed by the resistance, and the motion remains uniform; when the train has acquired uniform motion, there is a great deal of work accumulated in it; this work has been accumulating all the way on, from a state of rest up to this uniform velocity: now, take away the force which has generated all that accumulated work, and the engine goes on till the friction and other resistances are such as to destroy this accumulated work in the machine, as I have before observed.

6370. And you think that that will equally apply to the stream of air passing through the passages of a mine?

Most assuredly.

6371. Have you any means at all of saying what would be the length of time during

* The *vis viva* is the mass multiplied by the square of the velocity.

during which such an effect would continue, taking an average case as to the size of the passages, and the length of the large mines in the North? *Professor J. Hann.*

It would be quite impossible, unless we knew the resistances; if we knew those resistances correctly, and the friction (and if it were friction only), it would be one of the simplest things to calculate imaginable. We have no precise data, however, concerning aeriform fluids, and, therefore, it is impossible to make it a matter of exact calculation; if we had sufficient data, we could submit it to mathematical calculation immediately.

23d July 1849.

6372. Do you think that you would be able to give an approximation?

No, I think not; I think there is no possibility of it in the present state of our knowledge of aeriform fluids.

The Witness is directed to withdraw.

Ordered, That this Committee be adjourned to Thursday next,
Half-past Two o'clock.

LIST OF APPENDIX.

| Appendix | Page |
|--|------|
| A.—Instructions :—Mines Inquiry Commissioners - - - - - | 595 |
| B.—On Ventilating and Warming the York County Hospital, by Dr. Arnott - - - | 598 |
| C.—Improved Method of Ventilating Collieries, by W. Brunton, C. E. - - - | 600 |
| D.—Copy of a Letter from John Hutchinson, Esq., M. D., to the Right Honourable Lord Wharncliffe - - - - - | 602 |
| E.—Observations respecting Accidents in Mines, and their Causes; by Evan Hopkins, Mining Engineer - - - - - | 605 |
| F.—Extracts Correspondence previous to the Inundation of Workington Colliery (Read by M. Dunn, Esq.) - - - - - | 609 |
| G.—Extract from Mr. Dunn's Treatise upon "The Winning and Working of Collieries;" published in 1848 - - - - - | 609 |
| H.—On Parliamentary Interference with the Working of Mines;—addressed to Sir G. Grey, Bart.; by M. Dunn, Esq. - - - - - | 613 |
| I.—PLANS and DIAGRAMS, Nos. I. to XXXI. | |
| GENERAL INDEX to the Principal Matters contained in the Evidence - - - - - | 617 |

A P P E N D I X.

APPENDIX A.

INSTRUCTIONS:—MINES INQUIRY COMMISSIONERS.

Sir,

Whitehall, June 15, 1849.

THE frequent occurrence of serious accidents from explosions in Collieries having rendered it expedient that a general inquiry should be instituted into the state of the Collieries and Ironstone Mines in the principal Coal Districts, especially with reference to the system of Ventilation, I am directed by Secretary Sir George Grey to request that you will proceed, at an early period, to the Coal Districts in the Counties of

for the purpose of this inquiry.

I enclose, for your information, various Reports which have been from time to time laid before Parliament connected with this subject. It appears from these Reports, that the chief cause of the accidents which have occurred, and by which great loss of life has been occasioned, has been defective Ventilation, and it is therefore of importance to ascertain in what proportion of the Collieries, in the District assigned to you, the system of Ventilation is calculated to ensure the safety of the persons employed in them? what are the chief defects in others? how the most effectual remedy can be applied to those defects? and what general improvements can be suggested?

The risk, moreover, of accidents, from a want of proper attention to shafts, inclined planes, underground works, the machinery employed, and other causes, should not be overlooked.

Although, owing to the modifications of the varied conditions under which Coal and Ironstone (of the Coal measures) are worked in the different Local Districts, it is impossible to suggest with accuracy all the topics to which your inquiries should be directed; the annexed List of Questions may be of use in directing your attention to certain points of importance. Your own experience and practical knowledge will supply any deficiencies in that list.

You will exercise your own discretion as to the order in which you will visit different parts of your District, and the Collieries you will inspect; and you will report from time to time to the Secretary of State on any portion of the District, without waiting for the completion of your inquiry into the whole.

In case you should be of opinion that, either from defective Ventilation, or from any other cause, danger is to be apprehended to the lives of the persons employed in any Colliery, you will immediately acquaint the Managers of the Colliery with the opinion you have formed, and with the grounds of it, and suggest such measures as appear to you to be requisite to remove the causes of danger. If your representations should not be attended to, you will forthwith report the case to the Secretary of State.

If, during the progress of the inquiry, you should hear of the occurrence of any serious accident in any Colliery within your District, it will be desirable that you should visit such Colliery without delay, and attend any investigation into the causes of the accident, reporting the result, with your opinion, to the Secretary of State.

Your attention will be directed to any experiments which may come under your observation for extinguishing Fires in Collieries, for their better Ventilation, or for the improved safety of the Works in any other respect; and you will offer to the parties interested any information or suggestions which appear to you calculated to be of use; but it must be borne in mind, that the responsibility for the adoption of efficient measures for the safe and proper working of the Collieries rests upon the Owners and Managers.

The production of your Instructions will, it is hoped, secure to you, from the Owners and Managers, ready access to all Collieries in the District. If any obstacle should arise to your inspection in particular cases, you will report it to the Secretary of State.

I am, Sir,

Your obedient servant,

No. _____ County _____

- 1.—Name of Colliery or Ironstone Mine ?
- 2.—Nearest Post-town ?
- 3.—Name of Proprietor of Colliery or Ironstone Mine ?
- 4.—Name of Lessee or Worker ?
- 5.—If the Colliery or Ironstone Mine is under the superintendence of a resident or non-resident Viewer, attending only at stated times, the Name of the Viewer, and his times of attendance, if non-resident ?
- 6.—State of information respecting the common principles of Ventilation possessed by the minor Superintendents ; giving their occupations and the local names for them ?
- 7.—Number of persons engaged in the various occupations, with the local names for such occupations ?
- 8.—If Maps and Sections of the Workings are kept ; when kept, their condition and correspondence with the actual Workings ; the times at which they are brought up to the work, and the scales adopted ?
- 9.—Mode of Lighting adopted ; whether by naked Lights or safety Lamps ; specifying the kinds used, with the regulations in force respecting them ?
- 10.—Description and local names of the Coal-bed or beds worked in the Colliery, and whether liable to the escape of Fire-damp, Choke-damp, Sulphur, or by whatever names the noxious Gases found in Collieries may be known ? If such Gases get into the Workings from other sources than the Coal-bed or beds worked ?
- 11.—Whether the escape of these noxious Gases is much influenced by changes in the Weather, especially those accompanied by changes in the Barometer ?
- 12.—Whether the Colliery or Ironstone Mine is worked by Shaft, Inclined Plane, or Level ?
- 13.—If by Shafts, their number, depth, form and section, according to measurement ?
- 14.—If by a single Shaft, detail of its divisions, their several uses and portions actually available for ventilation, and free from obstructions. The condition of separating walls or brattices, and of what constructed ?
- 15.—If two or more Shafts, their respective uses ; and if any system of regular upcast and downcast Shafts adopted, whether any furnaces or other means (specifying them) are employed for Ventilation purposes ?
- 16.—Volume of fresh Air supposed to be introduced into the Colliery or Ironstone Mine by Shafts or Levels, and how far this corresponds with actual experiments made to ascertain the real volume of Air introduced, and its rate of motion through the workings ?
- 17.—Mode of distributing the Air introduced ; including that used for the Stalls, face of work, or by whatever name the places may be known at which the men actually cut the Coal ?
- 18.—Manner, if any, in which the Goafs, or other Wastes, may be ventilated ?

19.—How

19.—How far this distribution of Fresh, and the removal of Foul Air, may coincide with a proper system of Ventilation, all local conditions being taken into account?

20.—If the Colliery or Ironstone Mine be worked by Level or Inclined Plane, the mode of Ventilation adopted?

21.—Regulations in force respecting the state of the Air in the Workings before the men are admitted to them; and when constant working is adopted, the precautions taken for ascertaining the condition of the Air at stated times during the day?

22.—Regulations in force for ascertaining the state of the Air in the Goafs and Wastes not immediately in connexion with the actual Workings, but what may, under certain conditions, furnish noxious Gases that could escape into the actual Workings?

23.—Condition of the Foul or Return Air near the upcast Shaft, or other mode of exit?

24.—State of the Supports, natural or artificial, by which the Works are kept open, and the Roof up; of the doors, brattices, and other means by which the Ventilation is arranged; and of the underground Workings generally?

25.—Condition of the Shafts or Inclined Planes by which the men are raised or let down from, or to, the Workings, when they come up or descend by such means?

26.—Number of persons killed or seriously injured by Explosions or their effects; by Choke-damp, Accidents in the Shafts, or in the Workings from other causes (specifying them), during the last 10 years?

27.—General Remarks?

APPENDIX B.

YORK COUNTY HOSPITAL.

VENTILATING and WARMING.

In any building containing separate rooms, there cannot be perfect ventilation for all the inmates, and at all times, if the system be defective in regard to any one of the following six particulars:

1. Means of uniformly moving along the supply of air.
2. " measuring in the required quantity.
3. " duly distributing to the different rooms.
4. " properly diffusing the air in each room.
5. " causing the vitiated air to depart from near the ceiling where it tends to accumulate.
6. " giving to the admitted air, in cold weather, the fit temperature and moisture.

THE YORK COUNTY HOSPITAL.

100 Patients.

20 cubic feet per minute of ventilating air for each patient,—making 2,000 cubic feet per minute for the whole.

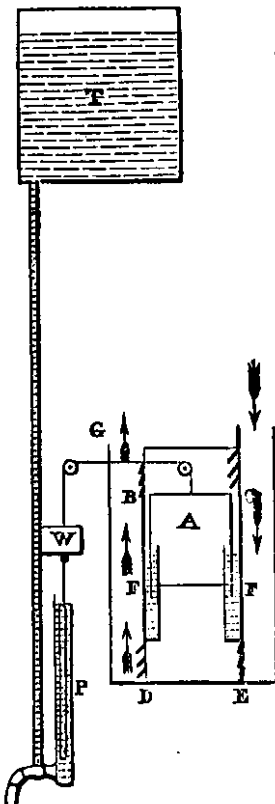

Requisite 1.—AIR PUMP.—A suspended cylinder of thin plate metal A balanced over pulleys by the counterpoise W, with its mouth dipping into water F F like the common gas-holder, but having an inclosed space also above it, B C F F, so that it expels its bulk of air equally whether rising or falling. The air passes through curtain-valves near D when falling, and near B when rising, into the beginning of the distributing channel D F B G, and air simultaneously enters the pump at the other side by the corresponding entrance-valves near C and E from the channel C F E by which the pure air approaches the pump.

A cylinder holding 500 cubic feet, moving up and down twice in a minute, would furnish the required quantity, or one of smaller dimensions and quicker motion, if this were more convenient.

The moving power to be the force of water descending from a tank T near the roof, which will be filled daily by the Water Company. This water, after doing the pumping work, to be used for the general purposes of the house. If the Water Company have not a high-service, the tank may be filled by a pump worked in the house. A tank of from six to seven feet cube, or of equal bulk with other dimensions will suffice.

The water to act on the piston of a small water-engine or pump P, in which friction is avoided by its having a mercurial joint for the piston, resembling the water-joint of the great air-pump. The pump will be made self-regulating, and will open and shut its valves as needed at the top and bottom of its stroke.

Requisite 2.—The air to be measured by the number of strokes of the pump allowed in the minute.

Requisite 3.—The air to be distributed by channels branching over the house and tapering as they have less air to carry, so that the warm air in winter may not cool by stagnating. A channel of 12 square feet will suffice for the whole air departing from the pump through the curtain-valves of that area. The amount of area in the branches should considerably exceed that in the single trunk or shaft. Gas-meters of the required construction are to be placed at convenient places to determine

determine the quantity admitted to each sub-division, and they must be within reach for adjustment.

Requisite 4.—Diffusion to be secured by letting the air issue from chinks all along the skirting-boards of the wards.

Requisite 5.—The escape of foul air to be by openings near the ceiling, provided with light curtain-valves to prevent any return there; and if the openings be into chimney flues, there must be in each a balanced metallic valve. The foul air must all issue into the atmosphere by chimney tops or other such openings above, but there will be no need to collect the whole into one shaft unless it be determined to warm the entering fresh air by making it traverse thin tubes immersed in the hot foul air going away.

Requisite 6.—The fresh air in cold weather to be warmed by two self-regulating water-stoves capable of heating about 800 feet of surface of water-leaves such as are used at the Brompton Hospital for Consumption.

All the open fires in the building should be supplied with fresh air by direct communication between them and the outside, at each of which there must be a regulating air-valve. Each fire-place should also have the hooded register flap now used in London, which prevents the waste of fuel and of pure warm air escaping by the chimney mouth. And to every chimney flue near the ceiling there should be a balanced chimney valve.

It would save much heat in winter to have double windows or double window panes.

Bedford-square, }
23 June 1849. }

NEIL ARNOTT, M. D.

APPENDIX C.

IMPROVED METHOD OF VENTILATING COLLIERIES, by W. BRUNTON, C. E.

FOR this purpose he constructs over the upcast pit, or over a chamber immediately connected therewith, a hollow drum, with radial compartments, through which the air is discharged with that degree of force due to the velocity with which the drum revolves.

The Diagrams A and B represent a drum, 22 feet exterior diameter, with radial compartments of 6 feet long each, and revolving 180 times per minute.

Taking 16 feet as the mean diameter of the compartments, the centrifugal force, at 180 revolutions, will be 88.5, which, multiplied by the weight of 6 cubic feet of air, = $\frac{44}{1000}$ of a pound, which will give a pressure of 39 lbs. on the square foot as the amount of rarefaction produced, which is much beyond what is obtained by the furnace. I have, however, chosen to calculate on a high degree of rarefaction, yet perfectly practicable, and considerably within the limits of capability.

This machine is an entirely new modification of the fan, presents the means of ventilation to any required extent, either as to the amount of rarefaction, or the quantity of air displaced. If driven to 210 revolutions per minute, would produce a rarefaction of upwards of 50 lbs. on the square foot; or unconnected with any lengthened air-course (*i. e.* mere displacement), it would discharge more than 800,000 feet in a minute. Its construction is of the most simple character—it has no valves or separate moving parts, has no attrition, and all the friction is resolved into a foot pivot moving in oil. When at rest, offers no resistance to air ascending from the pit; is very inexpensive, and liable to no derangement. In short, it is a simple mechanical implement whereby any degree of rarefaction necessary to ventilation is rendered certain and regular, being subject to the law of central forces, which is as fixed and determined as that by which a stone falls to the earth.

In order to possess the means of immediately increasing the ventilation, upon any sudden discharge of carburetted hydrogen, such an apparatus should have a steam engine of 12-horse power, though ordinarily one-third of that power may be sufficient.

It will be observed, that the essential peculiarity of this apparatus is the radial length of the apertures through which the air passes, combined with the centrifugal force with which they revolve.

The Diagram C represents a half-section of a drum of 22 feet diameter, revolving 120 times per minute; and the Table shows the effect of radial compartments from 2 to 6 feet of radial length.

| Length of Radial Trunks. | Mean Diameter of Ditto. | Centrifugal Force. | Number of Feet and Weight of Air. | Pressure per Square Foot. | Velocity of Air due to Ditto. |
|--------------------------|-------------------------|--------------------|-----------------------------------|---------------------------|-------------------------------|
| 2 feet. | 20 feet. | 49.2 | Two Feet, × .148 lbs. = | 7.25 lbs. | 56 feet per sec. |
| 3 " | 19 " | 46.6 | Three Feet, × .222 lbs. = | 10.35 lbs. | 67 " |
| 4 " | 18 " | 44.0 | Four Feet, × .296 lbs. = | 13.0 lbs. | 75 " |
| 5 " | 17 " | 41.8 | Five Feet, × .368 lbs. = | 15.4 lbs. | 80 " |
| 6 " | 16 " | 39.25 | Six Feet, × .444 lbs. = | 17.4 lbs. | 87 " |

In demonstration of what is stated, the model exhibits a small apparatus like what has been described, but turned with the central opening upwards, for the convenience of testing the amount of rarefaction by weight.

The diameter of the drum is 12 inches.

The radial compartments 4½ inches.

The mean diameter of do. 7½ inches = 6.25 of a foot.

Weight of 4½ cubic inches of air 1.35 grains.

Disc 2.85 inches diameter = 6.3 square inches = $\frac{1}{3}$ of a square foot.

| | | | |
|---|--|--------------------------------------|-------------------------|
| At 580 revolutions per minute, centrifugal force, | } = 35.8 × 1.35 × 6.3 = 304.47 grains. | Weight by Theory. | Weight actually raised. |
| At 830 " " " | | = 73.3 × 1.35 × 6.3 = 623.41 grains. | |

Results so nearly conforming with theory, demonstrate the great simplicity of the machine, and the certainty of its action, leaving no doubt as to the efficiency of the larger apparatus.

W. BRUNTON

W. BRUNTON having devoted much time and attention to this mode of ventilation, and visited this district for the purpose of introducing it, most respectfully solicits the attention of gentlemen practically interested in the subject. He will be happy to give any further information. May be professionally consulted as to local applicability, and, if approved, will supply the necessary drawings, and superintend the erection of the whole.

Letters addressed to Mr. Brunton, No. 12, Blackett-street, Newcastle, will have immediate attention till the 18th of November, when he returns to Newport, Monmouthshire.

W. B. will exhibit the model at the Central Exchange, on Saturday the 4th and 11th of November, between the hours of Ten and Five.

Newcastle, 28th October 1848.

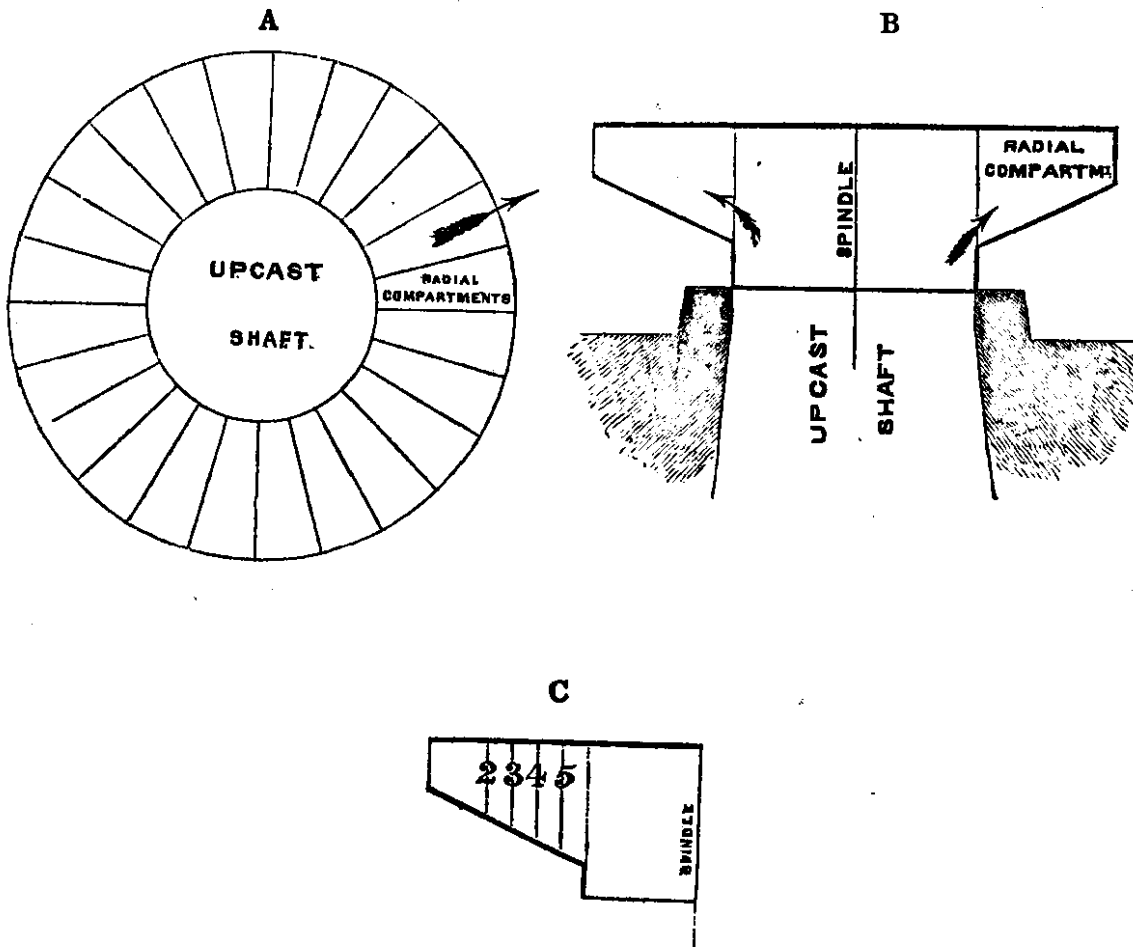

APPENDIX D.

COPY of a LETTER from JOHN HUTCHINSON, Esq., M.D., to the
Right Honourable LORD WHARNCLIFFE.Milton-street, Dorset-square, London,
19 July 1849.

My Lord,

ALTHOUGH the Committee over which you preside was appointed to examine into the causes of coal-mine explosions, yet I take the liberty of laying before your Lordship a few remarks upon the composition of "fire-damp," and the effects of "pit-air" upon the miners' health, because Government at present takes much interest in sanitary regulations for the benefit of "public health."

There is no trade in which the health of the workman is so dependent upon his master as that of the miner upon his superior; for the air which he breathes is entirely supplied by the command and according to the rule of the viewer.

OF THE GASES IN COAL MINES.

The chief gases generated in the coal-mines of England are, carbonic acid gas or "*choke-damp*," light carburetted hydrogen or "*fire-damp*."* I have nothing to say upon the properties of carbonic acid gas, because its nature as a direct virulent poison and its composition are already known.

OF "FIRE-DAMP," OR LIGHT CARBURETTED HYDROGEN.

A short time ago I obtained specimens of this gas from three collieries in the neighbourhood of Newcastle, viz., Hebburn, Killingworth, and Gateshead or Oakewellgate collieries. I collected these in person, with every requisite precaution to ensure their purity, and prevent admixture of atmospheric air. I gave them to my friend, Professor Graham; they were analysed,† and found to consist of light carburetted hydrogen, with the exception of a few per cent. The results were as follows:—

| | | | | | | | |
|----------------------|---|---|---|---|---|---|---------------------------|
| GATESHEAD Pit Gas | - | - | - | - | - | - | Specific gravity, 0·5802. |
| Carburetted Hydrogen | - | - | - | - | - | - | 94·2 |
| Nitrogen | - | - | - | - | - | - | 4·5 |
| Oxygen | - | - | - | - | - | - | 1·3 |
| | | | | | | | <hr/> 100·0 <hr/> |
| KILLINGWORTH Pit Gas | - | - | - | - | - | - | Specific gravity, 0·6306. |
| Carburetted Hydrogen | - | - | - | - | - | - | 82·5 |
| Nitrogen | - | - | - | - | - | - | 16·5 |
| Oxygen | - | - | - | - | - | - | 1·0 |
| | | | | | | | <hr/> 100·0 <hr/> |

HEBBURN Gas - - - - Specific gravity, 0·6327.

From this analysis it may be observed, that the "*fire-damp*" in different mines and from different coal-seams, viz., the Five-quarter, the Bensham and the Low Main Coal-fields, possess great similarity of composition, and in combination with a remarkable small quantity of oxygen, not exceeding one-and-a-half per cent.

One striking feature is, the remarkable power of this gas in resisting oxydation, or its union with oxygen gas; hence the necessity of a *white heat* to ignite it; therefore the gauze of the safety-lamp merely heated to redness is not sufficient to explode or unite it with oxygen. A white heat, *i. e.*, flame-heat, is absolutely necessary to make it combine with the oxygen; hence the purity and preservation of this gas.

Moreover, for the same reason, an explosive mixture is harmless to animal life, as it equally resists oxydation in the lungs, and when pure, although a poison, yet it is only classed as a negative poison—poisoning through the want of oxygen.

OF THE DIFFUSION OF FIRE-DAMP.

The law of the diffusion or intermixing of this gas with atmospheric air, although more rapid than other gases, yet, being so light, it floats near the roof of the mine, and sometimes acts as a train, communicating an inexplorative with an explosive atmosphere.

The velocity of the intermixing of this gas with others found in the coal-mine is as follows:—

| | | | | | | | |
|----------------------------|---|---|---|---|---|---|-------|
| Taking atmospheric air at | - | - | - | - | - | - | 1000· |
| Light carburetted Hydrogen | - | - | - | - | - | - | 1341· |
| Oxygen Gas | - | - | - | - | - | - | 949· |
| Carbonic Acid | - | - | - | - | - | - | 809· |
| Nitrogen | - | - | - | - | - | - | 1014· |

Of

* Now termed Proto-carburetted Hydrogen, C H³

† See Composition of Fire-damp, by Thomas Graham, Esq., F. R. S., Member of the Chemical Society of London, vol. iii. 8vo. London, 1848, p. 7.

OF THE EXISTENCE OF CHARCOAL, OR BLACK MATTER, IN THE LUNGS OF MINERS.

In my examination before your Lordships, I had an opportunity of noticing, that although a miner's occupation could not be considered as "destructive to health," yet, certainly, it is not a healthy occupation; and, perhaps, the diseases may be confined entirely to the lungs or to the respiratory organs in general (the heart and lungs). At a distance you may know a "pit-man" by his high shoulders and stooping back: at hand you may know him by his blanched look—wrinkled and bloodless face—the appearance of age in his youth. These symptoms are to be attributed to the deleterious quality of the air he breathes; an atmosphere densely and mechanically charged with carbonaceous matter. Upon the surface of the earth deteriorated air immediately ascends from the person, and passes off for ever; were this not the case, man would in a few hours perish, for want of a respirable atmosphere. In the mines this is not the case; the air has to circulate and bend its tortuous course from one lamp, horse and man, to another lamp, horse and man, and thus supply, probably, 150 men, 200 lights and 30 horses, before it ascends to pass off into the general atmosphere. The miner works many hours, even all his time, in a kind of "cul de sac," without a sweeping current of air playing immediately around him; his ambient air is nearly stagnant to all his feelings. This air is densely charged with coal-dust, dust in the most impalpable form, and his face becomes coated with it; the laborious work of "hewing" (striking the hard coal with the pick) excites, like other violent exercises, a great respiratory action; he breathes deep, and draws into his lungs with avidity this loaded mixture. His chest is bare, and the whole class of his respiratory muscles are in beautiful action; consequently he expectorates black matter; he breathes thick, and he is subject to asthma. If he has a consumptive taint, he speedily falls a victim to that disease; but should he be so fortunate as not to have any claim to this disease, his breathing is rarely natural, that is, inaudible; his blood is not aerated, and thus he presents the appearance already described—a man with a pale face: his general conformation is thin, because his nutrition is impeded. The appetite may be good, yet the nourishment deficient.

In this close and dusty hole the miner labours and breathes double quantity of air; therefore his six or eight working hours' respiration become equal to double that time of ordinary breathing when in a quiescent state.

The effects of such an atmosphere are insidious; gradually he becomes disordered in his breathing, and he is a victim to some chest affection before he is aware of it.

Ultimately his lung is loaded with black matter, solid or fluid, like printer's ink or common ink, or lamp-black, or charcoal powder, all insoluble and tasteless.

In mentioning a few cases as an illustration, I will notice a mine with perfect ventilation, and not producing these diseases in the lungs.

Professor Graham* examined the lungs of a collier, the greater part of which organs were obliterated with black solid matter, like lamp-black, and more than an ounce of charcoal was obtained out of the mass. This, Graham considers, came from ill-trimmed oil-lamps attached to the forehead of the miner.

I have known a case where a single floating-oil light in a bed-room nearly closed up the nostrils of the occupant with "soot or blacks," ultimately producing such a sensation of suffocation, that the person in question was awoke; he opened the window immediately, and ventilation carried off the offensive matter, to his no further annoyance.

Out of 10 cases of lungs infiltrated with black matter, recorded by Dr. Wm. Thomson,† nine of these are colliers, and one a "moulder" in iron-works. I here mention a few cases of the appearance of miners' lungs when examined after death:

D., æt. 43, collier, six years hewer; "whole of the lungs deep black."

A. B., æt. 59, collier, 12 years hewer; "lungs in every part uniformly black, and of a carbonaceous colour."

J. C., æt. 58, collier from boyhood; lungs uniformly black; "not a vestige of natural colour left;" he refers his disease to breathing an irrespirable atmosphere.

D. D., æt. 62, collier from boyhood; "lungs deeply stained with black infiltration."

G. H., æt. 40, overman; "lungs uniformly deep black through their whole substance," with a density equal to black "caoutchouc."

R. L., æt. 60, collier from early life; "lungs black throughout;" "parts quite solidified with black matter."

—, æt. 20, collier all his life; "whole lungs dyed with black matter."

—, æt. 35, collier all his life; "substance of the lungs charged with black matter."

L., æt. 40, collier; "lungs found as black as soot."

Professor Schoenlein, of Zurich, has noticed similar infiltration in the lungs of the miners of Wurzburg and Zurich. Mr. Philp, surgeon, of Aberdour, is of opinion that this black deposition is caused by inhaling impure air, and "that those pits and mines which have been noted for the impurity of the air, have given origin to the greatest number of cases; for instance, Cuttlehill Pit, and the Holborn Mine, in the workings particularly of the latter; out of a gang of 10 or 12 men, four have died with black lungs. In the Renown Pit the air is frequently impure, and the workmen often suffer from difficult respiration; whilst, on the contrary, the New Venerable Pit, remarkable for the purity of its air, has NOT FURNISHED ANY CASES."

This blocking up of the lungs with black matter is not confined to those miners who work in coal; but "sinkers" and others, who use gunpowder in working "stone-drifts," are also

* Edinburgh Med. Surgical Journal, 1834, 8vo. p. 323.

† Tr. Med. Ch. Society, London, vol. xx. p. 230, and vol. xxi. p. 340.

also liable to this disease. Such drifts are small, sometimes carried many hundreds of yards, with a temporary half-inch brattice, imperfectly jointed, which has to conduct in the air, and this partition is left many feet short of the men; consequently, when a "shot has been fired," or the stone blasted, a dense cloud of smoke, for an indefinite time, fills the place, amidst which the miner has to live and breathe. The duration of this smoke is modified by the degree of ventilation; a candle may burn well in a vitiated atmosphere, even where a man cannot live.

Although pathologists do not agree about the exact cause of the origin of this carbonaceous deposit in the lungs, whether it is by the mechanical inhalation of black matter or by a chemical action of breathing carbonic acid gas, this matters little to the miner; all agree that the lungs are blocked up with carbonaceous matter by "pit air," by something peculiar to the art of mining; and all agree, that the more pure the air, the more healthy the lungs. This allows me to urge for more air to circulate for better ventilation: upon sanitary grounds alone this may judiciously be requested and recommended for the consideration of the viewer. I have given an estimate in my evidence of a certain quantity of air for the health of the miner.* More air would not only give health and vigour to the miner, but at the same time prevent explosions. The nutrition of a man bears a strict relation to the purity of the air he breathes. In vain may he eat in a poisonous atmosphere; food may enter the stomach, but it *cannot enter* his system to refresh the blood, or give him strength against the wear and tear of life.

OF THE DEPTH OF A MINE UPON THE HEALTH OF A MINER.

It is well known that difference in atmospheric density affects the respiratory functions. In descending deep mines an increased atmospheric pressure is sensibly felt; so much so, that at South Hetton Colliery my attention was drawn to the subject, and, through the kindness of Mr. Potter, I made the following observations:—

Depth of the Mine 1,488 feet.

| — | Barom. | Therm. | Respirations per Minute upon Six Men. | | | | | |
|------------------|--------|--------|---------------------------------------|----|----|----|------|----|
| | | | Mr. P. | F. | H. | L. | W. | T. |
| At the Surface - | 28.72 | 39° | 15 | 20 | 16 | 14 | 18.5 | 18 |
| Below - - - | 30.26 | 51° | 16 | 24 | 19 | 15 | 22 | 20 |
| Difference - + | 1.54 | 11° | 1 | 4 | 3 | 1 | 3.5 | 2 |

Increased pressure, therefore, not exceeding the $\frac{1}{20}$ th of an atmosphere, caused an increase in the number of our respirations exceeding $\frac{1}{10}$ th above our quantity on the surface. Whether this was a temporary change or not, I cannot say; such was the effect for the first half hour. Precautions were taken for nothing to interfere with this experiment, as physical exertions, &c.; therefore this change is purely the effect of increased pressure. Such a change I did not expect, but rather the contrary. Candles have been found to burn quicker under pressure or in denser air, and people can live longer under water who go down from out of an atmosphere which is increased one-half in its density: the pulse or heart's action is increased, as might be expected from the above Table, because the heart and lungs "work to each other."

Of the effect upon the pulse by increased pressure of 1,488 feet.

| — | Barom. | Therm. | Pulse per Minute sitting on Six Men. | | | | | |
|------------------|--------|--------|--------------------------------------|------|-----|-----|-----|------|
| | | | Mr. P. | F. | H. | L. | W. | T. |
| At the Surface - | 28.72 | 39° | 65 | 98 | 72 | 90 | 88 | 85 |
| Below - - - | 30.26 | 51° | 59 | 98 | 68 | 88 | 93 | 100 |
| Difference - - | - - | - - | + 6 | same | + 4 | + 2 | - 5 | - 15 |

For the most part the pulse is increased, though less regularly than in the Table above. The effect of an increased respiration and pulse upon the life might be expected to cause an increased wear and tear upon our life; but I do not believe this degree of increased pressure can in any measure so affect the health of the miner, because the limit of difference in pressure in the coal-mines is within the common atmospheric changes of pressure as 1 to 2; but, weighing the matter in a more extended manner than would be necessary here to discuss it, I believe the effect of increased pressure at the depth of our coal-fields yet known is not injurious to health. With these remarks,

My Lord,

I beg to remain your Lordship's most obedient servant,
 To the Right Honourable Lord Wharnccliffe,
 &c. &c. &c.,
 JOHN HUTCHINSON, M.D.
 President of the Committee of Lords
 on Coal-Mine Explosions.

APPENDIX

APPENDIX E.

OBSERVATIONS respecting ACCIDENTS in MINES, and their CAUSES;
by EVAN HOPKINS, Mining Engineer.

In consequence of the numerous accidents in Collieries from explosions, it is generally supposed that they arise from the want of uniformity of working, and that if Government Inspectors were appointed, and any favourite system established, the accidents would be prevented. It is also thought by many that if more powerful ventilators were applied to the upcast shafts the cause of the explosions would be removed; but these are mistaken views. All improvements, short of scouring out the old workings, but more especially *in the upper cavities*, so as to prevent the accumulation of the inflammable gas, accidents will no more cease than they have done since the introduction of the safety lamp. It is a well known fact, that all cavities in the mines, *above the level* of the ventilating stream, favour the accumulation of the carburetted hydrogen, and if this extends over a considerable area without any means of escape *above*, the gas remains floating, and on the slightest check in the ventilation, it descends in large volumes and contaminates the air in the passages, and thus cause explosion. "Fiery" Collieries having such recesses, *i. e.* cavities or workings above the level of the returned air-way, are in perpetual danger. The greater the intensity of the current employed, by means of machinery, to prevent the gas expanding downwards, the greater the danger and the less time allowed for escaping, in the event of any interruption in the machinery of the ventilation.

Carburetted hydrogen is seven or eight times lighter than common air. It will always rise to the highest parts of the mine, like bubbles of air in undulating water-pipes, and would escape with great velocity *upwards* through any opening to the surface, and create a draught like the steam jets. I have seen a mere borer-hole of two and a half inches diameter, *from above*, sufficient to clear large workings from gas, which would have required a large passage and strong current to effect *horizontally*, and impossible, if attempted, to force the gas out by a *downward* action. It is by no means an unusual practice to *depress* the air-way, first carrying it up to a high ceiling and down again, under the impression that the light gas will descend and be thus easily carried away. Complicated undulating passages have sometimes been introduced to carry the gas to the upcast shaft, expensive, ineffective and dangerous, which by a simple air-drift, at a higher level, would not only remove but improve the draught very considerably.

The question of ventilation must be considered in its simple form. In a chamber in which a very light explosive gas is constantly evolving and ascending to the ceiling where it will accumulate and fill the space from above to the level of the passage below, it will remain there floating on the atmospheric current, however strong the stream may be in passing the floor and through the passages, as shown by the following sketch.

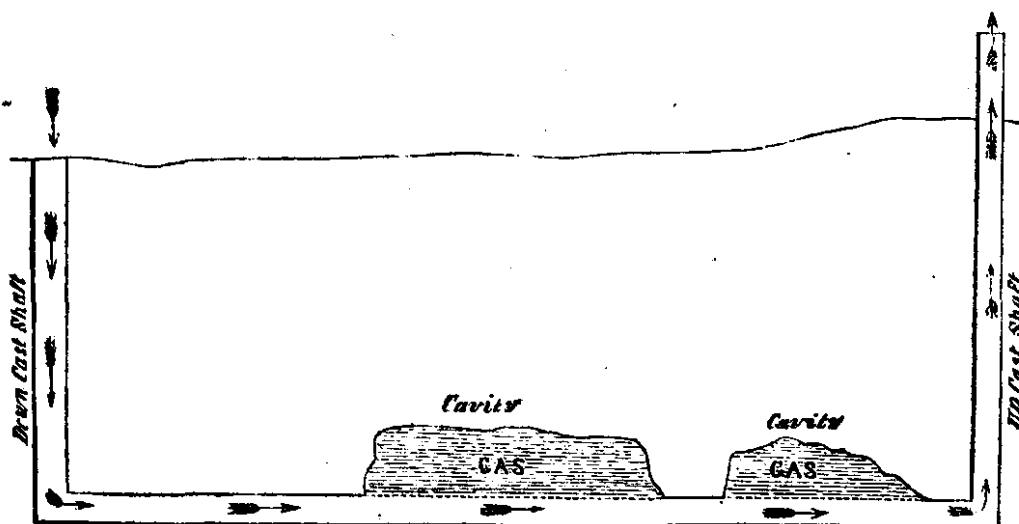

It matters not how much the intensity of the currents in the chimney be increased, or what kind of mechanical ventilators we apply to it, the evil will continue whilst the flue, or air-way, towards the upcast shaft, remains below the level of the roof of such cavities.

Some of the more careful viewers apply the following method to avoid the above dangerous accumulations :—

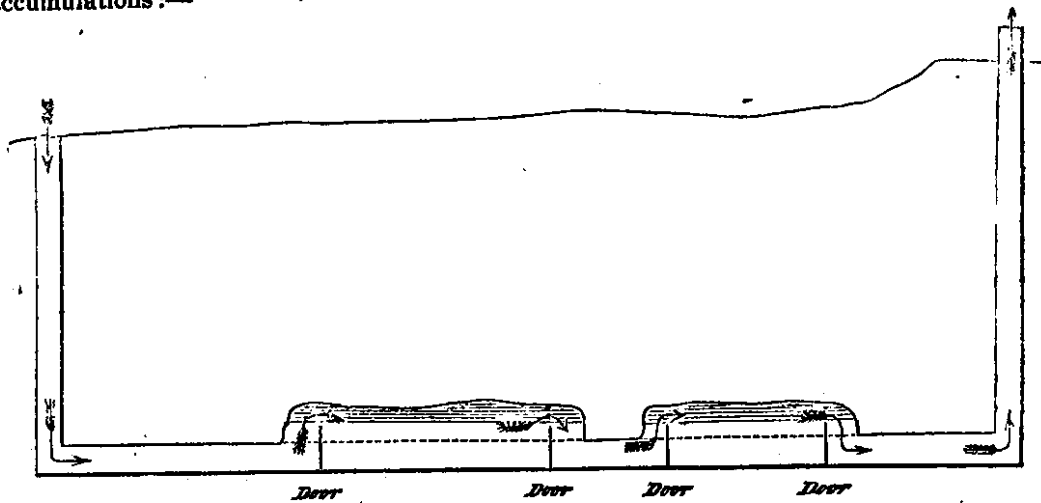

This plan is not only complicated but very ineffective, and liable of interruptions by the frequent opening of the doors, independent of the great difficulty of bringing down so light a gas. The Hebburn explosions have, I believe, been caused from the gas accumulating in the undulating roof, which is of considerable extent.

Again, many explosions take place in the "slants," that is, in working coal on the rise of the seams, and where the currents are made to circulate up and down; thus :—

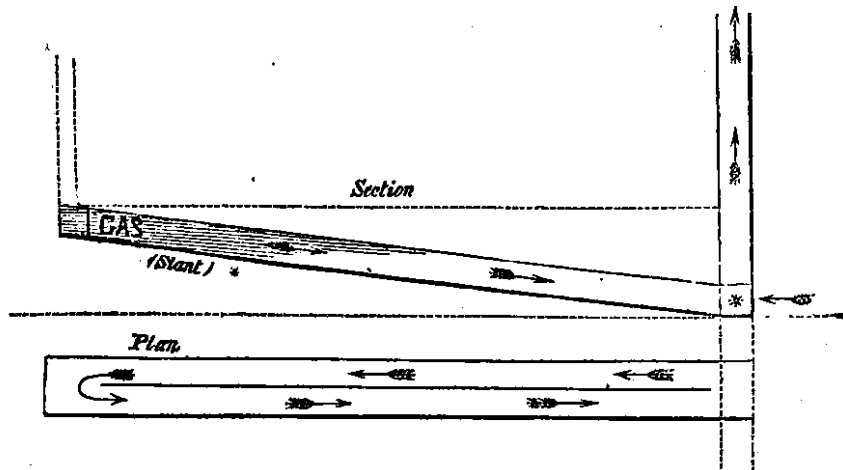

The above show the common cause of the explosion in Wales and the West of England. The former diagram represents the cause of the accidents in the thick coal of Staffordshire as well as Hebburn.

If the gas, or foul air-way, was always made as high as the higher workings of the mine, it would not only improve the ventilation by the rapidity with which the gas would ascend, but would also remove the great cause of the explosions.

In some districts they avail themselves of two seams of coal to effect the above desirable object. Indeed, the Collieries which I had to inspect a few months ago on the Continent, were so free from gas at all times, that safety lamps were seldom required.

The following sketch will give an idea of working two seams for the sake of ventilating, being the ordinary system in Belgium and near the Rhine :—

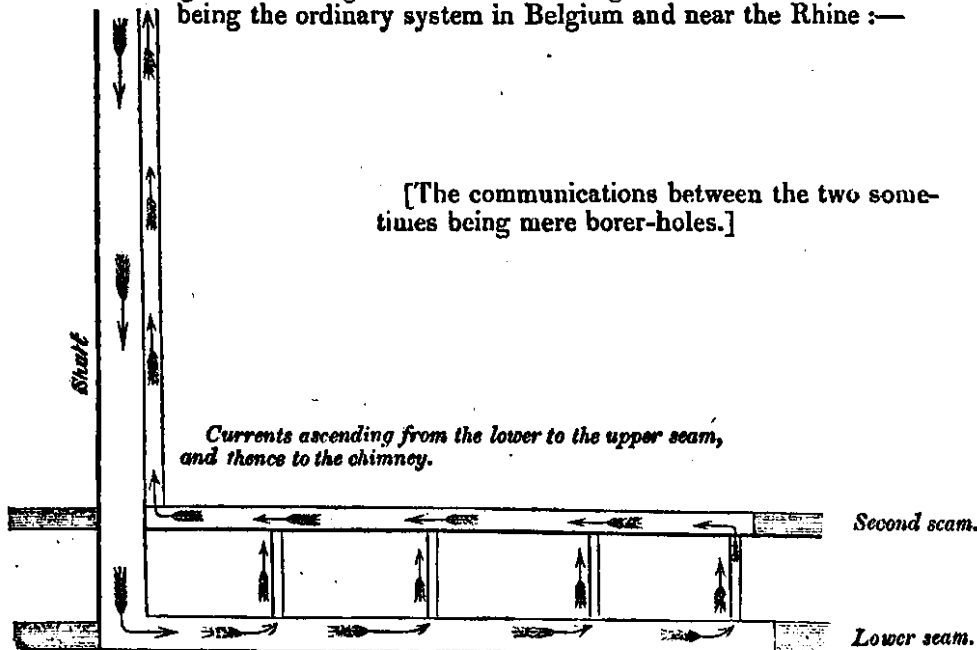

The natural current, without any artificial means, excepting a chimney above, is sufficient for the ventilation in the Collieries alluded to.

Notwithstanding that common sense dictates that gas, like smoke, *will always ascend*, two seams have been worked, and I believe are still at work, in a certain district, where they *reverse* the action of the current, i. e. make it to pass down from the *upper seam to the lower*, and thence up the shaft, by the aid of an artificial fire. The lighter gas naturally reacts against the current, and produces a very sluggish ventilation, and many accidents and sickness from the foulness of the air. Numerous apparent improvements are often brought forward respecting the system of working, &c., without the least consideration of the grand essential question of ventilating from the highest point. Some of those considered as model collieries in the North of England are equally susceptible of explosion from this very cause. Instead of working on a higher seam to ventilate the lower, or driving a small drift on a level with the highest part of the workings, or sinking the upcast shaft at the highest point of the beds, they bring back the foul air through a series of bends and crossings in a very expensive and ineffective manner, and always retain within, an immense magazine of explosive gas on a level with the passages.

No Colliery can be safe unless the air-way is placed on a level with the *highest cavity* in the excavations; and if this is done, a mere chimney, without fire, will drain a mine of its gas. If this is neglected, all the ventilators invented will not remove the danger. We may as well expect the gas at the ceiling of a confined room to be brought down, and taken up the chimney. A *hole in the ceiling* would be better than all the ventilators in the world applied to the top of the chimney.

In every case where the following method is adopted in the thick coal fo Staffordshire, there has been no explosion, nor the least trouble from the explosive gas :—

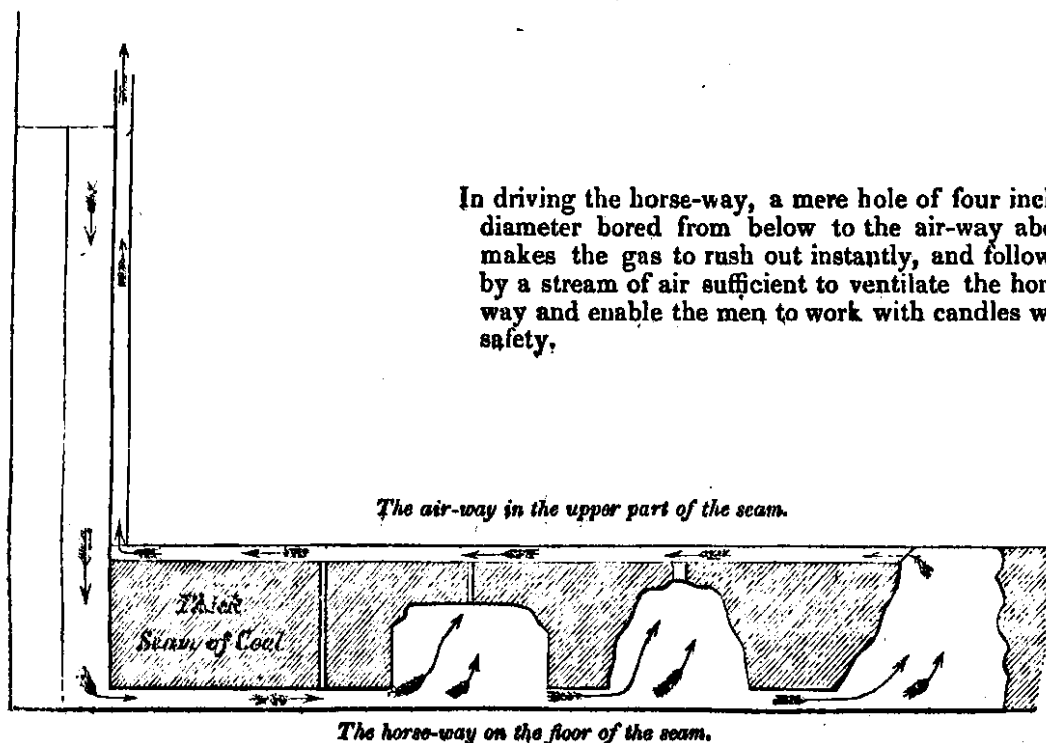

The coal is perfectly cleared of its gas in every part of the workings, simply by means of a chimney 80 feet high, connected with the flue in the pit.

Where the ventilating chimney is placed on the rise of the beds, at the highest point, we have no trouble from the lighter gas. Thus :

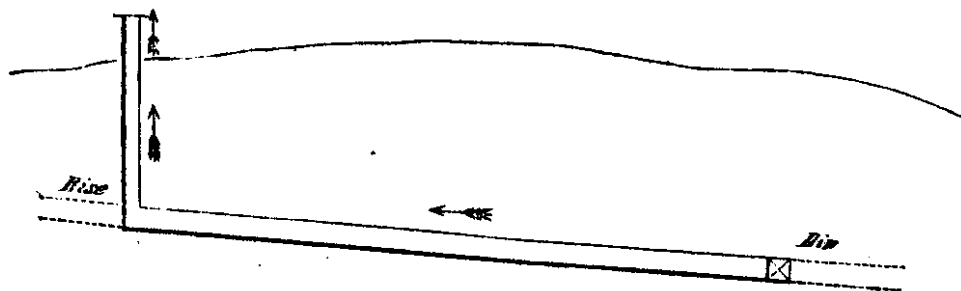

However, in working near the crop of the coal, we are seldom troubled with gas, and a very indifferent system of ventilation may be sufficient for the purpose; but on the dip on the other side of a fault, the case would be very different. I know a Colliery on the east side of a fault, where the coal seams rise towards the surface, the colliers have been working for upwards of 50 years without the least obstruction from fire-damp, and only an ordinary means of ventilation; whereas, on the west side of the fault, the seams are highly charged with

with carburetted hydrogen, being, as it were, retained by the fault. On the east side, ventilation is effected with the greatest facility; but on the west side of the fault, without the aid of a very judicious method for the escape of the gas as it evolves, the consequences would be very serious.

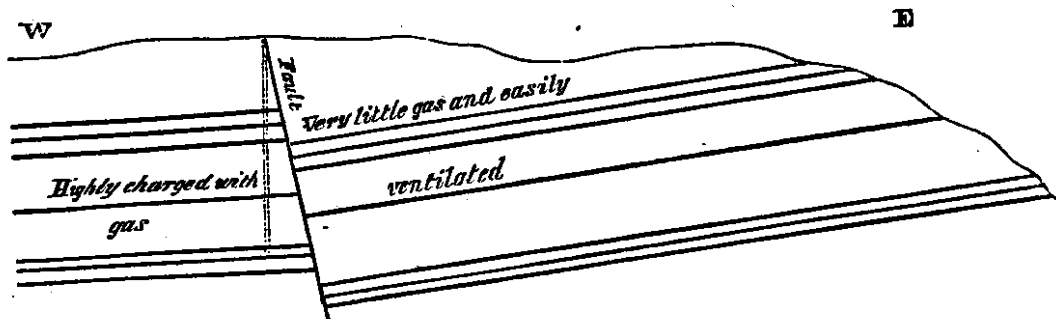

The local accumulation of the gas depends on the angular position of the cleavage and fault, and the character of the latter, and also the porosity or impermeability of the superior strata. A mere borer-hole from the surface is sometimes sufficient to drain such part of its gas.

I should leave all proprietors of mines to adopt any system of working they may deem proper; with this proviso, that the air-way should be placed as high as the highest excavations, to allow the gas to escape naturally upwards, and thus avoid accumulations in the workings. Plans and sections should be kept of all the underground workings, so as to show that this is being done. All other extra mechanical means of ventilation to increase the intensity of the current may be left to their discretion, as the former will be sufficient to remove all danger.

With respect to accidents in shafts, from breakage of ropes, chains, &c., every proprietor of mines should provide means for the men to descend and ascend in safety. In Cornwall, and on the Continent, such accidents seldom occur; they have always *ladder-ways* for that purpose. *Safety gearing*, or *ladder-way*, should be applied to all pit work.

The above being once established, the business of inspectors would be very simple, and two or three intelligent practical men would be sufficient to fulfil such a commission.

They would have to examine the plans and sections of the workings, and to see that the ventilating returning current occupies the higher level and not allowed to descend; and they should watch the cause of every accident which may occur. Should it happen that objections be made in any given district against applying the air-way sufficiently high for the purpose, owing to the expense or any other cause, the colliers of such districts should be publicly informed that such a colliery was always in danger of explosion, and that they should avoid working in it until the proprietor adopted the means of safety. Indeed, in the absence of Government Inspectors, the coroner of each district may be furnished with instructions so as to aid the jury to ascertain the real cause of explosions, and more especially if the plans and sections were presented in every case. The public exposure of the defects and consequences would be the means of checking and diminishing very considerably the accidents now occurring, and make the proprietors more careful in selecting and appointing underground agents.

If the following can be established no serious explosion can occur.

1st. The upcast shaft, or its air-channels below, shall always open, and be on a level with the highest part of the underground workings; and no cavities in "fiery" collieries allowed without the means of the gas *escaping upwards*, and prevented from accumulating.

2d. That the air-head shall be in perfect communication from the higher parts of the workings to the chimney, and be of sufficient size for the requirements of the mine at all seasons.

3d. That such air-ways should never be *depressed*, or pass downwards, below its level, but rather ascend towards the upcast shaft and chimney of the mine.

4th. That the colliery should have a chimney for the security of the uniformity in the ventilation.

5th. That every pit, where men are obliged to descend, should have a safety gear or ladder-way.

14 July 1849.

EVAN HOPKINS.

APPENDIX F.

EXTRACTS CORRESPONDENCE previous to the INUNDATION of WORKINGTON COLLIERY ;—read by MATT. DUNN before the Lords' Committee.

1837, April 10. "LADY Pit is now, and has been for some time, going double shift; and from accounts they are making very rough work among the pillars; and are, I am told, now splitting pillars. This, for a certainty will lead to something very serious after a-piece."

April 24. "The Camperdown coal is now working into very little compass, and are only leaving it very weak; and from the manner in which they are pulling out the pillars, both in Union and Lady Pits, one may expect soon a general creep, and which will, for a certainty, lead to very serious results."

June 2. "They are still making free with the pillars at Lady and Union Pits, which will tell a tale some day when they don't expect it."

June 27. Mr. Curwen to H. Lamb.—"I hasten to thank you for your very friendly letter, &c. &c. We are indeed sadly distressed by water, and no doubt — was too sanguine in working the Union coal, and we are now suffering for it. I am not aware that I can do more than follow up my present intention; but I am not the less obliged to you for the kind interest you express for me, and the friendship to us in your letter."

July 24. "At Lady and Union Pits they continue pulling out the pillars: in Camperdown they have had a gentle squeeze, which has very materially increased the water, which is rising in Isabella Pit-shaft four feet a week, notwithstanding they are also drawing with tubs."

July 29. "I am sorry to inform you — has made a complete finish of this Colliery at last. Last night, about eight o'clock, a burst of water took place in some part of Camperdown Lady Pit which filled the whole Colliery up level with the sea in course of four or five hours, inclosing 29 men and 28 horses. This morning the water in each pit is rising with the tide. It has made a very distressed place, and melancholy to see the wives and children of the sufferers. There is no one to say from what part the water has come, but there is no doubt it has come from the gut of the dyke at or near the same place where they had the last gentle squeeze. From the manner in which they had been working this some time, I fully expected this sooner. It is a great loss of life, but if it had happened in the day, it would have been much worse."

July 30. Mrs. C. to M. Dunn.—"You will be surprised to see a letter from me, if the fatal tidings which I am about to communicate have not reached ere this does. Alas! your worst predictions of — have come to pass, and by his self-willed obstinacy and ignorance he has ruined not only a whole family, but the whole town of Workington, by filling the three working pits with water, the sea supposed to have entered by two fissures at Sutter Beck, near Harrington (do you recollect the place?) accompanied by the loss of 27 lives. I believe you will not, for a moment, let any personal feelings stand in the way of seeing an afflicted family, but instantly set off for here, and see what or if anything can be done to retrieve the old Colliery."

APPENDIX G.

EXTRACT FROM MR. DUNN'S TREATISE UPON "THE WINNING AND WORKING OF COLLIERIES," published in 1848.

SECTION XVI.

ON PARLIAMENTARY INTERFERENCE with the MANAGEMENT of MINES.

THE above question has often and justly been mooted, especially as to whether such interference would tend to the prevention of accidents, and the consequent loss of life, when explosions take place, from which numerous lives are sacrificed and families left destitute. By such frequent explosions the public sympathy is excited for a short time, but there the matter rests, until the recurrence of some fresh catastrophe.

The first decided movement, on the part of the public, towards this object, took place in 1812, after the dreadful explosions at Felling Colliery, when a Society, with Sir R. Milbanke, Bart., at the head, was organised at Sunderland, as before-mentioned. This Society was instrumental, not only in giving publicity to the only and first safety-lamp of Dr. Clanny, but it was the means of bringing the subject immediately under the notice of Sir H. Davy, so as to produce his safety-lamp in the year 1815. The Report of this Society also gave publicity to the plans of ventilation then in use, and excited the philosophic world to work out improvement.

Notwithstanding the invention of safety-lamps, explosion followed explosion, till, in March 1834, a petition was presented to the House of Commons by Mr. Lyttleton, M. P., "On behalf of the coal masters and miners of the Staffordshire Collieries, and the Collieries in the neighbourhood of Dudley, praying that some Legislative measure may be provided to prohibit the sale of improper lamps, alleging, that within the last eight months, more than one hundred industrious men have been deprived of life, or injured in their persons by explosions of inflammable air."

The appointment of a Committee in 1835 was the result, who examined numerous persons, both practical and scientific; as also many descriptions of lamps; but the Report of the Committee did not contain any specific recommendation upon which to legislate, therefore matters were allowed to revert into their former channel. The next public movement took place after the explosion at St. Hilda Colliery, near South Shields, by which 52 persons were killed instantaneously. An association of gentlemen of South Shields was formed as a committee, whose meritorious labours are elsewhere noticed, who published their lucid Report in 1843, which contained many valuable suggestions, and amongst the others an earnest appeal to the Government, to interest themselves in this very important subject.

A succession of serious explosions, however, previous to the year 1843, produced various petitions to Parliament, and in that year Lord Ashley succeeded in procuring a Bill for the exclusion, from the underground department, of females and of boys under the age of ten years. Lord Ashley's Bill was intended to legislate much more extensively, and to extend to explosions and other accidents; but this part of the subject met with such stern opposition from the owners of mines, that it became limited as above.

However, the explosion at Haswell Colliery in the year 1844 again roused the feelings of the public, and more especially those of the working colliers, so that their "Attorney-general, Mr. Roberts," waited upon Sir R. Peel, then Prime Minister, for the purpose of requesting him to send scientific persons to examine and report upon the explosion at Haswell, which was accordingly done, and Messrs. Lyell and Faraday were thereupon sent to Haswell for that purpose.

The Report of these gentlemen contained several suggestions which were considered by practical viewers, as well as colliers, to be totally inapplicable, the chief of which consisted in recommending a series of cast-iron pipes to be carried into the goaves and other receptacles of the gas, and to be conducted thence into the return air-courses in a diluted state, in which state it was designed that it should pass out of the mine.

As their pamphlet was amply reviewed at the time by intelligent persons, as well as by a Committee of Coal-owners, I will not enter into detail, further than to state, that the Report terminated without any recommendation for Parliamentary interference.

These movements were followed by petitions, presented from time to time by Lord Ashley, Mr. Muntz and Mr. Duncombe, calling for Parliamentary interference; and the talented Editor of the "Mining Journal" not only laboured hard to advance the exertions of others in the cause of humanity, but also, individually, petitioned the House of Commons more than once upon the subject.

Since the publication of the above-mentioned documents, and from which I have quoted largely elsewhere, the subject has engaged the attention of many Members of the Legislature, as well as of scientific persons, and, in consequence, the proceedings of coroners' juries have been considerably more narrowly watched than formerly. In consequence of the proceedings of the coroner's jury at Haswell, the appointment of Messrs. Lyell and Faraday had its origin; and a second Government Commission took place after an explosion at Jarrow Colliery in September 1845, from which 50 persons lost their lives, although the explosion took place in the low main seam, in which the workings were not extended more than 300 yards from the shaft; and the evidence at the inquest represented the mine to be in an excellent state of ventilation.

This Commission was chiefly aided by Professor Playfair, aided by a mining agent from Cornwall. They scrutinised the state of the workings, as well as the principles of ventilation; they privately examined many of the workmen and agents, and came to the conclusion, that owing to the dangerous state of the mine in the lower seam, if worked at all, it ought to be done with safety-lamps exclusively, and that course has been accordingly pursued ever since.

A third set of Government Commissioners were put in requisition, from the explosion at Risca Colliery, South Wales, in the year 1846, whereby 35 persons were killed. In this Commission were found the distinguished names of Sir H. De la Beche and Mr. Smythe. The adjourned inquest, which took place on the 4th of February, was attended by Sir Thomas Philips, an eminent barrister, who was brought down special by the proprietors of the Colliery, and, after an examination which lasted eight hours, a verdict of "accidental death" was recorded.

This deplorable event was followed by the explosions at Oldbury, in Warwickshire, Coppul, in Lancashire, and Ardsley Main, in Yorkshire, and at all of these places dreadful loss of life was effected; but as they were all afterwards examined into, and reviewed by Sir H. De la Beche, aided by Dr. L. Playfair and Mr. Harrington Smythe, Government Commissioners, I will at once avail myself of their Reports upon the several occasions, and give such extracts as may serve to exhibit their sentiments as to the state of the facts, and also whether and to what extent (in their opinion) it would be advantageous for Parliament to interfere; and in so doing, I cannot avoid paying a well-merited compliment upon the delicacy of these gentlemen, in cautiously avoiding reflections upon the management and malpractice at any of the localities, but they rather study to throw a shade over the past, whilst

whilst they hesitate not to proclaim aloud their conviction as to what ought to be done in future; viz., "that the Government of the country should not hesitate further in enacting wholesome laws for the preservation of the lives of this valuable portion of the community."

EXTRACTS from the REPORTS of SIR HENRY DE LA BECHE and Dr. LYON PLAYFAIR
upon EXPLOSIONS in COLLIERIES.

(Report made after the Explosion at Jarrow Colliery.)

"June 1, 1846.—Various artificial means have been proposed to facilitate the withdrawal of fire-damp from a pit. Suggestions have been made to take advantage of the lightness of the gas, by favouring its ascent to the upper parts of the pits, and drawing it off by special air-ways; pipes let down into the wastes have been proposed for the same purpose, while other suggestions have been made of pipes to blow in air at the top of the passages, so as to cause the dilution of the gas."

"We do not stop to consider those plans, because, as we have already stated, the conditions under which coal is worked are so numerous, that a plan which might prove useful in one pit would be wholly inapplicable, and sometimes positively injurious, in another, and the Legislative application of any one plan might prove highly prejudicial to this great branch of national industry."

The Committee of the House of Commons, which sat in 1835, reported that, during 25 years, there had perished by explosions 2,070 persons, which number they considered much underrated.

It has been at various times proposed, during the last eight years, to employ electricity as a means of lighting Collieries. The electricity passing between two charcoal points, from Groove's or Benson's batteries, affords a light of much beauty, and perfectly safe, if completely surrounded by glass, but capable of igniting an explosive mixture if exposed.

They deprecate dependance upon a single bratticed shaft; those, however, who may possess an extended acquaintance with our Collieries in different parts of the country cannot but be aware that, as a whole, their general ventilation is very imperfect, good as it may be in some Collieries, particularly in certain districts.

"So various are the conditions under which Collieries are or can be worked in the United Kingdom, that we would suggest, for consideration of the Legislature, measures which would be deemed advisable, and, if an extension of the principle which regulates the employment of women and children in our mines be thought good, that effective discretionary powers should be vested in properly qualified persons, appointed in convenient districts, so that the needful adjustments to conditions may be effected, and no single system be attempted inapplicable to our Collieries as a whole."

"Any general system of legislation for conditions so different could only be productive of failure, or of injurious consequences, both to owners and workers; but a local examination and inquiry, with power to adjust to special conditions, would, we apprehend, remove the difficulties which the Legislature has felt in dealing with interests so important."

"Jealous as the Coal-owners should properly be of any undue intermeddling with their Collieries, it may nevertheless be true that a judicious system of superintendence, by which the proper ventilation of Collieries, efficient knowledge on the part of subordinate agents, and proper punishment for fool-hardiness or carelessness on the part of the Colliers, may be secured, would be of great advantage to them individually and collectively, and be the saving, not only of lives, but of much capital, securing them in the case of accidents from many an unjust accusation from neglect."

The Reporters also recommend that correct plans and sections of the various Collieries be kept, as recommended by the Committee of the House of Commons in 1835, and also as recommended by the South Shields Committee of 1843.

They conclude their Report as follows:—

"Careful investigations into the causes of explosion in Collieries—only part of which arrest public attention by their magnitude—appear to have led to the very general conclusion, that the condition of our Collieries is most equal, while, in localities, there is so little to improve, that it becomes subject of regret that such examples should not be more generally followed in others; it becomes matter of surprise how the works can be permitted to remain in so defective a state, seeing that the owners themselves suffer much loss thereby. Under such a state of things, and considering the number of valuable lives annually lost by Colliery explosions, the continued risk to which so many are daily exposed, the national injury sustained by the imprudent and careless mode of extracting coal in many localities—one often felt oppressively also by the parties engaged in Colliery speculations—and that the workings for coal must be adjusted to local conditions, we are led to consider that these evils might be at least mitigated by the careful and judicious inspection of convenient districts by competent persons—the necessary funds to be raised from such districts by a very slight impost, not even exceeding one farthing on each ton raised in it; and we believe that the cause of humanity, and the interests of the Coal-owners, would be alike benefited by a well considered Legislative measure of this kind."

January 1846.—The Second Report was made after the explosion at Risca, South Wales, by Sir H. De la Beche, but is confined to details regarding the explosion and the inefficient manner in which the Colliery was ventilated.

December 12, 1846.—A Third Report, on the explosions at Oldbury, in Warwickshire, and Coppul, in Lancashire, with examination of the thick coal-workings, by Mr. Warrington Smythe.

The Report of Mr. W. Smythe enumerates several fatal deficiencies in the system of ventilation, and after suggesting various precautions, concludes his remarks as follows:—

“No safety-lamp yet invented could indeed afford sufficient light for workings of so great a height, and candles must, therefore, continue to be used; but I have no hesitation in affirming that, from the small area of the works in operation at one time, and the comparatively trifling quantity of gas emitted from the coal, naked candles may be safely used, and that no accident, from an explosion of fire-damp, ought ever to occur in the Staffordshire thick coal, if due attention be paid to the simple precautions above alluded to.”

Mr. W. Smythe minutely describes the condition of Coppul Colliery, after that explosion, and concludes his Report upon this Colliery as follows:—“Under the conditions at present existing, some danger will always present itself in the workings of a seam producing so much gas as the Arly Mine at this place, unless due attention be paid to certain practical points in the employment of the system of ventilation; viz. first, the maintaining a sufficient draught in the upcast shaft, which, it may be observed, is too frequently far smaller than it ought to be, in proportion to the downcast; secondly, the diminution, as far as possible, of the distance which the air has to traverse; thirdly, the frequent examination into the air-tight condition of the stoppings and doors; fourthly, the continual advancement of the brattices up to the neighbourhood of the face of the work where the men are employed; and fifthly, the enforcing of obedience on the part of the workmen to rules which are laid down to ensure their own safety.”

The Fourth Report, dated March 22d, 1847, is signed by Sir H. De la Beche and Mr. W. Smythe, after the explosion of the Ardsley Main Colliery, near Barnsley. The chief part of the Report is devoted to the general investigations of the state of this Colliery previous to the accident, its general arrangement as to shafts and ventilation, and the probable causes of the explosion, upon which it is not my province to remark; but the conclusion is so important, that in justice to these gentlemen, as well as to the cause of humanity, I cannot avoid transcribing it. “While we thus feel a duty not to cast unmerited blame upon those in charge of this Colliery, we cannot avoid stating, that the great and melancholy loss of life lately sustained, with all the circumstances which have come to light in connection with it, most materially adds to the conviction as stated by one of us, in conjunction with Dr. Playfair, in a previous Report, that viewing the various conditions under which the Collieries of this country are worked, a system of inspection—one not over meddling, but, at the same time, securing the most effective ventilation and the proper use of lights—should be adopted.”

“We believe that this inspection, if rightly conducted, would be alike important to the employer and the employed; and when we reflect that the men who labour in our Collieries supply the great mass of fuel, which not only contributes to the household comforts of so large a portion of the inhabitants of this country, but also to the means by which its wealth and resources are so greatly advanced, we cannot but conceive that arrangements for the safety of their lives form a fitting subject for national care and legislative provision.”

“We would not unnecessarily appear to press the contribution of ever so small a sum, as a farthing per ton, and should this be thought too inquisitorial, though we have reason to believe that it would be cheerfully paid by many, and that the power of entering into a composition, would greatly remove difficulties on this subject, but should such or any similar plan be adopted, we would anticipate not only that there would be ample provision for all the inspection required, but also that there would be a large surplus available for the formation of district schools, where those things so needful to the coal-miner may be taught, and a considerable fund eventually established for the benefit of the widows and children of those who, notwithstanding all care, might still unavoidably perish by Colliery explosion.”

The coroner's inquest upon the occasion was, “The Jury are of opinion that efficient regulations are not enforced in this district to prevent the use of naked lights in those parts of coal-mines where inflammable gas is known to exist; and they are further of opinion, that the recurrence of accidents, involving so large a loss of human life, demands the immediate attention of Her Majesty's Government, and would justify Parliament in forming such a code of regulations as would give greater security to persons employed in mining operations.”

With these sentiments the Deputy Coroner, Mr. G. D. Barker, expressed his entire concurrence.

The subject of Parliamentary interference has already been adverted to in several of the extracts that have been given under the head “Diversity of Accidents,” therefore I will conclude this section by some reference to the policy pursued by Foreign Governments, although it is not to be denied, that with all the aid thereby afforded, the system of mining on the Continent is very inferior to that which is adopted in this country.

The Governments of France, Russia, Saxony and Belgium have been keenly alive to the well-being and improvement of their Mines, and have accordingly made them the subject of continual Legislation, which I am able to speak to from a casual visit to the Mining Districts of Belgium in the year 1843.

APPENDIX H.

ON PARLIAMENTARY INTERFERENCE with the WORKING OF MINES;—
Addressed to SIR G. GREY, Bart.

THE public mind having become excited by the continual recurrence of accidents by explosion, and the principle of legislation having been affirmed by Parliament, the present ministry have been induced to pledge themselves to the serious consideration of a comprehensive measure for the mitigation of such harrowing repetitions,—I therefore take the liberty of submitting a few observations, first, as to the general causes of such events,—and, second, as to the practicability of remedying, in any degree, so great an evil.

As a perfect knowledge of the disease is said to constitute half its remedy, I will endeavour briefly to explain the present state of knowledge and practice, with regard to ventilation, and other means adopted, not only to prevent accidents, but also for regaining the workings after an explosion has occurred; because it often happens that a greater number of lives are lost by the after-damp which results from explosions, and from the want of air occasioned by the demolition of the doors and stoppings, than from the fire or the explosion itself.

AMOUNT OF PRESENT KNOWLEDGE AS TO VENTILATION.

It is generally admitted that, in the North of England, this species of knowledge greatly exceeds that of any other part of the kingdom, and has been gradually and necessarily improved, in consequence of the deep sinkings and extensive workings in the northern coal mines, because of their producing such considerable discharges of gas. Hence, it may be well to state, explicitly, what principle is adhered to, as the most generally approved in collieries coming under the denomination of fiery. In those collieries which do not produce inflammable gas, these provisos are, of course, qualified according to the judgment and discretion of the managers.

First, then, whether the colliery consists of one bratticed shaft, or of duplicate shafts, it is indispensable that an area of at least 35 feet should be provided in each upcast and downcast shaft; and the larger the upcast, the better.

The main air-ways, also, should be *upheld* in a similar area, in seams of 4 feet thick; and where the seams are thicker, a proportionate increase is required.

The bottom of the upcast shaft should be furnished with a furnace, or fire-lamp, of from 15 to 20 feet area, placed within an arch, and guarded against the firing of the surrounding coal.

The top of the shaft must be sheltered from the influence of high winds; thus providing for the uninterrupted supply of a full and complete current of air.

As the workings extend, there is a necessity for guiding the column of air by means of stoppings; and this is generally done by building up certain openings with brick or stone, supported by a couple of yards of stowing, the better to guard against the effects of explosion. But, in many of the passages, doors are necessarily substituted; and these are fixed in frames, fitted closely in the passages. More fully to effect the desired object during the passage of horses, these principal doors are built in pairs, at considerable distances from each other, so that whilst one is open the other is shut.

These arrangements have reference to the main current; but, as the individual workings extend beyond the circuit of the air current, they are temporarily ventilated, by means of slit deal partitions, by which a partial current is made to circulate amongst the workmen, until the transverse communications are completed, which enable the temporary brattices to be withdrawn, and permanent stoppings inserted. Again, as the workings extend, it is often needful to subdivide the main column of air into other columns, passing under or over each other by means of arches, and all meeting by separate passages at the upcast shaft; some of the columns which have become highly adulterated, requiring an outlet apart from the ventilating furnace, called a dumb-drift.

To arrange and carry out the progressive changes which occur, a staff of daily managers is required, according to the extent of the work; their time being so arranged as that one or more persons shall be present during the whole of the working hours. The using of candles or safety-lamps is directed by such overlookers; and the safety-lamps are kept under the care of a person appointed for the purpose. The ventilating furnace is attended to day and night; and as it is expected that every operative will strictly abide by the orders of his superiors, there is a moral presumption that, in a mine so regulated, explosion will not happen.

But however perfect the arrangements may be, coal-mines producing inflammable gas will, at all times, be liable to unforeseen events. For instance, the neglect of doors—the demolition of stoppings or brattices—the sudden eruption of inflammable air by means of blowers—and, lastly, the non-compliance of the workmen with orders—may, and often do, produce serious explosions in collieries regulated on the most perfect and approved principles; and as the northern collieries, from the magnitude of their works, have necessarily larger complements of men, the loss of life is generally greater than in those of other districts; thus giving a colour to the assertion, that it is owing to imperfect ventilation, and the splitting of the air, that these collieries exhibit such dreadful results. The standard ventilating column may be stated at the speed of 8 or 10 feet per second, in an area of 30

feet, = 18,000 cubic feet per minute ; but to accomplish this in the chief passages after being split, the principal downcast ought to be three times as much. Such a current would extinguish a moderately sized candle.

In case of explosion, there is generally abundance of ready-made brattice and slit deals to be had, wherewith to fasten up the passages, and temporarily to substitute the stoppings which may have been carried away by the explosion, so as to restore a partial ventilation for the relief of persons suffering from the after-damp, which is still further aided by the application of a waterfall ; and these operations (so material to the saving of life) are greatly facilitated by the regularity of the workings, and the possession of correct plans of them.

DEFICIENCIES of other DISTRICTS.

If the above arrangements, then, be thought necessary in the northern collieries, to preserve a substantial and effective ventilation, what will be said of many of those collieries and districts which are deficient in almost every particular of such a system, save and except an abundance of shafts? In many instances, so deficient in efficacy is the ventilating furnace, (and many collieries have none at all,) that the air current, frequently affected by winds, the wetness of shafts or hot weather, becomes stagnant or reverses its course, which, in the language of Staffordshire, is called "the pits fighting with each other." Instead of the stoppings being constructed of stone or brick, they consist of loose rubbish or small coal. Instead of substantial frame doors and wooden brattices, the only guides for the air to individual places, and even in the main air-passages, consist of sheets of canvass loosely fastened up. The safety lamps are mostly left in the charge of the colliers, and the use of them or candles committed to their own discretion, in consequence of the absence of any regularly constituted managing staff. A serious evil prevails in the "Butty" or contractor system, by which certain parts of the work are sublet. The object of the contractors is, consequently, to save at all hands, regardless either of the lives of the people or of the permanent interests of the mine ; and it too frequently happens, that as soon as a contract price is fixed, the proprietor or his agent pays no more attention to the concern till a new bargain is to be made. In the mean time, the workmen have no one to complain to ; the contractor is their master ; and as the setting of timber and other processes are left in a great measure to themselves, if an accident happens by a fall or an indiscreet use of the lamp, it is either attributed to carelessness on the part of the collier, or pronounced to be accidental death. The contractors, besides, are generally connected, directly or indirectly, with shops and public-houses, by which the wages of the workmen are intercepted, and gross injustice and oppression ensue.

In case of explosion, there are no ready means of restoring ventilation, for slit deals and brattices not being used, none can be had. The colliery is probably worked in a very irregular manner and without necessary plans of the workings ; the contractor probably an uneducated man. Hence, a fatal delay takes place, to the destruction of many a human being, who might be saved were ventilation promptly restored.

Lastly, the collieries in the southern districts of England being generally upon a comparatively small scale, the proprietors labour under the erroneous impression that scientific or educated persons would not be suitable managers, inasmuch as they would adopt extravagant modes of proceeding, and would be less competent to counteract any strike or interested arrangements of the workmen, than those persons who are trained and brought up in the same manner. In point of fact, it is the interest of these butties and contractors to perpetuate this delusion, lest the system should be superseded by one of a more enlightened character, or like that of the North of England, where, in all the extensive operations carried on, there is not a single butty or contractor, the owner of the work, his viewer and overman supervising and regulating the whole underground department, and necessarily coming in constant contact with the workmen.

REFLECTIONS AS TO EXPERIMENTAL LEGISLATION.

In the foregoing pages I have endeavoured to show the distinction that exists between a well-regulated and extensive colliery, and those of a different character, for the purpose of offering some reflections as to the practical objects of legislation. Upon a former occasion, I took the liberty of suggesting the importance of uniting statistics of the population and of the mineral produce of the country, to measures for the safety and well-being of the people ; but I will, in this paper, confine my observations to the prevention of accidents, leaving the former subject for consideration at some future opportunity.

In order, therefore, to overcome the feelings and prejudices of coal proprietors, it is desirable that the measures to be enacted should be as simple, and the compulsory powers of officials should be as limited as possible, consistently with the carrying out of the object. I am, therefore, of opinion that an Act of Parliament would naturally induce coal-owners to avail themselves of such suggestions as might be made by properly constituted officers, rather than be reported as beneath the standard of prevailing improvement. The principal subject of legislation might, consequently, consist of the appointment of district inspectors, to visit the mines and report to Government, or to such supreme authority as might be appointed—to attend coroners' inquests—to listen to, and investigate the representations of operatives, and to examine into the state of the works—to attend in cases of serious accident, and to suggest general measures of prevention and safety. The latter practice would be a wholesome check, by becoming evidence during coroners' inquests ; and

and it may be instanced that great benefit would accrue from the provision, in each locality, of brattices and other means of restoring ventilation in cases of explosion, as the saving of time on such occasions is so imperative for the saving of life.

With respect to the powers, therefore, with which such individuals should be invested, I think it might almost be limited to *the suspension of such parts of a work as are satisfactorily made out to be in a dangerous state, with certain fines for refusing such information as might be demanded by the inspector.* I have known many instances in which collieries, and portions of collieries, were notoriously dangerous, and could easily have been amended; but no one was authorized to interfere, till at length an explosion or inundation happened, and life was lost. It is not only by explosion that lives are lost, but by bad ropes and chains, unguarded machinery, want of timber, neglect by officials, and other minor matters; and over all these subjects the district inspector would be a material check, without (as Sir H. De la Beche very properly remarks) "becoming over meddling."

As great controversy prevails with regard to the practical utility of such an Act, it might, in the mean time, serve to satisfy, not only the members of Government, but of Parliament generally, if one or two collieries in each district were examined, and their system of management duly reported upon, with such remarks as to the means of improvement as might be judged practicable; due allowance being, of course, made for the peculiar circumstances under which such collieries are placed, and which practical persons would know well how to appreciate. Such reports would go far to awaken inquiry, and to introduce measures of improvement, without necessarily producing dissatisfaction to the owners. Some persons object to projects for improvement, because they are unwilling to pay for the opinions and advice of strangers, under an uncertainty whether or no they will derive any benefit; and as no stranger is entitled to force his opinions upon persons unsolicited, hence the slowness with which mining improvements progress.

It would be quite necessary that the coal-owner should have the power of appealing against the unreasonableness of any order that might emanate from the inspector; and for this purpose, a Board must be constituted, either consisting of other inspectors, or of the Commissioners appointed to carry out the Act of Parliament.

I forbear from making any other observations on Mr. Duncombe's Bill of June last, than to say, that though it contains many useful clauses, it would be more acceptable if it had displayed greater deference to the feelings and prejudices of the proprietors of collieries, as I am persuaded that such a course would produce a more uninterrupted progress towards the desired object.

MATT. DUNN.

Newcastle-upon-Tyne,
10 August 1847.

PLAN N^o I.

DIAGRAMS OF GOLDSWORTHY CURNEYS APPARATUS FOR VENTILATING MINES.

Referred to in the Evidence of Goldsworthy Gurney, Esq^r of 22nd June, 1849; T. E. Forster, Esq^r of 5th July, 1849, and G. Elliot, Esq^r of 6th July, 1849. Pages 43, 51, 264, & 286.

Fig. 1.

VERTICAL SECTION OF UPCAST SHAFT.

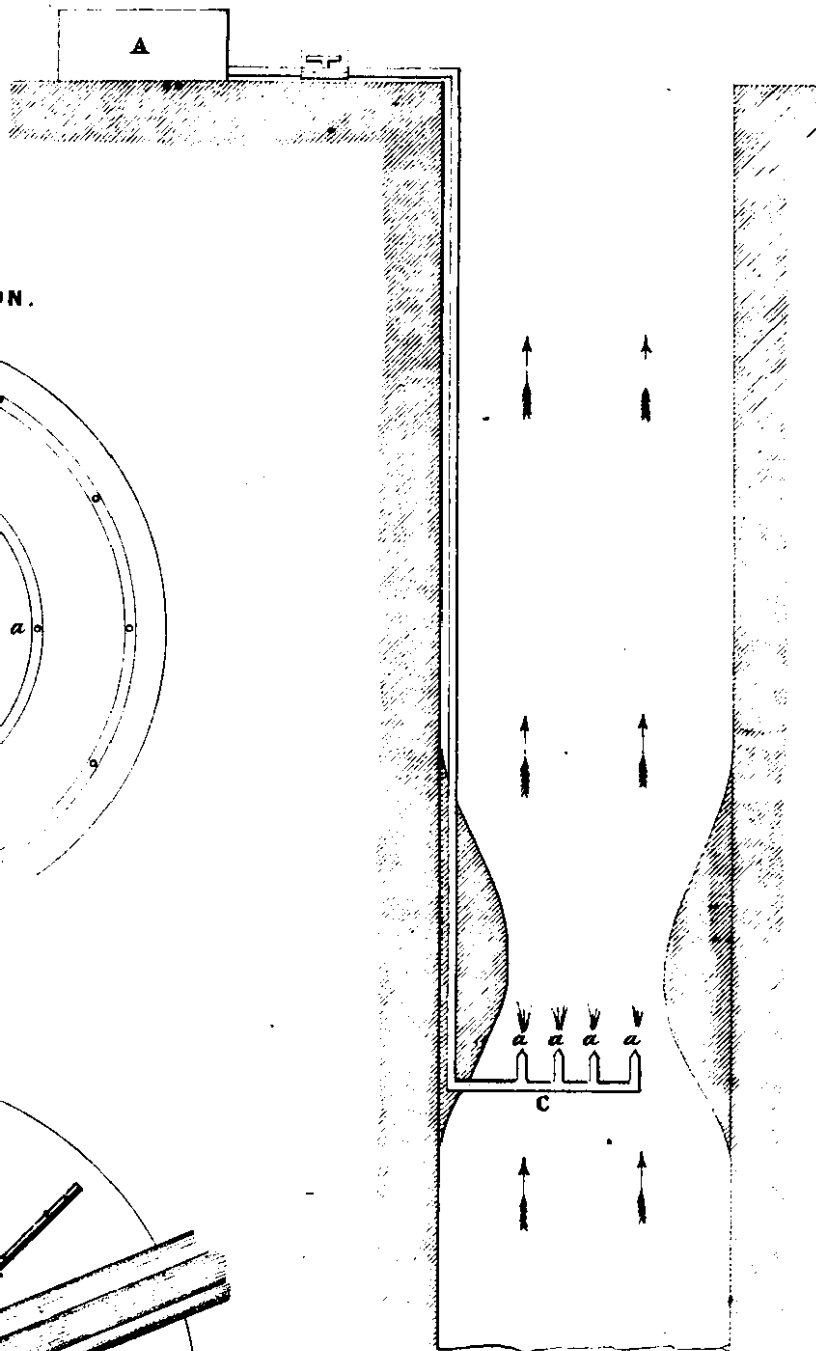

Fig. 2.

HORIZONTAL SECTION.

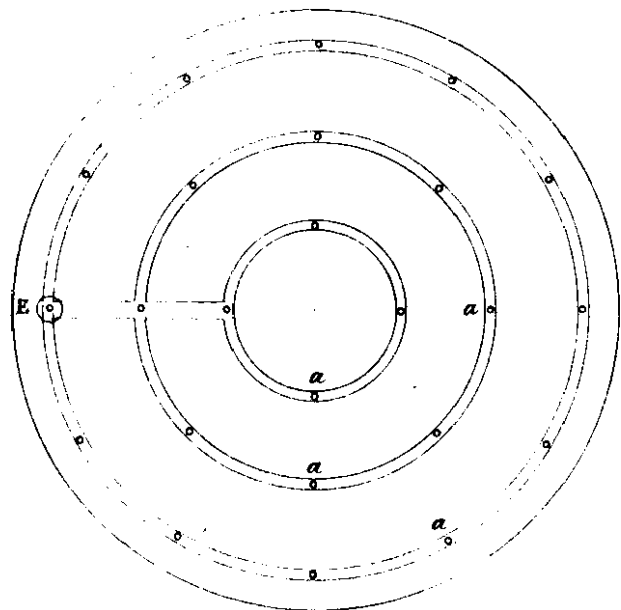

Fig. 3.

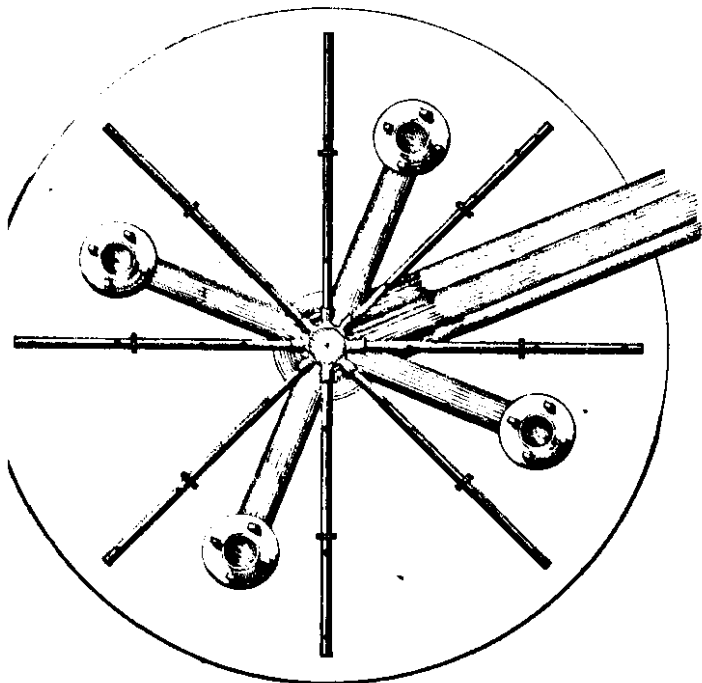
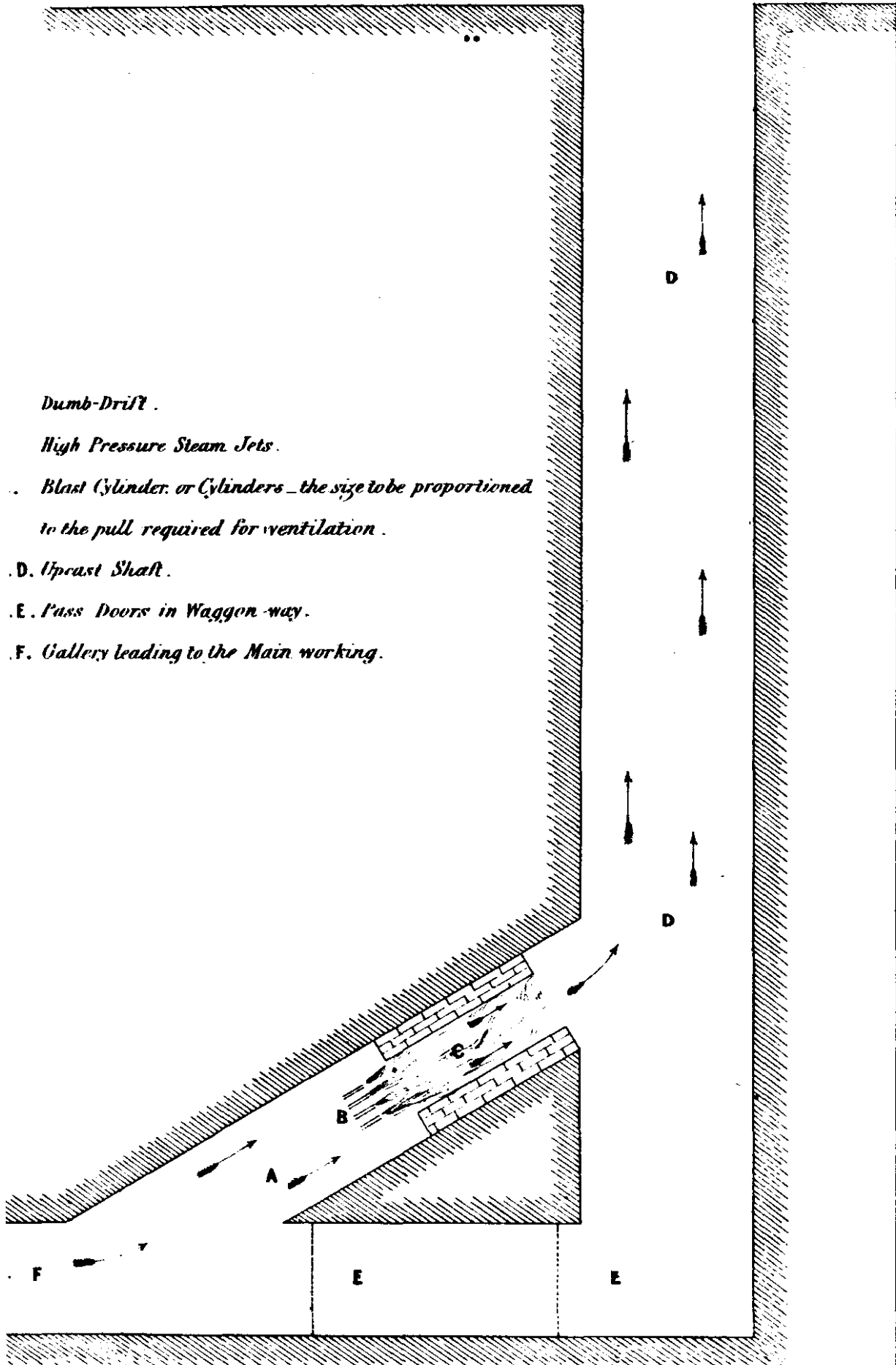

DIAGRAM SHEWING THE APPLICATION OF THE HIGH PRESSURE STEAM JETS IN THE DUMB-DRIFT.

[To illustrate the Evidence of Goldsworthy Gurney, Esq. 22nd June 1849. — Page 48.]



- Dumb-Drift .*
- High Pressure Steam Jets .*
- Blast Cylinder, or Cylinders — the size to be proportioned to the pull required for ventilation .*
- D. Upcast Shaft .*
- E. Pass Doors in Waggon-way .*
- F. Gallery leading to the Main working .*

G. Gurney

APPARATUS FOR PUTTING OUT A FIRE IN A COAL MINE.

[To illustrate the Evidence of Goldsworthy Gurney, Esq. of 22nd June, 1849, and J. Darlington, Esq. of 28th July, 1849. Pages 54 & 128.]

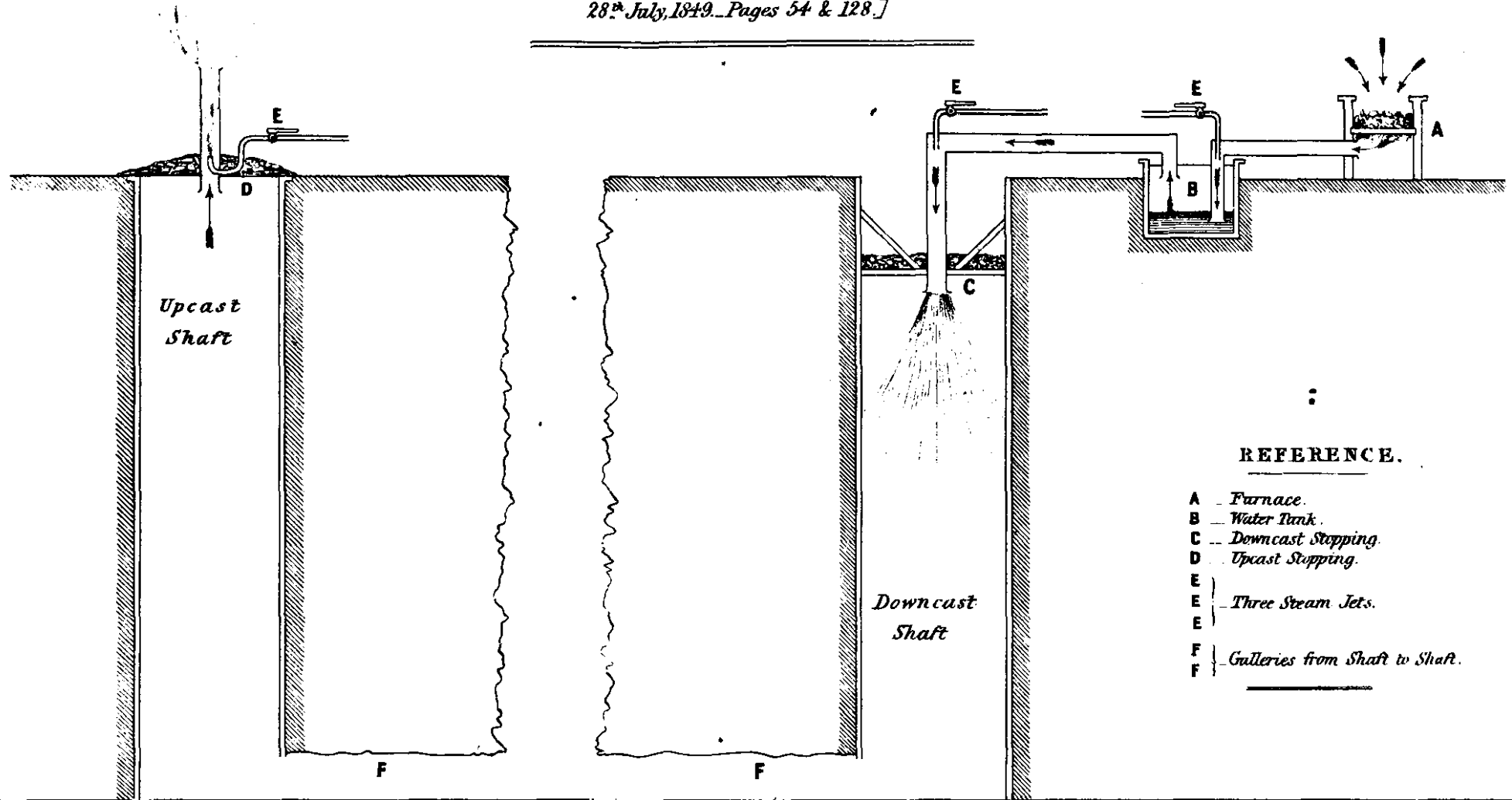

REFERENCE.

- A - Furnace.
- B - Water Tank.
- C - Downcast Stopping.
- D - Upcast Stopping.
- E } Three Steam Jets.
- E }
- F - Galleries from Shaft to Shaft.

PLAN N^o III.

No. 613. Ordered, by The House of Commons, to be Printed, 1st Aug^t, 1849.

Appendix I. Prevention of Accidents in Coal Mines Committee.

PLAN N° IV.

PLAN OF THE
TYNE MAIN COLLIERY.

[To illustrate the Evidence of Professor Ansted, M.A., F.R.S.
25th June 1849, Page 77]

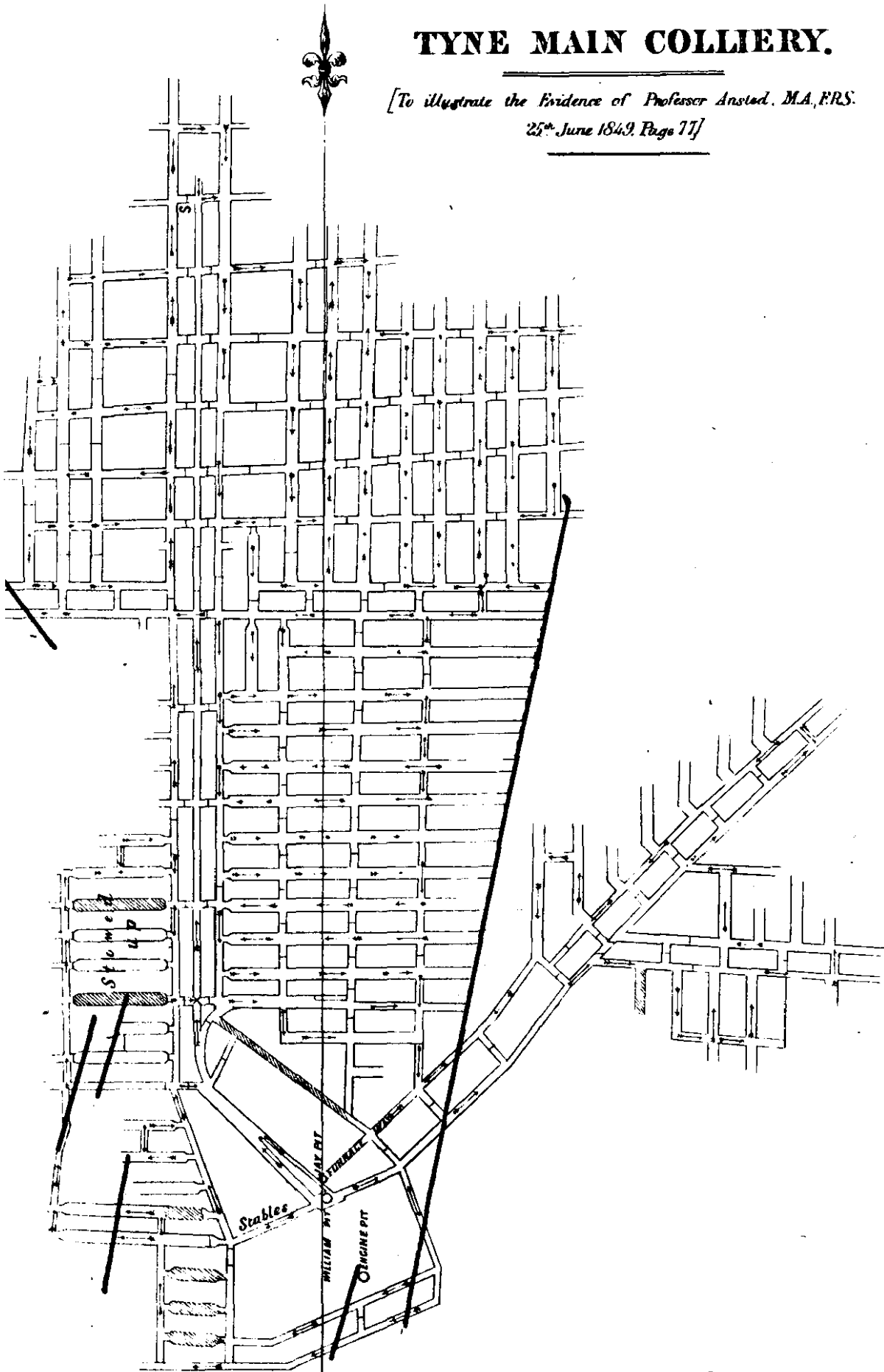

18th April, 1845.

M^r FOURDRINIER'S PATENT CAGE-GUIDE APPARATUS. PLAN, N^o. V.
[To illustrate the Evidence of M^r Edw. N. Fourdrinier, 28th June, 1849. — Page 129.]

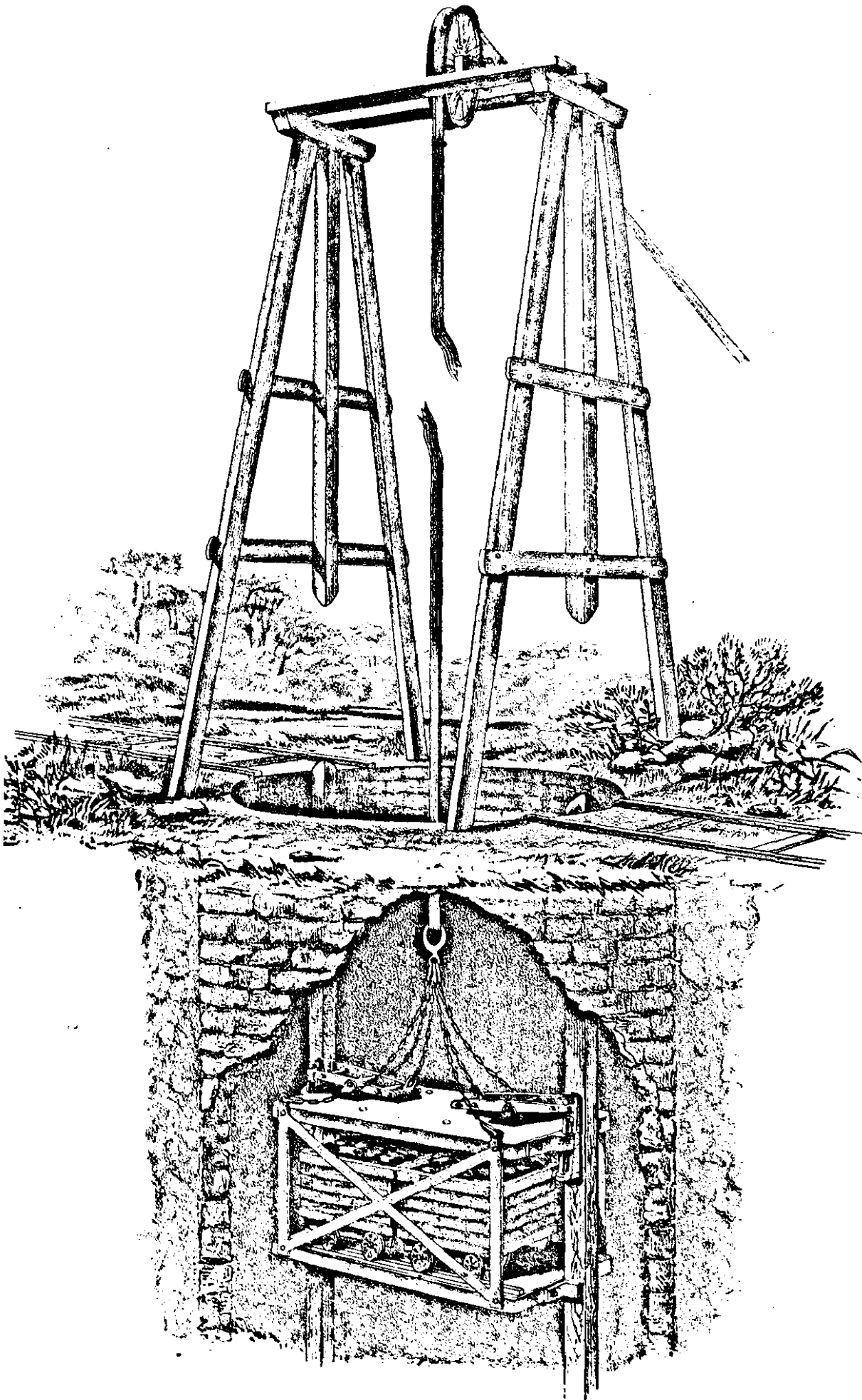

W. BRUNTON'S COLLIERY EXHAUSTING VENTILATOR.

[To illustrate the Evidence of W. Brunton, Esq., 28th June 1849. — Page, 133.]

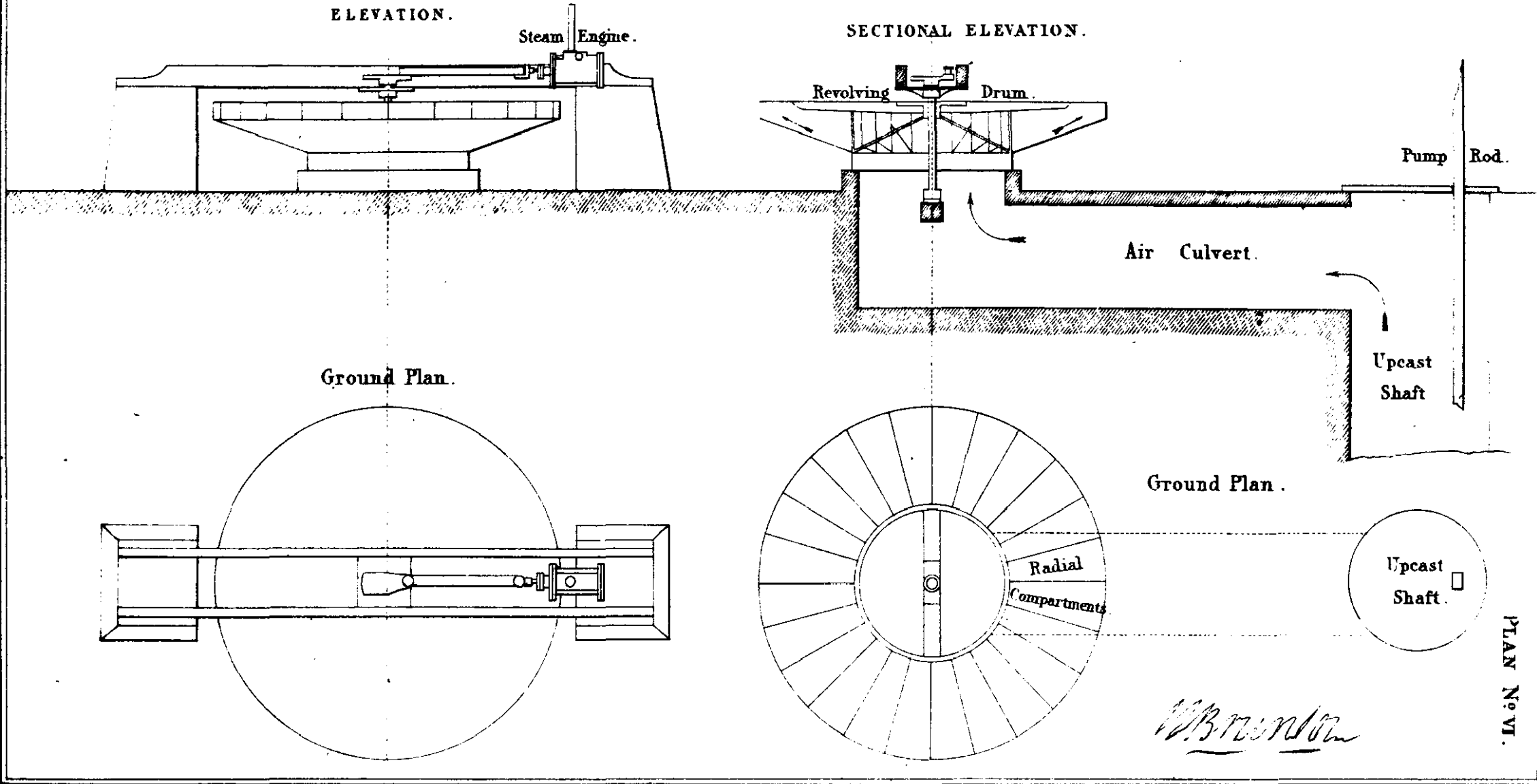

No 613. Ordered, by The House of Commons, to be Printed, 1st Aug¹ 1849.

Henry Rowland Printer

PLAN No VI.

W. Brunton

Appendix I. Prevention of Accidents in Coal Mines Committee.

DIAGRAM (N^o I.)

PLAN, N^o VII.

[To illustrate the Evidence of J. Hutchinson, Esq^r M.D.
of 29th June, 1849.—Page 143.]

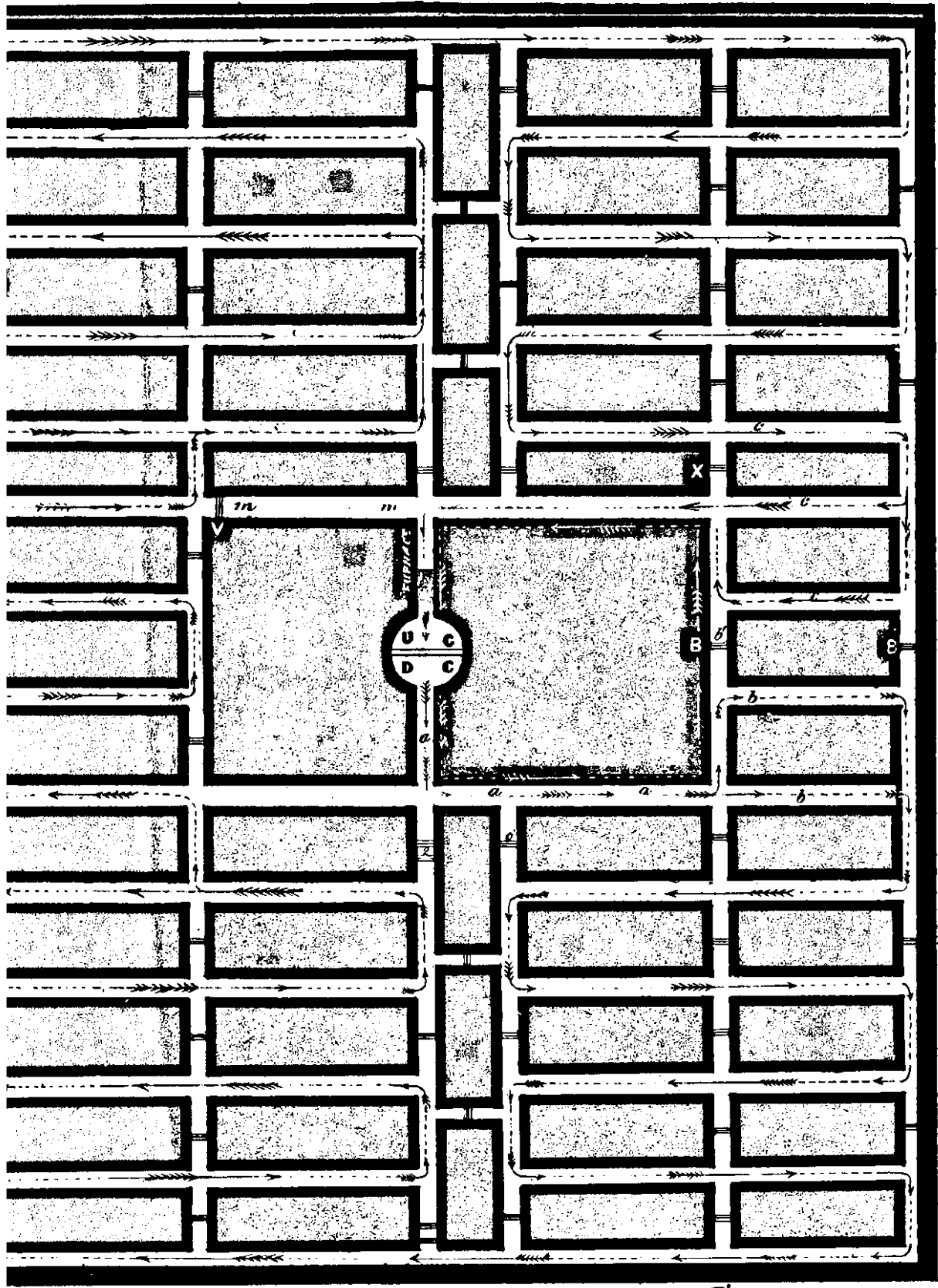

DIAGRAM (N^o 2.)

PLAN, N^o VIII.

[To illustrate the Evidence of J. Hutchinson, Esq.^r M.D.
of 29th June, 1849 - Page 144.]

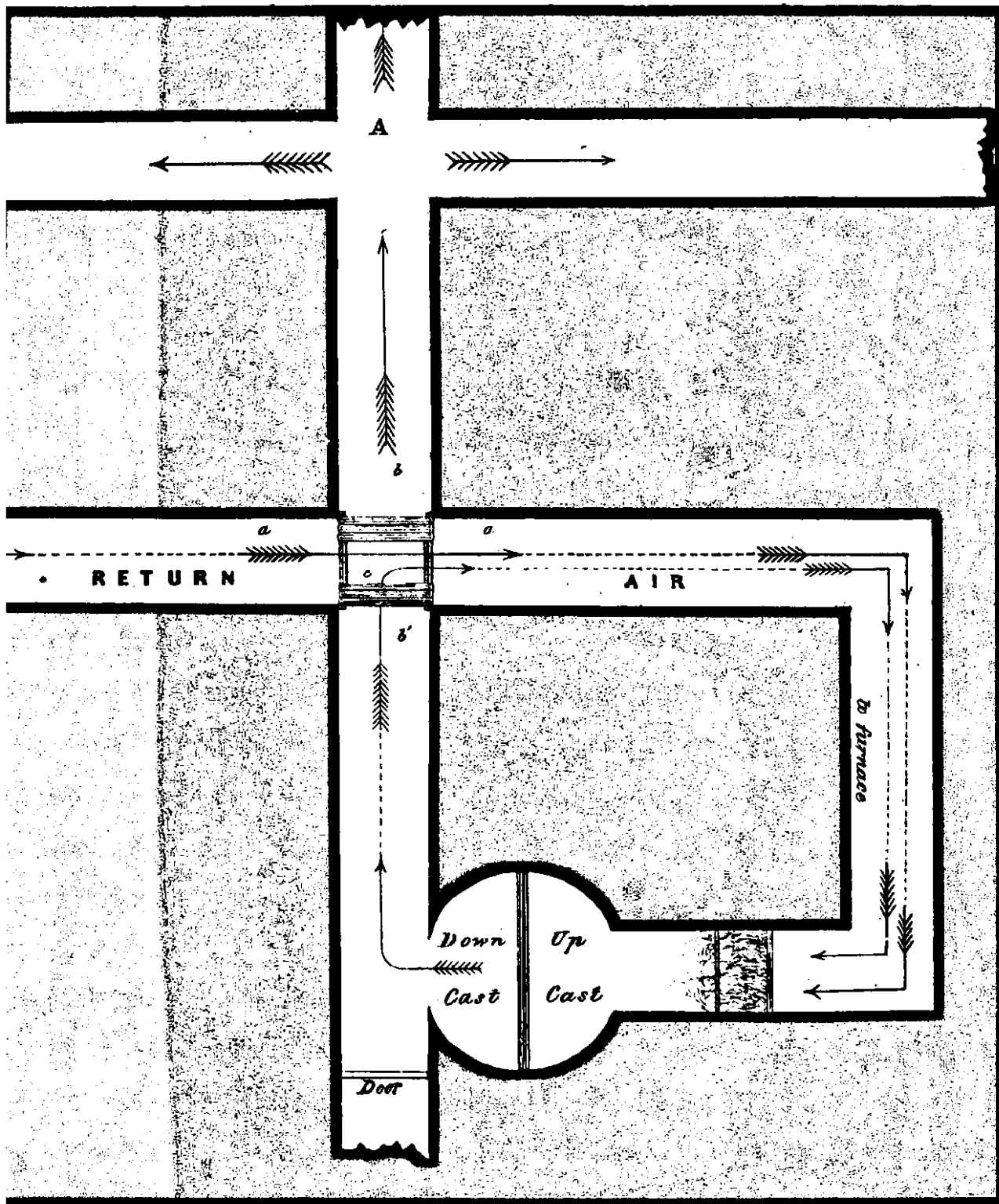
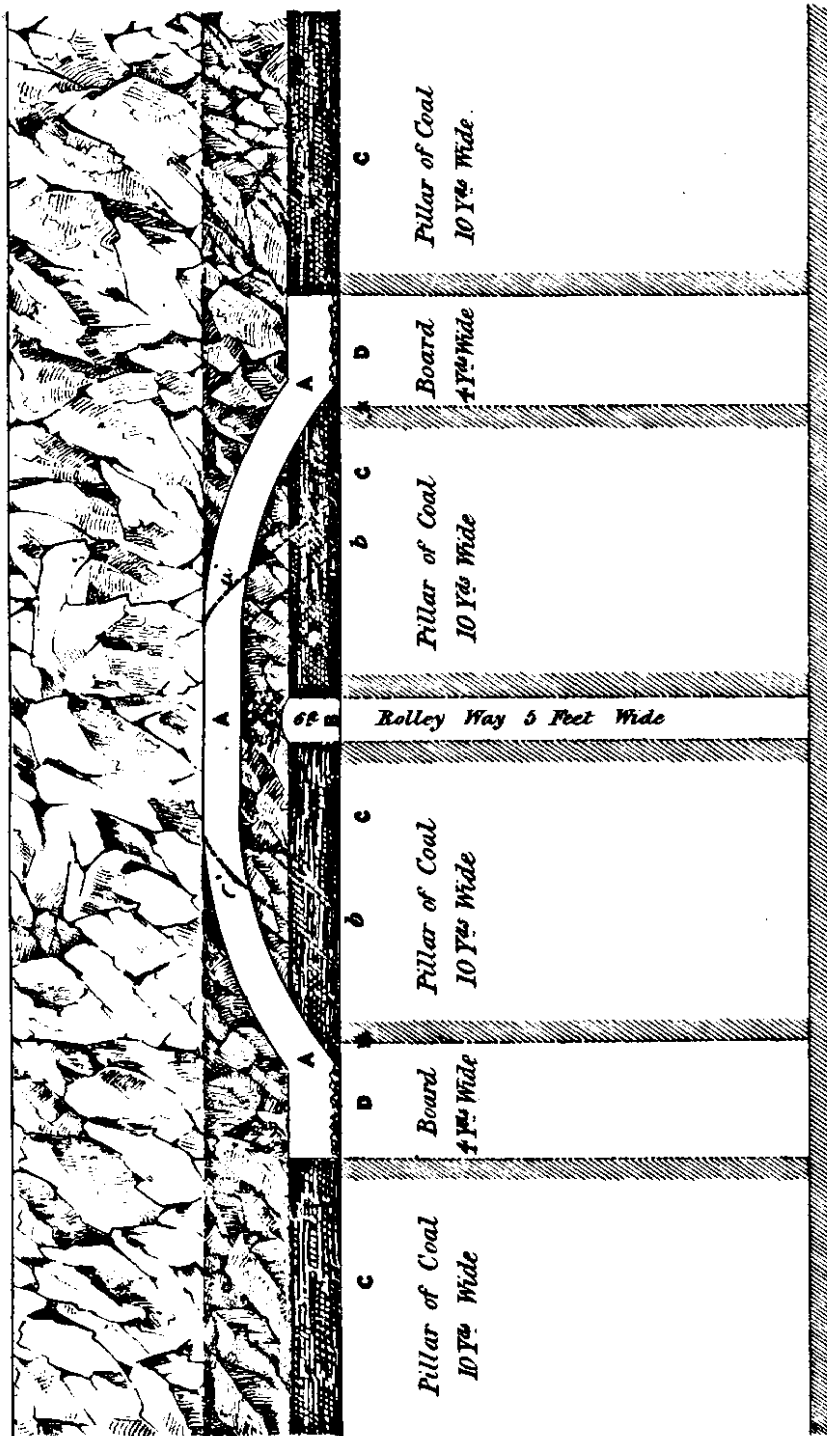

DIAGRAM (N^o 3.)

[To illustrate the Evidence of J. Hutchinson, Esq. M.D. of 29th June, 1849, Page 144.]



[Referred to in the Evidence of J. Hutchinson Esq^r M.P.
20th June 1849. Page 145.]

PLAN OF WORKINGS
ON THE NORTH EAST DISTRICT OF THE HUTTON SEAM
IN LITTLE PIT,
HASWELL COLLIERY.

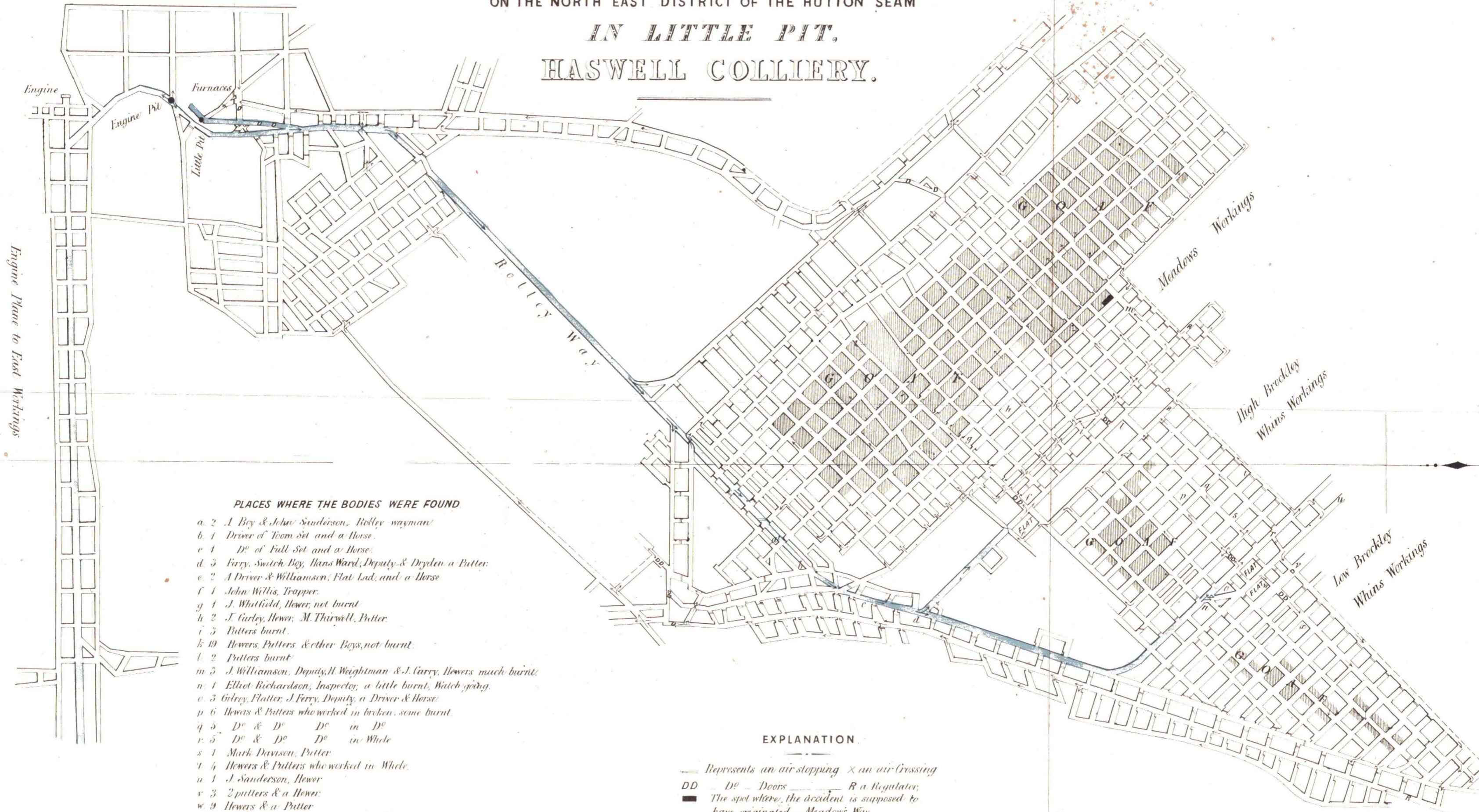

PLACES WHERE THE BODIES WERE FOUND.

- a. 2 A Boy & John Sanderson, Holly wayman
- b. 1 Driver of Tom Set and a Horse.
- c. 1 D^o of Full Set and a Horse.
- d. 3 Ferry, Switch Boy, Hans Ward, Deputy & Dryden a Putter.
- e. 2 A Driver & Williamson, Flat Lad, and a Horse
- f. 1 John Willis, Trapper.
- g. 1 J. Whitfield, Hower, not burnt
- h. 2 J. Curley, Hower, M. Thirwell, Putter.
- i. 3 Putters burnt.
- k. 19 Howers, Putters & other Boys, not burnt.
- l. 2 Putters burnt
- m. 3 J. Williamson, Deputy, H. Weightman & J. Garry, Howers much burnt.
- n. 1 Elliot Richardson, Inspector, a little burnt, Watch going.
- o. 3 Guley, Putter, J. Ferry, Deputy, a Driver & Horse.
- p. 6 Howers & Putters who worked in broken, some burnt.
- q. 3 D^o & D^o D^o in D^o
- r. 5 D^o & D^o D^o in Whole
- s. 1 Mark Davison, Putter.
- t. 4 Howers & Putters who worked in Whole.
- u. 1 J. Sanderson, Hower
- v. 3 2 putters & a Hower.
- w. 9 Howers & a Putter
- x. 17 D^o & Putters who worked in Broken, none burnt!
- 95 Total

EXPLANATION.

- Represents an air stopping x an air Crossing
- DD — D^o — Doors — R a Regulator.
- The spot where the accident is supposed to have originated. — Meadows Way.
- The Holly way in present use.
- Represents the direction of the Air Current.

SCALE, 2 CHAINS TO AN INCH.

J. Basire, litho.

DIAGRAM (N° 4.)

[To illustrate the Evidence of J. Hutchinson, Esq. M.D. of 29th June, 1849
Pages 160 and 162.]

Fig. 1

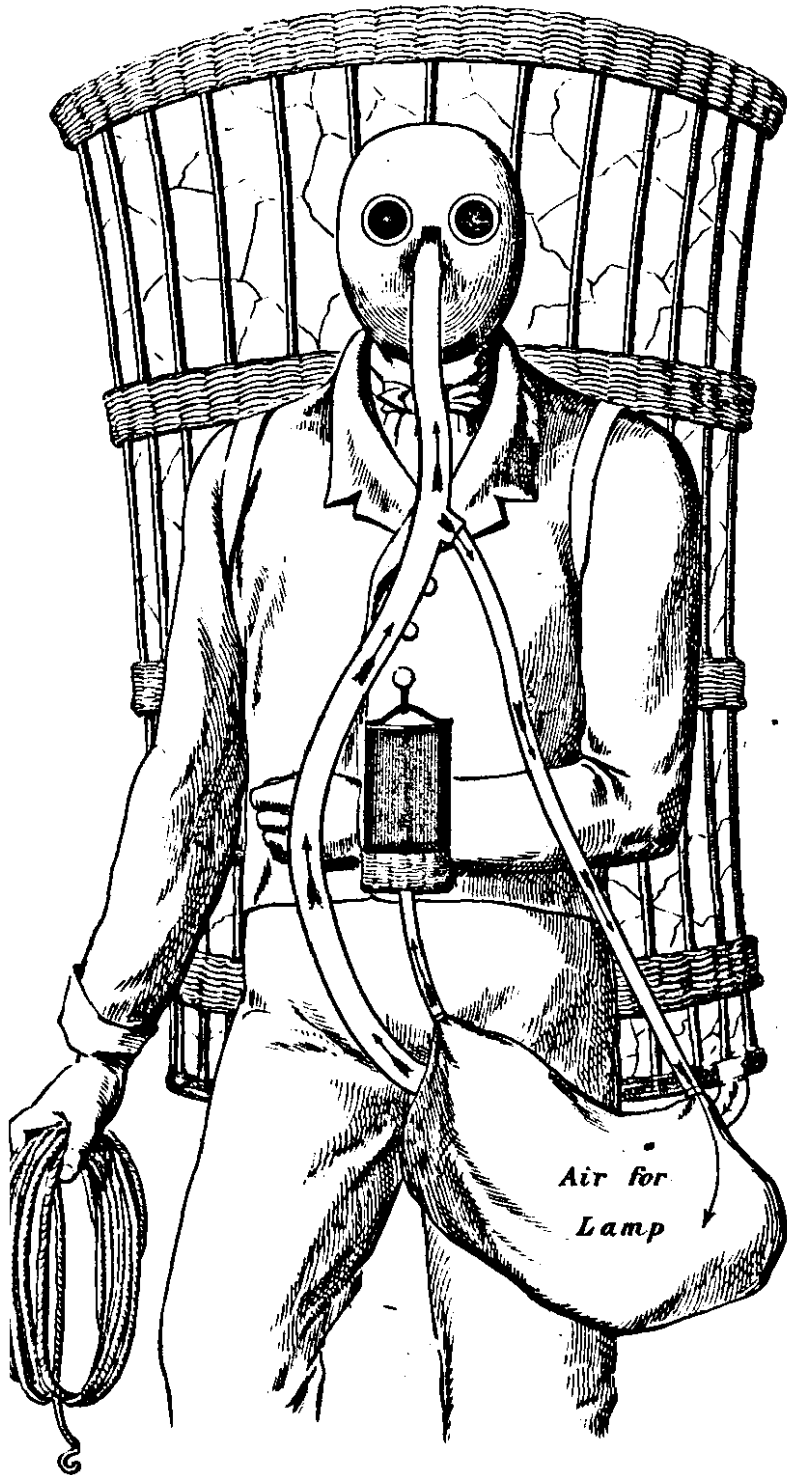

Fig. 2

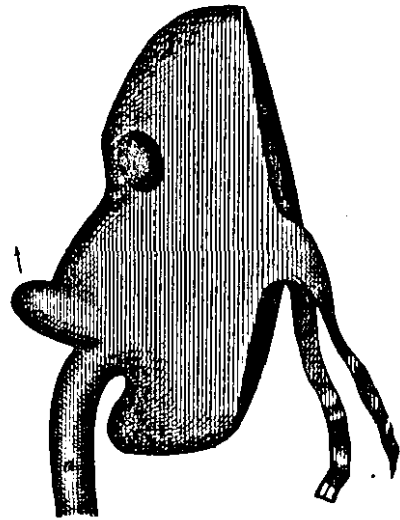

Fig. 3



Mode of Working and Ventilating the Coal at

ELSECAR COLLIERY,

Belonging to East Fitzwilliam.

[To illustrate the Evidence of B. Bram, Esq. 2nd July 1849. — Page 168.]

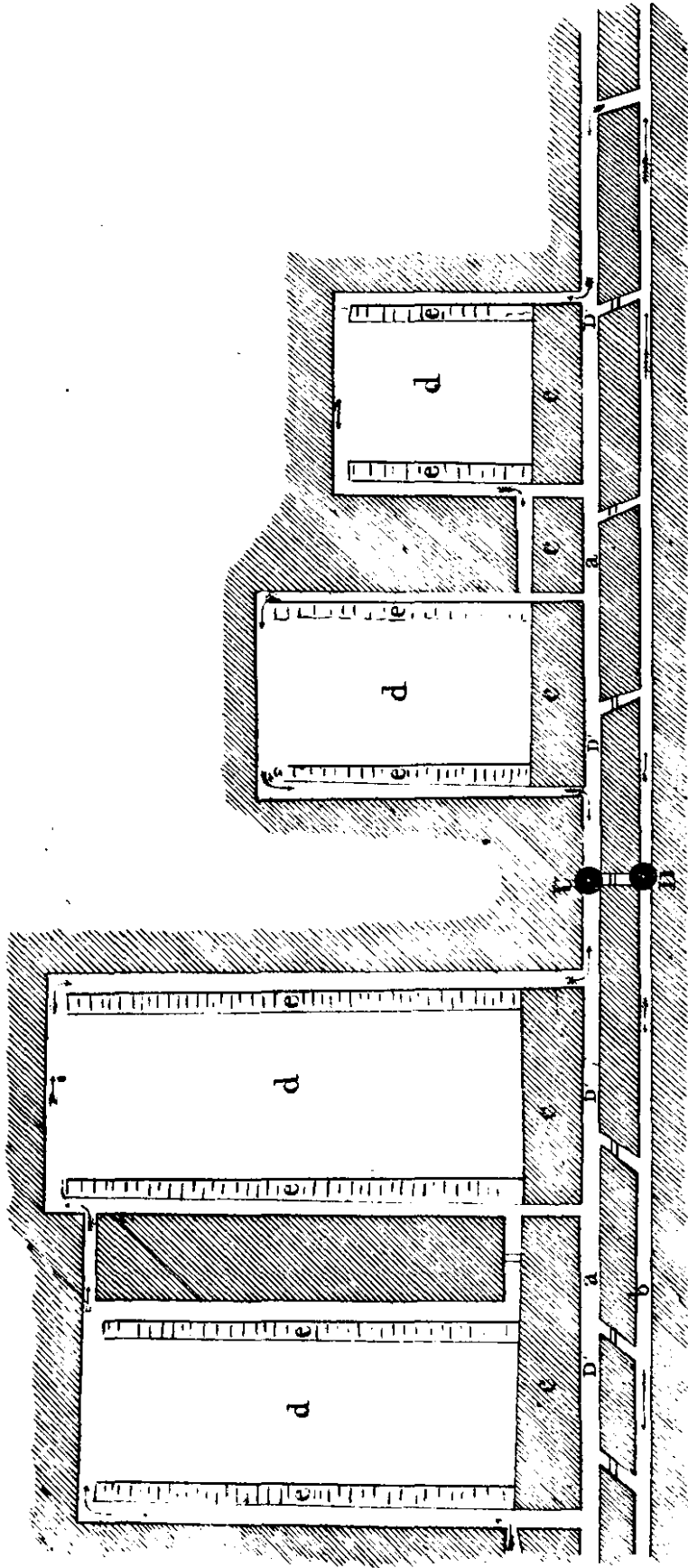

U. Upcast. D. descent shaft.

a Counter level.

b Water level.

c Pillars of coal left to support the roads.

d Pillars from whence the coal has been removed.

e Posts for supporting the roof on each side of the bunks which preserves a road for taking away the coal and for ventilation.

D D Posts for diverting the air.

Bram

PLAN. N. VII.

PLAN N° XIII.

REGISTERING CYLINDER,

For Recording the Revolutions of an Anemometer, for One Week.

FULL SIZE.

[To illustrate the Evidence of B. Biram, Esq. 2nd July 1849 — Page 179.]

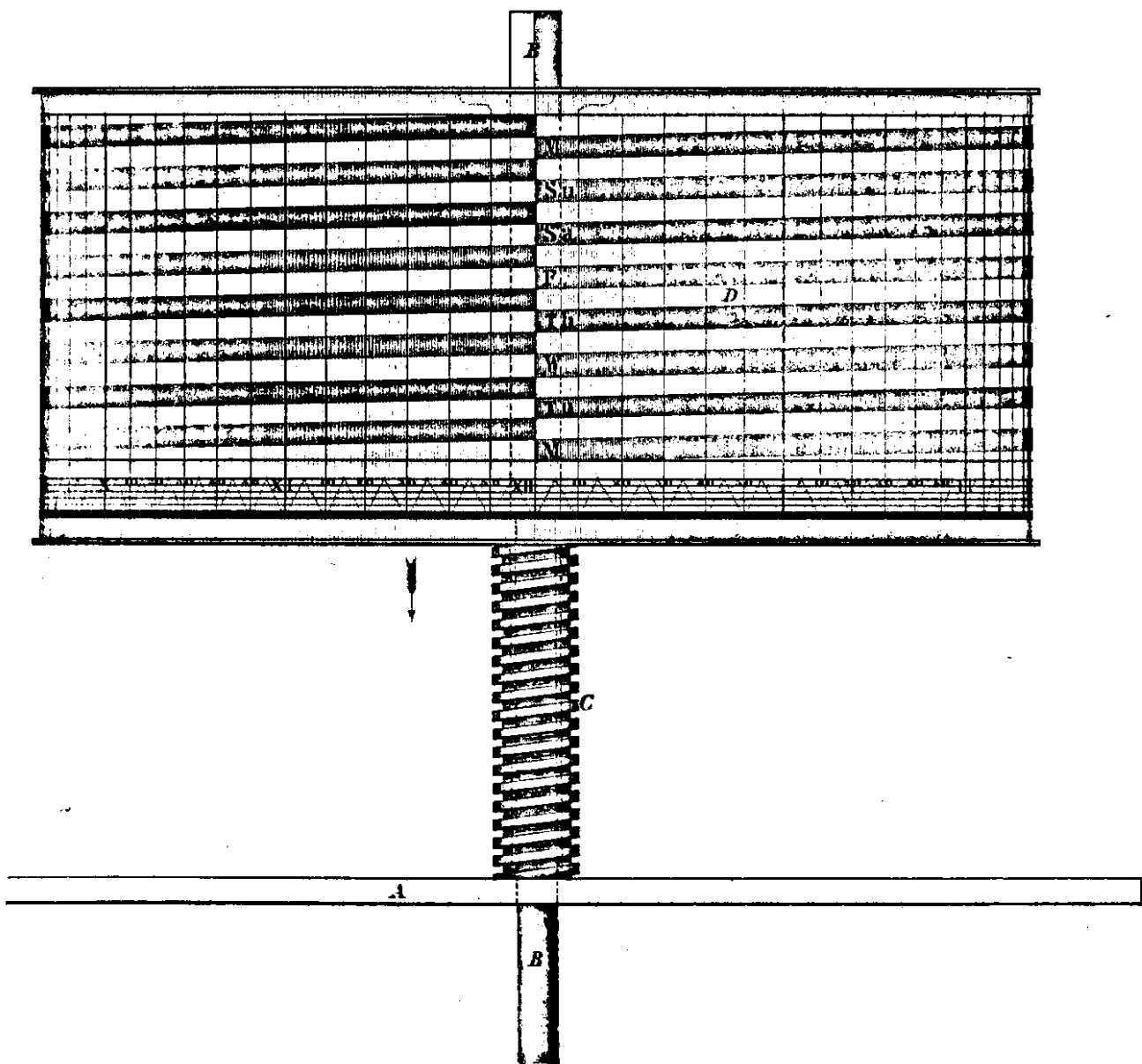

B. Biram.

(Fig. 1.)
PLAN

of part of the

WORKINGS IN THE HUTTON COAL SEAM,
AT
HETTON COLLIERY.

Showing the Mode of conducting the Air to the Furnace,
and to the Upcast Shaft

June 27th 1849.

Scale 1 Chain P. Inch

[Reserved to the Use of the Board of Ordnance, by Act of Parliament, 1849, Chap. 87.]

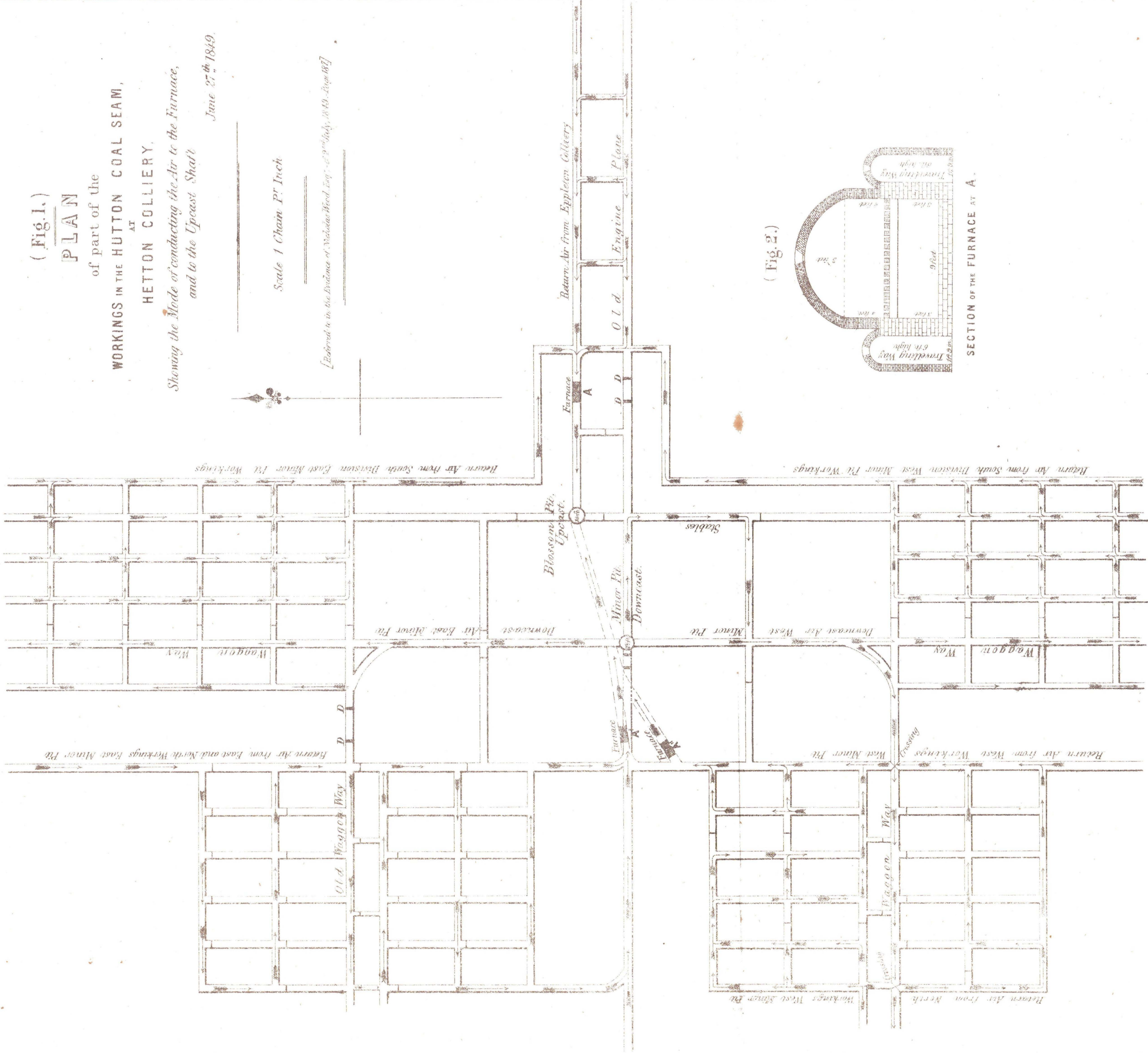

(Fig. 2.)

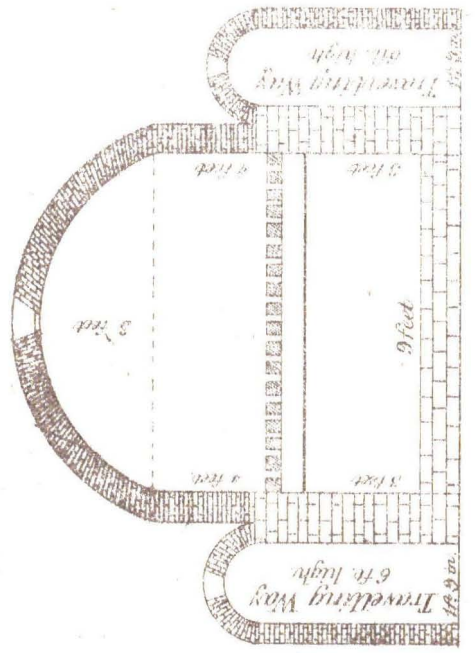

SECTION OF THE FURNACE AT A.

Diagrams illustrative of the inconvenience, and in some instances impracticability, of producing efficient Ventilation in Mines of shallow Depths, owing to the high Temperature required in the Upcast Shafts.

The annexed Diagrams of the Comparative Expansions of the Columns of Air in Upcast Shafts are constructed on the principle, that a Column of 100 parts of Air at the temperature of 32° Far. when heated to 212° , will expand into 137.5 parts, which gives 1.480th for every degree of temperature.

If, therefore, C = column of Air at any temperature above 32° T number of degrees above that point. - C' column of Air at any other temperature above 32° , and T' its temperature above 32° - then $C' = C \left(\frac{480 + T'}{480 + T} \right)$ - A series of eight Pits are assumed, from 25 to 200 fathoms deep, with a uniform average temperature of 60° in the Downcast Pits, and 110° in the Upcast Pits, it will be observed that the expansion A B of the columns due the difference of those temperatures, decreases as the depths, and that in order to keep up a uniform amount of expansion C D, the difference in these temperatures, must be increased in the inverse ratio as the depths of the Pits diminish.

The above formula may be applied to any of the examples which will be found to give the results in the diagrams. - The velocity in feet, per second, may be ascertained by multiplying the expanded columns A B or C D by 64's and extracting the square root of the product.

The pressure per square foot may be ascertained, by dividing the expansion in inches by 820, which will be equivalent to a column of water in inches with a square foot base; but the velocity and pressure so obtained will be found to be more than the practical result, owing to the contraction of and friction in the air passages of the Mine in the former case, and the superior density of the upcast column over that of the atmosphere at the same temperature, arising from smoke and carbonic acid in the latter case; and the motive column of the ventilation will also be found to be constantly varying with the thermometrical changes of the atmosphere.

Wm Price Stroud

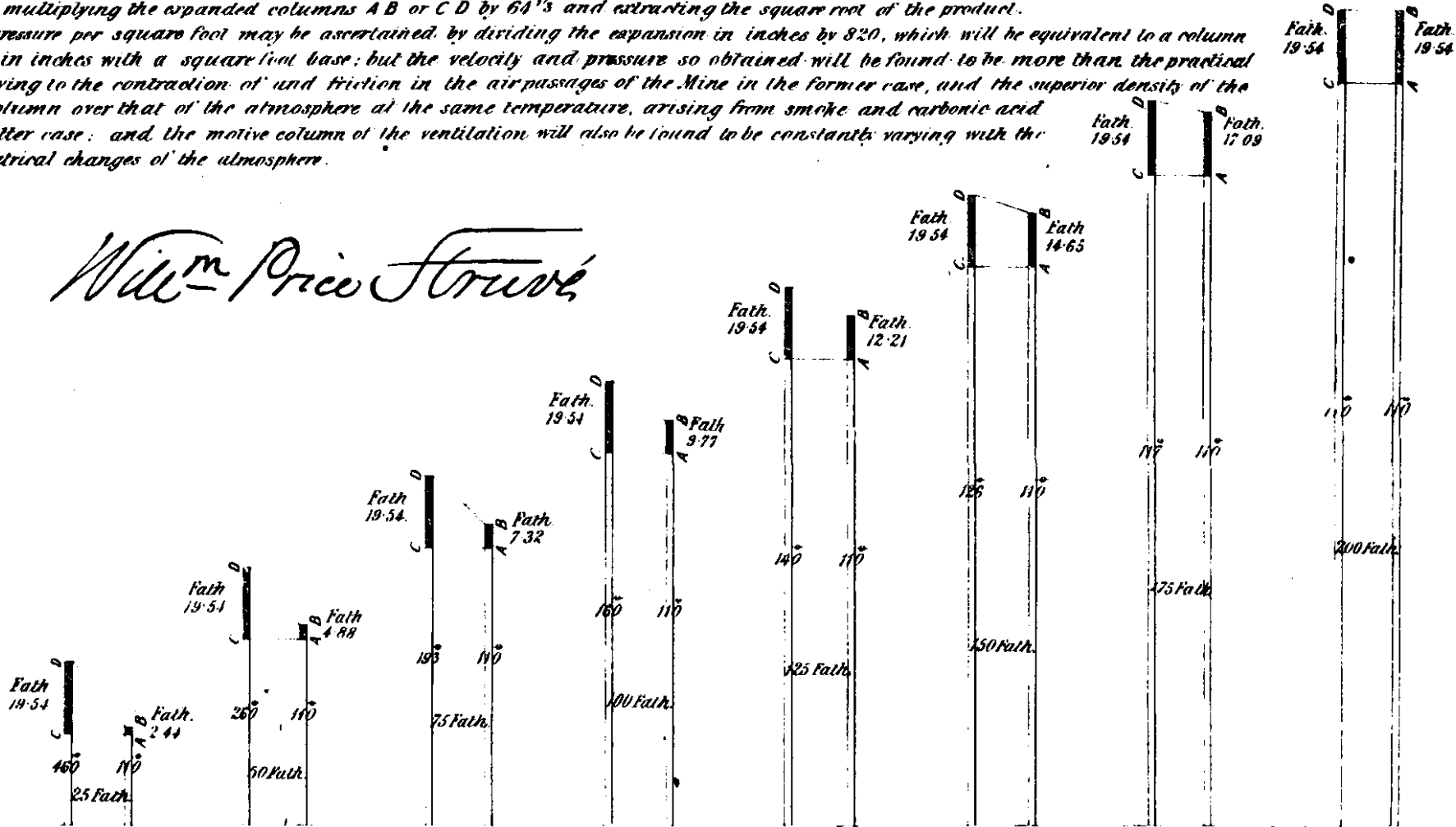

Scale, 44 Fathoms = 1 Inch.

PLAN No. XV.

Appendix I Prevention of Accidents in Coal Mines Committee.

Ordered by The House of Commons to be printed. 1st August 1843

PLAN N^o XVI.

PRACTICAL ILLUSTRATION

OF A HIGH ATMOSPHERIC TEMPERATURE REVERSING A FURNACE VENTILATION
AT A COLLIERY NEAR BRITTON FERRY.

Referred to in the Evidence of William Price Struve, Esq., of 5th July, 1849. Page 247.]

This Colliery is worked by level: the intake of the Air is along the Level for a distance of about 3/4 of a mile; it then returns through an Air passage, and after circulating through several Stalls, the "Return" ascends along the Seam at an angle of about 30° for a distance of 300 yards, to the Crop of the Seam, where a Furnace is placed, and a Culvert leading up the side of a hill, at an angle of about 30° for a distance of 130 yards, where another Furnace is placed, surmounted by a Chimney 50 feet high. These Furnaces blew down in the Summer of 1848. The above temperatures would produce an expansion of a 4 fathoms column of Air, as an excess of weight in the column of atmosphere in the Mine, over that of a corresponding column of atmosphere outside the Mine.

Temperature of Atmosphere 82°

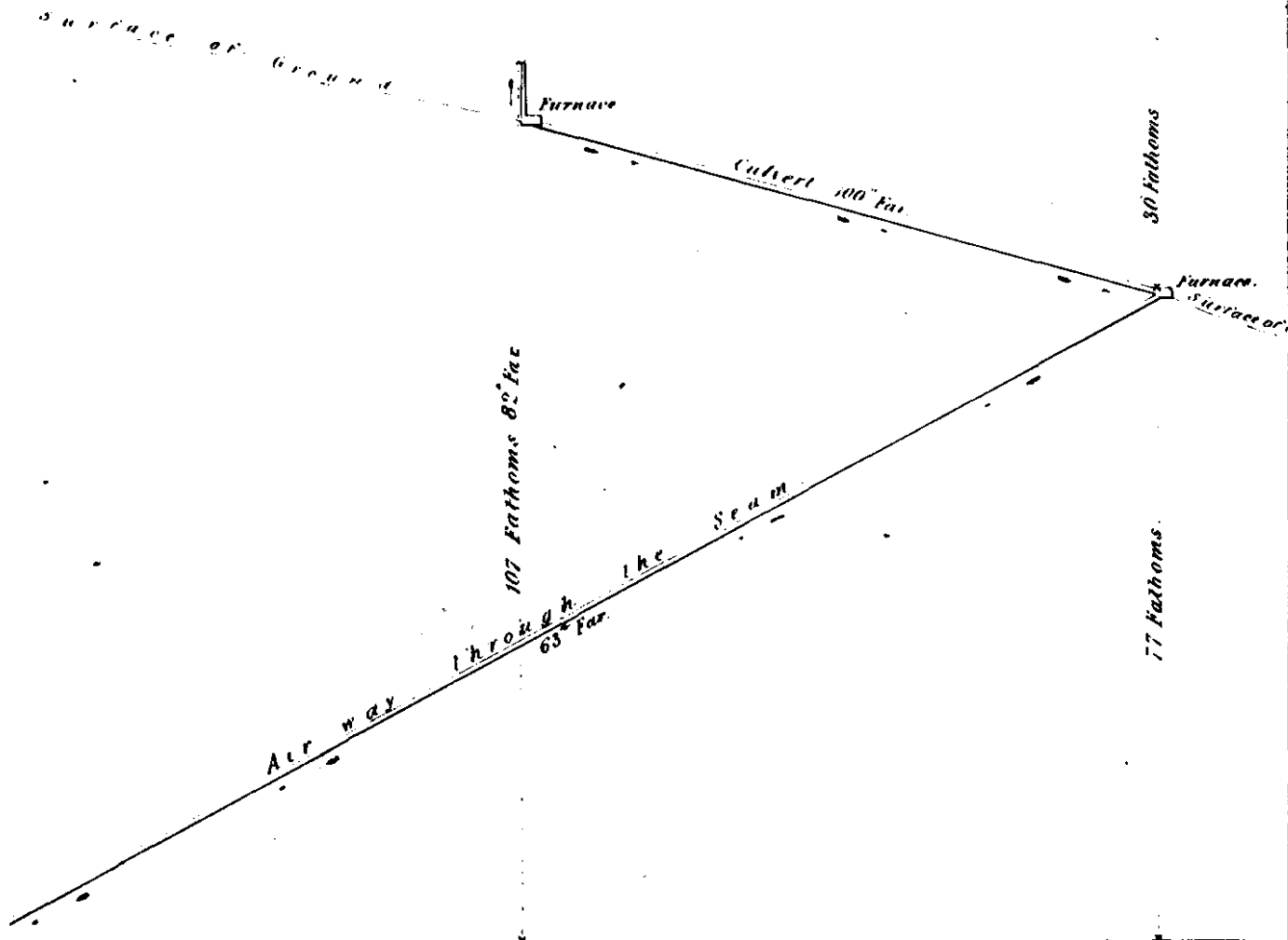

Scale. 2 Chains = 1 Inch.

Wm Price Struve

**STRUVÉ'S PATENT MINE-VENTILATOR, NOW AT WORK AT EAGLESBUSH COLLIERY,
NEAR NEATH, GLAMORGANSHIRE.**

INVENTED BY WILLIAM PRICE STRUVÉ, C.E. SWANSEA.

(Referred to in the Evidence of W.P. Struvé Esq^r of 5th July 1849.— Pages 248 & 259)

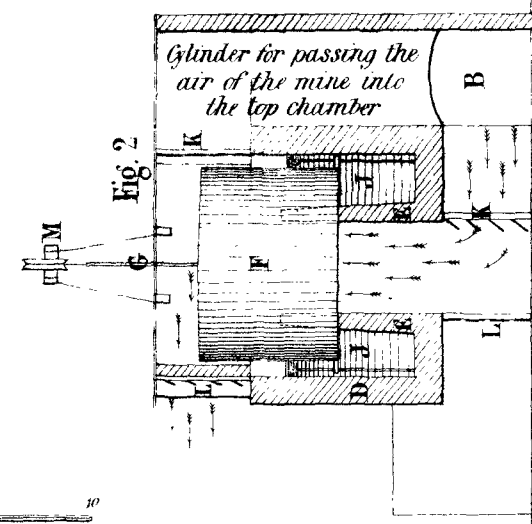
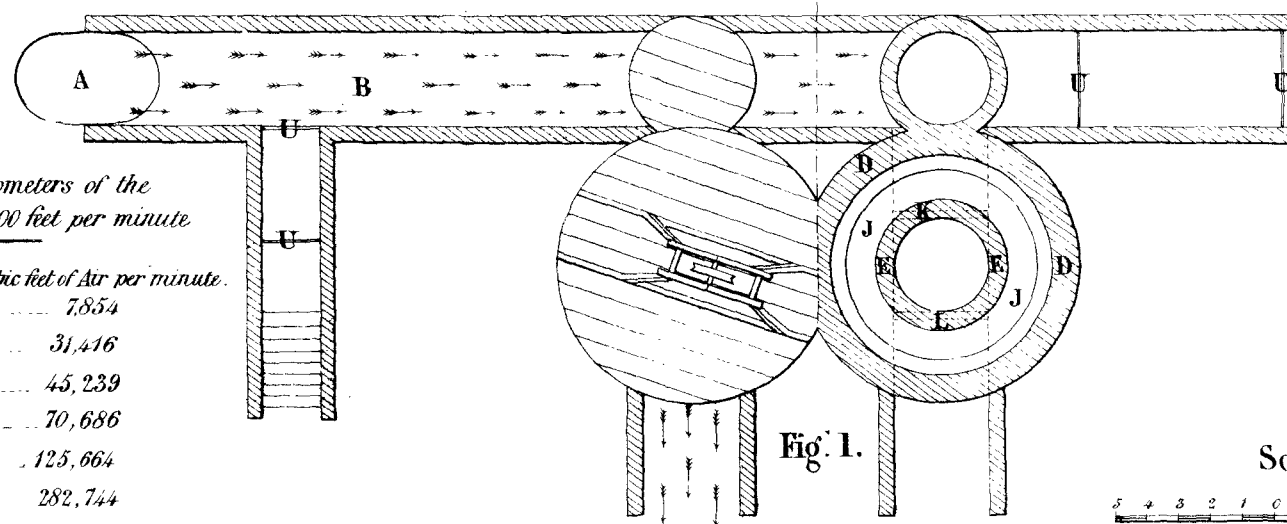
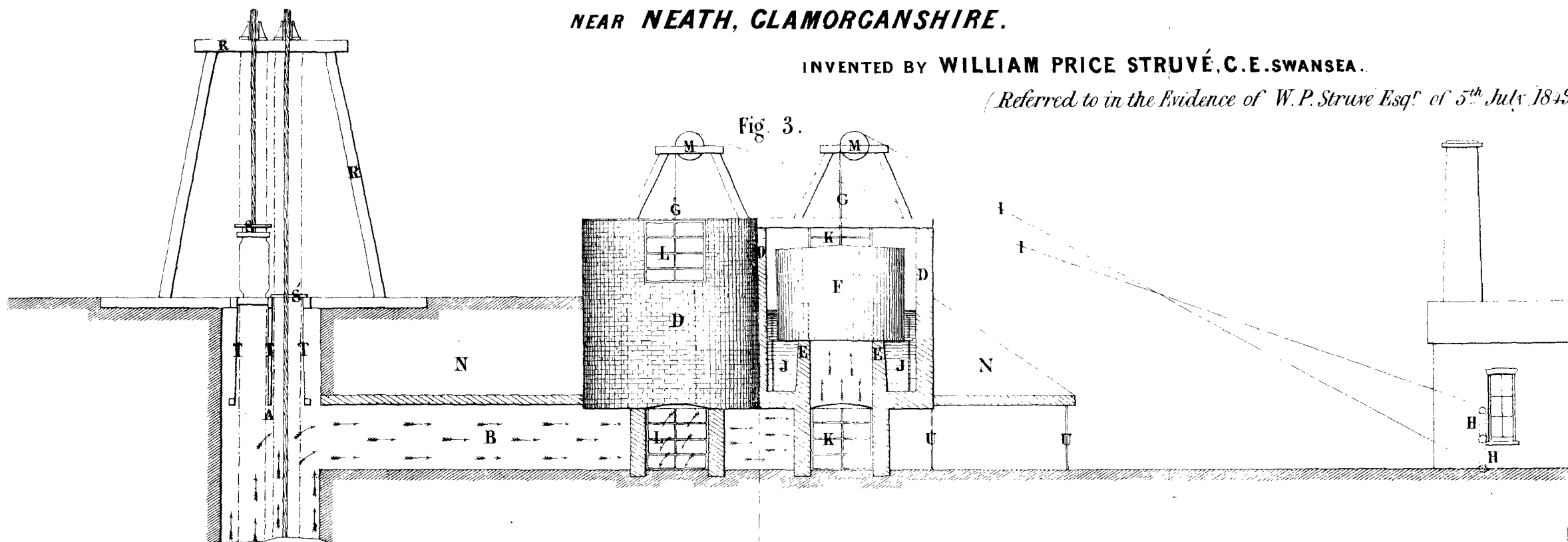

Quantity of Air discharged per minute by Airometers of the following dimensions, moving at the rate of 200 feet per minute

| Cost without moving power. | Diameter in feet. | Cubic feet of Air per minute. |
|----------------------------|-------------------|-------------------------------|
| £ 125 | 5 | 7,854 |
| 250 | 10 | 31,416 |
| 300 | 12 | 45,239 |
| 370 | 15 | 70,686 |
| 400 | 20 | 125,664 |
| 560 | 30 | 282,744 |

Scale of Feet.

Figures 1, 2 & 3 are Plan, Section and Elevation of the Mine-Ventilator now at Work at the Eaglesbush Colliery near Neath with the exception of the frame work, which is introduced into the drawing for the purpose of explaining the method intended to be adopted for closing a Coal Pit without interrupting the raising of Coal.

- A. represents the upcast pit which may be either the Coal or pumping pit but in this case it is a separate pit and is only 3ft. 6in. in diameter.
- B. is a culvert 5ft by 6ft connecting the upcast pit with the ventilator, thus an uninterrupted communication is established with the whole of the Air passages of the Colliery.
- D.D. are two cylinders of masonry 14 feet interior diameter and 16 feet high.
- E.E. are interior cylinders of masonry 9ft. 6ins. in length & 4ft. 6ins. in diameter: the space between the two cylinders is filled with water 7ft. deep and marked J, which prevents

- air escaping or being admitted, except through the inlet or outlet valves.
- F.F. are two airometers of 12 feet in diameter and 8 feet 6 inches long, made to balance each other and to move vertically in the water by means of guides.
- G.G. connecting rods with the chains from the crank, and which also serve as guides.
- H.H. two cranks placed in opposite directions, on a shaft and to which an Engine of about 5 horse-power is attached to give them a rotary motion.
- L.L. two chains connecting the cranks with the airometers, and giving a vertical motion to the airometers.
- K.K.K.K. four air ports, 4 feet square, fitted with valves to admit air from the mine.
- L.L.L.L. four air ports 4ft. square, fitted with valves for the discharge of the air into the atmosphere.
- M.M. are the framings which support two sheeves of two feet in diameter, over which the chains move, and which have to support the whole weight of the airometers.
- N. is the embankment formed from the cuttings of the foundations.

- R. is the framing of a pit for raising coal, showing the cover S, raised by the waggon and the platform of the waggon supplying its place, and also the other cover S' at rest on the other compartment of the pit, with the rope or chain working through it in order that the raising of coal may not interfere with the continuous current of air from the mine to the Ventilator, and in order to prevent leakage, the tubes TTTT. are attached to the top of the Pit, which the platform on which the waggon rests, enters before the cover S is lifted.
- The operation of the machine is as follows:— A Steam Engine of 5 H.P. gives a rotary motion to the shaft and cranks H.H. and by means of the chains L.L. a reciprocating motion is given to the Airometers F.F. equal to twice the length of the cranks, which in this case are either two feet or 3 feet, thus producing a four feet or a six feet stroke of two double acting Air Pumps of twelve feet diameter.
- U.U.U.U. doors through which the Apparatus may be inspected.

A PLAN OF THE EAGLESBUSH AND ESKYN COLLIERY, NEAR NEATH, GLAMORGANSHIRE.

[Referred to in the Evidence of William Price Struve Esq. of 5th July 1849. Page 250.]

Scale 4 Chains to 1 Inch.

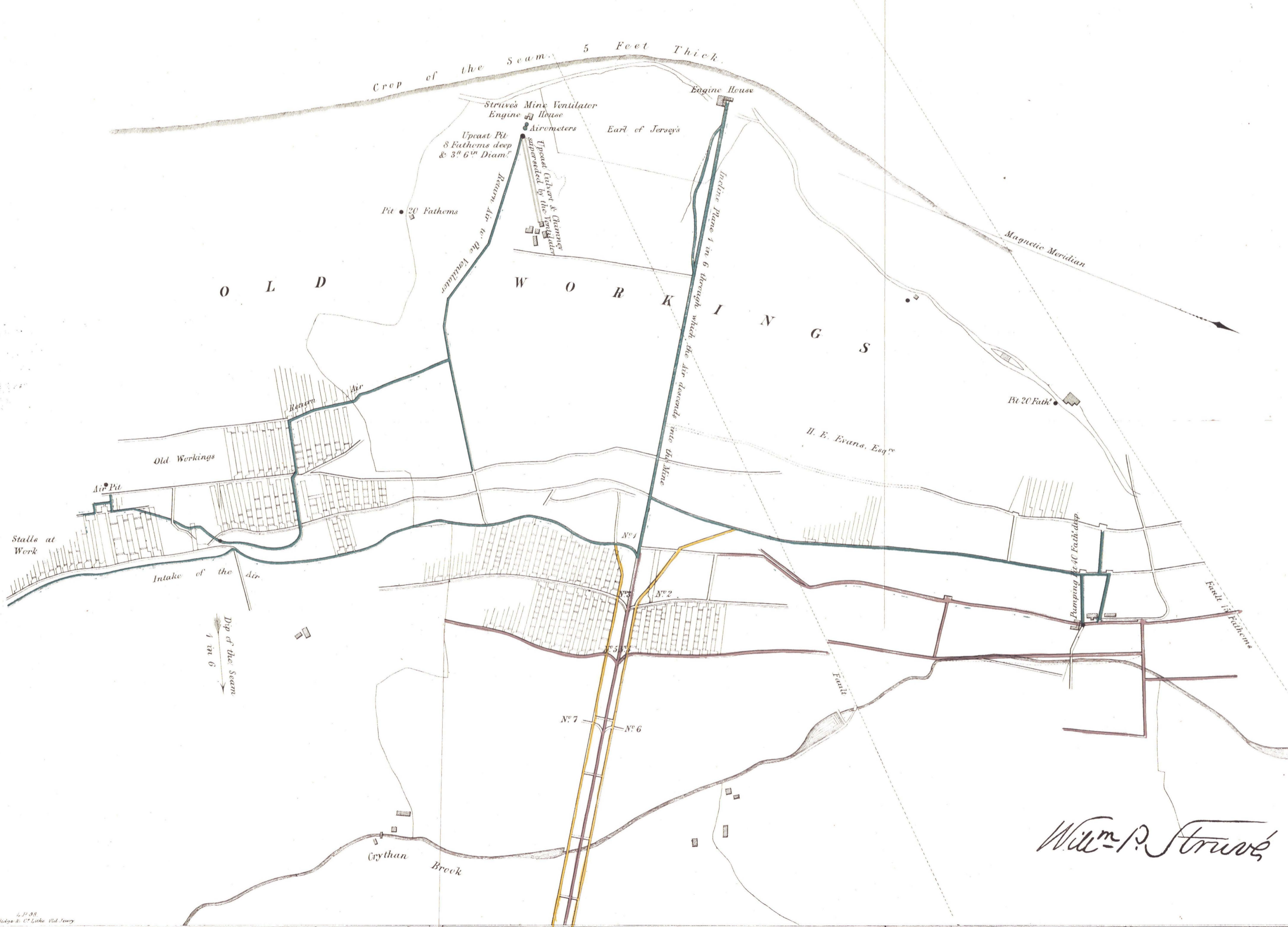

Wm. P. Struve

WEARMOUTH COLLIERY.

*Experiments made on the Temperature of the Upcast Shaft, A Pit, at the depth of
110 and 250 fathoms from the Surface.*

June 30th 1849.

Referred to in the Evidence of George Elliot, Esq.—of 6th July 1849.—Page 301.]

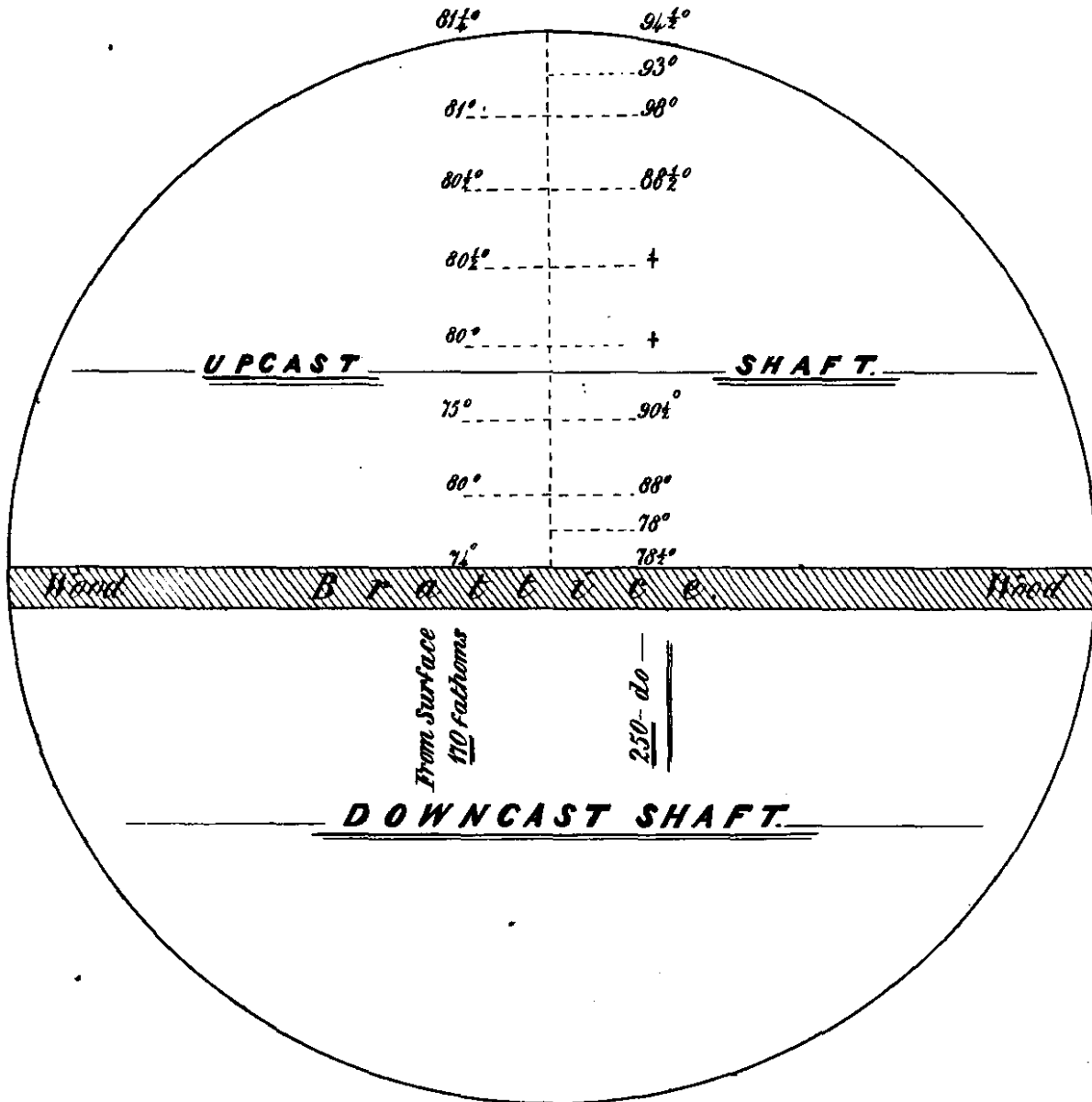

SCALE

1/2 Inch to a Foot.

PLAN de la CONCESSION
demandée par
LE SIEUR KEENE,
propriétaire et fabricant à la Saline de Briscous.

[To illustrate the Evidence of W. Keene, Esq. of 9th July 1849
Page 313.]

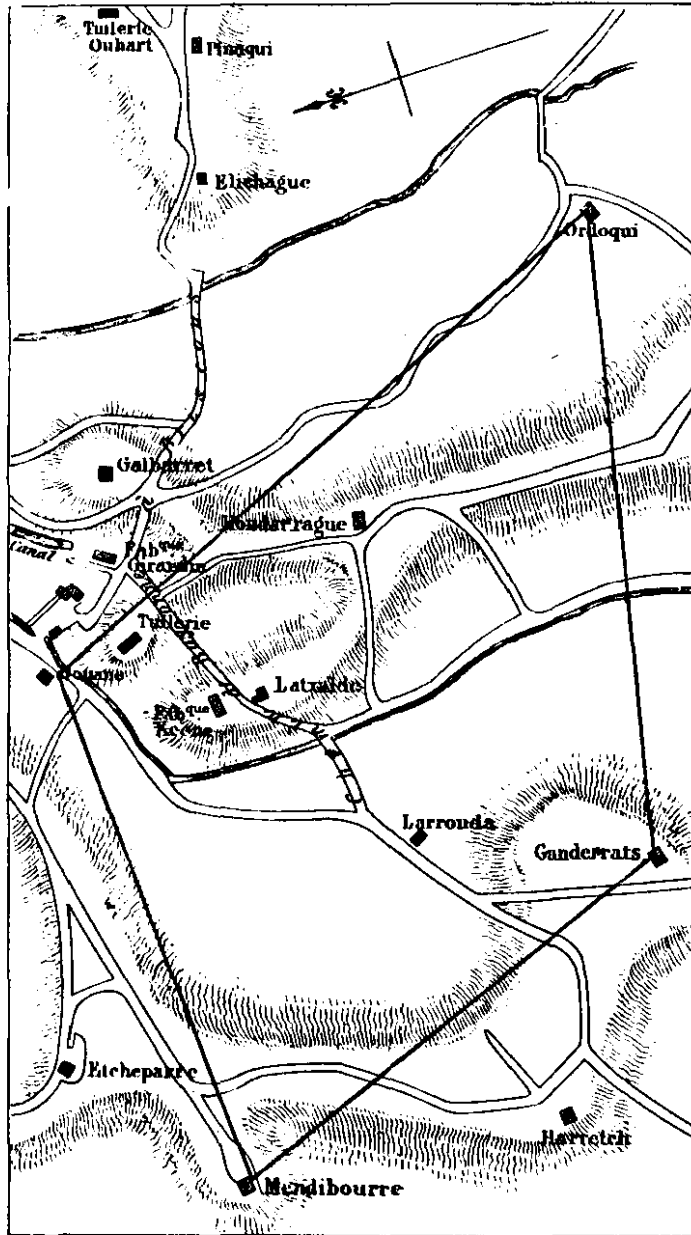

Echelle 1 à 10,000
0 50 100 Mètres

Nota. — Les limites de la Concession sont indiquées par des lignes rouges.

SECTION OF
CONDENSING AND VENTILATING APPARATUS
BY HIGH-PRESSURE STEAM.

[Referred to in Page 35A.]

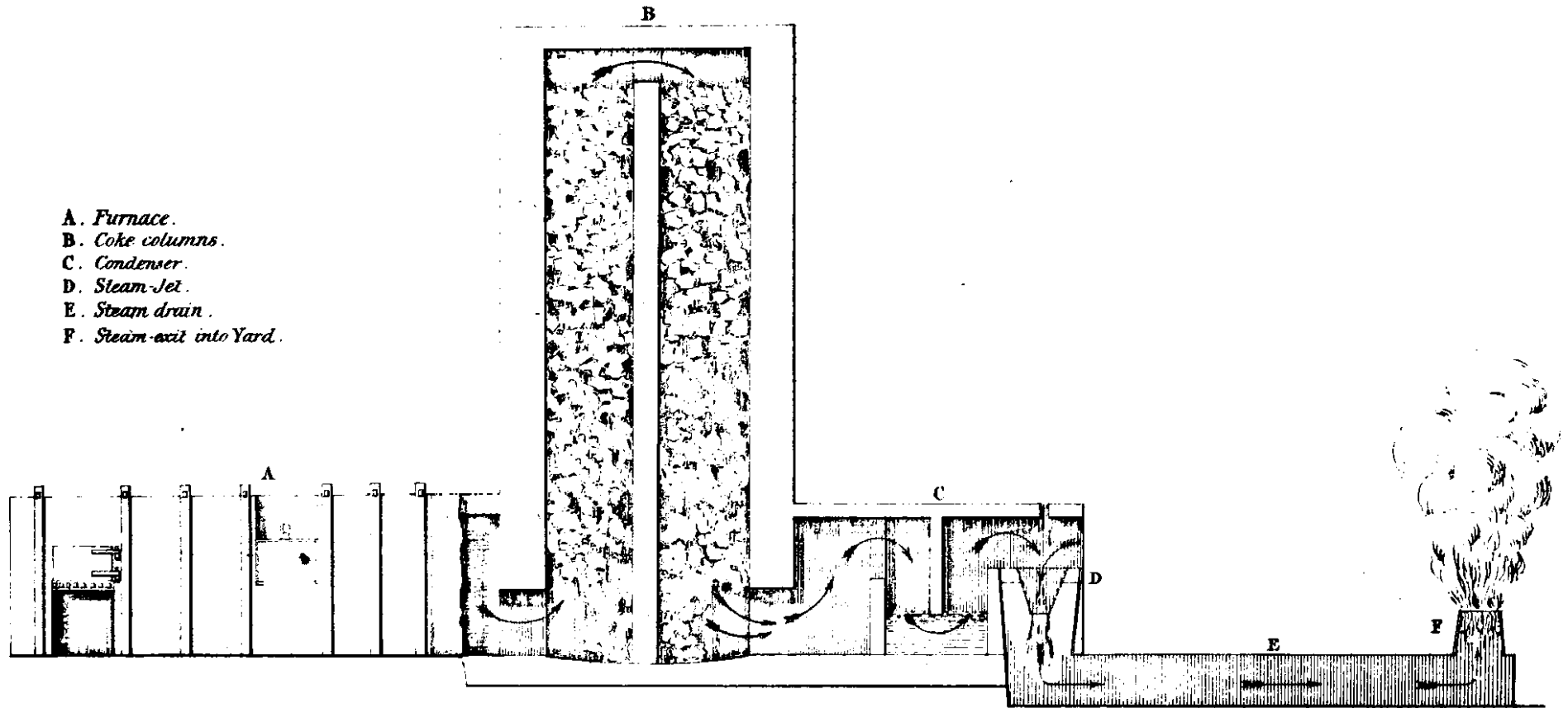

- A. Furnace.
- B. Coke columns.
- C. Condenser.
- D. Steam-Jet.
- E. Steam drain.
- F. Steam-exit into Yard.

PLAN, N^o XXI.

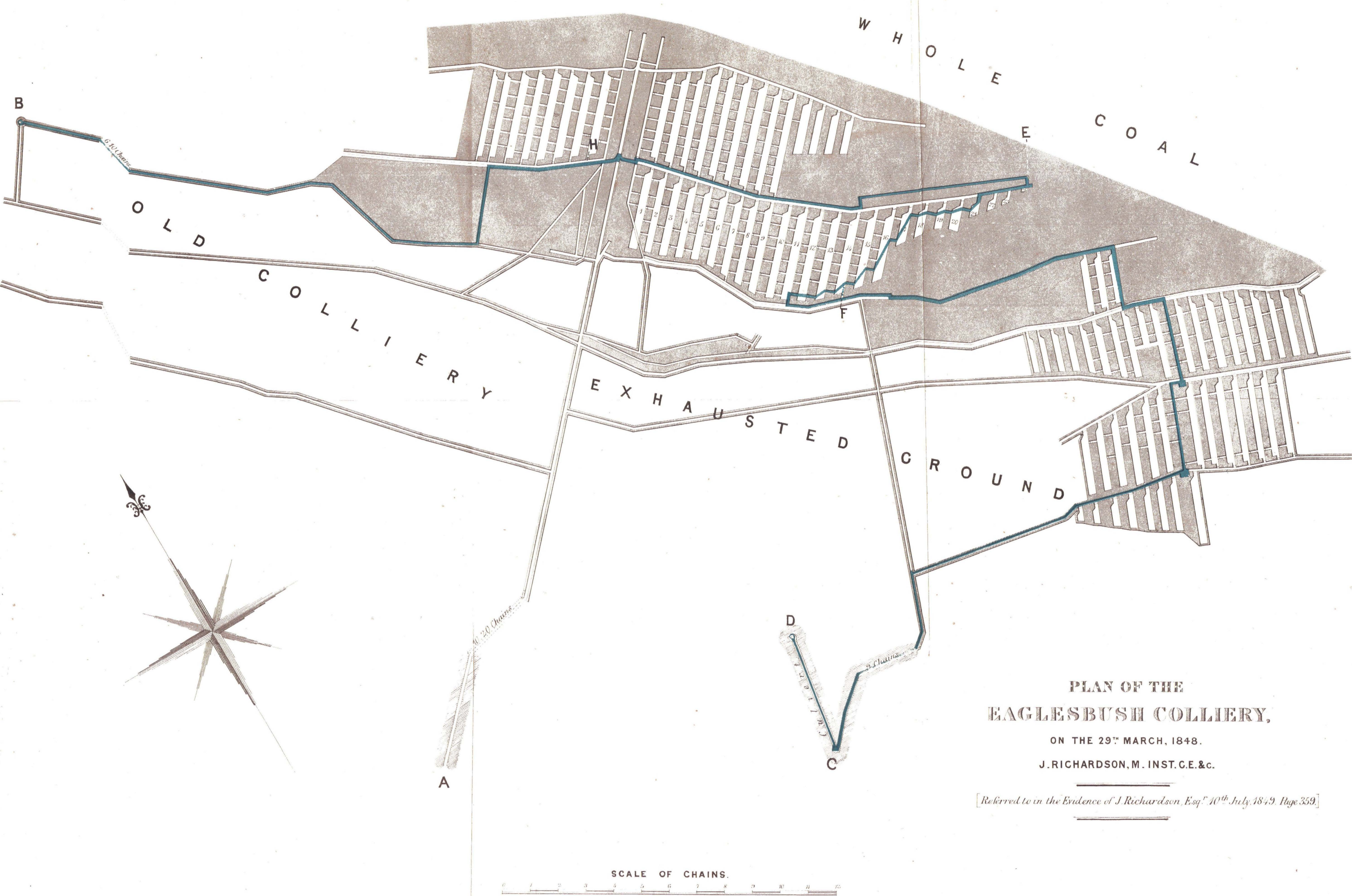

**PLAN OF THE
EAGLESBUSH COLLIERY,**

ON THE 29th MARCH, 1848.
J. RICHARDSON, M. INST. C. E. & C.

[Referred to in the Evidence of J. Richardson, Esq. 10th July 1849. Page 359.]

SCALE OF CHAINS.

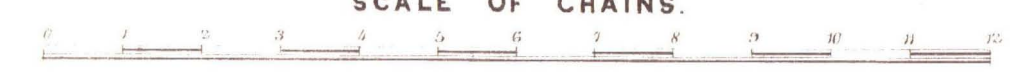

*10 p. 178
Study of the 20th July*

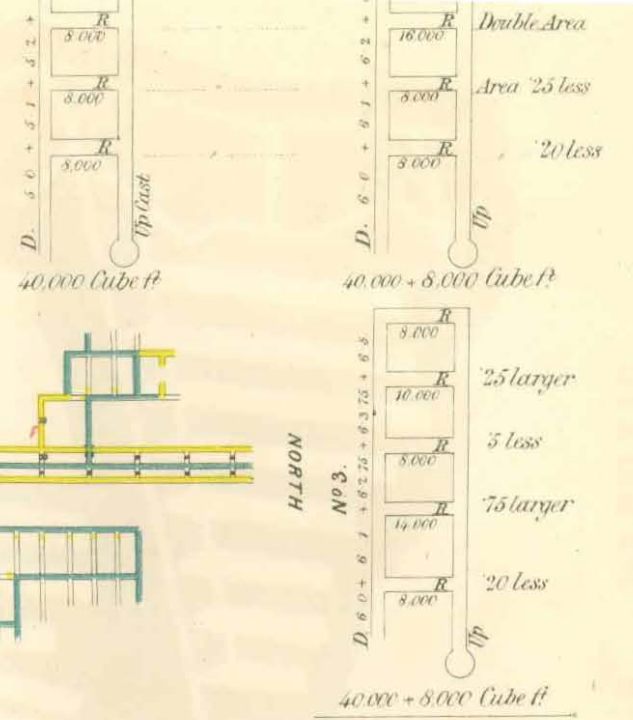
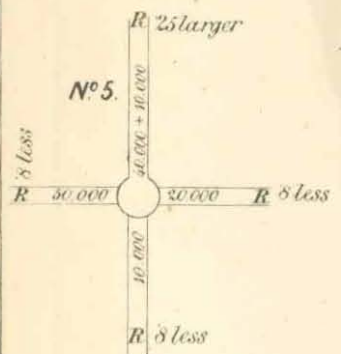
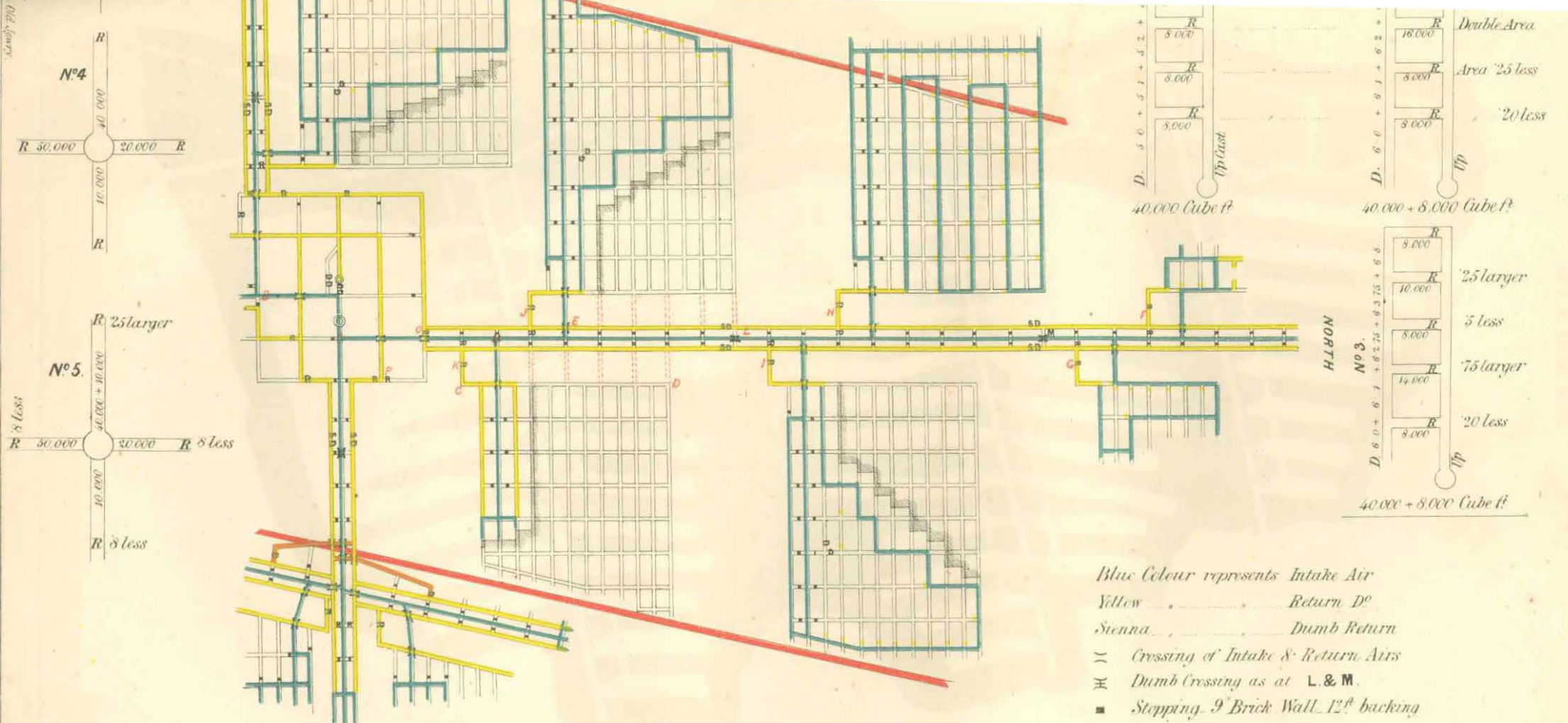

Blue Colour represents Intake Air
 Yellow " " " " Return D^c
 Sienna " " " " Dumb Return
 (Crossing of Intake & Return Airs
 ≡ Dumb Crossing as at L. & M.
 ■ Stepping - 9" Brick Wall 12" backing
 S.D. Swing Doors
 D. Door
 DD. Double Door
 R. Regulator
 ≡ Gallery in Coal

John T. Barkley
 17th July 1849

SCALE 400 FEET TO 1 INCH.

0 100 200 300 400 500 1000 1500 feet

PLAN N° XXIII.

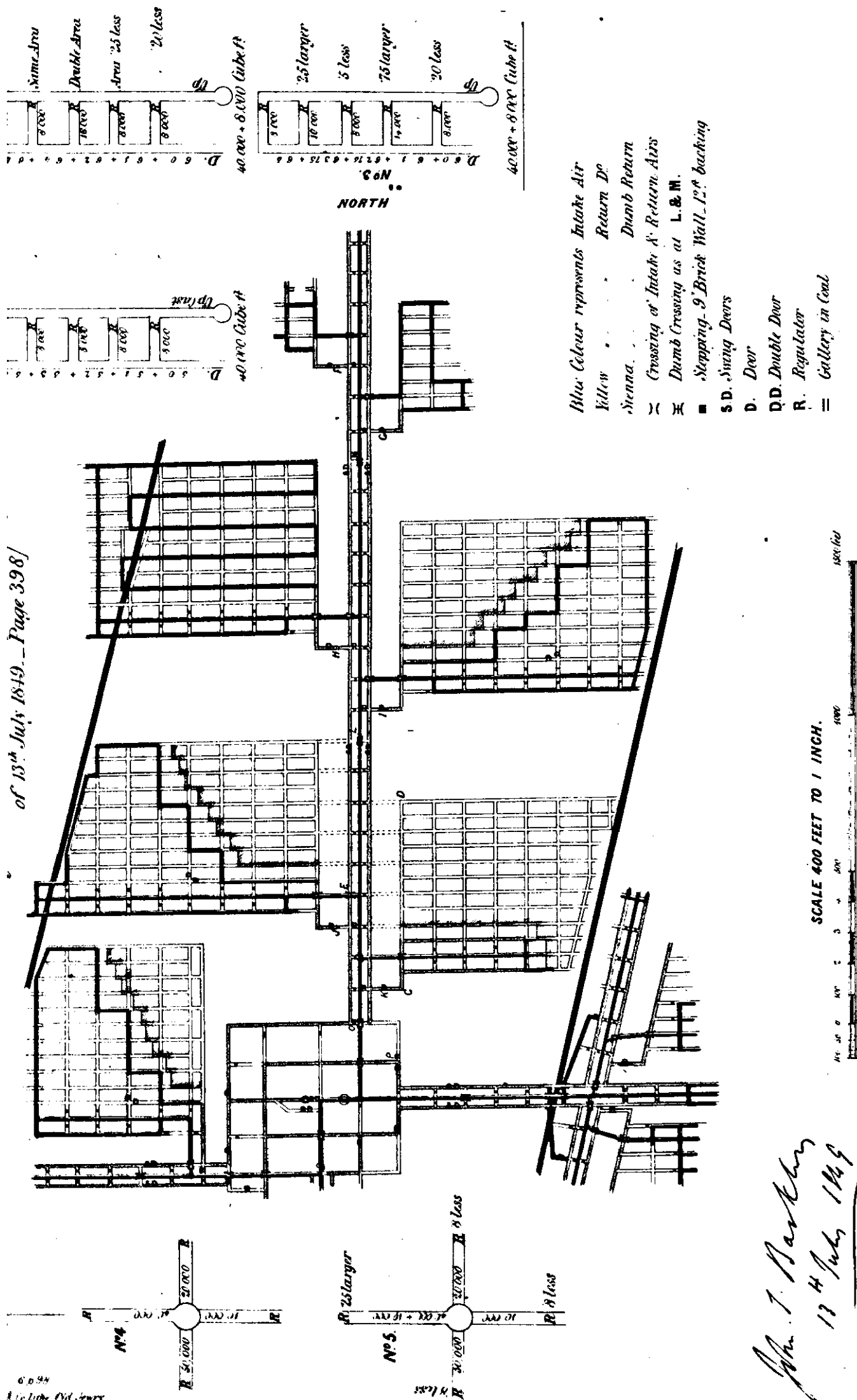

of 13th July 1849. — Page 398/

DIAGRAM (N^o 1.)

PLAN, N^o XXIV.

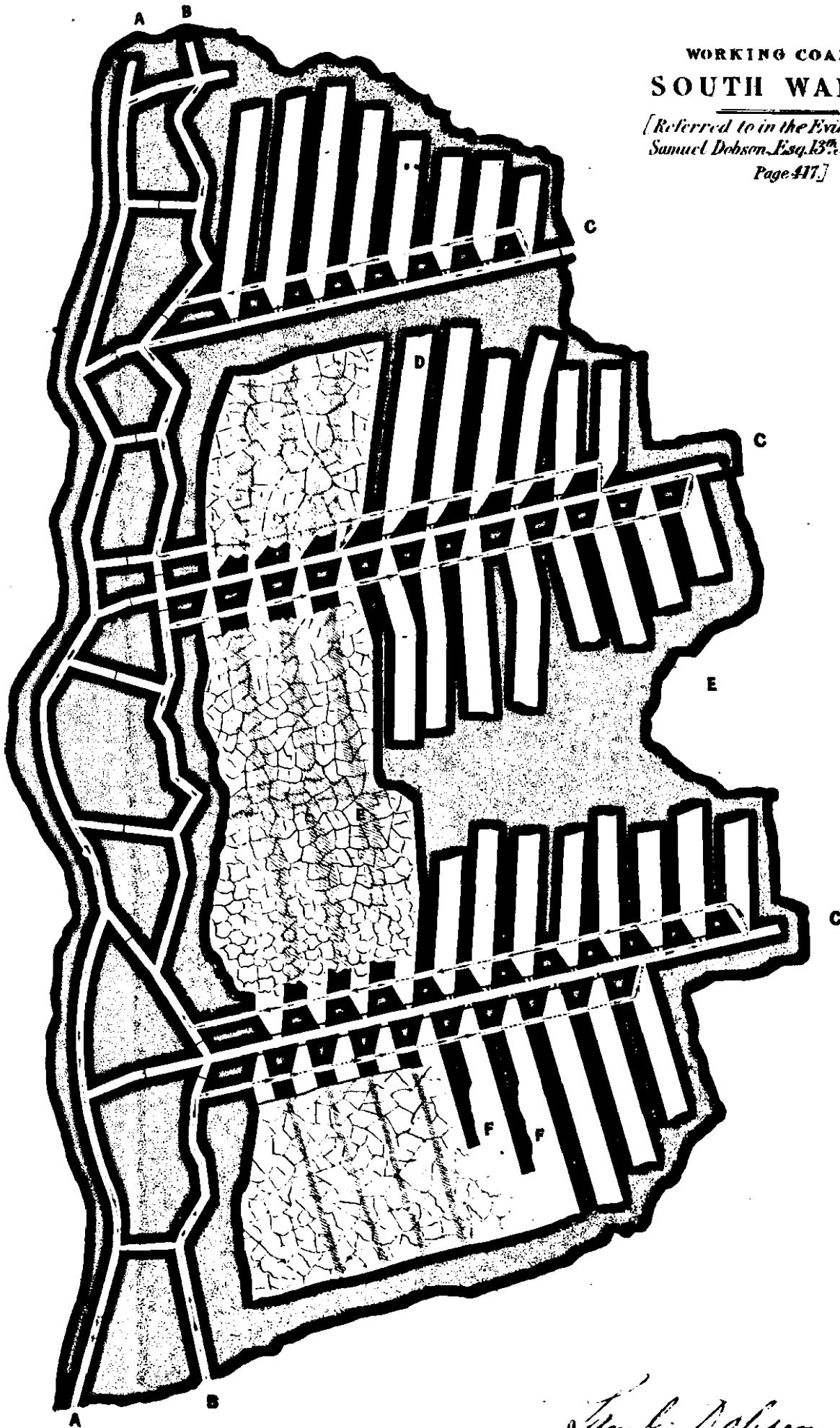

WORKING COAL IN
SOUTH WALES.

[Referred to in the Evidence of
Samuel Dobson, Esq. 13th July, 1849.
Page 417.]

Sam. L. Dobson.

DIAGRAM (N^o2.)

PLAN. N^oXXV.

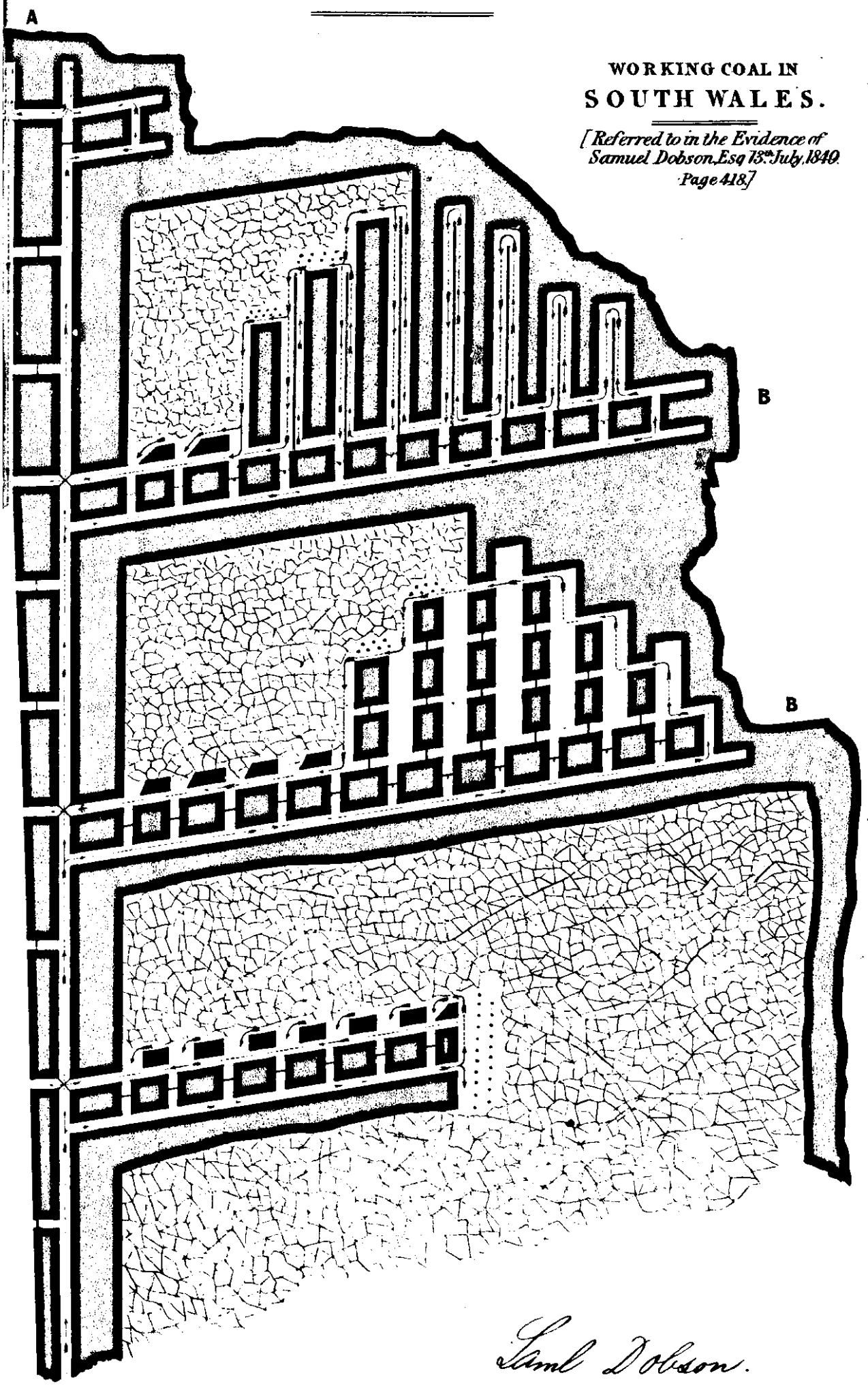

WORKING COAL IN
SOUTH WALES.

[Referred to in the Evidence of
Samuel Dobson, Esq 13th July, 1849.
Page 418.]

Saml Dobson.

SKETCH OF A SHAFT AND AIR-TUNNEL
To Ventilate Mines.

[To illustrate the Evidence of B. Gibbons, Esq. - 16th July 1849. - Page 429.]

..

If a Circular Tunnel is preferred to an Oblong one it would be constructed thus.

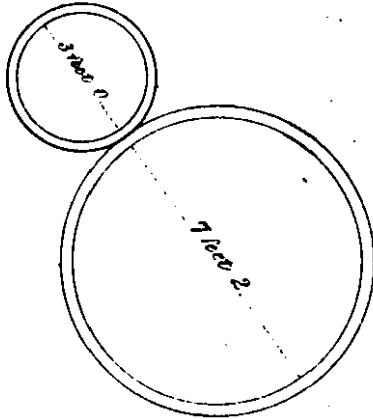

Sketch of a Shaft with two Air-Tunnels if required.

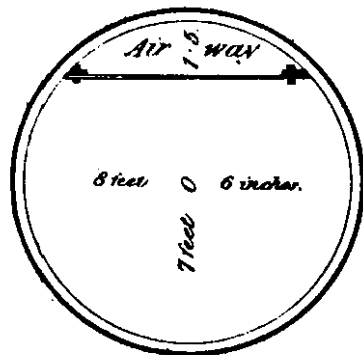
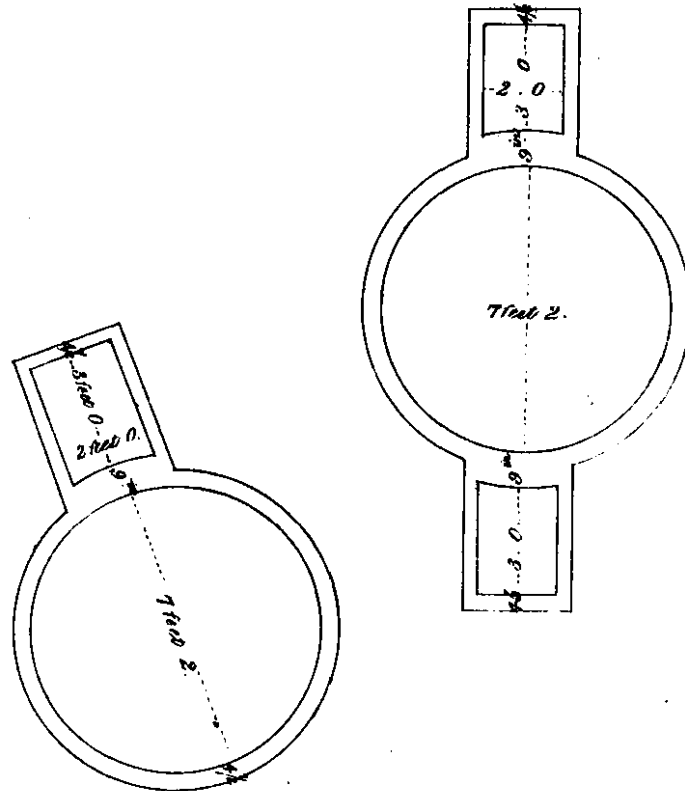

Sketch of an Iron Tube (with partition. Wroⁿ Iron, for an Air-way equal in area to the above) in case sand should be met with in sinking.

STAFFORDSHIRE THICK OR 30 FEET VEIN OF COAL.

[To illustrate the Evidence of B. Gibbons, Esq., 16th July 1849. Page 433.]

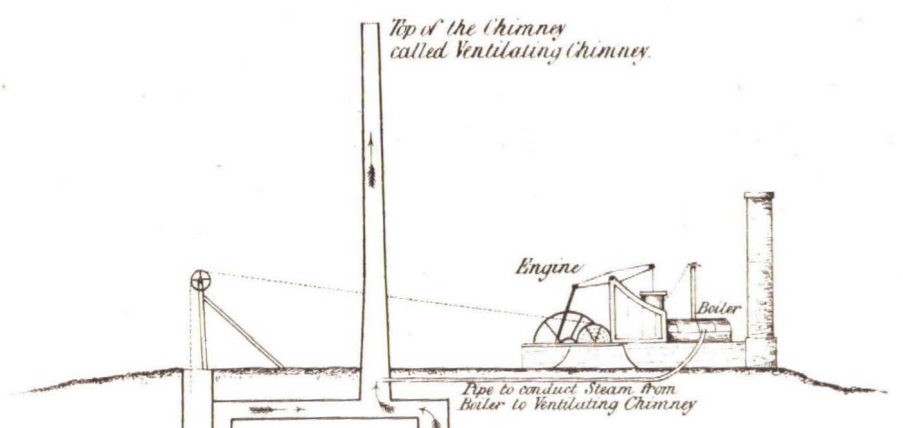

C R O U N D P L A N .

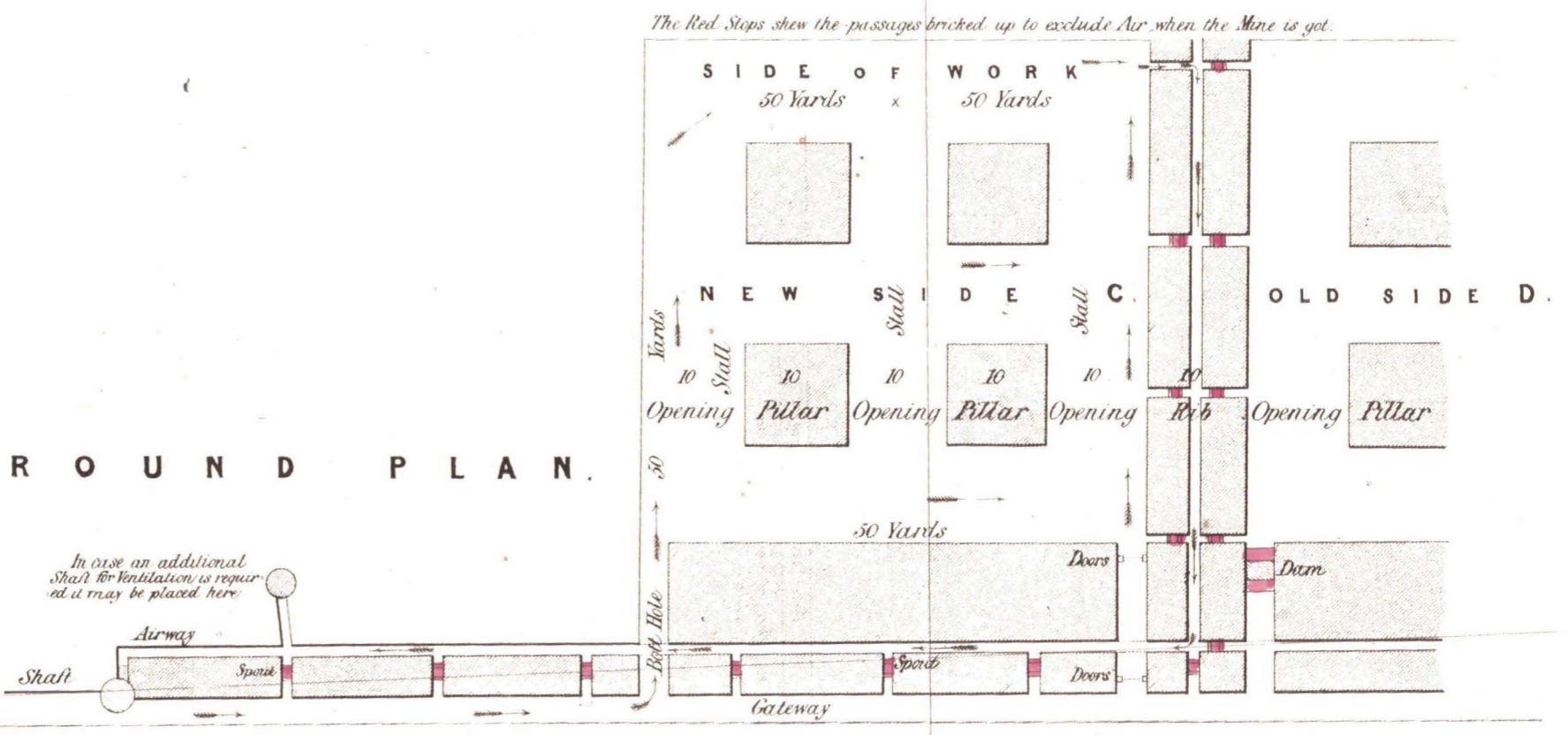

S E C T I O N .

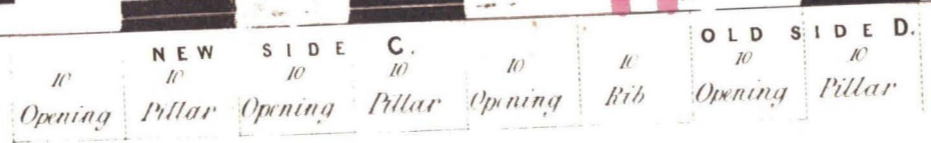
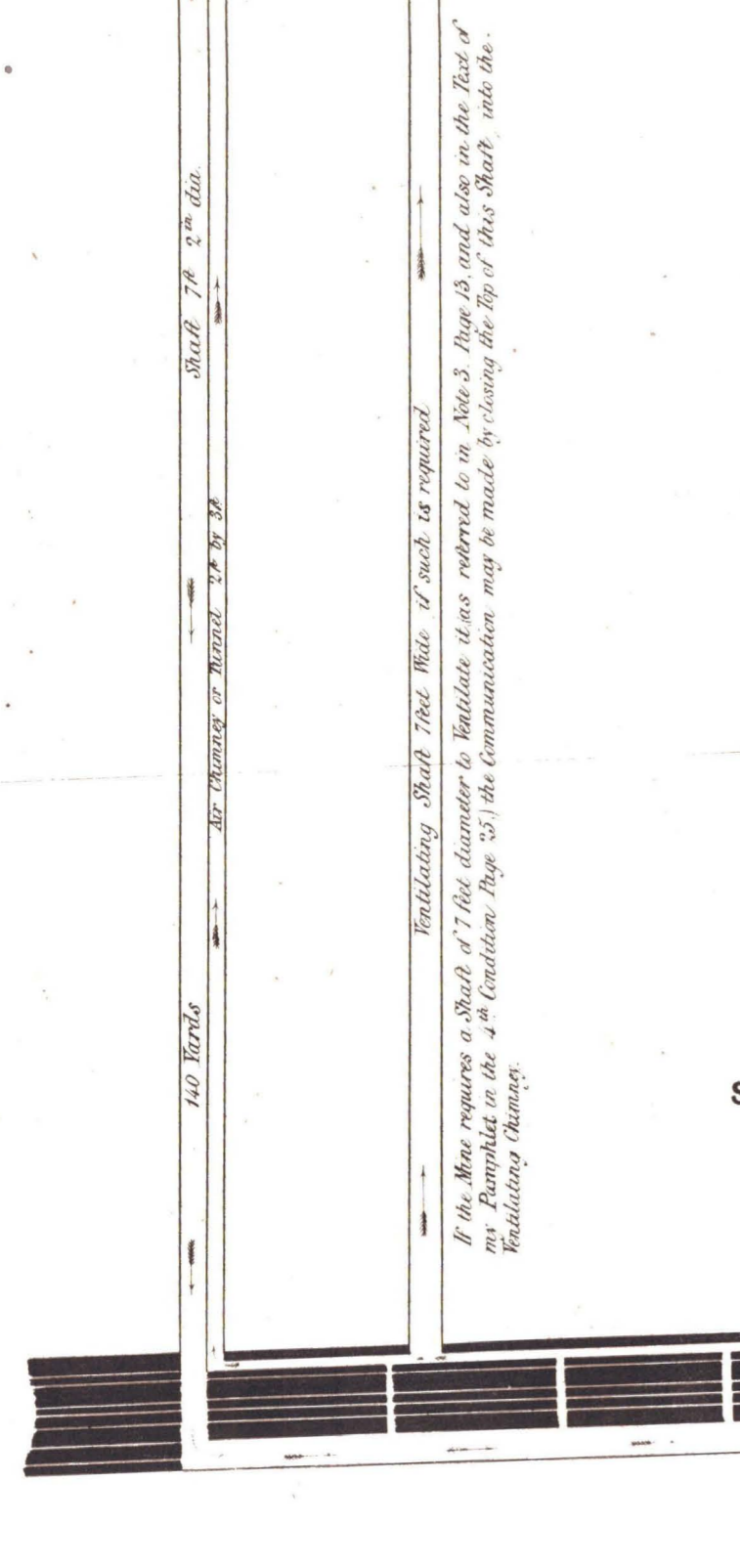

7 P. 96. Sharnidge & Co. Litho. London

ILLUSTRATIONS OF DIFFERENT MODES OF WORKING COAL.

[Referred to in the Evidence of M. Dunn Esq. of 19th July 1849 - Page 515.]

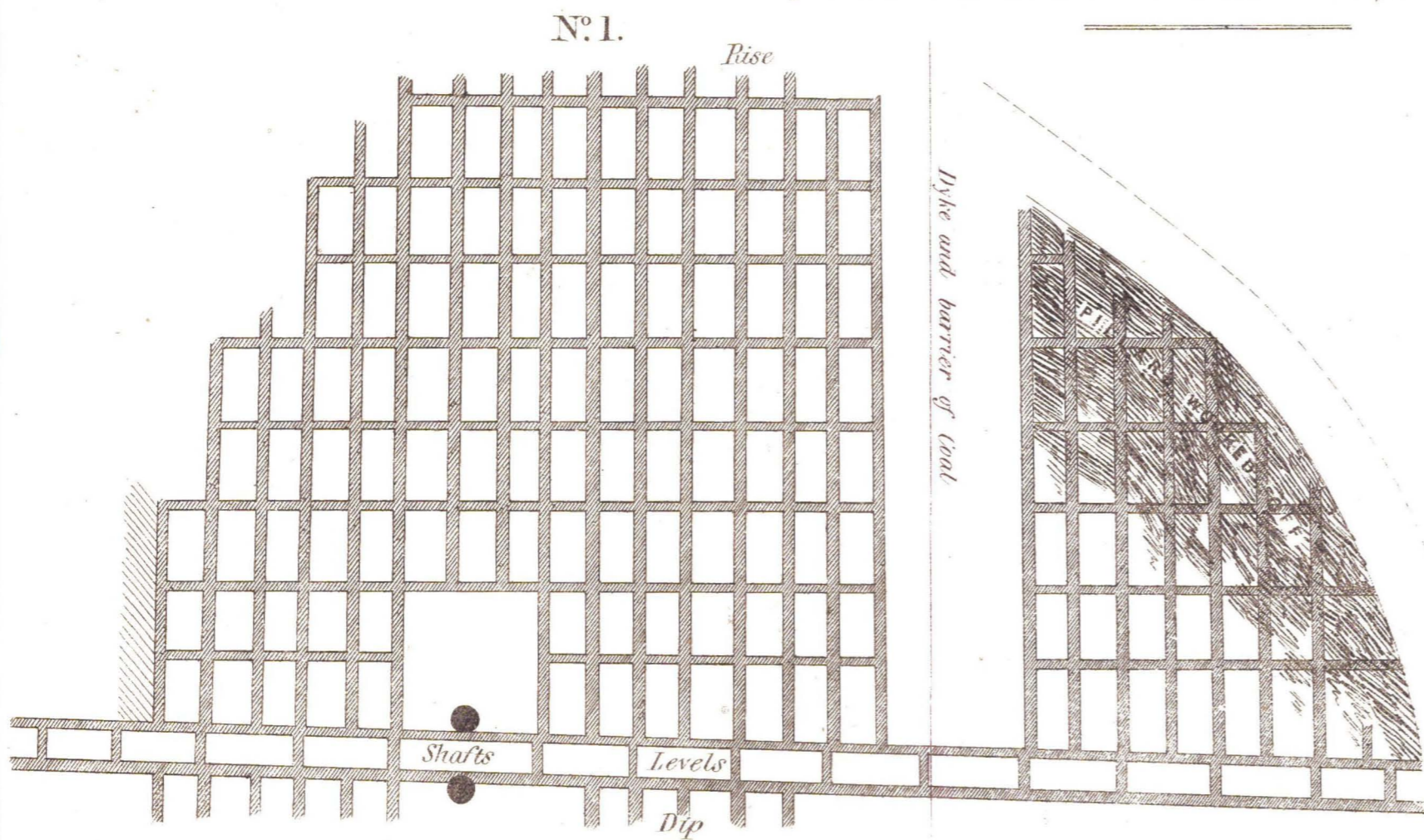

N^o 1. The almost universal method of laying out & working in the Counties of Durham & Northumberland, also, Cumbria, the pillar being proportioned to the depth from surface and other considerations. The shaded part shows the manner of working away the Pillars and of producing the Geaf.

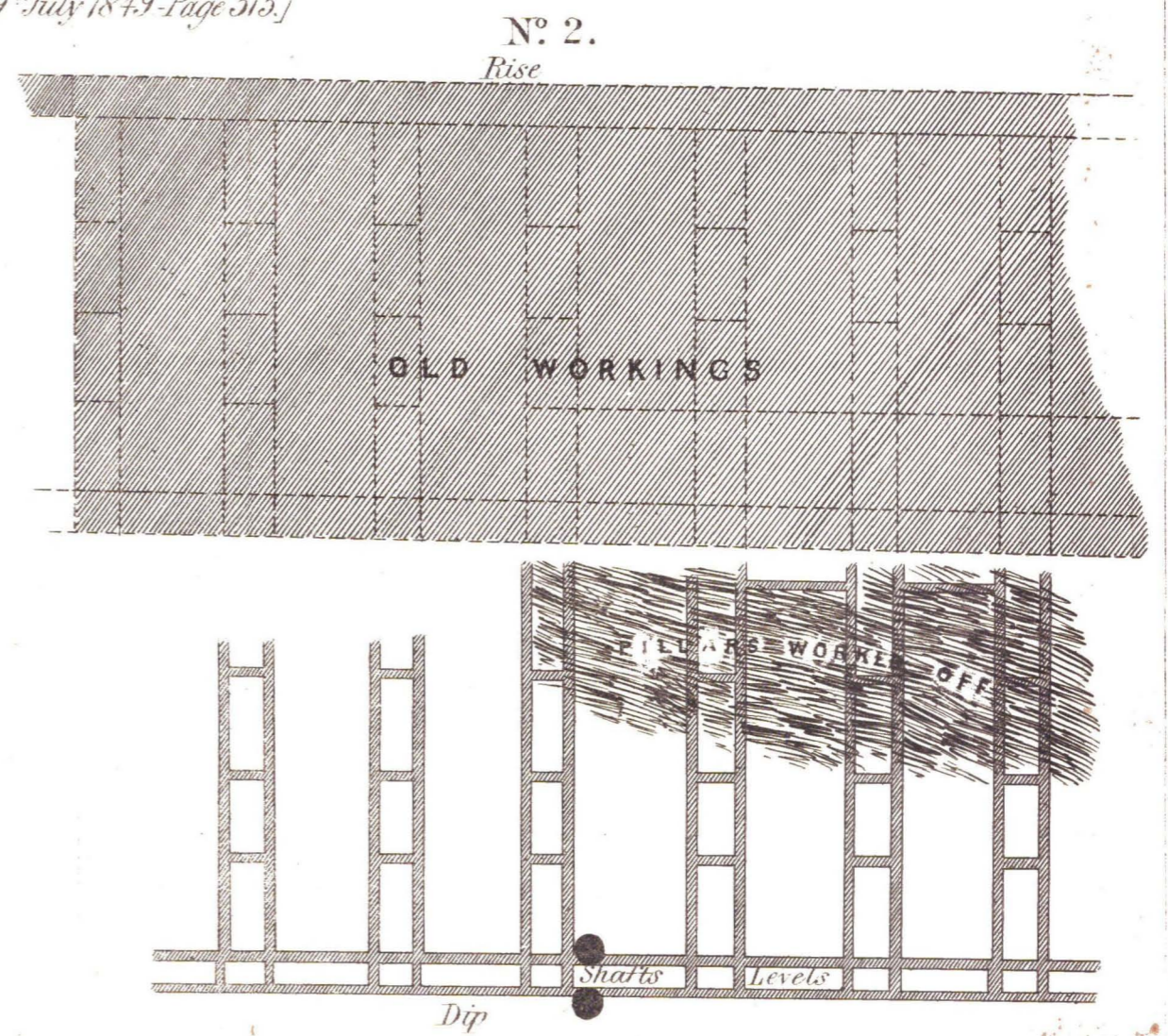

N^o 2. The method practised in Lancashire & Yorkshire; the openings being in general, 4 or 5 feet wide, and the pillars according to circumstances.

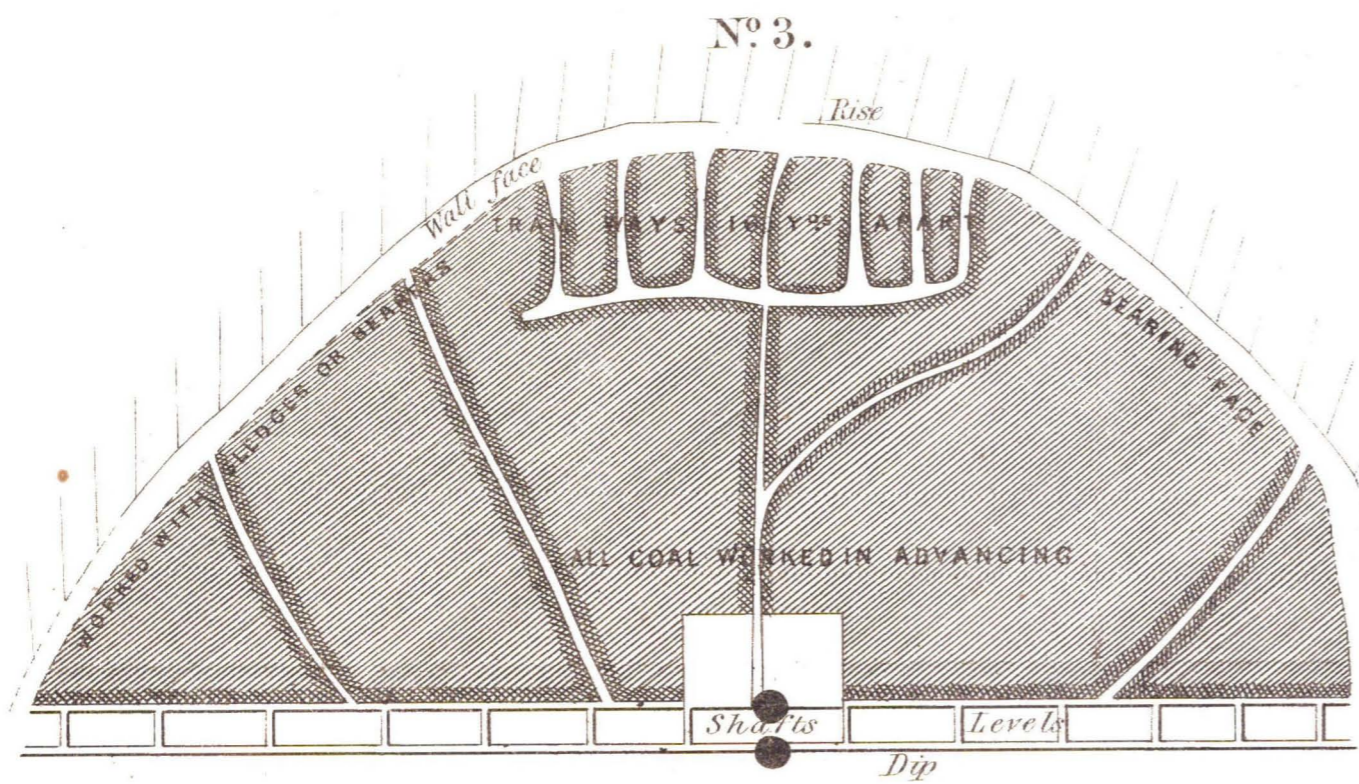

N^o 3. The long-wall system pursued in the Lethians and elsewhere. When the Bearing system prevailed, the roads were maintained at the distance of 60 or 80 yards distant from each other; but now, whilst Tramways are used, a road is provided at every 16 yards, the keeping of which under the pressure of the broken roof, is attended with great difficulty and expense, as well as the Carrying of the Air, the Graves becoming filled with either Choke-damp or Fire-damp which often renders the workings untenable for days and weeks.

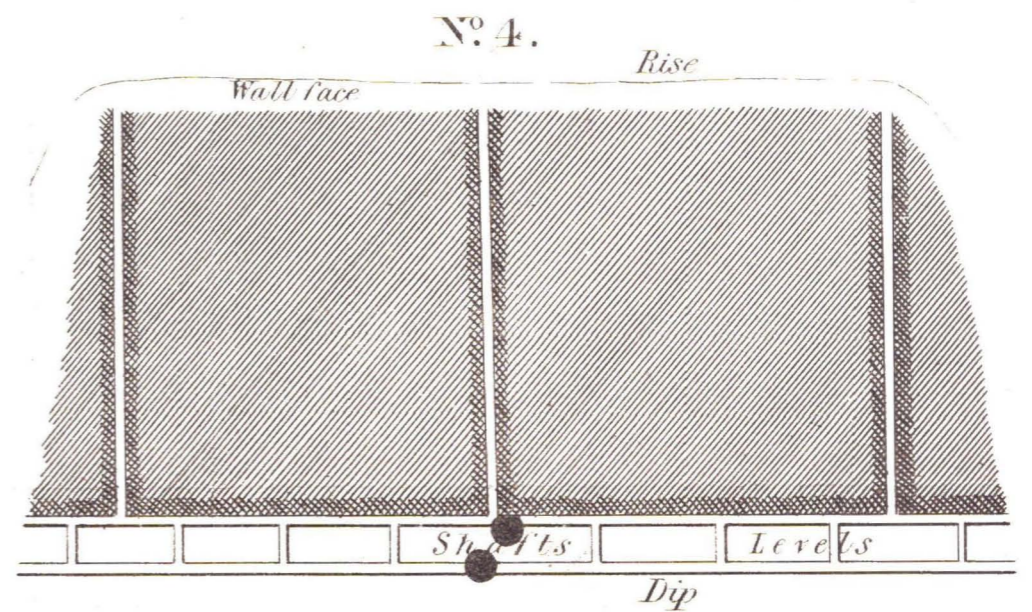

N^o 4. Leicestershire & Derbyshire method, where small penies are employed to bring the coals upon sledges along the wall face, and where they are often loaded into wheel Carriages & so conveyed to the shaft.

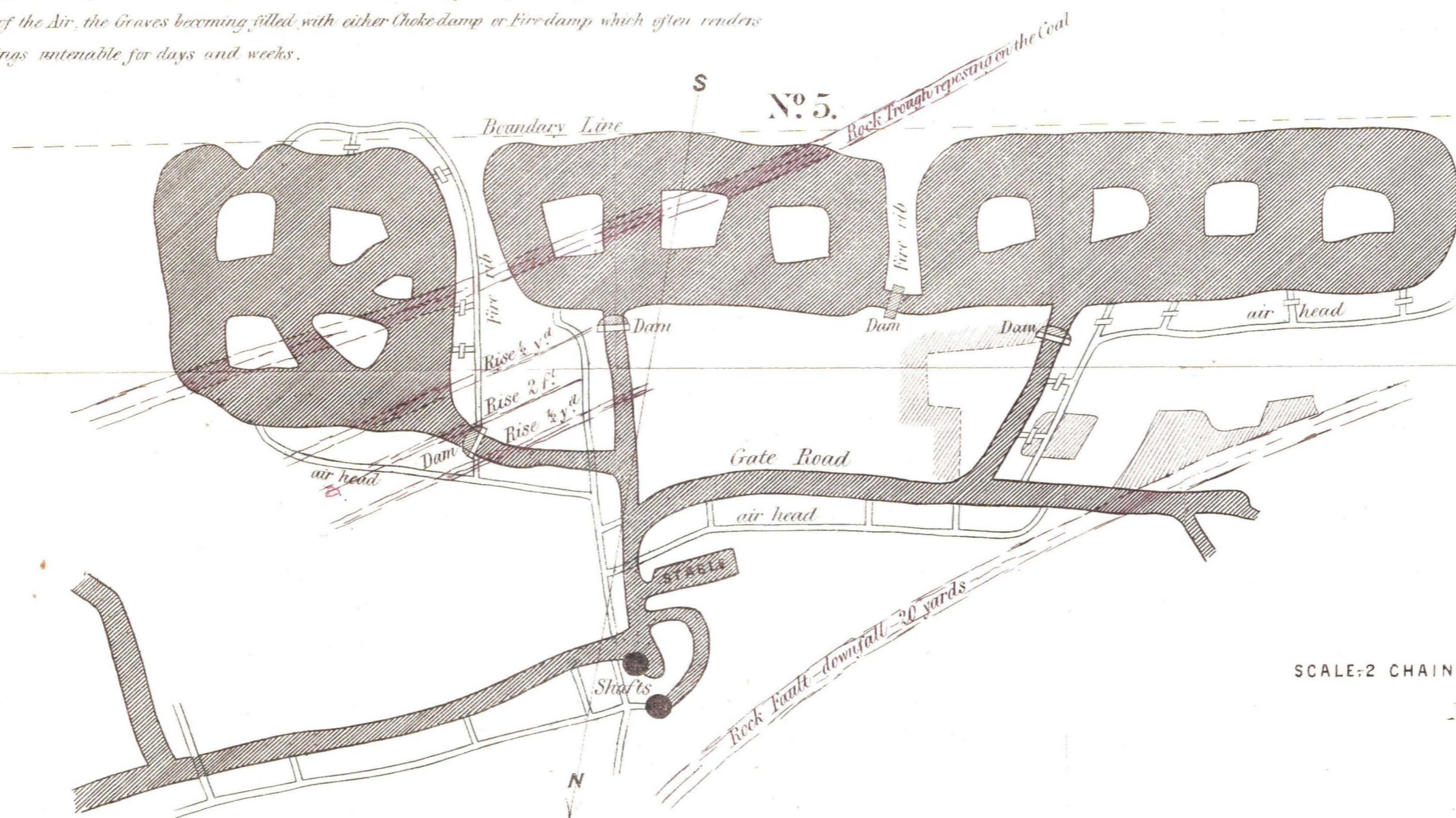

SCALE: 2 CHAINS TO AN INCH.

M Dunn. July, 1849.

N^o 5. Method of working the 30 feet seam in Staffordshire & Worcestershire. The Gate roads being driven along the bottom of the mine, and the Air-heads 5 or 6 feet area, carried upon a level with the top of Gate-road & so communicating the air into the various workings. These Air-heads are secured by dams, so as to carry forward the air as the workings progress; but in general they are utterly disproportioned to the immense excavations which they are designed to ventilate, and the bringing back the adulterated air along the Gate-roads is attended with great danger & inconvenience.

Owing to the immense deposit of small Coal & rubbish in these working places, they invariably take fire, and are then dammed off, and a fire rib of 12 or 15 yards in thickness is left between each set of workings for protection against the increasing Gases. The leakage of these dams is productive of great danger, as well as the enormous height of steam, which baffles ventilation & renders the use of timber next to impossible.

DIAGRAM OF 115 EXPLOSIONS;

Shewing the Numbers which have occurred
in the respective Months of the Year.

[Referred to in the Evidence of Thomas John Taylor, Esq. — of 20th July, 1849. Page 572.]



(N^o 1.)
DIAGRAM OF
STEAM JETS OUT OF THE SHAFT.

PLAN, N^o XXX.

[Referred to in the Evidence of Goldsworthy Gurney, Esq., 23rd July 1849. Page 379.]

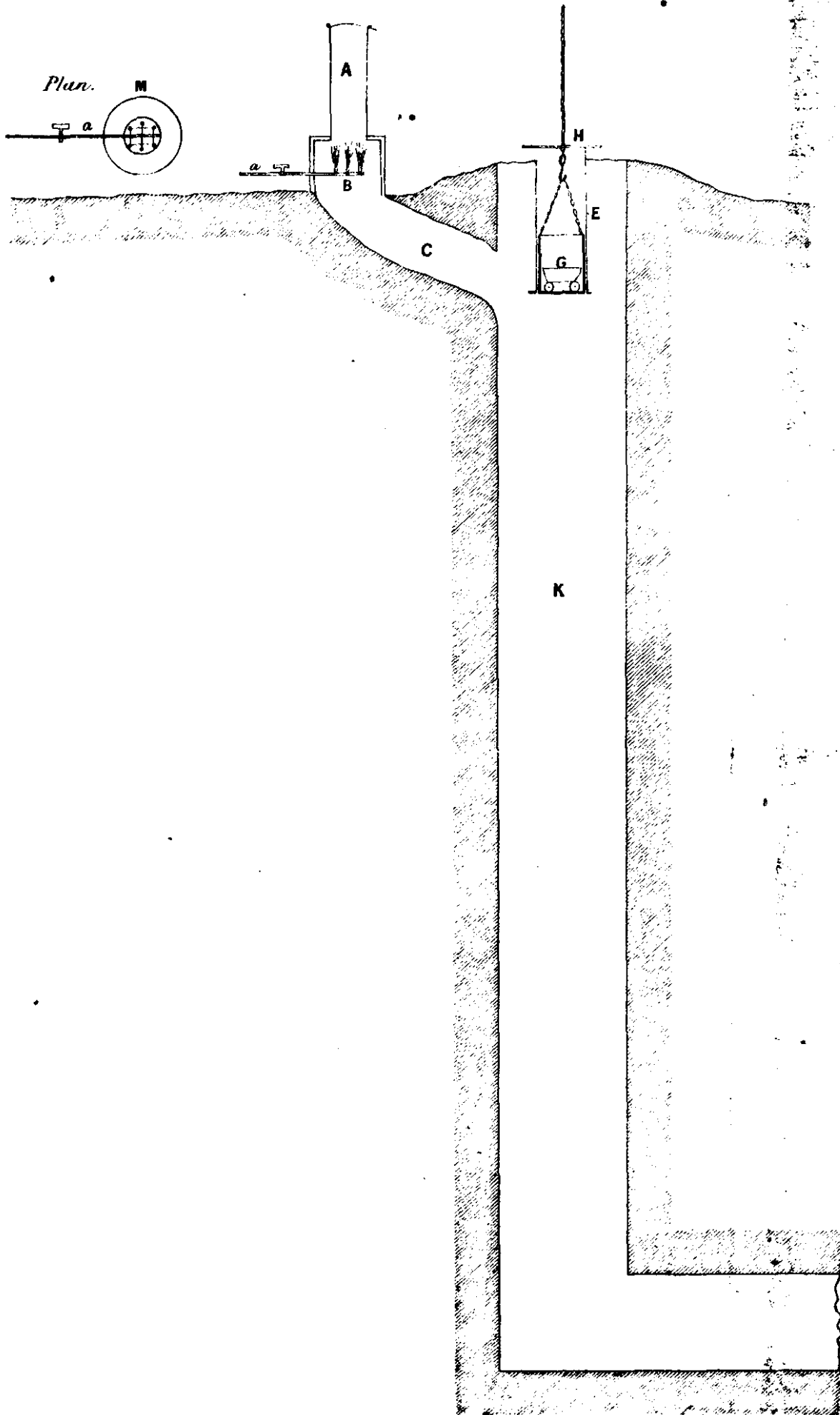

(N^o 2.)

DIAGRAM OF A

PLAN. N^o XXXI.

NATURAL BRATTICE.

[Referred to in the Evidence of Goldsworthy Gurney, Esq. 23rd July 1849. Page 581.]

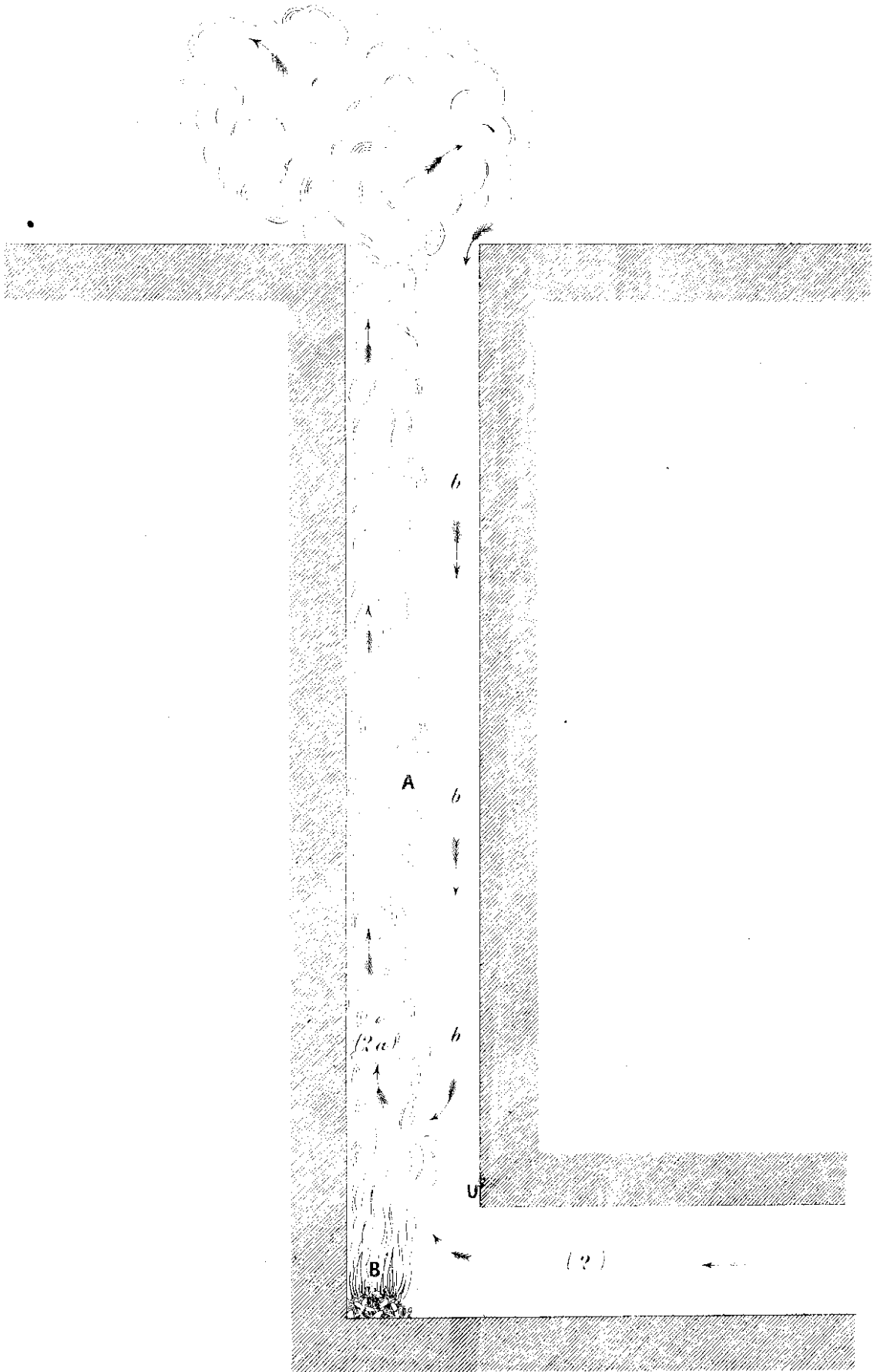

GENERAL INDEX

TO

THE PRINCIPAL MATTERS

CONTAINED IN

THE EVIDENCE

TAKEN BEFORE

THE SELECT COMMITTEE OF THE HOUSE OF LORDS,

APPOINTED TO INQUIRE INTO

**“The best Means of preventing the Occurrence of DANGEROUS ACCIDENTS in
COAL MINES.”**

Session 1849.

LIST OF WITNESSES.

| | Page |
|--|----------------|
| ANSTED, PROFESSOR DAVID THOMAS, M. A., F. R. S., - - - - - | 73. |
| ARNOTT, NEIL, Esquire, M. D., - - - - - | 86. |
| ATKINSON, JOHN, - - - - - | 516. |
| BARBER, EDMUND SCOTT, Esquire, - - - - - | 387. |
| BARKLEY, JOHN TREVOR, Esquire, - - - - - | 397. |
| BIRAM, BENJAMIN, Esquire, - - - - - | 167. |
| BRUNTON, MR. WILLIAM, - - - - - | 133. |
| CLANNY, WILLIAM REID, Esquire, M. D., - - - - - | 442. |
| COWIE, The Reverend BENJAMIN MORGAN, M. A., - - - - - | 588. |
| DARLINGTON, JAMES, Esquire, - - - - - | 93. 127. |
| DE LA BROHE, SIR HENRY THOMAS, C. B., F. R. S., - - - - - | 3. |
| DOBSON, SAMUEL, Esquire, - - - - - | 416. |
| DUNN, MATTHIAS, Esquire, - - - - - | 494. |
| ELLIOT, GEORGE, Esquire, - - - - - | 282. 328. |
| FOSTER, THOMAS EMERSON, Esquire, - - - - - | 262. |
| FOURDRINIER, MR. EDWARD NEWMAN, - - - - - | 128. |
| FOURDRINIER, MR. JOSEPH, - - - - - | 132. |
| GIBBONS, BENJAMIN, Esquire, - - - - - | 427. |
| GOTT, JOSEPH, - - - - - | 544. |
| GURNEY, GOLDSWORTHY, Esquire, - - - - - | 41, 579. |
| HANN, PROFESSOR JAMES, - - - - - | 590. |
| HUTCHINSON, JOHN, Esquire, M. D., - - - - - | 140. |
| JUDE, MARTIN, - - - - - | 528. |
| KEENE, WILLIAM, Esquire, - - - - - | 309. 366. |
| MATHER, JAMES, Esquire, - - - - - | 333. |
| NADIN, JOSEPH, Esquire, - - - - - | 321. |
| PEACE, WILLIAM, Esquire, - - - - - | 467. |
| PLAYFAIR, DR. LYON, - - - - - | 62. |
| RICHARDSON, JOSHUA, Esquire, - - - - - | 355. |
| ROBERTS, JOSEPH, Esquire, - - - - - | 575. |
| SMYTH, WARINGTON WILKINSON, Esquire, - - - - - | 227. |
| STRUVE, WILLIAM PRICE, Esquire, - - - - - | 245. 281. |
| SWALLOW, MR. DAVID, - - - - - | 451. 483. |
| TAYLOR, THOMAS JOHN, Esquire, - - - - - | 551. |
| TREMENEERE, SBYMOUR, Esquire, - - - - - | 24. 73. |
| VIVIAN, HENRY HUSSEY, Esquire, - - - - - | 115. 164. 411. |
| WHIELDON, GEORGE, Esquire, - - - - - | 107. |
| WOOD, NICHOLAS, Esquire, - - - - - | 186. |
| WOODHOUSE, JOHN THOMAS, Esquire, - - - - - | 369. |

GENERAL INDEX.

A.

General Heads.

Name of Witness and Number of Question.

ACCIDENTS, their causes:

1. Chemical; viz. explosion and suffocation,

| | | |
|--------------|---|-------------|
| De la Beche, | - | 7. 11. |
| Tremenheere, | - | 198. |
| Playfair, | - | 539. |
| Ansted, | - | 635. |
| Darlington, | - | 892. |
| Whieldon, | - | 981. |
| Vivian, | - | 1083. 1137. |
| Hutchinson, | - | 1419. 1621. |
| Biram, | - | 1575. 1626. |
| | - | 1760. |
| Wood, | - | 1915. 2048. |
| | - | 2157. |
| Smyth, | - | 2206. 2289. |
| | - | 2346. |
| Struvé, | - | 2468. |
| Forster, | - | 2763. 2822. |
| Elliot, | - | 3063. |
| Nadin, | - | 3356. 3455. |
| Mather, | - | 3708. |
| Richardson, | - | 3726. |
| Woodhouse, | - | 3860. 3985. |
| | - | 4035. |
| Barber, | - | 4130. 4173. |
| Barkley, | - | 4262. 4314. |
| Dobson, | - | 4376. |
| Gibbons, | - | 4501. |
| Clanny, | - | 4727. |
| Swallow, | - | 4743. 5198. |
| Peace, | - | 4932. |
| Dunn, | - | 5242. |
| Atkinson, | - | 5459. |
| Jude, | - | 5686. |
| Taylor, | - | 5996. 6223. |
| Roberts, | - | 6260. |
| De la Beche, | - | 77. 128. |
| Tremenheere, | - | 198. |
| Ansted, | - | 710. |
| Darlington, | - | 969. |
| Hutchinson, | - | 1419. |
| Biram, | - | 1752. |
| Wood, | - | 2065. 2090. |
| | - | 2174. 2300. |
| Smyth, | - | 2348. |
| Struvé, | - | 2483. 2487. |
| Forster, | - | 2778. 2802. |
| Elliot, | - | 3098. 3150. |
| Nadin, | - | 3406. 3436. |
| | - | 3729. 3829. |
| Richardson, | - | 3841. |
| Woodhouse, | - | 3860. 3948. |
| Barber, | - | 4203. 4223. |
| Gibbons, | - | 4632. |
| Swallow, | - | 4851. 5141. |
| | - | 5177. |
| Dunn, | - | 5224. 5362. |
| | - | 5372. |
| Jude, | - | 5772. |
| Taylor, | - | 6194. 6213. |
| Roberts, | - | 6278. |

2. Physical; viz. falling in of Roofs, &c.,

See EXPLOSION.

| General Heads. | Name of Witness and Number of Question. |
|--|---|
| | De la Beche, - 14. 24. |
| | Ansted, - - 753. |
| | Hutchinson, - 1419. |
| | Biram, - - 1763. |
| | Wood, - - 1922. 2021. |
| | Forster, - - 2763. |
| ACCIDENTS, from explosion, unavoidable, - - - | Keene, - - 3311. |
| | Mather, - - 3709. |
| | Woodhouse, - 3985. |
| | Dobson, - - 4376. |
| | Gibbons, - - 4501. |
| | Clanny, - - 4727. |
| | Swallow, - - 4777. |
| | Taylor, - - 6041. 6219, |
| | De la Beche, - 14. 90. |
| | Ansted, - - 650. |
| | Brunton, - - 1392. |
| | Hutchinson, - { 1424. 1439. |
| | - { 1523. |
| | Wood, - - 1915. 2013. |
| | Smyth, - - 2346. |
| | Struvé, - - 2468. |
| | Forster, - - 2550. 2803. |
| from other causes, avoidable, - - - | Elliot, - - 3065. 3099. |
| | Woodhouse, - 3988. |
| | Barkley, - - 4274. |
| | Dobson, - - 4378. |
| | Swallow, - - { 4779. 5184. |
| | - { 5194. |
| | Atkinson, - - 5534. 5599. |
| | Jude, - - { 5676. 5708. |
| | - { 5796. |
| | Taylor, - - 6041. 6168. |
| by negligence, whether punishable or not, doubtful, { | Wood, - - 2029. |
| | Swallow, - - 5144. |
| | Wood, - - 2039. |
| their increase, - - - - - | Mather, - - 3700. |
| | Peace, - - 5081. |
| | Jude, - - 5697. |
| | Taylor, - - 6006. |
| proportion of, in the North, to other districts, - - | Mather, - - 3726. |
| deficient information of, - - - - - | De la Beche, - 108. |
| | Struvé, - - 2486. |
| | Swallow, - - 5119. |
| cases of, showing the necessity of Government in- spection, - - - - - | Dunn, - - 5224. 5256. |
| list of, for three years, taken from Mining Journal, | Dunn, - - 5354. |
| | De la Beche, - 11. |
| | Hutchinson, - 1421. 1521. |
| | Biram, - - 1760. |
| | Wood, - - 1921. |
| | Smyth, - - 2346. |
| | Struvé, - - 2468. |
| AFTER-DAMP AND EXPLOSIONS, proportion of deaths from, - | Forster, - - 2822. |
| | Elliot, - - 3063. |
| | Barber, - - 4173. |
| | Barkley, - - 4314. |
| | Swallow, - - 5198. |
| | Taylor, - - 6223. |
| | Hutchinson, - 1521. |
| deadly poison, - - - - - | Wood, - - 1921. |
| | Clanny, - - 4695. |
| precautions in same, - - - - - | Hutchinson, - 1521. |
| time of its effect on life, - - - - - | Hutchinson, - 1526. |
| chemical means for counteracting its effects suggested, { | Hutchinson, - 1521. |
| | Barkley, - - 4316. |
| | De la Beche, - 45. |
| | Playfair, - - 552. |
| | Ansted, - - 749. |
| AIR, proportion of, for prevention of explosion, - - - | Arnott, - - 774. |
| | Wood, - - 1841. |
| | Mather, - - 3529. |
| | Clanny, - - 4690. |
| for removal of gas, - - - - - | De la Beche, - 49. |
| | Wood, - - 1841. |
| | Mather, - - 3529. |

| General Heads. | Name of Witness and Number of Question. | | | | | | | | | | | | | | | | | | | | | | | | | | |
|--|---|----------------|-------|--------------|-------------|-------------|-------|-----------|-----------|-----------|-------------|------------|-------------|-----------|------------------------|------------|-------------|----------------|-------|-----------|-------|-----------|-------|---------------|-------|---------|-------------|
| AIR, at what velocity inconvenient for workmen, - - - | <table border="0" style="margin-left: 20px;"> <tr><td>Tremenheere, -</td><td>314.</td></tr> <tr><td>Gurney, -</td><td>409. 444.</td></tr> <tr><td>Playfair, -</td><td>560.</td></tr> <tr><td>Ansted, -</td><td>680.</td></tr> <tr><td>Vivian, -</td><td>1128.</td></tr> <tr><td>Wood, -</td><td>1851. 1952.</td></tr> <tr><td>Struvé, -</td><td>2476.</td></tr> <tr><td>Forster, -</td><td>2578.</td></tr> <tr><td>De la Beche, -</td><td>20.</td></tr> <tr><td>Ansted, -</td><td>668.</td></tr> <tr><td>Vivian, -</td><td>1228.</td></tr> <tr><td>Hutchinson, -</td><td>1446.</td></tr> <tr><td>Wood, -</td><td>1838. 2054.</td></tr> </table> | Tremenheere, - | 314. | Gurney, - | 409. 444. | Playfair, - | 560. | Ansted, - | 680. | Vivian, - | 1128. | Wood, - | 1851. 1952. | Struvé, - | 2476. | Forster, - | 2578. | De la Beche, - | 20. | Ansted, - | 668. | Vivian, - | 1228. | Hutchinson, - | 1446. | Wood, - | 1838. 2054. |
| Tremenheere, - | 314. | | | | | | | | | | | | | | | | | | | | | | | | | | |
| Gurney, - | 409. 444. | | | | | | | | | | | | | | | | | | | | | | | | | | |
| Playfair, - | 560. | | | | | | | | | | | | | | | | | | | | | | | | | | |
| Ansted, - | 680. | | | | | | | | | | | | | | | | | | | | | | | | | | |
| Vivian, - | 1128. | | | | | | | | | | | | | | | | | | | | | | | | | | |
| Wood, - | 1851. 1952. | | | | | | | | | | | | | | | | | | | | | | | | | | |
| Struvé, - | 2476. | | | | | | | | | | | | | | | | | | | | | | | | | | |
| Forster, - | 2578. | | | | | | | | | | | | | | | | | | | | | | | | | | |
| De la Beche, - | 20. | | | | | | | | | | | | | | | | | | | | | | | | | | |
| Ansted, - | 668. | | | | | | | | | | | | | | | | | | | | | | | | | | |
| Vivian, - | 1228. | | | | | | | | | | | | | | | | | | | | | | | | | | |
| Hutchinson, - | 1446. | | | | | | | | | | | | | | | | | | | | | | | | | | |
| Wood, - | 1838. 2054. | | | | | | | | | | | | | | | | | | | | | | | | | | |
| method of splitting, explained, - - - | <table border="0" style="margin-left: 20px;"> <tr><td>Smyth, -</td><td>2174.</td></tr> <tr><td>Woodhouse, -</td><td>3999.</td></tr> <tr><td>Dobson, -</td><td>4898.</td></tr> <tr><td>Dunn, -</td><td>5313.</td></tr> <tr><td>Gott, -</td><td>5908.</td></tr> <tr><td>Taylor, -</td><td>6010.</td></tr> </table> | Smyth, - | 2174. | Woodhouse, - | 3999. | Dobson, - | 4898. | Dunn, - | 5313. | Gott, - | 5908. | Taylor, - | 6010. | | | | | | | | | | | | | | |
| Smyth, - | 2174. | | | | | | | | | | | | | | | | | | | | | | | | | | |
| Woodhouse, - | 3999. | | | | | | | | | | | | | | | | | | | | | | | | | | |
| Dobson, - | 4898. | | | | | | | | | | | | | | | | | | | | | | | | | | |
| Dunn, - | 5313. | | | | | | | | | | | | | | | | | | | | | | | | | | |
| Gott, - | 5908. | | | | | | | | | | | | | | | | | | | | | | | | | | |
| Taylor, - | 6010. | | | | | | | | | | | | | | | | | | | | | | | | | | |
| mode of measuring its velocity, - - - | <table border="0" style="margin-left: 20px;"> <tr><td>Ansted, -</td><td>667.</td></tr> <tr><td>Arnott, -</td><td>777. 829.</td></tr> <tr><td>Vivian, -</td><td>1221.</td></tr> <tr><td>Wood, -</td><td>1822.</td></tr> <tr><td>Smyth, -</td><td>2228.</td></tr> <tr><td>Forster, -</td><td>2596.</td></tr> <tr><td>Mather, -</td><td>3533.</td></tr> <tr><td>Barber, -</td><td>4193.</td></tr> </table> | Ansted, - | 667. | Arnott, - | 777. 829. | Vivian, - | 1221. | Wood, - | 1822. | Smyth, - | 2228. | Forster, - | 2596. | Mather, - | 3533. | Barber, - | 4193. | | | | | | | | | | |
| Ansted, - | 667. | | | | | | | | | | | | | | | | | | | | | | | | | | |
| Arnott, - | 777. 829. | | | | | | | | | | | | | | | | | | | | | | | | | | |
| Vivian, - | 1221. | | | | | | | | | | | | | | | | | | | | | | | | | | |
| Wood, - | 1822. | | | | | | | | | | | | | | | | | | | | | | | | | | |
| Smyth, - | 2228. | | | | | | | | | | | | | | | | | | | | | | | | | | |
| Forster, - | 2596. | | | | | | | | | | | | | | | | | | | | | | | | | | |
| Mather, - | 3533. | | | | | | | | | | | | | | | | | | | | | | | | | | |
| Barber, - | 4193. | | | | | | | | | | | | | | | | | | | | | | | | | | |
| current of, in wastes or goaves, - - - | Ansted, - 741. | | | | | | | | | | | | | | | | | | | | | | | | | | |
| volume of, necessary for miners' respiration, - - - | Hutchinson, - 1513. | | | | | | | | | | | | | | | | | | | | | | | | | | |
| cubic feet obtained by furnace (Hetton Colliery), - - - | Wood, - { 1819. 1838. 1949. 1982. | | | | | | | | | | | | | | | | | | | | | | | | | | |
| its natural velocity, - - - | Smyth, - 2239. | | | | | | | | | | | | | | | | | | | | | | | | | | |
| distribution and subdivision of, - - - | <table border="0" style="margin-left: 20px;"> <tr><td>Smyth, -</td><td>2291.</td></tr> <tr><td>Elliot, -</td><td>2834.</td></tr> <tr><td>Barkley, -</td><td>4274.</td></tr> <tr><td>Dobson, -</td><td>4378.</td></tr> <tr><td>Jude, -</td><td>5666. 5711.</td></tr> </table> | Smyth, - | 2291. | Elliot, - | 2834. | Barkley, - | 4274. | Dobson, - | 4378. | Jude, - | 5666. 5711. | | | | | | | | | | | | | | | | |
| Smyth, - | 2291. | | | | | | | | | | | | | | | | | | | | | | | | | | |
| Elliot, - | 2834. | | | | | | | | | | | | | | | | | | | | | | | | | | |
| Barkley, - | 4274. | | | | | | | | | | | | | | | | | | | | | | | | | | |
| Dobson, - | 4378. | | | | | | | | | | | | | | | | | | | | | | | | | | |
| Jude, - | 5666. 5711. | | | | | | | | | | | | | | | | | | | | | | | | | | |
| relative to area of shaft, - - - | <table border="0" style="margin-left: 20px;"> <tr><td>Smyth, -</td><td>2295.</td></tr> <tr><td>Mather, -</td><td>3545.</td></tr> <tr><td>Gurney, -</td><td>6311.</td></tr> </table> | Smyth, - | 2295. | Mather, - | 3545. | Gurney, - | 6311. | | | | | | | | | | | | | | | | | | | | |
| Smyth, - | 2295. | | | | | | | | | | | | | | | | | | | | | | | | | | |
| Mather, - | 3545. | | | | | | | | | | | | | | | | | | | | | | | | | | |
| Gurney, - | 6311. | | | | | | | | | | | | | | | | | | | | | | | | | | |
| cubic feet of, in Belmont Colliery, by furnace, steam-jet and steam-engine respectively, - - - | Elliot, - 2904. | | | | | | | | | | | | | | | | | | | | | | | | | | |
| how far impeded by friction, - - - | <table border="0" style="margin-left: 20px;"> <tr><td>De la Beche, -</td><td>39.</td></tr> <tr><td>Playfair, -</td><td>568.</td></tr> <tr><td>Ansted, -</td><td>677.</td></tr> <tr><td>Arnott, -</td><td>811. 817.</td></tr> <tr><td>Vivian, -</td><td>1560.</td></tr> <tr><td>Biram, -</td><td>1802.</td></tr> <tr><td>Wood, -</td><td>{ 1838. 1849. 1939.</td></tr> <tr><td>Smyth, -</td><td>2174. 2228.</td></tr> <tr><td>Elliot, -</td><td>3028.</td></tr> <tr><td>Mather, -</td><td>3539.</td></tr> </table> | De la Beche, - | 39. | Playfair, - | 568. | Ansted, - | 677. | Arnott, - | 811. 817. | Vivian, - | 1560. | Biram, - | 1802. | Wood, - | { 1838. 1849. 1939. | Smyth, - | 2174. 2228. | Elliot, - | 3028. | Mather, - | 3539. | | | | | | |
| De la Beche, - | 39. | | | | | | | | | | | | | | | | | | | | | | | | | | |
| Playfair, - | 568. | | | | | | | | | | | | | | | | | | | | | | | | | | |
| Ansted, - | 677. | | | | | | | | | | | | | | | | | | | | | | | | | | |
| Arnott, - | 811. 817. | | | | | | | | | | | | | | | | | | | | | | | | | | |
| Vivian, - | 1560. | | | | | | | | | | | | | | | | | | | | | | | | | | |
| Biram, - | 1802. | | | | | | | | | | | | | | | | | | | | | | | | | | |
| Wood, - | { 1838. 1849. 1939. | | | | | | | | | | | | | | | | | | | | | | | | | | |
| Smyth, - | 2174. 2228. | | | | | | | | | | | | | | | | | | | | | | | | | | |
| Elliot, - | 3028. | | | | | | | | | | | | | | | | | | | | | | | | | | |
| Mather, - | 3539. | | | | | | | | | | | | | | | | | | | | | | | | | | |
| AIR PUMP, Consumption Hospital, - - - | Arnott, - 778. | | | | | | | | | | | | | | | | | | | | | | | | | | |
| Marine Barracks, - - - | Arnott, - 788. | | | | | | | | | | | | | | | | | | | | | | | | | | |
| its applicability to Mines, - - - | Arnott, - 796. | | | | | | | | | | | | | | | | | | | | | | | | | | |
| its unlimited power, - - - | Arnott, - 802. | | | | | | | | | | | | | | | | | | | | | | | | | | |
| compared with other contrivances for ventilation, - - - | Arnott, - 818. | | | | | | | | | | | | | | | | | | | | | | | | | | |
| experiments with, compared with the fan and pneumatic screw, - - - | Smyth, - 2266. | | | | | | | | | | | | | | | | | | | | | | | | | | |
| AIR BAGS, suggested as security in after-damp, - - - | Hutchinson, - 1525. | | | | | | | | | | | | | | | | | | | | | | | | | | |
| AIR CROSSINGS, how made, - - - | Hutchinson, - 1434. | | | | | | | | | | | | | | | | | | | | | | | | | | |
| AIR COURSES, increased size of, desirable, - - - | <table border="0" style="margin-left: 20px;"> <tr><td>Forster, -</td><td>2797.</td></tr> <tr><td>Elliot, -</td><td>3019. 3033.</td></tr> </table> | Forster, - | 2797. | Elliot, - | 3019. 3033. | | | | | | | | | | | | | | | | | | | | | | |
| Forster, - | 2797. | | | | | | | | | | | | | | | | | | | | | | | | | | |
| Elliot, - | 3019. 3033. | | | | | | | | | | | | | | | | | | | | | | | | | | |
| Mr. Stephenson's opinion on, - - - | Mather, - 3613. 3641. | | | | | | | | | | | | | | | | | | | | | | | | | | |
| ANEROID BAROMETER, showing locomotive pressure, - - - | <table border="0" style="margin-left: 20px;"> <tr><td>Gurney, -</td><td>496.</td></tr> <tr><td>Biram, -</td><td>1644.</td></tr> </table> | Gurney, - | 496. | Biram, - | 1644. | | | | | | | | | | | | | | | | | | | | | | |
| Gurney, - | 496. | | | | | | | | | | | | | | | | | | | | | | | | | | |
| Biram, - | 1644. | | | | | | | | | | | | | | | | | | | | | | | | | | |
| ANEMOMETER, index of state of ventilation, - - - | <table border="0" style="margin-left: 20px;"> <tr><td>Gurney, -</td><td>501.</td></tr> <tr><td>Arnott, -</td><td>812.</td></tr> <tr><td>Wood, -</td><td>2013.</td></tr> </table> | Gurney, - | 501. | Arnott, - | 812. | Wood, - | 2013. | | | | | | | | | | | | | | | | | | | | |
| Gurney, - | 501. | | | | | | | | | | | | | | | | | | | | | | | | | | |
| Arnott, - | 812. | | | | | | | | | | | | | | | | | | | | | | | | | | |
| Wood, - | 2013. | | | | | | | | | | | | | | | | | | | | | | | | | | |
| of Mr. Biram - - - | Biram, - 1720. | | | | | | | | | | | | | | | | | | | | | | | | | | |

| General Heads. | Name of Witness and Number of Questions. |
|--|---|
| ANEMOMETER, its accuracy in measuring velocity of air, | { Biram, - - 1727. Wood, - - 1822. Smyth, - - 2284. Struvé, - - 2402. Woodhouse, - - 3960. Gibbons, - - 4545. Wood, - - 2018. |
| —— simple form of, adopted in the northern collieries, | - - - - - |
| ANSTED, Professor DAVID THOMAS, M.A., F.R.S., Evidence of, | - - - - - 620. |
| ARNOTT, NEIL, Esquire, M.D., Evidence of, | - - - - - 770. |
| ARDSLEY MAIN COLLIERY, cause of explosion in, | { Wood, - - 2211. Woodhouse, - - 3875. |
| ASTLEY COLLIERY, description of the mode employed by Mr. Gurney for extinguishing the fire in, | { De la Beche, - - 181. Gurney, - - 364. 455. Darlington, - - 837. Darlington, - - 892. |
| —— origin of the second fire in, | - - - - - |
| ATKINSON, JOHN, miner, Evidence of, | - - - - - 5452. |
| ATMOSPHERE, barometric, effect of, on the discharge of gas, | { De la Beche, - - 49. 77. Playfair, - - 581. Ansted, - - 692. Whieldon, - - 991. Brunton, - - 1401. Hutchinson, - - { 1450. 1471. 1486. Biram, - - 1626. 1637. Smyth, - - 2217. Mather, - - 3635. Woodhouse, - - 3955. Barber, - - 4163. Swallow, - - 4791. Jude, - - 5724. Gurney, - - 6311. Smyth, - - 2221. Taylor, - - 6035. |
| —— its effect on furnace ventilation in shallow mines, | - - - - - |
| B. | |
| BARBER, EDMUND SCOTT, Esquire, Civil Engineer, evidence of, | - - - - - 4116. |
| BARKLEY, JOHN TREVOR, Esquire, Mining Engineer, evidence of, | - - - - - 4241. |
| BARNESLEY COLLIERY, cause of last explosion in, | De la Beche, - - 76. |
| BAROMETER, relation of, to discharge of gas, | { De la Beche, - - 49. Ansted, - - 692. Whieldon, - - 992. Brunton, - - 1401. Hutchinson, - - 1450. 1474. Biram, - - 1617. 1636. Wood, - - 2012. Smyth, - - 2186. 2219. Nadin, - - 3398. Woodhouse, - - 3956. 3979. Barber, - - 4164. Barkley, - - 4260. Jude, - - 5727. Taylor, - - 6027. Woodhouse, - - 3967. |
| —— simple contrivance of, in Moira Colliery, | - - - - - |
| BELGIUM, tenure of mining property in, | Tremenheere, - - 267. |
| —— statistical statement of accidents in, and cause of the diminution of explosions, | Tremenheere, - - 291. |
| —— various mechanical means employed in, for ventilation, | Smyth, - - 2263. |
| —— ventilation and mode of working, compared with our own, | Dunn, - - 5397. 5426. |
| —— explosions in mines frequent, | Dunn, - - 5415. |
| BELMONT COLLIERY, result of experiments in, of relative merits of steam-jet and furnace, | Wood, - - 1882. Elliot, - - 2901. |
| —— cubic feet of air in, by furnace steam-jet and steam-engine, respectively, | Elliot, - - { 2852. 2986. 8005. |

| General Heads. | Name of Witness and Number of Questions. |
|---|--|
| BENSHAM SEAM, fiery nature of, - - - - - <i>See</i> JARROW COLLIERY. | { Hutchinson, - 1429. Wood, - 2021. Forster - 2641. |
| BIRAM, BENJAMIN, Esquire, Evidence of, - - - - - | - - - - - 1570. |
| BLOWEE, definition of, - - - - - | Ansted, - 636. |
| ----- extreme danger of, - - - - - | { De la Beche, - 24. Ansted, - 637. 755. Peace, - 5081. Taylor, - 6222. |
| ----- Gas issuing from, not easily ascertainable, - - - - - | Ansted, - 763. |
| ----- when most dangerous, - - - - - | Jude, - 5731. |
| Boys, at what age allowed to work in Mines, - - - - - | Atkinson, - 5635. |
| BRATTICES, their use and construction, - - - - - | { De la Beche, - 21. Playfair, - 542. Hutchinson, - 1416. Mather, - 3007. Jude, - 5739. |
| ----- incapable of resisting explosion. <i>See</i> EXPLOSION. | { Ansted, - 649. Hutchinson, - 1424. Wood, - 1924. |
| BRUNTON, MR. WILLIAM, Civil Engineer, Evidence of, - - - - - | - - - - - 1847. |
| ----- his Ventilating Apparatus described, - - - - - | { Brunton, - 1351. 1367. Dobson, - 4410. |
| ----- rarefaction produced by, - - - - - | { Brunton, - 1363. 1407. Barber, - 4145. Dobson, - 4410. |
| ----- expense of, - - - - - | { Brunton, - 1372. Barber, - 4185. 4201. Dobson, - 4424. |
| ----- velocity of current produced by, - - - - - | { Brunton, - 1400. Barber, - 4189. Dobson, - 4414. |
| ----- rarefaction produced by, compared with Furnace, &c. | { Brunton, - 1402. Barber, - 4193. Dobson, - 4427. |
| BUTTY SYSTEM. <i>See</i> STAFFORDSHIRE MINES. | |
| C. | |
| CANDLE, not a test of poisonous atmosphere, - - - - - | Hutchinson, - 1539. |
| ----- where safe, preferable to Davy Lamp, - - - - - | { Wood, - 2039. Barber, - 4155. Swallow, - 4765. |
| CARBURETTED HYDROGEN GAS. <i>See</i> GAS. | |
| CARBONIC ACID GAS. <i>See</i> GAS. | |
| CHESHIRE MINES, cases of accidents in, and their causes, - - - - - | Dunn, - 5231. 5283. |
| CHIMNEYS in FACTORIES superseded by use of the steam-jet, | Mather, - 3631. 3716. |
| CHOKE-DAMP. <i>See</i> SUFFOCATION. GAS. | |
| CLANNY, WILLIAM REID, Esquire, M.D., Evidence of, - - - - - | - - - - - 4654. |
| CLANNY LAMP, its advantages over the Davy, - - - - - | { Elliot, - 3046. Mather, - 3673. Gibbons, - 4621. |
| ----- why preferred by miners, - - - - - | { Clanny, - 4664. 4698. Jude, - 4713. Jude, - 5897. |
| ----- increased safety of, when fractured, - - - - - | { Mather, - 3683. Clanny, - 3683. Taylor, - 4675. |
| ----- its appearance in presence of explosive gas, - - - - - | Clanny, - 6000. |
| ----- its light and cost compared with the Davy, - - - - - | Clanny, - 4696. |
| ----- description of, - - - - - | Clanny, - 4698. Clanny, - 4733. |
| COAL, Nature of, in— | |
| Dean Forest, - - - - - | Roberts, - 6256. |
| Lancashire, - - - - - | Forster, - 2695. |
| Newcastle District, - - - - - | { Gurney, - 388. Ansted, - 765. Wood, - 2021. Richardson, - 3730. Atkinson, - 5487. Jude, - 5684. |
| Shropshire, - - - - - | Smyth, - 2318. |

General Heads.

Name of Witness and Number of Question.

COAL—continued.

| | |
|--|--|
| Staffordshire, - - - - - | { Ansted, - - 718. Smyth, - - 2182. Nadin, - - 3356. Gibbons, - - 4425. Vivian, - - 1090. |
| South Wales, - - - - - | { Struvé, - - 2466. Barber, - - 4120. |
| Warwickshire, - - - - - | { Whieldon, - - 981. 991. Biram, - - 1619. |
| Yorkshire, - - - - - | { Woodhouse, - - 3869. Swallow, - - 4756. |
| Scotland, - - - - - | { Dunn, - - 5297. |
| France, - - - - - | { Keene, - - 3162. 3184. |
| COAL, tons of, raised annually in England, - - - | { De la Beche, - - 40. 111. Playfair, - - 611. |
| — relative consumption of, by furnace and by steam-engines, - - - - - | { Wood, - - {1833. 1895. 1948. Elliot, - - 3006. Mather, - - 3649. Taylor, - - 6120. |
| — amount of, to be left in pillars, - - - - - | { Forster, - - 2732. Mather, - - 3522. Dobson, - - 4397. |
| COAL OWNERS, irritation amongst, in the Midland Districts, created by Mr. Duncombe's Bill, - - - | { Nadin, - - 3410. |
| COAL TRADE, property embarked in, - - - - - | { Taylor, - - 6151. |
| — great depression in, - - - - - | { Taylor, - - 6186. |
| COAL MINES, in what class of management chiefly defective, - | { De la Beche, - - 11. 40. 91. Tremenheere, - - 237. Ansted, - - 650. Darlington, - - 958. Wood, - - 2049. Smyth, - - 2172. Woodhouse, - - 3878. 4087. Peace, - - 4962. Taylor, - - 6183. |
| — mode of working in some districts unjustifiable, - | { De la Beche, - - 17. De la Beche, - - 92. Tremenheere, - - 214. Playfair, - - 524. Ansted, - - 632. Vivian, - - 1163. Forster, - - 2736. Mather, - - 3645. Richardson, - - 3726. Barkley, - - 4301. Dobson, - - 4380. Dunn, - - 5240. 5309. Atkinson, - - 5528. |
| — in what district management of, best, - - - | { De la Beche, - - 113. Playfair, - - 598. Wood, - - 2145. Richardson, - - 3808. Woodhouse, - - 4106. De la Beche, - - 6. 113. Tremenheere, - - 227. Playfair, - - 589. 604. Darlington, - - 961. Vivian, - - 1166. 1192. Hutchinson, - - 1492. Biram, - - 1730. Wood, - - 2119. 2135. Struvé, - - 2525. Forster, - - 2764. Elliot, - - 3134. Nadin, - - 3407. Mather, - - 3712. Richardson, - - 3800. Woodhouse, - - 4070. Gibbons, - - 4622. Swallow, - - 4816. 4839. Peace, - - 5066. 5097. Dunn, - - {5221. 5234. 5434. Atkinson, - - 5534. Jude, - - 5752. 5862. Taylor, - - 6153. |
| — steps taken by Government for their improvement, - | |
| — to what extent inspection of, by Government, desirable, - - - - - | |

| General Heads. | Witness and Number of Question. |
|--|---|
| COAL MINES, establishment of police in, suggested, - | - la Beche, - 95. Playfair, - 562. Gurney, - 414. Elliot, - 3093. Mather, - 3652. |
| ----- temperature of, - - - - - | Gurney, - 493. |
| ----- causes of combustion in, when hermetically sealed, in case of fire, - - - - - | Barber, - 4227. |
| ----- in case of trespass on, plaintiff debarred by statute, if after six years, - - - - - | Appendix. |
| ----- subdivision of, for ventilation purposes, illustrated, - | Jude, - 5809. 5831. |
| ----- false economy in the management of, - - - - - | |
| ----- different methods of working described; viz. | |
| 1. Long Wall, as in Yorkshire, Shropshire, Saxony, &c. | Ansted, - 709. Wood, - 2046. Smyth, - 2316. Struvé, - 2479. Forster, - 2721. Woodhouse, - 3912. Barkley, - 4287. Swallow, - 4746. Dunn, - 5441. Gott, - 5908. Smyth, - 2333. Struvé, - 2477. Forster, - 2713. Keene, - 3181. |
| 2. Post and Stall; as in the North, Belgium, &c., | Barber, - 4207. Barkley, - 4296. Peace, - 4941. Dunn, - 5445. Jude, - 5879. |
| 3. South Wales, - - - - - | Vivian, - 1113. Dobson, - 4895. |
| 4. Staffordshire, - - - - - | Playfair, - 568. Smyth, - 2304. Woodhouse, - 3946. Gibbons, - 4513. Dunn, - 5245. 5364. |
| 5. Lancashires, - - - - - | Peace, - 4941. Gott, - 5919. |
| 6. Dean Forest, - - - - - | Roberts, - 6243. |
| COAL MINES, Continental, diminution of Accidents in, owing to Government inspection - - - - - | Tremenheere, - 265. |
| ----- ownership of, explained - - - - - | Tremenheere, - 267. Vivian, - 1197. Keene, - 3201. |
| Belgium, - - - - - | Tremenheere, - 268. |
| France, - - - - - | Tremenheere, - 268. Keene, - 3201. |
| Germany, - - - - - | Tremenheere, - 268. |
| ----- mode pursued in, for securing ventilation, - | Tremenheere, - 312. |
| COLLIERS, want of education amongst, - - - - - | Hutchinson, - 1507. Smyth, - 2207. Swallow, - 6212. Atkinson, - 5617. Jude, - 5773. |
| ----- disposition amongst, to chest complaints, - | Hutchinson, - 1520. |
| ----- <i>à contra</i> - - - - - | Taylor, - 6174. Wood, - 2117. Smyth, - 2262. |
| ----- most desirous of education in some districts, - | Struvé, - 2513. Atkinson, - 5616. Taylor, - 6172. |
| ----- in England and France compared, - - - - - | Keene, - 3260. 3277. |
| COMBUSTION. See SPONTANEOUS COMBUSTION. | |
| CORNISH MINERS, opinions held by, on practical knowledge and on education - - - - - | Gurney - 503. |
| COWIE, The Reverend BENJAMIN MORGAN, Principal of the Putney College of Civil Engineers, Evidence of, - | - 6337. |

| General Heads. | Name of Witness and Number of Question. |
|--|--|
| D. | |
| DARLEY MAIN COLLIERY, accident in, accounted for, - | Biram, - - 1628. Wood, - - 1912. 2047. Smyth, - - 2211. Woodhouse, - 3877. |
| DARLINGTON, JAMES, Esquire, Evidence of, - - - - | - - - - 837. 1251. |
| Letter from, relative to Mr. Gurney's invention for extinguishing fire in Mines, - - - - | - - - - p. 58. |
| DAVY LAMP, its perfect safety, except under circumstances foreseen by its inventor, - - - - | De La Beche, - 142. Playfair, - - 580. Ansted, - - 731. 739. Hutchinson, - 1547. Wood, - - 2028. Forster, - - 2767. Barkley, - - 4331. Peace, - - 5002. Dunn, - - 5394. Atkinson, - - 5511. Taylor, - - 6042. Ansted, - - 732. Wood, - - 2032. Forster, - - 2762. Atkinson, - - 5499. Jude, - - 5775. Taylor, - - 6021. 6054. Ansted, - - 742. Clanny, - - 4694. Swallow, - - 4775. Atkinson, - - 5514. Jude, - - 5782. Taylor, - - 6048. Whieldon, - - 993. Vivian, - - 1126. Woodhouse, - 4030. Hutchinson, - 1492. Forster, - - 2755. Elliot, - - 3047. Biram, - - 1691. Swallow, - - 4787. Wood, - - 2028. Elliot, - - 3045. Mather, - - 3672. Barkley, - - 4335. Clanny, - - 4709. Peace, - - 4998. Jude, - - 5849. Elliot, - - 3045. Mather, - - 3683. Wood, - - 2030. Jude, - - 5777. Taylor, - - 6052. |
| its use in the Newcastle district essential, - | - - - - |
| its appearance in presence of foul air, - - - - | - - - - |
| not necessary in certain Mines, - - - - | - - - - |
| orders issued respecting its use in Northern Collieries, | - - - - |
| its light, compared with a wax or ordinary pit candle, | - - - - |
| cases of accidents arising from, - - - - | - - - - |
| in what respects objectionable, - - - - | - - - - |
| DE LA BECHE, SIR HENRY THOMAS, C. B., F. R. S., Evidence of, - - - - | - - - - 1. |
| DEPUTY, what education necessary for, - - - - | Atkinson, - - 5629. |
| DIAGRAM, showing elements essential for ventilation, - - | Brunton, - - 1392. |
| showing the relative value of stoppings, - - - - | Appendix. |
| showing air crossings on Mr. Easton's principle, - - | Appendix. |
| showing the effect of depth of shaft in furnace venti- lation, - - - - | Appendix. |
| showing application of Mr. Struvé's apparatus to a working shaft, - - - - | Appendix. |
| showing the method of ventilation as practised in South Wales, - - - - | Appendix. |
| showing improvements suggested for ventilation, - - | Appendix. |
| showing different systems of working coal in different districts, - - - - | Appendix. |
| of steam-jet apparatus, - - - - | Appendix. |
| DISLOCATIONS, where met with, - - - - | Peace, - - 4933. |
| DOBSON, SAMUEL, Esquire, Mining Engineer, Evidence of, - | - - - - 4367. |
| DUDLEY COLLIERY, explosion in, - - - - | Nadin, - - 3444. |
| DUNN, MATTHIAS, Esquire, Colliery Viewer, Evidence of - | - - - - 5217. |

| General Heads. | Name of Witness and Number of Question. |
|--|---|
| E. | |
| EAGLEBUSH COLLIERY, application of Mr. Struvé's ventilator in, | { Vivian, - - 1208. Struvé, - - 2400. 2443. Richardson, - - 3747. 3792. |
| — explosion in, - - - - - | { Struvé, - - 2466. 2489. Richardson, - - 3748. |
| EDUCATION, how far necessary for miners, - - - - - See COLLIERIES. | { Woodhouse, - - 4046. Gibbons, - - 4630. Swallow, - - 5208. Jude, - - 5769. |
| ELLIOT, GEORGE, Esq., Colliery Owner and Viewer, Evidence of, - - - - - | { - - - - 2828. |
| EXPLOSIONS, chief causes of: | |
| 1. Defective ventilation, - - - - - | { De la Beche, - - 1529. Tremenheere, - - 198. Ansted, - - 635. Vivian, - - 1135. Hutchinson, - - 1420. Wood, - - 1911. Smyth, - - 2211. Struvé, - - 2363. Nadin, - - 3447. Woodhouse, - - 3861. Barber, - - 4131. Barkley, - - 4246. Dobson, - - 4375. Peace, - - 4932. Dunn, - - 5277. Jude, - - 5666. |
| 2. Wind, and atmospheric changes, - - - - - | { De la Beche, - - 49. 77. Playfair, - - 531. Ansted, - - 692. Brunton, - - 1401. Hutchinson, - - 1450. 1474. Biram, - - 1626. 1636. Smyth, - - 2217. 2236. Mather, - - 3635. Woodhouse, - - 3966. Barber, - - 4163. Swallow, - - 4791. Jude, - - 5724. Gurney, - - 6311. |
| — in what collieries accidents from, assumed to be most numerous, - - - - - | { De la Beche, - - 108. |
| — increase of deaths from, during last ten years, - - - - - | { De la Beche, - - 109. |
| — same accounted for, - - - - - | { Wood, - - 2039. Mather, - - 3700. Peace, - - 3681. Taylor, - - 6006. Playfair, - - 541. Ansted, - - 644. Hutchinson, - - 1434. Wood, - - 1925. Barkley, - - 4254. Swallow, - - 4807. Atkinson, - - 5493. Taylor, - - 6220. |
| — violent effects of, - - - - - | { Swallow, - - 4743. 4782. Atkinson, - - 5459. |
| — appearance of, as described by eye-witnesses, - - - - - | { Swallow, - - 4792. Jude, - - 5727. Taylor, - - 6210. |
| — number of deaths from, in 55 Collieries, during six years, - - - - - | { Taylor, - - 6002. |
| EXHAUSTION, amount of, produced by Mr. Struvé's and Mr. Brunton's apparatus, respectively, - - - - - | { Vivian, - - 1559. |
| — its power in forcing gas from coal or goaves, - - - - - | { Brunton, - - 1398. Vivian, - - 4362. |
| EXPANSION, calculations on, in shafts of various depths, respectively, - - - - - | { Struvé, - - 2358. Elliot, - - 2642. |
| — power of, how calculated, - - - - - | { Struvé, - - 2360. |

| General Heads. | Name of Witness and Number of Question. |
|--|--|
| F. | |
| FAN , relative amount of fuel required for, and for the steam-jet, - - - - - | Gurney, - - - 512. |
| — in what cases most convenient and economical - - - - - | Struvé, - - - 2408. |
| — compared with furnace mode, - - - - - | Dunn, - - - 5845. |
| FELLING COLLIERY , explosion in, - - - - - | { Hutchinson, - 1490. Forster, - 2820. |
| FIRE IN COAL MINES , methods at present in use for extinguishing, - - - - - | { De la Beche, - 185. Darlington, - 852. Whieldon, - 1054. Biram, - 1773. Wood, - 1966. Forster, - 2807. Elliot, - 3145. Taylor, - 6201. De la Beche, - 181. Gurney, - 364. 455. Darlington, - 873. Wood, - 1977. Elliot, - 2693. Nadin, - 3432. De la Beche, - 189. Wood, - 1966. Gurney, - 480. Whieldon, - 1062. Biram, - 1785. Gurney, - 493. Vivian, - 1250. |
| — successful application of Mr. Gurney's steam-jet to, - - - - - | { De la Beche, - 45. Playfair, - 552. Ansted, - 749. Arnett, - 774. Wood, - 1843. Mather, - 3529. Clanny, - 4690. Biram, - 1770. |
| — other methods suggested, - - - - - | { De la Beche, - 24. Barkley, - 4262. Clanny, - 4682. |
| — its liability to second ignition when extinguished by the modes at present in use, - - - - - | { Clanny, - 4695. |
| — case of, in America, - - - - - | { Swallow, - 4853. |
| — case of, in Silesia, - - - - - | { Taylor, - 6035. Taylor, - 6043. |
| FIRE-DAMP , proportion of atmospheric air with, necessary to prevent explosion, - - - - - | { De la Beche, - 2545. Evidence of, - - - - - |
| — where found chiefly, - - - - - | - - - - - p. 50. |
| — when not explosive, - - - - - | Keene, - - - 3190. 3218. |
| — result of experiments with, - - - - - | { what class belonging to the state, and what to proprietors, - - - - - 3195. peculiar tenure of property in, - - - - - 3201. powers of inspectors, - - - - - 3208. 3237. owner of, how far responsible in case of neglect of inspector's suggestions, - - - - - 3225. how conceded by the state - - - - - 3201. 3226. power of the state to interfere in, in certain cases, - - - - - 3227. inspectors of, not cause of, jealousy to owners, - - - - - { 3233. 3285. 3343. wages of workmen in, - - - - - 3384. |
| FORSTER, THOMAS EMERSON , Esquire, Colliery Viewer, - - - - - | { De la Beche, - 39. Playfair, - 568. Ansted, - 677. Arnett, - 811. 817. Vivian, - 1560. Biram, - 1802. Wood, - { 1838. 1849. 1989. Smyth, - - 2174. 2228. Elliot, - - 3028. Mather, - - 3539. |
| — Evidence of, - - - - - | - - - - - |
| — letter from, relative to Mr. Gurney's steam-jet, - - - - - | - - - - - |
| FRENCH MINES , system of inspection in, - - - - - | - - - - - |
| — what class belonging to the state, and what to proprietors, - - - - - | - - - - - |
| — peculiar tenure of property in, - - - - - | - - - - - |
| — powers of inspectors, - - - - - | - - - - - |
| — owner of, how far responsible in case of neglect of inspector's suggestions, - - - - - | - - - - - |
| — how conceded by the state - - - - - | - - - - - |
| — power of the state to interfere in, in certain cases, - - - - - | - - - - - |
| — inspectors of, not cause of, jealousy to owners, - - - - - | - - - - - |
| — wages of workmen in, - - - - - | - - - - - |
| FRICTION , loss of air by, - - - - - | - - - - - |

| General Heads. | Name of Witness and Number of Question. | |
|---|--|------------------------------------|
| FOURDRINIER, Mr. EDWARD NEWMAN, Evidence of, - - - | - - - 1284. | |
| invention of, for preventing accidents from the breaking of ropes, explained, - - - - - | Fourdrinier, - - - 1269. | |
| | J. Fourdrinier, - - - 1326. | |
| | Wood, - - - 2078. | |
| | Forster, - - - 2780. | |
| | Elliot, - - - 3079. | |
| | Mather, - - - 3715. | |
| | Dunn, - - - 5385. | |
| | Fourdrinier, - - - 1276. | |
| | Wood, - - - 2080. | |
| | Elliot, - - - { 3073. 3096. 3466. | |
| successful experiments with, in Usworth Colliery, - - - | Mather, - - - 3714. | |
| | Woodhouse, - - - 4016. | |
| | Dunn, - - - 5380. | |
| its cost, - - - - - | Fourdrinier, - - - 1314. | |
| saving of expense caused by, in case of accident, - - - | Elliot, - - - 3492. | |
| strictures on same, - - - - - | Peace, - - - 5027. | |
| FOURDRINIER, Mr. JOSEPH, Evidence of, - - - - - | - - - - - 1325. | |
| FURNACE, its singular practical effect on ventilation beyond a certain point of heat, - - - - - | Gurney, - - - 436. 6311. | |
| | Darlington, - - - 955. | |
| | Hutchinson, - - - 1491. | |
| | Smyth, - - - 2285. | |
| | Struvé, - - - 2371. | |
| | Mather, - - - 3552. | |
| | Woodhouse, - - - 4111. | |
| | Barkley, - - - 4329. | |
| | Cowie, - - - 6340. | |
| | Hann, - - - 6355. | |
| | same accounted for, - - - - - | Gurney, - - - 6316. |
| | | Cowie, - - - 6340. |
| | | Hann, - - - 6355. |
| | effective as a mode of ventilation, - - - - - | De la Beche, - - - 32. |
| | | Ansted, - - - 663. |
| Hutchinson, - - - 1467. | | |
| Biram, - - - 1587. | | |
| Wood, - - - 1813. 1957. | | |
| à contra, - - - - - | Gurney, - - - 434. | |
| | Playfair, - - - 531. | |
| | Darlington, - - - 948. | |
| | Smyth, - - - 2284. | |
| | Struvé, - - - 2375. | |
| | Nadin, - - - 3432. | |
| | Mather, - - - 3619. | |
| | Barkley, - - - 4329. | |
| | Biram, - - - 1582. | |
| | De la Beche, - - - 177. | |
| mode of constructing, in Yorkshire, - - - - - | Wood, - - - { 1813. 1857. 1950. 2044. | |
| | Forster, - - - 2602. | |
| | Elliot, - - - 2394. | |
| | Nadin, - - - 3432. | |
| | Mather, - - - 3619. 3716. | |
| | Gibbons, - - - 4665. | |
| | Taylor, - - - 6120. | |
| | Gurney, - - - 6311. | |
| | Cowie, - - - 6349. | |
| | ventilation by, compared with steam-jet, - - - - - <i>See STREAM-JET.</i> | Wood, - - - { 1829. 1895. 1948. |
| Smyth, - - - 2275. | | |
| Elliot, - - - 3006. | | |
| Mather, - - - 3649. | | |
| Taylor, - - - 6104. | | |
| Vivian, - - - 1106. | | |
| Wood, - - - 1957. | | |
| Smyth, - - - 2271. | | |
| Struvé, - - - 2356. | | |
| Elliot, - - - 2842. 2851. | | |
| requisites for its efficient working, - - - - - | Mather, - - - 3538. | |
| | Barkley, - - - 4329. | |
| | Dobson, - - - 4403. | |
| | Hann, - - - 6362. | |
| | Wood, - - - 1816. 1982. | |
| | Elliot, - - - 3019. | |
| | Woodhouse, - - - 3950. | |
| | Taylor, - - - 6085. | |
| cubic feet of air produced by, in various Collieries, - - - | | |

| General Heads. | Name of Witness and Number of Question. | |
|--|---|----------------|
| FURNACE, ventilation by, compared with Struvé's apparatus, - | Struvé, - | 2400. 2824. |
| —— in what cases dangerous, - - - - - | Struvé, - | 2472. |
| —— affected by winds, - - - - - | Elliot, - | 2841. |
| —— its powers and expense compared with Mr. Brunton's apparatus, - - - - - | Nadin, - | 3431. |
| —— proportion of ventilation by, according to area of shaft, as shown in various Collieries, - - - - - | Woodhouse, - | 4005. |
| | Mather, - | 3635. |
| | Barber, - | 4134. |
| | Dobson, - | 4427. |
| | Gurney, - | 6311. |
| G. | | |
| GAS, nature of, in,— | | |
| Derbyshire, - - - - - | Nadin, - | 3356. |
| Dean Forest, - - - - - | Roberts, - | 6241. |
| Newcastle District, - - - - - | Ansted, - | 765. |
| | Wood, - | 2021. |
| | Forster, - | 2641. |
| | Atkinson, - | 5467. 5478. |
| | Jude, - | 5835. |
| Lancashire, - - - - - | Peace, - | 4968. |
| South Wales, - - - - - | Vivian, - | 1090. |
| Warwickshire, - - - - - | Whieldon, - | 982. 993. |
| GAS, Carbonic Acid, or Choke-damp, manufacture and application of, in case of the first and second fires in Astley Colliery, - - - - - | Gurney, - | 455. |
| | Darlington, - | 868. 912. 933. |
| —— effect of, on the brain and lungs, - - - - - | De la Beche, - | 159. |
| | Whieldon, - | 987. |
| | Hutchinson, - | 1523. |
| | Forster, - | 2791. |
| | Atkinson, - | 5468. 5505. |
| | Jude, - | 5684. 5835. |
| —— its advantages in extinguishing fire, compared with water method, - - - - - | Biram, - | 1778. 1797. |
| | Wood, - | 1973. |
| | Mather, - | 3666. |
| | Elliot, - | 3065. 3070. |
| —— its effects, how to be counteracted, - - - - - | Keene, - | 3312. |
| | Barkley, - | 4316. |
| See AFTER-DAMP. SUFFOCATION. | | |
| GAS, Carburetted Hydrogen, or Fire-damp, proportion of, in coal, - - - - - | De la Beche, - | 23. |
| —— when inexplusive, - - - - - | De la Beche, - | 24. |
| See FIRE-DAMP. | Barkley, - | 4262. |
| —— accumulation of, in old workings, - - - - - | Clanny, - | 4682. |
| See GOAVES. | De la Beche, - | 29. |
| —— its deleterious effects on health - - - - - | De la Beche, - | 158. |
| See FIRE-DAMP. EXPLOSIONS. | | |
| GAS-HOLDER, pump described, - - - - - | Arnott, - | 805. |
| —— applicable to mines, - - - - - | Arnott, - | 810. |
| GIBBONS, BENJAMIN, Esquire, Evidence of, - - - - - | - - - - - | 4455. |
| —— strictures on his mode of ventilation, - - - - - | Dunn, - | 5300. |
| | De la Beche, - | 29. |
| | Gurney, - | 389. |
| | Ansted, - | 755. |
| | Wood, - | 1917. |
| | Struvé, - | 2468. |
| | Forster, - | 2723. |
| | Elliot, - | 3019. 3029. |
| GOAVES, dangerous - - - - - | Keene, - | 3312. |
| | Nadin, - | 3383. |
| | Mather, - | 3705. |
| | Woodhouse, - | 3920. |
| | Barber, - | 4153. |
| | Dunn, - | 5318. |
| | Jude, - | 5680. |
| | Taylor, - | 6021. |
| —— previous opinions as to their form and ventilation, controverted, - - - - - | Barkley, - | 4258. |
| —— deduction as to causes of explosion in, - - - - - | Barkley, - | 4261. |
| —— suggestions of Messrs. Lyall and Faraday respecting, impracticable, - - - - - | Dunn, - | 5319. |
| | Jude, - | 5676. |
| GOTT, JOSEPH, Overman, Evidence of, - - - - - | - - - - - | 5886. |

| General Heads. | Name of Witness and Number of Question. |
|---|---|
| GUIDES for Shafts generally in use, - - - - | Wood, - - - 2068. Forster, - - - 2787. Elliot, - - - 3082. Nadin, - - - 3437. Woodhouse, - - - 4011. Barber, - - - 4924. Peace, - - - 5025. Dunn, - - - 5374. Gibbons, - - - 4649. |
| — economy of, controverted, - - - - | Gibbons, - - - 4649. |
| GUNPOWDER, cases of explosion caused by the use of, - - - | Swallow, - - - 4851. |
| — when to be prohibited, - - - - | Swallow, - - - 4863. Peace, - - - 5006. 5082. |
| GURNEY, GOLDSWORTHY, Esquire, Evidence of, - - - - | - - - - 315. 6284. |
| H. | |
| HAIGH COLLIERY, accidents in, from 1848 to 1849, - - - | Peace, - - - 5009. |
| HANN, PROFESSOR JAMES, Evidence of, - - - - | - - - - 6352. |
| HASWELL COLLIERY, explosion in, - - - - | Ansted, - - - 641. Hutchinson, - - - 1422. 1437. Mather, - - - 3536. Barkley, - - - 4324. Taylor, - - - 6022. 6230. Elliot, - - - 3019. |
| — ventilation in, by furnace mode, - - - - | Elliot, - - - 3019. |
| HAWKESBURY COLLIERY, fire in, - - - - | Whieldon, - - - 984. |
| HEAT of Furnace; its effect on tubing, chains, &c. See | Struvé, - - - 2449. Barkley, - - - 4329. |
| VENTILATION, - - - - | - - - - |
| — of Shaft; its effect on Ventilation. See SHAFT. So- | Taylor, - - - 6070. Gurney, - - - 6316. |
| LAB HEAT, - - - - | - - - - |
| HETTON COLLIERY, ventilation in, with result of experiments | Wood, - - - { 1816. 1844. 1982. |
| — on other modes, - - - - | - - - - |
| — peculiar nature of gas in, - - - - | Atkinson, - - - 5467. |
| HUTCHINSON, JOHN, Esquire, M. D., Evidence of, - - - | - - - - 1409. |
| — recommendations of, for more efficient ventilation, - | Hutchinson, - - - 1492. |
| HUTTON SEAM, Plan of, - - - - | Appendix. |
| I. | |
| INSPECTORS, limit of powers for, - - - - | De La Beche, - - 6. Tremenheere, - - 235. Playfair, - - - 589. 604. Ansted, - - - 695. Darlington, - - - 960. Vivian, - - - 1165. Hutchinson, - - - 1495. Biram, - - - 1737. Wood, - - - 2121. 2131. Smyth, - - - 2253. Forster, - - - 2765. Elliot, - - - 3139. 3142. Nadin, - - - 3411. Mather, - - - 3712. Woodhouse, - - - 4071. Barber, - - - 4231. Dobson, - - - 4445. Gibbons, - - - 4622. Swallow, - - - 4823. 4923. Peace, - - - 5066. 5097. Dunn, - - - { 5221. 5234. 5434. Atkinson, - - - 5634. Jude, - - - 5752. 5862. Taylor, - - - 6153. De La Beche, - - 6. Tremenheere, - - 232. Ansted, - - - 699. Darlington, - - - 962. Wood, - - - 2121. 2141. Nadin, - - - 3410. Mather, - - - 3712. Woodhouse, - - - 4073. Barber, - - - 4237. Gibbons, - - - 4622. Swallow, - - - 4823. 4923. Peace, - - - 5067. Dunn, - - - 5434. Jude, - - - 5755. Taylor, - - - 6152. |
| — not to have compulsory power - - - - | - - - - |

| General Heads. | Name of Witness and Number of Question. |
|---|---|
| INSPECTORS, their powers in Foreign Mines, - - - | Tremenheere, - 288. |
| | Biram, - 1736. |
| | Keene, - 3207. 3267. |
| | Swallow, - 4833. |
| | Tremenheere, - 256. |
| | Playfair, - 594. |
| — jealousy against, on the part of proprietors, groundless, | Wood, - 2148. |
| | Richardson, - 3806. |
| | Woodhouse, - 4079. |
| | Dobson, - 4453. |
| | Tremenheere, - 275. 303. |
| | Playfair, - 593. |
| | Ansted, - 698. |
| | Biram, - 1731. |
| | Wood, - 2140. |
| — desire for, in some districts, - - - - | Smyth, - 2246. |
| | Nadin, - 3421. |
| | Mather, - 3712. |
| | Richardson, - 3796. |
| | Peace, - 5061. |
| | Jude, - 5651. |
| | Vivian, - 1190. |
| | Wood, - 2132. |
| | Elliot, - 3142. |
| | Woodhouse, - 4108. |
| | Dobson, - 4449. |
| — what qualifications necessary for, - - - | Peace, - 5077. 5086. |
| | Swallow, - 5128. |
| | Dunn, - 5431. |
| | Atkinson, - 5564. |
| | Jude, - 5652. |
| | Taylor, - 6162. 6181. |
| | Roberts, - 6282. |
| — scheme for, approved of by Northern coal-owners, - | Wood, - 2135. 2144. |
| — grounds for objecting to, on the part of small coal-owners, - - - - | Woodhouse, - 4086. |
| — proposed number of, - - - - | Swallow, - 4870. |
| | Taylor, - 6177. |
| — steps to be taken in case of difference with proprietor, | Swallow, - 4889. |
| | Atkinson, - 5566. |
| — to be analogous to Inspectors of Factories, - - | Swallow, - 4895. 5164. |
| — powers required for, to be satisfactory to workmen, | Jude, - 5655. |
| | Roberts, - 6277. |
| INSPECTORS, FRENCH, their education, - - - - | Keene, - 3239. |
| — not considered vexatious, - - - - | Keene, - 3248. |
| — when first established, - - - - | Keene, - 3263. |

J.

| | |
|---|---------------------|
| JARROW COLLIERY, explosion in, - - - - | Playfair, - 541. |
| | Hutchinson, - 1446. |
| | Wood, - 2022. |
| | Atkinson, - 5493. |
| JUDE, MARTIN, Miner, Evidence of, - - - - | - - - - 5650. |

K.

| | |
|---|-----------------|
| KEENE, WILLIAM, Esquire, Civil Engineer, Evidence of, - - - - | - - - - 3152. |
| KILLINGWORTH COLLIERY, explosion in, - - - - | Ansted, - 635. |
| — mode adopted for extinguishing fire in, - - - - | Wood, - 1966. |
| — ventilation requisite for, - - - - | Mather, - 3250. |

L.

| | |
|---|---------------------|
| LAMPS, inventions and modifications in, - - - - | De la Beche, - 143. |
| | Playfair, - 569. |
| | Hutchinson, - 1547. |
| | Biram, - 1694. |
| | Wood, - 2033. |
| | Elliot, - 3048. |
| | Mather, - 3668. |
| | Woodhouse, - 4038. |
| | Clanny, - 4658. |
| | Dunn, - 5394. |
| — not substitute for ventilation, - - - - | De la Beche, - 156. |
| | Hutchinson, - 1553. |
| | Barkley, - 4331. |
| | Jude, - 5785. |

| General Heads. | Name of Witness and Number of Question. |
|---|---|
| LAMPS, of Mr. Biram, - - - - - | { Biram, - - 1694. |
| ----- might be superseded by ventilation, - - - | { Elliot, - - 3058. |
| <i>See DAVY LAMP. CLANNY LAMP.</i> | { Woodhouse, - - 4040. |
| | { Mather, - - 3702. |
| LANCASHIRE MINES, defective ventilation in, - - - | { Darlington, - - 948. |
| | { Wood, - - 2056. |
| | { Smyth, - - 2206. |
| | { Swallow, - - 5187. 5193. |
| | { Dunn, - - 5279. 5293. |
| | { Gott, - - 5925. |
| | { Taylor, - - 6145. |
| ----- royalty in, - - - - - | { Darlington, - - 950. |
| ----- peculiarity of, - - - - - | { Peace, - - 4933. |
| ----- system of management in, - - - - - | { Peace, - - 4994. |
| LOCOMOTIVE ENGINES, their principle applicable to Coal Mines, - - - - - | { De la Beche, - - 168. |
| | { Gurney, - - 422. |
| | { Playfair, - - 546. |
| | { Keene, - - 3849. |
| LONG WALL METHOD, where inapplicable, - - - | { Ansted, - - 709. |
| | { Woodhouse, - - 3944. |
| | { Barkley, - - 4293. |
| | { Dunn, - - 5445. |
| ----- where applicable, preferable to other methods, - - - | { Ansted, - - 709. |
| | { Smyth, - - 2314. |
| | { Struvé, - - 2482. |
| | { Woodhouse, - - 3916. 3990. |
| | { Barkley, - - 4293. |
| LUNGS, inflation of, by pumps or bellows, dangerous, - - - | { Hutchinson, - - 1536. |
| <i>See GAS.</i> | |
| M. | |
| MASK, use of, recommended for miners in choke-damp, - - - | { Hutchinson, - - 1524. |
| ----- figure of, - - - - - | { Appendix. |
| MATHER, JAMES, Esquire, Evidence of, - - - - - | - - - - - 8507. |
| MIDLAND DISTRICTS, defective ventilation in, - - - | { Nadin, - - 3422. |
| | { Woodhouse, - - 3861. |
| MONKWEARMOUTH COLLIERY, enormous depth of, - - - | { Ansted, - - 728. |
| | { Fourdrinier, - - 1369. |
| ----- speed in raising coals in, - - - - - | { Elliot, - - 3090. |
| | { Elliot, - - 3090. |
| MUSELER LAMP, principle of, - - - - - | { Mather, - - 3688. |
| | { Dunn, - - 5417. |
| N. | |
| NADIN, JOSEPH, Esquire, Colliery Owner and Viewer, Evidence of, - - - - - | - - - - - 3852. |
| NAPOLEON, decree of, relative to accidents in Belgium, - - - | { Tremenneere, - - 300. |
| NEWHALL COLLIERY, extent, management of, &c., - - - | { Nadin, - - 3856. 3401. |
| O. | |
| OVERMEN, deficient education of, - - - - - | { De la Beche, - - 78. |
| | { Tremenneere, - - 203. |
| | { Playfair, - - 562. |
| | { Ansted, - - 654. |
| | { Hutchinson, - - 1495. |
| | { Biram, - - 1577. 1673. |
| | { Wood, - - 2050. 2062. |
| | { Smyth, - - 2257. |
| | { Elliot, - - 3122. |
| | { Jude, - - 5765. |
| ----- what qualifications necessary for, - - - - - | { De la Beche, - - 81. |
| | { Vivian, - - 1150. |
| | { Biram, - - 1686. |
| | { Wood, - - 2106. |
| | { Forster, - - 2740. |
| | { Elliot, - - 3116. |
| | { Woodhouse, - - 4046. |
| ----- in South Wales, competent, - - - - - | { Vivian, - - 1147. |
| | { Struvé, - - 2516. |

| General Heads. | Name of Witness and Number of Question. |
|--|--|
| P. | |
| PEACE, WILLIAM, Esquire, Colliery Agent, Evidence of, - - - - | 4928. |
| PETITION of Colliers and Miners of Northumberland and Durham, - - - - - } | Jude, - - - 5852. |
| PLAYFAIR, DR. LYON, Evidence of, - - - - - | 519. |
| PUMP. See AIR-PUMP. | |
| PYRITES. See SPONTANEOUS COMBUSTION. | |
| Q. | |
| QUICK LIME, its effect on carbonic acid gas, - - - - | Elliot, - - - 3065. |
| R. | |
| RADCLIFFE BRIDGE COLLIERY, accidents in, - - - - | Swallow, - - - 5188. |
| RAREFACTION, amount of, produced by Mr. Brunton's apparatus, - - - - - } | Brunton, - - - 1363. Barber, - - - 4145. Dobson, - - - 4410. |
| ——— what amount of, necessary for safety, - - - - - } | Brunton, - - - 1392. Smyth, - - - 2281. |
| ——— term defined, - - - - - | Brunton, - - - 1396. |
| ——— by steam and furnace, compared, - - - - - } | Elliot, - - - 2972. Gurney, - - - 6290. |
| ——— relative to depth of shaft, - - - - - | Mather, - - - 3546. |
| RESPIRATION, quantity of air requisite for, - - - - | Hutchinson, - - - 1513. |
| ——— result of observations on, - - - - - | Hutchinson, - - - 1521. |
| RICHARDSON, JOSHUA, Esquire, Mining Engineer, Evidence of, - - - - - } | - - - - - 3717. |
| RISCA COLLIERY, explosion in, - - - - - | De la Beche, - - - 8. 13. |
| ROBERTS, JOSEPH, Esquire, Evidence of, - - - - - | 6237. |
| ROYALTIES, comparative size of, in the Northern and Midland Districts, - - - - - } | Ansted, - - - 729. |
| S. | |
| SCHOOL OF MINES, France, - - - - - | Keene, - - - 3240. |
| SEATON DELAVAL MINE, ventilation in, before and after application of steam-jet - - - - - } | Gurney, - - - 382. 6326. Forster, - - - 2555. Mather, - - - 3582. 3716. Dunn, - - - 5346. Jude, - - - 5732. Taylor, - - - 6068. |
| ——— insufficiency of furnace mode in, - - - - - | Forster, - - - 2555. |
| ——— wages of workmen in, - - - - - | Forster, - - - 2745. |
| SHAFT TEMPERATURE, experiments on, - - - - - } | Hutchinson, - - - 1455. 1490. Taylor, - - - 6110. |
| ——— for mines of different depths ventilated by furnace, - - - - - | Hutchinson, - - - 1490. |
| SHAFT, expense and difficulty of sinking, in certain cases, - - - - - } | Ansted, - - - 728. Wood, - - - 1964. Forster, - - - 2647. Mather, - - - 3618. Woodhouse, - - - 3899. Gibbons, - - - 4589. Vivian, - - - 1106. Smyth, - - - 2221. 2275. Struvé, - - - 2356. |
| ——— depth of, important in furnace ventilation, - - - - - } | Elliot, - - - 2842. 3971. Mather, - - - 3538. Barkley, - - - 4320. Dobson, - - - 4403. Hann, - - - 6362. |
| ——— ventilation by, when inclined and perpendicular, - - - - - } | Struvé, - - - 2373. Elliot, - - - 2847. |
| ——— its requisite proportions, - - - - - } | Dunn, - - - 5299. Jude, - - - 5807. Taylor, - - - 6018. |

| General Heads. | Name of Witness and Number of Questions. |
|--|---|
| SMYTH, WARINGTON WILKINSON, Esquire, Evidence of, - - - | - - - 2165. |
| SOLAR HEAT, influence of, on ventilation, - - - | - Hutchinson, - 1466. 1468. |
| SOUTH WALES MINES, defective ventilation in, - - - | { Vivian, - 1090. Struvé, - 2355. Richardson, - 3735. Barber, - 4125. Dobson, - 4375. Taylor, - 6145. Vivian, - 1124. |
| — precautions against accidents in, - - - | - Mather, - 3510. |
| SOUTH SHIELDS COMMITTEE, its origin, - - - | { Whieldon, - 983. 1076. Vivian, - 1242. Wood, - 2155. Keene, - 3166. Nadin, - 3384. Woodhouse, - 3908. Gibbons, - 4540. Dunn, - 5248. Gurney, - 6303. |
| SPONTANEOUS COMBUSTION, causes of, - - - | { Whieldon, - 982. Wood, - 2156. Gurney, - 6306. |
| — in what districts only, - - - | { Playfair, - 565. Ansted, - 720. Smyth, - 2181. 2200. Nadin, - 3426. Gibbons, - 4467. Smyth, - 2193. Nadin, - 3366. Dunn, - 5242. |
| — erroneous opinion concerning, - - - | { Smyth, - 2194. Ansted, - 710. Smyth, - 2182. Nadin, - 3426. Dunn, - 5362. |
| STAFFORDSHIRE MINES, defective ventilation in, - - - | { Gibbons, - 4486. Gibbons, - 4529. |
| — ventilation, how far requisite for, - - - | { Gurney, - 324. Forster, - 2594. Elliot, - 2936. 2999. Keene, - 3326. 3840. Mather, - 3716. Gibbons, - 4527. Cowie, - 6349. |
| — "butty system" in, - - - | { Gurney, - 358. 442. Dobson, - 4433. |
| — chief cause of dangers in, - - - | { Richardson, - 3778. Clanny, - 4083. |
| — gas, how conveyed from, - - - | { De la Beche, - 28. Gurney, - 455. Darlington, - 897. Biram, - 1778. Wood, - 1977. |
| — steam, how applied in, - - - | { De la Beche, - 173. Gurney, - 424. 6802. Playfair, - 553. Arnott, - 834. Wood, - 1971. Forster, - 2626. 2881. Keene, - 3316. 3349. Nadin, - 3432. Mather, - 3626. Barkley, - 4325. Vivian, - 4362. Gibbons, - 4574. Taylor, - 6206. |
| STEAM, high and low pressure, - - - | { De la Beche, - 177. Gurney, - 342. 424. Darlington, - 983. Forster, - 2602. 2626. Keene, - 3351. Mather, - 3631. 3648. |
| — its tendency to draw in air tested, - - - | |
| — applied in South Wales in 1828, - - - | |
| — its neutralizing effect on fire-damp, - - - | |
| STEAM-JET, successful application of, by Mr. Darlington, | |
| — generally applicable to mines, - - - | |
| — its unlimited power, - - - | |

| General Heads. | Name of Witness and Number of Question. |
|---|---|
| | De la Beche, - 191. |
| | Gurney, - 512. 6290. |
| | Darlington, - 938. |
| | Vivian, - 1101. 4357. |
| | Forster, - 2594. |
| STEAM-JET, its advantages, compared with other apparatus. | Elliot, - 2880. |
| See FURNACE, - - - - - | Keene, - 3349. |
| | Mather, - 3582. 3631. |
| | Woodhouse, - 4006. |
| | Barkley, - 4325. |
| | Gibbons, - 4564. |
| | Roberts, - 6283. |
| | Gurney, - 329. 6284. |
| | Forster, - 2580. |
| — process of ventilation by, - - - - - | Elliot, - 2881. |
| | Keene, - 3840. |
| | Gibbons, - 4527. |
| | Cowie, - 6349. |
| — apparatus, - - - - - | Appendix. |
| — cost of same, - - - - - | Gurney, - { 403. 513. 6290. |
| | Forster, - 2623. |
| | Gurney, - 407. |
| | Wood, - 1833. |
| — expense of, compared with furnace, - - - - - | Forster, - 2615. 2688. |
| | Mather, - 3649. |
| | Gibbons, - 4566. |
| | Taylor, - 6104. |
| — not affected by atmospheric changes, - - - - - | Gurney, - 430. |
| | Mather, - 3635. |
| — how to be applied, - - - - - | Gurney, - 440. |
| | Forster, - 2634. |
| | Gurney, - 452. 516. |
| | Wood, - 1907. |
| — what essential for its working, - - - - - | Forster, - 2606. |
| | Elliot, - 2952. |
| | Keene, - 3950. |
| | Gibbons, - 4581. |
| — expense of, as applied in Astley Colliery, - - - - - | Gurney, - 484. |
| | Darlington, - 915. |
| | Vivian, - 1101. 4337. |
| | Keene, - 3648. |
| — result of experiments with, - - - - - | Peace, - 4981. |
| | Taylor, - 6068. |
| | Gurney, - 6294. |
| — cause of its comparative failure at Hetton Colliery, - - - - - | Wood, - 1907. |
| | Mather, - 3654. |
| — its decaying effect on ropes, - - - - - | Struvé, - 2452. |
| — cubic feet of air by, and by steam-engine and furnace respectively, - - - - - | Elliot, - { 2908. 2989. 3005. |
| — in combination with furnace, recommended, - - - - - | Elliot, - 3007. |
| | Peace, - 4981. |
| — its application to Soda and Alkali factories, - - - - - | Mather, - 3635. 3716. |
| — its power of exhaustion on gases, - - - - - | Vivian, - 4364. |
| — experiments with, in conjunction with furnace, - - - - - | Peace, - 4990. |
| STOPPINGS, construction of, - - - - - | Hutchinson, - 1436. |
| | Barkley, - 4250. |
| | Jude, - 5813. |
| STRUVE, WILLIAM PRICE, Esquire, Mining Engineer, Evidence of, - - - - - | - - - - - 2353. 2823. |
| — apparatus of, - - - - - | Struvé, - { 2393. 2421. 2463. |
| — generally applicable, - - - - - | Struvé, - 2462. |
| — its cost, - - - - - | Struvé, - 2823. |
| SUFFOCATION and EXPLOSIONS, proportion of deaths from, - - - - - | De la Beche, - 11. |
| | Hutchinson, - 1421. 1521. |
| | Biram, - 1760. |
| | Wood, - 1921. |
| | Smyth, - 2346. |
| | Struvé, - 2468. |
| | Forster, - 2822. |
| | Elliot, - 3063. |
| | Barber, - 4173. |
| | Barkley, - 4314. |
| | Swallow, - 5198. |
| | Taylor, - 6223. |
| — remedy in case of insensibility from, - - - - - | Hutchinson, - 1538. |

| General Heads. | Name of Witness and Number of Question. |
|---|---|
| SULPHUR, supply obtained by steam-jet in smelting furnaces, | Mather, - - 3635. |
| SULPHURETTED HYDROGEN GAS in Hawkesbury Colliery, | Whieldon, - - 988. |
| SUPERINTENDENTS. See OVERMEN. | |
| SURGEONS for Collieries, - - - - - | Atkinson, - - 5607. |
| SWALLOW, Mr. DAVID, Miner, Evidence of, - - - - - | - - - - - 4734. 5101. |

T.

| | |
|---|-----------------------|
| TABLE, showing the velocity of different bodies of air through different areas - - - - - | Vivian, - - 1295. |
| ----- of explosions, in relation to days of week - - - - - | Hutchinson, - p. 152. |
| ----- of explosions, in relation to months - - - - - | Hutchinson, - p. 153. |
| ----- of explosions, in relation to wind - - - - - | Hutchinson, - p. 153. |
| ----- of differential temperature in ten coal mines - - - - - | Hutchinson, - p. 153. |
| ----- of explosions in relation to day temperature - - - - - | Hutchinson, - p. 154. |
| ----- of barometric pressure at Newcastle-on-Tyne, in relation to explosions - - - - - | Hutchinson, - p. 154. |
| ----- showing estimate of amount of ventilation necessary for safety under different degrees of fire-damp - - - - - | Struvé, - - 2493. |
| ----- showing extent of passages, pillars, &c. in mines of 100, 200 and 300 fathoms deep, respectively - - - - - | Mather, - - 3586. |
| ----- showing causes of deaths in mines, as recorded in Miners' Journal for 1848, &c. - - - - - | Richardson, - 3729. |
| ----- showing results of experiments with different jets in different blast-pipes, &c. - - - - - | Vivian, - - 4366. |
| ----- showing cases of accident at Haigh Colliery - - - - - | Peace, - - 5009. |
| ----- of accidents in Northumberland and Durham for six years - - - - - | Taylor, - - 6004. |
| ----- of Great Pit explosions during last 45 years - - - - - | Taylor, - - 6034. |
| TAYLOR, THOMAS JOHN, Esquire, colliery-viewer, Evidence of - - - - - | - - - - - 5993. |
| TEMPERATURE. See ATMOSPHERE. | |
| TREMENHERR, SEYMOUR, Esquire, Inspector of Mines, Evidence of - - - - - | - - - - - 194. 617. |

U.

| | |
|-----------------------------------|---|
| UNDERVIEWERS, duties of - - - - - | { Wood, - - 2092. Woodhouse, - 4058. |
|-----------------------------------|---|

V.

| | |
|-------------------------|---|
| VENTILATORS:-- | { De la Beche, - 20. Playfair, - 527. Darlington, - 948. Hutchinson, - 1467. Biram, - 1578. Wood, - { 1813. 1857. 1864. Smyth, - - 2271. Struvé, - - 2356. Elliot, - - 2837. 2870. Nadin, - - 3361. Mather, - - 3619. Gibbons, - - 4564. Peace, - - 4944. Gott, - - 5932. Taylor, - - 6125. Gurney, - - 6290. |
| 1. Furnace, - - - - - | { De la Beche, - 26. Arnott, - - 706. 817. Smyth, - - 2263. |
| 2. Pump, - - - - - | { De la Beche, - 26. Gurney, - - 509. Brunton, - - 1351. Biram, - - 1654. Struvé, - - 2408. Peace, - - 4972. Dunn, - - 5336. |
| 3. Fan, - - - - - | { Vivian, - - 1091. 1105. Biram, - - 1628. Elliot, - - 2870. |
| 4. Waterfall, - - - - - | { Vivian, - - 1091. 1105. Biram, - - 1628. Elliot, - - 2870. |

| General Heads. | Name of Witness and Number of Question. |
|---|---|
| VENTILATORS—continued. | |
| 5. Mr. Gurney's high-pressure steam, - - - | De la Beche, - 172. Gurney, - 323. 6290. Vivian, - 1101. 4366. Biram, - 1662. Wood, - 1857. 1884. Forster, - 2580. Elliot, - 2880. Mather, - 3619. Keene, - 3848. Gibbons, - 4527. 4565. Peace, - 4981. Dunn, - 5846. Taylor, - 6068. Roberts, - 6283. |
| 6. Mr. Brunton's apparatus, - - - | Brunton, - 1351. 1367. Barber, - 4134. 4184. Dobson, - 4404. 4425. |
| 7. Mr. Struvé's apparatus, - - - | Struvé, - 2378. 2468. Richardson, - 3747. |
| VENTILATION, how far affected by variation of surface, - | De la Beche, - 19. 54. |
| —— in what cases most difficult. See WIND, - | De la Beche, - 19. Nadin, - 3426. De la Beche, - 41. Playfair, - 541. Ansted, - 725. Hutchinson, - 1424. |
| —— by one shaft only, dangerous, - - - | Biram, - 1803. Wood, - 1961. Forster, - 2644. Mather, - 3615. Peace, - 4984. Jude, - 5709. |
| —— by high and low pressure steam, - - - | Gurney, - 324. Forster, - 2594. Elliot, - 2935. 2999. Keene, - 3826. 3840. Mather, - 3716. Gibbons, - 4527. Cowie, - 6349. |
| —— amount of, necessary, in case of fire or explosive gas, - | Gurney, - 380. Elliot, - 2893. Taylor, - 6019. |
| —— current of, necessary for safety, - - - | Gurney, - 412. |
| —— what instruments necessary for ascertaining its amount, - - - | Gurney, - 495. |
| —— by furnace, deceptive, - - - | Gurney, - 436. 6311. Darlington, - 955. Hutchinson, - 1491. Smyth, - 2285. Struvé, - 2371. Mather, - 3552. Woodhouse, - 4111. Barkley, - 4329. Cowie, - 6340. Hann, - 6355. Playfair, - 525. Ansted, - 712. |
| —— by furnace, in larger mines, efficient, - - - | Wood, - 2046. Mather, - 3645. Woodhouse, - 3926. Barkley, - 4301. Vivian, - 1106. Hutchinson, - 1487. Wood, - 1957. Smyth, - 2275. |
| —— by furnace, relative to depth of shaft, - - - | Elliot, - 2842. 2971. Mather, - 3538. Barkley, - 4329. Dobson, - 4403. Hann, - 6362. |
| —— estimated amount of, required in different degrees of fire-damp, - - - | Struvé, - 2496. |
| —— in what respects defective in northern mines, - - - | Barkley, - 4246. Jude, - 5666. |
| —— plan for its greater efficiency, - - - | Appendix. |

| General Heads. | Name of Witness and Number of Question. |
|--|--|
| | Playfair, - - 541. Ansted, - - 726. Biram, - - 1765. Wood, - - 1928. Gibbons, - - 4506. Swallow, - - 5198. Jude, - - 5822. Taylor, - - 6224. |
| VENTILATION, after explosion, - - - | Taylor, - - 6008. |
| —— in 1814, compared with present, - - - | Woodhouse, - - 3908. Clanny, - - 4712. Dunn, - - 5917. Taylor, - - 6190. Roberts, - - 6264. |
| —— economical, - - - | |
| VIEWERS compared, - - - | Tremenheere, - - 213. Ansted, - - 660. Wood, - - 2115. Elliot, - - 3116. |
| VIVIAN, HENRY HUSSEY, Esquire, Evidence of, - - - | { 1081. 1557. 4336. |
| W. | |
| WAGES in— | |
| Seaton Delaval Mine, - - - | Forster, - - 2745. |
| French Mines, - - - | Keene, - - 3334. |
| Dean Forest, - - - | Roberts, - - 6266. |
| —— rate of, in proportion to liability to accidents, - - - | Roberts, - - 6268. |
| WALLSEND COLLIERY, explosions in, - - - | { Hutchinson, - - 1429. Mather, - - 3672. Barkley, - - 4324. Jude, - - 5688. |
| —— precautions against, - - - | Jude, - - 5690. |
| WARWICKSHIRE MINES, peculiar nature of gas in, - - - | Whieldon, - - 982. 1014. |
| —— easy of ventilation, - - - | Whieldon, - - 1000. |
| WASTES. See GOAVES. | |
| WATER-GAUGE apparatus, - - - | Gurney, - - 344. |
| —— as measure of ventilation, deceptive, - - - | { Gurney, - - 436. Arnott, - - 812. Vivian, - - 1557. 1565. |
| WATER PRESSURE, for forcing ventilation, - - - | Gurney, - - 348. |
| WHIELDON, GEORGE, Esquire, Evidence of, - - - | 974. |
| WIND, its effect on explosions, - - - | { De La Beche, - - 77. Whieldon, - - 1069. Hutchinson, - - 1475. Biram, - - 1626. 1636. Wood, - - 1919. Smyth, - - 2286. Mather, - - 3635. Woodhouse, - - 3966. Swallow, - - 4793. |
| —— <i>à contra</i> , - - - | Ansted, - - 744. |
| —— in what quarter most prejudicial to ventilation, - - - | { Whieldon, - - 1069. Hutchinson, - - 1474. Smyth, - - 2289. Mather, - - 3635. Woodhouse, - - 3966. Jude, - - 5729. |
| WOOD, NICHOLAS, Esquire, Evidence of, - - - | 1806. |
| WOODHOUSE, JOHN THOMAS, Esquire, Colliery Viewer, Evidence of, - - - | 3955. |

GENERAL INDEX.

| <u>General Heads.</u> | <u>Name of Witness and Number of Question.</u> |
|---|--|
| WORKINGTON COLLIERY, accident to, - - - - | Dunn, - - - 5224. |
| WORKMEN, grades and duties of, - - - - | { Wood, - - - 2092. Woodhouse, - - 4058. |
| Y. | |
| YORKSHIRE MINES, how worked, - - - - | { Biram, - - - 1589. 1754. Wood, - - - 2045. Swallow, - - - 4746. Gott, - - - 5908. |

CHECKED
2003-04