

68848
Hoover (Engr)
Location theory on
the shoe and leather
industries.

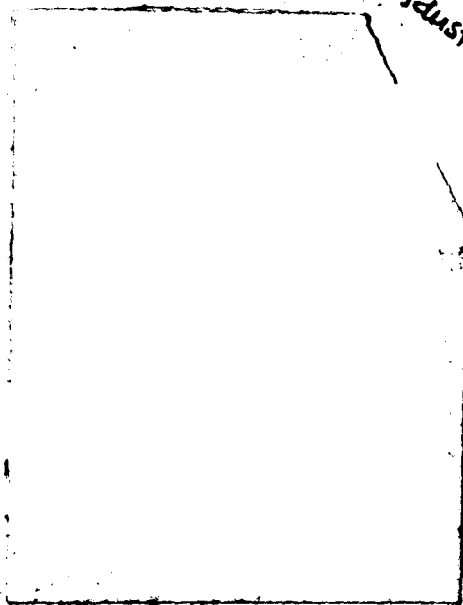

SERVANTS OF INDIA SOCIETY'S LIBRARY

POONA 4

X-9(M97)-294-73 (G)
Cl. No. Date of release for loan
Ac. No. 68848

This book should be returned on or before the date last mentioned below.

An overdue charge of 5 paise will be levied for each day the book is kept beyond this date.

2 8 DEC 1966	20 MAR 1971	
1 1 FEB 1967	19 FEB 1979	
2 0 SEPT 1967	21 JAN 1989	
1 8 DEC 1967		
2 2 DEC 1967		
2 2 JAN 1968		
2 4 FEB 1968		
2 5 JUN 1968		
2 AUG 1968		
2 MAR 1970		

Dhananjayrao Gadgil Library



: GIPE-PUNE-068848

HARVARD ECONOMIC STUDIES

- I. The English Patents of Monopoly. By William H. Price.
- II. The Lodging House Problem in Boston. By Albert B. Wolfe.
- III. The Stannaries: A Study of the English Tin Miner. By George R. Lewis.
- IV. Railroad Reorganization. By S. Daggett.
- V. Wool-Growing and the Tariff. By Chester W. Wright.
- VI. Public Ownership of Telephones on the Continent of Europe. By A. N. Holcombe.
- VII. The History of the British Post Office. By J. C. Hemmeon.
- VIII. The Cotton Manufacturing Industry of the United States. By M. T. Copeland.
- IX. The History of the Grain Trade in France. By Abbott Payson Usher.
- X. Corporate Promotions and Reorganizations. By A. S. Dewing.
- XI. The Anthracite Coal Combination in the United States. By Eliot Jones.
- XII. Some Aspects of the Tariff Question. By F. W. Taussig.
- XIII. The Evolution of the English Corn Market from the Twelfth to the Eighteenth Century. By N. S. B. Gras.
- XIV. Social Adaptation: A Study in the Development of the Doctrine of Adaptation as a Theory of Social Progress. By L. M. Bristol.
- XV. The Financial History of Boston, from May 1, 1822, to January 31, 1909. By C. P. Huse.
- XVI. Essays in the Earlier History of American Corporations. By J. S. Davis. 2 vols.
- XVII. The State Tax Commission. By H. L. Lutz.
- XVIII. The Early English Customs System. By N. S. B. Gras.
- XIX. Trade and Navigation between Spain and the Indies in the Time of the Hapsburgs. By C. H. Haring.
- XX. The Italian Emigration of Our Times. By R. F. Foerster.
- XXI. The Mesta: A Study in Spanish Economic History, 1273-1836. By Julius Klein.
- XXII. Argentine International Trade under Inconvertible Paper Money: 1880-1900. By J. H. Williams.
- XXIII. The Organization of the Boot and Shoe Industry in Massachusetts before 1875. By Blanche E. Hazard.
- XXIV. Economic Motives. By Z. C. Dickinson.
- XXV. Monetary Theory before Adam Smith. By Arthur E. Monroe.
- XXVI. Canada's Balance of International Indebtedness, 1900-1913. By Jacob Viner.
- XXVII. The History of the United States Post Office to the Year 1829. By W. E. Rich.
- XXVIII. The Theory of International Prices. By James W. Angell.
- XXIX. Forests and Sea Power. By Robert G. Albion.
- XXX. Banking Theories in the United States before 1860. By Harry E. Miller.
- XXXI. Karl Marx's Interpretation of History. By Mandell Morton Bober.
- XXXII. Grain Growers' Cooperation in Western Canada. By Harald S. Patton.
- XXXIII. The Assignats. By S. E. Harris.
- XXXIV. The Economic and Social History of an English Village. By N. S. B. Gras and E. C. Gras.
- XXXV. Direct Taxation in Austria. By John V. Van Sickle.
- XXXVI. The Greenbacks and Resumption of Specie Payments, 1862-1879. By Don C. Barrett.
- XXXVII. The Street Railway in Massachusetts. By Edward S. Mason.
- XXXVIII. The Theory of Monopolistic Competition. By Edward Chamberlin.
- XXXIX. Interregional and International Trade. By Bertil Ohlin.
- XL. The French International Accounts, 1880-1913. By Harry D. White.
- XLI. Twenty Years of Federal Reserve Policy. By S. E. Harris. 2 vols.
- XLII. The Illinois Central Railroad and Its Colonization Work. By Paul W. Gates.
- XLIII. American Treasure and the Price Revolution in Spain, 1501-1650. By Earl J. Hamilton.
- XLIV. German Monetary Theory, 1905-1933. By Howard S. Ellis.
- XLV. Wages in Eighteenth Century England. By Elizabeth W. Gilboy.
- XLVI. The Theory of Economic Development. By J. A. Schumpeter.
- XLVII. The Supply and Control of Money in the United States. By L. Currie.
- XLVIII. British International Gold Movements and Banking Policy, 1881-1913. By W. Edwards Beach.
- XLIX. State Control of Local Finance in Massachusetts. By Royal S. Van de Woestynne.
- L. Fluctuations in American Business, 1700-1860. By Walter B. Smith and Arthur H. Cole.
- LI. Money, Prices, and Wages in Valencia, Aragon, and Navarre, 1351-1500. By Earl J. Hamilton.
- LII. The Development of the Business Corporation in England, 1800-1867. By Bishop Carleton Hunt.
- LIII. Exchange Depreciation. By S. E. Harris.
- LIV. A Study of Fluid Milk Prices. By John M. Cassels.
- LV. Location Theory and the Shoe and Leather Industries. By Edgar M. Hoover, Jr.
- LVI. Federal Subsidies to the Provincial Governments in Canada. By J. A. Maxwell.
- LVII. Studies in Massachusetts Town Finance. By Eugene E. Oakes.

HARVARD UNIVERSITY PRESS
CAMBRIDGE, MASS., U. S. A.

HARVARD ECONOMIC STUDIES
VOLUME LV

THE STUDIES IN THIS SERIES ARE PUBLISHED BY THE DEPARTMENT OF
ECONOMICS OF HARVARD UNIVERSITY, WHICH, HOWEVER, ASSUMES
NO RESPONSIBILITY FOR THE VIEWS EXPRESSED

LONDON : HUMPHREY MILFORD
OXFORD UNIVERSITY PRESS

**LOCATION THEORY AND THE
SHOE AND LEATHER
INDUSTRIES**

BY

EDGAR M. HOOVER, JR.

ASSISTANT PROFESSOR OF ECONOMICS IN THE UNIVERSITY OF MICHIGAN



CAMBRIDGE, MASSACHUSETTS

HARVARD UNIVERSITY PRESS

1937

COPYRIGHT, 1937

BY THE PRESIDENT AND FELLOWS OF HARVARD COLLEGE

X9(M97):294.73

68845 ^{G7}

PRINTED AT THE HARVARD UNIVERSITY PRESS

CAMBRIDGE, MASS., U. S. A.

PREFACE

IN RECENT years various causes have combined to bring the locational aspects of economics into greater prominence. On the one hand, revolutionary changes in the techniques of production, transportation, distribution of energy, and marketing have altered old patterns of geographical specialization, and there has been a growing disposition to assume control over this as over other aspects of economic life. An understanding of the way in which locational forces act has thus been more and more urgently needed. On the other hand, rapid strides have been made in extending the theory of economics into a sort of No Man's Land which the geographers were not equipped to explore. It is at last realized that the economic relations between man and the scattered resources at his command can be adequately analyzed only in terms of economic principles.

It is natural, then, that this study should reflect both 'practical' and 'theoretical' approaches. In it I have examined historically the location of two important American industries, and, drawing on this and other factual material, have attempted to develop a set of tools for attack on a whole range of locational problems.

This book is not a complete history of the American shoe and leather industries, since I have tried to bring into the discussion only such matters as are relevant to the question of geographic distribution. Still less is it a study of current problems in those industries; for one of the conclusions I have reached is that short-run questions of locational adjustment require a rather special kind of analysis for which the kind developed in this book is merely the groundwork.

On the other hand, I must disclaim any attempt to provide an exhaustive treatment of the theory of location. The aim has been, rather, to present enough of the outlines of the theory to acquaint the reader with progress in this still somewhat esoteric field, and

to place the historical matter relating to the shoe and leather industries in its proper setting.

My motives in making this study were two, of which one was ordinary curiosity about the workings of locational forces. The second was a realization of the need for such investigation as a basis for eventual judgment on the desirability of migrations of population and industry and possible lines of public policy. In that direction, of course, this study is but a small first step. No matter how well acquainted we may become with the workings of locational factors, the question of social desirability is likely to remain a subject of debate. Economics does not settle the question of right and wrong; the task of the economist is to tell us what results will follow from given causes. But where an economic process is concerned, the more we know about its workings the better we are fitted to pass judgment on matters of policy, and, possibly, even to agree on some things as being unequivocally bad or good.

The present book is perhaps subject to the criticism that it pays little attention to monopoly elements or to imperfections of competition. As a matter of fact, I have gone even further than that for the sake of simplifying the chapters relating to theory, and have practically ignored such important factors as the influence of overhead and joint costs. The only answer to the anticipated criticisms is that it seemed important to set forth in a preliminary work of this kind the locational working of the price system under the simplest reasonable assumptions.

A current view is that spatial separation of markets is itself a 'monopoly' element in competition, which takes the form of oligopoly if we consider the various sellers as being separated into small groups, or that of product-variation if we consider location to be one of the variable aspects of the product on a par with price, quality, reputation, and the like. But such a view of the nature of spatial competition is not incompatible with the policy of taking our difficulties one at a time, and isolating the effects of distance for independent consideration. It may also be remarked that if one of our aims is to provide a long-run basis for criteria of

rationalization or planning, emphasis on costs as a price factor is perhaps not misplaced.¹

In the case of short-run adjustments, of course, the equilibrium of pure competition, or indeed any equilibrium, must be relegated to an inconspicuous place in the background. At the end of the book the reader will find the conclusion that many of the most significant questions relating to public policy are concerned with the minimizing of wastes of locational maladjustment due partly to monopoly elements but largely to market imperfections and lags in adjustment. A theoretical approach in terms of rates of change and rates of response, rather than equilibrium, is imperative. Perhaps it is even more important here than in most kinds of economic problems, because the agents of production, and particularly the human ones, are often less mobile spatially than in any other respect.

The necessary groundwork for this kind of theory, however, can be supplied only by the fullest possible familiarity with the nature and workings of locational forces over the long run; and this book is intended to be a contribution to our knowledge of these forces.

In Part I, I have laid out for the reader's inspection the principal theoretical tools at our disposal in this kind of investigation. Parts II and III are devoted to the leather and shoe industries respectively, and there the method has been to describe first the relevant characteristics of the industry, not only in order to acquaint the reader with the processes of production and marketing and the stages in their evolution, but also to signalize in advance the factors that probably have been of primary importance in locating the industry. Then some consideration is given to each of these primary factors, and to the effects of the major technical changes in each industry. The concluding chapters, in Part IV, bring together the threads spun in the preceding parts of the book, and outline some suggestions for further investigation.

¹ ". . . it must be conceded that for problems connected with the distribution of resources between different uses, and the distribution of the proceeds of industry between the factors of production, the assumption of competition forms a more useful starting-point. For instance, we have already found it necessary to appeal to perfect competition in order to find a criterion for exploitation." Joan Robinson, *The Economics of Imperfect Competition*, Macmillan, London, 1934, p. 307.

The two industries chosen as case histories cover a wide range of locational problems. Both have a history extending back to the first permanent colonization in this country; both have been subjected to changes in technique which radically altered the conditions of their location. The relations existing between the leather and shoe industries are also well worth considering, since by far the larger part of the product of the former serves as the chief material for the latter, so that they may be regarded as successive stages in one process. The leather industry, during most of its history and in most of its branches, has been located primarily with reference to the cost of transportation of one or another of the materials, and illustrates the behavior of a large class of industries of which that may be said. Shoemaking, on the other hand, is equally representative of a class of industries in which costs of transportation have generally been unimportant in comparison with such advantages as trained labor.

A large share of whatever credit this study may deserve should go to Professor Edwin F. Gay, who read several early drafts of the manuscript and supervised its preparation as a doctoral thesis in 1932. His introductions to persons connected with the shoe industry were invaluable in obtaining first-hand acquaintance with processes and points of view.

A grant of funds from the Harvard University Committee on Research in the Social Sciences was devoted in part to the preparation of maps and charts, most of which were drawn by Katherine H. Bessell and John O. Hallstrom.

I am greatly indebted to Mrs. George W. (Blanche Hazard) Sprague of Brockton, who gave generously of her time and her wealth of practical knowledge of the shoe industry and facilitated close-up views of actual manufacture. The officials of the Keith, Douglas, and Regal firms were kind enough to explain details of factory operation, and Messrs. Elmer J. Bliss, H. D. Reed, and George W. Robbins of the Regal Shoe Company were especially accommodating in this regard. Mr. Thomas F. Anderson, then secretary of the New England Shoe and Leather Association, and Mr. Maxwell Field, the present assistant secretary and statistician, have put me on the track of valuable information, and Mr.

Field's researches into labor organization in the Massachusetts shoe industry were very useful. Mr. John C. Leukhardt, while secretary of the Committee on Industrial Decentralization of President Hoover's Conference on Home Building and Home Ownership, allowed me full use of the materials gathered by that committee. Messrs. Joseph Brodinsky and George A. Wilson have materially aided my search for information on the labor problems of the shoe industry.

Professors Fritz Machlup, A. P. Usher, E. S. Mason, and J. M. Cassels, and Dr. J. K. Galbraith have read and helpfully criticized portions of the manuscript. I am indebted to Professor Derwent Whittlesey and to Mr. H. S. Kemp for some useful guidance from the geographer's point of view, and I have also received stimulating suggestions from Drs. August Lösch and J. F. Normano. My wife's encouragement and active assistance in preparing the manuscript have been indispensable.

Dr. Tord Palander was kind enough to read proofs of Parts I and IV after the type had been paged, and offered some suggestions which were incorporated so far as was possible at that stage. The theoretical chapters of this book owe much to his University of Stockholm dissertation *Beiträge zur Standortstheorie*, which came to my attention early this year.

Thanks are due to the many publishers and authors who have given their permission for the reproduction of text passages, maps, and charts. Chapter XVI of this book is largely an adaptation of an article published in the *Quarterly Journal of Economics* for February, 1933, under the title, "The Location of the Shoe Industry in the United States."

E. M. H., JR.

CONTENTS

PART I

THE THEORY OF LOCATION

CHAPTER I

INTRODUCTORY.	3
The problem of location, 3. The concept of mobility, 4. Plan of procedure, 5.	

CHAPTER II

THE EXTRACTIVE INDUSTRIES	7
Definition, 7. Market areas as affected by transport costs, 8. Market areas as affected by extraction costs, 12. The margin line and its significance, 16. Extensive production and alternative land uses, 21. Rent surfaces and land utilization, 23.	

CHAPTER III

TRANSPORTATION COSTS AND MANUFACTURING INDUSTRIES . .	34
Factors determining the location of points of minimum transport costs, 36. Transfer costs, 39. Assumptions involved in the concepts of ideal weights and the material index, 40. Isodapanes, 42. Determination of market areas for material-oriented industries, 44. Areas of material supply for market-oriented industries, 46. Orientation zones for industries not unconditionally oriented, 48. Factors tending to localize production at material sources, markets, and junctions, 52.	

CHAPTER IV

LABOR-COST DIFFERENTIALS	60
Wage differences and labor mobility, 60. Equalizing and real differences in money wages, 61. Factors determining equalizing differences, 62. Their locational effect, 63. Historical importance of equalizing differences, 66. Labor immobilities and real differences in wages, 67. Permanent and frictional immobilities, 67. Migration as a response to real differences, 68. Historical importance of real differences, 70.	

CHAPTER V

PRODUCTION-COST DIFFERENTIALS IN GENERAL	75
Distinction between the locational effects of transfer costs and production costs, 75. Alfred Weber's formulation: the critical isodapane,	

77. Shortcomings of the Weberian analysis, 78. Market areas of low-cost production points in competition with other locations, 79. Why market areas often overlap, 85. Rôle of the theory of location in cases where transfer costs are unimportant, 87.

CHAPTER VI

ECONOMIES OF CONCENTRATION	89
Review of some causes of local concentration already suggested, 89. Criticisms of Weber's theory of agglomeration, 90. Economies of large-scale production, localization, and urbanization distinguished, 90. Effect of localization economies on market areas shown by the margin lines, 94. Diseconomies of localization, 94. Effect of localization economies in modifying market orientation, 99. Effect of localization economies in modifying material orientation, 104. Trade-area investigations, 104. Economies and diseconomies of urbanization, 105. Complementary relationships of industries, 108. Large-scale economies, 109. Monopoly elements and a new approach to the theory of location, 110.	

PART II

THE LEATHER INDUSTRY

CHAPTER VII

ESSENTIAL CHARACTERISTICS OF THE INDUSTRY	115
Principal materials and markets, 115. Evaluation of transport-cost factors, 118. Production-cost factors, 122. Basis for economies of concentration, 123.	

CHAPTER VIII

THE TANBARK PERIOD	125
Nearness to source of tanbark originally not a conspicuously restrictive locational factor, 125. Beginnings of trade and extension of markets by coastwise shipping, 127. How the by-product character of hides furthered the location of tanneries at ports, 128. Exhaustion of tanbark near the Atlantic Coast, 130. Migration of hemlock and oak tanneries, 130. Effect of shifting markets, 132. Why the tanning of skins remained in the East, 134. Regional specialization, 135.	

CHAPTER IX

EFFECTS OF TECHNICAL PROGRESS	137
Oak and hemlock extracts, 137. Imported tanning agents, 142. Inorganic materials, 143. Use of power machinery, 146. Influence of internal and external economies, 147.	

CONTENTS

xiii

PART III

THE SHOE INDUSTRY

CHAPTER X

ESSENTIAL CHARACTERISTICS OF THE INDUSTRY 159

Fundamental processes; the family stage, 159. The handicraft stage, 159. The putting-out stage, 160. Machinery and the factory system, 161. The use of power, 166. Orientation of the early hand industry, 167. Orientation of the later machine industry, 169.

CHAPTER XI

MARKETS AND MARKETING 173

Early market advantages of the Boston district, 173. The development of styles, 174. Effect of styles on importance of nearness to markets, 176. Extent to which interregional and interstate migration of the industry has followed population movements, 179. Foreign trade in shoes, 184. Effect of styles on stability of production and regional specialization, 190. Reduction of sales-financing requirements an aid to the midwestern shoe industry, 193. Tendency toward the elimination of the independent jobber, 194. Control of retail stores by manufacturers, and the reverse, 196.

CHAPTER XII

THE LEASING OF MACHINERY 199

Reasons for introduction of the system, 199. Consolidation of machinery producers, 201. Locational effects of uniformity of royalty charges, 202. Other effects of the leasing system, 204.

CHAPTER XIII

LABOR 206

Degree of skill required, 206. Importance of a large specialized labor market, 210. Use of female and child labor, 211. Development of labor supply in early New England, 213. Specialization in the North Shore and South Shore districts, 217. The small towns of Northern New England, 220. The Midwest and its labor supply, 221. Influence of German immigration, 224. Influence of the mechanization of the industry in the '60's and '70's, 226.

CHAPTER XIV

LABOR ORGANIZATION 229

Reasons for union strength in the industry, 229. Beginnings of organization in Philadelphia, 229. The McKay machine and the

Knights of St. Crispin, 230. The Knights of Labor and the Boot and Shoe Workers, 232. Contrasting policies of Boot and Shoe Workers and independent unions, 232. Estimates of union membership, 233. Estimates of geographical distribution of membership and strength, 236. Bases of local variation, 238. Styles as a factor, 248. Cost of living, 241. Labor-cost differentials and migration, 242. Cumulative specialization in style lines, 254.

PART IV

SUMMARY AND CONCLUSIONS

CHAPTER XV

LOCATION OF THE LEATHER INDUSTRY	259
The tanbark period, 259. Use of concentrated tanning agents, 259. Other technical changes, 260. The locational relationship between tanning and shoemaking, 261.	

CHAPTER XVI

LOCATION OF THE SHOE INDUSTRY	263
1630-1760; local handicraft, 263. 1760-1860; regional specialization, 264. 1860-1900; the factory system and the equalization of regional advantages, 269. 1900- ; styles and labor organization, 271. Analysis of the distribution of shoe manufacturing in 1929, 275.	

CHAPTER XVII

THE THEORY OF LOCATION AGAIN	281
Review of the theory as outlined in Part I, 281. Locational determination as a whole, 282. The genesis of localization and nodality, 284. The Industrial Revolution, 287. More recent locational tendencies, 289. Monopolistic competition and the individual entrepreneur, 294. Short-run theory and locational stability, 295. The point of view of social welfare, 300.	

BIBLIOGRAPHY	301
------------------------	-----

INDEX	315
-----------------	-----

TABLES

1. Relative importance of occupational groups in the United States, 1910 and 1930	35
2. Comparison of percentage changes in three chief occupational groups, 1910-30	35
3. Approximate average importance of terminal costs in various forms of transportation	56
4. Examples of extreme rates of population change in selected counties, 1920-30	69
5. The tanning industry	116
6. Hides and skins treated in the tanning industry, 1899-1931	117
7. Weights of principal materials per unit weight of product in representative German tanneries, according to Link	120
8. Forms of power in the leather industry and in all manufacturing industry in the United States, 1929	121
9. Some comparisons between the leather industry and all manufacturing industries, 1889-1929	124
10. Consumption of hides and skins in the United States leather industry, 1879-1919	134
11. Relative consumption of skins and hides in the tanning industry, by states, 1879	136
12. Use of oak and hemlock bark and extracts in tanning, by states, 1889	138
13. Tanning of sole leather according to agent used, 1889-1919	139
14. Percentage of union to total tannage of sole leather, by states, 1889-1919	139
15. Tanning agents used in the United States leather industry, 1879-1919	139
16. The twelve leading slaughtering and meat-packing cities in 1879	141
17. The twelve leading slaughtering and meat-packing cities in 1899	141
18. Percentage of hemlock and oak extracts to total tanning agents used, by value, 1889, 1899	144
19. Percentage of 'chemical' to total tanning materials used, by states, 1909	145
20. Percentage of 'woods, barks, etc.' to total tanning agents used, by value, 1919	145
21. Principal leather-wholesaling cities, 1929	148
22. Average number of installed horsepower per wage earner in the leather industry, by states, 1929	150
23. Distribution of value of products in the leather industry, by states, 1889-1933	152
24. Percentage distribution of value of sole leather production, by states, 1889-1919	152
25. Percentage distribution of value of harness and belting leather production, by states, 1889-1919	153

26. Percentage distribution of value of calf, kipskin and upper leather production, by states, 1889-1909	153
27. Percentage distribution of value of tanned goatskin production, by states, 1889-1909	154
28. Regional specialization in tanning of hides, 1889-1919	154
29. Regional specialization in tanning of calf and kipskins, 1889-1919	155
30. Regional specialization in tanning of goatskins, 1889-1919	155
31. Regional specialization in tanning of sheepskins, 1889, 1919	155
32. Production of leather boots and shoes according to method of manufacture, 1919-33	163
33. Kinds of leather boots and shoes by method of manufacture, 1933	163
34. Number of pairs of shoes sewed on McKay and Goodyear Welt machines, 1878-95	164
35. Forms of power in the shoe industry and in all manufacturing industry in the United States, 1929	167
36. Percentage distribution of wage earners in the shoe findings and cut stock industries	178
37. Average number of wage earners per establishment in shoe manufacturing, by states, 1879-1933	178
38. Index of population specialization in shoe manufacturing, by states, 1859-1929	179
39. Percentage distribution of shoe production by states, according to value of product, 1849-1933	180
40. Index of population specialization in shoe manufacturing, by groups of states, 1879-1929	182
41. Coefficient of localization for shoemaking with respect to population, 1879-1929	184
42. Domestic exports of boots and shoes from the United States, 1890-1906	186
43. Exports of boots and shoes from chief exporting countries, 1913 and 1924	189
44. Exports and imports of leather footwear, 1919-34	190
45. Percentage ratio of minimum to maximum month's production of men's and women's shoes, 1923-34	191
46. Invested capital per dollar's worth of annual product in shoe manufacturing, by states, 1879 and 1899	193
47. Relative importance of various channels of shoe marketing, 1917 and 1919	195
48. Percentage distribution of sales of shoe manufacturers by type of outlet, 1929	195
49. Types of shoe outlets, 1929	196
50. Percentage distribution of shoe manufacturing and wholesale and retail trade, by geographic divisions, 1933	198
51. Some comparisons between the shoe industry and all manufacturing industries, 1879-1929	199
52. Labor and time costs per pair of shoes, 1863-1923	206
53. Bureau of Labor Statistics index of production, man-hours, and man-hour productivity in the boot and shoe industry, 1900-27	217

TABLES

xvii

54. Relative importance of upper-leather cutting as a cost factor in shoemaking, 1863-1923	209
55. Membership of chief American boot and shoe workers' unions, 1897-1923	234
56. Distribution of locals of the chief national boot and shoe unions, by states, 1929 and 1935	239
57. Average hourly earnings in the shoe industry in selected cities and states, as percentages of average for United States, 1924 and 1928	242
58. Value of shoes produced in principal shoe cities, as percentages of United States total, 1879-1933	253
59. Value of shoes produced in principal shoe cities, as percentages of value of product in states in which cities are located, 1879-1933	253
60. Shoe production by establishments in individual cities and districts, 1929	279
61. Forms of industrial power capacity in the United States, 1899-1929	292

PRINCIPAL FIGURES

Omitted from this list are a number of diagrams relevant only to the accompanying text.

2. The relationship of wheat prices to areas of demand and supply, 1910-14	10
5. Market areas for coal in Germany	14
23. Average freight revenue per ton-mile on principal American railroads, 1852-1934, actual and deflated	73
34. Market areas in Appanoose county, Iowa	106
35. Approximate boundary between hemlock and oak-chestnut forests	131
36. Distribution of tanneries in 1885	133
37. Distribution of tanneries in 1929	149
38. Distribution in 1929 of tanneries specializing in the lighter qualities of leather	151
39. Index of population specialization in shoe manufacturing, by states, 1859-1929	181
41. Seasonal variation in shoe production	185
42. Regional specialization in shoe manufacturing, 1929	188
43-46. Distribution of shoe factories in eastern New England, 1889, 1920, 1929, 1935	244-247
47-50. Distribution of shoe factories in Wisconsin, Illinois, Missouri, and Iowa, 1889, 1920, 1929, 1935	248-251
51. Migration of shoe factories from Lynn, Mass., August 1, 1933, to December 31, 1934	252
52. Shoe factories in the United States, 1929	276

**LOCATION THEORY AND THE SHOE
AND LEATHER INDUSTRIES**



PART I

THE THEORY OF LOCATION

CHAPTER I

INTRODUCTORY

As a specialized branch of general economic theory, the theory of location may take only three things for granted: One of these is the distribution of natural resources; another is the desires and tastes of human beings; and the third is economic technique, meaning by this the ways in which man is able to combine the agents of production so as to make natural agents yield consumable utilities.

The only element absolutely fixed in position is 'land,' or natural resources. In fact, for the purposes of this book I propose to adopt spatial immobility as the criterion of what we shall call land. The economics of location is concerned with the spatial adjustment of mobile production-agents to land, in a way determined by human wants and capacities.

The nature of the 'mobility' here in question will perhaps become clearer if we examine for a moment the concept of economic rent. There are two reasons why some land yields a higher rent. It may be intrinsically better in fertility or mineral content or surface form, or whatever happens to be the quality desired. Or, it may be located at a point where the density of population is high and the demand for land in general is large. The first of these reasons accounts for differences in the value of different qualities of land similarly located, and the second accounts for differences in the value of similar qualities of land differently located.

The other agents of production vary locally in productivity and price for the same two reasons. An inefficient laborer or manager will produce less than an efficient one in the same location, and will tend to receive less; and two men of equal abilities may command quite unequal returns if one is in a place where labor is scarce and the other in a place where it is superabundant. For each agent of production, we may speak of *quality differentials* and *local differentials* in productivity and returns.

In the case of land there is no tendency for either sort of differential to disappear; while in the case of capital, labor, or management, competition tends ultimately to eliminate the local differentials and to leave only those based on quality. I shall use the term *mobility* to denote the extent to which the price of an agent of production is equalized at different locations. The mobility of land is by definition zero; while the mobility of fluid capital may be nearly perfect over considerable areas. For labor, the returns to which are spent mainly where they are earned, the rate of real wages is naturally the price in question.

National boundaries are perhaps the most conspicuous barriers to spatial mobility, so quite naturally the classical theory of international trade started with the rough but convenient assumption that no agent of production had any international mobility at all. Under this assumption, the distinction among the several production-factors has no international locational significance. International trade is determined by the relative costs of producing different commodities in the several countries, and for that trade it makes no difference whether a particular country's advantage happens to be due to qualities of land, labor, capital, or enterprise. Differentials in the return to a factor of production in different countries are partly *local*, and thus of the nature of rent.

It is wrong, of course, to express all costs in terms of one factor; but I have suggested above the reason why it was so long possible for the orthodox theorists of international trade to continue to do just that. So long as all the factors of production were alike in their international immobility, the separate factors and their combination were matters of purely domestic concern.¹

More recently an increasing amount of attention has been devoted to the more realistic cases in which some degree of mobility is conceded to all factors of production except land. For in-

¹ Bertil Ohlin (*Interregional and International Trade*, Harvard University Press, 1933, chs. ii and vi) explains that trade between regions or countries without the possibility of transfer of factors results in a tendency toward the equalization of the return to the various factors. Since Ohlin considers different varieties or qualities as different factors, the principle of exchange between regions under these circumstances is identical with what it would be if only a single factor (say land) were used in production, and if it were available in different qualities in the several countries.

stance, in Professor Bertil Ohlin's *Interregional and International Trade* the following possibilities are considered:

Case	Where discussed by Ohlin (<i>op. cit.</i>)	Assumptions on mobility:	
		Land	Other factors
'Interregional trade simplified'	part i (see p. 10)	fixed	fixed
'International trade simplified' * . . .	part ii (see p. 68)	fixed	fixed
'Intraregional trade'	chs. x-xi (see p. 183)	fixed	fully mobile
'Interregional trade'	part iii	fixed	partially mobile
'International trade'	parts iv, v	fixed	partially mobile

Because when any factor is fixed it is locationally equivalent to land, I shall omit any further consideration of the first two of Ohlin's cases. It seems most logical to begin a development of the theory of location by ignoring immobilities of capital, labor, and enterprise, which will henceforth be referred to as the 'mobile' factors. We shall first consider them as perfectly mobile (in Chapters II and III) and subsequently examine the locational effects of their partial immobility.

It is important to note here that the concept of perfect spatial mobility for an agent of production implies *perfect divisibility* of the agent. Until we relax this assumption, then, the question of any sort of economies of concentrated production may be ignored. A further simplifying assumption is that the producers or sellers at any one location are in perfect competition.

The two chapters following this introduction will deal with the distribution of extractive and processing industries under the simplified conditions outlined above. The locational factors considered will be merely transportation costs and the distribution of natural resources, i.e., local differentials in costs of 'extraction.'

Subsequent chapters will see a gradual approach to the complexity of actual locational determination. In Chapter IV we

* International trade is "a special case [of interregional trade], where the regions are different countries." Ohlin, p. 68.

shall explore local differences in labor costs, and in Chapter V the effects of production-cost differentials in general. Chapter VI introduces the further complication that arises when manufacturing costs vary according to the degree of local concentration of production.

I have put a summing-up and synthesis of the theory not at the end of Part I, but in the final chapter of the book, which makes it possible to utilize such historical material as is introduced in Parts II and III. The first pages of Chapter XVII may usefully be referred to in connection with the reading of Part I.

CHAPTER II

THE EXTRACTIVE INDUSTRIES

THE simplest case of the adjustment of mobile to fixed factors of production occurs in the extractive industries, which work with a raw material in its natural state and location. In general, the process is essentially mere extraction from the earth; and I mean to include in the term 'extractive industries' only such activities as *must* be carried on at the source of the material. The felling of timber or the production of hydroelectric power, for instance, is such an activity, but the sawing of logs into lumber or the production of electricity from coal is not.

The reason for the greater simplicity of the locational adjustment in the extractive industries is that we need not inquire whether production will take place at the source of the material, at the market, or somewhere else, as we must for manufacturing industries. That question is settled for us. Extractive industries are, by definition, located at a source of their material; their location involves merely a choice among various possible sources.

If only one commodity were produced, and if each source yielded it at a cost which were constant regardless of the rate of output, then our problem would be quite simple. All the people, all the production, and all the consumption would be located at the cheapest source of the commodity. Evidently the major complicating factors are these three:

(a) More than one commodity is involved, so that one of the elements in the desirability of a natural resource is its nearness to points of consumption, including the sources of other materials.

(b) Costs are not independent of the scale of output per unit of area. After a certain intensity of exploitation has been reached, it becomes cheaper to bring additional sources into production.

(c) A given piece of land may be devoted to any one of several alternative uses. The question of land utilization is, in fact, merely that of location viewed from another angle.

For the present let us ignore all but the first of these factors. Its relative importance is well shown historically by the sequence in

which land was settled in the United States. Not the most fertile regions, but those nearest the coast, were occupied first: the stony hills of New England were tilled for generations before the far better soil of the Mississippi Basin ever felt the plow. As is well known, it was the observation of this order of settlement which led Carey to take issue with the Ricardian theory of rent.¹

To picture the effect of the transport-cost factor alone, the Launhardt-Fetter concept of market areas for rival selling points is relevant and adequate.² If the cost of extraction of each commodity at each source is given, the delivered price at any other point will be the cost at the source plus freight charges. The lowest combination of cost-plus-freight determines from which source any given consumption point will be served.

The most convenient way of representing this is by a system of contour lines or *isotims* connecting points of equal delivered price.³ Since the price is at a minimum at the source of supply, these isotims will be concentric about the source. Each isotim represents the locus of a delivered price one unit greater than that of the next line toward the source. Under the simplifying assumption of transport costs proportional to distance in all directions and for all distances, the isotims are concentric circles about each source, as shown in Fig. 1a; but any irregularity in the pattern of transport costs will of course distort the delivered-price pattern. Fig. 1b shows a set of irregular isotims, and Fig. 2

¹ Cf. Gide and Rist, *History of Economic Doctrines*, pp. 338-339; also Alfred Marshall's discussion in his *Principles of Economics*, book iv, chapter iii, §§ 5-6, with the marginal note: "But Carey has shown that Ricardo underrated the indirect advantages which a dense population offers to agriculture."

² Wilhelm Launhardt, *Mathematische Begründung der Volkswirtschaftslehre* (Leipzig, 1885); F. A. Fetter, *The Masquerade of Monopoly* (New York, 1931), chapter xx; also "The Economic Law of Market Areas," in *Quarterly Journal of Economics*, May, 1924, pp. 520-529.

³ The modern Swedish locational economists and geographers have been particularly active in developing the use of contour lines to indicate patterns of transport costs, delivered prices, delivery time, and the like. For the fullest treatment of this technique, the reader is referred to chapters vii, ix, and xii of Tord Palander's *Beiträge zur Standortstheorie* (Stockholm thesis, published at Uppsala, 1935; to be republished soon by the Royal Swedish Academy of Sciences, with additional chapters). Palander's work has influenced the present book to a much greater extent than it is possible to indicate by specific references.

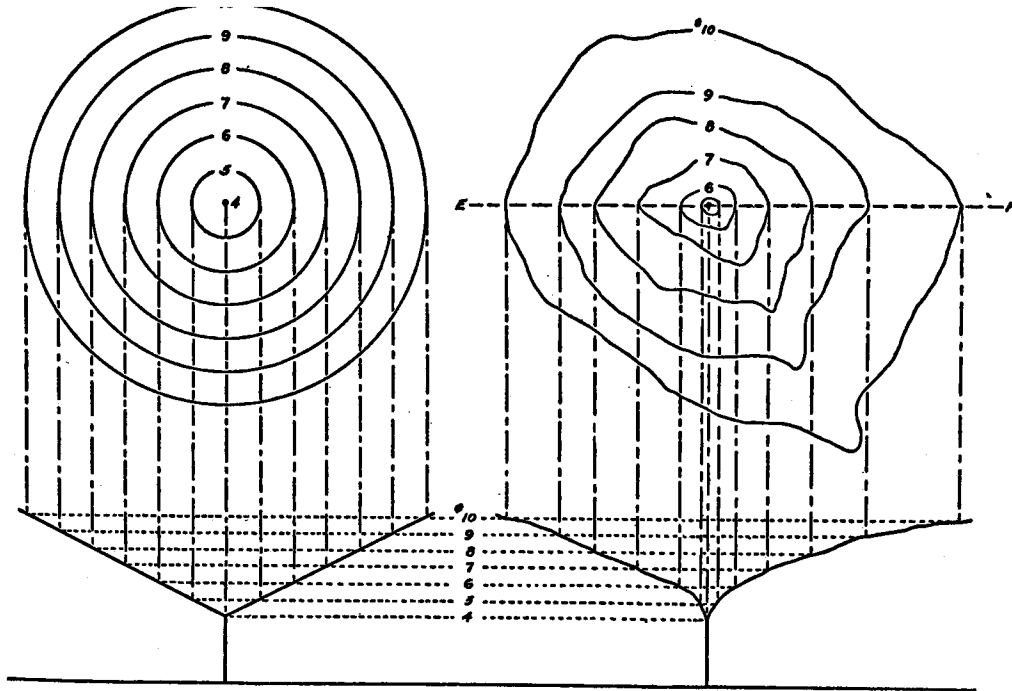

FIG. 1 a

FIG. 1 b

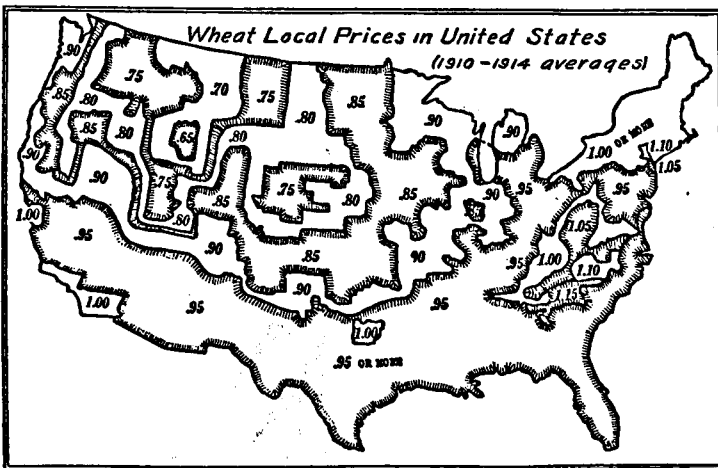
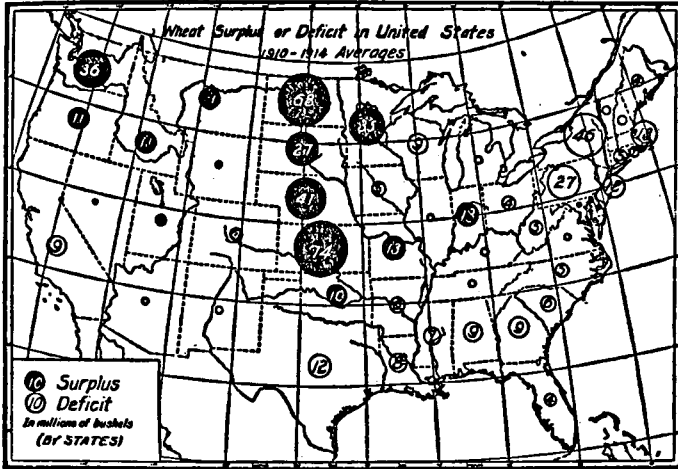

FIG. 2. The relationship of wheat prices to areas of demand and supply, 1910-14. Reproduced by permission from F. A. Fetter, *The Masquerade of Monopoly* (Harcourt, Brace, New York, 1931), pp. 295 and 297.

shows the way in which the price of wheat in the United States varies with distance from the main sources of supply.

Fig. 1 also illustrates the two ways of representing a spatial pattern of prices: by isotims in the upper part of the figure, and by *transport gradients* in the lower part. The transport gradient is restricted, of course, to points along one line. In Fig. 1b, the one shown in the lower part of the figure tells us nothing about any prices save those along *EF*.

Now the characteristic of any point on the boundary of the market areas of two extracting-points *A* and *B* is that the delivered price of the commodity is the same whether it comes from *A* or from *B*. That means that the lower-cost source must be enough farther away so that the difference in transport costs just compensates for the difference in extraction costs. If transport costs are uniformly *f* per unit of distance, then a point *P* will be on the boundary line if:

$$f(AP - BP) = K_B - K_A,$$

where K_A and K_B are the costs of extraction at *A* and *B* respectively. In the above equation these costs are given constants, as is likewise *f*. Accordingly, the geometrical form of the curve is defined by the condition that the difference of the distances *AP* and *BP* must be a constant. The curve is therefore always a hyperbola under the assumption that the costs and the ton-mile rate of transport costs are constant.

In Figs. 3 and 4 I have illustrated the construction of market-area boundaries under some other conditions. Fig. 3 implies that rates are the same in all directions but less than proportional to distance, while in Fig. 4 the rates are altogether irregular, much as we might find them in practice. Naturally the boundaries between market areas are not smooth hyperbolas in such cases.

To illustrate the application of the market-area technique to the case of an extractive industry, I have reproduced in Fig. 5 a map prepared by Regul to show the shifts in market-area boundaries for Westphalian, British, and Silesian coal in Germany, at three separate dates with different transport rate schedules. Fig. 6 shows the character of the three transport gradients involved; but

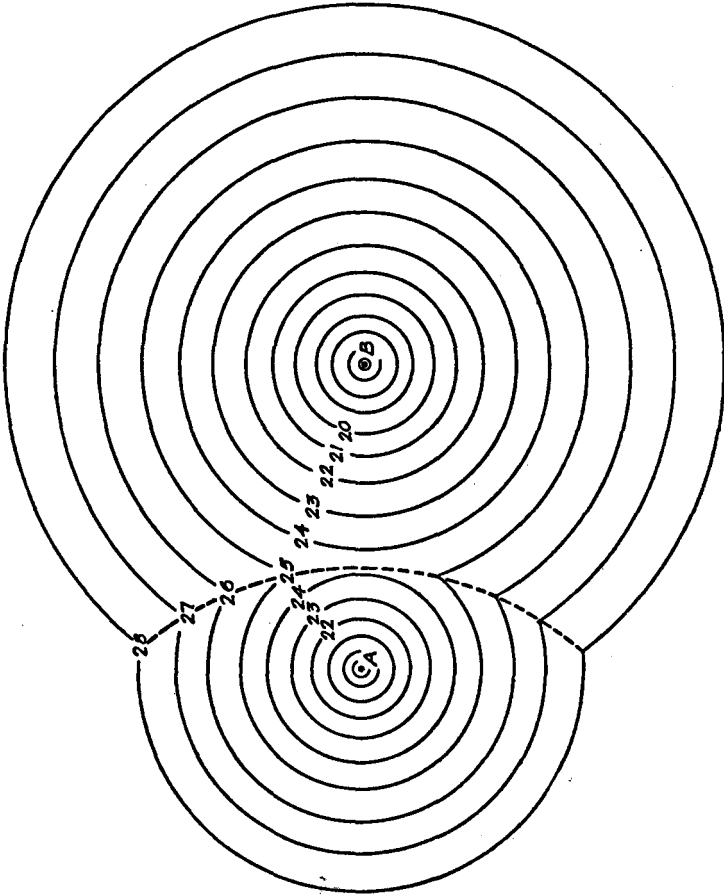

FIG. 3

it should be kept in mind that not only the indirectness of railroad routes but also the existence of certain exceptions to the tariffs play a part in shaping the market-area boundary.

It is now time to take into consideration the fact that the output of a material at a single point is not capable of indefinite increase at the same unit cost. Characteristically, the activity of

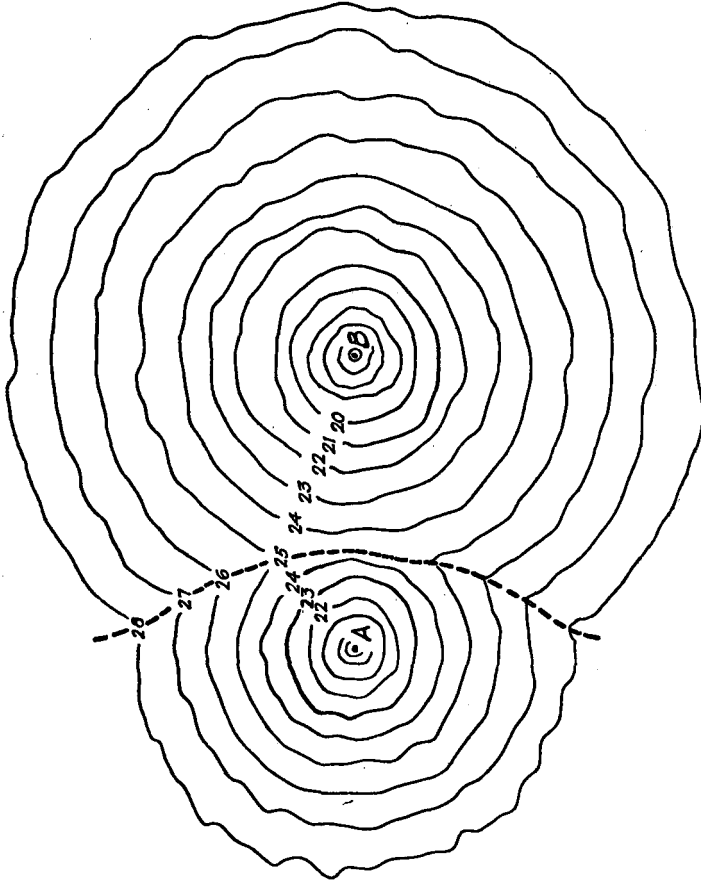

FIG. 4

extraction is always carried into the range of diminishing returns, where more intensive application of the mobile factors of production yields a less than proportional return.

It is *marginal* costs which will now tend to be made equal to the price. The *average* costs of applying the mobile factors will be more or less below the selling price — depending on the volume of

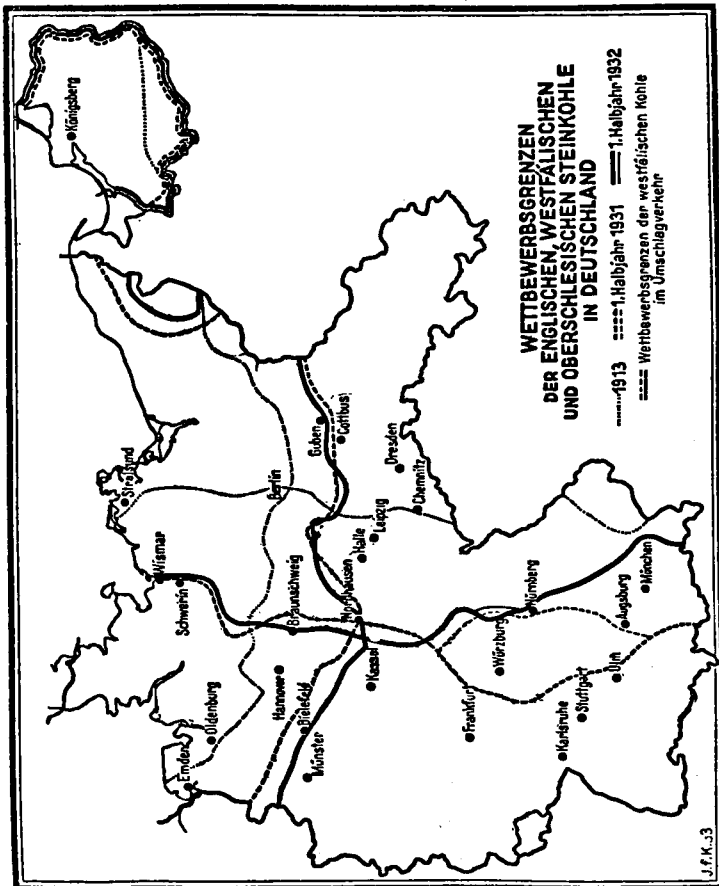

FIG. 5. Market areas for coal in Germany. Reproduced by permission from Rudolf Regul, "Die Wettbewerbslage der Steinkohle," in *Vierteljahrshefte zur Konjunkturforschung*, Sonderheft 34 (Berlin, 1933).

output — and the total difference between the costs of the mobile factors and the receipts constitutes the *location rent*.⁴

⁴ Location rent, as I have here called it, may be thought of as the local differential accruing to immobile factors of production in some places by virtue of their exclusive advantages of location.

Since spatial mobility may be anything from zero to 100 per cent there must be

The effect of diminishing returns on the competition of extraction-points is best seen by reference to Fig. 7, where *CQ* is a transport gradient showing the increase in delivered price with

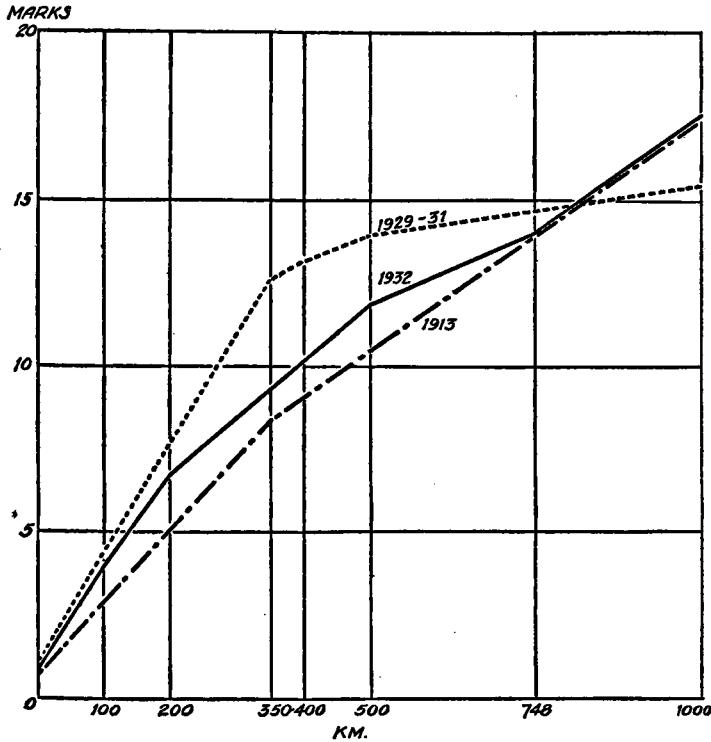

FIG. 6

distance from the source *A*. The height of a transport gradient depends on the price of the commodity at the point of extraction, and under the influence of diminishing returns this will rise as the market area — and therefore the total output — increases. For

the same sort of gradation between location rent and the other distributive shares as there is between ordinary economic rent on permanent goods and the interest on capital: i.e., a series of 'quasi-rents' of different degrees of resemblance to rent proper.

each rate of output there is a different position of the transport gradient. Fig. 7 indicates, for instance, that if A 's market area extends to L , the cost at A will be AC , and transport costs will make the delivered price at outside points grade up to LQ at L . If A 's market area extends to M , delivered price will range from AR at A to MS at M . An extension of the market area to N would make the transport gradient rise to TU . Similarly, the transport gradient of a rival extraction-point B will shift upward as the market area expands, assuming positions DG, HI, JK .

On these various transport gradients the significant points are those indicating the price at the edge of the market area. Such points are Q, S, U on A 's gradients and G, I, K on B 's. If we connect all such points we have a new line showing the way in which delivered price at the edge of the market area varies as the extent of the market area itself varies. This line (shown as a heavy curve in Fig. 7) I shall refer to as the *margin line*.

It is easy to see that in a case such as that of Fig. 7, where each source has its local market all to itself and price competition is restricted to intermediate zones, the outcome of this competition will be determined by the intersections of the respective margin lines. Equilibrium would be reached with the market-area boundary at Z .

But if the number of sources is large relatively to the number of consumption-points, the case is a little different. The complication arises from the fact that a single consumption-point may be able to absorb the whole output of several sources located at different distances, so that the outlying sources will be shipping their product past the nearer ones and competing in the central market.

Fig. 8 indicates a situation of this character. $A, B,$ and C are sources which send the bulk of their product to a market at T . The margin lines of the three sources are $EH, GJ,$ and FK , which are here given the same slope as the transport gradient on account of the fact that there is virtually no demand to the left of TL . To the right of TL , the horizontal scale indicates not additional distance, but amount sold in the consuming market, the demand curve of which is DD' . And here the sharp upward slope of the margin lines (or rather, *transferred supply curves*) indicates the

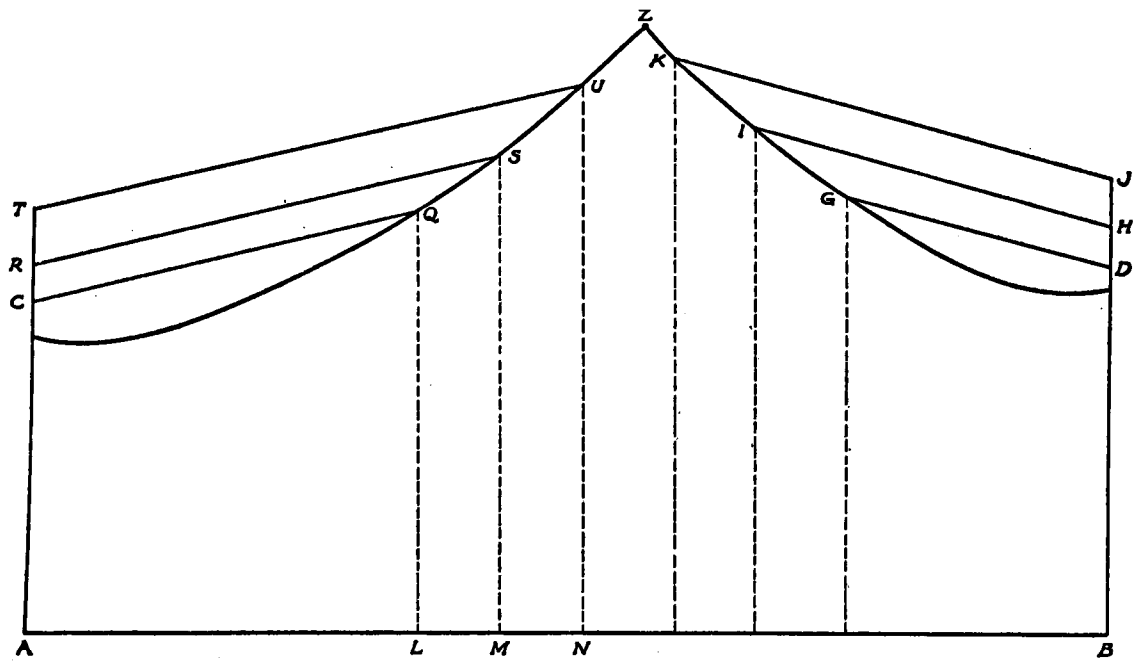

FIG. 7

reached when the price in the market (indicated by the ordinate of the heavy horizontal line LP) is such that the combined supply of the three sources just satisfies the demand: i.e., when $LM + LN + LO = LP$.

The transport gradient involved in this equilibrium will of course be QL , and marginal costs at the three sources will be AQ , BR , and CS respectively. It is evident that the competition between these three sources includes not only the central market at T but also whatever demand may exist to the left of T .

♦ The shape of the margin line involves a great many factors, which it would take us far too long to consider at all adequately. One element determining its shape is the way in which costs respond to total output, a functional relationship which we assume given. A further factor is the way in which total output depends upon the extension of the market area. To account fully for this we should have to know the elasticity of demand at each point, as well as the shape of the market area, the quantitative distribution of consumers, and the distribution of competitors on all sides of A . A still further factor is the way in which extension of A 's market area toward B (in Fig. 7) is related to changes in the total size of A 's market area. This is something about which it seems impossible to generalize without making assumptions that would render our conclusions entirely irrelevant to reality.⁵

It is legitimate to assume that, in terms of long-run equilibrium, there will be a chain of functional relationships linking the following variables:

- (a) Position of the boundary of A 's market area along the line between A and B .
- (b) The total size of A 's market area.
- (c) The total quantity of A 's product sold.
- (d) Costs of production at A .

⁵ "Lardner's Law of Squares," for instance (see Dionysius Lardner, *Railway Economy*, London, 1850), tells us that the size of the market area will vary inversely as the square of the mileage rate of transport (since the 'radius of transportability' is inversely proportional to the rate of transport). This holds good if transport costs are uniform and if the market area is circular, which implies the absence of any rival supply centers. If supply centers are distributed equidistantly and have equal costs, the market areas are equal hexagons.

In the diagrams the intermediate variables (*b*) and (*c*) are ignored, and the cost of production at *A* (hence, the height of the transport gradient) is shown as a function of the position of the boundary point on the line between *A* and *B*. The nature of the functional relationship would have to be determined *ad hoc* for any specific situation.

It is evident that in the range of diminishing returns the margin line will rise at a steeper slope than the transport gradient. And since it is the intersection of margin lines that determines market-area boundaries (e.g., at the point *Z* in Fig. 7), we may say that the influence of diminishing returns works in the same direction as that of transport costs. It restricts the dominance of the lower-cost sources and provides relatively sheltered local markets for higher-cost sources. The steeper the margin lines, the greater will be the number of different sources utilized; the flatter the margin lines, the more localized will the extractive industry in question be.

The most obvious of the factors affecting the slope of the margin line is the slope of the underlying transport gradients. Other things being equal, high transport costs mean scattered local production, and cheap transport means localized (i.e., concentrated) production.

Apart from the general *level* of transport costs there must also be considered the form of the tariff structure. In the more primitive modes of transport, the cost of carriage seems to be nearly proportional to distance, since most of the costs involved are those of actual movement.⁶ In the case of transport agencies with considerable terminal and general expense, however, there is a universal tendency for the rate per mile to decline as the length of haul increases: i.e., to make transport costs somewhat less than proportional to distance. This means that the typical transport gradient is convex upward, which retards the rise of the margin line in its outer reaches.

⁶ Much material on the history of transport costs is to be found in J. L. Ringwalt, *Development of Transportation Systems in the United States* (Philadelphia, 1888). In the data given by Ringwalt for the rates charged for road or pack-animal carriage, I have been unable to find any tendency toward a discount on long hauls. See also Table 3 in the next chapter.

The slope of the margin line depends also on the way in which consumers are distributed. If they are concentrated in the immediate neighborhood of the source, and are more sparsely distributed in the outlying parts of the market area, then a given areal extension of the market will mean a less than proportional increase in the number of buyers, consequently less pressure on the resources at the source, and a flatter margin line than the one that would result from a uniform distribution of consumers. On the other hand, if there is a large city in an outlying part of the market area, then a very small areal extension of the market may mean a large addition to the number of buyers and a correspondingly steep section of the margin line.

The elasticity of the demand for the commodity at each point in the market area is also of importance in determining the slope of the margin line. For as the market is extended and the marginal costs rise, the price rises at all points in the area (as indicated by the upward shift of the transport gradient), and presumably less is bought at any one point. If the demand is highly elastic, so that a great deal less is bought in such a case, then the extension of the market area may bring comparatively little increase in output and comparatively little rise in prices. The margin line will be flatter than it would be if demand were less elastic. Elastic demand, then, is a factor tending to localize extractive industries.

Last, but by no means least, is the influence of the cost function itself upon the slope of the margin line. If an increased output is forthcoming without much increase in marginal cost, the transport gradient will be relatively little affected, and the margin line will therefore be not much steeper than the transport gradient.

We may now turn to the class of extractive industries in which the question of alternative uses for a given piece of land is of consequence. Typically this means agriculture; and it is worth while to inquire just what special features distinguish this type of activity from others.

The extractive industries as a group are set apart from the others by the fact that they are technically bound to locate at the source of their materials. It is natural, therefore, that their optimum combination of productive factors generally involves a

greater proportion of land than is the case in manufacturing uses. For the extractive industries, land means not only space on which to erect buildings and to work; it is at the same time the source of the raw material. This extensive character of factor-combination appears most strikingly in agriculture, which, unlike mining or manufacturing, can generally utilize its space in only two dimensions: i.e., in one layer.

Although the unit of enterprise, or firm, is spatially extensive in agriculture, it is generally small in relation to the total resources devoted to producing the crop in question. In part, this arises from the extensive character of agricultural operations; in part, from the seasonal factor. The well known relative competitiveness of agricultural as compared with industrial production bears witness to the relative insignificance of the individual producer.

This means that within any area where conditions favor a particular crop, the same crop may be produced by hundreds or thousands of neighboring independent producers. Such seems in fact to be the rule.

[the principle of specialization] affirms, when applied to land, that any given area within which conditions are homogeneous tends to be used in producing one product and one only.⁷

The above considerations indicate that the most logical approach to the location of agricultural production is not that of the market areas of individual producing points, but rather the supply areas of individual consuming points. Not only is consumption more localized than production, so that the consumption points are fewer in number, but also the number of producers serving a single consumption point is likely to be large, so that the demand for the product of any one producer is almost perfectly elastic.

Given the price of a product at the point of consumption, the price at other points will be determined by costs of transportation. We may think of the price-pattern around a consuming market as being represented (in any one direction) by a downward-sloping transport gradient, or (in all directions at once) by a series of

⁷ *Research in Farm Management*, ed. by John D. Black (Social Science Research Council, Bulletin No. 13, June, 1932), p. 90.

isotims roughly concentric about the consuming market. The spacing of these isotims will depend, of course, upon the way in which transport costs vary with distance.

The amount of rent which can be obtained in a particular use of a particular piece of land depends on two things: (a) the cost function, which takes into account not only fertility but also labor and capital prices and efficiency, and (b) the price of the product. Since the cost function is at present taken as one of our basic data, the rent will depend on the price of the product.

From a given pattern of prices, then, we may determine a pattern of rents in the territory around a consuming market. If the amount of rent is represented by vertical distance, our pattern takes the form of a roughly conical *rent surface* for the particular use and particular price-pattern in question. In any one direction from the consuming market, a profile of the rent surface would give a *rent gradient* (see Figs. 11, 12, 14 below) depicting rent as a function of distance in the same way as the transport gradient depicts price as a function of distance.

It is important to realize that a rent surface represents the variation of rents in the production of only a single product. Over any given area there will be as many different rent surfaces as there are products which would more than pay for the cost of the mobile factors used in producing them. For other products (e.g., grapes in Scotland) rent would be non-existent. Furthermore, the rent surface for a given product will shift its position with every change in the price at the consuming market.

It is worth while to give some thought at this point to the principal factors determining the form of the rent surfaces for various land products. The most obvious is differentials in the cost of extraction (i.e., in the cost function) at different points. In large part, these differentials are based on soil and climate, and are thus beyond the scope of purely economic analysis. In part, however, they are economically systematic: for instance, regions of low food prices tend to be regions of low labor costs. The significance of this for the location of production in general will be examined in a later chapter. For the present it is necessary merely to note that a difference in the cost function between two different points

will deform the roughly conical shape of the rent surface. Points or areas of low cost will be indicated by humps or bulges in the rent surface; points or areas which for any reason have high costs will be indicated by hollows or dents in the rent surface. Naturally, the circumstances that would reduce local costs in the production of one crop might be relatively less advantageous, or even disadvantageous, in the production of another crop. So we should not expect the rent surfaces for different crops to have their bumps and hollows in corresponding places.

Another obvious factor influencing the form of rent surfaces is the level of transport costs. When this is high, the price of the product falls off rapidly with increased distance from the buying market, and rent falls with corresponding rapidity. This is a point too familiar to require more than passing mention.

It should also be noted that since transport costs are generally less than proportional to distance, the price will fall off more rapidly at short distances from the market than at long distances. Consequently, there will be a tendency to make the rent surface concave upward (i.e., falling more rapidly in the neighborhood of the market, and tapering gradually to zero in the outlying parts of the supply area).

It will be apparent from Fig. 9, however, that rent surfaces will be concave upward even when transport costs are directly proportional to distance. The cost function represented in the figure is that of *marginal costs of mobile production-factors* (vertically) and rate of output per acre per year (horizontally). Production will tend to be at the rate which equalizes marginal costs of mobile production-factors with the price of the product (represented by the horizontal line PQ), and the rent per acre per year will be proportional to the shaded area in the figure.

The only generalization we can make about the shape of the cost function is that it will be positively inclined; but so long as it is positively inclined, then a given change of price will mean a larger change in rent when the price is high than when it is low. A comparison of the two black areas in Fig. 10, which represent the changes in rent corresponding to two equal changes in price at different initial prices, will adequately attest this point. It follows

directly, then, that in the case of a single rent surface, under conditions of uniform proportional transport costs, the rent surface must always have a steeper slope near the market. It will be concave upward when the transport gradient is a straight line; when

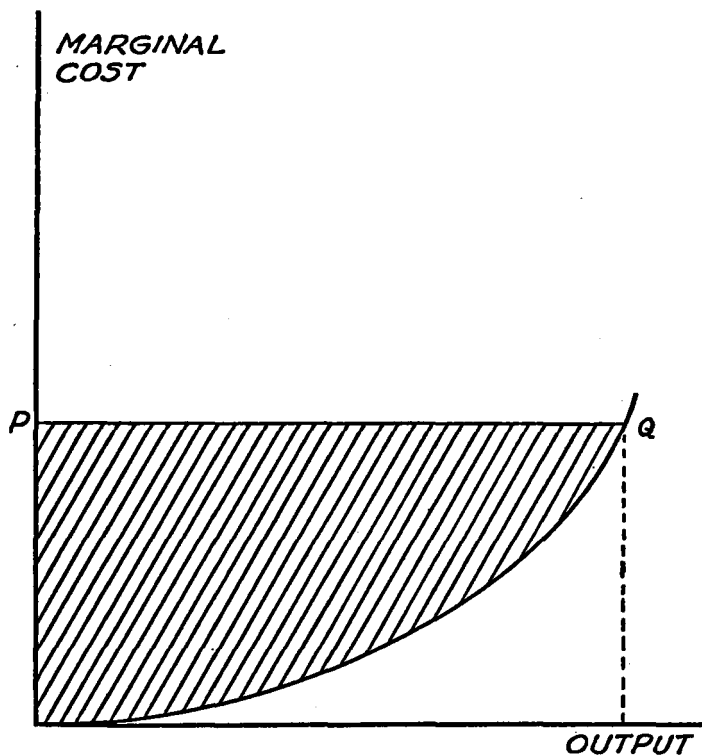

FIG. 9

the transport gradient itself is concave upward, as it usually is in practice, the rent gradient will be so *a fortiori*.

The common sense of our conclusion about the concavity of the rent surface will be evident on further thought. A fall in the price paid for the commodity affects the amount of rent in two ways: by lessening the amount paid for each unit, and by lowering the margin of cultivation so that it is not profitable to produce so

many units per acre. An extra dollar in transport costs will reduce rent more in the intensively cultivated areas near the market than it will in the outlying areas of extensive cultivation, because the reduction applies to more units of product per acre.

As between different products, the form of the rent surface will differ according to the amount of the product produced per acre of land; which, of course, depends ultimately on the nature of the cost function. If the transport rate per ton-mile is the same on all products, then a given added distance from the market means the same reduction in price per ton on all products. But if one product is characteristically produced at such intensities as 100 tons to the acre and another product at the intensity of one ton to the acre, the reduction in rent with increased distance will be very much more rapid — i.e., the rent surface will be much steeper — in the first case. If the first commodity is to be produced at all, it must be produced in the vicinity of the market.⁸

Rent surfaces for mineral industries, or in general for those restricted to localized sources, are likely not to show the complete conical form at all, but to consist merely of little fragments sticking up like stalagmites here and there — the reason being that in such cases the richness of the resource is a much more important factor than nearness to market. With such widely-distributed and bulky minerals as brick clay or gravel, however, the effect of transport costs, as shown in the tendency of the stalagmites to be higher in the vicinity of the market points, would be more easily discernible.

In Fig. 11 I have attempted to give an idea of the appearance of several different types of rent surface, as seen in cross-section. The picture is necessarily not only arbitrary but very much distorted, since the surfaces vary enormously in extent and slope. It would be impracticable to try to picture the rent surface for coal or wheat, for example, on the same scale as that for market gar-

⁸ On the effect of transport costs upon the prices of various commodities, see in particular Theodor Brinkmann, "Die Oekonomie des landwirtschaftlichen Betriebes," in *Grundriss der Sozialökonomie*, vol. vii, 1922, translated as *Theodor Brinkmann's Economics of the Farm Business* (Berkeley, Cal., 1935), pp. 82-83, and the *Report of the Joint Commission of Agricultural Inquiry* (67th Congress, 1st Session, House Report No. 408), part 3.

dening. So the reader is warned against taking the relative proportions of the diagrams too seriously.

Fig. 12 shows the pattern of *land utilization* that would result if the separate rent surfaces were as shown. The use affording the highest rent has at each point been adopted, and each use has in

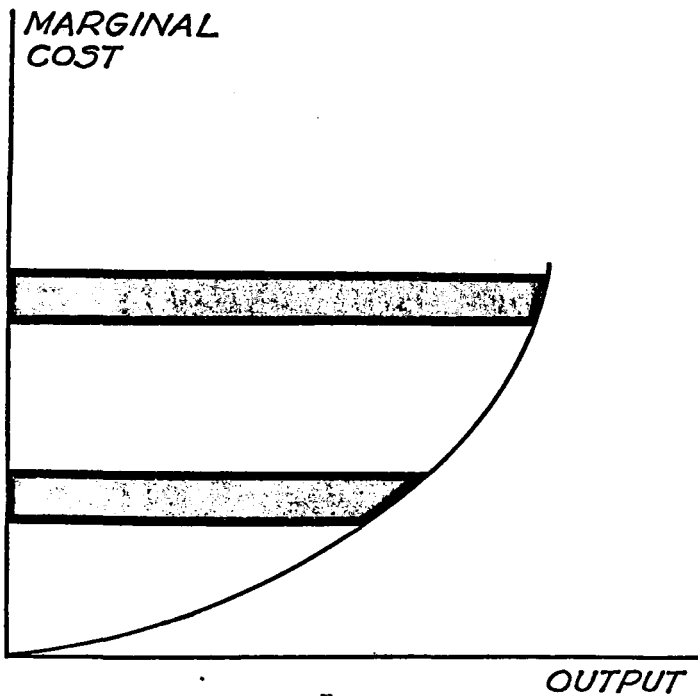

FIG. 10

some places been crowded out by one of the others. It is to be noted, by the way, that we have here still another reason why the actual pattern of rents around a buying market should show a more rapid decrease in the near vicinity of the market than farther away. Not only is the rent surface for each use concave, but the steeper surfaces are, in general, the highest bidders for the land near the market and the flatter surfaces are the highest bidders for the land farther away. The composite pattern of rent surfaces

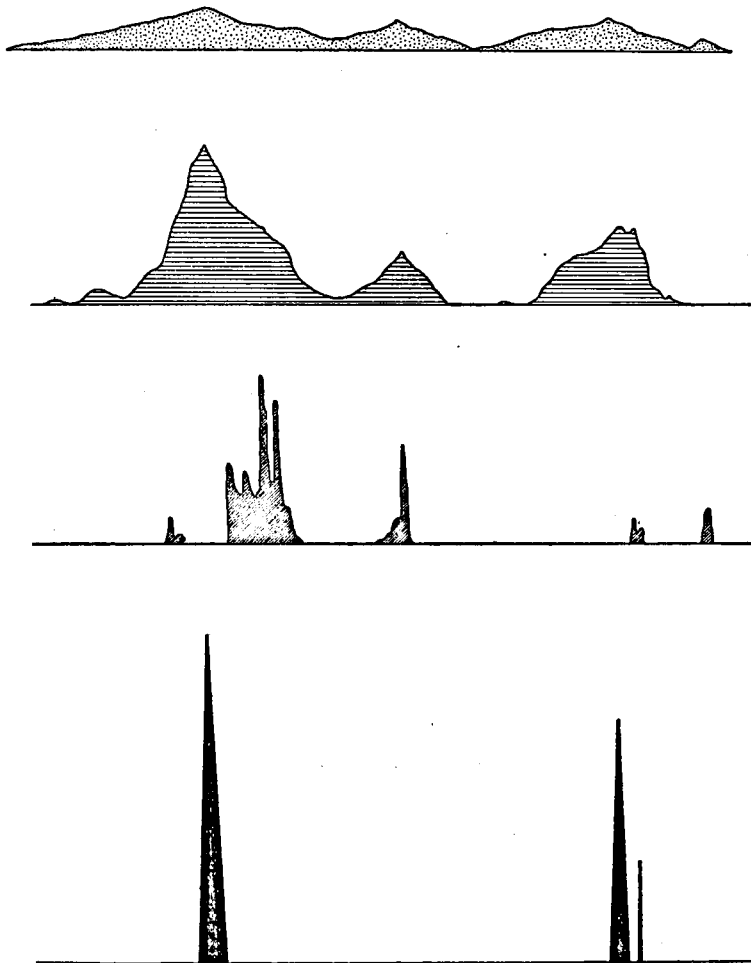

FIG. 11

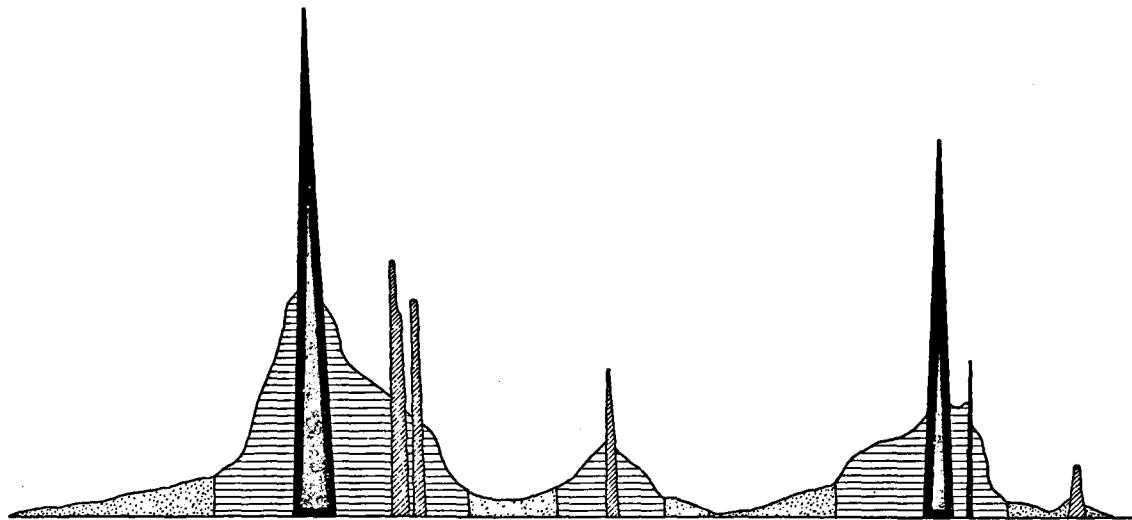

FIG. 12

should then be more concave than the rent surfaces which compose its various parts.⁹

A convenient illustration of rent gradients arises in connection with the production of milk, cream, and butter within a metropolitan milkshed.¹⁰ Strictly speaking, none of these is the product of a purely extractive industry, since it is technically possible to produce them with materials brought in from outside, and Dr. J. K. Galbraith informs me that this is done to a considerable extent in the Los Angeles and Boston milksheds. In general, however, the dairy industry utilizes materials found on the spot, and behaves therefore as an extractive industry.

One advantage of this particular example is that we know the relationship between the respective cost curves. In order to produce a gallon of cream it is first necessary to produce about ten gallons of milk; in order to produce a pound of butter it is first necessary to produce about twenty-five pounds of milk. If we ignore the small by-product differentials, the cost functions for the three products may be represented as in Fig. 13. I have taken hypothetical figures but preserved the 1:10:25 relationship among the curves.

To give the illustration a maximum of simplicity, let us assume that the transport rates on each of the three products is 5 cents a ton-mile. If now we take the prices at the consuming market as

⁹ The German literature of agricultural economics is particularly rich in factual examples. See for instance Brinkmann, *op. cit.*, Friedrich Aereboe, *Allgemeine landwirtschaftliche Betriebslehre* (Berlin, 1923), and the general discussion of the Thünen school in chapter iv of Tord Palander's *Beiträge zur Standortstheorie*.

An interesting American case is provided by a bulletin of the Department of Agriculture (No. 678: *Influence of a City on Farming*, 1918), p. 11, which gives average rents per acre for 100 farms grouped according to their distance from Louisville, Kentucky. The farms less than 8 miles from the city had an average rent of \$11.85 per acre; those 9 to 11 miles away, \$5.59; those 12 to 14 miles away, \$5.37; those more than 14 miles away, \$4.66. Truck crops and potatoes predominated on the farms nearest the city, while dairy and general mixed farming was the rule at greater distances.

¹⁰ This illustration is based on the one used by Professor J. D. Black in chapter vi of his *The Dairy Industry and the A.A.A.* (Washington, 1935). I understand that considerable attention is given to this sort of question in a forthcoming book on milk marketing by John M. Cassels. A preliminary summary of Dr. Cassels's study is in Harvard University, Graduate School of Arts and Sciences, *Summaries of Theses*, 1934, pp. 227-229.

2 cents a pound for milk, 15.6 cents a pound for cream, and 37.8 cents a pound for butter (an approximation of present levels), the transport gradients will be those shown in Fig. 13.

The rents obtainable in the production of each commodity at varying distances from the market may be calculated directly

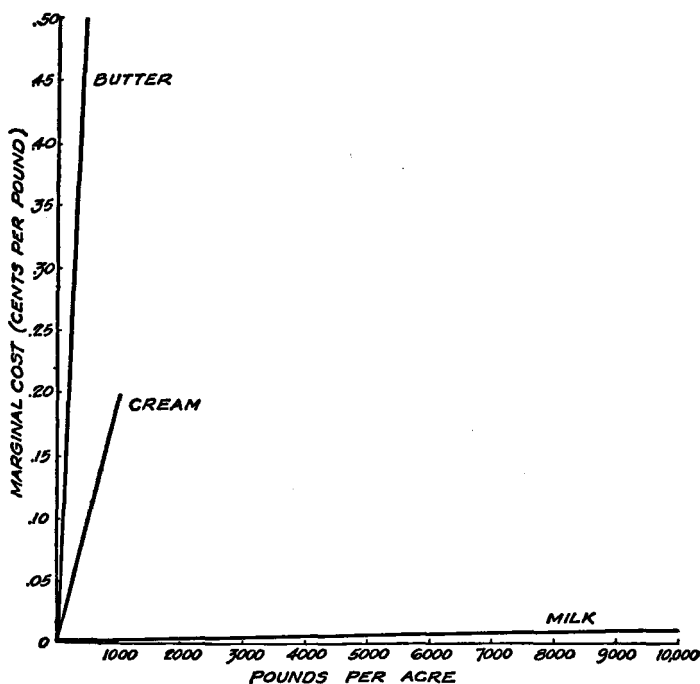

FIG. 13

from the data in the foregoing figures. They are the basis of Fig. 14, which represents the rent gradients for the three commodities.

It will be observed that these rent gradients are concave upward, and that their steepness is proportional to the quantity of the commodity produced per acre. At all points within about 200 miles of the market, milk production yields the highest rent, and presumably will predominate. In a zone about 120 miles wide and beyond the milk zone, cream production seems the most profit-

able; and beyond the cream zone butter appears as the highest bidder for the land.

These zones correspond generally with those observable in

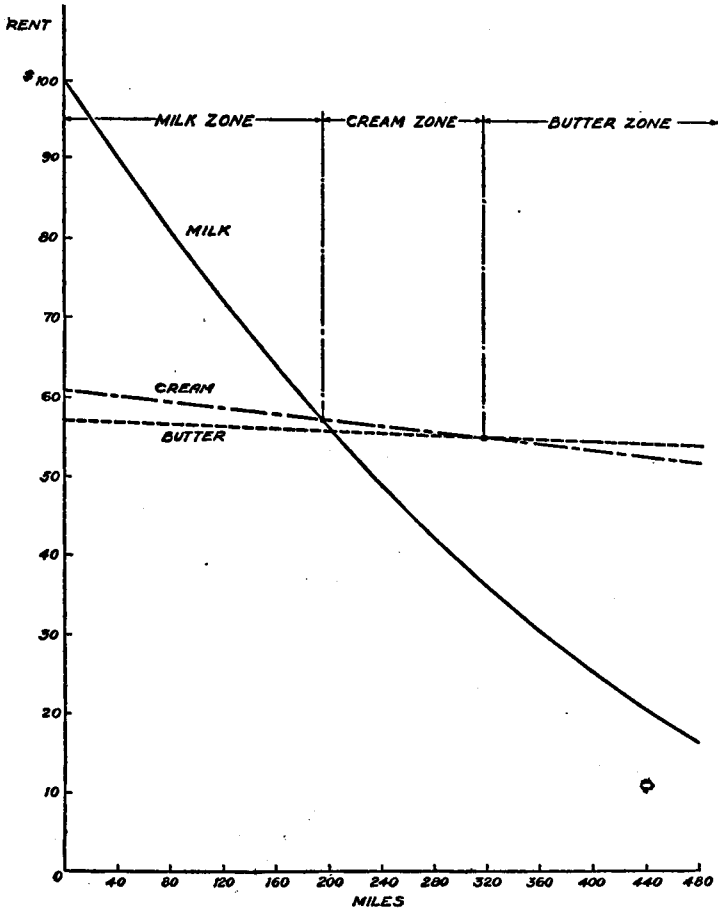

FIG. 14

practice, except that the cream zone actually is considerably narrower than Fig. 14 would indicate. This distortion was intentional, in the interests of clearness in the diagram.

So far, we have been assuming the elasticity of demand at the

buying market to be infinite. We have ignored the fact that prices, and hence rents, depend partly upon the total amount produced; which in turn depends on the relative rents obtainable in different uses. The rent surfaces must be regarded as shifting up or down according to the relation of demand and supply at the consuming market.

The distribution of uses pictured in Figs. 12 and 14 is intended to represent an equilibrium condition, in which supply and demand are equated and each piece of land has found its optimum use and optimum intensity of use. Now let us suppose a change to occur: using the milk-cream-butter illustration, suppose that the demand for cream increases. There are several intermediate steps before a new equilibrium can be reached. First, the price of cream rises, and the cream rent surface shows a corresponding rise. This means that some land formerly devoted to milk and butter production will be shifted to cream production, and also that production will be somewhat more intensive in the original cream zone. This in turn will curtail the supply of milk and butter and raise their prices, until finally a new equilibrium is reached with an enlarged zone of cream production and a different relationship of prices for the three products.

CHAPTER III

TRANSPORTATION COSTS AND MANUFACTURING INDUSTRIES

IN THE previous chapter I have described the way in which, under the assumption of the free mobility of all production factors except land, the extractive industries will be adjusted to the distribution of natural resources. If commodities were always ready for use as soon as extracted from the earth, we could at this point pass on to a consideration of immobilities of the so-called mobile factors of production. For the points of consumption would be determined by the distribution of extractive activity itself.

But between extraction and consumption lies generally a series of processing stages, which introduces two primary complications. In the first place, the path from mine or farm to the ultimate consumer is indirect; and we cannot say what the locational relationship between bread-eater and wheat-grower will be until we know what determines the location of flour mills and bakeries. If these processing industries, for instance, should be located primarily with reference to fuel supply, then the ultimate relationship may be somewhat as if the consumer of bread were buying a given quantity of coal with each loaf. This might entirely alter the relative advantages of different locations for the growing of wheat or the buying of bread.

Equally important is the fact that the processing industries employ a substantial proportion of the population, and hence determine the location of ultimate as well as intermediate markets. In terms of the illustration above, millers and bakers are likewise bread-eaters. Some idea of the importance of this consideration is given by Tables 1 and 2, showing occupational distribution of the gainfully occupied population of the United States. Recently, it appears, the relative importance of the extractive industries has declined, while that of manufacturing and marketing has gained. It will be evident that we cannot hope to see the question of location in its entirety without looking into the distribution of that

present three-fourths of the population which is *not* engaged in the extraction of materials from the earth.

Through the present chapter I shall continue to treat all factors of production save land as mobile: which, it will be recalled, has two implications. First, location becomes a question of transport costs alone; and secondly, none of the mobile factors of production can receive any monopoly return due to location.

TABLE 1
RELATIVE IMPORTANCE OF OCCUPATIONAL GROUPS IN THE UNITED STATES,
1910 AND 1930¹

(Percentages of total gainfully employed)

	1910	1930
All groups	100.0	100.0
Agriculture	32.5	21.4
Forestry and fishing	0.6	0.5
Extraction of minerals	2.5	2.0
Manufacturing and mechanical industries	27.9	28.9
Transportation and communication	7.0	7.9
Trade	9.5	12.5
Services	15.4	18.6
Clerical	4.5	8.2

¹ U. S. Census, 1930, *Population*, vol. v, p. 39.

TABLE 2
COMPARISON OF PERCENTAGE CHANGES IN THREE CHIEF OCCUPATIONAL
GROUPS, 1910-30¹

	Percentage change, 1910 to:	
	1920	1930
Manufacturing	+20	+32
Agriculture	-6	-8
Marketing	+19	+68

¹ Estimates by J. K. Galbraith and John D. Black, in "The Quantitative Position of Marketing in the United States," *Quarterly Journal of Economics*, May, 1935, p. 410.

Since it is the adjustment of manufacturing to extractive industries that we are to examine, the distribution of the latter types is to be taken as given. And lastly, the distribution of demand for the manufactured products must also be taken as given, since the distribution of population as a whole is something we are not yet prepared to explain.

The question of the location of manufactures may be resolved,

under these simplified conditions, into a balancing of the transport advantages of nearness to materials and nearness to markets. For each combination of material sources and market there must be a point or points at which the total transportation costs involved in assembling the materials and delivering the product to the market are less than they would be anywhere else. In the absence of production-cost differentials, the best location for the production process is at the point of minimum transport costs.

The foregoing formulation, originally set forth by Wilhelm Launhardt more than half a century ago, was revived and given relatively wide currency in 1909 by Alfred Weber.¹ The part of Weber's theory which deals with the influence of transport costs is almost wholly concerned with the determination of the point of minimum transport costs for given 'locational figures' or combinations of material and market points. The location of production in this restricted sense I prefer to denote by Weber's term *orientation*. By *transport-oriented* industries are meant those for which differentials in transport costs generally outweigh differentials in production costs; and the transport-oriented industries may be further classified into *material-oriented* and *market-oriented* according to which element of transport cost is predominant. As will be made clear in forthcoming pages, there is a large class of transport-oriented industries not oriented invariably toward either market or materials.

All this, however, is merely one part of the question. The number of conceivable combinations of material and market points is of quasi-astronomical order; an analysis of the influence of transport costs upon location must tell us *which* of these combinations will survive the test of competition. In other words, the theory

¹ Launhardt, *Mathematische Begründung der Volkswirtschaftslehre* (Leipzig, 1885). Weber, *Ueber den Standort der Industrien*, Erster Teil, *Reine Theorie des Standorts* (Tübingen, 1909), translated by C. J. Friedrich as *Alfred Weber's Theory of the Location of Industries* (University of Chicago Press, 1929). All my page references are to the translation unless otherwise indicated. Weber's part ii consists of student monographs on the location of separate German industries; a list of their titles appears in the bibliography at the end of this volume. Attention should be called likewise to Weber's further development of his theory, along what he called 'realistic' lines, in the article "Industrielle Standortslehre," *Grundriss der Sozialökonomik*, vol. vi, pp. 54-82 (Tübingen, 1914).

of market areas and the theory of orientation are complementary parts of the theory of location. It is unfortunate that they have been developed, to a great extent, independently of each other. Wilhelm Launhardt, indeed, ably discussed both;² but the main body of Weberian theory ignores the question of market areas just as fully as Fetter's "Economic Law of Market Areas" ignores orientation.³

Orientation is properly considered first. Before we can determine market areas, we must know whether the point of minimum transport costs for the industry in question is always at some source of materials, or always at some market; or perhaps neither; and also we must know how important the transport costs are as a whole, relative to differentials in production cost.

This question of orientation may be determined by constructing isotims, or contour lines of equal transport cost around given material and market points. The interval between adjacent lines represents, say, \$1 in transport costs per ton of the product. Now the relative spacing of the two sets of lines around the material and market points respectively will depend on several factors.

First, there is the weight of the material used per ton of the product; or inversely, in Weberian terminology, the percentage of 'weight loss' of the material in the process in question. Thus the extraction of gold from ore requires an extremely high tonnage of material per ton of product, and the weight loss is close to 100%; while the hand shoemaking industry has a very low percentage of weight loss, yielding practically a ton of product for every ton of materials used.⁴ The employment of 'ubiquitous' materials, prices of which are equal at all points, increases the importance of transport costs on the product relative to those on materials.⁵

Secondly, there is the relation between the ton-mile transport

² *Op. cit.*

³ F. A. Fetter, "The Economic Law of Market Areas," in *Quarterly Journal of Economics*, May, 1924, pp. 520-529. See also his *The Masquerade of Monopoly* (New York, 1931).

⁴ In this case, leather is what Weber would call a *pure* material.

⁵ The bottling of non-alcoholic beverages is a familiar case in point. R. M. Haig cites the manufacture of sulfuric acid as another process which is market-oriented by reason of its use of a ubiquitous material. "Toward an Understanding of the Metropolis," in *Quarterly Journal of Economics*, February, 1926, p. 192.

rates on material and product respectively. In most cases, the product is relatively bulkier, more fragile, and subject to a less elastic demand as regards its transportation, so that it pays a higher rate per ton-mile. However, if the material happens to be a perishable or fragile one the costs involved there may be the higher.

An illustration of the locational effect of small changes in relative freight rates on material and product appears in the American flour-milling industry. In general, this has been material-oriented, since nearly seven pounds of wheat are required to make five pounds of flour.⁶ This fact favored Minneapolis at the expense of Buffalo and Rochester after the center of wheat-growing had moved to the Plains states. But in the period 1905-30 two changes took place. First, customers became more particular about prompt delivery of flour in good condition, and the lake route from Minneapolis mills to eastern markets was inferior to rail routes in both respects. Secondly, the lake freight rates, during and after the War, were raised on 'packaged goods,' including flour, while the bulk materials traveling by shiploads, including wheat, continued to be carried at pre-war rates. The result of these two changes was to raise the cost of shipping flour on the lakes relative to that of shipping wheat on the lakes; and this, with other factors, turned the balance of advantage in Buffalo's favor. In 1930 for the first time Buffalo milled more wheat than Minneapolis.⁷

Another important element influencing orientation is the way in which transport costs vary with distance. Something has already been said about this in the preceding chapter. The simplest assumption is what Palander calls a uniform *transport surface*, in which transport rates for a commodity are the same per ton-mile in any direction for any distance. More realistic assumptions involve different rates in different directions (lower, for instance,

⁶ Disposal of the two pounds of by-products (feeds) is sometimes a limiting factor in location, but apparently not in the Minneapolis-Buffalo case cited for illustration.

⁷ Data on this case are taken from V. G. Pickett and R. S. Vaile, *The Decline of Northwestern Flour Milling* (University of Minnesota, Studies in Economics and Business, No. 5, 1933).

along developed routes or *transport lines*), and a tendency to lower ton-mile rates for long hauls.

It must be kept in mind that along with transport costs we should consider all disadvantages that vary systematically with distance. Over and above the freight rate charged by the transport agency, these include such things as interest, insurance, deterioration, either physically or in respect to style changes (hence the premium on speed for certain goods), and reliability of delivery. In many cases the transport charge made by the carrying agency is only a minor part of the total costs of distance. For the broader concept, Ohlin has coined,⁸ and I shall use generally henceforth, the term *transfer costs*.

The significance of the distinction is naturally greatest where styles change rapidly, as in some branches of the clothing industries. But even in the case of such durable goods as hardware it plays a part. In a fairly recent investigation of hardware distribution in a large section of the United States,⁹ the Bureau of Foreign and Domestic Commerce found six factors which wholesalers considered "fundamental in determining the limits of trade areas and the amount of business which could be obtained in them." The numbers in parentheses, below, indicate the number of wholesalers who named the corresponding factor as the one chiefly responsible for limiting their market areas.

- (a) "Competition from other wholesale centers" (57).
- (b) "Handicap of freight rates to distant points" (45).
- (c) "Time required for delivery to distant points" (24).

⁸ Cf. Ohlin, *Interregional and International Trade*, pp. 142, 211. E. H. Chamberlin (in his *Theory of Monopolistic Competition*, appendix a) argues for a separate theory of urban rents on the ground that the favorableness of the relation to markets is here measured by 'convenience' whereas for rural rents it is measured by transport costs. As I have indicated above, elements of transport cost are likely to be blended with other elements in any market relationship. Distance is a highly important factor in both cases, but costs are perhaps a different function of distance in the two cases.

⁹ Bureau of Foreign and Domestic Commerce, *Domestic Commerce Series*, Bulletin 52, *Hardware Distribution in the Gulf Southwest* (Washington, 1932), p. 28. It is interesting to note that the average time required to ship to the edge of a hardware wholesaler's market area, for the establishments covered by the investigation, was 45 hours.

- (d) "Prohibitive sales expense to distant points" (13).
- (e) "Different problems in marketing specialty as against staple lines."
- (f) "Seasons of good or poor business."

The first factor, "competition from other wholesale centers," tells us nothing at all, since competitive advantage presumably is determined by some or all of the other factors. But it is worth noting that "freight rates" scored only 45 votes as against 37 for speed and sales expense combined. The fifth and sixth factors, also entirely outside the scope of transport costs, seem to have had enough importance to be listed with the others.

In the special case where transfer costs are uniform per ton-mile regardless of distance, it is possible to combine the relative weights of materials and product and the relative mileage costs of transfer into a single coefficient. If, for instance, three tons of the material are used for each ton of the product, but the product takes twice as high a ton-mile rate as the material, we may legitimately simplify matters by giving the material an *ideal weight* of $1\frac{1}{2}$ tons per ton of product, and thereafter ignoring the rate difference.¹⁰

The ratio between the ideal weights (or cost per unit of distance) of material and product is what Alfred Weber termed the *material index* of a production process; and although the usefulness of the index was exaggerated by Weber and his followers, it does do us some service in indicating the tendencies of orientation.

¹⁰ Weber makes also a less felicitous attempt to allow for differences in the cost of materials at alternative sources. A high-cost coal mine he proposes to consider farther away than its real distance; a low-cost one, nearer. This concept of *ideal distance* has great shortcomings, and in this form would seem to be devoid of utility. It assumes, for one thing, that we know the location of production already (otherwise the expression 'farther away' meets with the unanswerable retort, 'farther away from where?'); yet the determination of the location of production with regard to materials and market is the ultimate goal of Weber's analysis of transport orientation. Professor Friedrich remarks, in the introduction to his English translation (*Theory of the Location of Industries*, Chicago, 1929, p. xxiii, note): "When Weber wishes to express possible differences in the price of fuel and raw materials at different deposits by additions to the distance between them and the place of production, this amounts theoretically to assuming equal cost of fuel and raw material throughout at their deposits, since the theoretical premises contain no assumption regarding the 'real' distance of any point."

In the case above, for instance, the material index is $1\frac{1}{2}$, which means that the isotims around the material source will be $1\frac{1}{2}$ times as close together as those around the market. In terms of Weber's analogy to the equilibrium of physical forces, the material will 'pull' production $1\frac{1}{2}$ times as strongly as the market will.

Strictly speaking, the ideal weights and the material index are not constants unless for each commodity the ton-mile transfer costs are uniform in all directions and for all distances. If, for instance, transfer costs are less than proportional to distance, the relation between the ideal weights of two materials, or of a material and its product, will vary. Each material or product, under these conditions, will have a higher ideal weight for short hauls than for long hauls.

It should be kept in mind, too, that the concept of an ideal weight implies that the same relative quantities of the various materials are used, regardless of their relative prices. To the extent that technique allows flexibility of proportions, in the sense of economizing on certain materials in places where they are relatively scarce, the ideal weights will vary according to location.

Despite these serious qualifications, the Weberian concepts of ideal weights and material indices are sometimes useful. If any one of the ideal weights is much greater than the sum of all the rest, after taking into account the probable range of their variation, then we are generally safe in saying that the production process in question will be oriented to the material (or product) with the preponderant ideal weight. If over a period of time the relative amount of a certain material used in an industry greatly increases, and if other things remain the same, we may expect that the sources of the material will exert an increasing influence on the distribution of the industry.

The only way of finding the minimum point, in cases at all doubtful, is to plot lines of equal transfer costs, which indicate all the peculiarities of the pattern of transfer costs for material and market separately. On the basis of these it is then possible to construct a new set of lines, connecting points of equal *total* transfer costs on materials and product together. In Fig. 15 this construction is shown. At any point on the \$8 line of the left-hand

system of contours, it costs \$8 to deliver enough of the material to produce a ton of the product. From any point on the \$9 line of the right-hand system of contours, it costs \$9 to deliver a ton of the product to the market *C*. Where these two lines intersect, evidently the total transfer costs are \$17 per ton of product. But they are also \$17 at the intersections of the lines for \$7 and \$10, \$6 and \$11, and so on. The locus of points with a combined transfer cost of \$17 per ton of product passes through all these intersections. Similarly, the locus of points with a combined transfer cost of \$18 per ton of product may be drawn through another set of intersections.¹¹

These loci of equal total transfer costs seem to have been used first by Alfred Weber, and by him were christened *isodapanes*. They are considered by Palander to be one of Weber's few really original contributions to locational theory.¹²

In Fig. 16 I have depicted a set of isodapanes for a production process with two materials. The construction proceeds along the same lines as the previous figure. The form of the contours of transfer costs for materials and product directly determines the isodapanes; and within the innermost isodapane of the series lies the point of minimum transfer costs. As the figure shows, there may be more than one such point when transfer costs are less than proportional to distance.

In the determination of orientation, we quite properly assume that the market is a given point. The ultimate question of location, however, is how the various material and market points will be associated. It may be put in two ways: as the demarcation of the market areas for production points supplied from given mate-

¹¹ The assumption that transport costs are proportional to distance is a tempting but very dangerous one, as subsequent discussion of Weber's conclusions from it will indicate. To avoid its pitfalls I have adopted for most of the transport-cost diagrams in this book a hypothetical schedule of costs which increases considerably less than in proportion to distance. The effect is shown in Figs. 15 and 17 by the way in which the interval between successive contour lines grows wider as the radius of the contours themselves increases.

¹² *Beiträge zur Standortstheorie*, end of ch. viii. Weber, however, did not use the isodapanes to determine the direction of transport orientation, but only to measure the deviability of production from the point of minimum transport costs in response to production-cost differentials.

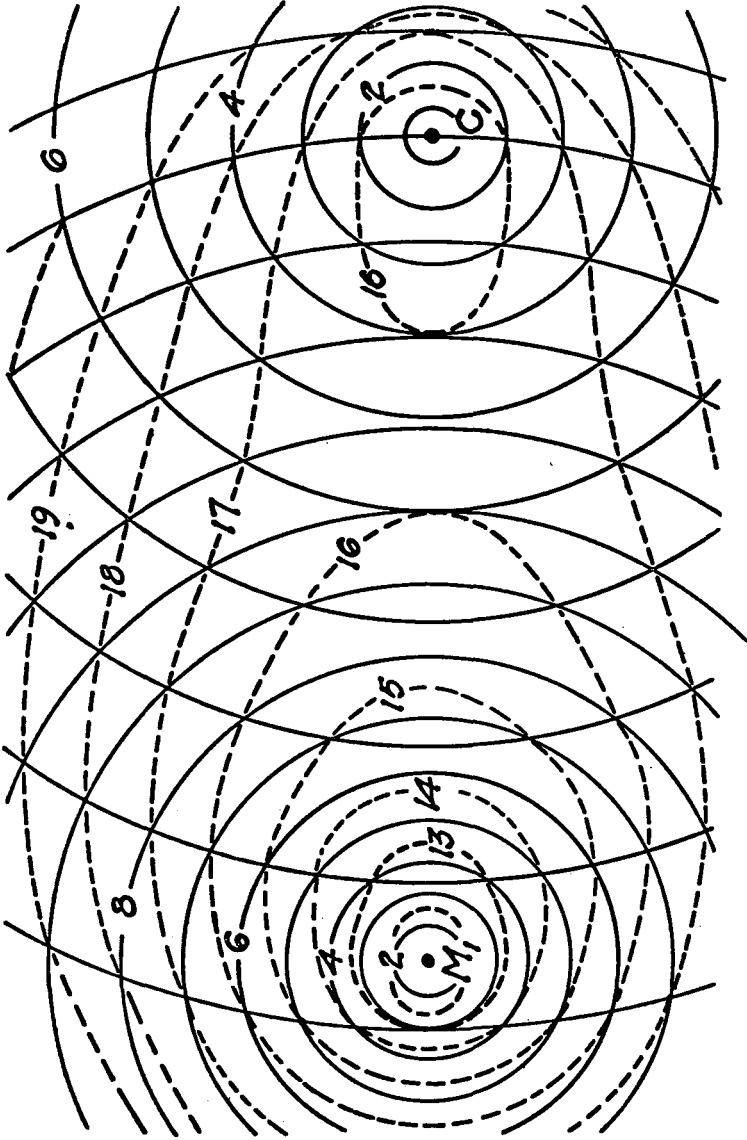

FIG. 15

rial sources, or as the demarcation of 'production areas' for given markets. And as in the case of the extractive industries, the choice of approaches will generally depend on the relative multiplicity of production points and market points respectively. Where production locations are relatively few, it is generally more appropriate to consider them as points and the market as an area to be divided up among them; where markets are few and localized, it is generally more appropriate to consider them as points competing in an area of supply. In most manufacturing industries, the former approach is the one indicated.

Let us confine ourselves for the moment to the cases in which one of the ideal weights is so preponderant that the question of orientation is settled irrespective of location. When a production process with a single material is material-oriented, its location is influenced by the same factors as that of the extractive industries: i.e., the costs of extracting the material and the costs of getting the product to more or less distant markets. The actual costs of manufacturing, under our present assumptions, are the same everywhere regardless of output, so they can have no effect on location. Consequently, the market areas of beehive coke ovens (material-oriented) could be analyzed along the same lines as the market areas of the coal mines to which they are oriented; and the location of cotton gins is practically the same thing as that of cotton growing. It will be recalled that in the previous chapter the manufacture of milk, cream, and butter was offered as an illustration of the 'rent surface' analysis of extensive extractive industries, even though all three of these are, strictly speaking, material-oriented manufacturing industries.

The only additional factor to be considered is the possibility of variation of manufacturing cost either as a function of rate of output or in response to some other immobility of production factors.¹⁸ Such variations will naturally take a hand in determining

¹⁸ Thus, cotton gins are material-oriented to the extent that the agents of production involved are divisible; their imperfect divisibility sets limits to the dispersion of the ginning industry. The representative gin some years ago gathered its cotton from an area within a radius of less than ten miles, but better roads are enlarging this typical area and localizing the business to some degree. See Bureau of Foreign and Domestic Commerce, Domestic Commerce Series, No. 49, *Cotton Production and*

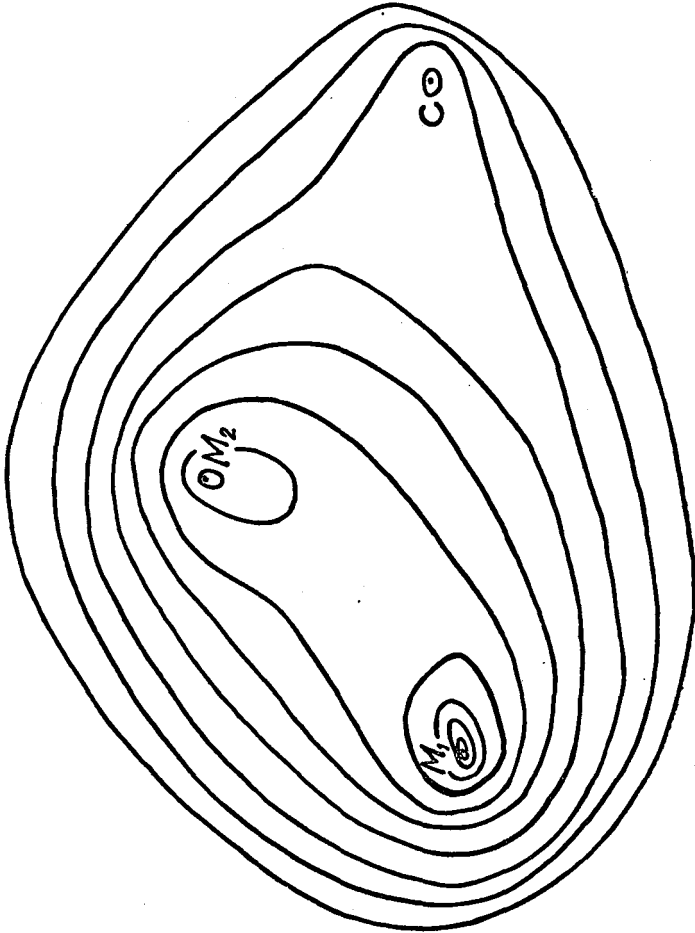

FIG. 16

the height and slope of the margin line or the rent surface. Their influence is excluded, however, by the assumptions governing the discussion at the present point, and they will be introduced in later chapters. The use of auxiliary materials in the production

Distribution in the Gulf Southwest (1931), pp. 45-46. Cost variations in response to scale of output or other factors are of much greater importance in some other generally material-oriented industries, such as copper smelting.

process hardly complicates matters so long as the process is always oriented to the sources of the preponderant material. Each source of this preponderant material will draw its auxiliary materials from the source which can supply them at the lowest delivered price (extraction-cost plus freight), and then the total plant cost of the product will be the sum of four elements:

- (a) Extraction-costs of auxiliary materials.
- (b) Transfer costs of auxiliary materials.
- (c) Extraction-costs of the preponderant material.
- (d) Manufacturing cost.

All these elements are, of course, independent of where the market is. The delivered prices of the product from a production point will be the sum of the above four elements plus transfer costs on the product.

The pattern of delivered prices around two such material-oriented production points is shown in Fig. 17, with the sources of the auxiliary materials and the market-area boundary also indicated.

In the case of a market-oriented production process, the only transfer costs involved are those on the various materials. Under our assumption of constant and uniform¹⁴ manufacturing costs, the 'market area' of each production point will be simply the point itself. But it is possible to mark off zones, within each of which the market-oriented production points will be supplied by a single combination of material sources.

In Fig. 18 the roughly egg-shaped systems of lines show the variation in the costs of bringing the proper combination of the two materials to various points from different combinations of sources: M_1 and M_2 , M_1 and M'_2 , M'_1 and M_2 , and M'_1 and M'_2 . It is shown in the figure that there is some area within which each of these possible combinations provides the cheapest combined delivered price. The shadings in each zone of the figure are parallel to a line drawn between the two material-sources supplying that zone.

¹⁴ *Constant* here means that the costs are independent of rate of output at the point in question; *uniform* means that they are independent of where that point happens to be. Modification of either assumption allows a 'market-oriented' industry to be somewhat localized with respect to markets.

There is, of course, another way of arriving at the same result for this particular case. The two rival sources of the first material (M_1 and M'_1) are competing directly with each other in supplying

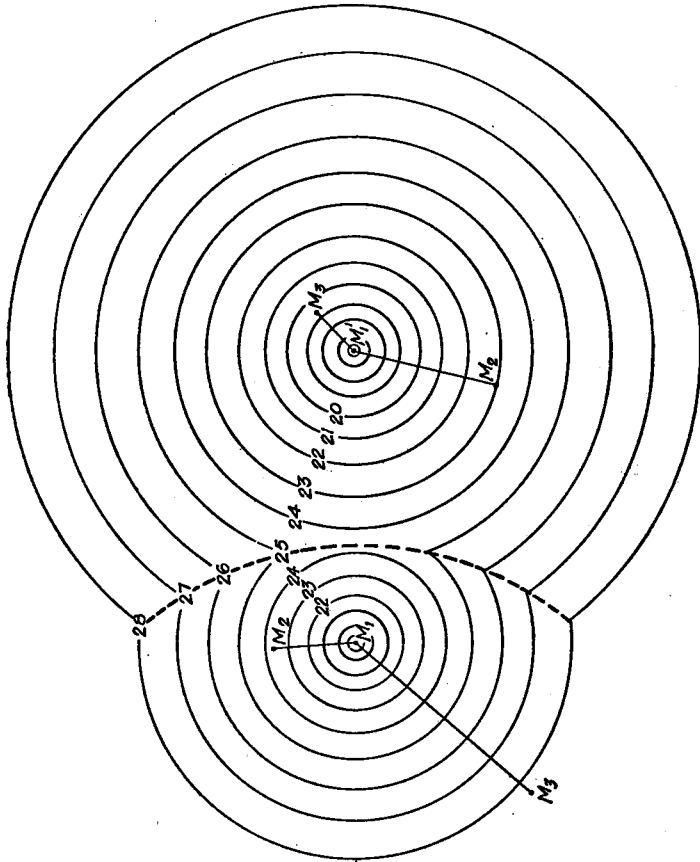

FIG. 17

the possible production points; so likewise are M_2 and M'_2 . We might construct market-area boundaries or lines of indifference to separate the field of M_1 from that of M'_1 , and that of M_2 from that of M'_2 ; and these would be the same zone boundaries as in Fig. 18.

We must now consider the quite common case of a production process which is not invariably oriented to any particular material or to the market. It will be evident that if the ideal weights

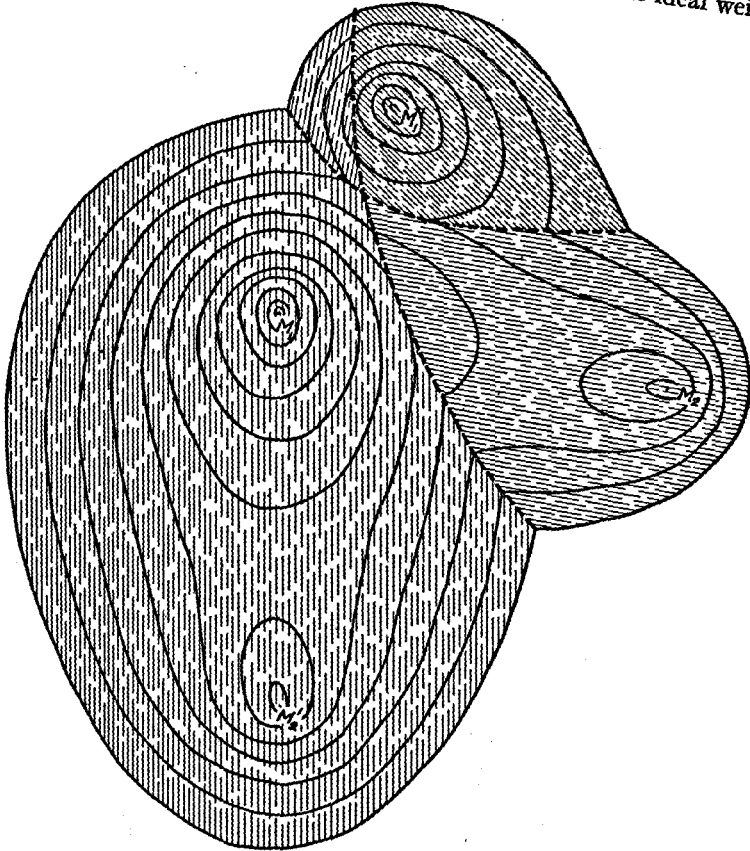

FIG. 18

are fairly equal, and subject to some individual variation, we are likely to have material orientation and market orientation in one and the same industry, according to local circumstances. The existence of several points of minimum transport costs in Fig. 16 above indicates the basis for this case.

The analysis here may be put in terms of market areas as in the simpler cases; the only difference is that we have more possible production points to consider. To reduce the question to its simplest form, let us suppose that only two materials are required and that there is only a single existing source for each of

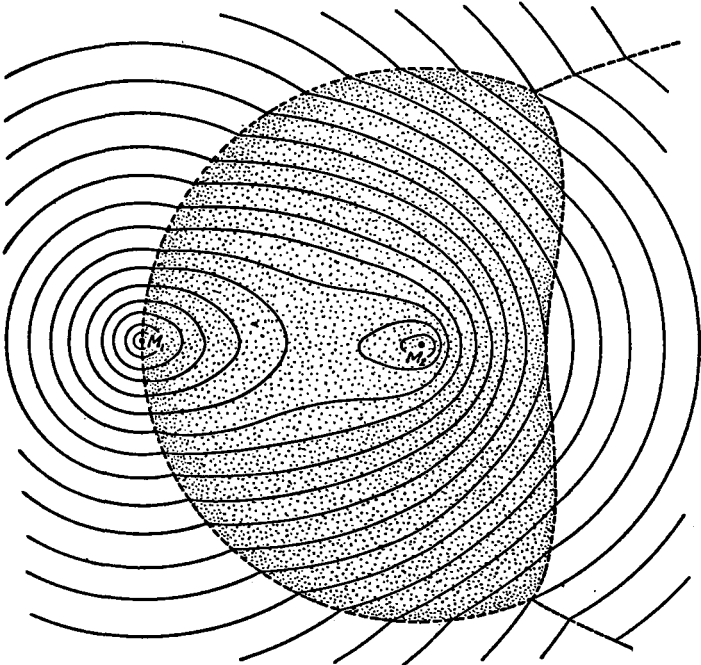

FIG. 19

these. The material sources are indicated by M_1 and M_2 in Fig. 19. Now we may construct three sets of isodapanes upon the figure, representing the patterns of delivered prices for the product when it is manufactured at M_1 , at M_2 , or at the market respectively. The first two sets represent price patterns under material orientation, and the last one under market orientation.

When M_1 or M_2 is the production point, the lines are roughly concentric circles. If production is to be located at the market, on

the other hand, they are curves of the same egg-like form as in Fig. 18.

The actual orientation of production for serving any particular market point will depend upon which of the three possible orientations offers the lowest delivered price. Consequently, the intersections of the three sets of lines trace out the lines of indifference, or boundaries between the three *zones of orientation*. For all markets in the zone at the left of the figure, the best production point is M_1 ; for all markets in the zone at the right, it is M_2 ; and if the market lies in the central stippled zone, production will be wherever the market is.

Now if we bring alternative sources of materials into the picture, similar systems of lines will indicate the price-pattern resulting from the use of different combinations of material sources and different orientations of production. In Fig. 20 we have the depiction of the price pattern and orientation zones where there are two alternative sources for each of the two materials, and consequently four possible combinations of material sources and no less than twelve conceivable orientations, viz.:

- (a) Production at M_1 , using M_1 and M_2 .
- (b) " " M_2 , using M_1 and M_2 .
- (c) " " market, using M_1 and M_2 .
- (d) " " M_1 , using M_1 and M'_2 .
- (e) " " M'_2 , using M_1 and M_2 .
- (f) " " market, using M_1 and M'_2 .
- (g) " " M'_1 , using M'_1 and M_2 .
- (h) " " M_2 , using M'_1 and M_2 .
- (i) " " market, using M'_1 and M_2 .
- (j) " " M'_1 , using M'_1 and M'_2 .
- (k) " " M'_2 , using M'_1 and M'_2 .
- (l) " " market, using M'_1 and M'_2 .

It will be evident upon further consideration that not more than eight of the twelve orientation zones can really coexist. For instance, if when production is at M_1 the second material is obtained from M_2 for *some* markets, it will be obtained from there (rather than from M'_2) for *all* markets served from M_1 . The position of the market has no effect on the choice of sources for the second material so long as production is taking place at the source

of the first material. If there is a zone (a) there cannot at the same time be a zone (d). The other pairs of mutually exclusive alternatives are (b) and (h), (g) and (j), and (e) and (k). In the

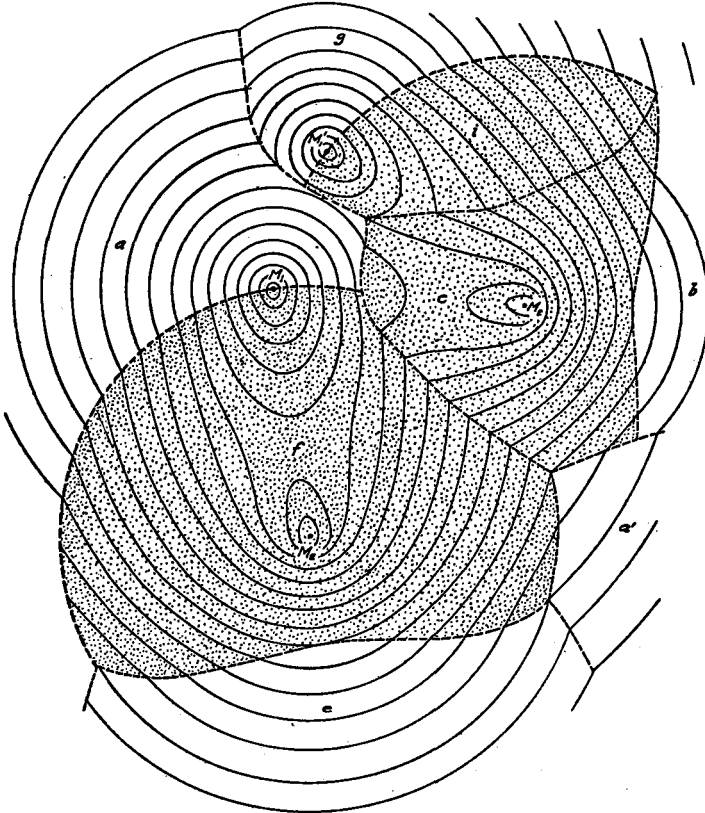

FIG. 20

figure as drawn, areas (a), (b), (g), and (e) are present, and consequently (d), (h), (j), and (k) are absent.

The assumption here is that M_2 and M'_2 , for instance, cannot both at the same time be the cheapest source of the material for a production point at M_1 to employ. Under more realistic conditions, involving varying costs, it is of course quite possible that

M_2 and M'_2 might both supply M_1 , at equal *marginal delivered costs*.

Much time was spent by the earlier theorists in the analysis of still another kind of transport orientation, not yet touched upon here. When two or more materials are involved, coming from different sources, and when the ideal weights are not too unequal, it is theoretically quite possible that the point of minimum transport costs will not coincide with any of the material sources nor with the market.

This kind of orientation, involving what I shall call a *separate* minimum-cost point, has been assumed to be vastly more important than it really is. Partly because of its actual infrequency, and partly because it cannot be analyzed theoretically in terms of transport orientation without rather absurd assumptions, I shall not consider it as a regular case of transport orientation at all. It is, of course, necessary to justify so drastic a step.

The first matter to consider is that the existence of a separate minimum-cost point depends not only upon none of the ideal weights exceeding the sum of the others, but to a large extent also upon the relative position of the material and market points. Let us for the moment accept Weber's assumption of uniform transport costs. Under those conditions, if the shape of a triangular locational figure is such that the angle formed at the 'market corner' is 150° , the material index may be as high as 4 without detaching the minimum-cost point from the market.¹⁵ On the other hand, if the angle at one of the material corners is as great as 150° , the minimum-cost point will be at that corner even if the ideal weight of that material is only $\frac{1}{4}$ of the sum of the ideal weights of the product and the other material.

It appears, then, that even if we accept the assumption of uniform transport costs, the possibilities of a separate point of minimum transport costs are much less than might be thought at first glance. This conclusion has been worked out in general terms by Launhardt and even in Georg Pick's mathematical appendix to Weber, but one wonders if Weber fully realized its significance.

¹⁵ Cf. Palander, p. 194.

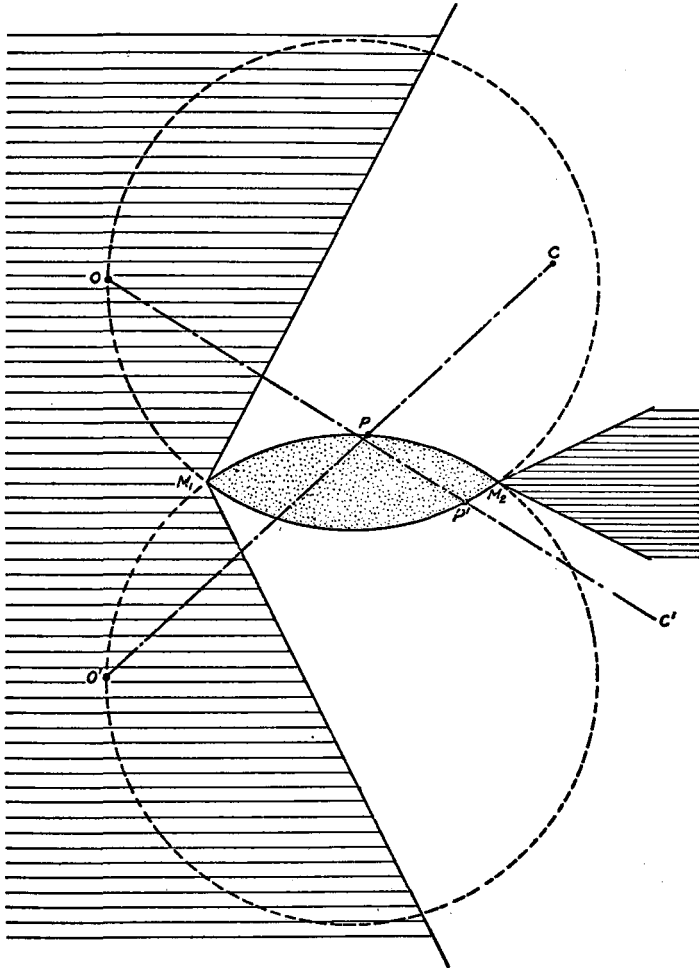

FIG. 21

Fig. 21 indicates the orientation zones under conditions of uniform transport costs. I shall not take space here to describe the geometrical construction involved, since it is fully dealt with in several places.¹⁶ Let it suffice to say that the shape of the figure in any given case depends on the relation between the ideal weights, in a way which is roughly illustrated by Figs 21 and 22. The points O and O' , called the 'poles,' are of especial significance.

For markets in the shaded sector at the left of the figure, the point of minimum transport costs is M_1 ; for markets in the shaded sector at the right, it is M_2 ; and for points in the stippled area between the arcs, it is wherever the market is. So far, the zones of orientation correspond to those marked out above in Fig. 19. But for any other market (i.e., points in the unshaded and unstippled territory) there will be *separate* points of minimum transport costs, located by drawing a straight line from the market point in question to the farther of the two poles. Such a line is CO' in Fig. 21. Where this line enters the stippled zone (i.e., at point P) is the point of minimum transport costs for the market point C .

It is immediately evident that there will not be as many separate minimum-cost points P as there are markets C in the unshaded and unstippled orientation zones. The point P is that of minimum transport costs not only for C but for all markets on PC and its indefinite prolongation. And similarly, P' is the point of minimum transport costs for all markets along the line $P'C'$ indefinitely extended.

Consideration of the figure will show that even when the ideal weights are all equal and transport costs are uniform, there will be separate minimum-cost points for only a portion of the market. Fig. 22, taken from Palander (*op. cit.*, pp. 149, 151), shows how the figure and the relative sizes of the orientation zones change when the relationship between the ideal weights is altered. As any one of the ideal weights approaches the sum of the other two, the

¹⁶ Launhardt, *op. cit.*; Weber, Mathematical Appendix (by Georg Pick) to *Ueber den Standort der Industrien*; L. von Bortkiewicz, "Eine geometrische Fundierung der Lehre vom Standort der Industrien," in *Archiv für Sozialwissenschaft und Sozialpolitik*, May, 1910, pp. 759-785; Palander, ch. vii.

corresponding orientation zone comes nearer to swallowing up the entire market; i.e., the orientation of the process tends to become *unconditional*.

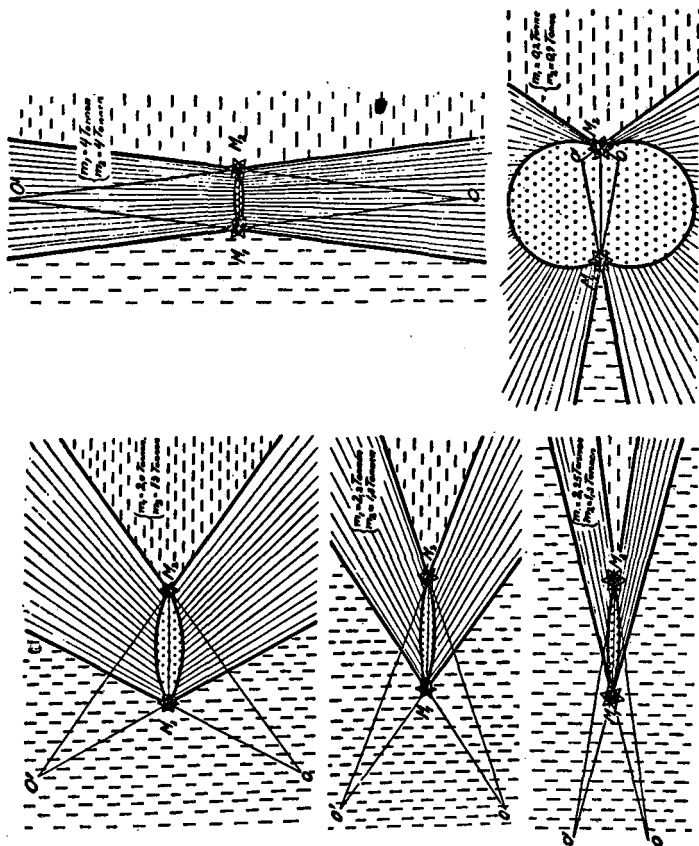

FIG. 22

A very important factor tending to reduce the possibility of separate production points is that costs of transfer are generally less than proportional to distance. This cannot be shown directly on the preceding sort of diagrams, because Launhardt's 'Pole Principle,' on which they are constructed, holds good only in the

case of uniform transport costs; but the influence of this new factor is readily indicated on general lines.

Not only is there likely to be an irreducible 'loading cost' which sets a minimum to short-haul rates, but over and above that the ton-mile rate generally declines with increasing lengths of haul. This is particularly true of transport agencies such as the railroad and the ship, in which the costs of carriage proper are a relatively small element in the total transfer costs; but it tends to be true, in some degree at least, of all forms of transport.

The relative importance of terminal and line costs for various means of transport is well shown in a series of figures prepared by Carl Pirath, the conclusions of which are shown in Table 3.

TABLE 3
APPROXIMATE AVERAGE IMPORTANCE OF TERMINAL COSTS IN VARIOUS
FORMS OF TRANSPORTATION ¹

Form of transport	Terminal costs as percentage of total costs for average haul
Natural waterways	45
Railroads:	
Passengers	18
L.c.l. freight (<i>Stückgut</i>)	47
Tonnage freight in carloads (<i>Massengut in geschlossenen Zügen</i>)	13
Motor bus:	
Germany	18
United States	30
Electric power	8
Street railways	5
Letter post	90

¹ Based on diagrams in Carl Pirath, *Die Grundlagen der Verkehrswirtschaft* (Berlin, 1934), p. 215. The percentages above were arrived at by measurement of Pirath's diagrams.

Pirath justly remarks that the structure of costs is in many cases not closely reflected in the structure of rates charged, and obviously the figures I have quoted cannot be used as more than a very rough indication of the differences in types of transport gradient.

The effect of tariffs that involve lower rates for long hauls is of course to encourage a small number of longer hauls in preference to a larger number of short hauls. This means that in a great many cases the point of minimum transport costs would be at a

market or material point under a graduated tariff, whereas under a simple mileage tariff it would be somewhere else.

The 'loading cost' factor may enter into the rate charged by the transport agency, may involve a payment to a supplementary handling agency (e.g., truck to the freight depot), or may rest simply upon the time and trouble of arranging for a shipment. It works, in any case, in the same direction as a graduated tariff. When there are two materials and production is at the source of one of them, or at the market, only two shipments are involved. When production is at some 'separate' fourth point, *three* shipments are required. Consequently we may say that whenever the minimum-transport-cost point would be fairly near one of the corners of the locational figure in the absence of a 'loading cost,' the presence of such a cost will shift it to that corner. This further restricts the possibility of a 'separate' production location away from market and materials.

Any economies of handling involved in production at a material or market point rather than elsewhere work in the way described for the loading cost. Thus, the advantages of integration between successive stages of a process¹⁷ further encourages location of any given stage of production either at the source of its materials or at the point of consumption, rather than at any intermediate point. The delivery of pig iron to the steel furnaces in a molten state, for example, offers fuel economies. This is a factor which tends to draw the steel and iron industries together.¹⁸

I have concluded that much of the geometrical analysis of transport orientation in terms of separate production points is rather useless. But production sometimes does seem to occur at places which are neither markets nor sources of materials for the process in question. How are we to explain such cases?

Most generally, perhaps, such a location is a sign that the process is not primarily transport-oriented at all. Plants have been

¹⁷ The word 'integration' is used here in a wider sense than is usual, to denote the *spatial contiguity* of successive steps in a productive process.

¹⁸ It should be noted that the attraction is *to*, not merely *toward*, because the advantage is in production costs rather than transport costs. The distinction between the two sorts of locational attraction will be given further attention in Chapter V.

deliberately placed away from the point of minimum transfer costs in order to obtain the advantages of cheaper labor or some other economy in production cost. The consideration of that type of case is deferred to the next three chapters.

But what are we to say of the steel mills on the shores of the Great Lakes, or of flour mills intermediate between western wheat fields and eastern markets? To understand such cases it is usually necessary to examine some of the quirks in the particular pattern of transport costs involved. American railroad rates present an especially rich collection of such peculiarities.

The flour mills in intermediate locations, for example, are said to be able to survive in competition only because of the 'milling-in-transit' privilege, which gives them the same benefits of the long haul as the mills at Minneapolis and Buffalo.¹⁹ Similar rate privileges for other commodities have often been secured in order to enable 'separate' production points to overcome their natural disadvantages.

A location at any natural break in transportation (a port, a portage, or a railhead, for example) may offer the same advantages as a material or market location in so far as the minimizing of the number of hauls and loading charges is concerned. When steel is made at Cleveland rather than in the immediate neighborhood of the coal fields, there is one less haul for ore and one more for coal. Pittsburgh itself is a point of contact between river and rail transport. Buffalo is strategically located at the meeting of lake, rail, and canal traffic.

The number of economical locations for such transshipment points is restricted, of course, by the fact that both the transport agencies and the loading facilities are subject to large-scale economies in their operation.²⁰ A large port, served by many highly-developed water and rail lines and provided with ample loading facilities, is generally to be preferred to a small one with inadequate docks and infrequent service.²¹

¹⁹ Cf. Palander, pp. 310-311.

²⁰ At lower Lake Erie ports in 1926, iron ore was transferred from ship to car for only 13 cents a ton. J. F. Froggett, "Transportation Recasting Industrial Map of United States," in *Iron Trade Review*, Jan. 6, 1927, p. 119.

²¹ See on this R. G. Hawtrey, *The Economic Problem*, ch. xi; also Palander's in-

A practical factor of great significance is the relatively greater degree of competition among transport agencies for traffic to and from these transshipment points, generally reflected in especially advantageous rates. This last applies also to *junction points* located on two or more routes of the same form of transport, including anything from the village crossroads to the railroad nexus of Chicago or the free port of Hamburg.²² Many of our large industrial cities owe a substantial part of their growth to the fact that they are railroad junction points and have thus enjoyed low competitive rates.

Entirely apart from the question of discriminatory rates, however, junction points may be points of minimum transfer costs even when they have neither materials nor market to offer. It can easily be shown that if materials come from points on two or more different routes and the market lies on still another route, the minimum-transfer-cost point is at the junction unless one of the ideal weights exceeds the sum of all the rest.²³

In practice, then, the influence of transfer costs tends to locate production at markets, at sources of materials, and at junctions or breaks in the transport network. The ways in which this pattern may be modified by differentials in production costs will be considered in the three chapters that follow.

genious demonstration (*Beiträge zur Standortstheorie*, p. 349) of the natural transport advantages of coastal indentations as port sites, and his discussion of the cumulativeness of entrepôt localization.

²² Places such as river crossings or good harbors, which are natural foci of transport routes, are said to possess 'natural nodality,' by H. J. MacKinder, in *Britain and the British Seas* (New York, 1902), pp. 329 ff. MacKinder mentions also the 'artificial nodality' which places either with or without natural nodality may acquire if routes happen to join or cross there. For instance, two railroads built across flat country may intersect at a point selected more or less at random, and devoid of natural nodality. Amarillo, Texas, would seem to be such a point. Once the railroads have been constructed, the junction point possesses the locational advantage of artificial nodality. J. E. Orchard, in *Japan's Economic Position* (New York, 1930), p. 134, misuses the term 'nodality' by including, apparently, all kinds of locational advantages.

²³ See the discussion of transport lines, junctions, and 'transport points' in chapter xii of Palander's *Beiträge zur Standortstheorie*.

CHAPTER IV

LABOR-COST DIFFERENTIALS

DESPITE the heralding of an 'Economy of Abundance,' direct human labor, including that of brain as well as hand, is a requisite in every production process. In many industries its importance has decreased relatively to that of other cost factors, but some labor there must be; and in certain industries the decisive locational factor is a plentiful, flexible supply of properly-trained workpeople at relatively low wages. To give a rough idea of the relative importance of labor costs to capital investment I quote some data assembled by Ohlin in an appendix to his *Interregional and International Trade* ¹:

There are industries in which wage costs are twenty-five times as high as capital expenses, whereas, in others, capital expenses are considerably higher than wage costs. The amount of capital per worker in the manufacturing industries of the United States has recently been estimated as follows: Chemical industry \$10,000, iron and steel industry \$4000, textile industry \$1900, tobacco industry \$1700. In Swedish industry before the War the relation between wages paid and interest expenses was for food industries 2/10:1, for pulp and paper factories 6/10:1, for wharfs [*sic*] 8:1, for stone quarries 26:1. A post-War investigation, made by Messrs. Alford and Hannum, showed that the output per 1000 hours of labour ranged from \$548 in the yarn and thread industry to \$10,870 in the die and punch-making industry in the United States.

Our task in this chapter is to inquire how local labor-cost differences arise. Like any other kind of differences in wages, they may be first separated into two categories: compensating and non-compensating. For the special case of differences according to location, however, these two categories do not have the same significance as in Cairnes's discussion of 'non-competing groups.' ²

¹ P. 572.

² J. E. Cairnes, *Some Leading Principles of Political Economy Newly Expounded* (New York, 1874), pp. 154-156; F. W. Taussig, *Principles of Economics*, third edition, revised (New York, 1925), ch. 47.

We are comparing wages not in different occupations, but in the same occupation at different locations.

Free mobility of a given grade of labor, if by that we mean the absence of any restrictions upon going wherever real wages are highest, leads toward uniformity of real wages at all locations. But it does not imply that this labor's money cost — its relative advantageousness to employers — will tend to be uniform. The laboring population of a desert mining camp, for example, may live no better and no worse than people in similar occupations in more settled areas; but such a camp would be a poor place to establish a shirt factory or any other labor-oriented type of industry, because money wages are high. They are high, in turn, because the cost of living is high.

In such a case we cannot say that there is any restriction on the mobility of labor, because there is no real-wage differential; but there is definitely a labor-cost differential, which is the important thing for the location of industries using much labor. Immobility of labor is, then, only one of the causes of labor-cost differentials.

Following the example of Ohlin, let us describe the two sorts of differences in labor costs as follows:³

(a) *Equalizing* differences, due entirely to local variations in the cost of living.

(b) *Real* differences, due to local variations in real wages and hence implying imperfect mobility of labor.

It should be remarked that 'real' wages here include only such items as figure in the budgets used in compiling cost-of-living index numbers. Intangibles such as climate or agreeable social surroundings cannot very well be counted. For greater convenience, Ohlin prefers to regard the force of these latter considerations as manifestations of imperfect mobility. A workman may be disinclined to go to Alaska even when offered higher real wages, because the climate and the strangeness repel him or because of the costs of making the move; but this merely means, in Ohlin's terms, that the workman's mobility, or ability to seek maximum real wages, is imperfect.

³ *Interregional and International Trade*, pp. 212-220. The discussion of the next few pages owes much to Ohlin.

Equalizing differences depend on variations in the cost of living, and would exist even if labor were perfectly mobile and real wages everywhere uniform. The cost of living is difficult to measure, and still more difficult to compare at two places or times; but it can be shown to display certain systematic responses to the distribution of natural resources.

The money cost of labor, as represented in the payroll, is paid to the workmen; but that is not the end of it. The average employee, in turn, may be supposed to spend his wages on a calculable average budget of goods. The prices paid for the goods in his 'market basket' will include costs of transfer on the goods from their points of production; and for the purposes of location we may consider the employee as a part of the productive machinery of the plant, and the food and other things he consumes as part of the essential materials used by the plant in its operations. Thus one may resolve the labor-cost factor into transfer relations with sources of materials. If real wages were everywhere uniform — that is, if only the *equalizing* differences of wages existed — we should not need to consider labor-cost differentials as an independent locational factor at all, but might simply add the materials consumed by the employees to those consumed by the inanimate part of the plant, and then apply the theory of transport orientation as outlined in the previous chapters.⁴

So each industrial plant is located with reference to two sets of materials: the industrial materials in the ordinary sense, and the *budget materials*, the prices of which determine the workmen's cost of living. This latter category consists largely of food, even in countries where the standard of living is high.⁵ There may be

⁴ Cf. Tord Palander, *Beiträge zur Standortstheorie*, p. 275: "Auf die Weise erhielt man den Preis für den Produktionsfaktor Arbeit, ausgedrückt als eine Funktion anderer Preise, vor allem der Lebensmittelpreise." The partial dependence of labor costs upon transport costs was also noted by Edward D. Jones, *The Administration of Industrial Enterprises* (New York and London, 1916), p. 39, and A. P. Usher, "Comment se placent les usines: l'exemple des États-Unis," in *Annales d'histoire économique et sociale*, Oct. 15, 1929, p. 526.

⁵ The recent Brookings Institution study, *America's Capacity to Consume*, by Maurice Leven, H. G. Moulton, and Clark Warburton (Washington, 1935), found that in 1929 the expenditures on food averaged 26.4 per cent of total expenditures for American families of all income groups together. For the 'subsistence and

some overlapping, of course, between the industrial and the budget materials. In any case the budget materials will include fuel and miscellaneous supplies of kinds that are also used in the industrial process.

To the extent that the two categories of materials fail to coincide, the locator of a factory must choose between good transfer relations with sources of industrial materials and good transfer relations with sources of budget materials. Which category will have the greater influence on location? Evidently this depends on the relative ideal weights of the two sorts of materials, and this relation will vary approximately as does the Weberian *labor coefficient* (labor costs per unit weight of materials and product moved).⁶

There is one difference, however. Weber's labor coefficient is not a pure number, but varies according to the units in which it is expressed. It has to be put as so and so many dollars per short ton, or marks per metric ton, or cents per pound; and unless this is supplemented by some information on rates of transportation, it gives no clue to the importance of labor costs relative to other locational factors.

But if we can resolve equalizing differences in labor costs into ordinary transfer costs of materials and product, the importance of labor relative to materials and product may be expressed as a pure number: the ratio of the ideal weight of all the budget commodities to the ideal weights of the industrial materials and the product together.⁷ That much, at any rate, is gained from the separation of equalizing from real differences in wages.

In so far as labor is mobile, then, labor-oriented industries will seek locations having good transfer relations with agricultural districts.⁸ This will be a factor working between town and coun-

poverty' group (incomes below \$1500 a year) the percentage was 40.6; for the 'minimum comfort' group (incomes \$1500 to \$3000 a year) it was 33.9.

In addition to the portion of the worker's income spent directly for food, we must take into account what he spends for services and for goods produced by local labor, which is partly resolvable into local expenditure on food.

⁶ *Theory of the Location of Industries*, p. 111.

⁷ Ohlin does not suggest the measure described, but its use would seem to follow naturally from his analysis.

⁸ "For skilled labor a major factor, for unskilled labor the all-important factor

try, within districts, and also between districts, since the cost of living varies in all these ways.⁹

If all industries were oriented primarily to low-cost labor, it would appear that under the above assumptions migration of labor would tend eventually to settle the districts of more advantageous agricultural production more thickly than others, so that the price of food (i.e., the cost of living) would in the long run be equalized. But for many industries, locational factors other than low labor costs are decisive. The entire group of non-agricultural extractive industries, for instance, plus those that are oriented to industrial materials, plus those oriented to markets — all these are nearly as likely to be found in regions of high living costs as in those where budget materials are cheap. The locational forces pulling them away from the low-cost-of-living locations will thus

determining the wages is the cost of living. This depends on:

- (a) Standard of living.
- (b) Cost of food and other necessities.

Location near areas of surplus agricultural production is then a permanent advantage, especially when much unskilled labor is used." Richard Hartshorne, "The Economic Geography of Plant Location," in *Annals of Real Estate Practice, Proceedings and Reports of Industrial Property Division*, vol. vi (1926), p. 53.

"Talora invece la localizzazione delle industrie . . . e nemmeno dalla loro capacità tecnica, bensì dai bassi salari che sono ivi possibili per le condizioni moderate di vita." Pietro Bellemo, *I fattori geografici nella localizzazione delle industrie* (Milan, 1925), p. 31.

"The connection between densely populated agricultural areas and the growth of proximate industrial areas in Lancashire has already been suggested by Mr. Fitzgerald, who says: 'There can be no doubt that the factor of accessibility to regions of densely settled population has played a big part both at the outset of the industrial career of the Ribble towns and in their recent development. The proximity of a large agricultural population in the Fylde meant for Preston easier access to abundant labour during the earlier years of factory industry than was provided for any other Ribble town.'" (John Jewkes, "The Localisation of the Cotton Industry," in *Economic History*, supplement to the *Economic Journal*, January, 1930, pp. 102-103).

⁹ This is well shown in the table of costs of living in various Swedish districts, presented by Ohlin on p. 215 of his *Interregional and International Trade*. Many N.R.A. codes in this country set up 'regional' and 'population' differentials in wages which were intended to vary in the same direction as cost of living. See the Brookings Institution Report, *The National Recovery Administration*, by Leverett S. Lyon and others (Washington, 1935), pp. 326-333, and Mercer G. Evans, "Southern Wage Differentials Under the N.R.A.," in *Southern Economic Journal*, January, 1934, pp. 3-13.

perpetuate the differentials in cost of living. To the extent that labor is mobile, these differentials will be reflected by equalizing differences in money wages.

The level of living costs in any location will depend, then, on whether budget materials or other essentials of production are the more easily advantageously obtained there. The analogy to familiar cases of 'comparative advantage' in international trade is close, and can be carried further. Say, for instance, that town *A* is located in a slightly better agricultural district than town *B*, and hence has an 'absolute advantage' in labor costs. But it also possesses iron ore, coal, and water power, which *B* lacks. Thus *A* has a much more considerable 'absolute advantage' in the cost of industrial materials. The *comparative* advantage of *A* is evidently in industrial materials; and *A* will attract industries of various sorts until the point is reached where living costs will be not lower but higher than at *B*, on account of diminishing returns, the necessity of cultivating poorer land, and perhaps of importing some food. From this point on, cheap-labor-oriented industries — those for which the cost of budget materials is of predominant importance — will be attracted to *B* rather than to *A*, and equilibrium will be reached with a permanently higher cost of living at *A*. If labor is mobile, money wages also will be higher at *A*.¹⁰

The influence of market-oriented industries is significant here.¹¹ These industries follow population, but, like all others, they bring with them additional mouths to feed. The general effect of market-oriented industries is to raise the cost of living, and there-

¹⁰ In Texas and Oklahoma cotton fields the picking is done with greater speed and less care than farther east, on account of the higher wages. This differential is ascribed to the influence of the oil industry, in Bulletin 49 of the Domestic Commerce Series of the Bureau of Foreign and Domestic Commerce, *Cotton Production and Distribution in the Gulf Southwest* (Washington, 1931), p. 39.

¹¹ I see no reason for failing to include under 'market-oriented' industries such activities as the service trades, local transportation and communication, police, fire, and health services, and such parts of the distributive and administrative structure as are best carried on in the midst of the concentration of population which they serve. The term *konsumgebunden*, or 'market-bound,' has been suggested by Palander for activities which for technical reasons must be carried on at the point of consumption. Evidently this concept is analogous to that of extractive or 'material-bound' industries, which for technical reasons must be carried on at the source of the material.

fore money wages, at locations of dense population. Other things being equal, this reduces the advantages of such places for labor-oriented industry, without increasing their advantages for industry oriented to industrial materials. As regions become more densely populated, and as cities increase in size, their activity tends to be restricted more and more to market-oriented industries, for which concentrations of population are a magnet, and which by raising living costs and rents will discourage other sorts of industry less specifically attracted thither.

This reasoning can as yet be accepted only provisionally, since it does not assign due weight to advantages of concentration; but examples of the effect mentioned can easily be found. For instance, in the shoe industry — and, I believe, in clothing industries in general — the manufacture of the more staple grades is forced out of the large cities to locations of lower rent and lower labor cost, while the finer grades and those in which style is most important congregate in the city, in close contact with the marketing organization and with the supply of the higher grades of skilled labor.

The locational importance of cheap labor in regions of agricultural surplus has varied from time to time. It was perhaps a principal factor in the ruralization of industry that took place in Europe at the end of the feudal period. By that time, transportation had been cheapened and freed from restrictions to the extent that individual villages no longer needed to be self-sufficient, and rural industries with market areas including several towns and villages were possible. Industries oriented to markets or to special kinds of skilled labor tended to concentrate in the towns, and by raising wages and rents they helped to push out into the country the industries oriented to cheap unskilled or semi-skilled labor. At the same time, the localizing effect of cheapened transportation was allowing materials and water power to attract some of the heavier industries into the country too.¹²

The great reduction in transport costs associated with the Industrial Revolution had conflicting effects on the locational im-

¹² We generally assume today that ruralization of industry means 'decentralization'; i.e., less localization. But the movement referred to above was, for the heavy

portance of equalizing differences in labor costs. To be sure, lower transport costs gave differentials in labor costs more weight relative to the attraction of materials and markets; but they tended also to equalize the prices of agricultural produce in various regions, thereby doing away with one important source of cost-of-living differentials.¹⁸

The foregoing discussion has shown that in so far as labor is mobile, its locational effect can be stated in terms of transfer costs, with the analytical tools already at hand. The same applies to any other factor of production. But as soon as we recognize any immobility in a 'mobile' factor of production (as manifested, for example, in real-wage differentials), a new tool is required.

There are many sorts of labor-immobilities, due to expense of migration and difficulty of making new contacts, disinclination to leave familiar surroundings, preferences for certain sorts of natural and cultural environment, and — particularly between countries — political and linguistic obstacles. The general result is interregional inequality in real wages. There are two fairly distinct classes of immobilities: *permanent* ones, and *frictional* or temporary ones, which tend to be eliminated by migrations.

Deep-seated human preferences belong to the former class, as is illustrated by the following remark relating to Southern California:

The sudden influx of persons attracted by the search for health rather than by resources has caused many occupations to become over-

industries, in the direction of more localization. Manufactures formerly carried on in every village and town came to be concentrated at a smaller number of rural establishments. For the labor-oriented industries, there was some real decentralization, since the work (e.g., in the woolen industry) was carried on in individual farm-houses. For a discussion of the ruralization movement, see Ritschl, "Reine und historische Dynamik des Standortes der Erzeugungszweige," in *Schmollers Jahrbuch*, 1927, p. 863, and Otto Quelle, "Industriegeographie der Rheinlande," in *Rheinische Neujahrsblätter*, 1926.

¹⁸ Weber argues that increasing density of population and cheaper transport, with more and more 'cultural differentiation,' strengthens the locational influence of labor-cost differentials ("Industrielle Standortslehre," in *Grundriss der Sozialökonomik*, vol. vi). He also points out, however, that capitalism gave labor a new mobility; which presumably would reduce wage differentials and their importance. See Oskar Engländer's criticism in "Kritisches und Positives zu einer allgemeinen reinen Lehre vom Standort," in *Zeitschrift für Volkswirtschaft und Sozialpolitik*, 1926.

crowded. Salaries, therefore, have become surprisingly low in comparison with the general level in the western country.¹⁴

Evidently this sort of thing comes under the head of labor-immobility only because of a roughness of definition. To get a workable concept, we were obliged to define mobility as the ability of labor to adjust itself instantaneously to local variations in the amount of budget commodities paid for a unit of labor. If it had been feasible to include such things as sunshine and scenery in our concept of real wages, the level of real income in the 'overcrowded' professions of Southern California would tend to be not lower than that elsewhere, but just equal. Total psychic income contains a larger percentage of intangible satisfactions in Southern California than it does, say, in a coal-mining region. And since the statistically measurable elements of income are mainly the contents of the market basket, we must fall back upon the concept of a 'permanent immobility' to explain the tendency toward a lower market-basket real income in pleasant places.

The most important cause of differentials in labor costs is frictional immobility. At any time, in a changing world, there are differences in real-wage levels that are really differences in psychic income, in process of being adjusted by migration. A recent investigation made by the Study of Population Redistribution throws much light on these responsive adjustments. It would appear that post-war migration within the United States falls mainly under three heads.¹⁵

First, there is a slow but steady response to long-standing differentials in income levels, with population moving out of regions where opportunities have declined or have failed to keep pace with the natural increase of population. Examples are the 'saturated' agricultural regions which are to be found in nearly all the major divisions of the United States.

¹⁴ J. Russell Smith, *Industrial and Commercial Geography* (Henry Holt and Company, New York, 1913), p. 170; quoted by Ohlin, *op. cit.*, p. 217.

¹⁵ Bulletin 2, *Migration and Planes of Living, 1920-1934* (Philadelphia, 1935). I am responsible for the threefold classification of the migrations. Also of interest is Bulletin 1 of the same study, *Internal Migration in the United States* (1934), presenting data on earlier currents of migration. At this writing, the final report, *Migration and Economic Opportunity*, has yet to appear.

Secondly, we observe a response to the business cycle, sending population from country to city during prosperity and back to the country again during depression. In the Midwest, even the short business recessions of 1924 and 1927 noticeably slackened the cityward drift of the 1920's. One of the recent 'symptoms of recovery' has been a resumption of this drift.

The third sort of migration consists of relatively sudden rushes into districts where some innovation has opened up new opportunities. In general the income level is higher in the new territory, as for example in the Florida resort and citrus sections, in Detroit during the automobile boom, and in the Texas and Oklahoma oil fields. In some cases, however, such as the migration into the semi-arid part of the Plains states during the 1920's, the migrants have accepted a lowered living standard at the start, in the traditional pioneer faith that better things are to come.

As one might expect, adverse conditions produce emigration more promptly in mining regions than in those devoted to agriculture. Most of the spectacularly large decreases in population during the 1920's were in mining districts. On the other hand, the spectacular *gains* in population also are more likely to be in mining, manufacturing, or recreational than in agricultural districts.

TABLE 4
EXAMPLES OF EXTREME RATES OF POPULATION CHANGE IN SELECTED
COUNTIES, 1920-30¹

County	Chief city	State	Activity	Percentage change in population
Hockley	Texas	Oil	+6686
Dade	Miami	Florida	Recreation	+234
Oakland	Pontiac	Michigan	Manufacturing	+135
Esmeralda	Goldfield	Nevada	Mining	-55

¹ Study of Population Redistribution, Bulletin 2, *Migration and Planes of Living, 1920-1934*, pp. 44-45.

Table 4 gives a few examples of extreme rates of increase or decrease in non-agricultural counties, taken from the bulletin already cited. Unfortunately the data for agricultural counties are not given in full, so no direct comparison can be made. It would be hard to believe, however, that such changes as the ones shown could occur in agricultural districts. Data are presented for the 29 agricultural counties with the highest percentage of persons on

relief in 1934.¹⁶ Out of the 27 for which population changes are given in the bulletin, the largest decrease was 31.9 per cent, in Kalkaska County, Michigan.

Labor-cost differentials due to immobility are not often accurately indicated by comparison of wage rates.¹⁷ The advantage of favored places is likely to be based on one or more of these three things:

- (a) Special skill.
- (b) A large labor market, providing an elastic supply of all grades of labor.
- (c) Relative freedom from the artificial restrictions imposed by unions or legislation.

Ritschl tells us that localized labor skill in particular trades first developed at or near the sources of highly-localized materials or special grades of materials. The origins of the Pawtucket-Attleboro jewelry district in New England could be cited as an illustration, since the skill of the workers of that district was developed by the supply of precious metals coming into Providence in early Colonial days.¹⁸

Somewhat less frequently, specialized labor skills develop early in market-oriented industries also. Certainly this was true of the manufacture of art goods and luxuries at feudal Kyoto, localized there by the attraction of Japan's imperial court.¹⁹ At more advanced stages of economic development this is quite common. Specialists of all kinds, from custom bootmakers to plastic sur-

¹⁶ *Ibid.*, pp. 44-45.

¹⁷ This is a large subject, to which inadequate scientific attention has been given. The most important discussion of the causes of labor-cost differences is in Weber's article "Industrielle Standortslehre," in *Grundriss der Sozialökonomik*, vol. vi (1914), pp. 58-86. This article is a sketch for a sequel to *Ueber den Standort der Industrien*, and sets forth Weber's 'realistic' or historical approach to the question of location, thus forming a necessary complement to the pure theory of the earlier book. See also the amplifications and criticisms of Ritschl and Engländer, *loc. cit.*

¹⁸ Malcolm Keir, *Manufacturing* (The Ronald Press, New York, 1928), p. 122. The Connecticut arms industry also owed its start to a supply of the right kind of raw materials (*ibid.*).

¹⁹ J. E. Orchard, *Japan's Economic Position*, pp. 63, 151-154. Cf. also Alfred Marshall, *Principles of Economics*, book iv, ch. x, § 2, on "the various origins of localized industries."

geons, are concentrated in New York City and other metropolitan centers by the attraction of the market, and thereby give such large cities a great advantage as locations for special kinds of work.

In any case, the development of differential advantages based upon labor skill depends upon the immobility of the labor: i.e., the extent to which diffusion is impeded by restrictive laws, inertia, or other obstacles. Ritschl cites the emigration of Italian masons into Germany as an example of diffusion,²⁰ and the difficulties encountered by English textile entrepreneurs in their efforts to smuggle skilled workmen out of the Low Countries illustrate the obstacles.

The Industrial Revolution meant, among other things, the lessening of restrictions upon migration from place to place and from occupation to occupation. Consequently it tended to weaken the force of local supplies of skilled labor as a locational factor. For decades and even centuries, however, this tendency was consistently outweighed by the progressive cheapening of transportation, which made industries much more easily divertible from the point of minimum transport costs. In other words, differences in labor skill became smaller absolutely but larger in relation to transport costs.

In the last few decades, the costs of transporting goods by rail or water have ceased to fall,²¹ while the mobility of labor has, for many reasons, increased. The automobile is perhaps the chief factor. The result is that labor orientation on the basis of skill has been a locational factor of decreasing importance in most manufacturing industries. In some, the decrease has been hastened by the substitution of machinery for manual skill, which allows a cheaper grade of labor to be used.²² Thus the supremacy of many of the specialized industrial centers of the nineteenth century, based largely on skilled labor, has been successfully challenged. The shoe industry, as Part III will show, is a case in point.

²⁰ *Op. cit.*, p. 858.

²¹ Cf. Fig. 23.

²² Striking evidence of this is furnished by seven industries selected for quite another purpose. See my article, "The Measurement of Industrial Localization," in *Review of Economic Statistics*, November, 1936, pp. 162-171, in which I com-

The wage differential between city and country would be less were it not for the imperfect mobility of labor. Outside the pioneer zones at any rate, the opportunities for labor have been increasing more rapidly in cities than in the country, while such differences in birth rate as exist are generally the other way. This means that so long as any hindrance to cityward migration exists, real wages must be higher in the city; and since the cost of living is already higher there, the differential in money wages is still larger.

In pioneer zones, the case is naturally somewhat different. When these are zones of expanding agriculture, as was our Midwest during the middle of the nineteenth century, costs of food are very low, on account of the low intensity of land use. But so long as there is a relative scarcity of labor (as indicated by a continuance of immigration) real wages are higher than in the more settled parts of the country, and at first this will mean that money wages are higher too.²⁸ When the Midwest was in process of agricultural settlement, it did not attract labor-oriented industries, as it later quite properly did, on the basis of low living costs. Instead it repelled that type of industry, because money wages were high on account of the great productivity of agriculture with labor as the scarce factor. Interregional immobility maintained a differential in real wages for some time, and intergroup immobility meant that for industries such as shoemaking, requiring skilled workers, the farmers would not have sufficed anyhow.

puted the ratio of semi-skilled operatives to laborers, for 1910 and 1920:

Industry	1910	1920
Cigars and tobacco	9.0	4.3
Harness and saddlery	15.7	9.0
Shoes	19.0	11.5
Leather	1.6	1.2
Cotton	7.3	4.0
Silk	19.0	11.5
Wool	9.0	5.7

(Computed from data in U. S. Census, *Occupations*.)

²⁸ For example, during the Australian gold rush, mine timbers were imported from Scandinavia in spite of the availability of Australian timber. High wages were the reason. In the same connection, it is said that the California Forty-Niners sent laundry out to the Hawaiian Islands.

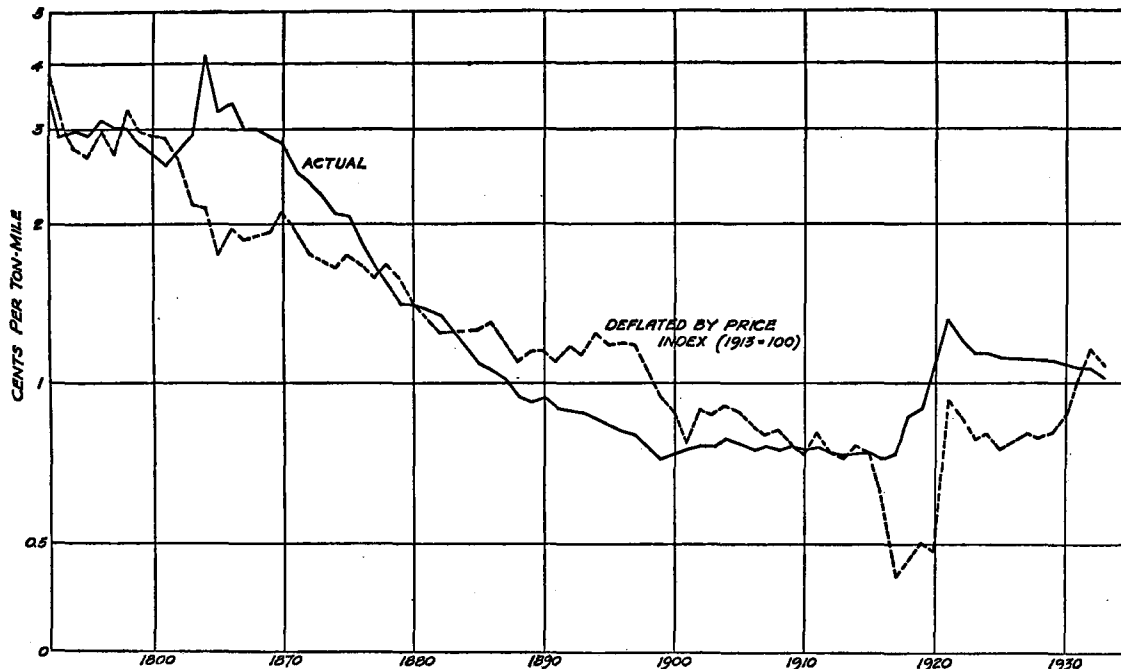

FIG. 23. Average freight revenue per ton-mile on principal American railroads, 1852-1934, actual and deflated. Based on data of the Interstate Commerce Commission, *Statistics of Railroads*, and for earlier years upon the Aldrich Report on *Wholesale Prices, Wages, and Transportation* (U. S. Senate, 52d Congress, 2d Session). The deflating index of wholesale prices is that published by the Bureau of Labor Statistics.

The third basis of labor-cost differentials previously mentioned is that of the size of the local labor market. Large cities offer the advantage of an extremely elastic supply of all kinds of labor: an advantage which may show up not in wage rates but merely in the avoidance of costly interruptions of work due to labor turnover or a sudden need of more hands. This point, however, really belongs in a discussion of industrial concentration in general, and will be taken up in a later chapter.

Labor organization affects costs in more ways than would be thought of at first approach. The essential fact is of course the greater bargaining power given the workers by their combination. Both piece and time wages will tend to be higher where labor is organized than where it is not. The managers of plants may not be able to call for overtime work so freely, and will have to pay a supplementary wage for it. There will be restriction of the 'hiring and firing' of employees. This is the aspect of unionism which gets deepest under the skin of the unsympathetic employer. In connection with this, the union may force a dividing-up of work in slack times, keeping a larger number on the payroll than is consistent with minimum costs from the firm's viewpoint.

The strongest weapon of organized labor, the strike, has also a relation to labor costs. Entirely apart from the final outcome, obviously both sides lose while it is going on. Also, failure to fill orders on time results in ill will and cancellations, with loss to the firm. A city that, like some of the shoe centers of Northeastern Massachusetts, gets a reputation for unreliability in delivering the goods on account of constantly-recurring labor troubles, is likely to be shunned by buyers, especially in lines of merchandise for which prompt delivery is particularly important.

Without pursuing further the question of what determines the immobility of labor, let us pass on to a consideration of its effect upon location. This will be found, in the following chapter, to be merely one aspect of the general question of location when the factors of production other than land partake of some of the characteristic immobility of land.

CHAPTER V

PRODUCTION-COST DIFFERENTIALS IN GENERAL

WE HAVE already considered, in Chapter II, the way in which the distribution of the extractive industries is determined jointly by the costs of extraction and the costs of transporting the extracted material to its market. Those industries being technically material-oriented by definition, the problem was relatively simple.

In the manufacturing industries, on the other hand, there is no absolute technical orientation of any productive process, so the analysis of location has been taken up by successive steps. In Chapter III, the influence of transfer costs was isolated for examination, by assuming that the production process proper could be carried on at the same costs at all locations, i.e., that the agents of production were ubiquities. In Chapter IV, the factor of labor-cost differentials was given special attention, and was found resolvable in part into transfer-cost relationships with sources of agricultural materials. There remained, however, a large element of labor-cost differential not explainable in terms of transfer costs at all.

Accordingly, we shall now inquire into the locational effect of production-cost differentials in general, including all locational factors not resolvable into transfer relationships. In the present chapter we shall assume that costs of production vary from place to place but are constant at each place: i.e., are independent of the degree to which production is concentrated in particular firms or in particular localities. Chapter VI will deal with the effects of the variation of production costs in response to these sorts of concentration.

I do not propose to analyze in detail the causes of local differentials in production costs. Some are due to 'natural' factors; in other words, to the same inequality in the distribution of natural resources as was taken into account in connection with the extractive industries. Woolen and cotton mills, for example, require a

high atmospheric humidity, and where this is naturally present the costs of supplying it artificially are obviated. The manufacture of patent leather, and to a still greater extent the curing of raisins and other fruits, requires sunshine.¹ Level land for building is a factor of some scarcity and importance in hilly regions. In Japan, for instance, it has played an important part in locating the chief cities, and seems to be the main reason for the slow growth of Kobe as compared to the otherwise less advantageously located city of Osaka.²

When any local resource is imperfectly elastic in supply, so that with increasing utilization it becomes an economic good, then the rent which it commands serves to ration it out to the land-uses which can bid most highly for it. This applies to urban building space, but not to any of the other elements mentioned in the paragraph above. The way in which the rent-mechanism works has already been indicated in Chapter II for the extractive industries, and except for the question of the distribution of land uses within cities it has little importance for manufacturing.³ In this chapter we may follow Weber's example and assume that non-extractible resources such as climate are free goods at their locations.

A whole category of production-cost differentials is due to artificial factors, involving either the imposition of a direct check on the mobility of the agents of production (for example, international or interregional barriers to the flow of labor and capital) or some form of tax, restriction, or subsidy (such as policies of community promotion). Only in so far as these differentials are contingent upon industrial concentration shall I analyze their causes, and that task is reserved for the next chapter.

The basic difference between the locational effects of transfer costs and production costs must be clearly appreciated. Coal supply and climate, for example, are both locational factors for many industries; but the former is a matter of transfer costs (nearness to the mines) and the latter is a matter of production costs. The advantage of nearness to a coal mine is represented by

¹ As it happens, however, this is not a decisive factor in the patent leather industry, which for other reasons is concentrated around Boston and Philadelphia.

² See J. E. Orchard, *Japan's Economic Position*, pp. 134, 138, 147, 170.

³ Cf. Weber, pp. 31-32.

the slope of the transfer gradient from the mine, while the advantage of a good climate is independent of transfer costs altogether. Production-cost advantages may indeed show a 'gradient' of their own (those of climate are quite likely to), but it has nothing to do with transfer costs. The important thing is that the production-cost advantages at any one point are completely independent of what they may be at any other point; the 'gradient' connecting the various points is determined not by transfer costs but by any of an indefinite number of factors, most of them altogether outside our province of investigation.

Alfred Weber's treatment of the locational effect of production-cost differentials runs in terms of orientation only. Such differentials either bring production to the place with lower costs or else do not affect its location at all. Their attraction can be for this reason referred to as *alternative*, in distinction from what we might call the *continuous* attraction of the factors of transfer cost. Production will move from the point of minimum transfer costs to the point offering, say, cheap labor, when and only when the economies realizable at the latter point are at least sufficient to offset the additional transfer charges incurred by forsaking the point of minimum transfer costs.

Weber introduces here the device of *isodapanes*, or lines of equal total transfer cost, with which we became acquainted in Chapter III.⁴ In the series of isodapanes around a given minimum-transfer-cost point, there is one which connects points at which the transfer costs exceed the minimum by an amount equal to the production-cost economies offered at some alternative production point. With respect to that point, then, the isodapane in question is called the *critical isodapane*. If the alternative production point lies inside it, the production economy there is more than worth the difference in transfer costs; if it lies outside the critical isodapane, the production economy is less than the extra transfer costs that would be entailed in a shift.

The spacing of the isodapanes is determined partly by the level of transfer costs. A low level will naturally spread the isodapanes

⁴ See p. 42 above, and Weber, pp. 102-104. The word *isodapane* is derived from *isos*, equal, and *δαπάνη*, cost.

out, since a dollar buys more miles. A steady cheapening of transfer costs would be expected, then, to lead to concentration of production at points of low production cost, with less dependence on nearness to materials or markets.

Another factor determining the spacing of the isodapanes is what Weber called the *locational weight* of the production process, meaning the total [ideal] weight of material and product that must be moved in the production and delivery of a unit weight of product. The locational weight evidently differs from the material index only in that it includes the weight of the product, here unity. Consequently the locational weight is always equal to the material index plus one. The larger the locational weight, the closer together the isodapanes will tend to be, and the less influence production-cost differentials can exert relative to transfer costs.

The fundamental defect of this analysis is that it runs solely in terms of orientation. That is, it applies only to the case in which the market and the sources of materials are given. As soon as we recognize the existence of other markets, other material-sources, or rival producing points, it breaks down, because it is not stated in terms of market areas.

Weber himself brought up one of these considerations, under the head of the 'replacement of material deposits.'⁵ This was a recognition of the fact that the shift of production away from a point of minimum transfer costs determined with reference to certain sources of materials may lead to the substitution of other sources of materials near the point of low production costs. For example, suppose that the location of minimum transfer costs for a worsted mill serving midwestern markets would be St. Louis, these minimum transfer costs entailing the use of wool from the western states and fuel or power from the immediate vicinity of the mill. Now if the actual location of this mill, for the sake of production-cost economies, happens to be in Eastern Massachusetts, the sources of power and perhaps also those of wool would be altogether different. The presence of such alternative sources of supply obviously has a great bearing on the responsiveness of an industry to differentials in production cost. In the extreme case,

⁵ Pp. 113 ff.

where the material in question is ubiquitous, each possible production location involves a different source. The more nearly ubiquitous (i.e., the less localized) a material is, the more chance there is for 'replacement of material deposits' and the greater the locational influence of production-cost differentials.

Weber explicitly realized this, although he failed to deal with it in any satisfactory manner. He did not take up the corresponding difficulty that arises when we consider that every shift in production means a new relation to markets as well as to materials. To revert to our example, the Massachusetts location for the worsted mill might be inferior to St. Louis for serving midwestern markets and at the same time superior to it for serving eastern markets.

Quite evidently this part of the theory of location needs development in terms of market areas.⁶ The effect of production-cost differentials is to enlarge the market areas of certain low-cost production points by making it possible for them to serve some markets for which they are not points of minimum transfer costs. By virtue of their lower costs of production, they can deliver the product more cheaply to those points than could production points located where transfer costs are a minimum.

In Fig. 24 we have a simple case, involving a production process in which the ideal weight of one of the materials is so preponderant that under the influence of transfer costs alone, production would always take place at one of the sources (M_1, M_1') of that material. Two sources of the lesser material (M_2, M_2') are also available, and under the influence of transfer costs alone the whole market would be shared between M_1 and M_1' , each using the most convenient source of the other material. But at a point F , production costs are lower than at M_1 or M_1' . For certain market points, the product can be delivered at equal cost from M_1 and from F , since the saving in transfer costs involved in production at M_1 is just balanced by the saving in production costs involved in production at F . Similarly, for certain other points the product can be delivered at equal cost from M_1' and from F . These two series of

⁶ This was recognized by Oskar Engländer, in "Kritisches und Positives zu einer allgemeinen reinen Lehre vom Standort," in *Zeitschrift für Volkswirtschaft und Sozialpolitik*, 1926, p. 462.

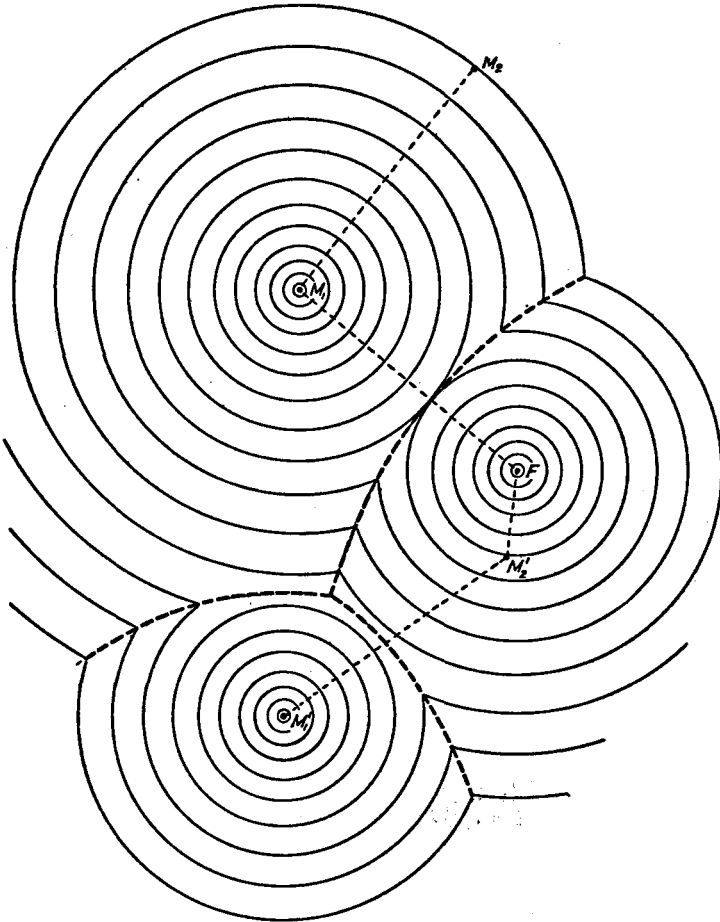

FIG. 24

points constitute the market-area boundaries between M_1 and F and between M_2 and F , as shown by heavy dotted lines in Fig. 24.

It is plain that F will have no market area at all unless it offers economies at least equal to the difference between the costs of shipping the material from its source to F and those of shipping the product the same distance. This minimum depends on the

distance between M_1 (or M_1') and F , and also upon the relative ideal weights of material and product. If, for instance, the material is very bulky and difficult to transport, while the product is relatively compact, then production costs must be very much lower at F to make it feasible to carry the bulky material that

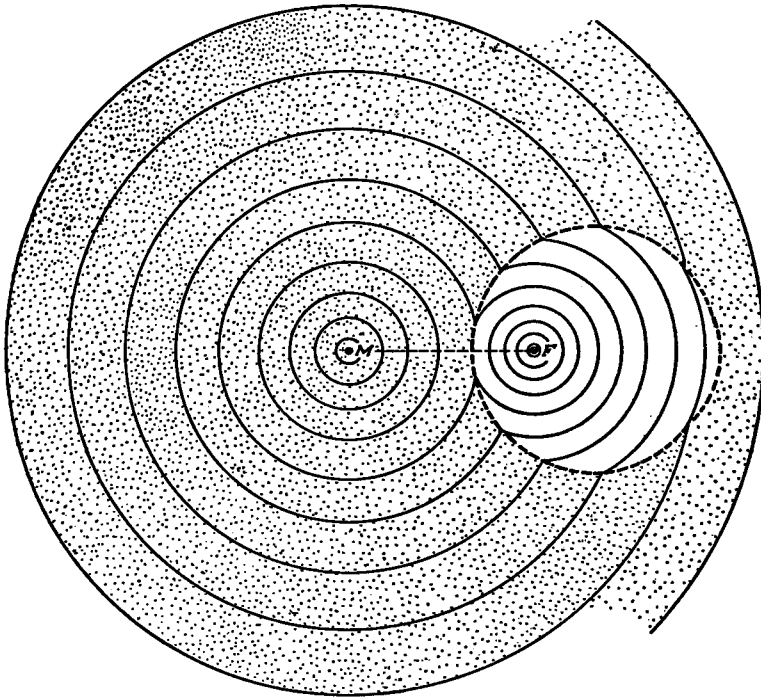

FIG. 25

much farther. If, on the other hand, the economies offered at F are greater than the sum of the costs of shipping the material from, say, M_1 to F plus those of shipping the product from F back to M_1 , then no production will take place at M_1 , and F can ship even to markets beyond that point.

A different case is indicated in Fig. 25, where the process is market-oriented. Here it costs more to ship the product than to

ship the material an equal distance. The alternatives, therefore, are production at F or production at *each* of the possible markets; and the heavy dotted line is the boundary between markets served by strictly local production and those served from F .

In this case F is in a less advantageous position, because it must ship the relatively bulky product (indicated by the close spacing of the isotims around F), while local market-oriented production points need pay only the transfer costs on the relatively compact material (indicated by the wide spacing of the isotims around M). But if F offers any economies at all, it will have a market area (that is, it can produce for some outside markets). Unless F 's economies are infinite, on the other hand, it cannot command the whole market.

Fig. 26 shows the situation when two materials are needed for a market-oriented process. In the absence of production-cost differentials, the area would be divided into zones of market-oriented production, drawing materials from M_1 and M_2 , M'_1 and M_2 , M_1 and M'_2 , and M'_1 and M'_2 respectively (as indicated in Fig. 18 in Chapter III). The point F happens to be located in the zone where it is cheapest to get materials from M_1 and M'_2 , so as indicated in Fig. 26 it uses those sources. Points in the stippled territory continue to be served by local market-oriented production, while those in the unstippled territory are served from F .

In Fig. 27 we have a still more comprehensive case, in which two materials are involved, with two alternative sources for each, and the orientation of the process is not unconditional but depends on the location of the market. Except for the introduction of the low-cost production point F , the situation is the same as that represented in Fig. 20 in Chapter III; outside of F 's market area, therefore, the two figures are identical. No new principle is involved in the construction of this figure.

The diagrams could easily be extended to show the market areas of several alternative production points F , F' , F'' , etc., offering different savings in production cost.

Hitherto it has been assumed that markets were essentially local and non-overlapping, so that competition between producers located at different points was confined to the market-area boun-

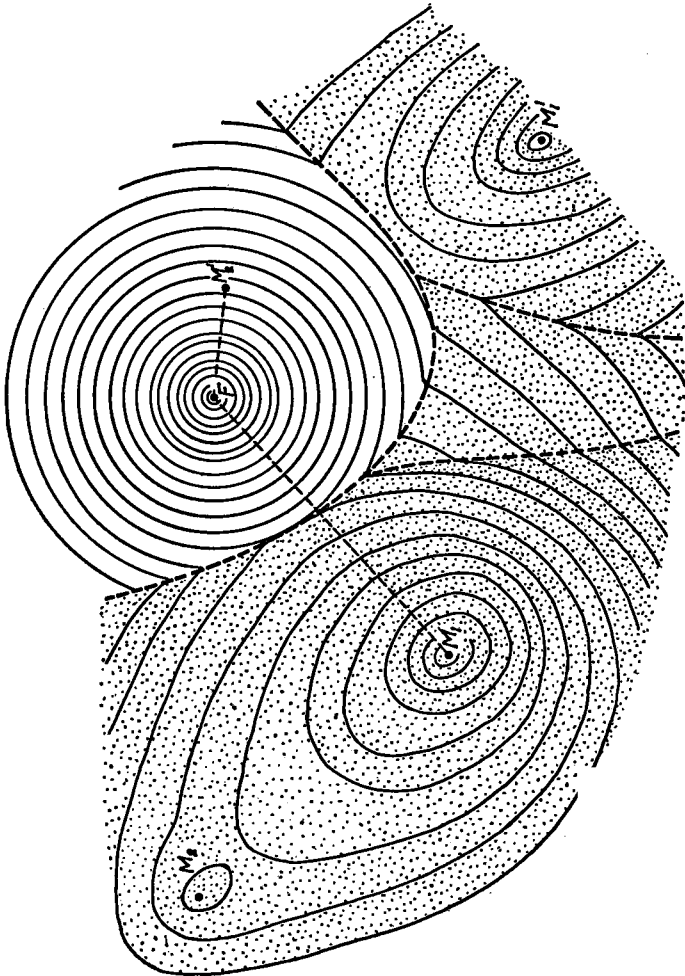

FIG. 26

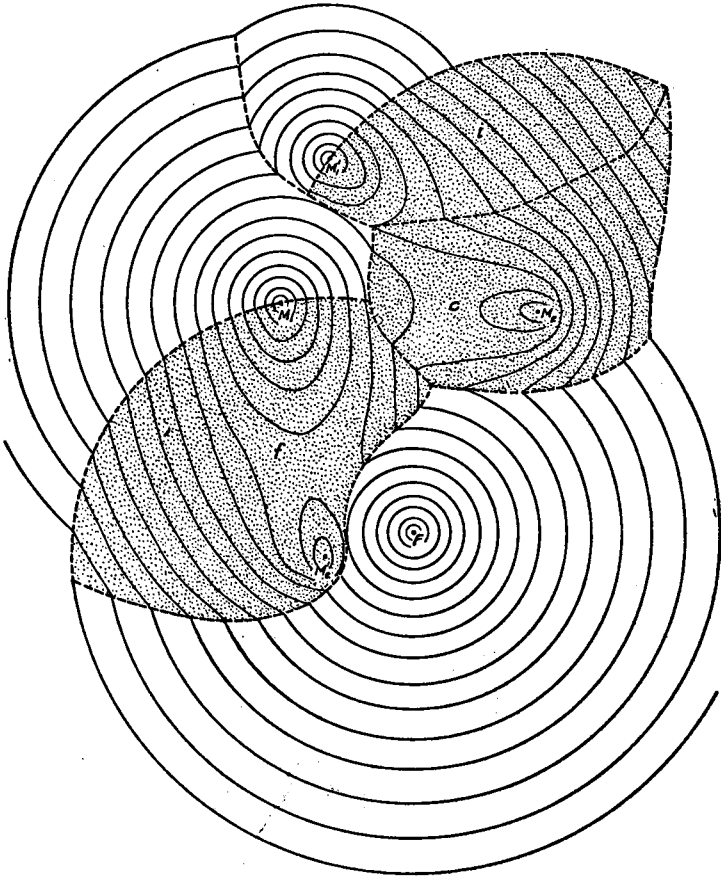

FIG. 27

daries. For standardized products in which transfer costs are of great significance, this assumption is a legitimate simplification.

But it is evident that in many commodities the market competition is not of that sort. Market areas overlap; producers sell into each other's home markets; in the extreme case, markets are national or worldwide, and transfer costs seem to be devoid of locational importance.⁷

We must remember that location is never actually in a state of equilibrium, but is merely tending toward a constantly changing 'normal' adjustment. So at any given time many markets are in process of being turned over from one producer or set of producers to another. But even ignoring the many possible temporary causes of cross-shipment, which may bring it to pass even in transport-dominated industries such as steel, one can find several causes for permanent overlapping of market areas.

So long as the goods of different producers are not perfect substitutes, it is evident that they can be sold in the same market at different prices. The market area of one producer does not end abruptly where his delivered price begins to exceed that of his distant rival, but tapers off gradually for a considerable distance beyond. For example, people do not necessarily buy automobiles from the concern which offers the lowest delivered price. German beer has been sold in England, and English beer in Germany, to meet the particular tastes of part of the consumers in each country.

Many products, moreover, are sold on a delivered-price basis which involves the 'absorption' of freight by the seller. In some cases this may be an intentionally discriminatory policy — I have indicated in a recent article some of the factors which determine the kind of spatial discrimination that is advantageous to the seller under various circumstances.⁸ But probably more often the policy of selling on a uniform delivered price basis arises from the desirability of having a convenient and stable retail price through-

⁷ For an interesting attempt to classify industries on the basis of the extent of their markets, see Clive Day, "The Distribution of Industrial Occupations in England, 1841-1861," in *Transactions of the Connecticut Academy of Arts and Sciences*, March, 1927.

⁸ "Spatial Price Discrimination," which I hope to have published during 1937.

out the country, or, say, everywhere east of the Rocky Mountains. In this way, price competition can be curbed and put in the background, allowing the emphasis to be put on the distinctive variations of the product which set it apart from rivals and substitutes. A necessary implement of this policy, in general, is some method of obtaining the coöperation of retailers in maintaining the price to the final consumer; for otherwise the pressure for lower prices would be reflected in the wholesale market as well.

The prices of many commodities contain only an insignificant element of transfer costs, and in such cases it may be simply not worth the trouble to quote different prices to buyers at different points. This is likely to be true whenever the producer has any interest at all in the stability of the retail price. A business man recently justified the practice of selling at uniform delivered prices by saying that his firm was interested in selling "goods, not transportation." What he meant was that other factors in pricing were so much more important than transport-cost differentials that those differentials could be ignored altogether; in other words, it was possible to make the near by buyers pay part of the freight for the remoter ones without losing their custom.⁹

Transport agencies likewise practice considerable 'blanketing' of rates, which makes some transport gradients resemble flights of

⁹ Several years ago the Federal Trade Commission made a comprehensive survey of price-basing methods in American industries, the results of which were published in its report on *Price Bases Inquiry: The Basing-Point Formula and Cement Prices* (Washington, 1932), chapter ii. Out of 3561 firms canvassed, 44.1 per cent sold exclusively on an f. o. b. basis, 17.8 per cent on a delivered-price basis, and 38.1 per cent both ways. A further breakdown of the 2038 firms selling partially or wholly on a delivered-price basis showed 36.2 per cent of them selling on the 'postage-stamp' plan of uniform delivered prices; 26.7 per cent on zoned delivered prices; 8.2 per cent on a basing-point system; and 28.8 per cent in other ways not classified. The proportions, of course, varied widely from industry to industry; out of the 15 industrial groups covered, the proportion of firms selling exclusively on f.o.b. terms varied from 2 per cent in the rubber products group to 68 per cent for textiles and 81 per cent for transportation equipment. In the leather industries, 65.2 per cent of the firms canvassed sold exclusively on an f.o.b. basis, and only 4.4 per cent exclusively on a delivered-price basis.

For discussions of the economics of delivered-price systems, see Tord Palander, *Beiträge zur Standortstheorie*, ch. xiv, Arthur R. Burns, *The Decline of Competition* (New York, 1936) and F. A. Fetter, *The Masquerade of Monopoly* (New York, 1931).

steps rather than smooth inclines. This factor alone would permit a large amount of cross-hauling.

A different reason for overlapping market areas lies on the side of production costs. When increased output means lowered costs, it will be worth while to seek additional business even if it nets less than the business already secured. To get new business in markets away from home, the seller must cut prices. Often it is possible and profitable to cut them only in the remote market: that is, to 'dump,' or absorb freights. Even if discrimination of this sort is not feasible, the competition between production points subject to decreasing costs is evidently likely to be of an unstable sort in which a small initial advantage may mean a large increase in market area, and in which the high stakes tempt the combatants to raids and price wars. Some of the results of this sort of cost variation will be discussed in the next chapter.

The market-area type of analysis is plainly not appropriate to cases in which markets overlap considerably or are national. In extreme cases we may think of the market as a *ubiquity*, since, so far as access to buyers is concerned, it is as if all the producers were located at the same point.

Furthermore, it is generally true that when transfer costs are insignificant in selling the product, they are likewise insignificant in securing materials. There are exceptions; but in general if the production costs overshadow transfer costs on the product, they will also overshadow those on the material. The shoe manufacturing industry is even more independent of nearness to leather supply than it is of nearness to markets, as Part III will show.

If both materials and markets can be regarded practically as ubiquities, then location becomes purely a matter of comparative production costs. Costs vary from place to place as they do from plant to plant; and the market of each enterprise will be limited by the extent to which its product can be substituted for those of its rivals and by the way in which its own costs respond to variations in output.

All this evidently involves far more than the theory of location. The rôle of that theory, in cases where transfer costs are unimportant, is restricted to explaining any systematic local variations

in production costs that may be observed. If one firm has a competitive advantage over another at the same location, that is not a locational question at all; but if firms in the South, or firms in large cities, or firms in specialized one-industry towns have generally a competitive advantage, that is a locational question, even though it may not be possible to lay out spatial boundaries between the markets of competing producers or competing centers. In the previous chapter some of the elements determining the local variation of labor costs were set forth; and we turn in the next chapter to an examination of certain other systematic local variations of production costs.

CHAPTER VI

ECONOMIES OF CONCENTRATION

WE HAVE noted that under the influence of transfer costs manufacturing industries tend to be concentrated in a relatively small number of separate places, each of these being the point of minimum transfer costs for a whole area of markets and perhaps for several different sources of materials. Anything which tends to make short hauls proportionately more costly than long hauls increases this tendency. And as a further factor, the 'channeling' of transportation along definite routes and between definite points restricts the choice of production locations to a relatively small number of nodal points having strategic transfer relations with materials and markets.

All of the above considerations have been expressed in terms of transfer costs, and have served to explain why the patterns of these costs show only a small number of separate minima in contrast to the almost infinite variety of possible combinations of material sources and market points. Production-cost differentials, which influence location by working against transport orientation, are a still further cause of concentration of production. A single cheap-labor center, for example, or a single city with especially low taxes or a bonus system to attract new industries, may capture what would otherwise be the market areas of several scattered production locations.

It remains for us to discuss those differences in production costs which depend upon local concentration. We are thus about to modify our initial assumption that manufacturing is carried on at costs which are constant regardless of the volume of production of the plant, the industry in the vicinity, or the size of the city.

Alfred Weber believed that 'the force of agglomeration' which manifests itself in the economies of concentration would be resolved into a reënforcing of the attraction of cheap-labor locations,¹ but none the less he developed a separate theoretical mech-

¹ *Op. cit.*, pp. 161-162.

anism to weigh the influence of agglomeration against that of transport costs. The basis of this was the same system of isodapanes as was described in the previous chapter. Two or more locational figures will merge, according to Weber, if the economies attainable by pooling their production at a common location more than compensate for the extra transport costs occasioned by the distortion of the pattern of transport orientation.

This is one of the least satisfactory parts of Weber's theory. Concentration of industry need not take place merely at locations of cheap labor; it may occur at a source of materials, at a strategically-located distributing point, or at a site with any sort of advantage in production costs. All of these possibilities I have discussed. The concept of a single 'agglomerative force' countered by a single 'deglomerative force' is one which many students of locational problems have rightly refused to stomach.² Some factors are important for some industries and at some times, others for other industries and at other times.³

In my mind, the greatest deficiency of the Weberian theory of agglomeration is that it combines three quite distinct influences upon local production costs:⁴

(a) *Large-scale economies* within a firm, consequent upon the enlargement of the firm's scale of production at one point.

(b) *Localization economies* for all the firms in a single industry at a

² In using his isodapanes to determine how far agglomeration will distort the pattern of transport orientation, Weber has in mind 'net agglomerative force' after allowance for the deglomerative factor of rent. Otherwise his isodapane system would not express the fact that for any single industry, the clustering of other activities at agglomeration-points is likely to raise the price of natural resources (i.e., rents) and is a centrifugal or dispersive force. Cf. Ohlin, *Interregional and International Trade*, p. 204.

³ For this line of criticism see Hans Ritschl, "Reine und historische Dynamik des Standortes der Erzeugungszweige," in *Schmollers Jahrbuch*, 1927, p. 824.

⁴ This distinction has already been suggested by Ohlin, p. 203. See also E. A. G. Robinson, *The Structure of Competitive Industry* (New York, 1932), pp. 140-142, in which the distinction is made between 'immobile' and 'mobile' external economies. The former correspond to what I have here called 'localization economies,' and the 'mobile' ones are those arising from the growth of the world output of an industry rather than from its localization. Robinson's remarks on the increasing relative importance of mobile external economies, and the consequent 'parasitic' relations of subsidiary concentrations of industry to principal concentrations, are worthy of attention.

single location, consequent upon the enlargement of the total output of that industry at that location.

(c) *Urbanization economies* for all firms in all industries at a single location, consequent upon the enlargement of the total economic size (population, income, output, or wealth) of that location, for all industries taken together.

In each of the above cases, of course, there may be diseconomies as well as economies. In Weber's agglomeration-concept, all three are inextricably mingled and further analysis is impossible without a preliminary unscrambling.

Palander shows clearly how Weber is led astray by this defect in his theory.⁵ The way in which Weber determines whether two locational figures will merge or not is to draw the critical isodapanes around the production points of both.⁶ If these intersect, then at any point within the zone of intersection the production process may be carried on with sufficient economies to justify the extra transport costs occasioned by moving production from both the former production locations to the new intermediate point (see Fig. 28). Palander points out that while it would be to the mutual advantage of producers at the two points to come together, it would not be to the advantage of any one of them separately to move to the intermediate segment, unless he were sure his competitors would simultaneously do the same. Furthermore, Weber does not tell us *where* in this segment the new combined production center is to be. The interests of the parties involved will naturally differ on that point, each wanting to move less than his share of the way. Consequently, Weber's conclusions are relevant only to the case of a single enterprise deciding whether or not to consolidate two branch plants at a single location.

A further difficulty of Weber's method was mentioned in connection with production-cost differentials in Chapter V: it provides no way of measuring the effect of 'replacement of material deposits,' which in Fig. 28 means the additional inducements to agglomeration afforded by the possibility of setting up a new locational figure such as $M_2'CM_1''C'$.

⁵ *Beiträge zur Standortstheorie*, ch. viii, § 10.

⁶ On the concept of the 'critical isodapane,' see p. 77 above, or Weber, pp. 104, 138-139.

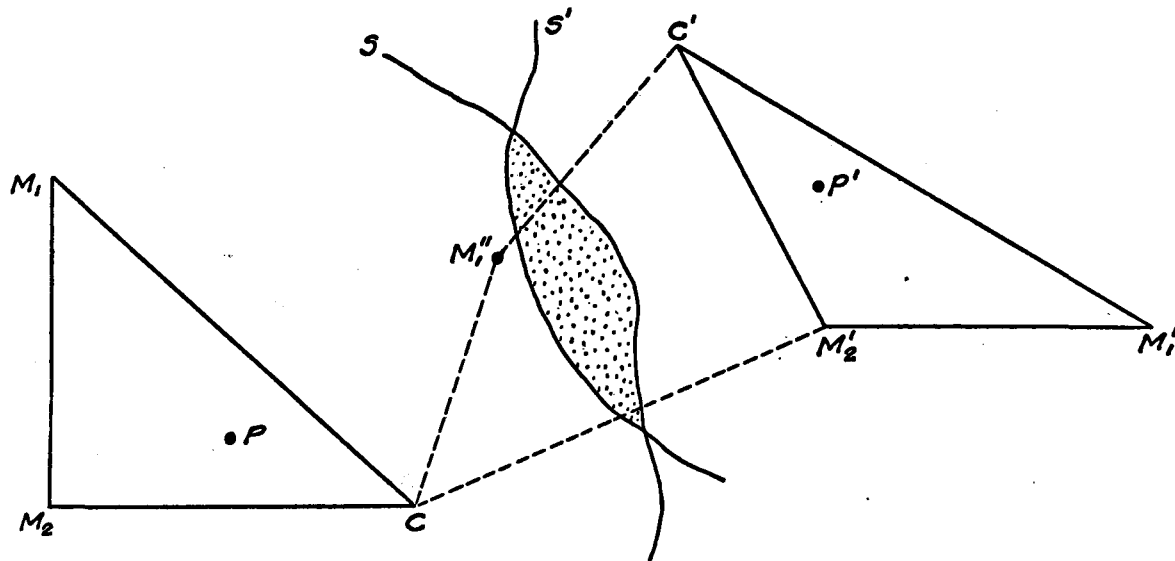

FIG 28. 'Agglomeration' as conceived by Alfred Weber. The points of minimum transport costs for locational figures M_1M_2C and $M_1'M_2'C'$ are P and P' . Anywhere in the stippled zone located within the critical isodapanes S and S' , costs of production and transportation are less than at P and P' , provided that production is concentrated at one location. M_1'' is an alternative source of one of the materials, which might be used if production were carried on in the stippled zone.

The confusion between different sorts of economies of concentration appears to have misled no less a person than Sombart. In his review of Weber's book he says:

The advantages of industrial concentration, in my opinion, do not belong in the theory of location at all. The question of location can be only: "Why is this industry here and not elsewhere?" . . . Why in the world should the cheaper gas or water supply of a large city not be put on the same theoretical footing as lower-cost coal or ore deposits? ⁷

There are several points on which Sombart may be challenged. If we are considering the location of a single industry, the advantages of urban location will indeed appear as an external, independent factor. But they are advantages in production cost, and therefore cannot work through transfer costs, as does nearness to fuel or mineral deposits or the source of any material. The essential distinction between production-cost and transfer-cost differentials has already been discussed in Chapter V.

If, on the other hand, the theory of location is to attempt to explain the growth of cities and not merely the orientation of individual industries with respect to the locational whole, then a great deal of attention must be paid to the reasons why concentration of population in itself may sometimes lead to still further concentration.

In any case, it is to be noted that Sombart alludes only to the economies of urbanization. For individual industries the more important constituents of Weber's 'agglomeration' would seem to be the two other sorts of economies, dependent on growth of the specialized industrial center and of the individual establishment respectively. We cannot possibly understand industrial location without an analysis of these influences, and they are influences that are not capable of being resolved into any of the theoretical constructions developed in the preceding chapters.

Let us first assume that each production location is occupied by a considerable number of firms in a given industry. This restricts our consideration, for the time being, to economies of localization. Now we inquire under what conditions some production points

⁷ Werner Sombart, "Einige Anmerkungen zur Lehre vom Standort der Industrien," in *Archiv für Sozialwissenschaft und Sozialpolitik*, May, 1910, p. 757.

which would have market areas in the absence of economies of localization will cease to have them, and therefore will cease to produce, when we bring such economies into the picture.

In Fig. 29, costs of production at a production center A are indicated vertically on AC , while distance from A is indicated horizontally to the right. The transport gradient CQ shows what the delivered price of the product will be at various distances from A when the price at A itself is AC .

Economies of localization mean that the cost of production will vary according to the size of the market area. Fig. 29 indicates, for example, that if A 's market area extends to L , the cost at A will be AC . But if the market area extends to M , costs will range from AR at A to MS at M ; a new and lower transport gradient has been substituted. An extension of the market area as far as N would make the transport gradient sink to TU .

On the various positions of the transport gradient, the critical points are those indicating delivered price at the edge of the market area, where A is in competition with some rival production point. Such points are Q, S, U . If we connect all such points we have a locus, the *margin line*, showing the way in which delivered price at the edge of the market area varies as the extent of the market area itself varies.

This same concept has already been used in Chapter II, above. The difference is that in the case of the extractive industries in Chapter II it was presumed that the general effect of increased output was to raise costs, while in the present case we are considering the possibilities of a lowering of costs through increase of output. There, the costs were those of extraction of a raw material; here, they are costs of manufacture. For a discussion of the assumptions involved in the construction of the margin line, and an analysis of some of the factors on which its shape depends, the reader is referred to Chapter II.

So long as extension of the market lowers costs, the slope of the margin line will be less steep than that of the transport gradient. In fact, it may even be negative. If the economies of localization are limited, and become diseconomies after a certain degree of localization is reached, the margin line will there assume a slope

greater than that of the transport gradient. The point at which it is tangent to a transport gradient is the boundary between economies and diseconomies of localization, or, in other words, the optimum size of market from the standpoint of production costs. Such a point is *U* in Fig 29.

Most generally, when localization brings diseconomies after a certain stage it is because production makes use of a raw material either impossible or expensive to transport. That is to say, the increased costs of production are due either to the process being partly of an extractive nature itself, or to its requiring so large a proportion of the local output of an extractive industry as to raise the price of the material by the mere fact of concentration.

An example of the former class appears in the steel industry. In certain restricted valleys in Eastern Ohio and Western Pennsylvania, where the industry is highly concentrated, it is said that the limit of the cooling capacity of the streams has been reached.⁸ Scarcity of good building sites is also frequently a factor discouraging localization; though it arises oftener from general concentration of population than from the localization of any single industry.

A rather different sort of diseconomy of localization is the tendency of labor organization to raise comparative labor costs in specialized centers. This factor will be given more extended attention in one of the chapters on the shoe industry, and seems to be fairly general in its application. Nearly a generation ago, New Jersey pottery owners were saying that "under present labor conditions, it is a disadvantage to be located in a pottery center, where labor union dictation is naturally strongest."⁹ Not only does this discourage localization, but also, since it works with a considerable lag, it tends to break up specialized industrial centers after they are established, and to keep industry on the move.

Returning to the general question of localization economies, we see in Figs. 30 and 31 the conditions under which one production-

⁸ Richard Hartshorne, "The Economic Geography of Plant Location," in *Annals of Real Estate Practice*, Proceedings and Reports of Industrial Property Division, vol. vi (1926), p. 55.

⁹ R. H. Whitbeck, "Specialization in Industry in Certain Cities, with Particular Reference to Trenton, N. J.," in *Journal of Geography*, October, 1909, pp. 32-38.

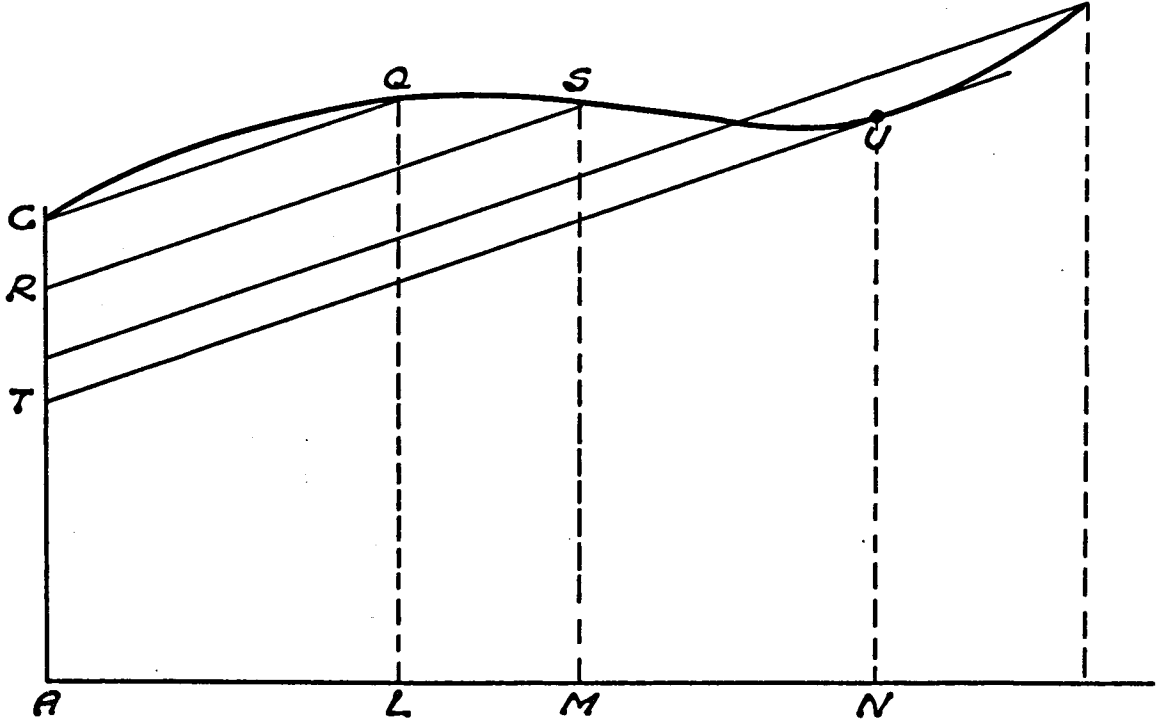

FIG. 29

location will drive another out of the market and bring about what Weber called 'agglomeration.' If *A*'s margin line cuts *BD* below *D*, as in Fig. 30, *A* will be able to drive *B* out of existence. If it does not, as in Fig. 31, the market will continue to be divided between *A* and *B*. It is evident that this locational factor works

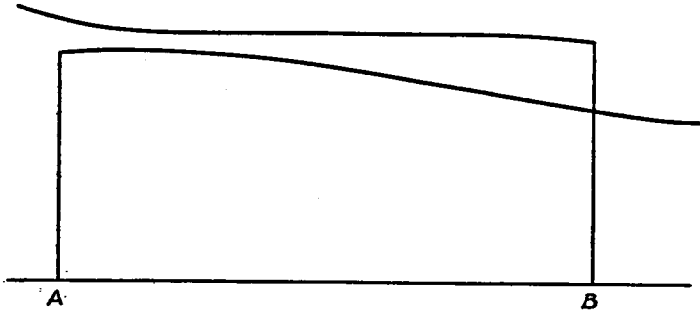

FIG. 30

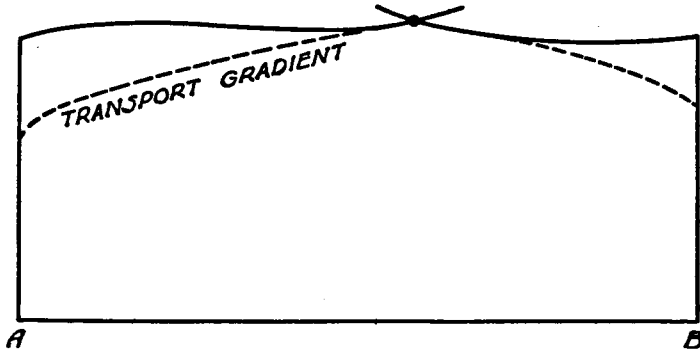

FIG. 31

somewhat like a lowering of transport rates, in that it enlarges the market areas of the low-cost producers and eliminates the high-cost ones. There are some important differences, however. The slope of the margin lines is not uniform for different production centers, nor even for different directions of market-area extension from the same center. Furthermore, the final pattern of delivered prices is not indicated by the margin lines, but (in Fig. 31) by the equilibrium position of the transport gradients.

The slope of the margin lines is obviously the important thing in determining the extent and character of localization. The following factors all tend to make the slope less, and therefore to increase the possibilities of localization:

(a) Greater scope for cost reductions as the output of a producing center rises. This is a factor which would depend on the conditions of the particular industry, and also upon institutions (e.g., the way in which wages are determined, the presence or absence of labor unions, the industrial-promotion and tax policies of the communities involved, etc.).

(b) Cheaper transportation, which diminishes the slope of the transport gradient and therefore, *ceteris paribus*, that of the margin line.

(c) A highly elastic demand for the product.

(d) Transport rates which are less than proportional to distance (as, for instance, railroad and water-transport rates commonly are). This sort of tariff can be represented by a transport gradient which is convex upward. This convexity will be reflected in the margin line, and will make it flatter in its outer reaches, thus giving the low-cost centers still greater opportunities to capture the trade of their neighbors.

It is conceivable that the economies of localization might exactly counterbalance the transport gradient (i.e., the increased costs of serving remoter markets). In that case the margin lines would be horizontal, and production would be concentrated at the location with the lowest margin line. It is much easier, however, to picture a situation like that of Fig. 29, where the margin line has a negative slope for a short distance, then turns gradually upward at an increasing slope, and ultimately (when further localization would actually increase production costs) slopes upward more steeply than the transport gradient itself. If (as shown in Fig. 32) two producing centers are so placed that their margin lines are negatively inclined in the region of their intersection, there is no equilibrium possible with a divided market. Whichever of the two centers gets the start of the other, in the case shown in the figure, will eventually absorb the entire market. This throws light on the oft-cited localizing factor of 'the momentum of an early start.'¹⁰

It remains to show the relationship between the economies of

¹⁰ Cf. F. S. Hall, "The Localization of Industries," in *Census of 1900, Manufactures*, part i, pp. cxc-ccxiv; also E. A. Ross, "The Location of Industries," in *Quarterly Journal of Economics*, April, 1896, pp. 247-268.

concentration and the 'nodality' of strategically-located transport junctions, which was given some attention in Chapter III. In particular, it should be pointed out that economies of large-scale production or localization inevitably affect the *orientation* as well as the *location* of production. We speak in general terms, for example, of 'market-oriented' industries; but very few of these are actually market-oriented to the extent of being carried on in each

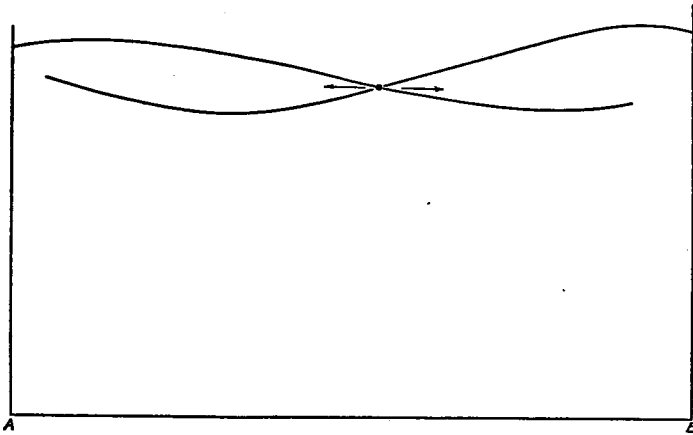

FIG. 32

hamlet or each city block. Similarly, cotton-ginning is 'material-oriented' despite the fact that cotton is regularly hauled several miles to the gin.¹¹

There is evidently a conflict, in such cases as these, between two locational forces: that of transfer costs, which would orient the industry still more closely to its material or market, and that of economies of concentration.

It is at this point that we may most fittingly give some consideration to the location of marketing and other 'intermediary' establishments, a usually underrated part of the economy.¹² The

¹¹ See above, p. 44, footnote 13.

¹² See Tables 1 and 2 in Chapter III, above, and J. K. Galbraith and John D. Black, "The Quantitative Position of Marketing in the United States," in *Quarterly Journal of Economics*, May, 1935, pp. 394-413.

reason is that these activities constitute a type in which costs are particularly responsive to volume of business (i.e., localization), and at the same time *not* strongly affected by other sources of production-cost differentials such as were discussed in Chapter V.

Fig. 33 is an attempt to set up the problem schematically, on the assumption that only three elements of cost call for consideration:

- (a) Costs of transfer from the factory.
- (b) Costs of operation of the intermediary establishment.
- (c) Costs of transfer to the consumer.

In the lower part of the figure is a generalized 'traffic flow map,' showing the path traveled by the commodity from the factory (at the left) through various major and minor distribution centers to the ultimate consumers (at the right). The thickness of the lines indicates the volume of traffic in the commodity along each route and sub-route.

In the upper part of the figure the three cost elements are represented by the heights of the three shaded and stippled areas. The ordinates of the diagonally-shaded area show how the costs of getting the commodity from the factory to the intermediary establishment vary according to the position of the latter along the path from factory to consumers. It will be observed that, in accordance with the observed pattern of transport charges, this cost rises rapidly at first, but at a decreasing rate as the length of haul increases. Beyond *R* it turns upward again, since that marks the meeting-place of rail and truck transport, and two independent hauls are necessary. Delivery to the door of the individual consumer would be very much more expensive, as is indicated by the sudden rise of the line near the right-hand end.

The height of the horizontally-shaded area shows the variation in the other element of transfer costs: from the intermediary establishment to the consumers. This starts out at zero at the consumers' end, and rises first rapidly and then more gradually as the establishment is moved farther and farther away from its clientèle.

Most generally, an intermediary marketing process increases the 'ideal weight' of the commodity in which it deals. Not only is an additional percentage of tare added as the goods advance one

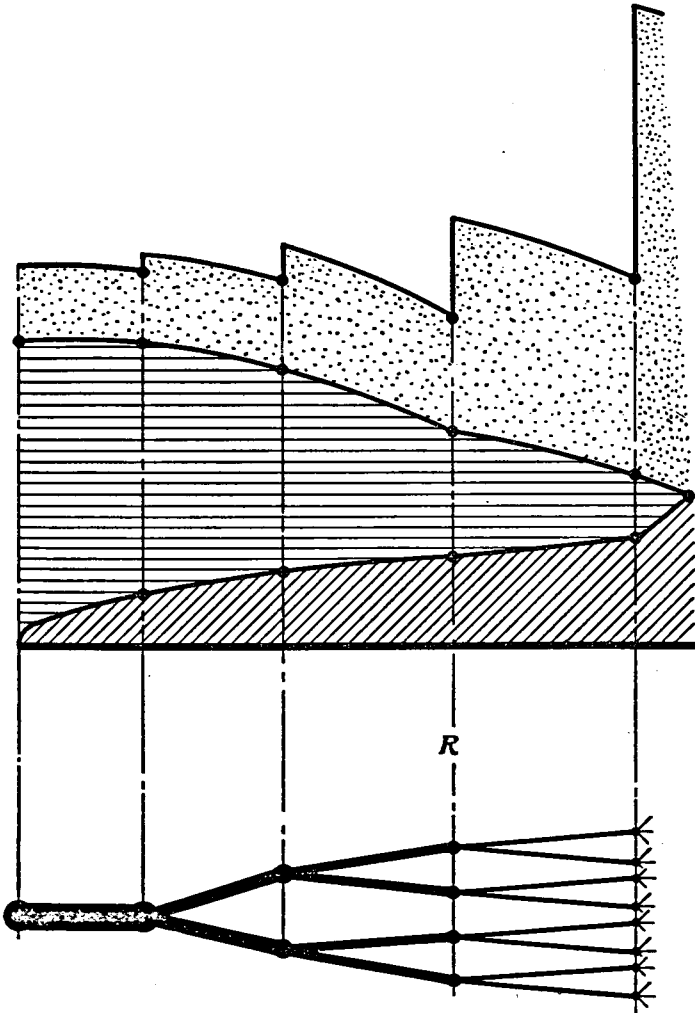

FIG. 33

more stage toward consumption, but the fact that the shipments are in smaller quantities and the increased value of the goods are valid reasons for expecting higher freight rates to apply. Still more important here are the elements of transfer cost that do not consist of freight charges, such as closeness of contact with customers, speedy delivery, and the like. It is safe to say that in most cases such considerations are more important on the sending end than on the receiving end; they therefore draw the intermediary stage *toward the consumers*. We must keep in mind, however, that new communication techniques for keeping in contact with consumers from a distance are constantly being developed in the effort to reduce this cost factor.

I have followed what would seem to be the more usual case, then, in making the costs of transfer to the consumer larger per mile than the costs of transfer from the factory. Accordingly, the sum of the two elements of transfer costs (represented by the ordinates of the upper boundary of the horizontally-shaded zone) is given a general downward trend from factory to consumers. That is to say, under the influence of transfer costs alone most intermediary stages would be market-oriented.

The third and last cost item to be introduced is the cost of the intermediary handling itself, apart from transfer costs. This I have assumed to depend upon the volume of business transacted, as indicated by the thickness of the lines in the 'flow map' at the bottom of the figure. The costs of the intermediary enterprise for various locations are indicated by the height of the stippled zone at the top of the figure. It will be observed that they are represented as equal for all points where traffic is the same, and that they rise suddenly to the right of every junction point.

The total of the three elements of cost is represented by the ordinates of the sawtooth line at the top of the figure, and it is at once evident that the distribution points or junctions are the only locations worth considering as optima. Costs at each such point total less than they do at non-junction points in either direction. This would appear still more plainly if the diagram were drawn so as to take account of the fact that transfer costs themselves are often disproportionately low to and from important junctions.

Not only are rates depressed by the competition of routes, but the handling facilities are likely to be better, the service more prompt and reliable, and so on. To take account of these considerations, the upper boundaries of the shaded zones would show dimples at each junction, and this would intensify the sawtooth effect at the top, where total costs are represented.

In the particular case represented in the diagram, the optimum location is apparently at *R* — which means at *each* of the four corresponding junctions indicated on the flow map at the bottom.

It is possible to form some idea of how this optimum will be located for various types of intermediary establishments. One factor is, of course, the separability of the process from factory production on the one hand or from individual consumption on the other. Château-bottled vintages and hand-tailored suits are contrasting examples. There is a wide range of variation in the relative responsiveness of different intermediary stages to the factors of market contact and economies of volume. Where the former are predominant, the stage is likely to be located at many small distribution points close to the consumer; where the latter predominate, localization in a small number of major distributing centers at or near the factory centers is the rule.

The automobile industry furnishes examples of both. The salesroom needs to be in close contact with its customers, in order to sell not only cars but repairs and accessories as well. Maximum efficiency apparently can be obtained in an establishment of quite moderate size. Consequently we find such salesrooms in every town, and even in the separate neighborhoods of cities.

On the other hand, the stage immediately preceding the salesroom — the assembly plant — is not quite so strongly market-oriented, because the advantage in nearness to the consumer is almost exclusively in transport charges. But to operate efficiently, an assembly plant must be large, as the repetitive nature of its processes would imply. Consequently, such establishments are few in number, each serving an area of many thousands of square miles; and in all but the most popular makes of cars the assembling is concentrated at the factory itself.

The foregoing discussion has dealt with intermediary stages

assumed to be primarily market-oriented, in which market orientation was more or less limited by the economies of large-scale production and localization. The opposite sort of case would be that of a primarily material-oriented process in which the material orientation cannot proceed all the way because of these economies. The ginning of cotton, the milling of grain, and the smelting of ores are examples. To picture the pattern of costs involved, we may again use Fig. 33, but must think of the material as moving from scattered producers at the right to a large market at the left. At each junction point new streams of 'traffic' are picked up, and consequently the costs of operating the intermediary stage drop suddenly at such points. Again, the junction points are seen to be the only logical choices for the location of the intermediary stage or stages, and the question of which junction points to choose depends on the relative importance of volume of business on the one hand and material orientation (that is, excess of transfer costs on material over those on product) on the other. In the case of cotton gins, a decentralized type of location results, with establishments at every minor junction point; in the case of flour mills, much more centralization results.

A rather interesting sidelight on the question of localization economies in marketing is given by William J. Reilly in a recent investigation,¹³ the conclusions of which are summarized in the following direct quotations:

. . . retail business gravitates from smaller cities and towns to larger cities in accordance with a definite law.

. . . outside trade increases at about the same rate as the population of a city increases. . . a city with about five times the population of another city draws about five times as much retail business from the surrounding territory.

. . . a city's outside business decreases faster than distance from the city increases.

Two cities attract retail trade from any intermediate city or town in the vicinity of the breaking point (i.e., the market-area boundary) approximately in direct proportion to the populations of the two cities and in inverse proportion to the square of the distances (via most direct improved automobile highway) from these two cities to the intermediate town.

¹³ *The Law of Retail Gravitation* (New York, 1931), pp. 5, 7, 8, 9.

Probably few would agree that we have here the statement of a fundamental economic law. Reilly himself calls attention to many qualifications, and claims merely that his theory fits the facts. He determined the retail trade area boundaries by field investigation in thirty cases, and the 'law' is merely an inductive expression of the trend of the results. The greatest discrepancy between the position of a trade area boundary as found by the general formula and by field investigation was only 12 miles, or 11 per cent of the distance between the cities in question.

Although the size of market areas differs very widely for different commodities,¹⁴ it is possible to speak of a trade area for retail trade in general. The Division of Review of the National Recovery Administration laid out the ambitious design of establishing, as future units for trade statistics and code administration, a set of several hundred primary and secondary trade areas covering the whole United States, and constructed on the following basis:

. . . a compromise or an average of all the factors which apply to people, buying power, standards of living, educational and amusement facilities, volume of business, strategic location and buying habits. They represent the nearest possible delineation of areas and as such provide a workable basis for economy of control.¹⁵

Turning now to the economies of urbanization, we find them displaying a significant relation to the other two types. If localization and large-scale economies alone existed, then every concentration of an industry in a town would make that town a less desirable place for most other industries. The cost of living would be raised, and thus money wages would tend to be higher. This would discourage labor-oriented industries. Similar increases in the cost of all materials produced under diminishing returns would

¹⁴ This is well shown in several of the bulletins of the Domestic Commerce Series of the Bureau of Foreign and Domestic Commerce, and likewise in maps published in several reports on *Retail Trading Areas* by the Committee on Business and Industry of the Iowa State Planning Board. Two of these are reproduced in Fig. 34. Cf. also Horace Secrist, *The Widening Retail Market* (Chicago and New York, 1926).

¹⁵ National Recovery Administration, Division of Review, Industry Studies Section, Work Materials Series, no. 42, *An Explanatory Report on the Study of Natural Areas of Trade in the United States and a Guide to the Methodology Used in its Preparation*, by Robert A. Dier (February, 1936). See also John Paver and Miller McClintock, *Traffic and Trade* (New York, 1936).

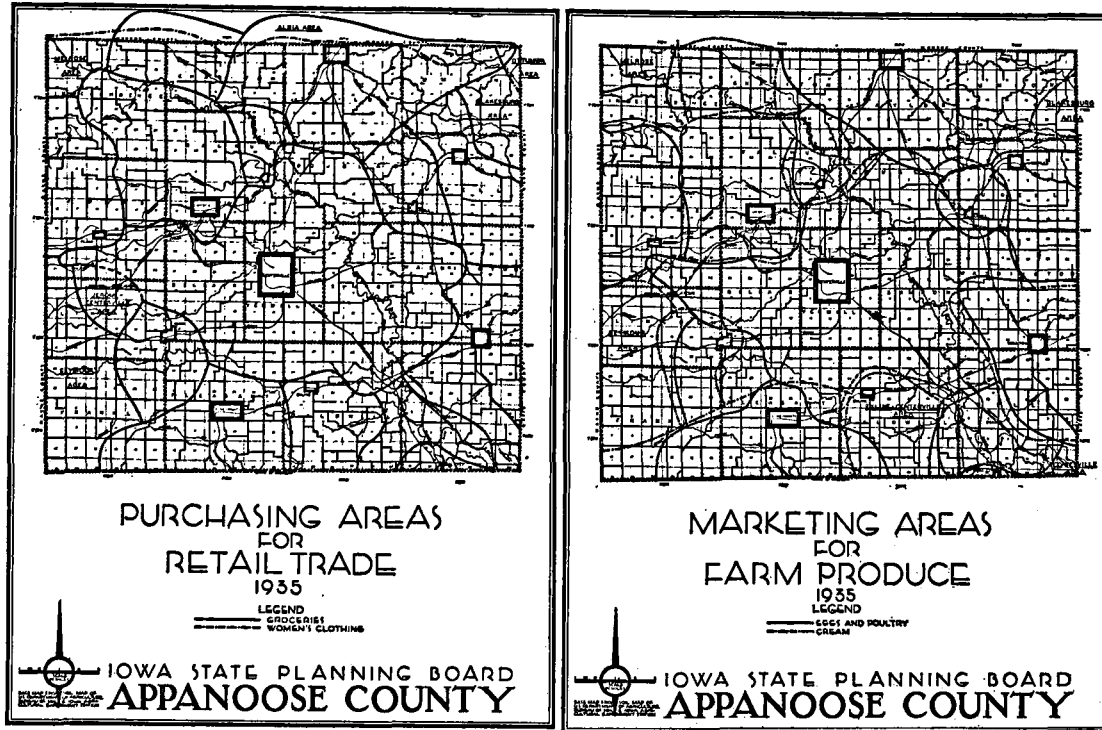

FIG. 34

discourage the material-oriented industries. In the city center, the rise in land values would be a still further burden on both types. Only the market-oriented industries and those dependent upon the industry in which the original concentration took place would find the town an advantageous location.

The higher the rents, the more incentive there is for a detailed separation of processes, those requiring much space and not imperatively requiring an urban location being relegated to the outer regions. In the printing and publishing trades, for example, there seems to have been a definite de-urbanization of such branches as bookbinding, lithography, and the printing of non-rush jobs such as books. Pratt cites the case of a map manufacturer who reduced his insurance costs 90 per cent by moving from New York City to suburban Westchester County.¹⁶ Other findings of his include the following:¹⁷

In almost every case, where a manufacturing plant has left the City of New York, the removal was caused by the high land values.

Waterfront property in Manhattan has become prohibitive for manufacturing concerns.

Thus the economies of large-scale production and localization by themselves would lead toward the development of specialized centers of production with only one or a few branches of industry. The reason for the rarity of that result lies of course in the third

¹⁶ Edward E. Pratt, *Industrial Causes of Congestion of Population in New York City* (Columbia University Studies in History, Economics, and Public Law, vol. xliii, no. 1, New York, 1911), pp. 73, 110.

¹⁷ Reprinted from Pratt, *op. cit.*, pp. 109, 51, by permission of Columbia University Press.

Since manufacturing industries compete for space just as extractive ones do, the 'rent surface' analysis of Chapter II may be applied here. But the land use is so much more intensive, and the displacements involved are relatively so small, that we do not need to consider rent as a locational factor for manufacturing industries unless we are investigating the relatively 'microscopic' phenomena of locations within an urban area. Cf. the discussion of this point in Weber, pp. 31-32. Among the interesting investigations into intra-city location are the publications of the Regional Plan of New York and Its Environs, the *New Survey of London Life and Labour*, *The Location Structure of Retail Trade* (in Baltimore: Bureau of Foreign and Domestic Commerce, Domestic Commerce Series, no. 80, 1933), and Lewis F. Thomas, *The Localization of Business Activities in Metropolitan St. Louis* (St. Louis, 1927).

sort of economies of concentration: those of *urbanization*, which are external to both the firm and the industry.

As a city grows it usually attracts not only the market-oriented industries and those whose concentration started the growth of the city in the first place; but it also attracts certain labor-oriented industries, in spite of high living costs. Ohlin explains this as follows:

... large cities with their concentrated labour market possess qualities of labour entirely absent in the country. The advantage of access to such a labour market, where any quality of worker can be found readily whenever needed, is an important element in the localisation of many industries.¹⁸

Not all labor-oriented industries, of course, will be attracted to large cities. The advantage of city labor lies not in low wages but in efficiency and flexibility of supply; so in general the industries oriented to *skilled* labor will be attracted and those using much low-grade labor will be repelled.

The seasonal factor is of primary importance in some industries. In the country, the seasons generally impose an annual variation in employment and thus create an off-season labor supply available for auxiliary occupations. If the industry is of a sort that can advantageously carry on the bulk of its production during the months when this labor supply is at hand, it is likely to find its labor costs lowest in a rural location. On the other hand, if the seasonal variation in labor demand in the industry does not fit in with the variation in that supply, the flexible and diversified labor supply of a large city is likely to prove more attractive.¹⁹

I have indicated above that the concentration of one industry in a city may be expected to bring with it a subsidiary concentra-

¹⁸ *Op. cit.*, p. 219.

¹⁹ A manufacturer of shoes and slippers in a large Middle Atlantic city is quoted as saying: "Due to the fact that our business is seasonal and that we employ the greatest number of people between July and December, it is advantageous for us to be in this city. We can get the labor as we want it here even though at a higher price, and can lay our people off during the slow periods when they can usually get temporary employment elsewhere." *Industrial Development in the United States and Canada* (published jointly by the Metropolitan Life Insurance Company and the National Electric Light Association, probably in 1928 but not dated), p. 31.

tion of dependent industries. In some cases, indeed, the auxiliary growth is an important element in the economies of localization. The relationship of the dependent industries to the principal one may be of any of several types. For instance, the dependent industry may be material-oriented and use as its principal material one of the products or by-products of the principal industry. Thus, we find glue factories in fishing, tanning, and meat-packing centers. Or the dependent industry may be market-oriented, and its product may be one of the materials, or part of the equipment, required by the principal industry. Examples are the manufacture of rope and marine supplies in port towns (water-borne commerce being here considered as the 'principal industry'), and the preparation of cut soles, findings, and boxes in shoemaking centers. Or again, the dependent industry may be oriented to a supply of 'parasitic' labor, performed by the wives or children of the men engaged in the principal industry, or even seasonally by these men themselves. An example of this is the shift of the silk industry to Eastern Pennsylvania to utilize the complementary female labor of the anthracite region.²⁰

We must now bring into consideration the economies of large-scale production, internal not only to the industry but to the firm as well: those which depend exclusively on the size of the individual firm's establishment in a given city. There are evidently two distinct optimum scales of production: one for the single firm, and one for the location as a whole. For instance, individual shoe factories might find it uneconomical to operate on a scale of more than 1000 pairs a day, that being the limit of internal economies. But various sorts of external economies might mean that with increased volume of shoe production in a single city the costs of all firms would be lowered, until the daily production in that city reached, say, 80,000 pairs. Beyond this second optimum, the addition of new firms would not bring any further economies.

²⁰ Mr. Hermann Brunck has coined the picturesque term 'by-product women' for use in this connection. R. M. Haig points out that in Pennsylvania the silk weavers are about 60 per cent women, while in New Jersey 60 per cent are men. "Toward an Understanding of the Metropolis," in *Quarterly Journal of Economics*, February, 1926, p. 195. He cites the manufacture of overalls, house dresses, and cigars as other industries attracted to complementary labor.

In some cases the scale of production determined for a given location by its market area may fall short even of the technical optimum for a single plant. In such a case there would of course tend to be only one plant at the location in question, since decreasing costs would apply there. In other cases, the optimum size for individual plants may be approximately attained — as will be indicated if several continue to exist at the same location — but the optimum production scale for the location as a whole may not be attained. This means that lower costs for all the firms might ensue, through external economies, if the extent of the market area permitted additional production to be localized at the same point. In still other cases (e.g., at the point *U* in Fig. 29) it may happen that not only each firm, but the producing location as a whole is permitted to attain the optimum scale of production. Many American industries have exhibited a tendency toward dispersion in the last decade or so, which may mean that the optimum degree of concentration was overestimated or has actually decreased.

So long as there are several firms at each producing location (which we have assumed heretofore to be the case), the economies of large-scale production within firms need not alter the locational pattern at all. The optimum size of firm can be attained at all points otherwise fitted for production.

If, however, the optimum size of firms is considerable enough so that some production locations have only a few firms, a whole new series of problems arises, due to the fact that we can no longer assume that these isolated firms will sell their products at a price bearing the same relation to cost as under pure competition. The existence of internal economies here expresses itself as a restriction on the complete mobility of the factors of production, and there is the possibility of a differential monopoly return to isolated producers.

Where such considerations become important, a reconsideration of the question of location from the standpoint of the individual firm is necessary.²¹ If sellers are unable to discriminate among

²¹ Considerable analysis has already been done in this direction, utilizing the mathematical technique and very drastic assumptions, such as uniformly distributed and perfectly inelastic demand, zero costs of production, transfer costs pro-

various classes of buyers, the monopolistic price-pattern will simply be higher (in general) than the competitive, but will display the same gradient of variation with transport costs. The selling locations at which competition is less pure²² will tend, evidently, to have relatively smaller market areas than they would under conditions of pure competition. If, however, it is possible for sellers to discriminate among buyers according to distance, the outcome may be quite different.²³

In either case, the monopoly element has an effect upon the choice of location not only for buyers but for the monopolists or oligopolists themselves. Further developments in locational theory must take this into account.

portional to distance, and the like. The principal discussions which have come to my attention are these, listed in chronological order: Harold Hotelling, "Stability in Competition," in *Economic Journal*, March, 1929, pp. 41-57; F. Zeuthen, "Theoretical Remarks on Price Policy: Hotelling's Case With Variations," in *Quarterly Journal of Economics*, February, 1933, pp. 231-253; E. H. Chamberlin, *The Theory of Monopolistic Competition*, appendix c (Cambridge, Mass., 1933); Erich Schneider, "Preisbildung und Preispolitik unter Berücksichtigung der geographischen Verteilung von Erzeugern und Verbrauchern," in *Schmollers Jahrbuch*, 1934, pp. 257-277; also "Bemerkungen zu einer Theorie der Raumwirtschaft," in *Econometrica*, January, 1935, pp. 79-105; and Tord Palander, *Beiträge zur Standortstheorie* (Stockholm dissertation, 1935), chapter xiv.

²² I am using the term 'pure competition' in the sense established by Chamberlin (*The Theory of Monopolistic Competition*, p. 6), as 'competition unalloyed with monopoly elements,' without reference to how 'perfect' or 'frictionless' the market is.

²³ See my article "Spatial Price Discrimination," cited in note 8 of Chapter V, above.

PART II
THE LEATHER INDUSTRY

CHAPTER VII

ESSENTIAL CHARACTERISTICS OF THE INDUSTRY

THE tanning industry is one of the most ancient known to man, and was carried on practically without technical change till well along in the past century. It consists essentially in the treating of animal skins with natural or synthetic chemical agents to preserve and toughen them, although the splitting and finishing of leather also occupy considerable time and labor. These supplementary processes have little effect on the transport relations of the industry, since they involve no great weight of extra materials or product.

Three important materials are needed in the process: hides or skins, water, and some kind of tanning agent. The water used, though considerable in quantity and subject to certain requirements as to quality,¹ may be regarded as practically a ubiquity. It also adds nothing to the weight of the product (in Weber's terminology, it is a completely 'weight-losing' material); so water supply will affect location only within restricted districts. A tannery generally requires to be situated on a stream or lake; but such sites are in most places not hard to find, so that this constitutes no considerable restriction on the choice of locations.

The chief tanning agents, and until a generation ago practically the only ones, have been the barks of various shrubs and trees, especially the hemlock, oak, chestnut, and sumac. In some trees, however, notably the South American quebracho, the part used is the wood; and one fruit, the myrobalan, appears in the list of tanning agents. In the past half-century the use of synthetic tanning agents and extracts of the natural materials has greatly increased. We shall see subsequently the effects which these innovations have had upon the location of tanneries.

¹ The water requirements are not the same for the lighter grades of leather, such as shoe uppers, as for sole leather. Alkali particularly must be avoided if a soft leather is being made. It is desirable in any case to have the water cold, making it easier to control the putrefaction process in hot weather.

TABLE 5
THE TANNING INDUSTRY¹

RAW MATERIALS	PROCESSES	BY-PRODUCTS	PRODUCTS	USES
1. HIDES AND SKINS				
<i>a</i> Cattle hides				
<i>b</i> Horse hides				
<i>c</i> Goat skins				
<i>d</i> Calf skins				
<i>e</i> Colt skins				
<i>f</i> Sheep skins				
<i>g</i> Pig skins				
2. Water	1. Washing			
3. Lime	2. Liming			
	3. Hairing.....	1. Hair	Plaster, mattresses, felt	
	4. Fleshing ...	2. Flesh	Glue, fertilizer	
	5. De-liming...	3. Ammonia	Chemical works, household uses	
4. Bark	6. Tanning			
<i>a</i> Hemlock				
<i>b</i> Oak				
<i>c</i> Sumac				
<i>d</i> Mangrove				
<i>e</i> Cutch				
5. Salt	7. Washing	1. Leather:	1. Shoes	
	8. Drying		<i>a</i> Sole Leather	2. Bookbinding
6. Dyes	9. Dyeing		<i>b</i> Morocco	3. Traveling bags
	10. Finishing ...		<i>c</i> Calfskin	4. Pocket-books
			<i>d</i> Russian	5. Gloves
		<i>e</i> Patent	6. Automobiles	
		<i>f</i> Crown	7. Furniture	
		<i>g</i> Seal	8. Harness	
		<i>h</i> Buckskin	9. Saddles	
		<i>i</i> Grain, etc.	10. Belts	
			11. Hose, etc.	

¹ Reprinted by permission from *Modern Business Geography*, by Ellsworth Huntington and S. W. Cushing, published by John Wiley & Sons, Inc. (Yonkers, N. Y., 1932), p. 245.

The kind of hide or skin used depends largely upon the qualities desired in the leather and upon the supply of the various animals. It must be kept in mind that hides have generally been a by-product of stock-raising,² with the meat, milk, or wool first in importance. Only in places where cattle have roamed free and cost nothing to raise, and at times when refrigeration or live transportation was not practicable, have hides been a primary product.

² Cattle hides are worth roughly 10 per cent of the value of the animals.

This means that the supply of hides and skins is largely independent of price changes. Wide and sustained price fluctuations are characteristic of the hide and leather markets.³ In terms of the theory of location, the situation is as follows: the raising of cattle, sheep, etc., is distributed with reference to relative natural advantages of localities for stock raising, and transport relations with consuming markets for meat, milk, wool, etc. The place where the animals are slaughtered will be determined by transport relations with the places where stock are raised and with the aforesaid consumption points, plus the effects of production-cost differences and economies of localization. And this slaughtering industry is the source of hides and skins. Because hides and skins are by-products, the causation works only one way: the location of markets for them (i.e., the location of tanneries) does not determine the location of packing plants.

We may, then, take for granted the location of the sources of hides and skins, which simplifies our task considerably. Some idea of the proportions in which the various types are used in the American tanning industry is given in Table 6.

TABLE 6
HIDES AND SKINS TREATED IN THE TANNING INDUSTRY, 1899-1931¹
(millions)

	Cattle	Calf and kip	Goat and kid	Sheep and lamb
1899	15.8	6.9	48.1	24.5
1909	18.4	19.7	48.1	26.1
1914	17.5	16.1	37.8	40.1
1925	21.4	15.7	50.0	32.0
1928	20.3	19.6	54.9	39.0
1931	16.2	12.4	48.6	32.5

¹ *Commerce Yearbook*.
A hide weighs more than 25 pounds; a kip from 15 to 25 pounds; and a skin less than 15 pounds (National Shoe Retailers Association, *Materials in Shoes*, pp. 4-6).

The principal buyer of leather is the shoe industry, which takes about 80 per cent of the cattle leather, 95 per cent of the kip, calf, and kid leather, and 40 per cent of the sheepskin leather.⁴

³ Richard Donham, "Problems of the Tanning Industry," in *Harvard Business Review*, July, 1930, pp. 474-481; also Malcolm Keir, *Manufacturing*, p. 441.

⁴ Estimates made by the National Industrial Conference Board, in *Trends in the Foreign Trade of the United States* (New York, 1930), p. 224.

These estimates include the establishments making cut soles and findings for sale to shoe factories and repair shops. In the chapters on the shoe industry it will be made clear that shoe factories have been located independently of leather supply at all periods when the latter has been at all localized. So the market for leather may, like the distribution of the sources of hides, be taken for granted. Our problem in these chapters on the leather industry is narrowed down to the explanation of the location of tanneries with reference to markets, materials, and other relevant known factors.⁵

Some tentative conclusions on the orientation of an industry may be reached by a computation of the relative 'ideal weights' of the materials and product and the relative importance of transport and production costs, as suggested in Part I. In each of the student monographs which make up the second volume of Alfred Weber's *Ueber den Standort der Industrien*,⁶ the author has evaluated the influence of the various materials and of market and labor locations by computing locational weights, labor coefficients, and the other Weberian key figures.

Even Weber's most devoted disciples realized that merely computing the weight ratios for the various materials involved in a given manufacturing process, and correcting them for differences in freight rates, does not enable the investigator to take ruler and compasses and mark out on a map the optimum locations for the industry. In the case of an industry whose location is determined mainly by one or two important materials or by the market, and when the rate structure of the transport agency involved is a straightforward one, the conditions are at their best for drawing definite conclusions from the results of such computations as Weber's students made. Even then, the conclusions must usually be built around some such general statements as this: "The in-

⁵ With regard to the other material, the situation is not quite so simple. In the first place, there have been two great changes in the use of tanning agents: the introduction of leached extracts (i.e., the technical and geographical separation of the extractive and manufacturing processes), and the introduction of inorganic tanning agents. In both cases, the tanning agent is the principal product, and therefore the location of the plant making the tanning agent may be dependent on the location of tanneries. The Census gives practically no information on the location of the manufacture of tanning materials.

⁶ A list of these appears in the bibliography at the end of this volume.

dustry in question, at a given historical period and in a given country, has a material index much less than unity and a very small labor coefficient. Therefore it will not in general be attracted either to material or to cheap-labor locations, but instead to the market."

This is by way of preliminary caution, lest the reader take too seriously the figures referred to in this chapter and in the corresponding one on the shoe industry (Chapter X). It seems worth while, however, to present the findings of Adolf Link, who published a locational analysis of the German leather and shoe industries in the Weber series of monographs.⁷

Link tells us that in the hand manufacture of sole leather in Germany, using oak bark, 200 kg. of hides and 500 kg. of tanbark made 100 kg. of leather and 20 kg. of usable by-products.⁸ The uncorrected material index, if we ignore the by-products altogether, is 7.0; if we consider them as pulling against the market attraction, it is 7.2.⁹ Provided, then, that costs of transport are equal per ton-mile on all three commodities, hides will influence the orientation of tanneries about twice as strongly as the market will, and bark will influence it about seven times as strongly. That being the case, production might be expected to take place uniformly at the source of tanbark.

A rough check on the above relative weights may be obtained from the United States Census of 1900,¹⁰ which states that in 1875 one gross ton of hemlock bark was required to tan 200 pounds of sole leather, while in 1900, owing to technical improvements, the same amount would tan 300 pounds. If we assume that the weight of the hide or skin is double that of the finished leather, as it is in Link's case, the uncorrected material index would be 13.2 in 1875 and 9.5 in 1900. The difference in tanning efficiency between oak and hemlock bark, and possibly the greater cheapness of bark in the United States, account for the difference in the results; but the significant fact for our purposes is that the American figures, even more strongly than the German, suggest a very strong tendency toward orientation to tanbark supply.

⁷ *Die Lederindustrie (erzeugende und verarbeitende)* (Tübingen, 1913).

⁸ Glue scraps and hair.

⁹ Link, p. 24.

¹⁰ Vol. ix, p. 715.

This was true so long as the bark was used in its natural state (i.e., before the development of leaching processes), and is characteristic of a long stage in the locational history of the tanning industry. The attraction of tanbark sources was still further strengthened by the fact that bark is bulky, fragile, and subject to deterioration through exposure, so that the expense and inconvenience of transporting it would be appreciably greater than that of carrying an equal weight of leather or hides an equal distance.

Technical developments, however, have altered the situation. Various imported barks and woods have been used, with a tannin content up to 50 per cent as compared with 5 per cent for oak bark,¹¹ which means that only a tenth as much bark would be required for a given weight of leather. Lighter hides and skins have come into use, which increases the waste and the labor cost. Processes have been developed for extracting the tannin from the bark or wood near its source of supply and then shipping the extract.

TABLE 7
WEIGHTS OF PRINCIPAL MATERIALS PER UNIT WEIGHT OF PRODUCT IN
REPRESENTATIVE GERMAN TANNERIES, ACCORDING TO LINK ¹

	Establishment tanning sole, calf, and belt- ing leather (bark process)	Establishment tanning kid leather (chrome process)
Hides, skins	1.9	3.6
Bark, extracts	2.6	...
Chemicals	2.3
Coal	1.2	14.6

¹ *Op. cit.*, p. 28.

The full evaluation of these changes must wait till later chapters. However, we may form some idea of their significance by an examination of Link's two other type cases, the basic data for which are presented in Table 7. In considering these figures it should be kept in mind that coal is ordinarily carried at a lower freight rate than the other materials, so that its real relative transport importance or 'ideal weight' is perhaps a third or a fourth of the actual weight.¹² Even so, it would seem to be a factor of some

¹¹ Link, p. 2.

¹² Link estimates the average rate on coal at one-third of that on the other commodities.

importance for the location of tanneries of the second type, making upper leather.

A pertinent question may be raised here as to the extent to which American tanneries purchase coal rather than, say, electricity. Table 8 answers that question for the year 1929; and the opinion may be ventured that the leather industry has shared since then in the general tendency of our manufacturing plants to use more purchased electricity and relatively less coal.¹³ It appears that in 1929 the leather industry was buying somewhat less electricity and more fuel, relatively, than most other industries.

TABLE 8

FORMS OF POWER IN THE LEATHER INDUSTRY AND IN ALL MANUFACTURING INDUSTRY IN THE UNITED STATES, 1929 ¹

(Percentages of total rated horsepower installed)

	All manufactures	"Leather: tanned, curried, and finished" ²
All forms.....	100.0	100.0
Steam engines and turbines	40.5	55.9
Electric motors (purchased current)	53.0	41.5
Water wheels and turbines	3.6	1.4
Internal-combustion engines	2.9	1.2

¹ Computed from data in U. S. Census of Manufactures, 1929, vol. i, p. 112, vol. ii, p. 795.

Link's data permit of only the roughest of generalizations regarding the orientation of the industry under the influence of transport costs for the various materials; but a few tentative conclusions may be helpful.

One of these is that nearness to tanbark supply is a dominant factor, except where extracts or other concentrated agents are used. Nearness to the source of hides or skins is important for all branches of the industry, but more particularly for those using skins, and making light upper leather. In those branches, there is naturally a much higher percentage of waste and by-products, owing to the smaller size and greater hairiness of the skins. According to Link's figures, only 28 per cent of the gross weight of

¹³ See Table 6r on p. 292, below.

goatskins is converted into finished leather,¹⁴ as compared with 53 per cent in the case of sole, calf, and belting leather and 50 per cent in the case of hand-made sole leather.

The disposal of by-products is not likely to have much effect on the location of tanneries in any case. Link tells us that the industries using *Leimleder* (i.e., hide scraps, etc., used for glue) and hair tend to be oriented to the tanneries,¹⁵ which seems reasonable in view of the loss in weight involved in the processing of this sort of materials.

It would appear from the figures cited that nearness to markets is a relatively unimportant factor in the orientation of tanneries. If we take Link's two representative cases in Table 7 and calculate the material index for each, dividing the actual weights of coal by three to take account of lower freight rates, the results are 4.9 and 10.8 respectively. Both hide supply and tanning-agent supply are apparently more important than nearness to market in each of the two cases.

What elements of production costs are likely to be of importance in determining the location of tanneries? Here again our generalizations must be very rough, but a few helpful conclusions may be reached through a consideration of the character of the industry.

For the hand tanning of oak sole leather, on the basis of German wages in 1912, Link computed a labor coefficient of 35.6 marks, or \$8.40, per locational ton. This means that a 10 per cent differential in labor costs would be sufficient to compensate for extra transport charges of 84 cents per metric ton. If the materials and product were carried at 2 cents a ton-mile, the 84 cents would buy 42 miles of extra transportation.

The labor coefficients in Link's other two cases, for mechanized tanneries, are 32.8 marks (\$7.74) and 143 marks (\$33.70), if we include only one-third of the actual weight of the coal used. This means that a 10 per cent differential in labor costs would be sufficient, if we assume a rate of 2/3 cent a ton-mile for coal and 2 cents a ton-mile for the product and other materials, to buy a

¹⁴ The percentage would be still smaller in sheepskin tanneries, which buy their skins with the wool on.

¹⁵ Link, p. 37.

total of $38\frac{1}{2}$ miles of transport in the manufacture of sole, calf, and belting leather, and $168\frac{1}{2}$ miles in the manufacture of chrome kid.

It would be absurd, of course, to attach any exact significance to such computations as these. Their only purpose is to indicate what order of importance labor costs are likely to possess relative to transport costs. For purposes of comparison, it may be worth while to state that the same sort of calculation applied to the factory manufacture of ladies' slippers (another of Link's cases) gives a labor coefficient of 6960 marks (\$1642). Under the assumption that coal travels at $\frac{2}{3}$ cent, the other materials at 2 cents, and shoes at 4 cents a ton-mile, a 10 per cent labor-cost differential would buy a total of 8210 miles of transportation! For hand-made shoes the figure would be much larger.

We should not be led to expect that the tanning industry is very responsive to ordinary differentials in labor costs. In his German investigation, Link was able to find only one case in which they had been a factor, and there the tannery had moved only twelve miles.¹⁶

Other factors, however, might work with labor costs to keep the leather industry out of the larger urban centers. The ground space required is relatively large, and the esthetic qualities of the tannery are low, so that rents and zoning laws could be expected to suburbanize or even ruralize the industry to some extent.

In view of the smallness of the labor-cost factor, any economies of localization in the leather industry must depend mainly upon advantages in access to specialized markets for materials, products, and supplies, in machinery servicing, and in the development of by-product industries. We shall find that in some branches of the industry, at least, such considerations seem to be important.

The importance of power or fuel costs indicates that the leather industry is one in which there is relatively large scope for economies of large-scale production for the individual establishment. Link indicates that many of the types of machine used can be economically operated only in good-sized plants. The fact that the tanning process is slow means that a great deal of capital is

¹⁶ From Mannheim to Weinheim (Link, p. 36).

tied up, which indicates a possible advantage for large established concerns which can get capital more cheaply.

These impressions on the optimum size of the establishment are borne out by Table 9, which compares the leather industry with all manufacturing industries in the United States.

TABLE 9
SOME COMPARISONS BETWEEN THE LEATHER INDUSTRY AND ALL
MANUFACTURING INDUSTRIES, 1889-1929 ¹

	Wage earners per establishment		Horsepower per establishment		Ratio of invested capital to value added by manufacture	
	All	Leather	All	Leather	All	Leather
1889	12	24	17	47	1.55	2.00
1899	10	40	21	68	1.86	3.54
1909	25	68	70	161	2.16	4.18
1919	31	106	102	321	1.77	2.38
1929	42	106	204	488

¹ Computed from Census data. No figures on capital investment were collected for 1929. The figures in the table are not suitable for time comparisons, on account of changes in the scope of the Census; but are meant to indicate the position of the leather industry relative to manufacturing industries in general in each Census year separately.

CHAPTER VIII

THE TANBARK PERIOD

PARADOXICALLY enough, at the beginning of this country's history, when tanbark was the bulkiest of the materials used in the manufacture of leather, it seemed to have no locational effect at all. This is explained by the fact that in all the settled parts of the country there was a seemingly inexhaustible supply of the trees used for tanning: oak, hemlock, sumac, and chestnut. Bark was a ubiquity, to at least as great an extent as water was. So the fact that production always took place at a source of bark was obscured by the fact that the choice of such sources was almost infinite.

Naturally those were selected which combined the greatest number of other locational advantages. Hides were available everywhere because the slaughtering business was a strictly local one. The high cost of transportation made 'locational figures' small, and allowed water supply, a factor that on any larger scale would have been considered practically a ubiquity, to exercise the only really restrictive effect. In each community the tannery was located on the most convenient stream.

The following passages are useful in giving us a picture of the tanning industry of the early Colonial days:

Cattle were slaughtered locally, and every community soon had at least one man who sank his vats in the stream running through his back yard, and tanned hides in the crude fashion of the day.¹

A tannery or two seem to have been uniformly a part of the economic outfit of the inland town. The working dress of the people was largely composed of leathern garments. . . . A large part of the material came from the hides of animals slaughtered on the farms and prepared at the village tannery. This was a primitive affair. . . .²

¹ Richard Donham, "Problems of the Tanning Industry," in *Harvard Business Review*, July, 1930, p. 474.

² Percy W. Bidwell, "Rural Economy in New England at the Beginning of the Nineteenth Century," in *Transactions of the Connecticut Academy of Arts and Sciences*, vol. xx, p. 261 (April, 1916).

Leather manufacture began with the first generation of settlers in each of the colonies. In accord with the policy of government supervision of industry, Virginia, in 1661, required each county to provide for at least one tanner, currier, and shoemaker. . . .³

It is significant that the second passage quoted refers specifically to inland towns only. For it was on the seaboard that the first signs of a new stage began to show. The real importance of tanbark as a locating factor shows up in the local specialization that soon set in. The sea provided one avenue of much cheaper transportation, and it was in districts convenient to coastwise shipping that there grew up the first specialized industry serving more than a purely local market.

The earliest specialized tanning district in the New England region was that immediately south of Boston, making use of the local supply of oak. Roxbury was known as a tanning center as early as 1647.⁴

But shipyards also were active on the South Shore, and eventually used up the oak timber of the vicinity. Instead of drawing its bark supply from farther afield, the South Shore tanning industry moved to the North Shore, where hemlock forests were available stretching almost uninterruptedly to Maine, Canada, and New York state. The utilization of distant supplies of the Northern New England bark was of course deferred till the coming of the railroads; but the supply was so large that the concentration of tanneries on the Massachusetts North Shore continued almost down to the present century on the basis of its easy access.⁵

What specialization there was among the different districts along the Atlantic Coast directly reflected differences in bark

³ Malcolm Keir, *Manufacturing*, p. 429. Quoted by permission of the Ronald Press Co., publishers.

⁴ Census of 1900, vol. ix, p. 731. There was a tannery detached from a household as early as 1630 at Lynn, but the center of gravity of the leather industry of the region was definitely on the South Shore for some decades after that. See Donham, *loc. cit.*

⁵ In 1639 Salem had one tannery; in 1768, four; in 1800, seven; in 1850, thirty-four; in 1880, fifty-two. Associated Industries of Massachusetts, *Industries of Massachusetts*, vol. i, p. 59. An early advantage of Salem was the abundance of 'sumack-trees' near there. Albert S. Bolles, *Industrial History of the United States*, 3d edition (Norwich, Conn., 1889), p. 446.

supply, which further indicates the importance of that factor. Massachusetts (after the industry had moved north of Boston) used mainly hemlock, producing a leather somewhat lighter than the oak tan of the middle and southern colonies, although to a certain extent all grades were produced in each of the colonies. There was a coastwise interchange of these two types of leather from a comparatively early date.⁶

But so long as tanbark was practically a ubiquity the limiting influence on location came mainly from hide supply and market, especially the former. To be sure, these two factors generally pulled together, because the hide supply depended on the location of herds of cattle, and these in turn were found always in close proximity to the consuming markets for meat, i.e., the population centers. It was the demand for meat, and secondarily for dairy products, in the thickly-settled districts around Boston, New York, and Philadelphia that provided a plentiful supply of hides there for the tanning industry⁷ and in addition provided a market for the leather.

The leading port towns had two advantages contributing to the more rapid growth of the tanning industry there. In the first place, their shipping services provided cheap transportation to an extended market; which in the case of the shoe industry, as we shall see, was the prerequisite to successful division of labor in the manufacturing process itself. And, secondly, the ships provided cheap transportation from remote material sources which otherwise could not have been utilized.

This second factor deserves further comment. Let us recall once more that hides are a by-product of the meat industry, and that the demand for hides has in general no effect on the supply. That peculiar circumstance accounts for the chronic shortage of hides in many parts of the colonies,⁸ as well as for the threatened shortage that in recent years has appeared world-wide. Tanbark was at first practically a free good; water was plentiful nearly every-

⁶ Keir, *Manufacturing*, pp. 430-431; Clark, *History of Manufactures in the United States, 1607-1860*, pp. 115, 167.

⁷ Cf. Bolles, *op. cit.*, pp. 446, 448.

⁸ See Bolles, pp. 445-447, and Keir, pp. 429-430, on the various laws which attempted to increase the local supply of hides in various colonies.

where; there was a considerable demand for leather; but there was not enough demand for meat to give rise to as great a supply of hides as if they had not been a by-product.

The supply of hides, rather than the market or the supply of bark, being the most stringent limiting factor, naturally the tanning industry developed to its fullest extent only at points where incoming ships could bring the necessary supplementary supply of hides. Connecticut, Rhode Island, and Maine, and of course Massachusetts, had tanneries before 1700; New Hampshire, more of an inland state, not until a century later.⁹ Really specialized tanning districts developed only in the immediate vicinity of Boston, New York, and Philadelphia.

The Boston district seems to have had the initial advantage, not only in number of ships calling but also with respect to ease of navigation. Keir cites the fact that the Hudson and the Delaware occasionally freeze, while Boston Harbor almost never does, as being one factor in Boston's early start.¹⁰ In another place he tells us:

The shoe industry as well as the cotton industry has been able to attain first place in New England because the sea was close at hand. Although shoemaking was a local industry in all the American colonies, it attained distinction in Massachusetts. Everywhere else the village cobblers were hampered by a lack of raw material and confined to a local market by the difficulties of transportation. Only at Lynn were these obstacles removed. Lynn lay between Salem and Boston, two of the principal colonial ports. The boats that carried fish and other products away from these harbors brought back cargoes of hides collected from scores of places touched on the voyages. Some vessels made special trips to the west coast of South America and California with the sole purpose of gathering hides for the New England tanneries. Lynn as a result never suffered from a scarcity of raw materials.¹¹

So far, I have pictured the first two stages in the development of the location of the tanning industry. The situation at the beginning of settlement, when each household or small community

⁹ Keir, p. 449.

¹⁰ *Ibid.*

¹¹ Keir, "Some Influences of the Sea upon the Industries of New England," in *Geographical Review* (published by the American Geographical Society of New York), May, 1918, p. 404.

tanned its own leather, represents an initial stage historically common to all the industries serving household wants. The growth of commerce and of other industries soon caused local demand to outrun the supply of leather that could be produced on the basis of the hides from cattle locally slaughtered and consumed.¹² Bark was still for all practical purposes a ubiquity; so that for the serving of the enlarged markets it became necessary to draw upon remoter supplies of hides. This greatly favored as production points the places which by virtue of shipping connections had cheap transfer relations with other such supplies.

The tanning industry of the early Colonial period, like the shoe industry, was carried on exclusively by hand. A few vats were the principal equipment, and there was no power machinery. As late as 1768 a horse-power bark grinder at Salem was regarded as a rather startling innovation.¹³ Little division of labor was possible. It would seem, then, that there was little scope for any economies of large-scale production or localization. Furthermore, the necessity of being near the bark supply kept tanneries small and scattered.¹⁴ It is safe to say, then, that whatever concentration may have occurred in the industry was due not to advantages of concentration *per se* but simply to a flocking of separate production units to a common point of minimum total transfer costs.

Having accounted for the fact that the tanning industry, though oriented primarily to the tanbark supply, found its earliest localization around the principal maritime cities, and especially just north of Boston, we may pass on to a consideration of the next stage in its location. As markets grew, the supply of hides had to be drawn more and more from outside the country.¹⁵ The Census indeed tells us that until 1815 the domestic supply sufficed, but we hear of much earlier imports.¹⁶ At any rate, in the '40's

¹² Undoubtedly the plentiful supply of fish in the shore settlements, by lessening the demand for meat, was partly responsible for the necessity of importing hides to supplement those obtained locally as by-products of the meat industry.

¹³ *Industries of Massachusetts*, vol. i, p. 59.

¹⁴ In 1849, the average number of wage earners per establishment was 3.8; in 1879 it was 6.4 (computed from Census data). Compare with Table 9 in Chapter VII.

¹⁵ Census of 1900, vol. ix, p. 716; Keir, in *Geographical Review*, May, 1918, p. 404.

¹⁶ Keir, *Manufacturing*, p. 432.

and '50's about two-fifths of the supply was coming from abroad, chiefly from Latin America.¹⁷ Until 1842, hides came in duty free, and the duty never exceeded 5 per cent prior to the Civil War.¹⁸

Not only the hides but also the bark had to be drawn from farther afield, and this was serious for the old tanning districts because so much bark was needed and because it was bulky and expensive to transport. The relatively small supply located close to tidewater was soon taken off,¹⁹ and as the near by bark resources of the eastern seaboard became depleted the tanneries there had to resort to expensive overland transportation or else move their bases of operations.

The latter alternative was the one adopted in many cases, and there set in a slow but steady migration west and southwestward on the trail of the retreating virgin forests. Like practically all 'industrial migrations,' this move was accomplished partly by the transfer of operations of existing firms and partly by the working of interregional competition, which made the leather business relatively more profitable in the newer production districts.

In Fig. 35, the heavy dotted line indicates the boundary between original forests of hemlock (to the north) and oak and chestnut (to the south).²⁰ The migration of tanneries, as we should expect, followed a double path. Hemlock tanneries went westward across New England to New York state²¹ and Northern Pennsylvania, then jumped across Lake Erie to Michigan and across Lake Michigan to Wisconsin. Oak and chestnut tanneries

¹⁷ Census of 1900, vol. ix, p. 717.

¹⁸ R. H. Foerderer, in *One Hundred Years of American Commerce, 1795-1895* (New York, 1895), vol. ii, p. 497.

¹⁹ As has already been remarked, the lumber industry hastened the exhaustion of local supplies of the trees furnishing tanbark. This was undoubtedly more the case with oak and chestnut than with hemlock; partly because those woods were in general located closer to markets (see Fig. 35), and partly because their wood is of greater value relative to their bark than is the case with hemlock.

²⁰ More detailed information on the distribution of individual species is available in the Census of 1880, vol. ix, *Forests*.

²¹ About 1822 New York City began to get the most of its leather from the Catskill district instead of from Western New England and the Middle Atlantic states as before. J. Leander Bishop, *A History of American Manufactures from 1608 to 1860* (Philadelphia, 1864), vol. ii, p. 239.

went westward to some extent, to Western Pennsylvania and Ohio, but in the main they tended southwestward along the Appalachians, to Virginia, West Virginia, Kentucky, Tennessee, and

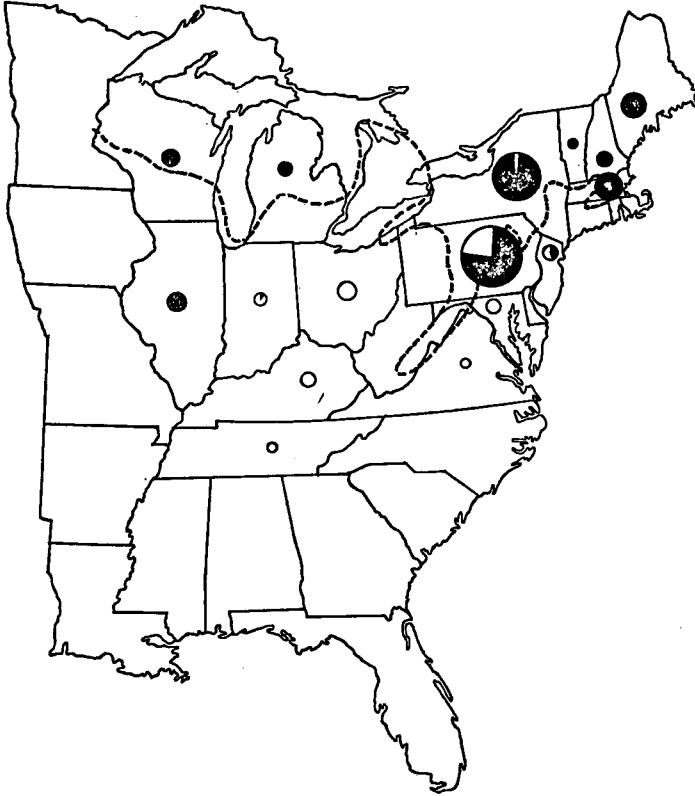

FIG. 35. Approximate boundary between hemlock and oak-chestnut forests, based on map in Goode's *School Geography*.

North Carolina. The migration did not really get under way until after the Civil War,²² so the earliest available Census figures (1880) should show the division referred to. The circles inscribed

²² F. S. Hall, "The Localization of Industries," in Census of 1900, *Manufactures*, part 1, p. cciii.

in the various states in Fig. 35 are proportional in area to the number of tons of tanbark consumed in the several states in 1879; the black sector indicates the portion of the state's tanbark consumption which consisted of hemlock, the white that portion which consisted of oak. It will be observed that the kind of tanning done in each state (with the exception of Illinois) is closely correlated with the nature of the forest. In the case of Illinois, water transport was available, and apparently the hemlock of Wisconsin was more easily available than the oak of Indiana.

Fig. 36 shows that in 1886 tanning was still essentially a local industry, carried on in practically every community of any size. Some traces of localization are observable, however, along the Atlantic seaboard (the region of initial localization) and down the Appalachians.

The relative improvement of the hemlock tanning process, which had previously been inferior to that using oak bark, was an important factor in the westward migration, and undoubtedly gave the hemlock states a larger share in the industry than they would otherwise have had. In 1879, according to the Census data from which Fig. 35 was prepared, more than three times as many tons of hemlock bark were used as of oak bark.

But the strength of the forces pulling the industry west and southwest was lessened by several considerations.²³ First of these was that the building of railroads had very much cheapened overland transport. Water freights were still lower than land freights, but not so much lower as they had been. And this meant that the narrow radius within which it paid to haul tanbark to meet waterborne hides was somewhat widened. The locational importance of the hide-supply factor was somewhat lessened.

Secondly, the factors of market and of hide supply were pulling together, toward the Atlantic seaboard. This in some cases was enough to outweigh the attraction of nearness to bark supply.

Nevertheless, it seems probable that the tanning industry would not have long outlasted the tanbark forests in the coastal

²³ The slowness of the migration is indicated by the fact that tanneries flourished in Pittsfield, Mass., from 1798 to 1850 (*Associated Industries of Massachusetts, Industries of Massachusetts*, p. 39).

region if certain further developments had not occurred. With the building of railroads new markets came into being in the Midwest. The tanneries serving these new markets were naturally located on the edges of the forest nearest the market. Thus, Ohio markets bought leather tanned in Ohio oak forests; Chicago markets, that tanned with Michigan and Wisconsin hemlock bark. Bark was still a compelling locational factor, although the migration of part of the industry must be explained in terms of new markets as well as of the necessity of seeking new sources of an essential material.

Reference has been made above to certain developments which checked the shift of the industry relative to population, and re-oriented it in some respects. The only one of these properly considered in the present chapter is the increase that took place in the latter nineteenth century in the use of calf, goat, and sheep skins relative to cattle hides. As Table 10 shows, the increase in goat-skin consumption, due to the taste for kid leathers and also to technical advances, was particularly sensational. The change is important locationally because, as will be recalled from the previous chapter, the weight loss is much greater on the smaller and hairier skins. More skin must be used for the same amount of leather. In the case of goatskins, this at least doubles the locational importance of nearness to skin supply.

TABLE 10
CONSUMPTION OF HIDES AND SKINS IN THE UNITED STATES LEATHER
INDUSTRY, 1879-1919¹

	(Relative to 1889 = 100)				
	1879	1889	1899	1909	1919
Cattle hides	90	100	121	140	170
Calf and kip	100	171	379	247
Goatskins	100	1620	1625	1865
Sheepskins	100	139	148	129
All skins	71	100	292

¹ Computed from Census data.

As the Midwest was opened up and the stockraising industry developed there, a domestic hide and calfskin supply prevented the imports of those materials from further increasing. Goats, on the other hand, were never extensively raised in this country; so

the supply of goatskins has come almost exclusively from abroad. Many sheepskins are also imported.

We should expect, then, that the tanneries remaining near the seaboard would be predominantly those using goat- and sheepskins, partly because the coastal location is more convenient with respect to the supply of those skins, and partly because the tanning of them is a process in which bark supply is less important relative to skin supply than it is in the manufacture of sole or belting leather.

In Table 11 I have attempted to show the development of this specialization in the two main types of tanning. The picture is complicated by the presence of two factors of technical change which I have as yet purposely avoided introducing; but the figures do seem to give some corroboration of the conclusions referred to. The tanning of skins shows considerable concentration in the eastern seaboard states of New Jersey, Massachusetts, Maine, and Pennsylvania, which in 1879 tanned about 81 per cent of the skins and only about 50 per cent of the hides. As a matter of fact, the figures understate the degree of regional specialization, since the large Pennsylvania skin consumption (nearly a third of the national total) was mainly concentrated in the Philadelphia district. Illinois appears among the specialized skin-tanning states on account of her large consumption of calfskins, in which branch she ranked as the most specialized state in 1889, 1899, and 1909.²⁴

Tanneries using cattle hides in particular — and secondarily those using calfskins — felt the full force of the westward and southwestward attraction of the receding tanbark supply. Those using imported goatskins were less dependent on nearness to bark supply and at the same time more dependent on nearness to ports of entry. And the increase in consumption of goatskins relative to the other types of hides and skins helped to retain near the coast a larger portion of the industry than would have remained there if heavy leather had kept its former relative importance.

The increase in consumption, which was greatly accelerated

²⁴ That is, Illinois's share in the national consumption of calfskins exceeded her share in leather production by a larger percentage than was the case for any other state. See Table 29 in Chapter IX.

after 1880, itself calls for explanation. This and other questions will be dealt with in the following chapter, which describes the dislodging of the tanbark factor in favor of others as the chief locational determinant.

TABLE 11
RELATIVE CONSUMPTION OF SKINS AND HIDES IN THE TANNING INDUSTRY,
BY STATES, 1879¹

	(a) Per cent of U. S. skin consumption	(b) Per cent of U. S. hide consumption	Per cent ratio (a)/(b)
United States	100.0	100.0	100
California	6.6	2.2	300
New Jersey	9.0	3.1	290
Illinois	7.5	3.4	220
Massachusetts	28.7	13.8	208
Maine	11.0	7.5	147
Pennsylvania	31.9	25.2	127
Michigan	1.7	1.6	106
New York	20.9	21.2	98
New Hampshire	2.0	2.4	83
Ohio	2.2	3.9	56
Wisconsin	1.2	2.7	44
Tennessee	0.3	1.4	21

¹ Computed from data in Census of 1880, vol. ii, p. 452. The currying industry is not included in these figures.

CHAPTER IX

EFFECTS OF TECHNICAL PROGRESS

THE locational importance of nearness to oak or hemlock forests was due to the fragility and perishability of tanbark and the large amount of bark required per unit weight of hides or product. But only about 10 per cent of the weight of this bark consisted of active tanning agents, the rest being of so little value that it was generally thrown away or burned as fuel in the tanneries.

As early as 1791 a patent had been issued on a process for the leaching of tanbark to provide an extract containing all the active ingredients;¹ but the idea lay fallow, so far as practical results were concerned, until nearly a century later. It was perhaps the wide distribution of tanbark and the extreme decentralization of the leather industry that was responsible for slowness in applying new methods.² As late as 1880 the Census took cognizance of only three tanning agents: oak bark, hemlock bark, and sumac. But by 1883 a hundred patents had been issued,³ and in 1890 the extracts were of sufficient importance to be reported separately by the Census, as constituting 5.6 per cent by value of all tanning agents used.⁴

Since the weight of tanning material transported per unit weight of product was reduced about 90 per cent by the use of extracts, the locational importance of nearness to bark supply relative to nearness to market was correspondingly lessened. On the basis of Link's first illustrative case (the hand tanning of oak

¹ Census of 1900, vol. ix, p. 713.

² The iron industry before 1840 presents an instructive parallel. There too, the presence of a practically ubiquitous supply of the most important raw material, charcoal, kept the industry scattered and technically backward in this country.

³ Census of 1900, vol. ix, p. 713. A classified summary of all leather-making patents issued down to 1883 is given by Robert H. Foerderer in his chapter on the tanning industry in *One Hundred Years of American Commerce*, ed. Chauncey M. Depew (New York, 1895), vol. ii, p. 496.

⁴ Census of 1890, *Manufactures*, part 1, pp. 712-713. See Table 15 below.

sole leather ⁶⁾ the weights of the materials per unit weight of product would be as follows:

	Bark tanning	Extract tanning
Hides	2	2
Bark	5	..
Extract	$\frac{1}{2}$

I have purposely taken the case of cattle-hide leather for illustration, because in skin tanning the relative weight of the skin is much greater, and there is no doubt of its locational dominance when concentrated tanning agents are used.

TABLE 12
USE OF OAK AND HEMLOCK BARK AND EXTRACTS IN TANNING,
BY STATES, 1889 ¹

	Percentage of oak bark to total bark used, by value	Percentage of oak extract to total extract used, by value
United States	27.9	56.2
<i>Hemlock states:</i>		
Massachusetts	1.2	20.4
New York	9.6	37.5
Illinois	0.8	2.7
Wisconsin	0.9	...
Maine	1.6	...
New Hampshire	33.3
<i>Oak states:</i>		
Ohio	87.1	89.5
California	100.0	87.0
Kentucky	99.3	93.2
<i>States using both oak and hemlock in important quantities:</i>		
Pennsylvania	21.4	79.4
New Jersey	41.0	30.4

¹ Computed from data in Census of 1890, *Manufactures*, part 1, pp. 712-713.

As a result of the diminished influence of nearness to bark supply, regional specialization of tanneries according to the nature of the bark supply began to wane. Oak tanning could henceforth be done in hemlock regions and hemlock tanning in oak regions. Table 12 shows to what lengths this had gone as early as 1889. Tanneries in the hemlock regions developed a considerable production of 'union' leather, with a mixture of hemlock bark and oak and hemlock extracts.

⁶ Cf. Table 7 in Chapter VII above.

TABLE 13

TANNING OF SOLE LEATHER ACCORDING TO AGENT USED, 1889-1919¹
(Percentages of total number of sides tanned)

	1889	1899	1909	1919
All agents	100.0	100.0	100.0	100.0
Oak	13.0	16.6	21.4	51.1
Union	23.0	19.9	32.3	37.1
Hemlock	64.0	63.5	44.7	8.8
Chrome	1.6	3.0

¹ Computed from data in Census of 1900, *Manufactures*, part 3, p. 708, and Census of 1920, vol. x, p. 502.

TABLE 14

PERCENTAGE OF UNION TO TOTAL TANNAGE OF SOLE LEATHER,
BY STATES, 1889-1919¹
(According to number of sides)

	1889	1899	1909	1919
United States	23.0	19.9	32.3	37.1
Wisconsin	92.6
West Virginia	46.2	55.0	69.5
Pennsylvania	27.5	28.9	39.9	47.4
Massachusetts	85.7
New York	10.7	36.0
Michigan	11.7

¹ Computed from data in Census of 1900, *Manufactures*, part 3, p. 708, and Census of 1920, vol. x, p. 502.

TABLE 15

TANNING AGENTS USED IN THE UNITED STATES LEATHER INDUSTRY,
1879-1919¹
(Percentages of value of total tanning agents used)

	1879	1889	1899	1909	1919
All agents	100.0	100.0	100.0	100.0	100.0
Oak bark	²	22.4	21.0	} 81.1 ⁴	} 17.8 ³
Hemlock bark	²	58.0	48.6		
Gambier		3.0	5.9		
Sumac	²	2.0	2.9		
Quebracho			1.9	} 51.0 ⁵	} 31.0 ⁶
Hemlock and oak extracts		5.6	4.6		
Chemicals		8.9 ⁷	15.0		

¹ Computed from Census data.

² No comparable figures given for the different materials. The consumption of hemlock bark in 1879 was 1,107,546 tons; of oak bark, 353,245 tons; of sumac and other materials, \$707,465 worth.

³ "Wood, bark, etc." (principally oak and hemlock bark).

⁴ All vegetable tanning materials.

⁵ Solid and liquid extracts.

⁶ Including dyes and dyestuffs.

⁷ "Miscellaneous."

To the extent that it is cheaper to extract the tannin from bark at the tannery rather than elsewhere, the forests retained some of their locational attraction. The preparation of extracts for shipment requires an additional process which is obviated in tanneries located at the bark supply. This helps to account for the fact that the consumption of extracts by the industry, after reaching 5.6 per cent of the total value of tanning materials in 1889, was only 4.6 per cent a decade later.⁶ Not until well after 1900 did extracts become a factor of first importance.

To the extent of their use, however, they fundamentally altered the orientation of the industry. Tanneries were now free to develop where plentiful supplies of hides were available: i.e., at the slaughtering centers.

Before refrigerated transportation became practicable, the meat industry was necessarily market-oriented. It was thus highly decentralized, and operated generally in small units. If the leather industry had secured its emancipation from bark at that stage, doubtless it would have come to be distributed like a market-oriented industry, more or less according to the population pattern. But refrigeration, by weakening the market factor in the location of meat packing, allowed that industry to concentrate at especially advantageous points,⁷ and also to move farther west to save transportation on the materials.⁸ Chicago had al-

⁶ Census data.

⁷ In part, Chicago and St. Louis and the rest were advantageous locations because of their excellent transport connections in all directions; in part, because of their location near the Corn Belt, which provided feed for fattening the cattle brought to the stockyards; and in part because they offered, as large focal points of population, the advantages of concentrated production (e.g., the utilization of by-products). Table 16 shows the extent to which the meat industry was concentrated as early as 1879.

⁸ The movement of the cattle-raising industry is well shown in dot maps prepared by the Department of Agriculture and extending back to 1860. Some of these are reproduced in plate 143 of C. O. Paullin's *Atlas of the Historical Geography of the United States* (Carnegie Institution, Publication no. 401, 1932). The 1860 map shows beef cattle spread rather uniformly over nearly the whole eastern half of the country, with some concentration in Texas, California, and Southeastern Pennsylvania. By 1890, the present distribution had become manifest, with a great concentration in the Corn Belt and a scattering over practically the entire western half of the country as well as the eastern half. Since 1890 there appears to have been a relative thinning-out in the old western open-range districts, and a more even distribution; but the concentration in a zone extending some hundreds of miles west from Chicago persists.

TABLE 16

THE TWELVE LEADING SLAUGHTERING AND MEAT-PACKING CITIES IN 1879¹

	Value of product (millions of dollars)	Percentage of U. S. total	Cumulative percentage
Chicago	85.3	28.1	28.1
New York } Jersey City } Newark }	57.4	18.9	47.0
St. Louis } East St. Louis }	16.4	5.4	52.4
Cincinnati	11.6	3.8	56.2
Boston } Somerville }	10.8	3.6	59.8
Indianapolis	9.0	3.0	62.8
Philadelphia	7.9	2.6	65.4
Milwaukee	6.1	2.0	67.4
San Francisco	6.0	2.0	69.4
Cleveland	5.4	1.8	71.2
Louisville	4.3	1.4	72.6
Buffalo	3.4	1.1	73.7

¹ Computed from data in Census of 1900, *Manufactures*, part 3, pp. 391-392.

TABLE 17

THE TWELVE LEADING SLAUGHTERING AND MEAT-PACKING CITIES IN 1899¹

	Value of product (millions of dollars)	Percentage of U. S. total	Cumulative percentage
Chicago	256.5	32.6	32.6
Kansas City, Kan.	73.8	9.4	42.0
South Omaha	67.9	8.6	50.6
New York } Jersey City } Newark }	54.0	6.9	57.5
Paterson } St. Louis } East St. Louis }	40.6	5.2	62.7
St. Joseph	29.7	3.8	66.5
Indianapolis	18.8	2.4	68.9
Boston } Somerville }	17.0	2.2	71.1
Milwaukee	13.0	1.7	72.8
Philadelphia	12.0	1.5	74.3
Buffalo	11.6	1.5	75.8
Cincinnati	10.4	1.3	77.1

¹ Computed from data in Census of 1900, *Manufactures*, part 3, pp. 391-392.

ready far surpassed Cincinnati by 1879, and after that date St. Louis, Omaha, Kansas City, and St. Joseph underwent a rapid development as meat-packing centers.

This came in time to provide a new basis of distribution for the tanning industry when dependence on the location of tanbark was giving way. There was a new migration, this time a movement of intraregional centralization, a clustering in and near the larger meat-packing cities. In 1889, nearly 76 per cent of the Wisconsin tanning industry was concentrated in Milwaukee, and 90 per cent of the Illinois tanning industry was in Chicago.⁹

It was to be expected that the use of extracts would become most important in regions of two sorts: those where the most convenient part of the tanbark supply had already been exhausted, and those where the presence of a concentrated meat-packing industry provided a powerful locational factor drawing production away from the forests. These expectations are borne out by Table 18. The high proportion of extracts in Kentucky is no doubt due to the packing industry of Cincinnati and Louisville, which together accounted for 15.9 per cent of the 1879 output.¹⁰ Also worthy of note is the relatively small use of extracts in upstate New York and in Maine, Wisconsin, and Pennsylvania — all of which still had a great deal of bark left and none of which were especially noted for meat packing.¹¹

Along with oak and hemlock extracts, certain tropical or semi-tropical vegetable materials containing a high proportion of tannin began to be used in the '90's. Gambier, one of the earliest of these, accounted for about 3 per cent of the total value of tanning agents in 1889, although it never became much more important than that.¹² Quebracho, a South American wood of extreme hardness,¹³ has been a very important agent. It accounted for 1.9 per

⁹ Computed from data in Census of 1900, *Manufactures*, part 3, pp. 391-392.

¹⁰ *Ibid.*

¹¹ It is worth noting that although New York State has two major meat-packing centers — New York City and Buffalo — most of its tanning is done elsewhere in the state. In 1929, according to the Census of Manufactures for that year, 7.8 per cent of the value of the product of the state's leather industry was accounted for by New York City and 6.0 per cent by Buffalo.

¹² Census of 1890, *Manufactures*, part 1, pp. 712-713.

¹³ Its name is said to be derived from *quebra* ('breaks') and *hacha* ('axe').

cent of the total value of tanning agents used in 1899 and more than 16 per cent in 1919.¹⁴

The long search for a good inorganic tanning agent was likewise successful in the early '90's,¹⁵ and the new 'chrome' process quickly came to be preferred for shoe-upper leather. The growth of chrome tanning in America is ascribed by Link partly to the protective tariff in force on the finer grades of leather.¹⁶ Originally only goatskins could be tanned by the new process, but it was very quickly adapted to calfskins, and even to the lighter hides known as kips. By 1895 glazed kid, Vici kid and other chemical leathers, made largely from calfskins, had replaced sumac-tanned morocco as the specialty of the Philadelphia district.¹⁷ For sole and belting leather and the other products of heavy cattle hides, however, chrome tanning has not met with so much favor.¹⁸

Some attention has already been given to the nature of the locational changes which we should expect to follow the introduction of concentrated materials. To a certain extent, the tropical and synthetic ones had the same effect as hemlock and oak extracts: they diminished the importance of nearness to the source of supply of the tanning agent. Orientation of tanneries to hide

¹⁴ Computed from Census data.

¹⁵ The first experiments with any inorganic materials other than alum were carried on in 1794, using iron salts. The leather was too brittle to be useful, however, and for decades all efforts to produce a good chemical tanning solution were unsuccessful. Heinzerling took out a German patent in 1878 for a process using salts of chromic acid, but it was still not a commercial proposition. Finally a German chemist in Philadelphia found a way of neutralizing the excess acid and getting a flexible product. On this see Link, *Die Lederindustrie*, pp. 17 ff.

¹⁶ From 1890 to 1897 there was a 10 per cent duty on sole leather and 20 per cent on upper and patent leather. Hides were on the free list. For a table of hide and leather duties from 1789 to 1894, see R. H. Foerderer, in *One Hundred Years of American Commerce*, vol. ii, p. 497.

¹⁷ Foerderer, *loc. cit.*, p. 495; see also Clark, *History of Manufactures*, p. 465.

¹⁸ In 1933, according to the Census of Manufactures for that year, only 3.3 per cent by value of the sole-leather output was 'chrome and combination' tan. Only recently has chrome tanning been adapted to some kinds of side leather and sheepskins. See J. R. Arnold, "Leather Industries — Tanning," in *Encyclopaedia of the Social Sciences*, vol. 9, p. 301. A large sheepskin tannery in Eastern Massachusetts, recently visited by the present writer, uses chrome, quebracho, and hemlock tan-nages as well as certain mixed vegetable tanning solutions marketed under brand names.

and skin supply, and concentration in meat-packing and seaboard cities, were furthered by all of the new processes.

The use of imported extracts, however, presumably had a lesser effect on the interior tanneries than on those near the coast. And the use of inorganic agents quite definitely influenced the lighter leathers alone, orienting their production still more closely to the supply of skins. Goatskins, it will be remembered, come mainly from abroad. Calfskins, which can be made to imitate kid leather closely, are about half imported and half domestic.

Under these conditions we should expect to see a three-way distribution of the tanning industry:

(a) On the seaboard, using imported skins and hides and a large proportion of synthetic and tropical agents.

(b) Around the meat-packing centers, using domestic hides, calfskins, and sheepskins, and all kinds of tanning agents.

(c) In the forest regions, still using a large proportion of bark.

Tables 18, 19, and 20 confirm these expectations.

TABLE 18
PERCENTAGE OF HEMLOCK AND OAK EXTRACTS TO TOTAL TANNING AGENTS
USED, BY VALUE ¹

	1889	1899
United States	5.6	4.6
Kentucky	22.9	35.1
Ohio	27.1	21.4
Massachusetts	11.4	13.3
New Jersey	13.0	7.8
New York	0.3	1.7
Pennsylvania	4.0	1.1
Michigan	0.8
Illinois	9.2	0.5
Wisconsin	0.7	0.1
New Hampshire	8.9	...
California	7.5	...
Maine	0.5	...

¹ Computed from Census data.

The diminution of the importance of the available supplies of tanbark, and the increasing importance of extract and chemical tanning at the source of hide or skin supply, is indicated by the

TABLE 19
 PERCENTAGE OF 'CHEMICAL' TO TOTAL TANNING MATERIALS USED, BY
 STATES, 1909¹
 (According to value)

United States	17.9
Delaware	98.7
New Jersey	36.5
Massachusetts	29.0
Illinois	23.6
Pennsylvania	18.1
Wisconsin	17.5
New York	13.5
Michigan	13.5
West Virginia	7.6
Virginia	3.0
North Carolina	2.4

¹ Computed from data in Census of 1910, vol. x, p. 728.

TABLE 20
 PERCENTAGE OF 'WOODS, BARKS, ETC.' TO TOTAL TANNING AGENTS USED,
 BY VALUE, 1919¹

United States	17.8
California	69.3
Virginia	45.0
Tennessee	39.3
Maine	33.6
Michigan	27.2
Pennsylvania	17.1
West Virginia	16.5
Kentucky	12.5
Wisconsin	11.9
Massachusetts	9.7
New York	8.3
Illinois	5.2
New Hampshire	5.0
New Jersey	3.6
Delaware

¹ Computed from data in Census of 1920, vol. x, p. 500.

case of Wisconsin. In 1899 that state used more than the United States average percentage of tanbark and much less than the average percentage of extracts or chemicals, because of the still fairly abundant hemlock supply. The fact that the bark supply was

receding, however, is probably indicated by the fact that Milwaukee's percentage of the state's tanning product fell from 75.6 in 1889 to 51.1 in 1899. By 1909, Wisconsin was using nearly as great a proportion of chemical materials as the country as a whole, and in 1919, owing to forest depletion and the availability of hides and calfskins, she used 11.9 per cent bark and wood, and 46.8 per cent chemicals, while the United States as a whole was using 17.8 per cent bark and wood, and 31 per cent chemicals.¹⁹

Thus far little attention has been given to the fact that during the '80's the leather industry joined the movement toward mass production and the use of power machinery. This was made possible by the introduction of concentrated tanning agents, and in their turn the economies of concentration accelerated the change in location from the old bark-oriented pattern. By 1889, the average establishment reported by the Census had 24 employees and 47 horsepower of installed power equipment, which represents a degree of mechanization rather ahead of manufacturing industry in general at that time. The ratio of capital invested to value added by manufacture more than doubled in the tanning industry between 1879 and 1899, while for all manufacturing industries together it went up only 32 per cent.²⁰

Despite the increased power requirements of the industry, it seems unlikely that its location has been affected by consideration of nearness to coal mines or power stations. It will be recalled that there are three main geographic divisions of the industry: the meat-packing cities, the Atlantic seaboard, and the tanbark forests. The first two of these are so advantageously supplied with fuel and power that little could be saved by forsaking them for Niagara Falls, for instance; and in the forest regions the burning of spent tanbark lessens the fuel requirements, while at the same time most of the forest tanneries are in Pennsylvania, West

¹⁹ Computed from Census data. All percentages are by value.

²⁰ Computed from Census data; cf. Table 9 above. It is significant that the large packing companies took up tanning seriously in 1892, and that the first successful attempt to concentrate control of any branch of the industry into the hands of a single corporation was the formation of the United States Leather Company in 1893, with the intent of dominating the sole and belting leather field. See Clark, *History of Manufactures in the United States, 1860-1914*, pp. 467-468.

Virginia, Virginia, Tennessee, and Kentucky, with coal deposits practically at their doors. Here again it would be difficult to reduce fuel expense by any conceivable move.

On the basis of other locational factors, upper-leather tanneries seem to be characteristically suburban. Chemical and imported tanning agents are used, which means that there is no advantage in being near the bark supply. The chemicals used are so various, depending on the requirements for the finished leather, that no single source of supply can be specified for them;²¹ but that in itself means that the characteristic good location for the chemical tannery will be a place having good transfer relations with several different sorts of chemical plants. If the different ones are located in different places, the requirement can be stated as good general transfer relations. Hence places on navigable water or at the junction of many important land transport routes are indicated; which fits in with the requirements from the point of view of skin supply. In so far as tanning materials or skins are imported, a seaboard location is of some advantage. Goatskins, for example, come almost exclusively from abroad; and, as Table 27 shows, they are tanned almost exclusively in the seaboard states from Massachusetts to Delaware. The market factor constitutes an attraction toward the principal shoe centers of the country, as Table 21 shows. In the case of most of the lighter leathers, the market factor is stronger than the mere weight relations would indicate, because accelerated style changes have made speed and service vital.

The effect of economies of concentration varies in the different branches of the industry. We may usefully preserve here the distinction between the heavy sole and belting industry, on the one hand, and the tanning of light skins for shoe uppers, gloves, etc., on the other.

²¹ Chemicals of different sorts are used at many stages of the process aside from tanning proper. "Chromite, the mineral ore from which salts used in chrome tanning are made, is found in the western states of this country, but most of this material used here is imported from out-of-the-way corners of the world. British and Portuguese Africa supply most of our chromite, and Greece, Cuba, Brazil, and French Oceania provide us with quantities greater than we produce in the United States." J. G. Glover and W. B. Cornell, *The Development of American Industries* (Prentice-Hall, Inc., New York, 1932), p. 256.

In the heavy leather industry, the possible economies are chiefly within the individual plant, and can be traced to the fact that the most efficient unit size of machine has a fairly large capacity.

Advances in machine technology make possible a curtailment of the time required for production, and consequently a larger volume of output. But since most of the machine installations can be used to advantage only on a large scale, this advantage depends upon concentration.²²

TABLE 21

PRINCIPAL LEATHER-WHOLESALE CITIES, 1929¹

(Sales of wholesalers of leather and leather goods (excluding gloves and shoes) to industrial consumers)

	Thousands of dollars	Percentage of U. S. total	Cumulative percentage
Boston	119,511	42.9	42.9
New York	47,073	16.9	59.8
Chicago	21,326	7.6	67.4
Philadelphia	19,148	6.9	74.3
St. Louis	11,036	4.0	78.3
Cincinnati	6,646	2.4	80.7
Indianapolis	5,000	1.8	82.5
San Francisco	4,518	1.6	84.1
Rochester	2,781	1.0	85.1
Milwaukee	2,363	0.8	85.9
Haverhill	1,075	0.4	86.3

¹ Census of 1930, *Distribution*, vol. ii, table 3.

Heavy-leather tanneries therefore tend to be large; but there are no very great external economies to be secured from a clustering of establishments in this branch of the industry. Concentration is motivated only up to the point where enough production is gathered at a single point to employ one establishment of technically optimum size. Scores of heavy-leather tanneries are scattered in out-of-the-way valleys of Pennsylvania, the Virginias, and other states where a local supply of tanbark is the sole advantage.²³

The light-leather tanneries, on the other hand, we should expect to find somewhat less mechanized, and less subject to internal economies. There is no very satisfactory way to test this, since more labor is required for a given amount of light leather and con-

²² Link, p. 41.

²³ See Fig. 37.



FIG. 37. Distribution of tanneries in 1929, according to the *Shoe and Leather Reporter Annual*. No distinction according to size has been made. Large dots indicate major tanning centers with a large number of establishments.

sequently a tannery that handles less bulk or weight of material may employ more men. Delaware, for instance, which specializes in kid, had the highest average number of wage earners per establishment in 1929.

TABLE 22
AVERAGE NUMBER OF INSTALLED HORSEPOWER PER WAGE EARNER IN THE
LEATHER INDUSTRY, BY STATES, 1929¹

United States	4.60
Tennessee	8.99
California	7.36
Maine	6.72
North Carolina	5.84
Illinois	5.57
New York	5.56
West Virginia	5.53
Wisconsin	5.25
Virginia	4.69
Michigan	4.43
Kentucky	4.38
Massachusetts	4.25
Pennsylvania	4.23
Indiana	4.18
New Jersey	3.92
Maryland	3.55
Ohio	3.24
Delaware	1.81

¹ Computed from Census data.

External economies are more important for light-leather tanneries, for nearly the same reasons as those which account for the greater importance of labor costs in such establishments. The variety in the product is much greater, and it is subject to style changes. Greater skill is required of labor, and much more labor is used. Marketing is more complicated, on account of the greater variety of the products. For these and doubtless other reasons, tanners of light leather find an advantage in clustering near one another, developing specialized leather centers and districts rather than giant plants.²⁴

²⁴ Some of the larger tanneries, however, have such an advantage in the importing of skins in quantity that the small tanneries buy their skins through them.



FIG 38. Distribution in 1929 of tanneries specializing in the lighter qualities of leather, according to the *Shoe and Leather Reporter Annual*. No distinction according to size has been made. Large dots indicate major tanning centers with a large number of establishments.

TABLE 23

PERCENTAGE DISTRIBUTION OF VALUE OF PRODUCTS IN THE LEATHER INDUSTRY,
BY STATES, 1889-1933¹

	1889	1899	1909	1919	1929	1933
United States	100.0	100.0	100.0	100.0	100.0	100.0
Massachusetts	16.3	12.8	12.2	13.9	18.4	20.5
Pennsylvania	28.9	27.3	23.8	22.8	19.9	18.4
New York	13.6	11.4	8.4	10.5	11.2	12.4
Illinois	4.8	3.8	4.5	6.5	7.8	8.7
Wisconsin	6.5	9.8	13.6	10.2	6.2	6.6
New Jersey	6.4	6.7	8.7	8.4	8.2	5.6
Michigan	1.0	2.9	4.7	4.9	4.0	4.3
Delaware	2.4	4.6	3.7	5.4	4.3	4.0 ²
Ohio	3.9	2.5	3.1	2.7	3.3	3.7
North Carolina	0.1	0.7	1.7	1.9	3.7	2.8
West Virginia	0.5	1.6	3.8	2.6	3.0	2.2
Virginia	0.7	2.3	2.5	2.3	2.0	1.3
California	4.1	3.6	2.9	2.3	0.9	1.3
Kentucky	2.0	1.8	1.3	0.9	0.7	1.2
Maryland	0.6	0.9	0.8	0.6	1.2	1.1

¹ Computed from Census data. Comparable data for years prior to 1889 are not available because the tanning, currying, and dressed skins industries, reported separately until that date, overlap in the values of their products. The above table includes all states accounting for more than 1 per cent of the 1933 total.

² This figure is for 1931; production figures for Delaware were not disclosed in 1933.

TABLE 24

PERCENTAGE DISTRIBUTION OF VALUE OF SOLE LEATHER PRODUCTION, BY
STATES, 1889-1919¹

	1889	1899	1909	1919
United States	100.0	100.0	100.0	100.0
Pennsylvania	59.9	51.8	45.1	46.2
New York	17.7	8.4	6.7	10.2
West Virginia	0.7	3.1	11.6	9.3
Wisconsin	1.1	8.1	5.0	6.0
Michigan	1.2	5.6	8.3	5.3
California	4.0	4.6	3.5	4.0
Virginia	0.8	3.9	5.5	3.9
Kentucky	3.1	4.2	3.1	...
North Carolina	0.2	3.0	...
Tennessee	1.4	2.0	1.4	...
Maine	3.6	2.6
Ohio	0.3	1.8
Alabama	1.8
Illinois	2.3	0.6
Massachusetts	2.6	0.5
Maryland	0.8	0.4

¹ U. S. Census data.

TABLE 25
 PERCENTAGE DISTRIBUTION OF VALUE OF HARNESS AND BELTING LEATHER
 PRODUCTION, BY STATES, 1889-1919¹

	1889	1899	1909	1919
United States	100.0	100.0	100.0	100.0
North Carolina	0.3	2.7	...	15.4
Virginia	3.1	5.5	7.5	15.1
Wisconsin	9.5	17.8	25.1	6.8
California	6.0	8.3	8.1	6.1
Michigan	1.9	4.2	3.8	5.8
Ohio	13.8	10.5	8.0	5.6
New York	4.1	3.6	5.2	2.7
Pennsylvania	30.7	10.6	6.2	...
Indiana	3.6	5.0	4.8	...
Missouri	4.4	2.6	3.8	...
Kentucky	6.8	4.7	3.1	...
Massachusetts	1.4	4.0	1.2	...
Tennessee	3.7	3.9	0.9	...
Maryland	0.7	1.1	0.4	...
New Hampshire	1.2	4.4
West Virginia	1.8	4.0
Georgia	0.6	2.0
Connecticut	1.0	1.7
Illinois	3.6	0.9

¹ U. S. Census data.

TABLE 26
 PERCENTAGE DISTRIBUTION OF VALUE OF CALF, KIPSKIN AND
 UPPER LEATHER PRODUCTION, BY STATES, 1889-1909¹

	1889	1899	1909
United States	100.0	100.0	100.0
Wisconsin	8.8	21.7	34.1
Massachusetts	17.7	26.9	26.8
Illinois	10.7	12.5	11.9
New York	19.8	19.9	9.7
Michigan	0.3	2.0	5.1
New Jersey	19.2	5.4	3.8
Pennsylvania	10.1	6.5	2.6
California	2.3	0.8	0.5
Maryland	0.5	1.0	...
Maine	0.7	0.9	...
New Hampshire	2.2	0.5	...
North Carolina	0.2	0.2	...
Ohio	0.9	0.1	...

¹ U. S. Census data.

TABLE 27
PERCENTAGE DISTRIBUTION OF VALUE OF TANNED GOATSKIN PRODUCTION,
BY STATES, 1889-1909¹

	1889	1899	1909
United States	100.0	100.0	100.0
Pennsylvania	37.3	44.3	48.8
Delaware	13.4	24.2	25.0
New Jersey	9.3	8.6	12.3
Massachusetts	22.2	16.8	11.9
New York	10.7	5.3	1.0
Total, 5 states	92.9	99.2	99.0
Illinois	4.6
New Hampshire	0.6	...
Wisconsin	0.5

¹ U. S. Census data.

TABLE 28

REGIONAL SPECIALIZATION IN TANNING OF HIDES, 1889-1919¹

Each of these figures represents the percentage share of a state in number of hides tanned, divided by the percentage share of that state in value of leather production.

	1889	1899	1909	1919
United States	1.00	1.00	1.00	1.00
West Virginia	1.29	1.44	1.50	1.69
California	0.96	1.00	1.17	1.44
North Carolina	2.97	1.38	1.20	1.42
Illinois	0.81	1.24	0.80	1.40
Virginia	1.47	1.18	1.36	1.35
Wisconsin	0.92	1.36	0.99	1.18
Michigan	1.70	1.62	1.66	1.16
New York	1.26	1.10	1.06	1.15
Ohio	0.98	1.04	0.91	1.00
Pennsylvania	1.29	1.12	1.24	1.00
New Jersey	0.22	0.37	0.48	0.69
Massachusetts	0.67	0.51	0.56	0.53

¹ Computed from Census data. "All hides" figures used for 1889 and 1899; "cattle hides" for 1909 and 1919.

TABLE 29

REGIONAL SPECIALIZATION IN TANNING OF CALF AND KIPSKINS, 1889-1919¹

Each of these figures represents the percentage share of a state in number of calf and kipskins tanned, divided by the percentage share of that state in value of leather production.

	1889	1899	1909	1919
United States	1.00	1.00	1.00	1.00
Wisconsin	2.14	3.22	2.60	2.82
Massachusetts	0.64	1.95	2.26	2.30
New York	2.05	1.03	1.27	1.50
Illinois	5.57	4.35	3.38	1.35
Michigan	0.26	...	0.98	...
New Jersey	0.05	0.98	0.22	...
California	0.55	0.38	0.21	...
Pennsylvania	0.36	0.16	0.03	...

¹ Computed from Census data.

TABLE 30

REGIONAL SPECIALIZATION IN TANNING OF GOATSKINS, 1889-1919¹

Each of these figures represents the percentage share of a state in number of goatskins tanned, divided by the percentage share of that state in value of leather production.

	1889	1899	1909	1919
United States	1.00	1.00	1.00	1.00
Delaware	4.24	6.25	4.75
Pennsylvania	0.29	1.67	2.02	2.20
New Jersey	3.78	1.54	1.52	1.30
Massachusetts	1.69	1.58	1.07	0.74
New York	1.21	0.31	0.07	...
Illinois	1.44

¹ Computed from Census data.

TABLE 31

REGIONAL SPECIALIZATION IN TANNING OF SHEEPSKINS, 1889, 1919¹

Each of these figures represents the percentage share of a state in number of sheepskins tanned, divided by the percentage share of that state in value of leather production.

	1889	1919
United States	1.00	1.00
Massachusetts	2.10	2.85
New York	1.40	2.48
California	2.19	1.91
Illinois	0.94	0.68
Pennsylvania	0.17	0.60
New Jersey	0.20	0.58
Michigan	1.40	...

¹ Computed from Census data.

PART III
THE SHOE INDUSTRY

CHAPTER X

ESSENTIAL CHARACTERISTICS OF THE INDUSTRY¹

IN THE making of shoes there have always been four basic processes:

- (a) Cutting out the parts of the upper and soles.
- (b) Stitching the parts of the upper together.
- (c) Stretching the completed upper over a wooden form (the *last*), and tacking it temporarily into position there.
- (d) Attaching the sole to the upper.

Until about a century ago, machines or power played no part in the making of shoes. Eight simple tools (knife, awl, needle, pincers, last, hammer, lapstone, and stirrup) constituted a complete outfit for shoemaking. The art of using them was something that every farmer possessed to a sufficient degree to keep himself and his family shod. There was little question of division of labor except as between the adults and children of the household. And quite evidently there was no very complex locational problem as yet; market, labor, and materials were all at hand at each populated place.

A separate market first came into existence under the handicraft system. In this stage the shoemaker — a type foreshadowed by the itinerant cobbler — had his own shop where he worked for others, at first only to order but later also for stock. By 1750 it appears to have been fairly general through New England for people to have their shoes made by settled shoemakers in shops.² Throughout the handicraft stage, shoemakers taught their apprentices all the processes involved. There was as yet no suggestion of the elaborate division of labor that was later to appear.

¹ The material on the organization of the shoe industry in this chapter is drawn largely from Blanche E. Hazard, "The Organization of the Boot and Shoe Industry in Massachusetts Before 1875," in *Quarterly Journal of Economics*, February, 1913, pp. 236-262, and from a book by the same author and with the same title published by the Harvard University Press in 1921. Whenever it is necessary to make specific references to these sources the article will be cited as 'Hazard, in QJE,' and the book as 'Hazard, *Organization*.'

² See Hazard, *Organization*, p. 9.

The handicraft period has been divided into two sub-periods: that of 'bespoke' or custom work exclusively, and that of 'sale' work for stock. It is not hard to discern the origins of the second stage in the conditions of the first. Disposal of spoiled or refused goods, utilization of slack time, and other motives built up a 'ready-made' shoe business.

Ready-made shoes became the rule at different dates, depending on local conditions. About 1760 the makers of women's shoes in and about Lynn had developed this system of production for sale in Boston, their market town; but in Bridgewater, Massachusetts, 'sale work' was regarded as a new departure as late as 1811.³

It was a natural transition from handicraft work to the *putting-out system* which marked the next stage in organization. The shoemaker now lost his contact with the consumer as well as part of his independence. He worked in a home shop with materials and tools generally furnished by a capitalist entrepreneur, who assumed also the risks and profits of marketing.⁴

In some Massachusetts towns (e.g., Lynn) the putting-out system was well established before the Revolutionary War. At first the entire shoe was still made in the shoemaker's shop, either by himself or by members of his household under his direction. But the Revolution and the protective tariff on shoes which followed in 1789 inevitably hastened the specialization of the industry and brought on a second stage of the putting-out system. The sudden growth of markets⁵ made mass production economical, and organization had already reached such a point that the producer and consumer rarely came into contact. Quality standards were lowered, for the time being, and with them the standards of labor skill.

A wide difference arose not only between the quality of custom and domestic work, but between the wages of 'real journeymen' and shoemakers.⁶

³ Hazard, in QJE, p. 241, note 2, and p. 244; *Organisation*, p. 21.

⁴ Cf. Hazard, *Organisation*, p. 24.

⁵ A very important market factor was the demand for large quantities of shoes for the slaves on Southern and West Indian plantations. See next chapter.

⁶ Hazard, in QJE, p. 249.

The putting-out system was adapted to serving a larger market than was the handicraft organization, but it possessed in its original form grave weaknesses, which led to its modification as rapidly as circumstances permitted. These weaknesses arose mainly from the loosening of the personal control of the merchant-entrepreneur over the actual producers. As in the textile industries, it was found that the workmen in their decentralized shops were not above appropriating scraps and selling them for their own gain. Then, too, it was difficult to be sure of having a lot finished up on time and according to specifications. These were considerations which the wider, more impersonal market and the growing intensity of competition made increasingly important.

So after about 1820 certain operations came to be performed in a 'central shop,' the characteristic institution of the second stage of the putting-out system. Miss Hazard describes it thus:

The stock was cut there, and portioned out, ready to deliver to workers to do the 'fitting,' i.e., the work on the uppers, siding up of seams, binding, counter and strap stitching. When this process was completed the uppers were returned to the central shop and given out with the proper number of roughly cut soles, as well as a definite quantity of thread, to 'makers' who would last and then sew the boots and shoes. The makers had to wait generally for their work to be inspected or 'crowned' at the central shop.⁷

In the central shop specialization very soon set in. The demand for greater uniformity, fancier styles, and finer finish created openings for workmen who knew only a few operations but knew them well. The practice of apprenticing boys out to learn the trade from top to bottom died out with remarkable suddenness, and was obsolete in Massachusetts after 1840.⁸

Division of labor paved the way for machinery, the characteristic of the next stage. Some machinery was, to be sure, used by workers in their homes, notably the relatively expensive and not very satisfactory sewing machines of the '50's. But it was in the central shop itself that the machine could be used to best advan-

⁷ Hazard, in QJE, p. 250.

⁸ Hazard, in QJE, p. 254, note 2.

tage. Here power could be applied and continuous running and adequate care assured.

The centralizing force of the need for supervision and control became ever stronger as markets widened and competition intensified. As machine after machine was invented, process after process was irresistibly drawn from the worker's home to the central shop, which thus evolved by stages into the modern factory.

One of the earliest of these mechanical inventions was the peg-making machine (1820). It turned out shoe pegs so cheaply that many New England farmers are reported to have been taken in by 'city slickers' selling them shoe pegs as seed oats.⁹ In 1845 came a machine for rolling sole leather, which did as much work in a minute as a man with a hammer in an hour and a half.¹⁰

During the late '40's the first sewing machines were put on the market, but it was several years before they would sew anything heavier than cloth,¹¹ and they could not be called really satisfactory before 1860. Other inventions prior to the Civil War included pegging, skiving, and sole-cutting machinery.¹²

Much the most important invention of all, however, was the McKay sewing machine, which solved the difficult problem of sewing soles to uppers mechanically. It was named after Colonel Gordon McKay, who bought the patent rights and commercialized it in the early '60's. The McKay process is still the leading one in the manufacture of women's and children's shoes, particu-

⁹ Albert S. Bolles, *Industrial History of the United States*, 3d edition (Norwich, Conn., 1889), p. 455.

¹⁰ Malcolm Keir, *Manufacturing* (New York, 1928), p. 456.

¹¹ The difficulty encountered in making a machine to sew leather may account for the importance of cloth uppers in the women's and children's shoes of the Civil War period. This is suggested by Victor S. Clark, *History of Manufactures in the United States* (Carnegie Institution of Washington, 1916, 1926), p. 468. On the gain in productivity of labor made by the first leather-sewing machines (1851) see Keir, *op. cit.*, pp. 455-457, and U. S. Industrial Commission, *Report*, vol. xiv (1901), p. 502.

¹² See William B. Rice, chapter on the shoe industry in *One Hundred Years of American Commerce*, vol. ii, p. 567; American Sole and Belting Leather Tanners, Inc., *Nothing Takes the Place of Leather* (New York, 1924); Hazard, in QJE, p. 255; and Clark, pp. 32-33. Interesting contemporary advertisements of machines in use in 1858 are found in W. H. Richardson, Jr., *The Boot and Shoe Manufacturer's Assistant and Guide* (Boston, 1858).

larly those of the cheaper grades (see Tables 32 and 33). It has the disadvantage of leaving exposed stitches on the inside of the shoe, which in all but the cheapest grades necessitates inserting a special 'sock lining' to protect the foot; but it has the virtues of cheapness and simplicity and (as compared with nailed, pegged, or screwed shoes) greater flexibility.

TABLE 32
PRODUCTION OF LEATHER BOOTS AND SHOES ACCORDING TO METHOD OF
MANUFACTURE, 1919-33¹

(Percentages of total production)

	1919	1927	1929	1931	1933
Total	100.0	100.0	100.0	100.0	100.0
Welt	42.1	38.4	37.5	35.3	32.2
McKay	33.8	32.1	36.0	34.6	28.0
Stitchdown	6.7	19.6	17.4	14.1	15.7
Peg or screw				6.5	8.4
Compo				3.5	11.6
Turn				6.0	4.0

¹ Computed from Census data.

TABLE 33
KINDS OF LEATHER BOOTS AND SHOES BY METHOD OF MANUFACTURE, 1933¹

(Percentages of total of each kind)

	All	Men's	Youths' and boys'	Women's	Misses' and children's
All methods	100.0	100.0	100.0	100.0	100.0
Welt	32.2	68.9	37.6	15.5	13.4
McKay	28.0	6.0	20.3	48.0	22.7
Stitchdown	15.7	3.4	3.6	4.4	60.7
Compo	11.6	... ²	... ²	26.4	0.6
Peg or screw	8.4	21.5	38.4	0.1	0.1
Turn	4.0	... ²	... ²	5.5	2.6

¹ Census of Manufactures, 1933, pp. 392-393; percentages computed.

² "Data withheld from publication to avoid disclosing approximations of production of individual establishments."

It was the McKay machine that enabled the New England, New York, and Philadelphia shoe shops to take care of the great demand of the Northern armies in the Civil War despite the depletion in the ranks of the shoemakers. Certain improvements, such as the adaptation to high-tension waxed-thread sewing in

1867, gave added impetus to the introduction of the machine. As Table 34 shows, it was used in 1895 on about 120,000,000 pairs of shoes, or more than half of the country's production.¹³

Even after the McKay machine was invented, most of the best quality shoes continued to be bottomed by hand, because the machines had not yet mastered the welt system. This method of attaching the sole is more complicated and expensive than the McKay, but leaves nothing exposed inside the shoe. It has the further advantages of maximum flexibility and ease of resoling.

TABLE 34
NUMBER OF PAIRS OF SHOES SEWED ON MCKAY AND GOODYEAR WELT
MACHINES, 1878-95¹

	(millions)	
	McKay	Goodyear Welt
1878	60	
1880		2
1881	82	
1885		4
1890		12
1895	120	25

¹ William B. Rice, chapter on the shoe industry in *One Hundred Years of American Commerce*, vol. ii, p. 568.

Inventors worked for many years on the problem of machine welt sewing, but it was not until 1869 that Charles Goodyear, Jr., and his associates succeeded in adapting Destouy's machine of 1862 to practical manufacturing.¹⁴ For another decade after that, its adoption proceeded quite slowly, being retarded by the much greater cheapness of the McKay method. Finally in the '80's the Goodyear machine came into use fairly rapidly.

The other machines developed after the Civil War, though very numerous, were of minor importance compared to the McKay and Goodyear. They included the following:

¹³ The Census reported 179,409,388 pairs produced in 1889 and 217,965,419 pairs in 1899.

¹⁴ See on this Keir, p. 458; Clark, p. 470; and *A History of the Shoe and Leather Industries of the United States*, ed. Charles H. McDermott (Boston, 1918), ch. viii.

1869-75: the screw bottoming machine, for attaching soles with wire screws made by the machine itself. This process is used only in stiff heavy shoes and boots.¹⁵

1870: the heel building and attaching machine. This was an improvement over the previous heeling machine in that it made it possible to use formerly worthless V-shaped scrap leather, by pressing the heel to the correct shape. The number of pairs of heels attached by McKay and Bigelow heelers increased from 10,000,000 in 1871 to 45,000,000 in 1881 and 72,000,000 in 1890.¹⁶

1882: the lasting machine, invented by J. E. Matzeliger to perform an operation which the older generation of shoemakers had said 'couldn't be done' by machinery. In its initial form the Matzeliger machine increased the operator's output a dozen fold.¹⁷ By 1900, machine lasting was the rule in Philadelphia and New England shops except for custom work and turned shoes.¹⁸

Keir speaks of the cutting of upper leather as the last hand process to be mechanized.¹⁹ This operation, in which the varying texture of the material must be taken into consideration as well as the minimizing of scrap, is the most highly-skilled and best-paid job in the factory. The cutting room is almost always on the top floor of the building so that a maximum of daylight will be available. A cutter is said to keep on improving indefinitely with added experience; and obviously a job so complex and depending so much upon a trained eye and touch is not easy to mechanize.

The hand process uses flat patterns, which are laid on the leather to guide the cutting knife; while in the machine process dies are inserted in a press. In both cases, only a single thickness of leather can be cut at one time. The machine process is on the whole quicker and surer, but the cost of the many dies required, and the time spent in changing them, may outweigh this advan-

¹⁵ On the invention and improvement of metallic fastening machinery see Rice, p. 568, and McDermott, pp. 78-84.

¹⁶ Rice, p. 568; see also C. G. Washburn, *Industrial Worcester* (Worcester, Mass., 1917), pp. 244-246.

¹⁷ Associated Industries of Massachusetts, *Industries of Massachusetts* (reprints from special issues of *Industry*), vol. i (Boston, 1928), p. 63.

¹⁸ U. S. Industrial Commission, *Report*, vol. xiv, p. 298. The turn method, used principally for very high-grade women's shoes, consists in sewing the shoe together wrong side out, like a slipper, and then reversing it. The most flexible shoes are made in this way.

¹⁹ Keir, p. 459.

tage when any considerable variety of styles is being turned out. There is, consequently, a considerable amount of hand cutting still going on, and the machine has reduced the cost of this operation perhaps less than that of any other.

In the cutting of soles and cloth linings, the material is more nearly even in texture, and the variety of the shapes is much less, so that machine work is practically universal. Several thicknesses of lining cloth are cut at one time.

An account of the technical development of the industry would not be complete without mention of the pulling-over machine, put into use just prior to the War, and the new 'compo' process of sole attachment, which involves the use of adhesives and pressure rather than stitching. As Table 33 indicates, this method has become a formidable rival of the McKay and welt systems for women's shoes.

Difficult to mechanize, the shoe industry was also difficult to adapt to power machinery. Most of the operations require very frequent starting and stopping, and must be under the perfect control of the operator. It is not surprising, then, to find that practically all of the shoe machinery in use prior to the Civil War was operated by hand or foot power.²⁰ The really significant use of power began with the McKay machine in the early '60's, and as late as 1869 there was a total installation of only 3069 horsepower in the country's shoe shops.²¹

The advantages of electric power are obvious, and account for its popularity with shoe manufacturers (see Table 35). No engines or turbines are necessary; the power can be purchased, and usually is. Individual motors for each machine save the losses incident on keeping idle shafting turning. Rehe points out that electric power is particularly well suited to industries operating on short hours.²²

²⁰ On the early use of power machinery in shoemaking see N. S. B. Gras, *Industrial Evolution* (Cambridge, Mass., 1930), p. 137; also Rice, p. 568.

²¹ U. S. Census data. This figure would seem to discredit Rice's statement (p. 568) that "after 1860 few (eastern shoe manufacturers) of any pretension . . . did not use either steam or water power. . . ."

²² Carl Rehe, *Die deutsche Schuhgrossindustrie* (University of Jena dissertation, 1908), p. 29.

The use of power in the industry has increased steadily. In 1899 the costs of power and heating in American shoe factories averaged 0.6 per cent of the total costs of materials; by 1929, the figure had risen to 1.0 per cent.²³

We may get some notion of the orientation of the shoe industry by inquiring into the elements of transportation and production cost which may depend on location. Since the two greatest changes in these costs have been the cheapening of land transportation by the railroad and the reduction of labor costs by mechanization, let us consider the earlier hand industry and the more recent mechanized industry separately.

TABLE 35
FORMS OF POWER IN THE SHOE INDUSTRY AND IN ALL MANUFACTURING
INDUSTRY IN THE UNITED STATES, 1929¹

(Percentages of total rated horsepower installed)

	All manufactures	Shoe industry
All forms	100.0	100.0
Electric motors (purchased current)	53.0	67.5
Steam engines and turbines	40.5	29.5
Water wheels and turbines	3.6	1.5
Internal-combustion engines	2.9	1.5

¹ Computed from Census data.

The principal material is leather, and slightly more than a pound of materials is required to make a pound of shoes. In Adolf Link's locational investigation of the German shoe industry under the guidance of Alfred Weber, it was found that the weight of materials per unit weight of product, for three representative types of shoe, was 1.05, 1.08, and 1.04.²⁴ This means that the transport advantages of nearness to materials and nearness to markets will approximately balance one another, unless the materials and product are carried at different freight rates.

In the early stages of the industry, we have no reason to believe that such a difference existed. Shoes were commonly shipped in

²³ Census of 1900, vol. ix, pp. 762-763, 766-767; Census of Manufactures, 1929, vol. ii, p. 802.

²⁴ Link, p. 75.

barrels, and the weight of the barrels would hardly more than offset the small weight loss incident to manufacture. Much more significant for the early period is the fact that transport was so much cheaper by water than by land. We should not expect to find a strong orientation toward either materials or market, but should expect that locations on water-transport routes would have a great advantage in serving extended markets if any differentials in production costs existed.

The relative importance of production and transport costs for the early hand industry can be measured only in a broadly approximate manner. In the 1898 report of the United States Commissioner of Labor are found some compilations of labor cost per pair for various representative types of hand-made shoes, ranging from 57 cents for cheap cowhide brogans to \$5.56 for men's fine calf welts.²⁵ It should be noted that the former figure is for 1855 and the latter for 1865, at the peak of the greenback inflation. In Link's investigation, he found the labor cost of a pair of ladies' kid boots (Germany, 1912) to be 3.70 marks, or about 87 cents. A dollar a pair was a fairly general price for cheap shoes during the early nineteenth century, as it was for cheap watches a century later. So perhaps it is fair to say that labor costs during the hand-work period ranged generally between 60 cents and \$3.00 per pair.

This tells us nothing until we know the costs of shipping shoes. Link's 'ladies' kid boots' weighed a little more than a pound per pair, while shoes are shipped nowadays on American railroads in cases weighing about 65 pounds and containing on the average about 30 pairs,²⁶ which gives an average shipping weight of a little

²⁵ Reproduced in Census of 1900, *Manufactures*, part 3, p. 757. See also Bureau of Labor Statistics, Bulletin 360, *Time and Labor Costs in Manufacturing 100 Pairs of Shoes, 1923* (Washington, 1924).

²⁶ Interstate Commerce Commission, *Reports*, vol. xvii, Opinion 1733: Kiser Co. v. Central of Georgia Ry. Co. The average weight of the cases was checked by personal inquiry from manufacturers. The average number of pairs in the cases shipped out of Brockton in the period January 1, 1914, to November 1, 1924, was 24.6. Data collected by *The Brockton Enterprise* and quoted in Bureau of Labor Statistics, Bulletin 384, *Labor Conditions in the Shoe Industry in Massachusetts, 1920-1924* (Washington, 1925), p. 42. This is a low figure, since it applies to a men's shoe center; women's and children's shoes run 30 or 36 pairs to the case.

more than two pounds per pair. Taking into account the fact that the earlier shoes were a stout product, but scantily packed, one to two pounds a pair seems a reasonable estimate for the product of the early hand industry.

Overland carriage charges by wagon seem to have averaged around 20 cents per ton-mile, or about 0.01 cent per pound per mile, over good roads.²⁷ If we take this figure to represent transport costs, then a 10 per cent differential in the amount paid in wages (60 cents to \$3.00 a pair) would pay for 600 to 3000 miles of shoe transport if we assume each pair to weigh a pound, or 300 to 1500 miles if we assume each pair to weigh two pounds.

Since the 'ideal weight' of the leather was about equal to that of the product, the above figures would also measure the relative importance of labor costs and nearness to leather supply. If location at a source of cheap labor meant drawing away from *both* markets and materials, a 10 per cent labor-cost differential might compensate for as little as 150 miles of deviation (or less on inferior roads).

One might deduce that some branches of the early hand shoe industry in the interior of the country would be purely local, unless labor costs varied by at least 10 per cent in 150 miles. The lighter the shoe and the greater the amount of labor put into it, the longer this distance would be. But in places located on water routes, with freight rates perhaps 1/20th as much as by land, transport costs would be altogether subordinate to production costs. At a rate of 1 cent a ton-mile, a differential of only 3 cents per pound of shoes would pay for 6000 miles of freights!

What can now be said about the locational effect of the railroad and the machine? In general, they have been opposite influences, the railroad lessening the relative importance of transport costs and the machine lessening the relative importance of production costs. Have these influences counterbalanced one another?

Fig. 23 in Chapter IV gives an idea of the extent to which railroad freight rates have fallen since the early '50's. The average

²⁷ Based on an examination of the many instances of actual rates given in J. L. Ringwalt, *Development of Transportation Systems in the United States* (Philadelphia, 1888) *passim*.

receipts per ton-mile were less than 1 cent in every year from 1888 through 1919. But it is not permissible to assume that the materials and product are carried at this average rate. Shoes have generally been second-class freight (average rate about 3 cents a ton-mile since the War), and leather fourth-class (average rate about 2 cents). On this count alone, nearness to the market is evidently of greater importance than nearness to sources of materials. If we follow Link's example by including fuel as one of the materials, its weight (somewhat less, according to Link, than the weight of shoes and leather together) must be heavily discounted to take account of the low rates applying on coal traffic. A rough estimate places the average coal rate at about one-sixth of the rate on shoes,²⁸ so that nearness to fuel supply cannot be considered an important locational factor.

For one pound of shoes, then, the estimated transport charges per mile are 0.0015 cent for the shoes themselves, 0.0010 cent for the leather, and 0.00025 cent for coal.²⁹

Mechanization appears to have reduced the average labor cost of a pair of shoes by 80 or 90 per cent. The lowest average wage cost per pair reported in any Census year was 27 cents in 1899, and a high of 72 cents was touched in 1921. Shoes have become lighter, but are now packed in cases rather than barrels, so that an estimated shipping weight of two pounds per pair may be taken to hold good for the machine industry. This means that the lowest likely figure for labor costs per pound would be about 15 cents.

A differential of 10 per cent of this (i.e., 1.5 cent per pound) would, according to my estimates of transport costs, pay for the transporting of shoes 1000 miles, leather 1500 miles, or coal 6000

²⁸ I am indebted to Mr. Francis Dowd, traffic expert of the Associated Industries of Massachusetts, for information and advice on this point.

²⁹ "The transportation charge on the material entering into a pair of shoes made in a St. Louis factory averages one and one-quarter cents . . . result of a definite calculation by one of the largest shoe manufacturers of the country." Logan G. McPherson, *Railroad Freight Rates in Relation to the Industry and Commerce of the United States* (Henry Holt and Company, New York, 1909), pp. 51, 53.

" . . . the largest item in the cost of a shoe is material, but the variation in costs of similar materials in different parts of the country is so slight that it can be neglected as a variable factor." Boston Chamber of Commerce, *The Shoe Manufacturing Industry of New England* (Boston, 1925), p. 13.

miles. If location at a source of cheap labor meant drawing away from all three, the 10 per cent labor-cost differential might conceivably be the equivalent of as little as 545 miles of distance. A higher labor-cost figure would increase the distance proportionately.

It seems evident that, so far as land transport goes, transport costs have been reduced relatively more than labor costs. We should expect the industry, under modern conditions, to seek locations of advantageous labor supply rather than those with best access to markets and materials. At the same time, the advantages of water relative to land transport have been greatly reduced, so that localization may be expected in the interior as well as along the coast.

No other elements of production cost can have an effect comparable to that of labor costs, though some of them may occasionally influence location. The Bureau of Labor Statistics has published itemized cost figures for 17 North Shore shoe factories in 1920-24 and 23 Haverhill factories in 1925-27, from which an idea of the relative importance of the various elements may be obtained.³⁰ Averaging the figures for all the plants in all the years given, we find interest charges amounting to 3 per cent of labor costs, insurance 2 per cent, and rent 6 per cent. The only one of these that seems likely to have any significance is the rent item, which would determine the part of a given city in which a factory should be placed. As regards the competition between cities and districts, we may ignore all three of these factors.

The cost item 'fuel, light, and power' is also reported for the same series of factories, and seems to be of about the same importance as interest charges. Taxes are likewise a very small item.

One or two other characteristics of the industry may be noted as relevant to its orientation. The unevenness of the material, responsible for many of the difficulties of mechanization, keeps the process far enough from uniformity to make skilled labor essential.

³⁰ Bureau of Labor Statistics, Bulletin 384, *Labor Conditions in the Shoe Industry in Massachusetts, 1920-1924* (Washington, 1925), pp. 35-40; Bulletin 483, *Conditions in the Shoe Industry in Haverhill, Mass., 1928* (Washington, 1929), pp. 100-107.

Because of this and in view of the relative unimportance of transport costs, we should expect the industry to be highly localized. On the other hand, the product is of such a personal nature that there may be advantages in nearness to market in addition to the small saving in transport costs. To settle these and other points we must turn to the record.

CHAPTER XI

MARKETS AND MARKETING

MASSACHUSETTS shoemakers had a surplus of shoes for sale elsewhere as early as 1761. At that time they were sent chiefly to the southern colonies and the Maritime Provinces by coastwise vessels,¹ but later a substantial part of the market was on the West Indian plantations. The primacy of New England as a shipping center greatly increased this early trade, though it was not until 1818 that the first *full cargo* of shoes left Boston.²

Boston's real advantage in marketing lay in water transport. Southeastern and Pacific Coast markets could be supplied from there as well as from anywhere, but for the whole interior of the country the peripheral position of Boston was a handicap. None the less, when trade with the interior assumed importance Boston was a long-established wholesale center and point of transshipment for imports. It was simple to include shoes in the frequent westward shipments, and the metropolis of New England held undisputed leadership as the principal shoe market for the whole country.³

Even in the Midwest, Massachusetts shoes remained long pre-eminent. The Yankees had two great advantages: they were in a position to give long credits to the country storekeepers, and a large proportion of the commercial classes in the interior of the country were native New Englanders, who kept up their home connections and as a matter of course patronized Boston wholesalers. The shoe merchants were no exception. Notably in Chicago, many of the pioneer shoe jobbers were men from Massachusetts who had learned the business there.⁴

At first, the New England wholesalers dealt directly with the

¹ Keir, *Manufacturing*, p. 450. In 1768 these shipments amounted to 13,000 pairs, or about a week's capacity output for a medium-sized factory of the present day.

² *Ibid.*

³ *Ibid.*, p. 453.

⁴ Rice, in *One Hundred Years of American Commerce*, vol. ii, p. 569.

grocers, hardware merchants, and general-store keepers who sold shoes in the South and West. The shoes were paid for only as fast as they were disposed of at retail, which meant credits of considerable and indeterminate length.⁵

After about 1830 the larger cities of the interior began to have jobbers of their own, who bought shoes in Boston⁶ and distributed them to the local retailers. This did not take place on a sufficient scale, however, to counteract the trend toward the concentration of marketing in Boston.

Beginning in 1829, Boston wholesalers gave up consigning shoes to merchants, a method used to introduce them in new markets, and insisted that buyers come to Boston. Of course this added to New England's prestige.⁷

Even after the Civil War, offices were being moved to Boston from New York, Philadelphia, Baltimore, Cincinnati, St. Louis, and other cities.⁸ The total sales of shoes by Boston wholesalers mounted from one million dollars in 1828 to fifty millions in 1856.⁹

In production also, the Boston district was growing faster than most. Between 1849 and 1879 Massachusetts increased her share of the total value of shoes produced from 44.7 per cent to 57.8 per cent.¹⁰ Since transportation costs were by that time an insignificant element in the price of shoes, it might have been expected that the localization of the industry in the original eastern districts would continue to increase. The refinement of the product, however, brought a new element into the picture.

It was upon the relatively large-scale production of shoes of the most ordinary grades that Massachusetts built up her reputation as the country's shoemaking center.¹¹ Mass production led to the

⁵ *Ibid.*, p. 571.

⁶ The New England manufacturers gave several months' credit to these inland wholesalers, generally making payment due after the harvest. Rice, p. 571.

⁷ Keir, p. 453.

⁸ Albert S. Bolles, *Industrial History of the United States*, 3d edition (Norwich, Conn., 1889), p. 455.

⁹ Keir, p. 453.

¹⁰ See Table 39.

¹¹ Bolles, *op. cit.*, p. 453; Keir, pp. 469-470; Charles G. Washburn, *Industrial Worcester* (Worcester, Mass., 1917), p. 243.

introduction of many important technical improvements in the New England shops: for instance, separate lasts for left and right shoes,¹² tin patterns instead of wood, and standardization of sizes, which was a prerequisite for large-scale marketing.¹³

Better sidewalks and pavements made it unnecessary to wear such heavy shoes as before, and shortly after the Civil War top boots and brogans went out of style in the cities. Brockton and other towns which had based their reputation on these were able to keep up with the times by changing to more graceful footwear with uppers of French calf, 'Vici' kid, or kangaroo.¹⁴

Many changes in footwear styles took place in the period 1860-90. The idea that men's shoes could possibly be any other color than black was a novel one until the '80's.¹⁵ The variety of lasts and styles was enormously increased at the same time that sizes were standardized, and new tanning processes paved the way for a larger use of the lighter upper leathers.¹⁶

Shoe designing, particularly for women's footwear, came into its own as an art after the Civil War, being much encouraged by the development of new tanning methods and their successful application in the Philadelphia district. In the single five-year period 1895-1900, imports of goatskins doubled.¹⁷ Better tannage made possible the use of kid leather in almost all parts of fine men's shoes, even the vamps, whereas previously it had been restricted to women's and children's slippers and 'low-cuts' and to the tops and quarters of men's shoes.¹⁸

The outstanding development of the past generation in the shoe industry has been the further acceleration of style changes, affecting women's shoes in particular. In that branch the emphasis has entirely shifted from durability and quality to novelty, and styles have been known to change as often as once a month.¹⁹

¹² This innovation was at first applied only to men's shoes.

¹³ Keir, p. 454.

¹⁴ Clark, *History of Manufactures*, p. 476.

¹⁵ *Ibid.*, pp. 476-477.

¹⁶ *Ibid.*, p. 475.

¹⁷ U. S. Industrial Commission, *Report*, vol. xiv, p. 507.

¹⁸ Census of 1900, vol. ix, p. 732.

¹⁹ Keir, p. 469.

A woman buys four pairs of shoes to one pair purchased by a man. . . . It is due partly to style and partly to the shorter wearing quality of women's shoes because of thinner soles and uppers and poorer quality of leather.²⁰

One of the results of emphasis on style is that access to markets has regained some of its former locational importance. Cheap but slow methods of transport cannot be used when every day counts and shoes are ordered for delivery only a week or two ahead. The more distant manufacturer is hampered not so much by larger freight bills as by the difficulty of serving the market satisfactorily at long range under modern exigencies of speed and style.²¹

It has become particularly important to consider facilities for service in supplying small communities. Nearness is here a great advantage. The manufacturer in the same district as his small-town market can make more frequent sales canvasses, quicker deliveries, and perhaps better credit arrangements; he can keep more closely in touch with the local variations in style demand, which differ from region to region and almost from town to town.²²

²⁰ Federated American Engineering Societies, Committee on Elimination of Waste in Industry, *Waste in Industry* (New York, 1921), p. 139. The chapter on the boot and shoe industry in this report was written by Sanford E. Thompson.

²¹ J. Russell Smith (*Industrial and Commercial Geography*, New York, 1913, p. 539) errs in ascribing the rise of the shoe industry in the Midwest solely to the saving in freight rates, and even makes this factor outweigh certain disadvantages. The freight on a pair of shoes never amounts to more than two or three cents, and the differences between the freight rates from, say, New England and St. Louis would be too small to be worth counting. This is borne out by the fact that in regional location of factories the question of long-distance freight rates is never thought worthy of being taken into consideration.

The importance of speed is shown by the frequency with which shoe shipments are made by parcel post. In April, 1920, congestion on the railroads caused parcel post shipments of a carload and more at a time to be sent out of Middleboro, Haverhill, and other New England centers. *Boot and Shoe Recorder*, April, 1920, *passim*. Mr. Carlton R. Blades, traffic manager of the George E. Keith Company in Brockton, informs me that at present (spring of 1936) 55 per cent of the product is shipped by rail, 20 per cent by truck, 10 per cent by water, 10 per cent by parcel post, and 5 per cent by express. These proportions are stated to be fairly typical for shoe factories along the Atlantic seaboard; in the Midwest there would be less water and more rail shipment. Style grades are rarely shipped by water.

²² Chain marketing organizations find that they can often dispose of leftovers by moving them to a different locality where the styles are different or show a greater lag.

The western manufacturers can serve the rural and small-town market in their own localities much more easily than the New Englanders can. The retail merchant may order on a Monday, on the basis of his previous week's sales, and have the goods arrive in time for the Saturday trade.

A second handicap for Massachusetts, applying also to Philadelphia and New York City, is that their shoe centers are so maturely developed that they are specialized to an extent rarely found elsewhere. This is primarily due to specialization of skilled labor, a factor which will receive consideration in subsequent chapters, but partly also to the distribution of auxiliary industries such as the manufacture of findings.²³ Both can be accounted for by early localization.

New England is made up largely of a group of manufacturers making certain distinct or special grades of shoes. Their product fits in with the requirements of the merchants located in the larger trading centers throughout the country, or of the non-manufacturing general line and specialty wholesaler, of the chain-store and mail-order houses. Our weak point is in getting the product to the medium and small trading centers at a reasonable and competitive cost.²⁴

As was indicated, the plant specialization referred to is characteristic not only of Massachusetts but also of New York City and Philadelphia, and even to some extent of Chicago. These cities, however, are metropolitan in character, and their specialized shoe industry arose to supply a metropolitan market where even specialties can be marketed in quantities. Massachusetts, on the other hand, had always been purveyor to the country as a whole, and could not hope to retain her hold on the shoe industry without selling to all kinds of markets.

Table 37 gives the average sizes of the shoe factories of the principal producing states in various Census years. It shows clearly that in the states which go in for style and specialty manufacture the representative factory is much smaller than elsewhere.

Out of 145 New England factories canvassed by the Department of Commerce a few years ago, 107 stated their principal

²³ See Table 36.

²⁴ Boston Chamber of Commerce, *The Shoe Manufacturing Industry of New England* (Boston, 1925), pp. 12-13.

TABLE 36
PERCENTAGE DISTRIBUTION OF WAGE EARNERS IN THE SHOE FINDINGS AND
CUT STOCK INDUSTRIES¹

	FINDINGS			CUT STOCK	
	1919	1929	1933	1919	1929
United States	100.0	100.0	100.0	100.0	100.0
Massachusetts	65.9	46.6	50.9	47.7	29.6
New York	7.6	12.6	12.0	3.9	2.5
Missouri	5.4	9.5	8.9	16.4	29.5
New Hampshire	7.7	7.2
Ohio	4.2	3.3	2.8	...
Wisconsin	2.7	2.7	2.7
Maine	3.1	2.9	1.8
Rhode Island	1.0	0.9	1.6
Pennsylvania	1.8	3.8	...
New Jersey	0.6
Illinois	3.0

¹ Computed from Census data.

TABLE 37
AVERAGE NUMBER OF WAGE EARNERS PER ESTABLISHMENT IN SHOE
MANUFACTURING, BY STATES¹

	1879	1889	1899	1909	1919	1929	1933
United States	57	64	89	138	146	153	169
Missouri	49	94	118	294	324	409	452
Tennessee	424	401
Ohio	63	91	157	222	235	285	340
Kentucky	406	309
Illinois	62	71	103	109	150	227	263
Maryland	42	47	42	76	172	255
Maine	75	120	134	120	254	238	230
Wisconsin	59	92	63	80	122	189	218
New Hampshire	75	123	179	209	237	199	207
New York	49	60	71	73	102	114	137
Massachusetts	63	64	92	97	162	126	120
Pennsylvania	54	48	63	77	104	102	111
New Jersey	37	47	53	80	83	71	85

¹ Computed from Census data.

market to be either in New England itself or in the Middle Atlantic states (especially New York City). Only 38 gave the Midwest as their principal market. Forty-six sold nationally, and 20 reported foreign sales.²⁶

²⁶ Bureau of Foreign and Domestic Commerce, Domestic Commerce Series, no. 281, *Industrial Structure of New England* (Washington, 1930), p. 429.

In view of the revived importance of the market factor, it is interesting to inquire whether the westward drift of the industry can be accounted for as merely an adjustment to shifting markets. I have attempted to throw light on this question by calculating the 'index of population specialization in shoe manufacturing' which appears in Table 38 and which is the per capita importance of shoemaking in individual states relative to the per capita importance of shoemaking in the United States. 'Per capita importance' is measured by dividing the number of wage earners employed in shoe manufacturing by the population.

TABLE 38
INDEX OF POPULATION SPECIALIZATION IN SHOE MANUFACTURING, BY STATES¹

(Proportion of boot and shoe wage earners to total population in each state, relative to the same proportion for the United States as unity.)

	1859	1869	1879	1889	1899	1909	1919	1929
United States .	1.0	1.0	1.0	1.0	1.0	1.0	1.0	1.0
New Hampshire	3.8	2.8	5.8	10.0	15.4	15.1	13.9	18.8
Massachusetts	13.0	10.8	15.7	14.3	11.0	11.1	10.4	7.7
Maine	1.2	1.3	2.7	4.7	4.9	4.4	6.5	7.5
Missouri	1.0	2.5	2.6	4.1
Wisconsin	1.1	1.5	2.2
New York	1.1	1.2	1.2	1.2	1.2	1.6	1.8
Illinois	1.2
Ohio	1.6	1.7	1.2	1.1
New Jersey	1.1	1.0	1.3	1.7	1.2
Pennsylvania	1.2	1.3

¹ Computed from Census data. In 1850, only male labor of 15 or more years of age was included. Data for custom and repair shops are excluded in reports for 1879 and subsequent years. Blanks indicate an index figure of less than 1.0.

The most striking thing brought out by Table 38 is the spectacular climb of New Hampshire, which has increased its hold on the shoe industry in spite of having a decreasing percentage of the country's population. As a result, there is now about twenty times as large a proportion of shoe workers in the population of New Hampshire as in the population of the country as a whole. Maine has had a similar experience, while the figures for Massachusetts show a steady decline in the degree of specialization in shoemaking since 1879.

TABLE 39

	PERCENTAGE DISTRIBUTION OF SHOE PRODUCTION BY STATES, ACCORDING TO VALUE OF PRODUCT ¹									
	1849	1859	1869 ²	1879 ²	1889	1899	1909	1919	1929	1933
United States.....	100.0	100.0	100.0	100.0	100.0	100.0	100.0	100.0	100.0	100.0
Massachusetts ...	44.7	50.4	59.0	57.8	52.8	45.3	46.1	38.3	25.0	23.1
New York	14.4	11.9	12.1	11.4	10.7	9.9	9.4	16.5	19.6	17.9
Missouri	1.0	0.9	1.6	1.2	2.1	4.4	9.5	9.5	13.8	13.2
Illinois	0.9	1.2	1.6	1.9	4.0	3.6	3.3	3.4	7.6	8.3
New Hampshire ..	4.8	4.2	3.3	4.4	5.4	9.0	7.7	6.4	6.9	6.4
Wisconsin	0.5	1.0	0.8	1.0	1.3	1.8	2.7	3.8	5.7	6.2
Ohio	4.3	4.0	2.0	2.5	3.8	6.9	6.2	6.2	5.3	5.6
Maine	1.8	2.1	2.2	3.5	4.7	4.8	3.0	4.2	4.0	5.5
Pennsylvania	10.4	9.2	7.5	5.8	4.7	5.1	3.9	5.7	4.3	4.5
Tennessee	0.2	0.2	...	1.1	2.0
Maryland	2.5	1.4	1.4	1.3	0.7	0.4	0.3	0.4	0.9	1.1
Indiana	0.9	1.2	0.7	0.3	0.1	0.2	0.2	0.2	0.8	1.0
New Jersey	3.2	2.0	1.9	2.8	3.3	2.7	1.6	1.1	0.7	0.8

¹ U. S. Census data.

² All establishments with product valued at over \$5000.

³ Factory industry only.

The midwestern states in general seem to have grown faster in shoemaking than in population, but only in Missouri and Wisconsin has any considerable specialization been reached. Ohio now has hardly more than the national average percentage of shoe workers in its population, and Illinois never has been a really specialized shoe state.

The two other states, Pennsylvania and New Jersey, drop out after 1869 and 1899 respectively, and since then (despite the fact that Pennsylvania alone produced 4.5 per cent of the national output of shoes by value in 1933) they have actually been *underspecialized* in the industry. A few other states which have not been included in the table also lost their early positions of specialization. For instance, in 1879 California had an index figure of 1.3 and Connecticut a little over 1.0.

It would appear that a considerable part of the shifting of the industry relative to population has been intraregional.²⁶ Two

²⁶ A great deal of it, of course, has been intrastate, but adequate measures of this are lacking. Some attention will be given to intrastate migration in the next two chapters.

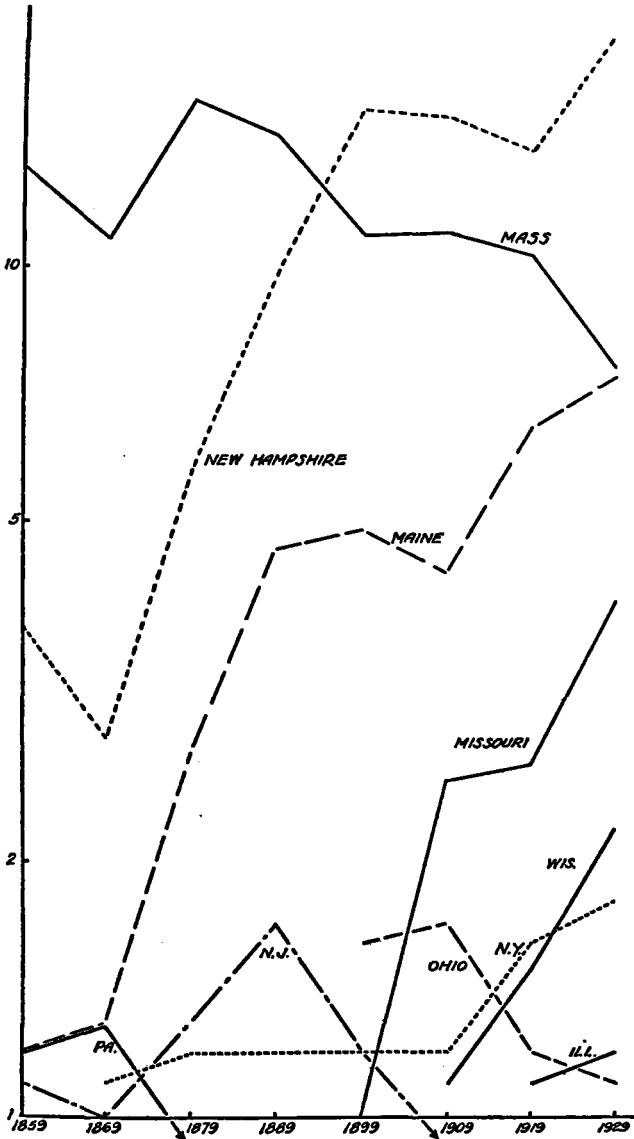

FIG. 39. Index of population specialization in shoe manufacturing, by states, 1859-1929 (see Table 38).

New England states have become more specialized in shoemaking, and one important midwestern state (Ohio) has become less specialized. Some further light on the question of interregional shifts is given by Table 40, in which the index of population specialization has been calculated for three groups of states. The New England group shows an accelerating decline after 1889, while the midwestern group has gained steadily and the Middle Atlantic group has first lost and then — since 1909 — turned again toward specialization. At no time, however, has the importance of the industry relative to population in the three New England states been closely approached in either of the other groups.

It would appear from these data that two sorts of adjustment have been going on. Interregionally, there seems to be a long-run tendency toward a more equal distribution of the industry relative to population, which would indicate that the attraction of markets has had considerable influence. At the same time, certain states (notably New Hampshire, Maine, and Missouri, but to a lesser extent Wisconsin and New York as well) have become more and more specialized, and to an increasing extent are producing for outside consumption. This shows that nearness to market is not the only factor at work.

TABLE 40
INDEX OF POPULATION SPECIALIZATION IN SHOE MANUFACTURING, BY
GROUPS OF STATES, 1879-1929

	1879	1889	1899	1909	1919	1929
Massachusetts } New Hampshire } Maine }	11.2	11.7	10.6	10.5	10.3	8.6
New York } New Jersey } Pennsylvania }	1.1	1.0	1.0	0.9	1.1	1.4
Ohio } Illinois } Missouri } Wisconsin }	0.4	0.6	1.0	1.3	1.3	1.8

A generalized measure of localization relative to population for the country as a whole is the 'coefficient of localization' which I

have described in a recent article.²⁷ In the present case, the data used are Census state totals. For each Census year, the states are arranged in order of the ratio of shoe workers to population, and then a simultaneous state-by-state cumulation of shoe workers

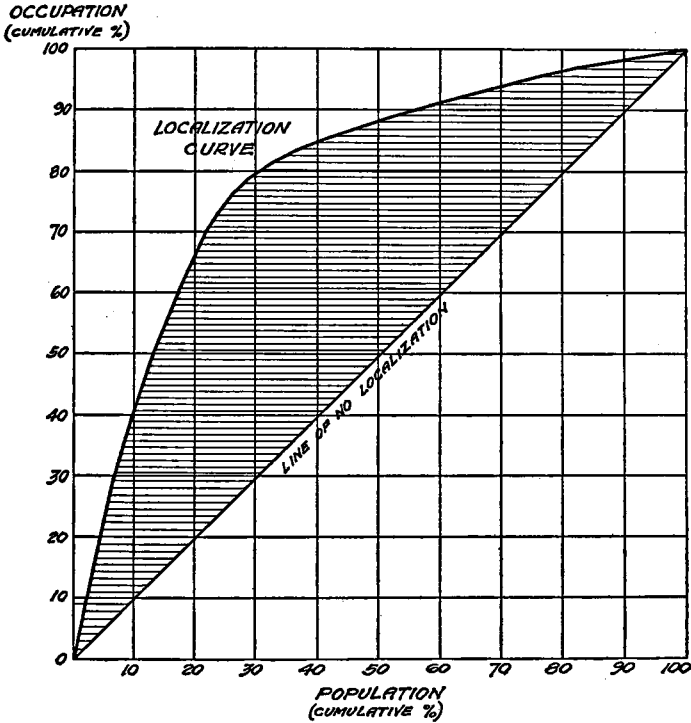

FIG. 40

and of population is made, both series being expressed in percentages of the national total. The final item in each cumulation is of course 100 per cent, since all the population and all the shoe workers have been accounted for.

If the cumulated items are plotted on a diagram like Fig. 40, measuring percentages of United States population horizontally

²⁷ "The Measurement of Industrial Localization," in *Review of Economic Statistics*, November, 1936, pp. 162-171.

and percentages of United States shoe workers vertically, the points will mark out a 'localization curve' bulging up and to the left of the diagonal of the figure. The bulge of the curve (that is, the area included between it and the diagonal) is determined by the degree of variability in the ratio of shoe workers to population from state to state (as indicated graphically by the progressive decrease of the slope of the localization curve from left to right). If the industry were distributed among the states in the same proportions as population is, the slope for each state would be equal and the localization curve would then coincide with the diagonal of the figure. On the other hand, the greatest conceivable localization relative to population (all the shoe workers in one state by themselves) would give a localization curve nearly coincident with the left and top margins of the figure.

What I have called the coefficient of localization is the ratio of the area between the curve and the diagonal (shaded in Fig. 40) to the whole triangular area above the diagonal. Its limiting values, then, are 0 and 1. The values of this measure for the shoe industry are given in Table 41 for a series of Census years. It appears there that almost every decade shows a decrease in the coefficient, which would indicate a tendency for the interstate distribution of the shoe industry to conform more closely to that of population.

TABLE 41

COEFFICIENT OF LOCALIZATION FOR SHOEMAKING WITH RESPECT TO
POPULATION, 1879-1929¹

1879	0.828
1889	0.796
1899	0.773
1909	0.798 ²
1919	0.781
1929	0.750

¹ Calculated by method described in my article "The Measurement of Industrial Localization," in *Review of Economic Statistics*, November, 1936, pp. 162-171.

² The figures for 1909 include the manufacture of cut stock and findings, accessory industries which are more localized than shoemaking proper (see Table 36), so this figure is somewhat too high.

As we have seen, a large part of the market on which the early specialization of Massachusetts was based was in the export trade. Boston was by far the leading port in the shipment of shoes

*% OF AVERAGE
PRODUCTION*

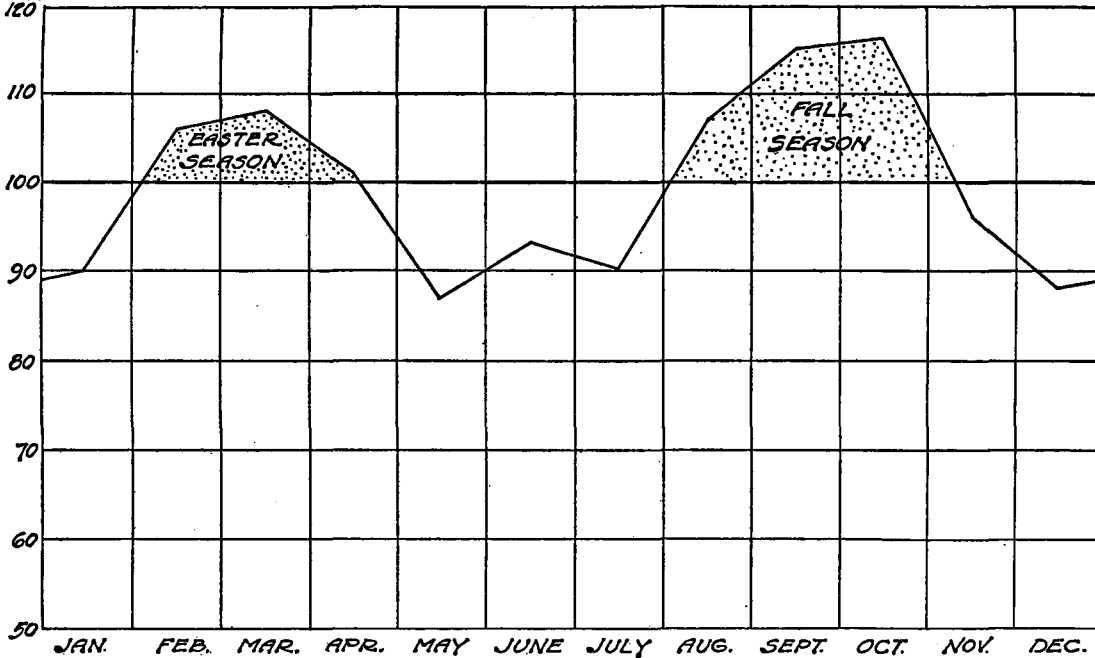

MARKETS AND MARKETING

FIG. 41. Seasonal variation in shoe production. The figure represents a seasonal index computed by the Persons median-link-relative method from monthly production figures of the Department of Commerce for 1924-28 inclusive, and adjusted for differences in the length of the months.

abroad. These export markets, however, became relatively less important as the domestic demand increased, and in the '60's and '70's they almost ceased to exist. American shipping and trade connections were disrupted by the Civil War; the attention of our manufacturers was diverted to domestic markets by war needs and then by the opening of the West by railroads; and last but not least, American shoe machinery began to hum and clatter in lands that had formerly imported shoes.²⁸

TABLE 42

DOMESTIC EXPORTS OF BOOTS AND SHOES FROM THE UNITED STATES, 1890-1906¹
(Value in thousands of dollars)

1890	663
1891	651
1892	915
1893	591
1894	777
1895	1010
1896	1437
1897	1708
1898	1817
1899	2711
1900	4277
1901	5526
1902	6182
1903	6665
1904	7239
1905	8058
1906	9143

¹ *Foreign Commerce and Navigation of the United States.*

Not until the '90's did our manufacturers — at first those in the East — again entertain the idea of an export market. America's dominant position in technical development had made this country a leader in the creation of new footwear styles. At expositions

²⁸ The United Shoe Machinery Corporation, dominant in this line in the United States since its formation a generation ago, has also been dominant in many other countries, and furthered the spread of American shoe machinery and methods to Europe and elsewhere. See on this Chapter XII, below; J. Russell Smith, *Industrial and Commercial Geography* (New York, 1913), pp. 538-539; U. S. Bureau of Manufactures, Special Agents' Series, no. 49, *Shoe and Leather Trade in the United Kingdom* (Washington, 1912), p. 8; and Bureau of Foreign and Domestic Commerce, Special Agents' Series, no. 226, *Shoes, Leather, and Hides in Great Britain* (Washington, 1924), p. 8, note.

abroad and at the Chicago World's Fair, American-made factory shoes began to take prizes and to command admiration. At the same time our own frontierward movement of population suddenly slackened. Shoe factories had grown up in the Midwest and, with their cheap labor and materials and nearness to local markets, had taken away much of the business of the old eastern firms that had shod a generation of Midwesterners. These eastern manufacturers were naturally the ones to turn their attention abroad. Some firms, either individually or in association with others, set up agencies in foreign countries, supplying dealers directly so that they no longer had to send individual orders to the United States to be filled.²⁹ Still more important, some of them actually began to make the sort of shoes the foreign customers wanted and were accustomed to wearing.³⁰

This revived export trade of the '90's, in which, while New England led the way, a few manufacturers in other sections also participated, was chiefly with the West Indies, Australia, and Great Britain. Table 42 gives an idea of its growth. There was a fairly important exportation to Canada until 1899, but the development of a Canadian shoe industry³¹ caused this to fall off sharply. Exports to Canada in 1900 were valued at less than half a million dollars.³²

The tendency was, according to the Industrial Commission, to export the better grades of shoes.³³ Since the Civil War our manufacturers have rarely been able to market cheap shoes successfully abroad.

New England retained its commanding position in the export trade, and in 1913 was anxious to secure its share of the great gains

²⁹ Clark, *History of Manufactures*, p. 476; Industrial Commission, *Report*, vol. xiv, p. 501.

³⁰ Cf. Clark, *loc. cit.* As late as 1900, however, the Industrial Commission reported that the general run of American manufacturers did not adapt their patterns for the export trade. *Report*, vol. xiv, p. 505.

³¹ The Canadian shoe industry is centered in Montreal, which in 1925 had 58 factories listed in the *Shoe and Leather Reporter Annual* and seemed to be of about the same importance as Milwaukee. The other important Canadian shoe centers are Quebec, Toronto, and Kitchener (Ont.).

³² Industrial Commission, *Report*, vol. xiv, p. 501.

³³ *Ibid.*, p. 502.

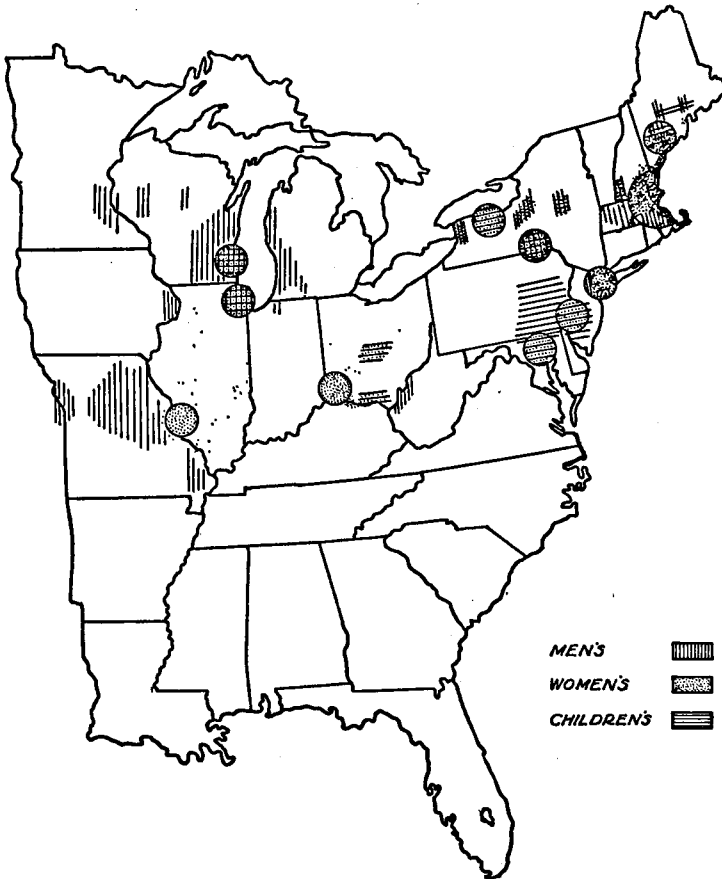

FIG. 42. Regional specialization in shoe manufacturing, 1929. The shading indicates the predominant type of shoe manufacture, according to information in the *Shoe and Leather Reporter Annual*, 1930. Circles represent major shoe centers.

expected to follow from the opening of the Panama Canal. At the annual meeting of the New England Shoe and Leather Association held on January 15, 1913, a resolution was passed favoring instruction in Spanish and Portuguese in New England shoe towns in preparation for the anticipated boom in Latin-American trade.³⁴

³⁴ *New England Shoe and Leather Industry* (journal of the association), January, 1913, pp. 6-7.

TABLE 43
EXPORTS OF BOOTS AND SHOES FROM CHIEF EXPORTING COUNTRIES,
1913 AND 1924 ¹

	Millions of pairs		% change 1913-24
	1913	1924	
Great Britain	17.5	11.5	-34
United States	9.9	6.5	-34
Germany	8.8	4.6	-48
Spain	1.5	0.4	-73
France	0.3	0.1	-67

¹ Quoted by Hugo Weil, *Die deutsche Schuhindustrie in der Nachkriegszeit* (Leipzig dissertation, 1926), p. 119, from *Schuh und Leder*, 1925, no. 92.

This boom, however, failed to materialize. During the war years, the development of shoe manufacturing in countries which had formerly imported their footwear was quite general, and — as Table 43 shows — seriously affected the trade of all the principal exporting countries. American exports of shoes fell off from 4.3 per cent of the national production in 1914, and 6.5 per cent in the exceptional year 1919, to 3.1 per cent in 1921 and 1.7 per cent in 1922. There was only a slight revival in subsequent years, and in 1930 only 1.2 per cent of the total production was sold abroad.³⁵

It has already been indicated that Massachusetts had a disproportionate share in each of the two periods of shoe exportation.³⁶ Her favorable position on the seaboard and the facilities of the port of Boston undoubtedly had something to do with this,³⁷ although we find that in 1928 only 32.1 per cent of the shoes exported from Massachusetts passed through the port of Boston.

³⁵ *Foreign Commerce and Navigation of the United States*.

³⁶ The *Foreign Trade Survey of New England* published by the Bureau of Foreign and Domestic Commerce in 1931 tells us (pp. 10-12) that in 1928 New England furnished 69 per cent of the national total of leather footwear exports, a percentage larger than in any other product. Since the bulk of this came from the Brockton district, it is plain that that district had a very much larger relative stake in export trade than any other. According to the 1927 Census of Manufactures, in that year the three New England shoe states produced 34.3 per cent of the national output, by value; Massachusetts alone produced 25.1 per cent.

³⁷ W. M. Reynolds and S. M. Rosenberg, "The New England Boot and Shoe Industry," in *The New England Economic Situation* (Harvard undergraduate essays in economics), Chicago-New York, 1927, pp. 197-210.

Practically all the rest (58.3 per cent) sought the better connections available at New York.³⁸

Another reason for the relative prominence of the export business in New England was the fact that that section had the poorest access to the growing interior markets of the United States, had outgrown its own comparatively restricted market possibilities, and early formed the habit of selling a part of its product elsewhere. When the midwestern wholesalers and retailers began to buy nearer home, the eastern manufacturers naturally turned elsewhere in search of an outlet.

TABLE 44
EXPORTS AND IMPORTS OF LEATHER FOOTWEAR, 1919-34¹
(ooo omitted)

	Exports		Imports	
	Pairs	Value (\$)	Pairs	Value (\$)
1919	21,354	74,837	62	226
1920	17,069	67,683	191	790
1921	9,019	24,776	146	573
1922	5,643	12,671	643	939
1923	7,697	17,966	1,944	1,888
1924	6,607	15,412	2,652	2,844
1925	7,275	15,667	1,990	2,915
1926	6,047	13,279	2,355	4,033
1927	5,869	13,100	3,003	5,918
1928	4,744	11,344	4,423	9,590
1929	4,807	11,658	8,359	18,773
1930	3,684	8,291	5,700	11,262
1931	1,780	3,934	3,391	6,229
1932	847	1,552	1,442	2,099
1933	746	1,318	2,049	2,125
1934	861	1,772	2,301	2,315

¹ *Foreign Commerce and Navigation of the United States, and Foreign Commerce Yearbook.*

Some reference has already been made to the effect of fashion changes in increasing the importance of access to markets. As a further consideration, styles have indirectly influenced location through production costs. In all style branches of the shoe in-

³⁸ Bureau of Foreign and Domestic Commerce, Domestic Commerce Series, no. 40, *Foreign Trade Survey of New England (Manufactured Products)* (Washington, 1931), pp. 38, 39, 45. Of the shoe exports from Maine, 62.8 per cent went through New York; of those from New Hampshire, 64.3 per cent.

dustry there are two peak seasons every year, for which new fashions are devised; a large part of the 'overcapacity' of the industry is accounted for by this fact.³⁹ Two features of this seasonal movement deserve special attention. Reference to Table 45 shows that the production of women's shoes is much more highly seasonal than that of men's shoes, and that in both branches, but particularly the former, the amplitude of seasonal variation has increased since the War.

TABLE 45
PERCENTAGE RATIO OF MINIMUM TO MAXIMUM MONTH'S PRODUCTION OF
MEN'S AND WOMEN'S SHOES, 1923-34¹

	Men's	Women's
1923	67.4	59.2
1924	67.8	62.2
1925	73.2	67.4
1926	65.2	66.7
1927	75.8	53.5
1928	69.0	51.9
1929	66.4	50.2
1930	62.6	42.5
1931	61.9	29.5
1932	63.9	40.0
1933	63.1	46.6
1934	75.7	40.9

¹ National Recovery Administration, Division of Review, *Report of Survey Committee on Operation of Code for the Boot and Shoe Manufacturing Industry*, July 16, 1935, p. 22.

This irregularity in production is indicative of 'hand-to-mouth' buying by the middlemen, which in turn is due to the emphasis on differentiation. It is not hard to see why the average size of shoe factories is so much smaller in the districts devoted primarily to the production of women's style shoes. Orders are smaller, patterns must be changed more often, and the economies of large-

³⁹ The Committee on Elimination of Waste in Industry (*Waste in Industry*, p. 16) estimated that the shoe industry is normally busy about 65 per cent of full time during the year. The general impression prevails that this is a badly overequipped industry, but it would appear that a good deal of the idle capacity is due to seasonal variation and other factors at present out of the manufacturer's control. The Brookings study (*America's Capacity to Produce*, Brookings Institution, Washington, 1934) gives the shoe industry a relatively clean bill of health, with an estimated 80 per cent of capacity operations.

scale production, management, and marketing are much more limited.

It is because so many New England shoemakers have produced women's shoes that that section is the home of many small-scale shoe factories in which the turnover in ownership has been rapid.⁴⁰

Almost all lines are affected to some extent, however.

It is significant that the one large concern, — the International Shoe Company, — which attempted to stabilize its production by overcoming the style factor and manufacturing for stock has been forced recently to abandon its programme.⁴¹

It would seem that Massachusetts, and the eastern urban centers generally, came to specialize in the style lines mainly because of their long experience in the industry, building up a class of expensive but expert operatives and contact with market outlets in the large cities. Just as Massachusetts was the first to go into the mass production of staple shoes, so was she — together with New York City, Philadelphia, and a little later Rochester — in the lead in specializing in non-staples.⁴²

It is interesting to note that the New York garment industry went through the same evolution. Seasonal variations are now greater there than in other centers because New York is the place where the styles start and consequently the place where there is the most emphasis on novelty.⁴³

In a later chapter I shall discuss this sort of regional specialization in terms of labor, which is the most important element in it. There are grounds for believing that 'style localization' is both characteristic and cumulative. We may note here, however, that the pressure for style variation appears to come mainly from the middlemen, who at present are trying to introduce additional

⁴⁰ Keir, *Manufacturing*, p. 469.

⁴¹ Abraham Epstein, "The Stabilization Nonsense," *American Mercury*, January, 1932, p. 70.

⁴² The specialty of the majority of Massachusetts factories, particularly those in the North Shore district, is 'women's novelty McKays.' They do not average high in price, but style is all-important. The new compo process, a cheap and quick way of attaching the sole with an adhesive, is important chiefly for this type of shoe.

⁴³ Mabel A. Magee, *Trends in Location of the Women's Clothing Industry* (Chicago, 1930), chapters iii and iv, *passim*.

seasons and sub-seasons into the year so that shoes will go out of style more promptly.

This brings us to the question of the relations between manufacturers and middlemen in the various channels of marketing. We have seen that the eastern manufacturers of the pre-Civil War days customarily financed sales themselves, extending credit to the western and southern merchants until the shoes were actually bought by the wearer. The scarcity of capital in the newer parts of the country made this the only feasible plan of marketing factory shoes.⁴⁴

TABLE 46
INVESTED CAPITAL PER DOLLAR'S WORTH OF ANNUAL PRODUCT IN SHOE
MANUFACTURING, 1879 AND 1899¹

	1879 Cents	1899 Cents
United States	25.9	39.0
Indiana	47.5	62.8
Pennsylvania	37.8	51.8
Wisconsin	31.6	51.6
New York	32.8	46.8
Illinois	54.3	46.8
New Jersey	20.6	45.2
Maryland	26.7	44.2
Ohio	27.7	42.1
Maine	23.5	41.9
Missouri	32.4	37.2
New Hampshire.....	23.5	34.7
Massachusetts	22.0	32.1

¹ Census of 1900, *Manufactures*, part 3, p. 752.

This capital shortage, however, tended to grow less acute; and after the commercially disastrous panic of 1873 short-time or cash payment became the rule in the trade.⁴⁵ The elimination of the long credits to local dealers removed one of the former handicaps to midwestern shoe manufacturing: the difficulty of getting enough circulating capital. As we shall find in a later chapter, the

⁴⁴ Cf. the quotation from Scharf's *History of St. Louis* on p. 221 below; also Charles Cist, *Sketches and Statistics of Cincinnati in 1851*, pp. 175-179, cited by Isaac Lippincott, *A History of Manufactures in the Ohio Valley to the Year 1860* (New York, 1914), p. 176.

⁴⁵ Rice, in *One Hundred Years of American Commerce*, vol. ii, p. 572.

actual production of shoes entails unusually small capital requirements; so when the financing of sales was shifted to the shoulders of the jobber or retailer, it became possible for men of relatively slender resources to go into the business of making shoes. Here we have another factor facilitating the break-up of the early localization of factory shoemaking in New England, New York, and Philadelphia.

A trend toward the elimination of the wholesaler or jobber was in evidence even half a century ago. As increasing differentiation of the product put a premium on speed and close contact, and as the retailer began to play a less passive rôle in merchandising, it became more and more important for the manufacturer to come into close touch with the consuming market. Certain trade abuses also had made jobbers unpopular, and in 1895 it was being suggested that the shoe manufacturer should ally himself to one particular jobber, sell direct to retail stores, or set up his own outlets.⁴⁶ Only a few of the larger eastern manufacturers were in a position to consider the last alternative.

Direct selling to retailers had begun as early as the '80's. One result was that there came to be a more or less definite guarantee for the line of each well known manufacturer. Public good will became an asset again for the first time since the disappearance of the handicraftsman, and the way was open for the development and advertising of brands.

In 1917 and 1919 the Federal Trade Commission made two investigations of shoe and leather marketing, which give us an idea

⁴⁶ *Ibid.* I estimate that in 1929 the average shoe factory could supply about forty shoe stores of the average size. The total product of the 1341 shoe factories in the United States in that year was valued at \$965,922,694, which gives about \$720,000 as the value of the year's output of the average factory. The sales of the 24,259 shoe stores totalled in the same year \$806,829,000, which gives an average of \$33,200 per store. About \$30,000 of this may safely be assumed to have consisted of shoes. Assuming a 40 per cent mark-up, the wholesale value of the shoes sold by the average store would be \$18,000, or about one-fortieth of the value of the output of the average manufacturing establishment.

This estimate is based on data from the Census reports on manufactures and distribution, and is presented without claims as to its accuracy, merely to give a rough idea of the relation between the size of factories and stores. In general, chain shoe stores are nearly twice as large as independents, and stores in large cities sell more than those in towns or smaller cities.

of the extent to which direct selling had increased by that time. The results are shown in Table 47. It appears that about half the shoes went direct from manufacturer to retailer, and somewhat less than half to wholesalers, with small percentages being sold to the consumer by the manufacturer himself or his subsidiaries.

TABLE 47
RELATIVE IMPORTANCE OF VARIOUS CHANNELS OF SHOE MARKETING,
1917 AND 1919 ¹

	Percentage of Total Sales	
	1917	1919
Direct to retailers	50	48
To jobbers	42	47
Through factory-owned chain stores	5	4
Direct to wearers	2	1

¹ Federal Trade Commission, *Report on Leather and Shoe Industries*, 1919, p. 167, and *Report on Shoe and Leather Costs and Prices*, 1921, p. 27. The former covered the 1917 sales of 730 manufacturers and the latter the 1919 sales of 496 manufacturers. The time intervening between the two investigations is of course too short, and the difference in their scope too great, to indicate any trend. The two sets of results merely furnish a check on each other.

TABLE 48
PERCENTAGE DISTRIBUTION OF SALES OF SHOE MANUFACTURERS BY TYPE OF
OUTLET, 1929 ¹

Sales to	Percentage of Total Sales
Wholesalers	21.8
Manufacturer's own wholesale branches	26.4
Retailers	44.8
Manufacturer's own retail branches	6.2
Industrial and other large consumers	0.4
Household consumers	0.4
<hr/>	
Total direct sales	97.3
Through manufacturer's agents, selling agents, brokers, and commission houses	2.7
<hr/>	
Total sales	100.0

¹ Fifteenth Census, *Distribution of Sales of Manufacturing Plants*, 1929, pp. 32-33.

When we put these figures beside those of the 1929 Census of Distribution we see evidences of a great change. In 1929 the manufacturer dealt with retailers or consumers for nearly 80 per cent of his output, and sold only 21.8 per cent to wholesalers. The

independent jobber is apparently becoming restricted to a few special lines.⁴⁷

In recent years there has been a rapid trend toward union of manufacturers with large distributors. In part, this has followed the earlier line of acquisition of retail outlets by manufacturers; but to a still greater extent the initiative has come from the retailers. Chain stores, mail-order houses, and department stores have found it to their advantage to control their own sources of supply, and have expanded into the manufacturing field to a surprising extent in a very short time.⁴⁸

TABLE 49
TYPES OF SHOE OUTLETS, 1929¹

	Sales, in Millions of Dollars	Percentage of Total Sales
Shoe stores	806.8	66.1
Department stores	208.3	17.1
General stores	49.7	4.1
Mail-order houses (catalogue)	35.5	2.9
Family clothing stores	31.4	2.6
Men's clothing stores	29.2	2.4
Dry-goods stores	27.4	2.2
Women's ready-to-wear specialty stores	15.6	1.3
Variety, 5 and 10, and to-a-dollar stores	14.2	1.2
Total	1218.0	100.0

¹ Bureau of the Census, *Retail Distribution — Shoe Retailing, 1929 (R-8c)*, p. 20.

This is an interesting outgrowth of the increased power of the retailer in the shoe market. Partly it is a question of size. In 1929,

⁴⁷ In an investigation of the firms listed in the *Shoe and Leather Reporter Annual* for 1930 I found that sales to jobbers were reported as general only by the manufacturers of that part of New England north of Boston. Other districts, in so far as outlets were reported, appeared to be selling predominantly to retailers. It seems, then, that the function of the jobber nowadays is to handle the output of the small and specialized women's shoe factories of the northern New England district. Cf. Table 60 in Chapter XVI below.

⁴⁸ This tendency is so recent that there is no published material which gives an adequate idea of it; but some information only a few years old may be found in the Federal Trade Commission's *Report on Chain-Store Manufacturing, 1933*. On pages 8 and 9 are lists of the principal manufacturing firms which have taken up retailing and the principal retailing firms which have taken up manufacturing.

I am indebted to Mr. Maxwell Field of the New England Shoe and Leather Association for calling my attention to the importance of the movement described.

38 per cent of retail shoe sales were made by chains, 17 per cent by department stores, and 3 per cent by mail-order houses;⁴⁹ thus a total of 58 per cent of the market was in the hands of large or multiple organizations. Small wonder that the manufacturers complain of a 'buyers' market!' ⁵⁰ By 1933 the chain stores had increased their percentage from 38 to 46,⁵¹ and the trend has apparently continued since. It is safe to say that by this time (1936) not more than 30 per cent of this country's shoes are sold by small independent stores.

The motives of the large retailers in acquiring factories are various, but 'control of quality' is the reason most often given in response to questions by the Federal Trade Commission.⁵² Representative statements quoted from its report are these:

Our principal reason and advantage for manufacturing shoes for ourselves is that we are certain to continually keep the standard of construction that we desire. Too often manufacturers who have not the 100 per cent interest of the retailer at heart will deviate even if only slightly from the standard if necessity compels them to.

In manufacturing our own shoes we know exactly what we are giving to our trade in the way of quality at all times.

We prefer to manufacture all the shoes we sell.

In this way we know exactly what goes into our shoes and can sell under a guaranty.

It is significant that although the chain-store manufacturers rarely make *all* the shoes they sell, they nearly all have private brands. The emphasis is on 'something a little different.'

⁴⁹ See Table 49.

⁵⁰ "... during the depression the shoe manufacturer has been selling his shoes not according to the cost of production but under what is called a buyers' market. This refers to a situation where the retailer or jobber sets his price for the grade of shoes that he desires and the manufacturer must meet this price or lose the sale." Quoted by permission from an unpublished thesis of Maxwell Field, *An Industrial Relations Program for the Massachusetts Shoe Industry* (Amos Tuck School of Administration and Finance, 1934), p. 12.

⁵¹ Bureau of the Census, *Retail Distribution, 1933—Chains and Independents*, p. 2A.

⁵² Federal Trade Commission, *Report on Chain-Store Manufacturing* (73d Congress, 1st Session, Senate Document no. 13, 1933), pp. 44-45 and note.

TABLE 50

PERCENTAGE DISTRIBUTION OF SHOE MANUFACTURING AND WHOLESALE AND
RETAIL TRADE, BY GEOGRAPHIC DIVISIONS, 1933¹

	Manufacturing	Wholesale	Retail
United States	100.0	100.0	100.0
New England	35.0	17.9	9.3
Middle Atlantic	23.2	22.4	34.3
East North Central	21.5	8.1	22.8
West North Central	13.8	40.2	7.9
South Atlantic	1.1 ²	3.2	8.2
East South Central	2.5	1.5	3.0
West South Central	0.8	4.9
Mountain	0.2	1.4
Pacific	0.3	3.3	8.1

¹ Computed from Census data. The 'Wholesale' and 'Retail' percentages are based on net sales of shoe wholesalers and shoe retailers respectively.

² This figure would be somewhat larger if the Census disclosed production figures for Virginia. Such gaps in the data, as well as rounding-off of figures, account for the fact that the percentages do not total exactly 100.

CHAPTER XII

THE LEASING OF MACHINERY

It is not surprising, when one considers the antecedents of the modern shoe manufacturing business, to find that the entrepreneurs engaged in it during the period when the chief machines were introduced were men of small means. Not so long before the Civil War, shoes had been made by individuals for individuals, no capital being involved other than a simple kit of hand tools, a little leather, and a "ten-footer" shop to work in. Under the wholesale handicraft and putting-out systems a greater amount of circulating capital was needed, but the fixed-capital require-

TABLE 51
SOME COMPARISONS BETWEEN THE SHOE INDUSTRY AND ALL MANUFACTURING
INDUSTRIES, 1879-1929¹

	Wage Earners per Establishment		Horsepower per Establishment		Ratio of Invested Capital to Value Added by Manufacture	
	All	Shoes	All	Shoes	All	Shoes
1879	11	49	13	5	1.41	0.67
1889	12	49	17	12	1.55	0.93
1899	10	67	21	25	1.86	1.10
1909	25	103	70	50	2.16	1.19
1919	31	146	102	80	1.77	1.32
1929	42	153	204	105

¹ Computed from Census data. No figures on capital investment were collected for 1929. The figures in the table are not suitable for time comparisons, on account of changes in the scope of the Census; but are meant to indicate the position of the shoe industry relative to manufacturing industries in general for each Census year separately.

ments were very low relative to the volume of business. Establishments were small. Even as late as 1869, when the factory system had quite a good start, less than 68 per cent of the workers of the industry were in establishments with a product valued at as much as \$5000 a year.¹

¹ Computed from Census data. The average number of workers per establishment was 29 for the establishments with products valued at over \$5000; if we include all the establishments with an annual product of \$500 or more, the average number of workers was only 5.8.

The tradition of independence created by the centuries in which shoemaking had been an individual and peculiarly esteemed craft is a factor which makes itself felt to this day. It served to keep shoemaking establishments even smaller than they would otherwise have been.²

The representative merchant-manufacturer was commonly able to afford the simple and relatively inexpensive machines brought out prior to the Civil War. Those who were not able to afford them could do without and still remain in the business. But in the early '60's the manufacturers were confronted by the McKay sewing machine, the most important in the history of the industry, which effected such an enormous saving in labor costs that thereafter no manufacturer of the ordinary sorts of shoes could afford to be without it. It was a competitive necessity. It was also large, complicated, delicate, and, last but not least, expensive. Many small shoe manufacturers would have had to go out of business on account of inability to obtain capital for such an investment.

In order to place the machines more readily, therefore, Colonel McKay decided to lease rather than sell them. The lessee paid a moderate sum to cover the cost of installation, and then royalties for the use of the machine, as indicated by a meter. In some cases payment of the royalties was effected by the purchase of stamps by the user of the machine, who had to attach them to the product.³ Gifts of stock in the company were included with every large purchase of stamps.

The leasing system had the further advantage of keeping the business of servicing the machines and supplying spare parts in the hands of the McKay company. It provided a generous return on the large capital which the company had invested in the machines, and was copied by other makers of the complicated and expensive shoe machinery that came into use in the latter decades of the century. When the Goodyear company entered the field with its welt-process machine, next to the McKay machine itself

² Cf. Keir, *Manufacturing*, p. 455.

³ A unique collection of such royalty stamps, issued by a number of machinery companies, is on exhibition in the museum of the United Shoe Machinery Corporation in Boston.

in importance, it found the leasing system so thoroughly entrenched that there was no choice but to adopt it.⁴

There was at first a great multiplicity of companies producing shoe machinery,⁵ but a remarkably swift movement of amalgamation set in, contemporary with that in the steel, oil-refining, and other industries. In 1899 the three principal companies remaining in the field — the McKay Shoe Machinery Company, the Consolidated and McKay Lasting Machine Company, and the Good-year Sewing Machine Company — combined to form the 'Shoe Machinery Trust,' under the name of the United Shoe Machinery Company.⁶ The consolidation involved considerable elimination of duplicate agencies, repair gangs, and so on, and thus was in part motivated by considerations of internal economy.

The Company was able to retain control over the supply of certain essential machines long after the patent rights had expired by the expedient of tying clauses, over which there was much litigation in the federal courts. The tying-clause contracts virtually involved giving the manufacturer the choice between taking the whole United line or no part of it. If he wanted to use a certain United machine, he was forced to contract to use United machines also for various other operations in which competing machines might exist.⁷

Whether the means by which the United Shoe Machinery Company retained its control are legal or justifiable, and whether the rates charged are excessive, are questions not relevant to our purposes. The essential facts are that the royalty policy has been

⁴ Keir, *Manufacturing*, p. 460.

⁵ "In the early nineties Lynn was said to contain about 100 firms manufacturing shoe machinery and kindred supplies." Clark, *History of Manufactures*, p. 472.

⁶ Keir, *Manufacturing*, p. 460. "Company" was later changed to "Corporation."

⁷ See Eliot Jones, *The Trust Problem in the United States* (New York, 1926), ch. viii. Alfred W. Donovan, in his *Shoe Machinery Analyzed* (Rockland, Mass., 1912) maintained that any manufacturer who wanted to be independent of the United company could do so if he had the capital necessary to buy other American and foreign machinery. It should be noted, however, that his pamphlet was avowedly a propaganda document written to influence opinion during the legal battle over the tying clauses. It cannot be denied that the path of least resistance for the manufacturer has always been the acceptance of the whole United line of machines, which involves also the purchasing of eyelets, tacks, etc., from the Corporation.

preserved,⁸ and that the royalty per unit of output is the same regardless of the location of the factory or the amount of use of the machine.

Despite serious pressure from the largest shoe manufacturers to introduce a sliding scale of royalties in accordance with the greater or less use of the machines, the United Shoe Machinery Company has never swerved from standard uniform prices. Consequently, the relative machine cost per pair has been the same for a shoe manufacturer with a production of 300 pairs [daily] as for one with an output of 3000 pairs.⁹

The absolute size of the royalty is fairly small, though regarded as excessive by some manufacturers. It rarely amounts to more than 5 cents on a representative pair of shoes, for all royalty machines together.¹⁰ Sixteen years ago, the charge for royalties in shoe manufacturing was stated to be less than that for cartons.¹¹

Professor Keir notes as a result of the specialized *outside* mechanization of the shoe industry the fact that

no New England shoe manufacturer has any superiority in mechanical equipment over any other maker of shoes anywhere in the country. This feature tends to spread shoemaking beyond the confines of New England.¹²

It seems probable that if the close control of machinery had not existed, there would have been geographical differentials in the prices of installation and use of the machinery. Presumably such differentials would have been in favor of districts of concentrated

⁸ In many cases sale prices are quoted on the machines, but are so much higher than the capitalization of the royalties that they are almost never paid. The manufacturer is thus encouraged to let the Shoe Machinery Corporation own and service the machines.

⁹ Keir, *Manufacturing*, pp. 460-461.

¹⁰ From statements of manufacturers. In 1912 the total royalty charges were quoted as 1 1/3 cents a pair on McKay shoes, 4 cents a pair on women's welts, and 5 cents a pair on men's welts, or about 2 2/3 cents a pair for the whole shoe production of the country. All the above figures are approximate averages, from Donovan, *Shoe Machinery Analyzed*, pp. 62, 70.

¹¹ *Boot and Shoe Recorder*, May 29, 1920, p. 49.

¹² "Is Shoe Manufacturing Leaving New England?" *Boston Herald*, Sept. 23, 1922, p. 14.

production, since there the actual costs of installation, servicing, and so on, are at a minimum.¹³

It is also to be noted that concentration of machinery into the control of a single company makes possible a wider distribution of repair agencies than any one of a number of competing firms would be able to maintain:

. . . in every important shoe manufacturing center there is a branch office of the United Company, and . . . that branch office can and will promptly take care of and remedy any trouble that occurs in any shoe factory in its territory, on any machine that the company furnishes.

It is not credible that any such complete system of expert service could possibly be available if we were doing business with twenty or more shoe machinery concerns where we are now doing business with one.¹⁴

Furthermore, the standardization of machinery carries with it the more complete standardization of operations and increases the mobility of skilled labor from plant to plant. As Donovan puts it, . . . an operator on a certain type of machine is an operator anywhere. This . . . helps the shoe worker in more readily finding employment wherever he is.¹⁵

The original shoe districts of the pre-McKay era, and New England in particular, might otherwise have been able to retain the advantages of their early start in the shape of lower machinery costs and specially trained labor. But the standardization of machinery tended to decentralize production by reducing the first and, to some degree, the second of these advantages.

As has been said, a most significant point for the question of location is that the royalties are the same for small as for large manufacturers, the dissatisfaction of the latter notwithstanding. The absence of a sliding scale of rates deprives the large shoe manufacturer of part of the internal economies he would gain from his more intensive utilization of machinery if he owned the

¹³ The United Shoe Machinery Corporation's plant is located at Beverly, Massachusetts, in the center of the most numerous localized group of shoe factories in the country.

¹⁴ Donovan, p. 38.

¹⁵ *Ibid.*, p. 85.

machinery himself, and removes part of the incentive to regularization of operations.

The lease policy itself, aside from the question of relative rates, encourages small-scale shoe manufacturing by making the business an unusually easy one to enter. The space required is small, and plenty of suitable floor space is normally available in loft buildings in any factory town, so nothing is required to enter the shoe business but a small minimum of capital and some experience. Often the latter is dispensed with.

The result is that shoe manufacturing is dispersed in many moderate-sized establishments.¹⁶ This fact, together with the variations in style and quality of output in different factories and localities, has historically been of great force in discouraging combination in the industry and preventing the formation of anything resembling a 'shoe trust.' There were in 1933 more than 1200 producing establishments owned by nearly as many firms.¹⁷ The largest firm¹⁸ manufactured in all its plants something less than 15 per cent of the total output for the country.

Since 1914, if we measure plant size by number of employees or installed horsepower, there has been no very great gain in size. The scale of production seems to be stabilized with reference to the existing stage of technique,¹⁹ in contrast to the recent rapid growth of the marketing unit, described in Chapter XI.

In a manual of practical advice to shoe manufacturers, Small wrote in 1910:

It is a mistake to build big factories. . . . Specialization is going on all the time, and the factories today making the most money and hav-

¹⁶ See Bureau of Foreign and Domestic Commerce, *Industrial Structure of New England*, p. 433, and Table 51, above.

¹⁷ The 1933 Census of Manufactures listed 1132 establishments with an annual product valued at \$5000 or more.

¹⁸ The International Shoe Company.

¹⁹ There are many instances in which, during the past decade, large plants have been divided for more efficient operation in view of the increasingly non-staple character of production in most lines. I was told a few years ago by an Ohio manufacturer that on account of styles he had divided his 18,000-pair factory into two, and was planning to break it up into three. In any shoe town, particularly where women's shoes are made, it is common to see large factory buildings, apparently originally intended for single occupancy, plastered with the signs of half a dozen factories renting floors or parts of floors.

ing the steadiest run of business are those of a moderate size, say from 2500 to 5000 pairs daily capacity. The fewer the styles and grades the easier the plant is run.²⁰

Today the same advice would be still more applicable. In the style branches of the industry a factory capacity of 2500 pairs a day is unusually large.

²⁰ Frederic L. Small, *Organizing a Shoe Factory* (Boston, 1910), p. 3.

CHAPTER XIII

LABOR

THE position of labor as a technical factor in shoe production has been profoundly modified in the past eighty years. While the product has changed only in details and finish, the process of manufacture has evolved from a single skilled trade, carried through from start to finish by a craftsman, to a series of two or three hundred separate operations, the greater part of which are mechanized.¹

TABLE 52
LABOR AND TIME COSTS PER PAIR OF SHOES¹

	Labor Cost (dollars)	Time Cost (hours)
1863 (hand method)	4.58	18.32
1895 (factory)	0.60	2.36
1916 (factory)	0.37	1.43
1923 (factory)	0.55	1.07

¹ Bureau of Labor Statistics, Bulletin 360, *Time and Labor Costs in Manufacturing 100 Pairs of Shoes, 1923*, pp. 143, 149, 154, and 8. The data for 1916 and 1923 apply to the same establishment. See also the labor-cost figures given in the 1898 report of the United States Commissioner of Labor, selections from which are reproduced in the Census of 1900, *Manufactures*, part 3, p. 757.

The effectiveness of this technical development in reducing labor costs per unit of output is shown in Table 52. The trend to lower labor costs is evident through 1916 in both series, but between 1916 and 1923 it is overshadowed by the rise in money wages. Between 1914 and 1923² the amount paid in wages per

¹ "More than 50 machine operations are performed in an ordinary boot and shoe factory; in some shops the number is over 150. The number of independent processes, including hand operations, is still greater; fully 200 well-defined processes can be distinguished." National Industrial Conference Board, *Hours of Work as Related to Output and Health of Workers — Boot and Shoe Industry* (Boston, 1918), p. 8.

² "At the present time there are between two and three hundred different operations on a shoe . . . , and in many large establishments each operation is performed by a different employee." Bureau of Labor Statistics, Bulletin 360, *Time and Labor Costs in Manufacturing 100 Pairs of Shoes, 1923* (Washington, 1924), p. 4.

³ Census data. Figures for 1916 are not available.

pair practically doubled (36 cents ~~54¢~~ cents), and in the same interval the number of pairs per worker per year rose scarcely at all (1530 to 1560). This would indicate that the price of a given quantity of labor approximately doubled between 1914 and 1923.

The Bureau of Labor Statistics index numbers of shoe production, man-hours, and productivity, given in Table 53, show in some further detail the trend toward lower time costs per unit of output. The Bureau ascribes the rise in productivity to four factors, as follows:

- (a) Increased capacity of workers.
- (b) Application of mechanical power.
- (c) Improvements in technique.
- (d) Elimination of waste.

I should be inclined to eliminate the first of these as an independent factor, since if workers have become any more efficient it is probably a result of increased specialization, allowing the effects of continued practice to be concentrated on a smaller number of operations.

TABLE 53
BUREAU OF LABOR STATISTICS INDEX OF PRODUCTION, MAN-HOURS, AND
MAN-HOUR PRODUCTIVITY IN THE BOOT AND SHOE INDUSTRY
1900-27¹

(Base: 1914 = 100)

	Production	Man-Hours	Productivity
1900	77	77	100
1904	86	80	108
1909	100	100	100
1914	100	100	100
1919	113	105	108
1921	98	88	111
1923	126	106	119
1925	116	101	115
1927	125	101	124

¹ *Monthly Labor Review*, March, 1930. The production index is simply the total number of pairs produced, expressed as a percentage of the 1914 production. The man-hours or labor-input index is the product of an index of employment (based on the Census of Manufactures, with interpolations) and an index of prevailing hours of labor, both on a 1914 base. The productivity index is the production index divided by the man-hours index.

As we should expect, the trend toward mechanization has had a distinct bearing on the labor requirements of the industry. Its

former dependence on skilled labor has been lessened. Many operations are now within the grasp of employees with little or no ability or training; we find in the list of operations such things as 'tying up outsoles,' 'tempering (i.e., dampening) heel stock,' and 'pulling out tacks.' To an increasing extent such simple operations have been taken away from highly-paid workmen and given to cheaper and less skilled labor to perform.

But the strength of this tendency should not be overestimated. There had always been many shoemaking operations that could be performed by workers of a very moderate degree of skill. With increasing specialization, these easier operations could be segregated from the others and given to less skilled workers, and often eventually to machines, which saved the time of the more skilled. Precisely because the most repetitive and mechanical processes have been most mechanized, their time and money costs have become less significant. Some of the more difficult jobs less susceptible to machine methods now bulk larger than before. An example is the cutting-out of upper parts, perhaps the most highly skilled occupation in the whole shop. Table 54 shows the variation in the costs of this job relative to that of making the whole shoe, at various stages in the industry's technical development.

One factor retarding the tendency toward lower grades of labor is the steady improvement in quality standards of shoes since the early days of the putting-out system. Better shoes involve primarily better workmanship; more elaborate styles make good workmanship more and more important; and so it remains necessary to man shoe factories with a fairly large proportion of skilled workers.³ Some — cutters, vampers, Goodyear stitchers, and so on — are of the highest order of skill, requiring years to work up to full efficiency.⁴

³ Any classification of operations on the basis of relative skill is of course subject to some question, but the following apportionment of the labor in the shoe industry seems to be accepted as fairly accurate by those acquainted with conditions: Skilled, 40 per cent; Semi-skilled, 40 per cent; Unskilled, 20 per cent. These percentages were suggested to me by Mr. Maxwell Field, Statistician of the New England Shoe and Leather Association.

⁴ "In the shoe industry the cost of training an inexperienced man for cutting

TABLE 54
RELATIVE IMPORTANCE OF UPPER-LEATHER CUTTING AS A COST FACTOR IN
SHOEMAKING, 1863-1923¹

	Percentage of Total Labor Cost	Percentage of Total Time Cost
1863 (hand)	6.11	1.64
1895 (hand)	3.80	3.87
1916 ² (hand)	4.05	3.16
1916 ³ (hand)	4.44	3.60
1923 (machine)	8.17	5.06

¹ Computed from data in Bureau of Labor Statistics, Bulletin 360, *loc. cit.* There is some variation in the exact scope of the operations included in these figures. For 1863 and 1895 it is 'Cutting out vamps,' 'Cutting out tips,' and 'Cutting out quarters.' For 1923 (the same establishment as for 1916) I have included 'Cut vamp, top, tip, and tongue, machine'; and for 1916 I have given two figures, of which the first should be fairly comparable with 1863 and 1895 and the second with 1923.

² 'Vamp and tip cutters' and 'Top cutters.'

³ 'Vamp and tip cutters,' 'Top cutters,' and 'Tongue cutters.'

For most branches of the shoe industry, quality rather than mere cheapness of labor is still the chief factor to be considered with reference to location. Skilled labor is sufficiently important in the factory so that production will be oriented to it rather than to the more widely distributed low-grade labor.⁵ The following quotations are indicative of the importance that labor skill has had for factory location in the past:

Of the reasons for locating or continuing operations in New England, the one given most frequently was labor conditions. It appears that, in the minds of the manufacturers, the skill and availability of the New England workmen for making shoes are the principal factors.⁶

Many of the manufacturers and others who are well informed as to conditions in the industry, report shoe workers of Haverhill as unusu-

upper leather in a well managed shop is \$576; for a semi-experienced man, \$450; and to install an experienced man in a different shop costs \$50. For the average shop these figures are unquestionably low." Federated American Engineering Societies, Committee on Elimination of Waste in Industry, *Waste in Industry* (New York, 1921), p. 14. See *ibid.*, p. 159, for a chart showing the curve of efficiency against time in learning various shoemaking operations.

⁵ "... the industry is not attracted to the locations of lowest wage levels but seeks the most favorable labor locations. Locations with high absolute wages may still be favorable ones, since through greater productivity they may offer relatively lower labor costs." Link, *Die Lederindustrie*, p. 76.

⁶ Bureau of Foreign and Domestic Commerce, Domestic Commerce Series, no. 28, *Industrial Structure of New England* (Washington, 1930), p. 424.

ally skilled in making attractive, fancy, novelty women's shoes. A number of factories that moved out of Haverhill send work to the contract shops in Haverhill because the workers in these shops are more efficient than those in the cities and towns in which the factories are located, also because it is cheaper for them to have the work done by contract than it would be to equip a stitching room and organize and train a force of employees.⁷

Haverhill manufacturers most of them have risen from the bench. They know the business. Haverhill men are bred to know style and to be natural mechanics, which prevents the industry from being transplanted to any great extent outside of New England.⁸

Further testimony on the same point is furnished by a fairly recent locational study made jointly by the Metropolitan Life Insurance Company and the National Electric Light Association.⁹

If quality of labor is the deciding factor, then 'locational inertia' is evidently important. So also are the cumulative advantages of localization. For only by intensive concentration of production in special areas is it possible to develop and utilize effectively the specialized labor market that is necessary. When plants are clustered in a shoe district, and especially in a single shoe city, a manufacturer knows he can secure on short notice a skilled employee for any position in his plant. Replacements then do not involve the wasteful interruptions of production that occur in isolated establishments. There is the case of a certain shoe manufacturer who some years ago removed from Lynn and set up in a New England country town. In a short time he was, as he expressed it, 'kicking himself' for the move, since he found that every time one of his skilled men was off the job the whole plant was retarded until the owner could make a trip to a large shoe center and, often with some difficulty, get a man to come out. Had the manufacturer stayed in Lynn, a telephone call would have had the new man on the job in a few hours.¹⁰

⁷ Bureau of Labor Statistics, Bulletin 483, *Conditions in the Shoe Industry in Haverhill, Mass., 1928* (Washington, 1929), p. 10.

⁸ Haverhill Board of Trade, *Haverhill, Massachusetts; An Industrial and Commercial Center* (Haverhill, 1889), pp. 133-134.

⁹ Entitled *Industrial Development in the United States and Canada*. The study, based on questionnaires sent to manufacturers, covered 1926 and 1927 only. See particularly pp. 20, 21, 24, and 70 for cases in point.

¹⁰ I am indebted to Professor E. F. Gay for this instance.

Some of the more intangible labor advantages of industrial concentration have been described by Alfred Marshall in these terms:

When an industry has thus chosen a locality for itself, it is likely to stay there long: so great are the advantages which people following the same skilled trade get from near neighborhood to one another. The mysteries of the trade become no mysteries; but are as it were in the air, and children learn many of them unconsciously.¹¹ Good work is rightly appreciated, inventions and improvements in machinery, in processes and the general organization of the business have their merits promptly discussed. . . .¹²

The seasonal character of shoe production in the style grades, mainly a consequence of rapid changes in fashion, naturally increases the advantage offered by a large labor market. The factory turning out a product requiring skilled labor is just the one that will find its production schedule subject to the greatest seasonal fluctuation, and hence will want to be in the midst of a large labor market where there is a reserve supply of operatives always available and where diversity of manufactures helps to some extent to equalize the supply and demand for labor over the year. Table 45 in Chapter XI gives an idea of the increase in seasonality of employment in recent years, and also of the greater seasonality in the production of women's shoes.

At every stage in the organization of the industry, except that of the individual craftsman, the labor of women and children has been utilized. Prior to the full development of the factory system, these were chiefly home workers, the employees of the early central shops being men only. The industry has thus relied in considerable part upon 'parasitic' labor.¹³

¹¹ Cf. Link, *Die Lederindustrie*, p. 76, note 2: "So ist man in Pirmasens [a leading German shoe center] der Ansicht, dass die Geschicklichkeit der Eltern sich auf die Kinder übertrage."

¹² *Principles of Economics*, 8th edition (Macmillan, London, 1925), p. 271.

¹³ I.e., the labor of those whose location is determined by their status as dependents of other workers, normally fully employed. It is essentially part-time female or child labor. See Rice, in *One Hundred Years of American Commerce*, vol. ii, p. 567; Bureau of Labor Statistics, Bulletin 180, *The Boot and Shoe Industry in Massachusetts as a Vocation for Women* (Washington, 1915), pp. 8-9; and Isaac Lippincott, *A History of Manufactures in the Ohio Valley to the Year 1860* (New York, 1914), p. 177.

Unlike some other industries, however, the making of shoes has never been very closely oriented to this type of labor supply.¹⁴ One reason is that when home work was important in the industry, work was not as seasonal as now. At present, though there are two annual peaks of employment, there is also strict discipline and control over hours of work. Home work had died out long before the N.R.A.¹⁵

The proportion of women in the industry gradually increased as the factory system developed, substituting electric power for muscle and machinery for certain sorts of skill.¹⁶ In the past thirty years there has been some shifting in the jobs assigned to men and women, but little change in the proportion of the sexes.¹⁷

The relatively high percentage of women in the shoe industry might seem to indicate that it would find its labor supply most easily in places where the other local industries employ more than the average percentage of men. In fact Mr. Perley Walker¹⁸ takes the view that the shoe industry is located with reference to a surplus ratio of female labor. I should question this, since the most skilled operations, in which trained labor is indispensable, are cutting, vamping, McKay and Goodyear bottoming, pulling-over, and lasting — all of which, with the possible exception of vamping, are characteristically male operations.

The proportion of female labor does seem to vary rather systematically in the industry according to localities and lines of work. It is highest, generally, in places where lighter shoes, and particularly women's shoes, are made. And undoubtedly the choice of what sort of shoes a factory is to produce depends some-

¹⁴ Cf. Richard Hartshorne, "The Economic Geography of Plant Location," in *Annals of Real Estate Practice*, Proceedings and Reports of Industrial Property Division, vol. vi (1926), p. 54. Jewelry, silverware, sporting goods, and celluloid articles are among the examples he mentions.

¹⁵ On some of its last vestiges, see *Industrial Home Work in Massachusetts*, Women's Educational and Industrial Union, Studies in the Economic Relations of Women, vol. iii (Boston, 1915).

¹⁶ See Bureau of Labor Statistics, Bulletin 180, pp. 9-10; also Census of 1900, vol. ix, p. 742.

¹⁷ Cf. National Industrial Conference Board, *Hours of Labor as Related to Output and Health of Workers — Boot and Shoe Industry* (Boston, 1918), p. 7.

¹⁸ *The Industrial Development of Kansas*, University of Kansas, Engineering Bulletin no. 12 (Lawrence, Kansas, 1922), p. 40.

what on the proportion of women to men available. Keir¹⁹ calls attention to the fact that in Lynn, in 1922, almost half the working force were women, while in Brockton barely a quarter were women. Lynn has always made women's shoes and Brockton men's shoes. This might indicate that the regional and local specialization in the shoe industry can be partially explained in terms of the antecedent industries in each locality and the proportions in which they use male and female labor.

Child labor has never been very important in the shoe industry, since so few of the operations can be efficiently performed by children, and also on account of restrictive legislation.²⁰

Thus far we have been considering primarily the technical position of labor in the shoemaking process, with the variations that have taken place in the character of the labor required. We turn now to an analysis of the development, in certain parts of the country, of a labor supply so fitted to these requirements as to have played a significant part in locating the industry.

One of the most elusive locational factors, and at the same time one of those most in evidence here, is that referred to by Hall as "the momentum of an early start."²¹ Historical retrospect is particularly important in industries like shoemaking, where transfer costs are a minor element; and it is worth our while to examine the conditions surrounding the start of the shoe industry in this country, in the Massachusetts Bay region of New England.²²

¹⁹ "Is Shoe Manufacturing Leaving New England?" *Boston Herald*, Sept. 23, 1922, p. 14.

²⁰ In 1929 the Census of Manufactures reported a total of 205,640 wage earners in the shoe industry, but gave no data as to their ages. The 1930 Census of Occupations reported 209,928 shoe factory operatives 10 or more years old, of whom 61 per cent were male and 39 per cent female. Operatives between 10 and 17 years of age constituted only 6.2 per cent of the total number.

In 1917 the National Industrial Conference Board (*op. cit.*, p. 7) estimated the working force of the industry to consist of 65 per cent men, 33 per cent women, and 2 per cent children.

²¹ F. S. Hall, "The Localization of Industries," in Census of 1900, *Manufactures*, Part 1, p. ccxii.

²² General references on the ground covered by the material in the next few pages are: W. M. Davis, *The Physical Geography of Southern New England* (New York, 1896); Ellen C. Semple, *American History and Its Geographic Conditions* (Boston, 1903); Malcolm Keir, "Some Responses to Environment in Massachusetts," in

The colonists who came to those shores in the seventeenth and eighteenth centuries did not, as did those of most of the other colonies, penetrate gradually westward by the best natural route toward the retreating frontier. For in New England there was no natural route westward. The settlers spread up and down the narrow coastal plain and up the north-south river valleys of the Merrimack, the Blackstone, the Thames, the Connecticut, the Naugatuck, and the Housatonic. For two centuries after the landing of the Pilgrims the best way of getting from Boston to Springfield was to sail east, round Cape Cod, then west and up the Connecticut. It is no wonder that the territory which could be considered as tributary to Boston has never extended much farther west than the Blackstone Valley.²³

Cut off in this way from access to any hinterland, the Massachusetts colony seemed to have meager prospects of economic development. Added to the natural handicap of land isolation were a severe climate with long winters, and, as the legacy of the glacial period, a jumbled surface of assorted rocks and gravel, with a drainage system consisting of small ponds, marshes, and crooked little streams interrupted by falls and totally unsuitable for navigation.

The New England settlers realized their disadvantages, but they also saw certain advantages which their colony possessed. For one thing, this part of the Atlantic coast was nearer to Europe than the other colonies were. Likewise, it had a valuable profile. It shelves off gradually, and offshore are vast areas of comparatively shallow water, covering the fishing banks. Fisheries have always been an important part of New England's activity, and

Bulletin of the Geographical Society of Philadelphia, July and October, 1917, pp. 121-138, 167-185; Malcolm Keir, "Some Influences of the Sea upon the Industries of New England," in *American Geographical Review*, May, 1918, pp. 399-404; Malcolm Keir, "Is Shoe Manufacturing Leaving New England?" in *Boston Herald*, Sept. 23, 1922, p. 14; J. J. Menzies, "The Localization of Industries," in *Popular Science Monthly*, February, 1890, pp. 454-460; A. P. Usher, "Comment se placent les usines: l'exemple des États-Unis," in *Annales d'Histoire Économique et Sociale*, October 15, 1929, pp. 524-550.

²³ See the map in Werner Gley, *Die Grossstädte Nordamerikas und die Ursachen ihrer Entwicklung*, Frankfurter Geographische Hefte, 1927, Heft 2 (Frankfurt a/Main, 1927), p. 24.

have in devious ways exercised an even more than proportionate effect on her other activities. To this day, more than nine-tenths of the population of the six states dwells within fifty miles of the shore.

Commerce and fishing were industries admirably suited to the situation of the early Yankees. And to the sea they turned, finding a better livelihood there than in trying to develop the rocky hills into farms. Where good harbors were scarce, however, as along much of the Massachusetts South Shore, there was no choice but to make the best of what the land offered. From the earliest days there was a sharp differentiation in character between the maritime North Shore and the agricultural South Shore, though both were tributary to Boston.

For shipping and shipbuilding a further advantage was soon evident. New England was thickly clad with forest. It was regarded as fortunate that the wood was largely pine, which was easily worked and transported, sufficiently strong, and much more buoyant than English oak or the hardwoods of the middle and southern colonies.

Since fish and timber were then available almost everywhere, the fishing and shipbuilding industries tended to be locationally 'passive.' That is, they followed the pattern of localization initiated by the concentration of commerce at the best harbors, and thereby intensified it. Natural environment favored the specialized development of the shoemaking and other industries in early New England by building up a large concentrated market on her coast and by encouraging her to develop to the full the commercial routes of the sea that united her to still other and potentially larger markets to the south and west. This natural environment also provided a large cheap labor supply for such industries as shoemaking.

This was the result of two factors: first, the rigorous climate, which left the rural population with time on its hands for many months in the year, and, secondly, the circumstances resulting in the growth of a large seafaring population, as explained above. The sailors and fishermen had wives and families ashore who were glad to earn a little extra money while the men of the house were

away. These two sources of labor — the seasonal labor of farmers and their families, and the part-time labor of sailors' families — were the basis of the shoemaking industry in eastern Massachusetts. It began as a complementary industry, or side line, and only later attained the status of autotelic manufacturing.

Transportation costs, especially overland, were very high, and we should therefore expect transfer costs on materials and product to have considerable locational influence. So far as materials were concerned, the situation was quite different from that of today. The only power used in shoemaking was the human hand, and leather was produced almost everywhere in sufficient quantity to supply the small needs of the shoemakers of that day. Power and leather supply, then, could be left out of account. Not so the location of the market. That indeed was the dominant factor, in the days when shoes went to market by ox-cart and sailing vessel.

Two historical tendencies, however, tended to increase the importance of labor costs relative to that of nearness to markets. First, the fall in costs of transportation brought distant markets nearer and made a given saving in production costs sufficient to compensate for a larger number of extra miles of haulage on the product. The increase in local densities of population, also, made it possible to reach a larger market within a given radius.

Secondly, there was the gradual building-up of 'shoe towns,' in which there came to be peculiar labor advantages merely because shoemaking had been carried on there for generations. All the children were brought up to know at least a little about the trade, and many of them looked to it for their future livelihood; local lore and tricks of the trade were accumulated and handed down from father to son. Shoemaking became a full-time trade and laymen no longer knew how to practice it save on the far frontier.

The increasing specialization of callings obviously increased the importance of differentials in labor costs. Not only could shoes be made more cheaply in a shoe town, but also there was likely to be better workmanship, more dependable delivery, and greater possibility of finding men suited to a particular kind of work who at the same time were free to undertake a job on short notice.

It is not surprising that division of labor in shoemaking should have begun in the eastern Massachusetts district. It is, however, accidental that it should have begun at Lynn. In 1750 a shoemaker by the name of Dagyr²⁴ settled there and set about trying to improve the processes of manufacture. He imported European shoes and dissected them to find out their good and bad points.²⁵ Furthermore, he instituted in his shop the elements of scientific management, by dividing the work into a series of separate operations and assigning each job exclusively to one or more workers. As a result of his structural studies and his rationalization of production methods, Dagyr's shoes topped all others in quality; and Lynn, hitherto just another of the North Shore fishing ports where the sailors' womenfolk made shoes, began to be noted for the quality of its product.

It should be remarked that these were women's shoes; partly because those who sewed the uppers were women and less suited to the heavy work involved in the manufacture of the men's boots and brogans of the day, and partly because in the old country Dagyr had been a specialist in women's footwear. Lynn to this day, with the whole North Shore district, continues this specialization; whereas the South Shore or Brockton district, where the work was originally done by farmers and later by ex-soldiers who had learned the trade in the Revolutionary army, has always made principally men's shoes.²⁶

Why, in the midst of all this, did Boston itself remain devoted to the selling rather than the making of shoes and leather? As a great center for the actual production of shoes, Boston is newer than Cincinnati and almost as much an upstart as Milwaukee.²⁷

Until the Civil War period, shoe manufacturing was carried on largely in homes, since most of the operations were hand work.

²⁴ Also spelled Dagys, Dagyn, and in several other ways. See Hazard, *Organization*, for mention of him.

²⁵ It is interesting to note that a little more than a century later the pioneer Chinese shoe workers in California were ripping apart *Massachusetts* shoes for the same purpose. *A History of the Shoe and Leather Industries*, ed. Charles H. McDermott (Boston, 1928), p. 221.

²⁶ See map on page 188, above.

²⁷ See Table 58, below.

The few processes that required supervision or special skill, or for which machinery had been devised, were done in the central shops or so-called factories. For the other operations the material was distributed to a large number of individual workers, each of whom labored at home and how or when he pleased.

Such a system of production, which was largely due to the lack of machinery to perform most of the operations, was obviously suited to a rural or semi-rural habitat. The Massachusetts shoe centers were dependent for their labor supply on the primarily agricultural and maritime populations of the surrounding countryside. Shoemaking was complementary to farming and fishing. The same was true in the district around Philadelphia, the only other place in America where the making of shoes assumed comparable importance in the early part of the nineteenth century.²⁸

Under such conditions, a location in the city of Boston was evidently not advantageous. The city people had regular full-time jobs, lasting the year through and leaving no time for complementary work on shoes. It was much easier to secure cheap labor by going outside of Boston, though not so far away as to be at a disadvantage in marketing the product.

As New England industry grew, and as agriculture there passed its peak of importance, there came to be a second supply of labor as well: cheap labor off the farms, prepared to put in full time in the factories now that agriculture no longer offered a sufficient livelihood. During the putting-out stage both of these forms of labor were utilized: full-time men workers in the central shop, full-time and part-time (complementary) workers in their homes.

From the first, of course, there began to develop a tradition of training and skill which became a labor advantage of a third sort, more and more important as the making of shoes became an art set apart from the ordinary household tasks. The division of labor in itself did not destroy the importance of practice; it increased it by localizing the manufacture and by raising the standards of workmanship.

²⁸ Keir (*Manufacturing*, pp. 453-454) says that until the Civil War the only shoe manufacturing for more than local markets was in these four districts, named in the order of their development: New England, Philadelphia, Northern New Jersey, New York City.

For at least a century, therefore, in New England (and the same holds good of the other old shoe-producing districts in New York, New Jersey, and Pennsylvania) there have been three main sources of labor:

- (a) Cheap complementary labor.
- (b) Cheap labor displaced from agriculture.
- (c) Skilled specialized labor in shoe centers.

From what has been said of the development of skill as dependent on long establishment and localization, it is evident that highly-trained labor is usually found only in shoe towns, and more especially in shoe cities. Isolated establishments scattered through the countryside, or town establishments 'putting out' their work to country people, have turned out a rather ordinary grade of footwear, or special types requiring only a low order of skill and little or no machinery.

The case of Haverhill epitomizes several stages in the development of the industry. The town was first a market place because of its favorable commercial situation at a crossing of the Merrimack, and later became a shoemaking center because it was a market place.²⁹ The New Hampshire farmers worked on shoes all winter and in the spring brought them to Haverhill to sell. Before long, farmers' sons began to settle in the city and make shoes for a living instead of struggling with the farm.

By the time of the Civil War the concentration of operations in factories was well under way in Haverhill. For some of the establishments, at any rate, the advantages of centralized and more mechanized and controlled production had come to outweigh the advantages of cheap country labor. But for many decades both the factory and the putting-out system flourished there side by side. The Board of Trade reported in 1889:³⁰

²⁹ Haverhill was a center only for the organizing and merchandising parts of the business and for the central-shop operations, including cutting, packing, etc. A large part of the actual work was not really localized there at all, before 1860, but attracted to the cheap complementary labor of the country around. Therefore we cannot say the industry as a whole was market-oriented.

³⁰ Haverhill Board of Trade, *Haverhill, Massachusetts: An Industrial and Commercial Center* (Haverhill, 1889), p. 135.

The Haverhill shoe industry has had to face the competition of country workmen and country factories. Large freighting wagons, every day or two, make trips up through New Hampshire taking materials to be worked up into shoes in the farmhouses. But the concentration movement is lessening the amount of country shoe work that goes on.

Such 'country workmen' and 'country factories' were the backbone of the industry in New Hampshire and Maine, more important historically than the centralized town industry that later developed at a few places such as Manchester and Auburn.

So long as the industry remained predominantly rural and was utilizing complementary labor on a large scale, it could not develop a trained labor supply as did the cities and large towns of Massachusetts and Philadelphia and New York. The attractions offered by Maine and New Hampshire were in the form of only moderately skilled but plentiful and cheap labor.

The character of the labor, as well as the local market, determined the sort of footwear made in these northern New England states. Boots and heavy work shoes predominated, with slippers and other easily-put-together articles also represented. To be sure, both states now have full-fledged shoe cities, Manchester and Auburn being the best known, in which a good grade of product is turned out; but only in the past twenty or thirty years have Manchester and Auburn made as much as a third of the total product of the two states. In the smaller towns most of the production remains medium- and low-grade.

The migration of shoe manufacturing from Massachusetts into New Hampshire and Maine is a topic that will concern us more directly in a later chapter. Except in so far as state laws are a factor, there is no essential difference between this migration and the movement from Massachusetts shoe cities like Lynn and Haverhill to satellite towns in Massachusetts. It should be noted that these movements seem never to be motivated by a desire for skilled labor, but always for cheaper or more docile labor.³¹ Even in the larger towns of Maine and New Hampshire, the claim is rarely made that the labor is of as high a quality as in centers like

³¹ As well as lower taxes, less restrictive laws, free rents, and other inducements.

Brockton, Lynn, or Haverhill. Cheapness is the big appeal. Still more is this so in the small towns and the country.

In the Midwest, which by reason of diverse natural advantages had a large agricultural population and at the same time great commercial and industrial cities, a still different relation of labor to the shoe industry resulted. There was not the same early concentration of the population in a string of cities as was caused in Massachusetts by the fact that it was the sea which primarily determined economic opportunities. The percentage of rural population in the Midwest remained large. On the other hand, this region developed the great cities which Maine and New Hampshire lack.

These differences were reflected both in the market, much more extensive, and in the labor supply, much more diversified than in Maine and New Hampshire. The original dominance of agriculture lasted relatively longer in the Midwest because the soil was better and there was more of it. The commercial nodality of certain sites in the region (Cincinnati, Louisville, St. Louis, Chicago) made possible the growth of important cities before the saturation-point for agricultural occupation had been approached. At a time when labor was so dear (in other words, when agriculture was making so strong a bid for workers) that manufacturing was regarded as out of the question, St. Louis was an important commercial city. Of Cincinnati and Chicago the same was true. It was not until well after the Civil War that shoe manufacturing centers at all comparable with the eastern ones began to appear in the interior of the country. Scharf, the historian of St. Louis, writes of that city in 1835:⁸²

The scarcity of capital and skilled labor, and the cheap goods supplied by competing communities elsewhere, prevented these essentially home manufactures (shoes, among other things) from establishing themselves in the city upon anything like a large scale, or one commensurate with the community's needs.

In pre-Civil War St. Louis, in fact, the idea was prevalent that the city could never be anything more than a distributing center.⁸³

⁸² J. T. Scharf, *History of St. Louis City and County* (Philadelphia, 1883), vol. ii, p. 1322.

⁸³ *Ibid.*

The first lines of manufacturing which began to be established there after 1845 were based on local markets and on raw materials which began to come in more regularly as the population in the tributary territory increased.³⁴ In 1870 St. Louis, though by that time the world's leading saddlery center, was not yet important in the making of boots and shoes.³⁵

By the time the Midwest got its start industrially, the handicraft stage was fast disappearing save in remote regions where transportation was difficult. The earlier establishments were organized mainly on the putting-out system, and very soon afterward on the factory system. Owing to its later development, therefore, the midwestern shoe industry was free to orient itself to labor rather than merely to market as it would have had to do fifty years earlier. What were the sources of the most advantageous labor supply in the region?

They were in the main two: the surplus of labor on the farms, and the labor markets of the large cities. The two differed not so much in character (both were sources of comparatively unskilled and cheap labor) as in potentialities. The manufacture of more difficult grades of shoes, as it gradually developed, tended to be restricted to the cities and perhaps to a few specially favored small towns where plants were early established.

It should be noted that the original labor disadvantage of the Midwest was the agriculture of the region, which offered so much better opportunities at first that it seemed impossible to start any factories.

One hindrance to industrial development in the Ohio Valley, 1830-1860, was the greater profits to be obtained by investment in land and by agriculture. Sometimes laborers and artisans who came in from the East followed their old calling, but more often they followed the most profitable calling.³⁶

But once the saturation point had been reached, this same agriculture proved an advantage. The advantage of location in a

³⁴ Isaac Lippincott, *A History of Manufactures in the Ohio Valley to the Year 1860* (New York, 1914), p. 147.

³⁵ Clark, *History of Manufactures*, p. 131.

³⁶ Lippincott, *op. cit.*, p. 194.

region of agricultural surplus and consequent low living costs, discussed in Chapter IV, is not so important for the shoe industry as for some others using less specialized types of labor. None the less, there is a certain interdependence between wage scales for unskilled and skilled labor. The barriers between 'non-competing groups' were not impermeable in nineteenth-century America.

The shoe industry may be said to have gotten its real start in the midwestern cities on a factory basis in the two decades following the Civil War. We find Milwaukee, Detroit, Chicago, and other cities mentioned as having begun to manufacture shoes on a large scale in the '60's.³⁷ By 1866 Chicago was definitely on the map as a shoe center. Cincinnati seems to have anticipated Chicago a little in this, as she did in her career as a packing center and interior metropolis, whereas remoter St. Louis lagged a few years behind and had to catch up later.³⁸

In Rochester also, the shoe industry took a sudden start in the '60's. No one seemed to know exactly why. The Chamber of Commerce itself, in a booklet published in 1884,³⁹ confessed that it saw no precise reason, and pointed vaguely to water power, the most obvious of Rochester's advantages at that time. But we know better than to ascribe much importance to power as a factor influencing the distribution of the shoe industry. To get at the more probable reasons for the intensive development of the manufacture in Rochester, as well as in Milwaukee and certain other cities, we must go back a step and consider what the previous history of those cities had been. Was there anything in that previous history which made certain cities better fitted than others for the growth of shoe manufacturing?

A clue is furnished by Professor Hartshorne, who lists five factors as determining the efficiency of skilled labor in any locality.⁴⁰ One of these, not so far considered, is the racial composition of the labor supply.

³⁷ Clark, *op. cit.*, pp. 33, 131, 188.

³⁸ Charles Cist, *Sketches and Statistics of Cincinnati in 1859* (Cincinnati, 1859), pp. 175-179; also Lippincott, pp. 176-177.

³⁹ *The Commerce, Manufactures, and Resources of Rochester* (Rochester, 1884), p. 30.

⁴⁰ Richard Hartshorne, "The Economic Geography of Plant Location," in *Annals*

The immigration that we should expect to have an effect on the labor supply of the period just following the Civil War was, in the main, Irish and German. The Irish were poorer and less educated, and tended to go into manual trades of a low degree of skill such as bricklaying, street labor, and railroad and building construction; while the Germans were of a more promising type, with a large proportion of skilled workers.

A recent investigation of the wave of German emigration tends to refute the idea that it was merely a reaction from the political disturbances of 1848.⁴¹ The principal cause seems to have been an agricultural crisis in districts of small holdings in southwestern Germany. But the Germans who came to this country, though they pushed farther west than the Irish,⁴² did not all engage in farming by any means. They seem to have been especially trained in certain trades such as printing, chemical industries, photography, optical and scientific instrument making, brewing, pharmacy, and, last but not least, the tanning and working of leather.⁴³ Where the Germans went, they carried tanning and shoemaking with them. Where, then, did they go?

The cities in which there has been a conspicuous German element are Milwaukee, Cincinnati, St. Louis, Chicago, Rochester, Philadelphia, and New York. Of these the two last named were already shoe centers at the time of the immigration of the '50's, so the German influx merely strengthened their attraction as labor and leather centers. But Milwaukee, Cincinnati, St. Louis, Chicago, and Rochester constitute the nuclei of all the important shoe

of *Real Estate Practice*, Proceedings and Reports of Industrial Property Division of National Association of Real Estate Boards, vol. vi (1926), p. 54. See also Herman Feldman, *Racial Factors in American Industry* (New York, 1931).

⁴¹ Marcus L. Hansen, "The Revolution of 1848 and German Emigration," in *Journal of Economic and Business History*, August, 1930, pp. 630-658.

⁴² The farther westward spread of the German immigrants as compared with the Irish is well shown by two maps in the Census of 1870, vol. i, between pp. 326 and 327.

⁴³ In 1870 the German-born in the United States, though making up only 8.5 per cent of the total population, contributed 25.9 per cent of the boot and shoe makers. This is computed from data in Census of 1870, vol. i, pp. 705, 711. See also what Clark has to say of the importance of Germans in the leather industry in his *History of Manufactures*, p. 465.

districts in the United States that have arisen during the past century. A glance through the pages of a trade directory where the tanners and shoe manufacturers of those cities are listed will show that the names are to a large extent still German, sixty or seventy years after the establishment of the industry there.

But we have not explained very much unless we can offer a plausible reason for the resort of the Germans to those particular cities. Once they had started to develop their special lines of business there, other incoming German immigrants would naturally have flocked to the same cities in search of work and *Gemülichkeit*. A reason for the original choice on the part of the first immigrants of the '50's is what is so far lacking.

Mr. Harold S. Kemp of Harvard University has given me some indications with particular reference to Rochester. He writes as follows:

In my younger days, the cobblers in the middle west were always Germans — I recall the difficulty of making them understand what was wanted, even. Shoes may well have developed in Rochester as a result of a large German population. Lenses may have — quite probably did — develop there for the same reason.⁴⁴ . . . I should say that any development in Rochester which is based on a German population has just this much geography in its location; that the Germans went to those cities which, in 1849 and afterwards, were decidedly on the make, offering best chances of work and growth. Most of those cities lay westward at that time — Cincinnati, Milwaukee, St. Louis, etc. Rochester, with its flour, seems to have been the remote eastern outlier of this group. Had the German influx come a few years later, I think few of the Germans would have been tempted to stop in that city.

The German emigrants were not 'starved out' from their European homes quite so drastically as the Irish. Many of them left for political reasons, and some of those who did not still had savings. Consequently they were not forced to settle in the seaboard cities where they landed, but could and did look around for the most promising places to start their new careers. The Midwest in the '50's was a promising region to make fortunes in, and certain cities especially. Cincinnati was nearing her apogee but still

⁴⁴ Rochester has long been a leading center for the manufacture of scientific instruments. Soon after the Civil War it became a very important brewing center.

going strong; Rochester, Chicago, St. Louis, and Milwaukee were growing about as rapidly as at any time in their history, and faster than most other cities. So the Germans betook themselves there in force. Examination of data for chief American cities shows a strong association between a high proportion of German-born in 1870 and subsequent prominence in the shoe industry. All important shoe centers outside of New England and Philadelphia had in 1870 at least 12 per cent of German-born, or nearly three times the proportion for the country as a whole.

Enough has been said to indicate the great importance of German immigration in determining where the shoe industry was to get its start outside the older districts. Other occasional factors also influenced the outcome, of course. One was the distribution of army contracts during the Civil War. Partly because so many shoemakers had been recruited from New England and elsewhere into the ranks that the suddenly enlarged demand for footwear could not be met by the older districts, and partly in order to keep western business men happy and loyal, a considerable part of the army orders was given to shoe firms in Chicago, Detroit, St. Louis, and other interior cities. Much army saddlery was also ordered from St. Louis.⁴⁵

Various other factors combined to make the '60's and '70's the time of a spectacularly rapid expansion of the shoemaking industry to the Midwest. The invention of machinery (first and foremost the McKay machine) about this time made the quality of labor less of a problem than ever before, and so allowed the Midwest to consider shoe manufacturing as a practical undertaking. At the same time the new machines were ingeniously prevented from overburdening the small factory-owner with capital charges, which the Midwest could not have borne as well as the East, by Colonel McKay's idea of leasing rather than selling the principal machines. Railroads were enlarging the markets for the Midwest, and in so doing were encouraging the cattle industry and thus bringing into being a plentiful local supply of leather.

⁴⁵ Clark, p. 131. The demands of the southern market after (perhaps even during?) the war brought prosperity and growth to the Baltimore shoe industry in the '60's (*ibid.*).

All these reasons worked together in the '60's and '70's to get the shoe industry started in the Midwest.⁴⁶ Once started, the industry grew steadily there. Nothing hindered it save its newness, and each successive year lessened that handicap.

Just as in Maine and New Hampshire, the sort of labor available helped to determine the kind of shoes made during the first decades. The bulk of the midwestern labor was untrained, so the product consisted largely of heavy work-shoes requiring only a moderate degree of skill. The predominantly rural market and the kind of materials most advantageously available both pointed to that same grade of production. Only by stages did the Midwest work up to a more general line. For some of the overseeing and key jobs, of course, labor had to be moved in bodily from the East, and this was a handicap. But it was considered worth while to do it, and in some cases the whole crew was imported.

Interviews with shoe men tend to confirm the impression that the migration of the shoe industry is fairly analogous to what has been taking place in the cotton textile industry, to mention only a single example.⁴⁷ The non-staple lines, which change in style rapidly and need to be made near the style centers and the metropolitan markets by skilled workmen, tend to cluster in the older centers of the industry and in those with the easiest access to urban markets.⁴⁸ The staple lines, however, susceptible to mass production by labor of moderate skill and less affected by the necessity of changing styles every few months, are freer to move and scatter in response to the pull of cheaper or more docile labor or other local production-cost advantages.

There is evidence to the effect that the quality of *materials* used was better in the West than in the New England states in the period before 1893,⁴⁹ and this should not be surprising when we

⁴⁶ Most of the pioneer midwestern shoe enterprises were founded by New Englanders. See McDermott, *A History of the Shoe and Leather Industries*, p. 215.

⁴⁷ See Hermann Schumacher, "Die Wanderungen der Grossindustrie in Deutschland und in den Vereinigten Staaten," in *Schmollers Jahrbuch*, 1910, pp. 480-481.

⁴⁸ To the extent that the older shoe centers lost their advantage with respect to market the style factor may have a decentralizing effect, interregionally; but within a given district it furthers concentration, for reasons involving both market and labor.

⁴⁹ *Boot and Shoe Recorder*, March 24, 1886, p. 1631; cited by Clark, p. 472.

remember that durability was the watchword of the West and style was that of the East. The kind of women's shoes made in the small factories of the Massachusetts North Shore or Brooklyn are intended to wear only a few months, and there is consequently no need to use expensive materials. It is perhaps surprising, but true, that it requires more highly skilled labor to work with cheap inferior leather than with the better grades.⁵⁰

So far as staples were concerned, there was a steady westward migration beginning soon after the Civil War, which just about kept pace, as we have seen in the previous chapter, with the westward movement of the center of population. The influence of markets was predominant. Few of the eastern centers underwent any absolute decline in their production.

In the course of time the new centers built up their own complexes of auxiliary industries; their own bodies of specially-trained labor; their own trade secrets; their own local traditions and reputations. They then became able to compete with the older districts even where style goods were concerned, in so far as they had equally good access to markets and fashion sources.

⁵⁰ I am indebted to Mrs. George W. (Blanche Hazard) Sprague for calling my attention to this fact.

CHAPTER XIV

LABOR ORGANIZATION

MANY of the characteristics of the shoe industry are conducive to the growth of unions. For one thing, the labor employed is of a relatively high order of skill, not easily replaced from outside the industry, and not subject to competition from the masses of the unskilled. Partly for this reason, we have seen, the industry has been localized. Shoe operatives were massed by thousands in a few cities, in some of which they formed a considerable part of the population. The 'shoe town,' like the mill town, has been a familiar phenomenon in the northeastern part of the United States and especially in New England. Localized industry, specialized labor, and union organization go naturally together. Another factor favorable to organization was the tardiness of the industrial revolution in shoemaking, which means that even today something remains of the craft tradition of the shoemaker, so recently reduced to the status of wage worker.¹

The prevalence of small establishments would seem likewise to favor union organization by reducing the bargaining power of the individual employer. But on the other hand, the slim resources on which the employer operates in some branches of the industry, and the fact that his factory and machinery are often rented, means that if labor's demands become too drastic he will go out of business rather promptly, perhaps to bob up again as a new firm. These branches of the industry are highly elusive to the labor organizer.

Union organization in the industry dates almost from the first separation of employee from employer. Philadelphia, the original center of high-grade shoemaking, had a succession of wage-earners' organizations from as early as 1792, constituting a real force to be reckoned with by the employers.² But before the Civil

¹ Cf. *Commonwealth History of Massachusetts*, ed. A. B. Hart, vol. v, p. 378.

² Augusta E. Galster, *The Labor Movement in the Shoe Industry* (The Ronald Press Company, New York, 1924); John R. Commons and associates, *History of*

War there seems to have been little or no union activity outside of Philadelphia, New York City, and a few New Jersey towns. The New England cordwainers of the period were unorganized and much worse paid than those of the Middle Atlantic district.³

In 1835 Philadelphia shoemakers publicly complained that the Eastern States, meaning Massachusetts, did not do shoemaking as well as they, and charged less. This was probably true in all its order and sale work aside from its regular private custom work. New England was specializing then in brogans and cheap shoes for women. The Philadelphia shoe industry always made the highest grade shoes with skilled German workers. Boots were never made save as custom work. Those workers probably felt about Massachusetts shoemakers then as our Lynn and Brockton union shoemakers feel about the non-union workers in Maine today.⁴

Not till the introduction of the McKay machine in the '60's had put the industry on a real factory basis and threatened the aristocracy of skilled shoemakers was there a really nation-wide organization movement. By the end of the '60's, shoe machinery had been made thoroughly practical, so that a comparatively untrained workman could turn out nearly as good a product by machine as the ordinary journeyman shoemaker could by hand. With the perfecting of the McKay machine, 'green hands' became a real threat to the wages of the skilled workers in the industry. Even manufacturers who did not use the new sewing machines had to cut wages in order to stay in the business in competition with those who did.

This was the stimulus to the organization of the nation-wide order of the Knights of St. Crispin, in 1867. Shoemakers have always been proud of the traditions of their craft, and its lore of the patron St. Crispin was capitalized in the name and ritual of the society, which purported to be a descendant of the sixteenth-century Order of St. Crispin. Members were sworn to keep the 'secrets of the Lodge.'⁵

Labor in the United States (New York, 1918), vol. i, p. 108; *A Documentary History of American Industrial Society* (Cleveland, 1910), vol. iii, pp. 36, 37, 93.

³ Hazard, *Organization*, p. 142 and note; Galster, p. 29.

⁴ Hazard, *Organization*, p. 144, note 1.

⁵ Hazard (pp. 143-156) gives the best connected account of this organization.

The membership of this picturesque organization is said to have reached 50,000 at its maximum in 1870, about 40,000 of these being in Massachusetts.⁶ The fact that a Massachusetts man, Newell Daniels, had founded the organization⁷ was no doubt partly responsible for the degree to which it was concentrated in that state, but it must be remembered that the shoe industry itself was much more localized in New England in 1870 than it had been before the War, and also that Massachusetts was ceasing to be exclusively devoted to cheap staples.

The chief weapon of the Crispins was the strike. A wave of labor disturbances swept through the Massachusetts towns as the union gained in strength, culminating disastrously in the North Adams strike of 1872. This was ended by the importation of 107 Chinese strike-breakers from California, thus serving as a dramatic demonstration that

even a Chinaman who understood not a word of the English used by the foreman in the factory, who knew nothing of the processes of shoe-making, could turn out a satisfactory piece of work by using his eyes and imitating motions which he might or might not understand. When the threat of using Chinese labor with none of the boasted Yankee ingenuity was made by manufacturers and carried out by Sampson, of North Adams, it was an overwhelming surprise, a crushing answer to the arguments of Massachusetts boot and shoe workers that shoemakers had to be men of skill and highly intelligent.⁸

The business depression of the '70's, following upon this defeat, and aided by weakness in the financial organization of the Knights, led to this union's rapid decline and to its final dissolution in 1874.⁹ "Neither manufacturers nor non-members of the order took the organization, or its demands, very seriously,"¹⁰ and its locational influence during its brief span of life must have been small.

The chief other sources, especially D. D. Lescohier, *The Knights of St. Crispin* (Madison, Wis., 1910), are cited in her bibliography.

⁶ Lescohier, pp. 7-8; Hazard, *Organization*, p. 147.

⁷ Hazard, *Organization*, p. 145.

⁸ *Ibid.*, p. 143.

⁹ *Ibid.*, pp. 150-153; N. S. B. Gras, *Industrial Evolution* (Cambridge, Mass., 1930), p. 219.

¹⁰ Hazard, *Organization*, p. 153.

The Knights of Labor came on the scene just as the Crispins were passing off, and the shoe workers' part of this new organization had its main strength, as the early shoe unions had, in Philadelphia.

The shoe industry of Philadelphia was the first industry in any city to have 100 per cent organization in the Knights of Labor. In 1884, that city had eleven local assemblies in the shoe industry.¹¹

Philadelphia's prompt organization was a locational disadvantage so long as other centers remained unorganized. It was reported about 1885 that "Gardiner, who had one of the largest and best factories in Philadelphia, had moved to New York because he could get work done cheaper there."¹² But this situation did not long continue. A famous organizer, Harry Skeffington, was sent up from Philadelphia, and in a few weeks he had the shoe workers of New York and Brooklyn enrolled in the Knights of Labor.¹³

Through the influence of Harry Skeffington, there eventually arose from the ranks of the Knights of Labor a new national union, the Boot and Shoe Workers, which became and still is affiliated with the American Federation of Labor. This organization was not firmly on its feet until after the Rochester Convention of 1899, at which was established the principle of highly centralized control which has governed this union ever since and probably has had much to do with the conservatism of its policies.¹⁴ The Boot and Shoe Workers have always put their main efforts into persuading as many manufacturers as possible to sign the Union Stamp contract, which establishes a closed shop, but gives the employer the right to hire and fire individual union members, use the Union Stamp on his product, and be free from labor troubles as long as the agreement is in force. This union does not invite the adhesion of independents and has even been accused of 'scabbing' their strikes;¹⁵ for itself, it renounces the strike; its attitude

¹¹ Galster, p. 53.

¹² *Ibid.*, p. 57.

¹³ *Ibid.*

¹⁴ Galster, chapters v-vii; Clara Katzor, "Shoemaker's Story," in *American Federationist*, August, 1929, pp. 978-979.

¹⁵ Galster, p. 174. At the 1919 convention the General Executive Board of the Boot and Shoe Workers' Union said, "We claim that we have a perfect right to assume that this organization is the only organization that has any right to receive shoe makers as members." *Ibid.*, pp. 176-177.

toward existing local differentials in wages and hours is mainly passive. Among less conservative unionists it is regarded as 'yellow.' It is very doubtful, therefore, if the Boot and Shoe Workers have much affected the location of shoe factories.

Of a different character are the various 'progressive' unions born of secessions from the Boot and Shoe Workers, and continually merging and seceding among themselves. The Shoe Workers' Protective Union was formed in this way in 1899, by some Haverhill workmen who disliked the autocratic policy established at the Rochester Convention, and the United Shoe Workers arose in 1909 from another split. Both of these had their main strength on the Massachusetts North Shore, though the United also had some locals in the larger cities outside New England. Both represented a decentralized type of organization, sharply contrasting with the Boot and Shoe Workers; and both were more uncompromising in their tactics, putting their faith in strikes rather than in arbitration. In 1924, the United Shoe Workers was absorbed by the Shoe Workers' Protective, and in 1934 came a further merger resulting in the formation of the United Shoe and Leather Workers' Union as the second largest organization in the industry.¹⁶ At about the same time, still another secession from the Boot and Shoe Workers, involving the whole South Shore, created the Brotherhood of Shoe and Allied Craftsmen in that district.

It is difficult to get accurate information on the extent of union organization in the industry. The numbers stated by union officials are usually optimistic; but on the other hand, the number of dues-paying members understates the importance of the organization, because there are usually thousands who are registered with the union but are not paying dues because temporarily unemployed. For example, the United Shoe and Leather Workers' Union at the beginning of 1936 had only 17,000 members in good standing, but registered the names of about 30,000 more as potential dues-payers.¹⁷ 'Open-shop' employers are naturally as

¹⁶ Not all of the members of the Shoe Workers' Protective joined the new union. A sizable rump organization still exists under the old name.

¹⁷ Information provided by George A. Wilson, General Secretary-Treasurer, April 9, 1936.

eager to understate the importance of unions as the union officials are to overstate them.

As a result there is a startling range of variation in estimates. I have reproduced in Table 55 the figures given by Professor Leo

TABLE 55
MEMBERSHIP OF CHIEF AMERICAN BOOT AND SHOE WORKERS' UNIONS,
1897-1923¹

Year	Boot and Shoe Workers ²	Boot and Shoe Cutters ³	Shoe Workers' Protective ⁴	United Shoe Workers ⁵
1897	12,500	2,500
1898	9,400	2,500
1899	4,300	2,500
1900	4,700	2,500
1901	8,800	2,500
1902	14,600	2,500
1903	29,700	2,500
1904	32,000	2,500
1905	32,000	2,500
1906	32,100	2,500
1907	32,000	2,500
1908	32,000	2,500
1909	32,000	2,500
1910	32,500	2,200	2,500	4,500 ⁴
1911	32,700	1,500	2,500	8,900 ⁴
1912	33,300	1,500	2,500	15,200 ⁴
1913	34,300	700	2,500	14,400
1914	38,100	700	2,500	14,000 ⁴
1915	35,600	2,500	12,000
1916	39,000	4,000	15,000
1917	39,600	10,000	20,000
1918	35,800	10,000	23,000
1919	36,800	18,000	39,000
1920	46,700	18,000	33,000
1921	41,000	18,000	25,000
1922	40,200	20,000	22,000
1923	39,900	26,000 ⁵

¹ Leo Wolman, *The Growth of American Trade Unions, 1860-1923* (Publication No. 6 of National Bureau of Economic Research, New York, 1924).

² Reports of American Federation of Labor.

³ Union figures, except as otherwise noted.

⁴ New York Labor Bulletin.

⁵ Amalgamated with the Shoe Workers' Protective Union.

Wolman, which run through 1923. In 1932, according to Daugherty, the Boot and Shoe Workers had 17,000 members and the Shoe Workers' Protective 13,000; these two major unions together included then about one-sixth of the workers in the industry.¹⁸ In 1934, when the United Shoe and Leather Workers' Union was formed, it claimed a membership of 60,000, made up as follows:¹⁹

Shoe Workers' Protective Union (Haverhill and vicinity)	30,000
National Shoe Workers' Union (Lynn)	22,000
Shoe Workers' Union (Salem)	2,000
Shoe and Leather Workers' Independent Union (New York) . . .	6,000
	<hr/>
	60,000

These estimates should be regarded as maxima; so also should the following:

The employees of the industry are (1934) well organized, five unions claiming membership among the employees. Of the approximately 190,000 workers at present employed in the industry at least 50% are members of one of the five unions, and the number that can be influenced by the action of the unions is considerably larger. The unions are the strongest in Massachusetts where it is estimated approximately 75% of the employees are organized. The organization of employees gained considerably under the NRA, but the extent of such additional membership has not been accurately determined.²⁰

A figure of 50 per cent would certainly be too high for 1936. The most careful estimate of present memberships that I have been able to find is the following:²¹

Boot and Shoe Workers	25,000
United Shoe and Leather Workers	17,000
Brotherhood of Shoe and Allied Craftsmen	10,000
Shoe Workers' Protective	3,500
American Shoe Workers	1,200
	<hr/>
	56,700

¹⁸ Carroll R. Daugherty, *Labor Problems in American Industry* (Boston, 1933), p. 457.

¹⁹ Maxwell Field, *An Industrial Relations Program for the Massachusetts Shoe Industry* (typewritten thesis, Amos Tuck School of Administration and Finance, 1934), p. 47.

²⁰ Joseph Brodinsky, typewritten report, *Boot and Shoe Manufacturing Industry* (Washington, 1935), p. 3.

²¹ Information provided by George A. Wilson, General Secretary-Treasurer of the United Shoe and Leather Workers' Union, April 9, 1936.

The average number of wage earners employed in the shoe industry in 1935 was about 197,600, of which the approximately 56,700 organized would constitute a little less than 29 per cent. This is probably a reasonably accurate estimate of the actual status of union membership, and is a decidedly higher percentage than one would find in most other industries. Daugherty calculates that the percentage of workers organized in American manufacturing as a whole was as follows:²²

1910.....	11.6
1920.....	23.2
1930.....	12.5

At the same time he estimates the percentage for the shoe and leather industries together as:

1910.....	14.6
1920.....	29.4
1930.....	17.9

For the shoe industry alone the figure would certainly be higher, because only a very small proportion of the tannery workers were organized.

We are here interested mainly, of course, in the geographic distribution of union strength. Little information is available even as to the number of members in different states and cities, and numbers are but one of many factors determining bargaining power and labor costs. In his *Growth of American Trade Unions*, Professor Wolman recognized the need for investigation along geographic lines, but up to the present time (July, 1936) nothing has come to my attention beyond the rather sketchy materials presented in the following pages.

One useful historical cross-section is found in the report of a special committee of Haverhill shoe men who in 1921 made the rounds of the half-dozen largest shoe centers in order to compare wages and labor relations with those existing in Haverhill.²³ They

²² Carroll R. Daugherty, *Labor Problems in American Industry* (Boston, 1933), p. 502. Figures for 1910 and 1920 are based on Leo Wolman, *The Growth of American Trade Unions, 1860-1923* (New York, 1924), appendix, tables vi and vii.

²³ *Haverhill Evening Gazette*, extract: "Report of the Visit of the Special Industrial Commission from Haverhill to Rochester (and other cities), planned principally for

found Brooklyn and Rochester, both of which are quality and style centers, the most strongly organized, with nearly 100 per cent union men employed. In Brooklyn, where the American Shoe Workers' Protective Union and the United Shoe Workers had a tight grip, wages were definitely high and hours were only 44 per week (Haverhill was then on a 45-hour basis). In Rochester, there was not quite a closed shop, but a working arbitration agreement and wage rates about as high as in Haverhill. Labor relations were reported excellent.

Cincinnati was reported almost 100 per cent unionized, but by the moderate Boot and Shoe Workers' Union, so that labor was not exercising as great a measure of bargaining power as in the aforementioned centers. Wages were somewhat lower than in Haverhill, and hours longer, but comfortable relations existed.

In St. Louis, again, most of the workers belonged to the Boot and Shoe Workers, and their bargaining position was described as weak.

Unionism is not generally favored by the business men. Many classes of workers are entirely unorganized. There are occasional strikes and agitation, but conditions have been restored *satisfactory to the manufacturers*.²⁴

Philadelphia, which was not visited by the Haverhill group, would seem to come about here in order of union strength. Organizations there were still making slow headway against the anti-union tradition established by a successful smashing campaign in 1887.²⁵

In Chicago, organization was weaker still, with only three factories organized and those by the Boot and Shoe Workers. There and to a still more complete extent in Milwaukee, the employers were in control, and wages were relatively low. "The city is an unhealthy place for trade unions in general," was the comment about Milwaukee.

data to be used as one of the bases for all wage adjustment in Haverhill," May 1, 1921 (typewritten copy in Baker Library of Harvard Graduate School of Business Administration, Boston).

²⁴ *Ibid.* (italics mine).

²⁵ Galster, pp. 64 ff. "Since that time (1887) no labor union has received recognition from the Shoe Manufacturers' Association." *Ibid.*, p. 65.

The distribution of union strength indicated by these reports of the Haverhill commission has probably not changed very markedly since 1921. For more recent dates, we have the state-by-state distribution of the locals of the chief unions, as tabulated by the Bureau of Labor Statistics (see Table 56). This table shows the extent to which union organization is concentrated in New England and primarily in Massachusetts.²⁶ The midwestern shoe states, on the other hand, have very few locals of either of the progressive unions.

The strength of union organization varies markedly not only from district to district, but also between towns in the same district. It is natural that it should tend to be strongest where the industry has been the longest established, where many factories are in close proximity, and where the nature of the product requires highly skilled labor. All these factors would help to account for the higher degree of organization in the cities and specialized shoe towns and the almost complete absence of it in the smaller one-factory towns of the Midwest.

Perhaps a less obvious factor is that of styles. When patterns are changing frequently, the fixing of piece rates (the predominant method of payment in the shoe industry²⁷) becomes highly complex. There is endless scope for higgling over the hundreds of rates that may be involved at any one time, and much to be gained by

²⁶ It should be noted that the table does not take account of the Brotherhood of Shoe and Allied Craftsmen, the largest purely local union in the industry, which has about 10,000 members in the Brockton district. Cf. also, Boston Chamber of Commerce, *New England's Industrial Supremacy* (1921), p. 16: "In 1908 organized shoe workers represented approximately 43 % of the [shoe] workers in the state, but in 1921 this had increased to 93 %."

²⁷ On methods of wage payment see Bureau of Foreign and Domestic Commerce, Domestic Commerce Series, no. 28, *Industrial Structure of New England* (Washington, 1930), pp. 426-427; Boston Chamber of Commerce, *The Shoe Manufacturing Industry of New England* (Boston, 1925), p. 15; National Industrial Conference Board, Research Report, no. 7, *Hours of Work as Related to Output and Health of Workers — Boot and Shoe Industry* (Boston, 1918). The last-named source estimates the percentage of piecework payment at 70, running somewhat higher in New England and in the making of women's shoes. An estimate of 85 per cent appears in National Recovery Administration, Division of Review, *Final Report of Survey Committee on the Operation of the Code for the Boot and Shoe Manufacturing Industry* (Washington, 1935), p. 14.

aggressive bargaining. This is less true when the factory is making a staple article, the operations remaining standard for months or years on end and the bargaining margin reduced by close price competition.

TABLE 56
DISTRIBUTION OF LOCALS OF THE CHIEF NATIONAL BOOT AND SHOE UNIONS
BY STATES, 1929 AND 1935¹

	1929		1935		
	Boot and Shoe Workers	Shoe Workers' Protective	Boot and Shoe Workers	Shoe Workers' Protective	United Shoe and Leather Workers
Massachusetts	53	28	22	28	36
New York	8	7	15	7	4
Missouri	3	7	14	9	1
Illinois	11	2	18	3	1
New Hampshire	6	2	4	2	5
Wisconsin	6	..	16	1	..
Ohio	8	..	12	..	4
Maine	2	..	4
Pennsylvania	4	2	3	..	1
Tennessee	1	..	2
Maryland
Indiana	1	..	3
New Jersey	2
Other states	17	..	22

¹ Bureau of Labor Statistics, Bulletin 506, *Handbook of American Trade Unions*, 1929, and letter from Dr. Isador Lubin, Commissioner of Labor Statistics, March 5, 1936. The states have here been arranged in order of value of shoes produced in 1933.

Another effect of styles, as noted in a previous chapter, is to accentuate the seasonal variation in production and to put an added premium on speed. This evokes two natural reactions from the employee: in the first place, he seeks to get a higher piece rate or hourly rate in order to compensate for the large amount of seasonal unemployment,²⁸ and in the second place he soon perceives

²⁸ "A common rule in organized centers . . . is that manufacturers cannot make seasonal layoffs but must divide what work there is among the workers. But that means that during a large part of the year everybody will be working on part time. The workers then demand higher wages on the ground that otherwise their yearly earnings will be inadequate. Consequently wage rates tend to be fixed on the basis of part time work, resulting in higher costs and ultimately still less work." Boston Chamber of Commerce, *New England's Industrial Supremacy* (Boston, 1921), p. 18.

" . . . the union leaders, when they negotiate for a wage agreement, base the wage

that the semiannual rush season is a strategic time to present demands to the employer. The latter does not want to risk cancellation of his orders and may be forced to give in.

Thus in style centers labor has much to gain by collective action. Perhaps even more to the point, it has much to lose by not acting collectively, for the factors mentioned in the previous paragraphs work both ways. The complexity of wage-bargaining gives scope to the chiseling employer just as much as it does to the grasping unionist. The wastes of seasonal production spur the employer just as much as the employee to find ways to increase his share of the receipts of the business, and if at the rush seasons the employer is at the union's mercy, in the off seasons it is he who has the less to lose by a stoppage.

In places specializing in style shoes, then, we should expect to see wages and working conditions more subject to bargaining, and divergence of interest between employer and employee more marked. History bears us out, so far as the data go. Philadelphia was the early style center of the industry, and became organized more than a generation earlier than New England. For the past several decades the leading districts for style production have been eastern Massachusetts, Rochester, and New York City, which likewise seem to be the places most thoroughly unionized. Cities and districts devoted to the production of relatively staple lines (such as most of the Midwest and the smaller towns of northeastern New England) are organized either not at all or in a relatively innocuous union.

The shoe industry as a whole is not preponderantly an urban one, for a good half of the wage earners are employed in places of less than 20,000 inhabitants.²⁹ In view of the great advantages of

scales on allowances for seasonal employment, in an effort to assure their men a fair annual income." Maxwell Field, *An Industrial Relations Program for the Massachusetts Shoe Industry* (1934), p. 17.

²⁹ From statement of Frederick A. Miller, President of the National Boot and Shoe Manufacturers' Association, at public hearing before N.R.A. on "Migration of Shoe Factories from Massachusetts," January 29, 1935. The figures were stated to be "taken from reports, assembled and tabulated by the Bureau of the Census, acting for the Planning and Fair Practice Committee for the Shoe Manufacturing

localization and urbanization, discussed in previous chapters, this indicates that some definite decentralizing influence must be at work.

Costs of living average higher in the larger places, and this provides a partial explanation of the higher wage rates that prevail there. The National Industrial Conference Board estimated that the average cost of living (1927) in cities of 20,000 to 250,000 population is 2.7 per cent less than in cities of more than 250,000 population, while for places of less than 20,000 the differential is 8.9 per cent.³⁰ Such differentials evidently have some importance in keeping the manufacture of cheap staples out of the big cities, but they do not indicate the full range of variation in wage rates, some idea of which is given in Table 57.

The wide differences here are due largely to differences in union bargaining strength, which depends more upon the number of shoe factories in the town (i.e., the degree of localization) than upon the size of the town. On account of the complexity of the piece rate system it is very difficult to get a fair comparison of wages in different factories or at different times, but some careful investigations carried on by a person with much knowledge of the industry³¹ have shown that labor costs often vary by as much as 25 per cent between union and non-union towns in the same district. Perhaps even more striking is the fact that it is not unusual for two near-by towns, both organized under the same union, to differ by as much as 15 per cent. In such cases the difference rests upon the strength of the union and the relative sizes of the two towns. Haverhill wages, for example, have always been higher than those paid for the same work in smaller places near by.

Industry." The same statement shows only 20 per cent of the wage-earners of the industry in cities of more than 250,000 population, and only 5 per cent in the 'South' (mainly Virginia, Tennessee, and Kentucky). For some interesting data on the distribution of the industry according to size and type of community in 1929 and 1933, see Daniel B. Creamer, *Is Industry Decentralizing?* Bulletin no. 3 of the Study of Population Redistribution (Philadelphia, 1935), pp. 89-90. Creamer's figures show a relative growth of the shoe industry in metropolitan suburbs and small cities and towns and a relative decline elsewhere.

³⁰ *Ibid.*, based on data collected by the National Industrial Conference Board.

³¹ My informant prefers to remain anonymous.

TABLE 57
 AVERAGE HOURLY EARNINGS IN THE SHOE INDUSTRY IN SELECTED CITIES
 AND STATES, AS PERCENTAGES OF AVERAGE FOR UNITED STATES ¹

	1924	1928
United States	100	100
Massachusetts	115	118
Haverhill	157 ²	132 ⁴
"	126 ³	146 ⁵
"		136 ⁶
Lynn	126	116
Towns near Haverhill ⁷		100
Boston	103	128
Brockton	134	116
Remainder of Massachusetts	115	
New York State	106	108
New York City	137	145
Rochester		98
All outside New York City.....	96	
Philadelphia		101
Chicago		121
Milwaukee		101
St. Louis		102

¹ From absolute figures given in T. L. Norton, *Trade-Union Policies in the Massachusetts Shoe Industry, 1919-1929* (New York, 1932), p. 325. Based on data of U. S. Bureau of Labor Statistics.

² Prior to May, 1924, reduction.

³ Subsequent to May, 1924, reduction.

⁴ Based on wage rates after voluntary Union 10 per cent reduction in June, 1928.

⁵ Based on wage rates before voluntary Union 10 per cent reduction in June, 1928.

⁶ Based on 1927 scale and 7.6 per cent reduction of January, 1928, which was not accepted by the Union.

⁷ Lowell, Georgetown, and Newburyport, Mass., and Derry, N. H.

There is abundant evidence of the effect of organization in driving factories out of the larger localized centers; so much, in fact, that after reading some of these doleful accounts one is surprised to find that any shoes are still made in Haverhill and Lynn. Actually the migration or closing-down of factories in such centers gives an exaggerated idea of the extent to which the industry is shifting. From January 1, 1925, to August 1, 1928, for instance, Haverhill lost 129 factories which either moved away or closed. But during the same period no less than 123 new factories started operations.³² Since most of the budding entrepreneurs appear to

³² Bureau of Labor Statistics, Bulletin 483, *Conditions in the Shoe Industry in Haverhill, Mass., 1928*, p. 2.

get their start in the cities,³³ a steady outward migration and a high factory mortality do not necessarily mean that grass is growing in the streets.³⁴

To give a clearer idea of the extent of net migration, I have prepared Tables 58 and 59 and two sets of maps (Figs. 43-50), which indicate the relative growth of the industry in the chief cities and elsewhere. Table 59 shows particularly plainly that there has been a dispersion to satellite towns in recent years from all the larger cities. The longest and most spectacular decline is that of Cincinnati, which has lost to Portsmouth and Columbus as well as to smaller places. In Milwaukee, on the other hand, the dispersion has apparently been a post-1929 phenomenon, in which connection it should be recalled that Milwaukee was noted during the 1920's as the most completely unorganized of all the large shoe cities. In New York, the advantages of metropolitan location counterbalanced high labor costs down to 1929, but since then there has been a considerable loss.

For the maps, I have chosen two districts, one in New England and the other covering the larger part of the midwestern shoe area. All factories reported for these districts by the *Shoe and Leather Reporter Annual* have been included,³⁵ and some effort has been made to take account of differences in size. For 1889 and 1920, the *Annual* gives no indications, so I have made the areas of the points in each large city and in the remaining parts of each

³³ The presence of contract stitching shops and other convenient accessories makes it possible for any enterprising shoe worker with a small amount of capital to start a one-room 'factory' in such a center as Haverhill. "Stitching he can get done just as cheap as factories can, and he saves overhead so can undersell manufacturers using union labor. So his business increases, and finally he rents a factory. If he does not pay union wages he soon has a strike on his hands. This holds up his filling of orders, and they are cancelled, putting him out of business." *Ibid.*, p. 10.

³⁴ The great difference between actual movement of firms and industrial migration in the larger sense is illustrated by Fig. 51, which shows the destinations of all the shoe factories moving out of Lynn between August 1, 1933, and the end of 1934 (data from Gleason L. Archer, *The Shoe Industry in Massachusetts*, a brief prepared for the Governor's Committee on the Shoe Industry, Boston, 1935, p. 2). During the same period five concerns, employing a total of 545 workers, liquidated in Lynn. The interesting fact about Fig. 51 is that no firm moved beyond the confines of New England, and most of them moved less than 50 miles (the radius of the circle).

³⁵ The issue of the year following has been used as the source in each case.

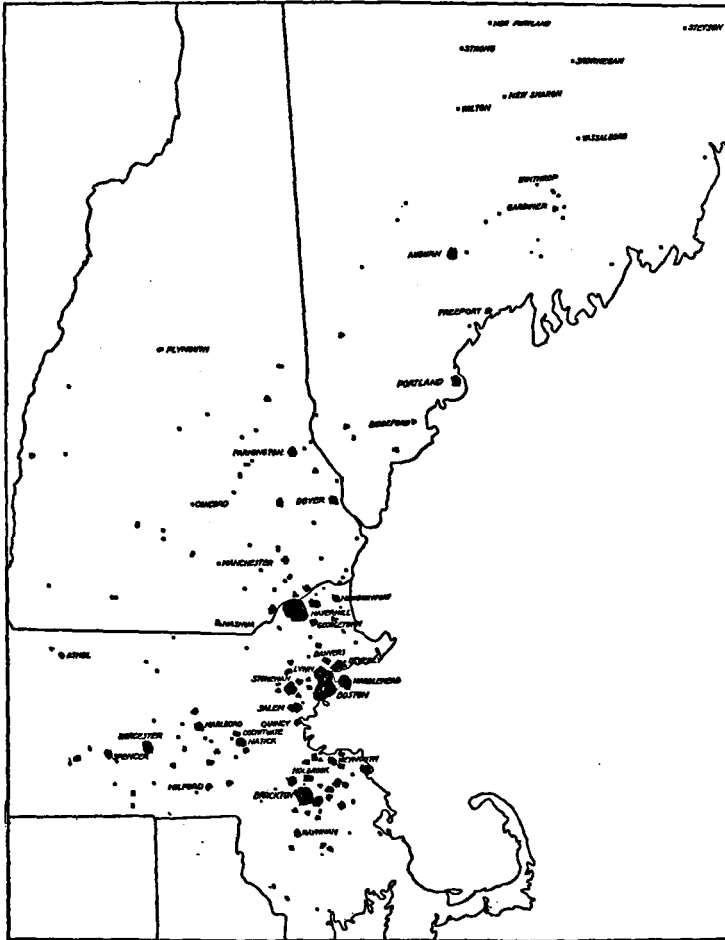

FIG. 43. Distribution of shoe factories in eastern New England, 1889.

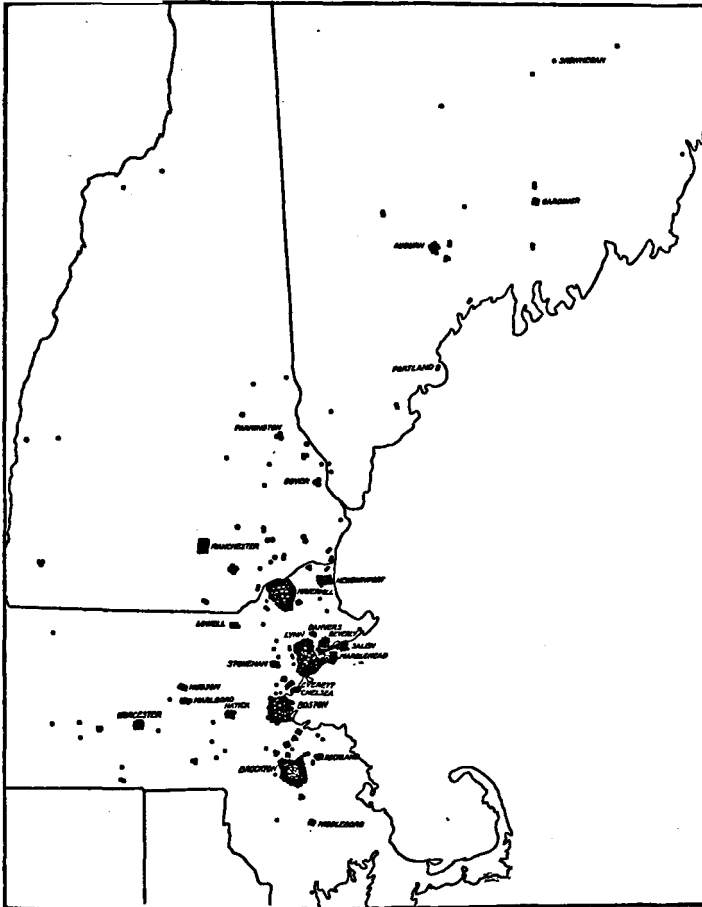

FIG. 44. Distribution of shoe factories in eastern New England, 1920.

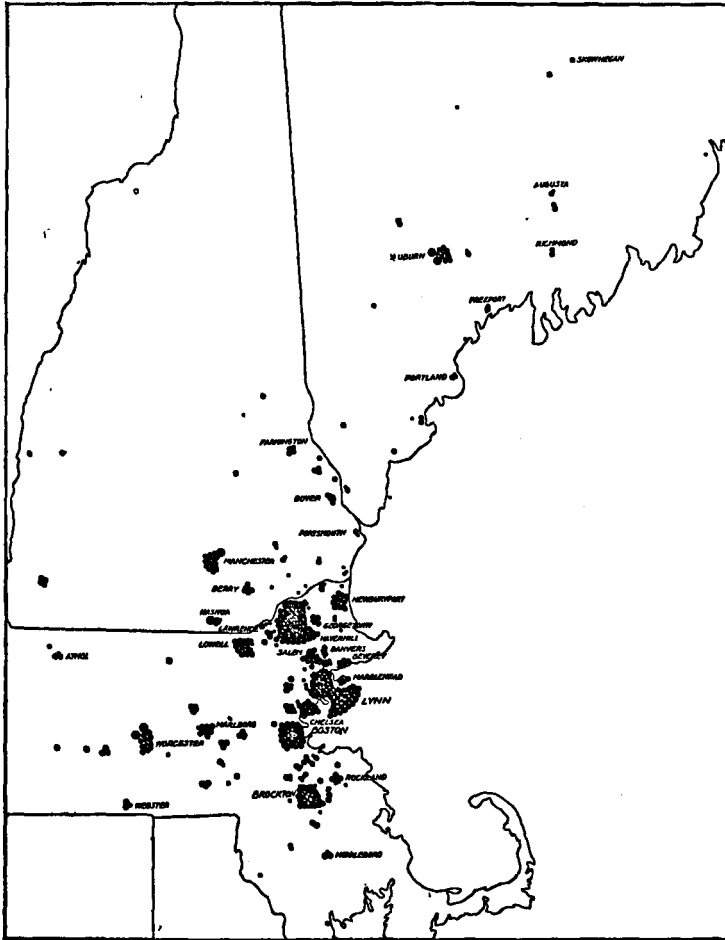

FIG. 45. Distribution of shoe factories in eastern New England, 1929.

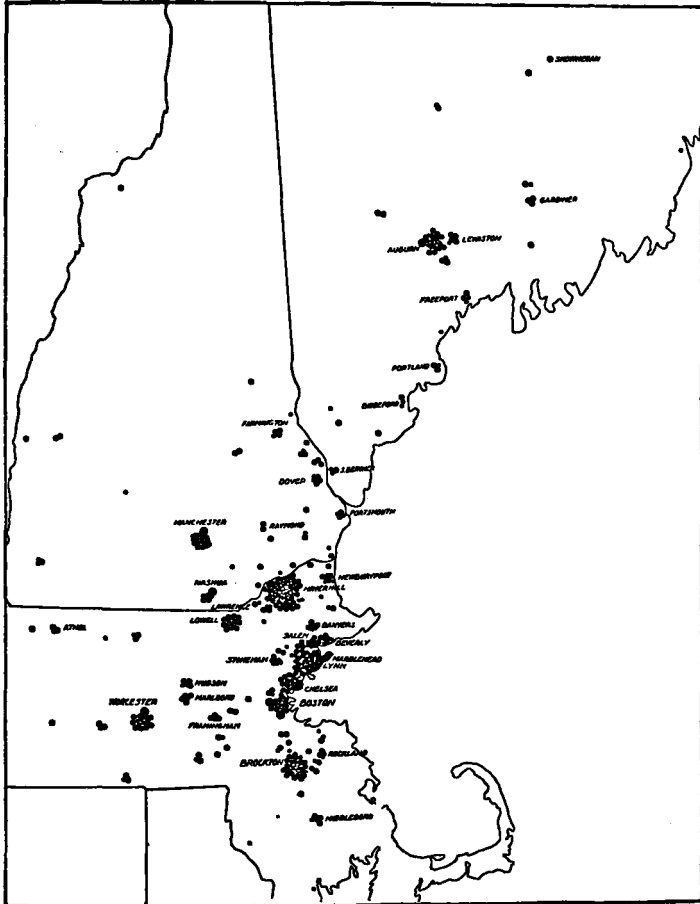

FIG. 46. Distribution of shoe factories in eastern New England, 1935.

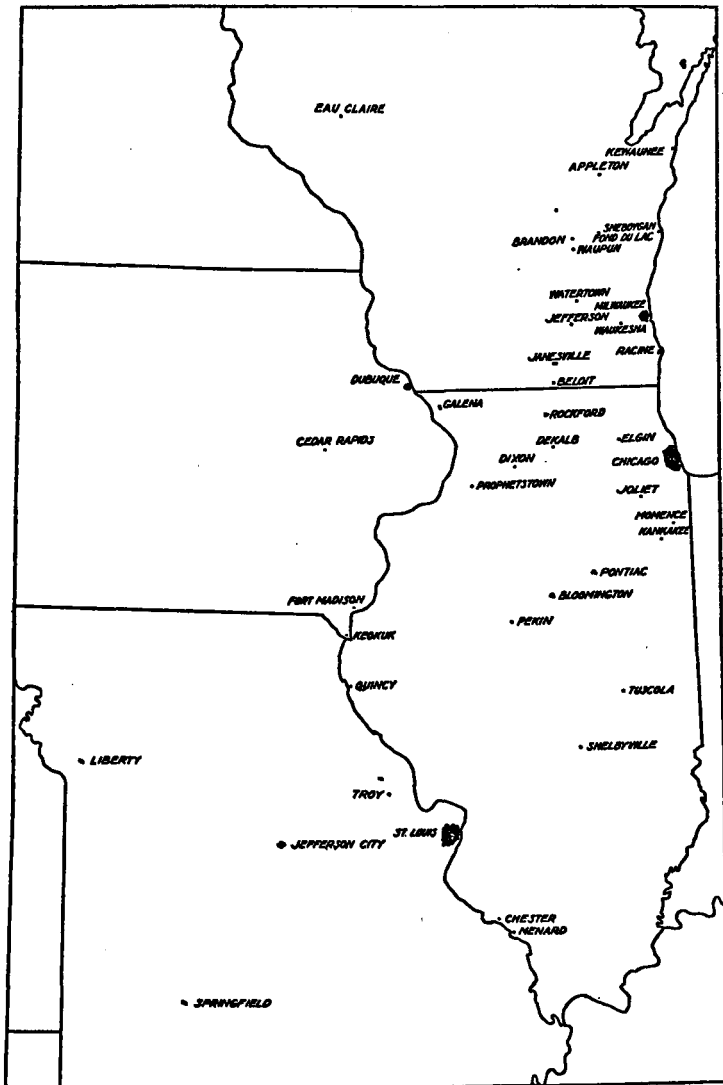

FIG. 47. Distribution of shoe factories in Wisconsin, Illinois, Missouri, and Iowa, 1889.

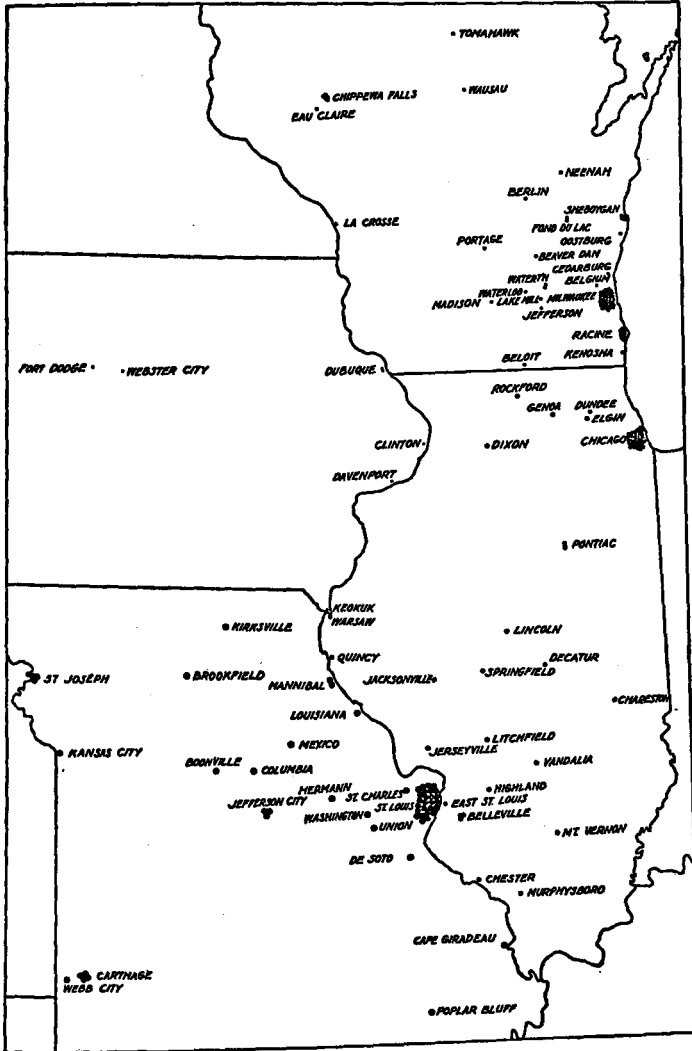

FIG. 48. Distribution of shoe factories in Wisconsin, Illinois, Missouri, and Iowa, 1920.

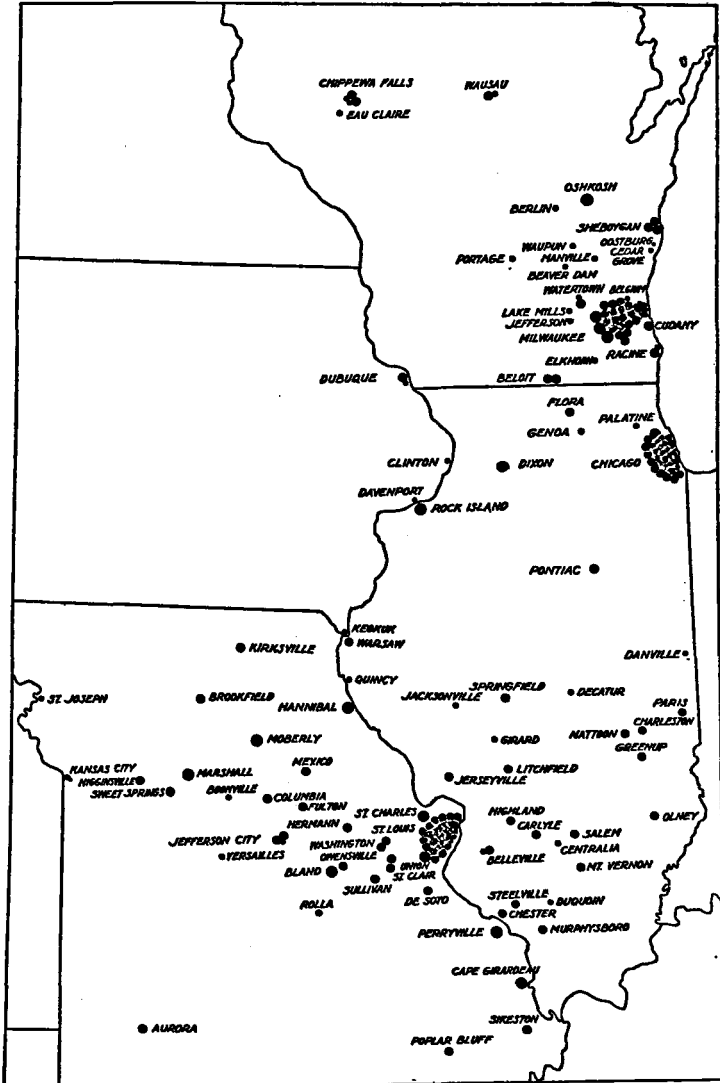

FIG. 49. Distribution of shoe factories in Wisconsin, Illinois, Missouri, and Iowa, 1929.

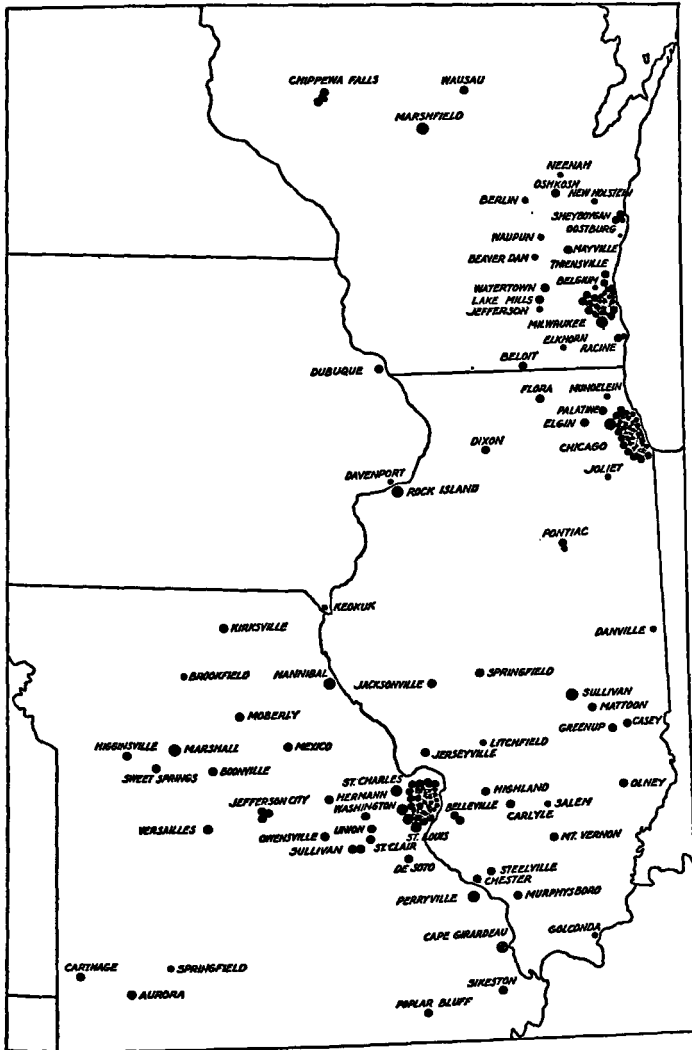

FIG. 50. Distribution of shoe factories in Wisconsin, Illinois, Missouri, and Iowa, 1935.

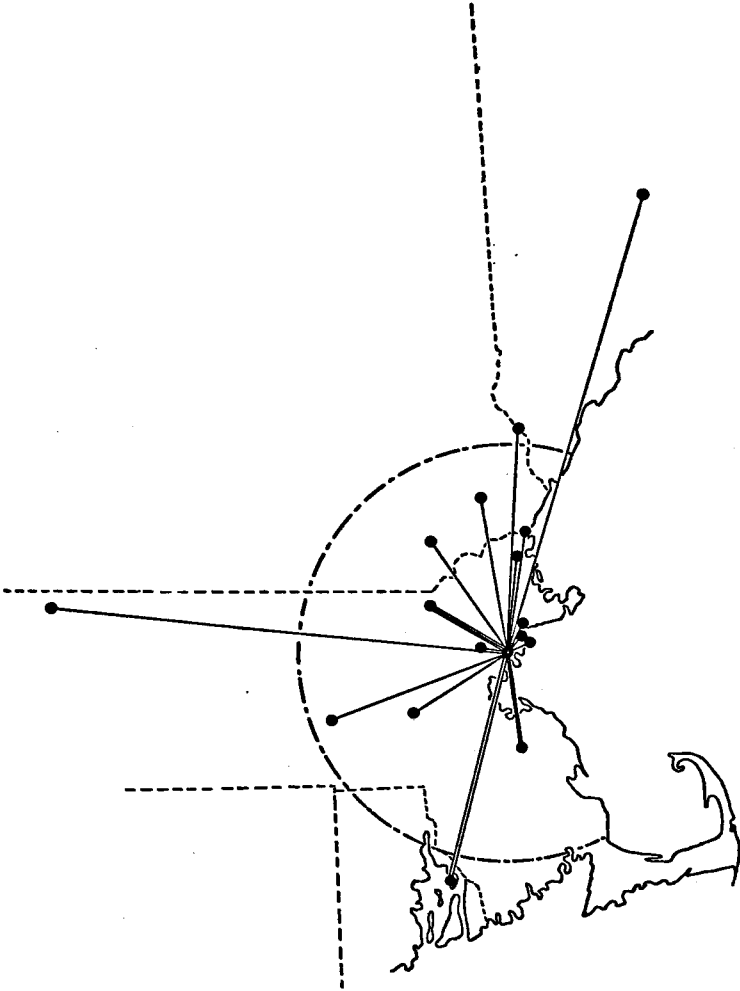

FIG. 51. Migration of shoe factories from Lynn, Mass., August 1, 1933, to December 31, 1934. Based on data in Archer, *op. cit.*, p. 2. The radius of the circle is 50 miles.

TABLE 58

VALUE OF SHOES PRODUCED IN PRINCIPAL SHOE CITIES, AS PERCENTAGES OF UNITED STATES TOTAL, 1879-1933¹

	1879	1889	1899	1909	1919	1923	1929	1933
New York	5.7	3.5	3.5	3.6 ²	5.8	8.5	8.5	7.0
Brockton	7.3	7.6	7.7	7.1	5.3
St. Louis	1.0	1.9	3.2	6.6	5.2	5.2	4.8 ³	3.0 ³
Haverhill	7.3	5.9	5.7	5.2	3.6
Milwaukee	0.4	0.7	0.6	2.3	2.6	3.5	3.8 ³	3.8 ³
Lynn	10.2	9.2	6.5	9.1 ²	5.8	3.1
Chicago	1.5	3.3	2.2	1.9	1.5	2.8	2.5 ³	2.1
Boston	1.2	0.6	3.6	5.1 ²	2.4	2.6
Manchester	1.6	3.4	2.9	2.2
Rochester	2.2	3.0	2.7	2.6	3.1	2.0	1.9	1.3 ³
Auburn	1.6	1.2	1.8	1.8	1.7 ⁴	..
Philadelphia	5.4	3.1	2.3	1.3	1.8	1.6	1.3 ³	1.0
Columbus	0.1	0.2	1.3	1.1	1.1	1.4	1.4	..
Cincinnati	2.5	2.7	3.4	2.9	2.7	2.1	1.2	0.4 ³

¹ Computed from Census data.

² The figures for 1909 include cut stock and findings, so exaggerate the importance of Boston, Lynn, and New York.

³ Census Industrial Area (in most cases there is little difference between the figures for the Industrial Area and the city proper).

⁴ Androscoggin county.

TABLE 59

VALUE OF SHOES PRODUCED IN PRINCIPAL SHOE CITIES, AS PERCENTAGES OF VALUE OF PRODUCT IN STATES IN WHICH CITIES ARE LOCATED¹

	1879	1889	1899	1909	1919	1923	1929	1933
New York	50	33	35	38 ²	35	44	44	39
Brockton	14	17	17	19	18
St. Louis	83	86	73	70	55	43	34 ³	23 ³
Haverhill	14	13	12	14	12
Milwaukee	38	54	46	57	68	61	67 ³	61 ³
Lynn	18	17	14	20 ²	15	11
Chicago	78	83	61	59	44	46	33 ³	25
Boston	2	1	8	11 ²	6	9
Manchester	18	45	45	40
Rochester	19	28	27	28	19	10	10	7 ³
Auburn	33	41	43	46	43 ⁴	..
Philadelphia	93	66	45	32	32	32	30 ³	21 ³
Columbus	3	5	19	17	14	23	27	..
Cincinnati	97	73	49	48	44	34	22	8 ³

¹ Computed from Census data.

² The figures for 1909 include cut stock and findings, so exaggerate the importance of Boston, Lynn, and New York.

³ Census Industrial Area (in most cases there is little difference between the figures for the Industrial Area and the city proper).

⁴ Androscoggin county.

state proportional to the average number of wage-earners per establishment there, as calculated from Census returns. As between states and principal cities, therefore, the average relative sizes are adequately indicated on the maps. In 1929 and 1935, most of the firms reported capacity (number of pairs per day), and four sizes of dots have been used to indicate individual factories equipped for more than 10,000 pairs per day, 1000 to 10,000 pairs, 100 to 1000 pairs, or less than 100 pairs.

The principal effect of labor organization thus appears to be as a 'diseconomy of localization.' And here we have a curious cumulative effect upon regional specialization. Certain cities and districts devoted largely to the style branches of the industry were the first to be organized. Organization made labor costs high there, which tended to drive the manufacture of staple grades to other places. The more intensely specialized in style lines a shoe center is, the higher its labor costs, the more it is restricted to just these branches of production. It would be profitable to inquire whether the same interaction of cause and effect has also operated in other industries or at other times.

Mention should be made of the promoting efforts made by chambers of commerce, real-estate agencies, power companies, and citizens' groups in small towns, which have enticed many a shoe factory away from the urban centers.³⁶ So eager are small communities to get factories that the manufacturer who is moving or building is in a very strong position. In January, 1935, for instance, the chamber of commerce of Bangor, Maine, undertook to raise \$15,000 by popular subscription to put a factory building in shape for a Massachusetts firm, while the owners of the building contributed \$15,000 more and the city council voted \$30,000 for "a grade school to prepare those who desire to enter the employ" of the new factory.³⁷ A very usual form of service is the

³⁶ See on this the N.R.A. reports previously cited, and also Gleason L. Archer, *The Shoe Industry in Massachusetts*, pp. 12-17. On p. 14 is reproduced a letter from a Lewiston, Maine, realty company to a Massachusetts shoe firm, with the statement, "I have promoted sixteen shoe concerns from Massachusetts and brought them all to Maine. Believe me, each one of them is pleased of its change."

³⁷ *Boston American*, January 6, 1935, quoted in Archer, *op. cit.*, p. 16. In most cases, the cost has been recovered by a percentage assessment on the pay envelopes of those employed.

provision of trucks to move the equipment; and tax and rent exemptions for a period of years are common.

It is reported that one of the largest firms in the industry, with factories scattered through the Midwest, does not find it necessary to build its own factories at all. As soon as it makes known its willingness to operate an additional plant, small towns in several states are bidding for the privilege of furnishing a building, which becomes the property of the company if operated a certain percentage of the time for a period of years.³⁸

Naturally it is the smaller places which have most at stake and are willing to make the greatest concessions to gain a new industry, and this promotional activity may account for a part of the tendency toward decentralization that has been evident in the shoe industry for the past several years.³⁹ It should be noted, though, that the cash inducements offered would not ordinarily be enough to make a firm relocate permanently unless it had reason to believe that costs would continue to be lower at the new location. They merely cover the cost and inconvenience of moving. Upon examination, it is found that the invitations inevitably contain a reference to low wage levels and almost always guarantee protection from unions. This 'protection' occasionally takes quite tangible form.⁴⁰

³⁸ R. L. Kringer, "In the Deep Middle West," in *Nation*, November 13, 1935, p. 569.

³⁹ Small-town promotional activity is not altogether a new phenomenon. Clark mentions its influence during the period 1873-93 in *New England (History of Manufactures in the United States, p. 473)*, and the Industrial Commission of 1900 reported that: "They bid very high for factories. Local business associations will build factories and give them a low rental and exempt them from taxation, etc." *Report*, vol. xiv, p. 502.

⁴⁰ See Kringer, *op. cit.*

PART IV
SUMMARY AND CONCLUSIONS

CHAPTER XV

LOCATION OF THE LEATHER INDUSTRY

THE history of the American leather industry began in a new country, economically atomized by high costs of transportation, in which tanning was an essential activity serving every member of the population. The market was more evenly distributed than today, but showed a definite localization in certain favored coastal districts. The necessary materials for the industry were hides, tanbark, and running water. Actual production costs did not vary enough to affect location significantly.

The limited number of places at which a suitable water supply was available was an important restriction on the local choice of tannery sites, but apart from this the tanbark was the most expensive material to transport; so tanneries were located on streams in close proximity to oak or hemlock forests. The depletion of the most convenient bark supplies brought into evidence the importance of access to bark, for the first major development in the locational history of the industry was a westward and southward migration.

There was little technical change in the tanning industry before 1880, and access to tanbark continued to be the leading locational factor, subject to the restrictive effect of water supply. Reduction of transport costs by the railroad meant an enlargement of market areas and (after about 1870) a gradual reduction in the number of tannery locations.¹

In the '80's came the introduction of three new sorts of tanning agents which altered the locational picture quite fundamentally. These were domestic bark extracts, concentrated vegetable ma-

¹ The number of tanneries rose to a peak of 7569 in 1869, partly as the result of "the great development of hemlock tanning, by which it became possible and profitable to establish a tannery of reasonable size close to any tract of hemlock forest land." American Sole and Belting Leather Tanners, Inc., *Nothing Takes the Place of Leather* (New York, 1924). In 1933 only 374 establishments were reported by the Census of Manufactures.

terials from abroad, and inorganic tanning agents. All were far more concentrated than tanbark, and their use rendered the industry practically independent of nearness to sources of tanning agents.

The use of bark extracts affected all sorts of tanning, and particularly that of heavy cattle hides; while the inorganic process has been applied mainly to the lighter skins. The locational effect in either case, however, was to bring a new factor into dominance. Generally, this was access to hide supply. There set in a considerable migration of the cattle and calf leather industry toward the midwestern packing centers, and Chicago, Cincinnati, Milwaukee, and other places became known for leather as well as meat. This concentration of tanneries helped to further the mechanization of the industry, and larger establishments became the rule.

In the case of the lighter leathers, the new situation was not so clearly defined. Much more labor and power and a greater variety of materials are necessary. The advantages acquired from long situation in one place and from the proximity of similar enterprises are much more important in the goatskin and sheepskin branches of the business. Furthermore, the goatskins and a considerable part of the other skins have always been imported, so the optimum location with reference to material supply is on the seaboard. For all these reasons the manufacture of lighter leathers, and particularly that of kid, has remained concentrated in two districts along the Atlantic coast: one practically suburban to Boston, and the other extending from Newark to Wilmington.

In the past half-century the use of power machinery has very considerably increased. But this has not meant that fuel or power costs have influenced the location of tanneries to any great extent. The use of transmitted electric power and the increase in fuel efficiency have tended to counteract the effects of increased power consumption in the industry. It happens also that other factors besides fuel and power costs have conspired to locate most of the tanning industry in places that leave little to be desired from the standpoint of economy in power costs.

Another recent development is the appearance of a style element in the lighter leathers. The 'standing order' has given way

to hurried telegraphic requests for a few dozen skins of some novelty finish which may be unsalable a month later. In the branches of the leather industry that cater to the fashion trades — this applies perhaps more to the sheepskin tanneries than to any others — style, speed, and service are essentials in marketing. Transfer rather than transport costs are the important thing.

Some consideration has been given to the factors determining concentration of production. In tanneries producing style leathers it may be that the optimum unit is becoming smaller as the market becomes more capricious; but the limitations on size are elastic. The huge quantities of pure cold water needed by a large tannery constitute a restriction on size and on the choice of possible locations, especially in well settled industrial regions where most of the available water supply is already preëmpted. Owing to differences in the nature of both materials and product, the heavy-leather industry seems less subject to localization in specialized 'leather towns' than the lighter branch.

The principal use of leather has always been in shoes and the principal material for shoes has always been leather, so the tanning and shoemaking industries might justly be regarded as stages of one productive process. Why have they not been locationally integrated to a greater extent?

Alfred Weber believed that 'split production' is the rule and locational integration the exception.² In order that two successive stages of production should combine at the same location, it is necessary either that the first stage should be market-oriented or that the second stage should be oriented toward the material furnished by the first stage. In practice, early stages of production are rarely market-oriented, on account of the high weight loss usually accompanying such stages and the still unfinished nature of their product; while later stages in production are unlikely to be material-oriented (except possibly to fuels).

Our first stage is here the tanning industry, oriented definitely to materials, albeit to different ones at different times. The second stage is the manufacture of shoes, oriented to markets or to labor supply according to the time and place. Both have been subject

² Weber, p. 178.

to considerable concentration since the introduction of power machinery, but shoemaking remains an industry of fairly small-scale production. Under these conditions the location of tanning and shoemaking should be generally independent, and such has been the case. The apparent similarity in their locational patterns is largely coincidence. Both developed first around Boston, New York, and Philadelphia, and both spread to the Midwest after the Civil War. But the similarity does not go much beyond that. Brockton, New York City, Rochester, Lynn, and St. Louis are shoe centers that do very little tanning; Wilmington, Detroit, Woburn, Peabody, Newark, and most of the hundreds of bark-tannery locations make few if any shoes.

The plentiful supply of leather is usually cited as a reason for the early start of the shoe industry in Massachusetts; but I have already indicated that the extent of the market (due to water connections and population concentration) was really the critical factor in shoemaking. If the tanneries of the early colonial period had been located at any other point on the coast, there is no reason to believe that the shoe industry of Massachusetts would have been much handicapped. Leather could have been brought in by water as easily as hides were. As it happened, the early tanning industry was highly concentrated in Massachusetts, because of bark and hide supply and markets. To the extent that markets were a factor, the location of shoe manufacturing may be said to have influenced tanning; but this can have been the case only so long as the materials used by the leather industry were practically ubiquitous.

The intermediate stages between tanning and shoemaking (that is, the wholesaling of leather and the manufacture of cut soles and findings) are more localized than either the tanning or the shoemaking industry.³ This seems to be due partly to the fact that many of our large cities are foci for both shoemaking and tanning districts, but partly also to the advantages of localization in the intermediate stages themselves.

³ See Table 21 in Chapter IX and Table 36 in Chapter XI.

CHAPTER XVI

LOCATION OF THE SHOE INDUSTRY¹

A SURVEY of the essential characteristics of the shoe industry (nature of processes, relative amounts of materials used, and relation between labor and transportation costs) pointed toward certain tendencies of geographical distribution.² Owing to the higher cost of transporting the finished product, nearness to market is more significant than nearness to materials. Owing to the importance of labor, the industry is attracted to places with low labor costs even when these are far from materials or market. The cheapening of transportation tends to lessen the relative locational influence of transport costs on materials and product, and thus increases the attracting power of locations with low labor costs. But the evolution from the hand to the factory industry has a contrary effect: reducing the proportion of labor costs to total costs and thus lessening the locational advantages of places where labor is cheap.

The history of the American shoe industry may be divided into four periods, in each of which a different set of locational influences was dominant. It is impossible, of course, to date these periods exactly, and the chronological mileposts which I shall set up are to be regarded merely as convenient approximations.

First period (1630-1760). In this period, which might be called that of local handicraft, each village and neighborhood community produced its own supply of shoes, using local materials. In the early part of the period, and in remoter regions, this was even true of the individual household. There was obviously not much choice of location, and the manufacture of shoes was distributed in the same pattern as population.

Almost from the beginning there was in the towns an elemen-

¹ A large part of this chapter appeared as an article entitled "The Location of the Shoe Industry in the United States," in the *Quarterly Journal of Economics*, February, 1933, pp. 254-276.

² See Chapter X above.

tary division of labor. Local craftsmen, first itinerant and later settled in their own shops, made shoes for the rest of the community. The knack of shoemaking soon ceased to be common property in the more settled regions. But this did not substantially change the location of the industry with respect to population. Each pair of shoes had to be made to measure, which meant that the dominant factor of location was the market. Shoemakers sought their customers. Since leather was still produced practically everywhere, very little transportation of either materials or product was involved in the making of shoes.

One sees very early the beginnings of the next stage: the localization of the hand industry. In certain districts along the Atlantic seaboard, principally in Eastern Massachusetts and around Philadelphia and New York City, population soon exceeded the limits of agricultural self-sufficiency. Commercial advantages, and in New England the poverty of the soil and the absence of direct routes to the interior, accounted for the fact that for the populations of these districts, and especially of Eastern Massachusetts, agriculture was of less relative importance than anywhere else on the coast or in the interior. There was a concentration of population in the coast towns, which were engaged in trading, shipping, fishing, and shipbuilding, and also in the tributary farming territory. This meant a concentrated market, a condition favorable for the development of manufacturing industry. Shipping connections were of great advantage in getting an adequate supply of materials and in reaching extended markets.

Division of labor in any line of manufacture, as determined by the extent of the market, obviously had freer rein in Eastern Massachusetts and the New York-New Jersey-Philadelphia district than anywhere else in the country. The access to a large and concentrated market was more fundamental than advantages in labor supply, which could be utilized only because the size of the market made advanced division of labor possible and profitable.

Second period (1760-1860). The first stage in specialization, consisting in the setting-up of the individual handicraftsman in the place of family manufacture, was realized earliest in the three districts named above; so likewise was the next stage, which con-

sisted in the division of the process of shoemaking into operations, with workmen specializing in one or more of these parts of the trade.

It is easier to learn to make part of a shoe than a whole shoe, and accordingly this division of labor permitted either a lowering of the standards of labor skill or a raising of the standards of workmanship. Both took place. A differentiation arose between the making of good shoes — better than ever before — for individual measure, and the making of cheaper shoes for stock. The two branches of the industry thus separated,³ pursued divergent paths.

The custom manufacture followed the old lines, and its geographical distribution has continued to be determined by the location of markets. It has never advanced very far in technique or organization, because the market is restricted and scattered. Each pair being made to individual measure, there are no two alike, and no great amount of standardization is possible. The division of labor has accordingly proceeded only a little way. Machines are used scarcely at all, and the modern custom shoemaking establishment is very like those of a century ago. The clientèle is now, however, practically limited to dancers, acrobats, and persons with abnormal feet.

The location of the now predominant branch of the industry which produces for wholesale order or for stock is a more complex question. Once the policy of manufacture beyond individual order work had been adopted, there was no reason why shoemakers in one place could not send their product to other towns and districts to be sold. Shoes had become an article of trade. The division of labor induced by the concentration of local markets lent itself to the serving of a more extensive market and was thus itself encouraged. I have placed the beginning of the second or localized-hand-industry period at 1760 because it was at about that time that both the Eastern Massachusetts and the New York-Philadelphia districts began selling shoes elsewhere.

All of the original districts on account of their concentrated populations, and Massachusetts in particular on account of the limitations of her agricultural possibilities, had a labor supply

³ The Census did not distinguish between factory and hand workers until 1880.

suiting to the new form of organization in the shoe industry. Since machines were as yet unknown, there was no need to concentrate all the operations in a single place. The parts of shoes are light and easily carried about. Consequently we find that home workers by the thousands, in Eastern Massachusetts and the three other states, were putting in their spare time in sewing uppers or performing other parts of the work. The nucleus of the production system was a central office or shop where the materials were sorted and given out and the product collected, and where certain of the operations might conveniently be carried on. The greater part of the actual work, however, was done in private homes by complementary labor.

The specialization observable in the Massachusetts North Shore and South Shore districts dates from the early part of this period, and was determined by the different types of complementary labor available in the two districts. On the North Shore, the sea had always been the chief source of livelihood, owing to the many good harbors. Fishermen's and sailors' wives and daughters were the labor supply for the first localized shoe industry, and the district specialized in women's shoes because the sewing on them was better suited to female labor. On the South Shore, on the other hand, there were few good harbors; the men stayed at home and made the best of farming. They were on hand to help out with the heavy work; and consequently — especially after the Revolution, when many of the men had learned shoemaking in the army — the South Shore district specialized in men's boots and shoes.

This specialization at such an early date suggests that in the period 1760-1860 labor was one of the chief factors of location. It was certainly of great importance; but we should remember that only those places which had facilities for reaching large markets could put into practice the division of labor that made it possible to employ low-paid home workers. The concentrated local markets and the shipping connections of the seaboard districts were, until the coming of the railroads, the most fundamental causes of the localization of shoe manufacturing. A few interior points were so remote from cheap transport connection with the eastern sea-

board that they made their own shoes, for an 'insulated' local market; but this applies practically only to the frontier zone. The rest of the country bought its ready-made shoes from Massachusetts, New York, New Jersey, or Pennsylvania, and made locally only the custom product.

The most important event in the period 1760-1860, for present purposes, was the coming of the railroad. It cheapened land transportation and greatly hastened the westward march of the center of population and the building up of cities in the interior. This radically reduced the commercial advantage of the seaboard cities. No longer were they the only ones that could tap distant sources of materials or serve extended markets. New England in her little corner felt the change most severely, since she had led in the coastwise shipping trade and now found herself most remote of all from the rapidly developing centers of population to the west and south.

It is true that the marketing advantage of the older districts was not immediately destroyed. There was still a much higher concentration of population and markets in the Northeast than elsewhere, and water transport was still cheaper than rail. But if Massachusetts, New York, New Jersey, and Pennsylvania were to retain their leadership in the ready-made shoe industry it must be by virtue of some other advantage.

Such was that of labor supply. The newer parts of the country were preoccupied with agriculture throughout this period. Mid-western cities were commercial centers serving the surrounding farming regions, and a surplus labor supply willing to sell its services cheaply to manufacturing industry was lacking. Furthermore, there was no experienced shoemaking labor at any price in the newer regions, except the local custom shoemakers. They could not compete with the eastern large-scale production of cheap shoes.

In the East, on the other hand, nearly a century of specialization in shoemaking was reflected in a relatively high level of competence on the part of the workers. They had not only carried on the same operations for generations, but had lived and breathed in the atmosphere of shoemaking and were a part of an organism

difficult to transplant. A still further factor tending to keep the shoe industry localized in the East even after the loss of special marketing advantages was the financial one. Shoes were sold in the rural markets on long credits, and correspondingly long credits were allowed the middlemen. The capital required was not so cheaply obtainable in the West as it was, for example, in Boston, the financial center of the country, or in New York, about to succeed to that position.

For these reasons the cheapening of land transport did not immediately decentralize the industry. Rather, by reducing the importance of nearness to markets, it increased the importance of low production costs, and the localization in the original eastern districts persisted on a somewhat altered basis. Only a few outside cities went into wholesale shoemaking before 1860, and their production was only for local needs. The East had the eastern market, and most of the southern and western markets, all to itself.

In the latter part of the period 1760-1860, however, there were signs of a transition to a further stage. The westward spread of population made the original producing districts, and particularly New England, more and more remote from the center of the country's markets, which was a disadvantage though not yet a decisive one. The supply of leather, too, began to be drawn from farther afield. Local eastern supplies of tanning materials had long been insufficient, and first the hides and then the tanbark had to be sought in more remote places. Tanneries were located with reference to hemlock, oak, or chestnut bark supplies, and as the bark was used up they moved southward and westward. The interior regions were also beginning to furnish an important part of the supply of hides.

Still more important, new machines were being introduced in the shoe trade at frequent intervals, and each new machine meant that one more process was consolidated in the central workshop, which was gradually metamorphosed into the modern factory. The standards of labor skill were lowered by this mechanization, and in an increasing number of processes no previous training was needed. At the same time parts of the West were developing a saturation of population with respect to agriculture, and a surplus

labor supply not unlike that which had helped the establishment of the original localized shoe industry on the eastern coast. With labor as well as capital becoming relatively cheaper and more abundant in the West, and with the requirements of previous training becoming less important, it was only a question of time before the western cities likewise could develop a localized shoe industry and compete in the national markets.

Third period (1860-1900). I have dated the beginning of a third stage of location by the introduction of the McKay sewing machine, which more than any other made the central shop a genuine factory and reduced the requirements of labor skill.⁴ By the later '60's, the factory manufacture of shoes was firmly established in such interior cities as Rochester, Cincinnati, Detroit, Chicago, St. Louis, and Milwaukee. The two first-named, farthest east, naturally led. Among all the midwestern cities the ones which by their promising prospects just previous to the Civil War had attracted a large share of the immigration from Germany were the ones to go furthest in the shoe and leather industries, since the Germans included a high proportion of village craftsmen skilled in these trades.

Everywhere that there was some concentration of population and a surplus labor supply, however, it was now possible to start shoe factories. After about 1880 the Massachusetts output increased less rapidly than that of New York and the midwestern states, and after the World War it suffered a serious absolute diminution. Pennsylvania and New Jersey likewise have lost in relative importance in the past half century.

There was naturally a difference in quality of product, reflecting the difference in the labor available in the old and the new shoe districts. Where the manufacture had been long established, it had become possible by the '70's to make a shoe of good quality by machinery. The custom shoemakers still shod the wealthier and more fastidious customers, but the factory product was encroaching more and more on their domain as the last processes were mechanized and the machines improved. In Philadelphia,

⁴ Even with the machine it requires a trained operative to do McKay sewing; but the proportion of the total force engaged on that operation was greatly lessened by the introduction of the machine.

New York, and the shoe towns of Eastern Massachusetts, New Jersey, and Eastern Pennsylvania, a better grade of factory shoes could be made than elsewhere, though not yet so good as the product of the local custom shops scattered over the country. Then, too, the character of the demand was different in the West and South,⁵ so those newer producing sections began by turning out a medium- or low-grade staple product. Gradually, as the machines were still further improved, as labor gained in experience, and as the needs and desires of consumers changed, the western manufacturers began to make shoes of a quality approaching that of the eastern factories. This happened first in the cities, notably Cincinnati, Chicago, and St. Louis. It was some time, however, before they caught up with the older districts.

During the period 1860-1900 the situation with regard to materials also changed. The process of bark-leaching and the use of concentrated tropical extracts and inorganic tanning agents made it no longer necessary for tanneries to locate near forests. They were free henceforth to be near the supply of hides. This meant increased development of the tanning industry in two places: the stockyard cities of the Middle West, and the ports which imported hides from South America and goatskins from Europe and Asia. The western as well as the eastern shoe industry thus had its leather supply at hand. The heavier cattle leathers produced in the Middle West were suited to the character of the shoe production of that region, just as the supply of lighter kid leather in the East was adapted to the character of shoe production there.

It is impossible to say whether nearness to market or low labor costs was the dominant location factor in the period 1860-1900, since this depended on the quality of shoe. For the higher qualities the skilled labor of the East was well-nigh indispensable, and transportation costs were secondary in importance; while for the lower grades more susceptible to standardized production western labor was good enough and probably nearness to market was the main thing. During the last decades of the nineteenth century the westward movement of shoe production could be accounted for in large part by the movement of population.

⁵ This applies also to Maine and New Hampshire.

The McKay machine and most of those that followed it were leased to shoe manufacturers, which kept down the amount of capital required to enter the business and allowed men of small resources to get a start. Undoubtedly this aided the newer districts. Another factor in keeping capital requirements low was the aftermath of the greenback inflation and the panic of 1873, which led manufacturers to demand cash payment from retailers or jobbers. Before the Civil War Boston had financed most of the shoe trade, but now all sections were on the same basis.

The equalization of advantages took other forms as well. The producers of shoe machinery, who gravitated rapidly toward monopoly and finally merged in 1899, leased machines on the same terms to manufacturers large and small. This deprived the larger ones of the advantage which their more intensive use of the equipment would otherwise have given them, and helped to keep shoe factories small. Furthermore, the 'Shoe Machinery Trust' gave exactly the same rates and the same service to manufacturers in all parts of the country, whereas under competitive conditions those in the concentrated eastern districts might have expected to come off somewhat better than their western rivals.

In the main, the period 1860-1900 was characterized by a levelling of locational advantages in the different regions. New England's advantage in market financing had passed away by 1873. The absence of highly-trained labor had become by the '70's not a hindrance to shoe manufacturing in general, but simply a factor limiting the quality of the product. Regional specialization by grades was mainly due to the newness of the western shoe industry, and as such could not be permanent.

It is difficult to know where to end the period beginning in 1860; 1900 has been set down as the terminal year, but one can point to no single event to justify the demarcation. In some respects a definite change to a new state of affairs had manifested itself by 1890, or even earlier; in others it was not clear till long after 1900.

Fourth period (1900-). The two new developments that seem to justify calling the most recent decades a separate period in the location of the shoe industry are the emphasis on styles and

the rise of labor unions to power. Both began half a century or more ago and rose in steady crescendo to their present great importance.

Fashions in footwear evidently could have little effect on the ready-made shoe industry before it had become possible to turn out in the factory a product of fairly high grade, approaching that of the hand shoemaker. Sometime near the end of the century this happened; events conspired to set the wheel of fashion in rapidly accelerating motion. The factories became able to turn out good enough shoes; in fact they took prizes at international exhibitions, where styles in women's shoes were already American rather than Parisian. The tanneries at the same time had mastered new processes of treating skins, and a host of new and ornamental varieties of light upper leather began to grace the market. Public taste came to demand greater variety and more frequent alteration of patterns.

The steadily increasing importance of fashion changes in shoes has brought many problems to the shoe industry, but for our purposes here the most significant effect has been the emphasis that has been put upon speed and close contact in marketing. Once before, nearness to market had meant low freight rates and that had been a decisive advantage. This advantage the railroads had ironed out. Now that speed became necessary, the factor of access to areas of consumption regained importance.⁶

More elaborate styles and quicker change in them meant that the merchandising of shoes, wholesale as well as retail, must be done in a much less offhand way than before. Except in the steadily less numerous staple lines, holding of stocks became impossible. The manufacturer on the spot, who could keep his ear to the ground and give quick and almost personal service, served a territory better than some far-away establishment whose shipments might arrive too late to catch the Saturday rush.

Since New England was farthest away from the markets that

⁶ For instance, I was told at a factory on the edge of the Chicago Loop district, producing high-grade shoes, that its location was advantageous primarily by reason of the nearness of the railroad terminals and hotels used by visiting buyers. From any other point of view a less central Chicago location would have been equally good, and for a producer of medium- or low-grade shoes there might have been a net advantage in being out of the city altogether.

were growing the fastest, she was the chief sufferer by this new importance of the factor of nearness to market. Her water transport lines were now of practically no use at all for the carrying of shoes, speed rather than low freights being the essential. Furthermore, the high degree of specialization which was the outcome of the concentration of the industry in Eastern Massachusetts, in particular, began to work adversely. The rural and small-town markets of the interior wanted a general line of shoes, whereas most Massachusetts manufacturers had small factories each wholly devoted to a single specialty. New England, having lost one of her special advantages by the coming of the railroads and another by the improvement of machinery, now was subjected to a positive disadvantage in reaching a growing section of the market.

In the '90's the Eastern Massachusetts manufacturers began, probably as a result of the reverses suffered in the domestic market, to show an interest in export trade, neglected since the Civil War. It was too late to build up a large export business on the basis of the advantage in machinery we had once possessed, since the machinery producers had been pushing their product abroad just as zealously as at home; but the eastern shoe districts of the country, and particularly the large Brockton manufacturers, made efforts which raised the total of exports to about 5 per cent of the domestic production. The principal markets were in Cuba and South Africa. During the World War, however, these and most of the other former shoe-importing countries erected tariffs and built up their own shoe industries, so that they are now self-sufficient. International trade in shoes was sharply curtailed, and at present there seems no likelihood of our exports recovering much of their former volume. Again Massachusetts is the chief sufferer.

The organization of labor in the shoe industry began to exert some influence on location as early as the '70's, and nearly everywhere the story was the same. In centers of concentrated shoe production, where there were several thousand workers together, the conflict of interest between them and their employers resulted in city-wide strikes. At first, the grievance was often the allowing

of 'green hands' to run the machines; occasionally it was the machines themselves; but usually it had to do with wages or working conditions. Labor has always been strong in shoe manufacturing, because of its intrinsic importance in the production process and also because of the peculiar conditions that have brought it about that the representative manufacturer is a man of small resources competing savagely with his fellows. Manufacturers' associations exist in all the important shoe centers, to be sure, and in a few of them have effectually hamstrung the unions; but in general the employer has mistrusted his competitors even more than his workmen.

As a locational factor, the higher costs resulting from organized labor have worked within rather than between regions. The industry's growth has been checked in the specialized centers and stimulated in satellite towns, and at times in metropolitan cities like Boston, with their unspecialized labor market and better conditions for the manufacturers. In recent years, most leading shoe cities have become less important relative to their tributary territories.

The movement toward decentralization has been somewhat aided by the inducements which booster organizations have offered to new factories. These include lower taxes or exemption for a period of years, free rent, free transportation of machinery, and even cash bonuses. The greatest inducement, however, is unorganized labor.

The present regional specialization of shoemaking has features which seem to be common to many of the clothing industries. In the older, more localized centers, the advantage is in labor skill and reputation, which has led those centers to specialize in the style lines of the product. This specialization leads in turn to highly seasonal production, small-scale establishments, and strong union organization among the operatives, and in at least two ways tends to increase labor costs. Seasonal production makes higher hourly or piece wages necessary to give the same annual earnings, and leads the unions to emphasize high rates; and the 'rush' seasons are highly strategic occasions for strikes. Also, the rapid turnover among manufacturers and the presence of a cordially

disliked 'fly-by-night' or 'chiseler' element undermines the solidarity of employers and makes the style branch of the business unstable in all respects. Under such conditions the older localized centers become unable to compete in staple lines at all, and their specialization increases.

This chain of causes and effects seems to me to account for much of the present situation of the shoe industry in Eastern Massachusetts. I shall not attempt to say how closely it has been paralleled in other sections or in other industries, but believe it is a fairly common sequence.

The most convenient way of obtaining a more detailed picture of the location of shoe factories than the Census figures afford is to use a trade directory such as that published annually by the *Shoe and Leather Reporter*. This directory includes most of the shoemaking establishments in the United States and Canada,⁷ and seems to be based on voluntary responses to an inquiry form. For a large proportion of the factories listed, some indication of the daily capacity is given, as well as of the kind of shoes manufactured and method of selling.

In Fig. 52 the location of practically all the factories listed in the 1930 directory has been indicated by dots.⁸ The major centers of the industry, here arbitrarily defined as those with ten or more plants, are shown on the map as large dots. There are twenty of these:

Auburn, Maine	Chicago	New York
Baltimore	Cincinnati ¹⁰	Newburyport, Mass.
Binghamton and vicinity, N. Y. ⁹	Haverhill	Philadelphia
Boston	Lowell	Rochester
Brockton	Lynn	St. Louis
Chelsea, Mass.	Manchester, N. H.	Salem, Mass.
	Milwaukee	Worcester, Mass.

⁷ About 1400 factories were listed for the United States in the 1930 directory. The 1931 Census of Manufactures, including all establishments with an annual product valued at \$5000 or more, listed 1156; the 1929 Census, 1341.

⁸ The only omissions are establishments specified as making only leggings, parts of boots or shoes, and footwear containing no leather; as well as half a dozen penal and other institutions.

⁹ Less than ten establishments, but including some of the largest in the country, chiefly those of the Endicott-Johnson company.

¹⁰ Since 1930, Columbus has forged ahead of Cincinnati (see Table 58).



FIG. 52. Shoe factories in the United States, 1929.

Some of the Massachusetts North Shore towns are rather over-rated on this basis, since the factories there are of a small average size; but the above list includes all of the thirteen cities listed by the 1923 Census of Manufactures (the latest giving these data for cities of less than 100,000 population) as those of largest shoe production.

The map shows plainly to what an extent the factories are restricted to the northeastern quarter¹¹ of the United States, with the greatest degree of concentration in the region around Boston. The scattered groups of factories located at such points as Seattle, Los Angeles, San Francisco, Atlanta, and Omaha are of practically no importance, most of the shops there being very small ones. The only outlying factories of any great importance are those in Lynchburg, Virginia, the headquarters of a large firm operating also in Milwaukee and St. Louis. Nashville is second in importance among the outside cities, and Tennessee's production has been gaining in recent years.

The great bulk of the factories in the United States would be included in a few zones in the northeastern quarter of the country. There is the zone of Eastern New England, most important of all, extending from Bangor to Brockton and west to the Connecticut River. Greater New York, including satellite cities in New Jersey and Connecticut, is another zone, and Eastern Pennsylvania, with Baltimore and the remainder of New Jersey, is another. We may consider the upstate New York factories as another swarm, somewhat more dispersed, with Rochester and Binghamton as the main centers.

West of the Alleghenies is a vast area fairly evenly sprinkled with shoe factories, including the states of Ohio, Indiana, Illinois, Missouri, Wisconsin, and parts of Kentucky, Michigan, Minnesota, Iowa, Kansas, Tennessee, and West Virginia. Any partition of this area into zones must be arbitrary, but at least we seem justified in saying that there should be three and only three such zones. They center respectively upon Cincinnati, St. Louis, and

¹¹ It is interesting to compare this area with what Sten De Geer calls "The American Manufacturing Belt," in an article of that title in *Geografiska Annaler*, vol. ix (1927), pp. 240-359.

Chicago-Milwaukee. There might be some question as to whether the Twin Cities region in Minnesota should not be constituted a fourth zone, but it is preferable to include it with the Chicago-Milwaukee district, since otherwise it would not only be much smaller and less important than any of the others, but would be the only one to lack a 'major shoe center' as previously defined.

In Table 60 is presented a detailed analysis of the factories and output of each district and the principal shoe towns within it. The symbols used are as follows:

Kind of shoes:

- W Women's and misses'
- M Men's
- C Children's and infants'
- B Boys'

Grade of shoes:

- F Fine
- M Medium
- C Cheap

Size of factories:

- VL Very large
- L Large
- M Medium
- S Small

*Method of distribution:*¹²

- R Through retailers
- J Through jobbers
- D Through department stores
- C Through manufacturers' chain stores

In every case the symbol denotes the predominant tendencies only. The symbol WC, for example, means that women's shoes are in general of first importance, with children's and infants' as a secondary specialty. When there are no data or no clearly-defined specialties, the symbol (. . .) is used. A rough cartographic representation of regional specialization in men's, women's, and children's shoes, based on the same data as the table, is given in Fig. 42, on p. 188 above.

¹² As explained in Chapter XI above, since 1930 there has been a strong trend toward direct selling to retailers and toward the integration of manufacturing and retailing. The 'D,' 'R,' and 'C' classifications have gained at the expense of 'J.'

LOCATION OF THE SHOE INDUSTRY

279

TABLE 6o
SHOE PRODUCTION BY ESTABLISHMENTS IN INDIVIDUAL CITIES
AND DISTRICTS, 1929

	Number of Facto- ries	Kind of Shoes	Grade of Shoes	Size of Facto- ries	How Sold
ST. LOUIS DISTRICT	108				
St. Louis	34	W	MF	L	R
Missouri (remainder)	37	MB	M	L	R
Illinois (part)	27	W	M	L	R
Ky., Tenn., Ind., Ia., Kan. (parts)	10	M	M
CHICAGO-MILWAUKEE DISTRICT	130				
Chicago	38	F	M	R
Ill. outside Chicago (part)	5	W	M	M	R
Indiana (part)	3	MB	S
Michigan (part)	6	MB	M	L
Minnesota	15	M
Iowa (part)	4	M	M	M	R
Milwaukee, with Cudahy	31	M	L
Wisconsin (remainder)	28	MB	M	L	R
CINCINNATI DISTRICT	54				
Cincinnati	17	W	MF	M	R
Columbus	6	WC	M	ML
Portsmouth	4	WC	MF	L	R
Ohio (remainder)	13	W
Indiana (part)	8	M	M
West Virginia	2	MB	ML	L
Kentucky (part)	4	W	M	L	R
PHILADELPHIA DISTRICT	124				
Philadelphia and Camden	40	WC	MF	S	R
Penna. outside Phila. (part)	61	C	M	ML
N. J. outside Camden (part)	8	C	M	SM
Delaware	1
Baltimore	11	WC	MF	S
Maryland (remainder)	3	M	L
NEW YORK CITY DISTRICT	244				
Manhattan and the Bronx	101	W	FM	S	R
Brooklyn	121	W	FM	SM	R
Queens	9	M	M
New Jersey (part)	9	M	MF	SM	R
Connecticut	4	C

TABLE 60—Continued

	Number of Facto- ries	Kind of Shoes	Grade of Shoes	Size of Facto- ries	How Sold
ROCHESTER DISTRICT	62				
Rochester	33	CW	MF	M
Binghamton and vicinity	3	VL	CD
Buffalo	4	MW	M	M	R
New York (remainder, outside New York City)	22	M	R
NEW ENGLAND DISTRICT	606				
Auburn, Lewiston, Mechanic Falls	18	W	M	ML	J
Maine (remainder)	36	W
Manchester	24	W	M	ML
New Hampshire (remainder)	55	W	M	ML	J
<i>North Shore:</i>	287	W	M	S	J
Haverhill	94	W	M	S	J
Lynn	85	WC	M	S	J
Salem	20	C	M	S	J
Chelsea	19	W	M	S	J
Newburyport	15	W	M	M	R
Other towns	54	W	M	S	J
<i>South Shore:</i>	75	M	MF	ML	R
Brockton	36	M	MF	ML	R
Other towns	39	M	MF	M	R
Boston	35	W	MF	ML
Worcester	14	W	M	ML	J
Marlboro	9	MF	ML	J
Lowell	17	W	M	M	J
Massachusetts (remainder)	36	MB	M	M	J

CHAPTER XVII

THE THEORY OF LOCATION AGAIN

IN PART I, I attempted to assemble a body of principles which would provide an understanding of the basis on which economic activities are geographically distributed. The schematic diagram here presented (Fig. 53) and the accompanying summary are intended to give a picture of the way in which the parts of the theory fit together; the diagram is a route map, as it were, for the discussion in Part I, with the numbered arrows indicating the nature and direction of the locational influences discussed in the corresponding chapters.

In Chapter II the distribution of natural resources and markets was taken as given, and the effect of these data upon the location of extractive industries was investigated. The theoretical tools thus developed enable us to take account of transportation costs, diminishing returns, and the distribution of resources, which are the elements involved in a solution of the problem.

In Chapter III the location of the extractive industries themselves was taken as given, and we inquired into the influence of transport costs upon the location of manufacturing industries. Three broad categories of transport-oriented manufacturing industries were distinguished: the material-oriented, the market-oriented, and those which are not unconditionally oriented and are likely to be found at markets, material sources, or junctions. It was also made clear that the theory of orientation, as developed by Alfred Weber, needs to be combined with a theory of market areas or spatial competition in order to explain location satisfactorily. The nature of this synthesis was indicated.

In Chapter IV the locational factor of labor-cost differentials was analyzed, and found to be due to two distinct causes:

(a) Differences in the cost of living, as determined by nearness to agricultural districts and by the intensity of local demand for commodities produced under conditions of diminishing returns.

(b) Immobilities of labor, which prevent or retard the equalization of such differentials in real-wage levels as may arise.

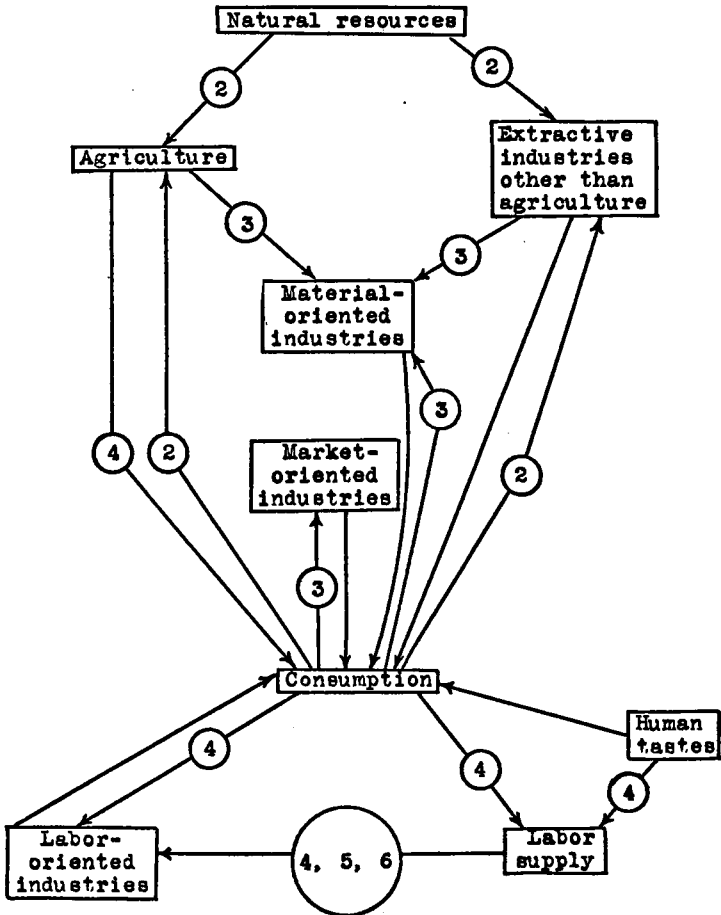

FIG. 53

The first of these involves transfer costs only; but the second is a real production-cost difference, independent of transfer costs.

Chapter V took up the general question of how the locational effects of transfer costs and production costs may be commensurated. When production costs vary from place to place, production will not always be at the point of minimum total transfer costs for each market. In some cases, transfer costs are of quite negligible importance, and market areas are not primarily spatial in character. Then the theory of location is confined to an explanation of systematic local differences in production costs.

Chapter VI dealt with certain modifications in the pattern of location ascribable to economies of concentration, for specific establishments or industries as well as for local clusters of industry in general.

One factor taken for granted throughout was the distribution of population, considered as market and as labor supply. To be sure, the variation in costs of labor between localities was partially accounted for, in Chapter IV, on the basis of the costs of obtaining 'budget materials'; but those costs are themselves dependent in part upon the distribution of consumer demand. To complete the picture, then, we should have to take into account the fact that each sort of economic activity is instrumental in locating population and thus markets for the products of economic activity in general.

It should also be noted that there are 'immobilities of consumption' analogous to the immobilities of labor introduced in Chapter IV. Both refer to the unwillingness or inability of human beings to migrate instantaneously to the places where they could obtain the maximum real income with the minimum of sacrifice. But the distinction between labor-immobility and consumer-immobility is more than a formal one. Many persons are free to live away from where their income originates, and hence have a different locational effect depending on whether they are considered as workers or consumers. Income from ownership, in general, creates consumers' demand without involving labor supply at all.

In order to make Fig. 53 legible, some omissions have been necessary. The whole distributive organization, for instance, is

left out. The effect of immobilities of capital and management, as well as those of monopolistic discrimination, complementary relationships between industries, and economies or diseconomies of concentration, would have to be added were the picture to be complete. None the less, the main outlines are there.

Everything in the figure seems to be determined by something else, with two exceptions. The distribution of natural resources we accept as a gift, and the factor of human tastes also lies outside our province. Furthermore, we must recognize that the whole locational adjustment depends upon the 'state of the arts': the technique of production, exchange, and consumption. To give reality to the theory it is necessary to add a third dimension to the picture: to take an historical view and show how locational patterns evolve. Here I shall try to indicate merely the broadest outlines of this development.¹

The most primitive sort of locational adjustment, both logically and historically, is that of self-sufficient agriculture. The 'basic agricultural stratum' of population, as Weber and Ritschl call it, is located quite simply according to the distribution of natural resources, with the more fertile districts presumably more intensively occupied and cultivated.

With transport develops trade and local specialization. A second stratum of population comes into being, carrying on simple village industries for the farmers. Since the materials, the market, and the labor are all furnished originally by the agricultural populations, the new 'industrial superstructure' is located with reference to that 'basic stratum.'

Historically this stage corresponds most nearly to that of village economy, but locationally it is already rather complex. The fundamental adjustment is that described in Chapter II: extractive

¹ For other discussions of the history of location see Alfred Weber, "Industrielle Standortslehre," in *Grundriss der Sozialökonomik*, vol. vi (1914); Hans Ritschl, "Reine und historische Dynamik des Standortes der Erzeugungszweige," in *Schmollers Jahrbuch*, 1927, pp. 813-870; Oskar Engländer, "Kritisches und Positives zu einer allgemeinen reinen Lehre vom Standort," in *Zeitschrift für Volkswirtschaft und Sozialpolitik*, 1926, pp. 498-505; René Maunier, "La distribution géographique des industries," in *Revue internationale de sociologie*, 1908; Adna F. Weber, *The Growth of Cities in the Nineteenth Century* (New York, 1899).

industries located with reference to natural resources and to markets determined by other extractive industries. Costs of transport, plus social or political restrictions, determine the size of market and supply areas.

The residents of one district, exchanging products with those of another, presumably send them along some fairly definite route. Route junctions are nodal sites for villages, by virtue of their special advantages in ease of transport in several directions. Inns and markets are naturally established at such places. Furthermore, certain locations possess definite advantages for village industries: water power for grist mills, for instance, and plentiful water supply for tanneries, fulling mills, and the like. At rich mineral deposits the localization of the material itself is enough to create concentrated settlement.

So at this early stage it is already possible to distinguish four embryonic types of urban cluster, each with its modern counterpart:

(a) The market town, with locational advantages primarily in transport relations (i.e., nodality). Sites with good harbors or commanding river crossings or mountain passes are the most conspicuous examples of this primarily commercial type of location, but any route junction possesses nodality.

(b) The manufacturing village, located generally at a water-power site to minimize production costs.

(c) The mining, fishing, or lumbering settlement, devoted to intensive extractive industry.

(d) The town located for other reasons, such as administrative or military considerations.

Of course most towns have the characteristics of more than one of the above types. Any one of the last three, for instance, acquires artificial nodality as routes are built to it from different directions, and thus becomes eligible to serve as a market town. All four types, but particularly the commercial and manufacturing, are dependent upon cheap transportation. Every reduction of the cost of carriage, and every lessening of restrictions on trade, tends to further the relative growth of these types of town. At the same time it allows further specialization. In the village economy, most manufactures are common to all villages. Nearness to mar-

ket being the most restrictive factor in the choice of locations, market areas are small and industries are distributed very nearly according to the population pattern. As transportation becomes cheaper, easier, and safer, the four types of town mentioned become more and more distinguishable.

This initial stage of location has been examined historically for the shoe and leather industries, and iron making is another good illustration. In the seventeenth and eighteenth centuries the fuel used was charcoal. This was a ubiquity in the eastern half of this country, and the other two necessary materials — ore and water power — were also widely distributed. As a result the iron industry was carried on at or near every little cluster of population.²

Certain goods capable of bearing high transport costs — because of great value in small bulk, localization of supply, or inelasticity of demand — foreshadow a subsequent stage of trade organization by being distributed over much larger areas than the village market territory.³ Salt, spices, and even millstones were shipped great distances during the Middle Ages when nearly everything else was produced by each community for itself. Art goods and luxuries of all kinds, being consumed by the wealthy and being produced at only a few places, were also sent long distances.

One of the bases for the early localization of certain industries was labor specialization, originating generally from localization of materials. The long-distance trade of the period of town economy thus consisted partly of products naturally localized in supply, such as amber, and partly of those produced by the specially skilled labor of certain localities. Guild organization attempted to preserve local labor advantages by restricting mobility.

As the improvement of highways, rivers, and canals steadily increased the possibilities of localization, 'town economy' gave

² As late as 1850, most of the charcoal furnaces and forges in Pennsylvania were using water power. *Documents Relating to the Manufacture of Iron in Pennsylvania*, published on behalf of the Convention of Iron Masters, Philadelphia, 1850.

³ Cf. Ritschl, p. 858: "Auf jeder Entwicklungsstufe [müssen] höhere Formen sich bereits in den Umrissen abzeichnen; ist doch jede Entwicklung ein fortgesetzter Uebergang."

place to 'provincial economy.' No longer was the town the center of a self-sufficient economic world, but industry was free to locate at any of several towns in each region, or even outside towns altogether. As a matter of fact, the countryside began at about this stage to offer considerable inducements to manufacturing industries, and a definite ruralization took place in many lines. The breakdown of feudal systems of land tenure, and in many places the declining fertility of the soil, gave rise to a surplus labor supply in rural districts. Some industries adapted to the use of water power sought rural locations for that reason, and became the nuclei of new mill villages or towns.⁴

The 'Industrial Revolution' meant, so far as location was concerned, primarily four things: the cheapening of carriage through new transport agencies, the removal of barriers to trade, the use of mechanical power, and the use of coal as a fuel. All these things tended to increase geographical specialization. The direct effects of easier transportation in widening market areas need no further explanation; but there were also some less obvious aspects of the change. Early village industries were market-oriented because they used local supplies of practically ubiquitous materials. Tanneries could operate practically anywhere in the eastern half of the United States, for instance, because tanbark, hides, and water were available in limited but sufficient quantities at every village. Similarly, the early iron industry on the Atlantic seaboard made use of charcoal and bog ore. For any industry requiring fuel, the forests provided the basis of a widely diffused locational pattern, with little specialization.⁵

The larger market areas created by improved transport gave importance to *quantity* as well as quality of resources. Local supplies which were not adequate to meet these new demands were

⁴ Iron smelting is the industry mentioned by Ritschl as the earliest to leave the towns in Germany; it was followed in the fourteenth and fifteenth centuries by the forging of iron and copper, in the seventeenth century by paper making, and in the eighteenth century by the manufacture of cotton textiles and glass. *Op. cit.*, p. 863; also Otto Quelle, "Industriegeographie der Rheinlande," in *Rheinische Neujahrsblätter*, 1926, p. 9.

⁵ Iron furnaces had to be diffused when they burned charcoal. The ordinary colonial furnace, producing a few tons of iron a day, required a woodlot two miles square. Malcolm Keir, *Manufacturing*, p. 181.

rapidly exhausted and abandoned. Such industries as tanning and iron making naturally responded to the altered conditions, then, by exhausting the old sources of their materials and migrating to virgin territory.⁶

The visible reason for these migrations was a differential in the cost of the necessary material (tanbark, charcoal, or ore) to the disadvantage of the older locations of the industry. One natural response, as suggested, was a shift of the industries to places where the materials were cheaper; but to regard this as the only logical response would be to assume that industrial technique is immutable. Equally logical was a change of technique designed to economize on the material which had risen in price. In iron making, and in fuel-using industries generally, this took the form of a substitution of coal for wood as a fuel. In tanning, it took the form of pre-concentration of tanbark to lessen the bulk to be transported, which had the effect of equalizing the price of the active tanning agent.

Thus the rapid changes in technique, and particularly the shift from wood to coal, were far from being merely accidental accompaniments of the improvement in transportation. Only as cheap carriage made localized production possible did it become imperative to replace the old bulky but ubiquitous materials by concentrated but localized ones.⁷

Reduction of transport cost likewise made it possible to localize production at points with lower manufacturing costs. This widened the market areas of towns and districts provided with large water-power sites or with a trained labor supply, and gave further scope to the *cumulative* concentration resulting from economies of large-scale production, localization, and urbanization. The nineteenth century saw an unprecedented development of regional and local specialization in particular industries, which

⁶ The term 'exhaustion' as applied here to a resource is a relative one. A deposit is economically exhausted when it can no longer supply the material at the price set by other sources, and this may come about either through rising costs at the source in question or through the tapping of new and better sources elsewhere.

⁷ This could be construed as a phase of the 'elimination of the organic in favor of the inorganic,' a technical trend discussed by Lewis Mumford in *Technics and Civilization* (New York, 1934), p. 47 and *passim*.

in the '90's began to attract the attention of statisticians and economists.⁸ Carried to its apparently logical conclusion, this tendency would have concentrated the industrial population in a relatively small number of highly-specialized production centers.

But certain contrary influences were also at work. Higher rents and food prices in congested districts exercised a selective effect on urbanization, so that the activities most subject to the specific economies of urban location elbowed out those less definitely urban. Still more important, the reduction of transport costs and the mechanization of processes tended to level off old differences in labor costs. In many industries, machine operatives became not only more footloose but more interchangeable.⁹ A further effect observable in some cases is a relative rise in labor costs at old localized centers, due not so much to higher costs of living as to the greater degree of labor bargaining power and to the irregularity of production incident to specialization in the non-staple lines of the product. The history of the shoe industry provides an illustration of all the factors mentioned in this paragraph.

It is not surprising, in view of these developments, that we have heard much in recent years about 'decentralization,' including interregional, intraregional, and even intraurban dispersion.¹⁰ In

⁸ It is noteworthy that the first two American contributions to the literature of location were Edward A. Ross's article, "The Location of Industries," in *Quarterly Journal of Economics*, April, 1896, pp. 247-268, and F. S. Hall's Census monograph, "The Localization of Industries," Census of 1900, *Manufactures*, part 1, pp. cxc-cxiv. Hall's survey was continued by Joseph D. Lewis in "The Localization of Industries," Census of Manufactures, 1905, part 1, pp. ccviii-cclxii. The unfortunate confusion between 'location' and 'localization' probably is due to this early emphasis on the latter.

⁹ Hermann Schumacher believes that this has gone so far that labor is no longer an important locational factor in the United States. "Die Wanderungen der Grossindustrie in Deutschland und in den Vereinigten Staaten," in *Schmollers Jahrbuch*, 1910, p. 462, and "Location of Industry," in *Encyclopaedia of the Social Sciences*.

¹⁰ Five recent American statistical studies are: F. B. Garver, F. M. Boddy, and A. J. Nixon, *The Location of Manufactures in the United States, 1899-1929* (University of Minnesota, Employment Stabilization Research Institute, vol. ii, Bulletin 10. 6, Minneapolis, 1933); Tracy E. Thompson, *Location of Manufactures, 1899-1929* (Bureau of the Census, 1933); W. N. Mitchell, *Trends in Industrial Location in the Chicago Region Since 1920* (University of Chicago, School of Business, Studies in Business Administration, vol. iv, no. 1, 1933); H. H. McCarty, *Industrial Migration in the United States, 1914-1927* (Iowa Studies in Business, no. vii, Iowa City,

addition to the causes just mentioned, this rests on certain recent developments.

The fact that long-haul railroad rates in this country practically ceased falling a few decades ago¹¹ helps to explain the slowing-up of the nineteenth-century localization movement. The motor truck has, in the main, reduced the costs and increased the convenience of short-haul traffic, so that the costs of transfer tend to be more nearly proportional to distance. It was shown in Chapter III that this should have a decentralizing effect, since it equalizes transfer advantages and makes additional points available for production.¹²

Another twentieth-century tendency, well illustrated by the history of the shoe industry, is the increasing importance of speed, style, and service in the manufacturer's relations with the market. In many cases, transport costs are an insignificant element in the total costs of transfer which determine the advantage of nearness to markets. The requirements of speed and convenience make a more decentralized location necessary to serve the market, and many industries besides shoemaking have shown a tendency to assume a locational pattern more similar to that of population. In some cases this involves splitting the process of manufacture or marketing, with branch warehouses or assembly plants; in other cases, a decentralization of the entire process.¹³

1930); Daniel B. Creamer, *Is Industry Decentralizing?* (Study of Population Redistribution, Bulletin 3, Philadelphia, 1935). Creamer distinguished between 'dispersion' and two forms of 'diffusion'; Garver, Boddy, and Nixon analyze three types of 'concentration'; Mitchell classifies industrial 'displacements' as 'unidirectional,' 'dispersional,' or 'concentric,' and also as 'inter-regional' or 'intra-regional'; Thompson and McCarty, without coining new terms, likewise differentiate between various forms of migration and localization.

¹¹ Cf. Fig. 23 in Chapter IV, above.

¹² On this see Palander, *Beiträge zur Standortstheorie*, ch. xii, § 24. I am also indebted to an unpublished paper of Mr. Benjamin Mark of Harvard University.

¹³ For instance, in the upholstered furniture industry, which until recently was concentrated in a relatively small number of large plants, the increasing variety of upholstery materials and colors has made it impracticable for the retailer to carry much more than samples. When the customer makes his choice, he wants delivery as soon as possible, and naturally this gives an advantage to near-by manufacturing plants. In order to match the quick delivery service of local factories, some of the large firms have had to set up branch factories. See Bureau of Foreign and Domestic

The substitution of electric transmission for the shipment of coal may be regarded as one example of a quite general tendency toward the reduction of weight losses in manufacturing by elimination of wastes at or near the source of the material. Since this 'beneficiation' of materials — to use the term applied to ores — involves an extra stage in manufacturing, it is associated with advancing technique and the development of a more complex division of labor. Other examples are the canning of fruits and vegetables, the making of milk into cheese, the preparation of tanning extracts, the preliminary concentration of the ores of iron and aluminum, and the earlier stages of the refining of copper, all of which are carried on as near the source of the materials as possible.¹⁴

The effect in all such cases is to reduce the advantage of nearness to the source of the material in question, so far as the main process is concerned. The replacement of coal by electricity is particularly important, because fuels are completely weight-losing materials, which transmit none of their weight to the product and have a correspondingly great locational attraction. The extent to which American manufacturing establishments have taken up the use of purchased electric power is shown in Table 61.

This would indicate that the most appropriate indicator of the relative importance of power costs as a location factor is no longer the weight of coal consumed per unit weight of product, but the number of horsepower-hours per unit of product. Where hydroelectric power replaces the direct use of water power, this means in

Commerce, Domestic Commerce Series, no. 75, *Furniture Distribution in the Midwest* (1932), p. 4.

¹⁴ Cf. Ritschl, p. 838. In the canning of fruits and vegetables the advantage is not so much in reduced bulk as in preservation, which enables the canned products to be marketed in a more leisurely and economical fashion. The 'ideal weight' is reduced in all these cases. Ritschl cites as a further example the coking of coal, but in this country only the beehive process is material-oriented. By-product ovens are located near the steel mills for two reasons: the demand for by-product gas in the mills, and the fact that coke is more friable than coal and hence not so efficiently transported for long distances. See Andreas Predöhl, "Die örtliche Verteilung der amerikanischen Eisen- und Stahlindustrie," in *Weltwirtschaftliches Archiv*, 1928, pp. 260-261, and Wilbert G. Fritz and T. A. Veenstra, *Regional Shifts in the Bituminous Coal Industry with Special Reference to Pennsylvania* (Pittsburgh, 1935), p. 39.

terms of locational theory the conversion of a resource into a material by extraction. No longer will great manufacturing cities grow up at water-power sites, unless these have other advantages too. But hydroelectric generation has led to the utilization of remote water-power supplies which otherwise might have run to waste indefinitely.

TABLE 61
FORMS OF INDUSTRIAL POWER CAPACITY IN THE UNITED STATES,
1899-1929¹

	1899	1914	1919	1929
Produced at factory (millions of HP)	9.8	18.4	20.0	20.2
Purchased (millions of HP)	0.2	3.9	9.3	22.8
Percentage of total power purchased .	1.8	17.4	31.7	53.1

¹ *Recent Economic Changes* (New York, 1929), p. 126; Census of Manufactures, 1929, vol. i, p. 112.

Where the use of carboelectric power replaces the generation of steam power at the factory, the change is differently stated in terms of locational theory. It is not the extraction of a natural resource that is in question here, but the insertion of a preliminary beneficiating stage in manufacturing, which results in less transportation for coal and the substitution of transportation of electric energy, which costs only about one-third as much.¹⁵ We may regard a carboelectric power plant, then, as a manufacturing establishment using one material (coal or coke) which has a weight loss of about 67 per cent. With a material index of 3, the carboelectric power industry ought to be very responsive to the location of coal supply; but the necessity of concentration in large-scale units, and the use of tremendous quantities of condenser water, generally interfere with the placing of such plants directly over the coal mines.

The locational relationship between electric power and coal is somewhat analogous to that between the truck and the railroad. In both cases the newer agency has reduced transfer costs for

¹⁵ From an address by Professor Francis G. Baily before the British Association for the Advancement of Science, reported in the *New York Times*, September 7, 1934, p. 7. This is, of course, a very rough and general estimate.

relatively short hauls, and increased the number of possible production locations, but has had no great interregional effect. In another respect, however, electric power and the truck have worked quite differently. Motor transport is more nearly on a mileage-tariff basis than railroads are, but electric power rates, within service areas, are generally not graduated according to distance.¹⁶ To date, no comprehensive survey of local variations in industrial power rates has been published, but releases by the Federal Power Commission seem to indicate that rates average lower in densely-populated areas.¹⁷ If this is generally true, it will encourage localization as between service areas, while at the same time the policy of blanket rates will encourage decentralization within any given service area. Some degree of suburbanization of industry would seem to be the logical outcome.

A factor often neglected is the great progress that has been made in increasing fuel efficiency, not only in the production of electric power but in direct uses as well. It has been estimated that between 1909 and 1929 the fuel requirements of American industries and railroads (including public-utility power plants) were reduced by about one-third per unit of product. The power

¹⁶ Walter E. Caine, "Uniform Rate Areas," in *Journal of Land and Public Utility Economics*, May, 1932, pp. 148-163.

¹⁷ With reference to residential rates, the Commission reported in March, 1936, that "the influence of the size of community upon the charges for electric service is unmistakable, and is especially apparent in the bills for 25 and 100 kilowatt-hours. The average bill for 25 kilowatt-hours is \$1.55 in the largest communities, increasing step by step to \$2.83 in communities under 250 population. . . ." (*New York Times*, March 16, 1936).

In its 1935 *Electric Rate Survey* (Rate Series no. 2 — State Reports), the Commission enumerated the factors determining electric rates as follows: "Availability of fuel resources and accessibility of water power go far, in some instances, to explain differences in rate levels. Geographic and economic conditions have a marked influence, as do the varying tax policies of the several States and communities. Density of population, seasonal requirements, presence or absence of large industries, variations in the purchasing power of the people, and even climatic conditions may give rise to rate differences not otherwise explainable. Finally, reference might be made to the extent of the authority and the effectiveness of State regulatory bodies, as well as the influence of competition, whether of a public or private electric company or a substitute commodity, such as gas. . . . Taken all together, they fall short of explaining the range of charges from minimum to maximum, which in many cases exceeds 100 per cent."

stations showed the greatest reduction (66 per cent), but oil refineries cut fuel consumption 36 per cent, iron and steel mills 25 per cent, and cement plants 21 per cent.¹⁸ Other things being equal, the importance of nearness to fuel sources has been reduced by these same percentages.

Finally, many recent locational developments have been ascribed to the passenger automobile. This means of transport has increased the travel range of labor and thus made possible the location of factories in suburban or even rural sites; and recent surveys show that the most rapid growth of new industry is in the peripheral zones around the larger cities. Such decentralization as has taken place is mainly suburbanization.

Some stages of the marketing process have become increasingly centralized and more closely integrated with manufacturing from the standpoint of location as well as control. In this too, the automobile has played an important rôle.¹⁹ Not only are consumers now able to shop within a larger radius, but their buying habits have become more standardized. This is not inconsistent with the growing emphasis on being up-to-date in style goods. All three factors make it advantageous to concentrate marketing in larger establishments and under more centralized management.

I have emphasized the fact that the sort of theory expounded in Part I, although it throws much light on historical processes, is merely a groundwork. Before the theory of location can be a very useful practical instrument, it must be developed in some directions in which barely a start has been made.

The first and perhaps the most obvious of the needed developments is an approach from the standpoint of the individual entrepreneur under conditions of monopolistic competition. It is now beginning to be recognized that distance is one of many factors which make actual markets something other than purely competitive, and much discussion of monopolistic competition has used distance as a convenient symbol for any one aspect of mar-

¹⁸ F. G. Tryon and H. O. Rogers, "Statistical Studies of Progress in Fuel Efficiency," in *Transactions of Second World Power Conference*, vol. vi (Berlin, 1930), p. 360.

¹⁹ Cf. Stephan Viljoen, *The Economic Tendencies of To-Day* (London, 1933), pp. 124-125.

ket-separation. Thus Hotelling develops Launhardt's case, and makes the conclusions apply to all forms of differentiation from the acidity of cider to the platforms of political parties; his precedent is followed by Zeuthen, Chamberlin, and Schneider.²⁰ The further development of the theory of location in this direction will be determined largely by progress in the general theory of monopolistic competition. Locational theorists may lend a hand to further this progress, at the same time keeping on the alert for any aspects of the problem that are peculiar to location and thus call for special consideration.

Hand in hand with a consideration of monopolistic elements in location (perhaps it would be more accurate to say locational elements in monopolistic competition) goes a development of locational theory for the short run. The forces of inertia are particularly powerful where distance is concerned: human beings are less mobile locationally than in many other ways, and durable instruments of production may approach the absolute immobility of land itself. At any given time, the actual pattern of location will be quite different from the norm or equilibrium toward which it is currently aimed.

The norm itself has been altered in the past by such diverse events as new processes for making steel, the increased consumption of sugar and cigarettes, growth of population, drought-resistant wheat, freedom of contract, discovery of coal deposits, anti-Semitism, mosquito control, erosion, minimum wage laws, legalization of betting on horse races, the 'emancipation of women,' and the radio. Obviously the tendency toward such a fickle norm is only a very rough and general guide.

As Palander has shown more clearly than anyone else,²¹ the locational situation at any time is determined very largely by the

²⁰ Harold Hotelling, "Stability in Competition," in *Economic Journal*, March, 1929, pp. 41-57; F. Zeuthen, "Theoretical Remarks on Price Policy: Hotelling's Case with Variations," in *Quarterly Journal of Economics*, February, 1933, pp. 231-253; E. H. Chamberlin, *The Theory of Monopolistic Competition* (Cambridge, Mass., 1933); Erich Schneider, "Preisbildung und Preispolitik unter Berücksichtigung der geographischen Verteilung von Erzeugern und Verbrauchern," *Schmollers Jahrbuch*, 1934, pp. 257-277, and "Bemerkungen zu einer Theorie der Raumwirtschaft," in *Econometrica*, January, 1935, pp. 79-105.

²¹ *Beiträge zur Standortstheorie*, ch. xi.

relative rates of adjustment of the factors concerned. The greater the lag in adjustment, and the greater the diversity among the lags of the several factors, the more maladjustment there is likely to be.

Contemporary economic theory is coming to the view that the wastes of short-time maladjustment, or 'instability' may be more important than the exact optimum long-run adjustment, since the latter is never realized anyhow. It may be sound policy to depart from the canons of long-run equilibrium in order to avoid sudden shocks. In tariff-making, for example, this consideration furnishes an argument for the practice of raising duties against the products of countries enjoying a temporary export advantage due to exchange depreciation. Logical extension of the principle would imply putting the brakes on too rapid interregional migrations of industry, so as to allow for an easier, and from a broad point of view a cheaper adjustment of the productive factors. The real problems are the definitions of 'too rapid migrations' and the 'broad point of view,' of which more will presently be said.

The object of short-run locational inquiry should be to investigate the rates of adjustment for the various factors involved in location: to find out, for example, how fast population will move from places where there are low wages and unemployment to places where there are high wages and full employment;²² how long an industrial plant in an obsolete location will continue to produce; how great are the factors of resistance to the transference of capital and entrepreneurship from one locality to another; how quickly a population group can learn new occupations; and so on. As the answers to these questions vary from industry to industry and according to time and place, there is plenty of scope for investigation.

Such inquiry should give us eventually a better idea of which factors lag behind others in the process of locational change. For instance, we might find that an industry was tending to migrate on account of an advance in technique that altered the conditions of its orientation. The migration requires eventually a locational

²² A noteworthy investigation of this kind is that of the Study of Population Redistribution (see Bibliography for titles).

adjustment of capital, entrepreneurship, labor, and auxiliary industries; but it is hardly likely that all of these will respond with the same promptness. Labor has in the past generally been the least mobile, though there are plenty of exceptions.²³

If we do find that some parts of the adjustment are outrunning the others, four policies are possible:

(a) To ignore the situation and let it work itself out, accepting the wastes of maladjustment as a part of the 'cost of progress.'

(b) To stimulate the mobility of the lagging factors, by subsidizing their migration or removing the obstacles that retard it. This may involve anything from vocational education, or the distribution of information bulletins, to special railroad rates for migrants or a broad 're-settlement' policy.

(c) To retard the mobility of the leading factors, by saddling them with the costs of (b) or by other means.

(d) To make a compensating shift in the technological or institutional set-up, calculated to offset some of the undesired repercussions of the original adjustment.²⁴ An example of this is the effort to develop new processes to use surplus materials or labor supplies, and the encouragement of substitute industries in depressed areas. The regulation of regional wage or tax differentials comes partly under this head and partly under (b) and (c). If, for instance, it were to be decided that the

²³ A frequently-cited example of the immobility of capital is the origin of the New Bedford cotton industry, based on the desire of whaling captains to invest locally the capital released by the decline of whaling. Dudley M. Phelps points out, in *The Migration of Industry to South America* (New York, 1936), that the absence of auxiliary industries is a major handicap for branch plants in South America.

²⁴ Historically I think this technological and institutional framework tends to become more flexible and allow more scope for collective initiative in changing the conditions of economic equilibrium. The extreme of this point of view is naturally expressed by the present-day Russian economic geographers, who have fitted a teleological theory of location into the Marxist ideology and regard Alfred Weber's professedly 'general' theory as little more than an apology for imperialism. See particularly the volume of essays edited by В. Ф. Васютин and Н. А. Ковалевский (V. F. Vasyutin and N. A. Kovalevski), entitled *Вопросы Экономической Географии* (*Questions of Economic Geography*) (Moscow, 1934). The lively interest in such matters in Russia, and the existence of a new German 'political' theory, are indicated by a two-column article in *Izvestia*, March 27, 1936, by А. Нейфах (A. Neyfach), entitled "Фашистский Экскурс в Теорию Размещения Промышленности" ("A Fascist Digression into the Theory of Industrial Location"), and concerned with a paper read at Dortmund in May, 1935, by Paul Berkenkopf, entitled *Die Auflockerung der Industrie-Standorte und der Anteil der Verkehrspolitik*.

further movement of the cotton textile industry out of New England were undesirable, one way to stop it would be to impose relatively higher taxes and minimum wages, or other restrictive conditions, in the South. The N.R.A. codes went a small step in this direction by setting up differentials that were generally smaller than those already in existence.

The choice of policies is not nearly so difficult a problem as that of knowing when to act at all. The idea that economic efficiency may ever be increased by lessening mobility will be a strange and shocking one to many economists. But that is only because we are prone to assume that the costs and returns that determine location under a system of private enterprise are the real costs and returns of the social group; that every 'sound business policy' is socially efficient and desirable.

A really complete welfare appraisal is of course an extremely complex thing. As F. H. Knight has pointed out, it involves a decision about what sort of wants it is desirable to encourage.²⁵ Taking any set of human wants as a datum on which to base criteria of efficiency is a deliberate simplification. As indicated at the beginning of this book, however, I am adopting this simplification, and not inquiring into the effect of economic conditions or policies upon wants.

There is, I think, general agreement upon the proposition that a free competitive price system would provide an ideal allocation of resources, provided the computation of costs and returns incident to a given step included all the costs and returns involved, and not merely those affecting the individual or firm which decided to take the step. In this sense a price system is the fundamental structure of all economics, and economic systems differ only in the way in which individual and collective sacrifices and satisfactions are weighted in determining these prices.

A broad criterion for the judgment of policies, then, might be this: If a policy has the result of making the costs and returns that determine location reflect more nearly the total social costs and

²⁵ F. H. Knight, "The Ethics of Competition," in *Quarterly Journal of Economics*, August, 1923, pp. 579-624, reprinted in a collection with the same title, New York, 1935. Few, I think, would now accept Professor T. N. Carver's idea that survival value is a ready-made and independent criterion of desirability.

returns, it is presumably to be approved; if it makes the determination of location less truly reflective of these total costs and returns, it is presumably to be condemned. Two difficult questions are involved here:

(a) The determination of what the true social costs and returns are in any given instance (for instance, how are we to value the enjoyment afforded by a park or a scenic highway?).

(b) The question of whether a given policy is likely to enhance or diminish the reliability of price as an indicator of the satisfactions and sacrifices of all concerned.

In many cases, the answer to the second question is relatively easy to give. Anti-smoke ordinances, for example, have the effect of bringing one of the real social costs of industrial development to bear upon the balancing of costs and returns that determines the location of smoke-producing industrial plants, which evidently makes for greater efficiency in the widest sense of the term.

Conflict between the interests of society and those of private enterprise may take various forms involving questions of location. Most prominent, perhaps, is the wasteful exploitation of natural resources which results from not taking into account the costs to others than the owner. This may injure coming generations (as in the case of oil or timber depletion, soil exhaustion, and erosion) or the present generation (as in the case of stream pollution).

Another group of possible conflicts arises from monopoly elements in industry, including those of both buyers and sellers. If, for instance, a basing-point system of prices distorts the distribution of plants using the product, and results in unnecessary cross-hauling, there is a *prima facie* argument against the practice.

A third source of possible conflict is in connection with urban concentration. In view of the complexity of the relationships involved, it would be a remarkable coincidence if the degree and kind of urban concentration determined by unfettered private enterprise happened to be the optimum from a social point of view. Mr. F. J. Osborn has put forth a promising line of attack on this question in his discussion of the optimum size of towns as collective units.²⁶ He points out that, because of insufficient con-

²⁶ F. J. Osborn, *Transport, Town Development, and Territorial Planning of Industry* (Publication no. 20 of the New Fabian Research Bureau, London, 1934).

sideration for this point of view, many well-intentioned public policies designed to relieve urban congestion have in fact the opposite effect.

In addition to these special groups of cases, there may be justification for interference with ordinary industrial migrations from one city to another. The real 'overhead costs' of an industry in a locality include a great many things besides the ones that enter into a firm's decision to move or not to move. Public policy should regard the region or town as a sort of economic enterprise having certain fixed costs to be taken into account when there is question of shifting industry from one region or town to another. The local labor supply, for instance, and the whole complex of auxiliary industries and services, represent costs which continue long after industry has migrated away.²⁷ If it is not feasible to make such costs variable, by stimulating the mobility of labor or otherwise, then the interests of efficiency would seem to demand that part of the costs of maintaining the community should be made to bear upon the decisions that locate enterprises.

This is but a hint of the enormous range of problems that any intelligent policy with regard to location must face. It is hoped that this book may serve as a basis for further inquiries into a field in which so much remains to be done.

²⁷ The reader will recognize that this is only a locational adaptation of the point of view advanced by J. M. Clark in *Studies in the Economics of Overhead Costs* (Chicago, 1923), ch. viii, "Labor as an Overhead Cost."

BIBLIOGRAPHY

BIBLIOGRAPHY

THIS list includes the sources found most useful in connection with the preparation of this volume, as well as a few to which I did not have access, but which are of too much importance to omit. For a more exhaustive bibliography of the literature of the theory of location, the reader is referred to Tord Palander's *Beiträge zur Standortstheorie*.

- Adamic, Louis. "Tragic Towns of New England," in *Harper's Magazine*, May, 1931, pp. 748-760.
- Aldrich, Nelson W. *Report on Wholesale Prices, Wages, and Transportation* (U. S. Senate, 52d Congress, 2d Session). Washington, 1892-93.
- Allen, Frederick J. *The Shoe Industry*. Boston, 1916.
- American Sole and Belting Leather Tanners, Inc. *Nothing Takes the Place of Leather*. New York, 1924.
- Andersen, Curt I. C. *Ueber die deutsche Filmindustrie und ihre volkswirtschaftliche Bedeutung unter Berücksichtigung ihrer internationalen Beziehungen*. Munich dissertation, 1929.
- Archer, Gleason L. *The Shoe Industry in Massachusetts*. Brief for Governor's Committee on the Shoe Industry, Boston, April 11, 1935. Typewritten.
- Arnold, J. R. "Leather Industries — Tanning," in *Encyclopaedia of the Social Sciences*.
- . *Hides and Skins*. Chicago and New York, 1925.
- Associated Industries of Massachusetts. *Industries of Massachusetts* (reprints from special issues of *Industry*), vol. i. Boston, October 15, 1928.
- Atwood, Rollin S. "Localization of the Cotton Industry in Lancashire, England," in *Economic Geography*, April, 1928, pp. 187-195.
- Black, J. D. *Introduction to Production Economics*. New York, 1926.
- . *The Dairy Industry and the A.A.A.* Washington, 1935.
- , editor. *Research in Agricultural Land Utilization*. Social Science Research Council, Scope and Method Series, no. 2. New York, 1931.
- Blanchard, Raoul. "The Utilization of Water Power in France," in *Harvard Business Review*, January, 1928, pp. 176-187.
- Bolles, Albert S. *Industrial History of the United States*, 3d edition. Norwich, Conn., 1889.
- Boot and Shoe Recorder* (weekly). Boston.
- Bortkiewicz, L. von. "Eine geometrische Fundierung der Lehre vom Standort der Industrien," in *Archiv für Sozialwissenschaft und Sozialpolitik*, May, 1910, pp. 759-785.
- Boston Chamber of Commerce. *New England's Industrial Supremacy*. Boston, 1921.

- Boston Chamber of Commerce. *The Shoe Manufacturing Industry of New England*. New England Industrial Surveys, no. 1. Boston, 1925.
- Bradford, Ernest S. "The Influence of Cheap Power on Factory Location and on Farming," in *Annals of the American Academy of Political and Social Science*, March, 1925, pp. 91-95.
- Brinkmann, Theodor. *Economics of the Farm Business* (translation). Berkeley, Cal., 1935.
- Brown, Robert M. "Cotton Manufacturing: North and South," in *Economic Geography*, January, 1928, pp. 74-87.
- Bureau of Railway Economics. *Commodity Prices in their Relation to Transportation Costs*. Washington, 1924 and later years.
- Burns, Arthur R. *The Decline of Competition*. New York, 1936.
- Caine, Walter E. "Uniform Rate Areas," in *Journal of Land and Public Utility Economics*, May, 1932, pp. 148-163.
- Carpenter, Niles. "Migration Between City and Country in the Buffalo Metropolitan Area," in *Economics, Sociology, and the Modern World: Essays in Honor of T. N. Carver*, ed. N. E. Himes, Cambridge, Mass., 1935.
- Chamberlin, Edward H. *The Theory of Monopolistic Competition*. Cambridge, Mass., 1933.
- Christiansen, C. Carl, *see* Weber.
- Clark, Victor S. *History of Manufactures in the United States, 1860-1914*. Washington, 1928.
- Commons, John R. "American Shoemakers, 1648-1895, a Sketch of Industrial Evolution," in *Quarterly Journal of Economics*, November, 1909, pp. 39-84.
- Cornelissen, Frédéric C. *Les industries des Pays-Bas: leur localisation géographique et leur évolution*. Paris, 1934.
- Creamer, Daniel B. *Is Industry Decentralizing? Study of Population Redistribution*, Bulletin 3. Philadelphia, 1935.
- Daggett, Stuart. *Principles of Inland Transportation*. New York, 1928.
- Day, Clive. "The Distribution of Industrial Occupations in England, 1841-61," in *Transactions of the Connecticut Academy of Arts and Sciences*, vol. xxviii, pp. 79-235 (March, 1927).
- De Geer, Sten. "The American Manufacturing Belt," in *Geografiska Annaler*, 1927, pp. 235-359.
- Depew, Chauncey M., editor. *One Hundred Years of American Commerce, 1795-1895*: New York, 1895. Section on tanning industry by R. H. Foerderer, vol. ii, pp. 494-497; section on boot and shoe industry by William B. Rice, vol. ii, pp. 566-574.
- Doane, Warren F. *The Flight of Capital and Industry from Massachusetts*. A study made for the Pennsylvania Manufacturers' Association. Philadelphia, 1935.
- Donham, Richard. "Problems of the Tanning Industry," in *Harvard Business Review*, July, 1930, pp. 474-481.
- Donovan, Alfred W. *Shoe Machinery Analyzed*. Rockland, Mass., 1912.
- Dorau, H. B., and Hinman, A. G. *Urban Land Economics*. New York, 1928.
- Dunbar, Seymour. *A History of Travel in America*. Indianapolis, 1915.

- Ely, Richard T., and Morehouse, E. W. *Elements of Land Economics*. New York, 1924.
- Engländer, Oskar. "Standort," in *Handwörterbuch der Staatswissenschaften*, 4th edition.
- . *Theorie des Güterverkehrs und der Frachtsätze*. Jena, 1924.
- . "Kritisches und Positives zu einer allgemeinen reinen Lehre vom Standort," in *Zeitschrift für Volkswirtschaft und Sozialpolitik*, 1926, pp. 498-505.
- . *Theorie der Volkswirtschaft*. Vienna, 1929.
- Epstein, R. C., and others. "Locality Distribution of Industries" (round table discussion), in *American Economic Review*, March supplement, 1929, pp. 172-178.
- Evans, Mercer G. "Southern Wage Differentials Under the NRA," in *Southern Economic Journal*, January, 1934, pp. 3-13.
- Federal Coördinator of Transportation. *Merchandise Traffic Report*, 1934.
- Federal Power Commission. *Electric Rate Survey*. Rate Series no. 1, 1935: Preliminary Report on Domestic and Residential Rates in Effect January 1, 1935, Cities of 50,000 Population and Over.
- Federal Trade Commission. *Report on Leather and Shoe Industries*. Washington, 1919.
- . *Report on Shoe and Leather Costs and Prices*. Washington, 1921.
- . *Report on Price Bases Inquiry; The Basing-Point Formula and Cement Prices*. Washington, 1932.
- . *Chain-Store Manufacturing*. Washington, 1933.
- . *Final Report on Investigation of the Chain-Store Industry*. Washington, 1935.
- Federated American Engineering Societies, Committee on Elimination of Waste in Industry. *Waste in Industry* (with chapter on the boot and shoe industry by Sanford E. Thompson). New York, 1921.
- Fetter, F. A. "The Economic Law of Market Areas," in *Quarterly Journal of Economics*, May, 1924, pp. 520-529.
- . *The Masquerade of Monopoly*. New York, 1931.
- Field, Maxwell. *An Industrial Relations Program for the Massachusetts Shoe Industry*. Typewritten thesis, Amos Tuck School of Administration and Finance, 1934.
- Fisher, A. G. B. *The Clash of Progress and Security*. London, 1935.
- Fitch, Edwin M., and Curtiss, Ruth L. *Industrial Trends in Wisconsin*. Bulletin of the University of Wisconsin. Madison, 1933.
- Foerderer, R. H., see Depew.
- Fox, Herbert L. *The Economics of Industrial Location with Especial Reference to Furniture Manufacturing in the United States*. Harvard undergraduate honors thesis (unpublished), 1934.
- Fraser, C. E., and Doriot, G. F. *Analyzing our Industries*. New York, 1932.
- Frisch, Ragnar. "Einige Punkte Einer Preistheorie," in *Zeitschrift für Nationalökonomie*, September 25, 1931, pp. 62-104.
- Fritz, Wilbert G., and Veenstra, Theodore A. *Regional Shifts in the Bituminous Coal Industry (with special reference to Pennsylvania)*. University of

- Pittsburgh, Bureau of Business Research Monographs, no. 4. Pittsburgh, 1935.
- Furlan, V. "Die Standortsprobleme in der Volks- und Weltwirtschaftslehre," in *Weltwirtschaftliches Archiv*, July, 1913, pp. 1-34.
- Galbraith, J. K., and Black, John D. "The Quantitative Position of Marketing in the United States," in *Quarterly Journal of Economics*, May, 1935, pp. 394-413.
- Galster, Augusta Emile. *The Labor Movement in the Shoe Industry, with Special Reference to Philadelphia*. New York, 1924.
- Gannon, Frederick A. *A Short History of American Shoemaking*. Salem, 1912.
- . *An Historical Sketch of American Leather Making*. Salem, 1916.
- Garver, F. B., Boddy, F. M., and Nixon, A. J. *The Location of Manufactures in the United States, 1899-1929*. Bulletins of the Employment Stabilization Research Institute, University of Minnesota, vol. ii, no. 6. Minneapolis, 1933.
- Gilboy, Elizabeth W. *Wages in Eighteenth Century England*. Cambridge, Mass., 1934.
- Gley, Werner. "Die Grossstädte Nordamerikas und die Ursachen ihrer Entwicklung," in *Frankfurter Geographische Hefte*, no. 2. Frankfurt a/ Main, 1927.
- Glover, J. G., and Cornell, W. B., editors. *The Development of American Industries*. New York, 1932.
- Goodrich, Carter, Allin, B. W., and Hayes, Marion. *Migration and Planes of Living, 1920-34*. Study of Population Redistribution, Bulletin 2. Philadelphia, 1935.
- Goodrich, Carter, and others. *Migration and Economic Opportunity*. Study of Population Redistribution, final report. Philadelphia, 1936.
- Gras, N. S. B. *Industrial Evolution*. Cambridge, Mass., 1930.
- Graves, W. Brooke. *Uniform State Action*. Chapel Hill, N. C., 1934.
- Haenger, see Weber.
- Haig, Robert M. "Toward an Understanding of the Metropolis," in *Quarterly Journal of Economics*, February and May, 1926, pp. 179-208, 402-434.
- Hall, F. S. "The Localization of Industries," in Census of 1900, *Manufactures*, part 1, pp. cxc-ccxiv.
- Hammer, see Weber.
- Hanrath, J. J. "Zum Problem der hypothetischen und konkreten Standortbedingungen. Dargelegt am Beispiel der Grossschlachtereien in den Niederlanden," in *Weltwirtschaftliches Archiv*, 1926, pp. 118-130.
- Hartshorne, Richard. "Location Factors in the Iron and Steel Industry," in *Economic Geography*, July, 1928, pp. 241-252.
- . "Location as a Factor in Geography," in *Annals of the Association of American Geographers*, June, 1927, pp. 92-99.
- . "The Economic Geography of Plant Location," in *Annals of Real Estate Practice*, Proceedings and Report of Industrial Property Division, vol. vi, 1926, pp. 40-76.

- Haverhill Board of Trade. *Haverhill, Massachusetts; An Industrial and Commercial Center*. Haverhill, 1889.
- Haverhill Evening Gazette*, extract: "Report of the visit of the Special Industrial Commission from Haverhill to Rochester (and other cities), planned principally for data to be used as one of the bases of all wage adjustment in Haverhill," Haverhill, May 1, 1921. A typewritten copy is on file at the Baker Library of the Harvard Graduate School of Business Administration in Boston.
- Hawtrey, R. G. *The Economic Problem*. New York, 1925.
- Hazard, Blanche E. "The Organization of the Boot and Shoe Industry in Massachusetts Before 1875," in *Quarterly Journal of Economics*, February, 1913, pp. 236-262.
- . *The Organisation of the Boot and Shoe Industry in Massachusetts before 1875*. Cambridge, Mass., 1921.
- Heberle, Rudolf. *Ueber die Mobilität der Bevölkerung in den Vereinigten Staaten*. Jena, 1929.
- Heer, C. *Income and Wages in the South*. Chapel Hill, N. C., 1930.
- Hill, Howard C. "The Development of Chicago as a Center of the Meat Packing Industry," in *Mississippi Valley Historical Review*, December, 1923, pp. 253-273.
- Högbom, Ivar. *Världssjöfarten. Dess geografiska och ekonomiska betingelser*. Göteborg, 1934.
- Holmes, W. Gerald. *Plant Location*. New York, 1930.
- Hotelling, Harold. "Stability in Competition," in *Economic Journal*, March, 1929, pp. 41-57.
- Huntington, Ellsworth, Williams, F. E., and Valkenburg, S. van. *Economic and Social Geography*. New York and London, 1933.
- Hurd, Richard M. *Principles of City Land Values*. New York, 1903.
- Iowa State Planning Board, Committee on Industry. *The Production and Marketing of Cornstarch Insulation Board* (mimeographed). Iowa City, 1935.
- Jessness, Oscar B., and Nowell, R. I. *A Program for Land Use in Northern Minnesota*. Minneapolis, 1935.
- Jewkes, John. "The Localisation of the Cotton Industry," in *Economic History* (supplement to the *Economic Journal*), January, 1930, pp. 91-106.
- Johnson, E. R., Huebner, G. G., and Henry, A. K. *Transportation by Water*. New York, 1935.
- Joint Commission of Agricultural Inquiry. *Report* (U. S. Congress, 67th Congress, 1st Session, House Report no. 408), part 3: Transportation.
- Jones, Edward D. *The Administration of Industrial Enterprises*. New York, 1916.
- Jones, Eliot. *The Trust Problem in the United States*. New York, 1921. Chapter viii on the United Shoe Machinery Corporation.
- Jones, M. Z. "Trend of Occupations in the Population," in *Monthly Labor Review*. May, 1925.

- Jones, Wellington D. "Ratios and Isopleth Maps in Regional Investigation of Agricultural Land Occupance," in *Annals of the Association of American Geographers*, December, 1930, pp. 177-195.
- Kahl, Erich, *see* Weber.
- Keir, Malcolm. "Economic Factors in the Location of Manufacturing Industries," in *Annals of the American Academy of Political and Social Science*, September, 1921, pp. 83-92.
- . "Is Shoe Manufacturing Leaving New England?" in *Boston Herald*, September 23, 1922, p. 14.
- . *Manufacturing (Industries of America*. Malcolm Keir, editor, vol i). New York, 1928.
- . "New England's Specialized Industries," in *Boston Herald*, September 24, 1922, section d, p. 6.
- . "Some Influences of the Sea upon the Industries of New England," in *American Geographical Review*, May, 1918, pp. 399-404.
- . "Some Responses to Environment in Massachusetts," in *Bulletin of the Geographical Society of Philadelphia*, July and October, 1917, pp. 121-138, 167-185.
- Krebs, P. "Die Frachtgrenze der deutschen Braunkohle," in *Technik und Wirtschaft*, 1924, pp. 213-218.
- Krzyzanowski, Witold. "Review of the Literature of the Location of Industries," in *Journal of Political Economy*, April, 1927, pp. 278-291.
- Kuhlmann, Charles B. *The Development of the Flour-Milling Industry in the United States*. Boston and New York, 1929.
- Lansburg, R. H. "Recent Migrations of Industries in the United States," in *Annals of the American Academy of Political and Social Science*, March, 1929, pp. 296-301.
- Launhardt, Wilhelm. "Der zweckmässigste Standort einer gewerblichen Anlage," in *Zeitschrift des Vereins deutscher Ingenieure*. March, 1882, pp. 104-115.
- . *Mathematische Begründung der Volkswirtschaftslehre*. Leipzig, 1885.
- Lewis, Joseph D. "The Localization of Industries," in *Census of Manufactures*, 1905, part 1, pp. ccxxviii-cclxii.
- Link, Adolf, *see* Weber.
- Lippincott, Isaac. *A History of Manufactures in the Ohio Valley to the Year 1860*. New York, 1914.
- MacKaye, Benton. *Employment and Natural Resources*. Washington, 1919.
- MacKinder, H. J. *Britain and the British Seas*. New York, 1902.
- Magee, Mabel A. *Trends in Location of the Women's Clothing Industry*. Chicago, 1930.
- Maunier, R. "La Distribution Géographique des Industries," in *Revue internationale de sociologie*, 1908.
- McCarty, H. H. *Industrial Migration in the United States, 1914-1927*. Iowa Studies in Business, vii. Iowa City, 1930.
- McDermott, Charles H., editor. *A History of the Shoe and Leather Industries*. Boston, 1918.

- McLaughlin, G. E. "Industrial Diversification in American Cities," in *Quarterly Journal of Economics*, November, 1930, pp. 131-149.
- McPherson, L. G. *Railroad Freight Rates in Relation to the Trade and Industry of the United States*. New York, 1909.
- Mitchell, William N. *Trends in Industrial Location in the Chicago Region since 1920*. University of Chicago, School of Business, Studies in Business Administration, vol. iv, no. 1. Chicago, 1933.
- National Electric Light Association Civic Development Committee, and Metropolitan Life Insurance Company, Policyholders' Service Bureau. *Industrial Development in the United States and Canada*. 1928(?)
- National Industrial Conference Board. *Hours of Work as Related to Output and Health of Workers — Boot and Shoe Industry*. Research Report no. 7. Boston, 1918.
- . *Trends in the Foreign Trade of the United States*. New York, 1930.
- . *The Competitive Position of Coal in the United States*. New York, 1931.
- National Municipal League, Committee on Metropolitan Government. *The Government of Metropolitan Areas*. New York, 1930.
- National Recovery Administration, Division of Review. *Final Report of Survey Committee on the Operation of the Code for the Boot and Shoe Manufacturing Industry*, July 16, 1935. Mimeographed.
- . *Boot and Shoe Manufacturing Industry*. Evidence Study no. 2, prepared by William P. Fallon. October, 1935. Mimeographed.
- . *An Explanatory Report on the Study of Natural Areas of Trade in the United States and a Guide to the Methodology used in its Preparation*. By Robert A. Dier, Work Materials Series, no. 42. Washington, 1936.
- . *Migration of Selected Industries as Influenced by Area Wage Differentials in the Codes of Fair Competition*. Work Materials Series, no. 45, mimeographed. Washington, 1936.
- National Resources Board. *Report*. Washington, 1934.
- . *State Planning*. Washington, 1935.
- . *Regional Factors in National Planning*. Washington, 1935.
- New England Council, Research Committee. Report at Second New England Conference, Hartford, 1926: *Merchandising New England Products — Shoes*. Boston, 1926.
- Norton, T. L. *Trade-Union Policies in the Massachusetts Shoe Industry, 1919-1929*. New York, 1932.
- Ogden, H. W. "The Geographical Basis of the Lancashire Cotton Industry," in *Journal of the Textile Institute*, 1927, pp. 1523-1594.
- Ohlin, Bertil. *Interregional and International Trade*. Cambridge, Mass., 1933.
- Orchard, John E. *Japan's Economic Position*. New York, 1930.
- Osborn, F. J. *Transport, Town Development, and Territorial Planning of Industry*. New Fabian Research Bureau, Publication no. 20. London, 1934.
- Palander, Tord. *Beiträge zur Standortstheorie*. Stockholm dissertation, 1935.
- Paver, John, and McClintock, Miller. *Traffic and Trade*. New York, 1936.

- Phelps, Dudley M. *Migration of Industry to South America*. New York, 1936.
- Pirath, V. G., and Vaile, R. S. *The Decline of Northwestern Flour Milling*. University of Minnesota Studies in Economics and Business, no. 5. Minneapolis, 1933.
- Pigou, A. C. *The Economics of Stationary States*. New York, 1935.
- Pirath, Carl. *Die Grundlagen der Verkehrswirtschaft*. Berlin, 1934.
- Pratt, Edward Ewing. *Industrial Causes of Congestion of Population in New York City*. Studies in History, Economics, and Public Law, Columbia University. New York, 1911.
- Predöhl, Andreas. "Das Standortproblem in der Wirtschaftstheorie," in *Weltwirtschaftliches Archiv*, 1925, pp. 294-321.
- . "Zur Frage einer allgemeinen Standorttheorie," in *Zeitschrift für Volkswirtschaft und Sozialpolitik*, 1927, pp. 756-763.
- . "The Theory of Location in its Relation to General Economics," in *Journal of Political Economy*, June, 1928, pp. 371-390.
- . "Die örtliche Verteilung der amerikanischen Eisen- und Stahlindustrie," in *Weltwirtschaftliches Archiv*, 1928, i, pp. 239-292.
- . "Die Südwanderung der amerikanischen Baumwollindustrie," in *Weltwirtschaftliches Archiv*, 1929, i, pp. 106-159.
- . "Die Wanderungen der amerikanisch-kanadischen Papierindustrie," in *Weltwirtschaftliches Archiv*, 1929, i, pp. 285-330.
- Pring, J. N., *Some Electro-chemical Centres*. Manchester, England, 1908.
- Procter, Henry R. *The Principles of Leather Manufacture*, 2d edition. New York, 1922.
- Raisz, Erwin. "The Rectangular Statistical Cartogram," in *Geographical Review*, April, 1934, pp. 292-296.
- Redford, Arthur. *Labour Migration in England*. London, 1926.
- Regional Plan of New York and its Environs. *Regional Survey*, vol. i, *Major Economic Factors in Metropolitan Growth and Arrangement*. New York, 1927; vol. ii, *Population, Land Values, and Government*. New York, 1929.
- Regul, Rudolf, "Die Wettbewerbslage der Steinkohle," in *Vierteljahrshefte zur Konjunkturforschung*, Sonderheft 34. Berlin, 1933.
- Rehe, Carl. *Die deutsche Schuhgrossindustrie*. Jena dissertation, 1908.
- Reichert, J. W. *Standorts- und Verkehrsfragen der Westeuropäischen Eisenindustrie*. Verkehrswissenschaftliche Forschungen aus dem Verkehrs-Seminar an der Westf. Wilhelms-Universität zu Münster I. W., Heft 5. Münster, 1935.
- Reilly, William J. *The Law of Retail Gravitation*. New York, 1931.
- Reinke, Kurt. *Der Standort des ostpreussischen Mühlengewerbes*. Königsberg dissertation, 1928.
- Reitell, Charles. "Mechanical Evolution and Changing Labor Types," in *Journal of Political Economy*, March, 1918, pp. 274-290.
- Retail Shoe Salesmen's Institute. *Materials in Shoes*. Vol. 3 of training course for retail shoe salesmen. Boston, 1920.
- Reynolds, W. M., and Rosenberg, S. M. "The New England Boot and Shoe Industry," in *The New England Economic Situation*, Harvard undergraduate essays in economics, pp. 43-63. Chicago and New York, 1927.

- Rice, William B., *see* Depew.
- Ringwalt, J. L. *Development of Transportation Systems in the United States*. Philadelphia, 1888.
- Ritschl, Hans. "Reine und historische Dynamik des Standortes der Erzeugungszweige," in *Schmollers Jahrbuch*, 1927, pp. 813-870.
- Robertson, D. H. *The Control of Industry*. New York, 1923.
- Robinson, E. A. G. *The Structure of Competitive Industry*. New York, 1932.
- Robinson, Joan. *Economics of Imperfect Competition*. London, 1933.
- Roe, Richard. "The United Shoe Machinery Company," in *Journal of Political Economy*, December, 1913, pp. 938-953, and January, 1914, pp. 43-63.
- Roscher, Wilhelm. "Studien über die Naturgesetze, welche den zweckmäßigen Standort der Industriezweige bestimmen," in *Ansichten der Volkswirtschaft aus dem geschichtlichen Standpunkte*, 3d edition (1878).
- Rose, John K. "Importance of Pipe Line Transportation," in *Economic Geography*, April, 1932, pp. 191-204.
- Ross, E. A. "The Location of Industries," in *Quarterly Journal of Economics*, April, 1896, pp. 247-268.
- Rühl, Alfred. *Die Nord- und Ostseehäfen im deutschen Aussenhandel*. Berlin, 1920.
- . *Das Standortsproblem in der Landwirtschaftsgeographie*. Berlin, 1927.
- Salin, E. "Standortsverschiebungen der deutschen Wirtschaft," in *Strukturwandlungen der deutschen Volkswirtschaft*, vol. i. Berlin, 1928.
- Salomon, *see* Weber.
- Sax, Emil. *Die Verkehrsmittel in Volks- und Staatswirtschaft*. Vienna, 1878.
- Scharf, J. T. *History of St. Louis City and County*. Philadelphia, 1883.
- Schilling, A. "Die wirtschaftsgeographischen Grundgesetze des Wettbewerbes in mathematischer Form," in *Technik und Wirtschaft*, 1924.
- Schlier, *see* Weber.
- Schneider, Erich. "Bemerkungen zu einer Theorie der Raumwirtschaft," in *Econometrica*, January, 1935, pp. 79-105.
- . "Preisbildung und Preispolitik unter Berücksichtigung der geographischen Verteilung von Produzenten und Verbrauchern," in *Schmollers Jahrbuch*, 1934, pp. 257-277.
- Schumacher, Hermann, "Location of Industries," in *Encyclopaedia of the Social Sciences*.
- . "Die Wanderungen der Grossindustrie in Deutschland und in den Vereinigten Staaten," in *Schmollers Jahrbuch*, 1910, pp. 451-481. Reprinted, *Weltwirtschaftliche Studien: Vorträge und Aufsätze* (Leipzig, 1911), pp. 401-429.
- Secrist, Horace. *The Widening Retail Market*. Chicago, 1926.
- Semple, Ellen Churchill. *American History and its Geographic Conditions*. Boston and New York, 1903.
- Shanahan, E. W. "Economic Factors in the Changing Distribution of Population Between Urban Centres and Rural Areas," in *Economic Journal*, September, 1927, pp. 395-403.
- Sherman, P. T. "A Study of the Causes of Congestion of Manufactures in

- New York City," in *Bulletin of the New York Bureau of Labor*, September, 1908, pp. 303-323.
- Shoe and Leather Reporter Annual*. Boston, Massachusetts.
- Smith, J. Russell. *Industrial and Commercial Geography*. New York, 1913.
- Sombart, W. "Einige Anmerkungen zur Lehre vom Standort der Industrien," in *Archiv für Sozialwissenschaft und Sozialpolitik*, May, 1910, pp. 748-758.
- Sorokin, Pitirim. *Contemporary Sociological Theories*. New York, 1928. Chapter iii, "The Geographical School."
- Sraffa, Piero. "The Laws of Returns Under Competitive Conditions," in *Economic Journal*, December, 1926, pp. 535-550.
- Study of Population Redistribution, see Thornthwaite, Goodrich, Creamer.
- Summerfield, Charles W. "Boot and Shoe Manufacture," in Pennsylvania, *Annual Report of the Secretary of Internal Affairs*, part iii, Industrial Statistics, pp. 7-57.
- Thomas, Lewis F. *The Localization of Business Activities in Metropolitan St. Louis*. Washington University Studies, new series, no. 1. St. Louis, 1927.
- Thornthwaite, C. W. *Internal Migration in the United States*. Study of Population Redistribution, Bulletin 1. Philadelphia, 1934.
- Thünen, J. H. von. *Der isolirte Staat in Beziehung auf Landwirtschaft und Nationalökonomie*. Hamburg, 1826.
- Timar, Margarethe. *Das Standortprobleme der australischen Industrien*. Vienna and Leipzig, 1934.
- Tryon, F. G., and Rogers, H. O. "Statistical Studies of Progress in Fuel Efficiency," in *Transactions of Second World Power Conference*, vol. vi. Berlin, 1930.
- United Shoe Machinery Company. *Goodyear Welt Shoes: How They Are Made*. Boston, 1911.
- . *An Industrial City*. Beverly, Massachusetts, 1911.
- . *Secret of the Shoe: an Industry Transformed*. Boston, 1910.
- . *The Story of Three Partners*. Beverly, Massachusetts, 1912.
- . *United Shoe Machinery Company: The Story of its Service and Methods as Told by Letters from the Shoe Manufacturers of the Country*. Boston, 1912.
- United States Bureau of the Census, 15th Census, 1930. *Shoe Chains*. 1932.
- . *Shoe Retailing*. 1933.
- United States Bureau of Foreign and Domestic Commerce. Domestic Commerce Series, no. 22. *The External Trade of New England*. 1928.
- . Domestic Commerce Series, no. 28. *Industrial Structure of New England*. 1930.
- . Domestic Commerce Series, no. 40. *Foreign Trade Survey of New England (Manufactured Products)*. 1931.
- . Domestic Commerce Series, no. 66. *Motor Truck Freight Transportation*. 1932.
- . Trade Information Bulletin, no. 582. *New England Manufactures in the Nation's Commerce*. 1928.
- United States Bureau of Labor Statistics. Bulletin 180. *The Boot and Shoe Industry in Massachusetts as a Vocation for Women*. 1915.

- United States Bureau of Labor Statistics. Bulletin 360. *Time and Labor Costs in Manufacturing 100 Pairs of Shoes, 1923*. 1924.
- Bulletin 384. *Labor Conditions in the Shoe Industry in Massachusetts, 1920-24*. 1925.
- Bulletin 483. *Conditions in the Shoe Industry in Haverhill, Mass., 1928*. 1929.
- Bulletin 499. *History of Wages in the United States from Colonial Times to 1928*. 1929.
- Bulletin 506. *Handbook of American Trade-Unions*. 1929.
- *Monthly Labor Review*.
- United States Department of Agriculture. Agriculture Circular 312. *Rural Factory Industries*. 1934.
- *Natural Land-Use Areas of the United States* (map with explanatory text). 1933.
- Bulletin no. 594. *Geography of Wheat Prices*, by L. B. Zapoleon. Washington, 1918.
- Bulletin no. 755. *Geographical Phases of Farm Prices: Oats*, by L. B. Zapoleon. Washington, 1919.
- United States Department of Labor, Women's Bureau. Bulletin 121. *Survey of the Shoe Industry in New Hampshire*. 1935.
- United States Industrial Commission. *Report*. Washington, 1900-02.
- Usher, A. P. "Comment se placent les usines: l'exemple des États-Unis," in *Annales d'histoire économique et sociale*, October 15, 1929, pp. 524-550.
- Vanderblue, Homer B. "Changes in the Localization of the Pig Iron Industry, 1901-26," in *Harvard Business Review*, July, 1926, pp. 417-424.
- Васютин, В. Ф., and Ковалевский, Н. А. (Vasyutin, V. F., and Kovalyevski, N. A.), editors. *Вопросы Экономической Географии. (Questions of Economic Geography)*. Moscow, 1934.
- Viljoen, Stephan. *The Economic Tendencies of To-Day*. London, 1933.
- Walker, P. F. *Industrial Development of Kansas*. University of Kansas, Engineering Bulletin no. 12. Lawrence, Kansas, 1922.
- Warshow, H. T., editor. *Representative Industries in the United States*. New York, 1928.
- Weber, Adna F. *The Growth of Cities in the Nineteenth Century*. Columbia University Studies in History, Economics, and Public Law, no. xi. New York, 1899.
- Weber, Alfred. "Industrielle Standortslehre," in *Grundriss der Sozialökonomik*, vol. vi, 1st edition, pp. 54-82. Tübingen, 1914.
- "Die Standortslehre und die Handelspolitik," in *Archiv für Sozialwissenschaft und Sozialpolitik*, May, 1911, pp. 667-688.
- *Ueber den Standort der Industrien*. Part i (Tübingen, 1909), *Reine Theorie des Standorts*, translated by C. J. Friedrich as *Theory of the Location of Industries* (Chicago, 1928). In part ii the following monographs have appeared:
1. Otto Schlier. *Der deutsche Industriekörper seit 1860*. 1922.
 2. Carl Christiansen. *Chemische und Farben-Industrie*. 1914.

3. Adolf Link. *Die Lederindustrie (erzeugende und verarbeitende)*. 1913.
 4. Wilhelm Haenger. *Standortsgeschichte der deutschen Musikinstrumentenindustrie*. 1919.
 5. Elisabeth Salomon. *Die Papierindustrie des Riesengebirges in ihrer standortsmässigen Bedingtheit*. 1920.
 6. Erich Kahl. *Die deutsche Kohlensäureindustrie vom Standpunkt der Standortslehre*. 1921.
 7. Rudolf Hammer. *Der Standort der deutschen Bijouterieindustrie*. 1922.
 8. August Zimmermann. *Die Tabakindustrie, unter besonderer Heranziehung badischen Materials*. 1931.
- Weeden, W. B. *Economic and Social History of New England, 1620-1789*. Boston and New York, 1890.
- Weil, Hugo. *Die deutsche Schuhindustrie in der Nachkriegszeit*. Leipzig dissertation, 1926.
- Whitbeck, R. H. "Geographical Influences in the Development of New Jersey," in *Journal of Geography*, January, 1908, pp. 177-182.
- . "Specialization in Industry by Certain Cities, with Particular Reference to Trenton, N. J.," in *Journal of Geography*, October, 1909, pp. 32-38.
- Wolman, Leo. *The Growth of American Trade Unions, 1860-1923*. National Bureau of Economic Research, Publication no. 6. New York, 1924.
- Women's Educational and Industrial Union. *Industrial Home Work in Massachusetts*. Studies in the Economic Relations of Women, vol. vii. Boston, 1915.
- Wright, John K. *The Geographical Basis of European History*. New York, 1928.
- Zapoleon, *see* United States Department of Agriculture.
- Zeuthen, F. "Theoretical Remarks on Price Policy: Hotelling's Case with Variations," in *Quarterly Journal of Economics*, February, 1933, pp. 231-253.
- Zimmermann, A., *see* Weber.
- Zimmermann, Erich W. *World Resources and Industries*. New York and London, 1933.

INDEX

INDEX

- Absorption of freight, 85 ff.
Agglomeration, 89 ff.
Agriculture, 21 ff.; and labor supply, 63 f., 108, 218 f., 223, 268 f.
Alabama, tanning, 152
American Federation of Labor, 232
Auburn, Maine, shoe industry, 220, 253, 275 ff.
Automobiles, assembly and distribution, 103; in passenger transportation, 71, 204
Auxiliary industries, as a factor in the localization of shoe manufacturing, 177, 228; as an economy of localization, 109, 297 n., 300
- Baltimore, shoe industry, 174, 226 n., 275 ff.
Bangor, Maine, shoe industry, 254, 277
Basing-point systems, 86 n.
Beneficiation of materials, 291 f.
Binghamton district, N. Y., shoe industry, 275 ff.
Blanketing of freight rates, 86
Boot and Shoe Cutters' Union, 234
Boot and Shoe Workers' Union, 232 ff.
Boston, advantage in shoe marketing, 173; export trade in shoes, 184 ff.; financial center for the shoe trade, 268 ff.; hide supply, 128; leather wholesaling, 148; meat packing, 141; shoe industry 173 ff., 184 ff., 217, 242, 253, 262, 268, 271, 273, 275 ff., 286 ff.; tanning, 126 ff., 260, 262
Branch plants, 91, 290 n.
Bridgewater, Mass., shoe industry, 160
Brockton, Mass., *see* Massachusetts, Brockton or South Shore district
Brodinsky, Joseph, quoted, 235
Brotherhood of Shoe and Allied Craftsmen, 233, 235, 238 n.
Brunck, Hermann, 109 n.
Budget materials, 62 ff., 283
Buffalo, N. Y., meat packing, 141, 142 n.; shoe industry, 280; tanning, 142 n.
Building sites as a factor in location, 76
By-products, 109; in meat packing, 140 n.; in tanning, 122
- California, Chinese shoe workers, 217 n.; real wage levels, 67; shoe industry, 180, 217 n., 277; tanning, 136, 138, 144 f., 150 ff.
Canadian shoe industry, 187
Canning of fruits and vegetables, 291 n.
Capital requirements, in marketing shoes, 173 f., 193 f., 268, 271; in shoe manufacturing, 199 f., 204, 221, 226, 271; in tanning, 123 f.
Carey, on rent, 8
Cassels, John M., cited on milk prices, 30 n.
Cattle raising, 140 n., 226
Central shops, in the shoe industry, 161 f., 218 f., 266 ff.
Chain shoe stores, 194 ff.
Chamberlin, E. H., 39 n., 111 n., 295
Chelsea, Mass., shoe industry, 275 ff.
Chicago, leather wholesaling, 148; meat packing, 140 f., 260; shoe industry, 173, 177, 221, 223 ff., 237, 242, 253, 269 f., 275 ff.; tanning, 142, 260
Child labor, in the shoe industry, 161, 211 ff., 266
Cincinnati, leather wholesaling, 148; meat packing, 141 f., 260; shoe industry, 174, 217, 221, 224 ff., 237, 243, 253, 269 f., 275 ff.; tanning, 260
Cities, optimum size, 299. *See also* Urbanization economies
Climate and industrial location, 76
Clothing industries, 192, 274
Coal, freight rates on, 11, 12, 15, 120; market areas in Germany, 11, 14; replaces wood as fuel, 287
Coke ovens, 44, 291 n.
Columbus, Ohio, shoe industry, 243, 253, 275 n., 279
Community promotion, 220 n., 254 f., 274
Complementary labor, 109; in the shoe industry, 211 ff., 215 ff., 266
Compo process, 163, 166, 192 n.
Connecticut, shoe industry, 180, 277 ff.; tanning, 128, 153
Consumption, mobility of, 283
Contract shoe stitching shops, 243 n.
Copper, refining, 291; smelting, 45 n.

- Cost of living, 108; according to size of city, 241; reflected in wage differences, 61 ff., 223
- Cotton, ginning, 44, 99; growing, 65 n.; textiles, 287 n.
- Critical isodapane, 77, 91 f.
- Cross-hauling, 85 ff., 299
- Custom shoemaking, 159 f., 265, 268 ff.
- Cut stock and findings industry, 118, 177, 262
- Cutting of shoe uppers, 165 f., 208, 212, 219 n.
- Dagyr, 217
- Daugherty, C. R., on labor union membership, 235 f.
- Decentralization, 66 n., 95, 107, 287 ff.; in the shoe industry, 220 f., 242 f., 252 ff., 274
- Delaware, shoe industry, 279; tanning, 145, 150 ff.
- Delivered prices, 85 f.
- Department stores, shoe sales, 196 f.
- Detroit, shoe industry, 223, 269; tanning, 262
- Diminishing returns, 13, 40
- Direct selling of shoes, 194 f.
- Discrimination, spatial, in pricing, 85 f., 110 f.; in transportation rates, 59
- Elasticity of demand, 19, 21, 32, 286
- Electric power, 291 f.; in the shoe industry, 166 f., 291; in tanning, 121, 146
- Equalizing differences in wages, 61 ff.
- Exports of shoes, 184 ff., 273
- External economies, "mobile and immobile," 90 n.
- Factory system, in the shoe industry, 162 ff., 199, 212, 268 f.; in tanning, 124, 146 ff.
- Federal Power Commission, *Electric Rate Survey*, 293
- Federal Trade Commission, on chain-store shoe manufacturing, 196 n., 197; on price basing systems, 86 n.; on shoe marketing, 194 f.
- Female labor, 109; in the shoe industry, 211 ff., 215 ff., 266
- Fetter, F. A., on market areas, 37 ff.
- Field, Maxwell, on integration of shoe manufacturing and retailing, 196 n.; on labor skill in the shoe industry, 208 n.; on shoe marketing, 196 n., 197 n.
- Fisheries, influence on tanning, 129 n.; on shoemaking, 214
- Flour milling industry, location, 38, 58
- Food, importance of expenditures on, 62 n.
- Freight absorption, 85 ff.
- Friedrich, C. J., 36 n.; on ideal distance, 40 n.
- Fuel efficiency, 260, 293 f.
- Furniture industry, branch factories, 290 n.
- Garment industry, 192, 274
- Georgia, shoe industry, 277; tanning, 153
- German immigration, and the shoe industry, 224 ff., 230, 269; and other industries, 224
- German "political" theory of location, 297 n.
- Gild organization, 286
- Glass industry, ruralization, 287 n.
- Glue factories, location, 109
- Goodyear welt process, 164, 208; machines leased, 200
- Handicraft stage, in shoemaking, 159 f., 199, 263 ff.; in tanning, 125 f., 129
- Hand-to-mouth buying, of leather, 260 f.; of shoes, 176 f., 191
- Hardware distribution, 39 f.
- Hartshorne, Richard, quoted, 64 n.
- Haverhill, Mass., leather wholesaling, 148; shoe industry, 171, 209 ff., 219 ff., 236 ff., 241 ff., 242, 253, 275 ff.; skill of labor, 209 ff.; wages, 241 f.
- Hazard, Blanche, 159 n., 228 n.; quoted, 160 f., 230 f.
- Home work, in the shoe industry, 212, 215 ff., 219 n., 266
- Hotelling, Harold, 111 n., 295
- Ideal distance, 40 n.
- Ideal weight, 40 f., 54, 59, 291 n.; in shoemaking, 169; in tanning, 118
- Illinois, shoe industry, 178 ff., 193, 239, 275 ff.; tanning, 132, 135 f., 138, 142, 144 f., 150 ff.
- Immigration, Irish and German, 224 ff.

- Imports, of hides and skins, 128 ff., 134 f., 150 n., 260, 270; of shoes, 190; of tanning agents, 120, 142 f., 147, 270
- Indiana, shoe industry, 180, 193, 239, 277 ff.; tanning, 150, 153
- Indianapolis, leather wholesaling, 148
- Industrial Revolution, locational aspects, 71, 287
- Integration, 57; of meat packing and tanning, 146 n.; of shoe manufacturing and retailing, 196 f., 278 n.; of tanning and shoe manufacturing, 261
- International Shoe Co., 192, 204 n.
- International trade theory, 4 f.
- Interregional trade theory, 5
- Iowa, shoe industry, 277 ff.
- Iowa State Planning Board, on trade areas, 105 n., 106
- Irish immigration, 224 f.
- Iron industry, before 1840, 137 n., 286 ff.
- Isodapanes, 42, 49, 77, 91
- Isotims, 8 ff., 37, 41
- Jewelry industry, labor supply, 70, 212 n.
- Junction points, locational advantages, 59, 102 ff. *See also* Nodality
- Kansas, shoe industry, 277 ff.
- Keir, Malcolm, quoted, 128, 174, 202
- Kemp, Harold S., quoted on German immigration, 225
- Kentucky, shoe industry, 178 ff., 277 ff.; tanning, 131, 138, 142, 144, 147, 150 ff.
- Kid leather, 134 f.
- Knights of Labor, 232
- Knights of St. Crispin, 230 f.
- Labor coefficient, 63
- Labor costs, importance, 60, 216; in cotton growing, 65 n.; in shoemaking, 168 ff., 206, 216, 254 f.; in tanning, 122 f., 150; Weber on, 63, 70 n.
- Labor markets, large, advantages, 70, 74, 108; in shoe manufacturing, 211
- Labor organization, 70, 74; effect on labor costs and localization, 95, 241 f., 254; geographical distribution of union strength in the shoe industry, 229, 236 ff.; membership in the shoe industry, 233 ff.; N.R.A., 235; "pro-gressive" unions, 233 ff.; "protection" against, 255; styles, 238 ff., 274 f.
- Labor orientation, 71; and agglomeration, 89
- Labor supply, and agriculture, 63 f., 108, 218 f., 223, 268 f.; population as, 283
- Land, 3
- Land utilization, 21 ff.
- Lardner, Dionysius, Law of Squares, 19 n.
- Large-scale economies, 90, 102, 109 f., 288; in marketing, 294; in power production, 292; in purchasing of skins, 150 n.; in the shoe industry, 178, 191, 194 n., 199, 204 n., 205, 229, 274, 277; in tanning, 123 f., 129, 148 ff., 260; in transshipment and handling, 58. *See also* Size
- Lasting machine, 165
- Launhardt, Wilhelm, 8 ff., 36 f., 52, 54 f.
- Leasing system for shoe machinery, 200 ff., 226, 229, 271
- Link, Adolf, on orientation of the shoe industry, 167 ff.; on orientation of the tanning industry, 119 ff.; quoted, on labor skill, 209 n., 211 n.
- Loading cost, 20, 56 f.
- Localization, coefficient of, 182 ff.; curve, 184; diseconomies, 95, 241 f., 254, 280 f.; origins of, 70 n., 286
- Localization economies, 90, 93 ff., 210 f., 216, 288; in marketing, 104, 262; in tanning, 123, 129, 260 f.
- Locational weight, 78
- Lowell, Mass., shoe industry, 275 ff.
- Lynn, Mass., division of labor, 128, 217; labor supply, 210 ff.; putting-out system, 160; shoe factory emigration from, 243 n., 252; shoe industry, 128, 160, 210 ff., 213, 217 ff., 242 f., 252 f., 262, 275 ff.; shoe machinery, 201 n.; tanning, 128
- McKay, Gordon, 162, 200, 226
- McKay machine, 162 ff.; leased, 200, 226, 271; skill requirements, 212, 230, 269, 271
- MacKinder, H. J., on nodality, 59 n.
- Mail-order houses, shoe sales, 196 f.
- Maine, shoe industry, 178 ff., 190 n., 193, 220 f., 239, 275 ff.; tanning, 128, 135 f., 138, 142, 144, 150 ff.

- Manchester, N. H., shoe industry, 220, 253, 275 ff.
- Margin line, 16 ff., 94
- Market areas, 8 ff., 42 f., 79 ff.; boundaries, 11, 85, 104; overlapping, 85
- Market contact as a locational factor, 39, 66, 102, 290; in the shoe industry, 172, 176 f., 192 ff., 272; in tanning, 261. *See also* Speed; Transfer costs
- Marlboro, Mass., shoe industry, 280
- Marshall, Alfred, quoted on localization, 211
- Marxist locational theory, 297 n.
- Maryland, shoe industry, 178 ff., 193, 239, 275 ff.; tanning, 150 ff.
- Massachusetts, Brockton or South Shore district, shoe industry, 168 n., 174, 176 n., 189 n., 213, 217 ff., 233, 238 n., 242, 253, 262, 266, 273, 275 ff.
- Massachusetts, North Shore district, shoe industry, 171, 192 n., 196 n., 213, 217 ff., 228, 242, 266, 275 ff.; tanning, 126 f.
- Massachusetts, shoe industry, 174, 177 ff., 184 ff., 192 f., 212 n., 213 ff., 230 ff., 235, 239 f., 242, 253 f., 264 ff., 273, 275 ff.; tanning, 128, 132 n., 135 f., 138 f., 144 f., 150 ff., 160 ff. *See also* names of cities
- Material index, 40 f., 78; in shoemaking, 167 ff.; in tanning, 119 ff.
- Materials in shoes, cost, 170 n.; quality, 227 f.
- Matzelliger, J. E., and the lasting machine, 165
- Meat packing and tanning, 109, 116 ff., 140 ff., 146 n., 260, 270
- Michigan, shoe industry, 277 ff.; tanning, 130, 134, 136, 139, 144 f., 150 ff.
- Migration, 61, 67 ff.
- Milk, cream, and butter, supply areas, 30 ff.
- Milling in transit, 58
- Milwaukee, leather wholesaling, 148; meat packing, 141; shoe industry, 217, 223 ff., 237, 242 f., 253, 269, 275 ff.; tanning, 142, 146, 260
- Minimum transport costs, 36, 41 f., 48, 54 ff., 77; away from materials and market, 52 ff., 57 f.; at junctions, 59
- Minimum wage differentials, 64 n., 298
- Minnesota, shoe industry, 277 ff.
- Missouri, shoe industry, 178 ff., 193, 239, 275 ff.
- Mobility, 3 ff., 14 n., 34, 298; of capital, 296 f.; of labor, 61, 71, 203, 283, 294 ff., 300
- "Momentum of an early start," as a locational factor, 98, 213
- Monopolistic competition, 110 f., 294 f., 299
- Motor transport, 71, 290, 292 ff.; for shoes, 176 n.
- Nashville, Tenn., shoe industry, 277
- National Recovery Administration, and labor organization, 235; trade areas, 105; wage differentials in codes, 64 n., 298
- National Shoe Workers' Union, 235
- Newark, N. J., tanning, 262
- New Hampshire, shoe industry, 178 ff., 190 n., 193, 220 f., 239, 275 ff.; tanning, 128, 136, 138, 144 f., 152 ff.
- New Jersey, shoe industry, 178 ff., 193, 218 n., 239, 264, 267, 269 f., 277 ff.; tanning, 135 f., 138, 144 f., 150 ff.
- New York City, leather wholesaling, 148; meat packing, 141, 142 n.; shoe industry, 163, 177, 192, 218 n., 224, 228, 232, 237, 240, 242 f., 253, 262, 264 ff., 275 ff.; tanning, 127 f., 136, 138 f., 142 n., 262
- New York State, shoe industry, 178 ff., 193 f., 220, 239, 242, 275 ff.; tanning, 130, 142, 144 f., 150 ff. *See also* names of cities
- Newburyport, Mass., shoe industry, 275 ff.
- Nodality, 59 n., 99 ff., 285; illustrated in Haverhill, 219; in meat packing, 140 n.; in midwestern commercial centers, 221; in New England, 215
- Non-competing groups, 60, 223
- North Adams, Mass., shoe strike of 1872, 231
- North Carolina, tanning, 131, 145, 150 ff.
- Ohio, shoe industry, 178 ff., 193, 239, 275 ff.; tanning, 131, 134, 136, 138, 144, 150 ff.
- Ohlin, Bertil, 4, 39, 60 f., 90, 108
- Orientation, 36, 42, 99 ff.; zones of, 50, 54 f.
- Osborn, F. J., 299

- Overcapacity, in the shoe industry, 191
 Overhead costs, social, 300
- Palander, Tord, 8 n., 38, 54 f., 62 n.,
 111 n., 295; on agglomeration, 91; on
 milling in transit, 58 n.; on Weber, 42
- Paper industry, ruralization, 287 n.
- Parasitic labor, 109. *See also* Comple-
 mentary labor
- Peabody, Mass., tanning, 262
- Pennsylvania, shoe industry, 178 ff.,
 193, 239, 269, 275 ff.; tanning, 127 f.,
 130 f., 135 f., 138 f., 142 f., 145 f.,
 148, 150 ff.
- Philadelphia, leather wholesaling, 148;
 meat packing, 141; shoe industry,
 163, 174, 177, 194, 218, 220, 224,
 229 f., 232, 237, 240, 242, 253, 262,
 264 ff., 275 ff.; tanning, 127 f., 135,
 174, 262
- Pick, Georg, mathematical appendix to
 Weber, 52
- Piece rates in shoe manufacturing, 238
- Pirath, Carl, on terminal costs in trans-
 portation, 56
- Pirmasens, German shoe center, 211 n.
- Pittsfield, Mass., tanneries, 132 n.
- "Poles" and the theory of orientation,
 54 f.
- Population specialization, index, 179 ff.
- Portsmouth, Ohio, shoe industry, 243,
 279 f.
- Potteries and labor organization, 95
- Power machinery, in shoe manufactur-
 ing, 161 ff., 186, 200 ff., 269 ff.; in
 tanning, 121, 129, 146, 260
- Pratt, Edward, E., quoted, 107
- Printing and publishing, decentraliza-
 tion, 107
- Private brands of shoes, 197
- Productivity of labor in the shoe indus-
 try, 207
- Public control of location: methods and
 criteria, 296 ff.
- Pulling-over machine, 166
- Putting-out system in the shoe industry,
 160 ff., 218 f., 222, 266 ff.
- Quality of shoes, 174 ff., 187, 197, 208,
 220, 227, 269 f., 272; of shoe ma-
 terials, 227 f.
- Real-wage differences, 4, 6r, 67 ff.
- Regul, Rudolf, market areas for coal,
 11 f., 14 f.
- Reilly, W. J., quoted, on trade areas, 104
- Rent, 3, 8, 14 n., 23 ff.; as a locational
 factor for manufacturing industries,
 39 n., 76, 107, 171, 274; gradients and
 surfaces, 23 ff.
- "Replacement of material deposits," in
 Weber's theory, 78, 91
- Resettlement, 297
- Retail gravitation, law of, 104
- Retail shoe trade, 194 ff.
- Rhode Island, shoe industry, 178
- Ritschl, Hans, 70, 284
- Robinson, E. A. G., on external econo-
 mies, 90 n.
- Rochester, N. Y., leather wholesaling,
 148; shoe industry, 192, 223 ff., 237,
 240, 242, 253, 262, 269, 275 ff.
- Rochester convention of the Boot and
 Shoe Workers' Union, 232
- Ruralization of industry, 66, 287. *See
 also* Decentralization; Urbanization
- Russian locational theorists, 297 n.
- St. Louis, leather wholesaling, 148;
 meat packing, 141; shoe industry,
 170 n., 174, 221 ff., 237, 242, 253, 262,
 269 f., 275 ff.
- Salem, Mass., shoe industry, 275 ff.;
 tanning, 126 n., 129
- San Francisco, leather wholesaling, 148;
 shoe industry, 277
- Schneider, Erich, 111 n., 295
- Schumacher, Hermann, on labor-cost
 differentials, 289 n.
- Screw bottoming machine, 165
- Seasonal variation, in labor supply, 108,
 215; in shoe production, 185, 191, 211,
 239 f., 274, 289
- Shoe and Leather Workers' Independent
 Union, 235
- Shoe machinery, 161 ff., 186, 200 ff.,
 269 ff.; exported, 186, 273; royalties,
 202 f., 271
- Shoe Workers' Protective Union, 233 ff.
- Shoe Workers' Union, 235
- Silk industry, complementary labor, 109
- Size of shoe factories, 178, 191, 194 n.,
 199, 274, 277; and styles, 204 n.,
 205, and unions, 229; of shoe stores,

- 194 n., 197; of tanneries, 123 f., 129 n., 148 ff., 260
- Skeffington, Harry, and shoe union organization, 232
- Skilled labor, 66, 70 f., 286; in cities, 108; in shoe manufacturing, 160 f., 170, 192, 206 ff., 218 f., 223 ff., 227 ff., 265 ff., 287 ff.; in tanning, 150
- Slaves as shoe market, 160 n.
- Sombart, Werner, quoted, 93
- Speed as a factor in marketing advantage, 39, 102, 290; for hardware, 39; leather, 261; shoes, 176 f., 239, 272
- Standardization of shoe sizes, 175
- Steel industry, location, 57 f., 95
- Strikes, 74; in the shoe industry, 240, 243 n., 274; policy of the Boot and Shoe Workers' Union, 232
- Style and location, 66, 289 f.; cumulative "style localization," 192, 227, 254, 274 f.; in shoe manufacturing, 175 ff. 186 f., 190, 204 n., 238 ff., 254, 271 f., 274 f.; in tanning, 260 f.
- Substitute industries for depressed areas, 297
- Tanbark depletion, 126, 130 ff., 146
- Tanning agents and processes, 118 n., 137 n.; bark extracts, 121, 137 ff., 144, 259, 270, 288, 291; chrome, 143 ff., 147 n., 260, 270; imported, 120, 142 f., 147, 270
- Tariff, protective, 296; on hides, 130; on leather, 143; on shoes, 160
- Taxes, as a factor in industrial migration, 255, 274
- Tennessee, shoe industry, 178 ff., 239, 277 ff.; tanning, 131, 136, 145, 147, 150 ff.
- Terminal costs, 20, 56 f.
- Trade areas, 104 f.
- Transfer costs, 39 ff., 52, 55, 76, 102, 172. *See also* Market contact; Speed; Transportation costs
- Transport lines, 39, 59 n.; points, 59 n.; surfaces, 38
- Transportation agencies, for shoes, 176
- Transportation costs, effects of reduction, 66, 71, 259, 263, 285 ff.; railroad, 132, 169 ff., 226, 267; on shoes, 168 ff.; variation with distance, 11 ff., 20, 24, 38 ff., 41 ff., 52, 55, 86, 98, 290, 293; wagon, 169, 216
- Transshipment, 58
- Turned shoes, 165 n.
- Tying clauses, in shoe machinery leases, 201
- Ubiquitous materials, 37, 79, 262, 286 ff.
- Union leather, 138 ff.
- Union stamp contract, 232
- United Shoe and Leather Workers' Union, 233 ff.
- United Shoe Machinery Company (*and* Corporation), 186 n., 201 ff., 271
- United Shoe Workers' Union, 233 ff.
- Urbanization, 66, 71, 74, 93; diseconomies in shoe manufacturing, 240; diseconomies in tanning, 123; economies, 70, 74, 91, 108, 211, 288; selective, 289; welfare aspects, 299
- Village economy, 284
- Virginia, tanning, 131, 145, 147 f., 150 ff.
- Wages in the shoe industry, 230, 238, 240 ff., 254 f.; extent of piecework payment, 238 n.
- Walker, Perley, on complementary labor in the shoe industry, 212
- Water power, 285, 287, 292; in shoe manufacturing, 167; in tanning, 121
- Water supply, for power stations, 292; for tanneries, 115, 261, 285
- Water transportation, for shoes and leather, 132, 168 f., 173, 262 ff., 267, 273
- Weber, Alfred, 36; on agglomeration, 89 ff.; industry studies, 118; isodapanes, 42; on labor-cost differentials, 67 n., 70 n.; on locational integration, 261; Marxist attitude on, 297 n.; material index, 40; on population distribution, 284; on production-cost differentials, 77; on rent, 76, 107 n.; transport costs assumed proportional to distance, 52
- Weight-losing materials, 37, 291 f.; in tanning, 115
- Welfare economics and location, 298 ff.
- West Virginia, shoe industry, 277 ff.; tanning, 131, 139, 145 ff., 150 ff.
- Wheat prices in surplus and deficit areas, 10
- Wholesale trade in leather, 148, 262; in shoes, 173 f., 193 ff., 198, 268, 271;

INDEX

323

- tendency to eliminate shoe jobbers, 173 f., 194 ff., 271
- Wilmington, Del., shoe industry, 262; tanning, 145, 150 ff.
- Wilson, George A., 233 n., 235 n.
- Wisconsin, shoe industry, 178 ff., 193, 239, 275 ff.; tanning, 130, 134, 136, 138 f., 142, 144 ff., 150 ff.
- Woburn, Mass., tanning, 262
- Wolman, Leo, 234
- Woolen industry, ruralization, 67 n.
- Worcester, Mass., shoe industry, 275 ff.
- Zeuthen, F., 111 n., 295
- Zone delivered prices, 86 n.

CHECKED
BOOK-04

X9(M97):294.73 G7 68848

Hoover (Edgar M.): Location
theory and the shoe and leather
industries.

Name of borrower

Lent on

Received
back on

SERVANTS OF INDIA SOCIETY'S LIBRARY
POONA 4.

1. Books taken from the Library may not be retained for more than a fortnight.
2. Borrowers will be held strictly responsible for any damage done to books while the books are in their possession.