



GIPE-PUNE-021687

# HIGHWAY COSTS

SERVANTS OF INDIA SOCIETY'S LIBRARY,  
POONA 4

Cl. No.  
Ac. No.

Date of release for loan

otor  
ates

This book should be returned on or before the date last mentioned below.

*An overdue charge of 5 paise will be levied for each day the book is kept beyond this date.*

26 MAY 1968

ou

ig

ls

X 411:873.73.N39t.  
G7

L. C. Card No. A 39—137

21827

## FOREWORD

From the fact that

- vast sums of money have been expended for improving and maintaining highway facilities during the past third of a century,
- all of this money has been derived from some sort of impost on the general public through property taxes and bond issues or on motor vehicle owners and users through registration fees, gasoline taxes and other imposts,
- all of this money has been spent by some unit of government, such as Federal, State, county, road district or municipality,
- these improved highways and streets have become a roadway for a great transportation system, and
- they are used by a vast number of automobiles which furnish individual transportation for persons, whether on pleasure or business bent, and by a large number of trucks and buses engaged in commercial operations in competition with other transport agencies, including the railroads,

arise two important questions.

It is generally conceded that this competition should be fair. If it is to be fair, then, apart from the question of comparable regulation, highway transport should directly or indirectly pay fully for the costs of providing and maintaining its roadway facilities, just as railroads must provide and maintain their roadways.

We have asked three eminent highway engineers, of long experience and training in highway construction, design and cost to study this problem and report their conclusions to us. They have made an investigation and written a report. That report is submitted herewith.

**ARE HIGHWAY USERS FULLY PAYING FOR THE FACILITIES PROVIDED FOR THEM AND WHICH THEY USE?** They answer, No. In the twelve-year period 1921-1932 for which data are available, they have failed to pay fully for the facilities provided for them and which they use by \$9,756,000,000. For the year 1932 the deficiency amounted to \$682,000,000. This is subsidy. Subsequent figures show that the subsidy was not diminished for the succeeding years up to and including 1937.

**HAVE DIFFERENT TYPES OR CLASSES OF MOTOR VEHICLES HAD IMPOSED UPON THEM COSTS COMMENSURATE WITH THE FACILITIES THEY REQUIRE AND WITH WHICH THEY HAVE BEEN PROVIDED?** They again answer, No. The failure to pay by groups or classes of motor vehicles is shown in the study for the year 1932 and fair approximation for the year 1937. For the year 1932 the deficit or subsidy ranges per vehicle from \$876 for a three-ton truck to \$2,000 for the heaviest permissible truck, and for a seven-passenger bus, \$75 and a twenty-passenger bus, \$376.

This study demonstrates beyond any doubt that highway transport has been and is being substantially subsidized by government.

These are the facts. What is to be done about it?

J. J. PELLEY,

*President, Association of American Railroads.*

January 26, 1939.

MR. J. J. PELLEY,  
*President*, Association of American Railroads,  
Washington, D. C.

Dear Mr. Pelley:

In complying with your request, we submit herewith a report based upon extended investigation covering highway costs for the United States and a proper apportionment of these costs to motor vehicle owners.

We present immediately hereafter the findings that we have made with respect to highway costs and a proper allocation of these costs to motor vehicles.

Following these findings is a condensed statement of the principles and methods which we have employed in the study.

Then follows the complete and detailed study of the subject.

Very truly yours,

C. B. BREED,  
CLIFFORD OLDER,  
W. S. DOWNS.

## FINDINGS

1. Total highway cost for twelve-year period 1921-1932:

(a) State highways _____	\$4,749,071,000
(b) County and local roads _____	8,996,345,000
(c) City streets _____	7,130,730,000
Total _____	\$20,876,146,000

2. Highway costs properly chargeable to motor vehicle owners for the twelve-year period:

		<i>Per cent of Total Cost</i>
(a) State highways _____	\$4,269,373,000	89.90%
(b) County and local roads _____	8,074,413,000	89.75%
(c) City streets _____	3,444,563,000	48.31%
Total _____	\$15,788,349,000	75.63% aver.

3. Subsidy to motor vehicles for twelve-year period was:

Total costs chargeable to motor vehicles _____	\$15,788,349,000
Total payments of motor vehicles _____	6,031,395,000
Total subsidy _____	\$9,756,954,000

4. Subsidy to motor vehicles for the year 1932:

Cost _____	\$1,495,218,000
Motor vehicle payment _____	812,685,000
Subsidy _____	\$682,533,000

5. In 1932 typical motor vehicles failed to pay their proportion of highway and street costs:

	<i>Amount Chargeable</i>	<i>Amount Paid</i>	<i>Deficit</i>
Passenger car _____	\$42.40	\$27.13	\$15.27
Truck, 1 1/2 tons and less (private) _____	96.40	51.43	44.97
Truck, 1 1/2 tons and less (for hire) _____	208.71	100.71	108.00
Truck, 3 tons and less than 5 tons (private) _____	809.90	196.02	613.88
Truck, 3 tons and less than 5 tons (for hire) _____	1,145.73	269.01	876.72
Trucks, 5 tons (private) _____	1,432.36	270.88	1,161.48
Trucks, 5 tons (for hire) _____	2,024.45	369.81	1,654.64
Truck, over 5 tons (private) _____	1,705.53	356.40	1,349.13
Truck, over 5 tons (for hire) _____	2,412.41	491.76	1,920.65
Bus, over 20 passengers (common carrier) _____	1,318.48	441.61	876.87

6. After 1932 and until 1938 partial figures only are available for highway expenditures, but an analysis of these figures shows that in the year 1937 there was no less subsidy than in 1932.

## PRINCIPLES AND METHODS EMPLOYED

The problem involves a study of the expenditures on all highways and streets down to the latest year for which such data are available.

An analysis of these expenditures requires two important steps:

1. The determination of the total annual cost of highways and streets, the portion of these annual costs actually contributed by motor vehicles and by general taxation and the equitable amounts motor vehicles and the public should have paid. From the above the amount of subsidy to motor vehicles as a whole, if any, follows.

2. The determination of the equitable distribution of highway costs, chargeable to motor vehicles as a whole, among the different classes of vehicles. If a subsidy is found, the amount by which each class of motor vehicles has failed to pay its fair share should then be determined.

The period specifically reviewed was 1921-1932.

The year 1921 was chosen as the beginning of this period because the records for previous years were incomplete and in many respects unobtainable. The year 1932 was selected as the end of the period because that year was the last one for which comprehensive data were available.

The depreciated value of all highways and streets as of the end of 1920 was brought forward into the period 1921-1932 by estimating its original cost and assuming that one-half of its service life had been used up. Rights-of-way values were excluded and therefore left as a contribution by the public.

The data for subsequent years so far as available, have been compiled and analyzed and are included in the study separately.

A part of the expenditures for the period under review was provided by general taxation and a part by motor vehicle charges. The later charges were fixed by legislative action in the various States without the benefit of any economic analysis of highway costs.

To determine whether or not motor vehicles as a whole paid their fair share during the period under review there was required an analysis of highway costs on some equitable principles that would determine the fair share of the annual costs of highways which should be borne by the users. This led to the use of public utility principles as the proper basis of analysis of highway expenditures and financing.

These principles and the public utility concept as applied to highways have been approved by many authorities and have been sustained by the courts as applicable to highway finance and to charges to users for highway service.

On this basis all capital expenditures were then converted into annual costs by applying a proper service life to the various highway elements purchased through capital expenditures. To these were

added all other annual costs such as maintenance and operation interests and taxes on the unamortized portions. The sum of these cost items represented the annual costs year by year for the twelve-year period.

The total of annual costs for the twelve-year period amounted to about 21 billion dollars.

Just here arises the problem of determining the equitable amounts that motor vehicles on the one hand and the public on the other should have paid. The year 1904 was chosen as the year just preceding any substantial influence of the motor vehicle. For a long period before 1905 the public paid through general taxation for all highways and streets. The annual rate of such expenditures amounted to about \$1.00 per capita for rural roads and \$4.20 per capita (city population) for city streets. Even though it is well known that prior to 1905 a large part of highway expenditures was for commercial transportation, we have assumed that the amount the public would have been willing to continue to pay for highways during the period under review would have been the same per capita as it had actually paid for several years prior to the advent of the motor vehicle.

There was, therefore, charged against the general public each year \$1.00 per capita for rural road expenditures and \$4.20 per capita (city population) for city streets as equitably dividing the highway costs between motor vehicles and the general taxpayers.

We have determined on the basis set forth above that the motor vehicles should have paid during this period about 16 billion dollars. They did pay about 6 billions. We have determined that general taxpayers should have paid about 5 billions. They did pay about 15 billions.

*Thus, there was a subsidy of about 10 billion dollars enjoyed by motor vehicles as a whole for the twelve-year period.*

*Motor vehicles actually paid about 30 per cent of the annual costs of highways and streets and the public paid about 70 per cent. Our study concludes that motor vehicles as a whole should have paid 75 per cent and the public 25 per cent of the total annual costs.*

The next step required the distribution of the annual costs of highways and streets between the different classes of motor vehicles so that the subsidy as a whole might be appraised for each class of vehicle.

Some of the highway and street elements have been provided solely for heavier and wider vehicles, practically all used in commercial transport. The capital cost of these elements that has been especially provided for these larger and wider vehicles has been determined. For rigid and flexible pavements this amount was determined by application of the increment method proposed by the Joint Committee of Railroads and Highway Users according to which each class of vehicle should pay its fair share of the total annual cost and "the total additional cost of construction, improvements and maintenance to make a road suitable for a type of vehicle requiring such additional cost should be shared by each vehicle of that type and each vehicle

of greater size. Thus, each should share in the base cost plus all increments of cost up to and including cost required by it."

Twelve per cent of the capital costs for cuts and fills for pavements and structures on rural roads was determined as fairly chargeable solely to the wide vehicle. This 12 per cent was applied only to the amounts expended for the roads requiring improved surfaces.

It is then necessary to charge to each motor vehicle its fair share for the use it makes of the highway system as a whole. The motor vehicle owner who operates his car 20,000 miles in a year should obviously pay more than the owner who operates only 5,000 miles. Consequently, the individual motor vehicle is charged the costs allocated to its class on the basis of the number of times it uses the road, that is, on a vehicle mile basis.

Because some maintenance costs vary with weight of vehicle and others do not, the maintenance costs are charged to each motor vehicle partly on a ton mile basis and partly on a vehicle mile basis, viz., three-fourths of maintenance costs on rural roads are chargeable on a ton mile basis and one-fourth on a vehicle mile basis; on city streets, one-half is charged on the ton mile basis and the other half is on a vehicle mile basis.

To illustrate the application of the adopted principles the year 1932 has been chosen because it was the latest year for which complete data were available. The analysis shows for the year 1932 that the passenger motor vehicles paid 64 per cent of the amount charged to them and the largest and heaviest trucks paid only 25 per cent of the amount charged to them. Intermediate types of vehicles in all instances paid less than their fair proportion. The type which came closest to paying its proper share was the farm truck, which contributed 83 per cent of the amount we have determined it should have paid.

These percentages are, of course, general and apply only to this national study. The application of the principles in this report to a study of any individual State may show different percentages of subsidy and may in some instances show that for certain types of vehicles there is no subsidy.

The study as a whole indicates clearly that there has been a very large subsidy to highway transport.



# HIGHWAY COSTS AND THEIR ALLOCATION FOR YEAR 1932

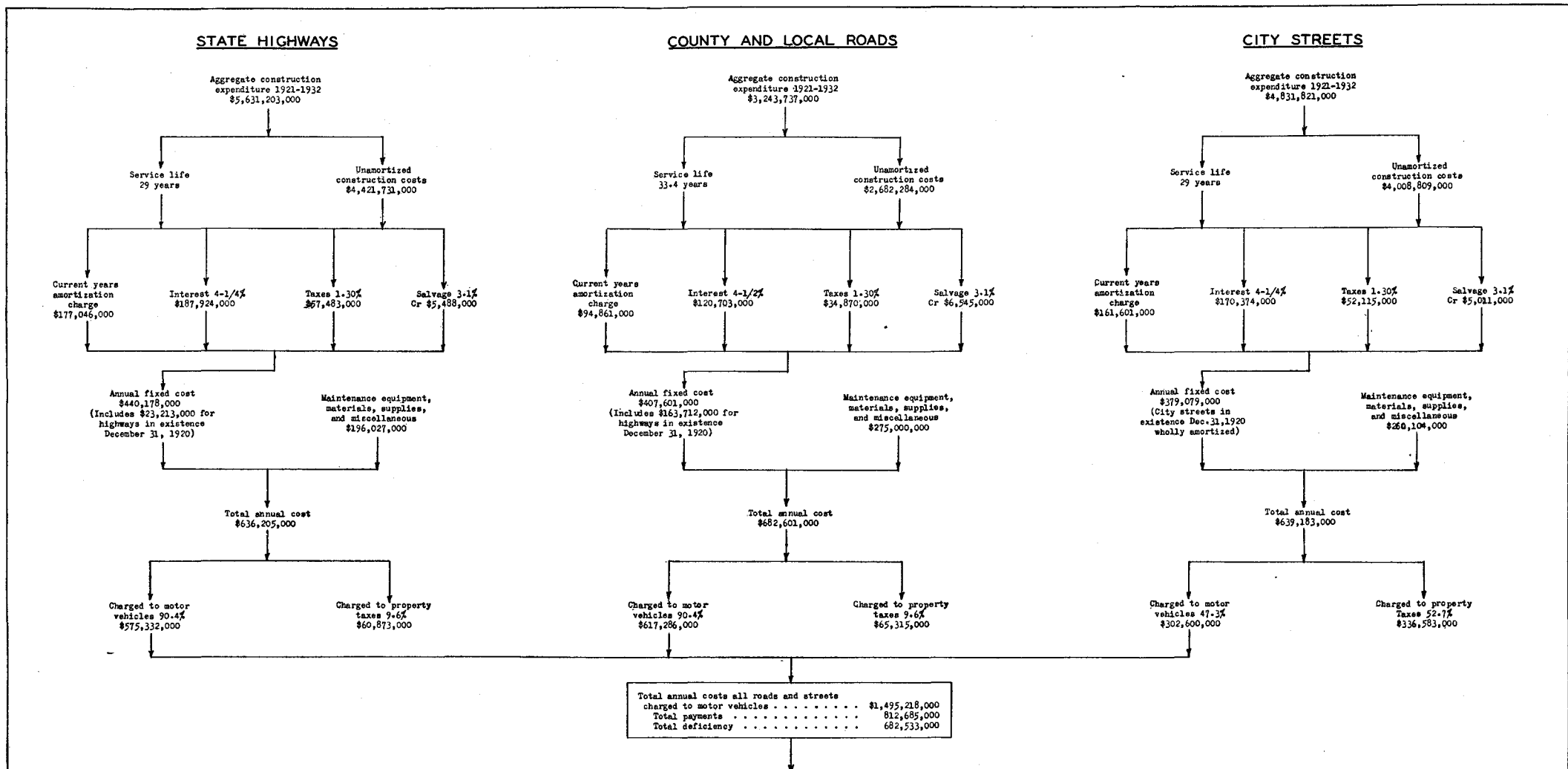

Item	Contract Carrier Buses			Common Carrier Buses			Private Trucks										For Hire Trucks											
	Passenger cars	Taxicabs	School buses	7 pass-engers & less	8 to 20 pass-engers	Over 20 pass-engers	7 pass-engers & less	8 to 20 pass-engers	Over 20 pass-engers	Farm trucks	1 1/2 tons & less	Over 1 1/2 tons & less than 3 tons	Combin-ations	3 tons & less than 5 tons	Combin-ations	5 tons	Combin-ations	Over 5 tons	Combin-ations	1 1/2 tons & less	Over 1 1/2 tons & less than 3 tons	Combin-ations	3 tons & less than 5 tons	Combin-ations	5 tons	Combin-ations	Over 5 tons	Combin-ations
Annual charges per vehicle	\$42.40	\$169.61	\$124.69	\$87.47	\$263.99	\$373.74	\$220.92	\$789.19	\$1 118.48	\$33.00	\$96.40	\$187.53	\$250.40	\$809.90	\$581.41	\$1 432.36	\$1 433.13	\$1 705.53	\$1 946.57	\$208.71	\$361.93	\$354.41	\$1 145.73	\$823.16	\$2 024.45	\$2 026.29	\$2 412.41	\$2 754.94
Annual payments per vehicle	27.13	89.11	73.34	55.89	125.18	243.56	146.20	297.75	441.61	27.42	51.43	97.73	144.89	196.02	219.75	270.88	305.38	356.40	486.30	100.71	166.87	213.26	269.01	320.41	369.51	432.26	491.76	707.89
Deficiency per vehicle	15.27	80.50	51.35	31.58	138.81	130.18	74.72	491.44	876.87	5.58	44.97	89.80	105.51	613.88	361.66	1 161.48	1 127.73	1 349.13	1 460.27	108.00	195.06	141.15	876.72	502.75	1 654.64	1 594.03	1 920.65	2 047.05

# TABLE OF CONTENTS

## CHAPTER I

### HIGHWAYS, A PUBLIC UTILITY

	<i>Page</i>
The Public Utility Concept.....	1
Principles to Be Applied According to the Public Utility Concept.....	4
Highways of a State a Single Utility.....	5
The General Taxpayer and the Highway User.....	7

## CHAPTER II

### PUBLIC UTILITY CONCEPT AND HIGHWAY FINANCE

Principles of Utility Finance and Accounting.....	12
The Salter Plan .....	13
The Ontario Report .....	14
The Basic Period Plan .....	14
The Basic Year .....	15
Rural Roads .....	21
City Streets .....	21

## CHAPTER III

### ANNUAL COSTS

Service Lives of Rural Highway Elements.....	27
Surfacing .....	27
Grading .....	28
Structures .....	29
Salvage Value .....	29
Service Life of City Streets.....	33
Prior Investment Carried Over Into 1921-1932 Period.....	33
Interest .....	33
Equivalent Property Taxes.....	34
Maintenance .....	34
Summary .....	34

### CHAPTER III (Contd.)

	<i>Page</i>
Costs Chargeable to Motor Vehicle Operators.....	35
State Highways .....	35
County and Local Roads.....	41
City Streets .....	44

### CHAPTER IV

#### COSTS AND PAYMENTS

Analysis of Tables.....	51
Summary .....	53

### CHAPTER V

#### ALLOCATION OF ANNUAL COSTS BETWEEN VARIOUS CLASSES OF MOTOR VEHICLES

Bases of Allocation.....	56
The Basic Vehicle and the Basic Road.....	57
Pavement Classification .....	58
Square Root of the Wheel Load Basis for Allocation of Capital Cost.....	59
Square Root Relation—Rigid Pavements.....	59
Impact .....	62
Effect of Thickness on Cost.....	62
Relation Between Wheel Load and Thickness of Flexible Pavements.....	63
Gravel and Other Untreated Pavements.....	66
Relation of Pavement Thickness to Cost of Flexible Pavements.....	67
Grading .....	68
Earth Roads .....	68
Structures .....	69

### CHAPTER VI

#### ADDITIONAL WIDTH AND OTHER FACTORS IN DESIGN OF HIGHWAYS

Effect of Vehicle Widths on Pavement Widths.....	72
Effect of Volume of Mixed Traffic.....	75

## CHAPTER VI (Contd.)

	<i>Page</i>
Effect of Vehicle Speeds on Pavement Width.....	76
Alignment .....	77
Gradients .....	78
Structures .....	80
Additional Costs of "Other Factors".....	80

## CHAPTER VII

### MAINTENANCE

Factors Affecting Maintenance Costs on Paved Roads.....	81
Earth Road Maintenance .....	82
Gravel Roads, Macadam, Sand-Clay, and Light Bituminous Wearing Coats placed upon such Pavements.....	83
Comments on Abrasion as a Factor in Maintenance of Untreated Roads	83
Pavements consisting of Bituminous Wearing Courses Laid Upon Gravel and Macadam Bases.....	85
High-type Rigid Pavements.....	85
Conclusion .....	87
City Streets .....	87

## CHAPTER VIII

### ALLOCATION OF COSTS

Bases of Allocation.....	88
Capital and Maintenance Costs.....	88
National Versus State Data.....	90
1932 as Illustration.....	91
Summary .....	98

## CHAPTER IX

### LATER PERIOD

Character of Data Available.....	101
Analysis of Data.....	101
Conclusion .....	105

# INDEX

<i>Tables:</i>	<i>Page</i>
1 Per capita highway expenditures, 1893 to 1932.....	16
2 Motor vehicle registrations in the United States—Years 1895 to 1937 .....	17
3 Highway expenditures—1904-1934 .....	22
4 Highway mileage—1904-1930 .....	23
5 Expenditures for city streets—1904 to 1932.....	24
6 Year in which first State aid law passed.....	30
7 Ratio of railway taxes to railway investment—Years 1921 to 1932 .....	35
8 Estimated cost, less depreciation, of State Highway Systems, as of December 31, 1920 .....	36
9 Annual cost 1921-1932, of that part of the State Highway System in existence December 31, 1920 (2 sheets).....	38-39
10 Total annual cost of State Highway Systems, 1921-1932.....	40
11 Annual cost 1921-1932, of that part of county and local road system in existence December 31, 1920.....	42
12 Total annual cost of county and local roads, 1921-1932.....	43
13 Expenditures for construction of city streets, 1921-1932.....	45
14 Cost of operation and maintenance of city streets, 1921-1932.....	46
15 Expenditures for construction of city streets, 1904 to 1920.....	47
16 Annual construction cost of city streets, 1904-1920.....	48
17 Annual cost, 1921-1931, of that part of city streets in existence as of December 31, 1920.....	49
18 Total annual cost of city streets, 1921-1932.....	50
19 Allocation of State motor vehicle taxes as made by State authorities, 1921-1932 .....	52
20 Comparison of motor vehicle users' proportion of the cost of highways and city streets with receipts from motor vehicle taxes, 1921-1932 (2 sheets).....	54-55
21 Pavement classification .....	59
22 Allocation of costs to classes of motor vehicles and comparison with payments made—1932 (2 sheets).....	92-93
22a Allocation of annual capital cost of high type rigid pavements, using "Corner Formula—Vehicle-mile" basis.....	94
22b Allocation of annual capital cost of flexible pavements, using "Square Root of Wheel Load—Vehicle-mile" basis.....	96
22c Allocation of annual capital cost of earth roads, grading and structures of all highways and streets on vehicle-mile basis.....	97

**INDEX (Contd.)**

<i>Tables:</i>	<i>Page</i>
22d Allocation of additional annual capital cost incurred for increased width of highways, on vehicle-mile basis.....	99
22e Allocation of annual maintenance cost of rural highways and city streets, on various bases as indicated.....	100
23 Total annual cost of State Highway Systems, 1933-1937.....	103
24 Total annual cost of county and local roads, 1933-1937.....	103
25 Total annual cost of city streets, 1933-1937.....	104
26 Comparison of motor vehicle users' proportion of the cost of highways and city streets with receipts from motor vehicle taxes, 1933-1937 .....	104
 <i>Charts:</i>	
1 Per capita highway expenditures, 1893-1923.....	16
2 City streets—per capita expenditures—1904-1932.....	25
 <i>Figures:</i>	
1 Diagram showing how wheel loads are distributed to the subgrade	64
2 Diagram showing distribution of wheel load pressure through a flexible type pavement indicating the assumptions made in deriving design formulas.....	65
3 Two passenger cars passing on an 18-foot pavement with right wheels 2 feet from edge.....	74
4 Truck and passenger car passing on an 18-foot pavement.....	74
5 Truck passing truck with 3.6-foot clearance 22-foot pavement required .....	74
Appendices .....	107

## CHAPTER I

### HIGHWAYS, A PUBLIC UTILITY

The term "public utility" may be defined as a publicly or privately owned enterprise which functions as an agency of the State to perform a service to citizens of the State. Such an enterprise sells its services to the general public in order to obtain the revenue for its support.

Highways and streets fall clearly within this definition of a public utility.

#### THE PUBLIC UTILITY CONCEPT

The public utility character of highways and streets has always existed and had been recognized more or less definitely long before the motor vehicle appeared. Prior to the development of railroads, highways when improved were generally used for long hauls and were operated as toll roads in accordance with the public utility concept. Railroads were first conceived as toll roads similar to highways and canals. Whether publicly or privately owned, they perform the same character of service as the highways and have always been treated as "public highways." One is just as much a public utility as the other.

When tramways and electric street cars appeared as a new form of highway transport, the promoters sought to use the public roads and city streets. This permission was granted in the form of a franchise but only under certain conditions. The tram cars and electric cars needed highway improvements in the form of track upon which to operate, just as the motor vehicle which appeared at a later period required highway improvements in the form of a pavement. Public policy did not approve of the idea that general taxes should pay for the highway improvements which were required for electric cars, although the so-called social, community or private land benefits existed to no less extent when a street car line was built than when a public highway was paved. Despite these so-called social and community benefits, the electric street car, in return for its franchise privileges to use the public rights-of-way, was required to provide at its own expense all the necessary track facilities and, in addition thereto, to improve the rights-of-way which it occupied so that horse-drawn vehicles and pedestrians might have even better roadway and street facilities than they had before. All of these costs were paid from charges for services rendered.

When the motor vehicle appeared it was only another form of street car possessing all the commercial possibilities of the electric car. It differed primarily in that any person might own and oper-

ate his own vehicle. The motor vehicle needed a track or roadway upon which to operate. It found within the cities pavements that had been constructed largely for commercial purposes, which served the local requirements of motor vehicles fairly well. These pavements, however, did not extend far into the rural areas nor were they connected into an improved highway system such as the motor vehicle demanded for the wide range of operation for which it was adapted.<sup>1</sup>

When the motor vehicle appeared, the local aspect of the highways and streets was changed so that long-distance travel by highways was again introduced. It demanded an extensive system of smooth paved roads connecting all the communities.

It was impossible to induce private capital to finance such necessary highway facilities under a toll system because the vehicles already had free use of city streets, and they did not appear in sufficient numbers on rural roads to justify financing such roads by a system of tolls. A strong element of public opinion was opposed to the inconveniences of such a method. There was apparently no way to secure improvements through any method of direct payment for service. Reliance was placed upon government to finance these improvements out of general taxes.

It was not long, however, until public policy demanded that highway financing follow the principles of the public utility concept. Toll roads were not established but the people learned a new way to charge the motor vehicle owner for highway service. The motor vehicle owner was required to pay a license fee and a motor fuel tax, which are, in effect, a form of toll. As the number of vehicles increased and their commercial aspects became more clearly recognized, the charges were increased, with the entire approval of the vehicle owner, provided the receipts were used on the highways.

Taxpayers, moreover, became more and more reluctant to furnish public money for highway improvements, which were so clearly an economic or commercial enterprise. Except for the large appropriations now made by the Federal government, general taxation is a rapidly diminishing source for highway funds, so much so that future improvements must depend more and more upon the revenues received from motor vehicles. Thus, it has become the public policy to look upon the highway system as a public utility enterprise:

---

<sup>1</sup>After the railroads appeared rural roads were no longer used for long hauls. They had become more or less byways serving as feeders for the railroads, for waterways and the local municipalities, over which pedestrians and horse-drawn vehicles could reach the established transport routes. Their value as a public utility dwindled until they were no longer self-supporting through tolls and became a public charge against general taxes. Their use was primarily local in character.

"Everywhere the problem was purely local in character. The range of travel was extremely limited, there were no requirements for heavy type roads and there was no recognition of anything more than a local responsibility."

(Brosseau, A. J., Highway Finance, p. 6.)



First, in the collection of motor vehicle imposts in some proportion to the services rendered;

Second, in recognizing these imposts as belonging to the highway utility; and

Third, in the refusal or reluctance of the people to increase highway appropriations from general taxes.

There are other reasons of an economic nature why the highways should be managed and financed as a public utility enterprise. One is that the capital invested in the highway system serves to produce wealth. This wealth benefits all the people but it does not distribute itself uniformly among the citizens or in proportions equitable with the payment of general taxes. It is distributed approximately in proportion to highway use or services rendered, which is the fundamental purpose for which the highways are constructed. Consequently, the cost of the highway system should be paid for in proportion to highway service.

Another economic reason for considering highways as a public utility relates to the general welfare. The motor vehicle has become a strong competitor of other forms of transport which are managed and financed as public utilities. Each form of transport has its natural economic advantages; and in order to preserve the economic balance, all must be on an equal footing. If the government pays the cost or a part of the cost of providing facilities for one form of transport and not for others, the public will not use these agencies according to their true economic merit; and in the final analysis the public will be paying more than is necessary for transportation requirements.

The public utility concept as applied to highways is widely accepted. Roy W. Crum, Director of the Highway Research Board, states:<sup>2</sup>

“The concept of highways as public utilities is sound, and I believe that established principles of public utility management could well be applied to highway finance and administration.”

In discussing the needs for a uniform system of highway accounts, Dean Marston of Iowa State College makes the following statement:<sup>3</sup>

“The author believes that the cause of the inadequacies and inconsistencies of our present highway accounts is mainly a fundamental error in our concept of the true status of highway systems. We have thought of them as merely special examples of general governmental activities like legislative, executive, judicial and police activities, all housed, maintained and reduced by taxes levied on all rather than by charges to individuals for the actual services rendered to each. In contrast to this erroneous concept our highways are simply great public

---

<sup>2</sup> Civil Engineering, January, 1938, p. 35.

<sup>3</sup> Sixteenth Annual Proceedings of the Highway Research Board, page 48.

utilities comparable to publicly owned power and light plants, water works and the like. So-called highway taxes and fees are comparable to the bills against customers of power and light plants for the services rendered them individually. Highway revenue charges should be distributed among highway users in equitable proportion to services rendered. Highway accounting systems should provide all accounting data needed to show true present actual (depreciated) values of highway property and the true annual actual total cost of highway systems, including their true annual actual depreciations."

The United States District Court has said:<sup>4</sup>

"The highway system owned by the state and its subdivisions is a public utility supplying facilities which constitute an actual monopoly which is subject to intergovernmental regulation and control. The annual cost of operating such utility should be determined in the same manner as for a privately owned public utility."

We believe this is the proper concept to apply to an economic analysis of the costs of highway facilities and adopt it in this study.

#### PRINCIPLES TO BE APPLIED ACCORDING TO THE PUBLIC UTILITY CONCEPT

The first principle of the public utility concept is that the costs shall be paid for entirely by the users. If part of these costs are paid for by general taxes or by government aid, it becomes a subsidized public utility.

A second principle is that the costs shall be distributed among the users of the facilities on an equitable basis through the rates charged.

A third principle is that the enterprise is a monopoly within its own field of service.

A fourth principle relates to the ability to pay. The facilities of the public utility can only be developed to the extent that the users thereof can pay the cost, which, in effect, means only to the extent that there is profit to the user of such facilities at the rates which he must pay. Consequently, the type and character of the facilities must be adjusted to the kinds of use which are economically justified—that is, to the use which may be allowed.

A fifth principle is that the public utility shall be considered as a system in which all parts work together cooperatively for common service. It recognizes that in union there is strength, both in the character of the service rendered and the ability to finance adequate and satisfactory service.

---

<sup>4</sup>In the findings of facts and conclusions of law by the Judge of the District Court of the United States for the Southern District of Illinois in the recent case styled *Brashear Freight Lines, Inc., et al., Plaintiffs, versus Edward J. Hughes, Secretary of State of the State of Illinois et al., Defendants.* (Nov. 14, 1938).

## HIGHWAYS OF A STATE A SINGLE UTILITY

Physically, all highways and streets in the State belong to one system. The motoring public recognizes no political boundaries, nor is the motorist concerned if he leaves one class of highway to travel on another. He expects to use all of the roads when he so desires and hopes to find them all serviceable. Each road and street in the public highway system depends upon other roads and streets to justify its existence, because each highway receives or delivers most of its traffic from or to some other highway. Generally speaking, the city streets represent terminal facilities for the trunk highways and the secondary rural roads are branch lines or feeders for the trunk highways. In this respect the highway system is not unlike a railroad system in that the trunk lines are dependent upon branch lines and terminal facilities for the business which comes to the system.

The highways are necessarily divided by State boundaries into separate organizations for management and finance, each of which constitutes a separate public utility. By reciprocal agreement between the States, services are exchanged but because highway management must conform to the laws of the State, both in operation and finance, the roads of each State must constitute a separate entity in the public utility concept. All the highways in the State constitute one system of connected and interdependent highways extending into every corner of the State and subject to the same State laws. Because the State has delegated to one agency, the State Highway Department, certain roads termed State Highways and to other agencies such as county courts, township supervisors or city councils other roads called county and township roads or city streets, does not make one road any less a State road than the others. In legal contemplation, as distinguished from popular terminology, all are State roads. They are all controlled and operated by the State through its various agencies and, therefore, the undertaking must be considered as a unit.

While Federal aid has been and may continue to be expended in all the States, the problem of financing the highways is one which the State alone must solve. The funds which have been used for road and street work are derived from various sources, such as special assessments, ad valorem taxes, excise taxes, Federal aid and certain privilege taxes or fees, including gasoline taxes, registration fees and special license fees. All of these road revenues, except Federal aid, were determined by acts of the State legislature.

Federal aid roads have sometimes been referred to as national highways. They are, in fact as in law, an integral part of the State highway systems. Full responsibility for their management and finance rests with the State. There has been some recent consideration, however, of so-called superhighways to be built across the country by the Federal government. The Federal government has not yet adopted such a plan. Until it does, highways and streets remain State public utilities. If such a plan is adopted and carried out, there

will then be superimposed upon the State utilities a national highway utility.

The public utility aspect has forced the State to look upon the privilege tax and fees as a proper source of highway revenue so that such imposts, including gasoline taxes, now form a very substantial and ever increasing proportion of the highway revenue from all sources. These motor vehicle taxes are exacted for the most part in exchange for the privilege of using any and all the roads and streets in the State. The value of such privilege depends upon the broad right to pass over all rural roads and city streets. If taxes and fees earned by the highways and collected by the State or its political subdivisions are to be credited to highway construction and maintenance, they should be credited against all the highway facilities for the use of which the privilege is granted, namely, all the rural roads and city streets. All such privilege taxes and fees and all such highways and streets must be taken into account and credited or charged to the whole system in considering the financial status of the highway utility.

It is a recognized principle of a public utility that no management can rightly insist that the branch lines and terminal facilities, or the extensions be separately self-supporting, nor is the volume of traffic over a road, much less the origin of traffic, any criterion for the method of financing such facilities—notwithstanding it may be a very important consideration in determining the location and kind of improvement which is made and, hence, it may influence the cost. The so-called local highways have an importance in the highway utility much greater than is indicated by the 15 or 20 per cent of motor vehicle traffic which they may contribute directly to the total volume of traffic. Not only are they important “feeders” or “terminal facilities” for the main highways but their ready-to-serve value to the motor vehicle is very real.

Furthermore, the business on the main highways is in the carrying of traffic which originated on or is destined to local roads or city streets. Upon the basis of both theory and fact, therefore, the public utility policy demands that motor vehicles accept responsibility in the same measure for all highway expenditures made for their benefit, whether such outlays be made for primary or secondary roads or city streets. No basis appears in theory or in fact for restricting motor vehicle taxation to that sum necessary to build State highways or trunk highways while asking that the expenditures for local roads and city streets be made primarily from general taxes levied upon land.

The motor vehicle has removed the local use concept from these highways. The requirement of the payment of a gasoline tax and graduated privilege tax through legislative action definitely endorsed the public utility concept. Distinction between classes of roads and even city streets and rural roads is fast disappearing. It is recog-

nized that all classes of roads are essential for the full service of the highway and street facilities.

Since the privilege, therefore, of using the highways of the State extends to all of its highways indiscriminately; since the exercise of the privilege is limited only by the pleasure of the motor vehicle operator; since all highways are a part of one connected and interdependent system throughout the whole State; and since the privilege taxes or fees wherever collected are actually earned by the operation of vehicles over every mile of every public thoroughfare within the State, all the highways, including local roads and city streets, necessarily constitute one State public utility.

This conclusion was aptly expressed by J. A. Sourwine of the U. S. Bureau of Public Roads. Mr. Sourwine said:<sup>6</sup>

“To select one arbitrary stretch of highway; to ignore all branch highways leading into that highway, and to ignore both the sources and destinations between which vehicles move,—seems comparable to the cutting off of a man’s feet at his ankles, his hands at his wrists, and his head at the neck, and still count him a living organism, and proceed to figure the operating efficiency of the parts remaining, which constitutes the portion normally connecting the feet with the hands, and both feet and hands with head. Under such an assumed condition, the working organism will be dead. There will be no use in figuring out a theoretical value for the parts remaining. The activity of the organism will have ceased and so will its value—and the value of each of its parts. We can not but see the analogy of an actively operating highway system to a human organism. The highway system also is a living organism. Its body, consisting of main traffic highways, is an important part of the system as a whole,—but to be a living, active, effective organism, it requires also hands and feet and head. The persons and material transported over it have in each case a source and a destination.”

#### THE GENERAL TAXPAYER AND THE HIGHWAY USER

Highway improvements on all and any part of the public utility are made solely for transportation purposes. If transport benefits to be derived from the use of the improvement, considering all the benefits that may be derived therefrom by traffic in the use not only of the special improvement but all other highway facilities in the State, will not justify the cost, that expenditure should not be made. If the improvement on this basis will justify its cost, then traffic will fully pay the cost provided the privilege rates are fixed in the State in proportion to services rendered.

The highway public utility, like all other utilities, is composed of various parts such as trunk lines, branch lines which are usually referred to as county and local roads, and city streets. All of these parts of the public utility work together for the combined transporta-

<sup>6</sup> Tenth Proceedings, Highway Research Board, p. 363.

tion service as a whole. The highway utility in all its parts is improved for the transport needs which it is expected to serve. The different parts of the public utility will neither carry the same burden of traffic nor will they be improved to the same degree. There will, therefore, be a considerable disparity between the percentage of funds expended upon the different parts of such utility. On urban streets the expenditures per vehicle mile will probably be low because of the greater traffic density. Trunk highways will follow closely upon urban streets as to low unit cost of service. The county or local roads will usually show a much higher unit cost. When all these costs, however, are combined and balanced against the total highway traffic in miles or ton-miles traveled, there will result a figure which represents the total cost of the services that may be allocated upon some equitable unit such as a vehicle mile or a ton-mile, as the case may be.

It follows, therefore, if the highway management and finance are on a sound basis, the traffic on any part of the public utility, paying rates equitably proportioned, will meet its full responsibility for all the highway improvements on all parts.

There is, of course, the further question of the kind and character of the vehicle which requires and uses the highway facilities and whether or not the highway costs should be further segregated in proportion to the responsibility of different classes of vehicles for different types or kinds of highway facilities.

When the farmer living in a rural community has paid the imposts which the State exacts for his use of highway facilities, he should then not be expected to tax himself for further highway improvements on a theory of land benefits. Land benefits in the case of the farmer are no more evident as the result of road improvements than are similar benefits in the case of a factory, store or home located in another community. In either case, however, justification for the highway improvements must depend upon the savings in transportation cost and not upon land production or increased land values. If the saving in transport costs and that alone will not exceed the cost of highway improvements, the improvements are not justified and, therefore, ought not to be built.

There has been an accumulation of capital investment poured into highway facilities which were provided for the benefit of transportation and for no other purpose. Clearly, all these funds are proper charges against motor vehicle operation under the public utility concept. Just as the user of electrical current provides his own equipment and pays for the electric service he requires to operate it, so should the motor vehicle owner pay for the highway services which he requires to operate his equipment.

Of course, when a highway is improved for motor vehicle traffic, the other uses represented by animal or foot traffic may continue and the general public, other than motor vehicle owners, may thus profit by the improvement; or may suffer inconveniences dependent

on the dangers inherent in mixed traffic. Usually the foot traffic is forced from the pavement to the side of the road and the highway becomes more dangerous for animal traffic. Highway occupancy by telephone or telegraph lines, water, gas or electric conduits, sewers and drains, are more often burdened than benefited by highway improvements; the right-of-way and that alone constitutes their chief highway requirement.

Likewise light and air requirements within the cities have nothing to do with street improvements. They demand only space and it might be an open field or in the case of the street, the open right-of-way. Paving the right-of-way, it will be admitted, is a distinct health and sanitary provision which benefits city dwellers in a manner that cannot be realized in rural communities. But here again, the motor vehicle uses the pavements, requires all the facilities, and city dwellers receive no greater benefits from the paving than motor vehicles receive from the storm sewerage or drainage system for which they do not pay. The building of sidewalks is a requirement that has nothing to do with motor vehicle service and for which they should not pay.

National defense is no reason for highway improvements any more than it is a reason for building railroads, telegraph, telephone, electric or any other public utility service. In case of necessity all the national resources will be used for defense.

The idea has been advanced that school buses, ambulances, police cars, fire trucks and other publicly owned motor vehicles are instruments of social use and as such their use of the highways justifies a charge against general taxes for the support of highway facilities. Perhaps general taxes should pay the highway costs allocated to such vehicles but only to the extent that they are units in the vehicle classifications to which they belong. Because they are publicly owned and operated, the highway service is no more or no less valuable than if they were privately owned. They serve to increase efficiency and decrease the cost of the public service to which they belong. Such vehicles are included in the registration list for motor vehicles and can be classified and considered when highway costs chargeable to motor vehicles are allocated. It is only a question of public policy whether the license fees and gasoline taxes for such vehicles are to be paid directly into the public treasury or the amount credited to the highway transport industry.

When the highways and streets, other than the sidewalks, are used for postal service, it is usually a motor vehicle that performs the services. If it is not a government owned vehicle, and usually it is not, it pays license fees and a gasoline tax like any other privately owned vehicle. If such fees and imposts are passed on to the government when it contracts for the private service, let it be observed that the government profits no more or no less than all other highway users when they use the facilities.

The question of special benefits to the owners of private property

by reason of close proximity to highway improvements admits of no consideration in the allocation of highway costs for rural roads. In the first place, the public highway improvements are made in response to traffic requirements and not for the purpose of benefiting private property, any more than are the railroads or other public utilities built for the purpose of benefiting private property. Private property, as may be shown, is as often damaged as benefited by the close proximity of rural roads which become trunk highways. The benefit or damage from an improved highway neither adds to nor subtracts from land productivity. If the road serves to increase land use by making available a better market for produce, or if it reduces transportation costs it may be assumed that the extra use of the highways by vehicles engaged in transporting the products will pay their fair share of the highway costs.

Since it is accepted that highway improvements are justified solely by transportation requirements for all highway improvements, then there is no more reason for charging part of the highway cost to the land than there is for making a similar charge in the case of other public utilities.

All public utility improvements such as highways, railroads, power lines, telephones, water and gas, serve important social needs in a community but in no case should the land or general taxes be charged with the cost of providing such service.

Whenever studies have been made to allocate highway costs, the public utility concept has appeared and its principles have been followed. Such for example is the case in highway studies made in New York, New Jersey, Illinois and in Missouri; also in Great Britain, Canada and other foreign countries.\*

In accordance with the fundamental principle applying to public utilities, namely, that the cost of the facilities must be paid by revenue derived from the users, it has been conceded that any support derived from general taxes or the government is a subsidy and that such utility receiving such aid is a subsidized public utility. Such contributions are no less a subsidy, whether justified or not.

It is difficult to make a highway cost study for the nation as a whole because the highway systems in the several States are separate utilities. Local conditions in one State usually require different highway facilities from those in another State. Because the heavy traffic in metropolitan areas requires roads of a heavy construction, is no reason why the roads in a State consisting entirely of rural communities or smaller cities should require similar roads. Local conditions may also permit roads to be built more cheaply in one State than in another, even when the same standard type of road

---

\*"Motor Vehicle Taxation in New York," W. S. Downs; "Motor Vehicle Taxation in New Jersey," W. D. Ennis; *Brashear Freight Lines vs. Edward J. Hughes*, Sec. of State of the State of Illinois; "Study of Missouri Highway and Street Costs"; No. 665, *In Equity*; Report of the Conference on Rail and Road Transport, Great Britain, July 29, 1932; Report of Annual Highway Costs, Province of Ontario, February, 1938.



is constructed. For these and other reasons the highway costs vary among the States and the allocation of such costs between the motor vehicles will vary. In other words, highway costs as between the States or between different public utilities may vary in the same manner as electric costs may vary between two electric utilities located and operating under different conditions.

Moreover, when a national study is attempted it is very difficult to secure the data which are required for a comprehensive report. Therefore, a national highway study can do little more than point the way to similar studies which should be made in each individual State for the purpose of assessing motor vehicle costs. The national study, however, presents a composite picture, and on the basis of available data will indicate the total annual costs and to what extent, if any, subsidy exists.

## CHAPTER II

### PUBLIC UTILITY CONCEPT AND HIGHWAY FINANCE

The fact that highways were being financed by the government through general taxes on land and other property when motor vehicles first appeared and that the government has continued to a considerable extent even to the present time to levy property taxes for highway purposes complicate the problem of determining the proper costs which should be imposed upon motor vehicles for the services they receive from this great public utility. This public policy was not in accord with public utility finance and accounting. The problem is now to place highway financing on a public utility accounting basis.

#### PRINCIPLES OF UTILITY FINANCE AND ACCOUNTING

The change from the horse-and-buggy age to the motor vehicle era was not immediate. It was a gradual process extending over many years until finally the motor vehicle had substantially superseded all other vehicles and modes of highway travel and proceeded to monopolize the highway facilities.

Those uses of the highways which existed before the motor vehicle appeared gradually merged into the economic aspects of the motor vehicle and finally disappeared in the public utility concept, just as the old town pump disappeared when the modern water supply came into existence as a public utility.

In this period of change highway improvements were made at a rapidly increasing rate. Such improvements were primarily for the benefit of motor vehicles which proceeded to use them. The improvements, moreover, represented capital investments in highway facilities that remained useful for many years after they were made. Such facilities constitute real values in the present highway utility. Much of the capital so invested was derived from general taxes. Some of it represented contributions made by motor vehicles. Since these capital costs are the basis for a large part of the annual highway costs, the chief problem is to determine when the motor vehicle responsibility for such costs began and what proportion of the annual cost for any year is chargeable to motor vehicles.

A very simple approach to the problem would be to follow the precedent established in the case of street cars, water, electric or other public utility services which use the highways. Considering, therefore, the modern highway improvements as a public utility which occupies or uses the public lands or rights-of-way which were set aside or otherwise provided for public use, it appears that all highway improvements which are used or useful to motor vehicles should be paid for by motor vehicle users. And if it is necessary to

straighten an old road or otherwise improve its location to better serve the motor vehicle, the cost of such new rights-of-way is the motor vehicles' responsibility. Thus, the old rights-of-way, only, constitute the government's real responsibility with respect to the costs of the present highway utility. The rights-of-way may be used by any public utility enterprise such as water, gas, electric, telephone, street car, or motor vehicle highway,—each utility being responsible for the cost of the improvement which it requires. They also furnish access to land, light and air; and may, therefore, be classed as a common social requirement.

Since all highway improvements such as grading, drainage structures, bridges and surface improvements are essentially a motor vehicle requirement, the motor vehicle users should pay all the costs of such facilities.

Such plan, if accepted, would require motor vehicle users to assume all the annual costs based on the capital invested in such improvements which must be properly amortized from year to year. It would result in their paying all the present and all the future highway costs. It would not, however, determine the time when such payments should have begun, or the accumulated deficit if any, which now exists in motor vehicle payments.

#### THE SALTER PLAN<sup>1</sup>

The Conference on Rail and Road Transport of Great Britain adopted the public utility principle. This so-called "Salter Report" concluded that the present road users enjoy a substantial "legacy from the past" in respect both to the road system existing before the motor vehicle era and to the heavy capital expenditure on highways during the motor vehicle era. It concluded that "community use" on the one hand and "legacy from the past" on the other might fairly be regarded as cancelling each other, and that after 1930, the total contribution payable by all classes of mechanically propelled vehicles, whether in the form of license duty or petrol duty should be equal to the current expenditure on roads.<sup>2</sup>

---

<sup>1</sup> Reference is made to the Report of the Conference on Rail and Road Transport submitted to the Minister of Transport in Great Britain, 1932. This is commonly referred to as the "Salter Report."

<sup>2</sup> This was for the year 1930. It should be stated in this connection that the report contemplated the inclusion of future loans or bonds in the annual road expenditures, but excluded therefrom any item in respect to the service of past loans. Loan charges in Great Britain at that time (1930-31) amounted to only 9,342,000 pounds in a total expenditure of 72,842,000 pounds, after deducting for unemployment relief. Thus it appears from the findings of the Salter Report that motor vehicles in Great Britain in 1930 should be charged with about 87% of the expenditures. Since past debt service charges will gradually disappear, the proportion of the highway costs chargeable to motor vehicles would increase and they soon would assume the payment of the entire cost of the highways.

## THE ONTARIO REPORT

In the province of Ontario, Canada, a Royal Commission on Transportation was appointed in 1937 and instructed to investigate highway costs and taxation. After lengthy hearings a Summary of Findings was issued under date of December 23, 1938.

The Commission considered all the rural roads and city streets within the Province as integral parts of one system and proceeded to apply public utility principles in the analysis.

The Commission considered the year 1903 as the year when motor vehicle responsibility for highways began but concluded that "since the intensive use of motor vehicles and the accompanying extension of highway building programs began at the close of the war," the year 1919 should be accepted as the first year for determining the responsibility of motor vehicles for highway costs. No highway values, however, in existence at the end of 1918 were considered a charge against motor vehicles. Beginning with 1919 the motor vehicle is charged with all highway and street expenditures, except that the Commission concluded that there was an element of so-called "social necessity value" in the roads and streets which amounted to \$3.00 per capita and that this amount should be contributed annually by the general taxpayer.

### THE BASIC PERIOD PLAN

This plan is to determine government expenditures for highway improvements on some equitable basis prior to the appearance of the automobile which is to be compared with expenditures for improvements thereafter made to accommodate it. If a period or a representative year can be found which fairly marks the beginning of this transition, the expenditures of that time can be used as fairly measuring the money value of those traditional uses of the highway before the motor vehicle became the predominant factor. Certainly, all the costs beyond this amount are chargeable to the motor vehicle.

There is abundant reason to conclude in the United States, as in Great Britain, that the government's participation in the cost of highway facilities in the past has brought into the present highway public utility, improvements, the value of which will more than compensate for any so-called traditional use that is not directly a motor vehicle charge.

As highway improvements brought forward from pre-automobile days have decreased in value through depletion and obsolescence, so have the so-called traditional uses decreased due to the predominance of the motor vehicle. Consequently, there should come a time when the motor vehicle should properly be charged with all highway and street costs, excluding rights-of-way and sidewalks.

When more complete data are available, perhaps in the near future, such conclusion may fully appear; but for the purpose of this national study government responsibility for the cost of highway and street

facilities has not been eliminated, even in the last year covered by this report. If this procedure is in error, it benefits the motor vehicle at the expense of the taxpayer, because it leaves the highways still a subsidized public utility.

We have adopted the basic period plan for this study.

An acceptance of the proposition that some part of the present highway and street costs is a charge against general taxes is a major concession to those who contend that there are some highway costs which do not clearly benefit the motor vehicle. There is no way to isolate these costs if they do exist; nor is there any way to prove that all the so-called traditional uses which included important commercial uses, have been merged in the public utility aspects of the present highway system. It is a liberal concession, therefore, to the motor vehicle user to assume that all highway and street costs which were incurred before the motor vehicle appeared were a proper government expense.

In order to conform to these conditions it is necessary to determine the measure of government responsibility for costs which can be applied in recent years. It is futile to speculate as to what would be the highway costs today and who would pay them if the motor vehicle had never existed. The fact is that the motor vehicle does exist. It has superseded other kinds of highway vehicles and is now the instrument of use for which highways are improved and maintained.

If, however, we turn to the period when there were no motor vehicles, available data indicate that the highway expenditures in several States and probably in the United States were for many years, quite uniform in proportion to population. This per capita expenditure was not the same in all the States, but it did not increase appreciably for many years prior to the appearance of the motor vehicle. This per capita expenditure before the motor vehicle era may well be taken as the measure of so-called traditional uses, inasmuch as it represents the amount which the people were willing to spend for highway facilities when there was no motor vehicle influence. The relation between the average annual per capita highway expenditure in a period before the motor vehicle era and that in a period of motor vehicle operation may be assumed to represent the *maximum* proportion of the annual highway cost for the later period that can be charged to so-called social or community requirements.

#### THE BASIC YEAR

The annual highway expenditures for certain individual States, where such figures are available for an extensive period before the motor vehicle appeared, indicate clearly that per capita expenditures remained rather uniform up to about the year 1904, after which the trend moved upward as the number of motor vehicles increased (See Table 1 and Chart 1). In the United States as a whole, 1904 is the

**TABLE 1**  
**PER CAPITA HIGHWAY EXPENDITURES, 1893-1932**

Year	All rural highways United States	Rural highways			Year	All rural highways United States	Rural highways		
		New York	Illinois	Massachusetts			New York	Illinois	Massachusetts
1893	.....	\$0.47	....	....	1914	\$2.47	\$2.47	....	\$2.08
1895	.....	....	....	\$0.76	1915	2.85	2.51	....	2.54
1897	.....	....	....	0.83	1916	2.87	2.02	....	2.29
1898	.....	0.52	\$0.59	....	1917	2.90	2.08	....	2.75
1899	.....	0.49	0.64	....	1918	2.91	1.80	....	2.42
1900	.....	0.51	0.58	....	1919	3.83	2.40	....	2.82
1901	.....	0.59	0.66	....	1920	.....	3.09	....	3.89
1902	.....	0.71	0.68	....	1921	8.72	4.85	....	4.42
1903	.....	0.75	0.74	....	1922	8.70	4.55	....	4.31
1904	\$0.97	0.79	0.75	....	1923	7.84	4.98	....	4.90
1905	.....	0.47	0.78	....	1924	9.04	5.59	....	....
1906	.....	1.26	0.79	....	1925	9.29	6.10	....	....
1907	.....	1.20	0.86	....	1926	9.17	6.49	....	....
1908	.....	1.03	0.85	....	1927	9.98	8.34	....	....
1909	1.57	1.12	0.94	1.22	1928	10.91	8.34	....	....
1910	.....	1.57	0.94	1.46	1929	10.91	8.73	....	....
1911	.....	1.80	1.00	1.53	1930	12.60	9.56	....	....
1912	.....	2.29	0.99	1.80	1931	11.80	10.24	....	....
1913	.....	2.24	1.20	2.16	1932	9.47	6.71	....	....

Source: All highways—based on data from reports of the Bureau of Public Roads and Bureau of the Census. New York figures from "Motor Vehicle Taxation in New York", by W. S. Downs. Illinois figures based on reports of the State Auditor. Massachusetts figures from Massachusetts Highway Commission, and Massachusetts Division of Corporations, and Taxation from "Statistics of Municipal Finances."

**CHART 1**  
**PER CAPITA HIGHWAY EXPENDITURES, 1893-1923**

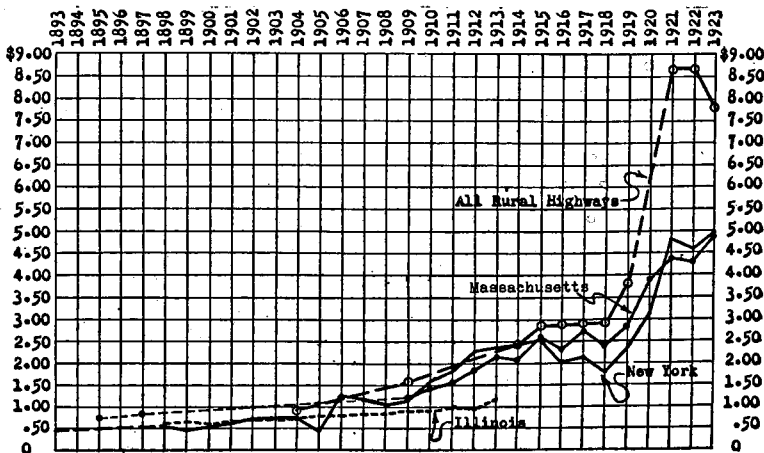

Note: Figures for Indiana, received too late for inclusion, will be found in Appendix P.

first year for which highway expenditures are available.\* Figures are not again available until the year 1909, and then in 1914 when

**TABLE 2**  
**MOTOR VEHICLE REGISTRATIONS IN THE UNITED STATES—**  
**YEARS 1895 TO 1937**

Source: United States Department of Agriculture,  
Bureau of Public Roads a

Year	Registered motor vehicles, private and commercial			Per cent of total		Other registered vehicles	
	Total	Passenger cars, taxis and buses	Trucks and road tractors	Passenger cars, taxis and buses	Trucks and road tractors	Trailers and semi- trailers	Motor- cycles
1895	4	4	.....	100.0	.....	.....	.....
1896	16	16	.....	100.0	.....	.....	.....
1897	90	90	.....	100.0	.....	.....	.....
1898	800	800	.....	100.0	.....	.....	.....
1899	3,200	3,200	.....	100.0	.....	.....	.....
1900	8,000	8,000	.....	100.0	.....	.....	.....
1901	14,800	14,800	.....	100.0	.....	.....	.....
1902	23,000	23,000	.....	100.0	.....	.....	.....
1903	32,920	32,920	.....	100.0	.....	.....	.....
1904	55,000	54,590	410	99.3	0.7	.....	.....
1905	78,000	77,400	600	99.2	0.8	.....	.....
1906	107,000	105,900	1,100	99.0	1.0	.....	.....
1907	142,000	140,300	1,700	98.8	1.2	.....	.....
1908	197,500	194,400	3,100	98.4	1.6	.....	.....
1909	312,000	305,550	6,050	98.1	1.9	.....	.....
1910	458,500	458,500	10,000	97.9	2.1	.....	.....
1911	639,500	619,500	20,000	96.9	3.1	.....	.....
1912	944,000	902,600	41,400	95.6	4.4	.....	.....
1913	1,258,062	1,194,282	63,800	94.9	5.1	.....	.....
1914	1,711,339	1,625,739	85,600	95.0	5.0	.....	.....
1915	2,445,666	2,309,666	136,000	94.4	5.6	.....	.....
1916	3,512,996	3,297,996	215,000	93.9	6.1	.....	.....
1917	4,983,840	4,657,340	326,000	93.5	6.5	.....	.....
1918	6,146,617	5,621,617	525,000	91.5	8.5	.....	.....
1919	7,555,446	6,771,074	784,372	89.5	10.5	.....	.....
1920	9,231,941	8,225,859	1,006,082	89.1	10.9	.....	.....
1921	10,463,295	9,483,391	979,904	90.6	9.4	22,685	196,231
1922	12,238,375	10,959,571	1,278,804	89.6	10.4	29,328	182,714
1923	15,092,177	13,539,606	1,552,569	89.7	10.3	*	171,872
1924	17,693,677	15,460,849	2,133,028	87.9	12.1	*	153,925
1925	19,937,274	17,496,420	2,440,854	87.8	12.2	83,625	140,348
1926	22,001,899	19,237,171	2,764,222	87.4	12.6	99,430	131,546
1927	23,133,241	20,219,228	2,914,018	87.4	12.6	123,451	120,303
1928	24,498,124	21,379,125	3,118,999	87.3	12.7	148,169	117,946
1929	26,501,443	23,121,589	3,379,854	87.2	12.8	193,044	114,845
1930	28,545,281	25,059,262	3,486,019	86.9	13.1	262,507	107,811
1931	26,814,108	22,347,800	3,466,308	86.6	13.4	349,930	101,074
1932	24,136,879	20,903,422	3,233,457	86.6	13.4	412,998	91,296
1933	23,827,290	20,600,543	3,226,747	86.5	13.5	472,789	91,987
1934	24,933,408	21,524,068	3,409,335	86.3	13.7	615,315	93,492
1935	26,221,052	22,568,847	3,655,705	86.1	13.9	733,414	92,768
1936	28,221,291	24,197,585	4,023,606	85.7	14.3	869,859	98,541
1937	29,705,220	25,449,924	4,255,296	85.7	14.3	1,019,985	104,686

a Figures for some of the earlier years not reported by Bureau of Public Roads were taken from reports of the Automobile Manufacturers Association.

\* Not available.

Notes: Figures for public owned vehicles (Federal, state, county and municipal) are incomplete and are therefore excluded from this table.

<sup>a</sup> U. S. Department of Agriculture, Office of Public Roads, Bulletin No. 32, page 7.

With respect to the accuracy of these figures, the Office of Public Roads recounts the difficulty of securing reliable data and the effort which was



Road Commissioners, Supervisors and Business Men's Club of Kewanee, Neponset, and Wethersfield, starting on tour of inspection of dragged earth roads maintained by Galva Good Roads Association, Galva, Henry County, 1907.



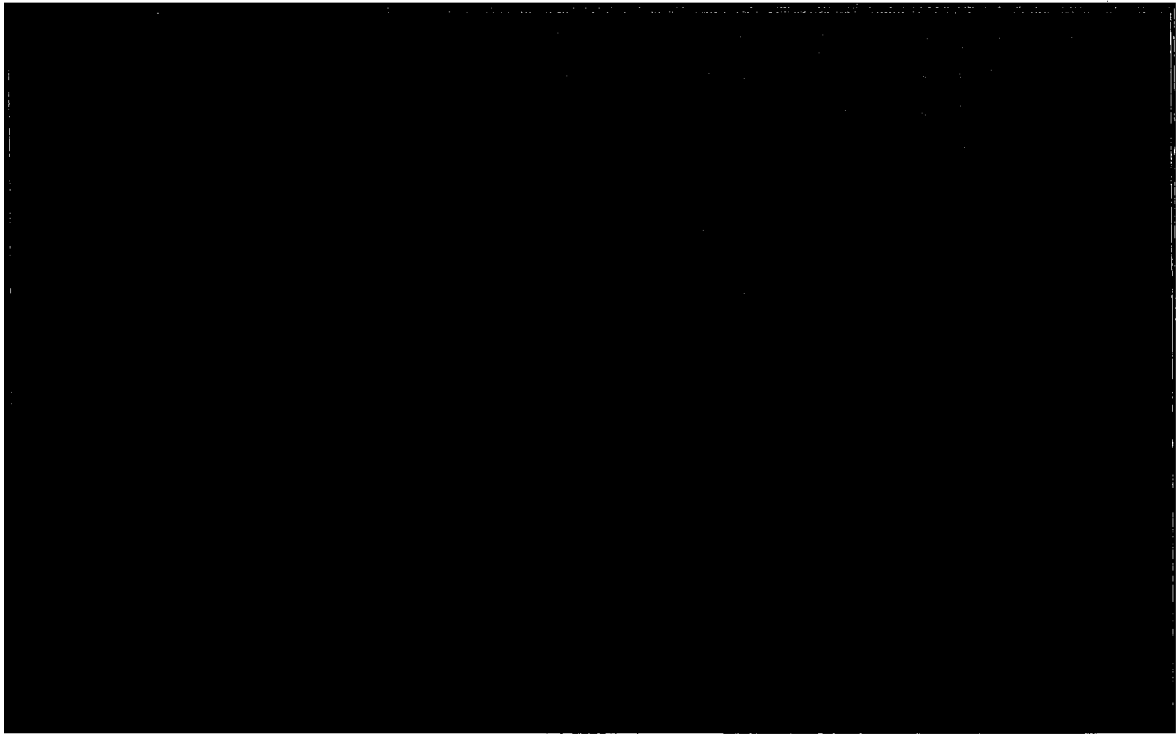

Road Commissioners, Supervisors and Business Men's Club of Kewance, Neponset, and Wethersfield, starting on tour of inspection of dragged earth roads maintained by Galva Good Roads Association, Galva, Henry County, 1907

the influence of the motor vehicle on highway expenditures had become predominant.

It will be noted that in 1904 there was a reported registration of 55,000 motor vehicles. The rapidity with which registration rose is seen in Table 2.

The real significance, however, is not in the rapid rise of highway expenditures or in the rise of motor vehicle registrations, but in the fact that men began to think of road and street improvement in terms of the motor vehicle, when this influence became a factor in the amount of money expended for highways and streets. "A real awakening to the advantages of good roads came only after the advent of the automobile, about 1900."<sup>4</sup>

There is abundant evidence to prove that the motor vehicle had stimulated interest in road improvement before 1904 and its effect on road expenditures after that date was very marked.<sup>5</sup> (See picture, page 18.)

---

expanded to overcome them, but concludes with the following statement: "In view of these facts the Department cannot vouch for the absolute accuracy of all the figures given in the tables, but it is believed that taken as a whole, they can be accepted as fairly correct and that they will form a valuable basis for comparison and for future work of this kind."

<sup>4</sup> Chatburn, "Highways and Highway Transportation," page 62.

<sup>5</sup> In April, 1903, Gen. Roy Stone of New York addressed the National Good Roads Convention at St. Louis as follows:

"Comparing the conditions of today with those of ten years ago we see the progress of the country most strikingly displayed. But progress in road sentiment is perhaps more marked than in any other line. The convention of 1892 was called by a few private enthusiasts, with fear and trembling for the result; this convention was called by a multitude of high officials in perfect confidence of the Nation's interest and participation. In 1892 our delegates were self-appointed; here they are appointed by municipalities, States and public bodies. In that convention we dared not whisper 'National aid to road building' save in secret; now we can about it on all the highways and byways. At that time a majority of the people of the United States had never seen a good road; today, through National object lessons and good roads trains, it is a familiar sight to nearly every one. Then, even State aid was denounced as a dangerous experiment; now it is being generally adopted. In those days to borrow money for good roads was denounced as 'robbery of future generations;' today it is accounted a blessing, and especially to them. Everywhere counties are borrowing money for highways, and the States of New York and Pennsylvania are preparing to issue road bonds amounting to many millions of dollars. At that time you would have paralyzed a Congressman by even hinting at a Government appropriation for public roads; now he only asks 'how much,' and puts his ear to the ground again.

• • • • •  
"Since 1892 an entirely new force has appeared in the good roads field and one whose influence can not now be measured or bounded. Already the automobile industry is one of the most active and powerful in the land, and its representatives fully realize that its ultimate success is bound up with that of road improvement, for in France, where the roads are good, it leads all other manufacturing industries in size and profit." (U. S. Dept. of Agri. Office of Public Roads Inquiries, Bulletin No. 26, p. 46.)

---

On March 10, 1913, there was transmitted to the Secretary of Agriculture the results of a study of "Repair and Maintenance of Highways," later published as Bulletin No. 48, Office of Public Roads. The study was con-

Although 1904 is the first year for which dependable data on a national basis are available for highway expenditures, the available data for States indicate that per capita expenditures in that year were not greatly in excess of the average for many years preceding. The expenditures for 1904 are, therefore, considered a generous measure of the monetary value of traditional uses and are accepted in this report as representing the per capita expenditure which the people were willing to make for highway and street facilities without motor vehicle influence.<sup>6</sup>

ducted obviously during the preceding year or earlier. In this report appear the following statements:

"The rapidly increasing automobile traffic on highways has measurably stimulated interest in road improvement and profoundly modified methods of construction and maintenance." Page 6.

"During the years from 1906 to 1913 there has been a great increase of automobile travel upon first-class country roads. It is now demonstrated beyond doubt that the ordinary waterbound macadam cannot successfully withstand the action of a considerable amount of automobile traffic." Page 19.

"The development of automobile traffic upon public highways *within the past decade* is perhaps the most significant influence affecting the road problem since MacAdam's time." Page 68.

"The use of automobile trucks for commercial purposes is rapidly increasing. The final estimate of the economic advantage of using automobile trucks must certainly include as a factor the increased cost of construction and maintenance required upon the highways. There are already marked tendencies toward increasing the strength and durability of road foundations and toward the adoption of more costly road surfaces, with a proportionate low cost of maintenance." Page 71.

The Massachusetts Highway Commission in the year 1904 reported 3,743 automobiles registered and 100 dealers in automobiles. There were 692 professional chauffeurs licensed in that year.

"Perhaps the most important discovery of the year (1907) is the extraordinary destructive effect upon roads of the large number of swiftly moving automobiles. Practically all of the main roads are thus affected \* \* \*. The number of automobiles has rapidly increased during the year, and this increase will, in the opinion of the Commission, continue indefinitely."

(Mass. Highway Commission Report 1907.)

"The advent of the automobile has doubled the expense of maintaining the State highways."

(Mass. Highway Commission Report 1908.)

"I deem it my duty to call your attention to the injurious effect of rapidly driven power vehicles upon the public highways of the state, especially those of macadam surface. The question can not longer be ignored. \* \* \* It is only within the past two or three years that the remarkable increase in the number of automobiles as well as in their weight and speed has made noticeable the effect upon the public highways. \* \* \* The damage done to the surface of our macadam and gravel roads by these appliances is so great that the question of a remedy is creating considerable agitation all over the different counties of the state."

(Frederick Skene, State Engineer, Annual Report, Fiscal year ending Sept. 30, 1907.)

\* There are two kinds of units by which these expenditures may be presented. One is the annual expenditure per mile of highway. The other is the per capita basis. Either unit might be used. Since highway mileage figures are somewhat uncertain for 1904 and even later years it has been decided in this study to use the per capita basis. The results would not be materially different if reported highway mileage was used. (See Table 4 for highway mileage.)

*Rural Roads.* The expenditures on rural roads in 1904 are reported to have been \$79,771,418, as shown in Table 3. Population figures for that same year were 82,386,000. Calculated from these figures the per capita expenditure for that year was 97 cents, which will be called \$1.00 per capita when used in subsequent calculations. For each year of the period under consideration \$1.00 will be used to determine the amount chargeable to property taxes and the remainder will be the amount chargeable to motor vehicle users. It will be noted that this method gives the highway users a free right-of-way, appraised in 1904 at \$341,899,306, which increased in value with settlement and development of the country.<sup>7</sup> This, then, is the basis with which to begin.

*City Streets.* The only available information on expenditures for city streets is to be found in the Bureau of the Census reports on "Financial Statistics of Cities." The figures in these reports are limited to cities with a population of 30,000 or more. There are no figures available for smaller cities or for villages, towns and other incorporated places. The available data for larger cities, however, have been grouped according to population and a study of these groups indicates that the trend in per capita expenditure is downward as the population decreases.

As shown in Table 5 and also in Chart 2, the per capita expenditure for cities having a population of 30,000 and more was \$5.32 in 1904. There was little increase in such annual expenditure up to and including 1919. In this respect the record of expenditures for street facilities differs from that shown for rural highways and leads to the conclusion that the higher degree of improvement of city streets which existed in 1904 offered facilities which were satisfactory for the use of the rapidly multiplying motor vehicles in the course of succeeding years. It was not until the highly intensified use of these facilities by motor vehicles and the increase of their unit weight within the period just preceding and following the World War had either greatly damaged them or rendered them inadequate and unsatisfactory that a rapid increase in per capita expenditures occurred. For this reason a fair and reasonable conclusion is that street facilities provided by a relatively stable per capita expenditure in pre-motor vehicle days were far beyond those defined here as community uses. They were satisfactory for motor vehicle use until after the World War, without requiring any material increase in per capita expenditures.

No doubt pre-automobile standard of street facilities extending into the period under consideration furnished services to motor vehicle users for which they should pay a part of the cost. There is no feasible method, however, to reduce the per capita expenditure in 1904 to a figure more truly representative of the cost of facilities that community use alone would require, because data are not available to make such a calculation. Rather than assume an arbitrary division

---

<sup>7</sup> U. S. Department of Agric., Office of Public Roads, Bulletin 32, p. 11.

**TABLE 3**  
**HIGHWAY EXPENDITURES—1904-1934**

Year	Total highway expenditures	By general accounts		
		Construction and right-of-way a	Maintenance, equipment supplies and miscellaneous	Interest on bonds and notes
<b>ALL HIGHWAYS</b>				
1904	\$79,771,418	*	*	*
1909	142,000,000	*	*	*
1914	240,263,784	*	*	*
1915	282,000,000	*	*	*
1916	288,000,000	*	*	*
1917	295,000,000	*	*	*
1918	300,000,000	*	*	*
1919	400,000,000	*	*	*
1921	981,000,059	\$633,511,707	\$308,143,478	\$44,844,874
1922	1,000,901,077	631,779,029	318,069,248	51,052,800
1923	936,493,223	541,624,005	327,616,939	67,263,879
1924	1,093,219,721	660,642,168	356,567,846	76,009,707
1925	1,141,369,513	681,873,361	379,490,350	80,005,802
1926	1,163,747,971	648,424,254	414,948,517	100,375,200
1927	1,283,944,336	727,747,233	445,900,602	110,296,601
1928	1,418,540,212	820,357,853	481,425,410	116,756,949
1929	1,444,668,985	813,982,436	506,574,948	124,111,601
1930	1,680,493,095	1,009,711,591	537,508,438	133,273,066
1931	1,616,781,586	981,839,846	487,596,887	147,844,853
1932	*	723,445,859	471,027,423	*
<b>Total years 1921-1932</b>	*	<b>8,874,939,342</b>	<b>5,029,868,886</b>	*
1933	*	*	*	*
1934	*	*	*	*
<b>STATE HIGHWAYS</b>				
1921	884,381,362	296,136,179	77,828,347	10,416,836
1922	410,901,077	301,779,029	93,069,248	16,052,800
1923	414,807,424	299,338,800	97,946,565	17,522,059
1924	559,601,149	404,806,105	183,294,393	21,600,649
1925	597,902,372	416,907,597	152,833,710	28,161,065
1926	576,016,847	382,706,035	159,620,761	33,690,051
1927	640,494,369	438,566,878	166,647,170	36,280,821
1928	759,318,068	538,043,138	184,324,896	36,950,034
1929	799,876,344	557,400,625	196,641,188	46,834,591
1930	979,397,847	713,117,045	216,212,661	50,688,141
1931	979,532,093	730,964,832	186,776,182	61,862,079
1932	816,765,481	551,445,859	196,027,423	69,292,199
<b>Total years 1921-1932</b>	<b>7,919,654,933</b>	<b>5,631,202,122</b>	<b>1,861,221,546</b>	<b>427,231,265</b>
1933	666,061,710	446,841,168	158,699,699	60,520,943
<b>Interim period—1933-34 b</b>	<b>107,054,000</b>	<b>65,132,000</b>	<b>33,637,000</b>	<b>8,285,000</b>
1934	843,631,000	554,278,000	222,050,000	67,308,000
<b>Total years 1921-1934</b>	<b>9,536,401,643</b>	<b>6,697,453,290</b>	<b>2,275,608,145</b>	<b>563,840,208</b>
<b>COUNTY AND LOCAL ROADS</b>				
1921	596,618,697	337,875,528	225,315,131	33,928,038
1922	590,000,000	330,000,000	225,000,000	35,000,000
1923	521,685,799	242,285,205	229,669,274	49,781,320
1924	538,618,572	255,836,063	223,273,451	54,509,058
1925	543,467,141	264,965,764	226,656,640	51,844,737
1926	587,781,124	265,718,219	255,327,756	66,685,149
1927	643,449,467	289,180,355	279,253,332	75,015,780
1928	659,222,144	282,314,715	297,100,514	79,806,915
1929	644,792,641	256,581,811	309,933,760	78,277,070
1930	700,295,248	296,594,546	321,295,777	82,404,925
1931	637,189,493	250,835,014	300,821,705	85,482,774
1932	*	172,000,000	275,000,000	*
<b>Total years 1921-1932</b>	*	<b>3,243,737,220</b>	<b>3,168,647,340</b>	*
1933	*	*	*	*
1934	*	*	*	*

Source: Reports of the United States Department of Agriculture: Year 1924 from Bulletin No. 32; 1909 from U.S.D.A. Year Book 1912; 1914 from Bulletin No. 1279; 1915 from circular No. 68; 1916 from circular No. 74; 1917, 1918, and 1919 from "Public Roads" July 1918, July 1919 and September 1920 issues, respectively. Figures for remaining years, except for county and local roads 1932, were taken from annual report F-2 and F-5 of the Bureau of Public Roads. Figures for county and local roads in 1932 are estimates.

a "Construction and right-of-way" expenses include administrative and engineering expenses for all years. See Appendix D for details.

b Figures for the year 1934 are based on calendar year. Figures for 1933 include figures for some states that reported for years ending in other months than December. The figures shown are for the interim or overlapping period for such states which reported figures for other than calendar year in 1933. These figures are additive in any compilation of state highway expenditures by years.

\* Data not available.

**TABLE 4**  
**HIGHWAY MILEAGE—1904-1930**

State Highways and County and Local Highways to End of 1930

Year	Total mileage	Surfaced mileage			Non-surfaced mileage
		Total	High type	Low type	
<b>All Highways:</b>					
1904	2,151,879	158,530	.....	.....	1,997,849
1909	2,199,645	190,476	.....	.....	2,009,169
1914	2,445,761	257,291	.....	.....	2,188,470
1915	2,451,660	276,320	.....	.....	2,174,740
1916	2,455,761	287,047	.....	.....	2,168,714
1917	2,457,834	296,290	.....	.....	2,161,044
1918	2,478,652	299,135	.....	.....	2,179,417
1921	2,924,605	387,457	86,088	351,419	2,537,048
1923	2,995,727	439,341	64,189	375,152	2,556,386
1924	3,004,411	471,667	73,788	397,879	2,532,744
1925	3,006,083	521,260	76,905	444,355	2,484,823
1926	3,000,190	550,064	82,987	467,077	2,450,126
1927	3,013,584	588,721	91,986	496,735	2,424,863
1928	3,016,281	626,137	102,559	523,578	2,390,144
1929	3,024,233	652,435	112,454	540,981	2,361,798
1930	3,009,066	693,659	125,708	567,951	2,315,507
<b>State Highways:</b>					
1921	202,915	84,372	21,415	62,957	118,543
1923	251,611	111,400	34,187	77,213	140,211
1924	261,216	132,109	41,478	90,636	129,107
1925	274,911	144,854	48,349	96,505	130,057
1926	287,928	163,069	53,949	109,110	124,869
1927	293,853	176,566	60,189	116,427	116,787
1928	306,442	193,138	68,373	124,765	113,304
1929	314,136	208,324	75,113	133,211	105,812
1930	324,496	226,221	84,112	142,109	98,276
<b>County and Local Roads:</b>					
1921	2,721,590	303,085	14,628	288,462	2,418,505
1923	2,744,116	327,941	34,187	293,754	2,416,175
1924	2,748,195	339,558	32,816	307,243	2,408,637
1925	2,781,172	376,406	28,556	347,850	2,354,766
1926	2,712,262	387,005	29,088	357,967	2,325,257
1927	2,720,231	402,155	21,797	380,358	2,308,076
1928	2,709,839	432,999	34,186	398,813	2,276,840
1929	2,710,097	454,111	37,341	416,770	2,255,986
1930	2,684,570	467,338	41,596	425,742	2,217,232

NOTE: The foregoing table shows the mileage for both State highway and county and local roads, down to the end of the year 1930, the latest year for which complete data for all highways are available. Mileage figures for State highways, however, are available for later years on a somewhat different basis than in previous years.

During 1931 and subsequent years various State Highway Commissions have taken over the supervision of the construction and maintenance of certain county highways, which together with some road mileage previously reported, form a secondary system of State highways. Figures for the year 1934 are as follows:

**STATE HIGHWAY MILEAGE—1934**

Item	Miles	, Miles
Rural roads under state control:		
Primary state road system	324,812	
Secondary road system	170,244	
Total—rural roads		494,556
Urban extensions of connecting streets in State Highway System		12,458
Total roads and streets under State control		507,014
Surfaced		358,078
Non-surfaced		148,936

a Excludes 3,708 miles of urban extensions or connecting streets which are not in designated State system.

SOURCE: Report of the United States Department of Agriculture as follows: years 1904, 1909 and 1914, from Bulletin No. 1279; 1915 from circular No. 63; 1916 from circular No. 74; 1917 and 1918 from "Public Roads" July 1918, and July 1919, issues, respectively. Figures for years 1921 to 1930 from Annual Tables M-4 and M-5 of the Bureau of Public Roads. Figures for 1934 Bureau of Public Roads Table SM-1.

**TABLE 5**  
**EXPENDITURES FOR CITY STREETS—1904 TO 1932**  
For cities having population of 30,000 or more  
Source: Bureau of the Census, Financial Statistics of Cities

Year	Expenditures for construction and right-of-way		Cost of operation and maintenance <sup>a</sup>		Total expenditures	
	Amount (000)	Per capita	Amount (000)	Per capita	Amount (000)	Per capita
1904	\$65,987	\$3.03	\$49,794	\$2.29	\$115,781	\$5.32
1905	63,774	2.86	50,041	2.24	113,815	5.10
1906	63,041	2.75	54,491	2.38	117,532	5.13
1907	83,079	3.53	61,665	2.62	144,744	6.15
1908	87,442	3.63	62,275	2.59	149,717	6.22
1909	84,141	3.29	62,439	2.44	146,580	5.73
1910	92,196	3.38	70,022	2.75	162,218	6.13
1911	108,328	3.79	74,995	2.63	183,323	6.42
1912	102,576	3.50	77,745	2.65	180,321	6.15
1913	101,952	3.38	80,271	2.66	182,223	6.04
1914 <sup>b</sup>						
1915	117,549	3.77	86,194	2.77	203,743	6.54
1916	101,085	3.13	84,232	2.61	185,317	5.74
1917	108,075	3.25	87,580	2.63	195,655	5.88
1918	107,942	3.14	93,317	2.72	201,259	5.86
1919	83,497	2.41	98,549	2.84	182,046	5.25
1920 <sup>b</sup>						
1921	124,481	3.33	121,645	3.26	246,126	6.59
1922	187,692	4.85	156,481	4.04	344,173	8.89
1923	204,643	5.22	158,062	4.04	362,705	9.26
1924	249,391	6.24	164,130	4.11	413,521	10.35
1925	317,498	7.79	178,511	4.38	496,009	12.17
1926	332,250	7.94	198,138	4.74	530,388	12.68
1927	394,963	9.25	208,757	4.89	603,720	14.14
1928	389,688	8.97	212,401	4.89	602,089	13.86
1929	379,943	8.57	225,591	5.09	605,534	13.66
1930	427,526	9.01	221,474	4.67	649,000	13.68
1931	299,481	6.20	222,951	4.62	522,432	10.82
1932 <sup>c</sup>	160,755	4.26	157,053	4.16	317,808	8.42
Weighted average: 12 years 1921 to 1932	.....	6.91	.....	4.44	.....	11.35

<sup>a</sup> Figures for 1904 to 1910, inclusive, and for year 1913, include relatively small expenditures on waterways. These expenditures were not reported separately in those years. Cost figures for all years include cost of street cleaning.

<sup>b</sup> Data not available.

<sup>c</sup> Cities of 100,000 or more population.

until better data are available, it is decided for this report to charge against the taxpayers all the per capita expenditure in 1904 as their obligation.

The average per capita expenditure for cities of 30,000 and over for the period represented by 1904 was \$5.32 (Table 5). An estimate has been made of the expenditures in cities of less than 30,000 based on \$3.00 per capita.\* The weighted average expenditure, therefore, for all cities in 1904 was thus found to be \$4.20 per capita, which represents the amount chargeable to property taxes.

It has been suggested that, inasmuch as the costs of labor and materials were not uniform in the years following 1904, a comparison of facilities requires that costs be equated. This idea is rejected for

CHART 2  
CITY STREETS — PER CAPITA EXPENDITURES — 1904-1932  
For cities having population of 30,000 or more

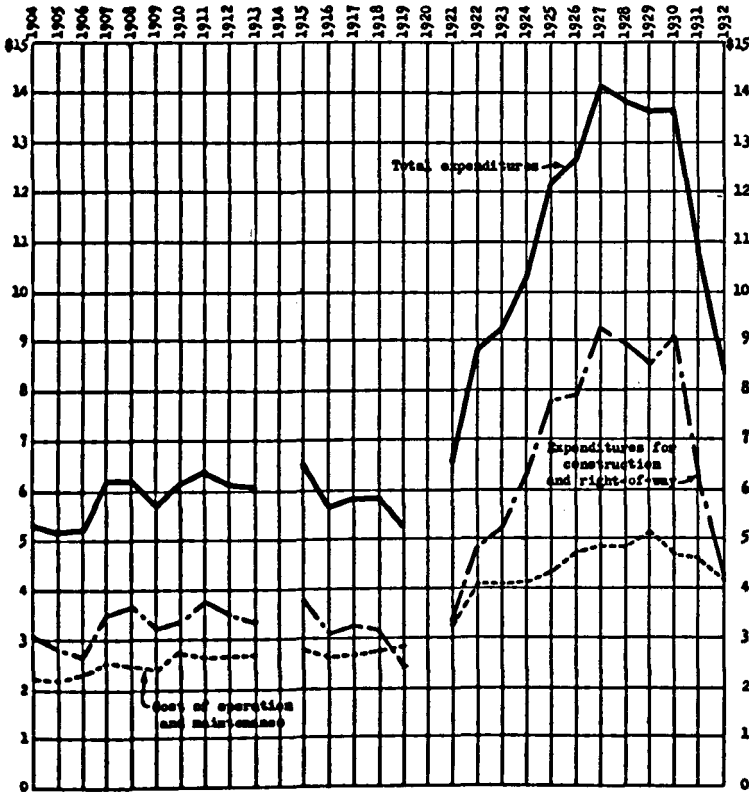

\* The trend of per capita expenditures shown by the data available for the larger cities supports this figure.



the reason that fluctuations in prices such as occurred in the later period could have had little or no effect on the amount of money which was expended for highways. The best measure of the willingness of the public to provide highway facilities is the actual number of dollars appropriated or expended rather than the amount of work that was done. There is, of course, a further consideration that the improvements made in the equipment used and in the art of road-building, including better designs, would tend to balance any increase in costs of labor or material. Consequently, *\$1.00 per capita for rural roads and \$1.20 per capita for city streets is used throughout the period under review.*

The 12-year period 1921-1932, for which comprehensive data are available, has been selected for special review, with a survey of data in later years in so far as they have been found dependable.

## CHAPTER III

### ANNUAL COST

The determination of the total annual cost of highway facilities should include the annual amortization of capital costs, interest and taxes on unamortized capital, annual maintenance and operation, including administration.

As soon as a highway is built, it begins to wear out. A portion, therefore, of the capital cost must be retired each year, that is, amortized. The remaining capital investment or unamortized cost is the amount upon which interest and taxes are charged. It follows, therefore, that instead of annual expenditures being used, the principle of amortization or depreciation should be applied to them. If this be done, it then becomes necessary to ascertain as accurately as possible the service life of each highway element. Since a definite period is under review in this study, facilities provided in previous years come forward into such a period in so far as their service life had not been used up.

#### SERVICE LIVES OF RURAL HIGHWAY ELEMENTS

There are three main elements in the highway to which amortization should be applied. They are:

1. Surfacing or pavements.
2. Grading.
3. Structures.

There are other elements of the highway that represent capital costs. One of these is rights-of-way. These might be considered as lasting forever except for obsolescence through relocation or new alignments. In recent years there has been considerable relocation and realignment. As to relocation, while practices differ, generally the costs of new rights-of-way are borne by counties from general taxes and such costs are not included in highway accounts. This element of cost does not receive further consideration in this study. Costs of realignment and other capital costs, are later discussed along with other factors (page 77).

*Surfacing.* The length of the service life of a pavement depends upon such factors as the type of pavement, the safety factor in design with respect to traffic loads, action of the natural elements, and changes in traffic use. When the pavement has reached a point of unserviceability which leads to replacement, there may still be in it usable material for a new or another pavement. That is, there may be some salvage value in it.

There are many types of pavement on rural roads, functioning

under varying conditions of climate and use. A fair average service life will not fit all local conditions; it is an average of many types of pavement, of many varying uses. Experience, observation and such records as are available must be relied upon. The rapidly increasing use of highways by heavier and wider vehicles has rendered many pavements obsolete, so that reconstruction has become necessary.

A study of available data in the State of New York, reaching back to 1894, indicates an average service life of all pavements, based upon replacements in the pre-war period of about 7.4 years. From other data of roads built from 1923 to 1934 the service life of all pavements on the State System appears to be about 12.6 years.<sup>1</sup> This calculation includes obsolescence.

Of the rural highways in New England, Professor C. B. Breed, Consulting Engineer, Mass. Institute of Technology, says concrete pavements will have failed to a sufficient degree as to require a covering of bituminous concrete in 20 to 25 years; a bituminous macadam pavement, if tar, will require a thin seal coating every 3 to 6 years, and, if asphalt, every 10 to 15 years.<sup>2</sup>

The Bureau of Public Roads has estimated the service life of concrete pavements at 20 years, with 15% salvage value.<sup>3</sup>

While highway engineers generally failed to foresee the full demands that would be made upon the roads which they were called upon to construct in the period under review, and hence obsolescence was abnormally high, conservative judgment may place the service life of pavements as follows:

- a. High type pavements.....20 years
- b. Intermediate type pavements.....10 years

*Grading.* The grading of a highway, if undisturbed, might be expected to last indefinitely. It might even grow better with use. Great changes, however, have been made both in relocations and in realignments. "As a matter of general information, I think," says E. C. Lawton, Assistant Commissioner of Highways, New York, "it can safely be said that the necessity for fully 50% of the reconstruction in New York State has been brought about by improper alignment, grades, curvature, and sight distance incorporated in earlier highway designs. This is one of the most important economic factors facing highway administrators."<sup>4</sup> A more level country would, of course, not require so much change.

In view of what has taken place since 1920, and in view of possible new developments, it is believed that a wise public policy would be to amortize completely this element of the highway within a 50-year period.

<sup>1</sup> Downs, W. S., *Motor Vehicle Taxation in New York*, pp. 27-8, Table 33.

<sup>2</sup> Breed, C. B., *Relative Road Costs*, p. 23.

<sup>3</sup> Bur. of Pub. Roads, *A Study of Costs of State Highways in Penn.*, 1930.

<sup>4</sup> *The Low Bidder*, "New York Highways," December, 1933.

*Structures.* Bridges and culverts are a relatively costly element of the highway. For this reason they have been slower to develop to a standard adequate for the service required of them. Available data indicate an increasing inadequacy of structures to carry existing loads on all rural highways.\*

The record shows that vehicles and traffic on the highways and over the structures have become progressively heavier, larger and more frequent, with the result that structures are being destroyed or rendered obsolete.

In the light of these considerations, a conservative judgment would dictate that—

a. While for structures on the State Highway Systems as a whole a service life of 40 years may reasonably be expected from bridges built during the later years of the period under review (1921-1932), the average service life of bridges in existence during the period may be estimated at 30 years.

b. For structures on other rural roads, an average service life of 20 years is a reasonable estimate.

*Salvage Value.* The service life of concrete pavements in the period under review is set at 20 years. In adopting this figure it is recognized that the practice with reference to maintenance and repair of concrete pavements varies widely. In some districts it is customary, before the pavements reach complete failure to cover them with bituminous surfacing. If this covering is laid before the concrete pavement has badly failed, then there is considerable salvage value in the concrete pavement. When, however, the pavement is used until complete failure has occurred, then there is not only no salvage value but there is the added cost of removing the old pavement to make way for the new concrete pavement. It is obvious, therefore, that the life and salvage are interrelated and are influenced by the practice in the different States. The life is also influenced by the quality of the concrete.

The salvage value of the intermediate type of pavement has been set at 30%. Generally speaking, in constructing a new bituminous pavement it often comprises a top course of definite thickness laid upon the old worn bituminous pavement, the latter forming a sub-base or foundation for the new pavement after its surface has been re-formed. If road locations and grades were not modified, the salvage value adopted for bituminous pavements in general would be higher than 30% because then it would not be necessary to remove any of the old pavement; it could be incorporated as a part of the new pavement and thus have high salvage value. On the other hand, where alignments are straightened and grades reduced or made

\* The Forgotten Bridges, H. E. Colburn, Bridge Engineer, Allegany County (N. Y.) Dept. of Highways, Readers Digest, Sept., 1935, pp. 53-5; Shall We Build Highways for Motor Vehicles, etc., Association of American Railroads, 1935. Hearings Federal Aid Highway Act 1938, H. R. 8838, Table 6, pp. 19-20.

more uniform, long stretches of original pavement often have to be abandoned, in which case there is no salvage value.

Grading has no salvage value. The same is usually true for structures.

From the determination of the service lives of these elements of highways and streets may be ascertained the basis for annual capital costs. The method and the tables are given later.

It will be recalled that the National Good Roads Association was successful in securing State aid. Proof of that success has been given in Table 6, showing dates of State legislative acts embodying such aid.

TABLE 6  
YEAR IN WHICH FIRST STATE AID LAW PASSED

1891—New Jersey	1905—Illinois	1911—Nebraska
1892—Massachusetts	1905—Michigan	1911—Nevada
1895—California	1905—Minnesota	1911—Oklahoma
1895—Connecticut	1905—Washington	1911—South Dakota
1898—Maryland	1906—Virginia	1911—Wisconsin
1898—New York	1907—Missouri	1911—Wyoming
1898—Vermont	1908—Georgia	1912—Kentucky
1901—Maine	1909—Arizona	1913—Arkansas
1901—North Carolina	1909—Colorado	1913—Montana
1902—Rhode Island	1909—New Mexico	1913—Oregon
1903—Delaware	1909—North Dakota	1915—Florida
1903—New Hampshire	1909—Utah	1915—Mississippi
1903—Pennsylvania	1909—West Virginia	1915—Tennessee
1904—Iowa	1910—Louisiana	1917—Indiana
1904—Ohio	1911—Alabama	1917—South Carolina
1905—Idaho	1911—Kansas	1917—Texas

There followed, naturally and perhaps inevitably, the assumption of jurisdiction by the State over increasing mileage of rural highways.<sup>6</sup> Out of this grew a classification, on the basis of jurisdiction, responsibility and control, of rural roads into State Highway Systems and other, or "County and local," roads.

The records give no classification of these rural roads until 1921, the beginning of the period under review. State aid, however, quickly became an important item, as indicated heretofore.

With the passage of the Federal Good Roads Act of 1916, great additional impetus was given to activities of State highway departments already in existence and to the organization of such departments in the few States where they did not exist. State control of rural highways was a required condition for receiving Federal aid, 50% of the cost of construction up to \$20,000 per mile.<sup>7</sup>

<sup>6</sup> Agricultural Year Book of Department of Agriculture, 1924, p. 98.

<sup>7</sup> U. S. Department of Agriculture Circular No. 914. Also Year Book, 1924:

"To the extent of the money it appropriated, the Federal-aid road act authorized the Secretary of Agriculture to participate in the improvement of post roads up to 50 per cent of the cost of the improvement, providing

In the period studied it becomes necessary to deal separately with the rural road mileage in the State systems as distinguished from the remaining rural road mileage under county and local control. The State systems are presumed to comprise the main roads, those most frequently travelled and thus requiring a higher standard of improvement. As shown in Table 3 funds have been concentrated upon their improvement. Federal aid had to be matched, generally, by the State, for which purpose the State used special fees and gasoline taxes collected from motor vehicle operators.

The States usually collected motor vehicle license fees, gasoline taxes and other important imposts, and so held the purse strings of the resulting funds. The Bureau of Public Roads, with its millions of Federal tax money to spend, held the purse strings controlling Federal aid to the States. This aid was limited to a selected part of rural highways under supervision of State Highway Departments. This fact accounts for the concentrated expenditure.

Annual costs, therefore, are calculated for the period, 1921-1932, separately for State Highways and Other Highways. City streets are treated separately throughout.

The foregoing discussion of service lives and salvage values may be summarized as follows:

(a) State Highways	Service Life (Years)	Salvage Value (per cent)
High type pavements .....	20	none
Intermediate type pavements .....	10	30
Grading .....	50	none
Structures .....	30	none

To ascertain the weighted average life of the entire State highway system requires the distribution of construction expenditures. A study by the Bureau of Public Roads\* covering expenditures on State highways for the period 1923-1931, inclusive, gives data from which the following distribution can be calculated:

Highway Element	Per cent
Higher type surfacing .....	47.2
Gravel and waterbound macadam .....	10.3
Excavation .....	26.0
Structures .....	16.5
<b>Total</b> .....	<b>100.0</b>

that the aid granted any particular project did not exceed \$10,000 a mile, exclusive of the cost of bridges more than 20 feet long." p. 101.

"The importance of the Federal legislation then is that it embodies and applies those principles which have been found to be most successful in the experience of the most advanced States, and it has caused the adoption of these principles by all States much sooner than they would have been adopted on the initiative of the States. Among these principles, the application of which is extended to all States by the Federal laws, are (1) the engineering control of main roads by State highway departments, (2) the designation of connected systems of main roads to be constructed under State supervision with funds under State control, and (3) the continuous maintenance of such roads by the State highway departments." pp. 101-102.

\*J. L. Harrison, "An Index of the Cost of Highway Construction," "Public Roads," Vol. 14, pp. 81-92, July, 1933.

The term "higher type" in Harrison's study includes bituminous macadam, which in the previous discussion is included with intermediate type pavements. As the total mileage of bituminous macadam roads in 1932 was 20,009 miles, or about 18 per cent of the total of the high type group, the error resulting from this difference in classification will not be important in the final result.

The calculation of the weighted average life of State highways is as follows:

<i>Highway Element</i>	<i>Per Cent of Investment to Be Amortized</i>	<i>Service Life</i>
Higher type surfacing .....	47.2	20
Gravel and waterbound macadam.....	7.2	10
Excavation .....	26.0	50
Structures .....	16.5	30
<b>Total .....</b>	<b>96.9</b>	
Weighted average life .....		29 years
Salvage .....		3.1 per cent

<i>(b) County and Local Roads</i>	<i>Service Life (years)</i>	<i>Salvage Value (per cent)</i>
Higher type pavements .....	20	None
Intermediate type pavements .....	10	30
Grading .....	50	None
Structures .....	20	None

Information regarding the distribution of construction expenditures made on county and local roads during the period 1921-1932 is not available. A fairly accurate estimate of the distribution, however, may be made by a comparison of amounts shown in Column II of Appendix A, for each type of road, with corresponding amounts computed for the mileage of each type at the end of 1930 (the last year for which the classification of county and local roads is available). The difference between the two totals is a measure of the amount expended between 1921 and 1930, and by means of the percentages given in Columns 10-12, of Appendix B this amount may be broken down by highway elements. The calculation produces the following distribution:

<i>Highway Element</i>	<i>Per cent</i>
High type pavements .....	9.1
Intermediate type pavements .....	23.1
Grading .....	47.0
Structures .....	20.8
<b>Total .....</b>	<b>100.0</b>

From the above data the weighted average life of county and local roads is computed as follows:

<i>Highway Element</i>	<i>Per Cent of Investment to Be Amortized</i>	<i>Service Life</i>
High type pavements .....	9.1	20
Intermediate type pavements .....	16.2	10
Grading .....	47.0	50
Structures .....	20.8	20
<b>Total</b> .....	<b>93.1</b>	
Weighted average life .....		33.4 years
Salvage .....		6.9 per cent

### SERVICE LIFE OF CITY STREETS

For the service lives of the various elements of city streets the figures developed for State highways will be used, since city streets are fairly comparable from the standpoint of character of improvement to State highways.

#### PRIOR INVESTMENT CARRIED OVER INTO 1921-1932 PERIOD

Data as to expenditures for highway construction and maintenance are available for 1921 and subsequent years. For the investment made prior to 1921, it is necessary to estimate the depreciated cost of the highway plant as it existed on December 31, 1920, and to this estimated amount apply rates of amortization which will produce the annual charges therefor in the period under consideration.

Again, in the absence of statistical information, reliance must be placed on experience and judgment in assuming service lives which will determine the rates of amortization. The following tabulation is an estimate of the total service lives of the elements of highways in existence on December 31, 1920:

	<i>State Highways (years)</i>	<i>County and Local Roads (years)</i>
Surfacing .....	15	11
Grading .....	50	50
Structures .....	25	15

*It will be assumed in subsequent calculations that one-half of the service life, including salvage of each element had expired on December 31, 1920, in view of inadequacy of construction and maintenance and the intensive, destructive use from 1917 on.*

For city streets in existence on December 31, 1920, a service life of 20 years will be taken and the assumption made that one-half of this life had expired at the beginning of the period.

The foregoing has dealt with the cost element of amortization, which includes both depreciation and obsolescence. In addition, there are other elements making up the total annual highway cost.

*Interest.* Not only have millions of dollars been borrowed by States and counties for highway improvement, but it is also true that for correct accounting of a public utility there should be set up a fair interest charge on the invested capital. This is in accord with



the accounting systems for the Panama Canal and the Tennessee Valley Authority. It has also been recently accepted as a proper charge for highways by the U. S. District Court for the State of Illinois and by the Royal Commission on Transportation of the Province of Ontario. It is also an accepted principle for other publicly and privately owned utilities.

A study of the average interest rates on State highway bonds issued in the period under consideration, shows a general upward trend. In addition to the actual interest paid, there are other costs which have to be borne by the States when the bonds are sold. A fair average rate to be used in the computation of interest on State highway investment would be  $4\frac{1}{4}$  per cent per annum.

Counties and other subdivisions of the State government usually have to pay a somewhat higher rate of interest on their bond issues; therefore, an average interest rate of  $4\frac{1}{2}$  per cent per annum will be taken as the rate to be applied to investment in county and local roads.

The same rate,  $4\frac{1}{4}$  per cent, as selected for State highways, will be used for computing interest on city street investment.

*Equivalent Property Taxes.* The goal sought is the setting up of accounts for a highway system to the extent it is used for general transportation purposes. These accounts should contain every element of cost that a competitive private enterprise has to meet. This would, of course, include taxes for support of government. In this instance, the rate of tax has been taken corresponding to that which has been imposed upon railroads during the period under consideration. As shown in Table 7 the average rate is 1.30 per cent.

*Maintenance.* Highway accounts have not been so kept as to distinguish clearly between capital costs and maintenance. Government records, however, show figures so classified. It is not possible to go behind the published official figures which are accepted for the period reviewed. They are given on an annual basis.

*Summary.* The elements making up annual costs of rural highways and city streets, therefore, are as follows:

1. Amortization of capital investment
2. Interest on unamortized investment
3. Taxes on unamortized investment
4. Maintenance

There are other annual costs, which may be classed as operating expenses, not included in this study. Lack of information prevents their use. They are represented by the cost of police supervision, traffic lights, and similar items. There are large expenditures here, most of which are chargeable against motor vehicle operators. These are in part balanced by certain items of revenue, not included in the tabulations because of inadequate information. These items will be further discussed in connection with the chapter on motor vehicle payments.

**TABLE 7**  
**RATIO OF RAILWAY TAXES TO RAILWAY INVESTMENT**

Class I Railways—Years 1921 to 1932

Source: Annual summaries of the Interstate Commerce Commission

Calendar year	Investment in road and equipment less accrued depreciation	State tax accruals	Ratio of taxes to investment (per cent)
1921	\$18,639,555,982	\$238,256,622	1.28
1922	18,870,006,285	248,765,088	1.32
1923	19,745,848,975	254,370,020	1.29
1924	20,445,871,353	266,562,842	1.30
1925	20,900,177,570	271,689,796	1.30
1926	21,441,836,810	279,935,486	1.31
1927	21,894,017,897	291,007,156	1.33
1928	22,265,476,592	300,715,170	1.35
1929	22,767,297,310	306,564,917	1.35
1930	23,178,795,461	308,220,666	1.33
1931	23,075,777,014	293,100,089	1.27
1932	22,949,719,997	263,108,874	1.15
<b>Total 12 years 1921-1932</b>	<b>256,174,380,246</b>	<b>3,322,296,726</b>	<b>1.30</b>

#### COSTS CHARGEABLE TO MOTOR VEHICLE OPERATORS

At the beginning of the period to be reviewed the highway system, generally speaking, had not reached a high degree of improvement. At the end of 1921 there were 36,038 miles of high type surfaced roads and 351,419 miles of low type surfaced roads out of a total mileage of 2,924,505 miles (Table 4). A great deal of this improved mileage was inadequate as to width, alignment, gradients, and strength or durability of the surfacing, to accommodate the heavier types of buses and trucks.

There was a substantial investment, however, in the old facilities which came over into the period and which were used, and in part are still being used, to the benefit of the motor vehicle operator. In the absence of statistics of annual expenditures, it is necessary to determine from such information as is available, the approximate value or depreciated cost of these facilities.

*State Highways.* Appendix A gives the distribution by type of road of the estimated cost of State highways in existence December 31, 1921, using a cost study of the Bureau of Public Roads, with certain adjustments as noted. Appendix B carries the analysis a step further and develops the percentage distribution of the cost of highway elements as of December 31, 1921.

Table 8 is a calculation of the estimated cost less depreciation of

**TABLE 8**  
**ESTIMATED COST, LESS DEPRECIATION, OF STATE HIGHWAY SYSTEMS, AS OF DECEMBER 31, 1920**

Type of road	Mileage at end of 1921 <sup>a</sup>	Per cent of total mileage	Estimated mileage at end of 1920	Average cost per mile, Federal aid roads, 1917-1924 <sup>b</sup>	Average cost reduced 25 per cent to reflect lower price level and lower type construction	Estimated cost of highways in existence Dec. 31, 1920 (Col. 4 x Col. 6) (000)	Estimated service life exhausted prior to Dec. 31 1920 (one half of Col. 7) (000)	Estimated cost less depreciation Dec. 31, 1920 (000)	Distribution of estimated cost less depreciation <sup>g</sup>			Service life remaining at Dec. 31, 1920 (years)	
									Element	Per cent of total	Amount (000)		
(1)	(2)	(3)	(4)	(5)	(6)	(7)	(8)	(9)	(10)	(11)	(12)	(13)	
Vitrified brick and block	2,003	0.99	1,758	<sup>c</sup> \$44,700	\$38,525	\$58,937	\$29,468	\$29,469	Surfacing Structures	51.60	\$325,342	7.5	
Portland cement concrete	9,860	4.86	8,681	88,300	28,725	247,925	123,963	128,962		15.50	97,728	12.5	
Bituminous concrete and sheet asphalt	2,844	1.40	2,486	<sup>e</sup> 83,500	25,125	62,461	31,230	31,231		Grading	32.90	207,437	25.0
Bituminous macadam by penetration	6,708	8.30	5,861	29,100	21,825	127,916	68,958	68,958		Total	100.00	630,507	....
Water-bound macadam	16,976	8.37	14,865	17,500	13,125	195,103	97,551	97,552					
Miscellaneous <sup>d</sup>	993	0.49	870	<sup>e</sup> 16,900	12,975	11,027	5,513	5,514					
Gravel, etc.	86,279	17.88	31,755	9,900	7,425	235,781	117,891	117,890					
Sand-clay and top-soil	8,709	4.29	7,619	7,400	5,550	42,285	21,143	21,142					
<b>Total surfaced</b>	<b>84,372</b>	<b>41.58</b>	<b>73,845</b>	.....	.....	<b>981,435</b>	<b>490,717</b>	<b>490,718</b>					
Improved (established to grade and drained)	21,384	10.54	18,719	7,800	5,850	109,506	54,753	54,753					
Unimproved earth, and partly graded	97,159	47.88	85,036	<sup>f</sup> 2,000	<sup>f</sup> 2,000	170,072	85,036	85,036					
<b>Total non-surfaced</b>	<b>118,543</b>	<b>58.42</b>	<b>103,755</b>	.....	.....	<b>279,578</b>	<b>139,789</b>	<b>139,789</b>					
<b>Grand total</b>	<b>202,915</b>	<b>100.00</b>	<b>177,600</b>	.....	.....	<b>1,261,013</b>	<b>630,506</b>	<b>630,507</b>					
<b>Average per mile</b>	.....	.....	.....	.....	.....	7,100	.....	8,550					

<sup>a</sup> Bureau of Public Roads. Table M-4 (1921).

<sup>b</sup> Bureau of Public Roads. Bulletin No. 914, page 113.

<sup>c</sup> Block paving assigned same cost as brick; sheet asphalt assigned same cost as bituminous concrete

<sup>d</sup> Classification not known.

<sup>e</sup> Average for all types of surfaces.

<sup>f</sup> Estimated.

<sup>g</sup>. See Appendix B.

the State highway system as of December 31, 1920. In obtaining the totals in Column 5, unit costs prevailing on Federal-aid projects built in the period 1917-1924 were used, except as to unimproved earth roads. It is probably true that the standard of construction in all State highway systems of this earlier period are lower than the standard used in the Federal-aid projects. To allow for this difference, the average costs in Column 5 were reduced by 25 per cent except as to unimproved earth roads. As previously stated, it is also estimated that 50 per cent of the service lives of the earlier improvements had been exhausted at the beginning of the period under consideration. Therefore, the totals in Column 7 were reduced 50 per cent, resulting in the final depreciated cost for State highways as shown in Column 9 of \$630,507,000, or an average per mile of \$3,550.

Table 9 is a computation of the annual cost, 1921-1932, of that proportion of the State highway system in existence on December 31, 1920. The total depreciated cost derived in Table 8 is made up of

\$325,342,000 for surfacing
97,728,000 for structures
207,437,000 for grading
<hr style="width: 20%; margin: 0 auto;"/>
\$630,507,000 Total

These amounts are amortized, using the remaining service lives previously given, interest calculated at the rate of  $4\frac{1}{4}$  per cent per annum, and equivalent property taxes calculated at the rate of 1.30 per cent per annum, both being applied to the unamortized cost. These computations produce the annual cost of that part of the State highway system in existence on December 31, 1920, for each year of the period and the total for the period, the latter figure being \$741,178,000.

Table 10 is a tabulation of the total annual cost of the State highway systems, 1921-1932. The construction expenditures shown in Column 2 have been revised from those reported by the Bureau of Public Roads for the years 1921-1927, to include a prorata share of administration and engineering expenses. The method of making the adjustment is shown in Appendix C.

Refunds for construction work performed for others, given in Column 3, are taken from an analysis of miscellaneous revenues shown in Appendix D. Using the adjusted amounts, interest during construction was computed for a one-half year period at the rate of  $4\frac{1}{4}$  per cent per annum. In the remainder of the table the computation of annual costs is carried out including amortization based on a 29-year life, with a salvage recovery of 3.1 per cent, interest at  $4\frac{1}{4}$  per cent per annum and equivalent property taxes at 1.30 per cent per annum, the two latter items being computed on the amortized cost. To these items of capital costs are added the annual expendi-

TABLE 9

ANNUAL COST 1921-1932, OF THAT PART OF THE STATE HIGHWAY SYSTEM IN EXISTENCE DECEMBER 31, 1920  
(All amounts in thousands)

Year	Cost of surfacing, less depreciation, Dec. 31, 1920, \$325,842 a				Cost of structures, less depreciation, Dec. 31, 1920, \$97,728 a			
	Current year's amortization charges (7½ year life after 1920)	Unamortized cost at beginning of year	Interest on unamortized cost at 4.25 per cent per annum	Equivalent property taxes (1.30 per cent of unamortized cost at beginning of year)	Current year's amortization charges (12½ year life after 1920)	Unamortized cost at beginning of year	Interest on unamortized cost at 4.25 per cent per annum	Equivalent property taxes (1.30 per cent of unamortized cost at beginning of year)
(1)	(2)	(3)	(4)	(5)	(6)	(7)	(8)	(9)
1921	\$48,879	\$325,842	\$13,827	\$4,229	\$7,818	\$97,728	\$4,153	\$1,270
1922	48,879	281,968	11,988	3,666	7,818	89,910	3,821	1,169
1928	48,879	288,584	10,140	3,102	7,818	82,092	3,489	1,067
1924	48,879	195,205	8,296	2,588	7,818	74,274	3,157	966
1925	48,879	151,826	6,453	1,974	7,818	66,456	2,824	864
1926	48,879	108,447	4,609	1,410	7,818	58,688	2,492	762
1927	48,879	65,068	2,765	846	7,818	50,820	2,160	661
1928	21,689	48,879	1,844	564	7,818	48,002	1,828	559
1929	.....	.....	.....	.....	7,818	35,184	1,495	457
1930	.....	.....	.....	.....	7,818	27,366	1,168	356
1931	.....	.....	.....	.....	7,818	19,548	831	254
1932	.....	.....	.....	.....	7,818	11,730	499	152
<b>Total</b>	<b>825,842</b>		<b>59,917</b>	<b>18,829</b>	<b>98,816</b>		<b>27,912</b>	<b>8,587</b>

**TABLE 9 (Continued)**  
**ANNUAL COST 1921-1932, OF THAT PART OF THE STATE HIGHWAY SYSTEM IN EXISTENCE DECEMBER 31, 1920**  
**(All amounts in thousands)**

Year	Cost of grading, less depreciation, Dec. 31, 1920, \$207,487 a				Total annual cost (Cols. 8, 4, 5, 6, 8, 9, 11, 12, 14)
	Current year's amortisation charges (25 year life after 1920)	Unamortised cost at beginning of year	Interest on unamortised cost at 4.25 per cent per annum	Equivalent property taxes (1.30 per cent of unamortised cost at beginning of year)	
(10)	(11)	(12)	(13)	(14)	(15)
1921	\$8,297	\$207,487	\$8,816	\$2,697	\$94,486
1922	8,297	199,140	8,468	2,569	91,185
1923	8,297	190,848	8,111	2,481	87,884
1924	8,297	182,546	7,768	2,378	84,582
1925	8,297	174,249	7,406	2,265	81,280
1926	8,297	165,952	7,058	2,157	77,977
1927	8,297	157,655	6,700	2,050	74,676
1928	8,297	149,358	6,348	1,942	70,889
1929	8,297	141,061	5,995	1,834	66,896
1930	8,297	132,764	5,642	1,726	62,002
1931	8,297	124,467	5,290	1,618	57,108
1932	8,297	116,170	4,937	1,510	52,218
<b>Total</b>	<b>99,564</b>		<b>82,519</b>	<b>25,242</b>	<b>741,178</b>

a See Table 8

**TABLE 10**  
**TOTAL ANNUAL COST OF STATE HIGHWAY SYSTEMS, 1921-1932**  
 (All amounts in thousands)

Year	Construction expenditures <sup>a</sup>	Refunds for construction work performed for others <sup>b</sup>	Net construction expenditures (Col. 2-3)	Interest during construction (4½ per cent for one-half year on net expenditures)	Estimated salvage recovered and reused (Col. 14)	Total construction costs to be amortized (Cols. 4, 5, 6)	Current year's amortization charges (29 year life)	Unamortized construction costs at beginning of year (Col. 7-8)	Interest on unamortized construction costs at 4½% per annum	Maintenance equipment, materials, supplies, & miscellaneous	Equivalent property taxes (1.30 per cent of unamortized cost at beginning of year)	Estimated salvage (3.1 per cent of Col. 7)	Current year's credit for salvage recovered (29 year life)	Annual cost of highways built since 1920 (Cols. 8, 10, 11, 12—Col. 14)	Annual cost of highways in existence Dec. 31, 1920 (Table 9, Col. 15)	Total annual cost of state highways (Col. 15 + 16)
(1)	(2)	(3)	(4)	(5)	(6)	(7)	(8)	(9)	(10)	(11)	(12)	(13)	(14)	(15)	(16)	(17)
1921	\$296,136	\$3,303	\$292,833	\$8,223	.....	\$299,056	.....	.....	.....	\$77,828	.....	\$9,271	.....	\$77,828	\$94,486	\$172,314
1922	301,779	3,759	298,020	6,333	.....	304,353	\$10,312	\$299,056	\$12,710	93,069	.....	9,435	.....	119,659	91,185	210,844
1923	299,339	7,074	292,265	6,211	\$320	298,796	20,807	693,097	25,207	97,947	\$3,888	9,263	\$320	151,026	87,384	238,910
1924	404,809	6,093	398,713	8,473	645	407,831	31,111	871,088	37,021	133,294	11,324	12,643	964	211,780	84,582	296,368
1925	416,998	12,130	404,788	8,602	964	414,354	45,174	1,247,806	53,032	152,834	16,221	12,845	1,400	265,861	81,230	347,141
1926	382,708	7,645	375,061	7,970	1,400	384,431	59,462	1,616,986	68,722	159,621	21,021	11,917	1,843	306,993	77,977	384,960
1927	438,567	3,289	435,278	9,250	1,843	446,371	72,718	1,941,955	82,533	166,647	25,245	13,838	2,254	344,889	74,676	419,565
1928	538,043	4,998	533,045	11,327	2,254	546,626	88,110	2,315,808	98,413	184,325	30,103	16,946	2,731	398,220	50,889	449,109
1929	557,401	6,497	550,904	11,707	2,731	556,342	106,959	2,774,124	117,900	196,641	36,064	17,526	3,316	454,248	26,896	480,144
1930	713,117	5,440	707,677	15,038	3,316	726,031	126,454	3,232,507	137,382	216,213	42,023	22,507	3,920	518,152	25,002	543,154
1931	730,955	9,079	721,876	15,340	3,920	741,136	151,489	3,832,084	162,864	186,775	49,817	22,975	4,696	546,249	24,108	570,357
1932	551,446	9,931	541,515	11,507	4,696	557,718	177,046	4,421,731	187,924	196,027	57,463	17,289	5,488	612,992	23,213	636,205
Total	5,631,203	79,228	5,551,975	117,981	22,089	5,692,045	889,642	.....	983,708	1,891,221	300,899	176,454	27,577	4,007,893	741,178	4,749,071

<sup>a</sup> Figures adjusted to include a proportion of engineering expenses. For adjustments see Appendix C.

<sup>b</sup> See Appendix D

tures for maintenance, equipment, materials, supplies, and miscellaneous. To the total annual cost thus determined for State highways built in the current period is added the cost of the State highways constructed prior to 1921, with the resultant total annual cost given in Column 17, of \$4,749,071,000 for the period.

*County and Local Roads.* An inventory of county and local roads as they existed on December 31, 1921, is given in Column 3 of Appendix A. If these roads had been built to the 1917-1924 Federal-aid standards, the average cost per mile would have been \$3,657 as shown in Column 7. A reduction of 25 per cent below the calculated cost (except as to unimproved earth roads) was made in the case of State highways to allow for construction on lower standards. Since there was a greater difference in standards of construction of the local roads, a reduction of 33 1-3 per cent in the Federal-aid unit prices would be a conservative basis for estimating local road costs, except for earth roads. The average original cost of local roads, therefore, will be estimated at \$2,973 per mile. This amount will be further reduced by 50 per cent to take care of the estimated accrued depreciation at the beginning of the period, leaving \$1,486 per mile as the depreciated cost of the county and local roads to be carried over into the period under consideration.

The \$1,486 per mile is next apportioned between the three highway elements, grading, structures, and surfacing, by use of the percentages given in Appendix B, and then the total amount for each element calculated, based on the estimated 2,597,400 miles in the county and local road system at the beginning of 1921.

The percentages, per mile costs and amounts assignable to each highway element are given in the following tabulation:

<i>Highway Element</i>	<i>Percentage Distribution</i>	<i>Cost Per Mile</i>	<i>Total Cost (000)</i>
Grading	58.52	\$869.61	\$2,258,718
Surfacing	17.30	257.08	667,734
Structures	24.18	859.31	933,284
<b>Total</b>	<b>100.00</b>	<b>\$1,486.00</b>	<b>\$3,859,736</b>

Table 11 is a computation of the annual cost, 1921-1932, of that portion of the county and local road system in existence on December 31, 1920, using the amounts shown in the last column of the tabulation above, amortizing them by the use of the remaining service lives previously determined, calculating interest at 4½ per cent per annum and equivalent property taxes at 1.30 per cent per annum, both being applied to the unamortized investment.

Column 14 of the table gives the annual cost for each year and the total for the period, the latter figure being \$4,276,253,000.

Table 12 gives the development of the total annual cost of county and local roads for the period 1921-1932, in a manner similar to that previously described for State highways. The total annual cost,



**TABLE 11**  
**ANNUAL COST 1921-1932, OF THAT PART OF COUNTY AND LOCAL ROAD SYSTEM IN EXISTENCE DECEMBER 31, 1920**  
 (All amounts in thousands)

Year	Cost of surfacing, less depreciation, Dec 31, 1920, \$667,734				Cost of structures, less depreciation, Dec. 31, 1920, \$983,284				Cost of grading, less depreciation, Dec. 31, 1920, \$2,258,718				Total annual cost (Cols. 2, 4, 5, 6, 8, 9, 10, 12, 13)
	Current years amortiza- tion charges (5½ years life)	Unamor- tized cost at be- ginning of year	Interest on unamor- tized cost at 4½ per cent per annum	Equivalent property taxes (1.80 per cent of unamortized cost at begin- ning of year)	Current years amortiza- tion charges (7.5 years life after 1920)	Unamor- tized cost at be- ginning of year	Interest on unamor- tized con- struction cost at 4½ per cent per annum	Equivalent property taxes (1.80 per cent of unamortized cost at begin- ning of year)	Current years amortiza- tion charges (25 years life after 1920)	Unamor- tized cost at be- ginning of year	Interest on unamor- tized cost at 4½ per cent per annum	Equivalent property taxes (1.80 per cent of unamortized cost at begin- ning of year)	
(1)	(2)	(3)	(4)	(5)	(6)	(7)	(8)	(9)	(10)	(11)	(12)	(13)	(14)
1921	\$121,406	\$667,734	\$30,048	\$8,681	\$124,438	\$983,234	\$41,998	\$12,133	\$90,349	\$2,258,718	\$101,642	\$29,363	\$560,058
1922	121,406	546,323	24,585	7,102	124,438	808,846	36,898	10,515	90,349	2,168,369	97,577	28,189	540,559
1923	121,406	424,922	19,121	5,524	124,438	684,408	30,798	8,897	90,349	2,078,020	93,511	27,014	521,058
1924	121,406	809,516	13,658	8,946	124,438	559,970	25,199	7,280	90,349	1,987,671	89,445	25,840	501,561
1925	121,406	132,110	8,195	2,387	124,438	435,532	19,599	5,662	90,349	1,897,322	85,379	24,665	492,060
1926	60,704	121,406	5,463	1,578	124,438	311,094	13,999	4,044	90,349	1,806,973	81,314	23,491	406,380
1927	.....	.....	.....	.....	124,438	186,656	8,400	2,427	90,349	1,716,624	77,248	22,316	325,178
1928	.....	.....	.....	.....	62,218	124,438	5,600	1,618	90,349	1,626,275	73,182	21,142	254,109
1929	.....	.....	.....	.....	.....	.....	.....	.....	90,349	1,535,926	69,117	19,967	179,438
1930	.....	.....	.....	.....	.....	.....	.....	.....	90,349	1,445,577	65,051	18,793	174,193
1931	.....	.....	.....	.....	.....	.....	.....	.....	90,349	1,355,228	60,985	17,618	168,952
1932	.....	.....	.....	.....	.....	.....	.....	.....	90,349	1,264,879	56,920	16,443	163,712
<b>Total</b>	<b>667,734</b>	<b>.....</b>	<b>101,070</b>	<b>29,198</b>	<b>983,284</b>	<b>.....</b>	<b>181,991</b>	<b>52,576</b>	<b>1,084,188</b>	<b>.....</b>	<b>951,871</b>	<b>274,841</b>	<b>4,276,253</b>

**TABLE 12**  
**TOTAL ANNUAL COST OF COUNTY AND LOCAL ROADS, 1921-1932**  
 (All amounts in thousands)

Year	Construction expenditures	Interest during construction (4½ per cent for one-half year on construction expenditures)	Estimated salvage recovered & reused (Col. 12)	Total construction costs to be amortized (Cols. 2, 3, & 4)	Current year's amortization charges (33.4 year life)	Unamortized construction costs at beginning of year (Col. 6-6)	Interest on unamortized construction costs at 4½ per cent per annum	Maintenance equipment, materials, supplies, & miscellaneous	Equivalent property taxes (1.30 per cent of unamortized cost at beginning of year)	Estimated salvage (6.9 per cent of Col. 5)	Current year's credit for salvage recovered (33.4 year life)	Annual cost of local roads built since 1920 (Cols. 8, 9, 10—Col. 12)	Annual cost of local roads in existence Dec. 31, 1920 (Table 11, Col. 14)	Total annual cost of local roads (Col. 13 + 14)
(1)	(2)	(3)	(4)	(5)	(6)	(7)	(8)	(9)	(10)	(11)	(12)	(13)	(14)	(15)
1921	\$337,376	\$7,691	.....	\$344,966	.....	.....	.....	\$225,315	.....	\$23,803	.....	\$225,315	\$500,058	\$725,373
1922	330,040	7,425	.....	337,425	\$10,328	\$344,966	\$15,523	225,000	\$4,485	23,282	\$718	254,623	540,559	795,182
1923	343,355	8,451	\$718	348,449	30,431	673,063	30,345	229,899	8,737	17,145	1,410	287,670	521,058	808,728
1924	255,836	5,756	1,410	263,002	27,870	900,081	40,564	223,273	11,701	18,147	1,923	301,425	501,561	802,986
1925	294,946	5,962	1,923	272,851	35,744	1,135,313	51,048	225,557	14,755	18,527	2,446	325,778	482,060	807,838
1926	265,718	5,979	2,446	274,153	43,913	1,372,320	61,764	255,228	17,840	18,917	3,030	375,808	405,890	781,155
1927	289,180	6,507	3,030	298,717	52,121	1,602,570	72,116	270,253	20,833	20,611	3,596	420,727	325,178	745,905
1928	282,315	6,352	3,596	292,263	61,065	1,849,166	83,212	297,100	24,039	20,166	4,313	461,298	254,109	715,313
1929	255,582	5,773	4,313	266,568	69,815	2,080,364	93,616	269,934	27,045	18,393	4,810	495,593	179,423	675,026
1930	296,893	6,673	4,810	308,085	77,796	2,277,117	102,470	321,296	29,605	21,258	5,368	525,797	174,193	699,990
1931	250,865	5,645	5,368	261,898	87,020	2,507,406	112,833	300,822	32,596	18,071	6,004	527,267	168,952	696,219
1932	173,000	3,870	6,004	181,874	94,861	2,682,284	120,703	275,000	34,870	12,549	6,545	518,899	168,712	687,611
<b>Total</b>	<b>\$3,248,737</b>	<b>\$72,994</b>	<b>\$33,540</b>	<b>\$3,350,261</b>	<b>\$580,964</b>	<b>.....</b>	<b>\$784,059</b>	<b>\$3,168,647</b>	<b>\$226,507</b>	<b>\$231,167</b>	<b>\$40,085</b>	<b>\$4,720,092</b>	<b>\$4,276,255</b>	<b>\$8,996,345</b>

both for the highways constructed during the period and for those built prior thereto, is given in Column 15 as \$8,996,345,000.

*City Streets.* Practically the only source of statistical information covering the costs of construction and maintenance of city streets is the annual publication of the Bureau of the Census, "Financial Statistics of Cities Having a Population of 30,000 and Over." To the amounts thus reported, it is necessary to add the cost for cities of less than 30,000 population. Table 13 shows, in Column 2, the total construction costs for cities of 30,000 and over, as reported by the Bureau of the Census. The population of these cities is also shown and the per capita cost calculated in Column 4. Per capita costs for the years 1923-1931 for cities having a population of between 2,500 and 30,000 were taken from a study made by the Bureau of Railway Economics.<sup>9</sup> Figures for the years 1921 and 1922 are estimated from an index derived from Column 4, in which the year 1923 was taken as 100. These per capita costs were then multiplied by the total population in each group of cities to obtain the estimated cost of construction shown in Column 7.

A similar calculation was made for incorporated places having a population of less than 2,500, using the same per capita costs, but deducting 25 per cent to allow for State highways which pass through many of the smaller towns, since the streets so occupied are constructed and maintained by the State highway departments.

Table 14 is a computation of the costs of maintenance and operation of city streets, using the reported data for cities having a population of 30,000 and over and estimating the amounts for cities of a lesser population. The reported data for the years 1921 and 1922 were adjusted to exclude an estimated cost for waterways or drainage structures.

The amounts shown in Column 2 include expenditures for:

- (a) Street cleaning
- (b) Supervision
- (c) Repair of roadway
- (d) Snow and ice removal
- (e) Street lighting

Because of the lack of basic information, it was necessary to estimate the depreciated cost of rural road facilities constructed prior to 1921 and brought over into the period. This procedure is not necessary in the case of city streets, since with the exception of two years, information as to construction expenditures on streets for cities having population of 30,000 and over is available for a long period of years.

These expenditures are tabulated in Table 15 for the years 1904-

---

<sup>9</sup>An Economic Survey of Motor Vehicle Transportation in the United States, Bulletin 60, Page 205.

**TABLE 13**  
**EXPENDITURES FOR CONSTRUCTION OF CITY STREETS, 1921-1932**

Year	Cities having a population of 10,000 and over			Cities having a population of between 2,500 and 10,000			Incorporated places having a population of less than 2,500 <sup>d</sup>				Total construction costs (Col. 2+7+11) (000)
	Total construction costs <sup>e</sup> (000)	Population <sup>e</sup>	Per capita cost	Estimated construction costs per capita <sup>b</sup>	Population <sup>e</sup>	Estimated construction costs (Col. 5 x 6) (000)	Estimated construction costs per capita Same as Col. 5	Population <sup>e</sup>	Estimated construction costs (Col. 8 x 9) (000)	75% of estimated construction costs (Deduction of 25% made to allow for State Highways) (000)	
(1)	(2)	(3)	(4)	(5)	(6)	(7)	(8)	(9)	(10)	(11)	(12)
1921	\$124,461	37,331,611	\$3.33	\$1.91	18,034,803	\$34,446	\$1.91	8,990,662	\$17,172	\$12,879	\$171,806
1922	187,692	38,736,657	4.85	2.79	18,516,889	51,662	2.79	9,012,083	25,144	18,858	258,212
1923	204,643	39,172,168	5.22	3.00	20,134,949	60,405	3.00	9,033,504	27,101	20,326	285,374
1924	249,891	39,981,105	6.24	3.59	20,755,802	74,512	3.59	9,054,925	32,507	24,880	348,283
1925	317,498	40,757,434	7.79	4.48	21,408,263	95,909	4.48	9,076,346	40,662	30,497	443,904
1926	332,250	41,840,033	7.94	4.56	21,754,954	99,203	4.56	9,097,767	41,456	31,115	462,568
1927	394,063	42,716,411	9.25	5.32	22,307,865	118,678	5.32	9,119,188	48,514	36,986	550,027
1928	389,688	43,442,300	8.97	5.15	23,010,755	118,505	5.15	9,140,609	47,074	35,306	543,499
1929	379,943	44,318,900	8.57	4.93	23,563,955	116,170	4.93	9,162,030	45,169	33,877	529,990
1930	427,526	47,431,028	9.01	5.18	21,880,866	113,343	5.18	9,183,453	47,570	35,678	576,547
1931	299,481	46,280,412	6.20	3.66	22,067,278	78,560	3.56	9,204,872	32,769	24,577	402,618
1932	f 160,755	f 27,784,912	f 4.26	g 2.45	g 23,177,688	g 81,285	2.45	9,226,293	22,604	16,953	258,993
<b>Total</b>	<b>3,468,311</b>	.....	.....	.....	.....	<b>1,042,678</b>	.....	.....	<b>427,772</b>	<b>320,882</b>	<b>4,831,821</b>

<sup>a</sup> Source—Bureau of the Census "Financial Statistics of Cities."

<sup>b</sup> Figures for years 1923 to 1931 taken from Appendix N, Table II, Bureau of Railway Economics Bulletin 60, "An Economic Survey of Motor Vehicle Transportation in the United States." Figures for the years 1921 and 1922 were estimated from an index derived from Column 4, in which the year 1923 was taken as 100.0. Figure for 1932 computed by same method as used to develop data for years 1923 to 1931.

<sup>c</sup> Data for 1921 and 1922 estimated. Data for 1923 from Bureau of Railway Economics: "An Economic Survey of Motor Vehicle Transportation in the United States," page 205. Data for 1932 computed on same basis.

<sup>d</sup> According to the reports of the Bureau of the Census, there were 12,857 incorporated places in the United States in 1920 having less than 2,500 inhabitants, while in 1930 there were 13,433.

<sup>e</sup> Estimated on actual figures of the Bureau of the Census for the years 1920 and 1930.

<sup>f</sup> Cities having a population of 100,000 and over.

<sup>g</sup> Cities having a population between 2,500 and 100,000.

TABLE 14

COST OF OPERATION AND MAINTENANCE OF CITY STREETS, 1921-1932

Year	Cities having a population of 80,000 and over			Cities having a population of between 2,500 and 80,000			Incorporated places having a population of less than 2,500 d				Total operation and maintenance expenses (Col. 2+7+11) (000)
	Total operation and maintenance expenses a (000)	Population a	Per capita cost	Estimated maintenance and operation per capita b	Population c	Estimated operation and maintenance expenses (Cols. 5 x 6) (000)	Estimated maintenance and operation per capita Same as Col. 5	Population e	Estimated operation and maintenance expenses (Cols. 8 x 9) (000)	75% of estimated operation and maintenance expenses (Deduction of 25% made to allow for State Highways) (000)	
(1)	(2)	(3)	(4)	(5)	(6)	(7)	(8)	(9)	(10)	(11)	(12)
1921	\$121,645	87,881,611	\$8.26	\$2.02	18,084,808	\$86,480	\$2.02	8,990,662	\$18,161	\$18,621	\$171,696
1922	166,481	88,736,657	4.04	2.50	18,516,899	46,292	2.50	9,012,088	22,590	16,898	219,671
1928	169,062	89,172,168	4.04	2.50	20,184,949	50,887	2.50	9,083,504	22,584	16,938	225,837
1924	164,180	89,981,105	4.11	2.54	20,755,802	52,718	2.54	9,064,925	28,000	17,250	234,098
1925	178,511	40,767,484	4.88	2.71	21,408,268	58,016	2.71	9,076,846	24,597	18,448	254,976
1926	198,138	41,840,089	4.74	2.98	21,754,964	69,742	2.98	9,097,767	26,666	19,992	281,872
1927	208,757	42,716,411	4.89	3.03	22,307,865	67,593	3.03	9,119,188	27,691	20,729	297,078
1928	212,401	43,442,800	4.89	3.08	23,010,765	69,728	3.08	9,140,609	27,696	20,772	302,896
1929	225,591	44,818,900	5.09	3.15	23,568,955	74,226	3.15	9,162,080	28,860	21,645	321,482
1930	221,474	47,491,028	4.67	2.89	21,880,866	68,286	2.89	9,183,453	26,540	19,905	304,615
1931	222,951	48,280,412	4.62	2.86	22,067,278	68,112	2.86	9,204,872	26,826	19,745	305,808
1932	f 157,058	f 87,784,912	f 4.16	g 2.57	g 88,177,688	g 85,267	2.57	9,226,298	28,712	17,784	260,104
Totals	2,225,194	.....	....	.....	.....	780,692	....	.....	298,298	228,721	8,179,607

a Source—Bureau of the Census, except that cost figures for 1921 and 1922 were adjusted to exclude an estimated cost for waterways. Cost figures for all years include cost of street cleaning.

b Estimate (\$2.50) for year 1923 taken from Bureau of Railway Economics:—"An Economic Survey of Motor Vehicle Transportation in the United States," page 205. For the remaining years the figure for 1923 was increased or decreased on the basis of an index derived from Column 4 (cities of over 80,000) using 1923 as the base year.

c Data for 1921 and 1922 estimated. Data for 1923 to 1931 from Bureau of Railway Economics:—"An Economic Survey of Motor Vehicle Transportation in the United States," page 205. Data for 1922 computed on same basis.

d According to the reports of the Bureau of the Census there were 12,857 incorporated places in the United States in 1920 having less than 2,500 inhabitants, while in 1930 there were 18,433.

e Estimated on actual figures of the Bureau of the Census for the years 1920 and 1930

f Cities having a population of 100,000 and over.

g Cities having a population between 2,500 and 100,000.

**EXPENDITURES FOR CONSTRUCTION OF CITY STREETS, 1904 TO 1920**

Year	Cities having a population of 30,000 and over			Cities having a population between 2,500 and 30,000 plus incorporated places having a population of less than 2,500			Total construction costs (000)
	Total construction costs a (000)	Population a	Per capita cost	Estimated construction costs per capita b	Population c	Estimated construction costs (000)	
(1)	(2)	(3)	(4)	(5)	(6)	(7)	(8)
1904	\$65,987	21,660,876	\$3.03	\$1.74	20,375,893	\$35,454	\$101,441
1905	63,774	22,319,718	2.86	1.64	21,215,937	34,794	98,568
1906	63,041	22,922,119	2.75	1.58	22,027,663	34,804	97,845
1907	83,079	23,511,039	3.53	2.03	22,795,048	46,274	129,353
1908	87,442	24,065,539	3.63	2.09	23,626,104	49,379	136,821
1909	84,141	25,603,949	3.29	1.89	23,473,250	44,365	128,506
1910	92,196	27,316,407	3.38	1.94	23,233,682	45,073	137,269
1911	108,823	28,559,142	3.79	2.18	23,436,080	51,090	159,418
1912	102,576	29,320,579	3.50	2.01	23,899,772	48,039	150,615
1913	101,952	30,194,677	3.38	1.94	24,360,805	47,260	149,212
1914	e 109,838	30,681,000	3.58	2.06	25,209,185	51,931	161,769
1915	117,549	31,168,150	3.77	2.17	26,057,594	56,545	174,094
1916	101,085	32,267,415	3.13	1.80	26,293,461	47,328	148,413
1917	108,075	33,259,769	3.25	1.87	26,637,139	49,810	157,885
1918	107,942	34,326,669	3.14	1.81	26,904,471	48,697	156,639
1919	83,497	34,664,860	2.41	1.39	27,900,608	38,782	122,279
1920	e 105,198	36,654,359	2.87	1.65	27,334,130	45,101	150,299
Total	\$1,585,700	.....	....	....	.....	\$774,726	\$2,360,426

47

a Source: Bureau of the Census "Financial Statistics of Cities."

b Estimated from an index derived from column 4, in which the year 1923 (\$5.22) was taken as 100.

c Bureau of the Census. Incorporated places having a population of less than 2,500 derived by interpolation from actual census years.

e Estimated; actual data not available.

1920, inclusive (figures for 1914 and 1920 estimated, as reports are not available for those years). The expenditures for cities of less than 30,000 were estimated by the same method used in the preparation of Table 13 and explained above.

The total construction expenditures for all city streets for the period 1904-1920, inclusive, as shown on Table 15, are \$2,360,426,000.

Table 16 develops the depreciated value of these street facilities as of December 31, 1920, using a service life of 20 years as heretofore discussed (page 33).

The depreciated value of the street facilities brought over into the period 1921-1932, is \$1,470,787,000 as shown in Column 5 of Table 16.

**TABLE 16**  
**ANNUAL CONSTRUCTION COST OF CITY STREETS, 1904-1920**  
(All amounts in thousands)

Year	Total construction expenditures (Table 15 Col. 8)	Interest during construction (4½ percent for one-half year on construction expenditures)	Total construction costs to be amortized (Col. 1+2)	Current year's amortization charges (20 year life)	Unamortized construction costs at beginning of year
	(1)	(2)	(3)	(4)	(5)
1904	\$101,441	\$2,156	\$103,597	.....	.....
1905	98,568	2,095	100,663	\$5,180	\$103,597
1906	97,845	2,079	99,924	10,213	199,080
1907	129,353	2,749	132,102	15,209	288,791
1908	136,821	2,907	139,728	21,814	405,684
1909	128,506	2,731	131,237	28,800	523,598
1910	137,269	2,917	140,186	35,362	626,035
1911	159,418	3,388	162,806	42,371	730,859
1912	150,615	3,200	153,815	50,511	851,294
1913	149,212	3,171	152,383	58,202	954,598
1914	161,769	3,437	165,206	65,821	1,048,779
1915	174,094	3,699	177,793	74,081	1,148,164
1916	148,413	3,154	151,567	82,971	1,251,876
1917	157,885	3,355	161,240	90,549	1,320,472
1918	156,639	3,329	159,968	98,611	1,391,163
1919	122,279	2,598	124,877	106,610	1,452,520
1920	150,299	3,194	153,493	112,854	1,470,787
<b>Total</b>	<b>\$2,360,426</b>	<b>\$50,159</b>	<b>\$2,410,585</b>	<b>\$899,159</b>	<b>.....</b>

Table 17 gives the annual cost of that part of the city streets in existence on December 31, 1920, based on the above depreciated cost, estimating the unused service life to be 10 years and calculating interest at  $4\frac{1}{4}$  per cent per annum and equivalent property taxes at 1.30 per cent per annum, applied to the unamortized investment. The total amount for the period is \$1,920,000,000.

Table 18 is a calculation of the total annual cost of city streets for the period 1921-1932, using the method previously described. The total annual cost, both for the city streets constructed during the period and for those built prior thereto, is given for each year and for the period in Column 15, the latter figure being \$7,130,730,000.

**TABLE 17**  
**ANNUAL COST, 1921-1931, OF THAT PART OF CITY STREETS IN**  
**EXISTENCE AS OF DECEMBER 31, 1920**  
(All amounts in thousands)

Year	Estimated cost, less depreciation, December 31, 1920, \$1,470,787 a				Total annual cost (Cols. 2, 4, 5) b
	Current year's amortization charges (10 year life from 1920)	Unamortized cost at beginning of year	Interest on unamortized cost at $4\frac{1}{4}$ percent per annum	Equivalent property taxes (1.30 percent of unamortized cost at beginning of year)	
(1)	(2)	(3)	(4)	(5)	(6)
1921	\$147,079	\$1,470,787	\$62,508	\$19,120	\$229,000
1922	147,079	1,323,708	56,258	17,208	221,000
1923	147,078	1,176,629	50,007	15,296	212,000
1924	147,079	1,029,550	43,756	13,384	204,000
1925	147,079	882,471	37,505	11,472	196,000
1926	147,078	735,392	31,254	9,560	188,000
1927	147,079	588,313	25,003	7,648	180,000
1928	147,079	441,234	18,752	5,736	172,000
1929	147,078	294,155	12,502	3,824	163,000
1930	147,079	147,076	6,251	1,912	155,000
1931	.....	.....	.....	.....	.....
<b>Total</b>	<b>\$1,470,787</b>	<b>\$8,089,315</b>	<b>\$343,796</b>	<b>\$105,160</b>	<b>\$1,920,000</b>

a See Table 19, Col. 5. b For detail figures see Table 18, Col. 14.



**TABLE 18**  
**TOTAL ANNUAL COST OF CITY STREETS, 1921-1932**  
 (All amounts in thousands)

Year	Total construction expenditures (Table 13, Col. 12)	Interest during construction (4½ percent for one-half year on construction expenditures)	Estimated salvage recovered and reused (Col. 12)	Total construction costs to be amortized (Cols. 2, 3, 4)	Current year's amortization charges (29 year life)	Unamortized construction costs at beginning of year (Col. 5-6)	Interest on unamortized construction costs at 4½ percent per annum	Operation and maintenance expenses (Table 14, Col. 12)	Equivalent property taxes (1.30 percent of unamortized cost at beginning of year)	Estimated salvage (3.1 percent of Col. 5)	Current year's credit for salvage recovered (29 year life)	Annual cost of city streets built 1921-1932 (Cols. 8, 8, 9, 10-Col. 12)	Annual cost of city streets in existence Dec. 31, 1920 (Table 17, Col. 6)	Total annual cost of city streets (Col. 13+14)
(1)	(2)	(3)	(4)	(5)	(6)	(7)	(8)	(9)	(10)	(11)	(12)	(13)	(14)	(15)
1921	\$171,806	\$3,651	.....	\$175,457	.....	.....	.....	\$171,696	.....	\$5,439	.....	\$171,696	\$228,831	\$400,527
1922	258,212	5,487	.....	263,699	\$6,050	\$175,457	\$7,457	219,671	\$2,281	8,175	\$188	235,271	220,663	455,934
1923	285,374	6,064	\$188	291,626	15,143	433,106	18,407	225,337	5,630	9,040	470	264,047	212,496	476,543
1924	348,283	7,401	470	356,154	25,199	709,589	30,156	234,098	9,225	11,041	782	297,898	204,329	502,227
1925	443,904	9,433	782	454,119	37,480	1,040,544	44,223	254,875	13,527	14,078	1,163	349,042	196,161	545,203
1926	462,568	9,830	1,163	478,561	63,139	1,457,183	61,930	281,372	16,943	14,660	1,648	414,236	187,994	602,230
1927	550,027	11,688	1,648	563,363	69,469	1,877,605	79,798	297,073	24,409	17,464	2,154	468,595	179,827	648,422
1928	543,499	11,549	2,154	557,202	85,895	2,371,499	100,789	302,896	30,829	17,273	2,756	520,653	171,660	692,313
1929	529,990	11,262	2,756	544,008	108,109	2,839,806	120,692	321,462	36,917	16,864	3,352	583,828	163,492	747,320
1930	576,547	12,252	3,352	592,151	126,868	3,275,705	139,217	304,615	42,584	18,357	3,934	609,350	155,325	764,675
1931	402,618	8,556	3,934	415,108	147,287	3,740,988	158,992	305,808	48,633	12,868	4,567	656,153	.....	656,153
1932	268,993	5,504	4,567	269,064	161,601	4,008,809	170,374	260,104	62,115	8,341	5,011	639,183	.....	639,183
<b>Total</b>	<b>\$4,831,821</b>	<b>\$102,677</b>	<b>\$21,014</b>	<b>\$4,955,512</b>	<b>\$339,240</b>	<b>.....</b>	<b>\$932,037</b>	<b>\$3,179,607</b>	<b>\$285,093</b>	<b>\$153,620</b>	<b>\$26,025</b>	<b>\$5,209,952</b>	<b>\$1,920,776</b>	<b>\$7,130,730</b>

## CHAPTER IV COSTS AND PAYMENTS

### ANALYSIS OF TABLES

Table 19 shows the contributions made by motor vehicle operators through the payment of motor vehicle fees and gasoline taxes during the period 1921-1932. The total shown on this table as \$6,031,395,000, is after certain adjustments have been made in the reported figures (see Appendices E and F) to place the administration and collection expenses on a comparable basis for all years of the period.

Table 19 also shows the allocation of motor vehicle receipts to State highways, county and local roads, and city streets, as actually made by the States during this period. It gives the method used in apportioning a part of the receipts for which information as to actual allocation is lacking.

The total net receipts shown on Table 19 are exclusive of Federal excise taxes on automobiles, parts and accessories, gasoline and lubricants, such taxes having aggregated \$944,683,000 in the period 1921-1932. Federal excise taxes are imposed as revenue measures for government support. In the earlier years of the period under consideration, the excise taxes were a part of the war emergency taxes and applied also to freight receipts and passenger fares on the railroads, telephone and telegraph messages and other similar services. The Federal excise taxes now in effect are also for the purpose of government revenue; they were not imposed as a highway tax and should not be considered as a payment by motor vehicle users toward the cost of highways and streets.

As previously referred to (page 34) certain items of expenses are not included in the tables because of lack of authentic and complete data, and similarly Table 19 omits certain items of revenue for the same reason. These items of revenue and expense are:

1. Miscellaneous State revenue, consisting principally of motor carrier special taxes and bridge tolls.
2. Municipal, county, and local motor vehicle taxes.
3. Annual cost of city traffic police.
4. Annual cost of State highway patrols.

Such partial information as is available leads to the conclusion that the omitted revenues (Items 1 and 2) tend to balance the omitted costs (Items 3 and 4) and the resulting effect on annual cost due to the omission of these four items is of little or no importance.

Personal property taxes on motor vehicles should not be considered highway revenue. To the extent, however, that some States include such taxes in the registration fees paid by motor vehicle owners, they have been unavoidably included with motor vehicle payments for the highways in this study.

**TABLE 19**  
**ALLOCATION OF STATE MOTOR VEHICLE TAXES AS MADE BY STATE AUTHORITIES, 1921-1932**  
 (All amounts in thousands)

Year	Net receipts a			Receipts allocated to road authorities by states b							Total net receipts apportioned to road authorities on basis of allocation made by states		
	State motor-fuel receipts	State motor vehicle receipts (registration fees, licenses, permits, etc.)	Total	State highways		Local roads		City streets		Total	State highways	Local roads	City streets
				Amount	Per cent	Amount	Per cent	Amount	Per cent				
				5	6	7	8	9	10				
1	2	3	4=2+3	5	6	7	8	9	10	11	12=4x6	13=4x8	14=4x10
1921	\$5,867	\$114,728	\$120,095	\$94,193	81.12	\$21,924	18.88	.....	....	\$116,117	\$97,421	\$22,674	.....
1922	12,669	142,426	155,095	123,503	82.26	26,641	17.74	.....	....	150,144	127,551	27,514	.....
1923	98,451	177,013	215,474	174,755	85.31	34,999	16.69	.....	....	209,754	179,511	35,963	.....
1924	80,223	211,224	291,447	238,104	81.92	47,452	16.68	\$4,000	1.40	284,556	238,754	48,613	\$4,080
1925	147,954	243,742	391,696	298,642	77.77	81,118	21.12	4,242	1.11	384,002	304,622	82,726	4,848
1926	187,075	267,988	455,063	344,377	76.09	101,684	22.47	6,507	1.44	462,568	346,257	102,253	6,553
1927	257,966	283,269	541,235	408,451	76.68	119,676	22.47	4,529	0.85	532,666	415,011	121,613	4,601
1928	803,803	304,935	608,738	464,053	77.71	123,100	20.61	10,042	1.68	597,195	478,050	125,461	10,227
1929	430,193	328,386	758,579	572,393	76.88	187,398	21.14	14,769	1.98	744,560	583,195	160,364	15,020
1930	492,224	334,264	826,488	612,811	76.01	180,425	22.38	12,995	1.61	806,231	628,214	184,968	18,306
1931	538,858	320,952	854,810	616,305	74.21	198,627	23.81	20,563	2.48	830,495	634,355	199,256	21,199
1932	509,676	303,009	812,685	522,480	70.99	195,325	26.54	18,145	2.47	735,950	576,925	215,687	20,073
<b>Total</b>	<b>2,999,459</b>	<b>3,031,936</b>	<b>6,031,395</b>	<b>4,465,067</b>	<b>.....</b>	<b>1,233,369</b>	<b>.....</b>	<b>95,792</b>	<b>....</b>	<b>5,844,223</b>	<b>4,604,896</b>	<b>1,327,092</b>	<b>99,407</b>

a Net receipts were compiled from annual reports of the Bureau of Public Roads. Figures here are adjusted to exclude refunds, and collections and administration costs. For adjustments of "State motor fuel tax receipts" see Appendix E; for "State motor vehicle receipts" see Appendix F.

b The difference between the amounts in columns 11 and 4 represent, for the most part, diversions of motor vehicle taxes to other than road purposes. The amounts in columns 5, 7, and 9, are the totals allocated to road authorities by states for construction and maintenance of roads and for road bonds. They are shown here only for the purpose of establishing a basis for the distribution of the total net motor vehicle receipts to road authorities, as made in columns 12, 13, and 14.

Table 20 makes a direct comparison between motor vehicle users' proportion of the cost of highways and streets and receipts from motor vehicle taxes. Columns 2, 3, and 4 show the total annual cost of State highways, county and local roads and city streets, respectively. Columns 9, 11 and 15 show the proportion of these annual costs chargeable to the motor vehicle user. Columns 10, 12, and 16 show the percentage each class is of the total for each year. The total amount chargeable to motor vehicle users for the period 1921-1932 is given in Column 17.

Columns 18, 19, and 20 show total motor vehicle taxes apportioned to the three classes of highways and streets, on the basis of the percentages shown in Columns 10, 12, and 16; that is, in proportion to the motor vehicle operators' obligations for each class. It will be noted that this apportionment differs substantially from the apportionment as actually made, which is given in Table 19. The apportionment given in Columns 18, 19, and 20 of Table 20 is the application of the principle that receipts should be credited in the same proportions as the obligations are incurred.

Columns 22 to 25, inclusive, show the amounts by which the motor vehicle taxes, as apportioned, failed to meet the motor vehicle users' obligations for State highways, county and local roads, and city streets, and the total for all classes.

#### SUMMARY

The significant information on this table may be summarized as follows:

1. For the 12-year period 1921-1932, the total annual costs of all rural highways and city streets was \$20,876,146,000.
2. Of this amount, \$5,087,797,000 was allocated to general taxes.
3. The remainder, \$15,788,349,000, was charged to motor vehicle users.
4. Of this amount, the motor vehicles paid \$6,031,395,000.
5. There was, therefore, a subsidy to motor vehicles in this 12-year period of \$9,756,954,000.
6. There was a subsidy to motor vehicle users for each year of the period and for all roads of the State system, county system and city streets.
7. On a percentage basis, 89.90% of the costs of the State highway system, 89.75% to county and local roads, and 48.31% to city streets was charged to motor vehicles.
8. The percentage of total costs charged to motor vehicles was 75.63% for this period and the amount charged against general taxes was 24.37%.

**TABLE 20**  
**COMPARISON OF MOTOR VEHICLE USERS' PROPORTION OF THE COST OF HIGHWAYS AND CITY STREETS**  
**WITH RECEIPTS FROM MOTOR VEHICLE TAXES, 1921-1932**

(Receipts apportioned on basis of motor vehicle operators' obligations for highways and city streets)

(All amounts except population in thousands)

Year	Total annual cost				Total population a	Amount allocated to general taxes based on 1 dollar per capita b		Motor vehicle users' proportion of total annual cost				Urban population a	Amount allocated to general taxes based on \$4.20 per capita of urban population	Motor vehicle users' proportion of annual cost of city streets		Motor vehicle users' proportion of total annual cost
	State highways	County and local roads	City streets	Total		State highways	County and local roads	State highways		County and local roads						
								Amount	Per cent	Amount	Per cent					
	1	2	3	4		5=2+3+4	6	7	8	9=2-7	10=9+17			11=3-8	12=11+17	
1921	\$172,314	\$785,373	\$400,527	\$1,358,214	107,417,063	\$19,324	\$88,093	\$152,990	15.60	\$697,280	71.12	64,357,076	\$270,300	\$130,227	13.28	\$950,497
1922	210,644	795,132	455,934	1,461,980	109,123,505	22,272	86,251	187,972	17.49	708,681	65.98	66,265,629	278,318	177,618	16.83	1,074,521
1923	236,910	808,728	476,543	1,524,181	110,829,948	25,269	85,561	213,641	18.97	723,167	64.20	68,840,821	287,031	189,512	16.83	1,128,320
1924	296,368	802,986	502,227	1,601,581	112,536,390	80,340	82,197	266,028	22.24	720,789	60.27	69,791,382	293,123	209,104	17.49	1,195,921
1925	347,141	807,838	545,203	1,700,182	114,242,833	84,841	79,902	312,800	24.31	727,936	56.67	71,242,043	299,216	245,987	19.12	1,286,723
1926	384,960	781,185	602,230	1,768,375	116,946,276	88,275	77,674	346,685	25.74	703,511	52.22	72,692,754	305,810	296,920	22.04	1,347,116
1927	419,565	745,905	648,422	1,813,892	117,655,718	42,356	75,300	377,209	27.24	670,605	48.42	74,143,464	311,402	337,020	24.34	1,384,834
1928	449,109	715,312	692,313	1,856,734	119,362,181	46,088	73,324	403,071	28.39	641,088	45.21	75,594,174	317,496	374,817	26.40	1,419,876
1929	480,144	675,026	747,320	1,902,490	121,068,603	50,316	70,753	429,828	29.45	604,273	41.45	77,044,885	323,589	423,731	29.07	1,457,832
1930	543,154	699,990	764,675	2,007,819	122,775,046	53,640	69,135	459,514	31.47	630,855	40.56	78,495,847	329,680	434,995	27.97	1,555,864
1931	570,357	696,219	656,162	1,922,738	124,481,459	56,054	69,427	514,303	35.13	627,792	42.88	79,552,592	354,121	322,082	21.99	1,464,137
1932	636,205	682,601	639,183	1,957,989	126,187,931	60,873	65,516	575,332	35.48	617,286	41.28	80,138,593	356,583	302,600	20.42	1,495,219
<b>Total</b>	<b>\$4,749,071</b>	<b>\$3,996,345</b>	<b>\$7,130,730</b>	<b>\$20,876,146</b>	.....	<b>\$479,698</b>	<b>\$921,932</b>	<b>\$4,269,373</b>	<b>27.04</b>	<b>\$3,074,413</b>	<b>51.14</b>	.....	<b>\$3,686,167</b>	<b>\$3,444,563</b>	<b>21.82</b>	<b>\$15,788,349</b>
Percentage chargeable to motor vehicle users								89.90		89.75				48.81		75.63

**TABLE 20 (Continued)**  
**COMPARISON OF MOTOR VEHICLE USERS' PROPORTION OF THE COST OF HIGHWAYS AND CITY STREETS**  
**WITH RECEIPTS FROM MOTOR VEHICLE TAXES, 1921-1932**

(Receipts apportioned on basis of motor vehicle operators' obligations for highways and city streets)  
 (All amounts except population in thousands)

Year	Total motor vehicle taxes apportioned to—				Amounts by which motor vehicle taxes failed to meet motor vehicle operators' obligations			
	State highways	County and local roads	City streets	Total	State highways	County and local roads	City streets	Total
1	18-21x10	19-21x12	20-21x16	21	22-9-18	23-11-19	24-15-20	25-17-21
1921	\$18,735	\$85,411	\$18,949	\$120,095	\$134,258	\$611,869	\$114,278	\$860,405
1922	27,126	102,332	25,637	155,095	160,846	606,599	151,981	919,426
1923	40,876	138,334	36,264	215,474	172,765	584,833	153,248	910,846
1924	64,818	175,655	50,974	291,447	301,210	545,134	158,130	904,474
1925	95,221	221,583	74,892	391,696	217,579	506,353	171,065	895,027
1926	117,123	337,624	100,296	455,063	229,552	465,877	196,624	892,053
1927	147,430	362,061	131,734	641,225	229,779	408,544	205,286	843,609
1928	172,821	375,210	160,707	608,738	230,250	366,778	214,110	811,138
1929	222,629	314,431	220,519	758,579	206,199	289,842	203,212	699,253
1930	260,066	335,223	231,169	826,458	229,418	295,632	208,826	728,876
1931	300,295	366,542	187,973	854,810	214,008	261,260	134,059	609,317
1932	312,721	336,476	164,488	813,685	262,611	281,810	138,112	682,533
<b>Total</b>	<b>\$1,780,901</b>	<b>\$2,649,892</b>	<b>\$1,400,803</b>	<b>\$6,031,395</b>	<b>\$2,488,472</b>	<b>\$6,224,521</b>	<b>\$2,043,961</b>	<b>\$9,756,954</b>

**NOTE a:** Population for other than census years estimated by increasing the yearly population by one-tenth of the increase actually reported from 1920 to 1930. This method results in a larger population estimate than by the Bureau of the Census and consequently allocates a slightly larger proportion of the cost of the highways and city streets to general welfare purposes.

**NOTE b:** Pro-rated between state highways and county and local roads on basis of respective percentage ratios of annual cost (Cols. 2 and 3) to the aggregate annual cost of state highways and county and local roads (Col. 2+3).

## CHAPTER V

### ALLOCATION OF ANNUAL COSTS BETWEEN VARIOUS CLASSES OF MOTOR VEHICLES

After determining the aggregate amount that should be charged to motor vehicle operators as a whole, there remains the problem of allocating annual costs to the different classes of motor vehicles. The allocation of these annual costs is influenced in part by the facilities required and in part by the use made of them.

#### BASES OF ALLOCATION

The sizes and weights of the vehicles will affect this allocation because there is an inescapable relation between weight and size of a motor vehicle and the design of a highway adequate for its use. The schedule of tolls on early turnpikes required higher charges for the larger and heavier vehicles and similarly, in modern times, higher charges for heavier vehicles prevail on toll bridges and tunnels.

Part of the annual cost deals with the capital cost of facilities which varies for different classes of vehicles. Another part of the cost is for maintenance and operation, which is more closely related to use as measured by either the ton mile or vehicle mile.

A study of these elements of highway costs involves technical considerations. The principal factors that determine highway capital costs are the weight, size and speed of the vehicles. As the weight of the vehicle increases, it not only causes additional wear on the surface but also requires stronger pavements because the wheel loads are greater. Size determines the highway space which the vehicle occupies and influences the width of pavements. Speed is a factor that must be considered in the alignment and grade and may also influence pavement width. There are other less important factors influencing highway costs.

If all roads and pavements were designed adequately for the maximum wheel loads which pass over them, this problem of determining the relative cost for different sizes and weights of motor vehicles would be less complicated because their service life could be predicted with more accuracy and the element of destruction would be eliminated. Thousands of miles of highways are carrying wheel loads for which they never were designed or intended. This was particularly true in the period under review when millions of heavy vehicles were operated over underdesigned highways, structures and city streets. This has caused the early destruction by heavy vehicles of many miles of pavement which would have adequately served the ordinary passenger car for many years. To accurately appraise this economic loss is a practical impossibility. Consequently, in allocating annual cost of facilities among the different types of vehicles, we

have assumed a design of road that is adequate for the traffic served and then determined the increase of cost required for each class of vehicle. In order to do this, the concept of a "basic road" for a "basic vehicle" has been employed.

#### THE BASIC VEHICLE AND THE BASIC ROAD

The earliest improvement of highways in the motor age was for the passenger automobile, and this improvement was also adequate for the small trucks which may be classified, so far as requirements in road improvements are concerned, as being in the first, or "basic," class of motor vehicles.

The "basic vehicle," represented by the passenger car, has a maximum axle load of 1800 pounds, and an overall width of 6 feet, which are the essential factors used in design. All other vehicles of greater weight and width are assigned in groups of such intervals as the available data will permit. Thus, the vehicles will be classified beginning with the "basic vehicle" and extending as the weights increase finally to the heaviest motor trucks and trailers allowed on the roads.

The "basic road" is one that is wholly adequate for the basic vehicle. It is not any particular kind of a pavement; it may be any one of the various types in use.

The "basic vehicle" is charged with its share of the cost of a "basic road," and each class of motor vehicle of greater size and weight is charged its share of the basic road plus the additional costs incurred in its behalf.

This principle is explicitly stated as follows:<sup>1</sup>

"The apportionment of special taxes among motor vehicles of various types should be based upon use of facilities required, and should be sufficient to pay their fair share of total annual costs, \* \* \*. Separate schedules should be determined for passenger automobiles, buses, and trucks.

"The basic cost of constructing, improving and maintaining a given highway should be determined from a highway designed for private passenger vehicles and other vehicles commensurate therewith. All vehicles using such highways should pay their proportionate share of that total as a base tax. The total additional cost of construction, improvements and maintenance to make a road suitable for a type of vehicle requiring such additional cost should be shared by each vehicle of that type and each vehicle of greater size. Thus, each group should share in the base cost plus all increments of cost up to and including cost required by it."

In order to apply this principle it will be necessary to study each of the different types of pavements to determine how the annual cost varies with weights and sizes of vehicles. In this connection it

<sup>1</sup> Recommendations of Joint Committee of Railroads and Highway Users, January 30, 1933, Paragraphs 63 and 64, page 16.



must be clearly understood that the requirement of the basic vehicle may be satisfied by a pavement of a much lower type and consequently less expensive than the type that is required for the heavier vehicle. It is not wholly fair, therefore, to make comparisons solely between different thicknesses of the same pavement.

The following study, however, relates to the different thicknesses of the *same* pavement required for different vehicle weights, based on similar conditions of subgrade and for the same factor of safety. It has been necessary to confine the study to this scope because this appears to be the most feasible approach. It certainly favors the heavy vehicle.

#### PAVEMENT CLASSIFICATION

Roads and streets may be classified according to their pavement type. By "pavement" is meant all layers of road material superimposed upon the natural soil. The term is used broadly in this report and includes all types from the modern concrete highway to a layer of earth composed of local material which has been compacted either artificially or by traffic.

Beginning with the lower class of roads, we have the improved earth road, principally made of a mixture of sand and clay; gravel roads; a wide range of bituminous pavements, and roads of Portland cement concrete, brick and stone blocks. Table 21 shows some of the accepted pavement classifications.

Intelligent selection of the type of pavement is essentially an economic problem involving anticipated character and volume of traffic, the solution of which is based on relative annual costs which are frequently affected by the availability of suitable local material.

After selecting the type of pavement, its design, i. e., choice of thickness and other dimensions, is primarily an engineering problem in which the wheel load and size of vehicle are dominating factors. Consideration is also to be given to the characteristics of the subsoil, or natural soil foundation, upon which the pavement is to be placed. While the thickness of pavement and the subsoil support are closely interrelated, it is essential to bear in mind that, *irrespective of subsoil conditions, the thickness of pavement varies with different wheel loads.*

*The required thicknesses of all pavements vary as the square root of the wheel loads imposed upon them.* This means that if a wheel load is four times as heavy as another it will require a pavement twice as thick. In the discussion we shall show the application of this principle to rigid type of pavement, then to the flexible pavement, and finally to gravel and earth roads. The variation in thickness of pavement required will be translated into cost ratios which will be used in allocating annual capital costs between different classes of vehicles.

**TABLE 21  
PAVEMENT CLASSIFICATION**

Classification for (Design)	Classification for Traffic (Economic)	Bureau of Public Roads Bituminous Classifications (Competitive)	Pavement Types	Descriptive Classifications (Construction)
Rigid Types	High Types		Portland Cement Concrete	Monolithic
			Brick on Concrete Base Stone Block Concrete Base Wood Block Concrete Base Asphalt Block Concrete Base	Block Types
		J	Sheet Asphalt Concrete Base Westphal, Duralithic, Laycold Macasphalt, Warcolite, Colprovia, Topeka, Warrenite, Willite, etc.	Closed Mix
		I	Bituminous Concrete-Concrete Base Westphal, Duralithic, Laycold, Macasphalt, Warcolite, Calprovia, Topeka, Tarvia, Warrenite, Willite.	
		H	Asphalt concrete, Tar concrete, Amiesite, Interaco, Petromuls, Trinidasco, Amulthlic, Hepburnite.	
		G	Natural Rock Asphalt, Concrete Base Kyrock, Oklahoma Rock, Etc.	Semi-Closed Mix
Flexible Types	Intermediate Types		Cement-bound Macadam	
		F	Bituminous Plant Mix Precote, Amulco, Fluxbak, Seal- drok, Flintlait	
		E	Modified Penetration Macadam	
		D	Bituminous Penetration Macadam	Open Mix
		C	Bituminous Road Mixes Retread, Dense open mix	
		B	Retread slow curing	
	Low Types		Waterbound Macadam	
		A	Surface Treatments Oil Treatments	Surface Binders
			Slag Roads Gravel Roads Chert Roads Broken Stone Roads Shell Roads Cinder Roads	Traffic Bound Open Course Aggregates
			Sand-Clay Roads Stabilized Soil-Bound Roads Shale Roads	Closed Mix Aggregates
		Dirt Roads		

**SQUARE ROOT OF THE WHEEL LOAD BASIS FOR ALLOCATION OF  
CAPITAL COST**

*Square Root Relation—Rigid Pavements.* A rational method for the design of concrete pavements was first developed as a result of the Bates Road Tests in Illinois (1920-1923);\* which were conducted under the direction of Clifford Older. In these tests pavements of different designs were laid upon the natural subgrade and sub-

\* See Bulletins Numbers 18 and 21, State of Illinois, Department of Public Works and Buildings.

mitted to intensive motor truck traffic. Wheel loads were increased by increments, and the progressive effect on each pavement section observed and recorded. This was the first comprehensive pavement research under actual moving loads undertaken in this country.

The experiments showed that the destruction of the rigid slabs always started with a break across the corner. Once this break occurred, failure of the slab progressed rapidly under additional passages of wheel loads. (See photograph, p. 61.) The tests pointed conclusively to the fact that the slab must be designed of sufficient strength to support the maximum allowable wheel load. Further observations showed that the concrete slab was frequently unsupported at the corner on account of the warping of the slab with changes in temperature and moisture content of the slab.

When the results of these observations were plotted, they were found to fit the corner formula which was consequently recommended for the design of thickness of the concrete slab. This formula assumes that the corner portion of the slab acts as an unsupported cantilever beam. The formula is written:

$$t = \sqrt{\frac{3W}{f}}$$

where  $t$  = slab thickness

$W$  = wheel load which is assumed to act over a point at the extreme corner.

$f$  = allowable fiber stress in tension which for design purposes should be taken as not more than one-half of a conservative value of the modulus of rupture of the concrete (i. e., one-half the stress at failure).

If a stress greater than one-half the modulus of rupture were allowed, the concrete would ultimately fail due to fatigue even if the stresses never reached the ultimate. The closer these stresses approach the ultimate (modulus of rupture) in amount, the sooner failure occurs due to fatigue.

Where two corners are so joined together as to cause one to assist the other in supporting the load, as is usually the case in the interior of the pavement, the formula becomes  $t = \sqrt{\frac{1.5 W}{f}}$ . This, then, applies to all of the slab except the outer edge.

During the period under review (1921-1932) the corner formula was extensively used for the design of concrete pavements.

Mathematical analyses of stresses in concrete slabs have been made by Dr. H. M. Westergaard.<sup>3</sup> Additional analyses have also been

---

<sup>3</sup>Public Roads, April, 1926, "Stresses in Concrete Pavements Computed by Theoretical Analysis," by H. M. Westergaard.

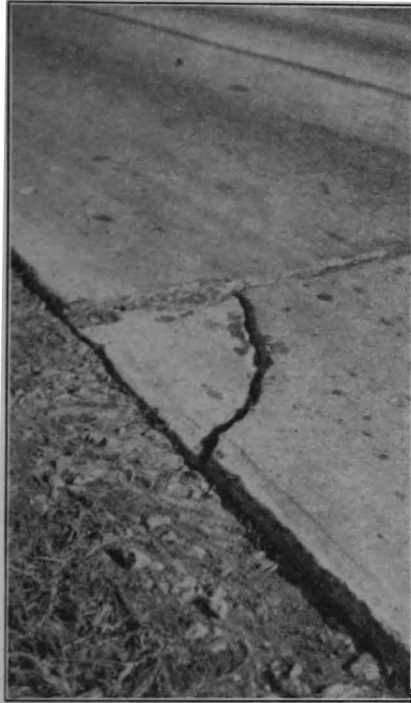

**TYPICAL CORNER BREAK OF CONCRETE PAVEMENT**



**RAPID PROGRESSIVE FAILURE AFTER CORNER BREAK**

made by M. G. Spangler.<sup>4</sup> These methods make certain assumptions relative to wheel load distribution and subgrade support. They result in very complicated mathematical formulas for stress in terms of slab thickness, wheel load, area of load distribution, and subgrade support. A discussion of these analyses and a comparison between the results which they show and those obtained by the corner formula will be found in Appendix G.

*For purposes of cost allocation the relative thickness of pavement required for different wheel loads is desired, and not the actual thicknesses.* The corner formula shows that the thickness varies with the square root of the wheel load. The more complicated Westergaard analysis shows substantially the same relation.

The laboratory tests and mathematical analyses made by Spangler show nothing which indicates that the required thickness of the slab is not substantially proportional to the square root of the wheel load.

Because the corner formula fits actual road service conditions as well if not better than any other, because it has been tried by experience and found to be reliable, because it has been used during the period under review and is still in general use,<sup>5</sup> and because it is extremely simple in application, we have used it in preference to the Westergaard method for determining the relation between wheel loads and pavement thickness required.

The application of this formula results in pavement *thickness proportional to the square root of the wheel loads.*

*Impact.*<sup>6</sup> Throughout the history of structural design, impact, when used, has almost universally been taken as a percentage of the loads. When this is done in the design of rigid pavements the *relative thicknesses* are the same as when no impact is considered. Thus, the introduction of a constant percentage impact factor in a design formula would merely have the effect of providing a uniform factor of safety for all loads. Tests have been made to measure impact on pavements but nothing appears from these tests to justify the acceptance of any impact factor for design other than a percentage of the load. Moreover, if the effect of the load suddenly applied, as distinguished from impact, be considered, the factor for design is a straight percentage of the load.

*Effect of Thickness on Cost.* Since all the elements of concrete pavement costs do not vary directly with the thickness, it is necessary to adjust the costs for the operations which do not vary, such as finishing subgrades, setting and removing forms, surface finishing and moving plant. A study of a very large amount of contractors' confidential cost figures for work done in several States under average

---

<sup>4</sup>Proceedings of the 15th and 17th Annual Meetings of the Highway Research Board, "Stresses in Concrete Pavement Slabs."

<sup>5</sup>"Concrete Road Design Simplified and Correlated with Traffic," Portland Cement Association.

<sup>6</sup>For discussion see Appendix H.

conditions indicates that there is a fixed cost per mile of \$2,525 and a variable cost of \$3,100 per inch of thickness per mile. Expressed as a formula:

Cost (in dollars) equals  $\$3,100 \times \text{Thickness (in inches)} + \$2,525$ . This formula will be used for translating thickness into cost ratio. It will be noted that Columns 2 and 3 of Table 22a give, respectively, the thickness in the middle of the slab and the edge thickness with an added allowance of 50 per cent for suddenly applied load. Column 4 is the ratio of these thicknesses, which is the same for both of the previous columns. The thicknesses in these columns were determined solely for the purpose of reaching a *ratio of thickness* which is translated into a *ratio of cost*. It should be kept clearly in mind that it is the ratio of thickness with which we are dealing. It is not a schedule of design thickness.

*Relation Between Wheel Load and Thickness of Flexible Pavements.* Any wheel load on a flexible pavement is distributed through the pavement to the surface of the subsoil in some such manner as is represented by Figs. 1 and 2. This well-known fact has been proved to be sound because, when pressure recording devices have been applied to the underside of pavements or in the subgrades below the pavements and the pressure distribution measured, it is found that the pressure directly under the wheel is the greatest and that it gradually grows less outward from that point. While this pressure distribution extends outward for a considerable distance, it is so small toward its outer fringe as to be negligible. It is permissible to draw two diagonal lines from the top of the pavement toward the bottom beginning at either edge of the wheel, as in Fig. 2, and to assume that all the wheel weight is distributed uniformly on the subgrade at the bottom of the pavement over a circular area defined by the base of a cone, the limits of which are represented by the two diagonal heavy lines marked "Assumed Limits of Load Distribution." These lines may be drawn at such an angle that the assumed uniform pressure will equal the maximum pressure. If the pavement is thicker, these lines diverge further and hence describe a bigger area on the top of the subgrade. Different subgrades will, of course, support different intensities of pressure. Given the intensity of pressure that a given subgrade can repeatedly support without permanent depression, it is only necessary to make the pavement thick enough so that the area on the subgrade over which the wheel load is distributed divided into the wheel load will not exceed the permissible supporting pressure on the existing subgrade.

It follows that for a given subgrade the heavier wheel loads must be distributed over greater areas which will require thicker pavements than the lighter wheel loads because the size of the circle of distribution can only be increased by thickening the pavement as illustrated in Fig. 1.

The thickness of the pavement required is dependent upon the wheel load irrespective of subsoil conditions. The relation between

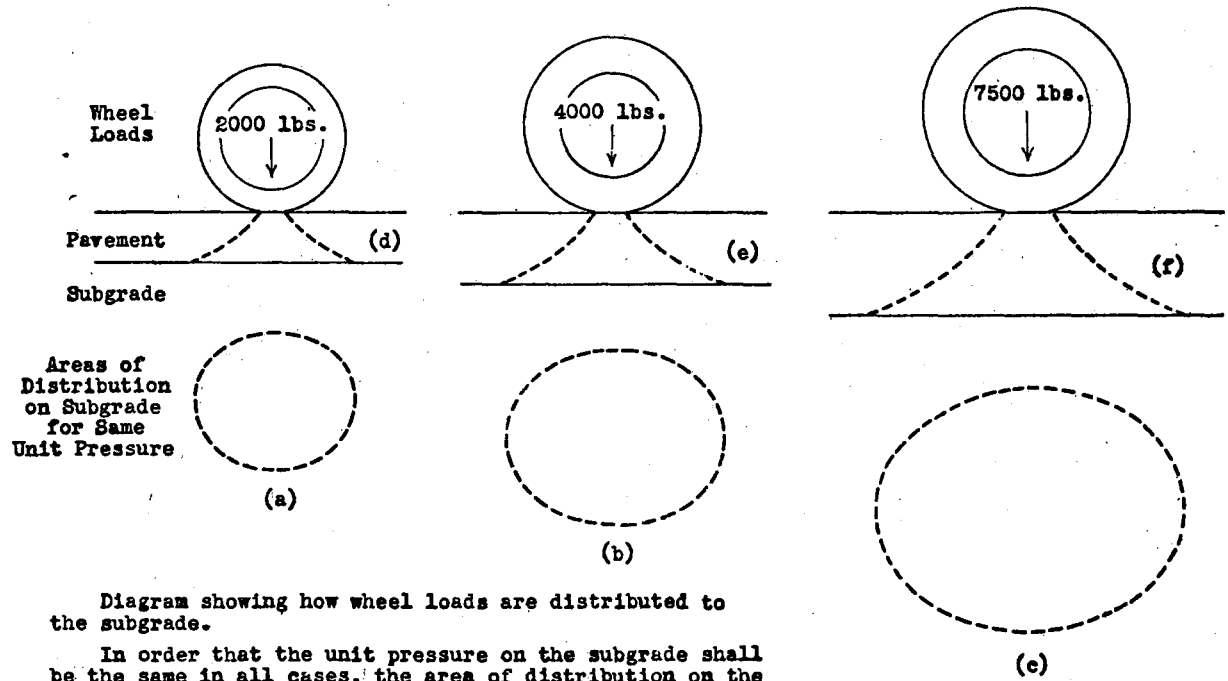

Diagram showing how wheel loads are distributed to the subgrade.

In order that the unit pressure on the subgrade shall be the same in all cases, the area of distribution on the subgrade must be increased with the wheel load as shown in (a), (b) and (c). This is accomplished by thickening the pavement as shown in (d), (e) and (f).

Fig. 1

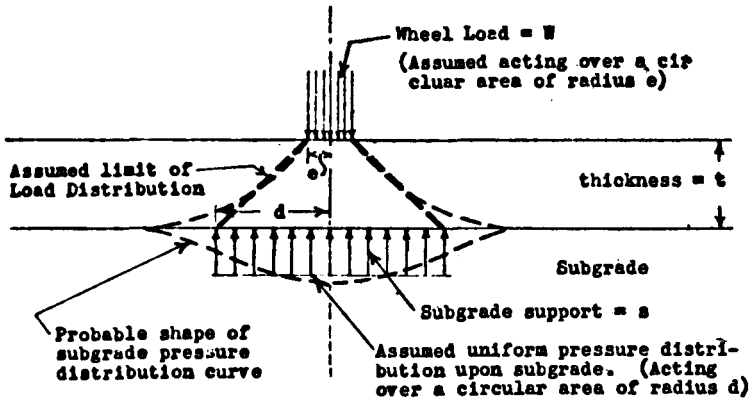

Diagram showing distribution of wheel load pressure through a flexible type pavement indicating the assumptions made in deriving design formulas.

When  $d = t + e$  (which is a reasonable assumption for flexible pavements)

$$t = \sqrt{\frac{W}{\pi s}} - e \quad \text{where } t \text{ and } e \text{ are in inches, } W \text{ in pounds, and } s \text{ in pounds per square inch.}$$

Fig. 2



wheel load and thickness is difficult to obtain theoretically on account of the many variables involved. Several formulas have been derived, however, as a result of observation and experiment, and will be found in text books and professional papers.<sup>7</sup> These formulas and rules, although different in form, agree in one particular, namely, that *the thickness required varies substantially as the square root of the wheel load.*

The formula given in Fig. 2,  $t = \sqrt{\frac{W}{\pi s}} - e$ , applies generally to flexible types. It is applied to bituminous types in particular in the latest issue of the Asphalt Institute entitled "Asphalt Pocket Reference for Highway Engineers, 1937" by Prevost Hubbard, Chemical Engineer, and Bernard E. Gray, Chief Highway Engineer of the Asphalt Institute. This latter publication was specifically prepared for guidance of highway engineers in the science of design and construction of bituminous pavements. The entire chapter dealing with the Design of Asphalt Pavements is reproduced in full in Appendix I of this report, together with a further discussion of the design formula and how it demonstrates that the thickness required varies as the square root of the wheel load.

Stiffer pavements, such as concrete slabs, distribute the wheel loads over larger areas than the more flexible pavements, such as bituminous pavements or gravel pavements. This is the reason why, on roads over which heavy trucks and buses operate, concrete pavements have usually proven to be more economical than thick bituminous pavements.

*Gravel and Other Untreated Pavements.* The theories of distribution of stresses through bituminous pavements likewise apply to pavement materials such as gravel, sand and clay, and lead to the same conclusion, namely, that the thickness required varies as the square root of the wheel load. The distribution of stresses in these materials can be obtained by the application of Boussinesq's theory as demonstrated in Appendix J. This theory also supports the square root

<sup>7</sup> Prof. C. E. Wiley in his text book "Principles of Highway Engineering" uses the Massachusetts Highway Dept. formula  $T = \sqrt{\frac{W}{4p}}$  where T = pavement thickness to inches; W = wheel load in pounds and P = allowable subgrade pressure in pounds per square inch.

Harger & Bonney in their "Handbook for Highway Engineers" use the formula  $D = \sqrt{\frac{W}{3P} + \frac{T^2}{9} - \frac{T}{3}}$  where D = pavement thickness in inches; W = wheel load in pounds, including impact; T = tire width in inches; and P = maximum pressure on the subgrade in pounds per square inch.

George E. Hawthorn in Bulletin No. 83, University of Washington, Engineering Experiment Station, 1935, gives the formula

$t = \frac{1}{\tan \phi} \sqrt{\frac{P}{\pi q}} - a$  where t = thickness of surface, P = the wheel load, q = the unit subgrade support, and  $\phi$  = the shearing or load-distributing angle.

relation, which is a further proof of the application of the square root of the wheel load theory to practically all kinds of soils as well as to pavement materials.

In this report, therefore, the square root relation is used as a basis for determining the relative thicknesses required for different wheel loads for all kinds of flexible pavements.

*Relation of Pavement Thickness to Cost of Flexible Pavements.*

In the construction of flexible pavements there are certain elements of cost which do not vary directly with the thickness. These are the final preparation of the subgrade preliminary to the pavement construction; a certain amount of subgrade drainage which applies to the higher classes of pavement; the surface treatment which applies to the bituminous pavements; moving of the plant to and from the job.

More so than in the case of rigid pavements, these items vary with the class of pavement and are not constant for any particular class. The preparation of the subgrade is perhaps the most constant item. Subgrade drainage is not always necessary. The surface treatment consists of the surface finish, which includes rolling, and in the case of bituminous wearing courses, a small amount of bitumen. It does not include the wearing course, which will itself vary in thickness depending upon the wheel loads, and which will usually require a stronger aggregate for heavy loads. The cost of moving plant and equipment varies somewhat in proportion to the class of the pavement, increasing for the high class pavements where more costly equipment is required. From the cost data available and the experience of engineers and contractors in widely separated States, it is concluded that the elements of cost which do not vary directly with the pavement thickness amount to approximately 10% of the total pavement cost.

Therefore, the total cost of flexible pavements has been allocated on the basis of 90% of the cost of the pavement in proportion to the square root theory, and 10% as a constant or flat charge, expressed by the equation:

$$x = \frac{90 K + 10}{100}$$

in which  $x$  gives cost ratios corresponding to the ratios of thickness, and  $K$  is derived from the square root of the wheel load relation.

It will be observed that this is, to all practical purposes, the same method as was used in the allocation of cost of rigid pavements.

This discussion has shown that for all types of pavement the square root of the wheel load relation is a proper method for all practical purposes to determine the increment of pavement costs for facilities required by groups of motor vehicles heavier than the basic vehicle. The problem then presents itself of allocating these increments of cost among the vehicles requiring the facilities on an equitable basis.

As has been said on page 57 all vehicles should pay their proportionate share of the basic road cost and likewise their proportionate

share of the additional cost of facilities required by each vehicle based upon the use of such facilities. "Thus, each group should share in the base cost plus all increments of cost up to and including the cost required by it."

Different units of use have been considered in this allocation, such as numbers of vehicles, vehicle miles, ton miles and a unit representing the road occupancy of the different types of vehicles. We, however, have not chosen to adopt *numbers* as a fair measure of use, because vehicles use the roads in different amounts; some will travel three or four thousand miles and others will travel forty or fifty thousand miles in a year. Therefore, the number of times they use the road should be an element in allocation. *This brings us to the conclusion that at least the vehicle mile should be the unit of measure of use.*<sup>9</sup>

Taking all things into consideration, *we have adopted vehicle miles as measuring the unit of use for pavement costs.*

#### GRADING

A substantial capital cost for grading was incurred during the period under review. That part of the cost which was incurred for larger and wider vehicles, including additional width and other factors, will be discussed later. The cost of pavements which were constructed on these graded highways has already been allocated on the assumption that the money expended produced pavements adequate for the anticipated wheel loads. On this assumption, a heavier vehicle will do no more damage to the subgrade and require no more cost than the basic vehicle. Consequently, *it is equitable to allocate the cost of grading to each vehicle each time it passes over the highway, namely, on the basis of vehicle miles.*

#### EARTH ROADS

The classification, "earth roads," covers a wide range from the lowest type which has had little or no choice of materials up to the graded and drained earth road in which the soil constituents are chosen to give the maximum resistance against displacement by traffic and the elements, without the addition of bitumen or other binding material. Calcium chloride or other stabilizing agents are sometimes added to improve the stability of the road, particularly in dry weather.

The lower types of earth road involve little capital investment other than that required for bridges and drainage structures. The serviceability of these roads and their structures, however, will be influenced greatly by the type and amount of traffic to be carried. Heavier vehicles will cause relatively greater deformation and displacement of surface material than lighter vehicles and will therefore be responsible to a greater degree for resulting maintenance.

---

<sup>9</sup> The ton mile is a better measure than the vehicle mile: Clifford Older. His views concerning units of use are given in Appendix K.

The higher type of earth road performs a load supporting function similar to that of the base course for a bituminous wearing surface, but lacks the strengthening and protecting help of such a surface course. The load supporting value of these high type earth roads is dependent upon a nice balance between internal friction and cohesion among the soil particles which allow them to resist displacement by traffic or the elements. This natural bond is not as strong or reliable as that furnished by bituminous materials and variations in traffic load will be more critical; that is, the surface may be able to withstand many passages of light passenger cars, but may fail quickly under a few heavy loads. The natural bond will vary with climatic conditions, being in general least effective in extremely dry or extremely wet weather. A combination of adverse weather conditions and a few heavy loads may ruin a road that would otherwise remain stable under passenger car traffic alone.

During the period under discussion (1931-1932), however, the stabilization of earth roads was in the experimental stage, and no data are available as to expenditures incurred on that account. Hence, it is concluded that no separate consideration of this special type of earth road is practicable.

Except for some recently built structures, the bridges on these earth highways have not been constructed for motor vehicle operation. When used by motor vehicles, and especially the heavier vehicles, such usage damages the structures and results in increased maintenance and replacement costs and reduced service life.

There is ample support for allocating earth roads on the basis of the square root of the wheel load. See Appendix J. From the standpoint of capital costs of common earth roads, it is evident, however, that for the great bulk of the mileage no effort has been made to build such roads to accommodate the heavier types of vehicles and that any damage done by these vehicles may be considered as being reflected in increased maintenance expenditures and not in capital costs. It is equitable, therefore, to allocate capital costs on earth roads equally between all vehicles using them, taking into consideration, however, the difference in mileage operated. Such costs *will be allocated on the basis of vehicle-miles.*

## STRUCTURES

The use of multiple axles makes possible excessive gross weight without exceeding the legal wheel load. Bridges are required to carry the gross weight, not the wheel load alone, because the usual spans of small bridges and the distance between the main supports of the floor system of long bridges is greater than the wheel base of trucks. Stronger and more costly structures are, therefore, required for these heavier vehicles. This is particularly true for short span bridges where the vehicle load has more influence on design than the dead load of the structure itself. For long spans, the dead weight

becomes controlling, but this is also increased by the necessity for stronger floor systems to transmit these heavy truck loads to the girders or trusses.

Attention is called to the fact that the American Association of State Highway Officials has adopted standard specifications for bridges, for loadings of 10-, 15- and 20-ton trucks. It is obvious that the weight of the bridges designed for these different loadings will vary and, consequently, their costs will vary.

The State of Washington Highway Cost Commission (previously referred to) prepared typical designs and calculations for the cost of structures for H-5 (5 ton truck gross weight) and H-15 (15 ton truck gross weight) loadings. The conclusion reached was that the cost of bridges designed for H-5 loading would be approximately 20% less than that for H-15 loading.<sup>9</sup>

During the period under discussion (1921-1932), many bridges were reconstructed because of truck traffic. In such cases, and they were many, a fair cost principle is that the passenger car should be charged with the carrying charge of the old bridge and the heavier vehicle should be charged with the carrying charge of the new bridge. In cases where bridges have not been reconstructed, the service life of such structures has been shortened and the maintenance cost increased.

The inadequacy of existing bridges at the beginning of this period is illustrated by the following quotations from the report of Massachusetts Highway Commission for 1919:

“Protection of Highways and Bridges from Excessive Loads—A great many bridges and culverts were destroyed by heavy trucks this year. The small country towns cannot afford to build bridges adequate to carry vehicles whose total weight exceeds 6 tons. The State cannot afford to build them, either, except on a few main routes. A very few figures will be convincing.

“A modern highway adequate to carry, say, 12 to 15 tons, will cost today from \$30,000 to \$40,000 a mile to build. If bridges of any great length were required, the expense for each bridge would be from \$30,000 upward.

“Motor trucks contribute about 7 per cent of the total traffic on most of our through highways. The motor trucks having a carrying capacity greater than 3 tons constitute only a small percentage of the total number of trucks (probably not over 15 per cent).

“About 1 per cent of the traffic using through routes, therefore, will be trucks whose total weight, vehicle and load, exceeds 6 tons. Taking a main highway carrying 1,000 vehicles a day on the average, about 10 only would exceed 6 tons weight for vehicle and load. It is evident that the owners of these

---

<sup>9</sup>The report of the Interim Committee for the State of Oregon, p. 65, states the percentage of additional cost for building bridges for standard highways above basic highways averages 28.6% (H-5 compared with H-15).

10 trucks should not be allowed to destroy the road, even if we assume or they assume that they can save a little money by using the heavy truck. The road is entirely adequate to carry all ordinary traffic for many years.”

• • • •

The trucks and buses larger than the basic vehicle should be assigned all additional elements of cost due to greater strength of the bridges required for them and particularly for strengthening and reconstruction which they have made necessary, if a segregation of such elements of cost could be made.

As has been pointed out above, wheel loads and gross weights are factors in the design of structures and therefore have an influence upon their costs. It is difficult, however, to ascertain with any degree of exactness, how much additional money has been spent to accommodate the heavier vehicles. Because of this fact, the allocation of the capital costs of structures will be made on the vehicle-mile basis, which will definitely favor the heavier vehicles. Later a portion of this cost is assigned solely to heavier and wider vehicles.<sup>10</sup>

---

<sup>10</sup>A percentage of the capital cost of structures should be allocated to heavier vehicles in the same manner that a percentage was used to express the cost of added width.—W. S. Downs.

## CHAPTER VI

### ADDITIONAL WIDTH AND OTHER FACTORS IN DESIGN OF HIGHWAYS

There are additional factors which enter into design of all improved highways irrespective of the type of pavement. These are width, alignment, gradients and structure. They are influenced by size and weight of vehicle, speed, volume of traffic and other elements. These factors will be discussed for the purpose of determining the additional cost of construction made to provide adequately the special facilities required for wider and heavier buses and trucks as compared with similar facilities adequate for the basic vehicle.

Of these factors, width has the greatest effect on costs. The additional width required will be discussed here.

#### EFFECT OF VEHICLE WIDTHS ON PAVEMENT WIDTHS

The maximum width of vehicles allowed in nearly all States is 8 feet. Through this period (1921-1932) most buses and heavier trucks engaged in long distance transport were 8 feet in width. There is no fixed relationship between weight and size in trucks. In general, the heavier and bulkier trucks are the widest, but the medium weight trucks often have wide bodies. A survey of truck widths and dimensions published in Public Roads, May 1935, showed the average width of trucks in operation in Maryland to be about  $7\frac{1}{2}$  feet. Thus trucks may be built 2 feet wider than passenger cars and actually are on the average  $1\frac{1}{2}$  feet wider. From a physical standpoint the truck and the bus are obviously the limiting vehicles in determining the minimum width of a traffic lane. The narrowest pavement upon which they can operate with any clearance between them in passing is 18 feet, which is evidently not adequate.

This width was only tolerated in the beginning because there were only a few of these wide vehicles on the highways and consequently they seldom had occasion to pass each other. On minor roads today, 14-, 16-, 18-foot widths are still built which adequately serve a small volume of passenger car traffic but will not serve the occasional truck unless one or the other makes use of the shoulder in passing.

Any additional width over 18 feet for 2-lane roads provides clearance for the wider vehicles which is *necessary* for their safe and unrestricted operation. It likewise provides additional clearance for the passenger car which is *desirable but not essential* except in the case of a passenger car passing a truck or bus. The general adop-

tion of the 10-foot lane was a necessity for the truck and bus; it was only a necessity for the passenger car on account of the presence of these wider vehicles.

Studies of the transverse distribution of traffic<sup>1</sup> show that most of the right wheel passages on an 18-foot pavement lie between 2 and 4 feet from the edge of the pavement when no car is passing in the opposite direction. When two cars pass in the opposite direction passenger cars run about 1 foot nearer the edge. From these operations it may be deduced that passenger car driver's preferred position brings his right wheel no nearer than about 2 feet from the outside edge of the pavement when passing other vehicles. Figure 3 shows the position of passenger cars passing on an 18-foot pavement with their rear wheels 2 feet from the edge. The clearance between vehicles in this case is about  $3\frac{1}{2}$  feet.

If, instead of two passenger cars, a truck and a passenger car must pass on an 18-foot pavement, the truck will require the entire 9-foot lane, leaving all the clearance between vehicles to come from the passenger car's lane. In this case, the passenger car must either sacrifice clearance as indicated in Figure 4, or move to the very edge or off the pavement onto the shoulder as shown by the dotted outline. The width of the truck in Figure 4 is 8 feet, which is the maximum allowed in most States, and generally utilized to the limit by trucks engaged in the motor freight business. Some States (Massachusetts, for example) allow an even greater width for the dual tires; they permit the tires to extend outside the legal body width, making the actual width of roadway occupied more than 8 feet.

If two trucks or buses of maximum size are required to pass on an 18-foot pavement, they will be forced to drive closer to the edge than shown in Figure 4, and the greatest clearance they can have and still stay on the pavement is 2 feet. If the two vehicles approach within 6 inches of the edge, their clearance would be but 1 foot on an 18-foot pavement. It is neither logical nor safe to provide less clearance for the large trucks and fast moving buses than for passenger cars.

If the same clearances are provided for the vehicle of maximum width as for the passenger car, a 22-foot pavement would be required as shown in Figure 5.

From the above it may be concluded that the motor truck and bus enjoy no more freedom of movement on a 22-foot pavement than does the passenger car on a 18-foot pavement, and that extensive use of 18-foot or even 20-foot roads by large vehicles *imposes a hazardous restriction* upon the clearance which they may have between them in passing each other, and likewise *impose a restriction on the passenger car* in passing because the latter must provide the large vehicle with a disproportionate amount of clearance from the lane it is occupying.

---

<sup>1</sup> Public Roads, March, 1929.



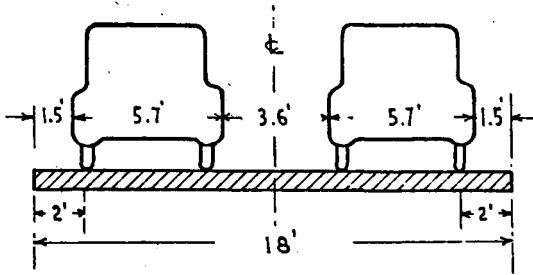

Fig. 3 Two Passenger Cars Passing on an 18 Foot Pavement with Right Wheels 2 Feet from Edge

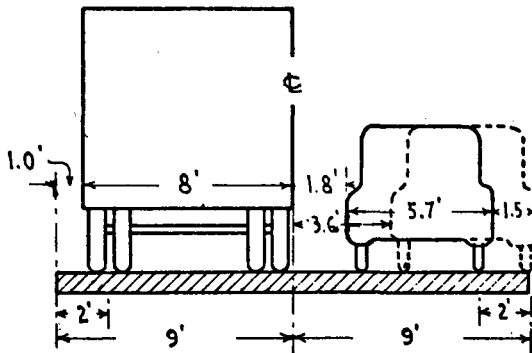

Fig. 4 Truck and Passenger Car Passing on an 18 Foot Pavement

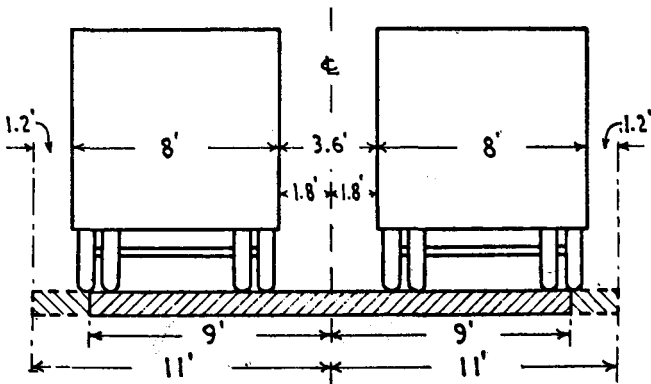

Fig. 5 Truck Passing Truck with 3.6 Foot Clearance 22 Foot Pavement Required

Figs. 3-4-5

The greater occupancy of these 18- and 20-foot roads by these wider vehicles *makes passing difficult and hazardous.*

From the above considerations it may be concluded that the progressive widening of pavement lanes during the period, 1921-1932, has been forced by the additional clearance required for trucks and buses.

#### EFFECT OF VOLUME OF MIXED TRAFFIC

During the period under consideration, there was a very rapid increase in ownership and use of motor vehicles.

In 1921 there were 9,463,391 passenger cars and 999,904 trucks, tractors and buses registered; in 1932 there were 20,797,722 passenger cars and 3,339,157 trucks, tractors and buses. This represents an increase of 120 per cent for passenger cars, and 234 per cent for trucks, tractors and buses. Registered trailers and semitrailers not included in the foregoing figures, during the same period, increased from 22,685 to 412,998 units, or 1,721 per cent.<sup>2</sup> This increase in registration, great as it was, still understates the increase in actual traffic because the annual mileage driven by both passenger cars and trucks increased during this period so that the per cent increase in travel was far greater than the increase in registration. This was particularly true of trucks and buses because these have a greater annual mileage than passenger cars.

This increase in the amount of mixed traffic was a major cause for the progressive widening of traffic lanes during this period and for the change from 2-lane to multiple lane roads. Had there been no trucks or buses in the traffic stream an increase in volume of passenger car traffic alone would not warrant the widening of traffic lanes and the construction of wider and firmer shoulders. With mixed traffic, however, the passages of truck with truck and truck with passenger car multiply rapidly as traffic increases and the necessity for greater clearance becomes more and more important. In many States, two 10-foot lanes have frequently proved inadequate for dense mixed traffic and consequently the adjacent two feet or more of shoulder have been paved. The larger vehicles have a major responsibility for this shoulder paving since they are prone to run off the pavement when passing other large vehicles and to force passing passenger cars from the pavement.

The first States to adopt 10-foot lanes instead of 9-foot and to provide paved shoulders were the commercial States in the northeast where the volume of traffic is large and the percentage of trucks high. In Massachusetts, 10-foot lanes were adopted on primary routes in about 1920, and by 1924 bituminous macadam roads carrying commer-

---

<sup>2</sup>Bureau of Public Roads original figures for passenger cars included buses. Figures here used were adjusted to exclude buses from the passenger classification and include them with trucks. According to "Bus Transportation," 20,000 buses were registered in 1920 and 105,700 in 1932.

cial traffic were constructed in 24-foot widths (two 12-foot lanes) and cement concrete roads were provided with 2-foot macadam shoulders as standard construction practice.

The importance which the motor truck and bus played in the design and planning for highways in the period under consideration may be gained from the following quotations from the "Connecticut Traffic Survey Report" made by U. S. Bureau of Public Roads in 1923.

"The general purpose of the survey was to obtain the traffic information necessary for the establishment of a definite plan of highway improvement based upon the present and expected future traffic significance of the various highways in the State.

"But the determination of the amount of traffic does not form sufficient or conclusive evidence for the final selection of highway design and type of pavement, to serve traffic adequately and economically.

"Highways are affected not only by the number of vehicles passing over them but also by the types of these vehicles. Variation in the capacity, loading and the equipment of the vehicle causes corresponding variations in the effect upon the highways."

#### EFFECT OF VEHICLE SPEEDS ON PAVEMENT WIDTH

During the latter part of the period under consideration there was a general increase in vehicle speeds; a tendency which has become even more marked since 1932. This speed increase has resulted from more powerful motors; and in no small part it has been encouraged by the general availability of smooth hard surfaces upon which higher speeds are possible. As vehicles are driven faster it becomes more difficult to hold them to a fixed path and wider lanes are desirable. For modern mixed traffic 10-foot lanes are generally conceded to be the minimum that should be built, and for 2-lane roads paved shoulders are also needed.

In recent years many States have been active in paving shoulders and widening pavements on account of the excessive maintenance and hazardous conditions resulting from vehicles running off the edges of the paved surface. The speed of trucks and buses as well as that of passenger cars has been increased and the resulting necessity for wider highways is a joint responsibility, with the truck and bus the greater factors since they do more damage when they go off the pavement, and when they do not go off the pavement they have a strong tendency to force passenger cars from the pavement; not necessarily because the latter do not have room enough, but because drivers are wary of the fast moving, massive bus and truck and give them a wide berth.

For the period 1921-1932, speed was not as dominant a factor as was the general growth in volume of mixed traffic. The influence of speed came later. This is borne out by the fact that no extensive surveys of speed were made during this period, whereas considerable attention was given to transport surveys dealing with characteristics of motor traffic, particularly trucks. Little or no authentic data are

available as to average speeds in the 1920's, although anyone who has driven during that period will remember that speeds of 30-35 miles per hour were considered fast. Surveys conducted since 1932 indicate that average speeds for automobiles in mid-western States are in the vicinity of 45 miles per hour and in the more congested northeast States, about 38 miles per hour.

Speed is important from safety considerations, but it is the difference in speed between vehicles that limits the efficiency of a highway. If all vehicles were driven at the same speed the capacity of the highway would be increased far beyond what is actually attained. In this respect the motor truck is a chronic offender because it is inherently slower, particularly on grades where it lacks the necessary reserve power to maintain reasonable speeds.

On highways where there are trucks, the faster passenger cars overtake the slower trucks, and congested situations are common where these faster vehicles are held up because they cannot readily pass the impeding vehicle. The slower vehicle may occasionally be a passenger car but more often it is a motor truck. The slow passenger car, however, can be passed readily because it does not occupy much of the width of the road and does not obstruct the view. With the motor truck a different situation exists. Its greater width and height obstruct the view and this fact together with its extra length require much more time and much more open road in the adjacent lane for passing than is the case for a passenger car. When delays become excessive and congestion frequently occurs additional lanes are required to relieve this situation (See Appendix L). Motor trucks have a definite responsibility for this extra width since their excessive size and inherent slow operation will require additional lanes earlier than would be the case for passenger cars alone. The States with high densities of heavy truck traffic have been the first to change from 2-lane to 3-lane and 4-lane highways.

#### ALIGNMENT

Curved roads are made more hazardous and less efficient for passenger car traffic on account of the presence of bulky slow-moving trucks. These obstruct the view and make passing difficult and dangerous. They cause delays on curves similar to those caused at hill tops. Curved roads are frequently so marked as to prohibit passing for long distances. If a truck is overtaken at these places the following vehicle or vehicles must reduce speed to that of the truck until an opportunity to pass is reached.

Alignment is influenced by the elements of speed and the sight distance required. The flatter the curve, the safer it is for both of these conditions. Curves are flattened both for the benefit of the passenger car and for trucks and buses. Similarly, summits are flattened to produce safe sight distance for the same sets of vehicles. It should not be forgotten, however, that the characteristics of the buses and

trucks are greater height, greater length and greater width—all of which have their influence here. There are thousands of miles of highways on State systems in use today on which the frequency and sharpness of curvature present little hazard to the passenger car but which present a situation that is definitely more hazardous when buses and trucks, or when trucks with trailers, attempt to operate around these curves. Eliminating and flattening curves of such roads is a much greater requirement of the truck and bus than to the passenger car. On such roads the passenger automobiles, traveling at a reasonable speed, can remain in their proper lanes, whereas the buses and trucks, because of their long wheel bases, cannot negotiate sharp curves without fouling the opposing lane of traffic, thus creating a most hazardous condition. Widening of pavement on curves, together with consequent widening of grading are, to a considerable extent, chargeable to buses and trucks and to trucks with trailers, which have long wheel bases.

#### GRADIENTS

The grade requirements of passenger cars and trucks vary greatly because of the difference in reserve power of these vehicles. Where the grades are not reduced to meet truck requirements, passenger cars are obliged to trail along behind slow-moving trucks, which situation very materially increases the cost of operation of these passenger cars, not only because of the additional expense for fuel but also because of the loss of time. Passenger cars have no difficulty in climbing grades up to 9 per cent, but only light trucks can maintain speed on grades over 4 per cent, and some of the heavier trucks are obliged to climb along grades of 3 per cent and greater at a snail's pace.

As a matter of fact, it is the present practice on highways where there is considerable truck traffic to provide maximum gradients of 4 or 5 per cent, whereas 8 or 9 per cent is acceptable for automobile use. Many trucks cannot negotiate even 4 or 5 per cent grades in direct drive, and consequently, experience a reduction of speed. That these grades are not further reduced to meet fully the truck requirements, is because of the enormous extra costs involved. The result is that automobile traffic is still penalized by an enforced reduction of speed, though to a less degree than if no consideration at all were given to truck requirements. The same relative grades that the passenger cars and trucks could fully negotiate prevailed in the period under review.

The variation of truck speeds is graphically shown in Chart—Appendix Q.

While it is true that large areas of the country are flat and grades of consequence do not commonly exist, it is also true that many of the States along the east and west coast have hilly topography coupled with relatively dense highway traffic. In hilly and mountainous por-

tions of the country the cost for producing grades suitable for motor trucks is often several times as much as for grades suitable for the basic vehicle.

When grade reductions are made below that required for passenger cars the resulting economic benefits are vastly greater to trucks than to passenger cars. This has been borne out by a study by Prof. R. A. Moyer.<sup>3</sup> He reaches the following conclusions, among others:

“The savings in fuel costs, resulting from grade reduction were greater for trucks than for passenger cars, although the total tonnage was the same.

“For grades lower than 9 per cent, the time saving obtained from grade reduction is negligible for automobiles but is an important factor in truck operation on grades steeper than 3 per cent.”

A similar investigation has been made by Shaw and Fontaine at the University of North Carolina.<sup>4</sup> In this report the following table is presented which shows the extra cost of gasoline on grades up to 6 per cent for different classes of vehicles and indicates the possible savings due to grade reduction.

**“ESTIMATED EXTRA COST FOR GASOLINE OVER THAT ON THE LEVEL, IN CENTS PER VEHICLE-MILE**

Class of Vehicle	Per Cent of Grade						
	0	2.5	3	3.5	4	5	6
Passenger cars .....	0	0	0	0	0	0	0
1½-ton and smaller trucks .....	0	0	0	0	0	0.4	0.6
2- and 2½-ton trucks.....	0	0	0	0	1	1.9	2.4
3½-ton trucks .....	0	0.9	1.2	2.3	2.7	3.5	5.9”

It will be noticed that grade reduction below 6 per cent is of no advantage to passenger cars but of considerable benefit to trucks, particularly the larger trucks. The authors commented as follows:

“Thus the conclusion is reached that the operation of passenger cars justifies very little, if any, expenditure for reducing grades up to 6 per cent, unless dense traffic causes low speeds and stops. Grade reduction, however, may be necessary in order to secure greater safety of operation.

“That grade reductions of grades up to 6 per cent must be justified mainly by the medium—and heavy-truck traffic.”

Hence it appears that grade reduction below 6 per cent not only involves unnecessary construction cost for passenger car traffic but also reduces operating costs for trucks without effecting similar savings for the passenger cars. Since primary routes have commonly been built with 5 per cent maximum grades, the extra cost for this limitation over a higher maximum and the resulting savings in vehicle

<sup>3</sup> Proceedings Fourteenth Annual Meeting of Highway Research Board, “Motor Vehicle Requirements on Highway Grades.”

<sup>4</sup> Bulletin No. 7, North Carolina State College Experiment Station, January, 1935.

operating cost to trucks alone represent special benefits to motor trucks.

### STRUCTURES

Wider bridges are also required for the larger and heavier buses and trucks than for basic vehicles in order to secure the same clearance. For roads with a considerable traffic, the clear width on bridges would have to be at least 24 feet and the increased width would be 4 feet over the width required for the basic vehicle. Widening the bridges as indicated has increased their cost at least in proportion to width or from 10 to 15 per cent.

### ADDITIONAL COSTS OF "OTHER FACTORS"

For the purpose of determining the proportion of annual costs incurred to provide special facilities for wider and heavier buses and trucks as compared with similar facilities required for the basic vehicle, it is concluded that the heavier and wider vehicles are responsible for:

1. An increase in pavement width which on some roads may amount to 22 per cent of the cost of the traffic lane
2. Additional traffic lanes that would otherwise not be required
3. An indeterminate amount of widening on curves, both for earthwork and pavement
4. Wider cuts and fills necessary for wider pavements, which may increase the yardage from 15 to 100 per cent, depending upon the nature of the terrain
5. A lower gradient than would otherwise be required on many highways, which results in an increase in the cost of grading
6. An additional cost of wider structures.

Therefore, based principally on the factor of additional width, all buses and trucks of greater width and weight than the basic vehicle must assume the extra responsibility of not less than 12 per cent of the annual capital cost of improved rural roads. This will not apply, however, to roads which are unsurfaced.

*The amount will be allocated solely to those classes of vehicles requiring additional roadway width using the vehicle mile basis.*

## CHAPTER VII

### MAINTENANCE

Maintenance costs are affected by so many variables that the influence of various classes of traffic is difficult to determine separately. No investigations have as yet been made which isolate the effect of traffic on these costs. The few attempts which have been made to correlate traffic and surface maintenance costs show that in general these costs increase with traffic for a given pavement type, but that there is no definite relationship between them. Also, roads of heavy truck traffic in general have higher surface maintenance than similar roads with lighter traffic. But there is no obvious way of determining in dollars and cents just how much of this increase was caused by trucks and buses alone. Attempts to correlate traffic and surface maintenance costs often give inconsistent and freakish results. This is because there are other factors controlling these costs which often outbalance the effect of traffic.

#### FACTORS AFFECTING MAINTENANCE COSTS ON PAVED ROADS

One of the factors is age. As a pavement grows older, its maintenance may increase for a time regardless of volume of traffic. When classifying roads according to traffic, age should be taken into account for otherwise the same type of pavement will show widely varying costs for the same traffic.

Width of pavement influences maintenance costs. A 2-lane roadway 24 feet wide does not suffer from the same concentration of wheel loads as does an 18-foot road. In general, multiple lane roads offer greater freedom of movement and will show less maintenance per square yard than 2-lane roads of similar type.

Climatic and subsoil conditions affect maintenance requirements of some pavements throughout their entire life. These conditions doubtless affect others more seriously in the latter period of their life.

The policy and financial condition of the Highway Department will influence maintenance expenditures. During the depression many States diverted money from the highway budget and left their Highway Departments hard pressed for funds. This resulted in a temporary tightening down on maintenance expenditures. In Massachusetts surface maintenance costs on the principal types of pavements dropped about 50% during the years 1931-1933, but rose again to normal levels in 1935.

Economic conditions affecting the cost of materials and labor will influence maintenance costs. There is no uniformity of cost accounting among the States and it is often a question as to what



is included or what is excluded in the sum reported for general maintenance.

General maintenance, however, includes many items which do not pertain to the traveled way and which are not dependent upon traffic. These items are often called right-of-way maintenance. They include trimming of grass, brush and trees, cleaning out drainage structures, grading slopes, repairs to guard rails, etc. The cost of these items bears no particular relationship to the character or volume of traffic, except that on heavily traveled routes a higher standard of roadside maintenance is maintained and the costs are higher.

Furthermore, there are almost always included as maintenance important items which are strictly betterment; they obviously should have been treated as capital cost. These often include a seal coat placed on the bituminous pavement, which was omitted in the first construction and added at a later date. Widening of shoulders, building superior shoulders, and structures such as guard rails, signs, connecting roadways, extensions and replacement of culverts are frequently charged to maintenance cost. "Stage construction" of intermediate roads very readily lends itself to charging to maintenance items that are strictly capital costs.

These conflicting factors all tend to make the influence of traffic difficult to isolate, both as to magnitude of cost and distribution between sizes of vehicles.

Maintenance cost records disclose no obvious method of allocating these amounts between different classes of vehicles. The allocation chosen is developed from the discussion of each type of road.

#### EARTH ROAD MAINTENANCE

The problem of earth road maintenance is one of continuous reconstruction to repair the damages caused by traffic and the elements. When it is very dry the traffic rapidly pulverizes and displaces the earth particles which are insecurely held together and they are blown away by the winds. When it rains the finely divided soil particles are easily washed away or the earth becomes soaked with water and the supporting power of the road is greatly decreased, thus causing a condition in which the wheel loads penetrate into the roadway in some proportion to the load. According to the tests made by A. T. Goldbeck<sup>1</sup> such penetration is in proportion to the square root of the load when the surface areas are the same. Also, tests conducted by the Bureau of Public Roads<sup>2</sup> show that the penetration is in direct proportion to the square root of the area when the unit pressures are the same. If these tests be accepted as applying to wheel loads on earth roads, the penetration is in proportion to the square root of the tire contact areas with

<sup>1</sup> Proceedings, American Society for Testing Materials, 1917.

<sup>2</sup> Public Roads, January, 1925.

equal unit pressures and increases as the unit pressures increase.

The abrasive action of vehicles is probably proportional to the contact area of the tires but varies with the intensity of pressure. Since contact areas are roughly proportional to wheel load, the abrasive effect varies with wheel load, and is a function of ton-mile use.

No small part of the maintenance cost of earth roads consists of repairs and the maintenance of structures. Such structures on earth roads are of a less permanent nature than corresponding structures on improved roads. They are not designed for heavy loads and are frequently broken by the passage of heavy trucks.

*It is concluded that the cost of this maintenance and repair varies in no less proportion than according to vehicle weights and mileages, i. e., on the basis of gross ton miles.*

#### GRAVEL ROADS, MACADAM, SAND-CLAY, AND LIGHT BITUMINOUS WEARING COATS PLACED UPON SUCH PAVEMENTS

An examination of the reports of the Bureau of Public Roads shows that the treated and untreated pavements of this group greatly predominated among surfaced roads in the period under consideration. They constituted about 85% of the total rural mileage having artificial wearing courses, and even today they constitute about 82% of the total mileage. Untreated sand-clay and gravel pavements undoubtedly constitute a very large proportion of this general group.

There is an abundance of evidence which indicates very clearly that the maintenance cost for these untreated sand-clay and gravel pavements consists largely of the cost of replacing materials which the wheels of passing traffic grind to powder and throw into the air to be blown away. A second element of cost in maintaining pavements of this nature is in shaping the surface by dragging operations.

#### COMMENTS ON ABRASION AS A FACTOR IN MAINTENANCE OF UNTREATED ROADS

The abrading effect of traffic on earth and gravel roads depends upon several factors:

- (1) Character of the materials of surface layer, loose or compacted, weakly cemented or strongly bound, dry or damp.
- (2) Area of tire contact.
- (3) Tire pressure.
- (4) Speed of vehicle.
- (5) Tire-type, high pressure or balloon.
- (6) Type of spring suspension and use of shock absorbers.

Loose surfaces are more susceptible to abrasion than compacted surfaces, so that the total amount of damage done by vehicles will be influenced by (1) character of surface, but the relative damage

caused by different vehicle types will depend upon the other factors (2) to (6).

The vehicle which presents the smallest area and intensity of pressure to the road surface with the least amount of rebound and air disturbance will do the least damage. In this respect the passenger car is least damaging from all considerations except possibly speed. Its tires are small and carry low pressures; they present a small scuffing area to the road surface and a relatively light pressure on that area. The cushioning effect of balloon tires and shock absorbers tends to keep the tires continuously in contact with the surface and prevents the formation of corrugations which result from the bouncing of wheels from the surface and accompanying scuffing effect as the weight of the vehicle bears down again on the accelerated wheel.

The greater speed of passenger cars may cause a disturbance in the air at the road surface with corresponding displacement of road material in the form of dust, but the larger bulk of the truck and bus produces conditions which create considerable disturbance even though they operate at somewhat lower speeds. Both create dust and remove road material.

The larger vehicles will be more damaging on account of their larger tires, higher pressures, and more rigid spring suspension. They offer a large abrading tire area to the road surface and bear down with a greater intensity of pressure, thus tending to pulverize the top road surface material more than the basic vehicles do. When lightly loaded or empty, they tend to bounce around on the road surface aggravating the formation of corrugations in the top surface material.

Considering the period 1921-1932, the first half saw passenger cars with high pressure tires and without shock absorbers as standard equipment; the latter half saw passenger cars almost universally adopt balloon tires and shock absorbers. The trucks continued for the most part on high pressure tires and without spring damping devices throughout the period. In the first part of the period light passenger cars, particularly Model T Fords as well as trucks, were responsible for corrugations. During the latter part, passenger cars caused much less damage of this sort; but throughout that period the heavier vehicles were the worst offenders, so far as material displacement and abrasion are concerned.

It would seem to be self-evident that the pulverizing action of wheel loads must bear a close relation to the gross load imposed by the wheels and the miles of travel.

Furthermore, it is easily conceivable that a pavement consisting of rather soft stone might sustain, without substantial pulverization, loads of a given unit pressure, whereas they would crush and pulverize under unit pressures perhaps 50% greater, which are common in heavy trucks and buses.

While in so far as is known, no exact data exist on which to base the relative destructive effect upon untreated sand-clay and gravel pavements by vehicles of various weights, it seems certain that there is a direct relationship between wheel loads and maintenance costs. Inasmuch as the *ton-mile unit reflects both weight and use, we have allocated maintenance costs for untreated roads on this basis.*

#### PAVEMENTS CONSISTING OF BITUMINOUS WEARING COURSES LAID UPON GRAVEL AND MACADAM BASES

The mileage of this class of pavement is only a small percentage of the total "surfaced" mileage in the rural system. The construction of this class of pavement varies between extremely wide limits. Sometimes a 2 or 2½ inch asphalt-bound layer is placed upon a macadam base 12 inches or more in thickness; in other cases a mere "carpet" layer, no more than ¾ inch in thickness, is placed on top of a 4 inch gravel base. Because the wearing course of these pavements is relatively thin, the base course is obliged to take most of the punishment due to concentrated heavy wheel loads. This results in the stone of the base course becoming displaced or pulverized in a manner similar to the destruction that takes place in the stones of the untreated gravel or macadam pavement.

Another factor is also involved here which is of great importance; namely, that many miles of these pavements are under-designed for sustaining the heaviest loads that pass over them. It follows that all such roads in this group which are of inadequate design, not only have their service life shortened but the maintenance costs are increased enormously because of the excessive weights of the vehicles which use them. There is no exact measure of such increased maintenance costs but it appears certain that these excess maintenance costs increase in some proportion to wheel load.

One thing is certain that when maintenance of a major sort develops, it is incurred in repairing breaks and ruts caused by heavy wheel loads.

In the case of these pavements, *it is fair to allocate surface maintenance costs at least on the ton-mile basis.*

#### HIGH-TYPE RIGID PAVEMENTS

There are approximately 85,000 miles of high-type rigid pavements or approximately 12 per cent of the total "surfaced" mileage in the rural highway system. Assuming pavements of this class, when built, were so designed and constructed as to be capable of supporting the heaviest wheel loads which they have since been called upon to bear, then the cost of maintaining such pavements would have been no greater for one class of vehicles than for another.

A substantial portion, however, of the 85,000 miles of this type of pavement was neither designed nor built sufficiently strong to support

without damage the loads which they have been called upon to carry during the period under consideration (1921-1932). Consequently, on many miles of highways used by heavy vehicles damage from this source has been serious and costly. This damage is clearly apparent at the present time even to a casual observer on such highways as U. S. Route No. 66, from Joliet to St. Louis, a considerable portion of U. S. Route No. 40 in Missouri, U. S. Route No. 40 in Kansas, the route from Washington, D. C., to Richmond, Va., U. S. Route No. 25 in Kentucky and many others, built during the period under review.\*

It is not possible to assign accurately the damage to the various weight classes of vehicles or to determine definitely the responsibility of each weight class for maintenance cost involved in the damage that has appeared. There can be no question, however, that the damage and consequent pavement maintenance costs increase in some manner with wheel loads.

This may be illustrated in the following manner: Assume a six-inch concrete pavement. Such a pavement would be ample to sustain basic vehicles indefinitely without damage. The maintenance cost of the pavement would be nominal in this case. Then assume that vehicles having wheel loads slightly in excess of the supporting capacity of such a six-inch pavement are permitted to use the pavement. As road builders have not yet learned how to build a pavement without any weak link or links, moderately excessive wheel loads would not destroy the entire pavement but would first cause failure of the weakest portions. These would then have to be patched, thus distinctly increasing the maintenance cost. Assume now that the wheel loads are again increased a moderate amount. The breakage would obviously extend and the maintenance cost would be increased by another and larger increment because of the failure of the next stronger portions of the pavement. If this reasoning is carried forward only a few steps, a load magnitude is soon reached which would be sufficiently destructive to make economical maintenance impossible and the pavement would have to be replaced. This is true because fatigue breakage of concrete increases at a rapidly accelerating rate as overloading increases.

It is clear, therefore, that prior to destruction complete enough to terminate service life maintenance cost increases rapidly with increasing wheel loads. It is not possible to determine an exact relationship between wheel load and maintenance cost, but it is evident that it must be recognized in the allocation of such costs.

This leads to the conclusion that the *allocation of maintenance costs of high-type rigid pavements, during the period under review, based on ton-miles of travel is more than fair to the heavier vehicle.*

---

\*A nation-wide report, made by the American Association of State Highway Officials, to a Committee of Congress, January 25, 1938, on the Federal Aid Highway Act, H. R. 8838. Hearings, pp. 19-20, shows that 57,755 miles of the "Main or Principal Highways" should be rebuilt, at an estimated cost of more than \$1,600,000,000.

## CONCLUSION

The foregoing analysis refers to that portion of the total maintenance figure that relates to the traveled way, including the shoulders. It shows that those maintenance items which relate to the traveled way of all roads are influenced by the weight as well as by the vehicle miles and should, therefore, be allocated on the basis of ton-miles.

But, as indicated earlier in this discussion of maintenance costs, there are many right-of-way maintenance items included in the total figures which are not influenced by weight of vehicle. These costs may properly be chargeable equally to all vehicles using or enjoying them, which leads to allocating these on the vehicle mile basis.

In the case of the 2,300,000 miles of earth roads, almost all the maintenance is expended in labor on the traveled way. On gravel roads, involving 417,000 miles, the costs of replacing lost road metal and labor on the traveled way comprise practically all of the maintenance costs of these roads. Furthermore, since those costs per mile run high, a large part of the total maintenance costs lies in the traveled way portion of gravel roads. In the higher types of pavements the right-of-way maintenance costs begin to bear a higher relative value when compared with the maintenance cost of the traveled way. But in these higher types, retreads, seal coats, improvement of shoulders, etc., are often performed by the maintenance gang and hence very often get into the maintenance figures, although they are actually a capital charge and should therefore be allocated as recommended for capital expenditures. Further, in the gravel road and in the lower type of bituminous pavements stage construction is prevalent and here, again, capital expenditures readily get into the maintenance figure.

Considering all of these factors, *a fair and equitable method of allocating the total maintenance costs as recorded for rural roads is to assess three-fourths of the total maintenance costs on the ton-mile basis and one-fourth of the total maintenance costs on the vehicle-mile basis.*

## CITY STREETS

The maintenance cost of city streets includes the items of supervision, repairs, street cleaning, snow and ice removal and street lighting. A portion of these costs are chargeable to motor vehicles.

A fair method for allocating these costs would be by the use of the vehicle-mile basis for the items of street cleaning, snow and ice removal, and street lighting, together with a prorata proportion of the cost of supervision, as these costs are not influenced to any substantial degree by wheel loads, and therefore should be divided equally among all vehicles, taking into consideration mileage operated. The cost of repairs is caused primarily by the wheel loads, and therefore this item and its prorata part of supervision, which amounts to 50% of the total maintenance cost in the years 1931 and 1932 is allocated *on the ton-mile basis.* The other 50 per cent is allocated *on the vehicle-mile basis.*

**CHAPTER VIII**  
**ALLOCATION OF COSTS**

**BASES OF ALLOCATION**

The several bases of allocation discussed previously are here summarized:

<i>Capital Costs</i>	<i>Basis of Allocation</i>
1. Rigid pavements	Corner formula—vehicle miles
2. Flexible pavements	Square root of wheel load—vehicle miles
3. Grading (incl. earth roads)	Vehicle miles
4. Structures	Vehicle miles
5. Additional width (and other related factors)	Vehicle miles
 <i>Maintenance Costs</i>	
1. All highways	75% on ton-miles 25% on vehicle miles
2. City streets	50% on ton-miles 50% on vehicle miles

**CAPITAL AND MAINTENANCE COSTS**

Using these bases, the proportion of the total annual cost chargeable to motor vehicle operators for 1932, the last year of the period, will be allocated to the various types of vehicles. Before this can be done, however, it will be necessary to divide the total amount among the various highway elements. Tables 10, 12 and 18 give the annual costs for State highways, county and local roads, and city streets divided between capital costs and maintenance, as follows:

<i>State Highways</i>	<i>Total Annual Cost—1932 (000)</i>	<i>Proportion of Total Annual Cost Chargeable to Motor Vehicle Users (000)</i>
Capital cost .....	\$440,178	\$398,072
Maintenance .....	196,027	177,260
<b>Total .....</b>	<b>\$636,205</b>	<b>\$575,332</b>
 <i>County and Local Roads</i>		
Capital cost .....	\$407,601	\$368,581
Maintenance .....	275,000	248,705
<b>Total .....</b>	<b>\$682,601</b>	<b>\$617,286</b>
 <i>City Streets</i>		
Capital cost .....	\$379,079	\$179,462
Maintenance .....	260,104	123,138
<b>Total .....</b>	<b>\$639,183</b>	<b>\$302,600</b>
<b>Grand Total .....</b>	<b>\$1,957,989</b>	<b>\$1,495,218</b>

The capital cost of State highways is further broken down by the application of the percentage given on Page 31 after making an adjustment to transfer the bituminous macadam pavements to the intermediate type group.

<i>Highway Element</i>	<i>Per cent</i>	<i>Amount (000)</i>
High type pavements _____	41.9	\$166,792
Intermediate type pavements _____	15.6	62,099
Grading _____	26.0	103,499
Structures _____	16.5	65,682
<b>Total</b> _____	<b>100.0</b>	<b>\$398,072</b>

The capital cost of county and local roads is divided by the use of the percentages shown on Page 32.

<i>Highway Element</i>	<i>Per cent</i>	<i>Amount (000)</i>
High type pavements _____	9.1	\$33,541
Intermediate type pavements _____	23.1	85,142
Grading _____	47.0	173,233
Structures _____	20.8	76,665
<b>Total</b> _____	<b>100.0</b>	<b>\$368,581</b>

In the absence of data on the distribution of city street costs, the percentages applicable to State highways are used, producing the following division:

<i>Highway Element</i>	<i>Amount (000)</i>
High type pavements _____	\$75,195
Intermediate type pavements _____	27,996
Grading _____	46,660
Structures _____	29,611
<b>Total</b> _____	<b>\$179,462</b>

A recapitulation of the above calculations is given in the following tabulation:

<i>Item</i>	<i>State Highways (000)</i>	<i>County and Local Roads (000)</i>	<i>City Streets (000)</i>	<i>Total (000)</i>
<i>Capital Costs</i>				
High type pavements _____	\$166,792	\$33,541	\$75,195	\$275,528
Intermediate type pavements _____	62,099	85,142	27,996	175,237
Grading _____	103,499	173,233	46,660	323,392
Structures _____	65,682	76,665	29,611	171,958
<b>Total capital costs</b> _____	<b>\$398,072</b>	<b>\$368,581</b>	<b>\$179,462</b>	<b>\$946,115</b>
Maintenance _____	177,260	248,705	123,138	549,103
<b>Grand Total</b> _____	<b>\$575,332</b>	<b>\$617,286</b>	<b>\$302,600</b>	<b>\$1,495,218</b>

It has heretofore been concluded (Page 80) that 12% of the annual capital costs of both classes of rural highways is chargeable to the wider vehicles. This figure represents the average estimated



percentage of added costs incurred during the period to provide increased width of highway pavements, grading and structures and takes into consideration other related factors. The cost thus determined is allocated separately to the classes of vehicles incurring it. No portion of the cost of city streets will be considered as chargeable to increased width. The 12% is applied to the costs of all types of pavements of State highways and of county and local roads in the above tabulation. It is applied to 74% of the amounts for grading and structures for State highways and to 17% of the same items for county and local roads. 74% (for 1932) and 17% (for 1930, the last year for which mileage data for local roads are available) are the percentages surfaced road mileage bore to the total mileage in the two classes respectively. It is assumed that unsurfaced roads and the structures in such roads were not as a general rule given additional width to accommodate the wider vehicles.

The estimated amounts expended to provide additional width are:

<i>Item</i>	<i>State Highways (000)</i>	<i>County and Local Roads (000)</i>	<i>Total (000)</i>
High type pavements .....	\$20,015	\$4,025	\$24,040
Intermediate type pavements.....	7,452	10,217	17,669
Grading .....	9,191	3,534	12,725
Structures .....	5,833	1,564	7,397
<b>Total .....</b>	<b>\$42,491</b>	<b>\$19,340</b>	<b>\$61,831</b>

By subtracting these amounts from the totals in the tabulation immediately preceding, the following regrouped amounts to be allocated are obtained:

<i>Item</i>	<i>State Highways (000)</i>	<i>County and Local Roads (000)</i>	<i>City Streets (000)</i>	<i>Total (000)</i>
High type pavements .....	\$146,777	\$29,516	\$75,195	\$251,488
Intermediate type pavements.....	54,647	74,925	27,996	157,568
Grading .....	94,308	169,699	46,660	310,667
Structures .....	59,849	75,101	29,611	164,561
Additional width (and other related capital costs) .....	42,491	19,340	_____	61,831
<b>Total capital costs .....</b>	<b>\$398,072</b>	<b>\$368,581</b>	<b>\$179,462</b>	<b>\$946,115</b>
Maintenance .....	177,260	248,705	123,138	549,103
<b>Grand Total .....</b>	<b>\$575,332</b>	<b>\$617,286</b>	<b>\$302,600</b>	<b>\$1,495,218</b>

#### NATIONAL VERSUS STATE DATA

The data in these tables and the discussion throughout have been on a national basis. They have been used primarily for the purpose of establishing principles and defining methods to equitably allocate to various groups of motor vehicles the costs for which they should be responsible. The data are not applicable to any individual State. The method and principles are. It is not intended that the data or

the conclusions derived therefrom should be made the basis of taxation in any given State. One practical use that can be made of this study is to apply the principles to the more complete data available within a State and the particular conditions existing therein.

#### 1932 AS ILLUSTRATION

For the purpose of illustrating the method, the foregoing principles and procedure are applied to the motor vehicle users' proportion of total annual highway and city street cost for the year 1932, this being the last year for which complete information is available. In a later chapter, partial information as to highway and street expenditures together with complete data as to motor vehicle payments will be given for the period 1933-1937, although the information available is too incomplete to determine definitely annual costs during this later period, or their allocation to various types of motor vehicles.

Columns 1 to 7 inclusive, and columns 14 to 20 inclusive of Table 22 are based in part upon data contained in "Taxation of Motor Vehicles in 1932" by the Bureau of Public Roads, and in part on other studies.

Average annual mileage figures (Column 7) are necessary in any study dealing with all motor vehicles in the United States. Likewise, the final results from such a study will be averages. Before such averages can be treated in a practical way, further consideration must be given to those vehicles which are not in the average class. In other words, a study of motor vehicle subsidy from a national viewpoint does not reflect varying conditions. Obviously a bus operating in city service with an annual mileage of about 20,000 is below the average and a bus in long haul interstate service running 70,000 miles annually is above the average.

The same condition is more pronounced with the truck operating exclusively within municipal limits or within municipal suburban areas compared with the vehicles in long haul service. Various studies show that trucks within such limited areas constitute more than half of all trucks (excluding farm trucks). Trucks in city or short haul service average an annual mileage of about one-third of the average annual mileage made by trucks in over-the-road service. Such a wide range in the use made of highways and streets must have consideration when the conclusions of a nationwide study are applied locally.

The total payments shown in Columns 17 and 19 have been taken from Table 19.

Columns 8 to 12 inclusive, show the charges per vehicle as calculated on the various bases of allocation, the detail calculations being shown in the supporting Tables 22a to 22e, inclusive.

Table 22a shows the allocation of annual cost of high type rigid pavements to the various classes of motor vehicles. Columns 2 and 3 show the center thickness of concrete slabs for various wheel loads with 50% allowance for suddenly applied load, and the edge thickness with 50% allowance for suddenly applied load, respectively.

TABLE 22

(Part 1 of 2)

## ALLOCATION OF COSTS TO CLASSES OF MOTOR VEHICLES AND COMPARISON WITH PAYMENTS MADE—1932

Class of motor vehicle	Number	Average rated capacity	Average gross weight (pounds)	Gross weight including allowable overload (pounds)	Wheel load under allowable overload (lbs.)	Representative tire type	Annual mileage per vehicle	Charges per vehicle						
								Table 24a Column 8	Table 24b Column 9	Table 24c Column 5	Table 24d Column 5	Table 24e Column 10	Total	
								(1)	(2)	(3)	(4)	(5)	(6)	(7)
Passenger cars*	20,848,387		2,865	3,400	900	Balloon single.....	7,000	\$3.75	\$2.89	\$18.80		\$17.46	\$42.40	
Taxis	77,222		5,000	5,500	1,680	Balloon single.....	20,000	26.80	16.78	53.48		72.55	169.61	
School buses	9,818		9,000	10,000	2,970	Balloon single.....	10,000	24.92	15.56	26.64		57.57	124.69	
Contract carrier buses:														
7 passengers and less.....	2,181	6 pass.	5,200	6,000	1,780	Balloon single.....	10,000	14.81	9.81	26.15			37.20	87.47
8 to 20 passengers.....	559	18 pass.	11,000	12,500	3,710	Balloon dual.....	10,000	37.41	23.42	25.50	\$107.29	70.37	263.99	
Over 20 passengers.....	574	35 pass.	16,250	18,650	5,640	Balloon dual.....	10,000	90.23	55.87	24.84	107.72	95.08	373.74	
Common carrier buses:														
7 passengers and less.....	3,696	6 pass.	5,200	6,000	1,780	Balloon single.....	25,000	37.08	28.23	66.86		93.75	220.92	
8 to 20 passengers.....	7,306	18 pass.	11,000	12,500	3,710	Balloon dual.....	30,000	112.23	70.26	80.01	\$21.60	205.09	789.19	
Over 20 passengers.....	25,323	35 pass.	16,250	18,650	5,640	Balloon dual.....	35,000	315.81	195.55	93.65	\$75.19	338.28	1,318.43	
Farm trucks.....	833,163	3,000 lbs.	7,597	9,700	3,580	Balloon single.....	2,500	8.49	5.23	6.68		12.55	33.00	
Private trucks:														
1½ tons and less.....	1,659,790	2,500 lbs.	6,608	8,437	3,070	Balloon single.....	8,505	21.84	13.63	22.74		38.19	96.40	
Over 1½ tons and less than 3 tons.....	281,584	4,000 lbs.	9,467	12,087	4,400	High pressure dual.....	11,017	56.46	35.25	29.45		66.37	187.53	
Combinations.....	37,702	6,000 lbs.	12,310	15,484	5,070	Balloon single.....	17,019	43.70	27.25	45.48		133.95	250.40	
3 tons and less than 5 tons.....	100,458	7,000 lbs.	14,526	18,546	7,010	High pressure dual.....	17,841	256.07	159.02	47.63	\$91.25	155.88	309.90	
Combinations.....	15,711	8,000 lbs.	16,088	20,541	4,400	High pressure dual.....	18,586	95.25	59.48	49.61	199.22	177.85	581.41	
5 tons.....	20,447	10,000 lbs.	19,083	24,365	9,000	High pressure dual.....	19,898	582.71	360.61	53.22	213.81	222.51	1,432.86	
Combinations.....	3,903	10,000 lbs.	19,083	24,365	9,000	High pressure dual.....	19,898	582.71	360.61	53.57	213.23	222.99	1,433.11	
Over 5 tons.....	39,507	15,000 lbs.	26,022	33,224	9,000	High pressure dual.....	22,527	659.70	408.26	60.27	241.47	335.83	1,705.53	
Combinations.....	5,218	20,000 lbs.	32,427	41,402	9,000	High pressure dual.....	24,600	720.41	445.83	65.57	263.65	451.11	1,946.57	
For hire trucks:														
1½ tons and less.....	117,566	2,500 lbs.	6,608	8,437	3,070	Balloon single.....	18,417	47.29	29.50	49.23		82.69	208.71	
Over 1½ tons and less than 3 tons.....	37,971	4,000 lbs.	9,467	12,087	4,400	High pressure dual.....	21,267	108.99	68.05	56.82		128.07	361.93	
Combinations.....	6,800	6,000 lbs.	12,310	15,484	5,070	Balloon single.....	24,073	61.82	38.56	64.30		139.73	354.41	
3 tons and less than 5 tons.....	22,893	7,000 lbs.	14,526	18,546	7,010	High pressure dual.....	25,236	362.21	224.93	67.47	270.52	220.60	1,145.73	
Combinations.....	6,830	8,000 lbs.	16,088	20,541	4,400	High pressure dual.....	26,230	134.74	84.13	70.45	231.33	252.00	523.16	
5 tons.....	1,415	10,000 lbs.	19,083	24,365	9,000	High pressure dual.....	23,146	824.26	510.09	73.89	301.94	314.27	2,024.45	
Combinations.....	2,142	10,000 lbs.	19,083	24,365	9,000	High pressure dual.....	23,146	824.26	510.09	75.43	301.65	314.86	2,026.29	
Over 5 tons.....	3,119	15,000 lbs.	26,022	33,224	9,000	High pressure dual.....	31,865	933.17	577.49	85.32	341.57	474.86	2,412.41	
Combinations.....	3,046	20,000 lbs.	32,427	41,402	9,000	High pressure dual.....	34,797	1,019.08	630.63	98.61	373.10	638.57	2,754.94	
Total—All vehicles.....	24,204,326													

\* Includes motorcycles.

TABLE 22

(Part 2 of 2)

## ALLOCATION OF COSTS TO CLASSES OF MOTOR VEHICLES AND COMPARISON WITH PAYMENTS MADE—1932

Class of motor vehicle	Gasoline consumption per vehicle (gallons per mile)	Gasoline consumed per class (gallons)	Gasoline: Per cent of total gallons consumed	Net receipts State gasoline taxes consumed	State gasoline taxes per vehicle	State registration and license fees	State fees per vehicle	Summary of per vehicle payments by motor vehicles	Amounts by which payments failed to meet charges	
									Average per vehicle by class	Aggregate amount by class
									(14)	(15)
Passenger cars*	.066819	9,745,920.683	68.891	\$348,572,848	\$16.72	\$217,118,045	\$10.41	\$27.18	\$15.27	\$318,854,106
Taxicabs	.097809	150,287.912	1.054	5,371,982	69.57	1,508,985	19.54	89.11	80.50	6,216,871
School buses	.144708	14,200,196	.099	504,579	51.42	215,186	21.92	78.34	51.35	503,898
Contract carrier buses:										
7 passengers and less	.099913	2,179,103	.015	76,451	35.05	45,451	20.84	55.89	31.58	68,276
8 to 20 passengers	.165695	926,235	.006	30,581	54.71	39,391	70.47	125.18	138.81	77,595
Over 20 passengers	.215605	1,237,673	.009	46,871	79.91	93,938	163.65	243.56	130.18	74,723
Common carrier buses:										
7 passengers and less	.099913	9,231,961	.065	331,289	89.63	209,076	56.57	146.20	74.72	276,165
8 to 20 passengers	.165695	36,317,030	.255	1,299,673	177.89	875,696	119.86	297.75	491.44	3,590,461
Over 20 passengers	.215605	191,091,790	1.341	6,834,752	269.90	4,348,179	171.71	441.61	876.87	22,204,979
Farm trucks	.129053	268,805,878	1.886	9,612,485	11.54	13,232,402	15.88	27.42	5.58	4,649,060
Private trucks:										
1½ tons and less	.117459	1,658,111,952	11.636	59,305,871	35.73	26,064,831	15.70	51.43	44.97	74,640,756
Over 1½ tons and less than 5 tons	.149730	464,493,927	3.260	16,615,430	59.01	10,902,263	38.72	97.73	89.80	25,286,243
Combinations	.184605	212,705,602	1.493	7,609,459	112.40	2,199,845	32.49	144.89	105.51	7,143,238
5 tons and less than 5 tons	.199888	358,258,521	2.514	12,813,249	127.55	6,878,304	68.47	196.02	618.88	61,669,157
Combinations	.214179	62,541,265	.439	2,237,477	142.41	1,215,066	77.84	219.75	361.66	5,682,040
5 tons	.240312	97,771,992	.686	3,496,376	171.00	2,042,280	99.88	270.88	1,161.48	23,748,782
Combinations	.240312	18,663,084	.131	667,675	171.07	624,206	134.81	306.38	1,127.73	4,401,530
Over 5 tons	.296298	263,697,570	1.850	9,429,001	238.67	4,651,188	117.73	856.40	1,340.13	53,300,079
Combinations	.343728	44,121,890	.310	1,579,995	302.80	957,508	188.50	486.30	1,460.27	7,619,889
For hire trucks:										
1½ tons and less	.117459	254,323,709	1.785	9,097,712	77.88	2,742,231	23.33	100.71	108.00	12,697,123
Over 1½ tons and less than 5 tons	.149730	120,911,359	.849	4,327,147	113.96	2,008,950	52.91	166.87	195.06	7,406,623
Combinations	.184605	30,219,173	.212	1,080,513	158.90	369,671	54.36	213.26	141.15	959,820
5 tons and less than 5 tons	.199888	115,480,854	.810	4,128,374	180.33	2,030,160	88.68	269.01	876.72	20,070,751
Combinations	.214179	38,739,870	.272	1,366,313	201.50	818,124	118.91	320.41	502.75	3,458,290
5 tons	.240312	9,570,808	.067	341,483	241.33	181,805	128.48	369.81	1,654.64	2,341,312
Combinations	.240312	14,488,107	.102	519,869	242.70	406,032	189.56	432.26	1,594.03	3,414,412
Over 5 tons	.296298	29,448,151	.207	1,055,029	338.26	478,764	153.50	491.76	1,920.65	5,990,507
Combinations	.343728	36,432,301	.256	1,304,770	428.36	851,455	279.58	707.89	2,047.05	6,236,314
Total—All vehicles		14,250,173,296		\$509,675,759		\$303,008,967				\$682,082,529

\* Includes motorcycles.

**TABLE 22a**  
**ALLOCATION OF \$251,488,000 ANNUAL CAPITAL COST OF HIGH TYPE RIGID PAVEMENTS, USING "CORNER**  
**FORMULA—VEHICLE-MILE" BASIS**

Class of motor vehicles	Number of vehicles	Required concrete slab interior thickness (inches) a	Required concrete slab edge thickness (inches) b	Ratio of concrete slab thickness	Index of cost of required thickness (maximum = 100) c	Increments in index	\$251,488,000 times increments (Col. 6)	Total mileage per class of vehicle (000 omitted)		Cost per vehicle mile (cents)	Unit cost (cents)	Annual mileage per vehicle	Cost per vehicle
								Individually	Cumulative				
								(8)	(9)				
(1)	(2)	(3)	(4)	(5)	(6)	(7)	(8)	(9)	(10 = 7+9)	(11)	(12)	(13 = 11 x 12)	
Passenger cars	20,848,337	2.80	3.87	31.63	37.794	37.794	\$95,047,375	146,851,935	177,767,048	0.0535	0.0535	7,000	\$3.75
Taxicabs	77,222	3.50	4.04	42.58	47.756	9.982	25,053,234	1,844,440	31,115,113	0.0905	0.1340	20,000	26.80
Contract buses—7 passengers & less	2,181	3.65	5.17	44.40	49.418	1.680	4,174,701	21,810	29,570,673	0.0141	0.1481	19,000	14.81
Common carrier buses—7 pass. & less	3,696	3.65	5.17	44.40	49.418	1.680	4,174,701	92,400	92,400	0.0141	0.1481	25,000	37.03
School buses	9,813	4.72	6.67	57.42	61.280	11.844	29,786,239	98,130	29,456,463	0.1011	0.2492	10,000	24.92
Private trucks—1½ tons & less	1,659,790	4.80	6.79	58.39	62.146	0.885	2,225,669	14,116,514	29,358,333	0.0076	0.2568	8,505	21.84
Private trucks—combinations	67,702	4.80	6.79	58.39	62.146	0.885	2,225,669	1,152,220	1,152,220	0.0076	0.2568	17,019	43.70
For hire trucks—1½ tons and less	117,566	4.80	6.79	58.39	62.146	0.885	2,225,669	2,165,213	2,165,213	0.0076	0.2568	18,417	47.29
For hire trucks—combinations	6,800	4.80	6.79	58.39	62.146	0.885	2,225,669	163,696	163,696	0.0076	0.2568	24,073	61.82
Farm trucks	833,163	5.15	7.28	62.65	66.019	3.874	9,742,645	2,082,908	11,760,690	0.0828	0.3396	2,500	8.49
Contract buses—8 to 20 passengers	559	5.27	7.46	64.11	67.347	1.328	3,339,761	5,590	9,677,782	0.0345	0.3741	10,000	37.41
Common carrier buses—8 to 20 pass.	7,308	5.27	7.46	64.11	67.347	1.328	3,339,761	5,590	9,677,782	0.0345	0.3741	30,000	112.23
Private trucks—1½ to 3 tons	281,684	5.74	8.12	69.83	72.550	5.208	13,084,921	219,180	3,102,211	0.1384	0.5125	11,017	56.46
Private trucks—combinations	15,711	5.74	8.12	69.83	72.550	5.208	13,084,921	292,008	292,008	0.1384	0.5125	18,588	95.25
For hire trucks—1½ to 3 tons	37,971	5.74	8.12	69.83	72.550	5.208	13,084,921	807,529	807,529	0.1384	0.5125	21,267	108.99
For hire trucks—combinations	6,890	5.74	8.12	69.83	72.550	5.208	13,084,921	180,976	180,976	0.1384	0.5125	26,280	134.74
Contract buses—over 20 passengers	574	6.45	9.11	78.47	80.408	7.858	19,761,927	8,740	8,070,892	0.3898	0.9023	10,000	90.23
Common carrier buses—over 20 pass.	25,323	6.45	9.11	78.47	80.408	7.858	19,761,927	866,305	866,305	0.3898	0.9023	35,000	315.81
Private trucks—3 to 5 tons	100,458	7.25	10.25	88.20	89.263	8.855	22,289,282	1,792,271	4,178,347	0.6330	1.4353	17,941	256.07
For hire trucks—3 to 5 tons	22,893	7.25	10.25	88.20	89.263	8.855	22,289,282	577,728	577,728	0.6330	1.4353	25,236	362.21
Private trucks—5 tons	20,447	8.22	11.62	100.00	100.000	10.737	27,002,266	406,854	1,808,348	1.4932	2.9285	19,898	582.71
Private trucks—combinations	3,903	8.22	11.62	100.00	100.000	10.737	27,002,266	77,662	77,662	1.4932	2.9285	19,898	582.71
Private trucks—over 5 tons	39,507	8.22	11.62	100.00	100.000	10.737	27,002,266	889,974	889,974	1.4932	2.9285	22,527	659.70
Private trucks—combinations	5,218	8.22	11.62	100.00	100.000	10.737	27,002,266	128,393	128,393	1.4932	2.9285	24,600	720.41
For hire trucks—5 tons	1,416	8.22	11.62	100.00	100.000	10.737	27,002,266	39,827	39,827	1.4932	2.9285	28,146	824.26
For hire trucks—combinations	2,142	8.22	11.62	100.00	100.000	10.737	27,002,266	60,289	60,289	1.4932	2.9285	28,146	824.26
For hire trucks—over 5 tons	3,119	8.22	11.62	100.00	100.000	10.737	27,002,266	89,387	89,387	1.4932	2.9285	31,865	933.17
For hire trucks—combinations	3,046	8.22	11.62	100.00	100.000	10.737	27,002,266	108,992	108,992	1.4932	2.9285	84,797	1,019.03
Total	24,204,326												

Note a: Interior thickness calculated with 50% allowance for suddenly applied load. . . . .  $T = \sqrt{\frac{2.25 W}{300}}$

Note b: Edge thickness calculated with 50% allowance for suddenly applied load. . . . .  $T = \sqrt{\frac{4.5 W}{300}}$

Note c: Column 4 adjusted to take into consideration concrete pavement costs which do not vary with thickness—see text pages 62-68.

Column 4 shows the ratios of various slab thicknesses related to the thickness required by the heaviest wheel load as 100. It will be observed that the ratios are the same regardless of which schedule of thickness is used. As heretofore discussed (page 62), the cost of concrete pavements does not vary directly with thickness. The adjustment for this difference in relationship is made in Columns 5 and 6. By means of the increments in the index shown in Column 6, the total annual cost of high type rigid pavements is allocated to the various classes of vehicles in Column 7.

Column 8 shows the aggregate mileage for each class of vehicle and Column 9 the cumulative vehicle mileage by groups, and Column 6 shows the corresponding increment index. Dividing the amounts in Column 7 by the cumulative mileage in Column 9 produces the unit cost per vehicle mile for each class as shown in Column 10, and the unit total cost per vehicle mile is shown in Column 11. Multiplying these unit costs by the annual mileages shown in Column 12 produces the charge per vehicle shown in Column 13. These amounts are transferred into Column 8 on summary Table 22.

Table 22b shows, in a similar manner, the allocation of the annual capital cost of flexible pavements, except that in this calculation the ratio of the square roots of wheel loads as shown in Column 3 produces an index of relative thicknesses. It is not necessary to compute the actual thicknesses as only the relation between thicknesses is required for purposes of allocation. An adjustment in this index is made to allow for the fact that 90 per cent of the cost of flexible pavements vary directly with thickness ratio while the remaining 10 per cent is constant, regardless of thickness. The cost index is given in Column 5 and increments in the index in Column 6. By means of this index, the annual cost of flexible pavements is allocated to the various classes of vehicles in Column 7. By using the same procedure as above described for rigid pavements, the amount chargeable to each class was further allocated to the individual vehicle, on the vehicle mile basis, resulting in the unit charges shown in Column 13. These unit charges are transferred into Column 9 of summary Table 22.

It will be observed that this is, for all practical purposes, the same method throughout as was used in the allocation of the cost of rigid pavements.

Table 22c shows the allocation of the annual capital cost of earth roads, grading and structures for all highways and streets. The basis of allocation is vehicle miles operated by each class of vehicle. This produces the percentages shown in Column 3. These percentages applied to the total amount involved, and divided by the number of vehicles in each class, produce the charge per vehicle given in Column 5.

TABLE 22b

ALLOCATION OF \$157,568,000 ANNUAL CAPITAL COST OF FLEXIBLE PAVEMENTS, USING "SQUARE ROOT OF WHEEL LOAD—VEHICLE-MILE" BASIS

Class of motor vehicle	Number	Number requiring specified thickness	Ratio of square roots of wheel load	Index of 90% variable cost	Index of cost adjusted to 10% fixed cost (maximum = 100)	Increments in index	\$157,568,000 times increments	Total mileage per class of vehicle (000 omitted)		Cost per vehicle mile (cents)	Unit cost (cents)	Annual mileage per vehicle	Cost per vehicle
								Individually	Cumulative				
								(8)	(9)				
(1)	(2)	(3)	(4)	(5)	(6)	(7)	(8)	(9)	(10 = 7+9)	(11)	(12)	(13 = 12 × 11)	
Passenger cars	20,848,337	24,204,326	31.693	28.461	38.461	38.461	\$60,609,228	146,651,935	177,767,048	0.0341	0.0341	7,000	\$2.39
Taxis	77,222	3,355,989	42.557	38.301	48.301	9.840	15,504,691	1,644,440	31,115,113	0.0498	0.0399	20,000	16.78
Contract buses—7 passengers & less	2,181	3,278,767	44.472	40.025	50.025	1.724	2,716,473	21,810	29,670,673	0.0092	0.0091	10,000	9.31
Common carrier buses—7 pass. & less	3,696							92,400				25,000	23.28
School buses	9,813	3,272,890	57.446	51.701	61.701	11.676	18,397,640	98,130	29,456,463	0.0825	0.1556	10,000	15.56
Private trucks—1½ tons and less	1,659,790	3,263,077	58.405	52.565	62.565	0.864	1,361,387	14,116,514	29,358,393	0.0046	0.1602	8,505	13.63
Private trucks—combinations	67,702							1,152,220				17,019	27.26
For hire trucks—1½ tons and less	117,566							2,165,213				18,417	29.50
For hire trucks—combinations	6,800							163,696				24,073	38.56
Farm trucks	833,163	1,411,219	62.628	56.365	66.365	3.800	5,987,584	2,082,908	11,760,690	0.0509	0.2111	2,500	5.28
Contract buses—8 to 20 passengers	7,306	578,056	64.204	57.784	67.784	1.419	2,235,890	5,890	9,677,782	0.0231	0.2342	10,000	23.42
Common carrier buses—8 to 20 pass.	7,306							219,180				50,000	70.26
Private trucks—1½ to 3 tons	281,584	570,191	69.921	62.929	72.929	5.145	3,106,874	3,102,211	9,453,012	0.0859	0.3200	11,017	35.26
Private trucks—combinations	15,711							292,005				18,566	59.48
For hire trucks—combinations	37,971							807,539				21,267	68.05
For hire trucks—1½ tons	6,890							189,575				26,290	84.13
Contract buses—over 20 passengers	574	228,045	78.457	70.611	80.611	7.682	12,104,374	5,740	5,070,392	0.2387	0.5587	10,000	55.87
Common carrier buses—over 20 pass.	25,323							886,305				35,000	195.55
Private trucks—3 to 5 tons	100,458	202,148	88.255	79.430	89.430	8.819	13,595,922	1,792,271	4,178,347	0.3326	0.6913	17,841	159.02
For hire trucks—3 to 5 tons	22,893							677,728				25,336	224.93
Private trucks—5 tons	20,447	78,797	100.000	90.000	100.000	10.570	16,654,938	406,854	1,808,348	0.9210	1.8123	19,898	360.61
Private trucks—combinations	3,903							77,622				19,898	360.61
Private trucks—over 5 tons	39,507							889,974				22,527	408.26
Private trucks—combinations	5,218							128,363				24,600	445.83
For hire trucks—5 tons	1,415							39,827				28,146	510.09
For hire trucks—combinations	2,142							60,289				28,146	510.09
For hire trucks—over 5 tons	3,119							99,337				31,865	577.49
For hire trucks—combinations	3,046							105,992				34,797	630.63
Total	24,204,326												

96

**TABLE 22c**  
**ALLOCATION OF \$475,228,000 ANNUAL CAPITAL COST OF EARTH ROADS, GRADING AND STRUCTURES OF ALL HIGHWAYS AND STREETS ON VEHICLE-MILE BASIS**

Class of motor vehicle	Number	Total mileage per class of vehicle (000 omitted)	Per cent of total mileage	Allocation of \$475,228,000 on vehicle-mile basis	Charge per vehicle
	(1)	(2)	(3)	(4)	(5=4+1)
Passenger cars.....	20,848,837	146,651,935	82.497	\$392,048,843	\$18.80
Taxicabs.....	77,222	1,544,440	.869	4,129,731	53.48
Contract buses—7 passengers and less.....	2,181	21,810	.012	57,027	26.15
Common carrier buses—7 passengers and less.....	8,696	92,400	.052	247,119	66.86
School buses.....	9,813	98,130	.055	261,375	26.64
Private trucks—1½ tons and less.....	1,659,790	14,116,514	7.941	37,737,855	22.74
Private trucks—combinations.....	67,702	1,152,220	.648	8,079,477	45.49
For hire trucks—1½ tons and less.....	117,566	2,165,213	1.218	5,788,277	49.23
For hire trucks—combinations.....	6,800	163,696	.092	437,210	64.30
Farm trucks.....	833,163	2,082,903	1.172	5,569,672	6.68
Contract buses—8 to 20 passengers.....	559	5,590	.003	14,257	25.50
Common carrier buses—8 to 20 passengers.....	7,306	219,180	.123	584,531	80.01
Private trucks—1½ to 3 tons.....	281,584	8,102,211	1.745	8,292,729	29.45
Private trucks—combinations.....	15,711	292,005	.164	779,374	49.61
For hire trucks—1½ to 3 tons.....	37,971	807,529	.454	2,157,535	56.82
For hire trucks—combinations.....	6,880	180,875	.102	484,733	70.46
Contract buses—over 20 passengers.....	574	5,740	.003	14,257	24.84
Common carrier buses—over 20 passengers.....	25,323	886,305	.499	2,371,388	93.65
Private trucks—3 to 5 tons.....	100,458	1,792,271	1.008	4,790,298	47.68
For hire trucks—3 to 5 tons.....	22,893	577,723	.325	1,544,491	67.47
Private trucks—5 tons.....	20,447	406,854	.229	1,088,272	53.22
Private trucks—combinations.....	8,903	77,662	.044	209,100	53.57
Private trucks—over 5 tons.....	39,507	889,974	.501	2,380,892	60.27
Private trucks—combinations.....	5,218	128,363	.072	342,164	65.57
For hire trucks—5 tons.....	1,415	89,827	.022	104,550	73.89
For hire trucks—combinations.....	2,142	60,289	.034	161,578	75.43
For hire trucks—over 5 tons.....	8,119	99,387	.056	266,128	85.82
For hire trucks—combinations.....	3,046	105,992	.060	285,137	93.61
<b>Total.....</b>	<b>24,204,826</b>	<b>177,767,048</b>	<b>100.000</b>	<b>\$475,228,000</b>	<b>.....</b>



Table 22d shows the allocation of the additional annual capital cost incurred for increased width of highways and other factors. This allocation is also made on the vehicle mile basis, but only to those vehicles which require the additional width. In this group are included buses for hire with a capacity of 8 persons or more and trucks and combinations with a capacity of 3 tons or more.

Table 22e shows the allocation of the annual maintenance cost of all highways and city streets. Twenty-five per cent of the maintenance cost of all highways and 50 per cent of the maintenance cost of city streets are allocated on the vehicle mile basis and the remaining 75 per cent of highway cost and 50% of city street cost are allocated on the gross-ton mile basis. The total charges per vehicle are shown in Column 10.

The aggregate charges per vehicle are shown in Column 13 of Summary Table 22.

Columns 14 to 20, inclusive, show the methods used in arriving at the State gasoline taxes per vehicle, and the State registration and license fees per vehicle. The total of these payments is shown in Column 21.

Column 22 shows the difference between charges per motor vehicle (Column 13) and payments per motor vehicle (Column 21).

Column 23 shows the difference between charges and payments by classes of vehicles and the total amount by which payments failed to meet charges, for the year 1932.

#### SUMMARY

The significant information for the year 1932 to be drawn from these tables may be summarized as follows:

1. That each type of vehicle failed to meet the charges for which it was properly responsible;
2. That the deficit ranged from about \$15.00 for the passenger automobile up to about \$2,000 for the largest class of "for-hire" trucks;
3. That the total subsidy to motor vehicles for the year amounted to not less than \$682,000,000;
4. That the passenger automobile for this year paid 64 per cent of the amount properly chargeable to it, while the largest class of "for-hire" vehicle paid only 25 per cent of the amount properly chargeable to it.

**TABLE 22d**  
**ALLOCATION OF \$61,831,000 ADDITIONAL ANNUAL CAPITAL COST INCURRED FOR INCREASED WIDTH OF HIGHWAYS, ON VEHICLE-MILE BASIS**

Class of motor vehicle	Number of vehicles	Total mileage per class of vehicle (000 omitted)	Mileage per cent of total	Allocation of \$61,831,000 on vehicle-mile basis	Charge per vehicle
	(1)	(2)	(3)	(4)	(5=4÷1)
Contract buses—8 to 20 passengers.....	559	5,590	.097	\$59,976	\$107.29
Common carrier buses—8 to 20 passengers.....	7,306	219,180	3.800	2,349,578	321.60
Private trucks—combinations.....	15,711	292,005	5.062	3,129,885	199.22
For hire trucks—combinations.....	6,880	180,875	3.136	1,939,020	281.83
Contract buses—over 20 passengers.....	574	5,740	.100	61,831	107.72
Common carrier buses—over 20 passengers.....	25,323	886,305	15.366	9,500,952	375.19
Private trucks—3 to 5 tons.....	100,458	1,792,271	31.072	19,212,128	191.25
For hire trucks—3 to 5 tons.....	22,893	577,728	10.016	6,192,993	270.52
Private trucks—5 tons.....	20,447	406,854	7.054	4,361,559	213.31
Private trucks—combinations.....	3,903	77,662	1.346	832,245	213.23
Private trucks—over 5 tons.....	39,507	839,974	15.429	9,539,905	241.47
Private trucks—combinations.....	5,218	128,363	2.225	1,375,740	263.65
For hire trucks—5 tons.....	1,415	39,827	.691	427,252	301.94
For hire trucks—combinations.....	2,142	60,289	1.045	646,134	301.65
For hire trucks—over 5 tons.....	3,119	99,387	1.723	1,065,348	341.57
For hire trucks—combinations.....	3,046	105,992	1.838	1,136,454	373.10
<b>Total.....</b>	<b>258,501</b>	<b>5,768,042</b>	<b>100.000</b>	<b>61,831,000</b>	.....

**TABLE 22e**  
**ALLOCATION OF \$549,103,000 ANNUAL MAINTENANCE COST OF RURAL HIGHWAYS AND CITY STREETS,**  
**ON VARIOUS BASES AS INDICATED**

Class of motor vehicle	Number	Total mileage per class of vehicle (000 omitted)	Mileage in per cent of total	Allocation of \$168,060,000 maintenance cost on vehicle-mile basis	Charge per vehicle	Total gross ton-miles per class of vehicle (000 omitted)	Gross ton-mileage in per cent of total	Allocation of \$381,043,000 maintenance cost on gross ton-mile basis	Charge per vehicle	Total charge per vehicle
	(1)	(2)	(3)	(4 = Allocation x Col. 3)	(5 = 4 + 1)	(6)	(7)	(8 = Allocation x Col. 7)	(9 = 8 + 1)	(10 = 5 + 9)
Passenger cars	20,848,337	146,651,935	82.497	\$138,644,458	\$6.65	210,078,897	59.154	\$225,402,176	\$10.81	\$17.46
Taxicabs	77,222	1,544,440	.869	1,460,441	18.91	3,861,100	1.087	4,141,937	53.64	72.55
Contract buses—7 passengers and less	2,181	21,810	.012	20,167	9.25	56,706	.016	60,967	27.95	37.20
Common carrier buses—7 passengers & less	3,698	92,400	.052	87,391	23.64	240,240	.068	259,109	70.11	93.75
School buses	9,813	98,130	.055	92,433	9.42	441,585	.124	472,493	48.15	57.57
Private trucks—1½ tons and less	1,659,790	14,116,514	7.941	13,345,645	8.04	46,640,982	13.133	50,042,377	30.15	38.19
Private trucks—combinations	67,702	1,152,220	.648	1,089,029	16.09	7,497,532	2.094	7,979,041	117.86	133.95
For hire trucks—1½ tons and less	117,566	2,165,213	1.218	2,046,971	17.41	7,153,864	2.014	7,074,206	65.28	82.69
For hire trucks—combinations	6,800	163,696	.092	154,615	22.74	1,058,660	.299	1,135,508	186.99	193.73
Farm trucks	833,163	2,082,908	1.172	1,980,863	2.36	7,911,924	2.228	8,439,638	10.19	12.55
Contract buses—8 to 20 passengers	559	5,590	.003	5,042	9.02	30,745	.009	34,294	61.35	70.37
Common carrier buses—8 to 20 passengers	7,306	219,180	.123	206,714	28.29	1,205,490	.339	1,291,736	176.80	205.09
Private trucks—1½ to 3 tons	281,584	3,102,211	1.745	2,932,647	10.41	14,084,315	4.135	15,758,128	55.96	66.37
Private trucks—combinations	15,711	292,005	.164	275,618	17.64	2,348,885	.661	2,518,694	160.31	177.95
For hire trucks—1½ to 3 tons	37,971	807,629	.454	762,993	20.09	3,822,440	1.076	4,100,023	107.98	128.07
For hire trucks—combinations	6,880	180,875	.102	171,421	24.92	1,454,960	.410	1,562,276	227.08	252.00
Contract buses—over 20 passengers	574	5,740	.003	5,042	8.78	46,638	.013	49,536	86.30	95.08
Common carrier buses—over 20 passengers	25,323	886,305	.499	838,619	33.12	7,201,228	2.028	7,727,552	305.16	338.28
Private trucks—3 to 5 tons	100,453	1,792,271	1.008	1,694,045	16.86	13,017,266	3.665	13,965,226	139.02	155.88
For hire trucks—3 to 5 tons	22,893	577,728	.325	546,195	23.86	4,196,037	1.182	4,503,928	196.74	220.60
Private trucks—5 tons	20,447	409,654	.229	384,857	18.52	3,682,001	1.063	4,164,800	203.69	222.51
Private trucks—combinations	3,903	77,669	.044	73,946	19.95	741,011	.209	798,390	204.04	222.99
Private trucks—over 5 tons	39,507	889,974	.501	841,951	21.81	11,576,454	3.261	12,426,812	314.52	335.83
Private trucks—combinations	5,218	128,363	.072	121,003	23.19	2,081,210	.586	2,232,012	427.92	451.11
For hire trucks—5 tons	1,415	39,627	.022	36,973	26.13	380,005	.107	407,716	288.14	314.27
For hire trucks—combinations	2,142	60,289	.034	57,140	26.68	575,245	.162	617,290	288.18	314.86
For hire trucks—over 5 tons	3,119	99,387	.056	84,114	30.17	1,295,123	.364	1,386,997	444.69	474.86
For hire trucks—combinations	3,046	105,992	.060	100,836	33.10	1,718,496	.484	1,844,248	605.47	638.57
<b>Total</b>	<b>24,204,326</b>	<b>177,767,048</b>	<b>100.000</b>	<b>168,060,000</b>	<b>.....</b>	<b>355,138,069</b>	<b>100.000</b>	<b>381,043,000</b>	<b>.....</b>	<b>.....</b>

## CHAPTER IX

### LATER PERIOD

#### CHARACTER OF DATA AVAILABLE

The conclusions thus far presented with respect to highway costs and motor vehicle payments are based on data for 1932 and the preceding years, because 1932 was the last year for which complete information has been made public. Partial data are available for the period 1933-1937. Complete figures are at hand for the State expenditures on State highways up to and including 1937.<sup>1</sup> The cities' expenditures on city streets are to be found in the report of the Bureau of Census up to and including 1936.<sup>2</sup> Expenditures on county and local roads have been estimated by the Department of Commerce for a period of years ending with 1936.<sup>3</sup> There are also available figures for highway and street expenditures for 1936 and 1937 made by the Works Progress Administration.<sup>4</sup> The figures for motor vehicle payments are complete up to and including 1937.<sup>5</sup>

There are available also figures of the Public Works Administration on rural roads and city streets and expenditures made by the States on secondary and feeder roads.

#### ANALYSIS OF DATA

The above data have been carefully analyzed and Tables 23 to 26 inclusive have been constructed as a result of such an analysis. In the construction of these tables we have used the available figures wherever found reasonably reliable. Where the data are incomplete we have made estimates. In the case of Works Progress Administration expenditures, we have deducted 25 per cent in view of the purpose for which expenditures were made. We have allocated such expenditures to rural roads or city streets as the data indicate. Expenditures have been arbitrarily divided equally between construction and maintenance. We have not included any Public Works Administration figures or the amounts which the States have expended on secondary and feeder roads because the record does not clearly indicate that they may not already have been included. There are no figures included representing local relief funds that have been expended on highways and streets.

<sup>1</sup>Annual Reports, Bureau of Public Roads.

<sup>2</sup>"Financial Statistics of Cities."

<sup>3</sup>"Construction Activity in the United States, 1915-1937."

<sup>4</sup>Testimony F. C. Harrington, in Hearings before Congressional Committee on Roads on H. R. 8838, pages 267-294.

<sup>5</sup>Bureau of Public Roads, Annual Reports.

In Table 23 is shown the total annual cost of State highway systems for the period 1933-1937. In Column (2) are the construction expenditures, in Column (3) interest during construction, in Column (4) estimated salvage recovered or reused. Column (5) is a summary of the preceding three columns. Column (6) represents the current year's amortization charges on the basis of a 29-year life. There results then in Column (7) the unamortized construction costs at the beginning of the year, arrived at by subtracting the figures in Column (6) from the figures in Column (5). Interest on unamortized construction costs are shown in Column (8), maintenance equipment, materials, supplies and miscellaneous in Column (9), "Equivalent Property Taxes" in Column (10), estimated salvage value in Column (11) and the current year's credit for salvage in Column (12). The annual cost of highways built since 1932 are shown year by year in Column (13) and the annual cost of highways in existence on December 31, 1920, the values yet unamortized, is shown in Column (14). The total annual costs of State highways year by year are found in the final Column (15).

Table 24 contains similar figures for the total annual cost of county and local roads for the period 1933-1937. The same method is used as in Table 23. The total annual costs of local roads year by year are to be found in Column (15) with a summary at the end.

In Table 25 is shown the total annual cost of city streets for the period 1933-1937. The figures in this table follow consistently the same procedure as in Tables 23 and 24. In Column (15) are shown year by year the total annual cost of city streets with a summary at the end.

Table 26 shows a comparison of motor vehicle users' proportion of the cost of highways and city streets, with receipts from motor vehicle taxes, for the period 1933-1937. It will be noted that the receipts are apportioned in this table on the basis of motor vehicle operators' obligations for the cost of highways and city streets. In Columns (2) to (5), inclusive, are set forth the figures derived from previous tables and the total is summarized in Column (6) for each year, with a grand total at the bottom of the column. Column (7) gives total population and Column (8) the amount allocated to general taxes on the basis of \$1.00 per capita as applied to the annual costs of all rural highways. In Column (9) are given the figures for urban population and in Column (10) the amount allocated to general taxes based on \$4.20 per capita of urban population. In Column (11) will be found the total amounts allocated to general taxes year by year with a grand total at the bottom of the column, and the percentage of total cost. Column (12) shows the motor vehicle users' proportion of the total annual cost year by year with a summary figure at the end and also the percentage of total cost represented by the motor vehicle users' proportion. In Column (13) will be found the total motor vehicle taxes, regis-

**TABLE 23**  
**TOTAL ANNUAL COST OF STATE HIGHWAY SYSTEMS, 1933-1937**  
 (All amounts in thousands)

Year	Construction expenditures	Interest during construction (4½ percent for one-half year on net expenditures)	Estimated salvage recovered and reused (Col. 12)	Total construction costs to be amortized (Cols. 2, 3, & 4)	Current year's amortization charges (39 year life)	Unamortized construction costs at beginning of year (Col. 5-6)	Interest on unamortized construction costs at 4½ percent per annum	Maintenance equipment, materials, supplies, and miscellaneous	Equivalent property taxes (1.30 percent of unamortized cost at beginning of year)	Estimated salvage (8.1 percent of Col. 5)	Current year's credit for salvage recovered (39 year life)	Annual cost of highways built since 1933 (Cols. 6, 8, 9, 10-Col. 12)	Annual cost of highways in existence Dec. 31, 1920	Total annual cost of state highways (Col. 13+14)
(1)	(2)	(3)	(4)	(5)	(6)	(7)	(8)	(9)	(10)	(11)	(12)	(13)	(14)	(15)
1933	\$511,973	\$10,879	\$5,488	\$528,340	\$196,377	\$4,802,409	\$204,103	\$192,337	\$52,481	\$16,379	\$6,094	\$649,053	\$22,819	\$671,872
1934	554,276	11,778	6,084	572,140	214,496	5,134,473	218,315	220,050	66,748	17,736	6,698	712,813	17,735	730,548
1935	416,612	8,849	6,696	431,957	234,225	5,492,116	233,415	228,736	71,398	12,391	7,158	760,616	13,363	773,979
1936	607,244	12,908	7,158	627,347	249,396	5,697,848	242,159	273,339	74,072	19,448	7,829	831,137	13,963	845,040
1937	551,979	11,730	7,829	571,538	271,029	5,075,799	258,221	300,953	78,985	17,718	8,440	900,778	12,442	913,220
<b>Total</b>	<b>\$3,641,926</b>	<b>\$66,141</b>	<b>\$33,365</b>	<b>\$3,781,322</b>	<b>\$1,165,422</b>	.....	<b>\$1,186,112</b>	<b>\$1,315,445</b>	<b>\$353,634</b>	<b>\$84,872</b>	<b>\$36,307</b>	<b>\$3,884,407</b>	<b>\$78,762</b>	<b>\$3,933,169</b>

**TABLE 24**  
**TOTAL ANNUAL COST OF COUNTY AND LOCAL ROADS, 1933-1937**  
 (All amounts in thousands)

Year	Construction expenditures	Interest during construction (4½ percent for one-half year on construction expenditures)	Estimated salvage recovered and reused (Col. 12)	Total construction costs to be amortized (Cols. 2, 3 and 4)	Current year's amortization charges (33.4 year life)	Unamortized construction costs at beginning of year (Col. 5-6)	Interest on unamortized construction costs at 4½ percent per annum	Maintenance equipment, materials, supplies, and miscellaneous	Equivalent property taxes (1.30 percent of unamortized cost at beginning of year)	Estimated salvage (6.9 percent of Col. 5)	Current year's credit for salvage recovered (33.4 year life)	Annual cost of local roads built since 1933 (Cols. 6, 8, 9, 10-Col. 12)	Annual cost of local roads in existence Dec. 31, 1920	Total annual cost of local roads (Col. 13+14)
(1)	(2)	(3)	(4)	(5)	(6)	(7)	(8)	(9)	(10)	(11)	(12)	(13)	(14)	(15)
1933	\$185,800	\$8,056	\$6,545	\$194,401	\$100,307	\$2,769,297	\$124,616	\$135,800	\$36,000	\$10,053	\$6,921	\$289,802	\$158,472	\$448,274
1934	185,300	2,674	6,921	178,895	104,661	2,814,391	126,648	168,300	39,687	11,999	7,221	423,975	153,231	577,206
1935	111,100	2,500	7,221	120,821	106,867	2,893,625	129,763	111,100	37,487	8,337	7,590	389,637	147,991	537,628
1936	257,481	5,793	7,590	270,864	113,494	2,894,679	130,256	257,481	37,630	18,689	7,830	531,021	142,751	673,772
1937	285,946	6,434	7,830	300,210	121,594	3,051,949	137,338	285,946	39,675	20,714	8,390	578,168	137,511	715,679
<b>Total</b>	<b>\$953,627</b>	<b>\$21,457</b>	<b>\$36,097</b>	<b>\$1,011,179</b>	<b>\$549,913</b>	.....	<b>\$648,621</b>	<b>\$953,627</b>	<b>\$187,379</b>	<b>\$69,772</b>	<b>\$37,942</b>	<b>\$2,301,598</b>	<b>\$739,956</b>	<b>\$3,041,554</b>

**TABLE 25**  
**TOTAL ANNUAL COST OF CITY STREETS, 1933-1937**  
 (All amounts in thousands)

Year	Total construction expenditures	Interest during construction (4¼ percent for one-half year on construction expenditures)	Estimated salvage recovered and reused (Col. 12)	Total construction costs to be amortized (Cols. 2, 3, 4)	Current year's amortization charges (20 year life)	Unamortized construction costs at beginning of year (Col. 5-6)	Interest on unamortized construction costs at 4¼ percent per annum	Operation and maintenance expenses	Equivalent property taxes (1.30 percent of unamortized cost at beginning of year)	Estimated salvage (3.1 percent of Col. 5)	Current year's credit for salvage recovered (20 year life)	Annual cost of city streets built 1933-1937 (Cols. 6, 8, 9, 10-Col. 12)	Annual cost of city streets in existence Dec. 31, 1920	Total annual cost of city streets (Col. 13+14)
(1)	(2)	(3)	(4)	(5)	(6)	(7)	(8)	(9)	(10)	(11)	(12)	(13)	(14)	(15)
1933	\$144,972	\$3,081	\$5,011	\$153,064	\$170,880	\$4,116,272	\$174,942.	\$225,506	\$53,512	\$4,745	\$5,209	\$619,541	.....	\$619,541
1934	142,469	3,027	5,209	150,705	176,158	4,098,456	174,184	229,110	63,280	4,675	5,463	627,269	.....	627,269
1935	118,614	2,521	5,463	126,598	181,358	4,073,093	173,106	231,906	62,950	3,925	5,624	632,695	.....	633,695
1936	195,275	4,160	5,624	205,049	185,723	4,018,333	170,779	280,374	62,238	6,357	5,759	683,355	.....	683,355
1937	209,257	4,447	5,759	219,463	192,794	4,037,659	171,601	294,678	62,490	6,803	5,978	705,485	.....	705,485
<b>Total</b>	<b>\$810,587</b>	<b>\$17,226</b>	<b>\$27,156</b>	<b>\$854,969</b>	<b>\$906,913</b>	.....	<b>\$864,612</b>	<b>\$1,261,473</b>	<b>\$264,470</b>	<b>\$26,505</b>	<b>\$28,123</b>	<b>\$3,269,345</b>	.....	<b>\$3,269,345</b>

**TABLE 26**  
**COMPARISON OF MOTOR VEHICLE USERS' PROPORTION OF THE COST OF HIGHWAYS AND CITY STREETS**  
**WITH RECEIPTS FROM MOTOR VEHICLE TAXES, 1933-1937**  
 (Receipts apportioned on basis of motor vehicle operators' obligations for highways and city streets)  
 (All amounts except population in thousands)

Year	Total annual cost					Total population a	Amount allocated to general taxes based on one dollar per capita	Urban population a	Amount allocated to general taxes based on \$4.20 per capita of urban population	Total amount allocated to general taxes (11=8+10)	Motor vehicles users' proportion of total annual cost (12=6-11)	Total motor vehicle taxes, registration fees, etc.	Amount by which motor vehicle taxes failed to meet motor vehicle operators' obligations (14=12-13)
	State highways	County and local roads	Total highways and roads (4=2+3)	City streets	Grand Total (6=4+5)								
(1)	(2)	(3)	(4=2+3)	(5)	(6=4+5)	(7)	(8)	(9)	(10)	(11=8+10)	(12=6-11)	(13)	(14=12-13)
1933	\$671,382	\$548,274	\$1,219,656	\$619,541	\$1,839,197	127,894,373	\$127,894	80,138,525	\$336,682	\$464,476	\$1,374,721	\$820,719	\$554,002
1934	730,548	577,206	1,307,754	627,269	1,935,023	129,600,815	129,601	80,495,657	338,082	467,683	1,467,340	873,902	593,438
1935	773,979	528,828	1,302,607	633,695	1,936,302	131,307,257	131,307	80,788,589	339,312	470,619	1,465,683	942,651	523,032
1936	844,040	673,772	1,517,812	683,355	2,201,167	133,013,699	133,014	81,074,521	340,513	473,527	1,727,640	1,051,203	676,437
1937	913,220	713,674	1,626,894	705,485	2,332,379	134,720,141	134,720	81,360,453	341,714	476,434	1,855,945	1,161,611	694,334
<b>Total</b>	<b>\$3,933,169</b>	<b>\$3,041,654</b>	<b>\$6,974,723</b>	<b>\$3,269,345</b>	<b>\$10,244,068</b>	.....	<b>656,536</b>	.....	<b>\$1,696,203</b>	<b>\$2,352,739</b>	<b>\$7,891,329</b>	<b>\$4,850,086</b>	<b>\$3,041,243</b>
Percentage chargeable to motor vehicle users.....											77.0		

a See footnote, Table 20, page 55.

tration fees and other imposts year by year with a summary figure at the bottom. Column (14) shows the amount by which motor vehicle taxes failed to meet the motor vehicle operators' obligations year by year and for the period.

These tables, therefore, show the annual highway and street costs for this later period and the apportionment of costs which are chargeable to the motor vehicle. There are also shown the corresponding annual payments made by motor vehicles. The same procedure was used in these tables as was used in previous tables for the earlier period.

### CONCLUSION

To the extent that some of the basic data used in these tables was estimated, the results are an approximation. Some of the figures may change when more accurate information becomes available. It should be observed, however, that annual expenditure is not annual cost. The capital expenditure made in any one year is distributed over the period of amortization and, therefore, does not affect greatly the annual cost for any one year. In other words, considerable fluctuations in annual expenditure are not reflected immediately in annual cost. Hence, we may conclude that the figures of cost shown in these tables are a fair approximation. *They show that motor vehicle subsidy has not decreased materially since 1932 but that highway costs have substantially kept pace with the increase in motor vehicle payments and that in the year 1937 there was no less subsidy than in 1932.*

Official highway cost studies made by the State Highway Departments for Illinois in 1936 and for Missouri in 1935 show a large motor vehicle subsidy existed in these States in the years mentioned.

In the depression period (since 1929) highway and street expenditures by the States, counties and cities have been curtailed. Relief expenditures for highway improvements, however, have greatly increased.

It has just recently been recognized that highways which have been improved are deteriorating at an unexpectedly increasing rate. Such was the conclusion in the Illinois Study which reported that on the State primary system alone 444.9 miles of paved road have completely deteriorated and need to be repaved immediately and that during the next ten years 3,238.8 miles will have to be reconstructed.

In the hearings before the Committee on Roads\* the American Association of State Highway Officials in 1938 submitted figures showing that \$1,607,609,000 were needed to rebuild 57,755 miles of pavement on the State and Federal Aid system, including bridges, and that 22 per cent of the entire State highway systems needed to

---

\*Hearings before Congressional Committee on Roads on H. R. 8838, pages 19-20.



be rebuilt, relocated or widened "immediately" at an estimated cost of \$3,664,296,000.

These figures for deferred expenditures do not appear in our cost analysis, which is confined to the actual expenditures that have been made. If the highway and street investments are to be preserved, it will be necessary within the next few years to expend an enormous amount of money to replace the facilities which are now rapidly deteriorating.

## APPENDICES

	<i>Page</i>
<b>A</b> Distribution, by type of road, of cost of State highways and local roads, except unimproved earth roads, in existence December 31, 1921, on basis of 1917-1924 cost of Federal-aid roads.....	108
<b>B</b> Percentage of distribution of cost of highway elements in rural roads on December 31, 1921.....	109
<b>C</b> Construction expenditures on State highway Systems, 1921-1932, adjusted to include pro-rata share of administration and engineering expenses for years 1921 to 1927.....	110
<b>D</b> Analysis of miscellaneous revenue, State Highway Departments, 1921 to 1932.....	111
<b>E</b> State motor-fuel tax receipts, 1921-1932.....	112
<b>F</b> State motor vehicle receipts, 1921-1932.....	113
<b>G</b> A discussion of formulas for design of rigid pavements.....	114
<b>H</b> The factor of impact in highway design.....	117
<b>I</b> Discussion of formula for design of flexible pavements—extract from asphalt pocket reference for highway engineers.....	119
<b>J</b> Theoretical analysis of relation between wheel loads and thickness of flexible pavements required.....	129
<b>K</b> Highway use as affecting allocation of capital costs.....	137
<b>L</b> Study of motor vehicle speed in Massachusetts.....	142
<b>M</b> Federal appropriations for highway purposes—years 1917 to 1937.....	146
<b>N</b> Highway bonds outstanding—years 1904 to 1932.....	147
<b>O</b> State motor-vehicle receipts and motor-fuel taxes—years 1901 to 1935.....	148
<b>P</b> Amounts levied for rural highways in the aggregate and on a per capita basis, 1900 to 1920—State of Indiana.....	149
<b>Q</b> Road occupancy with mileage factor.....	150

**APPENDIX A**

**DISTRIBUTION, BY TYPE OF ROAD, OF COST OF STATE HIGHWAYS AND LOCAL ROADS, EXCEPT UNIMPROVED EARTH ROADS, IN EXISTENCE DECEMBER 31, 1921, ON BASIS OF 1917-1924 COST OF FEDERAL-AID ROADS**

Type of road	Mileage 1921 <i>a</i>		Average cost of Federal-aid roads 1917-1924 <i>b</i>	Total cost				Total cost adjusted*				
	State highways	Local roads		State highways		Local roads		State highways		Local roads		
				Amount (2×4)	Per cent of total	Amount (3×4)	Per cent of total	Amount	Per cent of total	Amount	Per cent of total	
	(1)	(2)		(3)	(4)	(5)	(6)	(7)	(8)	(9)	(10)	(11)
<b>Improved Type:</b>												
1 Improved earth (established to grade and drained).....	21,384	<i>c</i> 232,176	\$7,800	\$166,795,200	8.99	\$1,810,972,800	18.20	\$125,096,400	8.68	\$1,207,303,127	14.92	
2 Sand-clay and top-soil.....	8,709	54,467	7,400	64,446,600	3.47	403,055,800	4.05	48,334,950	3.35	268,701,180	3.32	
3 Gravel.....	36,279	163,351	9,900	359,162,100	19.35	1,617,174,900	16.25	269,371,575	18.70	1,078,105,819	13.32	
4 Water-bound macadam.....	16,976	60,333	17,500	297,080,000	16.00	1,055,827,500	10.61	222,810,000	15.47	703,877,961	8.70	
5 Bituminous macadam by penetration..	6,708	3,556	29,100	195,202,800	10.52	103,479,600	1.04	146,402,100	10.16	68,985,710	0.85	
6 Bituminous concrete and sheet asphalt.	2,844	3,735	<i>d</i> 33,500	95,274,000	5.13	125,122,500	1.26	71,455,500	4.96	83,414,166	1.03	
7 Portland cement concrete.....	9,860	5,905	38,300	377,638,000	20.34	226,161,500	2.27	283,228,500	19.66	150,772,826	1.86	
8 Brick and block.....	2,003	1,427	<i>d</i> 44,700	89,534,100	4.82	63,788,900	0.64	67,150,575	4.66	42,524,175	0.53	
9 Miscellaneous.....	993	10,311	<i>d</i> 16,900	16,781,700	0.91	174,255,900	1.75	12,586,275	0.87	116,169,438	1.44	
<b>Unimproved Type:</b>												
10 Earth and partly graded.....	97,159	<i>c</i> 2,186,329	<i>e</i> 2,000	194,318,000	10.47	4,372,658,000	43.93	194,318,000	13.49	4,372,658,000	54.03	
<b>Total.....</b>	<b>202,915</b>	<b>2,721,590</b>	<b>f</b>	<b>\$1,856,232,500</b>	<b>100.00</b>	<b>\$9,952,495,400</b>	<b>100.00</b>	<b>\$1,440,753,875</b>	<b>100.00</b>	<b>\$8,092,512,402</b>	<b>100.00</b>	
<b>Average cost.....</b>	<b>.....</b>	<b>.....</b>	<b>.....</b>	<b>\$9,148</b>	<b>.....</b>	<b>\$3,057</b>	<b>.....</b>	<b>\$7,100</b>	<b>.....</b>	<b>\$2,973</b>	<b>.....</b>	

*a* State highways from Bureau of Public Roads report M-4 (1920); Local roads from M-5 (1921).  
*b* Cost data from Bulletin No. 914, Bureau of Public Roads, Page 113.  
*c* Total earth roads (2,418,506 miles) was here divided on basis of 1923 proportion.  
*d* Sheet asphalt assigned same cost as bituminous concrete and block paving same as cost of brick.  
*e* Estimated.  
*f* Assigned average of all types.

\* Improved road figures were adjusted by reducing costs shown in Columns 5 and 7 for improved types Nos. 1 to 9. State highways (Column 5) reduced 25 per cent and local roads (Column 7) 33.3+ per cent. No adjustments were made in figures for type No. 10—Unimproved earth, and partly graded.

**APPENDIX B**  
**PERCENTAGE DISTRIBUTION OF COST OF HIGHWAY ELEMENTS IN RURAL ROADS ON DECEMBER 31, 1921**

Type of road	Percentage of average cost per mile represented by: a			Percentage of total cost		Percentage distribution of cost of State highways			Percentage distribution of cost of local roads		
	Grading	Surfacing	Structure	State highways d	Local roads d	Grading (5x2)	Surfacing (5x3)	Structures (5x4)	Grading (6x2)	Surfacing (6x3)	Structures (6x4)
(1)	(2)	(3)	(4)	(5)	(6)	(7)	(8)	(9)	(10)	(11)	(12)
<b>Improved Type:</b>											
1 Improved earth (established to grade and drained).....	72	..	28	8.68	14.92	6.25	.....	2.48	10.74	.....	4.18
2 Sand-clay and top-soil.....	46	25	29	3.35	3.32	1.54	0.84	0.97	1.53	0.83	0.96
3 Gravel.....	35	47	18	18.70	13.32	6.54	8.79	3.37	4.66	6.26	2.40
4 Waterbound macadam.....	20	69	11	15.47	8.70	3.09	10.67	1.70	1.74	6.00	0.96
5 Bituminous macadam by penetration.....	15	75	10	10.16	0.85	1.52	7.62	1.02	0.13	0.64	0.09
6 Bituminous concrete and sheet asphalt.....	12	82	6	4.96	1.03	0.60	4.07	0.30	0.12	0.84	0.06
7 Portland cement concrete.....	15	77	8	19.66	1.86	2.95	15.14	1.57	0.28	1.43	0.15
8 Brick and block.....	10	85	5	4.66	0.53	0.47	3.96	0.23	0.05	0.45	0.03
9 Miscellaneous.....	b 26	b 59	b 15	0.87	1.44	0.23	0.51	0.18	0.37	0.85	0.22
<b>Unimproved Type:</b>											
10 Earth and partly graded.....	e 72	..	e 28	13.49	54.03	9.71	.....	3.78	38.90	.....	15.13
<b>Total.....</b>	..	..	..	100.00	100.00	32.90	51.60	15.50	68.52	17.30	24.18

- a From Bureau of Public Roads, Bulletin No. 914, page 114. Ratios for grading include miscellaneous cost; ratios for surfacing include cost of shoulders.  
b Assigned average of all types.  
c Assumed to be the same as for graded and drained roads.  
d See Appendix A, Columns 10 and 12.

**APPENDIX C**  
**CONSTRUCTION EXPENDITURES ON STATE HIGHWAY SYSTEMS, 1921-1932**  
**ADJUSTED TO INCLUDE PRO-RATA SHARE OF ADMINISTRATION AND ENGINEERING EXPENSES FOR**  
**YEARS 1921 TO 1927**

Year	Construction expenses as originally reported <sup>a</sup>	Miscellaneous expenses as originally reported <sup>a</sup>	Per cent miscellaneous expenses of construction expenses	Miscellaneous expense incl. administration and engineering expenses as originally reported <sup>a</sup>	Estimated miscellaneous expenses	Estimated administration and engineering expenses	Total construction expenses incl. maintenance expenses as originally reported <sup>a</sup>	Per cent construction expenses of construction expenses including maintenance	Administration and engineering expenses pro-rata share to construction expenses	Construction expenses adjusted to include administration and engineering expenses
	1	2	3 = 2÷1	4	5 = 1×Av. of 3	6 = 4 - 5	7	8 = 1÷7	9 = 6×8	10 = 1+9
1921	\$284,802,460	.....	.....	\$16,417,808	\$1,884,925	\$14,532,983	\$349,135,619	81.430	\$11,838,719	\$296,136,179
1922	287,461,018	.....	.....	19,976,406	1,905,868	16,070,538	882,801,509	79.284	14,318,011	301,779,029
1923	279,992,788	.....	.....	26,407,129	1,856,852	24,550,777	855,821,946	78.800	19,846,012	299,388,800
1924	382,835,696	.....	.....	31,165,081	2,594,886	28,680,195	487,142,258	78.485	22,470,409	404,806,105
1925	359,827,894	.....	.....	38,618,053	2,581,241	36,036,812	508,680,944	76.544	27,580,218	418,907,597
1926	356,174,616	.....	.....	38,250,111	2,861,433	35,388,678	481,791,929	78.927	26,561,419	382,706,085
1927	404,217,317	.....	.....	48,828,297	2,679,951	46,148,346	548,000,675	74.441	34,949,551	435,586,873
1928	538,048,138	\$4,011,620	0.746	.....	.....	.....	.....	.....	.....	538,048,138
1929	557,400,625	5,524,858	0.991	.....	.....	.....	.....	.....	.....	557,400,625
1930	718,117,045	2,227,459	0.312	.....	.....	.....	.....	.....	.....	718,117,045
1931	730,954,832	4,312,553	0.590	.....	.....	.....	.....	.....	.....	730,954,832
1932	551,445,859	4,418,117	0.801	.....	.....	.....	.....	.....	.....	551,445,859
<b>Total</b>	<b>\$5,474,772,778</b>	.....	<b>Average 0.638</b>	.....	.....	.....	.....	.....	<b>\$156,429,844</b>	<b>\$5,681,202,122</b>

<sup>a</sup> From annual Tables F-2, Bureau of Public Roads.

APPENDIX D  
ANALYSIS OF MISCELLANEOUS REVENUES, STATE HIGHWAY DEPARTMENTS, 1921 TO 1932  
(All amounts in thousands)

**A—DISTRIBUTION IN YEARS FOR WHICH INFORMATION IS AVAILABLE IN REPORTS OF BUREAU OF PUBLIC ROADS**

Item	1925	1926	1927	1928	1929	1930	1931 <sup>a</sup>	1932 <sup>a</sup>
1. Fines, fees, tolls, permits, etc.....	\$511	\$388	\$239	\$1,732	\$181	\$1,790	\$7,407	\$8,091
2. Amounts indicated as refunds for work performed and other amounts representing a reduction of cost of high-ways, such as railroad participation, sale of material, cash discounts, equipment and garage rentals, etc.....	7,514	5,460	2,550	2,951	3,728	4,004	7,193	7,721
3. Interest received on deposits.....	471	854	1,109	264	1,440	2,246	1,503	1,289
4. Miscellaneous receipt, transfers, etc., not identified with users or constr.....	835	2,743	5,808	2,500	1,380	4,533	1,886	4,581
Total.....	9,331	9,445	9,706	7,447	6,729	12,573	17,989	21,682
Per cent item 2 of total.....	80.52	57.80	26.27	39.63	55.40	31.84	59.80	52.12

**111 B—DETERMINATION OF ITEM (2) BY YEARS ON BASIS OF AMOUNTS REPORTED PLUS A PORTION OF AMOUNTS NOT SEPARATELY REPORTED, ON BASIS OF PROPORTIONS FOUND IN (A)**

Year	Reported	Total not detailed	Proportion allocable to Item 2		Total item
			Per cent	Amount	
1921	.....	\$7,237	b 45.64	\$3,303	\$3,303
1922	.....	8,236	b 45.64	3,759	3,759
1923	.....	15,498	b 45.64	7,074	7,074
1924	.....	13,850	b 45.64	6,093	6,093
1925	\$7,514	5,721	80.52	4,606	12,120
1926	5,460	3,779	57.80	2,185	7,645
1927	2,550	2,816	26.27	739	3,289
1928	2,951	5,165	39.63	2,047	4,998
1929	3,728	4,998	55.40	2,769	6,497
1930	4,004	4,511	31.84	1,436	5,440
1931	7,193	3,155	59.80	1,886	9,079
1932	7,721	4,240	52.12	2,210	9,931
Total	\$41,121	\$78,706	.....	\$38,107	\$79,228

<sup>a</sup> Tolls received by the State of New Jersey in 1931 (\$5,961,348 and 1932 (\$6,868,140) from the Port of New York Authority and the Delaware River Joint Commission are disregarded in the apportionment of amounts not separately reported.

<sup>b</sup> Item (2) as adjusted, 1925 to 1932..... \$58,999  
Total miscellaneous income, 1925 to 1932..... 129,286  
Per cent item (2) to total miscellaneous income ..... 45.64

APPENDIX E

STATE MOTOR-FUEL TAX RECEIPTS, 1921-1932

Source: Annual reports G-1, of Bureau of Public Roads

Year	Gross receipts less refunds (all states)	For states reporting complete data			For states not reporting collection and administration cost		Total collection and administration cost (all states)	Net receipts (gross receipts less refunds, and collection and administration costs)
		Gross receipts less refunds	Collection and administration costs		Gross receipts less refunds	Collection and administration cost estimated		
			Amount	Per cent of gross receipts				
1	2	3	4	5=4+3	6=2-3	7=6×5	8=4+7	9=2-8
1921	\$5,382,111	.....	.....	a .272248	\$5,382,111	\$14,653	\$14,653	\$5,367,458
1922	12,703,078	.....	.....	a .272248	12,703,078	34,584	34,584	12,668,494
1923	38,566,338	.....	.....	a .272248	38,566,338	104,996	104,996	38,461,342
1924	80,442,295	.....	.....	a .272248	80,442,295	219,003	219,003	80,223,292
1925	148,858,087	\$79,851,186	\$217,393	.272248	68,506,901	186,509	403,902	147,954,185
1926	187,603,231	104,323,120	294,066	.281880	83,280,111	234,750	528,816	187,074,415
1927	258,838,813	168,245,481	573,693	.340986	90,593,332	308,911	882,604	257,956,209
1928	304,871,766	212,245,600	744,134	.350600	92,626,166	324,747	1,068,881	303,802,885
1929	431,811,519	330,868,880	857,703	.259227	100,442,639	260,374	1,118,077	430,193,442
1930	493,865,117	396,102,731	1,316,199	.332287	97,762,386	324,852	1,641,051	492,224,066
1931	536,397,458	492,403,493	2,331,669	.473528	43,993,965	208,324	2,539,993	533,857,465
1932	513,047,239	460,802,294	3,028,153	.657148	52,244,945	343,327	3,371,480	509,675,759
Total	\$3,011,387,052	\$2,244,842,785	\$9,363,010	.....	\$766,544,267	\$2,565,030	\$11,928,040	\$2,999,459,012

a No collection and administration costs being reported for the years 1921 to 1924 inclusive, the average for 1925 was here used.

**APPENDIX F**  
**STATE MOTOR VEHICLE RECEIPTS, 1921-1932**  
 Source: Annual reports MV-2, of Bureau of Public Roads

Year	Gross receipts (all states) <sup>1</sup>	Refunds	Gross receipts less refunds (all states)	For states reporting complete data			For states not reporting collection and administration costs		Total collection and administration cost (all states)	Net receipts (gross receipts less refunds, and collection and administration costs)
				Gross receipts less refunds	Collection and administration costs		Gross receipts less refunds	Collection and administration cost estimated		
					Amount	Per cent of gross receipts				
1	2	3	4=2-3	5	6	7=5+6	8=4-5	9=8x7	10=6+9	11=4-10
1921	\$122,478,864	.....	\$122,478,864	.....	.....	a 6.827850	\$122,478,864	\$7,750,268	\$7,760,268	\$114,728,888
1922	152,047,824	.....	152,047,824	.....	.....	a 6.827850	152,047,824	9,621,358	9,621,358	142,426,466
1923	188,970,992	.....	188,970,992	.....	.....	a 6.827850	188,970,992	11,967,801	11,967,801	177,018,191
1924	225,492,252	.....	225,492,252	.....	.....	a 6.827850	225,492,252	14,268,811	14,268,811	211,223,441
1925	260,819,621	\$412,696	260,206,925	\$284,105,973	\$14,818,875	6.827850	26,100,952	1,651,629	16,466,504	248,741,421
1926	289,282,852	45,801	289,236,551	240,353,799	15,892,875	7.024678	47,902,752	3,865,014	20,247,689	267,988,862
1927	301,061,132	138,454	300,922,678	258,574,518	14,876,410	5.866682	47,848,160	2,777,768	17,654,176	289,268,502
1928	322,630,025	62,583	322,577,442	277,536,727	15,178,999	5.469186	46,040,715	2,463,360	17,642,359	304,935,083
1929	347,843,543	248,131	347,595,412	314,902,390	17,402,798	5.526410	32,698,022	1,806,750	19,209,548	328,385,864
1930	365,704,860	185,587	365,519,273	321,084,542	19,196,926	5.978776	34,434,731	2,058,775	21,255,701	384,263,572
1931	344,337,654	107,470	344,230,184	318,181,389	21,516,119	6.762218	26,048,795	1,761,478	28,277,595	320,952,589
1932	324,278,510	216,352	324,062,158	303,175,225	19,690,116	6.494632	20,879,933	1,356,075	21,046,191	308,008,967
<b>Total</b>	<b>\$3,233,742,419</b>	<b>\$1,409,074</b>	<b>\$3,232,333,345</b>	<b>\$2,262,894,563</b>	<b>\$189,557,918</b>	<b>.....</b>	<b>\$969,438,782</b>	<b>\$60,839,081</b>	<b>\$200,896,999</b>	<b>\$3,031,936,346</b>

<sup>1</sup> No collection and administration costs being reported for the years 1921 to 1924 inclusive, the average for 1925 was here used.



## APPENDIX G

### A DISCUSSION OF FORMULAS FOR DESIGN OF RIGID PAVEMENTS

In this report the corner formula is used to establish the relation between wheel load and thickness of concrete pavement required. This formula as given on p. 60 has the following form:

$$t = \sqrt{\frac{3W}{f}}$$

where  $t$  = thickness of pavement  
 $W$  = wheel load  
 $f$  = allowable fiber stress in tension.

This formula assumes (a) that the slab receives no support from the subgrade for some distance back from the corner and (b) that the wheel load is applied at the extreme corner of the pavement slab. The distance of non-support is of no significance under the above assumptions, because this distance does not appear in the formula. Under these conditions the load-supporting capacity of the slab may be obtained by assuming it to act as a simple cantilever, and then applying the accepted laws of mechanics. As, in any such formula, the accuracy of the results depends upon the accuracy of the assumptions made in its derivation, (a) and (b) will be further discussed.

Two conditions that apply in the case of actual pavements confirm the correctness of the first assumption which presumes that immediately under the load the slab may frequently receive no support from the subgrade. The first of these conditions is due to the fact that pavements warp or curl, due to unequal temperatures in the top and bottom surfaces. Thus when the top surface cools at night the edges and corners curl upward to such an extent as to be entirely out of contact with the subgrade.<sup>1</sup> Exactly the same effect occurs when the exposed top of the slab dries out more rapidly than the bottom, the bottom being more protected as regards the evaporation of contained moisture.

The second condition is due to the fact that while a subgrade may possess distinct elastic properties, the elastic limit may be so low as to be greatly exceeded by the pressures imposed upon it where the deflection of the slab under load is greatest. If the pressure at and surrounding this point exceeds the elastic limit of the subgrade a permanent depression of the subgrade is inevitable and there is a separation between slab and subgrade when the load is released or passes on. This condition obviously applied in the case of the Spangler tests described in the Proceedings of the 15th Annual Meeting of

<sup>1</sup> See Bulletin Numbers 18 and 21, State of Illinois, Department of Public Works and Buildings.

the Highway Research Board.<sup>3</sup> When the separation due to warping is added to the permanent depression caused by load, even the maximum load may not produce contact between the slab and the subgrade at a point or area under the load.<sup>3</sup> It then becomes obvious that assumption (a) of the corner formula actually applies for the pavement slabs in service.

Assumption (b) that the load is applied to the mathematical corner is not strictly true, since when wheels are equipped with pneumatic tires the center of the area of load application may be near but never exactly at the corner when the full load is on one slab. When a load is applied at a distance from the corner, the stress is less than that indicated by the corner formula by an amount depending upon the relative distances of the load and the actual line of support from the mathematical corner. For example, if the center of the load is 4" from the corner and the line of support is 24" from the same point, the error is about 17 per cent. If the load is in the same position and the line of support is 36" from the corner, the error is only about 11 per cent.

As corner breaks almost always appear at distances of from two to three and one-half feet from the corner, the error may normally be assumed to be substantially less than 17 per cent and, in any case, *it is always on the safe side*. In other words, it theoretically introduces a small factor of safety.

In the application of the Westergaard and Spangler formulas, the actual position of the load is used, but it is assumed that the subgrade support at any point is in proportion to the slab deflection at that point. Or, expressed differently, that at the mathematical corner (in the case of corner loading) the subgrade support is greater than anywhere else. It has been shown, that for the critical condition caused by frequent warping, this cannot possibly be true and the condition is made worse in any case where the elastic limit of the subgrade has at any time been exceeded. The error due to this cause *is always on the dangerous side*. This is confirmed by the Spangler tests in which the observed maximum stresses were about 42 per cent and 55 per cent in excess of the maximum computed in accordance with Westergaard.<sup>4</sup> Similarly in a later study of a slab in which warping was prevented,<sup>5</sup> Spangler found that the corner formula gave a stress 46

<sup>3</sup> Spangler conducted tests on 10' x 12' slabs 6" thick on an artificial clay foundation. The experiments were conducted in the basement of a building under ideal conditions. Static loads were applied through circular loading blocks and stresses computed from strain measurements at different points near the corner of the slab. From his experimental data and using the Westergaard approach, Spangler developed formulas for maximum probable stress due to corner loadings.

<sup>4</sup> See Figure 3 of Bulletin Number 18, State of Illinois, Department of Public Works and Buildings.

<sup>5</sup> See figures 17 to 19 in Spangler's paper (Proc. 15th Annual Meeting Highway Research Board) from which relationships of the corner, Westergaard and Spangler formulas with respect to test results, may be derived.

<sup>6</sup> Proceedings 17th Annual Meeting Highway Research Board, 1936, p. 222.

per cent higher than the highest stress found experimentally, and that Westergaard method gave a stress 10 per cent lower.

From the above, we conclude that the simple corner formula should be used in preference to the Westergaard formula because it is the one that has exerted the greatest influence upon actual design and it is also decidedly more representative of the conditions that apply in the actual road slab.

## APPENDIX H

### THE FACTOR OF IMPACT IN HIGHWAY DESIGN

If there is no source of impact inherent within the vehicle itself there can be no impact effect providing the road surface presents no irregularities. Some years ago the Illinois Highway Department started an elaborate experimental investigation, *not of impact forces* but of the *stress effect of impact forces* upon the pavement slab itself. The distinction is very important. This series of tests resulted in the conclusion "that no allowance for impact need be made in the design of a pavement, the nature of which makes practicable the construction and maintenance of a reasonably smooth surface."<sup>1</sup> During the years 1924 and 1925, another series of investigations of the same nature was undertaken by the Illinois Highway Department which were reported in 1931 in "Illinois Division of Highways," "Reports of Investigations" Volume I by V. L. Glover, Engineer of materials. The results of this later investigation may be summed up in the words of a paragraph heading on page 30 which reads as follows: "Impact on Illinois Pavements a Negligible Quantity." It is of particular interest to note that all of the Illinois tests were made with solid rubber tire equipment and it is well known that pneumatic tires cause less impact than solid tires under otherwise equal circumstances. If no impact allowance be required for solid tires surely none is needed for pneumatic tires.

James A. Buchanan, Associate Engineer of Tests, U. S. Bureau of Public Roads, in an article entitled "Impact Reactions Developed by a Modern Motor Bus"<sup>2</sup> states: "So far as these tests have indicated, the impact forces developed by balloon and high pressure tires do not reach dangerous proportions as long as the surface is reasonably smooth and designed for the wheel loads involved." The words "designed for the wheel loads involved" as used in this connection can only mean the static wheel loads. It is of particular interest to note that this statement includes high pressure tires.

In more recent tests<sup>3</sup> Buchanan found that impacts of 1.1 to 1.2 times the static wheel load might be expected occasionally (from 0 to 140 times per mile) with balloon tires on smooth pavements of cement concrete or bituminous materials. In these tests, however, the impact was obtained indirectly from accelerations measured on the vehicle. The actual stresses induced in the pavements were not measured.

Due to the fleeting character of highway loads and the inertia of

<sup>1</sup> Highway Research in Illinois, by Clifford Older, Transactions American Society of Civil Engineers, Volume LXXXVII, page 1222.

<sup>2</sup> "Public Roads," April 1931.

<sup>3</sup> Road Impact Produced by a Heavy Motor Bus, "Public Roads," November 1932.

the pavement and foundation, the stresses developed under moving loads are probably less than those induced by an equivalent static load. Westergaard recognized this possibility and included it among the limitations to his formulas for design.<sup>4</sup>

A clear distinction should be made between the term "impact" and the effect of a suddenly applied load. Impact may be described as the blow which is experienced when a moving body expends some of its energy by suddenly striking an object. A load may be suddenly applied without impact when a body moving in the same plane with its weight supported on a smooth surface passes quickly from one place to another, as from one pavement slab to another. It is a recognized principle of mechanics that a load suddenly applied may double the stresses set up within the supporting member; but here again in the case of pavements the fleeting character of the wheel load (like a person skating on ice) develops stresses which are probably less than those induced by an equivalent static load.

On flexible pavements the time of duration of the load will have an even greater effect on the stresses imposed than for rigid types. A static load of a given amount standing on a flexible pavement might cause deformation of the surface, whereas the same load, passing rapidly over the surface, would be gone before deformation had time to occur. In such a case the static load would be more severe than the moving load. The relative effect of dynamic and static loads on flexible pavements is now being studied by European and American engineers.<sup>5</sup> Due to their flexible nature, these surfaces are able to absorb a considerable impact force due to irregularities without permanent injury.<sup>6</sup>

In actual practice some engineers have advocated a percentage allowance for impact (frequently 50 per cent) and others have made no allowance for impact in design. There are excellent reasons why a factor of 1.5 should be applied to the wheel load for design purposes. In concrete pavements, for example, there are always transverse joints or cracks over which wheel loads pass suddenly from one slab to the next. Loads suddenly applied and then left upon any elastic support momentarily cause twice the effect of the static load. Glover found by experience that this effect for rolling highway loads was about 1.5 instead of 2. The existence of this effect probably accounts for the fact that many concrete pavements have failed, although the Westergaard and even the Corner formula indicate that they should not have failed under the wheel loads permitted by them.

*In establishing ratios of thickness for the allocation of costs, the result will be the same whether or not a percentage is added to the static wheel load for a suddenly applied load.*

<sup>4</sup>Stresses in Concrete Pavements Computed by Theoretical Analysis, "Public Roads," April 1926, p. 35.

<sup>5</sup>Present Knowledge of the Design of Flexible Pavements, "Public Roads," January 1938.

<sup>6</sup>Effect of Pavement Type on Impact Reaction, "Public Roads," August 1928.

## APPENDIX I

### DISCUSSION OF FORMULA FOR DESIGN OF FLEXIBLE PAVEMENTS— EXTRACT FROM ASPHALT POCKET REFERENCE FOR HIGHWAY ENGINEERS

The formula  $t = \sqrt{\frac{W}{\pi s}} - e$  for the design of the thickness of flexible type pavements is given in Fig. 2 of the body of this report together with a graphical representation of the assumptions upon which it is based. The terms have the following meaning:

- t = thickness of pavement in inches
- W = wheel load in pounds
- s = bearing power of the subgrade in pounds per square inch
- e = radius (in inches) of the circle over which the wheel load is assumed to be distributed.

This formula does not mathematically demonstrate that the thickness of a pavement varies directly as the square root of the wheel load, because there are two terms in the right-hand side of the equation; the first term obviously does vary as the square root of the wheel load (since  $\pi$  and  $s$  are constants for a given subgrade) but the second term ( $-e$ ) is not under the square root sign. Actually,  $e$  which increases as the wheel load also varies approximately as the square root of the wheel load. For example, a wheel load of 2,000 pounds often has a tire with a contact area of about 34 sq. in., which is equivalent to a circle of radius 3.3 inches. A wheel load of 7,500 pounds often has an area of contact of about 79 sq. in. which is equivalent to a circle of radius 5.0 inches. In other words, when the wheel load is increased about four times the value of  $e$  does not quite double. The above discussion is based upon single tires for both 2,000 and 7,500 pound wheel loads, which is consistent with the assumption in the formula that the load is distributed over a circle. If dual tires are used the same relationship will apply.

Since  $s$  also varies substantially as the square root of the wheel load, then both terms on the right-hand side of the formula vary as the square root of the wheel load, and the application of the formula over the normal range of wheel loads will result in a thickness proportional to the square root of the wheel load.

This is demonstrated below where the formula is applied to bituminous types with appropriate values substituted for  $s$  in Fig. 23 reproduced from "Asphalt Pocket Reference for Highway Engineers." (See below.) This diagram shows that for any given subgrade support a wheel load of 8,000 pounds requires twice the thickness of pavement required for a 2,000-pound wheel load. For example, Fig. 23 shows

that if the subgrade support is 10 lbs. per square inch, the thickness required for a 2,000-lb. wheel load is about 5" and for a 8,000-lb. wheel load it is about 11"; similarly, for subgrade of 30 lbs. per square inch the relative thicknesses of pavement are about 2" and 4". This supports the square root relation, because when the load is quadrupled the thickness requirement is approximately doubled. The square root of the wheel load relation is therefore substantiated and recommended for design by one of the leading authorities in the bituminous pavement field.

The complete Chapter VII on "Design of Asphalt Pavements" from the Asphalt Institute's "Pocket Reference for Highway Engineers" is reproduced below.

#### "VII. DESIGN OF ASPHALT PAVEMENTS

"129. FLEXIBILITY AND RIGIDITY.—Bituminous pavements are classified generally as 'flexible surfaces.' Actually it is possible to build asphaltic concrete and similar types so as to behave like rigid pavements, but this is not desirable because a slight yielding to meet the changing conditions of temperature and traffic is a distinct advantage in providing for greater durability and lower maintenance.

"There are two approaches to the rational design of pavements. In the rigid type it has been assumed that by constructing a slab having high tensile strength, all weak areas in the subgrade would be bridged and the load thus transferred to stronger adjacent support. Cracking occurs when this support is not provided, and in a sense it is like designing a bridge without information as to location of the piers and abutments. In the flexible type it is assumed that the pavement will be always in continuous intimate contact with the subgrade and that the load will be transmitted to it in a substantially uniform manner without the concentration which occurs under bridging action.

"There has been some misunderstanding in regard to the manner in which loads are transmitted through flexible pavements to the subgrade. When a load is applied to such surfaces through a bearing area, there are two fundamental resistances developed; one, perimeter-shear which is a function of the length of perimeter of the bearing area, and second, internal compressive resistance which is a function of the area involved. As the load is applied and for surface deflections of minor character (.00 to .05 inches), resistance to perimeter-shear develops rapidly. This rate of increase in shear resistance with small deflections may be so great that there will be a negative moment under the center of the bearing area. As loading increases, resistance due to compression becomes a factor and further deflection is opposed by the combined effect of both perimeter-shear and the pressure resistance developed in the body of the pavement. In turn, lesser intensity loads are distributed to the base and subgrade; lesser because

applied over a greater area, and because of an irregular area of loading as contrasted with the area of tire contact.

“It is evident that the ability to transmit loads most efficiently (through high shear values) will thus depend:—upon the density of surface and base, upon a high degree of internal friction between

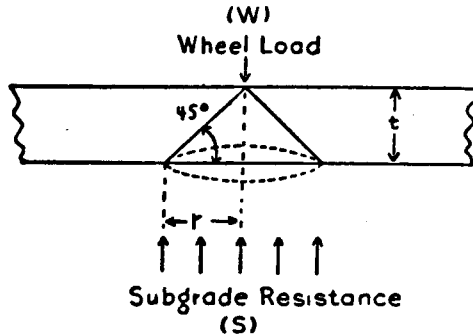

FIG. 21. DISTRIBUTION OF SURFACE LOADS THROUGH FLEXIBLE PAVEMENTS

particles or a combination of the two. The duration of load application is of great importance, as the shorter the period the more nearly does any surface behave like a completely elastic substance. This means that dynamic resistance usually outweighs any actual impact forces, and that a design which contemplates static load conditions will be entirely adequate for these same loads in motion. This has great bearing in highway and airport design where loads are fleeting in character.

“From these premises it is thus possible to proceed to a mathematical determination of thickness requirements.”

“130. DISTRIBUTION OF LOADS.—A static load applied to the surface of a stable, flexible pavement is distributed downward in a conoidal fashion. The boundary of this pressure cone is a surface which in cross-section is defined by the limiting angle of pressure distribution. This angle varies with the depth and with the applied load, but in regions of low stress (at bottom of pavement) approaches a slope of 2 to 1 (horizontal to vertical). For all practical purposes it is sufficient to assume this angle as 45°, and the area over which pressure is applied as a circle having a radius equal to the pavement depth. (See Fig. 21.) Pressure distribution over the base or subgrade while not absolutely uniform, may be so assumed for purposes of calculation and an adequate margin of safety to care for this variation will be provided by increasing the subgrade support 50% above that theoretically required.

“It is evident therefore that the pavement thickness must be sufficient to provide distribution of load over a large enough area of sub-



grade so that its total resistance shall not be exceeded. To have equilibrium the following equation is obvious.

$$W = \pi r^2 S$$

In the 45° triangle  $r = t$

$$\therefore W = \pi t^2 S$$

and  $t = .564 \sqrt{\frac{W}{S}}$

Where

- $t$  = thickness of pavement in inches.
- $W$  = wheel load in pounds.
- $r$  = radius of circle of load distribution (inches).
- $\pi r^2$  = area of circle of load distribution.
- $S$  = subgrade resistance in pounds per sq. in.

“This equation assumes application of load at a point, whereas actually it is applied over an area, this area depending upon the number and kind of tires, and their contact area when under load. The effect is to develop a higher resistance to shear and to distribute the load over a greater area of subgrade. This increased shear value and greater distribution of load exists up to a certain critical area, which is approximately 100 square inches. However, as this is about the maximum area of the tire contact under the heaviest truck loads, it is to be noted that the usual highway traffic is of a kind most favorable for development of the maximum bearing value in soils. (See Fig. 22.)

“The minimum required thickness is thus reduced as shown in the following equation:

$$W = \pi r^2 S$$

In the large 45° triangle  $r = t + e$

$$\therefore W = \pi (t + e)^2 S$$

or  $t = .564 \sqrt{\frac{W}{S}} - e$

where  $e$  = radius of tire area contact

“Fig. 23 shows the required thickness of pavement with relation to subgrade support..

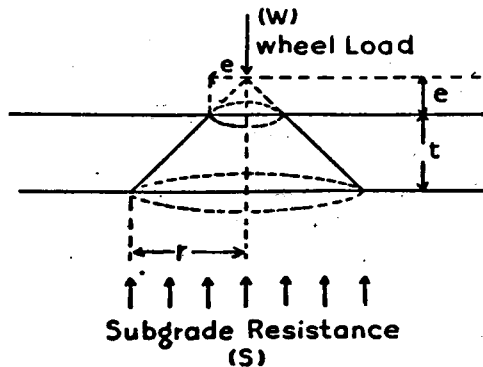

FIG. 22. EFFECT OF TIRE CONTACT ON LOAD DISTRIBUTION

“Subgrade resistance varies according to changes in moisture, and pavement thickness should be designed therefore for the most adverse condition, which is usually during early spring. Any soil at its optimum moisture content has a resistance sufficient to carry the highway load, and as reduced support comes usually from too much moisture, the first item in subgrade design is to provide adequate drainage. No matter what it costs to drain a roadbed properly, it is the cheapest method for insuring maximum subgrade support. Corrugated iron pipe or clay tile for culverts and seepage drains are both inexpensive, efficient and highly durable, while proper side ditches and an elevated roadbed should be obtained wherever possible, so as to lower the ground water level.”

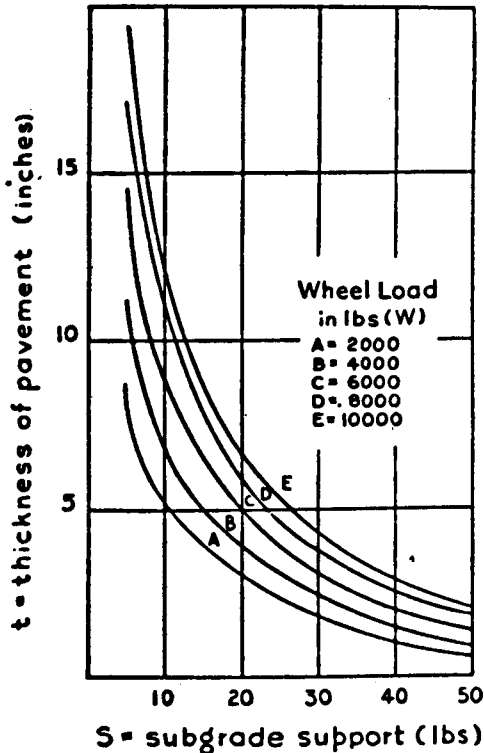

FIG. 23. THICKNESS OF PAVEMENT WITH RELATION TO SUBGRADE SUPPORT

“131. RELATION OF SUBGRADE TO DESIGN.—The design of flexible pavements thus includes two elements—the pavement itself and the subgrade upon which it rests. Economy in design can be obtained either by varying the pavement thickness according to the

natural subgrade support or by increasing the subgrade resistance through admixture of low cost aggregate, chemicals, bituminous products\* or combination thereof. Selected cheap local materials may be used to construct a course between subgrade and base. Such materials as sand-clay, disintegrated granite, tuff and pit-run gravel are employed. As a practical matter it is best practice to bring the subgrade to a uniform condition over the entire road length, so that pavement thickness will be uniform throughout and construction procedure simplified. The admixture of as little as 2 inches of stone screenings or sand to a subgrade will often change its support value from 10 lbs. to 20 lbs. or more per sq. in. thereby markedly reducing the required pavement thickness. Such possibilities are all too frequently overlooked, largely because evaluation of subgrade often is made by guess instead of by measurement. For example, from Fig. 23 it will be noted that for a 25 lb. subgrade, and a 10,000 lb. wheel load, a pavement thickness of a little over 5 inches is required, while for a 10 lb. subgrade and a 50 lb. subgrade and the same load, 12 inches and 2 inches respectively are required.

“For various types of asphalt pavements, there is usually a given thickness which is most economical to construct, by reason of either the aggregate particle size available from commercial production, or the limitations of equipment manipulation. Thus in penetration macadam, 2½ inches to 3 inches depth is best because stone can be prepared most efficiently in these sizes and asphalt can be forced into the voids in a satisfactory manner. Asphaltic concrete can be thoroughly consolidated in layers up to 4 inches depth for coarse mixes and 3 and 2 respectively for finer mixtures. Road-mix surfaces can be mixed thoroughly and spread and rolled efficiently in depths up to 3 inches, while surface treatments can be handled in amounts up to one inch depth.

“An asphalt pavement is thus designed from the surface downward, first selecting the wearing course, next the base, and finally, bringing the subgrade up to the required support. The base thickness should be determined by balancing the cost of its increased depth against the cost of raising subgrade support. Usually the base thickness is determined by the minimum thickness to which it is practicable to build it, as it is almost invariably true that it is cheaper to increase the subgrade support. For example, 4½ inch waterbound macadam base is an economical depth to construct in one layer, and would be generally employed. It is deep enough to use commercially available stone to advantage, and to be closely keyed together so that no weak area can develop. In combination with a 2½ inch penetration wearing course, it then becomes a simple matter to determine the amount of subgrade stabilization required. As a factor of safety, this subgrade support should be made approximately 50% above that shown in the table. Thus for the 7 inch pavement depth, under a

---

\* See Public Roads, May, 1936.

10,000 lb. wheel load, a subgrade support of 20 lbs. is indicated. It should be brought up to 30 lbs.

“The design of cross section for flexible pavements is also different from rigid pavements and, while a thickened edge is desirable for certain types of cold-laid mixtures and surface treatments, this is to prevent the entry of water between base and wearing course, rather than to give added support. The pavement thickness should be uniform and, if there is more danger of loss of subgrade support at the outside of a pavement, the remedy is to increase it at such points, rather than to thicken the pavement. It is necessary, however, that the base be of sufficient width so that a load applied at the edge of the surface course may be transmitted to the subgrade. This increased base width on each side should be at least equal to its depth, and as a matter of practice seldom should be less than 12 inches. The shoulder material should be brought over this widened base, so that traffic will be confined to the surface only.”

“132. BASES AND SURFACE COURSES.—The pavement proper is usually constructed in two layers, the lower layer called the base and the upper layer the surface course. This is done largely for the purpose of economy as, while the surface of a road must resist abrasion and the entry of water, the lower portion only needs to supply stability under distribution of traffic load. The relative thickness of base and surface course should be determined according to available aggregate, climate and traffic condition. As a rule the principal differences are the use in the base of larger size aggregate, a lesser volume of asphalt or both. For example, sand-asphalt uses the same aggregate but a leaner mixture for the base course, while asphaltic concrete bases contain both larger aggregate and less asphalt.

“Sometimes the base course is composed entirely of non-bituminous materials, such as waterbound macadam, portland cement concrete or sand-clay mixtures. (See Chapter X.) Macadam bases are employed under all types of surface but particularly penetration macadam and cold-laid mixtures. Sand-clay, limerock and similar bases are usually covered with heavy surface treatments.”

“133. TYPICAL CROSS SECTIONS.—A base thickness greater than 6 inches is rarely required, as it is usually possible to increase the subgrade resistance even under most adverse conditions to at least 25 lbs., for which value a total pavement thickness of 5 inches is sufficient. The surface course thickness is controlled largely by construction requirements, which include size of aggregate employed, and character of spreading and finishing operations. Mixed surface courses are usually  $1\frac{1}{2}$  to 2 inches thick when using sand and 2 to  $2\frac{1}{2}$  inches when using coarser aggregates, while for penetration macadam  $2\frac{1}{2}$  to 3 inches is required. As a general rule the base should be thicker than the surface course as more complete balance is thereby obtained. Some typical cross sections for different types, as shown in Fig. 24, will indicate these relationships.”

**“134. RELATION OF TRAFFIC TO TYPE AND DESIGN.—**  
 The several sections in Fig. 24 are not interchangeable for all conditions of traffic and climate, and there is thus brought in the selection of type for a given situation as the final item in design. In such selection, probable traffic changes within the expected pavement life should be appraised, after careful traffic surveys, and plans provided for additional pavement thickness as required. This latter procedure is termed stage construction, and often makes for great economy because of the very large difference in the traffic load upon the several classes of highways. The 10,000 lb. wheel loads are confined largely to city streets and trunk lines, and pavements thereon should be designed accordingly. Secondary and third class roads seldom have wheel loads exceeding 4,000 lbs. (a five ton truck) and, whereas for a 25 lb. subgrade a pavement thickness of 6 inches or more is required for the heaviest loading, one-half that amount is sufficient on the secondary roads.



1" hot surface treatment on  
 8" limerock base



2" macadam road-mix top on  
 6" gravel base



2½" penetration macadam top  
 4½" waterbound macadam base



2" asphaltic concrete top on  
 3" asphaltic concrete base



1½" sheet asphalt top  
 1½" asphalt binder course  
 6" p.c. concrete base



1½" sheet asphalt top  
 3½" asphaltic concrete base

**FIG. 24. TYPICAL SECTIONS**

“Thus surface treatments and road-mixes would be used for the lighter traffic situations, with asphaltic concrete, sheet asphalt and penetration macadam for heavy traffic. The selection of type within each group is largely a matter of aggregate availability rather than difference in durability. In the south where sand-clay and limerock are available, very strong bases may be constructed cheaply, and the hot asphalt surface treatment is all that is required to take abrasion and distribute the traffic load. Where excellent trap rock abounds, penetration macadam is the logical choice and similarly for coastal areas and sand mixes would be most economical, with stone or gravel types in more inland locations.

“In some cases purely local aggregates are not strong enough in themselves for a given type but are the only ones available. It has been learned that often a very small amount of imported aggregate will correct the deficiency and permit the use of local aggregates in mixtures, after first determining proportions as a result of a series of tests with the stability machine. (See 86.) Often soft stone or gravel will be substantially toughened after coating with asphalt and make satisfactory bases, while in an untreated condition they would not be suitable. Such potentialities may be developed through proper laboratory studies, which are all too often overlooked.”

“135. SURFACE TEXTURE.—In recent years much attention has been given to the non-skid character of pavement surfaces, with a marked tendency toward the construction of quite open coarse textures. This trend was emphasized until many wearing courses were being laid which were extremely porous. Recent exhaustive studies at Iowa State College have conclusively shown that the sand-paper finish usually present on sheet asphalt or asphaltic concrete has the highest coefficient of friction of all pavements. The action of balloon tires now produces a tearing action in place of the kneading action of the old hard tires, and there is now little tendency to close a pavement surface for which allowance need be made. In view of the fact that a dense surface is the most waterproof and durable, all open or porous texture surface courses should be finished with a thin but rich seal coat covered with fine aggregate. One-tenth to one-quarter gallon asphalt per square yard covered with a slight surplus of sand cover will usually be sufficient. Hot-mix surfaces and penetration macadam are exceptions as they carry such a heavy asphalt content as to be completely waterproof without sand asphalt seal coats. (See Chapter VIII.)

“One current practice in finishing sheet asphalt is definitely harmful; that of applying a dust cover to the finished surface. This cover serves no useful purpose, fills the voids between the sand grains of the surface and often covers defective construction procedure. Its requirement in specifications is a carry-over from the past when plant control was less efficient and, under no circumstances, should it be now permitted.”

“136. EDGE PROTECTION.—The practice of building portland cement concrete edging for rural asphalt pavements is not only a wasteful extravagance but also is detrimental to the pavement itself. This does not apply to urban and suburban curb and gutter construction which is an entirely different matter—where the curb is required for drainage control and sidewalk support. Except for curb and gutter construction portland cement concrete edging should be omitted. It adds nothing to the strength of the pavement and is certain to separate from it, thus permitting entry of surface water as well as retaining ground water which would otherwise drain off at the sides. Its cost is so high that either the asphalt pavement proper may be widened several feet or the entire shoulders may be of low cost asphalt construction such as surface treatment, road-mix or plant-mix for less than the cost of the edging.”

## APPENDIX J

### THEORETICAL ANALYSIS OF RELATION BETWEEN WHEEL LOADS AND THICKNESS OF FLEXIBLE PAVEMENT REQUIRED<sup>1</sup>

In approaching the problem of the relation between wheel loads and the required thickness of flexible pavements, from a purely theoretical view point, one naturally turns to the classical theory of load transmission developed by Boussinesq in 1885. According to this theory, if a load  $P$  is applied at a point on the surface of a supporting material, it will produce stresses within the material according to the following equation:

$$q = \frac{3}{2\pi} \frac{P}{z^2} \cos^3 \theta$$

wherein  $q$  is the vertical stress at any point within the material whose position is determined by its depth  $z$ , and the angle,  $\theta$ , between the vertical and a line connecting the given point with the point of load application. See Fig. 1.

The ideal material which Boussinesq had in mind when developing this theory would be best represented by a large block of steel. However, its application to other solids and to soils has given results which in general show at least a rough check with actual measurements; frequent use is made of the above formula for approximate determinations of pressures in soils.

Application of this equation is extremely simple. Assume a load of 1,000 lbs. on the surface of a pavement 8" thick. The stress on the subgrade directly under the load would be

$$\frac{3}{2\pi} \times \frac{1000}{82} \times 1 = 7.46 \text{ lbs. per sq. in.}$$

The stress 6" out from this point would be  $\frac{3}{2\pi} \times \frac{1000}{82} \times \left(\frac{4}{5}\right)^3 = 2.44 \text{ lbs. per sq. in.}$

Proceeding in this fashion to other points, a complete picture of the stress on the subgrade can be obtained, as shown in Fig. 2. Now suppose that the load is increased to 4000 lbs. A glance at the equation shows that the stress at every point on the subgrade would be quadrupled, the maximum becoming 29.84 lbs. per square inch. Or, in general, the intensity of stress increases directly with load.

Next assume that the character of the subgrade is such that the stresses produced by the thousand-pound load are about as much as the subgrade can stand. The quadrupled stresses under the

---

<sup>1</sup>Prepared with the advice of Dr. Glennon Gilboy, Associate Professor, and Mr. D. W. Taylor, Assistant Professor of Soil Mechanics, Massachusetts Institute of Technology.



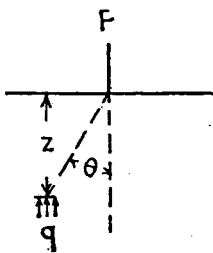

Fig. 1

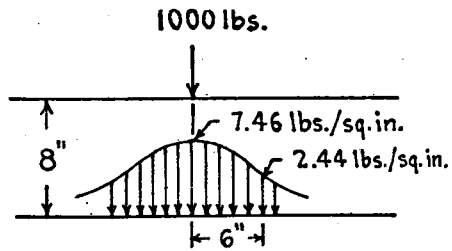

Fig. 2

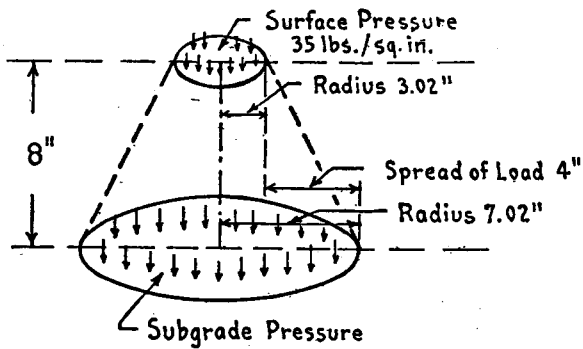

Fig. 3

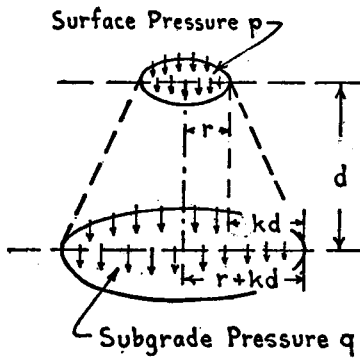

Fig. 4

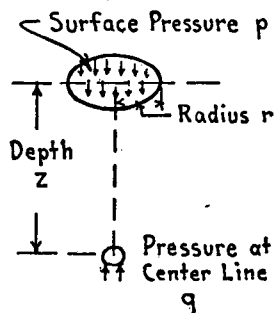

Fig. 5

4000-lb. load would, therefore, be expected to produce failure. The next question is: How much thicker should the pavement be to support the 4000-lb. load? The equation shows that if  $P$  is quadrupled,  $z$  must be doubled to obtain the same stresses. The pavement, therefore, should be 16 inches thick. Or, in general, the required thickness increases with the square root of the load.

The foregoing analysis has been based on a load applied at a mathematical point, which is, of course, a practical impossibility. A wheel load applied to a pavement is distributed over an area dependent on the characteristics of the tire. The next step is to investigate the effect of this distribution upon subgrade stresses. In particular, if tires were so designed and inflated that the 1000-lb. and the 4000-lb. loads of the previous example produced equal pressures per unit of area on the pavement, would not this equalization of surface pressure automatically produce equal stresses in the subgrade?

The answer to this question is not as easy to obtain as was the case with the point loads. However, a useful approximate solution can be developed by a method widely employed in the design of building foundations. This method consists of assuming the load to spread at a certain angle outward from the area of application, thus obtaining an average load intensity on any lower level. An illustration will make the method clearer than a mere detailed explanation.

Consider that the 1000-lb. load of the previous example is spread over a circular area such that the average pressure is 35 lb. per square inch. The area would then have a radius of about 3.02 inches. Assume a spread coefficient of  $\frac{1}{2}$ . Then at the bottom of an 8" pavement the radius would be 4" greater, or a total of 7.02 inches. The area of a circle of this radius is 154.8 sq. in. Dividing the load, 1000 lbs., by this area gives an average intensity on the subgrade of 6.46 lbs. per sq. in. as indicated in Fig. 3.

Now assume that this stress is about all the subgrade can stand, and work backward to find the thickness of pavement required for the 4000-lb. load. This load, at a pressure of 35 lbs. per sq. in., would be spread over an area of radius 6.04 inches. The radius of the subgrade area required to maintain an intensity of 6.46 lbs. per sq. inch would be 14.04 inches. Subtracting the two, the increment of radius produced by the spread would have to be 8 inches, corresponding to a pavement thickness of 16". Here again, quadrupling the total load requires doubling the thickness of pavement.

This result can be generalized by developing a simple formula. Let the average surface pressure be  $p$ , spread over a circle of radius  $r$ , and let the average subgrade pressure be  $q$ , over an area of radius  $r + kd$ , where  $d$  is the pavement thickness and  $k$  is the

co-efficient of spread. See Fig. 4. Since the total load is the same, the following relation must hold.

$$p \pi r^2 = q \pi (r + kd)^2$$

This can readily be transformed into

$$\sqrt{\frac{p}{q}} - 1 = \frac{kd}{r}$$

In this form, the equation is most instructive. If the surface pressure,  $p$ , is to be kept constant, an increase of total load merely means an increase in  $r$ ; quadrupling the load doubles  $r$ . Furthermore, if the subgrade pressure  $q$ , is to be held constant, the whole left-hand side of the equation is constant. Hence an increase in  $r$  must be exactly matched by an increase in  $d$ , *irrespective of any assumption made as to the value of  $k$* . Thus the conclusion is again reached that, for equal surface and subgrade pressures, the thickness of pavement increases with the square root of the load.

It might be argued that the simple spread assumption just outlined gives results so far from the real distribution that no valid conclusions can be drawn. In fact, however, solutions more nearly correct mathematically lead to the same general relation. For example, S. D. Carothers in "Elastic Equivalence of Statistically Equipollent Loads," Proceedings of the International Mathematical Congress in Toronto (1924), Vol. II, p. 518, gives for the maximum stress intensity beneath a circular loaded area the expression:

$$q = -\frac{p}{2\pi} \left( \omega - z \frac{\partial \omega}{\partial z} \right)$$

where  $\omega$  is the solid angle subtended by the loaded circle at the point and is equal to  $2\pi \left( 1 - \frac{z}{\sqrt{z^2 + r^2}} \right)$ , and where  $r$  is the radius of the loaded circle, which, differentiated, becomes

$$\frac{\partial \omega}{\partial z} = -\frac{2\pi}{\sqrt{z^2 + r^2}} \left( 1 - \frac{z^2}{z^2 + r^2} \right)$$

Calling compression positive and substituting the above values in the original formula, the expression becomes:

$$q = p \left[ 1 - \left( \frac{1}{1 + \left( \frac{r}{z} \right)^2} \right)^{\frac{3}{2}} \right]$$

the notation being as shown in Fig. 5.

Since the relation between  $r$  and  $z$  is a simple ratio, it is evident that for equal surface and subgrade pressures—i. e.,  $p$  and  $q$  constants—any change in  $r$  produced by a change in total load must

be matched by an equal change in  $z$ ; and, since  $r$  increases with the square root of the load,  $z$ , or the depth of pavement, must also increase with the square root of the load.

As a measure of the degree to which the strength of the subsoil is taxed, a more fundamental quantity than the direct stress  $q$  which has been used above is the maximum shearing stress,  $s$ . The formula from the theory of Elasticity for this stress caused by a point load  $P$  when Poisson's ratio is 0.5 is

$$s = \frac{3}{4\pi} \frac{P}{z^2} \cos^2 \theta.$$

A comparison of this formula with that given for  $q$  (page 129) will show that the conclusion based on that formula also holds for  $s$ . Thus, if  $P$  is quadrupled, the depth at which a given value of maximum shearing stress occurs is doubled, or,  $z$  varies as  $\sqrt{P}$ . It can also be demonstrated that this same relationship holds under loads which are distributed over finite areas, also for any given value of Poisson's ratio and in addition, when the soil is not isotropic. However, the formulas for these more complex conditions are too involved to be presented here.

The distribution of direct stress  $q$  and maximum shearing stress  $s$  below a circular area has been investigated by Dr. Leo Jürgenson<sup>2</sup> and is shown graphically in Fig. 6. Curves connecting points having equal maximum shear  $s$  are shown in the right-hand side of the diagram. Similar curves connecting points of equal direct stress  $q$  are shown in the left-hand side of the diagram. Note that values of  $s$  and  $q$  are expressed as fractions of  $p$ , the pressure intensity on the loaded area, and the depth to any given stress is expressed in terms of  $d$ , the diameter of the loaded area. That is, the depth to any given induced stress is proportional to the diameter of the loaded area. For a constant intensity of pressure  $p$ , the total load  $P = \frac{\pi d^2}{4} p$ , from which it will be seen that for different total loadings,  $P$  is proportional to  $d^2$  or conversely  $d$  is proportional to  $\sqrt{P}$ . Then since the depth to a given stress intensity is proportional to the diameter, it must likewise be proportional to the square root of the total applied load.

For example, if a load of 1000 lbs. is applied over a circle of diameter 8 inches, a direct stress of, say  $q = .20 p$  will be induced at a depth of  $1.22 d = 9.76''$  (See Fig. 6). If the load is increased to 4000 lbs. and  $p$  remains the same, the area of distribution will have to be increased 4 times. This is accomplished by doubling the diameter. For the same value of  $q = .20 p$  the depth now becomes  $1.22 \times 16 = 19.52''$ , i. e., twice what it was before. That

<sup>2</sup>"The Application of Theories of Elasticity and Plasticity to Foundation Problems," Journal, Boston Society of Civil Engineers, Vol. XXI, No. 3, July, 1934.

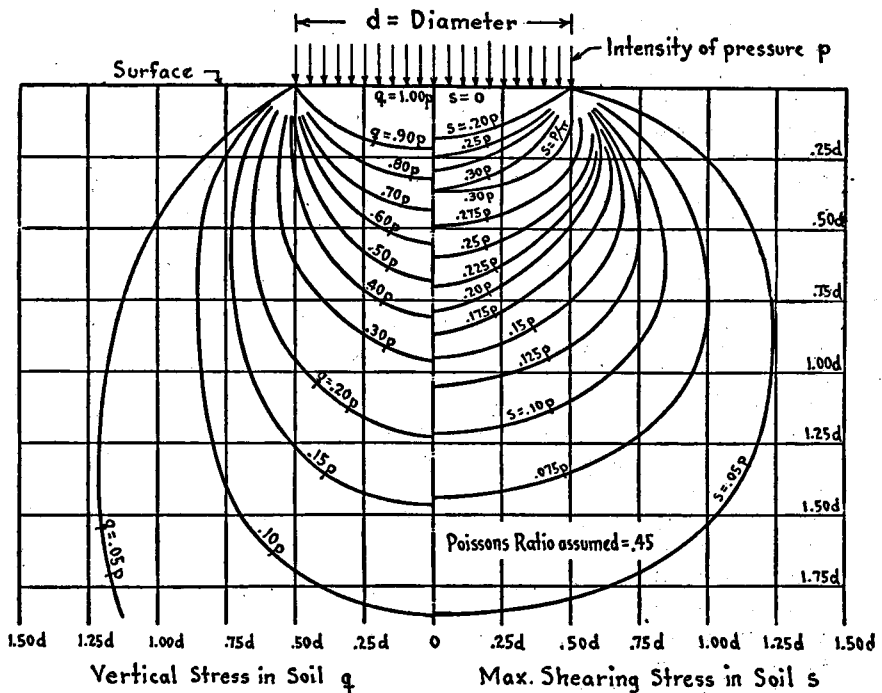

DISTRIBUTION OF STRESS UNDER A CIRCULAR FOOTING

Fig. 6

is, the depth to a point of equal stress has increased in proportion to the square root of the applied load.

A few words on the subject of bearing capacity are now in order. It has been assumed in this discussion that the subgrade could withstand a certain amount of stress, and that an excess beyond this amount would produce failure, irrespective of the area over which the stress might be applied. In other words, the subgrade stress  $q$  of Fig. 4, which has been described as the stress just causing failure, has been assumed to be a constant for any given soil and not dependent on the radius ( $r + kd$ ) of the loaded area. This assumption is reasonable for subgrades deriving the major portion of their strength from cohesion. However, it will not hold for cohesionless soils such as sand and gravel. The criterion is whether the soil is of approximately constant strength within the zone of stress, or whether it becomes stronger with depth. In isolated building foundations the zone below any footing within which appreciable stresses are caused extends down one or two times the footing diameter. Within this depth the strength of a highly cohesive soil is essentially constant. For a cohesionless soil, the

strength at any point is roughly proportional to the depth of the point. The average strength below footings on cohesionless soils therefore varies approximately as the size of loaded area. Thus, if a load of 3 tons on an area 1 foot square applied to a bed of gravel produces failure, an intensity of 9 tons per square foot, or a total of 81 tons, would be required to produce failure of an area 3 feet square. The reason is that under the larger area the stresses go correspondingly deeper, where the material is stronger.

This is of much importance in the design of building foundations, however, there are two reasons why this increase of strength of cohesionless soil does not sensibly vitiate the conclusions previously reached for highway subgrades. First, the weight of a pavement produces considerable surface strength in a sand or gravel subgrade, hence the increase in strength within the stressed zone is not as important as might at first be assumed. Second, experience proves that pavements laid on good sand or gravel subgrades seldom give trouble; the poorer clay subgrade types, which are by far the more numerous, are the ones requiring careful design; and these are the types of material to which the preceding analysis is most likely to be applied.

Up to this point of the discussion the limiting stresses considered have been stresses corresponding to complete failure. As a practical matter no road should be so designed. Rather than allow on the subgrade, the stress  $q$  which just causes failure, the allowable stress should be  $q$  divided by a reasonable factor of safety, which may be denoted by  $q'$ . Using  $q'$  as the permissible direct stress in the soil, the reasoning in the above derivations is in no way invalidated. Similarly  $s'$  may be used to denote an allowable value of maximum shearing stress and it may be concluded that with a given factor of safety, the required depth is proportional to the square root of the wheel load.

A thorough investigation into the problem should include a study of relative settlements which would occur in subgrades under various loads. To illustrate this, consider two pavements, the first carrying a load which is four times as large as that on the second, while the thickness is twice as much for the first as for the second, the two pavements being on similar subgrades. Since the square root of load is proportional to the thickness for the two cases the two are equally safe on the basis of the above discussion. However, under the larger load there is a deeper zone within which stresses, compressions and distortions occur and thus there will be greater settlement. From this viewpoint, if a given value of allowable settlement is adopted as a criterion, the law of thickness proportional to square root of load is unsafe and in the above example the second pavement would have to be more than twice as thick as the first.

Thus it appears that the best theoretical analyses now available support the conclusion derived from engineering experience that heavier vehicles require thicker pavements, even though the intensity of load on the pavement may be the same. For this case, increasing

the pavement thickness in proportion to the square root of the load seems to be a reasonable criterion. For the case of heavy trucks using inflation pressures twice to three times those of passenger vehicles, the situation is correspondingly aggravated, and pavements definitely thicker than those indicated by the square root relation appear necessary.

## APPENDIX K

### HIGHWAY USE AS AFFECTING ALLOCATION OF CAPITAL COSTS

#### VIEWS OF CLIFFORD OLDER

The principle adopted by the Joint Committee of Railroads and Highway Users, quoted on page 57, and adopted as basic in this report, states an equitable method of cost allocation, because—

1. It is obvious that all vehicles, without exception, require and use every facility necessary for the accommodation of the basic vehicle (ordinary automobile).

2. Each and every one should, therefore, share in the cost of providing the basic facility (basic road) *in proportion to its use of the facility.*

It is further obvious that if the cost assigned to the basic facility is fully adequate to provide the facilities necessary to serve every need of the basic vehicle, as we believe it to be, such vehicle should not be charged with any part of the costs of the added facilities made necessary wholly by the other classes of vehicles.

Likewise the added facilities made necessary by the second class of vehicles are required and used by all the succeeding classes as well and their costs should, therefore, be borne by the succeeding classes in proportion to their use of them. In turn, the second class should not be charged with any of the costs peculiar to the succeeding classes. This principle, of course, extends in the same way, step by step, up through all the succeeding classes.

Having determined as fairly as possible the cost of the facilities required by the various vehicles, the determination of the fair proportion of the annual capital costs that should be borne by each class of vehicle and each individual vehicle may easily be found, as in the report, by simple calculations, providing the *use* by classes of vehicles and by individual vehicles can be determined and expressed in terms of a fair common unit.

In the report the unit of use adopted is the vehicle mile. The adequacy of this unit may well be questioned. To illustrate the significance of a proper choice of the unit of use, a short section of highway will be chosen and the effect of use be analyzed. A toll bridge is selected because the relation between use and the revenue necessary to meet costs is readily visualized in such case.

In the case of the McKinley Bridge constructed over the Mississippi River at St. Louis about 25 years ago, the space between the trusses was designed and reserved for the sole use of interurban trains. On brackets outside of the trusses was built a narrow roadway on each side of the spans, thus providing for a single lane of highway



traffic in each direction which taken together correspond to a two-lane highway. There could be no passing of vehicles traveling in the same direction, which is also true in the case of a two-lane highway when the traffic in both lanes reaches a certain density. Toll was charged to compensate for the cost of adding these roadway lanes.

It is obvious that the bridge company might have designed the floor beam brackets and floor system for basic vehicles only and added only enough steel to the trusses to support the added weight of a continuous line of basic vehicles. In this case, use would be restricted to the basic vehicles. This would have involved a very definite and easily determinable annual capital cost chargeable through tolls to the basic vehicles that used the roadways. Regardless of all the intricacies of the six million dollar bridge structure, all the inducement that was offered to vehicle owners in return for the toll charge was the use of two roadway channels, strips or lanes of usable space, each of a definite width and height, and about one mile long.

The details of providing for such roadways suitable for any design and weight of vehicle follow the pattern well understood by all structural engineers. It is roughly as follows: If planned for automobiles only, the design (and cost) of the structural support immediately under the wheels would be a function of the wheel load of the basic vehicle while that of the trusses would depend upon the gross load of one basic vehicle multiplied by the number that could come upon each roadway at one time. Likewise for heavier vehicles the added cost of providing for them might easily be determined.

If the roadways were designed merely for the basic vehicle, to come out even the bridge company would then have to make the toll charge against each automobile such that the collections during the year from the users would equal the annual cost of the facilities provided for them. Suppose the traffic in each of the two roadway channels was 10,000 ordinary automobiles per day and that this included all the cars of normal length that could pass over the bridge in one day when traveling at the normal speed of such vehicles. In other words, the capacity of the roadways was equivalent to 10,000 round trips of an automobile per day and this amount of traffic used them. Then to gain the daily cost (annual cost divided by 365) the toll per car (each way) would have to be the daily cost divided by 20,000.

*Numbers.* It will be recognized at once that if in this case a certain 1,000 automobiles should each make ten round trips per day (20,000 total passages over the river) instead of 10,000 cars one round trip each per day, the 1,000 cars would consume the whole bridge capacity and the bridge company would be in the red 90 per cent of the cost unless each car was charged for each trip. This clearly illustrates the fact that the number of different vehicles alone is no reasonable measure of use.

*Vehicle Miles.* Clearly in the above case the proper charge against each vehicle of the same length that travels at the normal speed for vehicles of its class would have to be based upon the number of trips

and not upon the number of different cars registered or licensed. The same toll per car and per day would obtain if the charge for vehicles of the same class is based on a vehicle mile as the unit of use. This illustrates the vehicle mile basis of use adopted in the report. It is perhaps not altogether a satisfactory measure of use because all vehicles are not of the same length and they do not travel at the same speed. This introduces the element of road occupancy.

*Length-Number of Axles.* The length of the vehicle has an important influence upon fair charges. A commercial vehicle may have the same width and wheel load as the basic automobile and, while its gross weight might be much greater, its load per foot of length might be made the same by merely increasing length and adding axles in proportion. Such vehicle would then add nothing at all to the cost of providing the roadways for the basic vehicle and unless restricted by law (or by company regulation in the case of the bridge illustration) the vehicle in the form of a tractor-trailer combination might be of *any* length depending only upon the power plant that could be provided within the axle load limit. Now, suppose half of the vehicles using the bridge are of this type and although they might travel at the same speed as the normal vehicle, they are of such length that each uses up three times as much of the length of the roadway lane as the basic passenger automobile. In this case the total capacity of the bridge would again be cut to a gross of 5,000 vehicle round trips per day. Of these there would be 2,500 normal passenger automobiles and the same number of long vehicles. To compensate for loss of revenue, the bridge company would again either have to double the toll for all vehicles, which would obviously be unfair to the passenger automobile, or *triple* the charge for the long vehicle, which would obviously be the fair thing to do. This illustrates the fairness of multiplying vehicle miles by the number of axles supporting the vehicle.

*Length-Time Relation.* Speed determines the time of occupancy and is, therefore, an exceedingly important factor. Suppose that half of the vehicles (all of the same length and wheel load) should be so under-powered that they could maintain only 50 per cent the normal speed of the other half and that they were moving as mixed traffic. Then, in the case of the bridge illustration, only 5,000 round trips per day would consume the total capacity and the bridge company would again be in the red, this time to the tune of 50 per cent, unless it either doubled the toll on all vehicles, which would obviously be unfair, or tripled the toll charged the slow vehicles, which caused the loss of capacity, which would seem fair. Furthermore, if normally only 10 per cent of the half-speed vehicles should be on the bridge at the same time, a mixture of this 10 per cent would reduce the capacity and revenue by 50 per cent and the proper charge against the slow 10 per cent should then be 11 times that of the normal vehicle in order to place the burden squarely where it belongs and provide the necessary revenue.

It thus appears that the inverse effect of speed might properly be chargeable at a much greater rate than in direct proportion to speed reduction.

The highway utility has nothing whatever to sell except space channels or lanes and both time and space are the essence of their value to the user. Therefore, it might be argued that fair charges (stated mathematically) should increase directly with length and inversely with some power of the normal speeds of different vehicles or classes of vehicles. In other words, if a commercial or other vehicle should be both longer and slower than the normal passenger automobile, it is obvious that, in the case of the bridge illustration, the bridge company would of necessity apply a factor of speed and a factor of length in order to be fair to all users and at the same time recover the necessary costs.

The principle is believed to be rigidly correct for the conditions assumed, that is, whenever and wherever the traffic flow on a two-lane road is great enough to prevent or seriously hinder the passing of vehicles moving in the same direction. It may also be argued that it is correct, although the traffic volume on the greater part of the highway system is relatively small. For example, it is universally recognized that in the case of an office building, warehouse or rental factory it is fair to charge rent on a basis of the time and space reserved, although often they may not be enough to absorb the space available. There is no reason why the same principle should be different for highway time and space.

It then seems worth while to consider whether or not it is possible to determine a fair measure of the unit of use when both time and length (number of axles) are taken into consideration.

The length of a vehicle bears a somewhat definite relationship to its gross weight when the axle load is fixed. For example, to double the weight, the number of axles must be doubled and hence the length increased. To double the number of axles does not necessarily double the length, but practically it must very nearly be doubled if the axle load is constant. Furthermore, as the gross load is increased, the normal speed is usually decreased. Certainly this is true on hills. The double factor (speed and length), in terms of consumption of the usable space channel, varies directly with length and inversely with speed.

The ton mile suggests itself as possibly being approximately in proportion to this double factor and it is a common conception that ton miles measure use. As a test of this measure, assume that the gross weight of a passenger automobile is two tons and that of the maximum truck combination 20 tons. On the basis of ton miles as a measure of "units of use" the ratio would be as 1 is to 10, which should then be applied to the mileage as a measure of lengthtime occupancy. Comparison might be made as follows: The passenger automobile occupation of lanes as compared with that of the truck would be about as 13 feet is to 40 feet or as 1 is to 3. Now, assume that the inverse

relation of speed is as 1 to 2 (25 and 50 miles per hour). This would apparently make the total factor 6, but we have shown that an inverse speed factor of 1 to 2 should triple the fair charges for speed, even if there were as many of these trucks as automobiles. This would result in a proper unit of use as measured by length-speed responsibility in the proportion of 1 to 9, which is reasonably close to the 1 to 10 ratio found on the basis of ton miles. As a matter of fact, however, truck traffic is only about 13 per cent of the total, and this would greatly increase the ratio.

The sponsor of this Appendix believes that the ton mile as a measure of use is conservative and that it should be used instead of vehicle miles.

Buses usually operate at speeds comparable to those of passenger automobiles; hence, the speed factor does not apply. They are, however, usually from one to three times longer; hence, a factor for width should be applied.

In this Appendix, width is not considered as a factor of occupancy because, in the body of the report, the added costs due to width are allocated separately.

*Grading and Structures.* It is clear that the physical elements of grading and structures make available nothing more or less than the same usable space channels or lanes provided by the pavement. In fact, these elements are nothing more or less than a part of the basic road. When the available lanes in which the pavement on roadway surface is divided are occupied or partly occupied by traffic, the earthwork or grading and structures is correspondingly occupied. Hence, it is clear that the use made of the grading and structures by traffic is in exactly the same proportion as the use made of the pavement. The annual cost, therefore, of these items should be charged to the various vehicles on the same basis as the pavement—in other words, in proportion to whatever “unit of use” basis is selected for the pavement.

## APPENDIX I

### STUDY OF MOTOR VEHICLE SPEED IN MASSACHUSETTS

In 1934 the Massachusetts Accident Survey made an extensive study of motor vehicle speeds, distinguishing between passenger cars, light trucks, heavy trucks, and buses. Figure 7 shows typical results of this investigation for three different road conditions; straight-a-ways, hillcrests, and sharp curves. On straight roads light trucks travel on the average 2.4 miles per hour slower than passenger cars and heavy trucks 6.3 miles per hour slower. Buses, on the other hand, travel about 1 mile per hour faster than passenger cars. At hillcrests the light trucks run 2.5 miles per hour slower and the heavy trucks 7.9 miles per hour slower than passenger cars.

The speed distribution curve for hillcrests shows that about 12 per cent of the heavy trucks travel at from 10-15 miles per hour which is slower than the slowest passenger car recorded. Buses are also slowed down by hills and average 5.4 miles per hour slower than passenger cars. The retarding effect of hills on the different types of vehicles was as follows: passenger cars slowed down 14%, light trucks 15%, heavy trucks 22%, and buses 30%. On curves the different types of vehicles have about the same speed difference between them as on straight-a-ways, but the general speed of all traffic is slowed down about 8 miles per hour. The buses show a lesser tendency to slacken speed on curves than do the other types.

*Necessity for Multiple Lane Roads.* Because of the difference in speed of vehicles and particularly because of the slow speed of heavily loaded trucks extra lanes are required to prevent repeated delays and congestion resulting from the difficulty which the faster more mobile passenger cars have in readily passing the slower vehicles. Dean A. N. Johnson of the University of Maryland determined the working or free moving capacity of a 2-lane road as 1,000 vehicles per hour. His investigations were carried on largely during peaks in passenger car traffic and do not reflect the influence of trucks. Highways with a high percentage of trucks are now commonly built with 4 lanes even when the hourly flow seldom reaches 1,000 vehicles per hour.

A study of truck delays made by Professor C. B. Breed, showed considerable inconvenience and delay caused by trucks on a 2-lane road when the hourly flow was only about 250 vehicles. The effect of the slower trucks is to collect a line of cars waiting for opportunity to pass. This occurs especially where the alignment is crooked and the profile hilly. There may be long stretches of unoccupied road between these groups of vehicles, so that an observer standing by the road side would not get the impression that the road was congested, but the actual effect on vehicles trailing behind the trucks on this

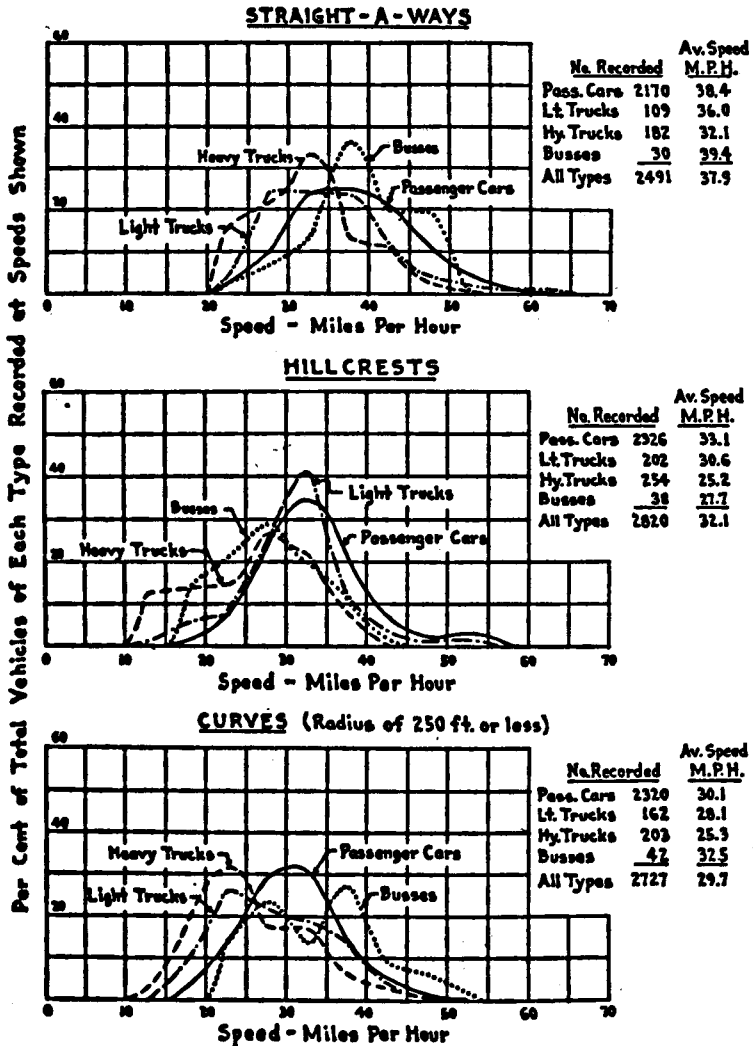

FIGURE 7

SPEED RANGE DIAGRAMS — COMPILED FROM RECORDINGS AT SIX TYPICAL LOCATIONS ON MASSACHUSETTS STATE HIGHWAYS FOR EACH ROAD CONDITION

road is the same as though general congestion was present. This congested condition often lasts several minutes and covers a number of miles until conditions favorable to passing are encountered.

This condition is particularly acute on grades where over-loaded trucks often cannot travel more than 5 to 10 miles per hour. These locations are usually marked with restricting center lines so that it is a violation of the traffic law to pass even if no opposing traffic is present. For safety 3-lane roads are commonly restricted to 2-lanes at summits by painting a white line along the middle of the middle lane so that the center lane which is usually available for passing slower vehicles cannot be used.

To relieve this situation, Massachusetts has in certain instances widened some of its 3-lane roads to 4 lanes at summits. The policy of widening 2- and 3-lane roads to 4 lanes at summits is being seriously considered by many States on roads where 2 or 3 lanes are ample for passenger car traffic alone. Obviously, the motor truck and the bus have a special responsibility for widening at hill tops and for the early adoption of multiple lane roads in general on commercial highways. These widenings are often very expensive.

*Delays and Inconveniences Caused by Motor Trucks.* In the foregoing discussion the delays and inconveniences caused by trucks on grades and curves have been pointed out. In order to obtain some quantitative data on this subject, a series of tests was run on 2-lane roads in Massachusetts. These tests were run on 18- and 20-foot roads typical of the period 1921-1932 with frequent curves and grades but not excessively hilly or crooked. The tests were made by attempting to drive at the normal speed for passenger cars on these roads and noting the delays caused by speed reduction on account of overtaking trucks or passenger cars or any other condition causing delay. The runs were made on a Monday in December, 1935, when traffic was light, amounting to only about 200 vehicles per hour. (Figure 6.)

These tests showed the following results:

1. Motor trucks were frequently trailed by one to three vehicles waiting for a chance to pass even when the density of traffic was not over 200 vehicles per hour including both directions of traffic.
2. Difficulty in passing motor trucks was the largest source of delay. On the average, these delays amounted to about twice those caused by overtaking and passing passenger cars.
3. Delays on account of railroad crossings, villages or intersection were less than those incurred in overtaking and passing either passenger cars or trucks.
4. On account of the difference in speed, a minute spent in trailing a truck on the average resulted in three times as much delay as a minute spent following a passenger car.
5. Passenger cars were frequently forced to travel on the unpaved shoulder in passing trucks on an 18-foot surface. When two trucks

passed each other they had to use both shoulders to get their desired clearance. The 18-foot surface was definitely inadequate for motor truck traffic.

6. Passenger car drivers were observed to take chances rather than wait behind trucks for a safe opportunity to pass.

7. Motor trucks were observed to obstruct the view of hazardous conditions along the road, such as railroad crossings, curves and intersections, thereby cutting off warning of these conditions from the trailing vehicles.



**APPENDIX M**  
**FEDERAL APPROPRIATIONS FOR HIGHWAY PURPOSES—**  
**YEARS 1917 TO 1937**

(Source: United States Government Reports)

Fiscal year in which appropriation became available	Federal-aid highway			
	Regular Federal-aid funds	Emergency and relief funds	Value of surplus war materials distributed	Total
1917	\$5,000,000	.....	.....	\$5,000,000
1918	10,000,000	.....	.....	10,000,000
1919	65,000,000	.....	.....	65,000,000
1920	95,000,000	.....	.....	95,000,000
1921	100,000,000	.....	\$100,000,000	200,000,000
1922	75,000,000	.....	17,110,751	92,110,751
1923	50,000,000	.....	22,663,235	72,663,235
1924	65,000,000	.....	58,111,836	123,111,836
1925	75,000,000	.....	8,978,412	83,978,412
1926	75,000,000	.....	8,160,801	83,160,801
1927	75,000,000	.....	9,574,965	159,574,965
1928	75,000,000	.....	.....	75,000,000
1929	75,000,000	b \$5,197,294	.....	80,197,294
1930	75,000,000	b 3,654,000	.....	78,654,000
1931	125,000,000	c 83,051,936	.....	208,051,936
1932	125,000,000	.....	.....	125,000,000
1933	125,000,000	c 120,000,000	.....	245,000,000
1934	a	d 400,000,000	.....	400,000,000
1935	a	e 143,143,175	.....	143,143,175
1936	125,000,000	f 500,000,000	.....	625,000,000
1937	125,000,000	.....	.....	125,000,000
<b>Total, 1917-37</b>	<b>\$1,540,000,000</b>	<b>\$1,255,046,405</b>	<b>\$224,600,000</b>	<b>\$3,019,646,405</b>
Amount deducted from regular Federal-aid fund in 1933, account of emergency loan of \$80,000,000 in 1933.....				16,000,000
Total appropriations—Federal-aid highways.....				\$3,003,646,405
Federal appropriations for highways other than Federal-aid:				
Highways in National parks, forests, public lands and Federal reservations				244,038,800
Mt. Vernon Memorial Highway.....				7,200,000
Arlington Memorial Bridge.....				12,000,000
Inter-American Highway.....				1,125,000
International Highway Congress.....				55,000
<b>Total.....</b>				<b>\$264,418,800</b>
<b>Total Federal appropriations for all highways.....</b>				<b>\$3,268,065,205</b>

a No regular Federal-aid appropriations made for 1934 and 1935.

b For emergency flood relief damages to highways.

c Includes \$3,051,936 appropriated for flood relief. It also includes an emergency appropriation of \$80,000,000 approved December 20, 1930, allocated as a loan to the States for matching Federal-aid and to be repaid over a period of five years beginning in 1933 by deductions from future Federal-aid allotments. The \$120,000,000 in 1933 was also allotted as a loan to match Federal-aid funds and was to be repaid over a period of ten years beginning in 1938 by deductions from future Federal-aid allotments. In 1933, about \$16,000,000 was deducted from the regular Federal-aid allotments as the first repayment on the \$80,000,000 loan, but under the Hayden-Cartwright Act, 1934, repayments of the remaining \$64,000,000 and of the entire \$120,000,000 were rescinded.

d Authorized by the National Industrial Recovery Act, 1933.

e Includes \$10,000,000 for emergency flood-relief for highways, and \$100,000,000 appropriated (\$200,000,000 authorized) for highway construction under the terms of the Hayden-Cartwright Act, 1934, and \$33,143,175 Loan-and-Grant funds made by the Public Works Administration in 1934 and 1935.

f Amount actually allocated according to provisions of Emergency Relief Appropriation Act of 1935. Of this amount \$200,000,000 was allocated for highway purposes, \$200,000,000 for grade crossing work and \$100,000,000 was provided as unappropriated balance of the \$200,000,000 authorized by the Hayden-Cartwright Act, 1934 (see note e). The Emergency Relief Appropriation Act authorized the allocation of an amount not to exceed \$800,000,000 for highways, roads, streets, and grade crossing elimination.

Notes: Table 3 does not include the sum of \$500,000 appropriated by Congress in 1912, prior to the enactment of the Good Roads Act of 1916, for the purpose of aiding the states in improving rural post roads. The appropriation of 1912 provided "That the State or local subdivision thereof in which such improvement is made under this provision shall furnish double the amount of money for the improvement of the road or roads so selected." (Public—No. 336—62d Congress, Post Office Appropriation Act—Approved August, 24 1912).

**APPENDIX N**  
**HIGHWAY BONDS OUTSTANDING—YEARS 1904 TO 1932**

Year	State highway and bridge bonds <i>a</i>	County highway and bridge bonds <i>b</i>	City street bonds <i>c</i>
1904	\$4,525,000	.....	\$256,267,042
1905	4,825,000	.....	266,493,219
1906	5,701,000	.....	308,204,813
1907	7,073,000	.....	334,823,179
1908	18,036,000	.....	370,975,948
1909	20,007,500	.....	424,612,232
1910	26,467,500	.....	462,175,265
1911	38,747,000	.....	479,616,523
1912	53,319,000	\$202,007,776	495,974,447
1913	82,544,000	229,403,355	.....
1914	93,264,000	229,438,582	.....
1915	111,958,500	.....	562,823,268
1916	123,578,000	.....	618,279,057
1917	139,915,000	.....	657,008,598
1918	147,101,500	.....	711,993,298
1919	176,645,000	.....	706,962,058
1920	212,147,900	.....	.....
1921	272,205,100	876,738,200	.....
1922	410,702,600	.....	.....
1923	472,868,300	.....	747,031,699
1924	549,684,750	.....	874,068,767
1925	700,575,850	.....	1,055,048,135
1926	765,677,950	.....	1,186,587,201
1927	857,314,950	.....	1,318,003,889
1928	892,539,150	.....	1,389,964,174
1929	1,008,856,150	1,826,924,000	1,538,215,258
1930	1,151,571,820	1,809,032,034	1,711,350,325
1931	1,226,934,601	1,764,985,210	1,736,093,708
1932	1,277,204,775	.....	1,599,258,151

*a* State highway and bridge bonds from records of U. S. Dept. of Agriculture, Bureau of Public Roads.

*b* County highway and bridge bonds from following sources: Years 1912 and 1913 from Bulletin No. 136, U. S. Dept. of Agriculture; years 1914 and 1921 from Bulletin No. 1279, U. S. Dept. of Agriculture; year 1929 from statement by Bureau of Public Roads entitled "Local Road Bonds Outstanding—1929 and Interest Rates"; years 1930 and 1931 were developed from data published by Bureau of Public Roads showing bond receipts and bond payments.

*c* City street bonds from reports of U. S. Dept. of Commerce, Bureau of the Census, covering cities having population of over 30,000. Bonds for cities having between 2,500 and 30,000 population estimated by Bureau of Railway Economics. (For method of estimating, see "An Economic Survey of Motor Vehicle Transportation in the United States," Appendix N, Table IV, p. 206—Bureau of Railway Economics, Special Series No. 60).

**APPENDIX O**  
**STATE MOTOR-VEHICLE RECEIPTS AND MOTOR-FUEL TAXES—**  
**YEARS 1901 TO 1935**

Source: United States Department of Agriculture, Bureau of Public Roads)

Year	Registration fees (Registration and other fees combined)	Motor-fuel tax receipts (Gross receipts less refunds)
1901	\$954*	.....
1902	1,082	.....
1903	26,865	.....
1904	33,411	.....
1905	62,509	.....
1906	192,706	.....
1907	335,624	.....
1908	486,380	.....
1909	942,675	.....
1910	2,234,913	.....
1911	3,967,475	.....
1912	5,661,043	.....
1913	8,192,253	.....
1914	12,382,031	.....
1915	18,245,711	.....
1916	25,865,369	.....
1917	37,501,233	.....
1918	51,477,419	.....
1919	64,697,255	\$1,022,514
1920	102,546,212	1,363,902
1921	122,478,654	5,382,111
1922	152,047,824	12,703,088
1923	188,970,992	38,566,338
1924	225,492,252	80,442,295
1925	260,619,621	148,358,087
1926	288,282,352	187,603,231
1927	301,061,132	258,838,813
1928	322,630,025	304,871,766
1929	347,843,543	431,311,519
1930	355,704,860	493,865,117
1931	344,337,654	536,397,458
1932	324,273,510	513,047,239
1933	302,694,065	518,195,712
1934	304,923,000	565,027,000
1935	322,776,536	616,851,671
1936	359,783,000	686,631,000
1937	399,613,000	756,930,000
Total to end of 1937	\$5,258,390,140	\$6,157,408,861

\* New York State, only.

NOTE: Latest revised figures used throughout this table.

**APPENDIX P**  
**STATE OF INDIANA**  
**AMOUNTS LEVIED FOR RURAL HIGHWAYS IN THE AGGREGATE**  
**AND ON A PER CAPITA BASIS, 1900 TO 1920**

Year	Population	Amount levied for rural highways	Amount per capita
1900	2,516,463	\$3,662,657.82	\$1.46
1901	2,534,903	3,885,075.85	1.53
1902	2,553,345	2,182,748.76	.85
1903	2,571,786	3,742,683.64	1.46
1904	2,590,227	2,318,127.22	.89
1905	2,608,669	3,666,551.89	1.41
1906	2,627,110	4,741,299.41	1.80
1907	2,645,551	5,131,793.53	1.94
1908	2,663,993	5,655,107.54	2.12
1909	2,682,434	6,157,992.00	2.30
1910	2,700,876	7,239,111.28	2.68
1911	2,723,827	7,700,248.04	2.83
1912	2,746,779	8,419,759.74	3.07
1913	2,769,730	9,508,546.80	3.43
1914	2,792,681	11,236,416.28	4.02
1915	2,815,633	9,621,379.25	3.42
1916	2,838,584	12,157,680.46	4.28
1917	2,861,535	12,170,493.66	4.25
1918	2,884,487	13,798,739.33	4.78
1919	2,907,438	14,270,777.71	4.91
1920	2,930,390	16,476,721.42	5.62

## APPENDIX Q

### Road Occupancy with Mileage Factor

equals Width × Height × Length × Time to travel Length × Mileage Factor

For Passenger Car	$5.7 \times 5.7 \times 13.5 \times \frac{13.5 \times 3600}{5280 M}$	$\times 1.00 = \frac{4030}{M}$	; Annual Mileage = 7,000, Factor = 1.00
For Truck (3-5 Tons Cap.)	$8.0 \times 10.5 \times 25.0 \times \frac{25 \times 3600}{5280 M}$	$\times 3.58 = \frac{12,800}{M}$	; " " = 25,000, " = 3.58
For Maximum Combination permitted in many States (A.A.S.H.O. Code limits)	$8.0 \times 12.5 \times 45.0 \times \frac{45 \times 3600}{5280 M}$	$\times 5.00 = \frac{690,000}{M}$	; " " = 35,000, " = 5.00

$M = \text{Speed in Miles per Hour}$

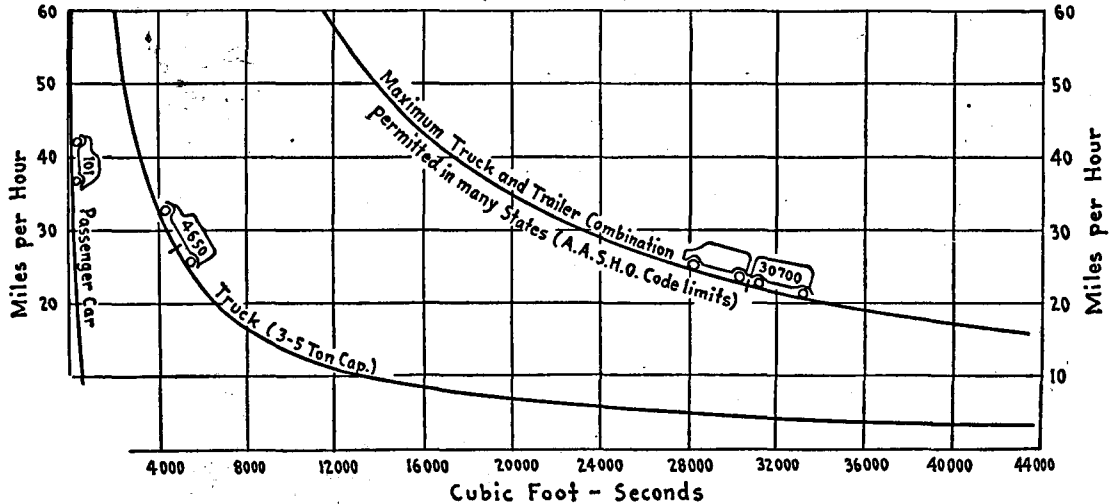

**ROAD OCCUPANCY WITH MILEAGE FACTOR**