

Dhananjayrao Gadgil Library



GIPE-PUNE-011350

LEADERSHIP IN A FREE SOCIETY

LEADERSHIP IN A FREE SOCIETY

A STUDY IN HUMAN RELATIONS BASED ON AN ANALYSIS
OF PRESENT-DAY INDUSTRIAL CIVILIZATION

BY

T. N. WHITEHEAD

ASSISTANT PROFESSOR, HARVARD GRADUATE SCHOOL OF BUSINESS ADMINISTRATION
LATE SCIENTIFIC OFFICER TO THE BRITISH ADMIRALTY

LONDON
OXFORD UNIVERSITY PRESS

1936

X:981

G6
11350

PRINTED AT THE HARVARD UNIVERSITY PRESS
CAMBRIDGE, MASS., U. S. A.

TO

ELTON MAYO

“WHAT HE UNDERTOOK THEREBY BECAME IMPORTANT”

PREFACE

ORDERLY society is based upon routine, custom and habitual association. These characteristics are the necessary foundation for human initiative and for the effective experience of individual adventure. The rise of modern technology has resulted in a new type of progressive society, and it has yet to be demonstrated whether under modern conditions social living can retain the stability needed for human satisfaction. More precisely, the practical problem is to investigate the type of social structure which can maintain itself whilst adapting its form to the ceaseless advance of material invention.

That is the problem with which this volume is concerned. It is written for those who seek a solution in intelligent evolution based on a faithful analysis of the observable facts, rather than in some radical departure from accustomed procedures.

Three characteristics of our civilization appear important to the present problem. First, we have the technical skills to produce a sufficiency of commodities not only to provide for the physical necessities of every man, woman and child, but also to provide them with a physical environment in which satisfying social relationships might be developed. Secondly, an industrial organization has been developed around these technical skills with little regard for the human satisfactions, and consequently adequate social living has not in fact developed to the degree which is possible, given our technical skills. The third factor is not that of greater knowledge, but the rise of technical procedures for a continuous *advance* in knowledge and especially in its practical applications. For the first time, the human race has set itself the problem of combining the stability of routine with adaptations to fast and continuous change. The possible extension of civilized living, as we understand it, depends upon the

ability of society to maintain a just balance between these two conflicting tendencies. The problem centres itself somewhere in the activities of business and industry.

The economic institutions of an industrial community are at once its chief danger and its best hope. These represent the most widespread and developed examples of orderly human association, and they are also directly responsible for the disorders resulting from rapid changes in everyday living. Consequently, the present essay is largely concerned with the impact of business and industrial institutions upon society at large. And if little explicit attention is given to less organized activities, such, for example, as art and individual expression, this is not through any doubt as to their importance for human satisfaction, but because the central problem at the moment appears to lie in the organization of industry and in its wider relations to society.

Even with this limitation, the subject is too vast for systematic treatment in one volume or by one author. Instead of attempting this impossible task, it has seemed wiser to consider a few typical problems and situations, and so by a judicious selection to present a picture which shall be sufficiently representative of the whole.

In Part I, the relations of business to social activity are considered, with particular attention to systematic studies of the functioning of working groups and to the place of leadership in collective action. Part II has a wider scope, and seeks to illustrate the ceaseless interaction between human motives and the shape and development of organized institutions. These two parts are not sharply distinguished, and in general the drift is from more restricted to broader considerations. Part III consists in a short restatement of the original problem as an outcome of the present inquiry.

It is impossible to write a book without becoming acutely aware of an indebtedness both to previous writers and to one's colleagues and associates. Effective thinking is to a large extent

a social process; it results from an interaction between members of a group, each contributing his individual experiences and attitudes to the common stock.

I have had the good fortune to work with colleagues who, from various angles, have been investigating the problems connected with human association, and especially as these relate to industrial communities. A working collaboration including physiologists, social anthropologists, sociologists, psychologists, those investigating various aspects of business administration, and industrial administrators, cannot fail to provide the conditions for a liberal education. My debt is correspondingly great. It is also difficult to define; for it is not so much a matter of acknowledging this or that specific idea, as of recognizing the degree in which the attitude of any one member is an outcome of a collective enterprise.

For the particular form in which this essay has taken shape, and for the opinions expressed, I cannot hold my colleagues responsible, but if there is any merit in this presentation it must be regarded as an individual expression of a genuinely social activity.

I owe too much to the inspiration of Professor Elton Mayo not to mention his name. It is not easy to express a real obligation without either appearing perfunctory where more is intended, or failing in a decent reserve. My colleagues will understand me when I say that without Elton Mayo's genius for integrating the activities of a working group, and without his unfailing generosity in putting his ideas and wisdom at the disposal of his followers, some of us, I in particular, would have had no insight by which to approach the critical problem of a civilization committed for the first time to a continuous technological evolution, with all that implies in the way of skilled social readjustment.

I am indebted to the editors of the following periodicals for permission to make use of the articles listed below. The four following articles, by the present author, were originally published in the *Harvard Business Review* and have been incorpo-

rated, with suitable alterations, into the present book: *Planning Standardized Components to Secure Variety in Products*, April, 1932; *The Scientific Study of the Industrial Worker*, July, 1934; *Human Relations within Industrial Groups*, Autumn, 1935; *Leadership within Industrial Organizations*, Winter, 1936. A fifth article, *Social Relationships in the Factory: A Study of an Industrial Group*, was published in *The Human Factor*, November, 1935, and has been extensively used in Chapter III. I am similarly indebted to Messrs. McGraw-Hill Book Company, New York, for consenting to the quotation in Chapter VIII from *Personnel Administration* by Tead and Metcalf, and to the editor of the *New York Times* for the quotation in Chapter XV from an address by President Lincoln, first published in that paper on the 12th of February, 1936.

Finally, my thanks are due to Miss Helen M. Mitchell for the various diagrams in this book, and to Mrs. T. H. Thomas for revising the proofs and providing the index.

T. N. WHITEHEAD.

Cambridge, Massachusetts
March, 1936

CONTENTS

PART I

THE FOUNDATIONS OF AN INDUSTRIAL SOCIETY

I. INTRODUCTION	3
I. Societies possess structure. Primary and secondary groups, their characteristics. Higher order primary groups, the factory, the nation. Formal and informal organizations, their characteristics.	
II. Social relationship, social action and social sentiment. A typical social act, example and characteristics. The connection between social acts and social sentiments.	
III. The insufficiency of the economic motive, taken alone, as an explanation of human action. The relatedness of factors influencing action. Boredom in work as an example of this. The opposing tendencies to maintain customary procedures, and to build up new combinations of ideas and sentiments influencing action.	
II. BUSINESS; THE ORGANIZATION OF SOCIAL ACTIVITY . . .	14
The economic purpose of an industrial plant. The social purpose of business. Employee attitudes; their dissatisfactions, trade agreements. The dual function of all major social activities. Business activity as a social process organized round the manufacture, circulation and consumption of commodities together with a reverse circulation of money. The concern of people for one another as an essential element in business activity; an illustration, the function of gold in an industrial society. An example of an embryonic business organization. An intermediate stage; trade in the Melanesian Archipelago. Business as <i>the</i> universal pattern of stable social organization.	
III. THE RELAY TEST GROUP	32
A study of a small industrial group over a period of five years. Researches in the human problems of industry by the Western Electric Company, U. S. A. The Relay Test Group, objects and nature of the experiment. Detailed description of relations between the employees, their sentiments and work activities. Work as a thread in the pattern of social living.	
IV. THE MEANING OF SOCIAL INTEGRATION	54
A study of another industrial group by the Western Electric Company; the Bank Wiring Group. The relations between employees, and between these and management, as related to work behaviour. Group sentiments and activities with particular reference to industry, and also in other situations. The social values and 'meanings' of skills and occupations.	

V. THE EVOLUTION OF MODERN LEADERSHIP 68

Simple forms of leadership, their characteristics. The skills of such leaders, their function in maintaining social integration. An example, the leading mechanic. The impact of technological advance on social custom. The gradual rise of logical thinking as a factor guiding social activity, the loosening of social custom and sanction. The growth of systematic invention and discovery; its consequences for society. The rise of modern leadership; the administrator. The problem of maintaining social cohesion during continual change.

VI. THE SOCIAL FUNCTION OF THE ADMINISTRATOR 82

I. The contrast between the simple leader and the modern administrator. The tendency for the latter to neglect the factor of leadership. The danger to society of this neglect.

II. Social well-being depends on the performance of purposeful activities which are simultaneously satisfying to the social sentiments. The administrator must lead to this end if his activities are not to disrupt social cohesion. Social customs and sentiments as a part of the data to which administrative logical thinking should be directed.

PART II

THE DEVELOPMENT OF AN INDUSTRIAL SOCIETY

VII. THE PROBLEM OF THE SMALL INDUSTRIAL GROUP 95

Two important sources of social discontent. The social inadequacy of typical industrial conditions. The behaviour and sentiments of industrial groups in such a situation. The need for adequate leadership by management. Ways in which management might assist their working groups to become integrated. The position of the junior supervisor with respect to his group and to management. The difficulties of his position. An alternative attitude on the part of management leading to a closer co-operation with the junior supervisor. Employee interviews by the Western Electric Company. The typical employee's fear of management. The training of the young supervisor.

VIII. PROGRESSIVE MANAGEMENT 108

The necessity for continual change in industrial occupations. The conditions for achieving change whilst maintaining integration. Making the necessity for change visible to those affected. Increasing the working group's scope for initiative. The reorganization of junior supervision. Evidence of initiative at this level habitually ignored by management. Vertical and horizontal organization within industrial plants. The type of initiative required by working groups. Keeping the formal organization in line with the actual activities involved. The difficulty of expressing social sentiments.

CONTENTS

xiii

IX. THE FINANCIAL REWARD 121

The satisfactions of money. 'Means' and 'ends,' all familiar objects are both at the same time. Incentives to activity; an eagerness for social participation and a fitting reward. The neglect of the former in modern industry and the over-emphasis of the money reward. Two principles relating to wage payments in industry; the social justice of the wage; the method by which it is computed is designed to provide a maximum of motivation. The social implications of the latter principle. Its effect on employee sentiment. The employee's reaction to his 'motivation' as related to his other sentiments regarding management. The over-complication of money wage systems. The financial reward as emphasizing the individual's social participation and status.

X. THE CARE OF PERSONNEL IN INDUSTRY 135

A review of progressive managerial policy with respect to employees. Evidence of managerial concern for employees, but little recognition of employee social sentiments as these relate to the actual work conditions. Employee representation, its function and its limitations.

XI. THE FUNCTION OF TRADE UNIONS 141

Two complementary ways in which the functions of an organization may be understood. The rise of trade unions in Europe resulting from a failure of industry to organize the new proletariat as an integral part of society. The social function of unions in Europe. The difference between unions on the Continent of Europe and those in England. The social integration of the working class. The favourable social situation of early industrial labour in the United States. The growth of unions in that country as a development of strike committees. The characteristics of these unions. The social situation of later immigrants into the United States. The consequent evolution of unionism in that country. The functions of any active human organization.

XII. THE ORGANIZATION OF A COMMUNITY 157

The dual function of a satisfying social activity; immediate social intercourse, the continuance and development of social living into the future. Occupations in which the latter function is inadequately performed; the bricklayer as an example. Security in such occupations involves the stabilization of industry as a part of an organized society. The function of stable organizations in an integrated society. The place of leading occupations and persons in such organizations. The decay of stability in modern society. The divorce between industrial firms and society at large. The business executive's function of leadership. The need for a closer integration between business firms and other social activities. Methods by which this could be promoted, consequently greater stability all round.

XIII. THE RISE OF FASHION AND THE CONTROL OF CONSUMER DEMAND	177
<p>Style as applied to manufactured articles. The pre-industrial meaning of style; modern emphasis on frequent change. Fashions. The evolution from social control in consumer demand to following the 'Joneses.' The social significance of this change, and its effect on the predictability of consumer demand. The reduction of variation in demand as between individuals at any one time. Modern advertising; the regimentation of an otherwise unpredictable demand. The limitations of advertising as a control of consumer demand.</p>	
XIV. THE PLANNING OF ENGINEERING DESIGN TO SECURE A VARIETY OF PRODUCTS	191
<p>Mass production has developed in such a way as to result in a rigid standardization of the end product; the consumer's commodities. An alternative planning of the component parts of these commodities to produce a wider range of consumer's commodities without losing the economies of standardized manufacture. The possibilities of this alternative are discussed.</p>	
XV. A NOTE ON THE RELATIONS BETWEEN INDUSTRY AND GOVERNMENT	202
<p>The dual attitude of business towards government: on the one hand, the former asks for complete independence, and, on the other hand, it asks for co-operation. Some functions of laws: the expression, clarification, emphasis, and implementing, of public opinion. Government can be no substitute for social consciousness. The prerequisite of an adequate public opinion. Government in an under-organized industrial society.</p>	
XVI. SOCIALISM AND OTHER SOCIAL SYSTEMS	211
<p>Some admitted defects of competitive societies as they are found in practice. Socialism as an instance of radically different alternatives. The socialistic system briefly described. This system is logically as coherent as our own, probably more so. The possibilities and limitations to individual satisfactions in a socialistic industrial state are unknown, and cannot be adequately estimated. Radical departures from customary organization in the past have not, on the whole, resulted in either the anticipated advantages or disadvantages. The possibility of changing an industrial society from a capitalistic to a socialistic organization. Gross underestimation of the degree in which wisdom in action is dependent on customary procedure. The desirability of evolving step by step from the present situation in the light of actual circumstances. All that can be asked of human foresight in complex situations is a general sense of direction, subject to modification by experience.</p>	

CONTENTS

PART III

CONCLUSION

XVII. RESTATEMENT OF THE PROBLEM 225

Section I. Industry has developed with an implied assumption that its activities would not greatly disturb the orderly run of society. This assumption is found to be false.

Section II. Individual liberty v. collective activity. A false anti-thesis. Individual liberty consists in the opportunity to make one's chosen, but fitting, contribution to a worth-while society.

Section III. Three forms of social disintegration: a bifurcation in the personal stream of social activity; unassociated groups within one society; a poverty of the personal stream of social activity. A short description of these three forms.

Section IV. The financial cost of social disintegration to the nation, and to the individual firm. National under-employment a condition of social unbalance; effective leadership lags behind its human resources.

Section V. Wisdom in action depends upon the continuance of understood ways of life. These latter are slight generalizations of concrete experience. The kinaesthetic way of life of the manual worker. The more intellectual way of life. The contemporary drift towards the latter. The human desire for orderly, i.e., understood, complexity of human associations. The limits within which the individual can understand new situations in terms of old.

Section VI. The motives of social activity. The satisfactions of an income. The need for occupations judged to be worth while. The preference for particular techniques. The immediate social satisfactions. The relation of these motives to codes of behaviour and conceptual schemes, i.e., to ways of life. The complexity of human motives and activities; their mutual dependence.

Section VII. The dominance of business firms has depressed other forms of social organizations. Hence the need for the former to assume their social responsibilities.

Section VIII. The ideal of a democratic society. The implications of this type of society. The need for widespread social responsibility. The spread of leadership in a truly democratic society. A particular form of social organization may permit of democratic control; it only achieves this to the extent to which each individual assumes personal responsibility for the conduct of affairs, and manifests social wisdom in action.

INDEX 261

PART I
THE FOUNDATIONS OF AN INDUSTRIAL
SOCIETY

CHAPTER I

INTRODUCTION

I

It is a commonplace to observe that human beings almost invariably live in groups or societies possessing a more or less determinate structure. An amorphous mass of men never remains united in actual practice; such a group would have no cohesion and so no likelihood of endurance. Perhaps a mob comes as near as any assembly to being an undifferentiated mass with a single will and action, and even here the presence of the mob is explicable only in terms of their various habitual associations. Mobs do not remain in being for many hours; either they develop structure or they dissolve. Very few mobs have ever survived the temporary interruption of a few hours of sleep.

Structure arises as soon as people begin to do something together, and is closely akin to the differentiation of function which inevitably takes place. This is obviously true even in a small group of friends spending the evening together. One of the party will act as host, someone will start a topic of conversation, a third will take the part of moderator if the discussion shows signs of becoming contentious. To an onlooker, the members will not appear as so many interchangeable units, but each person will be seen to make his individual contribution to the group activity. This is an extreme case of a flexible and temporary social structure, but more permanent structures are found in associations with a longer life, such as an industrial group. Some part of such a structure is logically compelled by the technical requirements of the group's activity, but other parts are not so necessitated and arise from the tendency of a group to enrich its social experience by a complication and regulation of human relations. The following chapters will give ample illustrations of this social tendency.

Thus we may take it as axiomatic that any group with the possibility of enduring over a period of time is possessed of some observable structure, although this may take any one of an innumerable variety of forms. Social structures are commonly classified in a number of alternative ways, two of which are especially relevant to our purpose.

(a) *Primary and Secondary Groups.* A village is a social structure nearly all of whose members are known to one another, and each individual has a direct, face-to-face relation with every other individual. This is an example of a primary group; and in its more extreme form it comprises a relatively small number of individuals, living or at least functioning in close proximity to each other, and engaged in overlapping activities. The members of one workshop form a primary industrial group. At the other extreme can be found groups whose members have never even seen each other. This is the situation of some international learned societies. Such a group is secondary, and its typical characteristics are a wide geographical dispersion, any number of members, large or small, with little or no physical contact. Most groups have a structure intermediate between these two extremes and their characteristics are importantly affected by their position along this sliding scale.

A primary group may have no explicit common purpose of any kind — explicit, that is, to the members themselves. I imagine that if a villager were asked why he lived in a given community, he would explain that his father had lived there before him, or that he had found a job of some sort; he certainly would not consider the *raison d'être* of the village as a whole. Of course most industrial primary groups are definitely conscious of a logical objective, though even here a surprising number of exceptions are encountered. On the other hand, it is very rare for an averagely active member of a secondary group not to have some idea of its nominal purpose. A member of a learned society, or of any other highly dispersed organization, would be unable to participate except at a relatively explicit level.

Not only is a secondary group almost necessarily in possession of an explicit purpose, but, in so far as it truly remains secondary, such a group is only related in its avowed capacity. The members, so long as they remain separated, do not directly affect each other's activities except as indicated by their terms of reference. As a contrast, the members of a primary group, whether in possession of an explicit purpose or not, inevitably affect each other's lives in a number of ways. It would hardly be an exaggeration to say that practically every activity of any member of a primary group is somewhat conditioned by the fact of that membership. This point will be illustrated in the succeeding chapters; it serves to explain the robust character of primary, as compared with secondary, groups. Primary groups are easy to build and difficult to break. Other things being equal, when two social structures come into direct conflict, that one will survive which more closely approaches the primary type. Thus in the World War, religious bodies, trade associations and international labour organizations all split on national lines. In no instance was a belligerent country itself broken in the interests of a relatively secondary structure of its own devising.

In a large factory, it would not be even approximately correct to suppose that every member knew every other member of the group, and yet a single factory of any size commonly exhibits the characteristics of a relatively primary structure. Such an organization is composed of many small and strictly primary groups; these groups overlap in every direction, and are also connected by mutual daily interaction. Other relatively primary collectivities cover members of smaller groups, as when a department includes several shop groups. Thus a large factory is a primary society of groups, rather than of individuals; and with no great metaphor these small groups may be described as being in daily face-to-face contact. This is an excellent example of a primary group of a higher order. It is not quite so easily built or maintained as a primary group of the first order, but as compared with secondary groups it has a rich variety of social connections and

is capable of great cohesion. On the other hand, a large enterprise with a number of plants located at considerable distances from each other may easily degenerate into a secondary structure of which the parts are not single persons but second order primary groups. Such a structure is held together by its logical purpose; but most successful enterprises of this sort make great efforts to obtain some of the benefits of a primary organization by promoting personal contacts between the separate plants; executives are transferred from one plant to the other, and so forth. Higher order secondary groups are obviously a possibility, and examples could be found; but their inherent weaknesses are so great as to make them comparatively rare and unimportant.

Nations form a class of groups which, in the present epoch, are showing a remarkable toughness of constitution. In the numbers of people involved a nation is by far the largest of the commonly stable groups.¹ It is true that no one individual knows more than a tiny fraction of his fellow countrymen, but as in the case of a factory, a nation is knit together by an incredible number of overlapping and interlocking primary groups. Moreover, the habitual contacts within each group, and as between groups, cover the entire range of human activity. A nation is the example, par excellence, of a higher order primary group. Hardly any member of a given nation is a member of a primary group which includes individuals of another nation. In this respect, a nation is at an advantage, as regards cohesion, as compared with a factory. Even secondary groups for the most part do not transcend national boundaries; and this warns us that the essential difference between primary and secondary groups is not one of size or extent, but depends on the immediacy and variety of social contact between the members; size is relevant only in so far as it affects the probability of obtaining a given type of human relationship.

¹ Some religious groups, e. g., the Catholic Church, have even more remarkable histories, but these are outside the scope of this book.

The human problems of industry are intimately bound up in the distinction between primary and secondary groups. From a certain point of view it would not be a gross exaggeration to state that many of these problems have arisen because industry thinks of its structures as secondary rather than as primary groupings.

A secondary group is maintained by those activities dictated by its formal objectives, and these require to be explicitly known. This need for a formal objective continuously maintained leads by easy steps to a formularization of the procedures by which the end is to be attained; and that introduces a second classification of social structures with which we need to concern ourselves.

(b) *Formal and Informal Organizations.* Not all groups have a formal organization, and indeed this is quite a common condition of many types of primary groups. The absence of a formal organization does not imply that any member can in practice do anything that occurs to him at any instant; what is implied is that each member's activity is guided by his immediate sense of fitness rather than by explicit rule. In a village the carpenter's wife is not commanded to cook her husband's lunch, although if she habitually neglects this task the woodwork of the neighbourhood will fall into disrepair. On the other hand, the organization of a factory is highly formularized. The firm has a written constitution and also a list of official positions of varying rank. The activities and responsibilities of each member are more or less clearly stated. A part of this formal structure is shown in the company's organization charts; diagrams in which lines of authority and relationships of function are schematically represented. In addition to these, each firm has a series of rules and regulations for the more general guidance of its members. Such documents and explicit statements embody the formal organization of a business group.

Some groups are without a formal organization, but there can be no such thing as a group devoid of an informal organization.

Volumes would not suffice to dictate the behaviour of each member of a group in every detail. It is obvious that almost every single particular act performed within a group has not been explicitly mentioned in any formal statement, and it is more than a matter of filling in the detail. Whole types of activity, and those amongst the most vital, cannot be a matter of dictation, for a group functions in the light of its sentiments and attitudes, it has a social colour of its own which pervades every action and human relationship. In consequence, those characteristics of a functioning group which distinguish it from a mechanical group, from a machine, in fact, are what may be described as its informal organization. Collaborations and associations, mutual assistance, temporary combinations to meet some minor difficulty, the mere habit of Dick to lunch with John — these habitually recurring patterns go to make up an informal organization. In detail, such activities may seem to possess little stability, but everyone knows that the social contours of two nominally similar groups are usually rather different, and moreover are surprisingly stable. The social contour within a formal organization is a determinant of a group's morale; and the study of industrial groups is in part an investigation into the mutual reactions between their formal and informal organizations.

II

The study of human organization is necessarily a study of social relationship, social action and social sentiment. However, these are treacherous phrases shot through and through with conventional implications, and it is safe to assert that the word 'social' conveys a somewhat different meaning to every individual who uses it. To many people, perhaps to most of us, a social occasion is one in which a group is doing something for its immediate pleasure; for instance, a dinner party; or we speak of social evils, referring to robberies and divorces. Correspondingly, the word 'society' is often used with the implications of a class

differentiation of the European type. But very rarely are these words used in their full meaning to cover all activity between two or more persons, whatever the explicit purpose of that activity may be. In this, its true sense, modern industry is the largest type of social organization that humans have so far evolved.

Consider a typical social act. Employee A hands a hammer to employee B, who takes it. This is an extreme example. A was aware that B wanted the hammer and he initiated an action likely to satisfy B; moreover A, in holding out the hammer towards B, was acting in the expectation that B would react appropriately by extending his hand and by taking hold. This expectation was verified, not because B necessarily anticipated A's behaviour, but because, seeing A's action, he grasped the implications and reacted to them. Here are two people each behaving in conformity with his understanding of the other man's needs, intentions and expectations, and the evidence on which each man based his insight was the result of face-to-face observation. A sliding scale of actions can easily be observed in practice, in which the social element becomes less and less pronounced. A might have merely put the hammer where B could find it when he wanted it. B might have been out of the room when A performed this act. A might not even be acquainted with B, but might know a mechanic was coming to effect a repair and that he probably would want a hammer. And so on all down the scale.

Two things are characteristic of an individual whose behaviour is in some degree social:

- (a) The actions of the individual are in part controlled by his 'concern' for others.
- (b) The individual has expectations regarding the nature of others.

The first of these characteristics implies that the individual is not wholly oblivious of the fact that his actions have implications

for others, and that his actions are guided thereby. It does *not* imply that he is benevolently inclined; it is a social act to knock a man down. The second characteristic is really implied in the first; for without some beliefs as to the ways that others think, feel and act, it would be impossible to have the least notion as to how anyone would react to a given situation, or whether he would be affected at all. A little thought will show that these two characteristics accompany by far the greater part of all human activity.

Both the concern and the expectation of a given type of response are obvious in the case of joint occupations, but they are rarely quite absent even when the activity might seem to concern no one beyond the actor himself. Thus when eating a meal alone, the routines observed are in some degree appropriate to social meals; again, the intimate dislike of cheating at solitaire is connected with an avoidance of personal shame — a sentiment relevant to social situations. Obviously, activity may be social in very varying degrees, but it is rarely quite devoid of this element. Two or more people indulging in acts guided by their concerns and expectations with respect to one another are in a condition of social relationship; and such a relationship will vary greatly in strength from one instance to another.

Finally, a social sentiment is a sentiment having reference to a person, or a group of people. Social sentiments are the outcome of social relations, directly or indirectly; and it will be seen that certain types of relations are found to coexist in the main with certain social sentiments. There is undoubtedly a close connection between activity and sentiment in social as in other situations. Sentiment has been described as the early emergence of mentality from action; certainly it is a primitive type of mentality and deeply rooted in human character. It is an observed fact that social sentiments accompany social activities, and they are for the most part of slow growth. Consequently group integration, which depends upon the existence of appropriate senti-

ments, results from routine relations between people developed over a period of time. And finally, just as action affects sentiment so does sentiment affect action. Sentiment and action habitually stand in a relation of mutual dependence.

III

There is no better way of failing to understand social phenomena than to assume that each action, or thought happens because of some one cause. For instance, the actions of industrial employees are often quite incomprehensible on the common supposition that they are only actuated by simple economic motives.

The logical and economic purposes of men form a single thread in the total pattern of their lives, other strands of which are their affections and dislikes, their skills, their interpretations or understandings of events and things about them, their many impulses and desires, and their accustomed forms of collaboration. Each person's way of life is composed of innumerable factors of this sort, and each factor is itself determined by the remainder. The activities of people are thus a manifestation of a complex and mobile balance between all the forces and tendencies of which they are composed.

Elton Mayo,¹ when discussing the problem of boredom in industrial occupations, shows that there is no simple relation between the work itself and the sentiment of boredom. Boredom when it exists is a part of the individual's attitude towards his total situation, and at no moment is his total situation so narrow as to include only the activity for which he earns his pay.

A mechanic may be performing a simple repetitive action, but he is necessarily doing far more than that: he is digesting his last meal and is vaguely conscious of a variety of bodily sensations; he has an attitude towards the company for which he works and

¹ *The Human Problems of an Industrial Civilization*. Macmillan, New York. Chapter II, Monotony. 1933.

for many of the individuals within it; he entertains loyalties and antagonisms, standards of conduct and expectations with regard to the conduct of others; he has thoughts and reveries, and he is in a working relation to other people; finally, the mechanic is performing his paid work. If this total pattern is pleasing, and if the formal work is satisfactorily adjusted to the remainder of the pattern, the chances are that the mechanic will not be bored. Thus boredom, like so many sentiments, is a part of an individual's attitude towards his way of life as it is being enacted at the moment.

Similarly, the particular attitudes and actions of the members of society are to be understood as being consistent with their whole situation within the society as it seems to them. There are times, especially in a crisis, when an individual's actions are sufficiently explicable in terms of some one factor. Anyone in a burning house will act under a strong desire to escape; at this moment, his activities arise mainly from a single motive, though even here other sentiments may intervene, such as a desire to save others.

However, the history of society over a period of time can only be understood as a delicate balance between a large number of factors each of which is dependent for its peculiar force and direction upon the condition of the remainder. The details are always changing, but interaction remains; and individuals and their societies exhibit the shifting balance of personal and social forces in the flow of their activities.

This does not imply that human history is a mere unwinding of a social process, any stage of which could be determined in terms of a previous condition — that may or may not be a useful working hypothesis, but it is certainly not an observed fact. There are no conditions known to us which made it necessary for Isaac Newton or Napoleon to be born or to play the parts they did; the same remark applies on a smaller scale to each one of us.

It is as misleading to discount the individual contribution to the social process as to neglect the steady pressure of social direction when assessing the contributions of particular men and women. It was Pareto¹ who in his general treatise of sociology contrasted the tendency for societies to maintain their way of life with an opposing tendency, chiefly exercised by the leaders, to build up new combinations of ideas and sentiments and so to redirect the flow of social activity. The interaction between these two opposing tendencies is a part of the balance of factors about which we have just spoken. It is this particular interaction, between the tendency towards a stabilizing social routine and the tendency to build up new patterns of social activity, with which the present essay is mainly concerned.

¹ *The Mind and Society*. Harcourt Brace & Company. First published in Florence, 1916. English translation, 1935.

CHAPTER II

BUSINESS; THE ORGANIZATION OF SOCIAL ACTIVITY

EVERY industrial group with a formal organization has an explicit economic purpose. The most narrow expression of that purpose is to state that the promoters of the group were guided by an anticipation of increasing their economic wealth. But this statement does not cover the other members of the group; and for their participation it is necessary that they also shall find in the group activities a possibility of increasing their economic position. Such a group is not an isolated self-sufficient society, and it is of the essence of its economic success that a wider public shall participate in its activities.

A manufacturing plant makes automobiles, but automobiles in quantity are of no use to the group producing them; to complete the economic process the public must be willing to buy the plant's products and, to continue the economic argument, such a situation will arise only if the purchasers thereby anticipate an augmentation of their well-being — an automobile is worth more to its owner than an alternative use of the money.

Any economic discussion of industry recognizes a variety of material interests, each of which must be satisfied if an industrial group is to have a successful enduring career. So much is a commonplace; it has been stated over and over again ever since Adam Smith first published his "Wealth of Nations" in 1776. This work, which antedated Malthus' famous treatise by twenty-two years and the "Origin of Species" by over eighty years, set forth the first really successful attempt to understand an important aspect of social activity in terms of regularities, or laws of human behaviour.

Social activity had been a preoccupation of many thinkers from the time of Plato, and, no doubt, before that; but Adam Smith was the first man effectively to deduce a set of logically

coherent laws of social behaviour based on observable, and so verifiable phenomena, and to elaborate a body of fact and deduction which could assist in the practical conduct of society. In short, the economic theory derived from the "Wealth of Nations" has the essential merits of a scientific inquiry; it is based on observation, it is held as an hypothesis susceptible of modification in the light of further observation, and it possesses predictive value.

Adam Smith, himself a philosopher, wrote from a background dominated by the Greek conception of society, the 'state,' as the ultimate source of values, through which each individual could obtain his spiritual and physical satisfactions only by the exercise of social functions and obligations. This sociological insight, Smith balanced with a patient investigation of one aspect of human activity. However, the enormous success of the new economic science, combined with other contemporary trends, caused 19th century industrialists to substitute for society Adam Smith's abstractions. Real social men were neglected in favour of the 'economic man.' This was never true of many 19th century thinkers,¹ but it does apply to the practical leaders of society, especially in the fields of industry, politics and law.² The effect of such a narrowing of social understanding has been a tendency to interpret human needs in strictly economic terms to the neglect of other considerations. So our first task must be to restate the purpose of an industrial group in terms which are at once acceptable to the economist and to our wider understanding of human nature.

The majority of those engaged in industry are situated at the bottom of a hierarchy, they are employees without supervisory capacity; moreover, these individuals, together with the lower ranks of supervision, are the chief constituents of small primary

¹ E.g., Hegel, Kant, T. H. Green, J. S. Mill, Herbert Spencer, Bosanquet, F. W. Maitland, and many others.

² Lawyers were in the habit of referring to labour as a commodity, open to sale as in the case of any other commodity, and, they argued, the same general considerations applied in all cases.

industrial groups, and it is on these groups that the whole structure of industry is supported.

The most cursory examination of prevalent types of labour unrest will give some indication of the needs and interests for which employees are seeking satisfaction in their industrial situations. Any mention of unrest raises the picture of industrial strikes. But a strike, although the most dramatic, is by no means the only manifestation of unrest.

1. Unrest is often, though by no means always, related to wages. But even here, though often expressed as a dispute about absolute wages, the real problem is frequently one of *wage differentials*. Every experienced executive knows this.

I knew a highly skilled mechanic who rather suddenly became dissatisfied with his wages. His employer offered him a raise, and, surprisingly, this was refused on the ground that he — the mechanic — had all he wanted. It then appeared that the mechanic's son had just obtained a semi-skilled job at nearly twice his father's wages. Wages are an expression of social function, and the relative wages of father and son failed to express their respective positions within the community. This is an extreme, and perhaps a trivial instance of the important fact that the expenditure of income is a highly socialized phenomenon. The wage differential is one of the numerous mechanisms by which sentiments, accompanying the differentiation of social activities, find their expression. Any executive, faced with the necessity of introducing a change in rates of payments, whether up or down, knows better than to alter the relative financial positions of his various labour groups. For nothing produces more unrest than to threaten the balance of a social structure. To do so is to threaten the most intimate security of every member within it.

Security is to a great extent socially evaluated. It is important, above all, to be securely placed with a stable and adequate group. Thus, in a well-organized army, bravery is the rule rather than the exception. The battalion in its social aspect

gives a form of security to the soldier, who is none the less exposed to the bullets of the enemy. The first need is to share the fortunes of an adequate group, rather than to stand alone.

2. Acute labour unrest is often provoked by an unwise dismissal. The threat to the integrity of a group whose members are liable to arbitrary dismissal is too well known to need comment.

3. Another expression of unrest is a high labour turnover. The simple explanation, based on the assumption that the employee behaves as an 'economic man,' is that he has left his employment to obtain a better one. Labour is selling itself in the highest market. This explanation is plausible, but it is not true. To give just one illustration: a few years ago a cotton mill in Philadelphia was faced with a labour turnover of roughly 240 per cent per annum in one of its shops. The employees, who were spinners, were paid good wages, conditions were apparently adequate, and the employees liked and trusted their manager. Nevertheless, on the average, each employee left the firm after about five months' service. The employees typically drifted about the neighbourhood, obtaining similar employment, and came back to the original shop for another spell.

It is a commonplace amongst personnel managers that as often as not an employee leaves a firm, not because on a rational calculation it pays him to do so, but in spite of his knowledge that it does not. S. Howard Patterson¹ states that "the rate of labour turnover is much higher for unskilled workers than for skilled workers." He says later, "Social unrest, as expressed in the passive form of labour turnover, is as important as that expressed in the active form of strikes and industrial conflict." Patterson might have added that unskilled workers do not quit with any idea of obtaining a skilled job for which they are not qualified. Such behaviour in the majority of cases represents the expression of an emotional unrest, based on a poverty in social work relationship.

¹ *Social Aspects of Industry*, New York: McGraw-Hill Book Company, Inc., 1935. Second ed., pp. 294-295.

4. A fourth manifestation of labour unrest is to be found in the phenomenon of restricted output. There are two levels for the consideration of human actions. The first, the explicit level, is logical. Output is restricted for this and that logical reason: the possibility of working out of a job; the likelihood of rate cuts; the dangers of physiological exhaustion; and so on. As always, such rationalizations have some basis in observed fact. Not one of these unpleasant possibilities is unknown to industry. But where it is found that a given procedure is as likely to produce the very dangers it is supposed to prevent, and in spite of that is tenaciously maintained, it is a fair conclusion that below the logical level is to be found an emotional non-logical factor.

It is the fashion to suppose that restriction of output is the invention of trade unions, or their equivalent. In an interesting investigation, Stanley B. Mathewson¹ studied restriction of output amongst unorganized workers in "over 105 establishments, in 47 localities, representing 25 classified industries, and 14 miscellaneous ones." His general conclusions are that restriction of some sort is an important factor amongst unorganized labour; and he implies that it is not closely related to the logico-economic arguments which provide its rationalization. It is more nearly connected with the maintenance of solidarity within the groups of employees, having impoverished interpersonal relations with their formal leaders, the management. We shall consider this in greater detail later.

5. Yet another form of labour unrest relates itself to the physical conditions within a plant. Such matters as safety, efficient illumination, cleanliness, etc., are obviously worthy of serious consideration. And here, as always, we find a logical basis for the employee's attitude. But any executive of experience will ask himself whether this logic is not cloaking something more. Not uncommonly, the clerical staff is provided with cotton towels, whilst the shop is given paper towels. The groups

¹ *Restriction of Output Among Unorganized Workers*. New York: the Viking Press. 1931.

use separate washrooms. Those for the clerical staff are sometimes kept locked. Such minor, and apparently trivial details emphasize a social distinction more acceptable to the clerk than to the shop employee, and the result is not infrequently an inordinate preoccupation on the part of the employees with respect to these matters; they are really addressing themselves not to the physical circumstances but to their social implications.

Again, the preoccupations of the clerical force with regard to the size, style and position of their desks are notoriously far greater than the concern of the mechanic with his bench, although it is the latter who has to perform the more critical physical manipulations. A bench carries with it little social significance. But place one desk out of line with the others and its occupant is proclaimed the senior clerk. Reverse its position so as to face the others and the head clerk becomes a supervisor. Give him a larger desk, a telephone and, if possible, a small red carpet, and the supervisor rises to the status of an executive. It is impossible to understand the prevalent preoccupation with physical conditions until it is clearly realized that the mechanical details of life all serve to emphasize the individual's position within his society.

6. The last form of unrest which we shall mention here is the resistance of the employee to change. It may seem illogical to refer to such extreme conservatism as unrest; but again this can be traced directly to insecurity.

A medium-sized firm manufacturing a quality product was faced early in the depression with a shrinkage in demand. The firm was not losing to its immediate competitors but to enterprises marketing a lower grade article. The commodity was highly styled and, other things being equal, there was a real place for quality manufacture. As matters stood, one of the shops, in which the employees were skilled girls, was facing a more or less complete shutdown.

The responsible executive conceived the idea of slightly altering the manufacturing process for his product in such a

manner as to decrease the labour costs without changing the quality. By this device, he calculated that the demand would be so stimulated as to provide work at the old wages for most, if not all, of his employees. He proceeded as follows. On a given morning, he went to the shop and spoke to the employees, explaining the decline in demand and pointing out the consequences to them. This, naturally, was no news. He then outlined his solution, which involved a slight change in the actual manufacturing procedures. Finally, one of the employees, who had previously been shown how to perform the new operations, gave an exhibition for the benefit of the other girls. All this occupied perhaps an hour or so. The shop then retired for lunch. On returning, the executive found the shop in an uproar. The girls were in tears; and in despair he sent the whole lot home for the day. The executive told me some months later that the girls had never fully accepted the change, and that they had lost their pride in the quality of their work.

This very typical situation is hardly an illustration of the 'economic woman' logically pursuing her best material interests. But nothing is more stupid than to write off non-logical behaviour as though it had no place in a well-ordered scheme. Emotions are not to be understood as disconnected exhibitions of low-grade behaviour; they have their own purpose, and their organization. The problem is to understand what that purpose may be.

A similar picture, showing the range of human motives, is given by 'trade agreements.' These so-called agreements are documents presented by one party — usually a union — for acceptance by the other party — the employers. Almost everything under the sun is the subject matter of some trade agreement or other, even down to the provision of adequate clocks in workshops. Presumably every matter regulated by a trade agreement has seemed of importance to someone, and the scope of these matters is so bewilderingly wide that at first sight nothing can be made of it. However, one thing clearly emerges from

a study of trade agreements: the employee is not confining his attention to strictly economic considerations, although he is thinking of these, too. The employee is thinking of his entire range of activities and interests, and evidently these matters do not seem to him to be adequately guarded by the ordinary industrial procedures.

Of course, any one trade agreement will only mention a very few items, apparently chosen at random but actually related to the peculiar conditions applicable to the groups involved. One agreement will specialize on clocks and conditions of dismissal, whilst another will minutely regulate the conditions under which a worker may be paid by cheque, a third will specify the apportionment of types of work as between grades of workers, and a fourth will determine at what place in a worker's daily travel he shall be deemed to be 'on the job.' And so on; the list is endless. If they did nothing else, trade agreements would again remind us that industrial groups are associations of men and women, organized for an economic purpose but necessarily involving, either directly or indirectly, the whole range of their members' interests and sentiments, and, above all, their social sentiments, which are amongst the oldest and deepest sentiments they possess.

It is the economic motive *within a social setting* that is of importance to human beings, for these two together constitute social living, from which most human satisfactions are ultimately derived. After all, the members of an industrial group spend many of the best hours of their lives in industry, and it would be astonishing if the need for adequate social living did not show itself in economic as well as in recreational activity. Practically every group which achieves stability assists its members to attain some future benefits which they could not so easily obtain without its help, and at the same time activity within the group ministers to a need for human intercourse. Where both of these elements — a future objective and present social satisfactions — are not simultaneously within the scope of the group's activities,

either the group disbands or it provides the missing element. Naturally neither element need be explicitly in the minds of the members, although usually one or the other is given as 'the reason' for the group's existence.

An example of a group which has often little or no future objective is a dinner party. This activity is undertaken for the immediate fun of the social contacts, but then dinner parties do not last for much longer than three or four hours. When an athletic group is organized on a permanent basis, there is a distinct tendency for it to develop some ulterior object for its present games in the form of contests with other groups or clubs. The members can thus enjoy their game and be simultaneously preparing for a future event. There is a well-known type of man who devotes his life to games and to little else, and it is noticeable that he is strongly of the opinion that people have a moral duty to develop their muscles and constitution by perpetual physical exercise. This cult of the 'muscular sportsman' is an heroic attempt to endow present satisfactions with an ulterior objective. Similarly, dining clubs, if they meet frequently, may develop 'helpful activities' of one sort or another, sometimes in the shape of shop talks. It seems to be in human nature that present satisfactions tend to pall unless they simultaneously advance some future objective; the imagination does not with pleasure live entirely within the present.

The converse is equally true; future benefits alone do not suffice to turn an otherwise empty present into a pleasant experience. The obvious utility of a dull task does not remove the boredom, though if the task be reasonably short the present may be endured for the sake of the future. However, it is not to be expected that people will cheerfully spend a lifetime in an impoverished present for any reason whatever. If the present activity is interminable, and if its social context is not sufficiently rich, great efforts will be made to elaborate the latter, and in so far as this effort is not adequate, unrest will be the result. This is the exact position of many industrial groups, and examples of

such groups enriching their social contexts will be given in the following chapters. For precisely this reason, attempts to engender a satisfied and co-operative atmosphere amongst employees, by offering them incentives based on future rewards, so often miss their mark. What is usually required is not an augmentation of the logical motive, but an enrichment of present social living.

It is a measure of the degree in which thinking has been warped by an overemphasis of economic motives, that it should be necessary to remind ourselves that satisfactory living is social living, and that social activities to be satisfying in the present must have the merit of leading on to an acceptable future. Only a very 'instructed' society could forget so simple a truth; for no group, large or small, has ever survived for long which failed to perform its double function in some fashion. This is implicit in the economic and social structure of every epoch. Consider our own times. Instruments for the transference of purchasing power — coin, notes, cheques, bills, and so on — pursue their course round and round society, assisting and giving point to human association at every step.

As the ultimate consumers, we make our purchases from groups designed to meet our convenience; that is their logical purpose. We buy at shops, railroad stations, theatres and the like; and an exchange is effected by which we, the consumers, receive some service or commodity and our money passes up to the shop. Thus the effect of this type of business is to call shops into existence, with all this implies in the way of human relations within these groups. The shop, however, obtains its wares from a wholesale firm; and commodities flow down from the wholesale to the retail establishments, money travelling in the opposite direction. Once again this flow of economic activities has created groups, of wholesalers this time, who are thereby experiencing human associations. And so the chain goes on; wholesalers buy from manufacturers, and the latter in their turn obtain machinery and raw or semi-manufactured materials from others. The ramifications are unending but the double flow is

unmistakable. Materials flow down the line towards the consumer, and money flows up the line from the consumer. At every stage, groups of men and women are organized which have as their economic purpose the promotion of this double stream, and, as their immediate activity, relations between people which would not otherwise exist. But every producer is also a consumer, and many consumers are producers. At every step in the upward flow of money, some of it is diverted from the main stream and rests with the members of each group to spend in their rôle of consumers. So every producer is, in one capacity, receiving goods from above and passing goods down below, whilst money flows through the chain in a reverse direction, some of it resting with each producer. In his other capacity, he passes the money up the line again and receives finished commodities.

What does the consumer buy? A part of his purchases keeps the consumer and his family alive, and here the social process again becomes evident. Families are small groups, having many ulterior objectives, apart from the immediate relations involved; and one effect of the economic structure is to emphasize some of these objectives. One or more of the adult members earn a living and support the children, whilst their mother probably organizes the home. The economic structure emphasizes the interlocking division of duties within the family life. However, except in the case of very impoverished families, most of the money is not spent on the bare maintenance of life. Food, clothes and shelter are almost invariably above the minimum requirements both in quality and in quantity. An employee in steady work will live in a home with several rooms, carpets, some ornaments, and styled commodities of every sort. His wife's clothes, as well as his own, are socially determined and are bought with a social end in view. The same applies to the fittings of his home; the variety and use of rooms assist a satisfactory family relationship, as well as relations between the family and their friends. The consumption of cigarettes, food and drinks is

made the occasion of social activity. The family automobile is an instrument of further social relationship. The very taxes paid by the consumer are spent by a larger group, of which the family is a part, in the furtherance of social welfare. The consumer returns his money once more up the economic line in the process of enlarging his social activities.

Actual economic procedures are far more complex than this sketch suggests. But every additional detail adds to the picture of a society in which its members, whether as producers or consumers, or as both, increase the complexity of the social structure by the prosecution of their economic activities. Very little organization is required merely to keep alive; but a modern industrial structure gives to each person a logical objective for the future, and the possibility of a complex yet orderly type of social living; it permits of purposeful relations between people. The whole system depends at every stage for its success on the conduct of people guided by their concern for, and expectations regarding others.

This could be illustrated by any economic activity, but the use of money is an interesting case in point. Most payments are made in token coin or token paper of some sort, and in either case the good faith of a person or of groups is implied. But expectations with regard to the value of tokens go far beyond any question of good faith. Token money ultimately rests on the value of gold. The gold may seem far away, and is ordinarily not in the explicit thinking of most people, but in every country, token money only maintains its value because in the last resort a mass of gold, kept somewhere under lock and key, is sure to remain valuable in all conceivable circumstances. On what does the value of this gold depend? Certainly not on its use; very little gold is used either in industry or as ornament. If bullion were to depend for its value on an alternative use, then that value would be substantially nothing. Gold remains valuable in all circumstances because each person believes that every other person will value it whatever happens.

This is an astonishing example of the power of social expectation. Everyone wants lamps, beds, houses, automobiles and other things; but in a war or a revolution the demand for these might diminish; therefore such commodities do not support token money. No one needs gold in any circumstances, but every person values it and expects his neighbours to believe that others will value it, and so the worse the revolution the higher stands the price of gold. All human intercourse, of which industry is an important example, rests on values socially created; and this can be illustrated at any point. But it is nowhere clearer than in the study of finance, that most exact branch of economic theory.

Perhaps it may seem that the social basis of modern industry arises somehow from its very complexity, and is not of the essence of commercial transactions. Nothing could be further from the truth. The same phenomenon can be seen at every level of social complexity. It seems that nowadays small boys no longer play at marbles as they did a few decades ago—or perhaps this is merely a delusion of middle age. However that may be, the activities and sentiments connected with games of marbles, as they were played thirty or forty years ago, provide a beautiful example of the emergence of economic trends in human association. Groups of boys would play marbles together week after week with the utmost seriousness. The game was one of skill and the winner invariably took the competing marbles from the loser as his reward for success. Each boy possessed a collection of marbles which he prized, and the size of the collection depended on his fortunes in play. But no one marble remained for long in any given collection; it circulated continually around the members of the group.

A boy was proud of his marbles, and an unusually large collection added to his prestige in the eyes of his associates. But there was nothing to be done with a marble except to compete with it; a marble had its value just because it was the instrument of intercourse and because every other member valued it. Some

marbles looked nicer than others, and it was a matter for special rejoicing when such a marble had been won in play. The similarity between juvenile activities connected with marbles and industry is very close. The marbles functioned partly as money and partly as commodities in modern society; in any case they circulated round the group, providing occasions for human association as they travelled, and simultaneously providing an economic purpose for that association. This is more than an analogy; the marble-social structure is an embryonic example of business-social structures in general.

Malinowski¹ describes the organization of trade activities amongst the natives of the Melanesian Archipelago, just north of the eastern limb of Australia. This Archipelago consists of a number of small islands disposed in the shape of a rough ring whose diameter is about one hundred miles.

An elaborately organized trade takes place between these islands at stated times of the year. This trade involves the circulation of just two types of articles. One article consists of long necklaces of red shell which travel round and round the Archipelago in a clockwise direction; the other article, bracelets of white shell, likewise travels round and round the islands, but this time in a counterclockwise direction. Any one of these articles will take from two to ten years to complete the circle of the islands, and at any one time it will be the occasion of a ceremonial relation between two men of different islands, one of whom will give it to the other. This type of trade is known to the participants as *kula*.

Every man in the *kula* is permanently associated with a partner in that island on his clockwise side and with another partner in that island on his counterclockwise side; he makes gifts of red necklaces to the former, receiving gifts of white bracelets; and he makes gifts of white bracelets to the other partner, receiving gifts of red necklaces.

¹ Argonauts of the Western Pacific. Bronislaw Malinowski. Second impression, 1932. George Routledge & Sons, Ltd., London, and E. P. Dutton & Co., New York.

Once in the kula always in, is the rule both for the men and for the articles. The bracelets and necklaces are essentially ceremonial articles, being rarely worn and never exchanged for any other type of commodity. They are nevertheless highly prized, and the social life of the Archipelago is built up around the kula activity. The building of canoes and the community organization within each island depend upon this institution, which has been elaborated to an incredible degree. Malinowski found that the spread of technological and social customs also followed the lines of kula activity. Kula stands midway between the boys' marble-economic organization and modern business in many respects, and in some of its features bears a striking resemblance to the latter.

The standing of a man in his locality is related to the degree of his participation in the kula, and his reputation will depend on the manner in which he observes the customs and ethics of kula activity. The whole system is based on commercial honesty of a high order. For instance, bracelets are never *exchanged* for necklaces, or vice versa. In every case A makes a gift to his over-sea partner B, and it is left to B to reciprocate suitably with a return gift of the other article in his own good time. If B, living on the clockwise side of A, has received a gift of a necklace, he may reciprocate with a bracelet of corresponding worth within a few minutes. But perhaps he has no such bracelet available at the moment, in which case the return present may not be given for months, or even for a year or two. There is no bargaining, but the obligation rests upon B by long custom. Gifts must be reciprocated in equivalent kula value item by item; several smaller bracelets are no adequate return for one valuable necklace. If B is unable to make his reciprocal gift within a reasonable time, he sends a small bracelet, not in part payment but as an 'intermediary gift,' or, as we should say, B pays interest on the capital owed to A.

Ordinary barter of consumable articles goes on between the islands under the protection of kula intercourse, but the two are

never mixed, and all social ceremony and social values refer to the latter, not the former. The Melanesians have thus separated to some extent the social functions of articles in circulation from their direct purpose in consumption. One set of articles performs one function, and another set performs the other purpose. However, the possibilities of barter for an individual are in fact related to his position in the kula.

Activities of this general kind and in varying degrees of complexity are to be found in all societies of any date. The chief characteristics of organized human intercourse on a large scale are: first, that they concern the making, the circulating or distributing, and the use of physical articles of one sort or another. Secondly, that each step in the history of the article is an occasion for human collaboration. These various occasions for collaboration are organized on customary lines and involve a number of obligations with their accompanying ethical sentiments or standards of conduct. Thirdly, the articles in use meet certain needs, often physical, as in the case of food, at the same time that they provide the satisfactions of orderly intercourse — for example, a typical family meal. Fourthly, articles are valued for their own sake and not merely as means to ends. Nothing in habitual use, whether it be a form of standardized conduct or a physical object, remains merely a means to an end. Every habitual thing becomes a focus for sentiment and is thus the object of a formed human attitude. Watches are not merely aids to time-keeping, and motor-cars are not merely means for locomotion; they are also objects of interest and sentiment to their owner, and assist in defining his position within the society. The importance of commodities in use and for their own sakes is well recognized by everyone, including advertisers. What is not always recognized is their use in circulation as promoters of human contacts. A very large part of orderly human association is organized around the making and circulating of commodities before they are ever put to their final use.

We started this chapter by observing that industry is not de-

void of social activity, but we have been led to expand this statement by reason of the facts about us. *Business is the universal pattern of stable social organization everywhere and always.* Men seek the society of their fellow creatures, but they need something more than mere physical propinquity. To be satisfying, social contacts must provide for activities performed in common which lead to an immediate pleasure in the exercise of social skills and sentiments, and which also are logically ordered in terms of an ulterior purpose; by these means, stable relationships between persons become established. The ulterior purpose is to contribute to the future social situation. Thus economics is the science of logically ordering social activity in terms of future social activity, and industry or trade is the order so described.

Quite generally, stable organizations involve social activities having the following characteristics in varying degrees:

- (1) They yield immediate social satisfactions.
- (2) They are purposeful in the sense of being concerned in ordering the future.
- (3) They are organized round material objects or commodities for which society has a regard.
- (4) They involve a high regard for certain codes of behaviour, customary ways, or ethical or moral standards and ideals.

This statement is applicable not only to trade and industry but to all widespread stable human associations. For instance, consider the organization of the Christian religion. The fact that religious activities are largely performed in common is evidence of the satisfactions which arise from doing things together. Then, however we may choose to express it, it is clear that religious activity has a future purpose. This form of social activity is less concerned with material objects than most; but even so the number of cathedrals and churches in any Christian community, the attempt to make these beautiful, and the sentiments relating to these, all testify to the need for material objects as a focus for activity and its accompanying sentiment. Religious pictures, so

typical of the Renaissance, images and sculptured figures all point in the same direction. Finally, the ritualistic and idealistic features of organized religion are too obvious to need comment.

At this point we are faced with a dilemma. Since industrial and trading activities are such important examples of enduring social structure, how does it happen that a poverty of social activity is found particularly within the walls of industry itself? There is no short answer, and the following pages are an attempt to throw light on this very problem. It will be argued that modern industrial societies are suffering from a wrongly directed emphasis on the logical aspect of social living; and that the ulterior purpose of business activity has been erroneously supposed to be the accumulation of wealth for its own sake, as distinct from its social function.

CHAPTER III

THE RELAY TEST GROUP

WE HAVE seen, in a general way, that human relations within a community are composed of mutually supporting activities together with their appropriate social sentiments. In this chapter, a small industrial group will be described with the intention of obtaining a more precise understanding of the connection between action and sentiment in such a situation. Fortunately, careful research by a large industrial firm supplies just the type of information required for the purpose.

The Western Electric Company manufactures instruments, apparatus and machinery for the telephone and telegraph system of the United States. It is thus one of the largest manufacturing companies in the country; and it has earned an enviable reputation, not only for the excellence of its products, but also for an enlightened policy with respect to its personnel.

The Company owns a number of manufacturing plants, one of which is situated at the western end of Chicago, in the state of Illinois. In normal times, this particular plant employs between 30,000 and 40,000 employees of both sexes and of diverse origins. The labour market in Chicago consists largely of first or second generation Bohemians, Poles, Italians and Irish, together with others of recent foreign origin. These employees tend to live in pools of their own nationality, and remain somewhat outside the main current of national life.

In 1927, at its Chicago plant, the Company began a series of interrelated researches, having as their object the better understanding of the human factors in industry, with especial reference to employee satisfactions as related to economic efficiency. These researches were broadly sociological in character, and were undertaken with the full consent and co-operation of the em-

ployees themselves. The various experiments were on very different scales, conducted by executives, supervisors and others, with varying outlooks and attainments. The largest experiment involved over 20,000 employees and the smallest, under 10 employees.

One of the experiments concerned a small group of six bench workers, one or two inspectors, a supervisor and at times an assistant. Of these bench workers, five were engaged in a task suitable for the purposes of statistical analysis, and the following description mainly concerns them. In 1927, five skilled workers, young women, were placed in a special test room and performed their usual work under continuous observation until the middle of 1932, a period of five years. These young women all possessed several years' previous experience in the assembling of small electrical relays, and this was the work they performed in the test room. These relays weigh a few ounces, contain some 40 to 50 parts, and are assembled in an average time of just under a minute.

Although the actual work itself was not altered in any significant manner, nevertheless the general conditions under which these girls worked in the test room differed in a number of respects from those to which they had previously been accustomed. They were informed as to the nature of the experiment. They were paid, as before, on the same system of group piece work; but the group, formerly containing over a hundred individuals, was now reduced to only six for purposes of payment. In addition, no pressure was put on this group to achieve any given level of output; and, in fact, they were warned against racing or forced output in any form; for the immediate object was not to increase output but to study the human factor.

The workers were seated in a row on one side of a long bench, and were permitted to talk. Conversation was the rule rather than the exception; it was sometimes general, and at other times was confined to more intimate conversation between neighbours. In addition to these innovations, certain other experimental

changes were introduced from time to time. Thus the length of the working day and the number of working days per week were varied; rest pauses were introduced, and so on.

Provision was made for keeping adequate records. One or more supervisors were stationed continuously in the test room throughout the whole experiment. They had certain routine duties to perform in connection with the supply of parts and the disposal of the assembled relays. In addition, these supervisors, with the full knowledge of the girls, kept an elaborate series of records and observations. Thus, an automatic instrument recorded, to about a fifth of a second, the instant at which each worker completed every assembled relay. So we have a minute-to-minute record of output for each worker over a period of five years. Other records relate to the quality of the output, and also to the quality of the parts supplied; reasons for temporary stops in the work; records of conversations; room temperature and humidity, etc. Besides these more formal records, the supervisors made observations on the characters and dispositions of the workers in the test room, and recorded the relationships that developed between them. I should perhaps add that the relations between the workers and the supervisors were at all times cordial. The girls were separately interviewed by an experienced interviewer on several occasions in another room; and finally they were examined by a medical officer about once in six weeks.

Figure 1 shows one way in which the output records can be presented. This diagram gives the weekly rate of output of every assembler in the test room throughout the whole duration of the experiment. The number of each assembler corresponds to the number of the seat she occupied, counted continuously along the work bench. It will be seen that occasionally one left and another took her place; thus, at the beginning of 1928, Nos. 1a and 2a were replaced by Nos. 1 and 2; again, for about ten months in 1929 and 1930, No. 5a substituted for No. 5. In about the middle of 1932, all the workers left the test room. From April, 1930 to February, 1931, the assemblers changed places on the work bench

-FIGURE 1-

RELAY TEST GROUP
(Western Electric Company)

WEEKLY RATE OF OUTPUT FOR EACH ASSEMBLER (RELAYS PER HOUR)

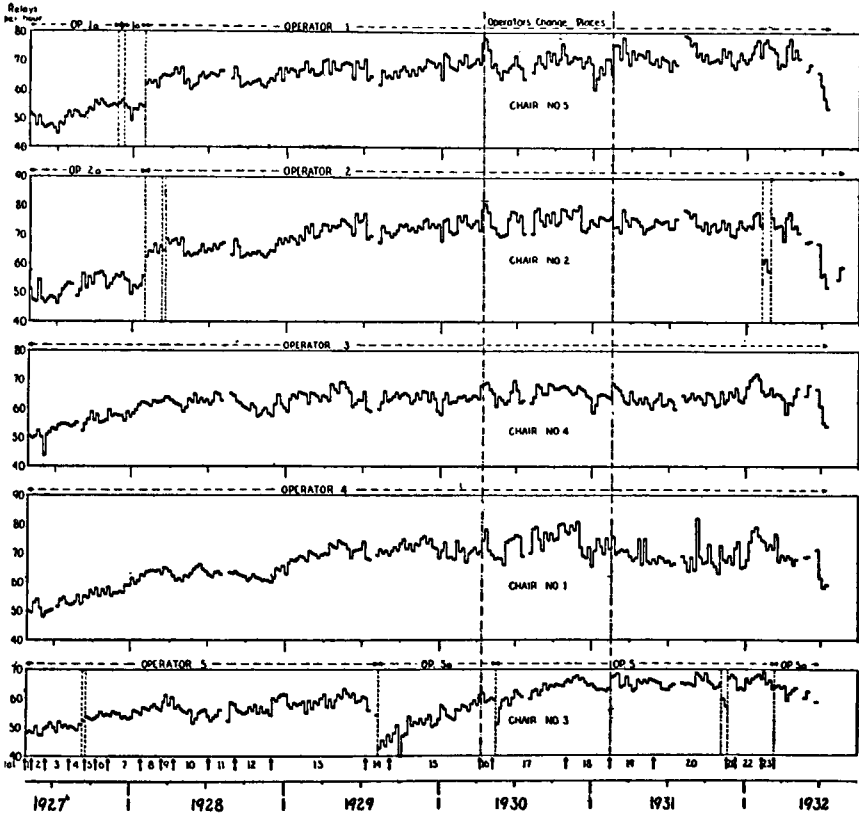

and occupied the positions indicated; they subsequently returned to their old positions.

These weekly rate-of-output graphs cry aloud for interpretation. For instance, why do a number of highly skilled young women, whose outputs had already reached a steady state, work so much faster after entering the test room? Why do the working rates of Nos. 2 and 4 continue to rise more abruptly than the rest, and then suddenly drop in 1930? And finally, why does No. 4 become so singularly irregular in 1931? These and many other questions are prompted by this diagram.

Looking at the graphs for Nos. 2 and 4 in Figure 1, certain similarities will become apparent. In both cases the rate of work rises unevenly until about December, 1930, when, in the case of both girls, the output suddenly drops. No. 2 suffers only a moderate drop in speed and continues on the same average level for the next twelve months or so. No. 4 drops more dramatically and continues to fall slowly for the next year; moreover, the irregularity of her weekly graph becomes very pronounced throughout this latter period.

Figure 2 contrasts these two in another way. In the middle graph, the output rate graphs for Nos. 2 and 4 have been copied from Figure 1 without any alteration. When the line for No. 2 lies above that for No. 4, the space between the lines has been filled up; in the reverse case it is left blank. In this way the comparative rates of work of these two can be easily compared. The difference between their rates is plotted in the top graph for greater convenience. You will see from this diagram that No. 2 is a slightly faster worker than No. 4, but the difference, for the most part, is not very great. On occasion, their speeds became almost identical. This is shown very clearly in the top graph.

Now look at the bottom graph; this shows the degree of correlation existing between the daily output rates of the two operators from time to time. The scale on the left hand side is called the 'Coefficient of Determination.' 'Determination' is the tech-

nical name given to a particular method of calculating correlations.¹ Near the end of 1930, the correlation between the daily output rates of the two workers is nearly perfect. This does not imply that their rates are identical, though this happens to be the case. What a perfect correlation does mean is that their rates are moving together, so that if one rises the other will rise in the same proportion, and vice versa; *they rise and fall together*. It is important to the argument to remember that these correlations are telling us nothing about the absolute speeds of the two workers, which may be very different. Nevertheless, in this particular instance, whenever the speeds of the two tend to coincide, then the correlation between their variations of speeds also rises, and vice versa. There is nothing in the mathematical procedure to make this probable, and it does *not* occur between any other pair of workers in the test room.

To interpret this, we must know something about the characters of the girls and their social relationships. No. 2 was very definitely the leader of the group, partly because she was the fastest worker, but also in virtue of her character. Of Italian extraction, and in her early twenties, No. 2 is the ablest of the group. She possesses, in a high degree, those personal qualities which mark out a woman as a social leader: quick wit, ambition, decision, a sense of responsibility and a ready temper. Owing to the death of her mother, No. 2, in effect, ran her father's household; and, by her earnings, materially contributed to the upkeep and education of her younger brothers.

No. 4, of Polish origin, is one of a fairly large family, and she lived with her parents in a Polish district in Chicago. The family are hard workers, frugal and self-respecting. The seven children received a more than averagely good education, one brother

¹ If the value of a *correlation* is $\pm(r)$, then the value of the corresponding *determination* is $\pm(r^2)$. Determinations have certain advantages as compared with correlations; but the point to remember is that determinations are always numerically smaller than their corresponding correlations—e. g., if $r = 0.8$, or 80%, then $r^2 = 0.8^2$ or 64%. For convenience in the text, the term correlation will be used in its wider sense to cover determinations.

graduating from college. No. 4 is intelligent, independent, even-tempered and hard working. She was one of the original members of the test room group. Before the arrival of No. 2 early in 1928, No. 4 was one of the two best workers and the most ambitious personality amongst the assemblers. In many ways she was qualified to take the lead, but never did so, perhaps in consequence of a certain lack of self-confidence which prevented an easy relationship with others.

No. 4 exhibited some of the characteristics typical of second generation Americans. Her parents were committed to the standards and customs prevalent in the country of their birth, but No. 4 as she grew up became attracted by the less restricted life of her own generation in Chicago. The common result of such a clash of cultures is a partial repudiation of the one, and a diffidence based on an imperfect assimilation of the other. No. 4 was ambitious in the sense that she wished for a social situation to which she was not quite able to attain. And for a somewhat different reason the same thing applied to No. 2, only her social desires were definitely explicit. No. 2 had no difficulties of personal relationship, but poverty and bad luck on one or two critical occasions had prevented her from obtaining the education and training she desired. In consequence, up to 1928, her occupations had not given No. 2 appropriate scope for her real abilities.

However, on entering the test room, this assembler at once entered into the life of the group and she sensed, in its comparative freedom from restraint and in the objects of the experiment, the possibility of an interesting outcome to a pleasant situation. No. 2 became the informal leader of the group by the process of making explicit her hopes for its future, and by entering into human relations with the others. This was not thought out; it happened. One effect was a growth of informal routines and customs connected both with work and with the girls' common activities in leisure hours.

It began to be noticeable that prestige, in the eyes of the group, was connected with achievement in work, or more accurately with

willingness and intention in work. No. 2 was the fastest worker and she expressed the group's approval of earnest work by a system of social favours and expressions of good will, whilst cold glances and semi-humorous contempt became the attitude towards anyone suspected of slacking. In a simple way, this small group mirrored the attitudes of larger societies, respecting those who contribute to the common life and showing good-humoured toleration for those who drift in the tide.

At first, No. 4 almost seemed to resent the domination of No. 2, and Figure 2 shows that for a year at least No. 4 worked substantially slower than No. 2 and that daily fluctuations of their output rates failed to correlate significantly. However, the attitudes of No. 2 were not unlike those of No. 4, and the latter began to show a practical sympathy by herself attaching more and more significance to the working situation, that is, to the economic objectives of the group. Simultaneously, these two girls began to form a friendship; No. 2 was genuinely attached to anyone who could share her social attitudes, and No. 4 became her chief collaborator in giving direction and form to the group's activities. This also represented achievement for No. 4, who became securely placed in a position of prestige she could not have obtained on her own initiative. Figure 2 shows that during 1929 both girls' output rate rose and that their daily fluctuations of rate began to correlate in a marked degree. By July of 1929, the upper graphs show that the two assemblers were working at nearly the same rate. By this time Nos. 2 and 4 were firm friends: they sometimes spent the evening together, No. 2 took the other girl to dances and generally acted as her social leader. This friendship was never subsequently shaken, but by the beginning of 1930 the statistical relationships had somewhat fallen. No. 4 was once more working substantially slower than No. 2 and their daily fluctuations of rate show a diminished correlation.

Early in 1930, for experimental reasons, the supervisor in charge decided to change the seating order of the five assemblers. The new arrangement is indicated by the chair number stated

-FIGURE 2-

RELAY TEST GROUP
(Western Electric Company)

OPERATORS 2 and 4 COMPARED

[40]

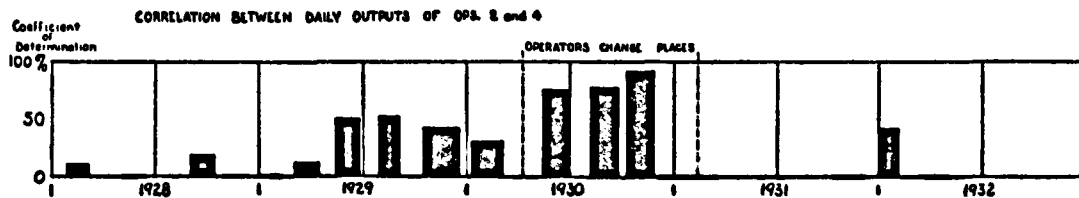
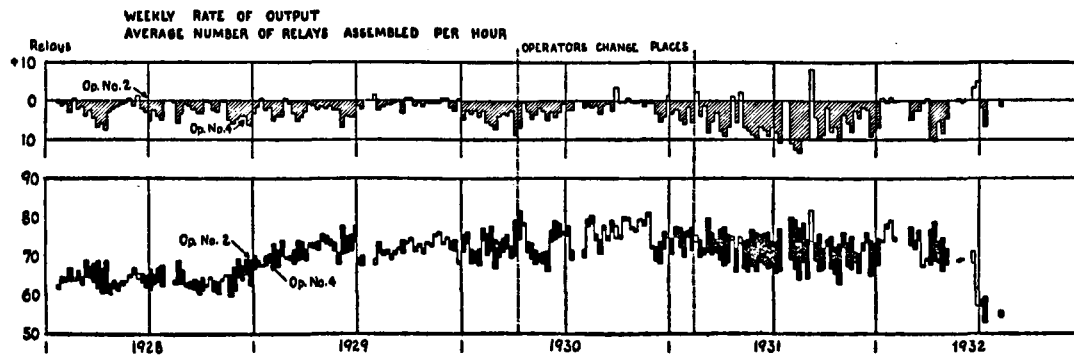

against each graph in Figure 1. Nos. 2 and 4 are now seated next to each other, and the result is clearly indicated in Figure 2. The working rate of both operators rises fast and the difference between their rates nearly vanishes. At the same time their daily fluctuations of rate show an almost perfect correlation. Towards the end of 1930, both assemblers are working fast and their statistical relationship is marked. However, a gradual change had been taking place in the attitudes of all concerned towards the test room experiment. Briefly, a suspicion was beginning to arise in the minds of the group that perhaps their future prospects had been overrated. The industrial depression was gathering momentum, and the outlook of industry in general was changing from one of optimism for the future to a grim determination to maintain the achievements of the immediate past. Something of this change was felt in the test room and contributed to a lowering of expectations in any case to be anticipated for other reasons.

In November of 1930, the firm shut down for Thanksgiving, and as work was slack the firm remained shut from Thursday until the following Monday. When the group reassembled, Nos. 2 and 4 had both returned to their lower speeds of some months before. Again, No. 4 worked substantially less fast than her friend, and their daily fluctuations of speed failed to correlate. For the next year, No. 2's output rate remained about constant, but No. 4 showed some characteristic symptoms. Her rate fell slowly and became unusually irregular. An investigation of a cotton mill by Elton Mayo, and other experiments by the Western Electric Company show that unusual irregularity is often produced by what has been variously described as 'unpleasantly toned pre-occupations,' 'compulsive reverie,' 'brooding.' After 1930, No. 4 expressed distress at her slow work and could not understand the cause. She and No. 2 still spoke as though they were collaborating in leading the group, though both were explicitly aware that this collaboration was no longer quite real. They remained close friends. At the beginning of 1932, for a brief period, the old col-

laboration with its statistical concomitants can again be seen, but this situation did not last.

The relation of Nos. 2 and 4 forms a contrast to that of Nos. 2 and 1. This latter pair had been friends before the experiment started, and this friendship was maintained. No. 1, of Polish origin, was a fast worker, easy and contented in her social contacts, and maintained a cheerful serenity under all conditions. On occasions, No. 1 worked practically as fast as No. 2. On other occasions, their daily fluctuations of rate showed a high correlation. But, and here lies the difference, the periods when their output rates fluctuated in unison were *not* the same periods as those in which their speeds were nearly identical. No. 1 had a humorous appreciation of the other girl's vigorous leadership, and she willingly played her part like the good citizen she was; but her collaboration in the group activity was one amongst several congenial social activities and had not the same significance for this girl that it had for No. 4. To a lesser extent, Nos. 3 and 4 had the same sort of relationship as had Nos. 1 and 2; the statistical relations of both pairs diminished as those for the 2-4 pair rose, and vice versa.

The history of this group illustrates several characteristics common to social systems of this general type. In the first place, even so small a group as five workers has its stratification and specialization of functions. One member becomes a leader and another is recognized as her assistant in that capacity. Just as each member is distinguishable from the rest by her character, so they are all distinguishable by their individual contributions to the group life. Standing in the group is dependent on the manner in which each contributes to the active life, and to the economic purpose of the group. A failure to participate adequately in one of these respects reduces the opportunities of an individual to participate fully in the other respect.

Social sentiments were thus found to run parallel to lines of social activity; in some cases social activity is based on prior sentiment, and in other cases the reverse is seen. More usually,

social activity and its appropriate sentiment arise together, being mutually supporting. Human relationship is seen to require time for its development; sentiments and appropriate collaboration are not elaborated in a day. The statistical relationships are revealing; for the five assemblers were engaged on individual though similar tasks, and the speed of one girl bore no necessary relation to that of another. Nothing in the formal set-up of the work would lead us to anticipate the high correlations sometimes found between daily fluctuations of speed. This form of activity bears directly on the problem of group integration, and the same group provides other examples.

Looking at Figure 1 once more, each graph can be imagined as being the resultant of a number of wavelike disturbances of differing wave lengths, each superimposed upon the one before. An ocean, such as the North Atlantic, only too frequently provides us with an analogy. So often it is simultaneously disturbed from shore to shore by ripples, waves, oceanic rollers, and by tides — four different types of wave-like disturbances, differently produced, and each with its characteristic range of wave lengths. In similar fashion, a work-speed graph can be thought of as simultaneously disturbed by superimposed fluctuations of very different wave lengths, or — as I prefer to call them — *time spans*, because in this case the length of the wave is measured in units of time.

By means of a statistical device, it is not difficult to break down a work-speed graph into a family of curves, each curve containing only those fluctuations lying between certain limits of wave length, or time span; and such that, if the ordinates of all these curves be added together, the original graph results. A certain a priori justification can be found for this procedure; however, its main justification, as in any other type of analysis, depends upon the significance of its subsequent use.

This analysis has been performed for each of the work-speed graphs shown in Figure 1. For instance, amongst others, one curve has been prepared for each girl, showing all those fluctua-

tions of speed whose time spans lie between one and four weeks — all other fluctuations have been eliminated from these particular curves. And these 1-4 weeks' time-span curves have been compared with each other to see in what degree the speed fluctuations of one girl correspond with those of another. By these means we know to what extent the speed fluctuations of any given pair of girls correspond in the 1-4 weeks' time span throughout the five years of the experiment. The following figures give this information for typical dates throughout the experiment.

Figure 3 refers to April, 1928. The five circles represent the five relay assemblers in the order in which they sat, the distinguishing number of each girl being placed within her circle. When the speed fluctuations of two girls show a significant correspondence in the 1-4 weeks' time span, then the pair in question are joined by a line; for example, the pairs 1, 2 and 3, 4. The figures against the lines indicate the strength of the correspondence stated in percentages, and when this correspondence amounts to 50% or more this is indicated by a thick line. As before, these figures are calculated as 'determinations.' All the correlations shown in the following figures are positive unless otherwise indicated. With this preliminary explanation, let us examine Figure 3.

The Relay Test Room had been running for about a year, but Nos. 1 and 2 had only been members of the group for the last three months of that time. The figure shows that these two girls correlated quite strongly. Workers 3 and 4, both of Polish origin, had been friendly since the beginning of the experiment, although they had little in common except their chance propinquity. Characteristically, No. 5 shows no correspondence in her speed fluctuations with any of the others. A Norwegian by birth, she had only lived in the United States a few years and spoke English with difficulty, and this, combined with the fact that she was married, was older than the others, and of a phlegmatic disposition, prevented her from ever entering fully into the life of the group. So Figure 3 shows correlations between two pairs of

- FIGURES 3-6 -

RELAY TEST GROUP

(Western Electric Company)

CORRESPONDENCE IN OUTPUT FLUCTUATIONS

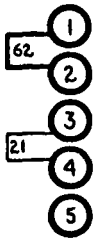

Figure 3 April 1928

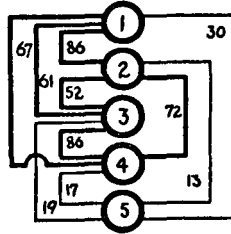

Figure 4 July 1929

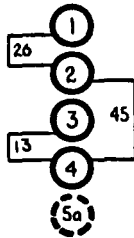

Figure 5 October 1929

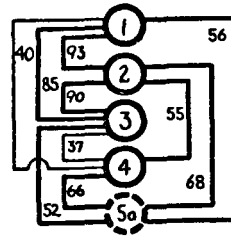

Figure 6 January 1930

friends, but nothing that could be described as a general state of mutual influence as between the five girls.

Figure 4 illustrates the state of affairs fifteen months later, in July, 1929. Here every girl correlates significantly with every other girl, and in many cases very strongly. It will be noticed that every correlation exceeds 50%, except those involving No. 5, which never exceeds 30%. During the fifteen months separating Figures 3 and 4, the group had been acquiring common activities, interests and loyalties. To a large extent, the group had taken their discipline out of the hands of the supervisor and were performing this function for themselves. To give only one instance: when a girl wished for a half day's leave of absence she had to obtain the necessary permission from the supervisor. But a custom had become established by which no girl could ask for such permission unless the group sanctioned it. This leave was seriously debated by the group and not always granted, and I do not think the supervisor ever reversed the decision of the group in this matter. Group solidarity had developed with No. 2 as the unofficial but acknowledged leader; and Figure 4 shows the extent to which the girls were mutually influencing each other in respect to speed fluctuations in a particular time span.

Figure 5 shows an almost complete collapse of group solidarity in this respect only three months later, in October of 1929. In the interval between Figures 4 and 5, No. 5 had left the Company's employment of her own free will and had been replaced by another relay assembler, No. 5a. This last girl was selected at the request of No. 2, and these two had been close friends for some years. No. 5a was in all respects more congenial to the group than her predecessor; she was of the same age as the others, unmarried, good-tempered and co-operative. Nevertheless, No. 5a was unaccustomed to working with her new associates, and quite unused to the type of integrated group activity of which she had no previous experience. The natural result was that, in the 1-4 weeks' time span, she correlated with no one. But, even more significant, other pairs not involving No. 5a also failed to show

much mutual influence. Integration had fallen all round in consequence of an unassimilated social element, and this in spite of the fact that No. 5a was more popular than her predecessor.

However, this state of affairs did not last long, and three months later, Figure 6, we find the highest state of integration ever observed in the group in this particular respect. No. 5a had established herself as a participating member of the group, and, being better adjusted in her surroundings than No. 5, correlations are higher all round. Figures 4 and 6 should be compared. Not only do pairs involving No. 5a show a higher correlation than those involving No. 5, but correlations not involving either girl are usually higher in the later figure. This once more illustrates the dependence of each 'pair relationship' on the total social situation within the group.

Figure 7 shows another change by June, 1930, five months later. Two events occurred to account for this. In the first place, the girls had changed seats, as can be seen from the figure. This rearrangement was introduced for experimental reasons in April of 1930 and was maintained for ten months. A change in seating may not seem important to those whose occupation permits them some liberty of bodily action during working hours, but it made a great difference to the relay group. Their work necessitated some degree of visual attention, as well as continuous finger and arm action; it thus determined the position of the body with respect to the work bench. So, of necessity, intimate conversation could only be carried on between neighbours, although general conversation in a raised tone of voice was not uncommon. Thus a change of seating order involved new associates, an entirely different perspective of the whole group, and consequently the need for a new orientation.

Secondly, shortly after this change, No. 5 requested the Company to take her back and to place her again in the test room. The circumstances surrounding this request were pathetic and the request was granted. But the responsible official had not realized the extent to which this action would be resented by the re-

- FIGURES 7-10-

RELAY TEST GROUP

(Western Electric Company)

CORRESPONDENCE IN OUTPUT FLUCTUATIONS

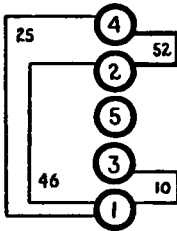

Figure 7 June 1930

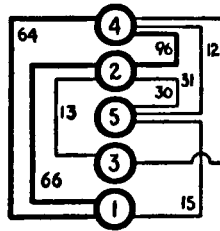

Figure 8 September 1930

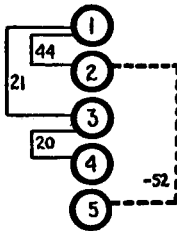

Figure 9 March 1931

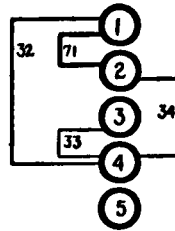

Figure 10 January 1932

mainer of the group. The fact was that No. 5a was decidedly popular, and was supporting an invalid father. Her removal from the test room resulted in a small drop in her wages (she was given a somewhat different occupation), and it was supposed to increase her chance of being laid off as a result of the industrial depression, which was then in its early stages. For both these reasons, the reinstatement of No. 5 was disliked by the group, and this dislike was transferred to No. 5 herself. In Figure 7, No. 5 has no statistical relations with anyone, and other correlations are few and relatively weak.

However, by September of 1930, three months later, the group began to show signs of reintegration (Figure 8). How far this might have gone it is impossible to say, for shortly afterwards the girls were put back into their original order of seating. The result is shown in Figure 9. Not only has integration in this respect collapsed, but Nos. 2 and 5 show a marked negative correlation. It will be remembered that No. 5a was a close friend of No. 2, and at this time the latter rarely spoke to No. 5 except to snub her. The result is seen in the variations of their working speeds; when one worked faster, the other worked slower. Their speeds varied in antiphase. This is the only instance of a negative correlation in the 1-4 weeks' time span, though more frequent instances are found in some of the other time spans.

Finally, Figure 10 shows the situation about ten months later, in January of 1932. By this time, the depression was at its height, many employees had been laid off, and quite evidently the process was bound to continue. For this reason, amongst others, the tone of the relay group had been gradually changing from optimism to resignation. The future was a matter for dread rather than hope; and No. 2 in particular was again restless in the feeling that her ambitions were not being realized. The self-discipline of the group showed signs of deteriorating, and the ten months separating Figures 9 and 10 resulted in little growth of co-operative action. The group had lost its spring. No. 5 was no longer the object of active resentment, but she was effectively outside

the common life and practically never spoke to any of the other girls.

One example of No. 5's isolation may be given. Whenever a girl had a birthday, the others gave her a present, and she invariably reciprocated by presenting the group with a box of chocolates. So invariable had this custom become, that on her birthday a girl would arrive already armed with her reciprocal present of chocolates. But No. 5 neither gave nor received presents from the others after her reappearance in 1930.

We have briefly compared synchronization of fluctuations, in the 1-4 weeks' time span, with the social sentiments of the workers themselves; and it appears that these two factors tend to vary in close accord with each other. This accord was considerably more detailed than I have space to indicate. Moreover, the story is much the same whatever time span be considered. Fluctuations have been examined with individual durations of a minute or two, at one end of the scale, up to those having durations of nearly three months at the other extreme.

In every case, the degree in which the speed fluctuations of two workers correspond, relates itself in some fashion to their mutual sentiments. However, the type of social sentiment involved does depend somewhat on the length of the time span chosen. Passing over a number of important differences, it is roughly true to say that in all the spans, mutual sentiments of approval usually result in positive correlations; and active antagonisms result in negative correlations; whilst an absence of significant correlations accompanies mutual indifference. But these three terms — *approval*, *antagonism*, and *indifference* — refer to different levels of sentiment corresponding to the various time spans considered.

Perhaps the outstanding thing about this complexity of statistical relations between any two girls is that nothing in the formal arrangement of their work necessitated, or even suggested it. Quite obviously, this situation was not even known to the girls themselves, much less could they deliberately have planned it. Here were five skilled assemblers engaged on interdependent but

similar work, sitting together and having ordinary social relations with each other; they entertained sentiments of friendship, annoyance, antagonism, interest in the group life, and expectations and sentiments regarding the future. This is the typical picture of a successful working group; and it is also representative of family life, or, for that matter, of any other small primary group. In addition, it is found that beneath the intentional activities of these individuals, lies a whole system of co-operative action, the existence of which no one had suspected. Two girls, sharing common sentiments and collaborating in group activities, are found to show similarities in the fluctuations of their rate of work in a variety of different ways. Social sentiments are seen to develop over a period of time as a result of activities performed in common.

It has been suggested that sentiment represents the first beginnings of mentality arising from action. However that may be, and there are grounds for entertaining this hypothesis, it is certain that the relationship between social sentiment and social action is very fundamental in human nature. Sentiment is in some sense an expression of action. But the test room also illustrates the opposite proposition, namely, that action is in some sense the expression of sentiment. Social sentiments are found to be accompanied by activities brought to light by statistical methods, and quite below the level of direct observation. Evidently group integration depends on the mutual support of social sentiment and social action, not only at an explicit level, but also in ways far below direct observation on what is rather misleadingly referred to as the 'unconscious level.'

An analysis of this and similar statistical data for the relay group shows that such statistical relations build up first between girls sitting next to each other, whilst 'distant pairs' only become related some months later. Similarly, when these relationships become weaker towards the end of the experiment, the loss occurs predominantly amongst 'distant pairs.' Thus collaboration starts first and lasts longest between 'neighbour pairs.'

So even in a group of only five members, neighbour pairs show the characteristic marks of primary groups in a greater degree than do distant pairs. This can be seen in another way; for negative correlations tend to be associated with antagonistic sentiments, and in another time span where these show more freely, most of the negative correlations are found between distant pairs. It has been seen that social sentiments are based on routine activities between people, developed over a period of time; and it is clear that neighbours in the test room were more prone to elaborate such activities than girls who were not sitting together.

More generally, the history of the relay test group illustrates the close relation of all the strands of any given individual's total activity, mental and physical. It also illustrates the interaction between the various activities, mental and physical, of a group or small society of human beings. In some ways an integrated group has the characteristic of a single organism, in which each part and each particular activity is in a state of accommodation or balance with the remainder.

Thus in Figure 1, the output rate of three of the five girls tends to descend, or at least not increase, after 1930. These are the three girls who were suffering the greatest financial anxieties, owing to the industrial depression. Their relatives were becoming unemployed and so forth. If the work of each individual be considered only in the light of her logical economic motives, it would seem that these girls should have worked faster, not slower, after 1930. The fact is that, within limits of physique and skill, work effectiveness is related to the general outlook of the individual and particularly to that part which can be described as his (or her) social situation. As this total situation deteriorated so did the work effectiveness decline.

The same connection between work effectiveness and total situation appeared in a more dramatic form in 1932. During the last year of this group's work in the test room, the depression was at its height, and the whole firm was working short hours. Finally the situation became acute about May, 1932. Several of the

operators were in financial straits. No. 2 was struggling, in the face of a difficult financial situation, to hold her home together. On the top of this, the group was informed that, as young employees with only a few years' service, their turn had come to leave the firm. The girls were given several weeks' notice and were paid a lump sum in addition to their wages when they left. As always, the firm was doing well by its workers, and nothing is more revealing than the steady belief in the humanity of the firm's policies, on the part of all its employees. Nevertheless, something not far short of semi-starvation, or charity, faced several of the relay group. A few weeks' employment was still left, and a determined effort to raise output would have done something to ease their financial situation. The actual fact is that output rate fell violently throughout these last few weeks (Figure 1).

I showed Figure 1 to operator No. 2 some months after she had been laid off and, without referring to my own opinion, asked her for an explanation of the final drop in work effectiveness. No. 2 replied, "We lost our pride." This answer in four words expresses the relation between the individual's total situation and her adjustment to it.

CHAPTER IV

THE MEANING OF SOCIAL INTEGRATION

IN THE last chapter, we studied a very small primary group. This group remained well integrated in spite of some vicissitudes in its history and it performed two functions. In the first place, the group led a relatively full social life, not only after hours but as a part of their work; and secondly, the group was actively looking after its economic purpose — the girls' working rates improved substantially after entering the test room, in spite of several years' previous experience in this work. It was also shown that even five people working together develop a social structure in which each person plays his individual part. A small group is like a larger group in this respect; integration is not a state in which everyone conforms to a single pattern, but on the contrary it implies an exercise of individuality by enabling each member to make his unique contribution to the whole.

Naturally, every group will have a character of its own, and the differences between small groups is very revealing. The relay assemblers just described were in many ways not typical of industrial groups; for one thing, they felt themselves to be in a privileged position. It is true that they were constantly subjected to experimental changes in a number of ways; hours of work, length and number of rest pauses, and so on, but in the details of these changes, the girls were themselves consulted; and, as showing that their opinions were given weight, it is worth recording that the girls objected to two proposed arrangements and neither of these was tried in consequence.

The Western Electric Company made an elaborate study of another small working group in which conditions were much more typical of those in industry at large. This group is described in great detail in another place,¹ and all that is necessary here is to

¹ "Industrial Research in Human Relations." F. J. Roethlisberger & W. J. Dickson, Harvard University Press (to be published in 1937).

indicate some of the authors' conclusions. The group consisted of fourteen men and a supervisor. Nine of the men were wiremen; their task was to affix insulated wire to very complicated banks of electric terminals. These wiremen were organized into three groups of three men, and to each group was attached a solderman who soldered the electric connections already prepared by his wiremen. Three wiremen and one solderman composed one 'soldering unit.' The three soldering units had attached to them two inspectors who reported directly to the inspection department. Each of these inspected the work of one and a half soldering units. This 'bank wiring observation room,' as it was called, though larger than the relay group, was nevertheless a small primary group in which all the members were in face-to-face contact with one another. The only change in the habitual routines of these men was to move them, together with their supervisor, out of a large shop into a room by themselves. An observer sat in the room continuously.

The authors in their account make it evident that besides the formal structure described above, these men evolved very elaborate social routines of their own. Sub-groups were formed of a few men each, and these sub-groups developed group relations with each other. The two main sub-groups were in some respects antagonistic, but in other respects they were united in common activities. These activities are described in great detail, and Figure 11 shows one such activity. The nine wiremen, together with their three soldermen, are represented by circles. A line joining two circles indicates that one of these individuals was observed to help the other; the arrow head points from the helper to the man helped. Some men helped more than others, whilst certain individuals were mainly helped. In the account, it becomes clear that this did not depend so much on the relative skills of the various men as on their temperaments and social positions within the group. One of the sub-groups obtained an ascendancy over the other men and this was found to be due partly to the nature of their work, which carried more prestige,

— FIGURE 11 —

BANK WIRING OBSERVATION GROUP

(Western Electric Company)

ASSISTANCE GIVEN AND RECEIVED BY VARIOUS MEMBERS

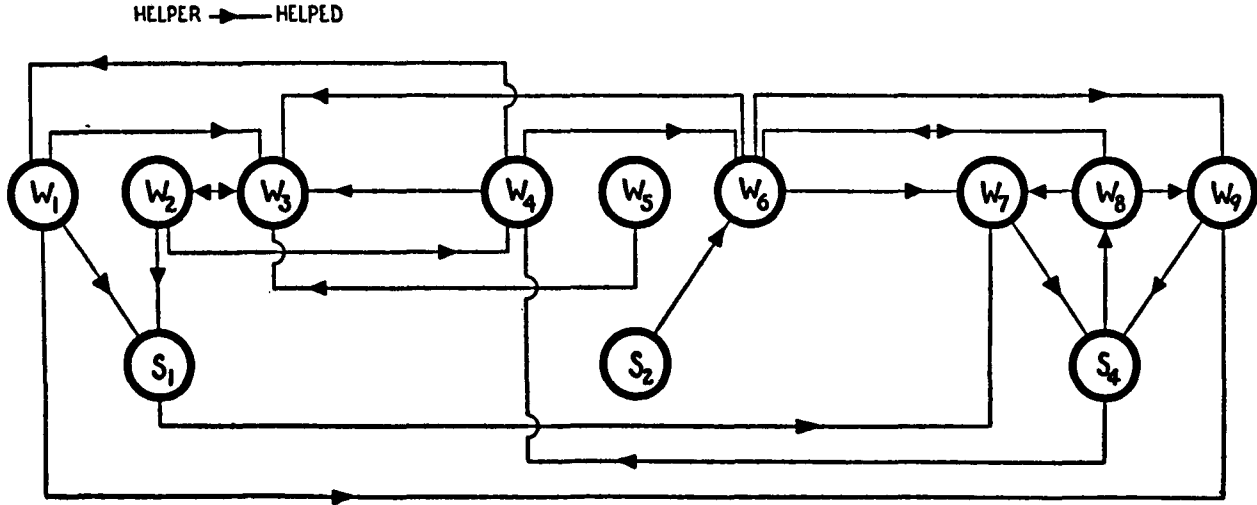

and partly to customs and attitudes elaborated within the group. In a great variety of ways, the authors show the complication of social relationship within this group, and they also show its relation to the habitual activities which were built up.

The bank wiring group, as described, has this in common with the Relay Test Room, that they both exhibited a varied pattern of human relationship. But the authors proceed to establish a fundamental difference between the two groups: the relay group were not only enjoying immediate human relations, but these were directed towards a satisfactory economic outcome. The group was actively pursuing its logical purpose.

In the case of the bank wiring group, great attention was also paid to the economic purpose, but the object of that attention was to prevent any change or evolution of whatever kind. Figure 12 shows the hourly rate of work for the nine wiremen over the period of the experiment and, with the exception of W9 whose output was abnormally low at all times, no wireman either improved his rate, nor did he let it vary in any important respect. Some of these graphs are remarkably good approximations to a mathematically straight line. This figure should be contrasted with Figure 1 for the relay group. These men's output rates did not remain so constant by accident, and a whole series of customs and attitudes were found to be the controlling factors; their general purpose was to emphasize the danger of change. If output goes up, something will happen; perhaps rates may be cut. If output goes down, something else will happen; the individuals may be in bad standing in the company. It made no difference that the company has a well deserved reputation for its employee relations. The bank wiring men were not deducing their opinions logically; rather they were possessed of certain fixed attitudes which can best be described as a fear of management, and their activities were found to be in line with these sentiments.

The attitude of alarm towards management on the part of employees is a very common one, far more prevalent than many leaders of industry are prone to imagine. These men may be

-FIGURE 12-

BANK WIRING OBSERVATION GROUP
(Western Electric Company)

WEEKLY RATE OF OUTPUT FOR EACH WIREMAN (ELECTRICAL CONNECTIONS PER HOUR)

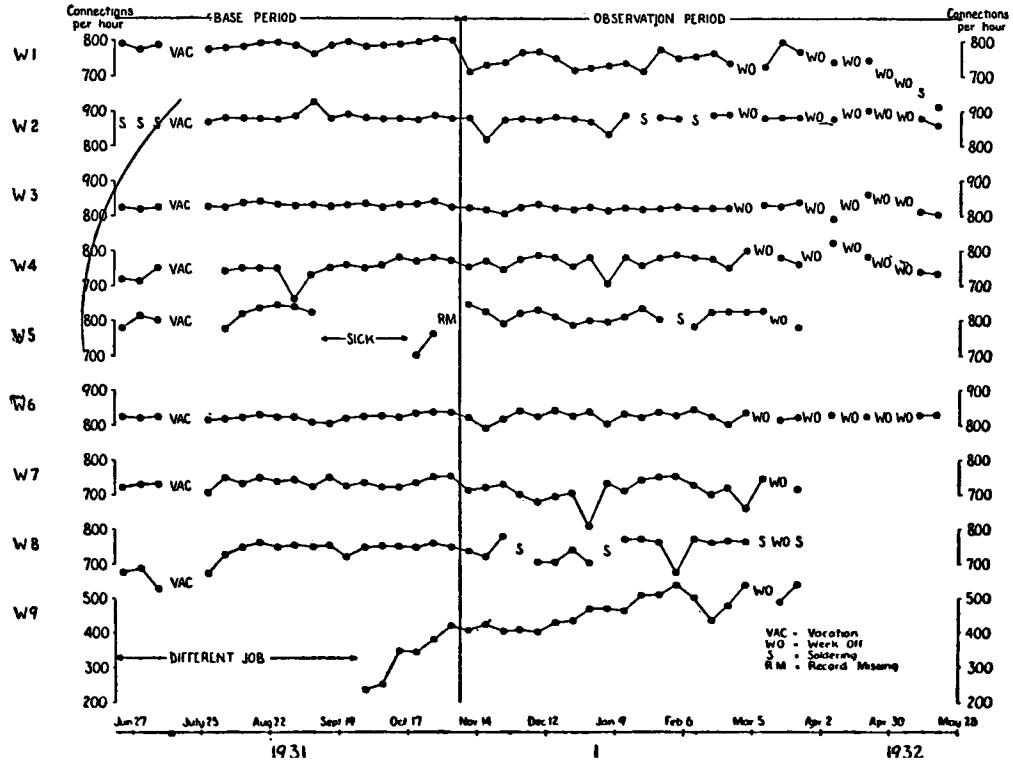

[58]

aware that they are giving their employees a 'square deal.' They pay wages which are standard or better, arrange for decent conditions within their factories, and do their best to assure even-handed supervision on the part of the junior executives. It would be illogical for the men not to recognize the substantial justice of their treatment and not to respond by working whole-heartedly for their own advantage. And yet this is precisely what employees are so apt not to do.

Not only does group integrity depend on routine relations, together with their appropriate sentiments, but the converse statement is equally true; the interruption of routine relations is the surest method of causing disintegration within a group. The social sentiments (friendships, loyalties and work interests) are cut off from their roots; for no sentiment is wholly without relation to action, although the connection is often hidden from easy view. Moreover, stable social sentiments are of comparatively slow growth for the most part; when broken down, not only do they rebuild slowly, but their decay is apt to be associated with disruptive attitudes on the part of those involved. Groups once integrated have a life and a vigour of their own and they resist violent extinction.

The bank wiring group is a case in point. Management, for no doubt adequate logical reasons, is prone to rearrange the working conditions of its employees with scant regard for the social routines and sentiments it is unwittingly breaking. In consequence, industrial groups develop a series of routines designed to nullify the effects of managerial activity. Such routines are not explicitly evolved for these reasons, and for the most part they are explained by the workers on entirely different grounds; none the less, they are only found in groups fearful for their own survival. I refer to such matters as eliminating fluctuation of output, which is closely related to restriction of output; a failure in passing information up the line; and a general lack of co-operation in the economic purposes of the organization. Mathewson's investigation, already referred to, bears out this statement. A

group behaves as though it has a 'will to live' and it guards its life in a manner analogous to that of a single individual. This does not imply some mystic group-life over and above the individual lives of its members; it merely means that each person has his sentiments and actions so oriented as to make for the preservation of his group. For a group only exists in so far as it is in the minds of its members. Many ultimate values of life spring from relationship with others, and to scatter a group is to lower the scale of human value for each and every person. Naturally, this is resisted.

One of the best proofs of this fact is to observe the behaviour of a stable group of long duration faced with a choice between two alternatives, one of which will assist the economic positions of the individuals at the expense of the social structure, whilst the other will maintain the social structure at an economic loss. The second alternative is almost always chosen. Of course the alternative is not so clear cut in the minds of the members; they cannot bear to lose the society on which their scale of values depends and so, by ingenious argument, they are apt to discount the price of its continued existence. Numberless examples might be cited from groups and societies of all sizes and conditions.

In Europe, aristocracies were based on the ownership of land and on a whole system of privileges and obligations appropriate to this situation. With the rise of modern industry, these aristocratic groups faced the alternative of going into industry as the natural leaders, or of suffering progressive impoverishment. But to enter industry would have involved so radical a break with the activities, customs and attitudes to which they were habituated, that broadly speaking the European captains of industry have not been drawn from the aristocratic elements of the various nations. In remaining outside industrial activities, this aristocratic group saved its immediate structure at the cost of relinquishing any practical interest in the logical purposes of society. Today, these aristocracies have practically vanished, and in so

far as any remnants still survive, it is through their continued leadership in politics.

In 1834, the English landlord class opposed the introduction of a poor law bill, the most obvious effect of which was to reduce the financial burden of the landlords themselves by taking from their shoulders the care of the rural unemployed. However, this rearrangement radically altered the social structure by reducing the function of the local squires as leaders of the countryside, and so was resisted by this class. The American Civil War provides another large-scale instance. It is generally recognized that by the middle of the last century, the Southern economy was failing to compete with free labour, and that the system, if handled sympathetically, would have evolved by economic necessity. However, Southern society was faced with the possibility of an abrupt change in its social structure, and against all economic motives it waged a long and exhausting war to maintain a social continuity. History is strewn with instances of small nations and peoples who have fought against hopeless odds to maintain their 'way of life'; for ultimately all worth-while living is conceived as directed activity within an accustomed social pattern.

The same phenomenon is just as prevalent in the case of smaller groups. Any country faced with a rapidly decaying industry of any size knows that one of the most difficult aspects of the problem lies in the fact that the workers involved will often face semi-starvation, rather than start life again in some other capacity and locality. This is especially true if the industry is both concentrated and isolated, so that its members form their own society and have not practically experienced any other way of life. It is often stated, and I imagine with some foundation, that precisely the same problem arises in any attempt to clear a slum and rehouse its members under better conditions; the immediate effect is to break down the habitual human associations of the neighbourhood. The histories of single firms tell precisely

the same tale. A major reorganization of a firm is commonly resisted by a whole host of so-called 'interests' within it. It is by no means always the case that the actual positions of the resisting members would be any worse, but they would be very different, and it is the change of setting that is being resisted. So violent is this resistance that usually a number of the firm's officers have to be dropped, for it is true to say that being unable to imagine a change in their setting they precipitate a total personal loss.

A serious difficulty as between a government's (or a firm's) departments, is their constant liability to inky warfare. Each department bombards the other with memoranda, reports, complaints and other documents, the chief purpose of which is to achieve a victory of manoeuvre in which some highly technical advantage is won for the successful group. In one of the leading countries during the World War, a fighting service appealed to a scientist to solve a pressing technical problem. He responded by pointing out that another fighting service of the same country had solved that very problem. The retort was, "We don't tell our secrets to them and we don't want to know theirs." This is yet another example of the lengths to which a group will go in guarding its status.

Finally the bank wiring group were found to be restricting output to their economic detriment in accordance with a confused belief that to do otherwise would upset the stability of the group. And this behaviour is not uncommon in small industrial groups; executives are apt to be sceptical of so sweeping a statement, but I have yet to meet anyone with actual experience as an apprentice or as a workman, who does not recollect such attitudes as being typical in his own experience. This does not necessarily imply hard feelings as between management and employees. They may have the kindest thoughts about each other; but the working groups will usually be found to exhibit a pattern of behaviour appropriate to their supposed safety, and not so appropriate to their logical, explicit interests.

Satisfactory social living implies an adequate, stable society addressing itself to its future situation or, in other words, pursuing its economic purpose. And we have seen that where the social structure is brought into opposition with its economic purpose it is the social structure that wins the day. The future gives way to the present. Now primary groups are characterized by the richness of their immediate social activities, whilst secondary groups are held together by their logical purpose, for their face-to-face activities are very limited; and that is why in a contest between two organizations it is the more primary of the two that usually wins. The few apparent exceptions are generally based on a faulty analysis of the human activities actually promoted by the two organizations. The first and immediate necessity for each man is to preserve the 'way of life' on which his scale of values depends. But this phrase, a 'way of life,' reminds us that living involves much besides human contacts; there are such things as skills and the habitual material arrangements of men's occupations, and these, too, are involved in a 'way of life.'

The various occupations and skills all have, for society, certain social implications; and these latter are only loosely related to the difficulty or labour involved in their acquisition or performance. The occupation of doctor ranks above that of a taxi-driver, and it is certainly more difficult and costly to be a doctor than a driver. But it is probably even more difficult to earn a living as a juggler, though he certainly does not take precedence. Social prestige is attached to occupations for a number of reasons, but usually good ranking implies that at some time the value to society of the occupation was rated highly.

Often an attempt is made to show that there is some logical reason for the prevalent social ranking of occupations, but the various reasons adduced are not mutually compatible. If the more honoured profession has the higher pay, one explanation is forthcoming; if the reverse, we are enlightened by an opposite line of argument. Moreover, the relative rankings in various contemporary societies are not in accordance with one another,

and the variations become even more marked if we include past civilizations.

It has been remarked that the nearest Roman equivalent to a modern university professor was the Greek household slave, and honesty compels one to admit that he was no unworthy representative of the calling. Different degrees of prestige will be found to accompany occupations so nearly identical that those involved cannot give any plausible explanation, whilst to an onlooker the occupations seem identical. An example of this is to be found in the account of the Bank Wiring Observation Room by Roethlisberger and Dickson. The wiremen were divided into two groups on the basis of an insignificant difference in their occupations. One group, by virtue of its job, ranked above the other. The authors trace the origin of this distinction and find it rested on a complex of social implications (not all based on fact) which had become related to the jobs over a period of years.

It is quite a mistake to suppose either that small variations in types of work do not habitually carry social implications, or that these are to be explained by easy deductions from some simple principle. The fact is that skills all have their 'meaning' for society and are part and parcel of the human organization.

Naturally, these meanings change from time to time. Not so long ago, and still in some groups, a clergyman, besides his obvious vocation, was a general counsellor, a wise man on whom a family would lean in difficulty of any sort. Then the family lawyer took his place. At one time, it seemed as though scientists might qualify for the job, but their skills were too remote, and the doctor stepped in. At the moment, it seems not unlikely that psychoanalysts may be next on the list, but this is not yet certain. Every society has its wise men; they mainly belong to some given occupation at any one time and place, but the reason for the choice is never very obvious. It is just the same in industry; each occupation has its traditional status and is regarded in a characteristic light. Any workman knows what to think of inspectors, tool setters, storekeepers, bricklayers, carpenters and so

forth. Moreover, he draws his distinctions with a fine show of finality, for no fact is more absolute, more 'really real,' than a socially determined value.

Social values or 'meanings' not only attach themselves to the various skills and occupations but also adhere to the accompanying instruments and physical circumstances. This has already been referred to in the second chapter where an illustration was given of the fact that an individual's prestige was partly determined by the details of his furnishings and the tools or instruments of his calling. But the 'meaning' of things goes deeper than that; a plough to a farmer *is* the kind of life he leads. My own occupation is bound up with my sentiments regarding pens and paper and similar implements of my trade.

Now all this is vital to an understanding of prevalent attitudes of industrial groups towards their management. The 'meanings' or attitudes of each individual are based on their social experience, but these attitudes are in the main not explicit, and they also embrace the visible symbols of the group's activity. Each man in a group has a unique position in his own thinking and in the thinking of the others (not the same position necessarily). This position is partly an effect of character, partly of occupation, (no two men have quite the same occupation; e.g., if one man sits nearer the door, then the other sits further from it), and partly the effect of his physical accompaniments which have traditional social values of their own.

It is this complex balance of social forces organized for a logical purpose that management is called upon to lead. Any unwise attempt at change will threaten the stability of this social structure and will be met by an alarmed and unthinking resistance on the part of the group. Naturally, the group cannot make clear to themselves or to others the nature of their fears, and they produce a series of elaborate pseudo-logical explanations of their subsequent actions. Such a group will resist any outside threat to its own integrity by withdrawing into a self-made shell, and so ceasing to collaborate effectively with the larger organiza-

tion around it. It elaborates routines to assist such isolation, and in these circumstances the group does undoubtedly maintain some sort of integration between its members, partly on the basis of these isolating routines. But the result is not satisfactory either to the group's own social sentiments or to its economic performance, for the internal integration is obtained through a loss of contact with its neighbour groups. This is internal integration at a low level. The logical purpose has been sacrificed for the immediate 'way of life,' and so human contacts are maintained without any sufficient objective. In fact, the isolating activities often have no purpose whatever except to guard the status quo.

Two contrasting types of situations have been examined. In the first, the relay group, management was in point of fact continually altering the conditions within the group. One or two of the changes did noticeably affect the integrating activities, but most of the reorganizations of working conditions produced no such effect. And never was there the slightest sign that the girls were resisting the leads given them by management. On the contrary, the group was co-operating whole-heartedly with its executives in promoting their economic well-being, and the effect was a satisfactory state of social living. This is no unique phenomenon, only to be found in an industrial laboratory. Leadership has been repeatedly successful from long before the time of Moses down to the present day.

On the other hand, the bank wiring group presents an opposite picture in which management, as a matter of fact, interfered comparatively little with the social life of the group and yet was perpetually feared as a menace to social integrity. This has been a common phenomenon in the past, but the history of employer-employee relations ever since the rise of modern industry does suggest an alarming lack of mutual understanding between industrial groups and their formal leaders.

As usual, we find a logical explanation of the situation. There exists, we are informed, an essential divergence of economic interests as between capital and labour. The former demands the

maximum of effort for the minimum of recompense, whilst the latter attempts to reverse this formula. For a while nothing seemed clearer than this. But as industry became more complex, it was noticeable that ownership and management began to part company. The owner hired his managers much as he hired his 'hands'; both in effect were employees. Then the owner faded away and his place was taken by scattered shareholders, thousands of them in many cases, each with a very small interest in the organization, and an even smaller knowledge of its personnel or activities. Thus the only vivid personalities left are a number of employees, some of whom are leading the others. There are still a number of interests to be guarded, and these interests are by no means identical, but our old friend Capital can hardly be represented in the persons of the hired management. Nevertheless, some unresolved difficulty lies in the way of integration throughout the ranks of industry.

We shall discuss the rise of modern leadership in the next chapter, and find some clue to our problem in its evolution from a socially controlled to a logically directed activity.

CHAPTER V

THE EVOLUTION OF MODERN LEADERSHIP

ORIGINALLY, a leader was one who showed the way and was followed by others; he quite literally led by performing some activity which was copied faithfully by his followers. In this sense, one man may lead others on a country walk. There is little implication of an organizing function in such leadership; the leader is an example to follow. It is doubtful whether a pure example of such primitive leadership could be found in any society, however simple, but much leadership does approximate to this type. And, in fact, the element of imitation is never entirely absent in any case. In a small industrial group, such as the relay test group, that member will obtain ascendancy over the others who, among other qualities, shows an unusual aptitude in an activity which the others also desire to exercise. If the group is interested in its work, then its natural leader will be that member who performs his work best, according to the group's criterion. In any case the leader will be one of the better workers. If the group be in violent opposition to its management, it will act in such a manner as to thwart the latter, and the most successful trouble maker becomes the leader or, in the current phrase, becomes the 'ringleader.'

A leader is in some sense chosen by the rest of the group as one who is both able and willing to assist them in doing that which they already wish to do. This act of choosing is not necessarily deliberate or even recognized by the group.

So leadership in its simple form has certain well-marked characteristics whether it be found in industry, among primitive tribes, or in the cities of modern society. In the first place, the leader is selected by the joint inclinations of the candidate himself and of the society or group of which he is a member. Secondly, he is selected for his skill in specific activities. His skill, in a simple

community, is usually a manual technical skill. Thirdly, the exercise of the given skill, and the objective promoted, accord with the social sentiments of the group.

Thus, the leader's function is such as to assist the group in maintaining its customs, its purposes and its attitudes undamaged by the chance ineptitudes of the less experienced or less skilful members. This is a conservative function, calculated to maintain the society in an unvarying circle of procedures. A group so maintained may be expected to display integration in a high degree. Not only are human relations shielded from external shock, but the social 'meaning' of every activity, and of the physical accessories to those activities, takes on the vivid colour of absolute ultimate fact. Nothing is more certain to a native than that his horn, or maybe his hearthstone, has some very real, though not accurately definable, relation to himself, to customs in which the article is involved, and to some legendary episodes or persons. Everything stands in a close and absolute relation to everything else.

If we analysed the attitudes of a typical English country squire of the recent past, we should find something like the following among those facts fundamental to his thinking.

1. To trap a fox is a bad act.
2. To hunt a fox is a good act.
3. Good men hunt foxes.
4. Good men believe (unquestioningly) in the Established Church of England. They attend divine service.
5. The Church shows people what's what, and teaches the lower orders their place; it makes them good.
6. Bad members of the lower orders trap foxes.
7. To trap a fox is a bad act.

.

And so we go round and round the circle of a closed, integrated system of social actions, sentiments and beliefs. The system is emotionally self-consistent; it relates everything to everything else

by a series of non-logical moral judgments and sentiments, each of which must be, and in fact is accepted as fundamental and absolute. It is a characteristic of such a society that thinking is in terms of absolute values, that hypotheses are not readily entertained, that problems are not argued on the basis of intellectual considerations but are judged in the light of an elaborate ethical code. This code rests on a myth, a mystical account of some sort, or on a formed religion which, being ultimate, is not itself open to rational investigation.

The social values and sentiments of any industrial group of workers, in so far as that group is integrated, will be found to run a course not unlike that just depicted. Persons, social acts and things all have their interlocking 'meanings'—judgments of good and bad conduct are accepted with unthinking conviction, although if questioned they will be defended by a string of rationalizations. To a considerable extent this is the thinking and sentiment of every individual but, as we shall see later, other elements may serve to modify the picture.

Clearly, leadership within a simple non-intellectual group is not a progressive affair if left to itself; on the other hand, it is highly competent from a certain point of view. It achieves two objectives: it integrates its groups, and it secures the future by a perpetuation of the best standard techniques of the community. From the standpoint of a modern code of values, this leadership has one capital defect: it is not progressive. The rise of this explicit urge for designed, technical progression is one of the unexpected developments of primitive leadership.

The primitive leader is well exemplified by the highly skilled mechanic. Such a man has by long application acquired an unusual skill in his art. He is also in possession of a traditional set of methods, or sequences of operations, with which he tackles his technical problems. Perhaps the outstanding characteristic of the mechanic-leader is his intense pride in, and unswerving loyalty to the detailed procedure by which he exercises his skill. Any attempt on the part of his 'boss' to modify these by one

hair's breadth will evoke the most unmeasured anger. It is as though a brutal assault had been made on his household gods. And that is exactly what it amounts to. The simple leader is above all things loyal to his skill and to its accompanying procedures. Every act of discriminating attention, every guarding and controlled movement has been practised a thousand times and is the basis of a deep sentiment; these *are* his ways of life, and on them his ultimate values are grounded.

But a sympathetic study of a skilled worker over a sufficient period will reveal an apparently erratic streak in his behaviour. Sooner or later in his work, our friend will surmount some particular difficulty by an elegant device, and he will explain with pride that 'in his young days' they were taught to do such and such, but that he had subsequently 'thought of' the procedure just demonstrated. No loyalty is shown towards the discarded traditional procedure, and his common sense would be outraged at the bare suggestion that any value could adhere to the inferior method. In all these respects, he would be followed without question by his group.

The fact is that our mechanic, for once in his life, is thinking for himself and he has temporarily discarded the whole lumber of social sanctions and taboos. Up to that moment he was possessed of an implicit skill in action — a practical wisdom below the level of speech. But in the continual practice of his art, he was learning to notice the connection, the causal relations, between the various operations involved. He began to understand the reasons why, and to be able to give a few logical explanations for some of his actions. He would have once declared that he did such and such because "that was the way to do it" — an appeal to social sanction. Now he can say that too heavy a feed on his lathe will result in 'chattering,' *because* of lack of rigidity in the construction of the slide. And a designing engineer would, by suitable calculation or experiment, be able to endorse the mechanic's logical deduction, based as it was on discriminating observation of the facts.

This is the first step in an individual liberty of thought; a liberation from the guidance of social custom. Having once achieved this enormous stride, it is a second and almost inevitable step, human nature being what it is, to practise these logical processes with small imaginary variations; what would happen if I stiffened the tool holder on the slide in such and such a way? The mechanic tries this out and is the proud inventor of an improved process.

To a university-trained engineer, the whole affair seems out of proportion. He is filled with respect for the mechanic's skills of operation, but as for the so-called 'invention' — why, his day is spent in the habitual exercise of far more elaborate constructions than that! However, the engineer would be wrong; the achievement of independent logical thought is one of the major successes of mankind, and in a greater or lesser degree it is achieved afresh by every individual at some stage in his life.

This, or something like it, is the story of technical advance in primitive communities, as well as amongst many industrial groups. And it is observable that the changes in non-progressive groups are in the first instance improvements in technical procedures; social changes arise as the unwitting consequences of these technical advances.

The steps leading to a technical advance are roughly as follows:

1. The leader shares with his group a profound loyalty to the technical procedures by which they prosecute their purposeful tasks. These procedures are their 'way of life.'
2. The leader is trusted as one who has unusual skill in these technical procedures. He is the guardian of the social customs and in these matters his word is final.
3. The leader, being genuinely a man of intelligence in this respect, obtains an unusual insight into the causal relations involved in his procedures. He begins to

reflect upon his technical actions and on the behaviour of the material he operates upon.

4. He continues in his traditional procedures, but less because of society's sanction and more because he sees the 'reason why.' He has partly shifted the grounds for his pattern of behaviour, unnoticed by himself and by the group.
5. Sooner or later, the leader, in his semi-rational reveries and reflections, stumbles on a technical improvement. He adopts this without misgiving because the group has accorded him the right to make decisions in technical matters—(this is my rationalization, not his).
6. The group follow their leader, and adopt the improved process without question; the leader is the right man to show the way, and the group's lesser but real insights with respect to their procedures dimly indicate the underlying logic.

Since technical procedures are part and parcel of a group's social structure, it follows that even a small technical advance will result in a modification of the structure. The dependence of society on its procedures is naturally not explicit in the minds of the group, and they may simultaneously adopt the new procedure and deplore the change or loss of 'meaning' involved in the departure from the 'good old ways.' The degree to which this sentiment is shown by all groups and societies is amazing. One manifestation of this sentiment consists in faking up new things or procedures to appear like the old.

For instance, some of the very earliest stone churches to be built in England have the stone worked in such a manner as to suggest a wooden structure; wood in those days (roughly, 8th century) being the traditional material. Similarly, there exists in Nova Scotia, or there did a year or two ago, a wooden bridge the piers of which were constructed of roughly hewn stone, shaped and piled on one another in crisscrossed fashion like wooden logs

in imitation of the more usual bridges of the neighbourhood. To this day, some of the ocean-going motor ships have quite unnecessary funnels in imitation of the traditional steamers. And the latter at one time were fitted with spars reminiscent of sailing ships, although they did not carry corresponding sails. I confess that an electric locomotive is not so 'real' to me as the steam locomotive with which I was familiar as a child, and I regret the manner in which the chimneys of the latter have been losing their original majestic height. Almost every new substance and many structures are introduced as more or less successful imitations of those they are supplanting. The same thing applies to human procedures and customs. On parade, Army officers present themselves in the guise of swordsmen, but on active service these parade swords are never taken into the trenches; hand-grenades and firearms are the modern instruments of warfare.

However, in modern industry most workers are quite explicitly aware of the connection between technological advance and change in social structure, and in consequence the former is often strenuously opposed. This opposition is explained on rational grounds, and frequently this is genuinely the real and sufficient basis for the action; but this explanation is not invariably the only motive.

In the absence of modern leadership, such as is typical in industry today, the pace of technological improvement in society would be sufficiently deliberate to prevent any radical break with the immediate past, and in his own thinking each man would carry on the traditions of his father. Primitive leadership is thus an instrument for holding a group closely to its norm, but in the course of generations the norm is subject to a slow wandering in the direction of technological improvement together with the consequent social adaptation. Such leadership is typical of unprogressive groups, whether these be agricultural societies of the Atlantic countries, some societies in the Far East, or many small employee groups in so far as they are not directed from above.

Naturally, the extent to which any given group approximates to this type is a matter of degree; and in modern industry the trend of employee mentality is away from the manually skilled worker towards that of the mentally adaptable thinker. This shift is perhaps not quite so emphatic as many would have us suppose. Observers are apt to be misled by their own sentiments; the hammer, the cold chisel and the file are still the symbols, for elderly mechanics, of manual skill, just as the sword is still symbolic of the warrior, and they are sceptical of a skill which seems to consist in controlling the levers of an automatic machine.

We have in outline traced the evolution of explicit logical skill from the implicit skill in action of the superior man, and we have noticed that skills to this day, and specifically in industry, are largely of the more primitive type. But explicit logical skill in itself will result in nothing more than sporadic bursts of change, arising directly from a contemplation of the current procedures. The final step which mankind has so far achieved is deliberately to organize logical thinking in such a way as to lead to a stream of improvements. Broadly speaking, what has been evolved is a direction of the thinking processes towards a continual evolution of better and better technological procedures.

It has been already noticed, as an exceptional trait, that the simple leader, in spite of an intense emotional loyalty to traditional techniques, showed no particular regret in deserting an old technique for a better one which he understood in terms of familiar fact. In so far as thought takes the form of pursuing the causal relations of accepted terms or things, i.e., in so far as thought is logical, the process arouses no particular sentiment. Emotional resistance makes its appearance when recognition is demanded for some fact or thing which is incompatible with an existing sentiment. Apparently small technical advances occasionally introduced by an accepted leader, based as they are on logical processes (not necessarily quite explicit), do not seem to involve a sufficient area of accepted practice to arouse resentment.

Resentment, and emotional resistance generally, is the guardian

of those attitudes and behaviours which cannot be investigated by logical procedures, given the mental development of the individual in question. The simple details of working tasks are matters about which leading men of all ages have been able to reflect, and for this reason they have been able to make comparisons between alternative possibilities without violating social sanction. This of course does not mean that such men conceived of reflection per se as being a virtue; exceptional people have shown this trait from early days, but as a widespread phenomenon, the evolution from the cheerful acceptance of sporadic technological advances to the deliberate quest for systematic development is a matter of comparatively recent history.

Socially guided thinking in simple groups or societies depends on the absolute 'reality' of social verdict. This *is* bad, that *is* good, and no doubts are entertained. However, logical thinking involves, or makes probable, a comparison of this with that. Two or more concepts or procedures are simultaneously entertained as possibilities. Neither is regarded as absolutely good or bad a priori, but the relative merits of the two are critically considered.

Such mental activities inevitably weaken the force of social sanction, at least with respect to those matters towards which this attitude is habitually adopted. Those matters first and chiefly liberated from social control in this way were the technological procedures; not until very recently were the social customs and attitudes themselves habitually subjected to the same process, and even now this is only possible to a much smaller extent than is sometimes supposed.

For the most part, social change has been the unwitting outcome of technical advance. However, the pace of the latter has been so great that in industrial societies people have found themselves living under conditions obviously different from those of their parents, and even changing unmistakably within their own lives. This not only prevents the individual from being closely conditioned for his present social situation, it also invites com-

parisons as between situations. Thus the modern intellectual tendency is to regard customs and procedures as having relative degrees of merit rather than as possessing the absolute force of a sanction. The merits of everything from reciprocating steam engines to marital relations are open to investigation, and opinions are held as hypotheses subject to modification. Moral and social sentiments, whilst in some sense 'believed' and acted upon, are held as being the current attitudes and as possessing merit relative to some other sentiments, but their foundations are no longer supposed to rest on a rock of absolute ultimate truth. This, at least, is what intellectualism would like to think of itself, and it contains some measure of truth as compared with less restless communities and groups.

However, society, or social behaviour in any form, would be quite impossible without fairly accurate expectations regarding the sentiments and behaviour of others, and these imply social tradition in some shape or other. Social custom with its accompanying moral and ethical codes performs the function of rendering the activity of human beings at once predictable and fitting to each other.

It is not difficult to see that the modern restless, experimental attitude is a natural outcome of sporadic reflection on well-practised routines, but we must beware of supposing that this evolution is in any sense necessary, or even very probable. The Chinese have been socially cultivated for centuries without exhibiting any great tendency towards a systematically sought progression. At the present time, impact from the West does seem to have started this process.

However that may be, the present industrial communities do appear to be committed to an explicit systematic development of their scientific and technological procedures, with whatever that may imply in the matter of social change. Great changes have already taken place in social function and structure, and more may be expected to follow. For instance, in any community of a few generations ago, and in many communities now, industrial

occupations were not properly distinguishable from social life in general. Purposeful activities of all kinds represented the ordinary procedures of mankind as they lived their lives. The distinction between a man tilling his field and his wife doing the housework was not profound either in his thinking or in ours. Both were guarding the total situation by the performance of interlocking and, to a large extent, overlapping activities. The leaders of such a community were similarly engaged.

In a modern society, a part of the purposeful activities are, as before, performed as social living, and are regulated, though in a lesser degree, by social usage. But another part of these purposeful activities has become singled out for a very different form of organization. These activities have been withdrawn from the main stream of social living and are highly organized from the standpoint of technological efficiency. This fraction of the purposeful activities is known as industry, or, more broadly, as business. The division of social activity into ordinary living on the one hand and business on the other was not the result of custom or of the direct needs of human intercourse; it depended on the chance evolution of technological procedures. The industrial organization is controlled without adequate regard for the social lives of those involved, by a type of man highly skilled in the logical, reflective thinking suitable to the rapid evolution of technology. This does not imply that the modern executive is indifferent to the welfare of those beneath him, but it is true that this welfare has not been the primary force in moulding the industrial organization. So long as industry formed a relatively small part of the total activities, this situation was perhaps not dangerous to social integrity; but at the present time so much activity is industrial that society is becoming seriously and increasingly disorganized.

The modern executive is indeed in a peculiarly difficult situation. Let us review his functions and see how they compare with those of a leader of an unprogressive group. In the first place, an executive does not literally lead his human material, he organizes

it. It is broadly true to say that he cannot compare with his employees in the performance of any one of their several tasks. The occupation of an executive is different, not only in detail but also in kind from that of his men; their respective sentiments and attitudes are based on radically different experiences. The modern 'leader' is no longer quite a member of his group, working by their side and sharing their daily lives.

Secondly, it follows from this that the social organization of the group is not oriented primarily towards their executive, but toward some informal leader of their own choosing — one of themselves. For every group has its leader, or an inner ring of leaders, a miniature aristocracy. Thus, whether he realizes the fact or not, the executive is in danger of directing a formed society from without; a society that will evolve defense mechanisms and sentiments of antagonism, if its social living appears to be in danger of interruption.

Thirdly, the executive is himself a social being and his general attitudes are oriented by his society, but this society is not the group he is directing and his attitude is not moulded by them. The executive is a member of a highly competitive 'progressive' society anxious for its preservation and for its advancement, and his more general outlook necessarily conforms to this social pattern. I say 'necessarily conforms' because this society chose him for that very reason. Thus his activities are directed by his society's desire for 'economic progress' rather than by any needs of his employees. It is true that these latter are also members of the society outside, though they may well come from a different stratum, but as a working group they have little part in forming and sharing their executives' social sentiments.

Fourthly, the control which the executive exercises over his group has no explicit relation to their social life. Its purpose is simply to organize their activities with a single eye to their technological efficiency, and with the intention of elaborating and introducing improved procedures as quickly as may be.

In the sense previously employed, it may be said that the mod-

ern executive is only too apt to stand in a secondary, rather than in a primary relation to his group; and the purpose of that relation is a logical one. We saw that the primitive leader promoted the integration of his group, guarded its future economic position, but was essentially unprogressive. The modern executive endangers the integration of his group, evolves procedures designed to improve their future economic position, and is thus progressive. The business man's functions come near to disintegrating the society whose economic future he is providing for. Naturally, this picture is softened in many respects; human situations always overflow any simple formula. For instance, it is obvious that executives are anything but indifferent to the sentiments of those beneath them; and narrow logical motives are always diluted with a greater or lesser measure of ordinary human decency, or in other words with social wisdom.

This review of executive functions is in no sense a criticism of individuals, but an attempt to analyse the actual structure within which executives have to operate. The situation may be summed up by stating that industry is built up of small employee groups, having many of the characteristics of simple communities: a great dependence on social sanction, a tendency to relate things and sentiments by customary ties supported by an uncritical belief in their absolute truth or value, occupations easily leading to set 'ways of life' with appropriate emotions, and so forth. These groups are directed by men from outside whose intellectual training and bias is above all things experimental and 'progressive.' Moreover, these men are under pressure from society to organize and direct their groups from precisely this standpoint.

And finally, we should have the candour to admit that hardly any of us could tolerate a society which did not display intellectual curiosity and a restless tendency towards experimental behaviour. In other words, there is no going back; the problem is not how to construct yet one more primitive community, but how to combine progress with immediate social satisfaction. One thing is apparent: social integrity can no longer be trusted to look

EVOLUTION OF MODERN LEADERSHIP 81

after itself. In the past, slowly developed ways of life possessed inherent stability, and the processes by which this stability was maintained were never explicitly recognized. But progress gives no time for the gradual development of instinctive wisdom, and the price of stability in the future will be the exercise by society of a critical self-knowledge.

CHAPTER VI

THE SOCIAL FUNCTION OF THE ADMINISTRATOR

I

IN THE last chapter, a distinction was drawn between a simple type of leader who literally led his own group, and a more developed society in which the leading men are often more or less outside the intimate lives of the groups they influence or direct; these latter men stand in a relatively secondary relationship to their directed groups, and the connection between the two is correspondingly less multifarious, but more explicit. Consequently, as compared with the simple leader, men of the second type lead less and are more concerned with the organization of their human material. To distinguish these two types, they may be called *leaders* and *administrators* respectively.

Naturally, prominent men and women cannot be classified neatly into one or other of these two groups. All leaders are to some extent administrators, and vice versa. At any time during the last few thousand years, both types have existed side by side. The earliest Pharaohs of whom we know were, to a significant extent, organizers; whilst at this moment, leadership is to be found all through the most progressive societies, and nowhere more than amongst the employees and junior supervisors of trade and industry. For so long as the social needs and ways of human beings remain substantially as we know them, leadership will always be of the first importance to social integration. With the increasing numbers of individuals habitually included within any given organization, and with the increasing complexity and technical efficiency of business activities, the trend has been away from leadership and is too exclusively concentrated in the organizing function.

We saw that this trend was not the only thing distinguishing the administrator from his earlier prototype. For together with the rise of complexity in organization, there has developed a radi-

cal change in the mental processes of the administrator himself. The organizer on a fairly small scale may depend for his insight on something approaching direct unsystematic contact with his organization, and his decisions are also likely to be based on an unanalysed sense of the fitness of things. But as the scale increases, so do the organizer's avenues of information have to be regularized if they are to be sufficiently adequate; at the same time his actions likewise tend to be the outcome of systematic logical thinking. The thought process must not be imagined as prior or subsequent to the change in typical scale of organizations; the two trends marched together and were in accord with the drift of the times. Mental procedures for maintaining a continual flow of technological advance have become typical of modern industrial societies, and this is supported by a sentiment giving progress, as such, a high rank in the social scale of values.

Thus the modern administrator has emerged as one whose connection with his groups is largely secondary. He is engaged in organizing these groups according to logically evolved patterns, for the declared object of enabling them to further their economic objectives in the most efficient manner; the test of efficiency is determined as a ratio between effort and economic achievement. Moreover, society's demand for progress makes it probable that the activities of working groups will be modified at fairly frequent intervals to conform with technological advances. The administrator, like everyone else, has his more general attitudes determined by his society, but this society is not identical with his sphere of direction; it is at least likely that the group he organizes will not have the same attitudes and social needs as those guiding his technical thinking and actions.

There have been instances of the deliberate remoulding of communities at all times. The various territorial conquests, the introductions of religions, and political revolutions are cases in point. *But, for the first time in history, we find large complex societies dedicated to the creed of continual never-ending change, controlled by relatively logical, scientific thinking.*

There can be no thought of reversing the present social urge, even if any substantial number of us really wished this. It is deeply imbedded in our sentiments and social attitudes. What does seem possible, is to go one step forward and improve the scope of our systematic thinking. Organizers control groups, not individuals, and groups have their social sentiments, their typical behaviours and their aspirations. So the next stage in the progress of an industrial society is surely to increase the range of systematic thinking to include not only the technological processes but also the social processes which hold men together, and so enable co-operative enterprises to endure and be successful.

For groups wish for a successful economic outcome to their labours; but, whether expressed clearly or not, they wish for achievement as an integral part of social living. The two aspects of social living — a satisfactory present, leading to a satisfactory future — cannot be disentangled, for they are essential parts of the same thing.

It may be objected at this stage that administrators, and specifically those directly involved in business, do in fact devote a great deal of consideration to the social aspects of their organizations. Undoubtedly this is true. But the consideration given is not quite of the type that the present situation seems to demand. The following is a composite list drawn from a number of sources, some printed and others spoken, illustrating the sort of qualities which are regarded as important for an executive.

1. Good health and energy.
 2. Technical proficiency.
 3. Enthusiasm.
 4. Integrity.
 5. Kindliness; a regard for others.
 6. An acceptable attitude and manner to those above him, to his equals and to those below him.
 7. A sense of justice.
 8. Quickness of comprehension and decision.
 9. Firmness in action.
-

Such a list could be extended indefinitely; and each item does undoubtedly refer to some desirable quality. Neglecting the physical and technical qualifications, we are met with a number of characteristics referring to the executive's human relations. Stress is laid on the importance of personal contacts both between the organizer and others, and, we may presume, as between individuals under the organizer's control. But these human contacts are all conceived from an individualistic standpoint, and from the standpoint of accepted social customs. Such considerations are very much to the point, but something more is required of an organizer if he is to avoid upsetting his society. He must systematically consider the social structure of his group and guide his technological progression in such a manner as to be acceptable to that structure. This does not imply achieving the impossible and undesirable feat of introducing technological change in such a manner as not to affect social customs and ways, but it does involve having some systematic thought as to the kind of social changes which will prove acceptable and compatible with continued integration, and then endeavouring to guide his technological progress accordingly.

Until very recently, the explicit definition of such an attitude was almost impossible, for no basis of systematically observed fact with regard to social behaviour was available; and that basis is slender enough at the present time. Careful fieldwork in the social field, deliberately shielded from the observer's sentiments so far as possible, is a new growth. Observers are bound to have sentiments, and the possibility of objectively valid observations must depend largely on the evolution of suitable techniques for observation, and for their measurement where possible. Such techniques are only just beginning to be evolved.

Thus it happens that administrators are indeed occupied with the sentiments and attitudes of the individuals under their care, but this preoccupation is guided almost exclusively by an unanalysed social sense rather than by any explicit understanding. An administrator will often regard the objective of his work in

economic terms narrowly conceived, and will then recognize that these objectives can only be reached in so far as human sentiments do not resist the required activities. What is required is that the social sentiments and activities of groups be regarded, not as hurdles to surmount, but as an integral part of the objective for which the organizer is working. Human satisfaction depends on activities pursued in common and directed towards some future achievement or purpose; so a society will only be healthy in so far as the human contacts are adequate in the present, and in so far as these contacts are efficiently organized for their purpose. It is this double objective which the administrator should aim at, not the economic purpose only.

It is true that the administrator, especially in business, sinks or swims according as he achieves the economic purpose. The ultimate test is the balance sheet. And had industrial communities been blessed with a satisfactory record of prosperous enterprises, set in a society likely to tolerate this situation indefinitely, there would be nothing more to be said. Unfortunately, balance sheets are too often 'in the red,' and increasingly so. Large masses of industrial workers are showing evident dissatisfactions of one sort or another; they are not whole-heartedly assisting the economic purposes of business. Society itself, that is the more general organization of large communities, is becoming increasingly brittle, and unable to prevent or cure its own ills by intelligent action. The world-wide depression of 1929-1935 is an illustration in point. Individuals do not believe themselves to be happy or suitably organized; the tendency to violent political revolutions and catastrophic changes shows this.

It would be absurd to blame administrators for social situations of which they are themselves the product. But if the practical test of an administrator is his balance sheet, it does seem likely that he will succeed better by a deliberate consideration of the social situation which his own actions are moulding, and on which his whole edifice is based. Such an attitude is undoubtedly growing on the part of some leading industrialists; but an effec-

tive change in this respect must depend on the growth of practical techniques based on adequate observation of the relevant facts.

II

The sociologist's view of a society is emphatically *not* that of a large number of individuals, each with their unrelated attitudes and sentiments, deliberately combining for the sake of certain mutual advantages. That was an 18th century belief which has failed to elucidate social behaviour as it is found in practice. The modern concept starts with the notion of truly social men and women; people who are unable to express themselves in characteristic fashion except in so far as they are acting with respect to one another. And it goes on to stress the extent to which social action and expression is non-logical and not even recognized in practice.

Fundamental to this picture are the small primary groups, which show the strongest cohesion, and the greatest resistance to interruption from outside. The members of a primary group are in constant contact with one another. The most modulated and elaborated method of contact is undoubtedly speech; but it would be a great mistake to suppose that speech is the only, or even the main avenue of contact between people. The essence of social contact is action on the part of each, guided by a concern for the others. The relay test group showed that this concern was evidenced by variations in speed of work, in a manner unsuspected by the individuals themselves, and quite beyond their logical comprehension. This social action nevertheless met a human need.

These mutual concerns and expectations, when suitably reciprocated over a period of time, give rise to strong sentiments supporting a continuance of the relations; and the actions and sentiments taken together are of the essence of social integration, and of conservative social tendencies. Of course, most groups are not industrial; but wherever they may be found, the activity of all

enduring groups satisfies two social needs. The first need is for ample human intercourse in the present, and the second need is that the activity be directed towards a satisfactory situation in the future. The first function of social activity is to provide *immediate expression*, and the second may be broadly described as promoting *economic* intentions. These two aspects of social living apply to contented, enduring primary groups at all times and in all places. Such groups have relations to one another, as a result of contacts between their members. Sometimes this results in a third small group of the same kind; at other times the original members meet as representatives of their respective groups, and the two groups act with a concern for each other. All sorts of complexities take place and result in higher order primary groups.

We have traced the growth of deliberate, logical thinking, and this has largely arisen from the economic aspects of group activity. Such thinking, with its partial independence of social custom and sanction, makes possible a great development of higher order groups and especially of secondary groups. It also enables groups to acquire a formal structure of written laws and regulations of one kind and another. Finally, it has encouraged the rise of a new social value, namely, the value of deliberately planned technological change. We have seen that this new attitude towards social living is grafted somewhat uneasily upon the old stock. For primary groups with their ways of conservative social expression are as necessary as ever to social living. I say 'conservative' deliberately, for social integration is based on routine activities all of which have their deep 'meanings' for the participants; any outside disturbance to these is violently resisted, and results in a lowering of the sentiments of human value for each and every member of the group. The problem today is to give compatible expression both to society's *immediate* and its *future* or *economic* aims.

It was the habit at one time to over-emphasize the intellectual aspect of human activity; but various trends, including the rise of psychoanalysis, have caused a swing to the other extreme. The

neglect of either aspect will prevent any discussion of the main problem, which is precisely the social integration of these two types of mental activity.

The activities of human beings can be conveniently divided into three classes, provided these are understood not as water-tight compartments but as three extreme positions.

An action may be:

- (a) logical,
- (b) non-logical,
- (c) irrational.

(a) If we are agreed that the room is uncomfortably hot, and you therefore open the window, that is a logical action. First, some result is desired, and an action is performed which could be supported by logical reasoning from agreed premises. The premises have been tested in the past by experiment or by experience. At no step in the argument is an appeal made to sentiment, but to experiment and deduction therefrom.

(b) If we, being men, meet a woman of our acquaintance, we take off our hats to her. This is an example of a non-logical action. The action can be easily defended as a socially integrating custom, one likely to lead to pleasant relationships with the woman in question, likely to preserve courtesy as between the sexes, and so forth. These statements are no doubt correct, but they are not the reasons why we lifted our hats. We acted as we did in conformity with the ruling social sentiment, which we entertain as vividly and as immediately as anyone else. We did not act 'for a reason' in any sense, although we can rationalize our actions as well as another if put to it. In a Christian church it is the height of disrespect for men to retain their hats, but in a Jewish synagogue it would be most improper not to do so. Sentiments with respect to this action happen to be reversed in the two groups and, in consequence, the fitting non-logical act is also reversed. However, no amount of sentiment in a logical act will affect the result. If the outside air is hotter than that of the room, in spite of

everyone's sentiments the room will get hotter when the window is opened.

So a non-logical act is one performed as an immediate outcome of social sentiment. It is in some sense a fitting, desirable act, but it cannot be defended apart from considerations of sentiment, and it is in fact performed from an immediate sense of fitness, i.e., because the performer entertains a social sentiment guiding the action.

(c) Irrational acts have this in common with non-logical acts; they do not arise from logical thinking. But they are not dictated by the prevailing sentiments of the relevant society. Thus, wantonly to smash things would be an irrational act. The habitual performance of startlingly irrational acts leads the performer into a lunatic asylum, though everyone does from time to time do things which are not in tune with his more prevalent social sentiments, or with those around him and which are recognized as irrational acts.

On the whole, acts which can be classed as irrational are much less common than is supposed. Most so-called irrational acts are in fact dictated by the social sentiments of the performer's group, although he may be unable to give expression to his motives. This is particularly obvious in the case of many actions taken by employees in opposition to their own economic interests, and often described by bewildered executives as irrational. An economic action can be logically defended, but the motives of a socially guided action can often only be expressed after much practice or to a very sympathetic listener; so rarely are we explicitly aware of the social sentiments by which we are motivated. It is often tacitly supposed that a 'sensible' action can always be supported by logical argument apart from any appeal to sentiment, and it is sometimes assumed that action which is non-logical is thereby 'silly,' in the sense of being irrational. But all social living depends in part on the guidance of action by sentiment, that is on the performance of non-logical actions.

The primitive leader holds his society together by guarding

its non-logical actions from abrupt and frequent change, and thus securing the growth and stability of the relevant social sentiments. In doing this, the leader himself is performing a non-logical action, for he is merely acting as his own sentiments dictate.

The modern administrator, if he is not to destroy his own society, must so act as to guard the non-logical actions of the groups under his control. But his habit of logically dictated action, and his secondary relation to his group, prevent his achieving this as a result of his immediate sense of 'fitness.' His route to socially wise action must be via logical reflective thinking, in which the non-logical acts of his society take their place amongst the observed facts about which he reflects. To this extent, the socially wise organizer of the future will conserve his society by logical action on his own part.

The trend from unconscious to conscious action, and finally to self-conscious analysed action, is the path trodden by man in his gradual evolution towards quicker and more fitting adaptations. It is the same path that man must tread in his social thinking. He has achieved a large measure of social consciousness and is now entering on a new phase of social self-conscious analysed action. Exceptional men have always possessed a large measure of social understanding. This is particularly true in the realms of religion and statesmanship, but never before have large numbers of men been required to guard their society by means of an explicit social understanding; for never before has a complex society dedicated its energies to unending technological progress.

The necessity for a guarding or conserving activity on the part of administrators has been emphasized before, and has not always stood in good repute. Conservatives have been decried as social evils, and with some appearance of truth at times. There are two points to be made in this connection. The need of the moment is social integration, at least in the industrial civilizations. Our society shows no tendency to stagnate, that is to remain unchanged generation after generation; but it is in grave danger of falling to pieces like an over-driven engine. This tendency to lose

cohesion can be seen as likely to accompany a vigorous quest for technological advance, and so the present danger may be expected for so long as we can forecast the future. However, social cohesion is not everything. For centuries, both the Chinese and the Red Indian tribes of North America probably possessed too great a social cohesion for our satisfaction, nor do we rate these two societies equally. Our sentiments lead us to wish for something more than mere cohesion, but at least some measure of cohesion is a first condition for the satisfaction of other social ideals.

The danger of shaking society to pieces has always been the conservative counter to suggestions for change, and it still is. The implications always are that a careful study of the existing society would show the danger of making the proposed change. In other words, the claim of the conservative is that his opinion is the outcome of logical reflective thinking based on data including, amongst other things, the sentiments and customary ways of the society. In so far as this is partly true, and it often is, the opinion has a right to serious consideration. On the other hand, such opinion may well be nothing more than a blind adherence to social sentiment, dressed in the phraseology of rational consideration — and this is also a common phenomenon, and one entirely incompatible with a society adapting itself to continual technological advance — this is the thinking of the primitive leader.

So in advocating a deliberate regard for social integration on the part of organizers in general, the last thing intended is an attitude of conservatism in the sense of immobility. On the contrary, what is required is a mental attitude or discipline which will enable the leaders to guide society through habitual change in an orderly manner, and without disruption. Whether this be a conservative or a radical attitude is not of the slightest moment; in any case it is largely a question of words.

PART II
THE DEVELOPMENT OF AN INDUSTRIAL
SOCIETY

CHAPTER VII

THE PROBLEM OF THE SMALL INDUSTRIAL GROUP

THE social problems of various groups, in business and out of it, are by no means identical, but very broadly they tend to fall into one or both of two classes. In so far as a group is found not to be contentedly participating in the society or organization around it, the cause may be:

- (a) That the immediate social routine activities are too few, or unsatisfactory;
- (b) That these routine activities do not lead to an adequate situation for the future — i.e., the economic purpose is not being successfully achieved.

The trouble may be local and specific; some member of the group is antagonistic to the others, or some fortuitous combination of circumstances has dealt unkindly with the group. The occasional breakdown of a particular group may indicate nothing more than a rearrangement of each individual case. But when some given type of group is habitually failing, either in contentment or in their economic purpose, it is reasonable to look for a general factor. The small industrial group is a case in point. It has been pointed out in a previous chapter that, by and large, industrial employees do not co-operate whole-heartedly in the economic purposes of their respective firms; nor are they a conspicuously happy and contented section of society. This is so universally acknowledged that the evidence need not be recapitulated. This does not mean that the personal relations between the executives and employees of many firms may not be cordial and kindly; this is often the case, as anyone with practical experience must know. But the employee has certain group anxieties and preoccupations which do influence his behaviour and his attitudes in such a manner as to increase the difficulty of organizing industry to meet its economic purpose.

It is found that employees are fearful for their economic future, and also show the symptoms of an impoverished immediate social life during their working hours. There is no question as to the uncertainty of a typical employee's future or as to the advisability of his planning to minimize this. But the researches already described and general experience both suggest a sequence of events something like this:

- (a) A group has inadequate opportunities for building up satisfying human associations during its working life.
- (b) To some extent, the group overcomes this defect by elaborating its customs and routines. These latter, however, are apt to exist in spite of managerial policy rather than to be assisted by it. In consequence, these customs and routines are not likely to be organized around the prosecution of the economic motive.
- (c) In fact, the group becomes organized somewhat in opposition to management. Its routines actually prevent the best possible economic outcome, by being organized around some confused need to increase the security of the group as such. In practice, this comes to mean that if the situation is held rigidly stationary the group will remain in being.
- (d) This action, not thought out, of course, does probably reduce the rate of change in the firm's organization, and so may prolong the life of each individual group; but at the cost of reducing the firm's efficiency and economic security for each member.
- (e) The group fails to experience the satisfaction of a developing situation adequately preparing itself for the future, and the present social situation loses much of its point. Anyone mixing on friendly terms with workmen who deliberately restrict their output knows the dissatisfaction which this supposed necessity engenders. The situation is substantially the same, though less explicit, in the case of men who do not deliberately

practise restriction but are guided by a set of customs which achieve the same end.

Thus, much of the difficulty in leading groups of industrial workers springs in the first place from a social poverty in their working associations. And as this is the difficulty which single firms can most easily modify without resorting to elaborate trade or governmental organizations, we shall consider this problem first, and take up the question of economic insecurity in a later chapter.

The management of an industrial firm naturally and rightly wishes so to arrange the activities of its employees as to secure the best economic results. This, in a progressive society, involves fairly frequent changes in detail quite apart from major reorganizations occasioned by large technological advances or by great shifts in demand. The management controls industrial groups rather than industrial individuals; for actions, attitudes and sentiments are performed and held in common rather than singly — every manager knows the 'tone' of his shop. There can be no question of maintaining an employee force as isolated individuals; the whole idea is antagonistic to human custom and behaviour, and in consequence it is as groups that management must guide the activities of its force.

We have already seen that each group represents a network of sentiments, mutual actions, and 'ways of life' or customary procedures. Such groups have many of the characteristics of simple societies with their strong cohesive forces and defensive attitudes when their continued existence is threatened. An individual tends to guard not only his own existence, but also that of his group, for so much of his 'way of life,' his sense of values, is contained in that group life. All this is fundamental to human nature as we know it, and the problem is not to devise a new sort of industrial creature but so to lead an industrial group as not to violate its customs and sanctions and yet to introduce the needful measure of efficiency and progress.

This problem falls into two halves. The manager has first and

foremost to assist his groups in building up their integrity, or social ways, and so far as possible in guarding these from unnecessary shock. In so far as he achieves this, he will be included in some sense as a member of that group, and as its leader. In this way, the group customs and sentiments will tend to become organized around the purposes of management rather than in opposition to them. The second problem is to use the position of leadership so obtained to introduce the needed change without offense or alarm to the group.

For the remainder of this chapter, we will consider the first question. How is the industrial manager to assist his groups in building up their social customs and ways, and so obtain the advantages of social sentiment oriented towards their mutual economic purposes? There are a number of ways in which this might be accomplished.

For instance, management might adopt a whole-hearted belief in the value of social integration. For, curious to relate, in spite of endless talk about the value of 'esprit de corps,' 'morale,' and the like, many executives become visibly uneasy when this sentiment begins to build up in the only way possible to it. What is so often asked of the worker is a vivid loyalty to some high abstraction variously referred to as 'Company Policy,' 'The Firm,' or even 'The Principles for Which We Stand.' But loyalty is a social sentiment and it is built on routine collaboration, starting with quite small groups within the structure, and gradually spreading outwards as these groups begin to integrate amongst themselves. The progress of loyalty is from small to larger associations, and this is the story of political growth almost everywhere: in the United States of America, Germany, Switzerland, South Africa, Australia, and so on. In fact, almost every modern state represents a spread of loyalty over what were once separate communities. This also represents the historical growth of many large companies. What is feared of integration within a small group is that it may organize itself in opposition to the larger whole — and this it will certainly do if its existence be threatened; but

equally, a protected group will endeavour to satisfy its wider interests by collaborating with the organization of which it is a logical part. In this way, its loyalty will extend to the firm as a whole.

Talking amongst workers is usually discouraged, and undoubtedly when over-indulged in, such behaviour leads to inefficient work; but there is evidence to show that, in some circumstances at least, permission to talk not only makes it possible for a group to integrate itself, but the very fact of permission is evidence of management's attitude towards the group. Western Electric experiments suggest that, in so far as the group is collaborating freely with the management, it will control talking and any other activity when the work shows signs of suffering thereby.

As a matter of fact, in most cases the alternative before management is not whether its groups shall or shall not talk, but whether conversation is to take place in defiance of management or with its consent. A manufacturing firm, in which I was an apprentice, forbade talking amongst its employees except when the work demanded it. With the full backing of our first-line supervisor, we saw to it that the work demanded almost continuous conversation, except when a senior official was about. As a matter of fact, our group was engaged in teamwork, and reasonable conversation could have done no possible harm. The only effect of the rule was to make us defy the management and to inculcate the feeling that this was a reasonable attitude to adopt. The experimenters in the Western Electric researches state that talking was as common amongst the bank wiring group, to whom it was forbidden, as in the Relay Test Room.

Certain firms absolutely forbid any communication between the workers of different departments. I have no first-hand experience of such a situation, but no doubt such a rule would only have been adopted to meet some specific difficulty or lack of discipline. The presumption is that the working groups of such a firm are out of sympathy with their management, and that the latter are attempting to overcome the effects of this by a stiffen-

ing of the discipline. It has been stated that this rule is becoming more common in American industry, and if this is really so, it is a symptom meriting close attention.

Again, rest pauses not only have a direct effect on work habits but also facilitate human association by enabling employees to circulate within their groups. Many industrial tasks, especially those in which the employee is seated, constrain his bodily position so completely that during working hours he has no possibility of circulating within his group. This may not prevent conversation and social (i.e., co-operative) action, but it does mean that each member views his shop and each other individual from one unvarying standpoint. This one perspective becomes an integral part of such a worker's way of life and is subject to disturbance if he is moved for any reason. It is important that a working group should be encouraged to 'pull together' and to express their integration in sentiment and action, but it is desirable that the situation for each man should be kept as flexible as possible, for there is no merit in elaborating unusually deep and narrow ruts of behaviour. To anyone whose work permits him to stroll about his office or visit a colleague, it is difficult to imagine the extent to which a worker may become dependent on a particular geometrical arrangement of his group. Perhaps the enormous importance of exact position to a worker does not sound credible to those who have not experienced it, but this is the opinion of those who have had the actual experience. In groups whose work is always performed sitting down, the various positions in the shop will carry differing degrees of prestige, or a different significance in some respect. Any opportunities for circulation, such as rest pauses, are likely to minimize this unfortunate tendency towards social rigidity.

Considerable efforts are made by many firms to promote friendly relations between their members by means of recreational and other leisure hour facilities. These have their place, but they are not addressed to the present problem, which is to assist working groups to build and then maintain their own social integra-

tion, and to have these sentiments and customs oriented towards the policies of the firm.

It is not always possible in a progressive firm to avoid breaking down groups as a result of technological advances or for other reasons. And in any firm, draughtsmen can be seen with plans of available floor space working out some improved arrangement of machine tools or of office desks. But every tool or desk presupposes a worker, and it is relevant to suggest that not only is there a better and a worse spatial arrangement for the stage property, there are also better and worse dispositions of the actors themselves. It would be very exceptional to see a planning department spending much time in devising arrangements to secure continuity of existing groups, and yet it would be well worth the trouble. One difficulty in the way of such planning is that the higher executives have no acquaintance with the sentiments of their working groups, and there is no available source of information in many cases. The first-line supervisors and foremen are in touch with their groups, but their training has not accustomed them to pass up the type of information required; nor have the junior supervisors any assurance that a realistic report of their groups' attitudes would not be regarded as evidence of poor managerial capacity on their own part.

- The junior supervisor is the key to much of the difficulty, and at present his position is only too often one of divided loyalty, to the policies of his seniors on the one side, and to the sentiments of his group on the other. Without a close co-operation between the junior supervisor and the senior executives not very much can be done to secure the integrity of the working groups. From one point of view the junior supervisor, or foreman as he is sometimes called, is a member of the managerial staff and is expected to represent the policies of management in his dealings with his men. But his contacts with management are relatively few; policies are elaborated in offices far above his effective reach, and to all intents and purposes his attitude towards the senior executive function is the same as that of his men.

The foreman has arisen from amongst his men, perhaps not from that identical group, but from a very similar group. He has shared their loyalties, their sentiments, he knows their devices for dodging unpopular rules, and he knows exactly how his men ease off production whilst maintaining an appearance of industry in the presence of a senior executive; in fact, not so long ago, the foreman was one of a similar group and doing the same thing himself. On promotion, the foreman is expected to shed his old skin and maintain a single-minded discipline over his group which shall prevent all irregular practices in the future. What is the foreman to do? He knows the ropes and cannot be supposed to be ignorant of them. He has the choice of catching out his men as a result of his inside knowledge, or of siding with them and attempting to hold irregularities within traditional limits. Naturally and quite inevitably, he adopts the latter course; no man with an average sense of loyalty to his associates could do anything else, and in any case his group could make life unbearable for him. In the Bank Wiring Room, the supervisor was observed to warn the group when a senior executive was approaching; this was an obvious precaution, for if any slackness was seen he would be held responsible.

It may be laid down as a general rule that to the extent to which management and its working groups fail to come to terms, to that extent will the first-line supervisors stand in a false position and be unable to serve either party whole-heartedly. In particular, realistic information respecting their working groups will never reach management under such conditions. And yet a realistic account of the attitudes, sentiments and customs of their working groups would probably be about the most valuable information any management could possibly obtain.

The recent interest in psychology, and particularly in the works of Freud and other psychoanalysts, has greatly altered the attitude of thinking men and women towards behaviour such as is typical of employees in most firms of any size. Not so long ago, a report of a working group, such as the bank wiring group,

would probably have resulted in the 'firing' of every member, in spite of the fact that the group in question is very representative of industry as a whole, and is not in any way an extreme instance. Today, an intelligent executive might ask himself what were the circumstances which caused men to co-operate so poorly in promoting the nominal purposes of each one of them. And only if this latter attitude were adopted, would it be possible for management to receive realistic reports from their juniors. For in that case, frankness on the part of the foreman would not be a betrayal of his men, but the means of adjusting their positions to their needs. With such an attitude on the part of management frankly declared, it is by no means impossible to obtain the kind of information required. The Western Electric Company's researches are again to the point.

In 1929 and 1930, the Hawthorne Plant interviewed over 20,000 of its 40,000 employees.¹ The object of this experiment was precisely to obtain a further insight into employee attitudes and sentiments. The average duration of an interview was about an hour, and was conducted by one of a small band of selected junior supervisors and employees who were trained for this work. Careful records of each interview were kept, but the 'interviewee' was guaranteed complete anonymity and protection, and anything likely to jeopardize this was omitted from the record. The statements made during the interviews clearly show that this guarantee on the part of the management was accepted in complete good faith, and it is pleasant to be able to record that this trust has been kept in every instance.

Naturally, as the interviewing went on, skill and techniques improved, and also the inherent limitations of a method which necessarily divorced every interview from the interviewee's work-setting became more obvious.

However, a study of this material leads to a few generalizations which are relevant to our present problem.

¹ For a systematic account of this company's employee-interviewing program, and their supervisory training partly based on these interviews, see F. J. Roethlisberger and W. J. Dickson, *op. cit.*

1. The very fact of being interviewed proved a real emotional release to most of the interviewees. Never before had they been listened to with intelligent sympathy by the hour, with only sufficient guidance to assist them in stating their preoccupations. This is an unusual experience for anyone at any time, but that an industrial management should be sufficiently interested in their employees to listen to them on this scale was an unheard-of innovation.

2. It was found that the most important single factor determining an employee's satisfaction in work was his relation to the first-line supervisor.¹

3. The employees showed a complete trust in the integrity and general decency of 'The Company' as such, as distinct from their opinions of particular executives. If an employee disliked an executive, then the latter was not faithfully carrying out the company's policies in the former's eyes.

Comparing these three findings, it appears that the employee sentiment towards 'The Company' and towards senior management was one of great trust and friendliness, whilst sentiment towards the junior and visible ranks of authority was mixed, varying from friendliness to watchful suspicion. The top few men of a large organization are apt to be more highly selected than the middle and lower ranks, but this divergent sentiment is the result of the form of organization rather than of the varying merits of the officials themselves.

The company has a long record of successful employee relations and a very fully developed service of welfare, extending from hospital and recreational facilities, to free legal advice. It is no accident that the employees should see in the company policies a guarantee of integrity and of solicitude for the individual. On the other hand, 'The Company' is a somewhat elusive entity a long way from the worker's bench. The only practical connection between an employee and 'The Company' is via the

¹ "Improving Employee Relations," M. L. Putnam (Western Electric Co.) *The Personnel Journal*, Vol. VIII. No. 5. Feb., 1930.

junior executives, beginning with the first-line supervisor, and there is, or seems to be, the danger that these men will not place before 'The Company' an adequate and unbiased account of the employee's circumstances.

What is feared of senior management is not its lack of good intentions but its *distance*, its inadequate understanding of the real non-logical situation amongst its men, and therefore its liability to 'strike out blindly' from well-meaning ignorance. The management is respected, but feared as a disturber of social living, apt to reason logically and justly from an a priori and inadequate viewpoint. Great confusion is often caused by the inability of senior executives to believe themselves distrusted by their men. The executives may be conscious of square dealing and are unwilling to suppose that their employees can have any doubts on the subject. Naturally, employees are not psychologists and their verbal expressions are not always consistent, but in a well-run firm they will behave as though they feared the social ignorance, not the integrity of their management. This is how the bank wiring group behaved — and it explains the surprising eagerness of the Western Electric employees to be interviewed. They poured out the details of their real (not conventional) situations with the emotional release of people who at last were becoming known in their acts and sentiments to 'The Company.'

Thus we may conclude that employees are only too anxious that their executives should understand the sentiments and loyalties of working groups, provided these executives make it clear beyond any doubt that their motives are not disciplinary, but spring from a real desire to understand and meet the needs of the groups, for their mutual economic benefit. This will not surprise anyone who has considered the ease with which intelligent and sympathetic priests, doctors, psychiatrists and others obtain full confessions from their 'patients.' The needs are not so different in the two cases.

It is not suggested that firms should devote thousands of

man-hours annually to the formal interviewing of their employees. The interviews described were undertaken as a research, not as a routine procedure. But something of the same effect must be obtained if management is to be regarded as the guardian rather than as the disturber of social living. And unless management does achieve this position, it will never enjoy the full collaboration of its working groups. The best chance of obtaining this relation between management and employee is through the first-line supervisor — the only level of executive in intimate contact with his men.

The young supervisor, soon after his initial promotion, is in a receptive frame of mind. He has just climbed the first rung of a ladder which may lead upwards to almost any height. On the other hand, the casualties along the way are known to be great; and worst of all there is no cut and dried technique by which an ambitious man may achieve proficiency in leadership. The courteous but commanding attitude, the exercise of quick decision, the kindly smile — every young man knows these infallible guides to greatness; and they tell him precisely nothing.

It is the almost universal experience that a course of training for young supervisors meets with a warm response, provided that the course has some real wisdom to impart, and that someone can be found to impart it. The Western Electric Company in its Chicago plant used its employee interviews as case material for supervisory training, together with material on the relay test group, the bank wiring group, and one or two other experiments of a similar type. In these young men, a very noticeable enthusiasm was aroused for the new and more realistic approach to the sentiments and behaviour of working groups under their care. No longer were junior supervisors to be caught between the conflicting attitudes of management and labour; it would not be their business to represent a group to management with the conventional expressions of loyal copy-book sentiments. Senior and junior executives were to collaborate in understanding the behaviour of their groups in terms of actual situation; and the im-

provement of these situations was to be a major care of management.

Only time will show what measure of success has been achieved; naturally, nothing can be perfect. But here is the beginning of a tradition in which executives include, as one factor for their logical thinking, the social activity and sentiments of their working groups.

Most persons with managerial experience agree that very young supervisors are open to new ideas. It is usually found that the next most flexible group are senior executives at, or close to the top of their respective firms. These men have achieved success, and are likely to be of high calibre; they often combine experience with the power of intelligent reflection. On the other hand, executives of medium rank are apt to fall into two groups. One group will consist of able young men on their way up the ladder, well thought of by their seniors and reasonably confident in their outlook; these executives may be expected to show the same intellectual flexibility as most of their seniors. In the second group are middle-aged men, often of somewhat inferior education or of mediocre talents, who have made their way slowly to their present position and are unlikely to advance much further. These men are apt to be fearful for their future, and like all alarmed people they may react negatively to any suggestion of change.

The difficulty of arranging for any radically new system of junior supervisor training, is that it is the medium rank of executives who would naturally be in control. In some firms, this difficulty does not seem to arise in any aggravated form. In other firms, the situation has been met by arranging for the junior supervisors to run their own study-groups. A few of the ablest are appointed group leaders, and may well be advised and coached by outside help, perhaps from a neighbouring university. These alternative arrangements are not mutually exclusive, and the placing of some initiative in the hands of the junior supervisors is likely to heighten their interest and enthusiasm.

CHAPTER VIII

PROGRESSIVE MANAGEMENT

PROBABLY we are all ready to admit that the maintenance of integrated industrial groups lies somewhere at the root of successful employer-employee relations, but the main problem has yet to be faced. It is possible to go a long way in the direction of encouraging group integration, both inside the group, and as between groups; but only to a very limited, though important, extent is it possible to prevent frequent changes in the social routines of each individual or small group. Co-operative sentiments are slow to build and easily broken, and if their existence in a firm were to depend on the rigid maintenance of the status quo, then the outlook for industrial leadership would be black indeed. So the real problem for industry amounts to this: Assuming every assistance on the part of management for the building and guarding of intra- and inter-group integration, under what conditions will the workers accord their management the right to lead them through the continuously changing path of economic efficiency?

This is, surely, the common need of all ranks from bench-hand to president; not one of these men is working for the pure joy of the activity. They all wish for a successful economic issue to their labours, but they wish for economic efficiency *as an essential aspect of their social framework*. The greater part of these men's lives is spent within the walls of the factory. If, in the process of securing economic efficiency, the social framework is destroyed, then the situation becomes intolerable; and equally, if, in securing a full measure of human collaboration, the economic purposes are neglected, again the situation collapses. Leadership is required to promote both the future and the present aspects of social activity. Each depends for its value upon the other, and together they constitute social living.

If the history of any group with a record of successful and enduring integration be carefully examined, two things will be noticed. First, the group is at its best during those periods in which the leadership is vigorous. And secondly, when the group is being effectively led, its character and functions are undergoing marked change. Of course, we must not be misled by names and formal descriptions. One of the unconscious devices by which a changing organization preserves its continuity is in the adoption of a formal description which will cover the extending range of its activity.

For instance, consider the Supreme Court of the United States. This group has a long and honourable history, and its formal description would cover that record from the beginning to the present day. But every American knows that the Supreme Court began with a strictly legal objective, the last court of appeal in a hierarchy of essentially similar institutions, and it has emerged as the guardian and interpreter of its country's governing activities — a complete and far-reaching evolution of function. One of the finest periods in the life of the Supreme Court took place under the leadership of Chief Justice Marshall, a vigorous leader during a period of great change. Another successful institution has been the British Parliament during the 19th century, and here again its effective activities have been during periods of strong leadership and marked evolution of function. Any group or institution, from religious bodies to industrial companies, will show the same relation between effectiveness, leadership and change. The outstanding period of American Trade Unionism, under the leadership of Samuel Gompers, was not characterized by a pedantic maintenance of the status quo in union activity.

Precisely the same thing applies to industry; firms disintegrate so soon as they cease to evolve; and in small industrial groups, involving only a handful of workers, their periods of effective integration are found to depend on evolution guided by competent leaders. This is plain common sense; a ceaseless struggle to maintain an unvarying situation would be a dreary prospect.

People, in so far as they are happy and active, hope for a positive outcome to their labours in the form of acceptable change.

Change, to be acceptable to a group, must come from within, and must appear as the visible need of its present activities. Change imposed from without is a disaster, comparable to an earthquake, breaking rather than assisting integrated evolution. So management in industry can lead its groups to just that extent to which it is itself accepted by those groups, and it can lead no further; anything beyond that will be resisted as compulsive interruption to social living.

Management in the past has made many and sincere attempts to capture the loyalty of its industrial groups; often the attempt has been disappointing, and even when successful the leaders have never quite explicitly stated the basis of their achievement. It is the business of the leaders to secure not only the social but also the technical, logical procedures on which the activity of their groups depends. At this level, the leaders are rightly considering activity in terms of economic abstraction. Their mistake lies in supposing that the actual daily integration of a group of workers can be made to depend on a logical proposition, rather than on habitual routines sensibly adapting themselves to meet a visible situation.

Any executive from his own experience can cite instances where some needed change in routine has been patiently and clearly explained to a group, only to find in the end that the group has ruined its chances by resisting the change. At first, the group seems to acquiesce, impressed by the logic, but soon resentment or some similar sentiment indicates a reversal of attitude. Neither management nor the workers themselves can usually explain what has happened; but the fact is, nothing in the workers' daily experience has indicated the need for change; it presents itself not as a sensible adaptation to a visible situation, but as a blow from management wrapped up in a tissue of unanswerable logic. The better the logic the more irritating is the blow.

At times of crisis, nations accept a leadership which would

ordinarily provoke the most violent opposition. Witness, for example, the actions of Mr. Roosevelt's administration during the banking crisis of 1933, or the loss of personal liberty cheerfully accepted by belligerent nations during the World War. But then the crisis was visible to every individual, and the remedial changes inaugurated by their leaders only expressed the sound sense of the society. Yet another example can be seen in the millions of employees who were laid off by management during the late depression. On the whole, this action was accepted by employees because their experience indicated the necessity. This was no question of abstract logic but of visible circumstance. Any such action on the part of management in normal times would inevitably lead to a social revolution.

Men actually welcome a leader who will organize them for the purpose of adequately meeting visible situations, for this involves the satisfaction of a need: integrated social living, and its effective continuance. But no one enjoys a disturbance to his social living if the need is not apparent in terms of his own experience, even though supported by the best of arguments. So it is quite useless for industrial leaders to attempt to 'sell' their policies to labour on the basis of reasoned statement alone, even though the need for those policies was originally detected by logical thinking. What is required is that a firm be so organized that the need for change is apparent to the relevant groups in terms of their own daily activities, and this is not so difficult of achievement as may appear at first sight.

Naturally, it is not suggested that no change should ever take place without the whole background being familiar to those involved. If this policy were pushed to its logical limit, then practically, evolution would come to an end. We all submit to a certain amount of direction, the object of which is not clearly apparent to us. But in industrial situations, the worker is subjected to an unusual amount of unintelligible restriction — unintelligible in the sense that *his* intelligence can make nothing of it in terms of familiar fact; equally, his opportunities for experiencing

intelligible leadership are far too few. The object of management should be to redress this balance; for in so far as the worker is habitually being led to achieve adjustments which his own sense requires, to that extent will he have confidence in his leaders, and he will give management the benefit of the doubt in those changes for which daily life cannot possibly have prepared him. Let us consider the possibilities of such an organization of industry a little more closely, for we have reached the very core of this problem.

One line of approach is through the junior supervisor. It was suggested in the last chapter that perhaps the simplest way for management to reduce the distance between themselves and their working groups was through a development of the foreman function. Social living consists in a wealth of routines directed towards the evolution of a satisfactory social future. It is this direction towards a future situation which calls forth the logical, reflective thinking of management. But it is a condition of planned change, that the change shall start from *here*; that is, from the present situation. Any gap or lack of continuity between one state and the next is essentially revolutionary and is destructive of the customs, sentiments and expectations on which social living must depend.

It is, we found, the foreman who is in the best position to ensure that management shall base its plans on a consideration of the situation as it is, and not on a situation as it might have been. The foreman is the only end of management with which the worker has real contact, in the sense of daily personal work relations. So it falls to the foreman to make visibly intelligent the policies of management to labour, and also to make equally visible to management the situation at the workers' level. If the foreman fails in this task, the organization will fall into two unconnected groups, one of which will be issuing unintelligible orders to the other.

Thus, in many ways, the foreman has the most critical job in the whole organization. Equally, in the nature of things, his is the least experienced and least tested of all the ranks of manage-

ment. And yet, in spite of this, the foreman is probably required to display a wider range of personal capacities than any other rank. Here is a description of the foreman's duties: "The all-round foreman is still, especially in smaller plants, required to assume the most multifarious tasks. He has been expected to fix rates, fix costs, supervise machine installation and repair, hire workers, keep production records, inspect work, train new employees, advise on progress changes, and secure the required output. He would indeed be a paragon who in this confusion of duties could be solicitous about the niceties of human relations. Inevitably, in the past there has been overwork on the one hand, and neglect of important functions on the other."¹ In larger organizations, some of these functions are taken over by specialized departments, although as the authors point out, there has been a swing away from over-departmentalization of the foreman's functions. In any case, the foreman remains a 'jack of all trades' rather than a master of one of them.

Nevertheless, the all-round foreman has one great merit, assuming that he can perform his functions; he integrates the multifarious factors of his workers' activities at the working level—that is, within full sight of his group. His problems present themselves in terms of his group around him, and his solutions are drawn from the texture of his group's daily life. Unfortunately, it is nearly hopeless to expect the foreman to evolve suitable adjustments unless his duties are simplified.

The departmentalization of the junior supervisory function does effect such a simplification, but at the expense of removing the task of integration, and therefore of initiation, from the workers' level. Under such a system, this takes place in the offices of the higher executives, and the outcome makes its first appearance on the floor in the form of executive orders. So, of these two systems, the first secures some measure of initiation at the workers' level, but places an intolerable burden on the fore-

¹ *Personnel Administration*, Chapter XII, Tead & Metcalf. McGraw-Hill Book Co. Inc., N. Y. C. 2nd edition, 1926.

man; the second relieves the foreman, but at the expense of removing all initiative from the level of the working groups.

It is a well-known fact amongst industrialists that the lines of authority in an organization are mainly vertical, from the worker to the president, but the lines of collaboration tend to run horizontally between officials of approximately level rank. This second line of collaboration has usually no recognition in the formal set-up of the company; it is an unofficial activity held in check by the formal organization built on more or less vertical lines. Now these two organizing principles correspond to a fundamental difference in the place at which initiative is exercised. Horizontal lines of collaboration, in so far as they are effective, result in daily adjustments being elaborated at the level at which the problems arise. Thus initiative remains in the hands of those whose daily activities have shown the need. On the other hand, when the process of collaboration is forced up the lines of formal authority, integration and initiative take place above and are brought down to the relevant level in the form of orders.

The all-round foreman is an instance of horizontal collaboration, only, as in the case of certain foreign dictators, he happens to comprise all the collaborators in his own person — he collaborates with himself in his various capacities; there lies his weakness, and implicitly he seems to know it. For any one with a first-hand experience of factory life will recognize the many unofficial ways in which a foreman creates a small group of collaborators officially denied to him. John, an elderly mechanic, shows some aptitude for training novices and he, unrecognized by the formal organization, is the *de facto* trainer for the shop. Tom is quick at figures and he looks after the foreman's paperwork. Someone else can fix the machines and keep them working; and so on. These men are the foreman's unofficial collaborators, and they represent him in his many capacities. Without such a shadow staff, the position of the foreman would be quite hopeless; but he very reluctantly admits to such assistance, for it is not recognized and is often not tolerated by the senior executives.

Thus the foreman, on his own initiative and in concert with his group, has elaborated a modification to meet a visible situation; visible, that is, to the working group. But management, so far from assisting this display of initiative at the relevant level, is usually blankly ignorant of it and tends to discourage what it sees. And yet a development on these lines is worthy of considerable thought, for it does make possible a modification within a group to meet the circumstances that arise there, and it simultaneously relieves the foreman of an impossible combination of tasks. The Western Electric Company is engaged in a careful survey of the extent to which such unofficial organizations have taken place, and its tentative findings are exceedingly interesting. They illustrate the continual tendency for adjustments to take place at the level at which the need becomes evident, and the degree to which a formal organization can easily act as a check on such natural growth. Thus, management unwittingly holds back its employees from effecting technical changes to meet needs visible to them. And this brings us to a generalization of wide application. *No society or organization is averse to change, provided the initiative for that change takes place at the relevant level — at that level where the daily activities have shown the need. Under those conditions, change will present itself not as an interruption, but as the natural flow of social living.*

This generalization is in line with our analysis of simple leadership in Chapter V. There we saw that a change is adopted as 'making sense' in those activities which leading people have observed for themselves, and have reflected upon sufficiently to grasp some causal relations of the various operations involved. This insight is particularly likely to be obtained in the technical ordering of activity for its economic purpose, for here the causal laws of physical science apply directly. Consequently, any group is apt to accept change in technical matters arising out of its own activities. It is not necessary for the average member to have explicitly seen the need or the advantage of the change in advance. What is required is that when the accepted leader points out the

way, something in the follower's own experience and reflections shall make him believe in the fitness of the suggestion.¹ A considerable portion of this sentiment of agreement arises from the follower's attitude of acceptance, or loyalty to his leader, and not from any direct understanding of the situation. This is a vitally important point, for it is impossible to suppose that all needed change in industrial groups will arise from circumstances with which the individuals are familiar.

Large questions of company policy do not usually disclose themselves in the daily activities of the workers. Such questions are visible only to the senior executives and, provided these are the accepted leaders, all ranks are willing to leave the initiative there. But most, not all, of the changes introduced by management into a working group do concern small matters which have arisen from within that group. The group are failing on delivery, have high operating costs, have neglected quality, or are careless of company property; circumstances like these give rise to most of the small detailed changes which are resisted so bitterly when initiated in the offices of the executives. And yet experiments and exceptional organizations here and there have shown that it would not be impossible to reorganize working groups, so as to enable them to supply much of the integration and initiative needed to cure their own ills. To the extent to which this is accomplished, management would represent itself as a body assisting its groups in working out their own visible problems, rather than as disturbers of social living. Management would be called upon to effect an integration as between small groups.

This is not a scheme for employees' representation, though that has its place; it amounts to suggesting that initiative should not be too exclusively concentrated at the top but should be encouraged at every level in those matters relevant to that level. Moreover, the form of the encouragement should be that of

¹ It is a relevant reflection that a standard author (e. g., Shakespeare) does not gain his reputation by making a series of statements which are inherently unbelievable or unlikely, but by making explicit in adequate language the half-formed reflections and beliefs of his readers.

evolving an organization which will enable each level to obtain a perspective of its own problems and then to handle them effectively.

Any large and enduring organization must possess a formal structure and forms of procedure. In the case of a nation, this comprises its constitution and its laws. A commercial company functions under the relevant laws supplemented by its own constitution and regulations. These latter require continual modification to meet changing conditions; but where the formal structure attempts to force new procedures at variance with the situation as seen by those affected—or worse, hampers attempts at natural growth, then poor integration is likely to result. An example in point is the habitual failure of the formal structure to accommodate itself to the existing horizontal collaboration. It should be the object of company regulation to give form and assistance to such a growth, and to insure its orderly evolution. As illustrations of the means by which management might secure orderly progress, with the unreserved backing of its employees, we have considered modifications of the foreman function and the encouragement of horizontal collaboration.

Objections are sometimes raised to both suggestions. It may be supposed that an encouragement of group social activity has its dangers and makes subsequent control more difficult. This objection has already been noticed. Observation shows that every group will elaborate a social situation of some sort; the questions are whether or not this situation shall content the group in the first place, and incline it to accept the leadership of management in the second. No one has ever experienced a group from the inside which did not have its habitual ways of procedure, its common attitudes and sentiments. Where such social understandings are conspicuously few, the picture is inevitably one of wild confusion. The same general remarks apply to the development of horizontal collaboration. It is regarded as dangerous to have activities flowing along lines other than those of authority. But the fact is that such activity is the order of the day, and no

complex community could survive for a moment under any other arrangement. Again, the question is whether this shall be recognized and persuaded to organize itself around the purposes of management by a recognition of its function, and by assisting that function to improve itself.

What is required is not so much a set of rules enforcing any particular collaboration, as an organization which will make it really effective. Thus, if some department is in fact habitually obtaining information from another by unofficial means, this rather suggests that the information is found useful, and a few procedures for obtaining it with less trouble might be devised. Where the need is experienced towards the top of the managerial ladder, the means are usually devised, but the same need is not so habitually recognized or favoured when it arises lower down.

These two suggestions are not intended to be exhaustive nor are they applicable to all cases. The central thesis of this chapter is that management, to be successful in leading its groups through successive changes, must ensure that the changes are designed with reference to the actual social activities of those groups. To accomplish that, initiative should be placed so far as possible at the level at which the change is to take place, and where its need is visible in terms of daily activity. This does not imply statements to the effect that management's 'door is always open' to suggestions from below, but the evolution of an organization such that it will naturally fall to the relevant body of people to take the initiative. The simplest way to achieve this is really to know the human situation within the firm, and to be alert for evidence of attempted initiative. With an unsuitable organization, such evidence often takes the form of unofficial, or even officially discouraged action. If activity of this sort is regarded not merely as a breach of discipline, but as the (possibly unwise) expression of a need, then the appropriate rearrangement will often suggest itself.

Executives are apt to deplore the lack of initiative amongst their subordinates, though an intimate acquaintance of the un-

official and unacknowledged activities within any firm rather suggests that initiative at the lower levels is running wild for lack of appropriate opportunity. Management must not recognize initiative only when it runs along the traditional channels; that would be to show a lack of initiative on their own part. The essence of initiative is the forming of a new combination or arrangement out of familiar elements to meet a situation. And the way to recognize initiative is surely to observe the ways in which activity is failing to remain within its formal limits.

In a simple community, having little in the way of a formal or written organization, there is no distinction between habitual *de facto* and *de jure* behaviour. But in modern complex organizations, there is the possibility of these remaining apart for indefinite periods to the detriment of everyone concerned. This possibility becomes a practical certainty in an organization whose formal structure is designed and modified in ignorance of the actual social activities involved. "If management does not intervene its employees then someone else will."¹ If management does not put itself in a position where it is able to understand the social activities of its employees in terms of their situations, then other organizations will arise to perform this very function. This function is performed by a variety of organizations at this very moment; trade unions and kindred bodies are obvious examples, and in some countries this function is also performed by political organizations, party organizations and other groups whose methods are not always desirable or easy to control.

Management's best guarantee against a socially and economically unsound leadership of its groups is to do the job itself; and this implies a permission to lead, resulting from an active concern for its groups' ways of life and social sentiments. This is equivalent to asking that management shall behave socially with respect to its groups; for what employees fear from the better type of industrial management is not lack of straight dealing so much as social ineptitude.

¹ Elton Mayo.

One thing more remains to be said before closing this chapter. People cannot express their social needs in the form of a direct statement. We have seen that social activity is not merely a matter of speech but of actions performed in common over a period of time, so that mutual expectations and concerns may be developed. It is the doing of things together that satisfies the social need; and speech is only one of the things, and not the most fundamental, that people do together. Thus much social activity takes place well below the level of easy observation, and maladjustment cannot readily be traced back to its real source, which is so often poverty of human collaboration. It is this difficulty which makes necessary the functions of priests and psychiatrists, and it is this difficulty which prevents the worker whose social activity is inadequate from detecting the cause of his own dissatisfactions.

Countless executives have had the experience of speaking freely with their workers, and of arranging conferences to air and discuss troubles, only to find that nothing of much consequence is brought forward. Then perhaps the workers present an unreasonable demand or even strike without warning. From the executives' point of view, these men are behaving irrationally; they have failed to express their requirements in spite of many opportunities. Often, the nominal trouble would have been easy to state at any time, but if so it was probably not the real cause. When our situations are unsatisfactory for reasons not easy to express, we all tend to fix the blame on something else. In fact, we all rationalize our hidden motives. People habitually behave non-logically, but any large-scale appearance of irrational behaviour is suspect; the cause is usually real enough in terms of social need, but is hidden from view. Thus conferences between management and its workers have great uses, but they are no substitute for direct observation of work situations on the part of management itself. When management has this knowledge and insight, then the conferences may be an ideal opportunity for discussing real, as distinct from rationalized issues.

CHAPTER IX

THE FINANCIAL REWARD

THERE is probably no one factor in the lives of people about which they think more explicitly or more continuously than their incomes. It is usual to explain that the actual money (token or otherwise) is not what is wanted, but rather those satisfactions which money can buy. In the same way, a steamer ticket is valued not for its own sake, but for the travel which it makes possible. But there is a distinction to be made between money and steamer tickets. No one sighs for the possession of tickets, or expresses his knowledge of foreign parts in terms of tickets; travel and peoples and countries are in the explicit thinking of the average person. But *money* is what people say they want; and it is in terms of money, not of the experiences that money can buy, that we tend to consider our own situations.

It would be easy to answer that the variety of human experience is wide and difficult to summarize, and that terms such as 'income' and 'money' are just so many convenient shorthand expressions to assist thought. Such an explanation is simple enough, but it fails to cover the known facts of people's thoughts and sentiments; this explanation is a convenient but inaccurate half truth. For the simple fact remains that receiving or possessing money yields a direct pleasure, and money is an object of contemplation in a sense which does not apply to steamer tickets.

It is natural, and for some purposes convenient, to divide things and actions into two classes; those that are 'ends in themselves,' and those that are merely means to ends. An end in itself is that which is felt to be good or satisfying, or, since there are bad as well as good ends, that around which sentiment is organized. An end in itself is an object of contemplation; for contemplation and sentiment follow hand in hand. Sentiment is always directed in some degree toward an object of contemplation, and there can

be no contemplation of a thing which is entirely without significance for the contemplator. Significance, regarded as a state of mind, is itself a sentiment. This division of things and actions into ends in themselves and means to ends, suffers from many difficulties if it is pressed too far; but its main objection for us is that it does not accord with the observed facts of human psychology. For nothing in constant use remains merely a means to an end. In our thinking, every well-used thing, such as money, becomes to some extent an end in itself. That is to say, sentiments and attitudes become associated with it, and it becomes an object of contemplation.

We have already considered the mechanic whose sentiments refer to his technical routines. It is natural to suppose that he performs such and such operations as a means to an end. So he does; but the operations are in themselves ends packed with appropriate sentiment. The mathematician, who uses 'x' as a symbol for a variable quantity, has a real feeling for 'x'; he greets 'x' as an old friend, not a better chap perhaps than 'k' (a constant), but a different one. For the mathematician recognizes the various letters of the alphabet by the different sentiments he has for each one of them. These symbols have become ends in themselves as well as being means to a further end. The fact is that every operation or element in directed activity is a means to a distant end and is, in a greater or lesser degree, an end in itself. Every human action is both a means and an end. And satisfying social living consists in a stream of human activities in which these two aspects, immediate social ends and means to further social ends, are adequately blended together in every action.

So money, in our thinking, is an end in itself — something to which we attach sentiment and which is an object for our contemplation. Money is also a means to further ends, for with it we can purchase our future living. This is a statement of a psychological fact; for the whole point is that people do actually think of 'money' in these two ways at once, although their relative im-

portance varies greatly from moment to moment. We cannot understand social attitudes and behaviour with respect to money unless these two strands are clearly recognized. There is nothing unique or surprising in this dual attitude; it is in fact very usual. We own automobiles in order to move expeditiously, but we also have sentiments about our automobiles, we like them in themselves. Any advertisement is a double appeal to our sentiments for the thing-in-itself and for what it can do. Table glasses have a utilitarian purpose and are also designed to be a pleasure in themselves. So in that respect, money is like most other things; a thing in itself, and a means to an end.

With these ideas in mind, let us see what place money has, what social functions it performs, in our own society. Its technical use in assisting the activity of the present to construct a future situation has been developed in great detail by the economists, but we shall consider only the sentiments which accompany social actions involving money. Even with this limitation, the subject is too wide, and attention will be further restricted to some of the sentiments arising from one particular social function in which money is involved; namely, receiving payments for work done or for services rendered: money paid as salaries or as wages.

One peculiarity about objects of contemplation is that the sentiment directed towards them is the same kind of sentiment which is directed towards many other things. And so objects of contemplation (e.g., money, honour, expensive houses, socialism) all tend to become knit together in the mind in one comprehensive scheme. The bonds between the parts of such a combination are not so much logical as sentimental. We have had occasion to notice this peculiarity before; for instance, the country squire in whose mind the Established Church of England and the undesirability of trapping foxes somehow became connected. However, country squires have no patent rights in the matter, we all think in this way; this is fundamental to personal integrity, although the total pattern or combination of thought may be profoundly modified by skilled, logical reflection.

We have also found, especially in the discussion of small industrial groups, that such mental combinations of things and sentiments have a great tendency to persist once they become established. This is the basis not only of personal but also of group integrity. And so we find that present-day attitudes towards money are inextricably bound up with social attitudes and social judgments of value, and that the bonds holding together this money-social combination are those of sentiment rather than of logic.

In some sense, the payment of wages (including salaries) is that which provides people with a motive to work; no firm could hold its personnel together unless it paid them wages. It is also true that work, in the sense of social activity directed towards future ends, was practised centuries before the introduction of any system of money payment, and is universal amongst really primitive peoples to this day. In such communities, the incentives consist in promoting the immediate social satisfaction of the activity, with very little emphasis placed on future expectations; these communities are unprogressive in consequence. Each major task, such as the carving out of a trade or a war canoe or the planting of a crop, is performed as part of an impressive ceremony which carries great emotional significance for those who take part in it. It would be difficult for an eyewitness to determine whether an industrial activity or a religious ceremony were taking place; the activity partakes of both characters. The harvest festival which is celebrated in some form all over Europe, and in New England is further transformed into 'Thanksgiving Day,' is a relic of this sort. Similarly, christening a ship immediately before launching it is a ceremony which adds emotional significance to the task. Under this system, each individual is socially obligated to take his share of the labour and is regarded, in the eyes of society, as entitled to a share of the benefits. The spur to action is social obligation working on an eagerness for social participation. The members of a primitive working group do not typically receive equal shares of the added wealth, the share is regulated by cus-

tom. But the shares so distributed are felt to be right, or, as we should say, just.

In a modern industrial society, everything is the other way round. Incentives to work consist in the emphasis placed upon future benefits (i.e., money payments), and the factor of social participation has been sufficiently neglected for one executive to be able to declare that there was no social element in his firm; he just got his men together and let them work out their problems in common. Apparently, in his mind this procedure was analogous to assembling the parts of a calculating machine.

Wages in modern industry are calculated in a number of different ways; the study of wage payment systems is a large subject in itself, and two principles appear to underlie all modern systems. The first principle is that payment must be appropriate. The wage received must be appropriate to the recipient, and to the man or company making the payment; for it is no longer the society which is regarded as the second party; at most, the ultimate consumers are envisaged. This concept underlies economic discussions of the supply and demand of labour, although the sentiments which form the basis of economic behaviour are usually not explored. The sentiment that a wage is fitting, or appropriate, is nearly but not quite the same as saying that it is just, though justice is the term usually used in this connection.

The second principle sheds a floodlight on the social health of industrial civilization. It is that the basis on which payment is calculated shall be such as to provide the utmost inducement for the recipient to co-operate in securing his own economic welfare together with that of his society. This is the principle of maximum motivation. It is this second principle which accounts for the complexity and variety of payment systems.

The social activity involved in modern industry is so unsatisfactory that an appropriate wage payment does not cause the individual to organize his sentiments adequately around the activities involved. This statement is not strong enough; for the typical employee is not negligent with respect to his activity,

he is in some sense reacting against it. This has been amply demonstrated in previous chapters and is besides universally recognized, and so the matter need not be elaborated here; it is a central fact in industrial civilization and should never be forgotten. It makes no difference to average wage levels whether payment be made on a basis of time, piecework, or anything else; an average wage of say \$x per week can be arranged under any system, but the motivation resulting from these systems may be very different.

On the face of it, industry is in danger of running in a vicious circle: social participation has been neglected, and to secure co-operation, future rewards are increasingly emphasized; this does not prove to be adequate and so future rewards are emphasized still further; social participation sinks still further into the background. This sounds rather like attempting to trim a ship by shifting the ballast still further towards the listing side.

It would be ridiculous to suggest that in a satisfactory society money payments should be abandoned. Money is one device for securing a distribution of the fruits of industry, and a very good one, too. Currency, in spite of some difficulties, has proved to be a most ingenious device for handling a complex problem. A tool, such as currency or a carpenter's plane, stands or falls on its technical excellence and not on some question of sentiment. But the use to which a tool is put is guided by sentiment; a carpenter may make a Chippendale chair, or one carved all over with cupids blowing trumpets and ornamented with pink bows. There is nothing wrong with wage payments; but when their detailed design is found to be guided not by social sentiments of fitness, but by an urgent need to increase participation in what is supposed to be a common good, then we are justified in being suspicious; and our suspicions become more acute as we realize that, broadly speaking, these money motivation devices have failed in their purpose of producing a contented labour force.

Not long ago, a visitor to America told me that he had spent over a year in studying methods of wage payment, and that he

had already discovered over 80 radically different systems. One's only surprise is that this visitor had observed so few. There are many variations of individual payment by time; for instance, consider the alternative ways of paying for overtime or for standard time during night shift and on holidays where such work is required. Individual payment for work done has many more possibilities; the degrees and manners in which speed may be emphasized in the pay cheque are almost endless. Then these two principles can be combined and payment made on a basis of time and output, any variety of one being combined with any variety of the other, and in any proportion. Again, account is sometimes taken of quality as well as quantity in output; there are all sorts of ways for penalizing neglected work.

The real complications come when individuals are paid on a mixed basis of group piecework and individual rating, often with a dash of time payment thrown in for good measure. These alternatives are not mere mathematical possibilities, they are in daily use all over the industrial world — and they all have one object in view: to spur on the employee to greater efforts by appealing to his economic sentiments. Now it is well known that similar systems of payment have surprisingly different effects when operating under superficially similar conditions, and often in different parts of the same firm.

Elton Mayo¹ describes a shop in a cotton mill near Philadelphia. This particular shop contained spinning mules, and was in several respects unlike the rest of the firm. Morale was good in the firm as a whole as evidenced, amongst other things, by a negligible labour turnover. The owner and manager was popular, and respected by his men. Yet in the shop in question the labour turnover amounted to roughly 240% per annum. Investigation showed that the men were discontented and pessimistic in their attitudes. Beyond their regular pay, these men were offered a bonus whenever they exceeded a given monthly output which

¹ *The Human Problems of an Industrial Civilisation*. Macmillan, New York. 1933.

was calculated as being well within their capacity. This group had never yet earned a bonus and they regarded it as a mockery, much as a superior donkey might regard the proverbial carrot held in front of its nose: something to induce effort but which can never be attained. A final symptom of disorganization was that whenever the mill had a press of orders the output of this shop declined. The work of these spinners was physically exacting, and at Mayo's suggestion, rest pauses were instituted with suitable arrangements to enable each man to lie down and relax. This was not a simple change of detail, for accompanying it, investigations had been instigated to discover the trouble, and a trained nurse was installed as a part of this. In many ways, management was showing a real concern. The rest pauses provided the needed physical rest, and the social implications were also favourable. The result was that labour turnover fell into line with the rest of the mill. Output rose so that a bonus was regularly earned, and thus became a source of contentment rather than of irritation. Attitudes became more cheerful all round. This, so Mayo tells me, even reacted upon the men's home lives. One of them informed him that he had actually taken his wife out to a show. This man was quite frankly as amazed at his unwonted behaviour as was his better half. Finally, from then on, the output of this shop rose to meet each peak demand instead of falling as before.

A financial motivation device may be regarded in either of two ways by the employee. Where the social situation surrounding a working group is not too inadequate, an enhanced reward for good work will often be taken as additional evidence of management's concern. The management is prepared to meet a special effort with a fitting reward. On the other hand, if the group is reacting against the purposes of its management, then it is likely that the added incentive may be taken as one more proof of management's attempt to drive its workers. In many cases, these attitudes are not explicitly stated by employees, but their whole behaviour indicates the pattern of their thinking. Senti-

ments with regard to the system of wages themselves conform to the general social sentiments of the group. In other words, a wage system designed to evoke high motivation is apt to increase the force of the motives already in being. If these are favourable to the policies of management, well and good; but if the case be otherwise, the more the employees are motivated the more they will resist their nominal leaders.

The relay test group, described in Chapter III, has already provided an example of the dependence of financial motivation on other supporting social sentiment. It will be remembered that during the last year, the output rate of the group tended to fall, and that finally during the last few weeks, working rate fell very rapidly. The girls needed the money more during these times than ever before, but as the situation of each girl became more unsatisfactory she found herself unable to work so effectively in spite of her best endeavours. It is not to be expected that increasing the motive factor in a fitting wage should be a substitute for adequate social activity, but within limits it may emphasize whatever social sentiments are present in the situation. However, the present over-development of the motive factor has become almost absurd. Since the whole point of a money motivation system is that the worker should be motivated, it should be above all things comprehensible to him. But even this simple precaution is often lost sight of in the quest for even more mathematically perfect devices for rewarding superior application.

In an excellent description of the wage payment system for the Bank Wiring Observation Group,¹ the authors first describe the system itself, and then expectations of its sponsors with respect to the effect on the workers. We then have an account of the workers' understanding of the system, and finally of its actual influence on their behaviour. The whole account is most illuminating. The workers misunderstood the system, and reacted in the most unexpected manner. In practice, this particular system

¹ "Industrial Research in Human Relations," by F. J. Roethlisberger and W. J. Dickson. To be published by the Harvard University Press in 1937.

operating upon the social attitudes of the group encouraged the workers to resist the ends of management. In another case which came to my notice, workers were paid on a group piecework basis complicated by differential personal ratings, and an occasional relapse into time payment, together with promotions in personal rating which did not, however, affect the total takings of the group. It was quite impossible to remember how the system worked from one day to the next.

An executive will state with pride that every one of his workers can calculate his own earnings. Quite usually this is not the fact, but in any case it is beside the point. Complicated wage systems are not designed for the purpose of exercising the workers' capacities in elementary mathematics, but in order to motivate them. Hence, what is required of the worker is not merely an ability to calculate, but an easy grasp of the influence of the several variables on the resulting figure. He must envisage the effect on his earnings of simultaneous movements of several factors, some of which are partially dependent upon one another. I have used physical formulae for years, but in spite of my best endeavours I find myself unable to get on easy terms with many actual examples of wage systems; and my experience is that workers tend to have some rule of thumb, and often quite misleading traditions as to the effect of the various factors involved, and of the purpose of management in designing them.

These systems are costly to run and to set up in the first instance; and, what is even worse, they are time consuming. It is impracticable in many cases to calculate the wages due to a worker to within several days of the current date; and so a system has sprung up in some places of paying weekly advances to the workers and of squaring up at intervals, e.g., every fourth week. The wages may be squared up to the previous pay-day. The advances represent some executive's estimate as to what the worker has probably earned. To prevent a serious disappointment in the 'squaring up' payment, the estimates are conservatively figured, with the result that every fourth payment is

exceptionally heavy. The result is that three payments out of four do not correspond to anything in particular, whilst the fourth is compounded of a guess for the current week plus the sum of the four errors of estimation for the second to fifth weeks previously. It need hardly be said that if weekly output and weekly payments are plotted together, it takes a statistician to detect the relationship between the two. And yet this complication arises from a desire to emphasize this relationship in the most vivid colours possible.

Poverty of social activity cannot be cured by great elaborations of the economic motive. The solution is to enrich the human collaborations, and arrange the organization of the work to give a sufficient opportunity for initiative and self-expression at all levels; and then to back up an adequate situation with a wage system which seems fitting and moderately motivating, *and which is above all simple.*

So it seems that far too much attention has been paid to the principle of maximum motivation and that more reliance should be placed on that of suitability or propriety. In point of fact, wages are regulated by a sense of what is fitting and proper; this, as has already been said, underlies the usual economic theory of wages. The sentiments which determine what is a proper reward for a given type of activity are socially determined and cannot be explained on logical grounds; although, *given these sentiments*, the economist is able to show that relatively small adjustments take place roughly in accordance with a calculus based on logical considerations.¹ To assume that the comparative levels of all wages (including salaries) are determined by logical considerations is to assume that all occupations are surrounded by the same customary sentiment.

¹ Incidentally, it is a sound generalization that any laws based on a discussion of marginal increments should never be assumed to apply to large changes without proof of their applicability. The original reasoning on which such laws are based makes great use of the assumption that an increment of change in one variable has not altered the value of other variables — i.e., mutual dependence is usually ignored.

For instance, in many countries high political officers and casual labourers are both paid about equally, the latter often leading slightly. Heads of departments are usually paid a salary, but in many cases this barely covers the necessary expenses for the prosecution of their duties. It is not uncommon to hear that so and so has refused an important appointment on the grounds of poverty. Quite obviously, these wage scales are determined by custom, supported by appropriate sentiment. The highest paid work is not always that which is most approved. There is one honour in being well paid, and another in the giving of service. Social attitudes with regard to wages are immensely complicated, and can best be understood in terms of the social history of the country in question.

Within a given occupation or an organization, the differences in rates of pay, and the manner in which they are paid, often carry a social significance out of all proportion to the difference in social participation which their respective purchasing power could obtain. Thus in a small working group, all of whose members are of the same rank, that member with the highest pay is apt to be regarded as something of a leader. This is especially true if his superior pay is due to some difference in his pay rating so that he earns more than another for equal work. This is quite a usual arrangement in group piecework, and it marks out the individual as being in some undefined sense intrinsically worth more to the society. Naturally, if the society (or group) sentiment does not endorse the principle on which the grading is based, there is trouble. The usual principles are proficiency, length of service, sex (male preference), occasionally family circumstances, conduct and so forth. The principle, length of service, is almost invariably in accordance with popular sentiment, especially amongst the senior members of a firm. When the employees are sympathetic to the aims of management, proficiency is also accepted as a factor in judging appropriate payment. Opinion on the justice of sex distinction is apt to be divided on sex lines, although married women may be favourably inclined on occasion.

In any case, the propriety of any given differentiating principle with regard to wages is a matter of social sentiment, and it depends on the particular social situations affected.

In some working groups, the workers are paid by the piece, perhaps with some bonus for high production, whilst their foreman may be paid a flat weekly wage. In the presence of any distinction, that individual obviously in a superior position (the foreman) is apt to obtain an additional status thereby. Since the top man is paid on system A rather than system B, system A becomes regarded as the mark of a superior man. But the foreman is paid on system A, and so the foreman is a superior man. This is not advanced as a circular logical argument, but as the actual route by which sentiment becomes transferred from one object to a second, and may become transferred back to the original object as a reinforcement; it is the real ground for many apparently trivial distinctions which are maintained to differentiate various classes and ranks of people. One not unknown effect of paying a foreman a flat wage, when his group are on piecework, is that the former may actually earn less than the latter on occasion. This results in a clash between two opposing sets of sentiments and is never regarded as quite socially appropriate by those involved.

An amusing instance of the adjustment of social sentiment occurs in the payment of first division civil servants in England. There are three ways of paying wages in England:

1. Weekly wages are paid to clerks and workmen.
2. Monthly salaries are paid in industry or for minor professional appointments.
3. Quarterly salaries are paid to higher professional men.

Naturally, there are many exceptions in practice. However, first-division civil servants are highly regarded by the community and they are paid quarterly salaries. But the pay is by no means excessive, and payment at such infrequent intervals might be inconvenient to the recipients. And so civil servants are paid

quarterly, but their pay is advanced to them monthly. This solution is in every respect appropriate to social sentiment, and I have even heard it defended by a government accountant on the ground that it simplified the bookkeeping.

Thus we see that wages stand for more than the mere purchasing power they represent. As in the case of every well-used thing or concept, sentiment has become attached to wages in general and each person's wages in particular. It is not only the amount of the wage but the way in which it is paid and the way that payment is expressed, and also the method of calculation, that is relevant to sentiment. Money takes its place as one of the innumerable things so organized as to illustrate and support the social structure both in its stratifications and distinctions and in its integrating relations.

CHAPTER X

THE CARE OF PERSONNEL IN INDUSTRY

AFTER reading the previous chapters, I can imagine those of my readers who may be business executives speaking in somewhat the following terms: "You have been explaining at length that we, the leaders of industry, have failed to provide adequate opportunities for social living amongst our employees. It is true that there exists some tension in the industrial world between management and labour, but we do not possess boundless resources; we have to work within our budgets and meet the just claims of our shareholders. Nevertheless, it is not true that the happiness and welfare of our people is not a first consideration with the better type of management, or that we do not spend both time and money in furthering these ends."

There is considerable truth in this statement; and in the present chapter we shall briefly review the main ways in which progressive management attempts to improve the lives of its employees. No attempt will be made to produce an exhaustive list of all the activities undertaken in one firm or another. Nor will the various activities be described in any detail. The only purpose of this chapter is to acknowledge freely what progressive firms are doing, and to see how far these activities, separately or collectively, amount to a due concern for the routine social activities of the workers during the course of their work.

Since our purpose is not to judge what proportion of firms adopt the best current practices, but to assess the purposes of these practices, we will imagine the best possible firm with an assured financial position supplying a staple commodity — a monopoly or a public utility if you like. We wish to consider the best practices of the best firm.

The following is a typical sample of personnel activities.

1. **Hiring and Firing.** Hiring has in some firms developed into a skilled art, in which each applicant is interviewed and attempts are made to discover his temperamental bias and his likes and dislikes. He is conducted to his future foreman and personally introduced. Precautions are taken to obviate arbitrary firing. Problem cases are investigated by the Welfare Department, and disciplinary cases are sometimes judged by a committee composed of executives and employees.

2. **Ability and Proficiency Tests.** These have been greatly developed in recent years. They assist the welfare of the individual by enabling him to be placed in occupations for which he is fitted and in which he is likely to be successful.

3. **Efficiency Engineering.** Many employees would deny that this activity was of benefit to them. But properly used, the efficiency engineer can assist the employee to earn higher pay without additional exertion.

4. **Changing Jobs.** It is becoming more common for firms to consult their employees' wishes in this matter.

5. **Increasing attention is being paid to conditions within the plant both as regards comfort and health and the prevention of occupational disease.** Safety devices and 'safety first' programs come under this head.

6. **Training of Employees.** In some firms, employees are regularly trained for their work. Also, classes on relevant subjects are sometimes available. Young employees are given special facilities in this direction. Attendance at classes may put an employee in line for promotion.

7. **Suggestions and inventions are encouraged from employees and adequately rewarded.**

8. **Canteens are provided where meals can be obtained cheaply and sometimes other things can be bought.**

9. **First aid and hospital facilities are provided, the latter being either free or available at suitable rates. Trained nurses who visit sick employees at their homes are retained by the firm.**

10. Various services are provided free, such as lawyer's advice, information as to holiday resorts, etc.

11. Saving and pension schemes are maintained for the benefit of employees. Employees in financial difficulties are assisted with loans and in other ways.

12. The firm collaborates with local government authorities, especially when layoffs become necessary.

13. Considerable money is sometimes spent in providing recreational facilities — playing fields, concert halls, etc., and in financing teams playing away from home.

Whilst not exhaustive, this list probably covers the various kinds of attention that management is giving to the well-being of its employees. Two major exceptions to this statement are financial remuneration and employee representation. The former was discussed in the last chapter, and the latter will be considered immediately.

The list as it stands covers managerial activities designed to provide fitting occupations for each employee, and also to assist him in training himself for his probable occupations. Then there are a number of actions whose object it is to make conditions of work physically safe and comfortable for the employee. Closely allied to these are means for assisting employees who may be unwell from any cause. Another set of activities increase financial security, and place skilled advice on kindred matters at the disposal of the individual. Some firms collaborate with outside authorities in making sure that these benefits shall extend more effectively over the whole of an employee's living conditions. Finally, a number of activities are concerned with the employee's opportunities for recreational activities, both athletic and, in the narrow sense, social.

This is an impressive list; and it may be assumed that few firms have undertaken these activities as a matter of pure theory, but because in fact a need for each action disclosed itself. Of course no firm does everything, but there are few medium or large-sized organizations that do not perform at least some of the serv-

ices mentioned above. These activities have arisen in response to a real demand, and there can be no question as to their utility in the majority of cases. But it is no criticism of what is being accomplished to point out that not one of these activities has any direct connection with the development of social living during working hours, so far as the average worker is concerned. We shall consider this further in discussing the claim of employee representation to meet this very need.

Employee representation may be taken to mean any device by which employees are given an opportunity for meeting their executives and considering matters of common interest. In all but the smallest firms, it is obviously impossible for every employee to be present in a committee, and some form of representation is consequently required. Alternative methods of choosing representatives need not be considered. It will be supposed for the sake of argument that the most suitable method is adopted in every case. Boards or committees consisting of executives and employees may function in one of several ways. They may be purely advisory or have certain powers of decision allotted to them. Again, the decision in the latter case may be retained by the management or shared by both parties.

For instance, it is not unusual for the chairman of such a committee to be a fairly senior executive who has the final decision in all matters. Or the decision may be reached by vote, but the executives may outnumber the employees. The distinction is not merely a matter of voting power, for in some sense the head of an organization always takes the final responsibility for all action; it is more a question as to how far he takes into consideration the opinions of others.

To take a familiar example, in a family council there is some sense in which the parents have the final responsibility and so the final decision. But, depending on the attention they give to the opinions and wishes of their children, the council may range all the way from a bunch of supplicants attempting to wheedle 'the powers that be,' to a real discussion in which each member tries

to consider the problem as a whole, and in the end feels that he (or she) has pulled his weight in arriving at the final decision. Only in the latter case will every member have the satisfaction of expressing his individuality as a contribution to a social situation.

Let us suppose that the committee, consisting of executives and employees, is so run that the atmosphere is one of true collaboration. Many joint committees of this sort do exist in industry. Here then is a committee in which some measure of initiative may be exercised by employees, and in which the latter are in a work relationship with their management. There is not the slightest doubt but that such committees perform an invaluable function; they do genuinely integrate an organization by providing real work routines as between the various ranks of those within it. But again it is no criticism of these methods, or of their importance, to point out that they are something different from the routine hour-by-hour collaborations in the average workers' group, during their working lives.

Satisfactory living for human beings is always social. And social living consists in activities performed in common, each member acting with a due concern for his neighbours or colleagues. Speech is only one form of social activity and not the most fundamental; action long preceded speech. The essence of social living is doing things together. But the satisfaction of doing things together depends upon the growth of stable routine conditions, in which reasonable expectations develop, and people become accustomed to one another. The element of chance interruption from outside must be reduced to a minimum, just because it upsets all expectations and confidence, which is of the essence of loyalty.

There are, we found, two supplementary ways in which outside interference should be reduced. One is that management should so plan its arrangements as to avoid breaking up working groups when possible. The second method is to give suitable day-by-day initiative to those groups in whose activities the need for change declares itself; for a change dictated by a visible need

appears to a group as an exercise of its social activity and not as an interruption. We saw that in holding all initiative in its own hands, management was actually damping down the initiative of its working groups. To invite a group to make suggestions to a higher authority is not to give it initiative. If you have to ask whether you may walk out of the room, then the other man exercises the initiative; initiative consists in walking out of the room on your own responsibility.

This, briefly, is the real problem in restoring to industrial workers the necessary minimum of social living, without which happiness and stability in society at large cannot be expected. Increase of social living is the major problem for all those who wish to avoid a collapse of the present type of industrial civilization. The present poverty in social living is largely a product of the industrial revolution. The social poverty and its recognition are both recent; consequently, it is no matter for surprise that the care of personnel in industry has not addressed itself to this problem. But the consideration of this factor cannot safely be delayed any longer. The most urgent need is not to arrange the individual's circumstances for his own economic or physical good; but to let him exercise his personal initiative in conjunction with others; and so, within reasonable limits, to place the individual in a position of immediate control over his own circumstances. He will do it much better than anyone else, and will develop a really effective loyalty to the purposes of his group's activity.

CHAPTER XI

THE FUNCTION OF TRADE UNIONS

ONE way in which the function of an organization may be understood is to examine its activities and stated objectives, and assume these to be the function which it is in fact performing. Our attitudes towards the organization will then be determined by two considerations: how far we are in sympathy with the stated objectives, and how efficiently or successfully they are being promoted; whilst if we have relations with the organization, these will tend to be guided by the answers given to these two questions.

There is a second approach to the same problem, more in line with modern sociological thinking. The actual activities of the organization may be studied with the object of ascertaining what social needs or sentiments led to these activities, and also what the more general effect on society of these activities may be. The stated objects of the organization would then be read not only as statements of fact, but also for the light they may shed on the actual sentiments involved. If this approach be taken, our attitudes would be determined by the degree of our sympathy for the sentiments guiding the activity, and by our opinion of the effect of the organization (actual sentiments and activities) on society itself.

The first approach is typically that of the 19th century sociologist, and one of its most convincing expressions is to be found in the preface to the first edition of *Industrial Democracy* written by the Sidney Webbs in 1897. It is proper to add that they performed the most thorough and reliable task of actual investigation that has probably ever been attempted in this field; but all through this monumental work the authors emphasize the value of the document, and assume that a statement of purpose and of activity is valuable in so far as it coincides with the real facts of the case. The other approach is a 20th century product and can

be found in the works of any social anthropologist, and nowhere better than in the writings of Bronislaw Malinowski.¹ The merit of this second attitude is that it consciously acknowledges the importance of non-logical thinking in the affairs of mankind, and so what for the Webbs is a disturbing 'bias' becomes a basis for further understanding in the hands of the modern sociologist.

These two ways of investigating human society are usually represented as being in opposition, and there is a real danger that investigators will come to underrate the importance of ideas and of logical thought to the extent to which these were overrated in the past. There is no incompatibility in the two attitudes; they each emphasize one aspect of the total problem. All human affairs are guided by general tendencies or laws, and also by particular design. The style of a house is conditioned by the fact that each and every massive body obeys the law of gravity. Hence we do not find a roof remaining unsupported above its walls. But it would be ridiculous to assert that the arrangement of a house owed nothing to the deliberate planning of its architect, or that the final result bears no similarity to that which he wished to produce.

So to understand the part which trade unions play in an industrial society, it is necessary to give full weight to their professed objectives and to the intentions of their leaders; but we must not neglect those social tendencies, which are often not in conscious thought, but which have guided the history of the movement and indicate its future possibilities. If in this short discussion, attention is almost exclusively directed towards the second aspect, this is not because of any superior importance, but because the reader already has every opportunity of becoming familiar with the formal purposes of these organizations.

Trade unions are of European origin, and they assumed something like their modern form as an organization of the 'proletariat' — a class created, at any rate in large quantities, by the in-

¹ E.g., "The Argonauts of the Western Pacific." Second impression, 1932. George Routledge & Sons, Ltd., London, and E. P. Dutton & Co., New York.

dustrial revolution. There had always been masters and men, but previously the relations between these had been personal, relatively permanent, and regulated by an historic system of mutual privileges and obligations. No doubt the privileges and obligations were not equally divided between the two classes but they existed, they were mutual, and they were appropriate to existing sentiment.

The advent of the factory on a large scale created a new human association which was not regulated by customary procedures. But the new order was in no sense democratic. The gulf between master and man remained as wide as ever; in fact, in some respects it became wider. For at least in the cities, the good apprentice craftsman looked forward to becoming a master in his day, but the capital involved in a factory organization of industry precluded any such hope on the part of most employees. In any case, such a system called for many men but only required a few masters.

The industrial society differed principally from the older landed system in that relations between master and men were mainly impersonal; the men had no security, nor had they any human function to perform in the social structure. In a landed society, the masters do not gladly tolerate any encroachment of their privileges, but at least they acknowledge an obligation to preserve their dependents from falling below that station 'to which God has called them.' Mutual regard was lost in early industry and is now only re-establishing itself with difficulty. In consequence, the factory hands, as they were called, were regarded as so much available energy and were effectively cut off from working relationship with the classes above them; moreover, they were in themselves without social structure — they had dropped through the bottom of society and taken their place amongst the machines.

This is not to say that the workers were harshly treated, although unfortunately that is also true. But one of the most interesting lessons of history is to notice how rarely large classes

have revolted merely because their lives were hard. When a revolt occurs, it will almost always be found that the group in question has in some way become cut off from the rest of society — cut off in the sense that its opinions and sentiments are of no interest to the rest, and do not in any way influence action; such men are virtually machines. Something always happens to isolated groups. They may start a revolution, or if the group is aristocratic it may fade away, as in the case of the surviving French aristocracy during the 19th century, who were stranded without function or influence. Industrial workers certainly have not faded away nor, on the whole, have they revolted, but they found a third solution in organization. And with many variations both of purpose and design this organization has chiefly taken the form of the trade union.

It is interesting to notice that many of the early workers' unions, especially but not entirely outside England, did not primarily aim to improve the material conditions of the worker. The movement was directed towards establishing a new ordering of society.¹ This new order, which with variations was always socialistic, would give to the workers the honourable task of leadership and organization within society. In other words, the workers were to recover a functional activity with a vengeance. However, it was a measure of the degree in which the proletariat had lost touch with their communities, that the loyalties or interests which the new order was to promote were not those current at that date. This was not so true of English unionism, but in Germany and France during the earlier part of the 19th century, the industrial workers showed little territorial sentiment, either for their cities, their communes or their states. Consequently, the new organization was to be international.

Almost all fairly modern revolutions start with an interna-

¹ For early union history on the continent of Europe, I am largely indebted to Epstein's translation of the sixth edition of Sombart's "Socialism and the Socialist Movement." This author gives an excellent account of unionism in Europe down to 1908. As regards England and especially America, he writes with less understanding.

tional bias. The usual explanation is that the revolutionists wish to share a good thing with peoples of other countries. I disbelieve this explanation and prefer that given by Sombart: people cannot be loyal to something they have not experienced. The masses, having stood outside their own territorially organized society, recognize in their own class the only exclusive relationship of which they have had first-hand experience. This is not giving a helping hand to another community, but ignoring the boundary because, for them, it does not exist.

The English unions adopted another policy; on the whole, they devoted their energies to improving factory and living conditions. Sombart assumes that the establishment of a new international society was the real object but that the English, being of a cold and practical nature, were burrowing methodically in the foundations of the existing system in order to bring it down with a crash. For once, Sombart's sociological instincts have completely deserted him, although the English unionists in their genial way have occasionally echoed the phrases of their continental brothers from that day to this; what the English unionists were really doing was to force co-operative action upon the rest of society, and secure for themselves better material conditions. During the early part of the 19th century, factory conditions in England were a disgrace to humanity, and were quite as bad as those to be found anywhere else; they were far more common, for England had an easy lead in industry. However, English society has always shown a curious mixture of aristocratic and democratic tendencies; and so in spite of hard conditions, the workingmen had never entirely lost touch with other classes of their countrymen.

In the main, continental unions copied the English in their activities although, especially in France, they showed an intermittent tendency to resort to revolutionary methods. The German unions had always been ahead of the English in one respect, for they had entered early into the field of politics. This the English did not do effectively until the beginning of the present cen-

tury. Up to the time of writing (1936) the Labour Party has twice formed the Government, although never with a clear majority over all other parties.

The trade unions are achieving two objects at once: they are looking after the economic condition of the working class, and simultaneously enriching their immediate social relations. Under the first heading come such activities as improving factory conditions and pay, and providing various forms of insurance and collective security against accident and extreme poverty. These activities are too well known to need description.

Closely allied to trade unions, and promoted by the same men in part, is the co-operative movement. This has also taken slightly different forms in various places. In England, the co-operative retail stores are to be found in practically any town, large or small; these are run by working men and women, they pay union wages to their employees, and sell at standard retail prices. The profits are distributed to members, who comprise a tolerable proportion of the working class. In such ways, the activity of workers' organizations is directed towards the future advantage of their members.

In many ways, the most impressive function of trade unions has been in the social activity they have promoted. In a country where labour is so highly unionized and where union activity is so great, it is natural that unions should have functioned in some ways as social clubs for their members, and they have taken their part in the organization of social gatherings in the narrow sense of the term.

A more important instance is the following. Owing to the class division of society in England, it is not easy to rise in one generation from one class to the next. Moderate financial success will not open the doors of the class above. In consequence, an able employee who accepts promotion within his industry is in danger of cutting himself off from the society of his old associates without acquiring the right to enter any other group. The greater the promotion, the worse will be the situation. By accepting promo-

tion, a workman risks social suicide. Consequently, it is not infrequent for an offer of promotion to be refused, and even if accepted, it probably does not result in more interesting or important human contacts. But the able workman urgently desires, both for himself and for his group, a significant function in a larger sphere. He is debarred from achieving this through the medium of his economic activities, but close to his hand is a parallel organization, his trade union. This is essentially a working-class enterprise, and promotion within it does not separate him from his friends; consequently, the ambitious and able workman becomes an official of his union, and here he enters importantly into the life of his country; he enters a sphere of activity in which he is assisting in the organization of his industry, and in which he is collaborating with management.

To be sure, the collaboration degenerates into open warfare at times, though on the whole there exists mutual regard between the two elements. In addition, the official is assisting in the organization of his union, which develops in him executive skills and a capacity for handling men. In fact, the union official has a satisfying social life; he may end in Parliament or even become a Cabinet minister. In this manner does the English working class take a part in the direction of its country's activities and policies. Of course, most union members hope for no career for themselves, but even as simple members they are identifying themselves with a democratic institution in which their voices are heard, and which links them effectively with an important range of activities.

Thus, whatever may be the economic success of unions in England and in some other European countries — and this must not be underrated — they do undoubtedly achieve one function of successful institutions. They provide their members with a social structure and enhance their opportunities for effective participation in the life of the community as a whole.

As a contrast to this account of unionism in Europe, consider the fortunes of trade unionism in the United States. What have been the needs of manual workers in this country, and how could

unions assist them? The early settlers came mainly from Great Britain and from Holland to seek freedom of conscience and personal liberty of action; that is how they have habitually expressed their motives. For the most part, they were of humble origin and had suffered from the oppressive control of the classes above them. Consequently, the early settlements along the Atlantic shore of America had certain strongly marked characteristics which differentiated them from their English and European contemporaries. The settlers had a thorough distrust of the formal instruments of government, as a result of their European experiences; to this was added an intolerance of authority and discipline, together with great self-reliance. These qualities were increased rather than diminished by conditions of life in the new continent.

Each small settlement was separated from the others by dense forests traversed at best by rough tracks; often the only practicable means of communication was by ocean. Within each colony there was little need, or for that matter possibility, of elaborate formal government. Land was to be had for the labour of clearing it, and everyone either was a farmer or might become one whenever he wished. Life was essentially democratic, and matters of common interest were settled by 'town meeting,' presided over by a 'moderator.' This is especially typical of the northern settlements where industry has mainly developed.

So the introduction of factories developed in an atmosphere of revolt against the master-servant division of society as practised in Europe, and this revolt was all the more self-conscious since industrial conditions were developed shortly after the colonies had gained their independence from England. Factory conditions and pay were regulated by the fact that employer and employee were socially and politically on a substantially equal footing, and by the possibility of turning to the alternate career of pioneer-farmer which was open to every man and was honourably regarded. Under these conditions, few men spent their whole lives as employees and no self-conscious class of workmen existed.

Statistically there was such a population but the turnover of individuals was high.

Significantly enough, the history of American industrial labour begins not with organizations but with strikes.¹ Employees required no union to give them a place in society, they had that already; but when conditions were unsatisfactory these men remained true to their traditions and they walked out. It was not until after 1830 that permanent unions began to be developed, as a result of forty years' experience of strikes supported only by temporary organizations created for the immediate purpose. These early unions were little more than strike organizations placed on a permanent basis; they performed no other service for their members, for there was no other service to perform. The employees had the status and the security of the rest of the society and had no need for social activity outside of it. Only with respect to bargaining power was the position of the employee substantially worse than that of the owner, and, just as a modern householder provides himself with a fire extinguisher, so the early American employee provided himself with a strike organization.

The townships were far apart and relatively isolated; consequently, there was no advantage in having unions which extended over more than one town or city, and this would have violated a strong sentiment of local independence. On the other hand, it strengthened the union to cover as many trades as possible within its town or city. Consequently, the early unions differed from the European pattern in being a union of all trades; a trades' union. These trades' unions had no other function except to strike, and organizations that do not function lose their membership. Consequently, the American unions have been distinguished by the number of their strikes, and by the vigour with which they have been conducted.

¹ For my facts with regard to labour unions, I am indebted to an excellent short summary by S. Perlman, "A History of Trade Unionism in the United States," 1923, Macmillan, and also to Atkins & Lasswell, "Labour Attitudes and Problems," 1924, Prentice Hall. These authors must not be held responsible for my opinions.

American and European unionism sprang from entirely different circumstances, and consequently their early attitudes and activities were not the same; the difference is well marked to this day, though this is not sufficiently recognized. *For documents circulate and can be compared, but the things men do can never be recaptured with their original detail in another time or place.* American statements and explicit objectives have owed much to European influence; but these are grafted somewhat clumsily upon attitudes and activities in line with actual situations of the time and place.

The early trades' unions were not conspicuously successful in obtaining concessions for their members; the need for frequent strikes made it inevitable that these should be unwisely undertaken and badly organized on many occasions. Because of this, and of the American distrust of combination in any form, the strikers often did not have the sympathy of the community. Besides this, the unions could not hold their membership between strikes, and they were perpetually out of funds. When a strike was imminent, workers likely to be affected or who hoped to benefit from the result, would join in great quantities, only to let their subscriptions lapse when the excitement was all over. Yet another difficulty was the tendency of employees to think in terms of ownership. They did not conceive of themselves as a perpetual class of hired men, and were apt to use their unions to form companies which, by successful enterprise, might earn the profits of management. This was the fate of several attempts at co-operative manufacture. Whether successful or not, these organizations tended to take on the form of an industrial company in which a limited number of ex-employees held an interest and hoped for substantial profit.

In these circumstances, it was natural that the trades' unions should not attract adequate leaders. The objectives of the unions were not of paramount importance, whether we think of their stated aims or of the social services which they might have performed; the demand was for leaders of strikes rather than for the

organization of social living. Able manual workers moved out of their occupations (I cannot say 'class,' for there was no self-conscious working class) and became owner-managers rather than union leaders.

This general picture was typical well on into the eighteenthies, with one major exception. The growth of railways had reduced the isolation of the various communities, and the need for a wider organization became apparent. This was no desire for 'internationalism' in the European sense, but evolution of a practical policy. The Knights of Labour was an organization which had as its object the unification, or at least the federalization, of all trades' unions in America. In 1886, this organization had a membership of over two-thirds of a million workers, but after that their power began to decline as trade unions organized round specific industries became the dominant form of union.

A new factor had been changing the status of manual workers in the United States. The early settlers were men of independent character and thought. Later waves of immigrants were beginning to come from further afield. The demand in the United States was for cheap labour, and it was to a country where wages were high that these later immigrants had been attracted. There was still land to be broken in, though much of the best of it was either under cultivation or at least was privately owned; but the background and attitudes of the later immigrants often incapacitated them from showing the initiative necessary for pioneer farming. Often they could not speak a word of the language, had no affiliations in this country, and arrived in a destitute condition. For these men, paid work was an immediate necessity.

Thus society in the United States broke into two distinct classes: Americans and foreigners. It has been assumed until recently that a foreigner, so soon as he learnt the language, would be absorbed and become an American.¹ America speaks of itself as a 'melting pot.' However, these expectations have not en-

¹ I am not of course talking of legal status, which is beside the point; at this moment, a large percentage of 'foreigners' are naturalized or native-born Americans.

tirely been realized. Eastern Europeans and others have immigrated in their millions and have settled down in groups of their own nationality, cut off from their fatherlands and largely unconnected with the main stream of American life. The gulf between these two classes, Americans and foreigners, is greater today than any that exists in England; for almost no traditions, relationships or common evolution tie these classes together. Moreover, foreigners were subjected to inferior factory conditions and tended to live in slums; their conditions in general were very similar to those in Europe.

Similar situations produced similar results, and by the middle of the last decade in the 19th century, trade unions had supplanted the Trades' Union as the workingman's organization. These trade unions were usually led by men of recent European origin, particularly British; and the most effective of them are to be found in those industries chiefly manned by foreigners. For instance, the miners are strongly unionized and mining is mainly performed by Southern and Eastern European immigrants, except in West Virginia where, according to Perlman, a large proportion of the miners are negroes or white mountaineers; and these latter have proved difficult to unionize. Another example is in the clothing industry, where the labour predominantly consists of Russians, Poles, Jews and Italians.

These examples could be multiplied, but one interesting exception deserves notice. The railway employees have been successfully unionized, and this is apparently one of the few unions which has consistently discouraged striking and arranged for mutual insurance and benefits. Perlman attributes this to the risks of their employment, which made railway men uninsurable in the ordinary way. This may be the explanation, but it does not sound entirely convincing; the same reasoning would apply to other industries which are not similarly organized. However, the point of a union insurance is lost unless members stand by their union and pay its dues.

The American Federation of Labour has achieved an impor-

tant position as a federation of trade unions in opposition to the Knights of Labour, who attempted to unite all trades' unions. The outstanding leader of the former was Samuel Gompers, who was born in England of Dutch-Jewish parents. However, neither the American Federation of Labour nor the trade unions have achieved a position comparable to similar institutions in England. Several important unions have remained outside the Federation, and those within it are subject to little control. One of the main activities of the A. F. of L. is to settle disputes as between its member unions, particularly with respect to the apportionment of particular processes; but the A. F. of L. has no power to enforce its decisions, and the unions involved do not always accept these when given.

The trade unions have a better hold over their members than had the trades' unions; for instance, the latter always lost their membership during every trade depression whilst the former are more fortunate in this respect. Nevertheless, union membership is poor as compared with other industrial countries. Unions have the greatest difficulty in interesting their members sufficiently to cause them to attend meetings in ordinary times. Thus the rank and file remain out of touch with the problems of their leaders and when some crisis arises, union opinion is apt to be both violent and uninstructed.

The union leaders undoubtedly have a difficult time, nor are they of consistently good quality; by the time an able worker has fitted himself to be a successful leader, he has also put himself in a position where he can expect advancement within the larger social structure. For, in spite of the closing of the frontier, America is still a land of considerable opportunity and, as compared with any other large country, it is socially democratic. Thus, with many exceptions, instructed ability is apt to rise socially, and so industrial employees possess no large reservoir of ability unable to exercise its faculties, such as can be found in Europe; nor do these employees find in their unions a needed link with the activities of the rest of the country.

The weakness of unionism in the United States has led to an alternative form of organization in the company union. This is an association of workers of a given company, with officers who can represent their wishes and attitudes to the management. The weakness of such unions as regards bargaining power is too obvious to be missed, and it is on these grounds that they are often condemned. Not infrequently, the companies have persuaded or practically forced their employees to join the company union precisely because it deprives the latter of any fighting strength. On the other hand, where the relations between management and employee are those of collaboration based on mutual trust, a company union has proved a flexible instrument and one capable of being adjusted to the real situation, and it has shown great possibilities under such circumstances. The only justification for a company union is when decisions are not made on a basis of comparative strength, but as an attempt to integrate the various interests involved.

In previous chapters, it has been suggested that in firms where managers and manual workers alike are employees, the real cleavage between the two is that direction is concentrated entirely in the hands of one of the parties, and that this is not exercised with due regard for the social living of the others. If initiative were suitably distributed and management considered its function to be that of promoting the social living of all concerned, shareholders, customers and workers, then it is not obvious that the traditional division between management and labour would have any significance. This does not imply that everybody's interests would become identical. There is no identity of interest between any two people anywhere. The interests of husbands and wives, or as between colleagues, are not identical. Neither management nor labour represent homogeneous bodies within which interests are identical. As a matter of fact, a junior supervisor in a large firm has much more in common with the workers than with his senior executives. But there is no reason why an

exceptionally large break should be perpetuated at one point in the hierarchy of those who earn their living in industry.

The future of trade unions will depend on the degree to which social living is made a first concern of those who are in a position to lead. In the United States, the period of rapid expansion is practically over, and a self-conscious class of manual workers is growing who will not think of themselves or their children as likely to occupy any other position. Under present conditions, this would almost certainly lead to a strengthening of trade unions. In spite of many exceptions, these unions are not adequately led and have no great traditions of collaboration with management, and the future history of human relations in industry might be an unhappy one.

On the other hand, the executive ranks of business contain many of the best brains of the country, and it is very possible that they will prove equal to the task of adapting the organism of industry on lines more satisfactory for those involved; if this happens, trade unions may lose their members, because they find in the direct collaboration within the factory all they need in the way of personal self-expression and of adequate consideration.

However, institutions die hard, and it is more likely that in such a case the unions would insensibly change their functions and become more exclusively a means for collaboration. This has already happened to a considerable extent in England where, although strikes are not uncommon, workmen have always regarded their unions primarily as organizations to force collaboration with the managers. For, quite apart from any question of opposing interests, there is a large field for investigation and organization in arranging the detailed activities of several million workers. About the most dangerous thing the managing class could do, would be to attempt to cripple unionism by unfriendly or unco-operative action. This would certainly lead to an increase of union activity in its most aggressive form.

However, the point of this chapter is not to indulge in predic-

tions concerning the future, but to illustrate the manner in which an organization with an adequate logical purpose will also be moulded to serve a number of other purposes which may not have been explicitly stated. Some of these additional purposes may also relate to future conditions, whilst others provide immediate social satisfaction by integrating the group in question. When the organization does not provide the latter service, as in the case of early American unions, the logical purposes alone do not suffice to maintain active support. In this respect, union and industrial organizations both illustrate the same principle: No organization involving much human energy is likely to be supported unless it has an adequate purpose and also provides immediate social satisfactions.

CHAPTER XII

THE ORGANIZATION OF A COMMUNITY

WE HAVE seen that satisfying activity performs two functions. It provides an opportunity for immediate social intercourse — for the doing of things together — and the purpose of this activity must be to continue and develop social living in the future. These two functions are recognizably different, and they vary to some extent in independence of each other. Thus, factory activity is often seriously deficient in the satisfactions of immediate social life; but these functions are also interconnected, and we found that the deficiency of one factor in factory life was leading to a failure in the other — the adequate preparation for future living. When the present is unsatisfactory, there is little incentive to work for its perpetuation. In this chapter, we shall consider the opposite possibility — namely, that in which relatively adequate present living is disrupted by a past failure to prepare for the future.

Let us take as an example the building industry, as it is commonly organized in America and in England. A builder, especially one who specializes in large buildings, will maintain a permanent skeleton labour force and for the rest, will hire his labour as he needs it for the duration of each particular building. As the industry is at present organized, this arrangement is almost inevitable, since the activity of any one firm is exceedingly erratic and unpredictable. And the industry as a whole is highly seasonal, not so much because the demand is seasonal as because the work has largely to be performed in the open. Finally, building is peculiarly sensitive to fluctuations in trade activity. Houses and factories are not consumed in the ordinary sense and during even a mild slump, building, other than that deliberately organized as government relief, is at a standstill. Consequently, the security

of a worker in the building trade, for instance a bricklayer, is exceedingly poor. Not only is he continually being laid off for reasons quite outside his control, but in most cases he has circulated round so many firms in the course of his working life that he has established no sort of permanent relations or claims on any one of them.

Bricklaying is a hard and exposed life. By the time a bricklayer reaches his fourth decade he is already becoming old for the work and is fortunate when he can persuade a foreman to give him another job. In spite of trade unions, hiring and firing is often carried on in the crudest of manners. The curious fact remains that relatively few bricklayers wish for any other life. A factory worker does not often develop so deep a satisfaction in his occupation; at any rate he will gladly change it for a better. But in the case of sailors, soldiers, miners, shipbuilders, farmers and others, including bricklayers, their occupations fill their imaginations and become for them a 'way of life' to an extent unknown in many other organized activities. This extreme form of loyalty to a given occupation will usually be found to be accompanied by a satisfying social relationship, and the working life of a bricklayer is no exception to this rule.

The group hired for a particular building will remain together for a few months, or at most a year or two. Owing to its temporary nature, and the changing condition of the 'layout' as the building takes shape, it is impossible for the technical organization to acquire that almost machine-like precision which is typical in many factories. Arrangements are extemporized to meet temporary and local conditions. There is freedom of movement and an exercise of initiative for all. This carries with it the need for action undertaken with a concern for the expectations and activities of others. A bricklayer running a 'course' is co-operating directly with others and with his assistant or 'mate,' who keeps him supplied with bricks and mortar. The whole situation favours an informal arrangement in which the group works together with liberty of action and freedom to talk, governed not so

much by a rigid supervision as by a group loyalty, and a loyalty to the customary attitudes of the craft which has come down with slow modification since the earliest times. The unforgivable sin in a building gang is to diverge from the traditional procedures, and men who cannot get on with the others are disciplined by the group, by their overseers or by their union, depending on which tradition they have violated; in any case they are eliminated.

The group is not turning out an endless stream of meaningless parts; from start to finish, they are building some one structure. The skill required is great; it is not easy to lay a good course. And the building rises as a visible monument to their labours. The relations between the men and their overseers are rough and ready, but human; there is little of the careful correctness of tone which often marks the conversation between a factory executive and his employee. Speech between a bricklayer and his overseer is not always printable; the actions taken are too often arbitrary, if not positively unjust, but at least there are not many reservations and the relation is a real one. Builders' gangs are marked by the strength of the friendships and of the antagonisms developed, by acts of generosity and of injustice, and by the fundamental loyalty which comes from working together under improvised conditions and enduring together the same discomforts, for a purpose which is taking visible shape under their very eyes.

There is no need to tell bricklayers that they are building a house, or to enlighten them as to the use to which houses may be put. The purpose of the builders' labours as well as his achievements is sufficiently obvious. Thus, so long as a job lasts, the builder's life has great merits. Human relations are sufficiently unrestricted and there is opportunity for the display of some initiative by all. Discipline is not typically rigid, and conditions are subject to a continuous variation, not as a result of some policy dictated from above, but as a direct and obvious outcome of the progress of the work. Wages during a spell of employment are good as compared with other trades requiring equal skill.

The physical conditions under which the work is performed are

not always easy, owing to the vagaries of climate. But provided moderate hardships are thought to be outside the control of men, and so to imply no indifference on the part of the management, they may well serve to heighten rather than depress a morale that is already fairly adequate.

This curious phenomenon is well known to anyone who has seen active service in the army or the navy. The effect of facing moderate hardships in a well-integrated group is to enhance their self-respect and their mutual reliance and to give a sense of achievement. This effect is greatly heightened if the group leaders are sincerely and visibly endeavouring to mitigate these hardships as they arise.

On the other hand, the human ties are broken at the end of each job for the average bricklayer, and simultaneously he is plunged into a period of economic insecurity if not of actual hardship; the bricklayer, unlike many other employees, has achieved little or no claim to the consideration of any one particular firm.

For all these reasons, it is natural to find that bricklayers have particularly strong unions and that these unions, from the standpoint of the employer, are apt to be unreasonable in their demands and to restrict the free expansion of the industry. This is particularly true of conditions in England, where unions are typically stronger than in the United States. The union is the bricklayer's answer to the insecurity of his future. The trade agreement with the Bricklayers' Union in America is designed very largely to minimize the immediate effects of this insecurity without much consideration to the long-time influence on the industry, of the restrictions imposed.

This is only an extreme instance of a type of insecurity which is very prevalent in most manual occupations in a greater or lesser degree. This constant liability, amounting in some trades to a practical certainty of violent fluctuations in the incomes of workers' families, is one of the important factors in social disintegration. It prevents these families from taking root in any given community, and also focuses attention upon short-time

considerations to the exclusion of wider trends. It would be absurd to expect a bricklayer to consider the future of the building industry in drawing up an agreement, when his most pressing problem is the practical certainty of unemployment every few weeks or months. A contented, integrated society must depend on the elimination, or at least the substantial reduction of this type of insecurity, just as it must also provide a worth-while life for its members during working hours.

The immediate answer to any suggestion of providing some degree of continuity to a bricklayer's wage (to continue with one special case) is that such a proceeding would ruin any contractor's firm that attempted it. This is quite true under the present arrangement, but for all that, the burden *is* falling on someone. For the plain fact is that bricklayers and their families do not die of starvation or sleep in the open between jobs. In some form or other, the families of wage-earners out of work are being supported by society at large.

To some extent, the wages of bricklayers have been adjusted to an expectation of slack periods. But this amounts to little more than a form of gambling, for no one knows what proportion of work to unemployment a given bricklayer will experience, or in what order the two conditions will be intermingled. It is almost impossible to organize a satisfactory family and community life on such a basis. Out-of-work benefits help to even out the ups and downs of intermittent unemployment, but this is not a socially desirable solution although it is better than nothing.

The fundamental problem is the stabilization and organization of industry as a part of an integrated society. Any attempt to stabilize or to organize industry in a largely disintegrated society is bound to be disappointing; neither half of the problem can be isolated from the other half. The solution of the bricklayers' problem lies in the organization of society as a whole. We will consider this problem in its relation to industry, and return to the bricklayers at the end of the chapter.

In any country, there always are certain institutions or or-

ganizations which are of predominant importance to a large number of people, and around which the many incidental activities of the communities have tended to cluster. For instance, two generations ago, both in America and in England, the churches were such institutions and to a lesser extent this is true today. Each church, as its primary purpose, was organized for the social exercise of religious worship, but other supporting activities were run by this parent organization. Social meetings of one sort or another, the care of the poor, the education of children, the care of social outcasts; all these are examples of activities which have been supported by church organizations. Earlier still, monasteries kept alive the tradition of learning and performed some of the functions of modern universities. The individual churches are related to each other in a larger organization; for example, the Catholic and the Protestant Episcopal organizations, to mention only two.

In Europe, the feudal system organized local communities around the large houses and estates, and formed a focus for many of the activities that were typical of the countryside. Universities perform much the same function today for their neighbourhoods. The number of people working for a large university today amounts to many hundreds, sometimes a few thousand, and with their families is the equivalent of a moderate-sized town. These families are more or less related through the university, and the workers amongst them reorganized into colleges, graduate schools, departments, and so forth. This represents a working organization, but the other social activities of the community tend to follow in the same shape. Families whose workers are colleagues in one department are apt to know one another, and each member of a university has some concern for the fortunes and actions of the others.

In America, many of the private day-schools quite deliberately attempt to act as a centre for the parents of their students. Parents' meetings and committees are arranged in quantities, and parents help to organize school activities of one sort or another.

To judge from the number of jokes and humorous articles on the subject, one may suppose the school organizations are more anxious to act as community leaders than the community is to receive them in that capacity; but the idea in the minds of those responsible for the movement is an interesting one. It springs from two sets of observed facts.

In the first place, it has been observed that the children find it increasingly difficult to adjust themselves to the daily alternations of school routine and home conditions. Then further observation convinced a number of teachers that the parents were expecting the schools to teach the children a co-ordination of purpose and action which was in direct contradiction to the life of the home as the child experienced it. This is partly an after-effect of the World War, no doubt, but the lack of accepted customs, codes of behaviour, and social sentiments generally is also typical of present-day trends in industrial communities.

Some schools, especially those of the more progressive sort, are attempting to remedy this situation by making the school a centre for both students and their parents; the hope being that this will assist the latter to obtain more stable social connections, and also bring the home and school atmospheres into a somewhat closer alignment. Whether the schools can arouse a sufficient community sentiment and interest to achieve such a leadership remains to be seen. There are obvious difficulties. The parents have no immediate interest in the school except in so far as it affects their children's lives, and this interest is fairly temporary, although some schools do seem to have had a limited success in this way. It is possible that the attempt may arouse a widespread interest in education as related to other interests in after life. At the end of the 19th century, elementary school teachers in England became one of the foci for arousing interest in the growing democratization of government. These men and women became a centre for the propagation of sentiments supporting an orderly evolution of social legislation. Such sentiments are far more widely accepted in England today than was the case thirty

or forty years ago, and the elementary school teacher is in part responsible for this change.

Almost any institution which is important to the lives of people in a neighbourhood is likely to act as a centre and a steadying force for some miscellaneous social activities, over and above those for which it was primarily intended. For instance, when the United States still possessed a frontier, the up-country store tended to perform such a function. Such stores were often placed at a crossroads and functioned as a centre for the dissemination of news and for the discussion of matters of common interest. An up-country store was a social centre of the locality, and the store-keeper might well be a natural leader. There is nothing incongruous in the fact that President Lincoln as a young man kept such a store, or that in that capacity he became a notable character in the district.

In the earlier days of railways in the United States, the up-country station also showed signs of being such a centre. To this day in some small towns in Vermont there live people who can remember when it was customary for the town to turn out in a body to meet the single train at the station. However, it seems that station masters are not typically the stuff from which leaders are made, or perhaps stations do not provide a pleasant informal atmosphere. Certainly, railway stations have never proved a great success as organizing institutions for social living. In parts of Africa to this day the stores, and to a lesser extent the railway stations provide the best opportunities for social intercourse amongst the European settlers.

Just as the co-ordination of social living has always tended to crystallize around certain institutions important in the lives of the people, so have certain occupations been looked up to as likely to produce leaders for the community. To a large extent, these occupations are related to the institutions, but not altogether. For instance, as co-ordinators of social living, lawyers and doctors have always been more important than their respective organizations. In England, the elementary school teacher has

been more important than his school; whilst in the United States today we may hazard the opinion that it is the progressive school organizations (including their buildings and other facilities) which are usually more important to society than the personalities of the teachers themselves. Undoubtedly, in an up-country railway station it was the station and the train, not the station master or his staff, that predominated.

Where both the organization and the occupation are simultaneously looked up to by the general run of men and women as the natural instruments of social integration, there is the possibility of great achievement. An obvious instance has been the church and its priest or minister. For many generations, first in Europe and then in America, religious organizations and their leaders have done more to integrate and maintain a worth-while social living than any other single type of institution or of person.

At the present time, there is an obvious lack of institutions and personalities who are both able and willing to vitalize the life of their communities by supplying them with the necessary organization and direction. The result is a growing restlessness and a lack of opportunity for the average person; he (or she) is no longer bound to the community by ties of loyalty and interest based on an active co-operation with others in local enterprises of one sort or another. If this is more true of America than of England, and more true of England than of France, it is because these countries have reached different stages of industrialization. Every advance of industry has so far been accompanied by a corresponding impoverishment in social living.

The rise of organized industry has reduced the importance of other institutions as integrators of society, without shouldering these functions itself. And the resulting social instability is so great as to threaten the industries themselves. As regards techniques, no widespread institution has ever been so well run as an average industrial firm. Its techniques for manufacture are unrivalled in any other generation, its techniques for selling its product are equally remarkable; the same thing applies to ad-

vertising, consumer-demand research, personnel organizations, account keeping, and everything else. The final result is that the life of a firm, from birth to bankruptcy, is becoming more and more hazardous.

Before the rise of modern industry, a competent workman (e.g., a carpenter, blacksmith, hostler, etc.) could usually expect continuous employment until he died; no sensible workman expects that now. It is no answer to point out that his wages are better than those of his ancestors; of course they are, but it is not the workman's rate of pay that produces trade depressions. The fact is that an industrial organization can be no more stable than the society of which it is a part, and the only way to stabilize a society is to organize it and to lead it. No group, large or small, can endure in which the members do not possess reasonably stable relations to each other, and in which their common activities are not adequately directed. The distinction between a democratic society and one ruled by a dictator is not that the former is unorganized and unled, but that each member has his appropriate share in the evolution of the organization and of its purpose, and that the type of leadership as well as the actual leaders are also matters for mutual consent. This consent is usually not exercised by formal vote, but by the formation of common expectation and its informal expression, and social expectation and its expression can be only adequate in so far as the society is already integrated.

There is ground today for supposing that industrial nations expect their vitalizing organizations as well as their leaders to come from industry; at any rate, these organizations and men are accepted whenever they show signs of fulfilling the rôle. A colleague of mine not long ago, speaking to a group of business executives, remarked that the really interesting human relationships he had experienced in a varied life of industry and affairs, had arisen from within his family circle and from his business connection. He declared that as compared with these he had experienced no equally important relations as a result of his

school or university (student) career, or through any other mode of social contact. This statement coincides with the opinion of most men that I have questioned on the point, and it goes to the very root of the matter.

The family as a focus for social activity and sentiment has been recognized for centuries, but the new element is the modern business firm as the next most important institution in the lives of millions of men and women. The curious thing is that, in spite of the prestige they have obtained, business executives have been singularly shy of identifying their firms with the life of their communities, or of personally taking a leading part in the organizations of the latter. The reason for this reluctance was traced in previous chapters to a too exclusive concentration on the technological aspects of industry, and a failure to recognize industry as being a part of social living. The result is that industry as a whole, and single firms in particular, are operating with a very minimum of general support and loyalty.

There are several ways in which a firm requires the loyalty of society if it is to possess a reasonable security. The public are invited to invest money in a firm. Comparatively few firms are built up on their own surplus profits. To the investing public, a firm is little more than a name with a certain expectation of successful operation attached to it. Actually, most investors do not even know the name, much less its reputation; they are advised in these matters by someone else. In any case, the investment leads to no particular interest in the firm on the part of the investor, beyond a determination to sell out in a hurry if the prospects seem disappointing. To insure against a serious mischance, it is usual for careful investors to spread their investments over as many different firms and as many different types of industries as possible. As an example chosen at random, one investor with a very moderate income has an interest in more than thirty firms of various sorts scattered over five countries in three different continents. This investor has not the slightest knowledge of any of these enterprises; they merely represent so many possible

vexations, for any one of them may have a run of ill fortune and so fail to pay dividends. Under present circumstances, this is a perfectly reasonable procedure, but it is not the action of a public who have a loyalty to the business organizations of their community.

A generation ago, bankers frequently invested on the basis of what is known as personal security, that is, on the known integrity and ability of an individual, or a group of individuals, who wished to promote or develop some enterprise. Nowadays, more attention is given to the tangible assets against which the investment will be secured. Investment against personal security is only practicable on any large scale in a stable community where the individuals involved do possess personal reputations, and where they are controlled by social custom and a traditional system of social ethics. Bankers who have experienced both types of investment state that, given the necessary social conditions, personal security is a far more reliable guarantee of ultimate solvency than tangible assets. The former does at least involve someone's personal honour, but a depreciated tangible asset has no honour to be involved; there is nothing so futile as a commodity nobody wants, whether it be a factory building or last year's models of women's dresses.

If communities and their local firms were bound together in the joint enterprise of running their neighbourhood, then the former would have a real interest in the fortunes of these firms. The result would be a greater tendency towards local investment, coupled with some knowledge of the firm's fortunes and a less precarious financial support. If the firm in question be a retail establishment, its customers will usually be members of the local community. There is very little loyalty in the relations between a typical shop and its customers; these relations have been whittled down to the bare acts of choosing a required commodity and paying for it. The result is great insecurity of custom for the shop and an enhanced retail price to the customers, to cover the consequent risks of retail business. Again, the firm is run by men and

women, and the lack of adequate collaboration between typical managements and their employees has already been discussed in earlier chapters.

Thus we find that on the whole business organizations are of predominant importance to a large portion of any industrial community. But the connection between the general life of the community and the highly organized activities of industrial enterprises has become so slight that neither is concerned to support and assist the other. If the local fire brigade or the local church is inadequately run, the result is apt to be some form of town meeting, or its more informal equivalent. The community feels the deficiency to be its immediate concern. But if the local factory or department store is going downhill, in spite of the obvious loss to the community, the loyalty and concern of the community is not involved. As individuals, members of the community may deplore the state of affairs, but as a formed community, the functioning of a business enterprise is no concern of theirs. In fact, no other action is generally possible. The community is not organized around its most important institutions and so remains largely disorganized in action and in sentiment.

These institutions have in the past habitually underestimated their dependence upon the support of organized society, and have actually repelled interest as being an impertinent interference with a matter of private concern to the owners (whoever they may be in a modern company). The solution is for the management of a business enterprise (whether this be a single owner or salaried executives) to recognize that it exists only as a working part of a formed society, and as the servant of that society. Stability and achievement would be increased by becoming an object of local pride and concern. Managers of enterprises should take their place as leaders of their communities; then their organizations would be the centres of local activity and so become indispensable institutions whose continued existence would be a matter of general interest. This may sound impractical; but business organizations are the only widespread type of institu-

tion that has ever attempted to achieve stability as divorced from the main current of social living, and the result is exactly what might be expected in the circumstances.

As a leader, the business executive has obvious qualifications. In general, executives are responsible men, selected largely for their ability to undertake and carry through complex practical affairs; they are well trained in the techniques of organization. In the running of community activities, executives have under their control firms accustomed to the use of skilled techniques, and with the necessary local prestige to undertake a job and see it through. As a matter of fact, the present tendency is towards a greater participation of firms in the activities of their communities. This participation often starts as a service designed for the exclusive use of a firm's employees, and it spreads out through the employees' families and relatives into the local community. In this way, many firms have taken an active part in organizing the athletic facilities of their districts. The same thing applies in other cases to medical facilities, housing and educational schemes, the organization of communal help in times of depression, co-operative stores or their equivalent, local transport, theatre and other recreational facilities, such as dances and bridge clubs, and so forth; the list of community activities exceptionally organized around a firm, or with its active help, is nearly endless. Many small industrial towns, in particular, are organized around the firm or industry upon which their economic welfare mainly depends; but the same thing can be found in districts of the largest cities, where a firm sometimes integrates the lives of the families and relatives of those within its employment.

In other ways, industry is showing a greater realization of its social responsibilities. For instance, during the late industrial depression, innumerable firms have spread their diminished activity over their labour force in ways calculated to minimize the consequent personal hardship and social disruption. However, speaking broadly, industry still avoids assuming its full social responsibilities, and efforts in a contrary direction are by

no means uniformly successful. We all know of firms accused of paternalism, antagonizing their employees by well-meant interference in their personal affairs. The distinction between paternalism and a full participation in social living is profound, but it is not easy to define; the difference lies not so much in the actual activities undertaken as in the attitude with which they are approached. Paternalism is in fact the opposite of social participation, for it actually prevents a collaboration between the individuals involved.

For instance, take the case of an employer who provides houses for his employees, has them regularly inspected, and dismisses those employees who do not maintain a tidy and attractive home. The logic at the back of such an employer's mind would run something like this: Private property is the absolute possession of the man who owns it to do what he likes with. This factory and these houses are my private property (assuming a one-man ownership for simplicity), therefore I have an absolute right to do what I like with them. I run the factory for my own gain; it was developed by my initiative or that of my forefathers. I build houses to attract a labour force; this force should behave as I dictate; and I do not choose to have my houses neglected.

No one denies the right of a landlord to have his property respected by his tenants; but most of us live in leased houses and this is true of almost all manual workers in industry. And landlords do in fact manage to protect their property without indulging in impertinent interference with the lives of their tenants. The above attitude of an imaginary, but not unreal employer is devoid of any social wisdom or understanding, and his actions would certainly be resented as paternalism.

The following is an alternative logic which would be likely to lead to social integration and satisfaction: The legal right to private property rests on the belief that under this system such property will be used on the whole for the benefit of mankind. The legal right to private property has the great merit of being workable and of being the understood system, but its moral sanc-

tion rests on the social benefits it promotes. I own this property and these houses, they were developed by my initiative as supported by the society (nation, state, community) in which I live. My concern is to maintain this social system, and in particular to maintain the activity of my factory and the condition of my houses. This is a social purpose in which this community (employees, etc.) is equally involved. I, as a member, will assist this group of people to organize our community life, and among other things to promote the activity of the factory and the care of the property; all must have their appropriate opportunities for self-expression and enterprise, but as the man in the leading position, I will assume the major responsibility.

This attitude is at the basis of intelligent democracy; activities promoted from this standpoint are welcomed, not resented; nor does the appropriate man find any difficulty in maintaining his position as the accepted leader. Men placed in positions of natural dominance, and particularly business executives, are apt to underestimate the security of their position as leaders, *provided they exercise this function*. There is an unwarranted fear that a democratic collaboration may result in a loss of their proper responsibilities. This is largely the fear of men who fail to take the leadership when the situation demands it; for in that case they tend to accumulate ill will and may even be faced with organizations developed in antagonism to their leadership. Some of the activities of trade unions and even of governments come under this heading. On the other hand, executives who genuinely do lead their communities have tremendous advantages, and these would become greater as a more general social sense amongst the people led to a settled expectation of leadership from that quarter.

Anyone who has taken a part in organizing one or two of the various activities in his neighbourhood knows the tremendous advantage of a leader who is in possession of an organization of some sort. To begin with very simple matters, letters have to be written and received and copies and originals filed; accounts have

to be kept, as well as minutes of meetings. All these things are very elementary, but a surprising number of people fail to perform them either through a natural disinclination or from inexperience. Many clubs and societies have been complete failures because their officers were irresponsible with regard to such details; and any group of people organizing themselves for some purpose are only too anxious for their business men to take the responsible posts. These men will not only keep out of elementary muddles, but they have the use of secretaries and stenographers, and they know the ropes. Consequently, business executives can run organizations at a far smaller expense of time than most people; and they are marked as men who are likely to be honest in such matters.

The next need of a community organization is often for semi-skilled advice with regard to legal matters, business customs and purchasing possibilities. Here again, the executive can draw upon the accumulated experience of his firm, without involving the latter in any particular expense. If the organization has the need to approach any public body, the business executive is again in request as its representative.

Then, many community organizations require facilities of some sort, such as playgrounds, committee rooms, meeting halls and such like. The economical way of obtaining these is to be in touch with some institution which has such facilities and is willing to lend them at off hours, perhaps charging a nominal fee for the small out-of-pocket expenses.

The final use of a business executive in community life arises from his training. He has acquired the habit of initiating group action and of seeing it through. He has ideas and a shrewd sense of the practical possibilities. One of the greatest difficulties of community organization is that most people are apt not to have practical ideas for group activities, or have no urge or possibility of launching them. The community sits back and does nothing and is consequently discontented and bored. A happy neighbourhood is one whose leaders supply the necessary impetus

and system to assist the remainder in doing what they would have liked to do, if only they had thought of it. This statement applies equally well to the organization of a football club or to unemployment relief.

Leadership of this sort stands in no danger of being resented; it is enthusiastically welcomed, and as business leaders develop an adequate social responsibility both as regards the expenditure of their own time, and as regards the proper functions of their firms, to that extent will the latter obtain the support and loyalty of their own neighbourhood. Equally, industry at large would have a national support which it does not now possess, and would be subject to far less unenlightened interference from other types of organizations.

Let us now get back to the bricklayers who were taken as an example of gross insecurity of occupation. How would social leadership by industry help to solve this evil? A significant part of this particular form of insecurity arises from the fact that, in any large centre, a number of building firms are hiring and discharging bricklayers more or less simultaneously and independently, and at frequent intervals. There results a haphazard circulation of bricklayers (amongst other builders' crafts) which no doubt evens out statistically, but the fortunes of any one man are unpredictable and fluctuating.

This is essentially a problem for collaboration between the building firms of the district, the local trade unions, the employment agencies, the local tramway and other transport companies, and so forth. It is impossible to lay down a precise plan for such co-operation, and under present conditions it is perhaps impracticable. In any case, the details would be different in each district. But it is easy to see that such co-operation would be far more feasible in a district effectively led by its industrial organizations. The habit of co-operative action would be greater, the interest of the neighbourhood in the problem would be more vivid, there would be less mutual suspicion between the various organizations involved, and finally social pressure would insist on

a solution. Everything is impossible in an uncoordinated and apathetic community. Not so long ago, it was 'impossible' to deal with labour organizations, to give accident compensation, or even to avoid the extensive use of child labour. This type of impossibility is a direct result of an asocial conception of industrial activity. In the case of builders' employees, the impossibility lies in the extreme difficulty of a collaboration which is not socially demanded. There is no fundamental impossibility in organizing a rational circulation of a given number of manual workers round a given number of jobs.

Another part of employee insecurity arises from seasonal variations in trade activity. These variations are obviously predictable and can be controlled by suitable organization; the prerequisites are stable firms and a coherent public opinion in the matter. As a matter of fact, some stable firms today have successfully met this difficulty; there is nothing more seasonal than amateur photography, which is a summer pursuit, but the Eastman Kodak Company, to mention only one example, have gone a long way towards organizing their production on a steady basis all the year round. Each industry has its own particular difficulties in this respect, but the plain fact is that there has been little effective opinion demanding that this problem shall be seriously considered. Again, everything is impossible in an apathetic society.

Insecurity arising from trade cycles is in another category, for there is no reason to suppose that anyone knows how to control these. But even here, a society integrated around its business institutions is likely to be in a superior position to attack this problem. During the 1929-1935 depression, one of the most instructive features of the various attempts at remedial action has been to notice the powerlessness of governments, or of trade associations, to persuade under-organized industries to adopt uniform measures, even when these were believed by all to be in the general interest. 'Chisellers' are the product of societies which have failed to develop an adequate control through public opinion.

Before closing this chapter, one last question should be raised and answered. Assuming that individual firms should function as social centres, as a part of their wider economic purpose, who is to pay for the incidental expenses? The firm is not a fountain of wealth, and in some shape or other all firms' expenses are passed on to the society at large. By what route should the expenses incidental to a wider activity be spread over the community served? For most of the activities are not productive in the narrow sense.

The advantages that the firm has to offer its society are as follows: initiative; vigorous personalities; a guarantee of competent management; the economies of an organization in being; larger institutional contacts; and the backing of a known reputation. These are assets, not expenses; and the obvious solution of the problem is that the persons benefiting should pay their way, as they do now. For instance, anyone joining a tennis club pays his fees and would continue to pay them if the club made use of a firm's facilities, but it is a fair presumption that the fees would be lower. Other services, such as a medical service for unemployed, might be paid out of the local taxes; but the service would not cost more if it were run in connection with responsible firms. The point is that firms should recognize their dominant position in the social economy, not that they should distribute largesse from some invisible source.

CHAPTER XIII

THE RISE OF FASHION AND THE CONTROL OF CONSUMER DEMAND

ONE of the most difficult tasks is the attempt to characterize one's own epoch and society. The difficulty lies in observing what is common to every event in experience. We are attracted by the unusual and fail to notice the ordinary things of life. Yet it is by the complexion of these ordinary things that posterity will characterize our present day. One way by which we may obtain some insight into our common attitudes is to take a rather obvious present-day characteristic, such as the 'styling' of commodities, and to trace its evolution from an earlier date, with especial attention to the implied changes in popular sentiment and outlook.

The word 'style' is applied to many things besides manufactured commodities; for instance, it is used in connection with modes of performance, as when we speak of a man's style in tennis. But here attention will be confined to style as it refers to the appearance of manufactured commodities such as coffee-pots or clothes. Most coffee-pots are designed with handles, spouts and lids, but these characteristics are not what is usually meant when speaking of the style of a coffee-pot. Handles and spouts are a part of its functional character, whilst the style of the pot is that arrangement of shape, surface and colour which is not primarily dictated by functional need but is none the less a part of the pot's character. Every pot must possess some shape, surface and colour of course, but, within limits, it makes little difference to its function whether these be arranged in one way or another. Again, as a protection against weather and through the pressure of social sentiments, we all wear clothes. But the history of clothes makes it evident that within wide limits the precise shape, surface and colour are not functionally important. Hence, we do not speak of the style of a man's appearance, meaning that

he is covered; but we do speak of the style of his clothes, referring to those characteristics, not involving function, in which the individual or at least the manufacturer is expected to exercise his own judgment. So, in the main, the style of a commodity is determined by those characteristics which are not fixed either by functional necessities or by widespread ethical sentiment.

But the word 'style' has come to mean something more than this. It also implies an appearance which is liable to frequent change, again at the dictate of inclination not governed by considerations of efficiency or ethical sentiments. At the present time, almost every detail of design which is not fixed by function is subject to deliberate and frequent changes, not necessarily because the new style is better, either as art or in function, but because it is different from the old. In this respect, we differ profoundly from societies dating before the industrial revolution.

So late as 1773, Johnson's Dictionary defines¹ 'style' as:

- i. Manner of writing with regard to language.
- ii. Manner of speaking appropriate to particular characters.
- iii. Mode of painting.
- iv. It is likewise applied to musik (*sic*).
- v. Title; appellation.
- vi. Course of writing. Unusual.

and the verb 'to style' is defined by Johnson as:

- i. To call; to term; to name.

Under each of these headings, Johnson gives several examples of the use of the word from the writings of standard authors, and there is no reasonable doubt as to the meaning intended. Style, in the 18th century, referred to certain characteristics of the use of language and to certain of the traditionally fine arts. Besides that, it was the way a thing was called or named. In every case, the characteristics were irrelevant to immediate function, but there is no suggestion of novelty as something to be striven for. Nor is there any suggestion of frequent change. Finally, it was rarely applied to the products of technological processes outside

¹ The last edition corrected by Samuel Johnson himself.

of the fine arts. The fact is that most useful articles were made according to traditional patterns; and though the patterns changed with time, this change was due to the accidental evolution of technology or the chance of a new idea rather than to any deliberate attempt at novelty. This does not mean that commodities were less beautiful then than now. In fact, the artistic value of antiques is a commonplace. But the maker of a commodity was attempting to do a good job in the customary manner, rather than deliberately trying to change that manner. Both he and his customers were insensibly controlled by the customary attitudes of a closely integrated and relatively stationary society.

One outcome of this social control was the constancy, and thus the predictability of customer demand. Every craftsman knew by his own social conditioning what his customer would want. He knew this so completely that he would not have expressed it in that way. A hatter would not have said, "My customers are demanding three-cornered hats," but rather, "The *proper* hat to wear is the three-cornered one." This latter statement contains a direct reference to social sanction as guiding the hatter in his work. And so before the rise of modern industry, the manner or character of a commodity was an expression of a formed social expectation. Consequently, the character of things was not subject to changes of fashion in the modern sense; in fact, for the most part, the phenomenon of fashions was unknown. Again the word is an old one, but for Johnson it meant the socially desirable norm to which people tried to approximate. There was no novelty or change involved in the idea. The style of a commodity that had the chief social sanction — which was felt to be the most fitting — was the fashionable style. Silk dresses were handed down from generation to generation and remained in the mode. This is the very opposite of the modern conception of a fashion — an arbitrarily selected style, subject to change at will.¹

¹ Undoubtedly, a small class have always indulged in fashions in the modern sense, but the number of people involved were few, and the range of articles subject to fashion in this sense was narrow.

The range of commodities subject to fashion in style, and the rate of change of fashion, have both been increasing steadily since the 18th century. At the present time, everything from the shape of spectacle lenses to bathroom fittings is subject to fashion. The range and rate of fashions is noticeably greater than it was thirty years ago. Simultaneously, it is more and more evident that a fashion is not set by social custom, but by the arbitrary decision of quite a few people, often themselves in no sense social leaders. No one supposes that a given fashion has any particular virtue about it — it is just the current convention. For instance, women's skirts may be short this year, but perhaps we are told that they will be longer next year. The change is anticipated as a matter of course. Before the World War these matters were decided by a few Paris dressmakers. I do not know who is responsible for the style of women's dresses today.

A year or two ago, I bought a moderately priced man's watch, and a year after that I tried to buy a duplicate for someone else. I was shown another watch made by the same firm at the same price, with the same movement and the same sized case. In all essentials, the watch was a duplicate of mine but the minor details of the case were differently styled. I was told that my watch was out of fashion and no longer procurable. There was no pretence that either watch was superior to the other, but the fashion had changed! Who had changed it? As a matter of fact, there was no fashion, in the sense of a general expectation, to change. If a group of men were shown both watches, not one in a hundred could say which style was in fashion and which was demoded. The manufacturer evidently thought that the later style would catch the eye and result in better sales; or he may have merely changed something for fear of being thought 'unprogressive.' The case was the most conspicuous part of the watch, and so he changed that. This is an extreme example of a change in style introduced, not in response to an evolution of social sentiment, but to increase sales. In this case, the manufacturer's action did not even induce a fashion; even if every man in the

district is wearing these watches none of them knows it. For some reason or other, men's pocket watches are not very subject to fashion, although their style changes. However, for the most part the style of commodities is changed by manufacturers without much reference to social expectation, for there is little expectation to refer to, but the result is usually a pronounced though very temporary fashion. That is to say, we tend to follow the 'Joneses,' and we are all 'Jones' to somebody.

The distinction between approximating to the social sense of fitness and following the 'Joneses' may seem at first sight to be hairsplitting, but in fact the difference is profound and is of the greatest importance to industry. The former attitude makes directly for stability and predictability of demand, whilst the latter attitude has the precisely opposite tendency. Consider the difference first from the point of view of society. In the case where the acceptable character of a commodity is determined by social sentiment, it follows that there must be such a thing as a customary sentiment on the subject. Customary sentiments are slow to change, and they commonly involve an attitude consistent with the belief that the custom is not merely the current convention, but possesses some absolute fitness. Thus the colour of men's ties is subject to fashion, and it changes frequently. But men in certain positions are obliged to wear ties of some sort in virtue of social sentiment. Consequently, it would be anti-social to attend a tea-party without a tie; and no change in this respect has taken place within living memory. This is an instance of the character of dress being controlled by social sentiment. Since this sentiment requires men to buy ties, it is also an instance of the social control of personal expenditure. The colour of ties is subject to fashion, but the wearing of ties is still controlled by social sentiment.

The character of commodities and personal expenditure are both highly controlled in integrated societies, and both phenomena are consequently relatively stable. Genuine advances in technology take place in such a society, as we saw in an earlier

chapter, but swings of fashion for no obvious cause are rare and take place relatively slowly. On the other hand, in an unorganized society relatively little either in the character of commodities or in personal expenditure is controlled by social sentiment; because organized sentiment, or in other words public opinion, is weak or non-existent.

This explains the absence of stability in style and expenditure; but something more is required to account for the strength of modern short-lived fashions. This arises from the social character of mankind. Human beings do not associate because of some economic advantage, as is often stated, but because it is their natural inclination to do so. It was found that in the Relay Test Room the girls, engaged in individual tasks, associated in their work by varying their speeds together. There was no economic motive for this behaviour, and the girls themselves were not explicitly aware of their social activities. Doing things together and sharing sentiments is a fundamental human need.

In an unorganized society there is a lack of adequate social intercourse; there are too few things to do together and too few shared sentiments for human satisfaction. Consequently, without being explicitly aware of the fact, in an unorganized society, people manufacture occasions for similar activities and for the sharing of common sentiments. They want to do things together and in the same way; it does not much matter what they do, provided it be done together. Consequently, if Jones wears a green tie we all wear green ties. Neither Jones nor we care what the colour is, provided it be the same for all, and so tomorrow we become attracted by tartan ties and we all wear those. There is no stability in the choice of a style, no sentiment of fitness is involved, but we all cling together. Our next choice is quite unpredictable, for it follows no modification in established sentiment; a clever sales program may change a fashion almost over night. This accounts for the well-known paradox that striking individualities are most common in highly integrated societies and not, as might have been expected, in times of social disintegration.

In the latter periods, everyone is copying everyone else for fear of being lonely, for fear of falling out of social intercourse. No one fears this in a highly integrated society, and consequently everyone goes his own way subject to the control of custom and sentiments as to what is right and fitting. Style in women's clothes changes much faster today than it did a century ago, but in any given party today the women's clothes are far more similar to each other than was the case previously. This statement holds even when comparing the dresses of today with those of the last generation.

Simultaneously with the rise of temporary fashions in manufactured commodities, has come the decay of individual variation; for both are symptoms of social disorganization. The sign of an organized society is a stability of the mode, coupled with high individual variation in matters not involving public sentiments of right and wrong, or of fitness and unfitness. In such a society there is no need to hang together for the mere sake of uniformity; no one is copying the Joneses, each man and woman is consulting his own social sense. Today, in countries where society has frankly collapsed, the mildest criticism of the run of affairs results in imprisonment at the very least. The mode of living is changing fast in such countries, but there is little room for individual variation.

From the standpoint of industry and business in general, the present tendency is extremely serious. Consumer demand at any given moment is very homogeneous but it is subject to rapid changes which are difficult to predict, just because they are not based on stable public opinion. However, in some way the manufacturer, not to mention the distributor, must predict them or fail in business. It is no longer possible for the manufacturer to be guided by an obvious social sense, and so we find large sums being spent in consumer-demand research. This is of some assistance, but it cannot predict a swing of fashion which will depend largely on a minor change in the future; at best, research can give early information of a demand that is actually

changing, and that is not soon enough. Consequently, we find that manufacturers have taken matters into their own hands. Instead of waiting for the public to change its fashion, and then trying to find out what the new demand may be, manufacturers attempt to dictate the time and nature of the new fashion themselves. They do this by means of advertisement campaigns.

It is instructive to compare the advertisements of a past generation with those of our own times. Advertising in the past was not mainly based on the idea that consumers wanted a novelty for its own sake, but on the contrary, assumed that the public knew what it wanted, and wished for the best of its kind and price. Consequently, the skill and experience of the firm, as well as the substantial merits of the product, were stated in straightforward, if optimistic terms. New products were mainly the outcome of a genuine technological advance, or of a new idea; and the advantages of the resulting product were clearly and logically stated. There was relatively little attempt at regimentation of opinion and sentiment, for that was already achieved by social organization. The concern of the manufacturer was not so much to discover the demand, as to meet the known demand better than his competitor. Modern advertising is based on the opposite assumption — that consumers do not know exactly what they want, but are subject to frequent and violent changes of fashion, and that they wish above all things to be like their socially fortunate neighbours.

When a manufacturer wishes to sell some commodity, for instance a fountain pen, his advertising manager or agent will build up the advertisement somewhat as follows:¹ A picture will show a young woman in full evening dress sitting at a table, in an enormous and richly furnished room, with a fountain pen in her hand. Here we have the very type of a successful hostess; you can see that by her triumphant expression. This young woman

¹ Fountain pens were chosen precisely because I can remember no advertisement for this commodity which corresponds closely to my description. Actual instances will occur to everyone from his own observation.

is as beautiful as the artist and reproduction process can make her; leaning over her in an elegant and tender attitude is the male equivalent, with meticulously dressed hair, and also in full evening dress. She is saying to him: "Darling, I used to dread every invitation, for it meant an extra letter to write, but since you have given me this X Y Z fountain pen every letter has become a pleasure; and though they are inexpensive each X Y Z pen is fully guaranteed."

Evidently this advertisement was not designed as being the most straightforward account of the commodity in question. To what motives and sentiments is such an advertisement appealing? In the first place, we are given some definite information. 1. There is a make of pen called the X Y Z. 2. It is not particularly expensive. 3. It is fully guaranteed. The statement that the pen makes letter-writing a pleasure hardly comes under the heading of fact, and no other information is given. However, a very definite picture is built up, which may rest in the mind and become connected with the X Y Z pen. Thus we find a socially prominent woman using the pen; in fact, dozens of socially prominent women are using these pens, for she is posted up all over the town. So a conviction begins to steal over us that the Joneses are all using X Y Z pens. This is an appeal to the tendency of a relatively unorganized society to herd together. It is known that if some idea, an idea of the X Y Z pens for instance, is habitually entertained at the same time as some sentiment, then the sentiment and the idea become attached to each other in our thinking. This occurs even if they had no obvious connection originally. Hence, the socially prominent woman is both young and beautiful, and she has some sentimental relation to the handsome and socially prominent young man. The young woman is smiling, and the setting is one of luxury and is intended to show taste. The whole advertisement is designed to fasten to the X Y Z pen, sentiments appropriate to uniformity of behaviour, with prominent persons, beautiful women, sentimental situations and luxurious surroundings.

It is easy to ridicule advertisements of this sort, but they do tend to make future consumer demand more ascertainable by regimenting sentiments in favour of some particular commodity. Few or no reliable facts about the commodity are usually given; the statements purporting to give facts are sometimes so grotesque that they cannot seriously be intended to deceive. The whole thing is generally designed to regulate fashion by organizing sentiment. Modern advertising is an alternative to the organization of sentiment by society. Advertisers have realized that behind fashion lies some sort of organized sentiment, and they attempt to do the organizing and so reap the benefits of a predictable demand.

The weakness of this procedure is that the sentiments organized around a given commodity are not in any sense particularly relevant; they would do equally well for any other commodity, and can be used by every other advertiser. Consequently, a competition of advertisements only increases the swings of fashion and does anything but promote stability of demand; nor does it help to integrate a seriously unorganized society. This is all the more regrettable since manufacturing processes have been steadily tending in the direction of mass production. That is to say, economical production often involves much highly specialized machinery which is very costly and can only pay its way if run to capacity over a period of time. But this involves a steady consumer demand. The only satisfactory solution seems to be the closer integration of society, which would reduce the tendency to copy the Joneses, and so diminish the violent and frequent change of fashions, and at the same time cause a larger proportion of expenditure to be controlled by the slower moving social sentiments.

With fewer swings of fashion, it is probable that there would be a somewhat greater demand for variety at any one time. And it also seems likely that the present lack of variety encourages changes in fashion; for the inability to choose from an adequate

range of styles reduces the possibility of individual expression in the case of many commodities (e.g., wall papers and house fittings generally).

To simplify the discussion, we have only considered the function of modern advertising in regimenting consumer demand, making this more predictable, and reducing its spread from the norm at any given time. But another factor is involved which must be considered in its turn, for not only is the public led to want what the manufacturer is in a position to supply, but he is persuaded to buy more of the commodity than he otherwise would.

The pressure to buy more takes different forms according to the nature of the commodity involved. If this be immediately consumable, as in the case of food, the advertising campaign will be directed towards making us consume more than we otherwise would, by reminding us of the pleasures and advantages of such consumption in the first instance, and sometimes by altering the customary balance of personal expenditure in the long run. The latter point is of the greatest importance over a period of time, for the allocation of expenditure over the range of alternative commodities is finally based on social custom to an astonishing degree; it is a great mistake to suppose that the fundamental urges of mankind dictate a given balance of expenditure. Thus, as compared with England, America is orange-juice minded; whilst many Englishmen carry walking-sticks in the street, a practice almost unknown in America. This type of pressure to consume more is closely related to the regimentation and development of fashion, and it provides an additional reason for expenditure on advertising; for any advertisement can perform both functions simultaneously.

In the case of commodities which are not directly consumed, or only consumed slowly, such as furniture or clothes, other tactics are often employed to increase expenditure upon particular types of commodities. The public is encouraged to discard these long-

lived commodities before they have ceased to be serviceable, and to replace them by further expenditure of the same nature. The best logical appeal is that technical advance has so greatly improved the newer model that to buy it is to obtain a substantially improved service. Thus year after year, we are persuaded that the present model of our favourite make of automobile is a substantial advance on all previous models. To a limited extent this is the fact, for the simplest way of persuading people of the truth of this proposition is to make it true, and vast sums of money are spent annually on research of one kind or another. But not every year sees an important advance in automobile design and manufacture, and our appetite for new models is maintained by introducing changes in style. Thus fashion, as a mass phenomenon, is promoted not only to make demand predictable but also to increase its volume for a particular commodity. This has long been recognized as the motive behind changes of style in women's clothes, but the range and intensity of style changes have been steadily increasing.

Thus we find that fashions are stimulated by business as a means of controlling demand, and the rate of change of fashions is also increased to improve volume of trade. The first factor has arisen partly as a result of the decay of the social control of personal expenditure, and the two factors together are greatly assisting this form of social disintegration. Again, the high rate of change in fashion adds greatly to the costs of mass production, and so reduces its outstanding merit.

There is another aspect to the acceleration of changes in fashion which must not be neglected. We have been thinking of each particular business firm in its endeavour to obtain a larger share of the consumer's expenditure, and we have been tacitly assuming that the total volume of the latter is more or less fixed; but this assumption is not warranted. For high-pressure advertising does not merely affect the distribution of expenditure, it also tends to increase the total expenditure of society, or in Maynard

Keynes' phrase it increases the social 'propensity to consume.' It is becoming more generally agreed that the tendency to chronic under-employment in industrial societies is related to a deficiency in the propensity to consume, amongst other things;¹ to this extent, advertising has a beneficial effect on social well-being; though it may be questioned whether any society can be regarded as adequate in which unemployment must be staved off by discarding the fruits of human labour so long as these are fit to use. This remedy consists in spreading a condition of material poverty rather than of abundance.

Thus we find that modern advertising performs a number of functions for society, some of them good and others bad. Amongst other things advertising:

- (1) Disseminates knowledge about commodities.
- (2) Organizes demand in a society too disintegrated to provide the necessary social controls; to this extent, it reduces manufacturing costs by avoiding mis-directed effort.
- (3) Encourages arbitrary fashions and increases their rate of change; this tends to increase manufacturing costs, and also to disorganize society still further by reducing the possibility of establishing social customs.
- (4) Tends to increase employment, but partly by the expedient of reducing the satisfactions to be obtained from manufactured commodities.

As a final observation, it should be remarked that whilst a state of social integration is no guarantee of a sufficient propensity to consume, to ensure full employment, a disintegrated society is one in which it is difficult to take full advantage of ideas for the organization of adequate social activities.

¹ For a brilliant discussion of the relation of the propensity to consume, and other factors, to national employment, see "The General Theory of Employment, Interest, and Money" by J. M. Keynes. Published 1936, Macmillan & Co., London; and Harcourt, Brace and Co., Inc., New York.

Modern methods of manufacture were the engineer's answer to an economy of great scarcity, and the present growth of rapidly changing fashions was not foreseen. However, the engineer could do something to reduce the costs of changing fashions, and of spread of demand at any one time, without losing the characteristic advantages of large-scale production. This matter is discussed in the next chapter.

CHAPTER XIV

THE PLANNING OF ENGINEERING DESIGN TO SECURE A VARIETY OF PRODUCTS

It HAS been seen that an integrated society is likely to demand a somewhat greater possibility of individual choice than is practicable with present manufacturing methods, and that at the present time the costs of manufacture are increased by rapid swings of fashion. It will be argued that a suitable modification of present methods would result in a greater variety of end products, and in a lesser disturbance due to change of fashion. Those who are not interested in a discussion of this rather technical character may prefer to proceed directly to the next chapter.

What is evidently required is some manufacturing organization which will permit of the economical production of a greater variety of commodities, coupled with a sufficient flexibility to enable a reasonable degree of change following progress in design. This would steady demand by giving it a larger basis for choice and at the same time broaden the variety demanded, thus diminishing the hit-or-miss character of future demand. This desirable result can be at least partly achieved by the rational development of *component design*.

To begin with a simple illustration, which will show the essential characteristics of component design: compare the radiators of automobiles with those by which we heat our houses. The essential element of an automobile radiator is commonly built up into one piece; it can neither be enlarged nor changed in any way without actually cutting metal; moreover, if the manufacturer wishes to change the radiator in future models, he is compelled to cut his metals to new shapes (or, of course, cast, mold, etc.). This might be called the unit design of radiators. The heating radiator of our homes is designed in another way; as can easily be seen, the radiator as a whole is assembled by bolting together a number of separate parts, or components, each of

which is a unit in itself. Hence, though the unit cannot be subsequently modified without actually cutting metal, the size of the complete radiator can be changed by merely rearranging the component parts. Thus, alternative house radiators can be constructed by assembling varying numbers of standard units, and no alteration in the size and shape of any piece of matter is involved. This is an example of component design.

Component design does not always lead to such flexibility in the end product; for instance, the engine of an automobile can be taken apart or assembled with the help of a wrench and a screw driver, and such an engine is an assembly of components; this renders replacements possible without modifying the size and shape of any single piece of matter, but it does not enable the engine to be itself varied in design, e.g., doubled in power by the addition of more units.

Component design may have a number of other characteristics, and to appreciate these we must consider the possible way of organizing components to form end products. The assembly of units may be '*simple*' or '*progressive*.' The house radiator is an example of a '*simple*' assembly in which a number of elementary parts, i.e., several similar castings, two or more long bolts, nuts and washers, etc., are placed in a relative position with respect to one another.

An automobile gives an example of progressive assembly, a typical arrangement being roughly as follows: the complete vehicle is assembled from such components as a body, a chassis, a battery, gas, oil, water, grease. Some of these components have previously been assembled from subcomponents; thus, the chassis was built by placing in their relative positions an engine, a frame, springs, two axles, steering gear, etc. These subcomponents were similarly assembled from lesser components; the rear axle, for instance, from castings, turned shafts, ball or roller bearings, etc. The roller bearings are assemblies of rollers, races and possibly cages. Here we have a hierarchy; components of the first order (that is, single pieces of metal) are assembled into

second-order components, these are assembled into third-order components, and so on, until the final end product is reached. The real picture is, of course, more complicated; thus, perhaps a second- and a fourth-order component may be assembled together with first-order components (e.g., bolts and nuts). Again, suppose two pieces of metal (first-order components) are welded together; is the result a first- or second-order component? The assembly in this case is 'irreversible.' A full discussion of component design would be out of place here; the point to notice in 'progressive assembly' is the tendency to proceed in stages of assembly, from the simplest unit to the final end product, via a series of subcomponents of growing complexity.

It is interesting to notice the results of progressive assembly as found in the structure of matter itself, and also the extent to which the leading features of this assembly are applicable to engineering design. Matter in its most elementary form is an assembly of two 'things'; namely, protons and electrons. About 90 elements are known and there are good theoretical reasons for supposing that very few remain to be discovered. These elements are assemblies, each consisting of a nucleus and one or more electrons. The third-order component is called a molecule and is formed by the chemical combination of two or more elements. This planet contains over 1,000,000 different sorts of molecules. The next assembly gives us formed matter — stones, mountains, rivers, clouds, etc. — and of these no two are quite alike, the variety running into countless billions. Higher combinations are such structures as crystals, the living cell, and the combinations of cells forming plants and animals.

Thus, the variety of the components at the various levels of the hierarchy is:

Order of Component (or end product)	Name	Variety
1	Proton and electron	2
2	Elements	about 90
3	Molecules	over 1,000,000
4	Formed matter	innumerable
5	Higher structures	

Some characteristics of the various levels can be summed up as follows:

1. At every stage beyond the first, a component is formed as an orderly arrangement of simpler components; it is the ensemble or the organization itself, which gives the built-up component its peculiar character.
2. At every level, the variety of the components is greater than at a lower or simpler level. Moreover, this increase of variety is very rapid; starting with two at the first level, countless billions are reached at the fourth. The possibility (*not* the necessity) of this depends on a mathematical law and can be foreseen by any mathematician.
3. On the whole, at every level the components will tend to have a less universal application than those on a simpler level. The possibility of this also can be anticipated by a mathematician and is a common feature of every sort of hierarchy.
4. The endurance, or invariability, of the type throughout the ages is, on the whole, greatest on the simplest level and diminishes as complexity increases.

These characteristics result in a system of progressive component assembly in which a very limited number of simple and enduring components are organized by stages into an enormous and flexible variety of end products. An examination of the products of engineering similarly reveals some degree of organization on the lines of progressive component assembly. At the first and simplest level, we find the raw materials of industry — metals, stone, earth, wood, and so forth. The number of these is not great, but the width of application of some of them is very great. The simplest (first-order) components made by man consist of such things as these:

- A. Chemical substances depending on their composition only (neither shape nor size involved) — e.g., liquid oxygen, pig iron, etc.
- B. Formed matter in which shape and size is relevant but is not completely adjusted to the final applications; e.g., metal

rods, sheets, bars, tubes, etc., wooden planks, and other standard forms; wire, thread, etc.

C. Formed matter in which the shape and size are finally determined and are of general applicability; e.g., nuts, bolts, washers, balls for bearings, screws, nails, bricks, piston rings, buttons for clothes, hooks and eyes, spur and pinion wheels (in so far as these are standardized), etc., and some few castings such as cast wedges, etc.

C̄. Formed matter in which the shape and size are finally determined, but used only for narrow applications; e.g., most castings (such as cylinder blocks for automobiles), back-axle shafts (automobiles), cloth as cut for individually fitting clothes, stampings for various purposes, many spur and pinion wheels; in fact, simple, unstandardized parts of all sorts (i.e., the standard is not recognized outside the limits of a particular company or very small groups).

The second order of components consists of assemblies of the first group (I am excluding end products from this list):

A. Simple standardized articles, — that is, hinges (for doors, etc.), ball bearings, electric switches (not an end product, for it requires further assembly with an electric circuit), castors (for furniture), carburetors, etc.

Ā. Simple unstandardized articles, that is, second-order subcomponents which have an application only to one model of end products; e.g., the steering gear of any given model of automobile. *Most second-order components of any mechanical contrivance fall into Ā rather than A.*

Higher-order components show the same characteristic; namely, that of frequently, but not invariably, having a range of application no wider than one model of end product for which they were specifically designed.

Thus, the organization of progressive component assembly as met with in industry lies somewhere between two rather opposite types, sometimes approaching one extreme and sometimes the other. One extreme is to design and to use each order of com-

ponents so as to utilize to the greatest extent its possible width of application; this is the method in which matter itself is organized, and a close approach is seen in those sub-groups of industrial components marked with unaccented letters above. The other extreme, marked with accented letters, also consists in designing a hierarchy of components which, when assembled in the logical steps, results in an end product, but in which no component at any level has a wider range of application than the particular model of end product for which it was specifically designed.

Any form of progressive component design results in more flexible end products than unit design or even simple component design (the logical application of unit design to more complex contrivances).

As between the two outstanding types of progressive component design, that type which standardizes each level of components and gives any one component its greatest possible range of application is the method which results in the possibility of the most varied (i.e., least standardized) range of end products, or consumer's commodities. This sounds like a paradox, but it is quite simply explained: in the case of an end product in which the components are designed especially for this one purpose, any change in the design of the end product will necessitate shutting down manufacture on several of the components, whilst a wide variety of models will destroy all the advantages of large-scale production. On the other hand, in so far as the end product is an assembly of standard components with wide application, a change, however radical, would merely involve the selection of other standard parts. For example, a change of automobile design does not seriously affect the manufacture of nuts and bolts, although other sizes may be selected by a given manufacturer. The limitations of this use of progressive assembly of standardized parts will be considered in a moment; for the present, consider its advantages over the assembly of unstandardized or individual parts. These advantages flow partly from

the greater ease of introducing both change *through* time (novelty) and change *at* a time (variety), owing to the smaller disturbance of manufacturing processes involved. This makes for variety because the manufacture of a wide range of models by any one company does not involve a miscellaneous variety of manufacturing processes, each on a small scale, but merely a more varied choice of standardized parts to be purchased, each particular line being bought in a correspondingly smaller quantity. Manufacture is disassociated from assembly and so increases standardization in the former with advantages to production methods, whilst assisting individuality in assembly and in the final consumer's commodities.

The advantages to manufacture are many:

1. A manufacturing program is not so dependent on the fluctuations in style of any one end product; hence, a greater stability of type and of demand, change being introduced only as dictated by genuinely improved methods or materials.
2. Greater width of application of a component not only increases the life of a given design, but increases its width of application, and so its demand, at any instant; this again assists economical manufacture.
3. A manufacturing company, having a wide experience in the production of its particular line, will be in an excellent position to conduct research and experiment leading to progressive improvement. The increased demand would diminish the economical time intervals between such changes; moreover, the actual machines employed in manufacture might be designed on the same principle as the end products and so might further increase flexibility. Not all improvement in a component alters the use of the latter; e.g., an improved $1/2$ inch bolt with a given pitch of thread would have the same nominal dimensions as before, but would adhere more closely to limits or be made from better steel. Thus improvement in components, wisely introduced, would not upset an assembling program. These are some of the manufacturing advantages of the progressive assembly of

standardized parts. As regards assembly, this is usually more elastic than machine work, variations implying less scrapping and rearrangement of plant.

I have skimmed very lightly over a number of engineering and manufacturing problems which cannot be elaborated here, but it is clear that there are certain limitations to this type of progressive assembly. A question arises as to whether the variety required in shapes and sizes of standard components would not be so great as to defeat its own ends. I can speak only from the standpoint of a mechanical engineer, but in this field, at least, I think that the objection does not hold. Balls for bearings are manufactured to limits of about 0.0001 of an inch; this is not because such a small difference between two bearings would have the least influence on their action, strength, or applications, but merely because the balls must fit their races accurately and the latter must fit their housings. Consequently, ball bearings (which are standardized for practically all purposes) are made to very fine limits, but the intervals between successive sizes are quite coarse, commonly an eighth or a quarter of an inch on the diameter, depending on the types and sizes considered. The same thing applies to screws, nuts, washers, split pins, cotter pins and a host of other simple standardized units. This would also apply to other similar parts not yet standardized or only partly so, such as spur- and pinion-wheels, back-axle shafts for automobiles, etc. It must be remembered that in the absence of any such standards, each designer uses individual dimensions, and a wide and meaningless variety of components results. But the whole range of automobiles could probably be easily met by a choice of a few dozen carefully graded back-axle shafts, *provided that these alternatives were known to the designers in advance*. This sort of standardization already applies to batteries, and the required range of these is small compared to that of automobile models; the same also applies in varying extents to magnetos (when used), electric bulbs for use in homes and elsewhere, carburetors, etc.

Components of a higher order can be found in which this type

of standardization has been developed — e.g., in pump assemblies — and the smaller range and lesser endurance of higher components is partly compensated by the fact that, in these, assembly would predominate over actual manufacture.

Practical engineers will look in the region of frameworks or housings for the most obvious limitations of the kind of designing here advocated. Obviously many limitations exist, but in practice they are not nearly reached and have not been systematically explored. *Mass production has drifted rather blindly towards standardization of the consumer's commodity, coupled with a relatively great variety of components.* What is required is the exact reverse of this. Clearly, though we may desire a variety in household fittings as regards their style and capacity, a rigid standardization of the parts involved in their inner mechanism could be only a blessing. For, though we desire variety in the final commodity, this desire affects only a small proportion of the components themselves and their arrangement (assembly); and standardization of the components assists an economical variability of the whole. The evolution of the progressive component design of standardized parts must usually start from the simplest units upwards; at the lowest level, this is already largely accomplished and, on the whole, represents the modern drift.

Would the realization of the possible advantages do anything to hasten this process, or are engineers already doing all they can to fit their products to the industry as they find it? Of course, a designer works for the profits of his company and is not expected to lead a crusade; to this extent, all evolution of method may be said to look after itself. But this is not the whole story. As between two or more alternatives, we choose that one which seems to fit the case best; this applies to such diverse matters as choosing between candidates for a job or between designs for a mechanical contrivance. But after the more obvious pros and cons have been weighed and balanced, it often happens that no certainty is reached; so many factors have been ignored, or their importance roughly guessed, that the alternatives, though per-

haps very different, seem about equally desirable. This does not imply that the choice is thought to be immaterial; it is often obviously vital, but no one knows the ultimate consequences involved in either decision. These are moments in which we all seek guidance in some general principle, and one very powerful guide is a settled belief as to which alternative has the future with it; which, in other words, is forward looking.

Anyone who has watched the introduction of radical departures involving serious financial risk must have observed that the 'coming' method or device is habitually adopted before a narrow calculation of advantages would really warrant the action. For instance, the introduction of motor ocean-going ships occurred at exactly this stage, and the ship companies buying motor ships must have been influenced by the possible advantages of gaining early experience in the handling of the coming type of engine. This alone made possible the future development of these engines, and so helped to bring about the very economies which the ship companies were hoping for and anticipating.

I wish particularly to stress this point, for it is not always realized to what an extent the actual decisions of engineers and scientists generally are based on judgments backed by very inadequate data. A report as presented to the higher executives may look logical and smooth enough, and mathematical reasoning has no doubt been freely used to assist the final judgment; but all this rationalization must not blind us to the fact that the selection of data on which the argument is built, as well as the weighing of conflicting evidence, depends in the last resort on sheer judgment and on nothing else. Consequently, in product planning (as in most other activities) the general trend is immensely influenced by any relevant idea which may cause the 'slack' or 'area of uncertainty' to be taken up habitually in one direction rather than in another. For this reason, it seems probable that if product planners (engineers and others) were ever to feel the desirability of obtaining a wide variety of end products by an intelligent standardization of components, this

would in itself be just as powerful an influence as has been the unfortunate idea that the benefits of large-scale production require a rigid standardization of end products with the consequent impoverishment of their variety.

Obviously, such bodies as trade associations, and possibly government investigations and actions relative to ways and means of standardizing components, might assist; but these can only follow a general recognition of the need, and they are probably no more indispensable to a new form of standardization than they were to the old.

CHAPTER XV

A NOTE ON THE RELATIONS BETWEEN INDUSTRY AND GOVERNMENT

PRESENT-DAY relations between industry and government are apt to indicate the divorce between industrial activities and society at large. On the one hand, there is a perpetual outcry from the leaders of industry against legislation designed to control the course of business, and, on the other hand, these leaders ask for that very thing. Instances of the latter are the tariffs of practically every industrial nation. These are primarily designed to control the course of business rather than to collect revenue, and almost invariably they were built up item by item at the insistence of the industries directly benefiting.

There is an apparent lack of consistency in this dual attitude of leading men of business, for individuals often do cling to two inconsistent attitudes simultaneously; but when a large and intelligent class of men seem to be in this condition for several generations and in a number of countries, then almost certainly the apparent inconsistency is based on a real distinction which has not been quite explicitly stated. What type of governmental action do business leaders resist, and what type do they welcome and promote? The two sorts of actions have not been clearly differentiated, and so we must not expect the distinction to be accurately held in every instance, but on the whole it is clear enough.

Laws are written directions regulating people's conduct in certain specified situations. Provision is made to coerce those who fail to adjust their actions accordingly. A law, to be successful, must be the formal expression of a social sentiment; it must voice the massive long-time intentions of the bulk of the people. A law which is not based on public opinion will fail to regulate people's conduct, however admirable its object may seem to be. Laws absolutely prohibiting the sale and purchase of intoxicating drinks have been enacted in more than one country and have

failed, because in each case a large part of the public was not in favour of so drastic a regulation. The force behind a law may seem irresistible to the inmate of a penitentiary. But the officers of the law are themselves members of society and in any case they represent only a small proportion of the population; their intention and ability to uphold a law rest ultimately on the wishes of the public.

Since a successful law only expresses what people wish to do in any case, why trouble to enact it? Many, in fact most, human regulations are controlled by social opinion without any assistance from the law. There is no law forbidding weary guests from going to sleep at a dinner party, but social opinion is sufficiently powerful to prohibit this form of behaviour in almost every instance. There are great advantages in social as compared with legal control when the former is practicable. For one thing, a law is never sufficiently flexible to cover unusual cases. Generally, a given act may be either socially desirable or hurtful according to the particular circumstances and the intentions controlling the act. But intentions cannot easily be scrutinized, and laws can only regulate actions, not intentions, whilst social pressure can and does take the latter into account. Thus, by law, persons are prohibited from taking human life unless in certain specified circumstances (e.g., death sentence; self-defence when in immediate bodily danger). No doctor may take the life of his patient in any circumstances. However, it is well known that in certain cases of advanced incurable and painful diseases many doctors do hasten the inevitable end. This action is illegal but has the approval of society, and the doctors are consequently protected. It would be impossible for the law to define the degree of illness that would justify such action, but society permits it with the proviso that any doctor who misjudges the occasion is liable to be tried for murder. To all appearance, the social control is both adequate and flexible in these circumstances. But it is to be noted that the doctor's only motive for causing his patient's death is a humanitarian one.

Laws are inflexible in another way, for unlike public opinion they do not insensibly become modified with the times. In England, divorce is not permitted for incompatibility. At one time, this voiced the public sentiment, but as that changed it became the habit to trump up an untrue story of infidelity when the real reason behind the divorce was not infidelity but incompatibility. It might seem simple to change the law to allow divorce for incompatibility, but that would not represent public opinion either. The real opinion is that divorce is a regrettable breakdown of social responsibility, and that sentiments of incompatibility are largely under the control of the two parties and should not be allowed to develop. When the situation is hopelessly beyond repair, the parties had sometimes better be divorced. That roughly has represented public opinion in England for the past generation, but all the while opinion has been gradually becoming less antagonistic to divorce for incompatibility, and it has expressed this gradual change by a steadily decreasing social punishment (ostracism) for those who do obtain divorces for this motive. The written law has proved quite incapable of following these varying shades of public opinion.

Social control, when it is effective, represents public sentiment far more faithfully than the most carefully drawn law, and unlike a law it is in no danger of getting permanently out of step with itself. Nevertheless, in many cases laws are required to implement public opinion.

For instance:

- (1) Certain persons may be tempted to ignore public sentiment, or even their own usual sentiments, for an immediate personal gain — e.g., laws against burglary.
- (2) People are forgetful and public sentiments cannot always be mobilized or ascertained on the spur of the moment; they require dramatic and formal statement — e.g., laws requiring the isolation of those suffering from infectious illnesses such as measles.

- (3) Public sentiment is directed towards a desired end; it often fails to indicate the means. In fact, the latter sometimes involve highly complex matters requiring technical knowledge — e.g., it is desired to have a uniform system of time-keeping in any one territorial area, but opinion is not competent to determine how the passage of time shall be ascertained. Hence we have government observatories and legal time (standard time, summer time, time zones and the like). Again, the public wishes its ships at sea to be safely constructed and handled, but the actual laws implementing this public sentiment are drawn up in consultation with marine engineers and other skilled experts.
- (4) Public sentiment may be sufficiently coherent but be out of touch with a group whose actions it wishes to guide — e.g., public sentiment in one country cannot directly influence the manufacturers of another country, hence the need for tariffs.
- (5) Where the actions of a number of people, often strangers to each other, interlock, it is important to know what each member is going to do. Sometimes certainty of expectation is more important than the precise code adopted. The public sentiment is merely that there shall be some reasonable code universally adopted — e.g., this applies in part to laws regulating contract and other business relationships.
- (6) An actual situation requiring immediate public attention is always local both in space and in time. The local sentiment may be temporarily biased and fail to represent the more stable sentiments of society at large — e.g., law-court procedures are laid down to guard against decisions which would not be sustained

by long-time public opinion. These procedures partly guard against mistakes of technique and partly against local bias.

- (7) There are many actions that each individual would desire, provided he could be sure that every other individual were acting similarly, but which, if performed by any small group, would fail in their purpose and create individual hardship — e.g., the payment of taxes, the closing of shops on Sundays.

These reasons for expressing some public sentiments in the form of law are by no means exhaustive, but they emphasize one characteristic of a successful law, namely, that it is expressing, clarifying, emphasizing, and giving effect to a widespread desire for a certain type of action and for a certain type of social organization. Effective laws follow rather than precede social opinion. This necessarily throws the responsibility for developing public opinion on society itself rather than on its legislators. Some wit defined democracy as a device for making sure that a country never had a better government than it deserved. Perhaps this is a way of stating that a democratic country is one whose government in the long run tends to follow developed public opinion.

Public opinion becomes developed and effective just in so far as there exists integrated social living. For opinions are not concerned with ascertainable matters of fact, but with sentiments about the human values of alternative forms of conduct. It would be absurd to canvass public opinion as to the numerical value of seven times nine; if there should arise any serious doubt about the matter, the proper procedure would be to consult a mathematician. On the other hand, there is no calculus for determining whether capital punishment should or should not be practised. Arguments may be adduced on either side, and frequently are. But in the last resort, the matter must be decided by each man for himself. Some of his sentiments may incline him to favour the punishment, as for instance his abhorrence of murder and his desire to deter possible murderers. Other sentiments will

point in the opposite direction; for instance, a dislike of legalized killing. The final opinion of each man will represent his individual balance of sentiments. A developed public opinion occurs when on this, or on any other matter of sentiment involving conduct, an overwhelming majority of the people all come to substantially the same conclusion.

But a difficulty arises almost immediately. The problem stated above was so worded as only to admit of two possible opinions: one in favour of capital punishment and the other against it. Consequently, there will always be a majority opinion on this matter in any given society. But consider the following problem: For what offenses should the offender be hanged? Here, there are as many possible opinions as there are offences to commit, and the number is legion. By what miracle can an overwhelming majority of society ever develop an agreed opinion on a matter of this sort? For this is the typical form in which a social problem presents itself. The answer is that a million people thinking in genuine independence of each other never could develop a formed public opinion. But a million people, all members of one integrated society, will have evolved common ideas, shared common experiences and sentiments, and will have been conditioned to a common attitude which is in tune with their activities and their circumstances. Such a society does in fact find itself in possession of reasonably formed public opinions on many matters of sentiment involving action. In short, an integrated society has a sufficiently uniform standard of ethics and so of conduct; and its members have a positive desire to fall into line with their neighbours. This is not a deduction from abstract argument but an observed fact, and it is supported by the evidence of history.

So we arrive at this general conclusion. The conduct of society must be regulated by public opinion in the last analysis; legislation may assist opinion but it cannot supplant it. The development of an adequate public opinion depends upon integrated social living, for it consists in making explicit the routines by which people live; and the integration of society involves ac-

cepted leaders acting with a concern for the society they serve. And, finally, the most important class of natural leaders in an industrial society are its business executives, to a great extent working with and through their business organizations.

But we have already found that, on the whole, business men have not as yet taken their place as leaders of society. That is to say, these men have been organizing some of the most important activities within their society with an inadequate concern for the needs and stability of the society as a whole. They have behaved like a surgeon who performs a major operation without thinking of the patient's general condition. The surgeon may cure the local trouble but the patient dies of heart failure. Our patient, the industrial society, has not actually died but it is showing alarming signs of disorganization. Moreover, it is being organized somewhat inefficiently by other leaders who have no direct responsibility for the industrial activities. And, since executives have failed as a class to lead the social living even within their own plants, other leaders are attempting this in response to a wide social (employee) demand.

The result is social legislation, directed to improving the conditions of industrial life, partly taking the form of controlling the actions of management. Society has a formed opinion that industrial management is a danger to its existence, and this opinion is being expressed in the form of laws. So we find laws indicating ways and means for obtaining social health not elaborated by the relevant experts — the industrial managers. Industrial managers in themselves form a moderately homogeneous social group, and they are being forced to act in accordance with laws that their skilled knowledge cannot always approve, and which do not express their group opinion. On the principle that no group will honour a law which does not express its opinion, we should not expect these laws to be an unqualified success, and that is the usual experience.

So, to answer the question with which this chapter began, industrial management welcomes laws which express their group

opinions, and resents those which affect their activities but which are initiated by social groups of which they are not members. Management as a class is obviously correct in supposing that industry cannot be organized except in ways which seem feasible to themselves. But the public at large is equally correct in declining to be controlled by men who are not its social leaders, and so act without a due concern for the welfare of society. So long as industrial managers confine their attention to the techniques of industry the impasse is complete, and they will be faced by legislation initiated elsewhere and largely in opposition to themselves. Someone must take the lead in integrating social living, if civilization is to continue, and also give expression to the resulting public sentiments. The solution, as we have already seen, is that the industrial leaders should themselves become the social leaders.

No one supposes that the present lack of co-ordination in industry can continue indefinitely. No society can tolerate an endless succession of industrial depressions such as we have just witnessed, or the insecurity of banking firms which has been typical in the United States, or the deplorable condition of the cotton industry in England. Someone must and will attempt solutions for these conditions. So far government legislation, either voicing sentiments not shared by the managing class or not voicing any widespread sentiments at all, has represented the chief attempts; and these could not be very successful in the circumstances. This is no criticism of those who have taken the initiative; something had to be attempted, and public opinion was inadequately led and largely non-existent. But a real solution will only come when society is integrated around its major activity, business; and when business leaders develop the necessary ways and means for obtaining that which their society needs — security of occupation, and a richer social life for all as a part of their occupations.

The greatest difficulty that industrial leaders have encountered in organizing their industries has been the lack of common links between one firm and another. Gentlemen's agreements between

firms in any given industry have proved fragile instruments, whilst attempts on the part of government to give legal force to such agreements have been equally unsuccessful. This is partly because written laws are insufficiently flexible in many instances, and because there was no formed public opinion to enforce them.

As early as 1864, President Lincoln, in an address delivered shortly after his second election, warned his audience that "It has long been a grave question whether any government not *too* strong for the liberties of the people can be strong *enough* to maintain its own existence in great emergencies."¹ These words were written towards the end of a long and exhausting war which had shaken American society to its foundations and had greatly reduced its immediate possibilities of integrated activity. United action would be necessary to rebuild the economic and social procedures; to restore prosperity. But no united public opinion or settled expectation existed on which a democratic government could base its labours. President Lincoln was facing the dilemma which, in one form or another, is exercising the people of every great nation today.

To sum up, at the present time industrial nations are split into three partly opposing camps, with a consequent loss of public concern in matters of social importance. First comes industry, led from the standpoint of narrow technology. Then society at large is inadequately led, partly in opposition to the dangers arising from a narrow industrial management. The third interest is government itself, which in its legislation sometimes expresses the group sentiments of business leaders, and at other times the sentiments of other sections of society. On yet other occasions governments, under the necessity for taking action of some sort, and in the absence of an adequate public opinion, take the lead in initiating legislation for the better organization of business; and on these occasions the chances are great that the opinions of no important group are being expressed.

¹ Address delivered from a window of the White House on November 10th, 1864. Published in the *New York Times*, February 12th, 1936.

CHAPTER XVI

SOCIALISM AND OTHER SOCIAL SYSTEMS

It is hardly possible to contemplate our own social conditions in any detail without recollecting that very different organizations have been proposed which, so we are told, should result in more happiness and more truly civilized living for the majority of men and women. The present widespread lack of satisfaction and opportunity gives us no warrant for supposing our present system to be the best that can be achieved. Nor does it result in a reasonable degree of material comfort, given the state of technological skill and knowledge we already possess.

A study of history, or even of different peoples in our own times, should convince us that we are not living under the only social system compatible with human nature as we know it. And finally, it is not possible to discredit at least some of the other possible systems on the grounds of illogicality or poverty of design. No doubt they are not perfect, but then our present society is not perfect either; and if our own social system were proposed in a planet that had never experienced it, the chances are that it would be declared illogical, unworkable and repugnant to all human sentiment.

So many things have come to pass and are admittedly an improvement in spite of being 'contrary to human nature,' that this argument has been discredited, and we all agree that our present industrial civilization is in something of a muddle.

In these circumstances, must we consider in detail each proposed system as a possible alternative to our own, and attempt the difficult task of comparing the relative merits of the condition we know with those we can know very little about? Or are there some general considerations by which we may guide our thinking in the matter? I think there are such general considerations, and they arise directly out of the viewpoint set forth in the preceding

chapters. Since we do not intend to consider the details of any one system, but only certain broad characteristics common to them all, it does not much matter which system is taken as an example. For convenience, let us take Socialism, remembering that what follows would apply in a general way to any other plan for the drastic reorganization of human relations.

Socialism is a term used to cover a number of rather different but similar plans for the organization of social activity. These plans all share the following characteristics:

- (1) They are designed to secure a larger participation on the part of the masses in important social activities, such as industry and government. They aim at a more complete integration of society at large.
- (2) Socialism involves a drastic reduction in the amount and types of property which may be owned individually by private persons. In its extremer forms, all means of production are to be the property of the state. This involves not only minerals and land generally, but also man-made property such as factories, machine tools, business organizations; in fact, everything except actual consumer's goods.
- (3) One of the three following types of procedure is advocated as the means for changing from our present to a socialistic organization.
 - (a) Gradual evolution by a state, most of whose people are to be convinced of the necessity by previous education and discussion.
 - (b) A fairly abrupt change over from one system to the other, but by constitutional means. That is to say, a convinced people will vote into power a government charged with the duty of organizing the change.
 - (c) An abrupt change inaugurated by revolution, backed by the necessary minimum of physical force and possibly, in the early stages, by frank dictatorship. This is really a communistic rather

than a socialistic program; but the distinction between the former and extreme socialism lies almost entirely in the method by which the new social condition is to be reached. The final condition is practically the same in both cases.

These three methods are not sharply separated, and many socialists take up intermediate positions.

Socialists, like other advocates of complete social systems, start with an analysis of the present-day social situation and they define a general direction in which it would be well for society to evolve or change (paragraph 1 above). They next produce a fairly definite plan of social organization which is fundamentally unlike anything that has been attempted in an industrialized state, and they affirm that under this plan the present social ills would disappear, or at least be greatly reduced. There is an implied assumption that other equally serious ills would not arise (paragraph 2 above). Finally, a second plan is produced to enable the necessary change, from the present to the future system, to be accomplished (paragraph 3 above).

Let us consider these three steps in the program of a socialist, one by one. We all agree that present social conditions are not perfect and that an improvement in this respect is desirable. We are also probably agreed that a careful investigation into present-day conditions would provide a factual basis for our subsequent thinking. It may be doubted whether such investigations are always performed in a sufficiently objective attitude, but at least the intention is praiseworthy. And it is, I believe, a fact that most people who have considered the matter seriously have arrived at the opinion that present industrial civilizations suffer greatly, owing to their lack of social organization. People believe that insufficient attention is given to this matter.

Enthusiasts with a strong belief in some particular panacea are apt to muddle up their diagnosis of actual conditions with their schemes for solution. They are also apt to impute disagreeable motives to groups who resist this solution. Finally, diagnoses

of social ills are often gross over-simplifications of the actual state of affairs. However, socialists proceed from the belief, to state it as simply as possible and freed from irrelevant matter, that industrial societies suffer greatly from social disorganization among large sections of their population; and with this belief, most of us concur.

As a cure for social ills arising from disorganization, socialists advance a radically new and comprehensive plan of organization designed to provide a reasonably full participation for all in the life of their community. This plan is often attacked and defended on the question of its logical adequacy. This seems to me to be about the least important aspect of the problem. Of course a minimum degree of logical adequacy is required of any worthwhile plan of action. For instance, if it is desired to open the window, it would be a bad plan to attempt this by stamping on the floor. But many able men, from Karl Marx onwards, have worked at the plan of the socialistic state, and as formal schemes go it is more coherent than most. Viewed in the abstract, the socialistic state is far more rational and self-consistent than the social organization in which we actually live. In any case most, if not all, social organizations were evolved by the light of little or no set plan. Nor is it the general experience that human organizations are successful in the degree in which they are logically simple and consistent. From this standpoint, nothing could be much worse than the British Constitution. It is exceedingly complex and indefinite. It is nowhere written down or adequately explained, it is always in the process of changing, and literally not one Englishman knows precisely what it is at any given moment. Nevertheless, judged by actual practice, there have been worse constitutions.

It would be a great mistake to quarrel with socialism on the score of its logical inadequacy. The final merit of a social organization, assuming that it can be set up, must lie in the degree of human satisfaction which that organization will promote, considered over a sufficient period of time. What grounds are

there for supposing that the socialistic state will result in greater human satisfaction on the balance than our present arrangement? There is one point in its favour; namely, that it would seem to favour social integration to a greater extent than is common at present. But there is no evidence that this could not be secured by far less heroic methods.

In any case, how much more integration and what sort of integration do we want? No one has much experience to guide him. It is one thing to proceed step by step in a given direction so long as each move appears helpful in the light of immediate circumstances; but it is quite another matter to become committed to a long journey on the strength of a hypothetical benefit at the far end. There is always a tendency to assume that a present evil is the only one to be surmounted. At the moment, we suffer from social disorganization, but there is probably such a thing as over-rigid organization too, although that is not our present trouble. There have been many instances of over-rigidity in past societies, but these are not much of a guide, because the character of those nations was so different from our own.

There is one thing that experience should have taught us; namely, that no society has in fact successfully imagined what life would be like under a very different régime. That does not mean that all major changes have been a failure — far from it, but both the resulting opportunities and the difficulties have come as a surprise to those who experienced them.

At the end of the 18th century, and for many decades after, it was not appreciated that industrial growth, in the way it was proceeding, would result in a decay of social cohesion. A few writers did anticipate something of this sort, but only in very general terms; they never predicted our present situation in all its particularities. No one, for instance, anticipated the increased severity of industrial depressions. Again, the authors of the American Constitution had no conception of modern America in their minds.

Only a generation or two ago, technology, and particularly

engineering, was thought to provide the key to a better life for all. Nations were living under an economy of scarcity, and it was not thought possible to provide the material conditions necessary for a general human improvement until mechanical invention had progressed. That was true; and at the present moment the purchasing power divided amongst all the people in a nation would not result in a very high standard of living. But we have gone far enough along the road towards an economy of plenty to have encountered a wholly unexpected obstacle, the problem of distribution. It was never supposed that a society would get into serious difficulties because it had not organized adequate ways for distributing its commodities and for keeping its industries running; especially when millions of people desire those actual things. Yet this is one of our present problems. If there is one thing more sure than another, it is that not one of us has the slightest conception of what it would be like to live in a highly industrialized socialistic state. It might prove delightful; and, on the other hand, it might be horrible. And this applies equally well to any other plan for social organization involving a drastic departure from practical experience.

Living under any given system implies a whole range of beliefs, expectations and sentiments, which in their particular applications would not exist in quite the same way under any other system. Certain types of opportunity would predominate over others; certain human traits and abilities would be more or less acceptable, according to the system involved. Any reasonable system, if worked with average integrity, will have a number of technical merits and equally characteristic defects, though what these would be it is impossible to guess. It is impossible to know what human motives and desires would find opportunity for expression, or what effect these would have upon the system itself.

It is often stated that in a socialistic system, by removing the possibility of personal fortunes, men would be deprived of the spur to great actions and great responsibilities. This seems to me to be a very doubtful proposition. Many of the largest industrial

enterprises are owned by thousands of small shareholders, and are managed by men on fixed salaries, as they would be in a socialistic state. Generals, admirals and statesmen shoulder great responsibilities without any hope of a large financial reward, and seem anxious to do this. To judge by the evidence, people in responsible positions are mainly motivated by the social position and participation involved rather than by great financial reward; the activity, together with its social implications, is the chief reward.

Again, the belief that a socialistic system would restrict opportunity for the exercise of individuality is equally suspect, assuming, of course, a society conditioned to its circumstances. The conventions and regulations of other groups than one's own always appear to be absurdly hampering. This feeling is well known to anyone who has lived in more than one substantially different society. The fact is that to the outsider a rule is a restriction and nothing more; to the native, it has become the obviously right way to behave, and it implies no conscious restriction to his initiative. On the other hand, the order made possible by averagely sensible conventions and laws opens up a number of possibilities which would not otherwise have existed, and these too are not recognized until the individual has become conditioned. Foreigners living in England are apt to be unfavourably impressed by the number of conventions regulating the activities of society; but I have heard any number of Englishmen declare, as a merit of their country, that they had absolute freedom to do whatever they liked. They were, in fact, doing what they liked, but they liked to do things in the accustomed manner; and so it is with us all. I know of no way by which it is possible to judge how much real opportunity for effective initiative would exist in a socialistic state, or what directions these opportunities would take.

So the first serious objection to socialism, or to any other radical plan for social reorganization, is not that it seems good or bad, but that it would be unreasonable to direct a nation's efforts over

a considerable period of time for the sake of arriving at some completely unknown goal. Judging from historical evidence, our present civilization, in spite of all its defects, is about the best the world has yet seen, and the chance that an unknown and untested arrangement would be any better does not appear to be very great.

Now consider the third item in the program of a fairly extreme socialist. Up to the present time, it has been assumed that a modern industrial nation could be changed into a socialistic nation if it wished this; but that is a large assumption and it must be scrutinized. The would-be reformer, according to his particular tenets, here takes one of two lines. He may say that it is impossible to determine in detail exactly how the change is to be effected, and that all social advances are the result of trial and error. This is all very true, but if, as he states, it is not possible to foresee the effects of even the intermediate steps, why have such faith in the effects of the last step, the completed plan? Surely, as the chain of events gets longer, the result must become more and not less doubtful.

Sometimes the other line is taken and it is assumed that the plan could be put into more or less rapid effect. As a matter of fact, I have never heard of a carefully worked-out program for changing over a modern industrial society. But suppose there to be one, however logically coherent, it could have little chance of success. A complex society functions through an incredible network of mutual expectations and arrangements as between people. Every city would become disorganized in a day if the food supplies were not regularly forthcoming, and if these were withheld for a week, thousands of people would be dead. The activities of all workers at this very instant depend on an elaborate system of mutual understandings, and no industry could keep going for a day if these understandings were not substantially honoured. There is no way of forcing people to live up to expectations except by the general will of the community; all engagements, whether written or not, would be void but for that general will.

The detailed arrangement of interlocking human activities is far beyond the power of any person to comprehend. The whole system has grown up by adding piecemeal to a relatively stable situation, so that at any given moment his own obligations are fairly comprehensible to each individual. More than that, people are motivated by their social sentiments, which, as has been seen, are built up by performing routine actions in common over a period of time. If these routine actions be destroyed, there is an abrupt end to the accompanying social sentiments and to predictable behaviour. The result could only be chaos. All organizations, whether it be the organization of the physical body, or a social organization, display a wisdom far greater than their explicit understanding. Each component part, a cell or an individual, behaves in its accustomed manner, and by long experience its actions become fitting to those of the surrounding components. But once the organization is disintegrated, all this experience goes for nothing, and the body or the society loses its wisdom. What is left is a helpless mass of component parts, no one of which can live in independence.

It has proved difficult enough to reorganize Russia after the revolution, but that country never has been a highly organized society. The country is predominantly agricultural and the various districts were mainly self-supporting; in fact, as regards bare necessities, each village practically supported itself or could do so at a pinch. The immediate result of a revolution was to throw each village and district on its own resources until the new régime could gradually take root.

Local expectations and activities are simple in Russia and were only partly affected; even so, the new régime has not been established without suffering. But an industrial society is not divided into a number of small districts and villages each more or less self-supporting, and a stoppage of the organization in being could only result in a wholesale collapse of human relations and activities.

Thus, supporters of radically new systems of social organizations appear gravely to underestimate the importance of social

wisdom (as distinct from explicit knowledge) as a factor in complex human affairs. They make little allowance for the slow and halting development of interlocking human relations; and they fail to realize that the motives insuring predictable and organized activities are the social sentiments surrounding accustomed routines. All civilization depends ultimately upon social routines and their accompanying sentiments.

So, if this argument be not at fault, there are two reasons why a radically new social organization can have no practical interest for an industrial nation. First, it cannot be applied except as a slow evolution. Secondly, no one can have the least notion of its practical merits and demerits, assuming it to be successfully set up. The results would certainly be quite unlike those predicted by its advocates. To these two objections to radically new systems, we might add a third consideration; namely, without belittling the importance of the formal structure, it is surely true that the manner in which an organization is worked, the consideration and interests by which it is guided, are of more importance to all concerned than the precise logic behind the system. The same nominal system which at one time and place is such a hopeless failure, may be a striking success elsewhere.

All this, however, is not a plea for doing and planning nothing on the ground that any change might be for the worse. In fact, the whole book is intended to suggest the advisability of a particular kind of modification. But the grasp of human understanding is limited, and foresight at long range is not possible when dealing with anything so complex as a modern society. What is possible is to advance step by step, observing the actual activities of groups with particular reference to their implied attitudes and sentiments. Groups should have appropriate opportunities for expressing their motives and beliefs, and for acting in accordance with them. But it should be remembered that people are not able directly to express their basic sentiments, and so demands and beliefs as stated are often somewhat trivial and fail to get at the root of the matter. For instance, a poverty of social experience is

apt to express itself in a listless dissatisfaction with each particular activity of society and in unreasonable apprehensions of one sort or another. This symptom is not usually recognized by the individual for what it is.

Successful societies are those in which the more active members have a concern for the attitudes and activities of their groups. And such societies have some capacity for diagnosing their immediate needs. Thus, our industrial society is beginning to realize that it suffers from insufficient co-ordination and that, as at present managed, industry is making this condition worse rather than better. Recognizing this, the next step is to introduce modifications designed to assist social integration. As a matter of fact, change of some sort is quite continuous, and those in control guide it in accordance with their understanding of the relevant circumstances. If industrial leaders believe social co-ordination to be relevant to their activities, this will become one of the factors guiding their actions.

There is no wisdom in attempting to force forms of activity which will not have the loyalty of those involved, but at any moment a number of practical possibilities are always open to the organizer and the legislator, and from amongst these he will choose that which achieves its immediate and limited purpose and is also in line with his larger attitude. Earlier in this century, legislation in the United States and elsewhere was guided by a belief in the social dangers of monopoly; there is evidence now that the general attitude, both in this and in some other countries, is swinging to a belief in the value of a co-operative organization of industry. These general attitudes are of vital importance to the trend of social evolution; and the necessary condition for a healthy society is that a general attitude should be based on adequate observation and understanding.

Provided the activities of a country are so guided, it can matter little whether their trend could be described as socialistic or as anything else. The point is that each modification will meet a real need and so be fitting to the occasion. Theorists may

note that these sometimes lean towards one formal system and sometimes towards another, but the relevant thing to notice is that they fit the circumstances. Thus it is immaterial whether a hundred years hence industrial societies shall have become broadly socialistic or even more capitalistic than at present, provided that each step be taken on its own merits, and not as a means of achieving some hypothetical Promised Land. Wherever a society finds itself, as a result of intelligent social guidance, will be suitable for the occasion, and will be expressing the needs and individualities of its members.

What is required is not an imaginative plan of some distant goal, but a sense of direction based on immediate social wisdom. This was well expressed by an Irish peasant who was asked by a motorist the way to a distant village. The Irishman, after several futile attempts to describe a cross-country route, finally remarked, "Maybe, Sir, you had better start from here."

PART III
CONCLUSION

CHAPTER XVII

RESTATEMENT OF THE PROBLEM

SECTION I

OUR problem in general terms is the stability of industrial civilizations, and especially those which might broadly be described as democratic. These civilizations have evolved to a degree which would have seemed quite incredible only a few generations ago, and yet a study of the contemporary world would hardly convince an impartial observer that our present ways of life have demonstrated their capacity to endure and to provide a workable framework for the human activities they promote. Our attitude has been in sympathy with those who hope for a better future in terms of an orderly evolution of the present understandings, rather than as a result of a violent repudiation of our historic past. Wisdom in action is the fruit of experience, and I can see no hope for any plan which repudiates that experience. The practical problem is to so use our social experience as to guide the present in the direction of a satisfying evolution, for continuing change is inevitable, given our present social system and human nature as we find it.

It is hardly worth stating that this essay makes no pretence of indicating a solution to the problem. The most that can be hoped is that it may bring to attention some of the factors which should be in the minds of those who are conscious of a responsibility to their society. Consequently, this chapter briefly restates certain of the considerations which have become apparent in the earlier parts without attempting any ambitious synthesis. In fact, it would be more realistic to state that there is no one problem which we are called upon to solve. Living is a continuing process during which practical decisions involving action are always being made, and the evolution of society depends upon the type of considerations which influence those decisions.

Every particular problem involving human action is limited both in space and in time, and in so far as its major factors can be stated and sufficiently described, the solution of the problem is sought in the application of a formal discipline or technology. Thus, problems relating to human action in industry are determined by the help of applied physics and mechanics and, in a slightly different area, by the help of economic theory. Each discipline rests upon some basis of observed fact which is stated more or less adequately. Besides the systematic disciplines, practical decisions also rest on individual wisdom based on less systematized personal experience and on the experience of others. Both the discipline and the personal wisdom make one over-all assumption which can never be quite explicit, but which can be pointed to by such phrases as 'other things remaining constant.' The general run of things at large is necessarily assumed to be substantially unaffected by the particular action contemplated. So an engineer charged with the building of a bridge must assume that the erection of this bridge will not seriously alter the character of matter in general; for example, the laws of gravity. If this assumption should ever become unwarranted, the engineer would unwittingly start a major revolution in the material world, and both his bridge and current engineering science would be meaningless from then on.

Economic science and the practice of business, like every other discipline and activity, are based on the assumption of other things remaining substantially unaffected. In particular, both economics and business have tacitly assumed that the general run of human behaviour in the mass will remain sufficiently unaffected by commercial and industrial procedures. This assumption was perhaps reasonable when the developed techniques of business affected only a small part of any society, but it has been my purpose to illustrate the inadequacy of this assumption today. It appears that business activity is very substantially affecting social organization in industrial communities, and that this organization is showing signs of diminished vigour in consequence. So

business finds itself in the position of an engineer who with every successive bridge weakens the stability of them all.

A vital factor, the run of orderly human association, has been neglected; and the only satisfactory solution is to recall this factor from the universe of things that can be neglected, and to include it as one of the relevant considerations in guiding human activities and, in particular, business activity. One obvious difficulty of this procedure is our ignorance of human society. We live within the organization, and it is difficult to perceive the shape and extent of a wood when standing at the centre. However, if our civilization is to continue in approximately its present shape, the study of human society must occupy a position of importance, and human action must be guided by social considerations in so far as these are understood.

SECTION II

From time immemorial, there have been those who have fought for individual liberty just as others have fought for collective action. These two sets of ideals are sometimes represented as alternative and mutually exclusive states; the more there is of the one the less can there be of the other. To those who believe this antithesis to be inevitable, it must appear as though the present essay is conceived with little regard for the individual as compared with his society or state. The exact opposite has been the intention. There are such things as individuals; but the life of a society only exists in the thoughts of those individuals. In any straightforward sense there is no corporate body, and there is no corporate mind. The observable facts are that human beings do react to one another in such a manner as to direct their actions to common ends, and the means taken to achieve a common end habitually involve a high degree of collaboration. Associated with these activities, the individuals are found to entertain sentiments about each other, about their common ends, their collaboration, and about groups as such. In general, people are found to place a high value upon social activities and upon societies.

People are also found to place a high value on what they refer to as individual liberty. It is also to be noticed that many people obtain the satisfactions of this liberty, whose habitual actions and thoughts are guided by a high regard for the activities and thoughts of others. In fact, people obtaining the satisfactions of individual liberty are very apt to be just those who participate to a high degree in the sentiments and activities of their own society. This suggests that there can be no necessary inconsistency between the claims of individuals and the claims they make for their societies, although conflicts between the two have not been infrequent in practice. We might go further and state that in general, the satisfactions of individual liberty are rarely experienced except within the framework of a fairly co-ordinated group or society. The evidence for this lies partly in the general field of psychiatry and morbid psychology, where it is found that much personal unhappiness arises from a failure of the individual to play an active part in a society for which he entertains a high regard. Further evidence comes from the field work of social anthropologists and sociologists who arrive at the same conclusion from an intensive study of particular communities or groups. There is the less systematic impression, derived from histories, memoirs and from direct observation, that on the whole most strikingly original characters, and those with strong individuality, are not the least influential members of highly integrated societies. Thus, on the basis of observed fact, it is reasonable to suppose that what is referred to as the pleasurable exercise of individual liberty can only be obtained within the framework of some kind of orderly society. Naturally, it does not follow that every type of social organization is equally likely to yield this particular satisfaction.

The craving for social relationship is extremely deep in human nature. One of the most striking instances is to be found in the character of certain religious institutions. For instance, the life of the hermit might seem to be eminently suitable for those who wish to devote their lives to religious contemplation. Thousands

of men and women have in the past and do now devote their lives to this cause, but not as hermits. The world is covered with monasteries in which this way of life is practised as a social activity. Some years ago, I visited a monastery in Europe in which the monks led purely contemplative lives, so much so that they were forbidden to speak to one another or to visitors. It was interesting to find that these men took their meals together at a common table whilst the only inmate allowed to speak, read to the others from a religious book. Men and women who practise contemplative religion are rarely found living alone. And the need for doing things together has led to a decline in the importance of purely contemplative orders as compared with those who exercise their social capacities in teaching or caring for the sick and destitute or in doing other things. It is true that hermits are said to be somewhat less rare in the Far East. But one is informed that these are usually elderly men who have already led an active life and wish to retire in their old age. The hermit is a rare phenomenon, and the general opinion is that the satisfactions of individual expression can only be obtained through some measure of social living.

What, then, is this need which is described as a need for individual liberty or a need for self-expression? It is clearly more than an urge towards adequate adjustment, and involves the possibility of expressing something to somebody. A small child of my acquaintance fell down and hurt herself. Her mother on hearing of the accident asked the child whether she had cried. "Oh no," was the answer, "you see nobody else was there." The urge is not merely to devise action appropriate to attitude, but to *communicate* this attitude to others. To communicate attitude to others and to be communicated with — this is somewhere at the root of human association. Moreover, these communicable attitudes are very usually focussed on activities having a logical purpose. The desire for individual expression is somehow connected with the desire to do 'worth-while' things together with other people. And the liberty consists in the opportunity

to make one's own chosen, but fitting, contribution to the purposeful activity of the group. To choose and to control the form of one's contribution is to exercise personal initiative; to stamp the group with a character it would not have otherwise had. This is to obtain the satisfaction of *personal adventure in social activity*.

Unless the individual has the freedom to choose the form of his contribution there can be no self-expression; and equally unless the group has, for the individual, a high value, it can be of no interest to contribute to it. Thus, it is of the essence of this satisfaction that the individual shall be acting with a respect for the continuing importance of his group. Social responsibility is required for satisfying self-expression. This enables an individual experience to become a part of something larger and, in his thinking, more important than the single person. However, if the group is too large, it is not easy for the average member to make a noticeable impression upon it. Hence, most people associate in fairly small groups, comparable in size with a large family; this is true even of those who control large enterprises. An individual who could make no direct impression on a large mass of people may be an effective, or even a leading member of a small group within it. This small group then makes its characteristic contribution to the larger organization, and in this way the individual becomes effective on a wide scale and avoids being submerged in a sea of undifferentiated humanity.

The hierarchy and the overlapping of groups, each with its purpose and its specific contribution, is an organization in which an individual can obtain the satisfactions of personal expression, but only to the extent to which it has value in his eyes. This does not necessarily imply that he approves of the particular organization but that it is a focus for his regard. The need for displaying initiative within a formed society appears to be universal. But the degree in which the individual requires the guidance of social routine varies greatly from one person to another. A situation that was an opportunity for Napoleon would appear as an unmanageable disorder to most of us. For most

people, not only must society provide the necessary stability for orderly initiative, but concrete suggestions for the lines that initiative shall take are also required. Without active leaders, there is little possibility of suggested and somewhat guided initiative, and then self-expression for the average man becomes too difficult.

To sum up: The problem of satisfactory living for the individual is very largely the problem of providing a satisfactory society, and fitting him to live in it. Individual liberty and collective action are not alternatives; each is bound up in the other.

SECTION III

It is my central thesis that a modern industrial society suffers from a dangerous lack of social integration, and that certain characteristics of industrial activity are likely to increase this condition unless steps be taken to prevent it. But the few examples of actual social integration and disintegration we have examined, make it abundantly clear that these phrases cover a number of different conditions, and some attempt should be made to classify the main ways in which a society can fail in adequate integration. To diagnose a society as suffering from disintegration is as though a doctor should declare his patient to be suffering from illness.

The words 'society,' 'group,' 'community,' and so forth are themselves extremely indefinite. They all indicate some people as being connected to the exclusion of others. A society, group, etc, may be thought of as a number of people who, from geographical or other reasons, are unable to live their lives or to engage in some important occupation without a substantial degree of mutual activity and mutual concern. For many purposes, a man and his wife belong to the same society or group, but for other purposes, such as paid occupation, this is often not the case. In some sense, all the members of a given nation belong to one society, and again in other senses this is not so. A society or group cannot be usefully considered apart from the activities it promotes and controls; but these are not limited to the nominal

purposes of the society as was seen in the case of trade unions. Most villages and towns do not possess a nominal purpose of any kind, although they do in fact promote and control many vital social processes.

A disintegrated society or group is one in which the satisfactions of living for each member are reduced, owing to a poverty of mutually accommodating activities. This lack of social cohesion can take a number of forms but it does not imply a social malady unless someone is the worse for it. For instance, if it be found that the inhabitants of the Nicobar Islands in the Bay of Bengal and the citizens of Paraguay are failing to act in concert, that would not necessarily indicate a state of social disintegration. There is no reason to suppose that these widely separated groups form one society, in the sense that the lives of either group are unsatisfactory because of a lack of more effective co-operation. So far as the satisfactions of either group are concerned, the other might probably never have existed.

There are various ways in which the conditions of social disintegration could be classified. The following provisional classification of these conditions into three main types is offered for what it is worth; it is obviously crude but I find it useful.

1. *A bifurcation in the personal stream of social activity.*
2. *Unassociated groups within one society.*
3. *A poverty of the personal stream of social activity.*

These types of social disintegration are not independent of one another; each facilitates the other two in some degree, and they all shade into one another.

1. *A bifurcation in the personal stream of social activity.*

This form of social disruption in its present degree is an outcome of the earlier phases of the industrial revolution, for society has been divided into two unbalanced parts by the impact of technological processes. On the one hand are the business activities of society. These activities are the direct result of applied science and of technological advance. They were chosen at random so far as any sociological considerations are concerned, and

they have been elaborated with a single eye to their logical purpose. These activities are seriously deficient in the opportunities they offer for immediate social satisfaction. The remaining widespread social activities are those which have been least affected by logical direction. They are apt to be deficient in purpose or inefficient in achieving their purpose. For the industrial worker, life is maintained in two relatively water-tight compartments, one of which is all purpose and not socially satisfying; whilst the other is deficient in achievement and is apt to be overweighted by purposeless pseudo-social occasions. This latter feature is a natural over-compensation for the social aridness of economic employment. An important feature of any industrial society is the emphasis placed on purposeless activity out of working hours. This alternation of detached spells of almost exclusively purposeful and then purposeless activity is about as satisfying as taking alternate meals off dry bread and pats of butter respectively. Neither form of occupation amounts to real social living, and the net effect is seriously to restrict the occasions for a true social activity which would be at once purposeful and immediately satisfying.

The effects of this bifurcation in the stream of life have been examined in some detail. It is not merely that two widespread types of social activity are developed side by side, each with little concern or loyalty for the other — that would in itself be serious, but each type of activity lacks an ingredient for its own survival which is found in great abundance in the other. We have traced the lack of interest of the industrial employee in the purposes of his formal leaders, and also the lack of vitality in the community outside the walls of industry. Each half of the social stream was found to need the other in order to provide interesting opportunities for individual initiative.

2. *Unassociated groups within one society.*

This form of social disintegration is as old, as society itself. Sometimes the groups have been divided by race or territorial origin, by social class or religion, or by the growth of incompatible

interests of one sort or another. However, the liability to this particular condition has been increased by the rise of the factory system, and the complexity and range of modern business. The pre-factory landed organizations of European society left much to be desired from the standpoint of the poorer sections of the community; nevertheless, it owed its stability for centuries to one great merit: it integrated society from top to bottom. Whatever may be thought of the proportion in which the various classes shared in the fruits of activity, it is true that the behaviour of each class was guided by a concern for the others. The landlord in particular recognized certain obligations towards his dependents; he organized the village life; provided for its secular needs and supported the church; he and his family among other things acted as an unemployment relief bureau and as a charity organization. The labourers may not have had much comfort in this life, but they had this little for so long as they lived and accepted their obligations within the system. The rise of the factory system in Europe did little immediately to improve the status or comfort of the employee, but it substituted an employer-owner for the landlord, and the employer recognized no social obligations towards his 'hands.' In consequence, the employees became a group dissociated from the main stream of national life. To a smaller extent this dissociation between class groups in an industrial community exists to this day.

In America, as we have seen, industry did not start with this wide social gap between employer and employee. But more lately, racial differences have been emphasizing the distinction between executive and employee in some American cities and industries, and in some respects these two groups are less intimately associated than in certain European countries.

Another way in which groups within one society may become dissociated is owing to the range and far-reaching spread of business. This has drawn into one society, in the sense defined above, communities that were formerly separate societies. It proves no longer possible for these communities to act in disregard of each

other's welfare without mutual impoverishment. Such communities are forced into one society by the logic of modern trade, but they are not necessarily united by ties of common customs and sentiments based on habitual face-to-face relations. They do not *feel* the common kinship which their logical purposes demand. The result is a formal organization embracing a number of groups which remain in a relatively secondary relation to one another, each endeavouring to influence the central authority in a sense favourable to its special interests. In America, this is illustrated by the rise of what is known as political pressure groups. A pressure group is a united body of opinion representing some particular sectional or trade interest, organized to influence the governmental authority to take action favourable to itself, without adequate consideration for the balanced needs of society at large. In the United States, the division between groups sometimes occurs on territorial lines, sometimes on lines of particular interests, or it may take place on racial lines. Naturally, these causes for division often, though by no means always, run together and reinforce one another.

(3) *A poverty of the personal stream of social activity.*

This social ill does not necessarily imply a bifurcation in the personal stream of activity, nor yet a cleavage between groups. It consists in each individual experiencing a lack of interesting associations with other people. The value of living for each individual is reduced, owing to a lack of meaningful social occupations.

Studies of industrial centres, such as the studies of Chicago undertaken by R. E. Park, E. W. Burgess, L. Wirth and others, emphasized the number of men and women of all ages living out of contact with their home circles and unable to form any other interesting associations. Such people are apt to exhibit symptoms of personal disintegration, and to become involved in undesirable activities. These are extreme instances. But after making due allowance for the present focus of interest, it seems clear that the number of actively unhappy and lonely people is

definitely increasing. Our society contains a high proportion of men and women whose desires, ambitions and social sentiments find no adequate expression in the adventure of social living.

Psychoanalysis can be no answer to this situation for two reasons. As a society becomes more and more disintegrated, the need for the psychoanalyst would outrun any reasonable supply; but this is the less important difficulty. The task of such a practitioner is to adjust a disorganized personality. To adjust him to what? An individual is not a self-contained, self-supporting entity. The parts of a steam-engine can be adjusted to each other; there can be such a thing as an adequately adjusted steam-engine on a desert island, even in the absence of fuel or engineers to run it. But human personality is not a mechanical assemblage of parts which can be internally adjusted. A self-sufficient human being is a contradiction in terms. To be alive is to be actively adjusting oneself to one's surroundings, and equally to be adjusting the surroundings to oneself. An essential ingredient of a human being's surroundings is his society; and a psycho-neurotic is one whose relationship with his society is seriously defective. In a disintegrated society, such a situation becomes probable, for by definition a disintegrated society is one in which people have not the opportunity for adequate partnership in a sufficient variety of satisfying and purposeful experiences. This is not a society to which a psycho-neurotic can be adequately adjusted.

A poverty of social activity is by no means peculiar to this age, but it has received an impetus owing to the *rate of change* of technological processes and consequently of social procedures. People can only get together on the basis of understood routines and customs which guide each to play his fitting part in the joint activity. And the rate at which society has had to accommodate itself to changing conditions has so reduced the number and the value of these routines and customs that an insufficient basis remains for social organization. In Chapter XI we found that industrial workers in Europe had been disintegrated in this sense,

amongst others; they were forced out of the social organization. And we also saw in the trade unions an answer to this situation. The unions were organizations evolved by the workers themselves to meet their social and, as a part of this, their economic needs.

SECTION IV

The degree to which social disintegration is mirrored in the national economic balance sheet, and in the balance sheets of individual firms, is difficult to realize. At the present moment, we are dogged by the spectre of technological unemployment. This is an ambiguous phrase and is in serious danger of becoming overworked. The fact is that a disconcerting number of industrial workers are unemployed, owing partly to changes of techniques, and no one knows how to remedy this situation. About the silliest explanation that has been seriously advanced is that the productive capacity of industry has outrun the human need for manufactured articles. This explanation never had a wide appeal, it is so obviously not in accordance with the plain facts of the case. But something very like this belief is implied in a wide-spread doubt as to whether our society will ever again be able to offer the bulk of its citizens full industrial employment. There is much talk about an 'economy of abundance,' and the need for educating the masses for leisure. How many of us are feeling so 'abundant,' even in the wealthiest nations? How many of us, in other words, are in a position to obtain the purchasable commodities and services we may desire? I am not referring to vague day-dreams of a financial status very different to our own; these dreams do not necessarily represent real wants. But how many of us *in our accustomed ways of life* do not wish for a moderate increase in our purchasing capacity? If there is one thing more sure than another, it is that no large society is suffering from a surfeit of material goods. Ask any man in the street how well this hypothesis applies to him.

A more plausible explanation is that of unbalanced production. It is admitted that we are facing no such thing as over-production

as a whole, but it is asserted that the relative proportions of the various commodities purchased are out of balance; some commodities in fact are over-produced. Clearly, industry as a whole depends on a just proportion of its parts, and the theory that this proportion has not been maintained is certainly attractive, and it contains a measure of the truth. But even here the evidence is not wholly clear. In so far as unbalanced production merely means that industry is failing in its job of producing a widespread activity, this is obviously true, but it only points back to the original problem. It is very doubtful whether many articles are manufactured in excess of actual wants, or whether this would be the case even if the productive powers of a nation were used to capacity. No doubt instances of such lopsided over-capacity could be specified, but they would be few. The fact is that the well-being of a community finally depends on the degree to which initiative is exercised and organized.

After the Napoleonic wars, England, in common with the rest of Europe, suffered a severe economic depression. Unemployment was great, wages were poor, and capital was non-existent. In spite of a growth of engineering, as compared with a generation before, the general economic condition of England was deplorable. It was in the midst of this situation that railways made their appearance as a practical engineering possibility. Railways as an idea became the national romance. They were the coming thing. People dreamed of railways much as they have subsequently dreamed of automobiles. Everyone became railway-minded. Even Herbert Spencer started life as a railway engineer. The final result was that in the 1840's England was not only covering herself with railways, but was financing similar activities all over Europe and also to some extent in America. And this railway activity promoted a growing era of well-being in England which may be said to have lasted until 1914. The most obvious characteristic of railroad construction is that the capital expended cannot possibly be recouped until the service has been in operation for a considerable number of years. On the face of it, no

impoverished country could afford the luxury of financing thousands of miles of railways; and yet this great (book-keeping) drain on the nation's resources was the very thing that promoted an *immediate* increase in well-being. A vitalizing idea had canalized the activities of a nation into a practical channel. A simple objective had appeared, around which industry could be and was organized. From being a disorganized and under-employed community, the nation became active and interested in an economically adequate adventure.

The essence of well-being is to be active with others in an economically adequate purpose; and a necessary condition is that organization and initiative should be sufficient for the human and material resources involved. Unemployment is in a real sense a condition of unbalance, for initiative and leadership are lagging behind their human resources.

After the Napoleonic wars, the east coast of America was threatened with technological unemployment but it was not unemployed for long. During those wars, its prosperity was largely built up on overseas commerce; this was the product of the European situation, the daring and imagination of the merchant-captains of New England, and the unrivalled ship-builders in the ports along the New England coast. The American clipper ships outsailed those of any other country, and their owners became wealthy by opening up new trade routes and by establishing themselves on those previously exploited by the warring European nations. This trade was checked by the termination of the Napoleonic wars and still later by the advent of steamships, which were more easily built in Europe. It is sometimes stated that the capital derived from the clipper trade was put into other industries, railways and cotton amongst others. But this can hardly be the important fact. There was much capital in the clipper trade; it took the visible form of ships and docks principally; but it is not clear how unwanted hulks and useless docks could either be sold or turned into anything else. Nor had New England invested large fortunes in other parts. The fact is that the leaders of New Eng-

land trade had the prestige and the initiative to enter into new projects. Human resources were balanced by an adequate leadership. So unemployment is to a large extent a measure of the inadequacy of social organization; initiative is failing to sustain the necessary degree of useful co-ordinated activity required for full employment.

Another form in which individuals and societies are paying for a lack of integration is in the absence of mutual support as between various types of interests. This we have already discussed. Management and the employee body are found to be behaving with an insufficient concern for one another, and the result is something less than an adequate co-operation from either side in their mutual purposes. The same thing was found to apply to the relations between industry and the community, whether the latter be regarded as investors, as consumers, or as co-inhabitants of particular territorial districts. The effect of a lack of mutual concern between sections or interests in a society is to render the activities of each more hazardous by depriving it of support. Institutions which are felt to be an integral part of a society's life are not allowed to collapse; conversely, institutions do not long remain stable after they have lost the loyalty of their communities.

It is a common complaint that initiative is lacking today, but a moment's glance at the technical progress of modern industry dispels that notion. It may be that initiative is inadequately guided, from too narrow an understanding of its purpose, but it certainly is not absent. So we come back to the central thesis, that leadership must be directed by a sufficient understanding as to the factors involved in human well-being, and that society must retain the necessary cohesion to be capable of being intelligently led.

SECTION V

The cohesion of society depends upon two things. The first is the habit of doing things together in understood ways; and the second is the sentiments which arise as to the high value of cus-

tomary procedures and which cause people to resist change in their habits. These sentiments are generalized in the form of codes of behaviour and of social ethics. Orderly activity can only take place if the function of each person is in some sense expected and understood, and if the attitudes and intentions of all are brought somewhat into line. It is therefore quite vital to social cohesion that custom should be preserved, or rather that it should evolve gradually. But it is important to be as clear as possible as to just what it is that has to be so carefully guarded.

No event ever quite repeats itself, and human beings show a considerable capacity for understanding one situation in terms of another and somewhat different situation. The life of a family remains essentially unchanged in its own thinking after moving into a new house. Actually, almost every action has been slightly changed but the pattern of life remains as before. It is the conceptual pattern, or understood way of life, which enables people to accept some degree of change without a breakdown in the adequacy of their behaviours and sentiments. This capacity for understanding a number of somewhat similar situations, in terms of a concept which is sufficiently general to cover them all, is of the essence of understanding. But for the most part, the concepts are not explicit, and they vary from one type of group or society to another. On the whole, it seems that stationary societies understand their activities in terms of less flexible and less general concepts than do those accustomed to more rapidly varying conditions. This, if true, is extremely important; for the capacity to experience changing conditions without disruption depends partly on understanding the new conditions, as fitting into the conceived way of life to which the individual is already emotionally oriented and within which he has a practical sense of his own proper activities.

Let us examine an understood way of life in an actual industrial situation, and see the manner in which it provided a bridge by which to pass from a relatively simple technological level to a more advanced one. I witnessed an interesting example of this

shortly before the World War, in a large engineering shop in England. The working group in which I was a temporary apprentice was composed of skilled mechanics trained in manual dexterity. These men might have been unfamiliar with the latest types of automatic machine tools, but they took an intense pride in their personal skills with the traditional tools of their calling. Amongst other things, every skilled mechanic at that date was an adept in the use of a hammer and cold chisel. If given a mild steel plate of about a foot square and an inch or two thick, in a few hours he could chip off the surface, making the plate perhaps an eighth of an inch thinner, and he would give it a surface which for truth and smoothness might almost have come off a modern machine tool. The highest praise of these men was to say that so and so "knows his hammer and chisel." Newcomers were given such a plate and told to reface it, and during the operation a close watch was kept by the members of the gang. There was no purpose in this task; the plate was quite useless and the newcomer knew it. The whole proceeding amounted to a test of skill and as such was accepted by everyone. If the mechanic failed in the job, he never recovered his status with the group.

On one occasion, a young Welshman was hired by the firm and put into my group. The group disliked his appearance, which was certainly not in his favour, and he turned out to be an unpleasant fellow. However, he was given his steel plate and set to work surrounded by the other mechanics. The Welshman did an outstanding job both for speed and quality, and the remarks of the group began to change in tone as the work went on. Finally, our gang boss expressed the sense of the company by saying, "Well, you certainly know your hammer and chisel." From that moment the Welshman was an accepted colleague; and if his obvious defects led to any criticism, it was always concluded with some remark to the effect that "Anyway, the fellow knows his hammer and chisel."

It is worth considering just what it meant to that group of mechanics to have as a new member, a man who knew his hammer

and chisel. In the first place, the new mechanic was possessed of a specific skill which might conceivably be required of the group, though as a matter of fact it never was, for it was rare even then to be reduced to such primitive techniques, and the plant in question was a progressive one, well equipped with modern machine tools. A hammer and chisel to these men was about as useful as a sword to an infantry officer. Most of them had been apprenticed fifteen or twenty years previously to smaller and more conservative engineering firms where a knowledge of the hammer and chisel was essential. It is also one of the simplest and yet the most difficult of the skills in manual engineering, and it is only acquired after years of patient practice, in which the mechanic grows to have an almost religious veneration for the controlled and sensitive strokes required to achieve success. To know oneself possessed of such discriminating art is a source of great contentment.

So to know one's hammer and chisel implied years spent in acquiring a particular professional attitude with satisfactions, loyalties and pride developed around the mechanic's way of life; and finally, it stood for a skill which was held in common by all men with the same emotional and conceptual orientation. To know one's hammer and chisel was the manifest sign of an inward conditioning. When the Welshman was found to know his hammer and chisel, he was immediately placed on terms of habitual intimacy with the group of mechanics; it was as though he and they had worked together for years and had built up the mutual sentiments appropriate between reliable colleagues. Thus, a common scheme of life fulfills the function of putting any two members of a society into the relation of habitual association, even though they be utter strangers to one another. The appropriate sentiments and the common understandings are quickly established, and efficient co-operation is possible almost at once.

The particular group of which I am speaking not only had no use for hammers and chisels, but they never had serious occasion

to use a tool of any sort. They were engaged in the shop-testing of medium and large-sized power plants which had been built by the firm in question. This involved some knowledge of engineering theory and an ability to handle simple algebraic and trigonometrical formulae. And to my knowledge, these men used to spend many of their evenings and week-ends learning this theory with the help of suitable textbooks.

The group was undoubtedly above the average both in intelligence and in ambition, and they were determined not to be left behind as casualties in the advance of engineering methods. They had individually applied for this particular department as likely to give them an insight into the more theoretical aspects of their calling. These men worked well together and spent a part of their leisure hours in common, sometimes visiting the local theatre, and at other times taking walks into the country. They were tolerant of newcomers and used to invite me to their lodgings or homes. The general effect was that of happy integrated men who were confident in their abilities to lead the life they wanted. Here was a group of superior mechanics who had been trained in an old-fashioned school of engineering; they had made a successful adjustment to a more advanced technology in which their high manual skills were of little use; this involved teaching themselves a new type of interest, involving their heads rather than their hands.

Several factors contributed to the success of this group, apart from their real abilities. The jump from a manual to what can be loosely described as an intellectual occupation did not involve a break with the class into which they were born. At a time when England was more sharply organized on class lines than at present, this point is of the utmost importance. They could still consort with people who held roughly the same ways of life as themselves, though it was noticeable that their friends tended to stand rather high in the scale of intelligence.

The second thing to notice is that each man made this jump on his own initiative; thus they were reacting as they saw fit to their

visible circumstances. No change of occupation had been imposed by someone in authority; to each man, the change appeared as an interesting development of his previous life rather than as an interruption to it.

The third point is that this change of occupation had been accomplished in terms of their original way of life or ideology. They still were the men who knew their hammer and chisel, with all that implied in the way of sentiment, thought and social wisdom. And it was these hammer and chisel men who, as an integrated group, were addressing themselves to a natural development of their occupation in terms of hammer and chisel concepts. Men with a similar conditioning were able to act together in changing circumstances with complete confidence and without loss of their social sentiments. This is the precise reason why a long-service regular regiment can be stationed all round the world and experience active service anywhere, and will finally come home with substantially the same social sentiments with which they set out. *Plus ça change, plus c'est la même chose.*

People with an intellectual training are apt to express themselves in abstract terms and this habit can easily become a vice, for it serves to hide the fact that sentiments and understandings are all ultimately based on concrete experience in some manner or other. In a sense we are all hammer and chisel men, and our conceptual schemes are generalizations of hammer and chisel situations. The practical question is how far we can adjust ourselves to new situations in terms of our old schemes, for these can only change slowly and to a limited extent once they have been formed. It is easy enough to express a generalization to fit any set of situations; the difficulty is to clothe it with appropriate sentiment and personal loyalty, and to possess the wisdom in action which comes with habitual experience. It is the practical understanding expressed in wisdom, and the emotional acceptance accompanying this, which sets the limits to human powers of meeting new situations and which defines the degree to which we have generalized our experience.

But though it is a fact that the wisdom in action of the intellectually trained man is closer to actual experience than his verbal generalizations might lead us to believe, yet it remains true that such men show a greater capacity for adjusting to varying situations than those whose training and occupation are strictly manual. It is not that the former show a greater capacity for changing the character of their concepts in later life; these are based on their experiences (including thoughts, of course) and are almost necessarily relatively fixed. The history of opposing schools of thought in any learned subject is sufficient evidence of the incapacity of men to alter their frames of reference. But the type of concept or generalization effectively held by those who have studied a few formal disciplines, and whose work depends on this knowledge, possesses a wider range of application than do those concepts which are built closely on kinaesthetic impressions and bodily skills; the former are also more explicit. This is the only excuse for abstract thought.

The point is that wisdom in action does not spring directly from occasions of experience but from a slightly generalized conception of these, which may be referred to as the individual's way of life. Within the limits of his generalized conception, the individual can display fitting activity, and beyond that limit he is relatively powerless. Consequently, the individual is intensely loyal to his generalized conception, his way of life, and resists any change which will put him outside of it.

A kinaesthetic way of life is closely akin to that of the artist; it appeals very powerfully and directly to the sentiments, and it has a narrow range of applicability. This is of the first importance to society, whether we consider industry or life in general. In industry, those engaged in occupations depending upon manual skill will be more disrupted by change than workers with a better education and those whose occupation involves the general supervision of machinery. Small changes which would pass unnoticed with the latter are matters of preoccupation for the former. This suggests one of the reasons why some firms find it

advisable to offer their young employees a more formal education than can be picked up at the bench. The drift in industry is away from the use of a narrowly manual skill and towards a type of employee with greater formal education; and it is likely that this will somewhat affect the possibilities of maintaining integration in working groups during periods of change. Society outside of industry is largely composed of these same people and their capacity for change with adequate leadership is also likely to rise. Education and prevalent types of occupation are matters of profound importance to a society which must maintain integration in the midst of rapid evolution.

The integration of a society is based on loyalty only possible between people who possess ways of life in common. Naturally, this does not imply an identity of occupation or sentiment as between all the members of a large society, such as a nation. In fact, such a condition would be intolerably dreary and unsatisfying. Human beings appear to seek a complication of motives and circumstances; the satisfactions of a wide circle of friends, of family life, of working associations, of political interests, and so forth, all attest to this desire for complexity. But complexity for the individual must not degenerate into chaos; he must retain some understanding of the organization or relationships between all those social activities in which he is involved. This understanding will not necessarily be verbalized but is evidenced by wisdom in action.

The problem for the administrator or the statesman, with his grasp of logical disciplines, is so to lead his fellow men that the immediate demands upon their activities can be met in terms of their more restricted wisdoms. The moment these limits are passed, the followers lose their sense of direction; the situation looks to them like chaos and they will in some manner repudiate their leaders. We have found that something like this is already occurring in industry, and the phenomenon is not unknown in government.

SECTION VI

The actual satisfactions which people seek when engaged in occupations are very complicated. Thus, people seek to obtain an income. This provides for physical needs; it enables the individual to participate in social activities by arranging his physical environment to this end; it also marks his social status in society to some extent, and provides physical objects which are themselves objects of pleasure to the owner. Finally, the fact of possessing such and such an income is a satisfaction to the individual, quite apart from ulterior considerations.

Secondly, it is a well-known fact that people will not work cheerfully and well for an adequate income if the work itself is judged by them to be useless. The test of a useful occupation is not very clearly expressed, but it seems generally to involve two factors. The first is that the service rendered, or the product made, should generally be wanted by somebody; and the second factor is that the service or product and its demand should have the sanction of social approval. The last point does not imply that society formally states its approval; in fact the activity may even be illegal; but the society must act as though it thought the activity to be not unworthy. Every practical manager knows the added satisfaction shown by employees in a firm with a deservedly high reputation for the quality of its products. Even if an employee is engaged in an unskilled occupation, he has a pride in his association with so worth-while an organization. The need to be associated with a group which plays an important part in its society is very real, for the contribution which an individual makes to society depends not only upon his own efforts but also upon the importance of his immediate group.

Thirdly, it is well known that some people prefer one type of occupation and some another type, even though these may both be judged equally worth while. For instance, some people prefer to be carpenters whilst others like to work with metals, or perhaps with woven materials. This preference for particular

techniques is quite marked, and is often associated with superior skill in the chosen direction. The satisfactions of skilled performance and those of working with preferred techniques are not identical, but they are closely allied in the thinking of the individual, and together they account for a significant part of his pleasure in work.

Lastly, not the least important satisfaction of any occupation lies in the immediate social situation involved; the doing of things together with other people and making a personal contribution to the immediate social situation, in the doing of these things. This satisfaction has been so consistently emphasized that it need not be enlarged upon again, but it is mixed up with the other factors just mentioned; for if any of these is not satisfactory to the individual, the chances are that his participation in the social activity will be to that extent less effective.

All these various satisfactions in activity depend, in a greater or lesser degree, upon the individual's understandings concerning the society in which he lives. He is tacitly assuming a set of values held in common through large parts of the community, and also certain habitual procedures or routines as maintaining its character. To a large extent, the value or sentiment is regarded as adhering to the routine and secondarily to the society which practices them. Thus, it is good to be truthful; hence, a truthful society is a good one. An alternative attitude to which we may give intellectual assent, but which is not so typical of ordinary daily thinking is as follows: This is a satisfying society; I notice that its members tend to tell the truth in certain types of circumstances; hence, in this society and in those types of circumstances it is a good rule to tell the truth. In the long run, ideologies do tend to capture our adherence for pragmatic reasons, but they then develop a life of their own and accumulate a value for their own sakes. There is nothing material or conceptual which we handle habitually which does not come to have a value for its own sake in our thinking. So it is quite possible to start an earnest discussion as to whether it is wrong to tell a lie, when on the

whole and over a sufficient period of time everyone would be the happier thereby.

The semi-independence of codes of behaviour and conceptual schemes of the particular circumstances from which they sprang is of the greatest importance for society. They both define the limits of change which a wise leadership will attempt, and within those limits they make possible evolution without social disruption. These codes and schemes and implicit understandings run all the way from systems of ethics, economic habits and formularized statements of these, routines of human association (e.g., taking off one's hat to a woman), to such vague appreciations of 'fitness' or seemliness as cannot be easily stated but have a powerful influence on thought and conduct. The 'hammer and chisel' understandings already described come under this general heading.

New techniques or details of procedure can usually be introduced into a society, without causing disruption, to the degree to which they can be subsumed under old understandings. It is these old understandings which form the values of living and in terms of which the individual can show wisdom in action; and he is consequently more tenacious of his codes, theories, and schemes than of the detailed experiences from which he derived them. Thus, a community may tolerate a new economic activity which can be brought under the current economic theory, but it will violently resist the same activity if it be described as involving, let us say, Marxian doctrines. It is usually argued that the novel doctrines are wrong in theory — that may or may not be true; it is often not true. But what is certain is that the community is not conditioned to show wisdom in action under the novel ideology. It was partly on these grounds that we considered the unwisdom of introducing routines involving violent changes in social, economic and political doctrines. Wise social evolution must satisfy the logical test of improving the efficiency of activity whilst not disrupting customs or routines. Luckily for the progress of mankind, these customs and routines are never understood

as absolutely definite and particular actions, but as a sort of generalized description or understanding of these, and it is these slightly generalized understandings to which our loyalties are attached. We have had occasion to notice the very small scope of some of these understandings, especially amongst manual workers in unskilled or semi-skilled occupations.

One of the difficulties in understanding human activity lies in the fact that it is never the consequence of one single and sufficient condition; so many factors are usually involved which react one upon the other, and any given activity is not understandable as a logical consequence of past conditions so much as a part of a present adjustment in which it is one factor. Thus, trade unions in Europe and in America have as a sufficient condition the desire to increase the bargaining power of the employee. But a glance at the actual histories of unions in various places show that they are not similar, and that nowhere would this simple explanation wholly account for what was actually taking place. We found that unions on the continent of Europe were performing different social functions to those in England, or to those in the United States. In the last country, the unions have had less opportunity to perform this function than in the others, and the union movement is correspondingly weak.

Very few human activities are entirely without a logical purpose and similarly, very few fail to yield some immediate social satisfaction to the actors. Moreover, the style of these activities will reflect the type of social situation in which the actors find themselves, as in the case of the unions. Another instance of this was seen in the contrasting attitudes and behaviours of the relay test group and the bank wiring group, or again a comparison was made of the social situations and the behaviours of the former group at various dates. The rise of fashion and the change in style of advertisements are yet other instances of the same thing.

The form of a social activity is determined by its logical purpose and by the social situation of the group involved, and the study of psychology is apt to stress the individual differences as

between people, whilst sociology emphasizes those ways in which people in similar situations behave similarly. We have noticed the differences between people in the individual contribution which each makes to his group, and in the choice of a group, and their similarities in the adherence of the group to common sentiments and common aims.

It is one of the peculiarities of human nature that logical purposes are easily expressed and that this expression is felt to form a justification for the action, but that the non-logical motives involved are difficult to state and are not always considered to justify the action. For instance, an organization has been 'explained' and justified, when we are told that it is an automobile factory, that its activities have been designed to that end, and that the public is prepared to buy its products at an economic price. It might sound less convincing to say that this human organization is a social process in which the activities of the various groups obtain the satisfaction of doing things together. The things they do have been so arranged as to produce automobiles, and this is a means of building up the future social satisfactions of the working force and of society at large.

Each of these statements emphasizes one factor in the stream of human living; but explicit attention is more easily directed to the definite actions involved than to the somewhat nebulous, though vital, satisfactions resulting from them. This is probably fortunate in practice, provided the technical operations are organized with regard for their ultimate purpose, but the latter must be recognized as being human satisfactions, and not some further technical operation or physical object. Thus administrators, statesmen and others are in the position of having to direct technical operations in terms of future technical operations, for the sake of human satisfactions which are rarely expressed.

The surest way of obtaining some insight as to the satisfactions sought, as to which are being adequately met and which are not, is to observe the style in which activities are being organized and performed. People will express their social needs

in action with an accuracy far exceeding their power to verbalize them. Every psychiatrist has observed this fact, and successful leaders and stable institutions act in the light of this knowledge, although the latter do not always make their wisdom explicit.

SECTION VII

In a simple society, there is comparatively little activity devoid of a business motive broadly understood, and there is also little activity in which the social element is not emphasized in some form or other. Living under these conditions is a relatively undifferentiated affair in which business and pleasure, and the various kinds of activities are all mixed up together. Moreover, activities of this sort are performed for the most part in small groups, rarely extending much beyond the family with the occasional co-operation of relatives and neighbours.

Business and industry, as those terms are used in industrial societies, do not refer to the whole spread of purposeful activity (e.g., making beds, cooking dinners), but to that part of it in which the techniques have been highly elaborated, and which are for the most part subject to continual modification as a result of skilled research. For various reasons, many of these highly elaborated activities are most efficiently performed in large groups, sometimes amounting to several thousand men and women, who originally had nothing in common beyond what is implied in the fact that they have all applied for work in the same group. These technical occupations are highly differentiated with the result that the variety of occupation experienced by each person is correspondingly narrow.

Moreover, a most undesirable differentiation of another kind has resulted more by accident than by design. The immediate satisfactions of social living have been largely divorced from the task of providing for a continuance of social living, with the result that neither recreational nor purposeful activities are entirely satisfying and neither obtains the full co-operation of the participants. Social living is based upon the production, circula-

tion and consumption of material objects, in any form of society; and roughly speaking, the possible satisfactions of living rise as the supply of material objects becomes more plentiful. It is the outstanding achievement of industrial societies that they have enormously increased the per capita supply of material objects. This is partly an achievement of the physical arts and sciences, but it is also due in no small measure to the degree in which human society has been organized around the techniques resulting from these arts and sciences. These human organizations are hardly less developed than the techniques themselves, and they have been designed with a single eye to the efficiencies they make possible.

The effect of this far-reaching type of human organization has been to depress the social value or importance of other types, such for instance as the landed organization or the churches. It is the evidence of history that the satisfactions of living depend upon the vitalizing power of organizations; for in so far as people are unorganized there is little possibility of making a personal contribution to a worth-while situation. Consequently, it is largely to the business and industrial organizations that we must look in the immediate future for leadership in initiating and guiding the social activity made possible by their technical achievements. This applies equally to the social activity involved in the work of industry and to that outside its walls. This does not imply that all human organizations should be primarily those of business or industry, but merely that no society can be vital in which its principal organizations do not conceive their responsibilities in social terms. This is particularly true when these organizations are engaged in rapidly modifying the customary conditions of life, and so endanger the traditions upon which any society is based, unless they act with a full appreciation of this problem.

SECTION VIII

Every society has its own ideal; and for some societies, including amongst others the English-speaking nations, the present ideal is

that of democracy. To some extent, such labels are misleading and are apt to indicate the preoccupation of the moment, rather than to correspond with any very marked peculiarity in the way in which society actually functions; a label often marks a reaction from a past ideal. Democracy is not a definite concept and it speaks with a different accent to each person and in each locality. Nevertheless, for many people both in America and in Europe, this term stands for a broad type of social organization which seems desirable to them; and for the English-speaking nations, amongst others, it is in the name of democracy that most people see the possibility of developing a more satisfying type of living.

What are the characteristics of a democratic society? We need not pay too much attention to formal definitions, but it is important to have some notion as to the type of activities and functions which a democratic society is intended to promote. I suppose that anyone calling himself a democrat¹ would agree that such a society is one in which each member has some effective opportunity to determine the manner in which he will make his individual contribution to the life of the society. This implies that the accident of birth shall not prevent the individual from obtaining an adequate education and social experience. These are vague phrases, but certain implications are worth noticing.

We have seen that no society can survive, in which its members act without regard for its stability and well-being. Hence there can be no absolute liberty regardless of consequences within a social framework. The only social liberty which is possible depends upon the loyalty of the individual to his society, and is proportional to that loyalty. This does not imply that the individual need suppose his society to be the best possible, indeed he would be a fool who thought that; but freedom is only possible for an individual in so far as he genuinely identifies his own satisfactions with the general well-being. Thus, democracy is not and never can be a condition of personal irresponsibility; it is, on the

¹ I am not using this word with any reference to the American system of party politics.

contrary, the wide diffusion of personal responsibility which characterizes a genuinely democratic society. Any attempt to organize a society on a basis of personal irresponsibility must end in chaos or in rule from the top, and there are plenty of instances of both conditions at the present time. The main danger to liberty seemed at one time to lie in the arbitrary power of traditionally favoured classes or persons, but that is no longer the case. The present danger is that in a disorganized world too little responsibility is assumed by the individual for the consequences of his own actions; or, to put the matter slightly differently, the individual has an inadequate range of social interests and concerns.

Democracy obviously cannot imply that all people are equal either in their natural endowment or in the functions they perform. Not everyone can be the head of a state or the manager of an industrial enterprise. In other words, there will always be pre-eminent men and women in any society. It is the manner in which these leaders are accepted, the conditions under which they retain that leadership, and the type of considerations that guide their activities as leaders, which determine the nature of the society and the opportunities of the individuals within it. The essence of democratic leadership is that it shall be so exercised as to promote opportunities for the fitting initiative of those within the society, and in the manner which these latter desire.

The actual organizations which can promote individual initiative depend upon the particular social sentiments that happen to be most highly developed. Thus in the United States, owing to its enormous territorial expanse, the size and diversity of its population, and its history, sentiment is not highly mobilized around the Federal Government. Consequently, activities of the Federal Government are apt to be contrasted in the minds of the people with actions performed by themselves. The activities of the Government in some sense are not a form of social activity in the popular thinking. In England, owing to its small size and to its history, the very opposite is believed to be the case. Consequently, the scope of the two central governments *as democratic*

institutions is somewhat different. It is fitting for the British government to act as a co-ordinator of people's activities to a degree which would cramp individual initiative in the United States. This difference is partly due to the mechanical and intellectual difficulty of legislating for the needs of a continent, but it is also a function of the orientation of social sentiment. These two factors are obviously mutually dependent.

The real leaders of America are not to be found so much in Washington as at the head of business enterprises, whilst in England the situation is reversed. Consequently, American business leaders have opportunities and social responsibilities somewhat greater than those in England, and the opposite is true of legislators and statesmen. This is only one example of the fact that the immediately possible functions of any given occupational or social group cannot be determined by abstract theory; the functions of a group depend upon the degree to which they are accorded leadership; that is, upon the degree to which the people identify themselves with the group in question. And exactly the same applies to the functions of any type of institution or specific organization whatsoever.

However, in no industrial society do large masses of the people believe themselves to be so led as to achieve a sufficient spread of personal initiative and responsibility. People do not find that they experience adequate social activities. This has been a central thesis of the present book; and the cause of this poverty in social living has not been found in a dearth of suitable material for leadership, but in an unduly narrow conception of their responsibilities and interests on the part of the leaders themselves. In any society, industrial or otherwise, the object of leadership is to achieve satisfying social living for everyone both now and in the future, and as a part of this task the leaders have the duty of organizing the economic procedures. But economic procedures are not an end in themselves, and leaders who neglect the end for the means cannot achieve a stable society. There can be no final solution to the problem of leadership in a progressive

society, for this is necessarily an endless evolution; but it is reasonable to assume that an adequate leadership will depend upon the continuous appraisal of the sentiments and understandings by which the society is guiding its actions, as one of the factors involved in the organization of purposeful activities. Thus, social sentiments must not be regarded as so many hurdles to jump in achieving a logical purpose, but as the *raison d'être* of that purpose. Social sentiments evolve and can be guided, but human order and satisfaction depend upon their existence in some form or other. In fact, these sentiments *are* a large part of the satisfactions themselves.

In any society, each member is to some degree a leader, whilst to a larger extent he is directed by others or by the ways of life he finds about him. For leadership consists in obtaining the permission of a group to make an individual contribution, to give it a way of life somewhat different from what it would otherwise have had. It is of the essence of a democratic society that individual initiative — that is, leadership, shall be shared in a relatively high degree by all its members. This, as we have noticed, implies a corresponding spread of social responsibility. This spread of responsibility in a democratic society makes it peculiarly vulnerable to a breakdown in the practical wisdoms of its members, and it suggests the extreme danger of introducing abrupt changes into the system; it also points to the duty of its members to inform themselves of the various social and political problems as these arise, for an ignorant or a negligent democratic society is a contradiction in terms.

The price of liberty is indeed ceaseless vigilance, not so much against the inroads of privileged persons and classes, as against the decay of widespread social responsibility which would necessitate excessive guidance from the top. A government elected by universal suffrage is not thereby a democratic instrument, and it only becomes this to the extent to which it is implementing an instructed and coherent public opinion. No formal devices for government can in themselves provide a people with a democratic

way of life, for the essence of such a life is the exercise of instructed and effective social concern. The danger of such a society has not proved to be that of technological inefficiency — democratic nations today are not inefficient in this sense; but rather that no over-all guidance will direct this activity along a socially acceptable route. This guidance is shared amongst the people, and what is required of them is not a superior technical efficiency so much as a constant regard for social values in the exercise of their particular activities.

Thus, a satisfying and progressive society is necessarily a self-analysing society, in which an experimental attitude with respect to social and political activities is combined with a wide-spread concern for the accepted ways of life; without the loyalties and understandings which adhere to the latter, the whole framework of society becomes utterly meaningless.

INDEX

INDEX

- Administrators, 82-86, 91
Advertising, 184-189
American Federation of Labor, 153
Authority, lines of, in industry, 114
Automobiles as examples of component design, 192-193
- Bank wiring group, 54-59, 66; attitude of supervisor, 102; restriction of output, 62; wage payment system, 129 seq.
- Bifurcation in personal stream of social activity, 232-233
Boredom in industry, 11-12
Bricklaying as example of manual occupation, 158-161
Building industry, organization, 157 seq.
- Business the pattern of stable social organization, 30
- Change, resistance to: as threat to stability, 65; examples, 59 seq.; in industrial groups, 110
Change, technological, 88
Changes, social: impossibility of foreseeing effects, 215 seq.; result of technical advance, 76
Chicago, industrial survey, 235. *See also* Western Electric Company
Christianity, organized, as type of social activity, 30 seq.
- Collaboration, lines of, 114, 117; suggestion for securing effectiveness of, 118; of workers with management through unions, 147
Collective action compatible with individual liberty, 227, 231
Company union, 154
Component design, 191 seq.
- Components, first and second orders, 194-195
Conferences between management and workers, 120
Constitution, British, 214; of United States, 215
- Co-operation between industry and society, dangers of insufficient, 240; importance of, 167 seq.
- Co-operative movement in England, 146
Co-ordination, essential to successful societies, 221; present-day lack in industry, 209 seq.
- Democracy, characteristics of a, 255 seq.
- Design, component, *see* Component design
Disintegration, social: reflected in unbalanced production, 237 seq.; types, 232 seq.
- Dismissal, arbitrary, a cause of labour unrest, 17
- Economic motives, over-emphasized, 23
Economic science, 19th century conception, 15
Economic theory, assumption underlying, 226 seq.
- Efficiency engineering, 136
Employees, representation on committees, 138 seq.; training classes, 136
Employer-employee relations, 66 seq., 104, 108
Ends, 'in themselves' as contrasted with 'means to further,' 121 seq.
- England, cotton industry, 209; mixture of aristocratic and democratic tendencies, 145; trade unions, 145; unemployment after Napoleonic wars, 238
Evolution of function essential to integration, 109
Expectation, *see* Social expectation
Executives as leaders in community, 167, 169 seq., 172 seq., 208, 257
Executives, senior, mental attitude compared with that of subordinates, 107

- Fashion, 179 seq.
- Federal government, *see* United States
- Financial motivation, *see* Motivation
- Foreman, *see* Supervisor
- Freud, Sigmund, 102 seq.
- Gompers, Samuel, 109, 153
- Government, activities in England and U. S. A. contrasted, 256 seq.
- Group, importance of social understandings within, 117; isolation within, 143 seq.
- Group, bank wiring, *see* Bank wiring group
- Group, relay test, *see* Relay Test Room
- Group integration, 109
- Groups, industrial: essentials to stability, 22 seq.; as formal organizations, 14; small, 95 seq.; structure, 3
- Groups, primary: as examples of social cohesion, 87; higher order, examples, 5, 6; second order, 6; small, 15 seq., 54
- Groups, primary and secondary: characteristics, 4 seq., 62; distinctions between, 6, 7
- Hammer and chisel men, 242 seq.
- Hawthorne plant, *see* Western Electric Company
- Hermits, 228 seq.
- Hiring in well-run firm, 136
- Individual choice of activity, 229 seq.
- Individual liberty compatible with collective action, 227 seq.
- Industrial groups, *see* Groups
- Industrial organization, contrasted with apprentice system, 143; effect on social living, 78
- Industrial revolution, 140, 142 seq.
- Industrial society, *see* Society
- Industry, human factor important in organization, 226 seq.; identity with social life in primitive communities, 77 seq.; increased recognition of social responsibility, 171 seq.; lack of co-ordination in, *see* Co-ordination; relation with government, 202 seq.
- Industry, modern: lack of stability in, 166; neglect of need for social participation, 126; separation of ownership and management in, 66 seq.; as type of social organization, 8
- Initiative, at different levels, 113 seq.; suitable distribution, 154
- Insecurity in seasonal trades, 174 seq.
- Institutions, social and religious, as integrating forces, 162 seq.
- Integration, dependent on evolution of function, 109; aided by management, 109
- Integration, group, *see* Group integration
- Integration, social: common understandings essential, 247; dependence on routine, 59 seq.; illustrated in relay test room, 54; importance of employer-employee relations, 66 seq.; lack in modern society, 231 seq.; maintained by conservative leadership, 69 seq.; need of consciously safeguarding, 80 seq.; in present-day industrial civilization, 91
- Johnson, Samuel, on 'style,' 178
- 'Keeping up with the Joneses,' 181 seq.
- Keynes, J. M., 'propensity to consume,' 189
- Kula trade in Melanesia, 27 seq.
- Labour unrest, causes, 16, 17, 19; manifestations, 17-19; types, 16
- Laws, dependence on social sentiment, 202 seq.; inflexibility, 203 seq.
- Leader, distinguished from administrator, 82 seq.; opportunities for business executive as, 257 seq.; primitive types, 68 seq.; type in modern industry, 78
- Leadership, characteristics, 68 seq.; functions and objectives, 69; involves change, 109; primitive contrasted with modern, 74 seq.; tends to maintain social integration, 69

- Lincoln, Abraham, as storekeeper, 164; quoted, 210
- Malinowski, Bronislaw, 27 seq., 142
- Management, conferences with workers, 120; distinct from ownership in modern industry, 66; problems in relation to small industrial group, 95 seq.; regarded with alarm by employees, 57; understanding of employees' social needs, 119
- Management, industrial: as aid to group integration, 116; attitude towards social legislation, 208 seq.
- Manual occupation, *see* Bricklaying
- Marbles, game, as example of socio-economic activity, 26 seq.
- Marshall, Chief Justice, 109
- Marx, Karl, 214
- Mathewson, Stanley B., on restriction of output, 18, 59
- Matter, composition, 193 seq.
- Mayo, Elton, 11, 127 seq.
- Mechanic, skilled, emotional and conceptual orientation, 242 seq.
- Melanesia, kula trade, *see* Kula trade in Melanesia
- Money, as 'end' and 'means,' 121 seq.; social functions, 123 seq.; token, 25 seq.
- Motivation, financial, 124 seq.
- Nations as higher order primary groups, 6
- New England, overseas trade and shipbuilding, 239 seq.
- Organization, industrial, *see* Industrial organization; social, *see* Social organization
- Organizations, formal and informal, as groups, 7 seq.; stable, 30
- Output, controlled to prevent change, 57, 59
- Output, restriction of: by bank wiring group, 62; causes, 18; an expression of labour unrest, 18; investigated, 18, 59
- Ownership, *see* Management
- Pareto, Vilfredo, 13
- Parliament, 109
- Paternalism prevents collaboration, 171
- Patterson, S., on labour turnover, 17
- Personnel activities, 136 seq.
- Prestige, 64 seq., 100
- Primitive communities, 124
- Procedures, technical, 73, 74, 77
- Production, unbalanced, 237 seq.
- Proletariat created by industrial revolution, 142 seq.
- Psychoanalysis, 236
- Psychology, results of interest in, 102 seq.
- Purposes, economic and logical, 11
- Radiators as examples of design, 191 seq.
- Railways, 238 seq.
- Relay Test Room, 33-53; compared with bank wiring group, 57
- Religion, organized, *see* Social activity
- Rest periods, 100, 128
- Roosevelt, President Franklin D., 111
- Russia after the revolution, 219
- Satisfactions, social, factors involved, 248 seq.
- Security is socially evaluated, 16 seq.
- Sentiment, social, 10
- Smith, Adam, social and economic theories, 14 seq.
- Social activity, basis, 253 seq.; develops social expectation, 120; dual aspect, 29, 157; organized religion a form of, 30 seq.; personal stream of, 232 seq.; in primitive communities, 124; promoted by trades unions, 146 seq.
- Social changes, *see* Changes
- Social expectation, developed through social activity, 120; illustrated by use of token money, 25 seq.; importance, 77; power, 25 seq.
- Social integration, *see* Integration
- Social living, 139-140
- Social organization, examples, 8; modern industry as a type, 9

- Social structure, *see* Groups
 Social systems, 211 seq.
 Socialism, 212-213
 Societies, balance of factors, 12 seq.;
 co-ordination in, *see* Co-ordination;
 structure, 3
 Society, industrial, contrasted with
 landed system, 143
 Sombart, Werner, on trade unions,
 145
 Spencer, Herbert, 238
 Stability, social, essential to satis-
 factory living, 63
 Stability, social and industrial, re-
 quire organization and leadership,
 166
 Strikes, as form of labour unrest, 16;
 frequency in American unions,
 149 seq.
 Style of manufactured commodities,
 177 seq.
 Supervisor (or foreman), all-round,
 113; difficulties, 101 seq.; duties,
 113; mental attitude compared
 with that of executive, 107; rela-
 tions with management and work-
 ers, 101 seq., 112; training, 106 seq.
 Supreme Court of U. S., 109

 Talking amongst workers, 99
 Tariffs, 202
 Technical procedures, *see* Procedures
 Techniques, introduction of new, 250
 Technological change, *see* Change
 Tests, ability and proficiency, 136

 Trade agreements, sentiments under-
 lying, 20 seq.
 Trade unions (and Trades' unions),
 142-147, 149-156, 251
 Training, of employees, *see* Employ-
 ees; of supervisors, *see* Supervisor
 Turnover, labour, 17

 Unemployment, after Napoleonic
 wars, 238 seq.
 Union, company, *see* Company union
 Unions, trade, *see* Trade unions
 United States, character of early set-
 tlements, 148 seq.; effect of mass
 immigration, 151 seq.; federal gov-
 ernment, 256; legislation, 221; sep-
 aration of groups, 234 seq.; trade
 unions, *see* Trade unions

 Wage differentials, as causes of labour
 unrest, 16
 Wages, an expression of social func-
 tion, 16; payment, 123-127, 129
 seq.
 Webb, Beatrice and Sidney, 141
 Welfare department in well-run firm,
 136
 Western Electric Company, Chicago
 plant, 32; Hawthorne plant, 103;
 employer-employee relationship,
 104 seq.; interviewing of employ-
 ees, 103 seq.; researches in human
 factors of industry, 32-59, 99, 115;
 supervisory training, 106. *See also*
 Bank wiring group; Relay Test
 Room