

KIRLOSKAR RET-4
an investment you recover in 60,000 Kilometers

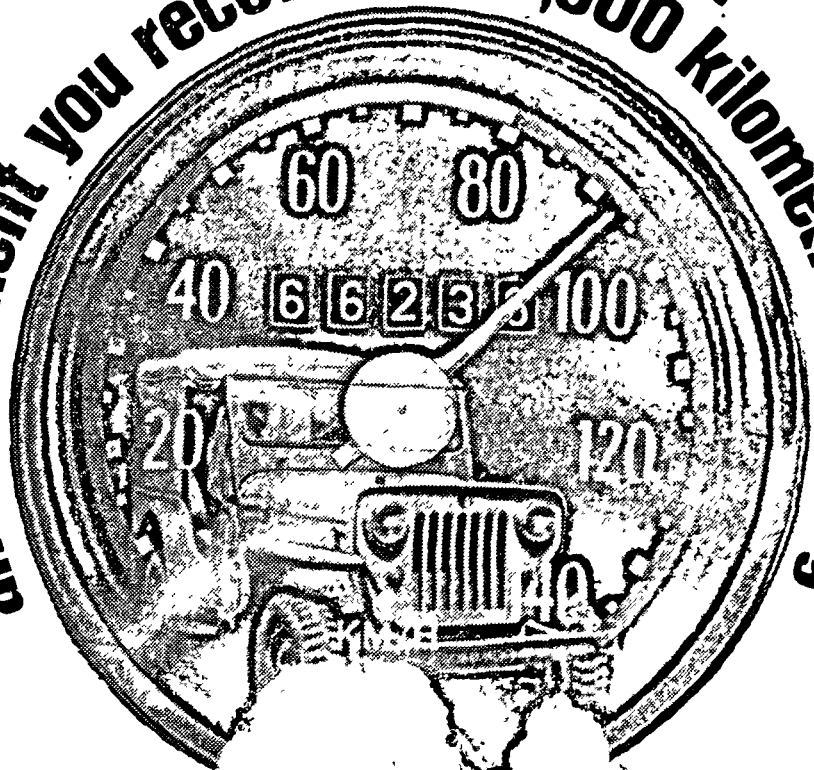

Brainchild of KIRLOSKAR R & RET-4 is a four cylinder diesel light (only 250 kg) this small packs a big wallop 65 bhp dieselizing wagons, vans, cars. Compare it with petrol engine same horsepower. You'll find operational costs LESS. It saves money every minute it runs. In 60,000 Km on it, you recover your investment on it.

It is a champion of two SHOOT (Poona to Leh) an clouds and back) and 1 (Poona to London and

bad roads, bad roads, summer heat, freezing cold, dizzy heights they are all the same to the RET-4. That's reliability for you. Wouldn't you like to repower your vehicle with it?

Write for information



KIRLOSKAR OIL ENGINES LIMITED

Khadki, Pune 411 003 (India)
 Registered Users Kirloskar Oil Engines Ltd., Pune 411 003

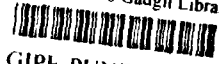

Pioneers in Chinchwad

Ruston & Hornsby
industrial and marine diesel engines and gensets.

David Brown Greaves
industrial and marine gearboxes.

Greaves Foseco
foundry fluxes, allied products and services.

Greaves and Chinchwad have progressed together

Greaves have been pioneers in many aspects of Indian industry. Recognising its strategic position and potential for development, they were the first to establish a manufacturing complex in the new industrial zone.

Today the Greaves Group at Chinchwad is a major employer and continues to contribute significantly to the development and prosperity of the area. There is no doubt that Greaves and Chinchwad will continue to flourish together.

GREAVES

SHREE METAL CONTAINERS MANUFACTURING CO.

44, KARVE ROAD, PUNE 411 004

SHEET METAL FABRICATORS

OF

**SHEET METAL PANELS,
INSTRUMENT CABINETS,
SHEET METAL PRESSED PARTS
AND**

P. F. I. CAPACITOR CANS

Phone : 50322

Please Contact :

P. T. C. SANGHVI CO.

Manufacturers of Industrial Quality

**COPPER & BRASS SHEETS / STRIPS / CIRCLES
AND**

**RE - ROLLERS OF SUPERIOR QUALITY STAINLESS STEEL
STRIPS OF 304 TYPE**

Office & Works :

110, Shivajinagar,
Pune 411 005

Phone : 56578 / 56579

Bombay Office :

Sole Selling Agents :

Allied Metal Co.

94, Kansara Chawl

Bombay - 400 002

Phone : 331263 / 334979

WE UNCOMPLICATE COMPUTERS

- In the forefront of data processing in India for over 50 years
- Pioneered indigenous manufacture of third generation computer systems - ICL 1901A
- Now gearing up to give you the latest in technology and the best in price performance - ICL 2904 computer system and peripherals for OEM

International Computers Indian Manufacture

think computers—think ICL



With Best Compliments from :

KRAN RÄDER PRIVATE LIMITED

MANUFACTURERS OF

DIE FORGED WHEELS & AXLE
SETS FOR CRANES & HEAVY
DUTY INDUSTRIAL CARS OF
STEEL PLANTS & HEAVY
INDUSTRIES

GEARS AND REDUCTION
GEAR BOXES
GEARED COUPLINGS
BOGIE WHEELS

KRAN RÄDER PVT. LTD,
29/1, Village Kharadi,
Pune-Nagar Road,
PUNE-411 014.

Phones : 20056, 26985 & 26994

Telex : 0145 - 320

Cable : KRANRADER, Pune 411 014

WITH BEST
COMPLIMENTS FROM

MORRIS ELECTRONICS LIMITED

Manufacturers of

MOR * RITE

Magnetic Components for TV Receivers, Radio,
Power Electronics and Telecommunications

MOR * DURA

Permanent Magnets for TV, Radio, Hi Fi, Vehicle
Ignition & Lighting, Magnetic gaskets for
Refrigerators & Freezers

Telephones :
82581 & 83235
Telex : 0145-240

Morris Electronics Limited
Bhosari Industrial Estate,
Pune 411 026

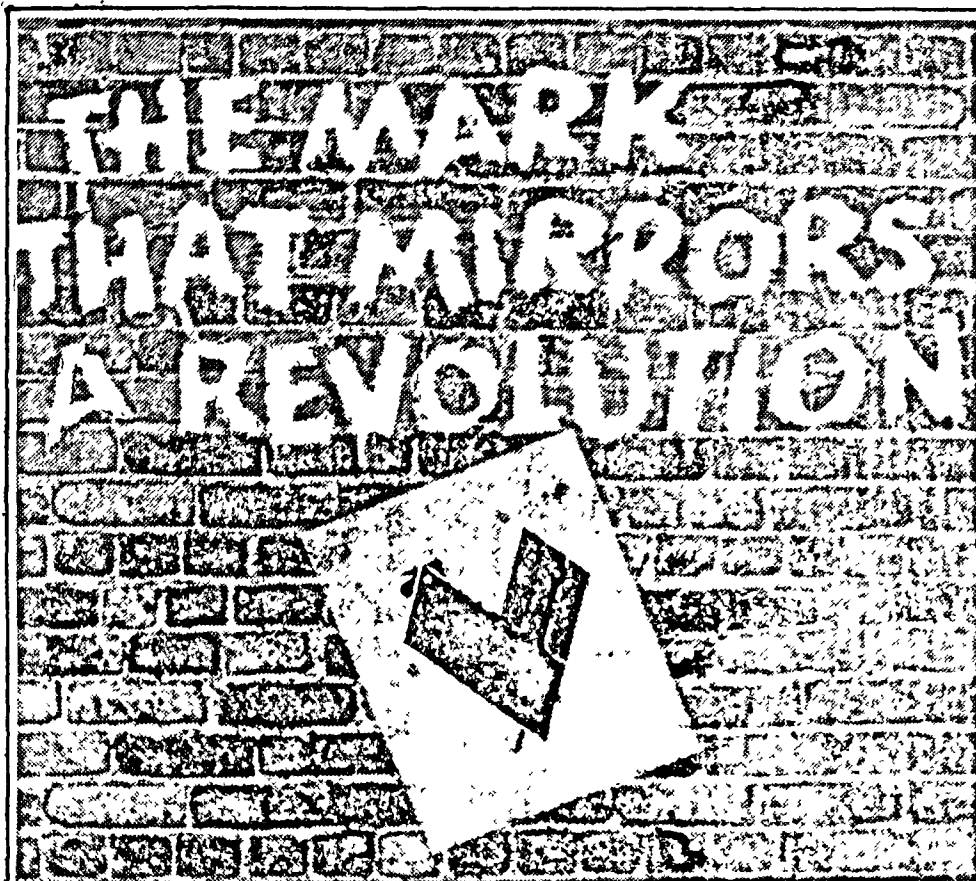

Seven years ago, the wonder bird, Babcock B-300 came to India a champion poultry breed, the best among layers
We're happy we brought it, and started a poultry revolution Its goodness is spreading everywhere.

Does our work read like a citation ?

- International standards in poultry know-how
 - Development of 92% of the industry
 - Export of eggs, chicks and know-how. earning over Rs 2 crore in foreign exchange
 - Turnkey capability in setting-up poultry plants
- Yes, we can offer you everything in the business...field studies, finance, equipment, training, complete working plants.

Our new symbol marks this high spot. It mirrors the poultry revolution ushered in seven years ago, by Babcock of USA, and us, of VH.



**Venkateshwara
Hatcheries
Pvt Ltd**
P. O. Girinagar
Pune-Panshet Road
Pune 411 025

PRATIHA 78 70

With Best Compliments From

POONA RADIATORS AND OILCOOLERS

Plot No. 93, Manjri (BR), Pune

Manufacturers of Radiators, Oilcoolers and Heat Exchangers suitable for Industrial, Marine, Locomotive, Automobile and Agricultural Applications.

'Original Equipment' suppliers to :

**Kirloskar Cummins Ltd.
Bharat Earth Movers Ltd.
Kirloskar Oil Engines Ltd.
Kirloskar Pneumatic Co. Ltd.
Diesel Locomotive Works
Atlas Copco (I) Ltd.
Ruston & Hornsby (I) Ltd.**

Phones : 7320, 7330 & 7402

Gram : 'RADIATOR' Pune

Telex : 0145-318

KAY BEE INDUSTRIES

Mfg. of Steel Furniture For Hospital & Office

11 GANGYAL INDUSTRIAL ESTATE
JAMMUL-PIN No : 180003.

Date, March 16th, 1978.....

URGENT

No. KBI/78-79/Kalat/ 3619



Parts Manager,
Roplas (India) Ltd,
POONA-411018.

Sub: Supply of side and rear door windows.

Dear Sir,

Please accept our heartfelt thanks for your extra strong and rigid fiberglass body which saved lives of six persons who met with a serious accident in which our Jeep fitted with your body fell into deep trench about 500 feet below the road level. The body was so strong that except the three windows - 2 of sides and one of rear door, the whole body was intact except minor cracks in body.

It is requested that three windows may please be despatched to us immediately on receipt of this letter. The document may please be negotiated through Punjab National Bank, GANGYAL Branch, Jammu - 180003 for payment and windows be despatched through a transport Co; which has a branch in our city.

Please also advise how to seal the cracks as the body is leaking during recent rains.
Awaiting your despatch instruction and advance copy of invoice.

Yours faithfully
for KAY BEE INDUSTRIES

S.K. SARIN
(S.K. SARIN)

ROPLAS BODY SAVES LIVES AGAIN....

**THIS IS A PROOF-IF PROOF WAS NEEDED
FOR THE TOUGHNESS OF OUR FRP BODY**



ROPLAS (INDIA) LIMITED
345, BOMBAY-POONA ROAD, PIMPRI, POONA-411018
TELEPHONE: 82781 & 83455 TELEX: 0149-350 SINTER
TELEGRAMS: ROPLAS PIMPRI P.

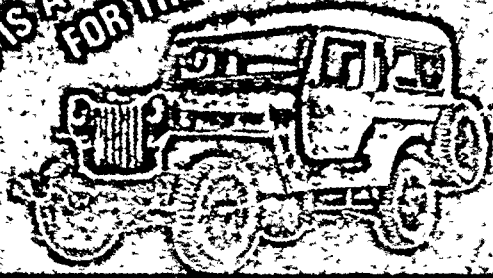

ONE CANAL GATES WATER
3 YEARS & RUNNING MORE

The Maharashtra Co-operative Engineering Society Limited, Kolhapur

Industrial Estate, Pune-Bangalore Road, Shirol, Kolhapur-416 005

* Phone—4374

* Gram—KRISYANTRA

* Telex—0195 - 216

* P. B. No. 175, KOLHAPUR-416 005

'A LEADING STATE LEVEL BODY, ONLY OF ITS KIND IN CO-OPERATIVE SECTOR, CONTRIBUTING TO THE DEVELOPMENT OF AGRO INDUSTRIAL SECTOR OF THE COUNTRY BY WAY OF GIVING MODERN AGRICULTURAL IMPLEMENTS LIKE MAYUR BRAND ISI MARKED DIESEL ENGINES OF 5 AND 6.5 HP, ELECTRIC MOTORS OF 3 AND 5 HP AND 10-13 HP MAYUR YANMAR POWAR TILLER'.

FOR FURTHER DETAILS PLEASE CONTACT ON THE ABOVE ADDRESS.

K. G. PAWAR
Vice-Chairman

B. K. PATIL-KAULAVKAR
Chairman

AUTOMOTIVE MANUFACTURERS LIMITED
Plot No. 10, Pune-Satara Road, Pune 411 009

Main Dealers of

ASHOK LEYLAND LIMITED

Telephones: 441269/441072 Telex: 0145-271

HO: KURLA, BOMBAY 70

Branches : Bombay, Nagpur, Ahmedabad, Rajkot,
Secunderabad, Vijayawada & Vishakapatnam.

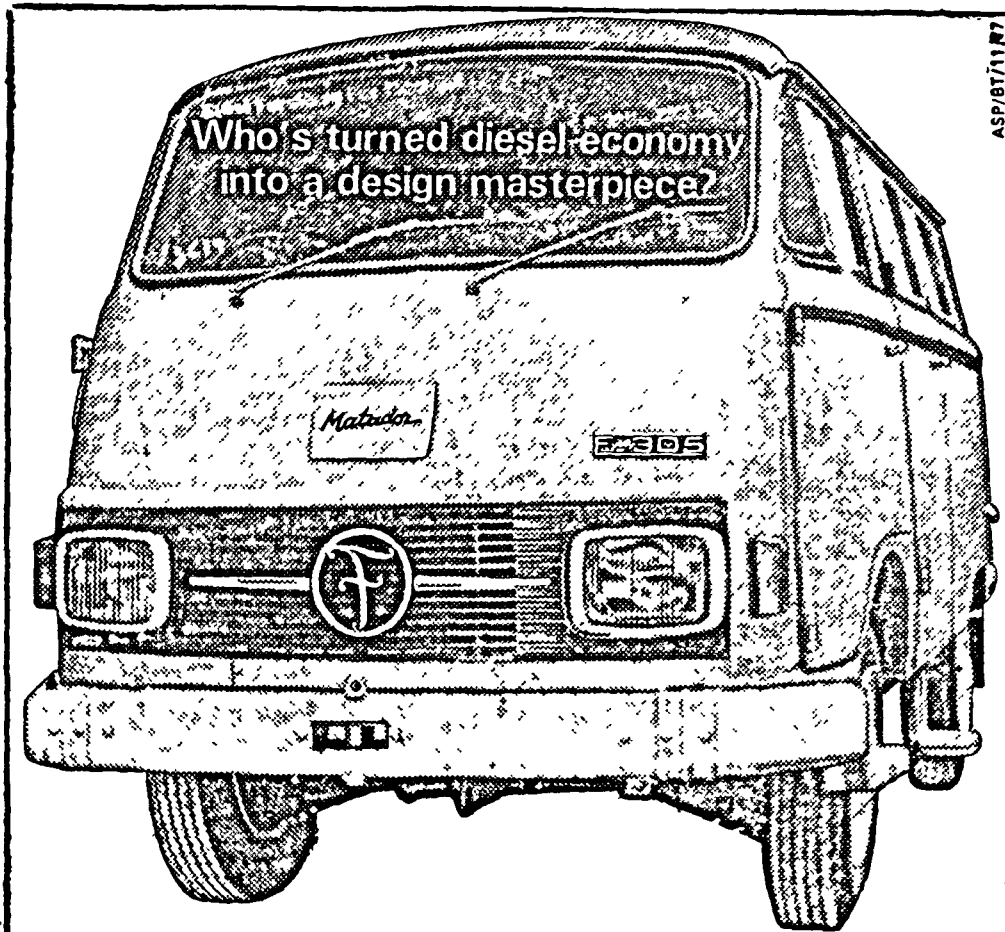

ASP/ST/1172

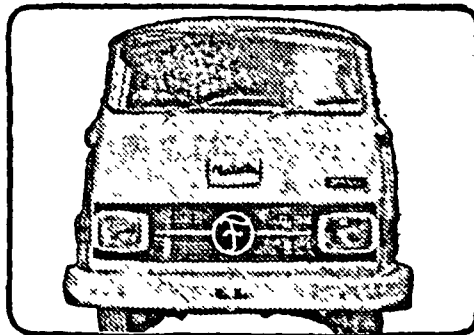

The new Matador F-305 now has the design excellence of a classy front, with more effective asymmetrical lighting; column-mounted combination light/horn/blinker switch; large door handle with push-type lock and blind key; and other design innovations! Also new—the world's most sophisticated braking system; improved front axle with new constant velocity joint and re-designed engine!

Pick-Up Truck • Delivery Van • Mini Bus
Station Wagon • Ambulance

Bajaj - Tempo
LIMITED

Bombay-Pune Road Akurdi Pune 411 035

Matador F-305

NOW EVEN BETTER

**MENON AND MENON
PRIVATE LIMITED**

VIKRAMNAGAR : KOLHAPUR

GRAM "MENO" TELEX : 0195-201 PHONE : 4356

MANUFACTURERS OF "MENON"
BRAND 5HP, 6HP AND 8HP DIESEL
ENGINES AND GREY IRON CAST
COMPONENTS FOR TRACTOR AND
AUTOMOBILES

Phone 443148

WATERLOO

DIESEL FUEL INJECTION SERVICE, PUNE

Authorised Distributors for MICO AND BOSCH PRODUCTS

461/2 SADASHIV PETH, TILAK ROAD, PUNE 411 030

Fuel Injection Equipment Sales and Service

DIESEL FILTER INSERTS; LUB OIL FILTERS FOR
CARS, TRUCKS, TRACTORS; AUTO BULBS;
BATTERIES; SWITCHES; SPARK PLUGS.

KIRLOSKAR PNEUMATIC at your service

COMPRESSED AIR

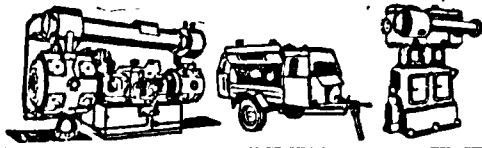

Full range of Air & Gas Compressors—diesel engine or electric driven, stationary or portable; Balance Opposed; Railway Brake Compressor; Jack Hammers, Sump Pumps and other Pneumatic Tools.

AIR CONDITIONING AND REFRIGERATION

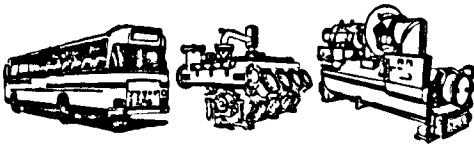

Centrifugal Refrigerating Packages; Air-conditioning and Refrigerating Compressors; Industrial Refrigeration and Comfort Air-conditioning Turnkey Projects; Transport Refrigeration and Air-conditioning units; Stop Valves; semi-hermetic Compressors, Flake and Automatic Ice Making Plants.

HYDRAULIC TRANSMISSION

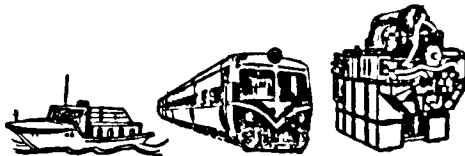

Hydraulic Torque Converters & Transmissions up to 1000 HP, Reverse Reduction Marine Gears up to 2000 HP, Industrial Gear Boxes up to 3500 HP, Fluid Couplings up to 600 HP & Controllable Pitch Propellers.



WITH BEST COMPLIMENTS FROM

DIGITRONICS

Electronic Instruments

125/5, Prabhat Nagar, Opp. Film Institute, Pune 411 004.

Tel : 52174

Mfg.: DIGITAL INSTRUMENTS FOR MEASUREMENT OF FUEL CONSUMPTION, TIMING, R.P.M., TORQUE, HORSE POWER ETC. AND OTHER ELECTRONIC EQUIPMENTS LIKE RELAY TESTERS, CABLE TESTERS, INVERTORS ETC.

With Best Compliments From

M/s JINKU RADIATORS PRIVATE LTD.

Manufacturers of

**Electrical Transformer
Radiators**

Plot No. 5, Gultekadi Industrial Estate
Pune-411 009

PHONE · 443595 & 441773

SUKRUT UDYOG

9/1A, ERANDAVANA, PUNE 411 004

MANUFACTURERS OF

- * Single Phasing Preventors
- * Electronic Liquid Level Controller for Oil and Water
- * Survo Amplifiers
- * Control Panels
- * Magnetic Oil Level Indicators 6" & 10" Dia
- * Flow Indicators for Oil and Water
- * Float Switches
- * Pressure Relief Valve

*Exclusively for Repairs
and Servicing of Your*

Tape-recorders, Transistors, Radios,
Changers, Radiograms, Car Radios,
Flash-guns, Cameras, Projectors, School
Broadcast, Shavers, Mixers, Stereo-equip-
ments Devices, Controls, T. V.'s etc.

Qualified Personnel and Technicians

Contact:

KOTHARI ELECTRONICS

640, Narayan Peth, Near Raka Book Agency
Pune 411 030

**M/s INDUSTRIAL
PRODUCTS**

ENGINEERS AND FABRICATORS

Richly Experienced in Fabricating
Industrial Fabrication in Mild
Steel and Stainless Steel

**B-17, 'H' Block, M.I.D.C. PIMPRI
Pune 411 018**

Phone : 82661, 83646



Phone : 443766
Ext.

**PRAKASH
PLATING INDUSTRIES**

Works: 1158, Sadashiv Peth, Pune 411 030

**ELECTROPLATERS,
BUFF POLISHERS,
SPECIALISED IN HARD-
CHROME AND
ALUMINIUM ANODIZING**

Leading Closed Die-Forgers
for
Trucks, Tractors, Scooters
and Diesel Engines

**TRINITY ENGINEERS
PRIVATE LIMITED**

14-D-1 MIDC Area, Chinchwad,
PUNE 411 019

Tel. : 83388 & 83536

Lunar Brand

**Chemicals for Photo Etching
Silver Nitrate double crys
also
Cadmium Compounds**

Lunar Caustic Private Ltd.

**Off Karve Road,
Pune 411 004.**

**Phone : 440825
440369**

**M/s Deccan Dyes
And Chemical Industries**

38, Vijayanagar Colony, Pune 411 030

Manufacturers and Exporters of :

**INK-BLUE,
MAGENTA,
REFLEX-BLUE.**

UNIVERSAL-TOOL
CARBIDE TIPPED
CARBIDE REAMERS, DRILLS, MILLING CUTTERS
MASONRY DRILLS, ENDMILLS COUNTER BORES
HOLEMILLS SPOT FACE & SIDE FACE CUTTERS
GUN DRILLS WOOD WORKING CUTTERS SPECIAL
CUTTERS WORKREST BLADE DRAWING DIES
TREPANNING CUTTERS WEAR PARTS & TOOLS

Labels for tools shown: DRILL, REAMER, SHELL REAMER, SLAB MILLING CUTTER, CARBIDE SPA. CUTTER, PILOTED GROOVING CUTTER, HOLE MILL, PILOT COUNTER BORE, T-BLOT CUTTER, FORM CUTTER, HOLLOW MILL, ENDMILL, CARBIDE WORE RESIST BLADE, GUN BORE REAMER, WOOD PLY L&V CUTTER, VALVE SEAT CUTTER.

UNIVERSAL ENGG. & MFG. INDUSTRY
 F2 BLOCK. W8 M 1 D C. PIMPRI, PUNE-411018 (India)

USE UNIVERSAL-TOOL carbide tipped TOOLS FOR LONG LIFE BETTER SURFACE FINISH
CUTTING HARD METALS & -REDUCING MACHINING COST & INCREASING
FEED SPEED & INCREASING PRODUCTION

Phone : 7495

Gram :
SOFTJAW

RIE RELEKAR

RELEKAR ENGINEERING
 38/39, Hadapsar Industrial Estate, Pune 411 013
 Manufacturers of **LATHE CHUCKS SPARES & SPECIALIST IN SOFT JAWS**

PRASANNA INDUSTRIES

**21, Hadapsar Industrial Estate,
Pune 411 013**

Manufacturers of

- * *Acid Alkali Resistant Strippable Lacquers.*
- * *Strip-off Lacquer for Electroplating.*
- * *STRIPPI Paint Remover.*
- * *N. C. Lacquer and Thinners.*
- * *Adhesives*

**Phone : 7356 Gram : PRASANNA
Telex : PRASANNA/MCCI PN-145-333**

**Phone: Residence : 22061 Gram : IDEAL
Office : 83295**

IDEAL ENGINEERING WORKS

**45 'S' Block, M.I.D.C. Bhosari
Pune 411 026**

- * Engineers * Manufacturers
- * Fabricators * Erectors

*We are specialised in Sugar Machinery,
Fabrication, Material Handling Equip-
ment and Chemical Plant Equipment.*

With Compliments from

JAI AGENCIES

**356/B Ganesh Peth, Pune 411 002
Phone : 447593, 470916**

Distributors & Commission Agents

Distributors for

- 1 Nirma Chemical Works,
Ahemedabad**
- 2 Lakanpal Pvt. Ltd. Bombay**
- 3 Rakesh Lamps, Poona**
- 4 India Cements Ltd., Madras.**

*Contact the Manufacturer for
Your requirements of
Dye Intermediates*

- i) P-Nitro Acetanilide
- ii) P-Nitro Aniline
- iii) P-Amino Acetanilide
- iv) P-Phenylene Diamine

Jai Scientific And Chemical Corporation

**VITA, Dist. Sangli
(Maharashtra)
Phone Vita 141**

IHL. FILLUNGER & CO., PVT. LTD.

**Foreign Manufacturers Representatives,
Import-Export Agents**

Regd. Office : 759/54, Deccan Gymkhana, Pune 411 004
Telephone : 54092

Branches at :

BOMBAY, CALCUTTA, BANGALORE & NEW DELHI
CABLES : ALL OFFICES : "FILLUNGER"

Proprietors of :

1. The New Poona Industries : (Tel. 82225)

Manufacturers of :

Bandsaws, Small Ancillary Machines etc.
for Spectacle Industry, Spare Parts of Tooth Brush
Machinery, Spectacle Hinges etc.

2. Chinchwad Precision Optical Frame Works :
(Tel. 82297)

Manufacturers of :

Precision Screws and Turned Parts from Brass and
Nickel Silver for several industries e.g. Measuring &
Electronic Instruments, Radios, Cameras, Spectacle
Industries etc.

Factories at :

Mile No. 103/1, Bombay-Pune Road,
Pimpri P. F., Pune 411 018

PROBLEM-SOLVERS

We have professional consultants who can assist you in solving your problems in the areas of :

Personnel & Production Management,
Reporting & Control,
Operations Research, Organisation & Methods,
Banking & Finance Availability,
Legal and Labour Matters,
Efficiency Engineering,
Materials Management.

We have very extensive problem-solving experience and our present list of clients is headed by some of India's top notch companies:

R. G. JOSHI & ASSOCIATES

Shree Management & Industrial Consultants
Credit-Technical Consultants-Valuers
Branches at: Bombay and Ahmedabad
198/22 (old), TILAK ROAD, PATIL BULDG., PUNE 411 030
Phones : 442331, 440886

29 Years of Service to the Traders, Industrialists, C.As., Tax Consultants & Economists

Editorial Office

Phone No. 27200

Publication Office

Phone No. 45349

Address : 393 Mangalwar Peth
Poona 11

VYAPARI MITRA

Yearly Subscription Rs. 15

Retail Price Rs. 2

Administration Office

Phone No. 55637

Address : 106/9 Erandavana

Parashuram Kati

Pune 411 004

The Most Popular Marathi Monthly of Industrialists and Businessmen, throughout the States of Maharashtra, Karnatak & Goa.

It gives the latest and upto date information about taxation and other laws and regulations (nearing about 50 in number) which are most valuable to the business and industrial community.

Regular Features

- (1) Supreme Court, High Court & Tribunal decisions on Tax Laws
- (2) Information about Income-tax, Sales tax and other Acts and mendments
- (3) Important Circulars on direct taxes and other laws
- (4) Queries & Replies thereto
- (5) Monthly market trend
- (6) Important features of the month
- (7) Articles about health problems and Yogasanas etc.

Specialist In
Manufacturing :

Tel Nos : 52074 & 52269

- MOSAIC
- TERRAZO
- PLAIN CEMENT
- MULTY-MARBLE

Please Contact

M/S VIKRAM TILES

Flooring Tiles
Known For Quality
And Durability

Plot No. 45, Shivajinagar,
Pune - 5

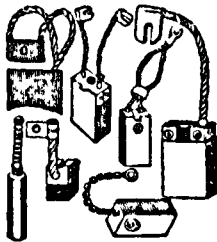

GOLDEN JUBILEE YEAR

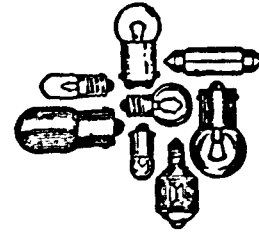

Manufacturers of:
— ALL TYPES OF —

- ★ Miniature, Auto and G.L.S. LAMPS
- ★ Exciter, Projection, Optic, Instruments, Medical LAMPS
- ★ COPPER and CARBON BRUSHES and HOLDERS
- ★ Glass Cartridge QUICK Action & SLOW BLOW FUSES
- ★ SHAN Electronic Running Lights Systems
- ★ Any LAMP in the WORLD — Only Source in Pune

SIDHESHWAR AND COMPANY

480, BUDHWAR PETH, PUNE 411 002 (INDIA)

Phones — Office : 448877 / Factory : 447866

**INCAB HAS OVER
HALF A CENTURY'S EXPERIENCES
IN ELECTRIC CABLEMAKING**

From its pioneering venture in 1920 INCAB has played a dynamic roll over its 55 years of life. INCAB product research and development teams study and keep abreast of technological progress in other countries and manufacture the argest range of products required for generation, transmission, distribution and utilisation of electrical energy.

THE INDIAN CABLE COMPANY LIMITED
QUALITY CABLEMAKERS—FIRST & FOREMOST

MUKESH ENGINEERS

14, Bhavani Peth
Near Palkhi Chowk
Pune 411 002

Phones : 25615, 26325

Authorised Dealers For :

**Crompton Electric Motors,
Pumping Sets, Domestic Monoblock,
F.H.P. Motors, Starters &
Main Switch.**

Nath Electricals

SPECIALIST IN HEATING

Manufacturers of
Electrical Equipment —

- Industrial Furnaces ■ Driers
- Ovens ■ Heaters
- Heating Mantles

AND

**ALL TYPES OF
HEATING ARRANGEMENTS**

**303 Ganesh Peth, behind
Ganesh Mansion, Pune 411 002**

Control panel wiring components :
Manufacturer & Supplier of Cable Identification marking (ferrules) of White-Yellow-Red colour and Terminal markers suitable to Elmex-Technoplast-and Tosha make terminals marking range 1 to 999 and nylon saddles-Clips for holding cables.

Contact:

Excelsior Trading Co.

P. O. Box No. 100, Ranika,
Bhavnagar 364 001

Tel. No : 6319 Gram : FERRULES

MACC ENGINEERING CO.

Office : 759/117 Deccan Gymkhana
Pune 411 004

Phone : 57596

Works : 1194/4 Shivajinagar,
Pune 411 005

Phone: 58498

Manufacturers of : Single Phase and Three Phase Transformers for Electrical and Electronic Instruments, Control Panels etc. Tube-Light Chokes, Fractional Horse Power, Shaded-pole motors For Instrument Cooling Fans, Laboratory Stirress, Projector Cooling Fans, Ultra-sonic Equipment etc.

Janata Electric Stores

F 9, Shanti Kunj, Sadhu Vaswani Road,
Opp. H. P. O. Pune 411 001

Telephone : 24787

Electrical Engineers & Licenced Contractors

We execute LT & HT and all types of electrical installation works to the entire satisfaction of our clients.

Always Insist on **SAMARTH**
Household Electric Appliances
Elegant ◊ *Economical* ◊ *Sturdy*

Geyser

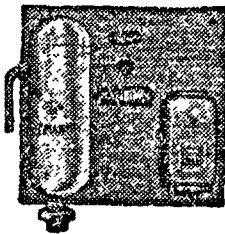

**MIDGET
Water Heater**

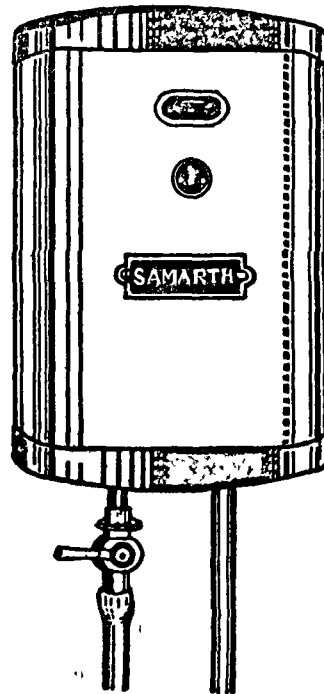

Swan Kettle

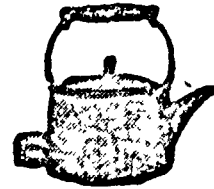

**Auto Water
Cooler**

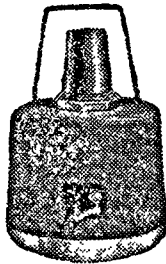

**Sause Pan
Kettle**

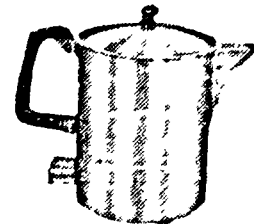

AVAILABLE AT ALL LEADING STORES WITH ONE YEAR GUARANTEE

PLEASE CONTACT FOR TRADE ENQUIRIES

HAKAMCHAND ISHWARDAS

488, Budhawar Chowk, Pune 411002 ☆ Phone : 446180

DEVAL UTENSILS FACTORY

15/1 and 5 Karve Road, Pune 411 004

1st and still the only silver platers in India having
I.S.I. certification mark

Manufacturers of 'Deval' Brand Silver-plated
Tableware

Which is better than pure silver ware in many
respects and is much much cheaper.

SILVER WARE

- 1 Very Costly.
- 2 Soft. Gets easily deformed.
- 3 A cause of anxiety
of being stolen.
- 4 Labour cost of making
of silver ware is very
high.

'DEVAL' WARE

- 1 Costs less than 15%
of pure silver ware.
- 2 Strong. Resists
deformation.
- 3 Quite safe. Almost
immune from being
stollen.
- 4 The cost of 'Deval'
ware is nearly equal
to the labour cost of
making silver ware.

As there is a thick layer of pure silver all over,
'Deval' ware, has all the hygienic properties
of pure silver ware.

The silver plating on 'Deval' Ware lasts for
5 years for careful daily use.

WRITE FOR CATALOGUE

Deval Utensils Factory

15/5 Karve Road, Pune 411 004

Old is Gold

Telegram : PACECOWORK

PATEL TILES

Of PATEL CEMENT CONCRETE WORKS

Makers of : Quality Mosaic Terrazo & Plain Tiles.

PATEL CEMENT INDUSTRIES

Manufacturers of : R. C. C. Grills, Blocks.

PATEL AGENCIES

Dealers of : White Cement, Marble Chips, Lumps & Powder,
Cement & Oxide Colours, Carborandom, Polishing Stones, Sagol etc.

Office - 42/1, Shivajinagar, Near S. T. Stand, Pune 411 005.

Phones : 56975, 53881, 57374.

With

Best

Compliments

From

Grindwell Norton Limited

The Best Deal for a Grinding Wheel

With the Compliments of



Chloride India Ltd.

Regd. Office :

Exide House, 59E, Chowringhee Road, Calcutta 700 020.

Main Offices :

**Calcutta-Bombay-New Delhi-Madras-Nagpur-Jullundur
Lucknow-Bangalore**

INDO-PLAST

Manufacturers of all types of Acrylic Plastic
Sheets & Tubes

| | |
|------------------------------|--------------------------------------|
| Factory : | Office : |
| Phone : Offi. 83 / Resi. 170 | Phone : 33 49 73 |
| Plot 161, | Cable : "INVACPAR" Chinchbunder |
| Vithal Udhyog Nagar, | Bombay. |
| Vallabh Vidya Nagar, 388 120 | 102, Ibrahim Allarkha Marg, |
| (GUJARAT) | (Banian Road) |
| | Tankiwala Building, Near Kika Street |
| | Bombay 400 003. |

Shri Bheruji

M/S. K. S. NAGORI

Dealers and Stockists :

All Kinds of Galv., Black, Seam & Seamless
Tubes, Fittings, Cast Iron Pipes, Specials and Valves.
872 Budhwar Peth, Sonya Maruti Chowk,
Pune 411 002

AUTHORISED STOCKISTS FOR

- | | |
|-----------------------------|---------------------|
| 1. 'R' Brand Pipe Fittings. | 4. APJ Make Valves |
| 2. Capstan Water Meters | 5. G. G. Valves |
| 3. Leader Make Valves | 6. Kirloskar Valves |

SUB-DISTRIBUTORS—ITC TATA TUBES

Phone : 447627, 445224.

**India's Premier Manufacturers of Import
Substitution Products :**

1. Sector Movements for pressure gauges and temperature gauges for dial size 2" to 10"
2. Zero adjustment micro pointers for process control instruments
3. Universal Pulsation Dampeners for line pulsations

Under development

1. Automatic Pressure Limiting Valve
2. Isolating Valve
3. Excess Flow Check Valve
4. Needle Valves

Contact :

**Hirlekar Precision
Engineering Co.,**

18/19 Industrial Estate, Gultekadi,
Pune - 411 009

Phone : 440633 Gram : INDBUREAU

With Best Compliments From
HORSTMANN INDIA PVT. LTD.

Nagar Road, Pune-411 014

Manufacturers of

'HIP' Precision Limit Gauges-THREAD PLUG GAUGES
 THREAD RING GAUGES
 ADJUSTABLE THREAD CALIPER GAUGES
 PLAIN PLUG GAUGES
 SPECIAL GAUGES TO REQUIREMENTS

Please send enquiries to our Distributors

GAUGES & SMALL TOOLS SALES CORPORATION

Nagar Road, Pune-411 014

Tel : 23886 (3 lines)

Grams : 'GAUGES' Pune

Telex : 0145-361

CO-OPERATIVE :

EMINENT VISITORS SAY

**SHETKARI SAHAKARI SANGH
 LIMITED., KOLHAPUR,**

- .. is a powerful co-operative institution which has written a golden chapter in the history of co-operation in India;
- .. has a united and selfless body of management which is working in the interest of the cultivator and consumer alike.

Share Capital
 Rs. 31.00 lacs

Reserve & Other Funds
 Rs. 145.28 lacs

Working Capital
 Rs. 4.20 Crores

ACTIVITIES : Marketing, Consumers & Processing.

V. S. SHINDE, Nesarikar
Managing Director

B. H. PATIL, Takwadekar
Chairman

SHARMA ASSOCIATES
BUSINESS & MANAGEMENT
CONSULTANTS

Offer :

- VARIOUS REGISTRATION SERVICES
- ACCOUNTING SYSTEMS
- INVENTORY SYSTEMS
- OFFICE WORK SYSTEMS
- INFORMATION SYSTEMS
- FINANCIAL REPORTING
- INCOME TAX & SALES TAX CONSULTATION
- INTERNAL CONTROL SYSTEMS & SERVICES
- COMPANY SECRETARIAL SERVICES
- PERSONNEL - PSYCHOLOGICAL TESTS.

Contact :

Phone : 440875
 VISHNU BHUWAN,
 1216, SUBHASHNAGAR,
 4th CROSS, PUNE - 411 002.

Oak Sunbreakers

1365 Sadashiv Peth, 'Commerce House' Bajirao Road, Pune-411 030

Phone : 440323



Manufacturers of
Venetian Blinds & Auto
Blinds, Plastic Moulders
and Industrial Painters

With Best Compliments from
Elpro International Ltd.

Affiliated with
GENERAL ELECTRIC CO.
U.S.A. . .

CHINCHWADGAON, PUNE 411 033

Telephones : Telegram :

| | |
|---------------|-------|
| 82201 | ORPEL |
| 83341 | PUNE |
| 83342 | |
| 82735 | |
| 82223 (Trunk) | |

Manufacturers of

Permanent Cast Alloy and Non-oriented hard Ferrite Magnets, Calrod heating elements, Lightning Arresters, X-ray equipment, Fluoroscopic and Intensifying Screens, Cobalt-60 teletherapy equipment.



अधिक सुंदर !



अधिक मजबूत !!

■
 घरे, बंगले, ऑफिसेस
 सुशोभित करण्यासाठी!...

■
 ऑर्डरप्रमाणे आम्ही
 टाईल्स बसवून देतो.

वंदना टाईल्स

सेल्स ऑफिस : ४६९/४ सदाशिव
 पेठ, पुणे ४११ ०३०
 फोन : ४४३४७८



With best compliments from

M/S. NANA INDUSTRIES

83 Shivajinagar, Pune 411 005

Manufacturers of :

**NANA BATTERY CHARGERS
INDUSTRIAL RECTIFIERS**

Import Substitutors for electrical equipments such as:

**SOLENOID SWITCHES
WATER FLOW RELAYS
ANNUNCIATORS**

**Electrical STARTING & STOPPING devices of Diesel Engines
For all your Electrical designs and developments kindly contact us.**

Tel, 55903

Racold

RACOLD APPLIANCES PVT. LTD.

BOMBAY-PUNE ROAD, PIMPRI, PUNE, 411 018

**Manufacturers of Quality Domestic
Electric Appliances, such as water
Heaters, Instantaneous Midget Water
-Heaters, Washing Machines, Oven-Cum
Griller, Etc.**

And

**All Types of Industrial and Commercial
Heating Elements**

FOR BETTER CASTINGS

metallurgical chemicals and equipments

CHEMICALS

All types of Fluxes, Degassers, De-oxidising Compounds for cast iron, steel and Non-ferrous castings, Core Oils, Die-lubricants, Mould and core dressings, Resin Coated Sand, Inoculants, De-sulphuriser, Exothermic Compounds for Sleeve making, Insu-

lating type Hot Tops, Anti Piping Compounds, No Bake Binders Airsetting Binders, P. F. Liquid Resins, Hot Box Resins, Insulating Round Sleeves and Flats, Teeming Powders, Liquid Binder for CO₂ process and breakdown agents, Core Binders, Liquid

Coal, Core Joining Pastes, Ferro Alloy additions, Products to improve Mould-sand condition, Mould Sealing Ropes, etc.

EQUIPMENTS

Throwaway Thermocouple Tips (Pt-PtRh 10% and Pt-PtRh 13%), Carbon Equivalent Apparatus, Argon Gas purifier.



AJAY METACHEM PRIVATE LIMITED

REGD. OFFICE :

784 OPP KAMALA NEHRU PARK

DECCAN GYMKHANA POONA 411 004 (INDIA)

TELEPHONE 57529, 54943 ● GRAM : METACHEM POONA

TELEX · 014-381

- Engineering Centre, II Floor
9, Mathew Road
Behind Opera House
BOMBAY : 400 004.
 - 1325, E Ward
Kothavale Bldg.
Shivaji Udyamnagar,
KOLHAPUR.416001.
Tel. : 6832
 - 34 Motilal Nehru Road,
Bhattacharya Banglow,
CULCUTTA—700029.
Tel. : 482764
 - 364 West Layout
Sonari,
JAMSHEDPUR-831011
Tel. : 7446
 - 22, 18th Cross Lane
8th Main Road,
Maleshwaram (West)
BANGALORE—560055.
Tel. : 30734 and 33027
- and also Belgaum, Madras

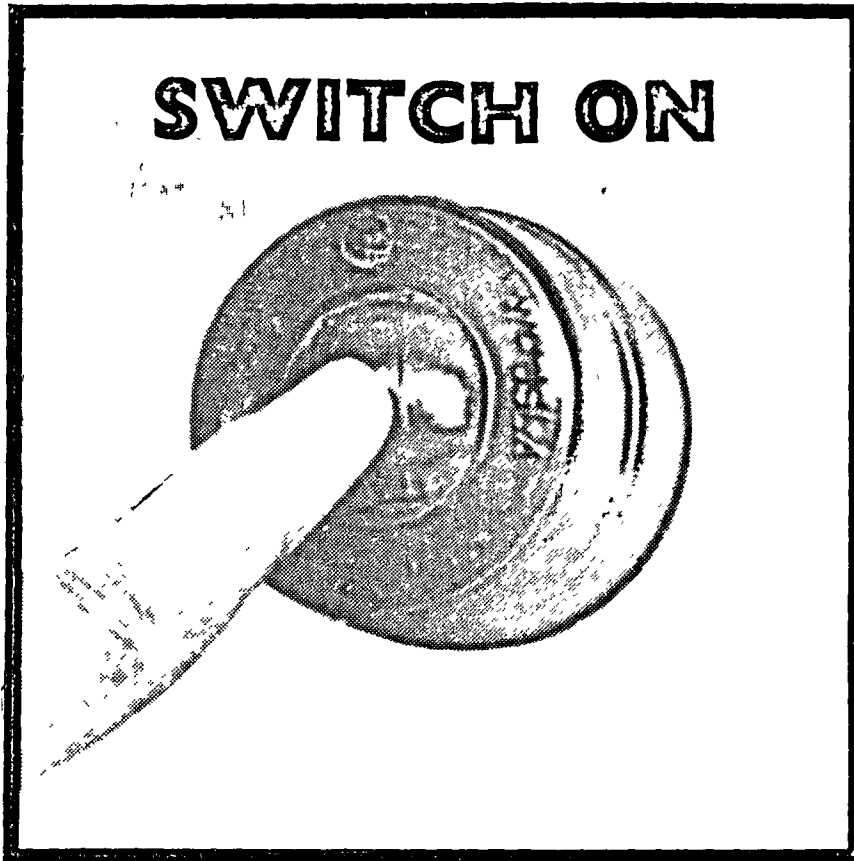

Year after year
They go ahead
Armed with quality,
They are
Khosla Electrical Accessories,
Competing, winning,
every time everywhere,
Plus competitive prices,
Timely deliveries,
It's been like that for 30 years.
Quality that gets only better

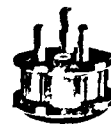

KHOSELA PLASTICS PVT. LTD.

43, Aundh Road, Kirkee, Pune-411 003

Foreword

This is the second edition of the Industrial and Commercial Directory of Pune. The first edition was published in the year 1972 and our efforts at compiling the industrial and commercial information of Pune was appreciated by all. This Directory aims at collecting original statistical and economic information about the industries and commercial activities of the city and if I may say so this is the first effort of its kind where an exhaustive coverage is attempted at to collect information from all industries in a region.

This Directory is divided into 10 broad sections. In the first section a brief note on industrial growth of Pune region and a note on the activities of the Chamber is given. The second section gives detailed information regarding industries in Pune region — products manufactured by them, their employment, capital investment, value of their production etc. A product index and a few classified lists of industries are also included in this section. In the fourth section statistical information regarding population, industries, employment, transport, electricity, telephone, education, civic administration are given. Two new sections — one on exporters from Pune and another one on commercial and industrial services have been added in this edition. The other sections are pertaining to dealers in different goods, tourism, publicity and publications and education. Two multi-colour maps of Pune and Pimpri, Chinchwad, Bhosari area are included in this Directory

The Chamber has put in special efforts to collect original and up to date information from the industries and from various other sources and readers will find a lot of original information collected in this Directory.

I take this opportunity to thank all industrial and commercial establishments, government offices, educational and other institutions, authorities of Pune Municipal Corporation and Pimpri-Chinchwad New Municipal Council and many others who helped the Chamber to collect the basic information required for this Directory. I also thank the numerous advertisers in this Directory, because without their financial support this publication would not have been possible. The Secretariat of the Chamber worked zealously for the completion of the project for which I am grateful to them. I am also grateful to Sangam Press Ltd., for their excellent job of printing this Directory, and to Shri G. T. Chavan, for his painstaking work in preparing press copy and proof reading.

We have made every effort to include most of the relevant information and bring it up to date as far as possible. However, it is possible that even with the best efforts there may still be a few omissions. I request the indulgent reader to bring them to our notice and also make any other suggestions so as to enhance the utility of this publication.

A handwritten signature in black ink, appearing to read 'S. P. Khosla', with a stylized flourish at the end.

S. P. Khosla

President

CONTENTS

| | | |
|------------|--|------------|
| | FOREWORD | |
| 1. | GENERAL SECTION | |
| | A. Pune, the New Industrial City | 1 |
| | Appendices : | |
| | (a) Landmarks of Development of Pune | 13 |
| | (b) Areas included in Pune Municipal Corporation | 15 |
| | (c) Schedule of boundaries of the New Township Municipal Area of Pimpri-Chinchwad | 16 |
| | B. Mahratta Chamber and its activities | 19 |
| 2. | MANUFACTURERS | 23 |
| 3. | EXPORTERS | 235 |
| 4. | STATISTICS | 245 |
| 5. | INDUSTRIAL AND ALLIED SERVICES | 277 |
| | I. Technical Testing, Research & Development and Consultancy | 278 |
| | II. Professional Services | 297 |
| | III. Allied Services | 328 |
| 6. | DEALERS | 339 |
| 7. | ASSOCIATIONS, TRADE UNIONS & GOVERNMENT OFFICES | 399 |
| 8. | TOURISM | 417 |
| 9. | PUBLICITY AND PUBLICATION | 431 |
| 10. | EDUCATION | 455 |
| 11. | INDEX TO ADVERTISERS | 467 |



A leading Press in Pune
for quality printing by Letterpress and Offset.

Sangam Press Limited

17 B, Kothrud, Pune 411 029



is booked
From Sahyadri Ranges
to the backwaters of Kerala...
to help set up a Paper Plant.

This time through

M/s. HINDUSTAN PAPER CORPORATION LIMITED

75-C, PARK STREET, CALCUTTA-700 016.



will be erecting and commissioning 3 Nos Coal Fired Boiler of 60 TPH
1 No Recovery Boiler of 4,40,000 Lbs/day 1 No. Turbogenerator of
15.25 MW Capacity including all auxiliaries, for 80,000 TPA

Kerala Newsprint Project

Village Vellor, Mavellor P O., Thalayolaparamba 686609, Dist Kottayam,
Kerala State.



is a team of globe trotters, which can operate anywhere on this planet
and has built the organization, stockpiled the resources to do lots of
work. Among these are Power Stations-Thermal, Hydel, Nuclear, Petro
Chemicals, Fertilisers, Sugar, Paper, Cement and many more.

ERECTION ENGINEERING IS OUR BUSINESS AND A SPECIALITY.



Western India Erectors Limited

SAHYADRI SADAN, TILAK ROAD, POONA-411030 (INDIA)

CUMMINS NHC-4 GENSET..

Grows with your power needs

Today a 50 KVA set may meet your needs. But, when your power needs grow to 75 KVA, what'll you do? Sell the small set? Replace it with a bigger one? Complement it with another? No.

Install a CUMMINS NHC-4 genset...NOW. It's the right answer.

That's because of its versatile PT fuel system. It can be set for a lower load...say 50 KVA...when you buy it, and, when needed, reset for full load . 75 KVA...without affecting fuel efficiency or economy.

Here are the economics:

- * Almost the same price per KW as other makes
- * Lower running costs due to exclusive Cummins features
- * Higher swept volume (495 cu. in./8.11 litres)
- * Longer life: strong construction (critical components designed for 180 horsepower when turbocharged)

NHC-4 is an international favourite exported regularly to USA, UK, Australia and Japan.

Comprehensive warranty (3600 hours of operation or one year)

The NHC-4 genset is for today and tomorrow...a cool answer to a vexing, hot problem.

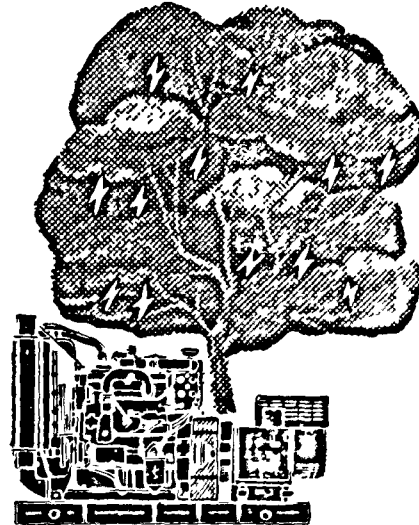

3754 Cummins gensets in the service of the nation
Total capacity over 500 MW

You can buy from any of 15 independent genset manufacturers. Please write for a list.

Kirloskar Cummins Limited

Kothrud Pune 411 029 Telephone 56461 Telex 0145 244 Cable CUMKIRK

New SKIPPER FM

a band ahead of time.

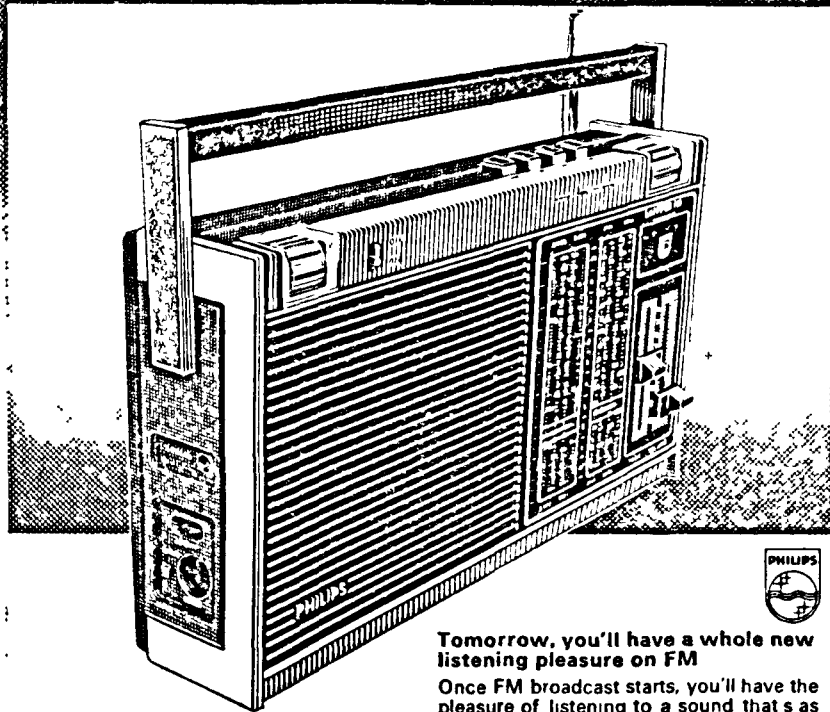

Today, FM will boost SW and MW reproduction to a new peak

The New SKIPPER FM has an exclusive FM band and an audio circuitry that acts as a catalyst, to boost SW and MW reproduction to rich and sonorous peak. A 15cm x 10cm elliptical, high-efficiency loudspeaker, housed in a brilliantly engineered cabinet, further enhances its acoustic brilliance

'Avant garde' features:

- Powerful audio-amplifier to increase the acoustic efficiency of your tape recorder/record player.
- Convenient tape-in facility.
- Three sensitive built-in aerials, one telescopic antenna.

There is also a Transmains version of SKIPPER FM which has an electromatic switch-over to battery power in case of power failure.

Tomorrow, you'll have a whole new listening pleasure on FM

Once FM broadcast starts, you'll have the pleasure of listening to a sound that's as rich and clear as from a TV set

What is FM?

In FM or 'Frequency Modulation' broadcasts, sound travels within the frequency carrier and is protected from extraneous noise. (In present AM or 'Amplitude Modulation' broadcasts, sound travels upon the carrier, so noise is a major problem) FM makes high-fidelity reception for mono and stereo broadcasts!

A choice of 2 models:

- 15 RL 557—Rs. 700/-*
- 15 RL 558—Rs. 775/-* (Transmains)

* Recommended price including excise duty. Local taxes extra.

PHILIPS

Philips India Limited

*With
Best
Compliments
from :*

PIENOSHI TRANSPORT

94-A Mahatma Gandhi Road, Pune 411 001.

Phones : 20700 • 24447

With Best Compliments from

MATHER AND PLATT (INDIA) LIMITED

CHINCHWAD, PUNE 411 019

Manufacturers of
**LARGE CENTRIFUGAL PUMPS FOR
INDUSTRIAL APPLICATION
FLAMEPROOF MOTORS
TEXTILE FINISHING MACHINES,
FOOD PROCESSING MACHINES.**

Phone : 274278

Telex : 011 - 3596

Grams : RAMOPOON

THE RAJA BAHADUR MOTILAL POONA MILLS LIMITED

**Hamam House, Ambalal Doshi Marg,
Fort, BOMBAY 400 023**

**Manufacturers and leading Exporters of
PITTIE FABRICS**

**Prints, Bedsheets, Bedcovers, Dress Materials
Bleached, Dyed Printed Poplins, Longcloth, Cambrics
Recognised "EXPORT HOUSE" by Government of India
Awarded "CERTIFICATE OF MERIT" by Government of
Maharashtra**

Retail Shop : Zilla Parishad Bldg., Pune 411 001.

ALSO ENGINEERING DIVISION

**Pioneer Manufacturers of Renowned
PITTIE**

**Drafting Machines, Mini-Drafters, Internal Grinding
Machines, Quick Change Chucks, Collets,
Reduction Sleeves etc.**

Mills : 5, R. B. Motilal Road, Pune 411 001.

Phone 27201

Telex 0145-304

Grams : RAMOPOON

With
Compliments
from :

Hiralal Mehta & Co.
Pharmaceutical Distributors
569 Sadashiv Peth,
Laxmi Road, Pune 411 030
Telephones : 444247, 444320

H. M. Sales Corporation
Pharmaceutical Distributors
Dapodi, Pune 411 012
Telephone : 82589

Hiralal Mehta
Chemists & Druggists
375, Narayan Peth,
Pune 411 030.
Telephone : 443320
444247

H. M. Gas Centre
Moledina Road,
Khadki, Pune 411 003
Telephone : 57131
and

H. M. Gas Centre
C. M. E. Compound
Dapodi, Pune 411 012
Telephone : 50134
Res : 57135
54050

“ TRUALINE ” is the name of :

All types of Graded couplings
Full geared type, Mill Motor type, Spacer type,
Insulated type, Shear pin type, Floating shaft type,
Half geared half rigid type, Single sleeve type.

All Ranges of Applications
Petrochemicals, Steel Plants, Railway, Pumps,
Rolling Mills, Cement Mills, Pharmaceuticals,
Turbines, Conveyor, Mining & Sugar Mills

Manufacturers :

HI-CLIFF ENGINEERS PVT. LTD.,

29/1, Village Kharadi, Nagar Road, Pune 411 014

Phones : 20056, 26985, 26994

Telex : 0145-320.

Cable : TRUALINE, PUNE

WITH BEST COMPLIMENTS FROM:

**THE WHITE CLOUD PAPER
MILLS**

412, Gultekdi Road, PUNE 411 009

PIONEER MANUFACTURERS OF QUALITY

FILTER PAPERS, FILTER PADS AND FILTER PULP

IN INDIA :

IMITATED BY MANY : EQUALLED BY NONE

PHONE : 441078

GRAM : WHITECLOUD

With Best Compliments :

SHRI LAXMI SAW MILL

240/A1 Bombay-Poona Road,
Chinchwad, Pune 411 019

Timber Merchant & Saw Mill Owners

Dealer in :

C. P. Teak, Dandoli Teak, Lal Teak & all kinds of
Jangal-Wood Size & Teak - Ballis

Mfg. :—All Sizes of Wooden Packing Boxes

Remember for :

**Calendar, Picture post
cards, Posters, Greeting
cards, Labels, Cartons
& Maps**

**Multi colour Photo
Offset Printing House**

**VASANT
FINE ART
LITHO WORKS**

Manohar Colony Road,
GONDIYA 441 601

Phone : 24 Gram: VASANTLITHO

NIRMAL TEXTILES

629, Sadashiv Peth,
Near Sweet Home,
Pune 411 030.

Mills Approved Retail Show Room For

**Jiyajeerao
Cotton Mills Ltd.**

Birlanagar M.P.

**JIJAJEE TERENE COTTON SUITINGS
& SHIRTINGS, DRESS MATERIAL**

the quality yarn for
faultless fabrics



'ENKALON'—the trusted
yarn in India and abroad.
A trust that is based on
Century Enka's dedication
to quality and
technological innovation.
That's the reason why
people rely on 'Enkalon'—
because 'Enkalon' meets every
test of fashion and durability.

Enkalon®
NYLON YARN

CENTURY ENKA LIMITED

© Registered Trade Mark of AKZO N. V., Holland. Licensed user: CENTURY ENKA LTD.

JAISONS 7176

- MILK PRODUCTS
- DRY FRUITS
- NAMKIN
- SWEETS

CHITALE BANDHU MITHAIWALE

Office:
777, Sadashiv, Bajirao Road
Pune 411 030
Tel. : 4 43208

लोणी
चक्का
तूप
पेढे-बर्फी
श्रीखंड-गुलाबजाम
आणि विविध मिठाईसाठी

चितळे बंधू मिठाईवाले

विक्री केंद्रे
बाजीराव रस्ता, पुणे ३०
दूरध्वनी : ४४३२०८
डेक्कन जिमखाना, पुणे ४
दूरध्वनी : ५७७४८

THE POONA MOTOR GOODS TRANSPORT

780, Sadashiv Peth, Pune 411 030
Phone : 44 3222

Branch :
Sadashiv Cross Lane, Khadilkar Road,
Bombay 400 004.
Phone : 352538

Daily Parcel and Lorry Load Service
between POONA & BOMBAY
on door delivery basis.
Special trucks available for
Maharashtra and Gujrath States

Phones: Office - 442454
Factory - 82170
Resl. - 447699
Gram: MASTERMIND

M/S K. D. JOSHI

429, Narayan Peth
PUNE - 411 030

RUBBER ACCESSORIES
AND
COMPONENTS
FOR TEXTILE INDUSTRY

Works :
M.I.D.C. Industrial Estate
'A' 83-85 'H' Block, Pimpri
PUNE - 411 018

With best compliments from :



**For the finest Welding Electrodes, Fluxes and
Equipment**

**Regd. & H.O. : Ador House, 6 K. Dubhash Marg,
Fort, Bombay - 400 023**

**Area offices at : Bombay, New Delhi, Calcutta, Madras,
Trivandrum and Raipur.**

**Factories at : Bombay, Pune, Raipur, Madras
and Visakapatnam.**

With best compliments from :



*For Quality WATER-PROOF
PAPER in Reels and Sheets*

Industrial Paper Co.,
715 Narayan Peth, Laxmi Road,
Pune 411 030.

Phones : 444093, 444849

Factory : M. I. D. C.
Bhosari, Industrial Area,
Pune 411 026.

Phone 82972

REMEMBER

SWEET HOME

for

- Fresh & Delicious sweets
- Ice Creams
- Perfect & Efficient Service
- We have no branch in Poona

SWEET HOME

765 Sadashiv Peth,
Pune 411 030.

Phone : 448846

With Best Compliments from :



**HOTEL
AVANTI**

1011 Shukrawar Peth,
Opp. Hotel Natraj,
Swargate, Pune 411 002.



Phones : 445975, 445976

Phones : { Office : 444390 Grams · PRAVASI
Resi. : 443090 PUNE

A Renowned name in Tourism

DATTA-DIGAMBAR YATRA CO.

(Estd. 1949)

To keep your mind afresh, enthusiastic and to relax from day-to-day problems, you desire Comfortable, Reliable, Honourable, Courteous and Prompt services in travel. You will experience all these qualities in various tours organised by well established yatra company in Pune. Before deciding for any tour, please contact—

**DATTA-DIGAMBAR
YATRA COMPANY**

Opp. Gokhale Hall, Laxmi Road,
Pune 411 030.

With best compliments from :

**IN DECORATIVE AND
INDUSTRIAL LAMINATES
AS ALWAYS
FORMICA INDIA
ARE
THE LEADERS**

FORMICA INDIA LIMITED

AKURDI

PUNE - 411 035.

AJCO HIGH VOLTAGE TRANSISTORISED INSULATION TESTERS

These solid state insulation testers feature simple push button operation, with D C. to D C convertors as the power source, and capability of rapid, efficient and accurate measurements

SPECIFICATIONS

| TYPE | Test Voltage | Insulation Resistance Range * | Centre Scale Mark |
|------|--------------|-------------------------------|-------------------|
| 5025 | 2500 | 5- 1000 megohms | 10 |
| | | 50- 10000 megohms | 100 |
| 5050 | 5000 | 10- 2000 megohms | 20 |
| | | 10-20000 megohms | 200 |

* Custom made ranges available

Manufactured By
AJCO Electronics
 Marketed By
AJCO ENGINEERING PVT. LTD.
 47/19 CHIPLOONKAR ROAD ERANDAWANA PUNE 411004 (INDIA)

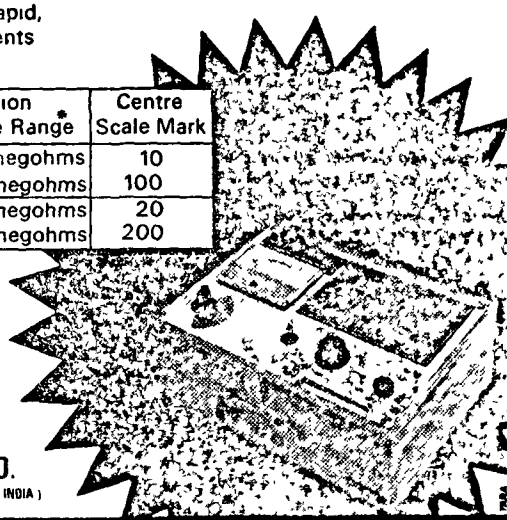

दीर्घानुभवानुन निर्मिलेली लॉन्डी मशिनरी

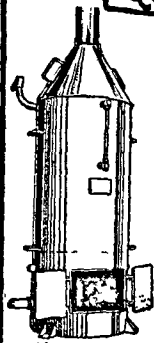

वॉटर हीटर

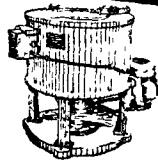

हायड्रो एक्सट्रॅक्टर

माफक किंमत
 अत्याधुनिक मशिनरी
 भरपूर उत्पादन आणि
 दीर्घकाल सेवा.

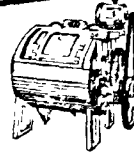

वॉशिंग मशीन

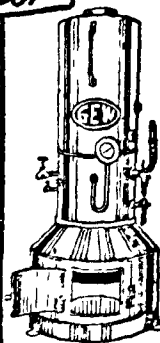

स्टीम बॉयलर

महाराष्ट्रातील अनेक उत्पादक

गणेश इंजिनिअरिंग वर्क्स सांगली

२५७ करदीकर बाजार, रावभाण, सांगली (महाराष्ट्र)
 एकमेव वितरक: गद्रे सेल्स, साधवदनगर (जि सांगली)

वितरक: निर्मला टेडिंग कॉर्पोरेशन

७६८ नवा, सदाशिव पेठ, कॉर्पोरेशन बँक बिल्डिंग पुणे - ४११०३०

SHIRKE-SIPOREX CONSORTIUM

Miracle of our Multi-quality Prefab
Factory-made Building Components

Quick Safe and Durable Housing in
India and Abroad

Shirke-Siporex Consortium Contributes Materially to Im-
plementation of the "Operation Urban Renewal and Recon-
struction of Bombay" by Construction of New Multi-
storeyed Buildings (Ground Plus Four/Five Storeys)

Exports Its Products Daily Worth Rs. 1,50,000 to Dubai
for Use In Prefab Housing

Has Earned More Than Rs. 10 Crores Worth Foreign Ex-
change

Will Be Earning Rs. 8 to 10 Crores Foreign Exchange
Every Year In the Coming Four/Five Years. Has Annual
Capacity to Produce Prefab Components Adequate For
15,000 Houses Each of 40 Sq. mtrs.

Refer Your problems of Major Mass
Housing Projects and visit our
Complex :—

B. G. SHIRKE & COMPANY
72-76, INDUSTRIAL ESTATE
MUNDHWA, PUNE-411 036

Telephone: 7151, 52, & 7232, 7727

Telegram: "BUILDALL"

Telex: 0145/258 "BGSPLTD"

SIPOREX INDIA LIMITED
72-76, INDUSTRIAL ESTATE
MUNDHWA, PUNE-411 036

Telephone: 7536, 7621, 7755,
7756, 7757

Telegram: "SIPOREX PN"

Tlx: 0145/281
"SIPOREX PN"

Estd. 1939

Phone : 22565

The Edison Electric Appliance Co.

Licensed Electrical Wiring
& Lifts Contractors



Lift Manufacturers,
Installation,
Refrigeration and
Car Air-Conditioning
Specialists, Rewinding
of Electric Motors
and Maintenance

337, Sachapir Street
Pune 411 001 (India)

शांत झोप व विश्रांतीसाठी
आरामच्याच गाद्यांना प्रथम पसंती मिळते
लोड, तक्के, उशा, रजया आदीची
वैशिष्ट्यपूर्ण बनावट.

आराम गादी कारखाना

कारखाना : पर्वती इंडस्ट्रियल इस्टेट,
शेड, नं. १६, स्वारागेट जकात नाक्याचे मागे,
पुणे ४११ ००९.

दुकाने :

- १) २६५ बुधवार पेठ, श्रीकृष्ण टॉकीजजवळ,
पुणे ४११ ००२, टेलिफोन नं. ४४७९८२.
- २) भित्तल अपार्टमेंटस्, कर्वे रोड, नळस्टॉप समोर,
पुणे ४११ ००४.
- ३) सहकारनगर, डॉ. वाड बिल्डिंग,
सारंग सोसायटीजवळ, पुणे ४११ ००९.

please refer



ELECTRIC COMPANY

461/1, Tilak Road
Near Dr. Phatak's
Hospital
PUNE 411 030

for

Industrial Electrification

Phone 44 3071

With
Best
Compliments
from :

QE

OUR QUALITY PRODUCTS

- Automatic Voltage Regulators
(Single Phase Three Phase Precision)
- Electronic Precision Timers
- Preset Ampere Hour Metres
- Custom Built Controls for
Automation
- Magnetisers & Demagnetisers
- Magnetic Test Equipment
- Import Substitution Projects

QUAD ENGINEERS

#50/3 Shivajinagar, Pune 411 004
 Phone 50933

WITH BEST COMPLIMENTS FROM

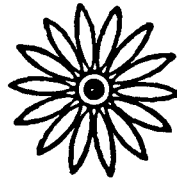

**A. T. C. (Clearing & Shipping)
Pvt. Ltd.**

**Regd. Office : Maharashtra Bank Building,
5th Floor, 45/47, Bombay Samachar Marg,
Bombay - 400 023.**

Office Phones : 256870 * 256932 - 256947

Godowns : Wadala : 448281

Tile Bunder : 371933

Grams : ASSOTRANCO

Telex : 011-2896-ATC-BY

Ultimate grace captured in a moment of perfection

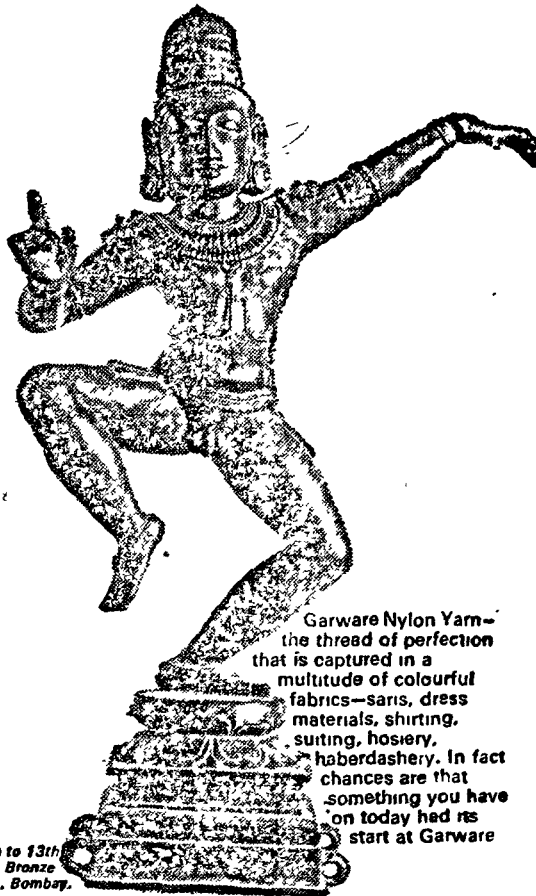

Garware Nylon Yarn—
the thread of perfection
that is captured in a
multitude of colourful
fabrics—saris, dress
materials, shirting,
sirting, hosiery,
haberdashery. In fact
chances are that
something you have
on today had its
start at Garware

*Dancing Balakrishna. 12th to 13th
Century A. D. Chola Bronze
—Courtesy Prince of Wales Museum, Bombay.*

GARWARE NYLONS LTD.

Chander Mukhi, Nariman Point, Bombay 400 021



GARWARE NYLONS-We are in more places than you think

Incisive/C.N.L. 2

General Section

- A. Pune, the New Industrial City
 - Appendices
 - (a) Landmarks of Development of Pune
 - (b) Areas included in Pune Municipal Corporation
 - (c) Schedule of boundaries of the New Township Municipal Area of Pimpri-Chinchwad
- B. Mahratta Chamber and its activities

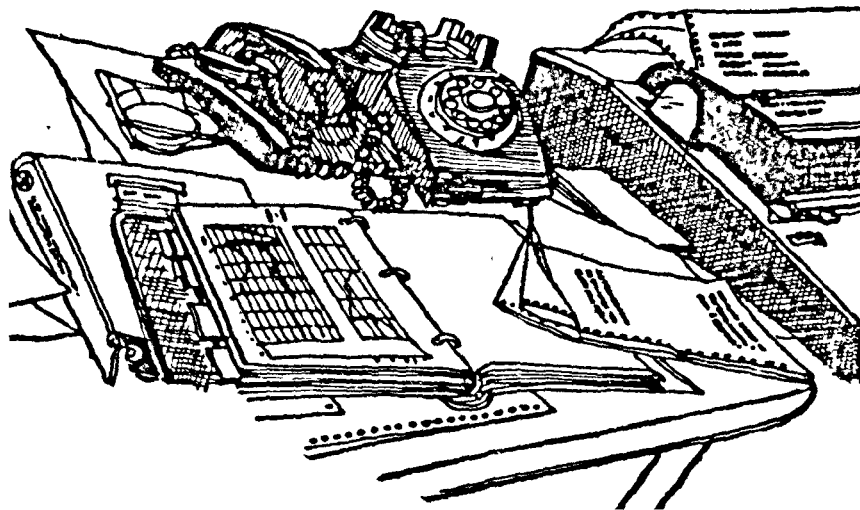

Pune, The New Industrial City

PUNE is one of those few places, like Bangalore, in India where the climate seems to have blended ideally with its people to produce an ethos which has built up, on the one hand, probably the best in Indian culture and education and, on the other, a vital part of the country's growing industry. Comparisons are odious, but for the benefit of a foreigner, contemporary Oxford is just about the most obvious analogue.

Pune has been building up modern industry against the background of its old traditions of learning and administration. The renaissance in education and industry started together in the eighties of the nineteenth century, but industry followed education in its strides of progress and even today though this city is being recognised as one of our new industrial cities, its eminence as an educational centre has not diminished.

As a result of the rapid industrial development in and around Pune, many swift changes have taken place in its civic life. In this small note, it is proposed to give some factual information regarding the city and then trace the important developments that have taken place during the last two decades.

Location

Geographical setting: Pune City is the divisional headquarters of Pune Division, which comprises the districts of Pune, Satara, Solapur, Ahmednagar, Sangli and Kolhapur. It is also the

district headquarters of Pune District. The city is situated in 18° 31'N and 73° 51'E and is 192 kilometres (by rail) away from Bombay. It is 570 metres above the sea level and in a straight line about 107 kilometres from the coast.

✓ The *Gazetteer of the Bombay Presidency* describes the geographical setting of the city in the following manner: "On the right bank of the Mutha river, in a slight hollow, the city and cantonment are bounded on the west by the Mutha, on the north by the joint Mula-Mutha, on the east by their feeder the Bahiroba and on the south-east and the south by the spurs and uplands that rise to the northern slopes of the Sinhagad-Buleshwar Hills. On other sides, except up the Mutha Valley to the south-west, the city and the cantonment are surrounded by uplands and hills. On the north-west is the soilless Ganeshkhind upland, and on the west, from the rocky slopes of the Chatushringi or Bhamburda Hills, bare waving ranges rise to the central peak of Bhamburda. To the south rises the low but sharp cut picturesque temple crowned top of Parvati and behind Parvati the broken outline of the Sinhagad-Bhuleshwar range".

Pune lies on an extensive plain, surrounded by singularly scarped hill from 580 to 700 metres high. The land between the Mula-Mutha and the Sinhagad hills is a plain, rising slightly to the east and south, the surface unbroken except near the river and along four of its smaller feeders which cross the plain from south to north. To the extreme west of the city is Ambil Odha running south-east to north-west. There are also a few other streams like Nagzari, Manik Nala or Bahiroba Nala which flow through the city. The city has a fall from south to north of about 22 metres being approximately 9.375 metres per kilometre.

Climate

Pune is situated at the eastern foothills of the Sahyadri range of mountains. It is within 48 kilometres of the highest peak. Its height from

sea level is 570 metres and perhaps that is the reason why Pune's climate is mostly dry. The Southern and Western approaches to the city are hill strewn and covered with forests. Because of its height and dry climate, Pune has an agreeable temperature even in summer. During the winter cold winds from the east blow on the city. With the beginning of January, winds from the sea blow in. By the end of April, Pune generally registers a temperature of 40°C. This causes occasional showers with thunder burst. The showers are usually preceded by very hot spells. May witnesses occasional but violent storms accompanied by cloud bursts. Wet western winds from the sea begin to blow since June, causing a considerable fall in summer temperatures. This heralds monsoon rains. During the rainy season, though the skies are clouded, weather is exhilarating and bracy because of the cool winds from the west.

Pune records 30 inches of rain annually. Most of it falls in July. Pune recorded a maximum of rainfall of 50 inches and 90 cents in 1892. In the same year 5 inches and 76 cents of rain have been recorded in 24 hours.

Pune, through history

The earliest reliable and express reference to the Pune City is to be found in the copper-plate inscriptions of the Rastrakuta Kings in the 8th and the 10th century. In these copper inscriptions Pune has been described variously as Punya Vishaya, Punaka Vishaya, Punakawadi, etc. The Rastrakutas were overthrown in 973 and Pune passed under the Yadav Kings of Daulatabad. In 1294 A.D. it came under Mohamedan Rule. According to the traditional account, Burya Arab built the fort of Chakan and from there administered Pune. Pune thus developed into a small town of the Mohamedans and came to be known as Kasbe Pune. Under the British Rule and till recently it was known as Poona.

In 1510, Shri Chaitanya Prabhu from Bengal, in his wandering through the country, came to

Pune. His disciple, Govind Das, has left an account of his impressions regarding the city as it was then. He speaks of a lake in the vicinity of the town, where several Brahmins and their disciples were busy in repeating vedic hymns. Govind Das found the city full of Pathshalas where Bhagwat Gita and Bhagwat were taught. Chaitanya was so impressed by the scholarship of Pandits in Pune that he referred to it as "Purnagrama".

When Pune City came under Shahaji Bhosale, the city had grown with habitation in areas of present Kasba, Shaniwar, Somwar and Ravivar Peths. Till 1630, the city was under his possession. In 1631, when Shahaji rose in revolt against Nizam and Adilshaha, Murar Jagdev Pandit, a Sardar of Adil Shahi, attacked Pune and captured it. He plundered the city and literally razed it to the ground. An ass-drawn plough was driven over the whole place. In 1637, the Pune Jahagir was again given to Shahaji. Shivaji came to reside in Pune along with his mother Jijabai around 1640. In 1656, the city came in the possession of Shivaji and the real progress of Pune may be said to have been started during the time of Chhatrapati Shivaji. Dadoji Konddev, one of the trusted assistants of Shahaji and a Guru (teacher) of Shivaji, played an important role in reconstructing the city. At that time Pune was supposed to be a cursed place as Murar Jagdev had levelled it with an ass-drawn plough. Dadoji Konddev performed some religious ceremonies to drive away the evil spirits haunting the place. He had the whole ground ploughed again by a plough made of pure gold. Dadoji Konddev restored law and order in the land; brought the fields, which had remained fallow for years, under cultivation and constructed a palace in the city, known as Lal Mahal,* for his young master Shivaji. But as Pune was too open

* At present there is a municipal garden—Jijamata Bag—at this place and the Corporation has plans to erect a permanent memorial of Jijamata on these grounds.

to attack and was bare of any natural defence, subsequently, Shivaji removed his capital to Rajgad.

Further growth of the city took place during the time of Peshwas. During the regime of Peshwas the town expanded into a city along the southern bank of the Mutha river. During this period, the total area occupied by the city was about 15.54 square kilometres and the population was in the neighbourhood of about one-and-a-half lakhs.

A few important dates showing the landmarks in the development of the city during the Peshwa period would be interesting: in 1721 Bajirao I appointed Bapuji Shripat as the Subhedar of Pune and charged him with the responsibility of developing the town. In 1730, Bajirao I built for himself Shanwarwada which stands even today. In 1734, Shukrawar Peth was founded by Bajirao I. Balaji Bajirao, the third Peshwa, added, in 1783, four new wards to the city, namely Vetal or Guruwar, Nagesh or Nihal, Ganesh and Narayan. In 1749, the main shrine on the Parvati Hill was built. In 1761 the Lakdi Bridge was constructed on Mutha River. In 1782 the city was provided with a drainage. In 1790 Nana Phadnavis built an aqueduct* and arranged for the continuous water supply to the city.

In November, 1818, when the English occupied the city and deposed the Peshwa, the British troops encamped in tents to the east of the city within the present cantonment limits. Pune cantonment thus dates from 1818. After the addition of the cantonment in 1818 the city did not expand further till well into the 20th century.

A few important developments during the period are the construction of Khadakwasla Dam in 1867 for supplying water to Pune City and

* Apart from this aqueduct, there were two more aqueducts constructed. Sardar Anandrao Raste constructed in 1778 an aqueduct and brought water from Kondhave, a village 7 miles east of Pune. Rup Ram Chaudhari constructed an aqueduct sometime after 1790 and brought water to the Shukrawar and Bhawani wards.

Cantonment; establishment of Pune City Municipality in 1858 and establishment of Pune Suburban Municipality in 1884; introduction of Pune-Bombay Railway line in 1856 and introduction of Pune-Miraj metre-gauge railway in 1886.

Pune as a Military Centre

By the end of the nineteenth century, Pune regained its importance as the seasonal capital of the Bombay Presidency and as a military centre. The Britishers developed the area around the city as headquarters of Southern Command and the cantonment grew into a township on the eastern side of the old city. During this period a number of educational institutions were established in Pune City and Pune came to be known as an important educational centre.

Pune attained all-India importance in politics during the first two decades of the twentieth century. In fact it was the cradle of Indian politics as Lokmanya B. G. Tilak, who led the extremist school and Prof. G. K. Gokhale, the liberal or moderate school, had Pune as their headquarters.

During the years from 1880 to 1920, the growth of the city received a setback owing to the spread of epidemics such as Plague and Influenza. Subsequently Pune was free from these epidemics and the salubrious climate and the other amenities of the civic life attracted large number of pensioners to settle in Pune, after retirement. Thus because of the large number of student population, as a result of Pune being an educational centre, and the preference of retired persons for Pune, this city came to be known as 'the City of Students and Pensioners.'

During the period after 1920, Pune city registered a commendable progress. Though the Lakdi Pool was constructed in 1761 and the Fergusson College was established in 1896, there was not much residential development across the river till 1920. The area of Bhamburda and Erandawana were developed only after 1920 when the

Plague and Influenza in Pune were brought somewhat under control.

Rapid Urban Growth after the Second World War

During the Second World War, because of the establishment of defence industries near Pune, the population of the city increased considerably. As a result of the partition of the country, immediately after Independence, there was an influx of refugees in Pune. In 1950 the Pune City Municipality and the Pune Suburban Municipality were merged together and the Pune Municipal Corporation was formed. As a result of all these developments in one decade, 1941-1951, the population of the Pune City suddenly increased from about 2.37 lakhs to about 4.81 lakhs, i.e., by 74% in a decade.*

After 1951, the city has undergone further transformation. Realising the changing times, Pune came forward to respond to the challenge of achieving rapid economic development, and during these two decades made a noteworthy progress in the industrial sphere. A large variety of industries—small, medium and large—have now grown in and around Pune. A new industrial township has grown in Pimpri-Chinchwad-Bhosari areas near Pune, and in the city itself, on all sides a good number of industries have been established.

The other developments which have helped Pune to grow during the last two decades are the establishment of the National Defence Academy, the National Chemical Laboratory, Pune University, a number of Defence establishments, Central Water and Power Research Station, etc. in and around the city. The Panshet floods in 1961 affected a large number of families living in the areas on the river banks. Thereafter a rapid expansion of the city is taking

* Detailed statistics of growth of population in Pune City from 1740 to 1971 have been given in the Statistical Section.

place; new residential colonies are being established and the city is expanding on all sides.

In 1962, the boundaries of Pune Municipal Corporation were further extended to include certain new areas.

Development of Industries in Pune

Pune's industrial growth barely spans a dozen odd years. The city had earlier no local tradition of large-scale trade or commerce. It has been a typical middle-class community. None of its leading entrepreneurs today claims a textile background which was the chief ingredient in the success formula of many a prominent business house in other parts of India.

Though Pune does not have any tradition of organised industries, attempts were made as early as in the last quarter of the 19th century to start industries in the vicinities of Pune. In 1885, Deccan Paper Mills was founded by Sardar Dorabjee Pudumjee and Sardar Nowrojee Pudumjee. In 1888, an attempt was made by Shri Anantrao Bhau Godambe to undertake large-scale production of brass and copperware with the aid of machinery. After running it for 20 years the factory was sold to its wholesale selling agents, Messrs. Hakamchand Ishwardas, and was renamed as "Gujarat Metal Factory". In 1893, Seth Hindumal Balmukund, one of the leading traders, started Raja Bahadur Motilal Poona Mills in Pune and Lokmanya Tilak had written a special editorial in *Kesari* welcoming this new venture of the Pune industrialist and his friends. With the blessings of Lokmanya Tilak an Industrial Fund named the Paisa Fund was started to give a boost to Swadeshi industries, which started a glass factory at Talegaon in 1908. It provided blowers to other glass factories in the country. In 1896 the famous artist Raja Ravi Varma had started a litho press at Malavali near Lonavala. These factories are still running and have recorded considerable progress during all these years.

Apart from these private efforts, the Govern-

ment set up its defence factories near Pune. Thus in 1869, Ammunition Factory was started at Khadki and during the First and the Second World War considerable expansion took place at this factory. In 1940 High Explosive Factory went into production at Khadki.

Though these large factories were started in good old days and they have progressed during these years, the establishment of these factories did not set further process of industrialization. Thus the picture of Pune industries in early 'fifties was the existence of these large-scale industries and the side-by-side existence of a few small-scale units producing a variety of consumer articles such as bidis, bricks, coarse cloth, brass and copper utensils, stationery, perfumes, soaps, etc. But the predominant character of Pune as an educational and administrative centre did not materially change.

This change was initiated with the establishment of Messrs. Kirloskar Oil Engines at Khadki in 1946. This factory gave an impetus to the setting-up of a number of small-scale units serving as feeders to the large-scale units. Subsequently a few more large-scale factories, like Ruston & Hornsby, Cooper Engineering, Buckau Wolf, K S B Pumps, Bajaj Auto were started and this gave further fillip to the growth of small-scale ancillary units in Pune.

In 1954, Ruston and Hornsby (India) Ltd., the first factory in Greaves Cotton Group, was set up at Chinchwad and Greaves Foseco, another factory in the same group, was also set up in the same premises at Chinchwad in 1957. In 1955, Hindustan Antibiotics Ltd., a public sector project, was set up at Pimpri, near Pune. The setting up of these manufacturing units encouraged considerable industrial development nearabout these factories in the Bombay-Pune rail-road corridor in Pimpri-Chinchwad area. This growth was further accelerated mainly because of the proximity and easy accessibility of this area to Bombay and also owing to restrictions imposed by the State Government on the

industrial expansions in Greater Bombay. The other factors, such as salubrious climate, availability of skilled personnel, necessary infrastructure facilities such as water, power, transport, etc. also played a great part in attracting industries to Pune. The establishment of Hadapsar Industrial Estate in 1956 by Pune Municipal Corporation and the exemption of octroi duty on the raw material and machinery of the units located in this Estate also attracted a few new industries to Pune.

In 1960, the Maharashtra Industrial Development Corporation (MIDC) undertook development of a large industrial area of 3000 acres at Bhosari in the Pimpri-Chinchwad Industrial Complex. A large number of industries both large-scale and small-scale have already been established in the area and the development of this area by the MIDC has helped the process of industrialisation in Pune further. Pimpri-Chinchwad-Bhosari Industrial Complex is one of the larger industrial complexes in our State.

The result is that now there are about 2500 units — both large-scale and small-scale — in and around Pune. On all sides of Pune City industries have now been established. And where once cattle grazed and farmers chatted under the cool shade of the banyan trees, there have sprung up new industrial areas at Pimpri, Chinchwad, Bhosari, Kothrud and at Hadapsar, and on both sides of Pune-Nagar Road. During night time, they provide a spectacle of lights with well-lighted factories with their neon-signed hoardings, and with their modern architectural designs showing prominently in lights.

Important large industrial units in Pune

Among the large units today are: Associated Bearing Co. Ltd. (ball bearings); Associated Batteries Ltd. (car batteries); Atlas Copco (India) Ltd. (air compressors); Ayurveda Rasashala (Ayurvedic medicines); Bajaj Auto Ltd. (scooters); Bajaj Tempo Ltd. (tempo vehicles); Bharat Forge Ltd. (industrial forgings); Buckau Wolf

New India Engineering Works Ltd. (sugar machinery); Cooper Engineering Ltd (machine tools); Dr. Beck & Co. (India) Ltd. (wire enamels, impregnating varnishes and synthetic resins for electrical industry); Century Enka Ltd. (nylon yarn); Dai-Ichi Karkaria (P) Ltd. (textile chemicals); Deccan Metal Works (non-ferrous rolling mills); David Brown Greaves Ltd. (worm reduction gears and marine gear boxes); Deccan Paper Mills Ltd. (paper); Elpro International Ltd. (lightning arresters, X-ray equipment, Allnico magnets and calrod heating units); Formica India Ltd. (laminated boards); Garware Nylons Ltd. (nylon thread); Garware Wall Ropes; Globe Electric Stores (electric fans); Greaves Foseco Ltd. (foundry fluxes); Gujarat Metal Factory (brass utensils); Western Insulated Cables Ltd. (electrical cables); Hindustan Antibiotics Ltd. (antibiotic drugs); Hindustan Precision Instruments (P) Ltd. (scientific instruments); Hortsmann India (P) Ltd. (precision gauges and small tools); Indian Cable Industries (P.V.C. cables); Indian Hume Pipe Co. Ltd. (pipes); Industrial Oxygen Ltd. (industrial gases like oxygen, hydrogen, etc.); Indian Card Clothing Co Ltd. (textile accessories); I.C.L. (India) Ltd. (punches, verifiers, sorters and tabulators); J. B. Advani-Oerlikon Electrodes (P) Ltd. (arc-welding electrodes); Jg Glass Industries (glass vials); J. N. Marshall (P) Ltd., Jaya Hind Industries Ltd., Jaya Hind Sciaky Ltd.; K.S.B. Pumps Ltd. (special purpose industrial pumps, motors and valves); Kanthal India Ltd.; Kinetic Engineering Ltd., Khosla Plastics (P) Ltd. (electrical accessories); Kirloskar Cummins Ltd. (diesel engines); Kirloskar Oil Engines Ltd. (diesel engines); Kirloskar Kisan Ltd. (petrol engines, sprayers, etc.); Kirloskar Pneumatic Co. Ltd. (air compressors); Kulkarni Foundries Ltd. (castings and foundry machinery); Mahindra Owen Ltd. (trailors of all types); Matchwell Electricals (India) Ltd. (A.C. motors and electric fans); Mather Greaves Ltd. (pressed calender bowls and textile machinery);

Morris Electronics Ltd. (ferrite rods); Philips India Ltd. (wireless sets and other electrical equipment); Raja Bahadur Motilal Poona Mills Ltd. (plain and printed cotton cloths); Racold Appliances Co (P) Ltd. (electrical appliances); Rescon Mfg. Co. (P) Ltd. (electrical components and carbon resistors); Ruston & Hornsby (India) Ltd. (vertical, horizontal and marine diesel engines); Sandvik Asia Ltd. (tungston carbide and rock drill steel equipment); Sanghvi Non-ferrous Metal Industries (steam cooker, household utensils, etc.); Sathe Biscuit and Chocolate Co. Ltd. (biscuits, cocoa and chocolates); Sahyadri Dyestuffs & Chemicals (P) Ltd. (synthetic dyes); Spaco Carburettors India Ltd; Spirax Marshal Ltd., S.T. Central Workshops (motorbody building, automobile parts); Sudarshan Chemical Industries Ltd. (textile dyes); Semi-conductors Ltd. (rubber goods, suction and delivery hose pipes, industrial and auto rubber parts, cables, oil-seals, gloves, rubber stoppers, shoes, etc.); Tata Engineering and Locomotive Co Ltd. (trucks and press tools); Thermax India (P) Ltd.; Thermolab Glass Products (P) Ltd. (packaging bottles, scientific glassware, B.T. bottles, milk bottles, vacuum flasks); PMT Machine Tool Automatics Ltd; Varma Pharmacy (P) Ltd. (pharmaceuticals); Vulcan Laval Ltd. (Dairy machinery and auxiliary equipment for food, chemical, dairy machinery); Vacuum Plants and Instruments Pvt. Ltd. (machines relating to vacuum technology), Wandleside National Conductors Ltd. (electrolytic copper conductors); Wanson (India) Pvt. Ltd.; Weikfield Products Co. (India) Pvt. Ltd. (food products); West India Chemicals Ltd. (sulphuric acid and single super-phosphate).

Variety in Production

✓ The peculiarity about industrialisation of Pune is that there is no concentration of any particular industry. ✓ Thus, there are industries in the large-scale sector, which manufacture textiles,

pharmaceuticals, biscuits and chocolates, electrical appliances, electronic instruments, diesel engines, electric fans, machine tools, air compressors, chemicals, dye-stuff, sugar machinery, scooters, trailers, paper, paper boards, cables, rubber goods, glass, plastics, etc. In the small-scale sector in addition to the traditional lines of manufacture, such as brass and copperware, furniture, toys, mulls, dhoties, sarees, hosiery, leather articles, dyeing and printing, a number of units have been started in such lines as chemicals, electrical equipments, soaps, pharmaceuticals, sports goods, stationery goods, printing, engineering, scientific instruments, electronic equipment, etc. A number of small-scale industrial units are also working as ancillaries to the new industrial units which are being started in the vicinities of Pune.

Locationally, industries in Pune are well distributed over the whole region, creating some well-demarcated pockets of industries. Thus to the north-west of Pune city are situated the well-known industrial areas of Khadki, Pimpri and Chinchwad. To its east are Hadapsar and Loni, to north-east is Yeravada, Pune-Nagar Road and Dhanori and within the city itself industries have concentrated along Karve Road, near the railway station, along the Shankarshet Road and near the Gultekadi area. A new industrial zone of 365 acres has been declared in Hadapsar and within the next few years this will be full of a variety of small-scale industries. Nearabout Pune, industries have been started at Bhor, Lonavala, Talegaon, Malegaon, Sansar and Walchandnagar in the district.

Electronic Industry in Pune

During the course of years, Pune has developed into a centre for electronic industry. Starting from basic transistors and other semi-conductor devices, components of all types are manufactured in the electronic industries in Pune. The small- and medium-scale equipment manufacturers are also specialised in different lines of

instrumentation, such as digital equipment, process control equipment, industrial equipment, consumer equipment, communication equipment, etc. The manufacturers of all these equipments and components need raw materials of various types, and most of these raw materials and electronic hardware are manufactured in Pune. No city other than Pune has such a unique collection of electronic manufacturers. In addition, in Pune we have a large number of research laboratories and other government establishments wherein continuous research and development in the field of electronics take place. The Government has also established a testing and development centre in electronics at Pune in the Engineering College. All this concentration and the necessary infrastructure facilities are certainly going to help further growth of electronic industry in Pune.

Institutions related to Industries

Behind this industrial effort and supporting it in terms of research and training, stands the city's complex of institutions — its social overhead capital. Thus, there are the College of Engineering, Government Polytechnic, Sir Cusrow Wadia Institute of Electrical Technology, Automobile Research and Development Laboratory, Central Mechanical and Engineering Research Institute, Indian Drug Research Institute, Industrial Training Institute and an Institute in Paints Technology. The National Chemical Laboratory — one of the 25 national laboratories — is also located in Pune. The State Government has put up its industrial research laboratory and Small Industries Research Institute at Pune. For small-scale industries there is an extension centre of Small Industries Service Institute which offers many common service facilities.

The Mahratta Chamber of Commerce and Industries is the parent body and has taken considerable efforts to promote and develop trade and industry in the Pune region. Founded in 1934 to spearhead the Swadeshi movement and

particularly to give impetus to the growth of local enterprise, it promoted the Bank of Maharashtra in 1935. This Bank was one of the leading regional banks and played a very useful role in financing industry and trade and more particularly local small-scale industries in Maharashtra State. The Bank was nationalised along with other banks in 1969. The Chamber also made an attempt to start a financial institution for providing medium- and long-term finance to industries. But this experiment, because of the apathy of the then Government, could not succeed. Some of the Office-Bearers of the Chamber had also made an attempt to develop an industrial estate called Pimpri Udyogpur at Pimpri, but the conditions then were rather unfavourable and the scheme met with failure. Now the Chamber has promoted two industrial estates: one exclusively for small electronic industries and the other for all types of small-scale industries. Both together, about 300 industrial units will be established in these estates.

The Chamber has played an important role in the industrial development of Pune. It submitted in 1953 detailed proposals for the proper development of Hadapsar Industrial Estate and requested the Corporation to exempt the industries in this Estate from the payment of octroi levy. In 1961, when a large number of industries in the city were affected by Panshet floods, the Chamber took considerable efforts to rehabilitate the flood-affected units. Emergency arrangements for their raw materials, machinery, finance and accommodation were made with the active assistance of the State Directorate of Industries. Present Parvati Industrial Estate is an outcome of these efforts. The Chamber then promoted Maharashtra Commerce and Industries Rehabilitation Society as a guarantee organisation for the finances of banks to such flood affected units. In 1962 the Chamber worked out a detailed scheme of Functional Electronic Estate and submitted it to Maharashtra Industrial Development Corporation. The scheme of this estate was accepted

and the Estate was established in Bhosari. The problems of regional development of Pimpri-Chinchwad area such as overbridge at Chinchwad, development of Chinchwad Railway Station, introduction of E M U coaches, water supply, uninterrupted power supply, police outpost, drainage system, development of roads, fire brigade, post and telegraph facilities, transport facilities, formation of civic authority in the area, etc., were taken up by the Chamber from time to time with the authorities concerned. Some of these problems have been solved and some are still awaiting solution. The Chamber was also closely associated with the work of Pune Metropolitan Regional Planning Board and assisted the Board in the preparation of the regional plan.

The Chamber is not a grievance-ventilating body, as is the common concept of any Chamber of Commerce, but during the course of years it has developed as a common service agency rendering important services to the business community. Thus it offers labour advisory services, industrial engineering services, group telex service, translation service, Xerox copying service, import-export and excise consultancy service and has organised an excellent commercial reference library, an audio visual laboratory, collects statistics, undertakes publications, organises training programmes, industrial tours, exhibitions, issues certificates of origin and price certificates, has set up two industrial estates and has organised many professional committees to look after day-to-day problems of business and industry.

The industrial development of Pune has given rise to a number of professional organisations like Poona Management Association, Institution of Engineers, National Institute of Labour Management, Institute of Industrial Engineers, Institute of Cost Accountants, Association for Quality and Reliability and so on. All these organisations are rendering special services to industries in Pune region.

It was feared that the rapid pace of industry would destroy the city's placid calm. Some people were visibly disturbed lest the process should lead to a gradual erosion of its people's zest for learning and for various other cultural activities. People earlier used to do all these with poise and grace and seemingly without rush. The frenzied pace and rhythm of modern industry, it was thought, would queer this age-old cultural stance.

All these fears have been laid at rest by the course of events. The industrial transformation of the city has made education all the more indispensable as a highroad to employment. There is not only more education in Pune now, but education in many more fields than before. There has been no lowering of standard either. Pune still holds its own as one of the good places to bring up children of school- and college-going ages. Commerce colleges, management institutes and polytechnics have sprouted up, new courses in business management have been now well established, a number of private bodies like Poona Divisional Productivity Council, Poona Management Association and Institute of Engineers have been conducting short courses on a variety of technical and management subjects. Not only education but the cultural activities in the city also have grown during the recent years. The film clubs, cultural groups, music circles, art societies have proliferated, the art exhibitions are held more frequently and the music halls and drama theatres carry packed houses all the year round. The civic body of Pune is the first in our State to build an air-conditioned playhouse — Bal Gandharva Ranga Mandir. A new air-conditioned drama theatre has been opened in 1976 — Tilak Smarak Mandir. In spite of the expanding industry, one little observes the rush and sick hurry in Pune that one almost accepts as a matter of course in a huge metropolis. It is not uncommon for a factory worker to run the whole gamut of work, recreation and games and the enjoyment of family solitude in the evening at a leisurely pace everyday.

Social Effects

It is extremely difficult to describe the changes which business organisations bring in the social fabric of a city. But one can see the new social pattern in the restaurants, in conference halls, in business organisations and associations. Probably, the "Deccan Gymkhana" area in the city symbolises the new Pune society. Once this locality was described as a "paradise of pensioners" who used to build small bungalows and feel a sense of achievement in their ownership and in the fading years of their lives. Now young men living here own cars, houses, and enjoy the benefit of modern living. Their families eat well, dress well and their children get education of their choice. This has brought about many social changes. One can now see a young couple with their children eating in an air-conditioned restaurant and pay the price of a good meal — perhaps equivalent to the monthly earnings of the young man's father. Shops are crowded and buyers offer a colourful spectacle with young men and women in dominating numbers.

Shops have not only increased in number but have a variety of goods to offer. Some hair-cutting saloons are now air-cooled for the comforts of the customers. The hotels and restaurants have multiplied. Scooters have tremendously increased and crowded the roads often to the exasperated honking of the cars which too have multiplied. The change has percolated to all localities and all strata of the society. Even abodes with modest appearance have TVs, radios and modern furniture.

Professional services found the growth of industries adequate to operate in Pune. New firms of auditors, legal advisors, architects, interior decorators, management consultants, advertisers, and specialists in a variety of subjects have come up and are expanding.

New Class of Entrepreneurs

It would be idle to try to identify all the factors that have worked towards the rapid social

transformation of Pune. The most important must, however, be mentioned. By far the most vital is the inbreeding of industrial leadership. Quite of the growth of Pune is from within, and much under its own steam. Here one is reminded of the Kirloskars, the Pittus, the Parkhes, the Vaidyas, the Sathes, the Rathees — all local people. The process is not over. Even now one will find a whole new generation of young technicians struggling hard to achieve success in industry. These are young graduates in Physics, Engineering, Chemical Engineering, Electronics and they are starting new small-scale industries in increasing numbers in this region. Normally these graduates — and there are many who have distinguishing university careers — would be occupying executives' jobs in large business offices or administrators' jobs in the administration. But the industrialisation in Pune has brought about a change in their value judgment. The industry has acquired respectability and an ambitious young man of Pune is today aspiring to have an independent enterprise of his own.

The upsurge of ambition in men wanting to go ahead is the motive force that has brought Pune to prominence as an industrial city. It is increasing and intensifying. Young men are making various things, be it electronics instruments or furniture. They run shops, manage industries, run goods haulers or audit accounts. This multiplication of productive activities may look diverse, often disjointed, but the unity of purpose and single-mindedness of men to achieve success is the same.

Special Characteristics

This is so far as industries. One would naturally think that as a result of this rapid industrialisation, Pune must have changed completely. But not so. Even today, amidst growing industries, it has been able to retain its importance as a centre of administrative, military, educational and social activities.

In historic times, Pune occupied a strategic

position for military purposes. Both Mohammedans and Marathas used Pune as military base. In modern times its importance further increased as a result of the location of the ammunition and high-explosives factories near Pune and as the headquarters of Southern Command at Pune.* The location of National Defence Academy at Khadakwasla near Pune, establishment of Armed Forces Medical College, Army School of Physical Training, Military Intelligence School and College of Military Engineering in Pune, setting up of quite a few defence research establishments round about Pune and the location of a large Air Force establishment at Lohagaon near Pune have further enhanced the reputation of Pune as a military centre.

As a result of the military centre, a large number of administrative offices concerning Defence work have been established in Pune. Many important departments of the State Government, such as Police, Public Health, Agriculture, Education, Forest, Survey and Settlements, Town Planning, Co-operation, Land Records, Animal Husbandry are still located in Pune. For about four months the Governor stays in Pune at the Government House, Ganeshkhind. Then as a result of various Central Government establishments, such as Meteorological Office, Central Water and Power Research Station, Film & T.V. Institute, Beam Wireless Station, Western Regional Office of Botanical Survey of India, and as a result of the administrative offices of Pune University, S.S.C. Examination Board, Text Book Bureau, etc. there is a large number of administrative staff in Pune. The satellite station in our country has also been set up at Arvi near Pune.

The educational importance of Pune needs no emphasis. Since long Pune is well known for its

* The association of Pune with military services in the minds of Westerners was reflected in an imaginary character. The gruff and adorable, if somewhat hard-drinking, "the Colonel from Poona" who was till recently famous all over the world.

good education. The city has facilities for education in Arts, Science, Engineering, Medicine, Commerce, Management, Architecture, Commercial Arts, and a wide variety of technical subjects. There are 26 colleges in Pune and the total number of students studying in these colleges is more than 30,000. The high-school-going students are estimated at over 1,75,000. Apart from these there are large number of students studying in various technical institutions, polytechnics and industrial training schools.

Apart from the colleges and institutions imparting education, Pune has eminent research institutions like Gokhale Institute of Politics and Economics, Bhandarkar Oriental Research Institute, Vaidik Samshodhan Mandal, Bharat Itihas Samshodhan Mandal, Deccan College, Virus Research Institute, Institute of Management Development and Research, National Chemical Laboratory, Central Mechanical Engineering Research Institute, etc. These institutions are carrying out important research work in their respective fields and have achieved all-India and in some cases worldwide eminence.

Association with Political Movements

The historic association of Pune with the freedom movement of the country is well known. In the early years, Pune produced such eminent men as Justice Mahadev Govind Ranade—the inspirer of Indian National Congress, Chaphekar brothers—the revolutionaries, Lokamanya Tilak—the father of Indian unrest and Gopal Krishna Gokhale—the leader of the liberal group. From Pune rose the resounding cry of Lokamanya Tilak “Swarajya (Independence) is my birthright and I shall have it”. The cry stirred the hearts of millions in India and Pune became a focus of political activity. For almost forty years from 1880 to 1920, Pune was in the forefront of political activity of the country.

Pune also had very intimate associations with Gandhiji's life and his fight for country's freedom.

Gandhiji was incarcerated in Pune several times; it was in this city that he underwent his famous operation within the precincts of the Sassoon Hospital; it was here that he undertook one of his famous fasts which led to the so-called Pune Pact. The city has become permanently associated with his biography because of the Samadhis of Srimati Kasturba and Mahadeo Desai, his friend and Secretary, in the grounds of the Aga Khan Palace. Recently, Pune was the spearhead of the Samyukta Maharashtra Movement, and the activities for the liberation of Goa too were carried from Pune. The prominent leaders of the Second Freedom movement in 1977 were also from Pune and they played a great role in this task.

If there is one feature, more than another, which is bound to strike the visitors to Pune, it is the institutional life which this city has succeeded in building up all these years. The cultural heritage has found expression in the establishment of institutions of social service based on the highest ideals of liberalism and social service. The Pune Sarvajanik Sabha was probably the first such institution which was established with a view to building a bridge or establishing a nexus between the common people and the Government. Since then a number of such institutions have been established and though a few have gone into oblivion there are a large number of such institutions working in Pune now. Their fields of activity range from Hindu philosophy to child welfare and from anthropology to international understanding. These institutions have produced a number of dedicated selfless men who have made signal contribution in their respective fields of activities.

The name of Pune cannot be mentioned without remembering names of many great men of the city who have added lustre to the recent history of the country, names which at one time or other have reverberated throughout India: Mahadev Govind Ranade, Bal Gangadhar Tilak, Gopal Ganesh Agarkar, Maharshi Jyotiba Phule,

Gopal Krishna Gokhale, Ramkrishna Bhandarkar, Maharshi Vithal Ramji Shinde, M. R. Jaykar, N. C. Kelkar, Maharshi Annasaheb Karve, Wrangler R. P. Paranjpe, N. V. Gadgil, Keshavrao Jedhe, D. R. Gadgil and many others. Obvious reasons do not permit references to living personalities, some of whom are still active in the life of the city and are playing an important role in the various fields of our country such as politics, industry, education, administration, social life, etc. Science and technology, politics and religion, banking and industry, linguistics and indology, not to speak of administration and social service, have all had distinguished recruits from Pune intellectuals.

Civic Administration

The Pune City is administered by Pune Municipal Corporation; Khadki and Pune Cantonments by the respective cantonment boards; Pimpri, Bhosari and Chinchwad by a Municipal Council and in some areas like Loni, Grampanchayat looks after the local affairs.

Pune Municipal Corporation

The civic affairs of Pune City are now managed by Pune Municipal Corporation which was established on 15th February, 1950 by amalgamating Pune City Municipality and the Pune Suburban Municipality.

The Pune City Municipality was functioning from 1858 and the Suburban Municipality from 1884. Public men of Pune were, in their days, members of the municipality. The Pune Municipal Corporation has now 73 corporators on its general body who are elected every four years. The General Body of the Corporation, the Standing Committee, the Municipal Commissioner, the Transport Committee and the Transport Manager are charged with the day-to-day administration of the Municipal Corporation.

Pimpri-Chinchwad New Township Municipal Council

As a result of the recommendations made by the Pune Metropolitan Regional Planning Board, and because of the general demand of the industry, Pimpri-Chinchwad New Municipal Council came into operation from 4th March, 1970. It comprises areas from the villages of Nigadi, Akurdi, Chikhli, Moshi, Bhosari, Pimpri, Ravet and Chinchwad. This Municipal Council is now an elected body and 'A' Class Municipality. It is one of the rich municipal councils and has an income of Rs. 5 crores a year.

Cantonment Boards

Pune Cantonment area was established in 1818 and Khadki in 1840. At present the Pune Cantonment area covers a total area of 13.80 sq. kilometres and is administered by 13 members out of which 7 are elected and 6 nominated. Khadki Cantonment covers an area of 13.28 sq. kilometres and is administered by a body of 11 members, out of which 7 are elected and the remaining nominated.

Pimpri-Chinchwad New Township Development Authority

In April 1972, the Pimpri Chinchwad New Township Development Authority was established by the Government of Maharashtra. It proposes to acquire 6,000 acres of land for the development of an entirely new township around the existing industrial area of Pimpri, Chinchwad and Bhosari.

Fear of stagnation

The growth of industries in Pune in the early 'fifties and early 'sixties has been spectacular. But during the last few years, no new major industrial units have been established in and around Pune and the whole picture is that of a

near stagnation. Whatever growth has taken place is at the level of individual units and that too has not been rapid enough and not more than what is essential for sheer survival. The tempo is maintained to a certain extent because of the establishment of quite a few industrial units in the small-scale sector either by technicians themselves or others. But the new industrial policy of the Government of India will not allow establishing large industries in towns where the population is more than 5 lakhs. Not only so but the Government is also considering to request financial institutions to deny support to industries, even in small-scale sector, in metropolitan and large industrial areas. This will be a crippling blow to Pune and if this policy is strictly followed, this city will have virtually no industrial growth in the future.

Industrial land in and around Pune is still available. Out of the total area of 8650 acres allowed by the Pune Metropolitan Regional Planning Board for industrial use, still an area of 2000 acres is to be occupied. The MIDC area in Bhosari is not full. In Hadapsar Industrial Estate, plots are still available. New areas at Ramtekdi, on Pune-Nagar Road at Wagholi and on Pune-Solapur Road are yet to be developed. Thus there is a plenty of scope for establishing industries in the Pune Region. The necessary skilled manpower is available and the class of entrepreneurs is also there. Pune has reached a take off stage and its further growth will be on its own without any special incentives from the Government. It has still a vast potentiality of industrial growth and it should not be throttled by any restrictive policy measures.

APPENDIX A

Landmarks of development in Pune

| <i>Year</i> | <i>Event</i> | <i>Year</i> | <i>Event</i> |
|-------------|---|-------------|---|
| 754 | Punyavishay was known to be the name of the present city of Pune | 1756 | Ganesh and Narayan Peths founded |
| 1600 | Original nucleus known as Kasbe Pune | 1761 | Lakdi (Sambhaji) Bridge constructed |
| 1637 | Town came under "SHAHIAJI" rule and Shaniwar, Somwar, Raviwar Peths founded | 1769 | Sadashiv and Bhavani Peths founded |
| 1656 | Town came in possession of Shivaji | 1774 | Nana, Rasta, Ghorpade Peths established |
| 1663 | Mangalwar Peth founded | 1790 | Phadnavis aqueduct was built |
| 1703 | Budhwar Peth founded | 1818 | British rule commenced Pune and Khadki Cantonments established |
| 1714 | Town came under the rule of the Peshwa | 1852 | First drama theatre established |
| 1721 | Bajirao Peshwa started reconstruction of Pune | 1856 | Pune-Bombay Railway introduced |
| 1730 | Shaniwar Wada completed | 1857 | Pune City Municipality established |
| 1734 | Shukrawar Peth was founded by Bajirao I | 1869 | Sassoon Hospital opened |
| 1749 | Parvati Temple was built | 1875 | Sangam (Wellesley Bridge) opened |
| 1750 | Guruwar or Wetal Peth founded and Katraj lake and aqueduct constructed | 1880 | Khadakwasla Dam constructed |
| 1755 | Nagesh Peth was founded, Parvati lake (now Saras Bag) constructed | 1881 | Mutha right bank canal started to |
| | | 1891 | |
| | | 1884 | Pune Suburban Municipality and Deccan College established |

| <i>Year</i> | <i>Event</i> | <i>Year</i> | <i>Event</i> |
|-------------|--|-------------|--|
| 1885 | Mundhwa Paper Mill started | 1956 | Hindustan Antibiotics Ltd. — first public sector undertaking at Pimpri; and |
| 1886 | Pune-Miraj Railway introduced | | Hadapsar Industrial Estate established |
| 1895 | Epidemics of Plague and Influenza to | 1961 | Development of Bhosari Industrial Estate by the MIDC started |
| 1920 | | 1961 | Panshet Dam disaster in Pune |
| 1896 | Fergusson College opened | 1962 | Pune Municipal Corporation limits extended |
| 1915 | Aryan Cinema Theatre started | 1967 | Constitution of Pune Metropolitan Regional Planning Board |
| 1916 | First Town Planning Scheme was undertaken by Municipality | 1970 | Plan of the Pune Metropolitan Region released |
| 1917 | Municipality undertook Laxmi Road, to Tilak Road Developments | 1970 | Constitution of Pimpri-Chinchwad New Township Municipal Council |
| 1925 | | 1971 | Vikram Satellite Earth Station at AIVI near Pune commissioned |
| 1919 | Underground drainage scheme introduced | 1972 | Establishment of Pimpri Chinchwad New Township Development Authority |
| 1920 | Municipal area extended to include parts of Erandawana and Shivajinagar | 1973 | Installation of T.V. Relay Tower at Sinhagad and introduction of Television in Pune |
| 1920 | Electricity introduced in the City and Lloyd (Nava/Shivaji) Bridge constructed | 1973 | Arbitrator appointed to prepare plans and layout of Hadapsar Industrial Township Scheme No. II |
| 1930 | Vishrambag Wada transformed into Municipal Office | 1977 | New Civil Air Port at Pune opened |
| 1934 | Mahratta Chamber of Commerce and Industries established | 1978 | Master Plan of Pimpri Chinchwad Municipal Council prepared |
| 1941 | Silver Jubilee Motor Transport City Bus Service started | 1978 | EMU Coaches on Pune-Lonavala Local Section introduced |
| 1950 | Pune Municipal Corporation established and Municipal Bus Service, National Chemical Laboratory started functioning | | |
| 1952 | First Master Plan of Greater Pune was prepared, University of Poona and National Defence Academy established | | |
| 1953 | A.I.R. Pune Station commenced | | |

APPENDIX B

Areas of the Pune Municipal Corporation

| Year | Total Area (Acres) | Population | Limits |
|---------|----------------------------------|---------------------------|---|
| 1857 | 1,912 | 90,436 | South—Shankarshet Road to Ambil Odha Road. North & West—Right Bank of the Mutha River. East—Wellesley Road to New Modi Khana on Nagzari side. |
| 1889 | 2,437 | 99,622 | Areas around Shankarshet Road, Satara Road, Gultekadi, Golibar Maidan were included in the above limits. |
| 1890 | 4,058 | 1,02,683 | Erandawana, Bhamburda (Village) and Shivajinagar, the area on the other side of Mutha river was included. |
| 1931 | 4,644 | 1,63,267 | Parvati Gaothan to Hingane Village border. |
| 1935 | 4,708 | 1,63,346 | Areas near Chaturshringi were included. |
| 1941 | 4,708 | 2,37,560 | No change in the limits. |
| 15-2-50 | 6,400 (City) 3,840 (Suburban) | | Greater Pune was established which includes Pune City and suburban areas. |
| Total | 10,240 | 4,00,000 (approximate) | |

Greater Pune : 1-8-1950, Bombay Government issued a Notification by which rural areas including 18 villages were included in the Pune Corporation limits and Greater Pune was established.

According to Notification of Local Self-Government and Public Health Department No. 5608-33, dated 7-2-1951 PMC 1160-C dated 26-9-1960 and PMC/1160-2305-C dated 23-3-62 following areas included in Corporation limits.

| Sr. No. | Name of the village | Included area |
|---------|---------------------|---|
| 1. | Bopodi | All civil area excluding area which comes under Khadki Cantonment limits. |
| 2. | Dhanori | Survey No. 39 to 47 and 86 to 89. |
| 3. | Yerawada | All civil area excluding area which comes under Khadki Cantonment limits. |
| 4. | Lohgaon | Survey No. 198, 199, 207 to 240, 101 to 114, 127 to 131, 133, 135 to 175, 183, 186 to 197, 200 to 203, 208 to 216, 221 to 271, 319 to 322, Maharwada and Wadi gavthan. |
| 5. | Wadgaon Sheri | Survey No. 29, 25, 34 A, 34 B, 24, 23, 26 to 28 and 30 to 33. |
| 6. | Ghorpadi | Survey No. 14 to 22, 24 to 34, and 80, Rifle Range Survey No. 81, Ghorpadi Railway Yard and Survey No. 78, 35 A&B, 36, AB&C, 37 to 39-40, 40A, 40B, 42-B, 43, 43A, 46 to 48, 74AB' 45, 45 A, 2, 71 to 73, 49, 50, 69, 70 A B, 67A B, 68, 51 to 53, 66, 66 A, 65, 64, 61, 60 A B, 54, 11, 58 B, 59, 62, 63, 13, Earthern Bund, 58 A, 50 A, 55 B, 56 B, 57 B. |
| 7. | Mundhwa | Survey No. 1 to 4, 42 to 71, 77 to 94, 96 to 99, 101, 102 and gaothan. |

| Sr. No. | Name of the village | Included area |
|---------|---------------------------|---|
| 8. | Hadapsar | Survey No. 1 to 6, 9, 84 to 86, 106 to 113, 119 to 122, 152 to 156, 161 to 166, 210 (Part), 211 (Part), 266 (Part), 226 to 230, 234 to 236, 254, 256, 258 260 to 263, 265, 296 A, 296 B to 298, 306 to 308, 313 to 316 including gaothan. 7, 8, 10, 11, 20 to 34, 76 to 83, 87 to 105, 123 to 151, 157 to 160, 207 to 211, 224, 225, 231 to 233, 257, 259, 264, 266, 267, 271, 310, 312, 317, 318 and Railway Yard, 114 to 118, 246 to 255, 283 to 289, 292 to 294, 299. |
| 9. | Kondhwe (Kd) | Survey No 1 to 7, 9 to 21, 63 to 65 and Gaothan 28, 30. |
| 10. | Pune City (Kasbe Pune) | Excluding the area limits of Poona Cantonment and including the area of Bibvewadi village |
| 11. | Dhankawadi | Survey No. 4 to 6, 9 to 19. |
| 12. | Parwati | Including gaothan and village |
| 13. | Erandawana | —do— |
| 14. | Hingane (Br) | —do— |
| 15. | Kothrud | Survey No. 102 (Part), 1 to 51, 59 to 61, 82 to 99, 103 to 148, 152 to 169 and gavthan. |
| 16. | Shivajinagar | Including gaothan and village. |
| 17. | Pashan | Survey No 1 to 7, 12 (Part), 14 to 68, 142, 114 (including Pashan Water Tank and Water Works etc) 146, 149, 151 and gaothan 8 to 13, 141, 147, 154. |
| 18. | Aundh | Including gaothan and village |
| 19. | Wanorie | Survey No 21 to 29, 83, 83 A, 82, 30 A B, 77 to 80, 31 to 33, 89, 93 B, 93/2, 93A/1, 90, 91, 34 A-B, 35, 36 (A to J), 37 A, B, C, D, 58 B, 38, 39 to 47 1 A, 1 B, 2 to 16, 87 gaothan, 50 to 53, 48 A, 49, 55, 64, 54, 75, 76, Chatra, 56 to 66, 66 A, 66 B, 67, 68, 71 to 73, 74 A, 74B, 70 A/3, 70 A/2, 70 A/1, 70 B, 87, 69 and kabarstan. |
| 20. | Bhosari | Survey No. 365, 471 (including plot numbers), 706 to 708 and Railway Yard. |
| 21. | Dapodi | Including gaothan and village. |
| 22. | Kalas | Survey No. 110 to 115 and 125. |
| 23. | Katraj | Survey No 1 to 9, 126 to 137, 145, 146. |

Source—Annual Reports of Poona Municipal Corporation.

APPENDIX C

Schedule of boundaries of the New Township Municipal Area of Pimpri-Chinchwad

North : Northern boundary of Village Nigdi from eastern boundary of Dehu Road Cantonment to western boundary of village Chikhali, along western boundary of village Chikhali up to northern boundary of Survey No 279, northern boundary of Survey No. 279 to 258, 256 to 252, 248, 226, 225, 229 to 233, 215, 207 to 201, 175 to 178, 188, 187, 183, 114, 116, 110, 109, 103, 104 and 96 of village Chikhali and 125, 114 to 112, 156, 155, 111 to 108, 106 to 104, 93, 95, 96, 97, 77, 78 and 80 of the village Moshi.

East . Eastern boundary of Pune-Nasik road up to the northern boundary of village Bhosari, along the northern boundary of village Bhosari up to defence area occupying the north-east portion of village Bhosari, northern, western, southern and eastern boundary of defence area again up to northern boundary of village Bhosari, and the triangular area comprising parts of Survey Nos. 148, 149 and 150 of village Bhosari intercepted between the above defence area and the northern boundary of village Bhosari, northern boundary of village Bhosari up to eastern boundary of village Bhosari, eastern boundary of village Bhosari up to northern boundary of College of Military Engineering Defence area, along the northern and south-

With Best Compliments from

M/s Vanaz Engineering Pvt. Ltd.,

85/1, Poud Road, PUNE-411 029.

Telephone : 57244-45-46 Gram : 'VANAZENG' Telex : 0145 - 379

Manufacturers of :

- Valves** : for Industrial, Medicinal High Pressure Gas Cylinders.
- Regulators** : for L. P. G. Natural Gas (Domestic and Industrial Type) and other low pressure gases.
- Caliper Brakes** :
- Coaster Brake Hubs and** : for Bicycles.
- Three Speed Hubs** :

Associates :

M/s Arudyog Engineers Pvt. Ltd.,

18/6, Hadapsar Industrial Estate., PUNE-411 013.

(Telephone No. 7222)

- Electroplaters** : For Bright Nickel Chrome, Zinc and Hard Chrome plating and anodizing. Nickel and Chrome Plating die case parts is our speciality.

With Best Compliments from :

Phone : 447892

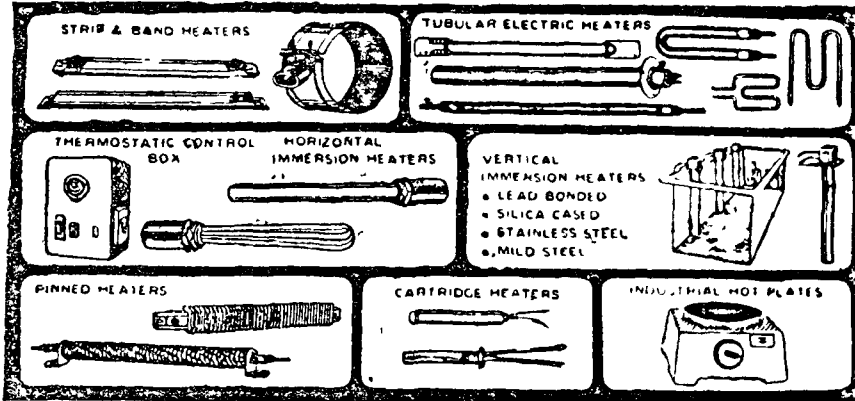

HIND ENGINEERING CO.

337, Budhwar Peth, Pune 411 002.

Engineering Contractors & Heat Engineers

Manufacturers of Industrial "Ever Glow" Heating Element For
 Chemical * Rubber * Plastic Water * Oil * Acid
 Glass & Other Various Industries. Alkalies Air & Furnaces
 Kanthal Super

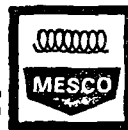
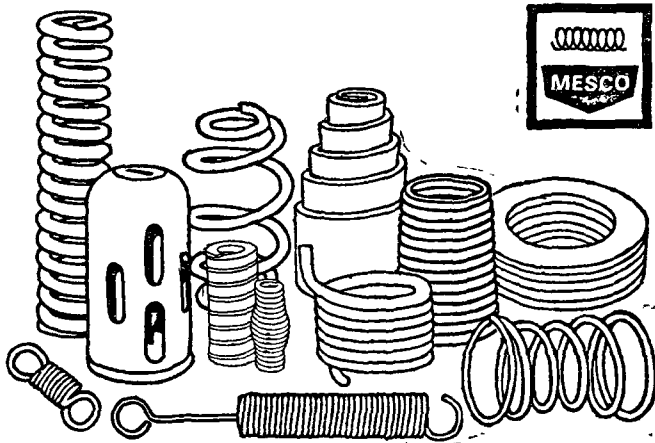

MESCO PRODUCTS

WE MANUFACTURE HEAVY DUTY & PRECISION SPRINGS AS WELL AS SHEET METAL PARTS.
 Material used-I.S. 4454, En 42
 En 45 and En 47

MANUFACTURERS OF
MODERN ENGINEERING & SPRING CO.
 UNIT NO. 11 & 207, SONA UDYOG ESTATE, PARI
 PANCHAYAT ROAD, ANDHERI (EAST) BOMBAY 400 049.
 GRAM: MESCOENG, BOMBAY-69 • TELEPHONE: 56347

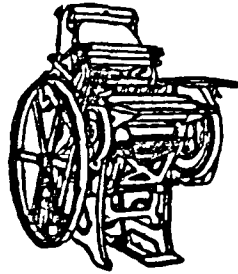

FOR ANY OF YOUR REQUIREMENTS
IN PRINTING TECHNOLOGY

A NAME TO REMEMBER

NAIK & SONS

DEALERS IN

- | | |
|--|---|
| <ul style="list-style-type: none">□ Printex & Guru Nanak Brand Printing Machines□ Complete Units for Book-binding, Office file making, Rubber Stamp and Box making etc. | <ul style="list-style-type: none">□ Wilson printing Inks□ Haunsa Graphic Art Chemicals□ Stitching Wire □ Rubber Rollers□ Polyurethane Rollers□ Cutting Machine Knives□ Press Room furniture etc. |
|--|---|

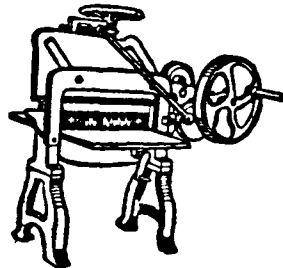

For further details please contact:

486 Shanwar Peth, Pune - 30

Phone : 470888

Sales Corner

530, Sadashiv Peth, Jondhale Chowk,
Pune 411 030

Authorised stockists

"Steel & Allied Products Ltd."

Stockists & Dealers in :

Bearings & V Belts, Cutting, Handling & Precision Tools, Machine
Accessories and Engineering Goods.



**UNITED
ENTERPRISES**

Manufacturers of :
**ALL TYPES OF SPRINGS
&
WIRE FORMS**

**Works : 1124 Sadashiv Peth,
Pune 411 030.**

Office : 74 Budhwar Peth, Pune 411 002

Works Phone : 446161

UNITED TYREKRAFTS

**S/5 Parvati Industrial Estate,
Satara Road, Pune 411 009**



Manufacturers
**Quick Release Coupling
For Pneumatic,
Hydraulic Applications.**

INTRODUCING ARTIFICIAL LEATHER BOARDS

For various applications such as : Sophisticated Shoe Making, Luggage Carriers, Ginning Washers, Industrial Flexible Couplings, Gasket Manufacturing and Insulation Boards etc.

- 1 mm to 40 mm Solid Thickness
- High Strength and Flexibility
- Easy to cut and stitch
- Unbelievable Economy.

ENQUIRIES WELCOME :

J. P. HANDMADE PAPER AND BOARDS MANUFACTURING COMPANY,

**Durga Shankar, K. P. Kulkarni Road,
1206/4- B, Shivaji Nagar, PUNE - 411 004. (INDIA)**

Telephone : 58277

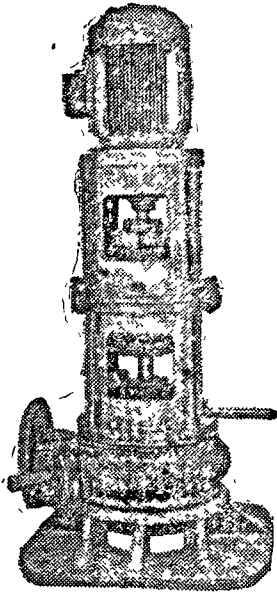

**HAVE ANY DIRTY
PUMPING PROBLEM?**

**WE HAVE A CLEAN
SOLUTION TO IT!**

Contact

**KISHOR[®]
PUMPS PVT. LTD.**

A13/H, MIDC Industrial Area, Pimpri, Pune-411 018

Vertical Nonclogging Pumps

Phone: 82616,

Gram: 'KISHORPUMP'

K-004

even
popular in
foreign
countries



**SAMBHAJI & RAJKAMAL
BRAND BIDES**



MANUFACTURERS:

m/s. sable waghire & co. ltd.

105, BHAVANI PETH, POONA-411 002.

PHONE-23139.

PAINT REMOVER

**FOR UNIVERSAL APPLICATION ON METAL, WOOD
AND ANY OTHER SURFACE**

- Harmless to surface
- Apply by Brush..... Wait for few minutes wipe out with cloth
- Application even by unskilled hands
- Saves COSTLABOUR.....TIME

ENQUIRIES WELCOME :

S. K. ENTERPRISES

DURGA SHANKAR, K. P. Kulkarni Road,

1206/4 - B, Shivaji Nagar, PUNE- 411 004.

INDIA

Phone : 58277

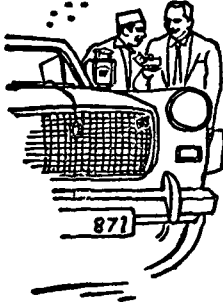

**HAPPY DRIVER
HAPPY PASSENGER**
No ground
for higgling

Diamond FARE METERS

Durable, strong, sturdy
Indigenous
Accurate
Moderate price
One year guarantee
Neatly designed
Diamond—a name you can trust upon.



★ **AVAILABLE FOR ANY MAKE OF TAXI AND AUTORICKSHAW**

sole selling distributors
M/S ANAND TRADERS
1180, budhwar peth, poona 2



manufactured by.
DIAMOND CLOCK MFG. CO. PVT. LTD.
h. o. 1180, budhwar, poona-2. phone: 56145
works: 59b, mundhwa, poona 1. phone: 26384



**उत्कृष्ट दर्जाच्या
आणि टिकाऊ
स्वस्वपाच्या**

मनीषा

**फाईल्स च्या
अपयोग करा.**

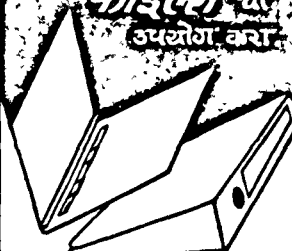

सर्व प्रकारचे फाईल्स, जर्नलस्
फाईल्स, कॅबिनेट फाईल्स,
प्लॅस्टिक फोल्डर्स, कल्पने प्रमाणे
फोल्डर्स करून मिळतील.
गोल्डन एम्बॉसिंग, स्पायरल
बाईंडिंग, थिसिस बाईंडिंग,
डायपॉन्चिंग करून मिळते
निर्माते :



मनीषा

एन्टरप्रायझेस

४२३/ब, शनवार पेठ.
राजमाचीकर गिरणी समोर,
पुणे ३० फोन : ४७०५८९

An Indian bank that's truly International.



Indian Overseas Bank

Central Office
762, Anna Salai, Madras-600 002, India.

Good people to grow with

International business calls for a bank like IOB which has branches in India, Hong Kong, Singapore, the Republic of Korea and Sri Lanka. Plus a wide network of associates and correspondents all over the world.

The wide range of international banking services offered by IOB include:

- Introduction to manufacturers, exporters and importers
- Import/export finance
- Assistance in setting up joint ventures
- Finance for turn-key projects and arrangement of off-shore finance.
- Issuance of bid bonds and performance guarantees
- Advisory service to non-resident clients

We can help you anywhere in the world. Most important, we have the time and the expertise to give personal attention to your particular needs.

BRANCHES AT PUNE

INDIAN OVERSEAS BANK
840, Laxmi Chambers
Laxmi Road
PUNE 411 002

INDIAN OVERSEAS BANK
Armed Forces Medical College Campus
Extension Counter, Wanavadi Road
PUNE 411 001

Right answer to your filtration problems

MASTER FILTER BAGS

Made out of Polyester, Nylon, Polypropylene, HDPE Acrylic Fibreglass and Teflon (Spun multifilament and monofilament) For chemicals, Pharmaceuticals, Pigments and Dyestuffs, Ceramics, Sugar Fertilizer, Aluminium, Copper, Iron & Steel, Engineering and variety of process plants

presses, vacuum Filters, Centrifuges, Leaf filter presses, Dust collection bags, dry and wet filtration plants and Air pollution control equipments

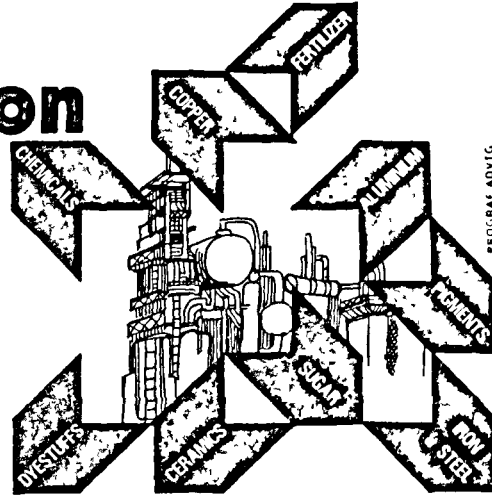

MASTER FILTER BAGS

Specially tailored to Suit individual needs of filter

Manufactured & Marketed by



759/97 Prabhat Road Cross Lane No. 2
Pune 411 004
Jijamata Road, Nasik-422001 Ph No 3187

SAPRE BROTHERS

Stationers

Near Gokhale Hall, Laxmi Road, Pune 411 030.

Tel Shop : 443376, Res. : 440592



Office Stationery,
Drawing Office Material,
Printers, Xerox,
Multi Printers,
Ammonia Printers.

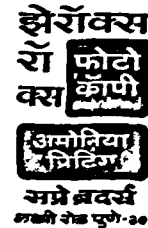

Distributors : ARROW Brand Ammonia Rolls
Speciality - Stationers of Pune

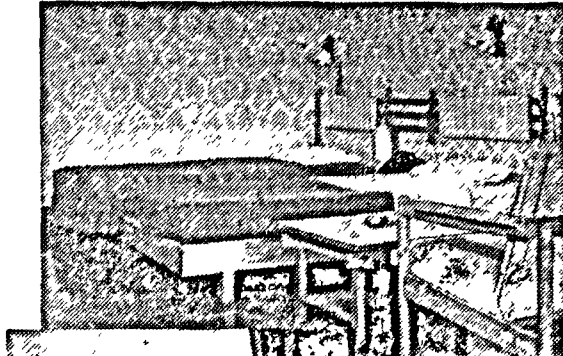

Elegant, spacious surroundings, excellent service, and the memorable food is better than ever! So conveniently located Right next to Pune Station—and the IA terminal office is in Amir We have two airconditioned conference halls—seating between 25-200 executives Fully equipped with audio-visual aids Wait till you hear the costs—that'll clinch the deal.

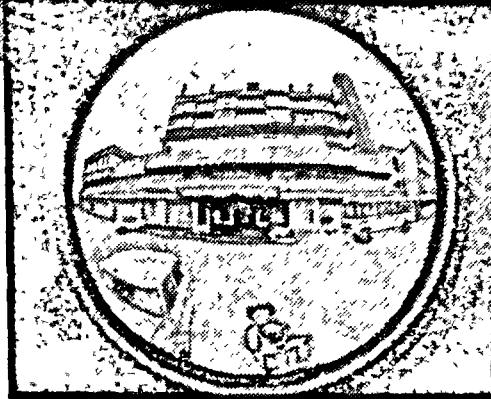
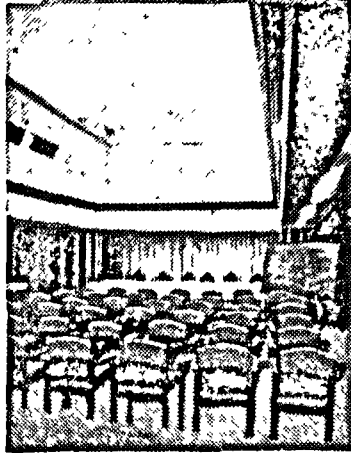

GIVE YOUR CONFERENCE THE Amir TOUCH

Our business conferences mean "business". That is why we select Hotel Amir.

Wanson (India)
Manager Co-ordination.

We mean business when we hold a conference. Hotel Amir is the place.

Indian Oil.



15 CONNAUGHT ROAD,
POONA - 411 001
PHONE 27371-2-3



शुभचिंतन
दि युनाइटेड वेस्टर्न बँक लि.
-अपनापेसे पेश आनेवाले अपने ही लोग



BEEJ



- Computerised Systems
- Cost Analysis
- Feasibility Report
- Work Study
- Financial Planning
- Market Research

UNIQUE SYSTEMS
713, Sadashiv Peth,
R.B. Kumthekar Road, Pune 411 030
Phones: 440038/443484/58136

Pragat

**FOR
BETTER UTILIZATION
OF POWER**

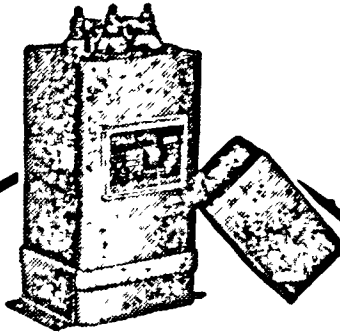

WINDMILL

Install

PRABODHAN

CAPACITOR

RANGE

1 to 25 KVAR

415/440 VAC

M S E B APPROVED

CAPACITORS FOR

MOTORS, FANS

TUBE LIGHTS

FURNESSES &

OTHER SPECIAL

APPLICATIONS

IS 2834



*FOR 5 KVAR & 10 KVAR 415 VAC

***GUARANTEED FOR TWO YEARS
AVAILABLE EX STOCK**

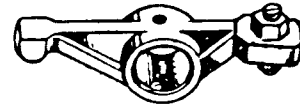
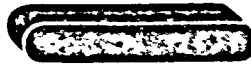

GADRE KEYS



Dealers in
SKF; ABC;
NBC;
NORMA
Bearings,
etc.

PRASHANT BEARINGS

1342, opp. Corporation, Shivajinagar,
Pune 411 005.

Phones : Office : 52490
Rei. : 53270

ALURKAR MUSIC HOUSE



Swapna Nagari,
Karve Road,
Pune 4.

Tel. 58652/50394

"Kings" Cassette Tapes

Gramophone Records

Radio | Transistors

Stereo Equipments

Tape Recorders



ATUR RUBBER PRODUCTS

Specialised in Rubber Tubing & Rubber Moulded Parts

Office :
ATUR FOUNDATION HOUSE
4 Dr. Ambedkar Road
PUNE 411 001
Cable : ATURUBBER
Phone : 23811

Factory :
Nagar Road
29/2 Kharadi
PUNE 411 014
Phone : 28137

LALIT PROFILES

- pioneers in
metal profile cutting in poona

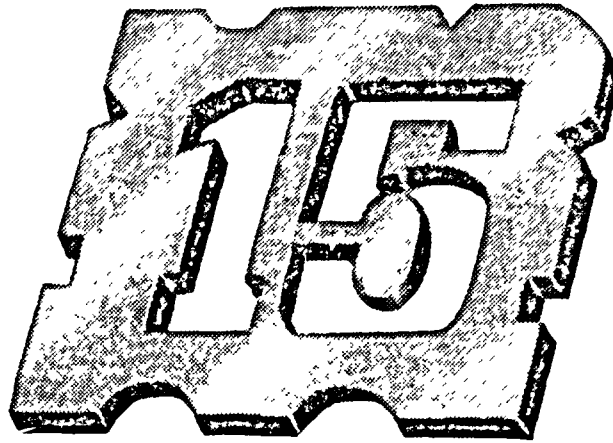

**complete 15 years of dependable,
dedicated service**

For over fifteen years LALIT PROFILES have perfected the art of profile cutting. Just specify the required shape and we ensure that you get your profile cut with precision-right on time and at the right price!

We cut profiles, in metal, from thickness of 5 mm to 350 mm, the only profile cutting people to offer you such a wide range. We can also supply you with M.S. sheets in any thickness and in any quantity.

Our guaranteed prompt service helps you reduce your inventory stocks drastically—you can divert your scarce capital to more urgent purposes. Remember: If you have a profile cutting problem—we'll solve it for you.

**LALIT PROFILES
QUALITY-PRECISION-PROMPTNESS
IN PROFILE CUTTING**



LALIT PROFILES
KASARWADI POONA 411 018
PHONE : 83566

Industrial & Automobile Belts

- * 'Fenner' V Belts !
- * 'Helicord' V Belts & Fan Belts
- * Nylon Sandwich Leather Belts
- * Flat Endless Belts

PHOENIX TRADING CO.

Opp. Shivaji Statue, Shivajinagar, Pune 411 005.

Phone - 52598 & 50312

(A sister concern of 'The New Ball Bearing Co., Opp. Shivaji Statue,
Pune 5, the place where you will get all Types of Bearing.)

*Through 50 years LVB has been growing bigger. Bigger to
serve you better. With more than 130 branches in South
and North. All in your service.*

*With many tailormade schemes and equipped for handling
worldwide foreign exchange business LVB is big enough to
serve you—however small or big your needs be.*



THE LAKSHMI VILAS BANK LTD.

Regd. Office : KARUR 639 001

Administrative Office : MADRAS 600 036

Branch at : 658, New Narayan Peth, PUNE 411 030

western boundary of Military Engineering Defence area up to its junction with the Pune Municipal Corporation limit.

South : Pune Municipal Corporation limits from its junction with College of Military Engineering lands up to Pavana river, northern bank of Pavana river up to Military Dairy Farm, then along the eastern, northern and western boundary of Military Dairy Farm again up to Pavana river, northern bank of Pavana river up to eastern boundary of Survey No. 221 of village Ravet.

West : Along eastern and northern boundary of Survey No. 221 up to eastern boundary of Ravet

Gaothan, along eastern boundary of Ravet Gaothan up to western boundary of Survey No. 224, western boundary of Survey Nos. 224 and 123, northern boundary of Survey Nos. 123 and 131, western boundaries of Survey Nos. 132, 183, 182, 186, 181, 141, 180, 154, northern boundary of Survey No. 155 of village Ravet, straight line connecting the point of intersection of northern and eastern boundary of Survey No. 155 with the point of intersection of boundaries of village Ravet, Nigdi, Akurdi and Chinchwad, along the common village boundary of Ravet and Nigdi up to its intersection with eastern boundary of Dehu Road Cantonment, along the eastern boundary of Dehu Road Cantonment up to northern boundary of village Nigdi.

are you planning a conference meeting or a seminar?

MAY BE A BOARD OF DIRECTORS' MEETING • DISTRIBUTORS' CONFERENCE • SALES MEETING
MANAGEMENT SEMINAR • SHAREHOLDERS' MEETING • CONVENTION • OFFICERS CLUB MEETING

Chamber's new building is an ideal place to hold these meetings. Here you will find the most comprehensive modern facilities — an Assembly Hall, an airconditioned Board Room, Lunch Room, a Library Hall, a training cum-classroom — to cater to any type of meeting. Chamber's premises are fitted with modern audio-visual aids, — such as loud-speakers, taperecorders, 16 mm film projector, slide projector etc.

On special request, Chamber's expert secretarial services can also be offered.
For details, please contact the Secretary of the Chamber.



CHAMBER'S BUILDING IS STYLED FOR MEETING IN COMFORT

FOR ADVICE ON
all labour matters

CALL
LABOUR ADVISORY SERVICE
OF THE MAHARATTA CHAMBER poona 440371 440472



Mahratta Chamber and its Activities

The Mahratta Chamber of Commerce and Industries was founded on 16th March 1934. In four decades it has become a leading spokesman and representative of Industry and Trade in Maharashtra.

Over the years, hundreds of companies have benefited from their association with the Chamber and by their participation and involvement with its activities.

The Central and State Governments have given the Chamber representation on various Committees, making it possible for the individual concerns, including the small-scale organisations, to have a share in the decision-making process that affects industry and trade as a whole.

Services Offered

A Storehouse of Information

All important developments concerning the business community are communicated to the members, by means of circulars, bulletin, lectures, discussion meetings and journals. The weekly bulletin in English 'World of Business' published by the Chamber is distributed free of charge to all members and contains Government Notifications and Public Notices on all aspects relevant to business such as: Sales-tax, Income-tax, Excise, Customs, Import & Export, Company Law, Labour laws, Industrial licensing, etc. All the Government notifications that are published till Friday evening are made available to the members on Monday morning through the

Weekly Bulletin. The Chamber also publishes a Marathi monthly 'Sampada' which is exclusively devoted to trade, industry and commerce.

Labour Advisory Service

The Chamber maintains expert staff specialised in the field of Industrial Relations. Industrial and commercial units can draw upon the expertise and experience of this staff on a reasonable charge. This service has proved particularly useful to units that are not large enough to afford a special department of their own to deal with the specialized problems of Industrial Labour such as handling day-to-day labour problems, negotiations with unions, appearances before Conciliation Officers, Labour Courts and Tribunals. The Labour Advisory Service also arranges periodical meetings, discussions and seminars on day-to-day labour problems facing the employers.

Small-scale Industries Wing

Special problems of small-scale industries are looked after by this wing. It has a separate Executive Committee and a Chairman and meets every month to review problems before the small-scale industrial units in this region. It also makes representations to concerned authorities and invites them for discussions. It also arranges its meetings at places outside Pune like Kolhapur, Satara, Ahmednagar, etc.

Group Telex Service

If the number of messages you send and receive by Telex does not warrant your own installation, you can make use of the Chamber's Group Telex Service and have access to the world Telex network at a very reasonable cost. This service is provided under a special licence from the Post & Telegraph Board, Government of India, and this is the only chamber which operates this service.

Xerox Copying Service

For the benefit of members, the Chamber offers Xerox copying service for taking out copies of their important documents, licences and other

papers. This service is also available for reproduction of important material from the commercial reference library of the Chamber.

Import-Export Advisory Service

If you need information on importing items for your business or advice on processing the import licence application, the Chamber can give you the necessary guidance. Import sub-committee of the Chamber, during the last few years, has been very active and has been responsible in bringing many changes in the procedural formalities of Import Policy.

The Chamber also has facilities for giving advice to exporters. The services cover all aspects of exporting — from information on likely markets, banking and financial facilities available to exporters, to guidance in advertising and publicity, shipping, insurance and packing. It also maintains a library of export literature, conducts training programmes for exporters, organizes seminars, lectures and discussions on the related subjects. The Export Sub-committee of the Chamber meets every month to discuss problems of exporters and to guide newcomers in the field.

Certificate of Origin

The Chamber has been authorised by the Government of India to issue certificates of origin to exporters. In addition it also certifies the invoices of exporters and issues certificates regarding prices of export items.

Trade Introductions

The Chamber receives numerous trade enquiries from various parts of the country and abroad. These are passed on to our members in concerned trade. Several member-concerns have established regular business relations through such introductions.

Statistics

Statistical information regarding import and export trade, industrial licencing, industrial production, employment, data on joint-stock com

panies, capital issues, prices, etc. is available with the Chamber for members' reference. Compilation of statistics on the above subjects is also undertaken on behalf of members at additional but reasonable cost.

Poona Divisional Productivity Council

This Council has been promoted by the Chamber which looks after the Council's day-to-day activities. Training programmes and audio-visual programmes, incountry and circuit teams, seminars, lectures relating to productivity are organized by the Council. It also maintains a library of technical books and films for the benefit of the members.

Industrial and Commercial Directory of Pune

Every four years, the Chamber publishes commercial and industrial directory of Pune. It gives detailed classification of industrial units in and around Pune and information about their capital investment, turnover, products manufactured, employment, etc. Information about more than 5000 dealers and those rendering various types of industrial services is also given. This is a unique attempt of collecting original regional statistics by a regional chamber of commerce.

Publications

Apart from its weekly bulletin and monthly journal, the Chamber undertakes publications from time to time on various subjects relating to industries. So far it has published a directory of financial assistance to industries, a handbook on plastic industry, energy crisis in India, exporters from Pune, Urban Land Ceiling Act etc., etc.

Industrial Estates

In order to solve the accommodation problem of small-scale industries in and around Pune, the Chamber has promoted two industrial estates: one exclusively for electronic industry and the other for all types of small-scale industries. More than 300 new industrial units will be established in the two estates together.

Industrial Tours

The Chamber arranges industrial tours both in India and abroad for the benefit of its members. So far three such foreign tours, one to Japan and two to Europe were organised by the Chamber. Local tours have been organised to Punjab, Rajkot in Gujarat, Southern Maharashtra and other places.

Commercial Reference Library

The Reference Library of the Chamber is unique of its kind in our country. Years of genuine efforts have gone into the compilation and careful classification of the material contained in the library and sincere efforts being made to update this material every day, add to its richness and open new sections.

Apart from a select range of reference books on commerce, banking, finance, taxation, labour, planning, small-scale industries, import, export, etc., it subscribes to a wide range of magazines and periodicals of interest to the man in business. The library also has commercial directories of most important countries in the world, a wide range of Indian manufacturers directories, all ISI specifications, all Indian patents, trade marks, State and Central Government gazettes, notifications for the last ten years on excise, customs, import, taxation, industrial licensing etc. It also has more than 4000 project profiles for use by small-scale units.

Other Activities

Memorial Lectures

On 16th October every year, the Chamber organizes the G. P. Ogale Lectures on a subject of current economic, commercial or industrial interest. Many leading businessmen, economists and administrators have delivered lectures in the series, which are printed and sent to members. So far 30 such lectures have been published by the Chamber.

Industrial Merit Prizes

The Chamber awards G. S. Parkhe Industrial Merit Prizes on 16th June every year for success-

ful product-marketing of a new invention or innovation. In this unique scheme, more than 200 products have received these prizes in the last 32 years. Apart from Parkhe Prizes the Chamber awards three more prizes in the names of a few other trusts for the new industrial products.

Kamat Memorial Prize

The Chamber awards this prize to the student securing highest marks in 'Commerce' at the Pre-Degree Commerce Examination through the B. M. College of Commerce, Pune.

Other Prizes

The Chamber has also instituted three prizes at the University of Poona in the names of the Late Shri D. V. Potdar, the Late Shri G. D. Apte and Shri A. R. Bhat respectively awarded to the student standing first in the examination in Electrical Engineering at the final B.E. examination, in the Diploma in Business Administration and in the paper on Newspaper Production in the Degree in Journalism of the University of Poona.

Pimpri-Chinchwad-Bhosari Sub-committee

To deal with their common problems, the Chamber has formed a sub-committee of industrialists in the above area. Difficulties facing these industries and the regional problems are discussed by this committee and followed up by the Chamber, with the concerned authorities.

A separate sub-committee looks after the problems of industries located on the Pune-Nagar Road and another one to look after industrial problems of Ahmednagar District.

Various Sub-committees

The Chamber has also various professional sub-committees of experts in the field of transport, import, export, excise and customs, taxation, company law, labour, etc. These sub-committees meet periodically to review problems in their particular fields.

Translation Service

The Chamber offers translation service for the following languages: German, French, Spanish,

Arabic and Japanese. This service has proved very useful to member-concerns with export business.

Training Programmes

Short-duration training programmes in industrial management, industrial relations, export marketing, business law, etc. are organised by the Chamber periodically. Experts in respective fields are invited to conduct these programmes, thereby giving an opportunity to the participants of deriving maximum benefit from the course.

Conferences, Lectures and Seminars

Conferences on topical problems, lectures and seminars on important legal enactments, is another feature of the Chamber. These have helped to focus the attention of the government and the public on problems facing the business community. Important officials of the government, statesmen, administrators, scientists, industrialists, bankers, traders, visitors and delegates from abroad are invited to participate and lead the discussion in lectures and seminars.

Discussions with Officials

Members are given an opportunity of discussing with officials from various departments of the State Government as well as the Central Government, on matters of individual or collective interest. This has helped considerably in solving many problems and overcoming many difficulties because in such direct confrontations, the Government has been able to better appreciate the day-to-day and practical difficulties facing the business and industry. Similarly these meetings have also enabled the members to understand and appreciate the thinking of the Government on new and proposed enactments and resulted in active participation from the business community in carrying out policies of the Government.

Conference Facilities

The Chamber has a well-equipped building with an auditorium, air-conditioned Board

Room, training-class room with all modern facilities. These are made available to members on a nominal charge.

Audio-visual Laboratory

The Chamber has set up a complete audio-visual laboratory and now it has two 16 mm projectors, two automatic slide projectors, professional cassette and ordinary tape recorders, epidiascope, overhead projector, loud speakers and other ancillary equipment. The Chamber has also plans to purchase complete video tape-recording unit and set up a collection of video tapes on technical and technological subjects. All this equipment can be used by the members at a nominal cost.

Exhibitions and Monthly Film Show

Periodically the Chamber organises exhibitions on various specialised products such as the electronic industry and plastic industry products from Pune, exhibition of technical journals, catalogues, balance-sheets, etc. It has also plans to organize an exhibition of Pune products at Bombay. Every month the Chamber arranges a film show on technical and industrial subjects for the benefit of the members.

Industrial Engineering Services

Through the courtesy of the Poona Divisional Productivity Council, services of industrial engineers can be made available for the members. Special assignments on production planning and control, stores reorganisation, work study, cost reduction, plant layout and such other subjects are undertaken by these industrial engineers.

Chamber at your Service

The Chamber, thus, has organised many common services for the benefit of its members and others in business. It is not just a grievance-ventilating body as is the common concept of any chamber of commerce, but is a common service agency rendering important services to the business community. It is continuously striving to add to its services and to be more useful to its members.

What does SVC Bank mean?

Safe. **V**ersatile. **C**o-operative.

Yes, that describes us aptly.

SVC—incidentally—also happens to be our name ..short for **THE SHAMRAO VITHAL CO-OPERATIVE BANK LTD.**

Either way it's a name that means a lot—moneywise.
So remember it next time you think of money.



DEEP 76 SV 03

THE SHAMRAO VITHAL CO-OPERATIVE BANK LTD.

H/2, Anandashram, Shamrao Vithal Marg, Grant Road, Bombay 400 007

Money...money...money!

Shankar D. Nadkarni
Chairman.

Shop floors at HMT BHEL ICF TELCO

*have one common factor
for precision measurement*

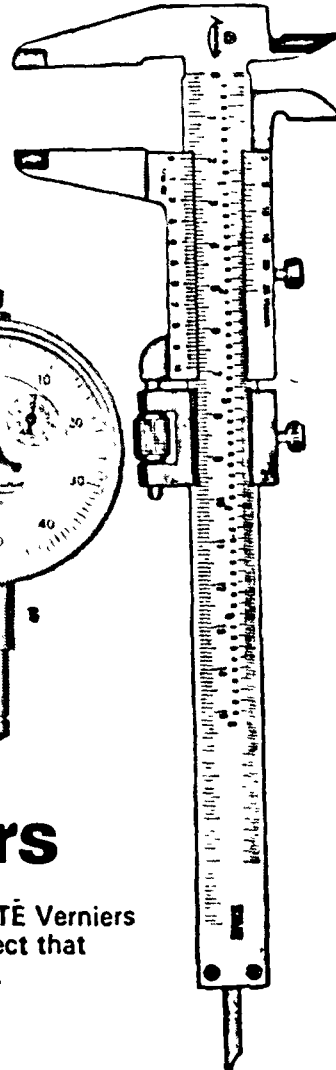
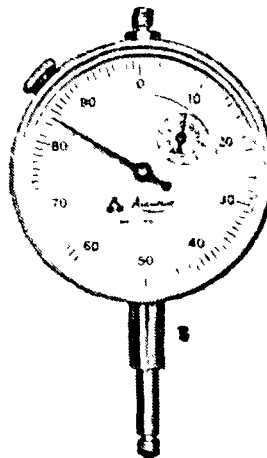
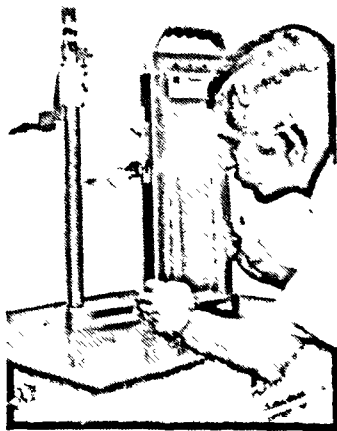

Accurate Dials & Verniers

Consistency in precision that only ACCURATE Verniers and Dials apt to render. Quality in every aspect that measuring area where very few made impact.



ACCURATE ENGINEERING Co. Pvt. Ltd.
67, HADAPSAR INDUSTRIAL ESTATE, POB NO 1202, PUNE 411 013
Tel 7158/59 Telex 0145-363 QRET IN Gram ACCURET

Manufacturers

Guide to Manufacturers

Addenda

Bakeries

Bricks

Government &

Semi-Government

Undertakings

Hosiery

Readymade Garments

Stone Crushers

Wood Working Units

Product Index

The figures relating to production, employment, investment etc. of the industries relate to the year 1977.

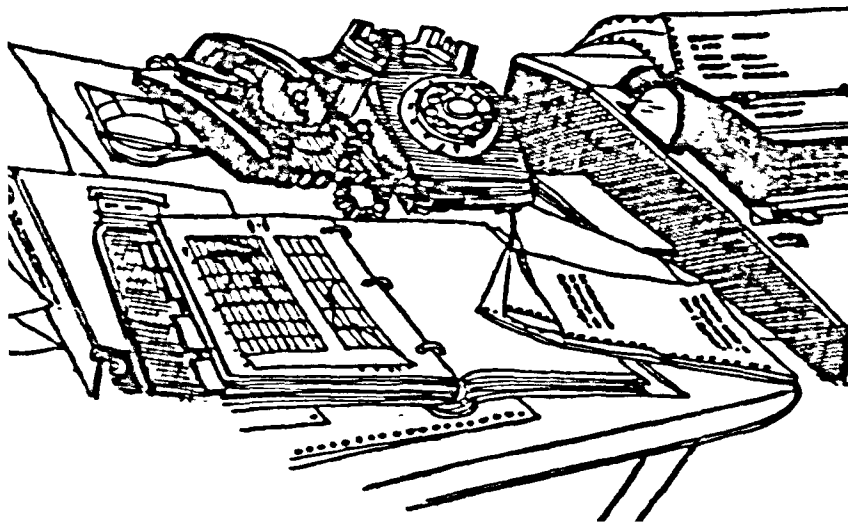

**EXPLANATORY
NOTES
FOR
GUIDE
TO
MANUFACTURERS**

1. 'Guide to Manufacturers' consists in-formation of manufacturers in Pune Metropolitan Region.
2. Names of the manufacturers are arranged in alphabetical order.
3. Serial numbers used in this Guide, are used as code numbers in 'Product Index'.
4. 'Production' means annual value of production or turnover for the year.
5. 'Capital' means investment in fixed assets plus current assets minus current liabilities.
6. Abbreviations used in this 'Guide' are as follows :
 - Estd. — Year of Establishment
 - Tel. — Telephone Number
 - Br. — Branch Offices
 - Cap. — Capital Employed
 - Prod. — Production

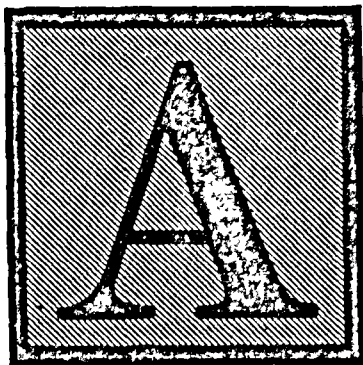

1. **A. B. ENGINEERING WORKS.** 335 Ghorpade Peth, Pune 2. Proprietary, 1976. Bank: Dena Bank. Cap. Rs.15,000. Prod. Rs.25,000. Workers 2 Products: Soft jaws, chucks, jobbing

2. **A. B. C. DRY CLEANERS.** 768 Sadashiv Peth, Pune 30. Tel. 443144. Factory: 505 Kasba Peth, Pune 11. Tel. 447142. Partnership, 1962. Bns. 8 in Pune; 2 each Aurangabad, Ahmednagar, Nasik. Bank: Bank of Maharashtra Cap. Rs.5,00,000 Prod. Rs.4,00,000. Workers 14 (at factory).

3. **A. G. ENGINEERING SERVICES.** 759/90 A Deccan Gymkhana, Pune 4. Tel. 55098, 54504. Factory: 20/5 Hadapsar Industrial Estate, Pune 13 Partnership, 1971. Bank: Bank of Maharashtra. Cap Rs.2,63,000. Prod. Rs 6,00,000. Workers 20. Products: Conveyors and accessories, screens for any material, crushers, feeders, handling systems, handling equipments, sugar graders, elevators, hoppers, chain conveyors, baggage conveyors, cane unloaders, stackers, reclaimers.

4. **A. G. JOSHI AND COMPANY.** S. No. 49/1 Parvati, Pune-Satara Road, Pune 9. Tel. 441729, 443278. Cable AGINDIA. Partnership, 1939. Sister concern: I.W.A Engineering Enterprise, Pune 9. Bank: Bank of Maharashtra. Cap Rs.6,32,000. Prod. Rs.4,85,000. Workers 10. Products: Surgical shadowless lights.

5. **A. H. INDUSTRIES.** 81/82 Ganesh Baug, Pingle Wasti, Mundhwa, Pune 36. Proprietary, 1973. Bank: Bank of India. Cap. Rs 60,000. Prod. Rs.44,000. Workers 8. Product: Jobbing.

6. **A. J. ELECTRONICS.** 39/55 Erandawana, 9/B Prabhat Road, Pune 4. Tel. 53060. Cable: CLADMETAL.

Factory: 34/10 Erandawana, Pune 4 Tel 53353. Partnership, 1970 Bank: Bank of Baroda Cap. Rs.8,00,000. Prod. Rs.18,00,000. Workers 30. Products: Bonduct brand aluminium plate-type heat exchangers for refrigeration evaporators and for solar energy collectors, bimetal strips for electrical industry, rolled fin tubes for industrial refrigerators and air conditioners, carbon brushes for automobile and industrial type.

7. **A. J. INDUSTRIES.** 'S'-83 MIDC, Bhosari, Pune 26. Partnership, 1974. Bank Bank of Maharashtra. Cap Rs 5,00,000. Prod. Rs 5,00,000. Workers 18 Products: Multipoint carbide tipped cutting tools, multipoint HSS special tools, machine and chuck accessories such as soft and hard jaws, parallel shank sockets, precision machine components.

8. **A. K. INDUSTRIES.** 914 Raviwar Peth, opp. Dagadi Nagoba temple, Pune 2 Tel 449204. Partnership, 1960. Banks Bank of Maharashtra, Bank of India. Cap. Rs.1,80,000. Prod Rs 5,00,000. Workers 19. Products: A. K. Brand brass taper, water-taps—1/4" BSP to 2" BSP.

9. **A. K. K. P. ENGINEERING CORPORATION.** 1314 Kasba Peth, Pune 11. Tel. 448076. Factory: B 21, H Block MIDC, Pimpri, Pune 18 Tel. 82180 Partnership, 1960. Bank: Bank of Maharashtra. Cap. Rs.57,500. Prod. Rs.9,00,000. Workers 25 Product: Non-ferrous castings.

10. **A. K. M. ELECTROPLATERS.** S-11 Parvati Industrial Estate, Pune 9. Tel. 441320 Proprietary, 1968. Banks: Bank of India; Trimurti Sahakari Bank Ltd. Cap. Rs.25,000. Prod. Rs.1,60,000. Workers 16 Product: Electroplating of all kinds

11. **A. N. C. ENTERPRISES.** 43 Shridharnagar, Chinchwad, Pune 33. Factory: 785 Bombay-Pune Road, opp. Jayashree Talkies, Chinchwad, Pune 19. Tel. C/o. 82034. Partnership, 1977. Bank: Indian Bank. Cap. Rs. 58,000. Workers 4. Products: Machine tool accessories like revolving centres, dead centres, reduction sleeves, long milling arbors, stud arbors, die holder attachment, drill chuck arbor, soft jaws for different chucks, etc.

12. **A. S. KADAM AND CO.** 710 Ganj Peth, Pune 2. Partnership, 1962. Bank: Poona Merchants' Co-op. Bank Ltd. Workers 9. Product: Wooden packing cases.

13. **A. S. ENGINEERING WORKS.** 228/29 Mangalwar Peth, Pune 2. Tel. C/o. 25284. Partnership, 1977. Bank: Vidya Sahakari Bank Ltd. Cap. Rs.15,000. Workers 3. Product: All kinds of jobbing.

14. **A. V. LIMAYE PERFUMERS.** 752 Sadashiv Peth, Pune 30. Factory: 1810 Sadashiv Peth, Pune 30 Proprietary, 1948. Bank: Bank of Maharashtra Cap Rs 15,000. Prod. Rs.1,00,000 Product. Agarbatti
15. **A ONE CEMENT CONCRETE WORKS.** 35/3 Erandawana, Karve Road, Pune 4. Tel 50298 Partnership, 1976. Bank Bank of Maharashtra. Cap Rs 1,50,000 Prod. Rs.2,40,000 Workers 9 Product: Mosaic, plain and terrazo tiles
16. **A ONE PRECAST INDUSTRIES.** C/o. Shri A. N. Malegaonkar, 103 Shivajinagar, Chunawala Chamber, Pune 5. Tel. 53762. Factory S. No 39/4/3 Vadgaon Sheri, Pune 14 Tel 22536. Proprietary, 1974. Bank: State Bank of India Cap Rs 2,60,000. Prod. Rs.3,00,000. Workers 15 Products: Hollow concrete and closed cavity concrete blocks of various sizes, solid blocks, floor and roof blocks (416×200×120), intel blocks, floor and roof planks for floor block, load bearing blocks, slit-type blocks and other quality concrete products for building
- ✓ 17. **ABHI CHEMICAL AND PHARMACEUTICAL PVT. LTD.** 'Ravikiran', 6th Lane, Prabhat Road, Pune 4. Tel.53948 Cable ABHICHEM Telex : 014-388. Factory Plot Nos. T 37 & 38 MIDC, Bhosari, Pune 26. Tel. 82979. 83077. Estd 1971 Bank State Bank of India Cap. Rs.28,36,111 Prod Rs 47,00,000 Workers 69. Products: Pharmaceuticals such as Dextrose Inj. IP 540 ml, Dextrose and Sodium Chloride 540 ml., Sodium Chloride inj IP 540 ml, water for inj. 5 ml, 10 ml etc. and some drops, syrups etc Chemicals such as Riboflavine 5, Phosphate Sodium BPC, Lithium Carbonate USP, Liquid Caramel IP, etc.
18. **ABHINAV PRINTERS.** 1262 Sadashiv Peth, Pune 30. Tel. 449430. Partnership, 1960 Bank: Bank of Maharashtra. Cap. Rs 50,000 Prod Rs 1,00,000 Workers 9. Product: Book-work jobs especially of mathematics and science
19. **ABHYANKAR OPTICIANS.** Bhanuvilas chowk, Laxmi Road, Pune 30. Tel. 447265 Proprietary, 1975. Bank: Bank of India. Cap. Rs.50,000. Prod. Rs.1,20,000. Workers 4. Products: Ophthalmic opticians, safety equipments, etc.
20. **ABHYANKAR PRECISION WORKS.** 45 Dr. Ambedkar Road, Pune 1. Tel. 22429. Proprietary, 1976. Sister concern: Quality Steel Castings, Pune 1. Bank: Bank of Baroda. Cap. Rs.80,000. Prod. Rs 1,94,845. Workers 30. Product: Job work of finishing and machining.
21. **ABLE TOOL ROOM.** 32/1/9 Erandawana, off Karve Road, Pune 4. Tel. 58884. Partnership, 1967. Bank: Bank of Maharashtra. Workers 12. Product: Jobbing
22. **ABRO ENTERPRISES.** S. No 51/3B/1 Vadgaon Sheri, off Nagar Road, Pune 14 Tel 20108. Proprietary: 1974 Bank: State Bank of India. Foreign representation Universum Verpackungs Gmbll, West Germany. Cap. Rs.1,30,000. Prod. Rs 4,00,000. Workers 8. Products: Non-ferrous castings of gun-metal, phos. bronze, lead bronze, aluminium bronze, aluminium alloys; bushes, bearings, pumps' parts, etc.
23. **ACCESSORIES AND COMPONENTS PVT. LTD.** 9/1B/2 Erandawana, Pune 4. Tel 56055. Estd. 1965. Bank : Syndicate Bank Cap. Rs 99,000. Prod. Rs 1,20,000 Workers 5 Products: Table-model wood turning machine; job work as precision components for diesel engines, piston rod assembly for pneumatic tools, etc.
24. **ACCURATE ELECTRICAL WORKS.** 1034 Nana Peth, Pune 2. Tel. 20132. Proprietary, 1974. Bank. Bank of Maharashtra. Cap. Rs.7,000. Prod. Rs.4,000. Workers 6. Product Repairing of electrical motors.
25. **ACCURATE ENGINEERING CO. LTD.** 67 Hadapsar Industrial Estate, Post Box No. 1202, Pune 13. Tel. 7158-59. Cable ACCURATE. Telex: 363. Estd 1963. Bank. Bank of Maharashtra. Cap Rs 15,00,000. Prod. Rs 34,00,000. Export: Rs.17,520. Countries U.S.A., Brazil. Workers 147. Products: Plain plug gauges, measuring pins cylinders, adjustable snap gauges, air gauges, dial gauges, vernier callipers, floating carriage dia measuring machines.
26. **ACME FOUNDRY FLUX COMPANY.** 264 Hadapsar Industrial Estate, Pune 13. Tel. 7338. Cable : AFFCO-FLUX. Partnership, 1964. Bank : Union Bank of India. Cap. Rs.6,00,000. Prod. Rs 10,00,000. Workers 10. Products: Foundry fluxes, exothermic compounds, binders, mould paints.
27. **ACOUSTICS ENGINEERS.** 1286 A, Shivajinagar, Pune 5. Tel. 56551, 57600 Partnership, 1973. Bank: Bank of Maharashtra. Cap. Rs 80,000. Prod. Rs.2,00,000. Workers 5. Products: Stereo amplifiers and P. A. amplifiers, tape recorders, studio audio mixing consoles, theatre amplifiers, loudspeakers, custom built audio equipments—paging system, piped-in music systems, conference equipment.

28. **ADARSHA PRINTING PRESS.** 538 Shaniwar Peth, Pune 30. Tel. 447221. Proprietary. Sister concern: New Field. Bank: Central Bank of India. Cap. Rs 3,500. Prod. Rs.25,000. Workers 7. Product: Printing of Marathi evening daily and other job work.
29. **ADEPT INSTRUMENT MOTORS.** 24/1 Karve Road, Pune 4. Tel. 57650. Factory : 176-A Parvati, Pune 9. Tel. 442642. Sister concern: Adept Laboratories. Partnership, 1962. Bank: Bank of India. Cap. Rs 93,000. Prod. Rs.1,80,000. Workers 12. Product: Synchronous electric motors.
30. **ADEPT LABORATORIES.** 24/1 Karve Road, Pune 4. Tel. 57650. Factory: 17/B Kothrud, Pune 29. Partnership, 1950. Sister concern: Adept Instrument Motors. Bank. Bank of Maharashtra. Cap. Rs 2,00,000. Prod. Rs 8,90,000. Workers 43. Products: Direct inking strip chart recorders, seismological instruments, special custom built instruments, synchronous motors
31. **ADVANI OERLIKON LIMITED.** Ador House, 6-K Dubash Marg, Fort, Bombay 23 Tel. 290505. Cable: CITOREX (Bombay). Telex: Superco-011-2781 Factory: Chinchwad, Pune 19. Tel. 82351, 82352, 82477. Cable. CITOREX (Chinchwad). Telex : Citodyn-0145-231. Estd. 1951. Brs. Calcutta, Delhi, Raipur, Madras. Sister concern: Britelight Carbon Ltd., Halole, Gujarat. Banks: Bank of India; Bank of Baroda; Bank of Maharashtra. Foreign collaboration: Welding Industries Oerlikon Buehrle Ltd., Switzerland; Cooperheat, England. Cap. Rs.661.52 lakhs, Prod. Rs.427.09 lakhs. Workers 577. Export: Rs.140 07 lakhs. Countries: Middle East and Far East countries, Africa, Europe, U.S.A. Products: (Manufactured at the Chinchwad plant) Automatic and semi-automatic submerged arc welders; automatic and semi-automatic gas shielded welders; modern static welding sources (rectifiers and specialised welding transformers); modern welding transformers, arc welding generators power and distribution transformers. Electronic items: (a) timers and flashers, (b) process control equipment and traffic control equipment, and (c) electronic flash guns; variable gang condensers, static drives and excitor supplies and static inverters; special equipments i.e. welding rotators, welding columns, booms, seamers, positioners and custom-built welding outfits, high voltage rectifiers for electrostatic precipitator application, rectifier plants for chemical processes. (The export figure is for all the manufacturing units of the company.)
32. **ADYAYAWAT BHARAT KALA GRIHA.** 567 Guruwar Peth, Pune 2. Proprietary, 1961. Bank: Merchant Co-op. Bank Ltd. Cap. Rs.12,000. Annual profit: Rs. 7,000, Worker 1. Products: Embroidery on sarees and readymade embroidery work.
33. **AESTHETICS (INDIA).** 126 Marathe Bldg., At Post: Narhe, Tal. Haveli, Dist. Pune. Proprietary, 1975. Cap. Rs 25,000. Prod. Rs 18,000. Workers 4. Products Hydroxycitronellal, Geraniol.
34. **AGARWAL CONTAINERS PVT. LTD.** 799/5 Bhawan Peth, Pune 2 Tel 26058, 26611 Cable. CONTAINERS-PUNE Telex. 0145-389. Factory. 33-35, F-2 Block MIDC, Pimpri, Pune 18 Tel 82569, 82041. Bank. Bank of Baroda Cap Rs 50 lakhs Prod. Rs.2 50 crores Workers 120. Product Mild steel barrels (200 lit capacity)
35. **AGARWAL ENGINEERING.** 434 Hadapsar, Pune 28 Tel. 7323 Proprietary, 1967 Sister concern. Ajay Industries Bank. Bank of Maharashtra Cap Rs 2,80,000. Workers 8 Products Heat exchangers, pressure vessels, oil coolers, etc.
36. **AGARWAL FABRICATIONS PVT. LTD.** 3 Wilson Gardens, Pune 1 Tel. 24959, 26527. Cable: AGARCOMP Factory: 32 Nagar Road, Ramwadi, Pune 14. Tel. 20592. Estd. 1965. Bank: State Bank of India. Cap. Rs 15 lakhs. Prod. Rs.65 lakhs Workers 75. Export Rs 3 lakhs. Countries: West Asia Products: Fabrication of steel and stainless steel chemical plants and machinery, agricultural equipments.
37. **AGRICULTURAL ENGINEERING CORPORATION.** Industrial Estate, 3/427 Sawarkar Nagar, Pune 9. Tel. 440948. Telex: VICMEC 0145-333. Partnership, 1971. Sister concern: Central Automobiles, Pune 2. Bank: Union Bank of India. Cap. Rs 6,00,000. Prod. Rs.7,50,000. Workers 22. Products: High pressure pipes and leakage oil lines for automobile diesel engines; diesel engine re-conditioning; brake and air pipes for automobiles.
38. **AGRIMECHA INDUSTRIES.** 83 Shivajinagar, Pune 5. Tel. 53674. Cable: AGROMACIND. Partnership, 1966. Sister concern: Sona Farm. Bank: Dena Bank. Cap. Rs.86,316. Prod. Rs.4,45,200. Workers 10. Products: Poultry equipments, cages and poultry feeds; also supply ready pullets and broilers.
39. **AGROPHARMA LABORATORIES.** 205 D-E 1025 Sadashiv Peth, Pune 30. Tel. 443186. Factory: 75 Dhayari, Tal. Haveli, Dist. Pune (Proposed at W 96 MIDC, Bhosari, Pune 26). Proprietary, 1976. Bank: Bank of Maharashtra. Cap. Rs.25,000. Products : α Naphthalene Acetic acid, diazepam; consultation.

40. **AGRO SCIENTIFIC INDUSTRIES.** 207/3 Mangalwar Peth, Pune 11. Tel. 27831. Partnership, 1967. Bank: Shree Suvarna Sahakari Bank Ltd Cap Rs.19,500. Prod Rs 3,90,000. Workers 8. Export Rs.52,382. Country: Singapore. Products: 'Multiplex' brand soil-testing equipments, enamelled wire-testing instruments, gas burners, scientific materials, fabricators of works as per designs.
41. **AHER ENGINEERING WORKS.** 309 Shukrawar Peth, Pune 2. Partnership, 1970. Cap. Rs.60,000, Prod. Rs 1,00,000 Workers 7 Product: Machining job work
42. **AHURA FLUX.** 12/F N.P.S Lines, Solapur Rd., Pune 1 Tel. 26460 Cable AHURA. Factory: 131/1 Hadapsar Industrial Estate, Pune 13. Tel. 7347. Proprietary, 1977. Sister concern: General Electronics. Bank: Central Bank of India Cap Rs 1,54,000. Prod. Rs 75,000 Workers 7. Products: Fluxes, binders, exothermic compounds, dressing materials, alloying elements, phenolic resin, etc
43. **AIR/ONE CORPORATION.** 20 Gultekadi Industrial Estate, Pune 9. Tel. 443274. Partnership, 1977. Sister concern: Azeez Mahedavi & Sons. Banks: Bank of Baroda; Muslim National Co-op Bank. Products: Complete range of fans and anti-air-pollution equipments e.g. dust collectors, scrubbers etc; cages, feeding-pans, etc. for animals; test-tube racks or stands.
44. **AIR-O-DYNE CORPORATION.** 34 Dapodi, Pune 12. Tel. 52069, 25079 Cable: DYNAFIL. Partnership, 1975. Bank: Bank of Maharashtra. Workers 9. Product: High efficiency air fillers for air conditioning and air handling systems
45. **AIR PLANTS CORPORATION.** 'Punch Ratna', Lulla Nagar, Pune 1. Tel. 26194 Factory: 4 Kondhwa Industrial Estate, Pune 1. Proprietary, 1972. Bank: Bank of Baroda. Workers 8 Products: Axial flow fans, aqua dust-collectors, filters, air classifiers, air curtains, centrifugal fans, cyclones, exhaust fans, fabric dust-collectors, roof extractors, roof inflow units, spray-painting booth, ventilation plant.
46. **AJMANI HOSIERY WORKS.** 292 Somwar Peth Pune 11. Partnership, 1965. Bank: Bank of Maharashtra. Cap. Rs 10,000. Workers 7 (part time) Products: Banians, stitching work.
47. **AJANTA ENGINEERINGS.** 26 Somwar Peth, Pune 11. Tel. 26046. Partnership, 1968. Bank: Bank of Maharashtra. Cap. Rs 10,000. Prod Rs.25,000. Workers 6. Products: Jobbing.
48. **AJANTA FARM MACHINERY CO.** A 49/50/51H Block MIDC, Pimpri, Pune 18. Tel. 82905. Partnership, 1967. Bank: Bank of Maharashtra. Cap. Rs 2,00 000. Prod. Rs 2,00,000 Workers 5 to 16 Products: 'Ajanta' border strip former (Sara Yantra), farm contour-marker, bund former, floating siphon.
49. **AJANTHA DRESSES.** 721 Guruwar Peth, Pune 2. Tel. 441256. Proprietary, 1960 Bank: Union Bank of India. Cap. Rs 1,02,000. Prod Rs 3,60,000 Workers 9. Product: Cotton garments for children.
50. **AJANTHA SOAP FACTORY.** 736 Kasba Peth, Pune 11. Tel. 448284 Partnership, 1962. Cap. Rs 50,000. Prod Rs 10,00,000. Workers 7. Product: Washing soap
51. **AJANTHA STEEL INDUSTRIES.** 499 Rasta Peth, Pune 11. Tel. 24824. Partnership, 1957. Bank: Central Bank of India. Cap Rs.20,00,000 Prod Rs.5,00,000. Workers 24. Products: Steel windows, doors, grills and other steel fabrications.
52. **AJAY ENGINEERING WORKS.** A-6/7/8 H Block MIDC, Pimpri, Pune 18. Tel. 82919. 82781. Partnership, 1973. Bank: Bank of India Cap. Rs.3,00,000. Prod. Rs.14,00,000. Workers 28. Products: Sheet metal industrial fabrication work, iron and steel structures, foundry chemicals.
53. **AJAY METACHEM PVT. LTD.** 784 Deccan Gymkhana, opp Kamala Nehru Park, Pune 4. Tel. 54943 Cable: METACHEM. Telex: 0145 381. Factory: Mundhwa, Pune 36. Estd. 1974. Brs. Bombay, Kolhapur, Jamshedpur, Calcutta, Madras, Bangalore, Belgaum, Nagpur. Sister concerns: United Metachem P. Ltd; Bharat Foundry Services. Bank: Bank of Baroda. Products Foundry fluxes and chemicals.
54. **AJCO ELECTRONICS.** 47/19 Erandawana, Chiploonkar Rd., Pune 4. Tel. 58339. Cable: AJCO. Partnership, 1962. Bank: Bank of Maharashtra. Cap. Rs.3,70,000, Prod. Rs.5,10,000. Workers 21. Products: Potentiometers—D. R., vernier type, portable D.C.; Bridges—Kelvin Double, direct reading wheatstone, self-contained conductivity; Galvanometers—reflecting type pointer electronic D.C., portable light spot; standard resistances; lamp and scale; thermocouple test set; bridge, insulation and earth testers; ohme meters, regulated D.C. power packs, transfer voltage standard, wow and flutter meters, 'Ninad' tape recorder, magnetic recording heads, digital instruments.

- 55. AJIT METAL WORKS.** 20/1 Hadapsar Industrial Estate, Pune 13 Tel. 7150. Proprietary, 1965. Bank: Bank of Maharashtra. Cap. Rs.15,000. Prod. Rs 60,000. Workers 15. Products: Ferrous, non-ferrous castings, manhole and chamber covers, flooring tiles and other commercial castings.
- 56. AJIT SOAP FACTORY.** 610 Ganesh Peth, Pune 12. Tel. 444836. Partnership, 1955. Bank: Bank of India. Cap. Rs.2,50,000. Prod. Rs 5,00,000. Workers 8. Product. Washing soap
- 57. AJIT TEXTILE.** 81/82 Ganesh Baug, Mundhwa, Pune 36. Proprietary, 1973. Sister concerns: Swati Textiles; Ashok Textiles. Bank: Central Bank of India. Cap. Rs 30,000, Prod. Rs.1,00,000. Workers 3. Products: Mulmul cloth, cambric cloth, cotton fabrics.
- 58. AJIT TOYS.** 248 Ganesh Peth, Pune 2. Proprietary, 1970. Cap. Rs 8,000. Product. Toys
- 59. AJITSINGH DAYALSINGH.** 33-A-7, 8, 9 Bopodi, Pune 3. Tel. 58449. Partnership, 1964. Bank: Bank of Maharashtra. Cap. Rs.20,000. Prod. Rs.1,50,301. Workers 18, Product: Iron and steel fabrication.
- 60. AKASH PLASTICS.** 33 Bombay-Pune Rd., Bopodi. Pune 3. Tel. 53048, 53642. Proprietary, 1974. Bank: Central Bank of India. Cap. Rs.5,00,000. Prod. Rs.6,00,000. Products: Polythene sheets, rolls, bags, plastic box strips, P.V.C. tubes, sleeveings, moulded articles.
- 61. AKSHAY ENGINEERS.** 376 Budhwar Peth, Pune 2. Factory: S. No. 5 Keshavnagar, Patil Vasti, Mundhwa, Pune 36. Product: Quick-changing, self-locking tool post for centre lathe.
- 62. AKSHAYYA MUDRANALAYA.** 443 Sadashiv Peth, Pune 30. Partnership, 1976. Bank: Bank of Maharashtra. Cap. Rs 60,000. Prod. Rs 80,000. Workers 5. Product: Stationery printing.
- 63. ALANKAR BAG INDUSTRIES.** 66 Ganesh Peth, Pune 2. Proprietary, 1969. Bank: State Bank of India. Cap. Rs.25,000. Prod. Rs 1,50,000. Workers 4. Products: All kinds of bags.
- 64. ALANKAR PRINTING PRESS.** 1453 Kasba Peth, Pune 11. Tel. 448144. Proprietary, 1970. Bank: Bank of Maharashtra. Cap. Rs.1,00,000. Prod. Rs.1,50,000. Workers 5. Products: Bill-books and other printing jobs.
- 65. ALANKAR PRODUCTS.** 240 Parvati, Chougule Bldg., Pune 30. Proprietary, 1972. Bank: Bank of India Cap. Rs.5,000. Product: Folding hangers.
- 66. ALCOP ENTERPRISES.** 32/1/6A Erandawana, behind Mahendale Garage, Pune 4 Tel. 53378. Cable. WHEELS. Partnership, 1972. Sister concern: Tridal Rubber, Pune 4. Banks: Bank of Maharashtra; The Sangli Bank Ltd; The Cosmos Co-op. Bank Ltd. Cap. Rs.1,50,000. Prod. Rs.7,00,000. Workers 8. Products. Industrial trolley wheels like cast iron wheels, fabricated wheels, solid rubber tyred patented wheels in various sizes, load capacities and in different bearings; various types of trolleys and wheel barrows; material handling equipments, hydraulic lift tables or platforms in various capacities.
- 67. ALERT ENGINEERS.** 279/7 Shanwar Peth, Tambe Lane, Pune 30. Proprietary, 1971. Bank: Vidya Sahakari Bank. Cap. Rs 35,000. Prod. Rs 48,000. Workers 3. Products: Tooling dies and jobbing.
- 68. ALPHA ELECTRONICS.** 930 Shivajinagar, F.C. Road, Pune 4. Tel. 50426. Proprietary, 1974 Bank: Bank of India. Cap. Rs 30,000. Prod. Rs.1,20,000. Workers 5 Products: Instrument power transformers, ferrite core transformer, A.C. to D.C. convertors, regulated D.C. power suppliers, battery chargers, audio and test oscillators, line voltage controllers, electro-convulsion therapy units, electronic timers, RFI power line noise suppressors, etc.
- 69. ALFA ENGINEERING WORKS.** 18 Ghorpade Peth, Pune 2. Tel. 442610. Proprietary, 1965. Banks: The Muslim Co-op. Bank Ltd; Bank of Maharashtra. Cap. Rs.21,941. Prod. Rs.46,792. Workers 6. Products: All types of brass water-taps, engine parts and jobbing.
- 70. ALKA MUDRANALAYA.** 195 Sadashiv Peth, Pune 30. Proprietary, 1968. Bank: Adinath Sahakari Bank Ltd. Cap. Rs.15,000. Products: Commercial printing, book-work.
- 71. ALKA TOYS.** 578 Budhwar Peth, Pune 2. Proprietary, 1920 Cap. Rs.7,000. Prod. Rs.18,000. Worker 1. Product. Toys.
- 72. ALL CAST ENGINEERS.** 115 H Block, MIDC, Pimpri, Pune 18. Partnership, 1976. Bank: Bank of Maharashtra. Cap. Rs.60,000. Workers 3. Products: Solenoid valves for sugar industry, and jobbing.
- 73. ALL IN SERVICE BUREAU.** 408/10 Gultekadi, Veer Savarkar Nagar, Pune 9. Tel. 441335. Estd. 1948,

- Bank. Bank of Maharashtra. Cap. Rs 4,00,000 Prod. Rs 12,00,000. Workers 30. Products: Flexible couplings, heat exchangers and fabrication jobs.
- 74. ALL INDIA SPORT INDUSTRIES.** 1032 Shivajinagar, Pune 16. Tel 56186 Cable. CLIMATIC Partnership, 1948. Banks Bank of Maharashtra; Union Bank of India. Cap Rs.63,575 Prod Rs 2,06,305 Export: Rs 20,730 Countries: Kenya, U. K., Canada, Abu Dhabi. Products: Tennis gut, squash gut, badminton gut, sheep gut.
- 75. ALLIANCE ENGINEERING COMPANY.** 1364 Shukrawar Peth, Natu Baug, Pune 2 Tel. 442546 Partnership, 1972 Bank: Shree Suvarna Sahakar Bank Ltd Cap. Rs 3,00,000 Prod. Rs 5,00,000 Workers 9. Products Spare parts for shot blasting machines, hydraulic jacks with power pack and controls, special type of fasteners for sugar and cement plants, boiler quality flanges as per I.B.R. & D.I.N stds, steel flanges, weld neck, slip on
- 76. ALLIANCES FORGE INDUSTRIES.** B. P. T. Plot No 45, 2/3 Ghodapdeo Rd, Bombay 33 Factory Block F2, Plot No. 42, MIDC, Pimpri, Pune 18 Partnership. 1977 Bank Bank of Baroda. Cap Rs 5,50,000 Workers 7. Products: High pressure pipe fittings, elbows, Ts, reducers, caps, forged in seamless pipe and M.S. rods.
- 77. ALLIED ENGINEERING SERVICES.** 1097 Shivajinagar, Pune 16. Tel 50887 Partnership, 1974 Bank: Union Bank of India Cap Rs.5,000. Prod Rs 1,10,000 Workers 4 Product. L D. polythelene covers
- 78. ALLIED FURNITURES.** 20 Mangalwar Peth, Barne Road, Pune 11. Tel 23339. Partnership, 1968 Bank: Central Bank of India Prod Rs 2,55,000. Workers 30 Products: Steel and wooden furniture fabrication
- 79. ALLIES ELECTRONIC INDUSTRIES.** 1243/1 Apte Road, Pune 4. Tel. C/o. 58254 Proprietary, 1972. Bank: Bank of Maharashtra. Cap. Rs 1,20,000 Prod. Rs. 1,00,000. Workers 6 Products Potentiometric recorders, xx recorders, potentiometric indicators, other control instruments
- 80. ALLOVERS AND LACE PVT. LTD.** (Poonam Embroideries). E-7-9 MIDC, Bhosari, Pune 26. Tel 82465 Cable: POONAM LACE. Estd. 1966. Br Bombay. Banks: The Indian Overseas Bank; State Bank of India; Punjab National Bank. Cap Rs 20,12,829. Prod. Rs. 54,72,922. Workers 146 Export: Rs.15,04,887 Countries: Gulf countries Products: Embroidering on cotton and other fabrics in motifs, allovers and laces.
- 81. ALLOY CASTINGS.** 45 Dr Ambedkar Road, Pune 1. Tel. C/o. 22518 Factory: 35/3 Patwardhan Plot, Erandawana, Pune 4. Tel. C/o. 50298. Partnership, 1972. Bank: Bank of India. Cap. Rs.62,000. Prod. Rs 2,50,000. Workers 9 Products. Ferrous and non-ferrous castings up to 600 kgs.
- 82. AMAR ENGINEERING WORKS.** 178 Deccan College Road, Yerawada, Pune 6. Tel. 26099. Proprietary, 1965. Bank: Bank of Maharashtra Cap Rs.3,00,000, Workers 21.
- 83. AMAR WINDING WORKS.** Opp. Backau Wolf, Station Road, Pimpri, Pune 18. Proprietary, 1964. Bank: United Commercial Bank. Cap Rs 6,000. Prod Rs 12,000 Workers 2. Product: Rewinding of electric motors and transformers up to 50 h.p. (or 37.5 kw) single or 3 phase, 50 c/s.
- 84. AMBALA ENGINEERS.** 204 M. G Road, Pune 1. Partnership, 1040 Bank. The Muslim Co-op. Bank Ltd. Cap Rs 2,00,000. Prod Rs 40,000 Workers 3 Products: Bolts, nuts, jobbing.
- 85. AMBEKAR INDUSTRIES.** 21/5 Karve Road, Pune 4 Tel. 57639 Factory 15/11 Karve Road, Kothrud, Pune 29 Tel 57637 Partnership, 1971 Banks Bank of Baroda; The Sangli Bank Ltd Cap. Rs 50,000. Prod. Rs 7,00,000. Products Decolite dry distemper, industrial paints and enamels, insulating varnishes
- 86. AMBEKAR RADIO ELECTRONICS.** 525 Narayan Peth, Pune 30 Tel 447747. Factory S/16 Parvati Ind Estate, Pune 9. Tel 446268. Proprietary, 1962. Bank Bank of Maharashtra. Cap Rs.70,000 Prod. Rs 45,000. Workers 2 Products: Muscle stimulator, short-wave diathermy, ultra sound, E.C.T. machine, paraffin wax bath, oscilloscope and other medical electronic instruments.
- 87. AMBIKA ENGINEERING WORKS.** At & Post Rajgurunagar, Tal Khed, Dist Pune. Proprietary, 1971. Bank Rajgurunagar Urban Bank Cap. Rs 22,000. Prod. Rs 36,847. Workers 4 Product Jobbing
- 88. AMBIKA FURNITURE.** 924 Budhwar Peth, Pune 2. Tel 446779. Proprietary, 1968. Bank: Union Bank of India. Cap Rs 52,000 Prod. Rs 30,000 Workers 6 Products: All types of furniture
- 89. AMBICA SALES CORPORATION.** 141 M G. Road, Pune 1. Tel. 27109. Partnership, 1972. Sister con-

- cerns: Maharashtra Cheap stores; Ambica Enterprises. Bank: Bank of India. Cap. Rs.1,22,310. Prod. Rs. 2,89,435. Workers 5. Products: Pencil erasers, liquid soap, liquid detergent, jelly soap, sanitary cubes, cleaning powder, etc.
90. **AMBIKA TEXTILE.** 14 Hadapsar Industrial Estate, Pune 13. Tel. 7288. Proprietary, 1970. Br. at Saswad. Products: Cotton fabrics, voils, dhotis, mulmul, etc.
91. **AMCO SAFE.** 339 Ghorpade Peth, Pune 2 Tel. 441399. Proprietary, 1970. Bank : The Muslim Co-op. Bank Ltd. Cap. Rs.25,000. Prod. Rs.50,000. Workers 6. Product. Steel furniture.
92. **AMEY INDUSTRIES.** 29/25 Somwar Peth, Pune 11. Tel. C/o. 24514. Partnership, 1970. Bank. Dena Bank. Cap. Rs.20,000. Prod. Rs.15,000. Worker 1. Product: Jobbing.
93. **AMIN PLASTIC.** 856 Kasba Peth, Pune 11. Proprietary, 1970. Sister concerns: Mina Enterprises, Amin Enterprises. Bank: Bank of Maharashtra. Cap. Rs.1,00,000. Prod. Rs.3,00,000. Workers 7 Products. Plastic parts, cosmetics.
94. **AMNAJI ENGINEERING WORKS.** 1281 Shukrawar Peth, Pune 2 Tel. 442815. Partnership, 1963. Bank: Syndicate Bank. Cap. Rs.1,00,000. Prod. Rs.1,70,000. Workers 8. Product: Precision jobbing.
95. **AMPHETRONIX LTD.** 105 Bhosari Industrial Estate, P. Box No. 1, Pune 26. Tel. 83363, 83463. Cable: AMPHENOL. Telex: 0145-337. Estd. 1972. Bank: State Bank of India. Foreign collaboration: Bunker Ramo Corporation, Amphenol Components Group, U.S.A. Cap. Rs.124.96 lakhs. Prod. Rs.119,40 lakhs. Workers 120. Export: Rs.1,00,000. Countries: Australia, West Germany, U.K. Products: Printed circuit connectors, rack and panel connectors, RF coaxial connectors, audio connectors, military service circular connectors.
96. **ANALOGUE AND DIGITAL MEASUREMENT COMPANY.** Shed No. A-6, Functional Electronic Estate, Bhosari, Poona 26. Tel. 83324. Proprietary, 1968. Bank: Union Bank of India. Cap. Rs.10,50,000. Prod. Rs.12,00,000. Workers 40. Products: Potentiometers—precision wirewound, trimming, rectilinear multturn, helical, servo pots, micro torque pots, W.W. resistors, ovens, furnaces, toroid winding machines, coil winding machines, continuous coils, special purpose W.W. machines.
97. **ANAND AGENCIES.** 1433/A Shukrawar Peth, Pune 2. Tel. 440735. Partnership, 1955. Bank: Bank of India. Products: Apparatus required for teaching of psychology
98. **ANAND AUTOMOBILES.** 292 Nana Peth, Pune 2. Tel. 28908. Factory. 691/A/2, Pune-Satara Road, Pune 9 Tel. 443745 Partnership, 1968 Sister concerns Atco (P) Ltd.; Beejay Associates P. Ltd ; Bharat Trading Co Bank Bank of Maharashtra. Cap Rs 75,000. Prod. Rs.1,00,000. Workers 8 Products Automobiles engine spares and repairing work
99. **ANAND ELECTROPLATING WORKS.** 1736 Shukrawar Peth, Pune 2 Proprietary, 1965 Bank : Dena Bank. Cap. Rs 20,000. Workers 2 Product Electroplating.
100. **ANAND INDUSTRIES.** Factory and Office: 893/3 Anand Chambers, F C Road, Deccan Gymkhana, Pune 4 Tel 57818. Foundry. Shed No. 12B, Parvat. Industrial Estate, Pune-Satara Road, Pune 9. Partnership 1961. Bank. Bank of Maharashtra Cap Rs.50,000, Prod. Rs.1,80,000 Workers 15 Products. Non-ferrous bushings, fuel level gauges, ferrous components for mopeds, machined components from various alloys.
101. **ANAND HOSIERY WORKS.** 25 Kasba Peth, Pune 11. Partnership 1976. Bank. Bank of Maharashtra. Cap. Rs.18 000 Prod. Rs 60 000 Workers 3. Products All varieties of hosiery.
102. **ANAND MUDRANALAYA.** 1523 Sadashiv Peth, Pune 30. Tel. 441980 Partnership, 1915. Banks : Bank of Maharashtra, Poona Peoples Co-op Bank. Cap. Rs.3,65,000. Prod Rs. 3,00,000. Workers 31. Products: Printing job work and books.
103. **ANAND TEXTILES.** 35 Erandawana, Pune 4. Proprietary, 1961. Cap. Rs.28,000. Prod. Rs.18,000, Workers 6. Product: Gray mulls.
104. **ANANDNATH ENGINEERING WORKS.** Mithapalli Estate, Shankarshet Road, Pune 9. Partnership, 1977, Cap. Rs.15 000. Product: Jobbing.
105. **ANANT ENGINEERING WORKS.** Plot No. 31, 'S' Block, Bhosari Industrial Estate, Pune 26. Proprietary. 1969. Bank : Central Bank of India. Cap. Rs.37,000. Prod. Rs 4,50,000. Workers 14. Products: Non-ferrous castings, proof machined and complete machined jobs.

- 106. ANANT LEATHER WORK.** 205 Ghorpade Peth, Pune 2. Products. Leather-canvas handgloves, mechanic shoes, all types of rexine, leather bellows, bellow covers and industrial leather-requirements
- 107. ANANT MACHINERY PVT. LTD.** Plot No 3B, Chinchwad Industrial Estate, Chinchwad, Pune 19 Tel 82179. Cable AMPL. Estd 1965 Bank: Bank of Maharashtra. Cap Rs 35,00,000 Prod Rs 24,00,000 Workers 100 Product Jobbing
- 108. ANANT METAL WORKS.** 1305 Kasba Peth, Pune 11, Tel 448586, 447803. Partnership, 1961. Sister concern Bharat smelting and refining company. Bank. Bank of Maharashtra Cap Rs 25,00,000. Prod. Rs. 30,00,000 Workers 39. Products Non-ferrous industrial castings of all sizes and shapes, ingots of copper-base alloys conforming to IS and BS or any other specifications.
- 109. ANANT PRODUCTS.** 338/E Rasta Peth, Pune 11. Proprietary, 1965. Bank: Bank of Maharashtra. Products Nozzle assemblies for compressors, jobbing.
- 110. ANANT TUKARAM KAKADE.** 550 Guruwar Peth, Pune 2 Proprietary, 1943 Bank United Commercial Bank. Cap Rs 20,000 Prod Rs 22,000. Workers 7. Product Brass utensils
- 111. ANANTRAJ PRINTING PRESS.** 1317 Kasba Peth, Pune 11 Proprietary, 1968. Bank: The Cosmos Co-op Bank Ltd Cap. Rs 10,000 Prod. Rs 5,000. Product. Printing job work.
- 112. ANIKHILA INDUSTRIES.** Plot No B7, B8, 'H' Block, MIDC, Pimpri, Pune 18. Cable: ANIKHILA, Proprietary, 1967. Bank Bank of Maharashtra Cap. Rs 7,93,000. Prod. Rs 5,68,455 Workers 47. Products: Different types of industrial undercarriages for portable applications of pumpsets, gensets, compressor sets, oil filtration plant, etc., agricultural trailers of all types; tractor-driven agricultural implements covering complete range of primary tillage implements, material-handling equipments
- 113. ANIL INDUSTRIES.** 1037 Shukrawar Peth, Tilak Rd, Pune 2. Factory. T-42 MIDC, Bhosari, General Block, Poona 26. Proprietary, 1969 Bank: Central Bank of India Cap Rs 2,35,000 Prod 15,10,000. Workers 8. Products. Non-ferrous castings, patterns and models, vacuum-formed articles, decorative castings, machined non-ferrous components.
- 114. ANITA PRINTERS.** S. No. 36/2A Vadgaon Sheri, Pune 14. Proprietary, 1973. Cap. Rs 25,000. Workers 4. Product. Printing job work.
- 115. ANJALI CHAPPALS.** 138/B Narayan Peth, Pune 30. Proprietary, 1957. Bank: State Bank of India Cap. Rs 10,000. Prod. Rs.15,000. Workers 2. Products. 'Anjali' chappals.
- 116. ANOOP ENGINEERING WORKS.** 3 Old Bazar, Khadki, Pune 3. Tel. 58325 Proprietary, 1962 Bank. Bank of Maharashtra. Cap. Rs.1,10,000. Prod. Rs 90,000. Workers 4. Products: Substitute parts for capsul-making machines, strippers, wedges.
- 117. THE ANTIFRICTION BEARINGS CORPORATION LTD.** 402 B Poonam Chambers, Dr. Annie Besant Road, Worli, Bombay 18 Tel. 372581-2-3. Factory. Pt Jawaharlal Nehru Marg, Lonavala, Dist. Pune. Tel 751-52-53. Estd. 1961 Banks: Bank of Baroda; Central Bank of India, Bombay Foreign collaboration. Steyr Daimler Puch, A. G. Austria, Cap Rs 6 33 lakhs Prod. Rs 5 6 crores Workers 648. Export Rs 1,36,000. Countries Iran, Kuwait Products Cylindrical roller bearings 26 to 50 mm bore, taper roller bearings 11 to 100 mm bore, thrust bearing 26 to 75 mm bore
- 118. ANUPAM INDUSTRIES.** A-5 Prakash colony, opp. Formica (I) Ltd, Akurdi, Pune 35. Tel. C/o. 82159 Partnership, 1976. Bank. State Bank of India Cap Rs 90,000 Prod. Rs.60,000. Workers 5. Product Jobbing.
- 119. ANUPAM PRODUCTS.** 1345 Sadashiv Peth, Pune 30. Tel 440176 Proprietary 1949 Bank. Bank of Baroda. Cap. Rs 47,371. Prod Rs 4,10,511. Workers 22. Products. Confectionery items such as Shrikhandwadi (small and big size) Ambawadi, Kaju Delight, Sunthawadi etc, and toffees.
- 120. ANUPAMA TEXTILES** 14 Hadapsar Industrial Estate, Pune 13. Tel. 7283. Proprietary 1977. Products: Cotton fabrics, voils, dhotis, mulmul, etc.
- 121. ANURADHA DRESSES.** 1383/84 Kasba Peth Pune 11. Tel. 449054 Partnership, 1964 Banks. State Bank of India Cap. Rs.1,40,000. Prod. Rs 1,75,000. Workers 6. Products. Readymade garments for children and women.
- 122. ANUSEU INDUSTRIES.** 19A Withalwadi, Pune 9. Proprietary, 1974. Bank: Indian Bank. Cap Rs 20,000 Prod. Rs 50,000 Workers 5 Products. Transformer accessories, line material for distribution of electricity.

- 123. ANUSUYA MUDRANALAYA.** 1398 Sadashiv Peth, Pune 30. Tel. 441530. Proprietary, 1948. Banks: Cosmos Co-op. Bank; Bhagini Nivedita Sahakari Bank. Cap. Rs.50,000. Prod. Rs.50,000, Workers 10. Product: Commercial printing and bookwork.
- 124. APEL (INDIA), D3/22 MIDC,** Chinchwad, Pune 19. Tel. 82666 83187, Proprietary, 1973. Sister concerns: Kiran Pattern Works; Hindustan Metal Works, Bombay Bank: Bank of Maharashtra. Cap. Rs.66,350. Prod. Rs. 73,740 Workers 9. Products. Oxygen and acetylen regulators, welding and cutting torches; spare parts for automobiles and oil engines.
- 125. APKAND INDUSTRIES.** 142 Shukrawar Peth, Pune 2. Factory: 615 (new) Shaniwar Peth, Pune 30. Tel. 448560. Partnership, 1969. Bank: Central Bank of India. Cap. Rs.50,000. Prod. Rs 40,000. Workers 16. Products: Nuts, bolts, engineering instruments as per drawings.
- 126. APOLLO BATTERIES.** 47/2 Pune-Satara Road, Pune 9. Tel. 441411. Proprietary, 1969. Bank: Central Bank of India. Cap. Rs.10,000. Prod. Rs.20,000. Worker 1. Products : Battery charging and repairing.
- 127. APOLLO INDUSTRIAL PRODUCTS.** Alankar Cinema Bldg, 2nd floor, Pune 1. Tel. 26862. Factory: Pimpri, Pune 18. Partnership, 1970. Banks: Central Bank of India. Prod. Rs.6,00,000 Products: Thermodynamic steam traps, pipeline strainers, ball valves, gate valves, needle valves, gauge glass cocks, safety valves, non-return valves.
- 128. APTE AND COMPANY.** 82/5 Sadashiv Peth, Pune 30. Tel. 441504. Proprietary, 1950. Bank: Bank of Maharashtra. Cap. Rs 1,50,000. Prod. Rs.25,000. Products: pickles, sun-dried products, squashes, masala powders.
- 129. AQUA PURA CORPORATION.** 1170/11 Shivajinagar, Pune 5. Tel. 56301. Partnership, 1965, Br. Baroda. Bank: Bank of Baroda. Cap. Rs. 50,000. Prod. Rs. 8,00,000. Products: Improved chloried plant, water treatment plant, swimming pool filters, clarifier, flocculator, pressure filters, rapid gravity type filtration plant, mobile chlorine plant and other pertaining equipments.
- 130. ARBALE CHEMICALS.** S. No. 42 Karve Road, Pune 4. Proprietary, 1968. Bank: Bank of Maharashtra. Prod. Rs. 9,000. Products: White cleaner, fountainpen ink and pad ink, cleaning solution.
- 131. ARBO'S ENGINEERING PVT. LTD.** 15/11. Kothrud, Pune 29. Tel. 55332. Cable: ARBOPUMPS. Estd. 1971. Banks: Bank of Maharashtra. Prod. Rs. 7,32,500. Workers 26. Products. Self-priming domestic water pumps, Kirloskar groundnut decorticators, threshers, components for submersible pumps, jobbing.
- 132. ARAM GADI KARKHANA.** 265 Budhwar Peth, Pune 2. Tel. 447982. Factory. 16-A Parvati Industrial Estate, Pune 9. Tel. 442370. Partnership, 1938. Br. Shop at 83-84 Sahakarnagar, Pune 9. Bank: Bank of Maharashtra. Cap. Rs.25,000. Prod. Rs. 80,000. Workers 7. Products: Mattresses, pillows, cushions, bolsters takkya, rajai, baby mattresses.
- 133. ARCHIE'S GARAGE.** 674 Shankarshet Road, Pune 2. Tel 440679. Cable: CARS. Partnership, 1939. Sister concern: Archie's Sales Corporation. Banks: Shree Suvarna Sahakari Bank Ltd.; United Commercial Bank. Product. Automobile repairing.
- 134. ARCO WHITNEY.** Akurdi Road, Chinchwad, Pune 19. Tel. 82568, 83319. Cable: ARCOWHIT. Telex: 0145-341. Limited company, 1968. Brs. Delhi, Calcutta, Madras, Bombay. Bank Bank of India. Foreign collaboration: W.A. Whitney, U S A. Cap. Rs 26,67,000. Prod. Rs.40,000. Workers 60. Products : Portable hydraulic fabrication equipments such as punches, shears, duplicators, gang punches, guillotine cutters, etc.; moulding press for bakelites, SMC, DMC rubber mouldings, open-throat pressers, bar straightening hydraulic power units, wheel centering presses, pipe pointing machines and powder compacting presses.
- 135. ARJUN MISTRI AND SONS.** 473 Raviwar Peth, Pune 2. Partnership, 1964. Banks: Sangli Bank Ltd.; State Bank of India. Cap. Rs.20,000. Prod. Rs.3,00,000. Workers 7 Products: Sewing-machine accessories such as table covers, cabinets; stands, machine tops and spare parts.
- 136. ARJUNDAS M. KRIPALANI STONE METAL WORKS.** 205/8 Bombay-Pune Road, Pimpri, Pune 18. Tel. 82337. Partnership, 1961. Br. Akurdi, Pune 35. Bank: Bank of Maharashtra. Cap. Rs.2,50,000. Prod. Rs.6,00,000. Workers 40. Product: Stone metal.
- 137. ARJUNWADKAR ASSOCIATES.** 170 Akurdi, Pune 35. Tel. 83487. Factory: A-21 H Block MIDC, Pimpri, Pune 18, Partnership, 1973. Banks: The Cosmos Co-op. Urban Bank Ltd.; United Commercial Bank. Cap. Rs.1,00,000. Prod. Rs 4,00,000. Workers 18. Products: Mechanical coal for boilers, gray iron castings.

- 138. ARKEY ENGINEERING SERVICES.** 37/4/A 6th Cross Lane, Prabhat Road, Pune 4. Tel. 50606. Estd 1977. Sister concern: Arkey Foundry Works. Bank: United Commercial Bank. Cap Rs.3,000. Workers 5. Product: Constant oil levellers for chemical pump manufacturing
- 139. ARKEY FOUNDRY WORKS.** 37/4/A 6th Cross Lane, Prabhat Road, Pune 4. Tel. 50606. Factory. Shembekar Industries Compound, Chinchwad, Pune 19. Tel. C/o. 82366, 82172. Proprietary, 1975. Sister concern: Arkey Engineering Services. Bank: Canara Bank. Cap Rs.10,000. Prod. Rs 50,000. Workers 4. Products Non-ferrous sand and gravity castings.
- 140. ARLABS LTD.** No. 6, 2nd floor, India House, Bombay 1. Tel. 262077-8-9. Telex: 5628. Factory: Bhor, Tal. Bhor, Dist. Pune. Tel. 24 Estd. 1940. Cap. Rs 2 crores. Prod. Rs.3.85 crores. Export: Rs 2.5 crores—all over the world. Products: Dyestuffs such as vats, solubilised vats, Phthalocyanine disperse, reactives, stabilised azoics, bases, oil colours, etc.
- 141. AROCHEM INDUSTRIES.** 874 Raviwar Peth, Pune 2. Factory: S 44 Bhosari Industrial Area Pune. 26: Partnership, 1973. Banks: Punjab National Bank; Sangli Bank Ltd. Cap. Rs.1,00,000. Prod. Rs.90,000. Workers 4. Products: Acid slurry, trisodium phosphate, detergent powder, cleaning powder, washing cakes, cleaning cakes, turkey-red oil, etc.
- 142. AROFINES.** 65/1 Ramdhun, Erandawana, Pune 4. Tel. C/o. 54704. Factory: S-42 MIDC, Bhosari, Pune 26. Partnership, 1973. Bank: Canara Bank. Cap. Rs 1,50,000. Prod. Rs 3,00,000. Workers 5. Products: Synthetic and rubber-based industrial adhesive for packaging, furniture, automobile, electronic, shoe industry and as per specific requirements.
- 143. AROGYA PHARMACY (ANIMAL DIVISION).** 1206 B/4 Shivajinagar, Pune 4. Tel. C/o 444613 Partnership, 1966. Bank: Bank of India. Cap. Rs.2,00,000. Prod. Rs.3,00,000. Workers 9. Products: 'Shamatone' tonic powder, 'Aroxar' mineral mixture for cattle and poultry, 'Arolicks' mineralised salt licks for cattle.
- 144. ARROW DEVELOPMENT CORPORATION.** Narali Baug, Gultekadi Road, Pune 9. Tel. Resi. 440357. Proprietary, 1971. Bank: Dena Bank. Cap. Rs.79,800. Prod. Rs.2,00,000. Export: Rs.50,000. Countries: Dubai, U.A E. Products: Decorative glass snack sets, murals in glass and ceramics, glass panels, corner pieces, wall pieces and other decorative articles.
- 145. AURORA ENTERPRISES.** S-23 MIDC, Bhosari, Pune 26. Tel. 82808. Partnership, 1976. Bank: Bank of Maharashtra Product: Jobbing.
- 146. ARSIDHA ENTERPRISES.** 594 Guruwar Peth, Pune 2 Proprietary, 1975. Bank: The Poona Merchant Co-op. Bank Ltd. Cap Rs.10,000, Prod. Rs 80,000. Workers 2. Product: Readymade children wears.
- 147. ART ALONE.** 351 Shanwar Peth, Pune 30. Tel. 448852. Proprietary, 1965. Banks. Bank of Maharashtra; Bank of India. Cap. Rs 1,25,000. Prod. Rs.5,00,000. Workers 8. Products: Wedding and greeting cards, embossed designs on handmade paper and golden foiled designs on coated card.
- 148. ART LEATHER LTD.** Sir Vitthalidas Chambers, 16 Bombay Samachar Marg, Bombay 23. Tel. 251204. Cable: ARCHITART Factory. Bhor, Dist. Pune. Tel. 42. Estd 1948 Subsidiary company of the Thackersey Group Bank. State Bank of India Cap. Rs 4,00,000. Prod. Rs.65,00,000 Workers 240. Export. Rs.21,00,000. Countries: Sri Lanka, Bangla Desh. Products Cotton healds, cotton healds with mail eyes, dobbie harness, pitch bound steel reeds, all metal reeds.
- 149. ARTI ENGINEERS.** Sonali, 5 Prabhat Road, Lane No. 6, Pune 4. Tel. 58912 Cable. ARTENGCORP. Export Code No. BA/001613. Factory: Plot No. E-1 MIDC, Bhosari, Pune 26 Partnership, 1975. Bank: Bank of India. Cap. Rs 50,000. Prod. Rs 3,50,000. Export: Rs.40,000 Country: Etheopia. Products. Machinery and equipment for fertiliser granulation plant, sugar machinery plant, storage tanks for oil, molasses, petrol, water, etc., gratings, pallets, special carriers, general fabricated parts.
- 150. ARTWOOD FURNITURES.** 339 Ghorpade Peth, Pune 2. Tel. 441393. Proprietary, 1975. Bank: Bank of Maharashtra. Cap. Rs 13,000. Prod. Rs 22,000 Workers 8. Product: Wooden furniture
- 151. ARUDYOG ENGINEERS PVT. LTD.** 18/6 Hadapsar Industrial Estate, Pune 13. Tel. 7222, 7123. Estd. 1973. Br. 66 Hadapsar Industrial Estate, Pune 13. Sister concern: Vanaz Engineers Pvt. Ltd., Bombay, Pune. Bank: Bank of India. Cap. Rs 3,77,500. Prod. Rs.10,56,000. Workers 90. Products: Cold headed bolts and screws—max 1/4" dia × 2 1/2" long, pneumatic coupling, all types of electroplating, hard chrome plating and anodizing, jobbing.

- 152. ARUN AND COMPANY.** 224 Shivajinagar, Pune 5. Tel. 54043. Factory: Plot No. E-3 MIDC, Bhosari, Pune 26. Tel. 83556. Proprietary, 1959. Bank: Bank of Maharashtra. Cap. Rs.3,42,000. Prod. Rs.3,00,000. Workers 20. Products: Bus and coach building; oil, petrol and water tankers; explosive vans; steel cabins; bodies on all types of automobile chassis; tipper bodies, storage tanks, insulated milk vans.
- 153. ARUN FABRICS.** 44 Shankarshet Road, Pune 9., Tel. 446221. Factory: 37 Gultekadi Industrial Area, Pune 9. Partnership. Bank: Bank of Maharashtra. Cap. Rs.75,000. Prod. Rs.25,000. Workers 14. Product: Textile clothing on power-loom.
- 154. ARUN MECHANICAL WORKS.** 1408 Kasba Peth, Pune 11. Partnership, 1965. Bank: Poona Urban Co-op. Rupee Bank Ltd. Cap. Rs.20,000. Prod. Rs.25,000. Workers 3. Products: Jobbing.
- 155. ARUN PRINTING PRESS.** 125 Shukrawar Peth, Pune 2. Proprietary, 1948. Cap. Rs.8,000. Prod. Rs.3,000. Workers 2. Product: Commercial printing.
- 156. ARUN STATIONERS.** 18/19 Raviwar Peth, Pune 2. Tel. 444222. Factory: 530 Ganesh Peth, Dal Ali, Pune 2. Tel. 443042. Partnership, 1960. Bank: United Commercial Bank. Workers 35. Product: Exercise books.
- 157. ARUN TRADERS.** 1088 Raviwar Peth, Bhaji Ali, Pune 2. Tel. 446434. Factory: 987 Bhawani Peth, Pune 2. Partnership, 1966. Bank: State Bank of India. Cap. Rs.2,00,000. Prod. Rs.5,00,000. Workers 19. Products: 'Lisha' brassiers, banians, drawers.
- 158. ARUNA METAL WORKS.** 427/A-2 Gultekadi Industrial Estate, Pune 9. Factory: 691/A-1 Pune-Satara Road, Pune 9. Proprietary, 1966. Bank: Bank of Maharashtra. Cap. Rs.5,00,000. Prod. Rs.7,00,000. Workers 8. Products: Shaft keys, gauges, precision components.
- 159. ARUNODHAY ENGINEERING WORKSHOP.** Vadgaon Sheri, Pune 14. Products: Electrical motors' rewinding, repairing of electrical equipments, water pumps, machinery maintenance, fabrication.
- 160. ARVIND ENGINEERS.** 15-A Bombay-Pune Road, Bhale Estate, Pune 3. Tel. 58871. Partnership, 1966. Sister concern: Ajay Engineering Works. Bank: Bank of Maharashtra. Cap. Rs.30,000. Prod. Rs.4,50,000. Workers 13. Products: Sheet metal pressing, mild steel fabrication, dry type air cleaner.
- 161. ARVIND ENGINEERS.** A-130 H Block, MIDC, Pimpri, Pune 18. Tel. 82644. Proprietary, 1969. Bank: Bank of Maharashtra. Cap. Rs.75,000. Prod. Rs.5,00,000. Workers 15. Products: Sheet metal machines, bending rolls of various sizes, fabrication, ancillary products.
- 162. ARVIND MINERAL INDUSTRIES.** C/o. Vinayak Hardware Stores, 955 Budhwar Peth, Pune 2. Tel. 445773. Factory: 145/9 Dhayari, Vadgaon-Dhayari Road, Tal. Haveli, Dist. Pune. Proprietary, 1971. Bank: Bank of India. Cap. Rs.25,000. Prod. Rs.1,00,000. Workers 3. Product: Sagol.
- 163. ASHA INDUSTRIES.** 90 Shukrawar Peth, Near Phule Market, Pune 2 Proprietary. 1975. Bank: Bank of Maharashtra. Cap. Rs 30,000. Prod. Rs.40,000. Product: Jobbing.
- 164. ASHA PACKAGING INDUSTRIES.** Plot No. 31. D-3 Block MIDC, Chinchwad, Pune 19. Tel. 83364. Partnership, 1974. Bank: Syndicate Bank. Cap. Rs. 2,50,000. Prod. Rs.7,50,000. Workers 20. Products: Corrugated boxes, rolls, boards, printed duplex cartons. commercial printing.
- 165. ASHA TIN PRINTERS.** 82/5 Navi Peth, Pune 30 Factory: 64 Hadapsar Industrial Estate, Pune 13. Tel. 7450. Partnership 1963. Bank: State Bank of India. Cap. Rs.1,00,000. Prod. Rs 1,20,000. Workers 5. Products: Advertising display tin boards, allied advertising materials like stickers, etc.
- 166. ASHCO ENGINEERING WORK.** 338 Ghorpade Peth, Pune 2. Tel. 440884. Proprietary, 1974. Bank: The Muslim Co-op. Bank. Cap. Rs. 25,000. Prod. Rs. 12,000. Workers 4. Products: Jobbing.
- 167. ASHMUND AND MESHAM.** 407/2 Nana Peth, Geeta Bhavan, Pune 2. Tel. 28707. Factory: 'Bharadwaj', 10th lane, Erandawana, Pune 4. Partnership, 1977. Bank: Indian Bank. Cap. Rs.28,000. Prod. Rs.8,00,000. Workers 9. Products: Cable harnesses, industrial handgloves.
- 168. ASHOK AUTO ELECTRICALS.** 46/2/1B Kaka Halwai Industrial Estate, Pune-Satara Road, Pune 9. Tel. 441827. Partnership, 1958. Banks: Central Bank of India; Bank of Maharashtra. Cap. Rs.75,000. Workers 6. Products: Automobile servicing and sales.
- 169. ASHOK BONTEX COLLARS.** 252 Bhavani Peth, Pune 2. Proprietary, 1971. Bank: Central Bank of India. Cap. Rs.2,000. Prod. Rs.10,000. Workers 3. Product: Bontex collars.

170. **ASHOK ENTERPRISES.** 721 Guruwar Peth, Pune 2 Tel. 441284. Cable: PUROFIL. Factory. 148 B Mahatma Phule Peth, New Timber Market, Pune 2. Partnership, 1974 Banks: Bank of Maharashtra; Vidya Sahakari Bank Ltd. Cap Rs 1,50,000, Prod. Rs.5,00,000. Workers 12 Products: High efficiency supermicronic agricultural and industrial filters.
171. **ASHOK INDUSTRIES.** Bhosarigaon, Pune 26. Tel. 82906. Partnership, 1974. Bank: Dena Bank. Cap Rs.1,95,000. Prod. Rs.7,00,000. Workers 12 Products: Safety equipments, such as handgloves, hand sleeves, leg guards, aprons of canvas, leather, rubber and asbestos.
172. **ASHOK INDUSTRIES.** Plot No. 86 MIDC, Bhosari, Pune 26. Tel 82369. Partnership, 1965. Bank: United Commercial Bank. Cap, Rs 50,000. Prod. Rs. 1,50,000 Workers 9. Products: Wooden furniture, packing boxes.
173. **ASHOK IRON AND STEEL WORKS.** 686 Shivajinagar, Pune 4. Tel. 55245. Partnership, 1965. Bank: Bank of Maharashtra Cap. Rs 30,000. Prod. Rs.2,00,000. Workers 6 Product: Steel fabrication.
174. **ASHOK PLASTIC INDUSTRIES GROUP.** 1186 Kasba Peth, Near Sat-Toit Police Chowki, Pune 11 Tel. 448654. Cable: SHRIBALAJI Factory: S. No. 8/3 Kapurhol, Tal. Bhor, Dist Pune. Partnership, 1975. Sister concern: R. K. Thinner and Varnish Mfg. Co. Bank : Bank of India. Cap. Rs.2,50,000. Prod Rs 4,00,000. Workers 6. Products: Polythelene bags, sheets, tubing
175. **ASHOK TEXTILES.** 14 Hadapsar Industrial Estate, Pune 13. Tel. 7507. Proprietary, 1973 Products: Cotton textile.
176. **ASHOK TEXTILES.** 81/82 Ganesh Baug, Mundhwa, Pune 36. Proprietary, 1973. Bank: Central Bank of India. Cap. Rs.60,000. Prod. Rs 2,00,000. Workers 6. Products: Mulmul cloth, cambric cloth, cotton fabrics
177. **ASHOK SAFE MANUFACTURING COMPANY.** 200 Mangalwar Peth, Pune 11. Tel. 22957. Partnership, 1963. Bank: State Bank of India. Cap. Rs.40,000. Workers 12. Product: Jobbing.
178. **ASIATIC DRESSES.** 344 Budhwar Peth, Pune 2. Tel. 448470. Partnership, 1966. Bank: Dena Bank. Workers 9. Product: Readymade garments.
179. **A. S. K. ENTERPRISES.** 1261 Sadashiv Peth, Pune 30. Tel. 441291. Factory: Industrial Shed No. 7 & 8, 691/A-2 Bibwewadi, Pune-Satara Road, Pune 9 Tel. 449081. Partnership, 1974. Br. Bombay Sister concern: Anilkumar Agencies, Pune 30. Bank: Indian Bank. Cap. Rs 3,00,000. Prod Rs 9,00,000. Workers 9. Products: Decorative waterproof cement paints, cement waterproofing compound (powder and paste), mortar plasticiser, concrete hardening and waterproofing liquid, bonding primer, expansion filler and other paint materials
180. **ASKA ENTERPRISES.** 19 Vithalwadi, P. O Wadgaon, Pune 9. Tel 447295 Proprietary, 1977. Bank: Bank of Maharashtra Workers 2 Products: Paint remover, various types of protective compositions for defence establishments.
181. **ASMITA ENGINEERING ENTERPRISES.** W 56-32 Technicians sheds, Bhosari Industrial Area, Pune 26. Tel. 83125. Proprietary, 1975. Bank: Bank of Maharashtra. Cap. Rs.3,30,000. Prod Rs 2,50,000. Workers 8. Products: Precision turned components used in electronics, electrical, automobile and machine tool industries on job work basis.
182. **ASSOCIATED BEARING CO. LTD. (S.K.F)** Chinchwad, Pune 33 Tel 82791, 82043. Cable PEN-BALL, PUNE. Telex. 0145-222. Estd 1964. Banks: Bank of India; Bank of America; City Bank; Grindleys Bank. Foreign collaboration: SKF (Sweden) Svenska Kullager-Fabriken, Gothenburg, Sweden. Cap. Rs 1,800 lakhs. Prod. Rs 1,762 lakhs. Workers 970 Products: Deep groove ball-bearings, taper roller bearings, textile components; pendulum arms, top rollers, spindle inserts, jockey pulley, cradles.
183. **ASSOCIATED ENGINEERS.** 34/11 B Erandawana, Pune 4. Tel. 54335 Partnership, 1970. Sister concern: Snap Controls, Pune 4. Bank: Bank of India. Cap. Rs 1,00,000. Prod. Rs. 2,50,000 Products: Standard and custom built instrument motors—shedded pole, servo, synchronous, potentiometric strip chart recorder
184. **ASU ENGINEERS.** Pune-Solapur Road, At and Post: Loni Kalbhor, Dist. Pune. Proprietary, 1969. Bank: Bank of Maharashtra. Cap. Rs.60,000. Prod. Rs 1,00,000. Workers 8. Products: Fabrication, transformer erection, repairs of agricultural machinery and tractor implements, engineering job work of lift irrigation schemes.
185. **ATCO PVT. LTD.** 18 Dr. Koyaji Road, Pune 1. Tel. 22640. Cable: ATCO. Telex: 0145-368. Factory: 70 Wanowri. Pune 1. Tel. 27263. Estd. 1972. Subsidiary company: Anand Engineering Corporation, Kanpur.

Bank: The New Bank of India. Cap. Rs.2,00,000. Prod. Rs. 2,50,000. Workers 19. Products: Auto parts, filter parts and jobbing.

✓186. **ATLAS AUTOMOTIVE COMPONENTS.** 221 Dadabhai Naoroji Road, Fort, Bombay 1. Tel. 267881 (10 lines). Cable: ATLACOM. Telex 011-2942. Factory: D/2 Link Road No. 11, MIDC, Chinchwad, Pune 19. Tel. 82256, 83029. Cable: ATLACOM, Pune. Telex: 0145-201. Division of Indokem Ltd. Foreign collaboration: Karl Schmidt Gmbh, West Germany Workers 140. Products: Aluminium alloy die castings and sand castings of various specifications required for diesel engines, automobile industries, railways and defence.

✓187. **ATLAS COPCO (INDIA) LTD.** Mahatma Gandhi Memorial Bldg., Netaji Subhas Rd., Bombay 400 002. Tel. 315623, 315724. Cable: ATLAS COPCO, Bombay. Telex. 011-2364. Factory: Sevanagar, Dapodi, Pune 12. Tel. 82416/7, 83416. Cable: ATLAS COPCO. Brs. Bombay, New Delhi, Calcutta, Madras, Hyderabad. Banks: Bank of India; Central Bank of India; City Bank N. A. Foreign Collaboration: Atlas Copco MCT AB, Sweden. Cap. Rs.4,29,57,212 Prod. Rs.4,05,11,490. Workers 368. Export: Rs.18,94,245. Countries: Sweden, Australia, Mauritius, Sri Lanka, Korea and Nepal. Products: Air Compressors, rock drills, pusher legs and other pneumatic equipment.

188. **ATLAS METAL INDUSTRIES.** Pune-Nasik Road, Bhosari, Pune 26. Tel. 82438. Partnership, 1960. Bank: State Bank of India. Workers 43. Products: Non-ferrous castings for various industries and valves.

189. **ATOM PLAST.** 'Bhavna', Prabhadevi, Bombay 25. Tel. 456446. Factory: S. No. 745 Bombay-Pune Road, Telegaon Dabhade, Dist. Pune. Tel. TGD 30. Partnership, 1964. Banks: State Bank of India; Bank of Maharashtra. Cap. Rs.4,00,000. Prod. Rs.25,00,000. Workers 9. Products: Processing low density polythene powder.

190. **AUDYOGIK TANTRA SHIKSHAN SANSTHA.** C-2 MIDC, Chinchwad, Pune 19. Tel. 82079. Public Trust, 1964. Bank: Bank of Maharashtra. Products: Power-tillers and spare parts thereof and jobbing.

191. **ATUL ELECTRO FORMERS PVT. LTD.** 408 Ghorpade Peth, Pune 2. Tel. 445543. Cable: LOWLOSS. Factory. S. No. 117/2 Loni Kalbhor, Tal. Haveli, Dist. Pune. Tel. 7555. Estd. 1972. Banks: The United Western Bank Ltd; State Bank of India. Cap. Rs.6,22,000. Prod. Rs.12,55,000. Workers 22. Products: Nickel screens for sugar industries and for other uses, grids for battery, nickel foil and sheet

192. **AUTO GARAGE.** 481 Rasta Peth, Sardar Mudliar Rd., Pune 11. Proprietary, 1947. Cap. Rs 10,000 Products: Automobile repairing, painting, dainting, cushioning, electrical work of automobiles, fabrication

193. **AUTO PRODUCTS.** 688/A-4 Pune-Satara Road, Pune 9. Tel. 449115. Partnership, 1977. Bank: Bank of India. Workers 4 Products: Small precision automatic turned components.

194. **AUTO STEEL INDUSTRIES.** C-2-1 Technicians Block, Bhosari Industrial Estate, Pune 26. Tel. 82987, 83541. Cable: MOULDERS. Partnership, 1966. Br. Bombay. Banks: State Bank of India; Bank of Baroda. Cap. Rs.15,00,000. Workers 78. Products: Rubber, plastic and bakelite items.

195. **AUTO TURN.** 1217 Fergusson College Rd., Pune 4. Factory: S-32 Bhosari, Industrial Estate, Pune 26. Tel. 83260. Partnership, 1972. Bank: State Bank of India. Cap. Rs.60,000. Prod. Rs 5,00,000. Workers 15. Products: Jobbing.

196. **AUTOMATIC COMPONENTS.** A-39 H Block MIDC, Pimpri, Pune 18. Tel. 82230. Partnership, 1967. Bank: Bank of India. Workers 16. Products: Nuts, bolts, studs, precision turned and threaded components.

197. **AUTOMATIC CONTROL EQUIPMENTS.** 8-6 Karve Road, Pune 4. Tel. 56225. Cable. TEKNIKRAFT. Partnership, 1969. Sister concern: Teknikraft, Pune 4. Bank: Bank of India. Cap. Rs.25,000. Prod. Rs.16 lakhs. Workers 14. Exports to Middle East, Mauritius, Ghana, Sri Lanka. Products: Automatic line voltage correctors, single phase and three phase low tension electrical control panels, voltage and current test boxes, refrigerator analyser.

198. **AUTOMATS.** 602 Mohannagar, Chinchwad, Pune 19. Partnership, 1974. Bank: Canara Bank. Cap. Rs. 40,000. Prod. Rs.70,000. Workers 5. Products: Automobile parts, machinery parts by job work.

199. **AUTOMOTIVE MANUFACTURERS LTD.** Plot No. 10 near Saibaba Mandir, Pune-Satara Road, Pune 9. Tel. 441269, 441072. Cable: WESTAUTO. Telex: 0145-271. Estd. 1967. Brs. Bombay (H. O and Br.) Amhedabad, Rajkot, Secunderabad, Vijaywada, Vishakhapatnam and Nagpur. Bank: Canara Bank. Workers 102. Products: Sale, service and repairs of Leyland vehicles and spares.

200. AVADHOOT ENGINEERING WORKS. Bombay-Pune Rd., Kasarwad, Pune 18. Proprietary, 1959. Banks: Canara Bank; Central Bank of India. Cap. Rs.60,000. Prod. Rs.1,87,000. Workers 15. Products: Dowels of all standards as per requirements, auto parts, grind bars and pieces.

201. AWATAR AUTOMOBILES ENGINEERING WORKS. 47/30 C Aranyeshwar, Satara Road, Pune 9 Tel. 441754. Proprietary, 1966. Bank: Bank of Maharashtra. Cap. Rs 80,000. Prod. Rs 1,00,000. Workers 9. Products: Cylinder liners for diesel and petrol engine cars, scooters and other automobiles.

202. AYURVEDA RASASHALA. 25 Karve Road, Pune 4. Tel. 56796, 58893. Cable RASAYAN. Charitable trust in the name of Rashtriya Shikshan Mandal, Pune, Estd. 1935. Cap. Rs.26,000. Prod Rs 27,00,000. Workers 46. Products : Ayurvedic medicines

203. AYURVED SUMSHODHANALAYA. 1379 Shukrawar Peth, Natubag, Pune 2 Tel. 447918. Partnership, 1969. Bank: Bank of Maharashtra Prod Rs.2,50,000 Products: Ayurvedic medicines

204. AVURVIDYA MUDRANALAYA. 992 Sadashiv Peth, Pune 30. Tel. 443055. Partnership, 1939 Bank of Maharashtra. Cap. Rs 1,50,000. Prod Rs 1,20,000 Workers 10. Products Printing job work

205. AZAD ELECTRICAL. S-48 MIDC, Bhosari, Pune 26. Partnership, 1974. Bank. Bank of Maharashtra. Cap. Rs 3,00,000. Workers 14 Products Contact breaker points of silver, copper and tungston compositors by powder technology.

206. AZIZ MAHADAVI AND SONS. 1602 Shukrawar Peth, Pune 2. Proprietary, 1947. Bank: The Muslim National Co-op. Bank Ltd. Cap. Rs 40,000. Prod. Rs. 30,000. Workers 5. Products. Animal-house cages, laboratory items, sheet metal work.

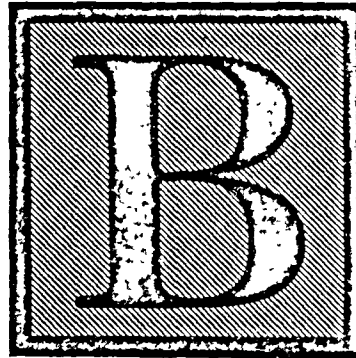

207. B. G. SAPRE AND CO. 45 Dr Ambedkar Road, Pune 1. Tel. 22518. Partnership, 1960 Bank State Bank of India. Cap Rs.6,00,000. Prod Rs 30,00,000. Workers 60. Product. Plant and machinery for paper and board mills between range of 5 to 20 tonnes per day

208. B. G. SHIRKE AND CO. 72-76 Industrial Estate Mundhwa, Pune 36. Tel. 7151, 7152. Cable BUILDALL' Telex : 0145/258, 'BGSPITDPN'. Partnership, 1944. Sister Concerns: B G Shirke & Co. Pvt Ltd ; B. G. Shirke Constructions Pvt Ltd ; Minato Shirke Concrete Machines Pvt Ltd ; Shirke Construction Equipments Pvt. Ltd.; Shirke Prive Reimbert Silos Pvt. Ltd. Banks: Bank of Maharashtra; The Chartered Bank, Bombay. Cap. Rs 1.18 Crores. Prod. Rs 2,86,78,000. Workers 2472. Export: Rs.2.30 crores. Countries: Dubai, U A E. Products. Fabricated structural steel viz. beams, purlins, columns, trusses, jigs, foundation bolts, fan hooks, steel gates, etc ; prefabricated houses of steel wood panel products and other prefab building materials/components.

209. B. H. PATOLE BRASS METAL WORKS. 529 Guruwar Peth, Pune 2. Proprietary, 1940. Cap. Rs 20,000. Prod. Rs.25,000. Workers 5. Products: Shewaya and chakali machine, moulds.

210. B. K. ENGINEERS. 427/A2 Gultekadi Industrial Estate, Pune 9. Tel. 440655. Proprietary, 1976. Bank: Vidya Sahakar Bank Ltd. Cap. Rs.5 lakhs. Prod. Rs 6 to 8 lakhs. Workers 18. Products: All types of Dowel pins, gauges and many other precision machinery components.

211. B. N. POPALBHAT WORKS. 464 Somwar Peth. Pune 11. Partnership, 1949. Cap. Rs.4,000. Prod. Rs. 2,500. Worker 1. Products: Coal press machine, motor work for lohari fabrication, all lohari work.

212. **B. R. ENGINEERING WORKS.** Shop No. 7, Survey No. 150, opp. Ruston & Hornsby Co., Chinchwad, Pune 19. Proprietary, 1975. Bank: Bank of Maharashtra. Cap. Rs.22,000. Workers: 2. Products: Jobbing.
213. **B. R. HEMADE WORKSHOP.** 370 Shukrawar Peth, Shivaji Rd., Pune 2. Tel. 442688. Partnership. 1928. Sister concern: Bhagirath Engineers, Bank: Bank of Maharashtra. Cap. Rs.1,00,000. Workers 5. Products: Repairing of oil engines, crushers, motor pumpsets etc. and jobbing.
214. **B. S. KHOT ELECTROPLATING.** 1665 Shukrawar Peth, Pune 2. Tel. 443027. Proprietary, 1977. Product: Electroplating.
215. **B.S.PAWAR AND SONS.** 308 Ganesh Peth, Pune 2. Tel. 447610. Factory: 782 Ganj Peth, Pune Partnership, 1923. Br. Solapur. Banks: Punjab National Bank; Sangli Bank Ltd. Cap. Rs.1,90,000. Prod. Rs.10,00,000. Workers 271. Product: Bidi.
216. **B. U. SHAH.** 281 Budhwar Peth, Pune 2. Proprietary, 1930. Cap. Rs.25,000. Prod. Rs.30,000. Workers 2. Products: Sewing thread, tubes, cones, etc.
217. **B. V. CONFECTIONARY WORKS.** 161 Gururwar Peth, Pune 2. Tel. 443504. Partnership, 1952. Bank: Bank of Maharashtra. Cap. Rs.70,000. Prod. Rs 2,00,000. Workers 7. Products: Confectionary.
218. **BABURAO BABAJI KAKADE.** 1315 Raviwar Peth, Pune 2. Tel. 444182. Proprietary, 1902. Bank: Syndicate Bank. Cap. Rs.50,000. Prod. Rs.10,000 Workers 5. Products: Tin-sheet-buckets, tawa, etc.
219. **BAFE LAB, PVT. LTD.** 'Ravikiran', 37/9 Prabhat Rd., 6th lane, Pune 4. Tel. 57064. Cable: BAFE LAB. Factory: T-37 & 38 Bhosari Industrial Estate, Bhosari, Pune 26. Tel. 83077. Estd. 1973. Sister Concern: Abhi Chemical & Pharmaceutical Pvt. Ltd. Banks: State Bank of India; The Sangli Bank Ltd.; Shree Suvarna Sahakari Bank Ltd. Cap. Rs.7,50,000. Prod. Rs.6,00,000. Workers 30. Products: 'AZO' & 'RIZO' bacterial fertilizers.
220. **BAGGA ELECTRONICS.** Bhosari Industrial Area, Pune 26. Tel. 82823. Proprietary, 1971. Bank: State Bank of India. Cap. Rs.6,00,000. Prod. Rs.4,00,000. Export: Rs.1,00,000. Country: West Germany. Products: Wire-wound and carbontrack potentiometers. Electronics equipments: fan regulator, temperature controller, voltage stabilizer, simple intercom sets, transistor tester; plastic moulding jobs.
221. **BAGSON PRINTERS.** 1599 Sadashiv Peth, Pune 30. Partnership, 1972. Bank: Bank of Maharashtra. Cap. Rs 2,000. Prod. Rs.12,000. Workers 3. Products: Textile transfer labels in all colours including silver and gold, polythene screen printing.
222. **BAJAJ AUTO LTD.** Bombay-Pune Rd., Akurdi, Pune 35. Tel. 82551. Cable. AUTORIKSHA. Telex 0145-308 Estd 1945. Brs Wakadewadi, Pune; Delhi. Bank: Central Bank of India. Foreign collaboration: Firms in Indonesia and Taiwan. Cap. Rs.16 84 crores. Prod. Rs. 51.81 crores. Workers 4725. Export: Rs.3.42 crores. Countries: Indonesia, Taiwan, Pakistan, Hong Kong, Kenya, Thailand, Iran, Yemen. Products: Scooters, three-wheelers, spare parts thereof.
223. **BAJAJ TEMPO LTD.** Bombay-Pune Rd., Akurdi, Pune 35. Tel. 82594-5-6-7. Cable. TEMPOWORK. Telex: 0145-352. Estd. 1958. Sister concerns: Jaya-Hind Industries Ltd.; Jaya Hind Sciaky Ltd.; Kinetic Engineering Ltd. Bank: Central Bank of India. Foreign collaboration: M/s Hanomag Henschel Fahrzeugwerke GmbH, Hannover, West Germany. Cap. Rs.11.34 crores. Prod. Rs.22.50 Crores. Workers 3000. Export: Rs.14,75,000. Countries: West Germany, Bahrain, Sri Lanka, Malaysia, Zambia, Iraq. Products: Light commercial vehicles below 3-ton capacity and diesel engines for automotive purposes and spare parts thereof.
224. **BALBODH MUDRANALAYA.** 993 Sadashiv Peth, Pune 30. Proprietary, 1963. Bank: The Poona Merchant Co-operative Bank Ltd. Cap. Rs.40,000. Prod. Rs 25,000. Workers 4. Products: Commercial printing.
225. **BALKRISHAN PANNALAL MALPANI AND CO.** 1539 Shukrawar Peth, Pune 2. Tel. 445510. Factory: 501 Ghorpade Peth, Swargate Corner, Pune 2. Partnership, 1952. Banks: Canara Bank; Bank of Maharashtra. Cap. Rs.1,00,000. Prod. Rs.75,000. Workers 12. Product: Snuff.
226. **BALODYAN PRESS.** 1372 Shukrawar Peth, Pune 2. Tel. 441034. Proprietary, 1916. Bank: Bank of Maharashtra. Cap. Rs.1,00,000. Prod. Rs.2,00,000. Workers 10. Products: Offset-printing, letterpress printing, block-making, plate-making and colour separations.
227. **BALWANT INDUSTRIES.** 32/1 Off Karve Rd., Pune 4. Tel. 56390. Proprietary, 1959. Sister concerns: Vaidya Industries; Anish Industries; United Marketing Co. Bank: Bank of Maharashtra. Cap. Rs.50,000. Prod. Rs.10 lakhs. Workers 26. Products: Castings in aluminium, phosphor bronze, aluminium bronze, etc. for industrial requirements.

- 228. BALAJI PLASTICS.** 200 Mangalwar Peth, Pune 11. Tel. 24977. Partnership, 1976. Bank: Bank of India. Cap. Rs 1,00,000. Prod Rs 6,00,000. Workers 7 Product: Plastic bags.
- 229. BARLI ENGINEERS.** 1927 Sadashiv Peth, Pune 30. Tel. 441713. Factory: 691/A, Pune-Satara Rd., Pune 9. Tel. 446990. Partnership, 1968. Bank Bank of Maharashtra. Cap. Rs 65,000. Prod Rs 1,00,000 Workers 5. Products. Hollow rebates, press parts, foundation bolts for machinery, etc.
- 230. BASWANTI TEXTILES.** 14 Hadapsar Industrial Estate, Pune 13. Tel 7507, 7497 Proprietary, 1973. Products: Cotton textiles
- 231. BATLIWALA SOAP FACTORY.** 1305 Kasba Peth, Pune 11. Tel 448484, 442762. Partnership, 1973 Sister concerns: Space Designer; Furniture Maker. Bank: Punjab National Bank. Cap. Rs 1,40,000 Prod. Rs.4,50,000. Workers 8 Product. Washing soap
- 232. BEANT ENGINEERING WORKS.** 170 Dnyaneshwar Colony, Akurdi, Pune 35. Proprietary, 1974. Tel. C/o. 83272. Sister concern: Vinkı Engineers Bank-Syndicate Bank. Cap. Rs.35,000. Prod Rs 80,000 Workers 6. Product: Cutting steel bars
- 233. BEEGEE ENGINEERS.** 363/18 Meera Society, Shankarshet Rd., Pune 9. Tel. 57635. Factory 12 Bombay-Pune Road, Pune 3. Tel. C/o. 56992 Partnership, 1972. Bank: Bank of Maharashtra. Cap. Rs 3 lakhs Prod. Rs 7 lakhs. Workers 17 Products. Ammonia valves, refrigeration float valves, compressor shut-off valves, safety valves, L. P. steam valves, etc.
- 234. BEEKAY ENGINEERING CORPORATION.** 99/100 'H' Block, MIDC, Pimpri, Pune 18. Tel. 83349. Proprietary, 1971. Bank. Bank of Maharashtra. Cap. Rs.2,00,000 Prod. Rs.2,50,000 Workers 15 Products: Machine tools, industrial and commercial trollies, toggle clamps, level adjusters, sigma mixers, vessels, steel furniture.
- 235. BELT INDIA CORPORATION.** 205 Deonani Chambers Annexure, Bombay-Pune Rd., Pimpri, Pune 18. Tel. 82642 Proprietary, 1975 Subsidiary company: Industrial Valves Trading Corpn. Bank: Bank of Baroda. Cap. Rs.1,00,000. Prod. Rs.6,00,000. Workers 2. Products: Fenner industrial V belts, conveyor and transmission belting.
- 236. BENCHEM LABORATORIES.** 323 Raviwar Peth, Pune 2 Tel. 444709. Factory A-105 H Block, MIDC Estate, Pimpri, Pune 18 Tel 82040. Partnership, 1968. Bank: Bank of India. Cap. Rs 1,74,179 Prod. Rs 6,41,861. Workers 15 Products. Methyl Paraben I.P., Methyl Paraben Sodium BPC, Propyl Paraben I.P., Propyl Paraben Sodium BPC. Butyl Paraben Jap. P.
- 237. BEND ENGINEERS OF INDIA.** B-3 Prakash Colony, opp Formica (I) Ltd, Akurdi, Pune 35. Tel C/o 82159 Partnership, 1974 Bank. Bank of Maharashtra. Cap. Rs 22,000 Prod. Rs 18,000 Workers 4 Products: Engineering jobs.
- 238. BENS ENGINEERS.** 59 Shukrawar Peth, Pune 2. Tel. 446714. Factory: 576/8 Dattawadi, Pune 30. Tel. 446036. Partnership, 1975 Bank Bank of Maharashtra. Cap. Rs 13,500. Workers 3 Prod. Rs 30,000. Product: Poly-alloy tanks
- 239. BESTALL ENGINEERING WORKS.** MIDC, Block D-3, Plot No 85, Akurdi-Chinchwad, Pune 19 Tel 82227 Proprietary, 1970. Bank: Bank of Maharashtra Cap Rs 1,50,000 Prod Rs 10,00,000 Workers 49. Products. Sugar machinery components, fabrication
- 240. BETA INSTRUMENT CO. (I) PVT. LTD.** 'S' Block, Plot No W-21, Bhosari Industrial Area, Pune 26. Tel. 82887, 50484. Telex : "BETA MCCI-PUNE, 0145-333". Estd 1974 Bank : Bank of Baroda. Foreign collaboration : Beta Instrument Co Ltd England. Cap. Rs.4,80,000. Prod Rs 6,00,000. Workers 10. Products: Contact diameter gauge, optical diameter gauge, capacitance monitor, high speed induction tandem wire annealer, universal spark tester, length-measuring system, data logger/potentiometers recorder.
- 241. BETTER LIVING.** 8/352 Boat Club Rd., Pune 1 Tel. 24020, 28875. Cable. "GERASBUILD". Factory: 77 Sangamwadi, Pune 3 Tel. 28242 Proprietary, 1948. Sister concerns : Raisahib Pritamdas T. Gera; Pritamdas Gera & Associates. Bank: Canara Bank. Cap Rs. 4,00,000. Prod Rs 5,00,000 Workers 25. Products: Office desks; revolving, tilting and visitors' chairs; steno tables; steno chairs; cabinets; side runners; receptionist units.
- 242. BHAGYESH MILLS.** 43/2 Karve Rd., Pune 4. Proprietary, 1965. Cap. Rs 14,000. Prod. Rs 9,300. Workers 3. Products: Gray mulmuls

- 243. BHAGAT AND SONS.** 51A Budhwar Peth, Pune 2. Partnership, 1951. Bank: Bank of Maharashtra. Cap. Rs.40,000. Prod. Rs.70,000. Products: Parts of scooters, rikshaws, motors etc., any engineering product.
- 244. BHAGDEO CONFECTIONERY.** 52 Bhawani Peth, Pune 2. Tel. 24393. Partnership, 1955. Bank: Bank of Maharashtra. Cap. Rs.22,000. Prod. Rs.40,000. Worker 1. Product: Extra-strong tablets.
- 245. BHAGIRATH ENGINEERS.** 497 Ghorpade Peth, Shivaji Rd., Pune 2. Tel. 443829. Partnership, 1974. Sister concerns: B. R. Hemade Workshop; K. B. Hemade. Bank: Bank of Maharashtra. Cap. Rs.1,20,000. Workers 5. Products: Turning, shaping, welding, fitting and repairing of oil engines, crushers, motor pumpsets, trucks, etc.
- 246. BHAGWAN SOAP FACTORY.** 243 Ghorpade Peth, Pune 2. Tel. 441285. Partnership, 1951. Bank: Bank of Maharashtra. Workers 4. Product: Washing soap.
- 247. BHAGWAT BROTHERS.** "Udyam", 176 Parvati, Pune 9. Tel. 446085. Proprietary, 1970. Bank: Bank of Maharashtra. Cap. Rs.50,000. Prod. Rs.80,000. Workers 10. Products: Book-display stands, wire products, merchandise display stands, records and cassette stands garment-display stands, pegboard, wire fixtures.
- 248. BHAGWANDAS TULSIDAS GANDHI.** 1599 Shukrawar Peth, Pune 2. Tel. 445011. Partnership, 1965. Bank: Bank of India. Cap. Rs.6,45,000. Prod. Rs.15,000. Products: Sweets.
- 249. BHAGYALAXMI ENGINEERING WORKS.** 170 Dnyaneshwar Colony, Akurdi, Pune 35. Tel. 82303. Partnership, 1971. Bank: Pune Urban Co-op. Rupee Bank Ltd. Cap. Rs.69,000. Prod. Rs.90,000. Workers 6. Products: Jobbing.
- 250. BHAGYASHREE MUDRANALAYA.** 394 Narayan Peth, Munjaba Lane, Pune 30. Tel. 442910. Proprietary, 1967. Bank: Bank of Maharashtra. Cap. Rs.35,000. Prod. Rs.25,000. Workers 3. Products: Printing jobs.
- 251. BHAGYATARA INDUSTRIES.** Akurdi, Chinchwad, Pune 19. Proprietary, 1971. Bank: Pavana Sahakari Bank. Prod. Rs.1,00,000. Workers 7. Products: Jobbing.
- 252. BHAIKONATH ENGINEERING WORKS.** 259 Ganj Peth, Pune 2. Tel. 445561. Proprietary, 1968. Bank: Bank of Maharashtra. Cap. Rs.1,00,000. Prod. Rs.2,00,000. Workers 8. Products: Precision machinery parts, jobbing.
- 253. BHAIKAV METAL AND ENGINEERING WORKS.** 113/14 Bhawani Peth, Pune 2. Tel. 27692. Partnership, 1965. Br. Nana Peth, Pune. Bank: Sangli Bank Ltd. Cap. Rs.2,41,000. Prod. Rs 6,00,000 Workers 16. Products: Household utensils
- 254. BHALCHANDRA INDUSTRIES.** 825 Sadashiv Peth, Pune 30. Tel. 443757. Partnership, 1955. Bank: Bank of India. Cap. Rs 1 lakh. Prod. Rs 3 lakhs. Workers 4. Products: Current and potential transformers
- 255. BHAMBURDA WELDING WORKS.** 365 Shivajinagar, Pune 5. Tel. 55572. Partnership, 1940 Br. at Parvati Industrial Estate, Pune Bank Bank of Maharashtra. Cap Rs 6,00,000 Prod. Rs 4,00,000. Workers 22. Product: Automobile repairs.
- 256. BHANDARI INDUSTRIES.** Building No. 161, Bombay-Pune Rd., Kasarwadi, Pune 18 Partnership. 1972. Bank: State Bank of India Cap Rs 25,000. Prod. Rs.75,000. Workers 7. Products: Brushes, pins, rollers, washers, rings, rods, turned components.
- 257. BHARAT ART WORKS.** 627 (New) Sadashiv Peth, Pune 30. Tel. 445608. Partnership, 1930. Banks: Bank of India; Cosmos Bank. Cap. Rs 2 50 lakhs. Prod. Rs.25,000. Products: Library stationery, metal signs, spray painting, sand blasting, badges, paper punching.
- 258. BHARAT AUTO AND METAL WORKS.** 19 Karve Rd., Pune 4. Tel. 57404 Partnership, 1947. Banks: Bank of Baroda; Bank of Maharashtra. Cap. Rs.1,88,594. Prod. Rs.23,69,000. Workers 45 Products: Window grills, gates, water tanks, steel windows, steel doors, heavy structural works.
- 259. BHARAT AUTOMOBILE ANCILLARY INDUSTRIES.** W-23 'S' Block, MIDC, Bhosari, Pune 26. Tel. 82887. Ext. 1. Partnership, 1973. Sister concern: Poona Auto Ancillaries Pvt. Ltd. Bank: Punjab National Bank. Cap. Rs.1.16 lakhs. Prod. Rs.3.58. lakhs. Products: Jigs and fixtures, precision components and automobile parts, hand honing machine and S.P.M.
- 260. BHARAT BINDING WORKS.** 12 Budhwar Peth, Pune 2. Partnership, 1927. Br. at Narayan Peth, Pune, Workers 5. Product: Binding.
- 261. BHARATI BOX MANUFACTURING CO.** 318/19 Chatusringi Rd., Sanghvi Bldg, Pune 16. Tel. 57914. Factory: 444 Kasarwadi, Bombay-Pune Rd., Pimpri, Pune 18. Tel. C/o. 82877. Partnership, 1975. Bank: State Bank of India. Cap. Rs.1 lakh. Prod. Rs 6 lakhs. Workers 5. Product: Wooden packing cases.

262. **BHARAT ENGINEERING CO.** 444 Kasba Peth, Pune 11. Factory: 932 Raviwar Peth, Pune 2. Tel 449414. Partnership, 1972. Bank: Bank of Maharashtra. Cap Rs.40,000. Prod. Rs.1.6 lakhs Workers 7. Product: KRP 100 Coolant Pump.
263. **BHARAT ENGINEERING WORKSHOP.** 170 Dayaneshwar Colony, Akurdi, Chinchwad, Pune 35, Proprietary, 1968. Bank Bank of India Workers 2, Products: Jobbing.
264. **BHARAT ELECTRONICS AND PLASTICS.** B-7 Electronics Estate, MIDC, Bhosari, Pune 26. Tel. 83171 Proprietary, 1969 Bank: State Bank of India Cap Rs 1,50,000. Prod Rs.4,50,000. Workers 9. Products: Adhesive tapes for defence and packing purpose, friction cloth, wax-coated rayon cloth
- ✓265. **BHARAT FORGE CO. LTD.** Mundhwa, Pune 36. Tel. 7451, 7391. Cable: FORGE Telex: 0145-234. Estd. 1961. Banks: Bank of Maharashtra; Bank of India; Canara Bank; Bank of Baroda; Syndicate Bank; Union Bank of India; Grindlays Bank Ltd.; United Commercial Bank; The United Western Bank Ltd; The Shamrao Vitthal Co-op. Bank Ltd.; Banque National De Paris Foreign collaboration: SIFCO Industries Inc, U S A. Cap. Rs 16 crores. Prod Rs.24 crores. Workers 2140 Export: Rs 18,32,860. Countries Greece, West Germany, Sri Lanka, Kuwait Products: Quality steel forgings, ring-rolled flanges, finish machined crankshafts, connecting rods, camshafts, front axle wheels, rear axle tubes, axle shafts, stub axles, gears, crane wheels, dead axles, big flanges, heavy fraction wheels.
266. **BHARAT FOUNDRY SERVICES.** 784 D. G. Pune 4. Tel. 54943. Cable: FOUNDRIMET. Factory: 6851, Bibwewadi, Pune 9. Tel 442518. Partnership, 1965. Brs. Kolhapur, Bangalore. Bank: Bank of Maharashtra. Workers 16. Products: Foundry fluxes.
267. **BHARAT KNITTING WORKS LTD.** 524 Budhwar Peth, Pune 2. Estd. 1926. Bank: Bank of Maharashtra. Cap. Rs.27,000. Prod. Rs.8,452. Workers 4. Product: Cotton hosiery.
268. **BHARAT PAPER BOX COMPANY.** 507-B Budhwar Peth, Pune 2. Tel. 449786. Proprietary, 1962. Bank: Bank of Maharashtra. Cap. Rs 25,000. Prod. Rs. 80,000. Workers 7. Products: Cardboard boxes for hosiery readymade garments and for sweets.
269. **BHARAT PENCILS.** 12 Bombay-Pune Rd, Pune 3. Tel. 56992 Proprietary, 1948 Bank: United Commercial Bank. Workers 10 Product: Chemical coal powder.
270. **BHARAT PLASTIC MANUFACTURING COMPANY.** 320 Nana Peth, Pune 2 Tel. 25423 Factory. 785 Bombay-Pune Rd, opp Jayashree Theatre, Chinchwad, Pune 19. Tel 82723. Partnership, 1970. Bank Central Bank of India. Cap. Rs 90,000. Prod. Rs 3,00,000. Workers 8. Products: Polythene layflat tubing, sheets and bags
271. **BHARAT PRECISION WORKS.** 77/1/1 Mundhwa, Pune 36 Partnership, 1971. Bank: Bank of India. Cap. Rs 4 lakhs Prod Rs 70,000. Workers 20 Products: Automobile spare parts, jobbing.
272. **BHARAT PRINTING WORKS.** 759 Kasba Peth, Pune 11. Proprietary, 1925. Bank: Sangli Bank Ltd. Workers 14 Product: Litho work.
273. **BHARAT ROLLING SHUTTERS AND ENGINEERING WORKS.** 82/2 Shivajinagar, Pune 5. Tel. 52153 Proprietary, 1967. Sister concern: Hubli. Banks: Central Bank of India; State Bank of India. Cap. Rs 1,50,000. Prod Rs 40,50,000. Workers 7. Products: Rolling shutters, fabrication jobs, lathe and milling works.
274. **BHARAT SILICATE INDUSTRIES.** 206/1 Pimpri, Pune 18 Tel 82816. Cable: SILICATE. Partnership, 1965 Bank: State Bank of India. Cap. Rs.5 lakhs. Prod. Rs 9 lakhs Workers 10 Product: Sodium silicate
275. **BHARAT SOAP WORKS.** 434 Guruwar Peth, Pune 2. Tel. 442994. Partnership, 1948 Banks: Sangli Bank Ltd; Bank of Maharashtra. Cap. Rs 1,50,000. Prod. Rs.2,00,000. Workers 5 Products: Washing soap and choora, B S. cakes, 515 bar, B. S and 515 choora, Suresh special.
276. **BHARAT STEEL WIRES.** Plot 78/3 MIDC, 'S' Block, Bhosari, Pune 26. Proprietary, 1977. Br. Bombay Bank: Bank of Baroda. Cap. Rs.3 60 lakhs. Workers 7. Products: M. S. wire nails, galvanized barbed wire.
277. **BHARAT TYPE FOUNDRY.** 250/C Shanwar Peth, behind Narayan Police Gate, Pune 30. Tel. 446905. Partnership, 1951. Bank: Bank of Maharashtra. Cap. Rs.3.5 lakhs. Prod. Rs.9.5 lakhs Workers 18. Products: Printing types in Devnagari and English, special faces in Devnagari script.

- 278. BHARAT VANASPATI PHARMACY.** At & Post Manchar, Dist. Pune. Tel. 75. Proprietary, 1920. Bank: Bank of Maharashtra. Cap. Rs 35,000. Prod. Rs 10,000. Products: Ayurvedic medicines and medicinal oils.
- 279. BHARATI SUVASIK AGARBATTI.** Kale Padal, Hadapsar, Pune 28. Proprietary, 1974. Cap. Rs.500. Prod. Rs.5,000. Workers 5. Product: Suvasik agarbatti.
- 280. BHARATIYA METAL INDUSTRY.** 4 Nana Peth, Pune 2. Tel. 28598. Proprietary, 1965. Cap. Rs 10,000. Prod. Rs.30,000. Workers 2. Product: Jobbing.
- 281. BHARUCHA INSTRUMENTATION AND CONTROL.** 7 Camanagar, Mile 3/1 Nagar Rd., P. O. Dunkirk Lines, Pune 14. Tel. 24788. Proprietary, 1973. Bank: United Commercial Bank. Cap. Rs.20,000. Prod. Rs.47,000. Worker 1. Products: Electro-medical instruments, repairs of sophisticated industrial and medical instruments.
- 282. BHATE BLOCK MAKERS.** 1589 Sadashiv Peth, Tilak Rd., Pune 30. Proprietary, 1937. Bank: Bank of Maharashtra. Cap. Rs.20,000. Prod. Rs.3,600. Product: Blocks for printing presses.
- 283. BHAWKAR GARAGE.** 726/727 Shivajinagar, opp. Shivajinagar Station, Pune 5. Tel. 57898, 55868. Cable: AUTO HOUSE. Partnership, 1933. Sister concern: Bhawkar Automobiles. Bank: Bank of Maharashtra. Workers 9. Product: Repairing of cars, jeeps, fitting diesel engines on cars.
- 284. BHAWNAGRI DRY FRUIT MART.** 4 Ambedkar Rd., Pune 1. Tel. 24243. Partnership, 1975. Br. 288 M. G. Rd., Pune 1. Banks: Bank of Baroda; Union Bank of India. Cap. Rs.2 lakhs. Prod. Rs.2 lakhs. Workers 6. Products: Processed dry fruits, Indian sweets.
- 285. BHIDE PACKING.** P. No. 11, Kaka Halwai Industrial Estate, Pune 9. Tel. 443897. Partnership, 1969. Br. Sunil Traders, Hubli. Bank: Bank of India. Cap. Rs. 3,50,000. Prod. Rs.2,50,000. Workers 7. Product: Wooden packing cases.
- 286. BHOGILAL KANKUCHAND PAREKH.** 835 (new) Budhwar Peth, Pune 2. Proprietary, 1968. Bank: Poona Merchant Co-op. Bank. Cap. Rs.12,000. Prod. Rs. 9,000. Worker 1. Products: Galvanized tanks, drums, trays, trunks, feeding-hoppers and steel furniture.
- 287. BHOLANATH ENGINEERING WORKS.** 170 Dnyaneshwar Colony, Akurdi, Pune 35 Proprietary, 1977. Bank: Bank of Maharashtra. Workers 5 Products: Jobbing.
- 288. BHOPATKAR ELECTRICALS.** 1032 Shukrawar Peth, Tilak Rd., Pune 2. Tel. 440416 Factory: S-5 Parvati Industrial Estate, Pune 9. Proprietary, 1973 Brs. at Madras, Bangalore. Sister concern: Electrolyn Marketing Enterprises. Bank: State Bank of India. Cap. Rs 50,000. Prod. Rs.1,50,000 Workers 5. Products: Current transformers, power transformers, rectifier units for electroplating, voltage stabilizers, battery chargers, automatic emergency lighting units.
- 289. BHOR RUBBER PRODUCTS.** Plot No. T-97 MIDC, Bhosari, Pune 26 Partnership, 1975 Bank: Syndicate Bank. Cap. Rs.4,85,000. Prod Rs 1,15,000 Workers 15. Products: Agricultural hose and oil engine parts, automobiles and industrial components, rubber channels.
- 290. BHORUKA INDUSTRIES PVT. LTD.** 98/99 Industrial Estate, Bhosari, Pune 26. Tel. 83054, 82956. Cable: CASTINGS. Estd. 1972 Brs. at Jamshedpur (H. O.), Sathanoor, Qulon. Bank: Bank of Maharashtra. Workers 29. Products: Alloy steel castings, CTC sigments.
- 291. BHUTANI AND SONS.** Bhutani Bhavan, Dapodi, Pune 12. Tel. 55482 Partnership, 1959. Bank: Bank of Maharashtra. Products: Electrical switches, rubber plastic moulds, machinery spare parts.
- 292. BHUVANESHWAR KHANDELWAL.** 674 (new) Ganesh Peth, Pune 2. Tel. 446676. Proprietary, 1974. Bank: Bank of Maharashtra. Cap. Rs 20,000. Prod. Rs.40,000. Workers 4. Products: Rubber stamps, engraving on plastic and all metals.
- 293. BIDRI METAL WORKS.** 436 Guruwar Peth, Pune 2. Tel. 440864. Partnership, 1958. Bank: Bank of Maharashtra. Cap. Rs.1,25,000. Prod. Rs.2,50,000. Workers 5. Products: Jobbing.
- 294. BIHAR ENGINEERING WORKS.** Nagarpalika, Pimpri, Pune 18. Partnership, 1967. Bank: Seva Vikas Co-op. Bank Ltd. Cap. Rs.20,000. Prod. Rs.15,000. Workers 2. Products: Jobbing.
- 295. BIO-MEDICAL LABORATORIES (POONA) PVT. LTD.** 397/5 Senapati Bapat Rd., Pune 16. Tel. 50539. Estd. 1973. Banks: Bank of Maharashtra; Bank of India.

- Cap. Rs 90,000 Prod Rs.70,000 Workers 3. Products: Preserved biological specimens, microscope slides, mountings and biological key cards
- ✓296. **BIOTECH LABORATORIES.** 397/7 Senapati Bapat Rd, Pune 16 Tel 50535 Cable: MICROTECH. Proprietary, 1956. Banks Bank of Maharashtra; State Bank of India. Cap. Rs 12½ lakhs Prod. Rs 7 lakhs Workers 7. Products Biological slides, cultures, projection slides, stains.
297. **B'JOY ENGINEERING WORKS.** 620 Bombay-Pune Rd., Phuge Wadi, Pune 12 Tel. 50507, 52156 Proprietary, 1972 Bank. Bank of Maharashtra Cap Rs 87,593. Prod Rs 34,887 Workers 6. Products Pressure relief valves, shaft keys, machine parts
298. **BLUE ARC INDUSTRIES.** 1470 Shukrawar Peth, Pune 2 Tel 440237. Factory 1369 Shukrawar Peth, Natu Baug, Pune 2 Proprietary, 1972 Cap. Rs 16,000 Prod. Rs.12,000 Products General fabrication, grills, steel windows, doors, steel furniture, hotel furniture, industrial products
299. **BLUELIGHT ENGINEERS.** A-110 H Block, MIDC, Pimpri, Pune 18. Tel. 83325. Partnership, 1971 Bank: United Commercial Bank Cap Rs 3 25 lakhs. Prod. Rs 16 lakhs. Workers 12 Products: Ferrous and non-ferrous castings for boiler, pump parts, truck parts.
300. **BODHE INDUSTRIES.** 842 Kasba Peth, Pune 11. Tel. 449593. Partnership, 1967 Bank-Poona Merchant Co-op. Bank Ltd. Products: Jobbing
301. **BOMBAY ART PROCESS.** Kanifnath Bhavan, Salisbury Park, Pune 1. Tel. 82177 Factory: Ganesh Nagar, Chunchwad, Pune 33. Tel. C/o. 445747, 449788. Partnership, 1970. Bank: Bank of Maharashtra. Cap. Rs.70,000. Prod Rs 3,42,000. Workers 12. Products: Duplex card cartons, labels and literature for pharmaceuticals and pesticides; jobbing.
302. **BOMBAY BUCKET AND IRON BRASS METAL WORKS.** 187 Ganj Peth, Pune 2. Tel. 442597. Partnership, 1947. Bank: Bank of India Cap. Rs 1,20,000 Prod. Rs 70,000. Workers 10. Products: Brass and aluminium containers and buckets, 'Stag' brand utensils, jobbing.
- ✓303. **BOMBAY BOOK MANUFACTURING CO.** 1105 Raviwar Peth, Pune 2. Tel. 445625, 449294. Factory: 691/A/10 Pune-Satara Rd, Pune 9. Tel. 442296, 448944. Partnership, 1961. Banks Sangli Bank Ltd.; Bank of India. Cap. Rs 10,00,000 Prod Rs 30,00,000. Workers 45. Products Exercise books, office files, PVC plastic folders, envelopes, diaries, synthetic pencil eraser
304. **BOMBAY IRON AND STEEL WORKS.** 557 Nana Peth, Pune 2 Proprietary, 1960 Product Steel fabrication.
305. **BOMBAY GAS WELDING WORKS.** 326 Nana Peth, Pune 2 Proprietary, 1951. Bank Punjab National Bank Cap Rs 5,000. Workers 4. Products Gas and electric welding works, press work
306. **BOMBAY MECHANICAL WORKS.** 41 Nana Peth, Pune 2 Tel 27136. Proprietary, 1970. Cap Rs 15,000 Prod Rs 10,000. Workers 3 Products: Jobbing
307. **BOPARAI ENGINEERING WORKS.** 45/B6 Prakash Colony, (opp. Formica) Akurdi, Pune 35. Tel. 82159 Proprietary, 1974. Bank. Syndicate Bank. Workers 5 Products HSS carbide special cutters and tools, Woodruf keyway cutters, HSS straight flute slotting cutters, machine centres, HSS cut off blades, HSS round and keyway small broaches, HSS step drills
308. **BORACHEM INDUSTRIES (P) LIMITED.** 156/B Ganesh Peth, Prema Chambers, Pune 2. Tel. 449377. Cable. BORACHEM. Estd. 1975 Sister concerns: Bora Transport Company; Bora and Company; Unique Sales Corporation. Bank: Bank of Maharashtra Cap Rs. 5,00,000. Prod Rs.5,00,000. Products: 'Bonila' gripe water and other pharmaceutical preparations
309. **BOX FAB.** 'S' 36 MIDC, Industrial Area, Bho-ari, Pune 26. Tel 82790 Partnership, 1977. Bank: Bank of Maharashtra Cap. Rs.7 lakhs Prod. Rs 18 lakhs Products: Boxes corrugated, cardboard and paperboard, corrugated rolls and sheets, etc.
310. **BOX-O-FINE INDUSTRIES.** 'Nandadeep', 247 Sahakarnagar No. 1, Pune 9. Proprietary, 1973. Bank: The Cosmos Co-op. Urban Bank Ltd. Cap. Rs.10,000 Prod. Rs 20,000. Workers 3. Products: All kinds of cardboard paper boxes.
311. **BOX-WELL (INDIA).** 550/A Nana Peth, Pune 2. Tel. 23933. Partnership, 1974. Br. Monarch Paper Box. Bank: Bank of Maharashtra. Cap. Rs 50,000 Prod. Rs 75,000. Workers 7. Products All kinds of cardboard boxes and golding boxes

312. BRILLIANT STONE METAL WORKS. Aland Rd., Pune 15. Tel. 27027, 55931. Partnership, 1965. Bank: Bank of Maharashtra. Cap. Rs.80,000. Prod. Rs.5,00,000 Workers 34. Product: Stone crushing.

313. BRIHAN MAHARASHTRA SUGAR SYNDICATE LTD. 980 Sadashiv Peth, Laxmi Rd., Commonwealth Building, Pune 30. Tel. 444491. Cable: SHREE Telex 0145-388. Factory: At & Post Shreepur (Via) Akluj, Dist. Solapur. Tel. 42. Estd. 1934. Sister concerns: Brima Sugar Ltd.; Brihan Bottlers and Distillers Ltd.; Baumgarten and Wala Pvt. Ltd. Bank: Bank of Maharashtra. Cap. Rs.180.44 lakhs. Prod. Rs.118.23 lakhs. Workers 217. Export: Rs 3.25 lakhs. Country: Canada. Products: Sugar, industrial alcohol, indian-made foreign liquor such as whiskey, brandy, rum, gin, vodka, pure grape brandy, malt whiskey and country liquor.

314. BRITE ELECTROPLATERS. 106A Shivajinagar, Pune 5 Tel. 54515. Partnership, 1962. Br at Pimpri. Bank: State Bank of India. Cap. Rs 1,10,000 Prod. Rs. 6,00,000. Workers 25. Product: Electroplating.

315. BROTHERS CHEMICALS. 46/2 Parvati, 12 Kaka Halwai Industrial Estate, Pune 9. Partnership, 1965. Sister concern: D. N. Chemicals. Bank: State Bank of India. Cap. Rs.76,000. Prod. Rs.5,50,000. Workers 8 Products: Silica Gel, thinners, Cobalt, Nickel Carbonet, Stoponax, agricultural chemicals, aluminium phosphide, etc.

316. BUCKAU WOLF NEW INDIA ENGINEERING WORKS LTD. Pimpri, Pune 18. Tel. 82264, 82265, 83265, 83266. Cable: DEVCORP, Pune 18. Telex: 0145-267. Estd. 1947. Br. at Bombay. Banks. Syndicate Bank; Vjaya Bank Ltd.; The British Bank of the Middle East. Foreign collaboration with: M/s Maschinenfabric Buckau Wolf AG., D-4048 Grevenbroich, Postfach 100460, West Germany. Workers: 775. Exports to: Malaysia, Kenya, El-salvador, West Germany, Iran, Thailand, Senegal. Products: Sugar-mill machinery, centrifugal machines, boilers for sugar plant, plants for breweries and malteries, closed system compost plants, spreader components for mining equipment.

317. BULLET ENGINEER. 200 Mangalwar Peth, Pune 11. Proprietary 1977. Bank: Union Bank. Cap. Rs. 32,000. Products: Jobbing.

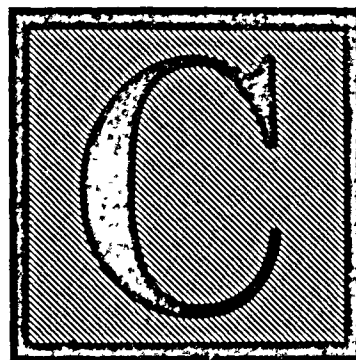

318. C. H. SUGANDHI AND SONS. 734 Ganesh Peth, Pune 2. Tel. 444210 Partnership. Product: Agar-batties.

319. C. V. ENGINEERS. 430 Budhwar Peth, Pune 2. Tel. 447708. Factory: 427 Budhwar Peth, Pune 2. Partnership, 1975. Sister concern: Central Cycles, Pune 2. Bank: Indian Bank. Cap. Rs 30,000. Prod. Rs 40,000. Workers 4 Products: Wheel-chairs—folding and non-folding, suitable to propell by hand or pushed by an attendant; invalid-tricycle for lame persons propelled by hand; luggage tricycle for light-weight transportation push and pull type; cycle trade accessories: wheel tracing machine, rim-re-rolling machine, tube vulcanising machine.

320. CAMBRIDGE INSTRUMENTS (INDIA) LIMITED. Bombay-Pune Rd., Pimpri, Pune 18. Tel. 82691. Cable: ELEKTRON. Telex: PN-265. Estd. 1962. Sister concerns: Spirax Marshall Ltd.; J. N. Marshall Pvt. Ltd. Banks: Bank of India; Union Bank of India. Foreign collaboration: Cambridge Instruments Limited, U. K. Cap. Rs.22,20,293. Prod. Rs 41,30,000. Workers: 100. Exports: Rs 59,000 (through J. N. Marshall Pvt. Ltd.) Products: Temperature indicator, temperature recorder, laboratory PH meter, industrial PH meter complete with accessories, mercury-in-steel thermometer, electrocardiograph, vapour pressure thermometer, electrodes for PH meter, potentiometric recorder, Cambridge cardiac monitor, ratemeter, auto recorder, Cambridge D. C. synchronised defibrillator with trolley, MP 11 demand pacemaker, CO₂ gas analyser.

321. CAPACITOR MANUFACTURING COMPANY. A-7 Functional Electronic Estate, M.I.D.C., Bhosari. Pune 26. Tel. 82960. Cable: POLYCAP. Partnerships 1973. Bank: Bank of Maharashtra. Cap. Rs.10 lakhs.

- Prod. Rs. 16 lakhs. Workers 31. Products: Corrugated boxes and rolls.
- 322. CARBTOOLS MANUFACTURING COMPANY.** 'S' Block, Plot No 22, Bhosari, Pune 26. Partnership, 1975, Bank: Bank of Maharashtra Cap. Rs 4 lakhs. Prod. Rs 5 lakhs. Workers 15. Products: Carbide tipped brazed tools—single point and multipoint; belt deburring machines, grinding machines.
- 323. CARAVAN ENGINEERS.** 1093 Sadashiv Peth Bajrao Rd., opp. Janata Sahakari Bank, Pune 30. Tel. 440093/449234. Factory: Plot No 38, Poona Small Scale Co-op. Industrial Estate Ltd., Gultekadi, Pune. Tel. 443686 Proprietary, 1974 Bank Shree Survarna Sahakari Bank Ltd. Cap Rs 12 lakhs Prod. Rs.20 lakhs. Workers 18. Products: Automotive and automobile rubber components, oil seals, O rings, gaskets, V cup seals, mountings, silent blocks, foundations made of viton, silicane, polyacrylic, neoprene, nitrile, rubbers.
- 324. CAST HEAT ENGINEERS.** MID.C. 'H' Block. Plot A/129 Pimpri, Pune 18. Partnership, 1976. Sister concerns: Majyokara Industries and Madhavi Enterprises. Bank: State Bank of India. Cap Rs 80,000. Prod Rs.3 lakhs. Workers 8. Products: Piston rings—import substitution; valve guides for automobiles and diesel engines; induction coils for induction heating generator; ferrous (high graded) and non-ferrous castings
- 325. CEMETILE INDUSTRIES.** 4 Mithapalli Estate, Shankarshet Rd., Pune 9 Tel. 22108 Factory: 61 Industrial Estate, Hadapsar, Pune 13. Tel 7234. Proprietary, 1969. Bank: Bank of Maharashtra. Workers 35. Products: Mosaic and plain cement tiles.
- 326. CENTRAL AUTO DIESEL WORKS.** 408/6 Gultekadi, Pune 9. Tel. 440684. Proprietary, 1962 Bank: Bank of India. Cap. Rs.10,000. Prod Rs.10,000. Workers 2. Products: Reconditioning of fuel injection pump and nozzles of Tata Mercedes Benz, Perkins, Leyland, International tractors, oil engines, etc.
- 327. CENTRAL ENGINEERING WORKS.** 234/B Shivajinagar, Pune 5 Proprietary, 1965. Bank: Bank of Baroda. Cap. Rs. 25,000 Prod Rs.30,000. Workers 2. Products: Job work, improved chlorinator—corrosion proof plastic type for gas.
- 328. CENTRAL HARDWARE STORES.** 923 Budhwar Peth, Pune 2, Tel. 445824. Partnership 1945. Br. 14 East Street, opp. P. O., Pune 1. Tel. 24534. Bank: Union Bank of India. Prod. Rs 90,000. Workers 10. Products: French polish.
- 329. CENTRAL PULP MILLS LIMITED.** 1183 Shivajinagar, Pune 5 Tel 55090 Cable: CENPULP Telex. CPMPN 278 Factory At and post. Central Pulp Mills Ltd. Pin CPM 394660, Taluka Fort Songad, Dist Surat (Gujarat) Estd. 1960. Brs. Bombay, New Delhi Sister concerns: Paper and Pulp Mills Ltd.; Eurokote (India) Ltd. Banks. Bank of Maharashtra; Bank of Baroda; United Commercial. Cap. Rs. 2,40,56,300. Prod. Rs 637.22 lakhs Workers 1000. Export: Paper grade pulp (Bambu Pulp) Rs.35 82 lakhs. Countries: Hancock, Japan, Switzerland. Products. Paper grade market pulp and varieties of quality papers
- 330. CENTRICAST ENGINEERS.** Plot 96, 'S' Block, MID.C., Bhosari, Pune 26. Tel. 447161. Proprietary, 1976 Bank: The Saraswat Co-operative Bank Ltd. Cap. Rs.2 lakhs. Prod Rs 1 8 lakhs. Workers 7. Products: Dependable non-ferrous casting by vertical and horizontal centrifugal processes, wooden patterns and packing cases.
- 331. CENTURY ENKA LIMITED.** Bakhtawar, 7th floor, Nariman Point, Bombay 21 Tel. 257730 Cable: CENENKA. Telex: 3704. Factory: Bhosari, Pune 26. Tel. 83624/7. Cable. CENENKA. Estd. 1966. Banks: Bank of Baroda; Bank of Maharashtra, Algemene Bank, Netherlands. Foreign collaboration: Akzo International by Arnhem, Holland. Cap. Rs 12 crores 53 lakhs Prod. Rs 8 crores 52 lakhs. Workers 320. Export: Rs.50 lakhs. Countries: U K, Saudi Arabia, Holland, Fiji, Singapore, Mauritius, Sri Lanka, etc. Products Nylon-6 textile yarn.
- 332. CERALAIN FILTERS (P) LIMITED.** 1221-C Apte Rd, Pune 4. Tel. 446535. Factory 126 Narhe. Tal. Haveli, Dist Pune. Estd 1973. Bank Bank of Maharashtra. Cap. Rs 32,530 Prod. Rs 16,170. Worker 1. Products: Water filters in different models i.e. domestic and industrial; candles as filtering elements.
- 333. CERAMIKA.** 21 Gultekadi Industrial Estate, Pune 9. Tel. 442640 Proprietary, 1969 Bank: Bank of India. Cap Rs 1 lakh Prod. Rs.95,000. Workers 6. Products. Miniature types of ceramic porcelain, steatite, refractory, etc. components for use in electrical and electronic fields
- 334. CHACHA ICE CREAM.** C/o Mamta Ice Cream, 567 Nana Peth, Pune 2. Tel. 26370/25937. Proprietary, 1964. Sister concern: Sonali Lodge. Bank: Bank of Maharashtra; The Oriental Bank of Commerce. Cap.

- Rs.3,50,000. Prod. Rs.5 lakhs. Workers 15. Products: Icecream, ice candy, sweets and snacks.
- 335. CHADHA INDUSTRIES.** 422 Badade Bldg, Hadapsar, Pune 28. Tel. 7110. Factory : 230 Hadapsar, Pune 28. Proprietary, 1974. Sister Concern : Standard Enterprises. Bank: Bank of India. Cap. Rs.95,000. Prod. Rs.1 lakh. Workers 9. Products: Door and window fixtures in mild steel; motor cycle and scooter accessories.
- 336. CHAFI INDUSTRIES.** 502 Shanwar Peth, Pune 30. Proprietary, 1973. Bank: Bank of Maharashtra. Cap. Rs.40,000. Prod. Rs.1.5 lakhs. Products: Printed circuit boards, gang condensers, small transformers.
- 337. CHAITANYA INDUSTRIES.** 1308 Kasba Peth, Pune 411011. Tel. 448286. Partnership, 1963. Bank: Canara Bank. Cap. Rs.2,50,000. Prod. Rs.2,25,000. Workers 5. Products. Parts for sugar machinery, cements machinery, tractors.
- 338. CHALLENGE FURNITURE WORKS.** 481 Gururwar Peth, Pune 2. Proprietary, 1970. Bank: Union Bank of India. Cap. Rs 20,000. Workers 3. Products: All kinds of wooden furniture.
- 339. CHANDAN GARMENTS.** 613-14 Sadashiv Peth, Sevasadan Bldg., Pune 30. Tel. 447098. Partnership 1970. Bank: State Bank of India. Cap. Rs. 2,25,000. Prod. Rs. 5,00,000. Workers 20. Products: Children's garments.
- 340. CHANDAN TEXTILES.** 14 Hadapsar Industrial Estate, Pune 13. Tel. 7288, 7425, 7497. Proprietary, 1971. Products: Cotton fabrics, dhotis, mulmul, etc.
- 341. CHANDRA TEXTILES.** Kunden House, 1150 Bhawani Peth, Pune 2. Tel. 26625. Cable: KUNDAN SARI. Factory: 33/40 Gultekadi Industrial Estate, Pune 9. Proprietary, 1970. Bank: Bank of Maharashtra. Cap. Rs.24,000. Prod. Rs.1,30,000. Workers 8. Product: Cotton cloth on powerloom.
- 342. CHANDRAKANT BELTING INDUSTRIES.** 44/3 Karve Rd., Pune 4. Tel. 446279. Estd. 1975. Sister concern: Chandrakant Tailors, Pune 4. Bank: Canara Bank. Cap. Rs.10,000. Workers 5. Products: Nylon belts and ropes used as substitutes for rubber 'V' belts.
- 343. CHANDRAKANT SILK FACTORY.** 593 Ganj Peth, Pune 2. Proprietary, 1960. Bank: Janata Sahakari Bank. Cap. Rs.75,000. Prod. Rs.56,000. Workers 15. Product: Twisting of art silk yarn.
- 344. CHANDRAKANT TAILORS.** 44/3 Karve Road, Pune 4 Tel 446279. Estd. 1970. Sister concern: Chandrakant Belting Industries. Bank: The Sangli Bank Ltd. Cap Rs 5,000. Workers 4. Products Industrial uniforms, other stitching, filters.
- 345. CHANDRAKANT WELDING WORKS.** 587/27 Shukrawar Peth, Pune 2. Proprietary, 1955. Bank: Syndicate Bank Cap Rs 5,000 Prod Rs 3,500 Workers 6 Products: Jobbing
- 346. CHARUDATTA MUDRANALAYA.** 154 Hadapsar, Pune 28 Tel. 7367 Proprietary, 1967 Bank: Janaseva Sahakari Bank Ltd Cap Rs 15,000. Prod Rs 40,000. Workers 3. Products: Printing work.
- 347. CHAVAN CLOTH STORES.** 77 (New), Raviwar Peth, Pune 2. Tel. 444261. Partnership, 1931. Bank: Canara Bank. Cap. Rs 5,00,000. Prod. Rs.10,00,000, Workers 9. Product: Ready-made garments.
- 348. CHAVAN AND COMPANY.** 594 Gururwar Peth, Pune 2. Factory: 21/3 Somwar Peth, Pune 11 Partnership, 1972. Bank: Bank of India. Cap. Rs.50,000. Prod. Rs. 1,50,000. Workers 6. Product: Manjarpat cloth.
- 349. CHAVAN IRON AND STEEL WORKS.** 384 Ganesh Peth, Pune 11. Proprietary, 1961. Bank: Poona Merchants Co. Bank Ltd. Cap. Rs.30,000. Workers 6. Products: Fabrication work.
- 350. CHAVAN READYMADE CLOTH STORES.** 337 Budhwar Peth, Pune 2. Tel. 448647. Factory: 467 Raviwar Peth, Pune 2 Partnership, 1942. Bank: State Bank of India. Cap. Rs.2,00,000. Prod. Rs.5,00,000. Workers 18. Product: Readymade garments.
- 351. CHELSEA CHEMICAL LABORATORIES.** 8 Hadapsar Industrial Estate, Pune 13. Tel. 7141. Cable: CHELSEALAB. Partnership, 1959. Bank: United Commercial Bank. Cap. Rs.1,20,000. Prod. Rs.5,00,000. Workers 6. Products: Pharmaceutical medicines, tablets, vitaminised food, drinks, veterinary medicine tablets, animal feed.
- 352. CHEM-E-LECK.** 107/1 Bhosari (General), M.I.D.C., Pune 26. Tel. 441869. Proprietary, 1973. Bank: United Commercial Bank. Cap. Rs.1,00,000. Prod. Rs. 3,00,000. Workers 4. Products: Epoxy adhesives, sealants, mortars corrosion resistant compounds, waterproofing compounds and rubber coatings, synthetic adhesives.

- 353. CHEMPACK INDUSTRIES.** 244 'Adhar', Narayan Peth, Laxmi Road, Pune 30. Tel. 444120 Factory: 134/B Kelkar Road, Narayan Peth, Pune 30 Tel. 447432. Partnership, 1976 Sister concern: Industrial and Allied Suppliers, Pune 30 Bank State Bank of India. Cap. Rs. 1,50,000 Prod Rs 1,00,000. Workers 4. Products: All domestic drugs repacked, 15 products manufactured: glycerine, liquid paraffin, castor oil, boric acid, etc.
- 354. CHEMI-FLOW RUBBER INDUSTRIES.** Avsari-
kar's Flats, 1st floor, opp S. T Stand, 18 Shivajinagar, Pune 5. Factory. Bombay-Pune Rd., opp. Ruston and Hornsby (India) Ltd., Chinchwad, Pune 19. Proprietary, 1977. Bank. Syndicate Bank. Cap. Rs 65,000 Prod. Rs. 1,75,000 Workers 8 Products: All kinds of sophisticated moulded rubber components.
- 355. CHEMORUBS (INDIA).** Plot No. W-15 'S' Block, MID C, Bhosari, Pune 26 Tel. (Resi) 441447. Proprietary, 1974 Bank State Bank of India Cap Rs 10,000 Prod. Rs 6,00,000 Workers 6. Products. Ingrain dyes (phthalogen dyes), rubber chemicals.
- 356. CHEMO LAB.** 1013/15 Shivajinagar, Swastik Colony, Pune 16. Tel. 53621 Factory 34 Aundh Rd, Khadki, Pune 3. Tel. 54804. Partnership, 1970. Bank Bank of Maharashtra. Cap Rs 50,000. Prod. Rs. 2,00,000. Workers 3. Products: Reprocessing job works, manganese salts.
- 357. CHETAN ELECTRONICS PVT. LTD.** 11-G Shanti Kunj, opp. G.P.O., Pune 1. Tel. 23109. Cable: CHANDRETAN. Factory: T-163, MID C., Bhosari, Pune 26 Tel 82582 Estd. 1975. Bank: Vjaya Bank Ltd. Cap. Rs 6,21,000 Prod. Rs. 24,00,000. Workers 20. Products: Paper condensor/capacitors from 180 MFD to 36 MFD.
- 358. CHETAN MUDRANALAYA.** 146/B Parvati, Pune 9. Tel 440023 Proprietary, 1973 Bank: Bank of Maharashtra. Cap. Rs. 35,000. Prod. Rs. 45,000. Workers 4. Product Printing job work.
- 359. CHETANA CAPACITORS.** Chinchwad, Pune 33. Tel. 82969. Partnership, 1974. Bank: Bank of Maharashtra. Cap. Rs. 45,000. Prod. Rs. 6,00,000. Workers 10. Products: Power capacitor, vacuum machinery, fabrication work.
- 360. CHETANA YANTRALAYA.** 10 Gultekadi, Pune 9. Tel. 441742. Partnership, 1968 Bank. Bank of India. Cap. Rs. 65,000. Prod. Rs. 3,00,000. Workers 25. Product: Job work.
- 361. CHETANA CHILDREN CHOICE.** 193 Guruwar Peth, Fulwala Chowk, Pune 2 Tel C/o. 444256. Partnership, 1962 Banks Canara Bank; Bank of Maharashtra. Cap. Rs 2,00,000. Prod Rs. 5,00,000. Workers 20. Products. Children's garments, school uniforms
- 362. CHHUGAL FOOD PRODUCTS.** 456/57 Guruwar Peth, Pune 2. Tel 441086 Proprietary, 1969 Bank. Poona Co-operative Rupee Bank Ltd Cap Rs. 40,000 Prod. Rs. 1,50,000. Workers 4. Products. Confectionery, peppermint, sugar-coated toffee, etc.
- 363. CHINKWAY INDUSTRIES.** Plot No. 111, General Block, M.I.D.C, Bhosari, Pune 26 Tel 82216, 83670. Partnership, 1963. Bank Bank of Maharashtra Cap. Rs. 8,00,000. Prod. Rs 7,00,000. Workers 18 Products: Flexible couplings, silent block, bush, silensor mounting for cars.
- 364. CHINOY ELECTRONICS.** 64 Koregaon Park, Pune 1. Tel 20498. Partnership, 1970. Bank: Central Bank of India. Cap. Rs 2,00,000. Prod. Rs 1,50,000. Workers 5. Products: Electronic controls, components including cadmium sulphide photo conductive cells, sequential controls, timers, etc., design and development work.
- 365. CHINTAMANI AND SONS.** 139 M.G Rd., Pune 1. Proprietary, 1940. Bank Bank of India. Cap. Rs 60,000. Prod. Rs. 36,000. Workers 3 Products Bushing of auto, repairing of sleeves, reconditioning of auto parts
- 366. CHITALE BANDHU MITHAIWALE.** 714 Sadashiv Peth, Pune 30 Tel 441990. Main shop. 777 Sadashiv Peth, Bajirao Rd, Pune 30. Tel 443208 Partnership, 1960 Bns. (1) 1254 Shivajinagar, Pune 5. (2) Dn Gymkhana, Pune 4. Bank: Janata Sahakari Bank Ltd. Cap. Rs 2,59,770 Prod. Rs. 42,04,472. Workers 115. Products: All kinds of sweets, kharamal, chakka, butter, khawa, curd, ghee—selling of it. Reselling of dryfruits, provisional goods, milk.
- 367. CHLORIDE INDIA LTD.** Exide House, 59-E Chowringhee Rd, Calcutta 20. Factory: D-2, M.I.D.C. Estate, Chinchwad East, Pune 19. Tel. 83213/14, 83482 Cable: CHLORIDIC Telex: 310. Estd. 1947. Bns. Calcutta, Bombay, New Delhi, Madras, Nagpur, Jullunder, Lucknow. Factory: Shamnagar, Calcutta. Subsidiary company. Chloride and Exide Batteries (Eastern) Ltd. Banks: Grindlays Bank; United Bank of India; State Bank of India. Foreign collaboration: The Chloride Group Ltd., U.K. Technical consultants. Cap. Rs. 868. 14

- lakhs. Prod. Rs. 1988.60 lakhs. Workers 2317. Export. Rs. 302 lakhs. Countries: Russia, Hungary, Middle East, Australia, U.K. Products: Automotive batteries, train lighting, stationery, minor cap lamp, ground starter etc.; servicing of all types of batteries.
368. CHOICE PRODUCT. S. No. 247 Ganeshnagar, Chinchwad, Pune 33. Tel. C/o. 82750. Proprietary, 1974. Bank: Bank of Maharashtra. Cap. Rs. 60,000. Prod. Rs. 30,000. Workers 5. Products: All spare parts of automobiles.
369. CINE UNIT OF INDIA PVT. LTD. 897 Amrai, Pune 4. Tel. 57904. Estd. 1949. Bank: Bank of Maharashtra. Cap. Rs. 30,000. Prod. Rs. 70,000. Workers 2. Products: Documentary, educational publicity films and educational film strips.
370. CITIZEN TIN WORKS. 83 Shivajinagar, Pune 5. Partnership, 1968. Bank: Bank of Maharashtra. Cap. Rs. 2,50,000. Prod. Rs. 60,000. Workers 8. Products: Car repairing, spray painting.
371. CIPY CHEMICALS. 229 Rasta Peth, Pune 11. Tel. 22943. Factory: 102 A/2 Hadapsar Industrial Estate, Pune 13. Proprietary, 1977. Bank: Indian Bank. Cap. Rs. 1,00,000. Workers 3. Products: Poly-urethan coatings.
372. CLEAN ENERGY SYSTEMS. 24 Gultekadij Industrial Estate, Pune 9. Tel. 440136. Partnership, 1970. Bank: Bank of India. Cap. Rs.2,20,000. Prod. Rs.7,40,000. Workers 6. Products: Industrial electric ovens and furnaces, degreasing units, phosphating plants, industrial washing booths, immersion heaters.
373. COAL AND COKE TRADING CO. 230-B, Mangalwar Peth, Pune 11. Tel. 27076. Partnership, 1965. Sister concern: Kotak Gandhi & Co. Bank: Punjab National Bank. Cap. Rs.80,000. Workers 12. Product: Coal powder.
374. COMEEX INDUSTRIES. 38/39 Hadapsar Industrial Estate, Pune 13. Tel. 7226. Cable: COMEEX. Proprietary, 1974. Bank: United Commercial Bank. Cap. Rs.77,000. Prod. Rs.3,00,000. Workers 4. Products: 'Comeex Universal' mini lathes.
375. COMMERCIAL SERVICES. 718 Kasaba Peth, Pune 11. Tel. 446142. Proprietary, 1962. Bank: Bank of Maharashtra. Cap. Rs.28,000. Prod. Rs.36,000. Workers 3. Products: Printing, binding, typing, cyclostyling.
376. COMPAX ENGINEERING. 430-A/32 Senapati Bapat Rd., Pune 16. Tel. 55350. Cable: COMPAXLAB. I. D...4
- Factory: 228/229 Mangalwar Peth, Pune 11. Tel. 25681. Sister concern: Compax Laboratories. Banks: Bank of Baroda; The New Bank of India Ltd. Products: Material handling equipments, pallets (wooden and steel), storage systems, non-toxic plastics for medical use, disposable sterile packs.
377. CONCRETE PRODUCTS CO. 347-A/2 Tadiwalla Rd., Pune 1. Tel. 24076. Partnership, 1950. Sister concern. Concrete Products Co., Jalgaon. Bank: Bank of India. Cap. Rs.2,00,000. Prod. Rs.3,00,000. Workers 10. Products: R.C.C. pipes, collars in all sizes and classes, R.C.C. water tanks, septic tanks, R.C.C. grills, concrete hollow blocks, plain mosaic flooring tiles, allied concrete products.
378. CONSOLIDATED HOISTS PVT. LTD. 29-30 Industrial Estate, Gultekadi, Pune 9. Tel. 442019, 441096. Cable: CONHOIST. Telex: 0145-257. Estd. 1966. Bank: Shamrao Vithal Co-operative Bank Ltd. Foreign collaboration: SWF Germany. Cap. Rs.3,46,500. Prod. Rs. 60,56,000. Workers 81. Export: Rs.1,74,000. Country: West Germany. Products: Electric hoists and cranes—capacity 500 kgs. to 15,000 kgs.
379. CONTINENTAL CHEMICALS. P. B. No. 112, Pune 1. Tel. 26850. Factory: Survey No. 38, Sant Bhagat Niwas, opp. N.E.I. factory, off Nagar Rd., Pune 14. Proprietary, 1969. Associate concern: Rama Traders. 7 Deccan Mansion, Nagar Rd., Pune 6. Br. Bombay. Cap. Rs.50,000. Prod. Rs.1,40,000. Products: Degreasing and cleaning compounds, multipurpose cleansers, liquid soap, detergents, paint, and rust removers.
380. COOPER ENGINEERING LTD. Chinchwad, Pune 19. Tel. 82461/62/63. Cable: COOPENG, CHINCHWAD. Telex: 0145-344. Estd. 1960. Brs. Acrow India Ltd., Bombay; Cycle and Motor Agency Ltd.; Hindustan Construction Co. Ltd.; Indian Hume Pipe Co.; National Rifles Ltd.; Premier Construction Co.; Ravalgaon Sugar Farm Ltd.; Share Investment Trust; Vikhroli Metal Fabricators Ltd.; Walchandnagar Industries Ltd.; Walchand & Co. Pvt. Ltd.; Walchand Tandur Cement Co. Banks: Bank of Maharashtra; Canara Bank. Foreign collaboration: Hermann pfauter, West Germany. Cap. Rs.954.27 lakhs. Prod. Rs.474.2 lakhs. Workers 1156. Export Rs.36.2 lakhs. Countries: U.K., W. Germany, Kenya, Tanzania, Iraq, Australia. Products: Medium and heavy duty shapung machines, planing machines, slotting machines, vertical turret lathes, gear hobbing machines, horizontal boring machines and special-purpose machines.

381. CO-ORDINATORS. 510 Budhwar Peth, Tapkir Galli, Pune 2. Partnership, 1968. Sister concern: Meera Commercial Printers, Pune 30. Banks: United Commercial Bank; Bank of Maharashtra. Cap Rs 40,000 Prod Rs 80,000 Workers 4. Product: Printing jobs.

382. CORRUGATED BOX INDUSTRIES. (INDIA) PVT LTD. 23/24 Waghute, Ogale Glass Compound, Pimpri, Pune 18. Tel. 82420. Cable C/o. Shree Products Ltd Cable 'SHRICAP'. Telex. 0145-338, Shricap. Estd 1960 Banks: Bank of Maharashtra; Sangli Bank Ltd Cap Rs 2,45,000. Prod Rs 10,31,000 Workers 23 Products: Corrugated boxes and sheets.

383. CRANKWEL. Plot No 5, Kaka Halwai Estate' Swargate, Pune 9. Tel 445459 Partnership, 1969 Sister concern Swastik Engineers, Pune 9. Bank Bank of Maharashtra. Cap. Rs 40,000. Prod. Rs 2,50,000 Workers 25. Products. 5 HP diesel engine crankshafts and other types as per requirement, repairing jobs of automobiles.

384. CROMEX COLOR STUDIO AND LABS. 1201-E Fergusson College Rd., Shivajinagar, Pune 4. Tel. C/o. 52195. Proprietary, 1972. Bank Bank of India. Workers 3. Products: Processing of colour negatives, making colour prints, transparencies, duplicates, etc.

385. CROWN ENTERPRISES. Alankar Cinema Building, 1st floor, Pune 1. Tel. 27703. Factory: 19/1 Hadapsar Industrial Area, Pune 13. Tel. 7492. Partnership, 1973. Sister concerns: Commercial Trade Corporation; Pravim Decorators; Artistic Painting Contractors. Banks: Dena Bank; Union Bank of India. Cap. Rs.2,00,000 Prod. Rs.3,00,000. Workers 9. Products: Industrial wooden packings.

386. CROWN ENGINEERING WORKS. Plot No. 29/14, D-II Block, Chinchwad, Pune 19. Tel. 82696 Partnership, 1976. Bank: Syndicate Bank. Cap. Rs.2,00,000. Prod. Rs.2,50,000. Workers 15. Products: Dish ends up to 20 mm thickness, pressure vessels for chemical, pharmaceutical and sugar industries, general fabrication work in mild steel and stainless steel.

387. C. T. R. MANUFACTURING INDUSTRIES LTD. Pune-Nagar Rd., Pune 14. Tel. 28777, 28778. Cable: CUTTAIR. Telex 0145-206. Estd. 1964. Brs. Aurangabad; Bombay Banks: Bank of Maharashtra, Canara Bank. Foreign collaboration Condensateurs, Fribourg S.A. Fribourg, Switzerland. Cap. Rs 239.07 lakhs Prod. Rs. 202 lakhs. Workers 485. Export. Rs. 9,39,565. Countries: U.S.A., Switzerland. Products: Milling cutters, pressed steel radiators, on-load tapchangers for transformers, LT oil circuit breakers, electronic plastic film capacitors.

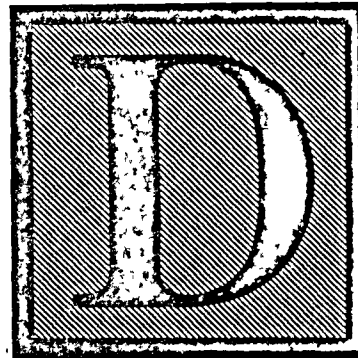

388. D. K. DAKARE. 100 Kasba Peth, Pune 11. Proprietary. Workers 2. Products: Hande (vessels).

389. D. N. CHEMICAL CORPORATION. 46 Narayan Peth, Pune 30. Factory: 46/2 Parvati, 12 Kaka Halwai Industrial Estate, Pune 9. Tel. C/o. 442239. Proprietary, 1976. Bank: Bank of Maharashtra. Cap. Rs.15,000. Prod. Rs.50,000. Workers 2. Products: Silica gel chromatographic grade (T.L.C. and Column). plast-coat.

390. D. P. ENGINEERS. 93-5 B, Erandawana, Pune 4. Tel 58211. Factory: 1089 Shukrawar Peth, Shivaji Rd., Pune 2. Tel. 442991. Partnership, 1968. Bank: Bank of Maharashtra. Workers 9. Products: Authorities on fuel injection equipment and reconditioners.

391. D. R. CHILLAL AND SONS. 2145 New Modikhana, Pune 1. Tel. 26103. Factory: S. No. 69/1B Wanawadi, Pune 1. Tel. 27466. Partnership, 1959. Bank: State Bank of India. Cap. Rs.2 lakhs. Prod. Rs.12 lakhs. Workers 32 Products: Pickles, spices, etc.

392. D. B. GHADGE MOULDING AND CUTTING. 1366 Kasba Peth, Pune 11. Proprietary, 1940. Bank: Bank of Maharashtra. Worker 1 Products: Mechanical moulding, motor spare parts.

393. DTKO PRODUCTS. 2136 Vajayanagar Colony, Sadashiv Peth, Pune 30. Factory. 35 Kasba Peth, Pune 11. Proprietary, 1969 Banks: Bank of Maharashtra; Bank of India. Cap. Rs.65,000 Prod. Rs.1,40,580. Workers 10. Product. Reconditioning of old and new pistons by chemical process

394. D'RONA ROHITRA PVT. LTD. 'Suyash', 882/A 4th Lane, Bhandarkar Institute Rd., Shivajinagar, Pune 4.

Tel. 57169. Cable: ROHITRA Factory: C-1 Functional Electronics Industrial Estate, Bhosari, Pune 26. Estd. 1972. Bank: Bank of Maharashtra. Cap. Rs.3 lakhs. Prod. Rs.2.5 lakhs. Workers 25. Products: Power, distribution, current, potential and furnace transformers and allied equipment.

395. D. S. M. ENTERPRISE. 2158 New Modikhana, Pune 1. Tel. 26675. Proprietary, 1972. Bank: Central Bank of India. Cap. Rs.22,975. Prod. Rs.64,150. Workers 5. Products: Hospital equipments, enclosures for electronic equipments, panels for electrical control system, X-ray cassettes.

396. D. V. INDUSTRIES. Akurdi Village, Pune 35. Tel. 82664. Partnership, 1968. Bank: Central Bank of India. Cap. Rs.1,00,000. Prod. Rs.5,00,000. Workers 14. Products: Scooters pillion seats, rickshaw hoods.

397. DABHOLKAR BROS. (PVT.) LTD. 2432 East Street, Pune 1. Tel. 22601. Press: 827/19 Dastur Meher Rd., Pune 1. Estd. 1949. Bank: Bank of Maharashtra. Cap. Rs.3,18,711. Prod. Rs.3,23,115. Workers 18. Product: Commercial Printing.

398. DABHOLKAR PRESS. 95-A Mahatma Gandhi Road, Pune 1. Tel. 28272. Proprietary, 1922. Bank: United Commercial Bank. Cap. Rs.1,10,000. Prod. Rs.90,000. Products: Commercial printing die-embossing, binding, etc.

398A. DAI-ICHI KARKARIA PVT. LTD. Liberty Building, Sir Vithaldas Thackersey Marg, (New Marine Lines), Bombay 20. Tel. 293633, 297224. Cable: NONIONIC, Bombay. Telex: 011-3222—UNIFERO Factory: 105th Milestone, Bombay-Pune Road, Pimpri, Pune 18. Tel. 82356, 83427. Cable: NONIONIC-Pimpri. Estd. 1960. Sister concerns: Universal Ferro & Allied Chemicals Ltd., Chemicals & Ferro Alloys Pvt. Ltd., Uni Ferro International Ltd., Uni Deritend Precision Castings. Stepan Chemicals Ltd., Kenitics Technology (I) Ltd; Uni Abex Alloy Products Ltd., Rubber Reclaim Co. of India Ltd. Banks: Bank of India, Central Bank of India, State Bank of India, Bombay; State Bank of India, Pimpri. Foreign collaboration: M/s Dai-Ichi Kogyo Seiyaku Co. Ltd, Japan. Cap. Rs.1,91,00,724. Prod. Rs. 5,61,91,291. Workers 329. Products: Surface active agents of all types—detergents, wetting agents, emulsifiers, dispersing agents, foaming agents, foam stabilisers, de-emulsifiers, defoamers, antistatic agents, anti-corrosion compounds, and softeners etc. Typical products—Ethylene oxide condensates, Alkyl Benzene sulfonates, fatty alcohol

sulfates etc. Speciality chemicals & process aids—Amulsifiers for emulsion polymerisation, viscose additives, modifiers etc. for rayon; spin finishers and finishing oils for synthetic fibres, textile auxiliaries; drilling mud chemicals, cement additives, de-emulsifiers deoilers, de-foamers and antistatic agents for petroleum production and refining and for other materials; concrete admixtures and foaming agents for foamed concrete; dust suppressing agents, and froth floatation aids for mining coal washeries and thermal power stations.

399. DAIRY SEALS. 508/C Shanwar Peth, Pune 30. Tel. 53114. Partnership, 1967. Bank: State Bank of India. Cap. Rs.35,000. Prod. Rs.75,000. Products: Dairy products, aluminum foil caps for milk bottles.

400. DALCO ENGINEERING PVT. LTD. H. A. Ltd. Compound, Pimpri, Pune 18. Tel. 82315, 82817. Estd. 1961. Sister concerns: Dalal Engineering Pvt. Ltd. Bombay, Dalfab Engineers, Baroda. Banks: State Bank of India; Bank of Baroda. Prod. Rs.75,00,000. Workers 80. Products: Storage tanks, pressure vessels, reaction kettles, autoclaves, crystallisers, separators, mixing tanks, vacuum receivers, steam jacketted tilting kettles, heat exchangers, fermentors, resin plants, distillation units, vacuum filters, distillation columns, fractionating columns, evaporators, trays, size cookers, size storage tanks, starch-mixing, tanks, juggers, sizing tanks, dyeing winches, blenders double cone vacuum dryers.

401. DALI AND SAMIR MFG. CO. Plot No. 36. D-II Block, MIDC Industrial Area, Chinchwad, Pune 19. Tel. 83448. Bank: Syndicate Bank. Partnership, 1972. Cap. 8,73,000. Prod. Rs.18 lakhs. Workers 18. Products: Silencers, tubular spanners, heavy sheet metal pressed components, dies and fixtures.

402. DAMODARDAS BHAGWANDAS PVT. LTD. 761 Raviwar Peth, Pune 2. Tel. 446115. Cable: AGARBATTI. Factory: 466 Raviwar Peth, Pune 2. Estd. 1872 (Incorporated as Ltd. Co. in 1947). Bank: The Sangli Bank Ltd. Cap. Rs.4,00,000. Prod. Rs.1,10,000. Workers 20. Export: Rs.80,000. Countries: Arabian countries, Middle East countries. Products: Agarbatti, Indian attars, dhoops, perfume bags.

403. DAMWELL INDUSTRIES. 1901 Sadashiv Peth, Sharda Nivas, Pune 30. Tel. 441897. Partnership. Sister concern: Aask Engineers. Bank: Bank of Maharashtra. Cap. Rs.1.5 lakhs. Prod. 6 lakhs. Workers 12. Exports to England, Germany. Products: Alloy steel components, heat treated thread roll components like studs, nuts, bolts, washers.

- 404. DANDEKAR INDUSTRIES.** 704 Sadashiv Peth, Pune 30. Factory A-8,F-2 Block, MIDC, Pimpri, Pune 18. Proprietary, 1971. Bank: The Poona Co-operative Rupee Bank Ltd. Cap. Rs.75,000. Prod. Rs.80,000. Workers 6. Products: Tripple rolling mills, tilting kettles, mini tiller, job work like machining of moulding boxes, match plates, gear blanks, couplings, sub-assembly of bus and trailers, fabrication—base plates, roller and belt conveyors
- 405. DARBAR INDUSTRIES.** Rathod Mill Compound, Mohan Nagar, Chinchwad, Pune 19. Tel. C/o. 83585 Factory 143 Ghorpade Peth, Pune 2 Proprietary, 1977 Bank Bank of India. Cap Rs 40,000. Prod. Rs.1,25,000. Workers 4. Products Side tank M. S. stores, brass and aluminium toys, idali stands and household articles, sheet metal press components
- 406. DARMARAJ ENGINEERING CORPORATION** ✓ 527 Ganj Peth, Pune 2. Tel. C/o. 445359. Proprietary, 1969. Banks: Mysore State Bank; Bank of Maharashtra. Cap Rs.55,000. Prod. Rs.11,000. Workers 2. Products. Window grills, welding machines.
- 407. DARSHANA TEXTILES.** 15/16 Kaka Halwai Estate, Pune 9. Tel. 441917. Factory: Plot No. 10, Kaka Halwai Industrial Estate, Pune 9. Partnership, 1973. Bank: Bank of Maharashtra. Workers 6. Product: Cotton fabrics.
- 408. DAS AUTO WORKS.** 10 Elphinstone Rd., Pune 1. Tel. 23882. Proprietary, 1960. Bank: Dena Bank. Workers 8 Products: Car repairing
- 409. DASHAMESH MOTOR REPAIRING WORKS.** 47/2 Pune-Satara Rd., Pune 9 Tel. 440913. Partnership, 1966 Bank. Syndicate Bank Cap. Rs.20,000. Prod. Rs.10,000. Products: Automobile repairing, welding jobs
- 410. DATAR KHARE AND CO.** 1158 Sadashiv Peth, Pune 30. Partnership, 1952. Bank. Peoples Co-op. Rupee Bank Ltd. Cap Rs.2,000. Prod Rs.3,000. Workers 5 (casual). Product: Furniture of all kinds
- 411. DATE TYPE FOUNDRY.** 1404 Sadashiv Peth, Pune 30. Tel 440495. Proprietary, 1948. Bank: Bank of Maharashtra. Cap Rs 70,000. Prod Rs 41,000. Workers 6. Products: Printing type and engraving of matrices
- 412. DATSONS ELECTRONICS.** 482 Shanwar Peth, Pune 30. Tel. 50343. Partnership, 1969. Bank: Bank of Baroda. Cap. Rs.25,000. Prod. Rs.2,26,510. Workers 6. Export: Rs.90,000. Countries: Middle East. Products: Automatic voltage stabilisers for domestic appliances, servo-controlled A C. voltage stabilisers, uninterrupted power supplies for surgical shadowless lamps, battery charger, electronic timers, stabilised DC supplies, inverters, single phasing preventers, etc
- 413. DATATTRAYA ARJUN BHOSEKAR.** Ramwadi. Pune 14. Proprietary, 1970. Bank: Canara Bank. Cap, Rs.1,00,000. Prod. Rs.50,000. Workers 8. Products: Motor winding, press tools, general repairs and supply of spares
- 414. DATTATRAYA ENGINEERING WORK.** 1248 Kasba Peth, Pune 11 Proprietary, 1976. Bank: Dena Bank. Cap Rs 28,000. Prod. Rs 48,200. Workers 6. Products. Piercing units, form plates, stipper plates, job work.
- 415. DATTATRAYA INDUSTRIES PVT. LTD.** Office and Factory 691/A Pune-Satara Rd., Pune 9. Tel. 442724 Cable: DIPRO. 148 Kasba Peth (Foundry), Pune 11. Estd. 1959. Br. office at Bombay 1. Bank: State Bank of India Cap Rs.12,70,000 Prod. Rs.24,45,000. Workers 28. Export: Rs 8,000. Countries: Netherlands, Nepal. Products: Plugs, sockets and connectors; agri-horticulture products like lawn sprinklers, hose nozzles, garden tools and non-ferrous metal castings.
- 416. DATTATRAYA MAHADEV SALUNKE.** 710 (New) Sadashiv Peth, Pune 30 Proprietary, 1940. Cap. Rs.3,000. Prod. Rs 3,500. Workers 2. Product: Tin-making.
- 417. DAVID BROWN GREAVES LTD.** 1 Dr. V. B. Gandhi Marg, Bombay 23. Tel 271524. Cable: GREAVES, BOMBAY. Telex: GREAVES 011-2517. Factory: Park-gear Works, Chinchwad, Pune 19. Tel. 82141/2/3; 83141. 83337. Cable DABGREAVES, PUNE Telex: Dabgear 0145-353. Estd. 1960. Sister concerns Ruston & Hornsby (I) Ltd., Pune; Greaves Foseco Ltd., Pune; Mather Greaves Ltd., Pune. Banks: City Bank; Grindlays Bank Ltd Bombay; Bank of Maharashtra, Pune; Oriental Bank of Commerce, Bombay; Syndicate Bank, Pune. Foreign collaboration. David Brown Gear Industries Ltd. England, till 1976. Cap. Rs.2,28,27,000 Prod. Rs.4,47,98,000. Workers 600. Export: Rs.23,32,000. Countries: England, Australia, Japan, Malaysia, Singapore, Thailand, Hong Kong, U.A.R., Iran, Sri Lanka, Philippines. Products: Industrial gear and marine gear boxes, flexible couplings
- 418. DAWOODBHAI ABDULALI.** 1571 Shukrawar Peth, Pune 2. Tel 445835. Factory: 1563 Shukrawar Peth, Pune 2, Partnership, 1860. Sister concern: Ezzi Printers Bank: State Bank of India. Cap. Rs.50,000. Prod. Rs 2,50,000. Workers 7. Products: Diwali account books,

diaries, khatavani, cash book, ledger, printed ledger excise bound books.

419. DEORAM GANGARAM SALUNKE. 889 Budhwar Peth, Pune 2. Proprietary. Cap. Rs.5,000. Prod. Rs.9,000. Workers 2. Products: Agricultural equipments, nails, tools and welding jobs.

420. DECAL INDUSTRY. 50 Pune-Satara Rd., Pune 9. Tel. 440060. Cable: DECAL. Partnership, 1965. Bank: Central Bank of India. Cap. Rs.3,00,000. Prod. Rs.6,00,000. Workers 26. Products: Aluminum anodised name plates, p.v.c. stickers, water transfer labels, screen-printed tinboards, etc.

421. DECCAN AGARBATTI. 791 Budhwar Peth, Pune 2. Tel. 448462. Factory: 1280 Kasba Peth, Pune 11. Tel. 448585. Partnership, 1955. Banks: Central Bank of India; Bank of Maharashtra. Prod. Rs.1,52,780. Workers 13. Product: Agarbatti.

422. DECCAN DYES AND CHEMICAL INDUSTRIES. 38 Vijaynagar Colony, Pune 30. Tel. 440825, 440369. Factory: 44 Shankarshet Rd., Pune 9. Tel. 449463, 449385. Partnership, 1961. Bank: Bank of Maharashtra. Cap. Rs.14,40,219. Prod. Rs.16,41,850. Workers 80-90. Products: S.O. dyestuffs.—ink-blue hly. con, basic magenta (lumps, powder); paints and varnishes—relfex-blue paste, pigment-violet.

423. DECCAN EMBROIDERY MANUFACTURING CO. 39/1-A Dr. Ambedkar Rd., Pune 1. Tel. 26316, 20741. Partnership, 1966. Br. Delhi, Calcutta, Hyderabad. Bank: Bank of Maharashtra. Cap. Rs.6.15 lakhs. Prod. 75 lakhs. Workers 45. Products: Sewing thread in bales, cones, tubes, chesis.

424. DECCAN ENGRAVING CO. 381/A/2 Shanwar Peth, Sat-sang Nivas, Pune 30. Proprietary, 1934. Bank: Bank of Maharashtra. Cap. Rs.10,000. Prod. Rs.5,000. Products: Engraving by hand on metals.

425. DECCAN FURNITURES. 122/6 Shivajinagar, Prabhat Rd., Pune 4. Tel. 58876. Partnership, 1944. Bank: Bank of Maharashtra. Cap. Rs.50,000. Prod. Rs. 1,50,000. Workers 8. Product: Wooden furniture

426. DECCAN LITHO WORKS. 156 Mangalwar Peth, Pune 11. Factory: Parvati Industrial Estate, Shed No. 10, Pune-Satara Road, Pune 9. Partnership, 1960. Bank: The United Western Bank Ltd. Cap. Rs.70,000. Prod. Rs. 2,00,000. Workers 15. Products: Commercial labels, posters, educational printing charts, graphs, etc.

427. DECCAN MARKETING CORPORATION. 721 Budhwar Peth, Pune 2. Tel. 449423. Factory: 250 Kasba Peth, Pune 11. Partnership, 1965. Br. 1615 Shukrawar Peth, Pune 2. Bank: State Bank of India. Cap. Rs. 1,00,000. Prod. Rs.2,00,000. Workers 8. Products: Engine hood covers and floor matting for Bajaj Tempo Matador.

428. DECCAN MECHANICAL AND CHEMICAL INDUSTRIES (P) LTD. 78 Bhosari Industrial Area, Pune 26. Tel. 82994, 82995, 83032. Cable: DEMECH. Telex: PN 388. Estd. 1969. Sister concerns: Link Conveyor Mfg. Co. (P) Ltd., Demech Erectors (P) Ltd., Arvind Engineers. Bank: Bank of Maharashtra. Cap. Rs.20,55,707. Prod. Rs.43,73,559. Workers 100 approx. Products: Sugar machinery fabrication and erection, piping erection, material handling equipment.

429. DECCAN METAL WORKS. 553 Rasta Peth, Pune 11. Tel. 22188. Cable: ROLLING. Partnership, 1937. Sister concerns: Gujarat Metal Factory; Hakamchand Ishwardas. Banks: Union Bank of India; Punjab National Bank. Products: Brass/copper strips and circles.

430. DECCAN PAPER MILLS CO. LTD. Commonwealth Bldg., Laxmi Rd., Pune 30. Tel: 444604. Cable: BROAD-SIDE. Factory: Mundhwa, Pune 36. Tel. 23953/4. Estd. 1885. Banks: Bank of Baroda; Bank of Maharashtra. Cap. Rs.32,95,131. Prod. Rs.52,85,000. Workers 198. Products: Paper of all kinds—badami, unbleached, brown, wrapping, blue match.

431. DECCAN PAPER BOX MFG. CO. 31/1-A Bombay-Pune Rd., Dapodi, Pune 12. Tel. 56639. Partnership, 1969. Banks: Bank of Maharashtra. Cap. Rs.5 lakhs. Prod. 18 lakhs. Workers 25. Products: Corrugated paper rolls, sheets and boxes.

432. DECCAN STONE CO. 228/29 Mangalwar Peth, Pune 11. Tel. 22706. Partnership, 1977. Prod. Rs.1 lakh. Workers 6. Products: Marble and cuddapah slabs, stone cutting and polishing.

433. DECCAN TYRES. 1248 Fergusson College Road, Pune 4. Tel. 58579. Proprietary, 1962. Br. Supreme Tyres, Pune 18. Bank: Syndicate Bank. Cap. Rs.20,000. Prod. Rs.75,000. Workers 4. Product: Remoulding of rubber tyres.

434. DEENBANDHU PRESS. 444 Rasta Peth, Pune 11. Tel. 25052. Cable: DEENBANDHU. Sree Yogi Anand Swami Public Charitable Trust, 1958. Product: Printing.

- 435. DEEP AND DEEP INDUSTRIES.** 1097 Shukrawar Peth, Pune 2. Tel. 448990, 442539, 449596 Partnership, 1973. Bank: State Bank of India Cap. Rs 65,574 Prod. Rs.50,000. Workers 2 Products. Agri-horticultural sprinklers. sprayers, tools, implements and allied products; electrical/electronic components; general engineering goods and non-ferrous metal castings
- 436. DEEPAK ELECTRIC INDUSTRIES.** 60 Guruwar Peth, Pune 2 Proprietary, 1962. Bank: Bharati Sahakari Bank. Cap. Rs.15,000. Prod. Rs.33,000 Workers 4 Products: Electric heaters, purses, pickles
- 437. DEEPAK ENGINEERING CO.** 3-B Lajawanti, 9/62 Erandawana, Karve Road, Pune 4. Tel. 55848, 54685 Proprietary, 1976. Banks: Bank of Maharashtra; Dena Bank Cap. Rs 25,000 Prod. Rs 75,000. Products: Coal firing equipments for boilers; anti air pollution equipments; air handling and control equipments.
- 438. DEEPAK HANDLOOM FACTORY.** 121 Ganj Peth, Pune 2 Tel. 442641 Factory: 436 Guruwar Peth, Pune 2 Partnership, 1962 Bank: Bank of Maharashtra Cap. Rs.40,000 Prod. Rs 1,50,000 Workers 15. Products: Handloom sarees.
- 439. DEEPAK INDUSTRIES.** 188 Gavade Colony, Station Rd., Chinchwad, Pune 33. Factory: T-72 MIDC, Bhosari, Pune 26 Proprietary, 1970. Cap. Rs.55,000. Prod. Rs.25,000. Workers 3 Product: Job work of mechanical nature
- 440. DEEPAK JYOTI CANDLE WORKS.** 1590 Shukrawar Peth, Pune 2. Tel. 445437. Factory: 646 Ganj Peth, Pune 2. Tel. 444846. Partnership, 1950. Sister concern: Vasudha Wax Candle Industries, Alandi. Bank: Dena Bank. Workers 15. Products: Wax candles, decorative candles and wax lamps
- 441. DEEPAK PRINTERY.** 444 Raviwar Peth, Pune 2. Tel. 448472. Proprietary, 1956. Bank: Sangli Bank Ltd. Cap. Rs 50,000 Prod. Rs.1,25,000. Workers 9. Products: Printing of commercial stationery, screen printing, job work.
- 442. DEEPAK TRADERS.** 83/84 Shivajinagar, Juna Tophkhana, Pune 411 005. Tel. 56012 (Res.) Proprietary, 1971. Bank: Bank of Maharashtra. Cap. Rs.10,000. Prod. Rs.68,000 Workers 6. Product: Engineering job work
- 443. DEEPASHREE AMMONIA PRINTING.** 1206/36-A Shivajinagar, Pune 4 Tel. 54489. Estd. 1966 Bank: Bank of Maharashtra Product: Ammonia prints.
- 444. DEEPJYOTI ENGINEERING WORKS.** 292 Somwar Peth, Pune 11 Proprietary, 1973 Banks: Bank of Maharashtra; Shamrao Vithal Co. Bank Ltd. Cap. Rs. 10,000 Prod. Rs 15,000 Workers 4 Products: Electrical coil winding, panel board wiring
- 445. DELHI MECHANICAL WORKS.** 205 Mahatma Gandhi Rd., Pune 1. Partnership, 1942. Bank: Jana-seva Sahakari Bank. Cap. Rs.45,000. Prod. Rs 13,000 Workers 3 Product: Job works
- 446. DEKHANE INDUSTRIES.** 514 Shanwar Peth, Pune 30, and 417 Shanwar Peth, Pune 30. Proprietary, 1971 Bank: Bank of Maharashtra. Cap. Rs 15,000 Prod. Rs 20,000. Product: Fountainpen ink
- 447. DEKOLENE INDUSTRIES.** 21/5 Karve Road, Pune 4 Factory: 15/11 Karve Road, Kothrud, Pune 29. Partnership, 1975. Bank: Bank of India. Product: Dry distemper, industrial paints and enamels, insulating varnishes.
- 448. DELIGHT ENGINEERING WORKS.** 41 Nana Peth, Pune 2. Proprietary, 1965. Bank: Bank of Maharashtra Cap. Rs 20,000. Prod. Rs.50,000. Products: Spare parts of Kirloskar Oil Engines.
- 449. DELIGHT PRINTERS.** 849 Sadashiv Peth, Pune 30 Proprietary, 1975. Bank: Mahesh Sahakari Bank. Cap. Rs.30,000. Prod. Rs 30,000. Workers 3. Product: Commercial printing.
- 450. DELITE PAINTS AND CHEMICALS PVT. LTD.** 124-A, H Block, M.I.D.C., Pimpri, Pune 18 Tel. 82266. Estd. 1968 Bank: Bank of Maharashtra. Cap. Rs 56,500. Prod. Rs 1,90,000. Workers 4. Products: Dry distemper, red oxide, pink wood primer, thinner.
- 451. DELTA ENTERPRISES.** W-40, MIDC Bhosari Industrial Area, Pune 26. Tel. 82839. Partnership, 1976. Br. Bombay. Bank: State Bank of India. Cap. Rs.2,00,000. Prod. Rs.3,00,000. Workers 45. Export: Rs.3,00,000. Country: U.S.A. Products: Readymade garments, electrical appliances, heating pads, electronic gas lighters, blankets, emergency systems, electrically heated outdoor wear for workmen.
- 452. DELTA SMALL TOOLS AND ENGINEERING CO.** Plot No. 31, Industrial Estate, Gultekadi, Pune 9. Tel. 442875. Cable: DELTA TOOLS. Telex: Delta via. 0145-333 Partnership, 1970. Bank: Bank of Maharashtra Prod. Rs 6,50,000 Workers 25. Products: Precision

- profile gauges, all types of H.S.S. circular and tangential form ground tools, carbide tools, threading tools, templates, galena blades, jigs and fixtures, job work.
- 453. DELUX TIMBER SUPPLYING CO.** 170 Dnyaneshwar Colony, Akurdi, Pune 19. Tel. 82509. Partnership, 1968. Br. Bombay (H.O.). Bank: State Bank of India. Cap. Rs.1,00,000. Prod. Rs.12,50,000. Workers 5. Product: Wooden boxes.
- 454. DE-LUXE COMMERCIAL PRINTERS.** 1468 Shukrawar Peth, Bhau Maharaj Lane, Pune 2. Tel. 446330. Cable: 'DELUXE'. Partnership, 1969. Brs. De-Luxe Trading Co., Pune; De-Luxe Plywood Centre, Pune 9. Bank: Bank of India. Cap. Rs.30,000. Prod. Rs.40,000. Workers 6. Products: Commercial printing, binding.
- 455. DE-LUXE DYERS AND DRY CLEANERS.** 1443 Shukrawar Peth, Pune 2. Tel. 443562. Factory: LIC Employees' Co-op. Housing Society, Prashant Nagar, Navi Peth, Pune 30. Tel. 440776. Partnership, 1960. Brs. 5 in Pune. Sister concern: Delight Dry Cleaners, Pune 30. Banks: Union Bank of India; Bank of India. Cap. Rs. 2,00,000. Prod. Rs. 6,50,000. Workers 70. Products: Dyeing, dry-cleaning, washing.
- 456. DEMURE PRODUCTS.** 8 Yerawada, Azad Ali, Pune 6. Tel. 25523. Proprietary, 1970. Bank: Bank of India. Cap. Rs.57,000. Prod. Rs.1,34,000. Workers 4. Products: Resin-bonded and metal-bonded diamond grinding wheels, diamond electro-diposited grinding wheels, single-point diamond dressers, diamond lapping paste, powder, hones, glass drills.
- 457. DEO ENGINEERING.** 117-118, Erandawana, Karve Rd., Pune 4. Factory: 36/18 Erandawana, Karve Rd., Pune 4. Tel. 50823. Proprietary, 1967. Bank: Bank of Maharashtra. Cap. Rs.85,000. Prod. Rs.1,25,000. Workers 7. Products: Precision turned parts, bakelite and plastic parts, press parts, dies and moulds, design and development work.
- 458. DESAI BROTHERS.** 1436 Kasba Peth, Pune 11. Tel. 447831, 447832, 449828. Partnership, 1901. Brs. Nizamabad, Mangalore, Bangalore, Jodhpur, Nadiad, Sriganganar. Banks: Canara Bank; Bank of Baroda. Cap. Rs.35,00,000. Prod. Rs.9.72 crores. Workers 400. Product: Bidi's.
- 459. DESAI ENGINEERS.** 200 Mangalwar Peth, Pune 11. Tel. 27118. Partnership, 1966. Bank: Bank of Maharashtra. Cap. Rs.5,00,000. Prod. Rs.6,50,000. Workers 19. Product: Job work.
- 460. DESHPANDE INDUSTRIES.** 15/205 Lokmanya Nagar, Pune 30. Tel. 440276. Factory: B-37 Parvati Industrial Estate, Pune-Satara Rd., Pune 9. Proprietary, 1963. Bank: Bank of Maharashtra. Cap. Rs.10,000. Prod. Rs.60,000. Workers 7. Product: Oil-engine spare parts
- 461. DEVDATTA ENGINEERING.** Purank Wada, Chinchwad, Pune 33. Proprietary, 1972. Bank: Bank of Maharashtra. Cap. Rs 10,000. Prod Rs 42,000 Workers 5 Product: Job work
- 462. DEVDAS COMMERCIAL PRINTERS.** 61 Budhwar Peth, Pune 2. Proprietary, 1940. Br. 51 Budhwar Peth, Pune 2. Bank: Union Bank of India. Cap Rs.20,000. Workers 2. Products: Commercial printing, binding.
- 463. DEVAL UTENSILS FACTORY.** 15/5 Karve Road, Pune 4. Tel. 56091. Partnership, 1939. Bank: Bank of Maharashtra. Cap. Rs 4,00,000. Prod. Rs.8,99,706. Workers 28. Export: Rs.15,964. Countries: Ireland, U.S.A., Canada. Products: Silver-plated table-ware, cream separator covers, silver-plated copperware for electronic industry, silver plating and gold plating of electronic components
- 464. DEVEN INDUSTRIES.** 346-D Sadhu Vaswani Nagar, Aundh, Pune 7. Tel. 54831. Factory: T-22, M.I.D.C., Bhosari, Pune 26. Tel. 83127. Cable: FINE-WORK. Partnership. Products: Moulds, dies, pressure rings, glass-making machineries.
- 465. DEVI INDUSTRIES.** 1271 opp. D.G. Post Office, Pune 4. Tel. 55475. Factory: Plot No. A-133 'H' Block, M.I.D.C., Pimpri, Pune 18. Tel. 83159. Partnership, 1967. Sister concern: Devi Plastics. Bank: Bank of Maharashtra. Cap. Rs.3,08,000. Prod. Rs. 12,50,000. Workers 23. Products: R.C.C. spun pipes and allied products.
- 466. DEVIDAS GENERAL REPAIRING WORKS.** Plot No. 38, Pune-Satara Rd., Swargate, opp. Saibaba Temple, Pune 9. Tel. 442816. Estd. 1968. Bank: State Bank of India. Cap. Rs. 75,000. Prod. Rs.1,00,000. Workers 9. Products: Automobile and automotive components and parts thereof.
- 467. DHANLAXMI METAL INDUSTRIES.** 69/B Hadapsar Industrial Estate, Pune. Tel. 7213. Partnership, 1974. Bank: Bank of India. Cap. Rs.5,00,000. Prod. Rs.20,00,000. Workers 20. Products: Water storage drums, buckets (plastic).

- 468. DHARIA ENGINEERS AND FOUNDERS.** 1070 Sahakar Nagar, Pune 9. Factory: W-8 'S' Block, Bhosari Industrial Area, Pune 26. Tel. 82887 Partnership, 1974 Banks: Bank of Maharashtra Cap Rs 1,50,000. Prod. Rs 3,50,000 Workers 9. Products: Non-ferrous castings of aluminium, gun-metal, p-bronze, al-bronze, mn-bronze, copper with machining, buffing, welding, drilling
- 469. DHERE CONCRETE PRODUCTS CO.** 731 Budhwar Peth, Laxmi Rd., Pune 2 Tel. 445891. Cable: SHIVAMRUT Factory: Near Saswad Road Rly. Stn. Fursungi Tal. Haveli, Dist Pune. Tel 7127 Partnership, 1967 Sister concern: Dhere and Sons, Pune Bank: Bank of Maharashtra Cap. Rs 10,00,000. Prod Rs 15,00,000 Workers 37. Products R C C spun pipes and collars, Ts and bends, septic tanks, water tanks, centry cabins, fencing poles, 'v' gutters, slabs
- 470. DHEERENDRA AUTO ENGINEERS.** Hadapsar, near Akashwani, Solapur Road, Pune 28. Tel 7527 Proprietary, 1969. Bank: Bank of Maharashtra. Cap. Rs 1,50,000. Prod. Rs.85,000 Workers 8 Products. Traub automats, job work of precision components for electronic, electrical and automobile industries
- 471. DHOMKAR TURNING WORKS.** 505 Ghorpade Peth, Pune 2 Tel 442584 Proprietary, 1964 Bank: Canara Bank Cap Rs 35,000. Prod Rs 20,000. Workers 5 Products Motor part repair
- 472. DHUMAL ENGINEERING WORKS.** 860 Sadashiv Peth, Pune 30 Tel 443245. Proprietary, 1964. Bank: Bank of Maharashtra. Cap. Rs.30,000. Prod. Rs 75,000, Workers 6 Product: Hand-operated rotary barrel pumps, oil-engine spares, axle unit for tractor trailers
- 473. DHUMAL UDYOG.** 884 Budhwar Peth, Pune 2. Tel. 445234. Factory: 632 Shukrawar Peth, Pune 2. Proprietary, 1960 Bank: Bank of Maharashtra. Cap. Rs.60,000. Prod. Rs 1,60,000 Workers 6. Products: Grills, fabrication work, steel windows, electrical boxes, steel furniture.
- 474. DHUMAUAT METAL INDUSTRIES.** 212 Raviwar Peth, Pune 2. Tel 444497. Factory: 109-110-111 Mangalwar Peth, Pune 11 Tel. 28857. Partnership, 1964 Sister concern: Ladhaji Lumbaji and Co Workers 30 Products: Brass utensils.
- 475. DIAMOND CHEMICALS.** Plot No. 66 'S' Block, MIDC, Bhosari, Pune 26 Partnership, 1974. Bank Bank of India. Cap Rs 25 lakhs Prod. Rs 5 lakhs. Workers 5 Products: Inorganic pigments—zinc chrome, lemon chrome, middle chrome, primrose chrome, scarlet chrome; organic pigments—toluidine red, post office red, lithol red
- 476. DIAMOND CLOCK MANUFACTURING CO. PVT. LTD.** 1180 Budhwar Peth, Pune 2. Tel. 443145 Cable HOROLOGER. Factory: 59-B Mundhwa, Pune 36 Tel. 26384. Estd. 1961. Br. New Delhi. Bank: Canara Bank Cap. Rs.9,00,000. Prod Rs.30,00,000. Workers 110 Exports: Rs 90,000. Country: Pakistan. Products: Taxi fare meters, auto rickshaw fare meters
- 477. DIAMOND DYE MAKING.** 1539 Sadashiv Peth, Pune 30. Tel 440754. Partnership, 1969. Bank: Bank of Maharashtra. Cap. Rs 80,000. Prod. Rs.20,000 Workers 4. Products: Dye punches and press parts.
- 478. DIAMOND CRAFTS.** Plot No. C-5 (20) Electronics Estate, MIDC, Bhosari, Pune 26. Tel. 83075. Partnership, 1969. Bank: Bank of India. Workers 4. Product: Fibreglass reinforced plastic mouldings.
- 479. DIAMOND LIME SUPPLY CO.** 103 Shivajinagar, Chunawala Chambers, Pune 5. Tel. 57100, 52087. Shop Tel. 24055. Proprietary, 1950. Sister concern: Shalimar Lime Products Banks: Dena Bank; Vijaya Bank; Canara Bank. Prod. Rs 6,00,000. Workers 30. Products. Elephant brand pink sagol, white sagol, chemical lime
- 480. DIAMOND PRINTERS.** 1025B Sadashiv Peth, opp Shivaji Mandir, Pune 30. Tel. 446078 Partnership 1973. Bank: Bank of Maharashtra. Cap. Rs 33,000 Prod Rs.50,000 Workers 2 Product: Commercial and art printing
- 481. DIAMOND PACKING AND WOOD INDUSTRIES.** Plot No. 34/11 Bombay-Pune Road, Dapodi, Pune 12. Tel. 82113. Proprietary, 1967. Bank: Bank of Maharashtra. Cap. Rs.1,00,000. Prod. Rs.3,00,000 Workers 6 Product: Wooden packing cases
- 482. DIGITRONICS.** 73/1/8, Chhaya Co-op. Society, Pune 4. Factory: 125/5 Prabhat Nagar, opp. Film Institute, Pune 4. Tel. 52174. Proprietary, 1975. Bank: Bank of Maharashtra. Cap. Rs. 60,000. Prod. 4 lakhs. Workers 6. Products: Digital STC/H.P./torque/indicators, frequency counters, digital meters, power supplies, industrial timers/industrial or laboratory time standards, emergency lighting units, digital R.P.M. indicators, analogue R.P.M. indicators; invertors/convertors, breakdown testers, A.C. voltage stabilizers.

483. **DILIP ENGINEERING WORKS.** 113/14 Bhawani Peth, Pune 2. Tel. 27480. Proprietary, 1964. Bank: Bank of Maharashtra. Cap. Rs.50,000. Prod. 1,20,000. Workers 9. Product: Job work.
484. **DILIP INDUSTRIES.** 1170/3 Shivajinagar, Pune 5. Tel. 55158. Factory: 167/A Happy Colony, Kothrud, Pune 29. Tel. 50015. Proprietary, 1972. Sister concern: Industrial Engineering Works. Bank: Bank of India. Cap. Rs. 45,000. Prod. Rs.2,20,000. Workers 15. Products: Machined precision components, job work.
485. **DILIP R. SHAH.** 44 Shankarshet Rd., Pune 9. Tel. 446221, 447478. Proprietary, 1962. Bank: Bank of Maharashtra. Prod. Rs.3,50,000. Workers 14. Products: Grey powerloom cloth of superfine, fine quality mulls and cambrics, loans and industrial tapes.
486. **DILIPKUMAR LIGHT HOUSE.** 27/3 Somwar Peth, Pune 11. Proprietary, 1968. Bank: State Bank of India. Products: Light lamp, transformer, tube patti.
487. **DINESH WOOD STEEL FURNITURE.** P. K. Chawl, Kalbhornagar, East Chinchwad, Pune 19. Proprietary, 1968. Bank: Bank of Maharashtra. Cap. Rs.28,000. Prod. Rs.30,000. Workers 6. Products: Heavy fabrication and building works.
488. **DIPAK MILLS.** 35 Erandawana, Pune 4. Tel. 56135. Partnership, 1961. Bank: Bank of India. Cap. Rs.25,000. Prod. Rs.50,000. Workers 3. Product: Mulmul.
489. **DIPAK KUTTY KENDRA.** 25 Somwar Peth, Pune 11. Tel. 27195. Partnership, 1975. Bank: Janata Sahakari Bank Ltd. Cap. 1 lakh. Prod. Rs.20 lakhs. Workers 15. Product: Kutty of kadaba.
490. **DIRECT SALE SERVICE.** 1137-7 Gokhale Road, Model Colony, Pune 16. Tel. 55806. Cable: DIRECT-SALE. Proprietary, 1965. Bank: Bank of Maharashtra. Cap. Rs.40,000. Prod. Rs.2,83,000. Products: Regain hands washing powder; fresh-liquid soap, syndet-synthetic detergent powder and liquid; formaclean for printing formes cleaning; termoreach for moth proofing; trans-lacque transparent lacquer for coinage metal and tools; rustend for the removal of corrosion and as a phosphatizing agent; portable solid fuel for warming food in 5-star hotels.
491. **DISUCO INDUSTRIES.** 335 Ghorpadi Peth, Pune 2. Proprietary, 1972. Bank: Bank of Maharashtra. Cap. Rs 40,000. Prod. Rs 50,000. Workers 4. Products: Same finishing of crankshaft, gears, damper cover, pully.
492. **DIWANE INDUSTRIES.** 718/719 Guruwar Peth, Pune 2. Tel. 440694. Cable: SPRAYPUMPS. Partnership, 1960. Bank: State Bank of India. Cap. Rs.1,60,504. Prod. Rs 6,56,352. Workers 40. Products: Spray pumps, agricultural equipments, dusters and hand compressors, foot sprayers, seed drill machines, hand cultivators and rocking sprayers.
493. **DNYANAVILAS PRESS.** 27 Budhwar Peth, Pune 2. Tel. 449123. Partnership, 1927. Banks: Janata Sahakari Bank Ltd. Cap. Rs 1,00,000. Prod. Rs 1,00,000. Workers 8. Products: Printing, binding.
494. **DNYANESHWARI PRESS.** 1457 Shukrawar Peth, Bhaumaharaj Bol, Rabde Wada, Pune 30. Tel. C/o. 444015. Proprietary, 1956. Banks: Bank of Karad; Bank of Maharashtra. Cap. Rs 50,000. Workers 8. Prod. Rs.60,000. Product: Commercial printing.
495. **DNYANESHWAR WELDING WORKS.** 15/2 Dhankawadi, Pune-Satara Rd., Pune 9. Tel. 445095. Proprietary, 1965. Cap. Rs 75,000. Workers 8. Products: Motor parts and repairs.
496. **DO ALL ENGINEERING.** Opp Akashwani, Hadapsar, Pune 28. Tel. 7418. Proprietary, 1972. Bank: Canara Bank. Cap. Rs.1,60,000. Prod. Rs.40,000. Workers 6. Products: Spare parts of radio, automobiles and instruments.
497. **DR. BECK AND CO (INDIA) LTD.** 61 Advent, 12-A General Bhosale Marg, Bombay 21. Cable: INSUBECK. Tel. 250596, 250535. Telex: Dr. Beck 011-2966. Factory: Pimpri, Pune 18. Cable: INSUBECK-Pune. Tel. 83243 (5 lines). Telex: Dr. Beck PN 0145-209 and Insubeck PN 0145-250. Estd. 1956. Br./Sales Offices: Pune, Calcutta. Banks: Canara Bank; Syndicate Bank; Union Bank of India; United Commercial Bank; United Western Bank, Pune; Grindlays Bank, Bombay. Foreign collaboration: Dr. Beck & Co., AG, West Germany. Cap. Rs.580 lakhs. Prod. Rs.730 lakhs. Workers 406. Export: Rs.4 crores approx. Countries: USSR, USA, UAR, West Germany, Bahrein, Dubai, Singapore, Ethiopia, Greece, Hong Kong, Iran, Iraq, Kuwait, Malaysia, Mauritius, Sri Lanka, Thailand and Nigeria. Products: High heat class wire enamels, insulating varnishes, epoxy and polyester resins for electrical industry.
498. **DUBE PATIL AND CO.** 377 Shukrawar Peth, Shivaji Rd., Pune 2. Estd. 1963. Bank: Central Bank of India. Cap. Rs.3,00,000. Workers 50. Products: Sugar factory machinery and mechanical handling equipments.

499. **DR. N. R. DAMLE AND CO.** 176 Parvati, Pune 9. Tel. 441968, Cable: GASPLANT. Factory: A-1C MIDC H Block, Pimpri, Pune 18. Partnership, 1946. Sister concern Sparkonix (India), Pune. Bank. Bank of India Cap. Rs 30,000. Prod. Rs 2,00,000 Workers 3 Products: Laboratory gas plants and chemical machinery

500. **DUGAR INDUSTRIES.** A-5 Functional Electronic Estate, Bhosari, Pune 26 Tel 83057 Cable: DUGSONS Partnership, 1971. Br. Calcutta (H.O.). Sister concern: R.B. Industries, Calcutta. Bank: State Bank of India Cap. Rs.2,50,000 Prod. Rs.6,00,000. Workers 17 Products: Aerials, DIN sockets and plugs, low voltage D C sockets, 2 and 3 pin mains cords, industrial plastic moulding and press parts.

501. **DUKENS COFFEE MANUFACTURING CO.** 436 Raviwar Peth, Pune 2 Tel. 448459. Proprietary, 1947 Banks: Bank of Maharashtra; Sangli Bank Ltd Cap. Rs 35,000. Prod. Rs.5,00,000 to 6,00,000. Workers 4 Products: Roasted beans, raw seeds, french coffee suppliers

502. **DURGA AUTOMOBILES.** 548 Rasta Peth, Pune 2 Proprietary, 1948. Cap Rs.5,000 Product: Repairs.

503. **DURGA TEXTILES.** 43/2 Karve Road, Pune 2 Proprietary, 1961. Cap Rs 28,000 Prod Rs 18,600 Workers 6 Product: Gray mulls

504. **DURAON PROCESS.** 893/3 Shivajinagar, Pune 4. Partnership, 1969. Banks Bank of India; Bank of Maharashtra. Cap. Rs 30,000. Prod. Rs.20,000. Workers 7, Products Anodising and industrial plating of cadmium, zinc and copper plating.

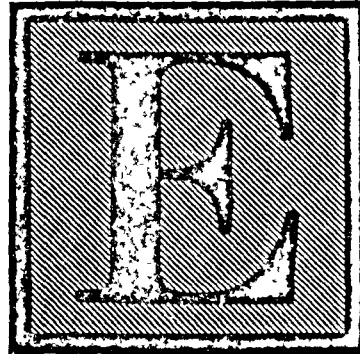

505. **E.L.F. INDUSTRIES.** 1491 Sadashiv Peth, Tuak Rd., Pune 30. Tel. 441695. Cable: FILAMENTS. Factory: 38/39 Hadapsar Industrial Estate, Pune 13. Tel. 7530 Proprietary, 1968 Bank. Bank of Maharashtra. Cap. Rs.2,50,000. Prod. Rs.7,00,000. Workers 15. Products Tungsten filaments required for miniature lamps, auto lamps, G.L S. lamps, electronic valves.

506. **E. M. MULLA.** 340 Raviwar Peth, Pune 2. Tel. 449485. Factory. 624 Raviwar Peth, Pune 2. Partnership, 1947. Bank: Bank of Maharashtra. Cap. Rs. 1,00,000. Prod. Rs.1,70,000. Workers 9. Products: Buckets, drums, cans, ghamellas, kadaies, tawas, all types of boxes

507. **EAGLE FLASK PVT. LTD.** 144/46 Sheriff Devji St. Chuckla, Bombay 3. Tel 322096, 322097. Cable. EAGLE FLASK, Bombay. Telex: EAGLE 011-3297. Factory Eagle Industrial Estate. Talegaon-Dabhade, Dist. Pune. Tel. 24, 25. Cable. EAGLE FLASK, Pune. Telex: EAGLE 0144-296. Estd. 1956. Brs. Bombay, Calcutta, New Delhi, Madras, Bangalore, Hyderabad, Cochin. Sister concerns: Eagle Enterprises Pvt. Ltd; Trade Team Pvt. Ltd. Talegaon, 410507. Banks: Bank of Maharashtra; Sangli Bank Ltd. Foreign collaboration: Riedel Glass, Vienna, Austria, for lead crystal glassware. Cap. Rs.95,53,000. Prod. Rs. 2,39,96,496 Workers 342. Export. Rs.24,60,279. Countries: West Germany, USSR, Japan, Middle East countries, East African countries. Products: Glass shells for vacuum flasks, vacuum flasks, insulated ware, lead crystal glassware.

508. **EAGLE HEATREAT SERVICES.** Shed No. W-12, 'S' Block, Bhosari Industrial Estate, Bhosari, Pune 26. Tel. C/o 82191 Partnership, 1975. Bank: Bank of Maharashtra Cap Rs 1,35,000 Prod. Rs 2,16,000. Workers 6 Product Heat treatment to ferrous and non-ferrous metals.

- 509. EAGLE LEATHER WORKS.** 51 Budhwar Peth, Pune 2. Proprietary, 1972. Bank: Poona Merchants Co-op. Bank Cap. Rs.2,500. Prod. Rs.27,000. Workers 3. Products: Chappals, sandals, and other footwear.
- 510. EAGLE METAL INDUSTRIES.** 349 (New) Ghorpade Peth, Pune 2. Partnership, 1970. Bank: The Muslim Co-op. Bank. Cap. Rs.60,000. Prod. Rs.35,000. Workers 8. Products: Brass and aluminium buckets, water tanks, kalsi, pressing and embossing jobs
- 511. EAGLE PRODUCTS.** 162/A Ghorpade Peth, Pune 2. Tel. 449302. Partnership, 1974. Bank: Bank of Maharashtra. Cap. Rs 10,000. Prod. Rs.50,000. Workers 4. Products: Chikky and gud-dani.
- 512. EAST INDIA CO.** 208 Ambedkar Rd., Mangalwar Peth, Pune 11. Tel. 24638. Cable: EENDEEYAN. Proprietary, 1960. Sister concern: Kalyan Co. Bank: Bank of India. Cap. Rs.50,000. Prod. Rs 40,000. Workers 2. Products: Polish, varnish, etc.
- 513. EFFICIENT ENGINEERING WORKS.** 200 Mangalwar Peth, Gadital, Pune 11. Tel. 22776. Proprietary, 1972. Bank: Syndicate Bank. Cap. Rs.35,000. Prod. Rs.1,08,000. Workers 8. Product: Job work.
- 514. EFFORTS ENGINEERS.** 156/3 Mangalwar Peth, Parge Chowk, Barne Rd., Pune 11. Proprietary, 1976. Bank: Canara Bank. Prod. Rs.40,000. Workers 3. Products: Oil filters, spare parts.
- 515. EISEN PHARMACEUTICALS PVT. LTD.** 1246-A Apte Rd., Deccan Gymkhana, Pune 4. Tel. 57063. Cable: EISEN. Estd. 1952. Bank: Bank of India. Cap. Rs.3,00,000. Prod. Rs.15,00,000. Export: Rs.1,00,570. Countries: Muscut (Oman), Liberia. Products. Tonics; oral and injectable potassium chloride, vit. B12, folic acid, niacinamide. Syrup—disodium hydrogen citrate; analgic tablets, cough syrup, anti-diarrhocal, capsules-iron vit. B12, acid and zinc; tr paregoric.
- 516. ELASTIC TAPES (INDIA).** 1258/2 J.M. Rd., Pune 4 Tel. 55370. Cable: SPANDEX. Factory: W-9, S block, M.I.D.C., Bhosari, Pune -26. Partnership, 1973. Bank: Canara Bank. Cap. Rs.5 lakhs. Prod. Rs.6.25 lakhs. Workers 18. Products: Narrow-width fabrics, textile and elastic tapes in cotton/rayon/nylon for garment industry.
- 517. ELECTRO CHEMICALS INDIA.** 591 Sadashiv Peth, Laxmi Rd., Pune 30. Tel. 444559. Factory: 222 Sadashiv Peth, Pune 30. Partnership, 1968. Bank: United Western Bank Ltd. Cap Rs.50,000. Prod. Rs.1,25,000. Workers 6. Products: Specially designed instruments for water supply schemes such as T.C.L. Solutioner doser, alum solution doser, chlorine generating plant, pressure chlorination plant, water level indicators of all types, chloroscopes, P.H. comparators, turbidity rods and meters, etc
- 518. ELECTRO COMPONENTS CO.** 68 Hadapsar Industrial Estate, Pune 13. Tel. 7428 Partnership, 1972. Bank: Canara Bank Cap. Rs 5 lakhs. Prod. Rs.25 lakhs Workers 60. Products: Paper capacitors, ignition condensers, plastic film capacitors, wire-wound resistors, precision resistors
- 519. ELECTROMARK ASSOCIATES.** 17A/3 Ganesh Chambers, Karve Road, Pune 4. Tel. 57875. Partnership, 1975. Sister concern: Modular Systems. Bank: Bank of Maharashtra. Cap. Rs 1,30,000. Prod. Rs.6,00,000. Workers 4. Products: Transistors, diodes, nixie tubes reed, switches, soft ferrites, alumina products, pot meter, zener, panel meter, CCR NCR PEC wire wound resistors, active and passive components
- 520. ELECTRON AND ELECTRONICS.** L.I.C Colony, Plot No. 1, behind Bhapkar Petrol Pump, Pune 9. Tel. 440918. Cable: PIPEMAN. Factory: S. No. 139 Katraj, Pune-Satara Rd., Dist. Pune. Partnership, 1971. Brs. Sangli, Satara. Sister concern: Makarand Trust. Bank: Bank of Maharashtra. Cap. Rs. 50,000. Prod. Rs.4,81,000. Workers 5. Products: Rigid PVC fittings, cement coupler, threaded coupler, elbow, bend, Ts, cross, flanged tail pc, end plugs y pieces, special irrigation tee, fibreglass linking and pvc lining.
- 521. ELEKTRODYNE INDUSTRIES.** 'Asha-Kiran', 75-76/44 Erandawana, Pune 4. Tel. 56651, 55135. Factory: W-25, MIDC, Bhosari, Pune 26. Tel. 82625. Partnership, 1972. Sister concern: Trio Sales and Services Corporation, Pune 11. Bank: State Bank of India. Cap. Rs.3,00,000. Prod. Rs.5,00,000. Workers 8. Exports: Rs.28,000. Country: Taiwan. Products: Eddy current dynamometer, a.c. motoring dynamometer, a.c. absorption dynamometer, engine test stands.
- 522. ELECTROMAKE EQUIPMENTS.** 1194/4 Shivajinagar, Ghole Rd., opp. Trivadi Bhuvan, Pune 5. Tel. 55260. Factory: Vithalwadi, Block No. 10, Pune 9. Partnership, 1977. Workers 4. Products: Current meter's parts.
- 523. ELECTRONIC LABORATORIES.** 1265 Subhashnagar, Pune 2. Proprietary, 1975. Bank: State Bank of

- India. Cap Rs.75,000. Prod. Rs.2,00,000. Workers 4. Products: Inverters, converters, d c power suppliers, transformers.
524. **ELECTRONICA.** 691/1-A Pune-Satara Rd., Pune 9 Tel 443532 Cable: ELESARK. Partnership, 1970. Bns. Delhi, Madras. Sister concern: Prav Electrosark Pvt. Ltd. Banks: Bank of Maharashtra; Shree Suvarna Sahakari Bank Ltd. Cap. Rs 2,75,000. Prod. Rs.30,00,000 Workers 14. Product: Spark erosion machine
525. **ELECTRO SERVO LABORATORIES.** 10 Kaka Haiwai Industrial Estate, Pune-Satara Rd., Pune 9. Tel. 441994. Proprietary, 1972 Bank: Bank of Maharashtra Cap. Rs.1,15,000 Prod. Rs.1,36,000 Workers 4 Products: Mechanical foot-operated suction machine, oil-immersed cabinet-model electrical suction pump, design and development
526. **ELEKTROMIN** 277 Narayan Peth, N C. Kelkar Rd., Pune 30 Tel 447019 Cable: CIRCUIITS. Partnership, 1966. Bank: Bank of Maharashtra Cap. Rs 1,00,000. Prod. Rs 7,50,000. Workers 8 Export. Rs.5,000. Country: U.S.A Products: Printed circuit boards and accessories thereof.
527. **ELEMAINTSE SERVICE.** 38 Pune-Satara Rd., Pune 9. Proprietary, 1974. Bank: Syndicate Bank Cap Rs. 32,000. Prod Rs 24,000 Workers 2 Products: Moulding from special type of powder, and bakelite moulding
528. **ELEMEC INDUSTRIES.** Plot No. 119/122, 'H' Block, MIDC, Pimpri, Pune 18. Tel. 82453 Partnership, 1973. Sister concern Shree Electricals, Pune 18. Bank: Central Bank of India. Cap. Rs.79,036, Prod. Rs.2,22,956. Workers 8. Products: Jigs and fixtures, machine components, service tools, dynamic balancing machines (vertical and horizontal).
529. **ELEMECH WORKS.** 65 Navi Peth, Pune 30. Proprietary, 1969. Bank: Cosmos Co-op Bank. Cap. Rs 50,000. Prod. Rs.40,000 Workers 3 Products: Heat exchanger for hydrolic pump to cool circulating oil, job work and maintenance work
530. **ELITE FABRICATORS.** Flatted Type Building, F-2 Block, Near Telco, MIDC, Pimpri, Pune 18. Tel 82517. Proprietary, 1973. Bank: Bank of India. Cap. Rs. 60,000. Prod. Rs. 80,000. Workers 6 Products: Fabrication such as steel furniture, control panel boards, check detedore boxes, sheet metal works, special types of trolleys.
531. **ELITE FURNITURE.** 1847 Sadashiv Peth, Pune 30- Tel. 440761. Proprietary, 1945. Bank: Bank of Maharashtra. Product: Wooden furniture.
532. **ELITE PLASTIC INDUSTRIES.** S-65, M.I.D.C., Bhosari, Pune 26 Proprietary, 1974. Banks: Central Bank of India. Cap. Rs 2,50,000. Prod. Rs.1,25,000. Products: Injection moulded industrial components and domestic products made from high/low density polythene, nylon, ploystyrene, polypropylene, ABS, polycarbonate, etc.; high/low density polythene tubing, bags, etc., other extruded plastics
533. **ELITE RUBBER PRODUCTS.** 44 Yeshwant Nagar, 53 S. V. Road. Andheri (West), Bombay 58. Tel 577538. Factory: 38/39 Hadapsar Industrial Estate, Pune, 13 Tel. 7635. Partnership, 1975. Sister concern: Elite Engineering Works. Banks: Bank of India; Indian Overseas Bank Cap Rs.50,000. Prod. Rs.1,30,000. Workers 8. Products: Synthetic rubber and natural rubber, 'O' rings, diaphragms, gaskets, belts, 'U' seals, rubber blocks, packing washers and special purpose rubber pents.
534. **ELITE TEXPRINTS.** 244 Narayan Peth, Laxmi Rd., Pune 30 Tel. 446886. Factory: 65 Navi Peth, Pune 30. Proprietary, 1973. Sister concern: Elite Dyers and Dry-cleaners Bank: Bank of India Workers 8. Products: Processing of textiles i.e. souring, bleaching, dyeing and printing of cotton, silk, art-silk and polyamide textiles and fabrics
535. **ELLORA STONE CO.** 35 Erandawana, Opp S.N.D.T. College, Karve Rd., Pune 4. Tel. 50298, 53158. Partnership, 1973. Sister concern: Joshi Enterprises. Bank: Bank of Maharashtra. Cap Rs.80,000. Prod. Rs 2,50,000 Workers 9. Products: Cut sizes of black kodalloh, various types of marble, kotah stone and allied stone articles.
536. **ELMECON MANUFACTURING CO.** No. 18, F-2 Block, Pimpri, Pune 18. Tel. 83547. Partnership, 1969. Sister concerns: Esskay Engineers. Bank: Bank of Baroda. Cap. Rs.1,40,000. Workers 8. Products: D.C. rectifiers for electroplating, anodising, power packs, control panels and other electrical equipments.
537. **ELMO MANUFACTURING AND SERVICE CENTRE.** 478-A Saukhyada Society, near Industrial Estate, Parvati, Pune 9. Tel. 440426. Cable: TECSALCO. Factory: Plot No 12, 'S' Block, M.I.D.C. Industrial Estate, Bhosari, Pune 26. Bank: State Bank of India. Cap. Rs.3,00,000. Products: Service station for all types of submersible pumps or motors and manufacture of submersible pumps

- ✓ 538. **ELPRO INTERNATIONAL LTD.** 'Nirmal', 17th floor, 241-242 Backbay Reclamation, Nariman Point, Bombay 21. Factory: Chinchwadgaon, Pune 33. Tel. 82201/2/3. Cable: 'ORPEL', Pune. Telex: 014-230. Estd. 1962. Br. New Delhi. Marketing Associates: International General Electric Co. (I) Ltd., Bombay. Banks: Bank of India, Pune; City Bank, Bombay. Foreign collaboration: General Electric Co., U.S.A. Cap. Rs.1,97,47,630. Prod. Rs. 3,84,26,829. Workers 334. Export: Rs.24,40,000. Products: Lightning arresters, high tension cutouts and accessories; domestic and industrial heating elements including water heaters, oil heaters and air heaters; alloy magnets, hard ferrites; X-ray and electromedical equipments, cobalt-60 teletherapy equipment; intensifying and fluoroscopic screens.
539. **EMARKONS.** 111/4 Erandawana, Pune 4 Tel. 57053. Factory: A-60 'H' Block, M.I.D.C., Pimpri, Pune 18 Tel. 83027. Partnership, 1967. Sister concern: Aqua Drillers, Pune 4. Bank: Canara Bank. Cap. Rs.4,00,000. Prod. Rs. 5,00,000. Workers 35. Products: Rock drilling rigs, agate factory plants, road-making machineries, automobile parts, special and high tensile fasteners.
540. **EME GEARS PVT. LTD.** 18 Parvati Industrial Estate, Pune-Satara Rd., Pune 9. Tel. 442374 Cable: RINGEARS, Estd. 1973. Bank: Shamrao Vithal Co-op. Bank Ltd. Cap. Rs.6,50,000. Prod. Rs.5,42,000. Workers 13. Products: Flywheel ring gears required by automobile, diesel and oil-engine industries, internal gears and other types of gears.
541. **EMENVEE SCIENTIFIC INSTRUMENTS PVT. LTD.** 'Emenvee House', 14 Gultekadi Industrial Estate, Pune 9. Tel. 441323/24. Cable: 'Emenvee' Pune. Estd. 1950. Bank: Bank of Maharashtra. Cap. Rs 2,00,000. Prod. Rs.10,00,000. Workers 26. Products: Rotary shaker, reciprocating shaker, incubator shaker, automatic fraction collectors, drop counter-cum-timer, laboratory fermentors, pilot plant fermentor, peristaltic pump, bio-flow pump, roller drum apparatus.
542. **EMITRONICS.** Unit No. 19, Block F-2, M.I.D.C., Pimpri, Pune 18. Tel. C/o. 82766. Partnership, 1977. Bank: State Bank of India. Workers 6. Products: Barrier blocks emi moulder terminal, terminal strips, terminals, instrument knobs, lamp holders, cords, plugs and sockets, spring terminal loaded.
543. **EMKAY ELECTRONICS.** 1231 Sadashiv Peth, L.B. Bhopatkar Path, Pune 30. Tel. 448873. Factory: 1183 Shivajinagar, Fergusson College Road, Paper and Pulp Co.'s premises, Pune 5. Tel. C/o. 55090. Proprietary, 1976. Bank: Bank of Maharashtra. Cap. Rs 40,000. Prod. Rs. 1,25,000 Workers 3 Products: Conductivity meters for D.M. water plants, D.C stabilized power supplies, A.C. voltage regulators (servo type), R.P.M. indicators (non-contact type), temperature indicators and controllers.
544. **EMPIRE BAKERY.** 575 Sachpir Street, Pune 1. Tel 24571 Partnership, 1959. Bank: Bank of Maharashtra Cap. Rs 2 lakhs. Prod. Rs.75,000. Workers 7. Products Bread, butter, biscuits, toast, buns, nans.
545. **EMVIK ENGINEERS.** Emvik House, A 97/98 'H' Block, M.I.D.C., Pimpri, Pune 18. Tel 82822 & 83347 Cable: EMVIK. Partnership, 1969. Sister concern: Emvik Engineers Pvt.Ltd. Bank: Bank of India. Cap. Rs.2,25,000. Prod. Rs 10,00,000. Workers 36. Products: Material-handling equipment, chemical plants, control panels, steel furniture for office, hospitals and canteens
546. **ENGINEERING ASSOCIATES.** 1278 Subhashnagar, Lane No. 6, Pune 2. Tel. 440160. Partnership, 1975. Bank: The United Commercial Bank. Cap. Rs 10,000. Prod. Rs 60,000. Workers 4. Products: Various types of coils, transformers, voltage stabilizers for T.V., fridge, air-conditioner, chokes, etc.
547. **ENGINEERING EQUIPMENT INDUSTRIES.** 336 Shukrawar Peth, Pune 2. Proprietary, 1955. Bank: Central Bank of India. Cap. Rs.3,000 Prod. Rs.27,500. Worker 1. Products: Pump repairs, oil engines, printing press, etc.
548. **ENGINEERING INSTRUMENT.** 571 Narayan Peth, Pune 30. Proprietary, 1960. Banks: Bank of Maharashtra; Bank of Baroda. Products: Slide-rules, drawing boards, T squares, import substitute articles and other drawing material, suppliers of slide rules
549. **EPICAST INDIA.** E 23 Bhosari Industrial Area, off Nasik Road, Pune 26. Tel. 83492. Partnership, 1971. Bank: Central Bank of India Cap. Rs.6,82,502. Prod. Rs.13,49,494. Workers 38. Products: Epoxy casted insulators
550. **ESCO (POONA) PVT. LTD.** 2432 East Street, Pune 1. Tel 26187 Factory S. No. 79 Mundhwa, Pune 36. Tel. 24134. Estd. 1952. Sister concern: National Tiles and Industries Pvt. Ltd. Bombay. Bank: Union Bank of India. Cap. Rs.6.70,634. Prod. Rs.17,17,469. Workers 58, Export: Rs. 4,96,223. Countries: U.A.E., Qatar, Saudi Arabia, Kuwait, Bahrein, Sultanate of Oman. Products: Marble, mosaic, terrazzo tiles; plain cement tiles; heavy duty steelcrete tiles.

- 551. ESEM INDUSTRIES.** A-15, MIDC F-2 Block, near Telco, Pimpri, Pune 18. Tel. 82766. Proprietary, 1973. Sister concern: Wey-weld India. Bank: Bank of Maharashtra. Cap. Rs.50,000. Prod. Rs 1,20,000. Workers 7. Products: L.D.P. and P.V.C. coating, wire meshes and other wire products, fabrication.
- 552. ESSAR ASSOCIATES.** 105 Shukrawar Peth, Near Badami Haud, Pune 2. Tel. 445875. Proprietary, 1976. Banks: The Poona Co-op Rupee Bank Ltd; Bank of India. Cap. Rs 12,000. Prod. Rs 1,40,000. Products: Dryers for grains, dal, chemicals (powder and granular); designing and manufacture of dryers for free flowing material which does not suit for the conventional tray, drum or oven type dryers.
- 553. EVER-READY ENGINEERS.** 659 Sadashiv Peth, Pune 30. Tel. 444208. Partnership, 1934. Bank: United Commercial Bank. Cap. Rs.3,00,000. Prod. Rs.2,50,000. Workers 9. Products: Ever Ready router radial arm routing machine, Ever Ready power beveller; all types of gears.
- 554. EVEREST ENGINEERS.** 364/5 Shuvajinagar, Pune 5. Tel. 52053. Proprietary, 1960. Bank: Bank of Maharashtra. Cap. Rs.3,00,000. Prod. Rs.4,00,000. Workers 8. Products: Glass moulds.
- 555. EVEREST INDUSTRY.** 603 Shukrawar Peth, Pune 2. Tel. 440104. Proprietary, 1964. Bank: Bank of Maharashtra. Cap. Rs.24,000. Prod. Rs.18,604. Workers 4. Products: Wooden and metallic patterns and non-ferrous casting, speciality in white metal lining and job work.
- 556. EVEREST GARMENTS.** 75 Navi Peth, Pune 30. Partnership, 1972. Banks: State Bank of India, Indian Bank. Cap. Rs.30,000. Prod. Rs.90,000. Workers 5. Products: Readymade garments and industrial uniforms.
- 557. EVEREST MODEL WORKS.** 603 (new) Ghorpade Peth, Pune 2. Proprietary, 1967. Bank: United Commercial Bank. Cap. Rs.20,000. Prod. Rs.10,000. Workers 3. Products: All types of science models.
- 558. EXART MECHANICAL WORKS.** Bombay-Pune Rd., Fugewadi, Pune 12. Proprietary, 1977. Bank: Bank of Maharashtra. Cap. Rs.35,000. Worker 1. Product: General engineering work.
- 559. EXCEL ENGINEERS.** 404 (new) Mangalwar Peth, near Hamal Panchayat Office, Pune 11. Tel. 23266. Partnership, 1973. Bank: Bank of Baroda. Cap. Rs 2,00,000. Prod. Rs 2,15,000. Workers 8. Products: Precision machining jobs, press tools and components, jigs and fixtures (designing and manufacture), plastic and rubber moulds, tool-room accessories.
- 560. EXCEL PHOSPHO CHEM.** Prop. Shroff's Technical Services Pvt Ltd. Excel Estate, S. V. Road, Goregoan (West), Bombay 62. Tel. 691921. Cable: 'ESTYES' Bombay Estd. 1962. Factory. H A Ancillary Compound, Pimpri, Pune 18. Tel. 82316. Cable: 'EXCEL' Pune. Banks: State Bank of India; Union Bank. Cap. Rs 35 lakhs. Prod. Rs 45 lakhs. Workers 40. Products: Phosphoric acid, technical I.P. AR, steel grade phosphorous pentoxide, sodium alginate, phosphorous acid, sodium glyceric phosphate.
- 561. EXCELLENT ENGINEERING WORKS.** 357-Ghorpade Peth, Pune 2. Tel. 445246. Partnership, 1971. Bank: Bank of Maharashtra. Cap. Rs 90,500. Prod. Rs. 2,97,000. Workers 5. Products: Defence equipments—rocket fuze, bomb-shell cases, cartridge cases and caps, signal mimiflare cartridges and all types of parts (precision); engineering inspection equipment—Universal engine mounting test beds for mounting engines, motors and other equipments required to be tested against dynamometers, etc.; cloud testing equipment—cloud droplet sampler, and gadgets.
- 562. EXPART TECHNICO.** 1027 Sadashiv Peth, Pune 30. Tel. 444759. Proprietary, 1965. Bank: Bank of Maharashtra. Workers 3. Products: Scooter spare parts, motor-cycle parts.
- 563. EXPERTS.** Guruprasad, Law College Road, Pune 4. Tel. 53186. Factory: 249 Kothrud Gavthan, Kothrud-Pune 29. Tel. 55358. Proprietary, 1970. Sister concern: Brans Enterprises. Banks: Bank of India; Bank of Maharashtra. Cap. Rs. 50,000. Prod. Rs 1,50,000. Workers 8. Products: Service in machine tool reconditioning; spare parts.
- 564. EXPERTO INDUSTRIAL ENGRAVERS PVT. LTD.** plot 18/4-19/4 Hadapsar Industrial Estate, Pune 13. Tel. 7521. Cable: EXPERTO Estd. 1968. Bank: Bank of Maharashtra. Product: Matrices for type casting and composing machines.

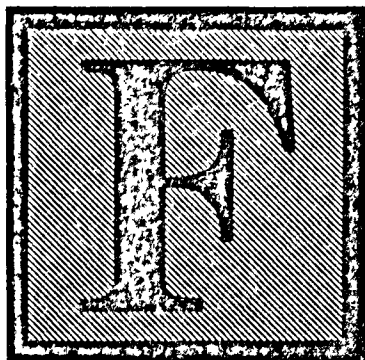

565. F. HOMI MFG. OPTICIANS. 870 D.M. Rd., Pune-
Tel. 20711. Office: 418 Budhwar Peth, Pune 2. Tel. 447707.
832 D.M. Rd., Pune 1. Tel. 20207. Factory: M.G. Road,
Ahmednagar. Tel. 527. Proprietary, 1953. Brs. Camp,
Pune 1, Ahmednagar. Sister concern: F.K. Industries, 3
Wanawadi Bazar, Pune 1. Bank: Union Bank of India.
Cap. Rs.1,00,000. Workers 9. Products: (prescription
opticians) optical lenses.

566. FAB ENGINEERS. 210 Mangalwar Peth, Pune 11.
Proprietary, 1977. Bank: Bank of India. Cap. Rs.15,000.
Workers 4. Product: Fabrication work.

567. FABRICA. 1225/1 Shivajinagar, Pune 4. Tel. 55286.
Factory: S/2 M.I.D.C., Bhosari, Pune 26. Partnership,
1973. Banks: Bank of Maharashtra, United Commercial
Bank. Cap. Rs.2,50,000. Prod. Rs.1,80,000. Workers 8.
Products: Job works—electronic and electrical outer
casing (metal boxes).

568. FABRICHEM ENGINEERS PVT. LTD. C/o.
D.P. Enterprises, Bombay-Pune Road, opp. Vulcan Laval
Ltd. Dapodi, Pune 12. Tel. C/o. 82232. Estd. 1977. Bank:
Bank of Maharashtra. Workers 7. Products: Chemical
equipments and plants, industrial and general fabrication,
furnaces and ovens.

569. FABRITEK. 59 Shanwar Peth, Pune 30. Tel. 50160,
54253. Proprietary, 1967. Sister concern: Teknika, Pune 30.
Bank: Bank of India. Cap. Rs. 1.5 lakhs. Prod. Rs.2.5
lakhs. Workers 8. Products: Electro-magnetic relays for
general purpose application in different voltage A.C. and
D.C. and different current capacities.

570. FABWELL ENGINEERS. Opp. Vulcan Laval Ltd.,
Bombay-Pune Road, Dapodi, Pune 12. Tel. 82232. Part-

nership, 1974. Bank: Bank of India. Cap. Rs.90,000. Prod.
Rs. 4 lakhs. Workers 12. Products: Canopies in aluminium
and M.S. sheet, panels, stands, brackets, etc.

571. FAHNSON (INDIA) CO. 1516 Sadashiv Peth,
Pune 30. Tel. 441672. Proprietary, 1972. Prod. Rs. 9,000.
Products: SILVEREX instant silver-plating and polishing
compound for copper, bronze brass

572. FAMOUS BAKERY. 645 Nana Peth, Pune 2.
Proprietary, 1972. Cap. Rs. 20,000. Prod. Rs. 2,00,000.
Workers 2. Products: Bakery products

573. FAZAL ENGINEERING WORKS. 732 Narayan
Peth, Pune 2. Proprietary, 1966. Cap. Rs. 10,000. Prod.
Rs. 20,000. Products: Engineering jobs

574. FARRAR INDIA. 49 S Block, M.I.D.C., Bhosari,
Pune 26. Proprietary, 1976. Bank: Punjab National Bank.
Cap. Rs. 2,50,000. Prod. Rs.5,00,000. Workers 5. Products:
All kinds of paints, varnishes

575. FERRI-MAG INDIA. W-13, F-2 Block, M.I.D.C.,
P. Box 27, Chunchwad, Pune 19. Tel. 82167. Partnership,
1973. Sister concern: Ferrites and Allied Sintered Products,
Pune 19. Bank: Syndicate Bank. Cap. Rs.2,00,000. Prod.
Rs.2,00,000. Workers 13. Products: Ferrite permanent
magnets for telephones, magnetic separators, mini and
micro motors, dram plugs, novelties, etc.

576. FERRITE MANUFACTURE CO. PVT. LTD.
B-4 Electronic Estate, M.I.D.C., Bhosari, Pune 26. 82434.
Cable: WECOP. Estd. 1971. Brs. Delhi and Calcutta.
Bank: Bank of Baroda. Cap. Rs. 7 lakhs. Prod. Rs.18
lakhs. Workers 27. Products: Soft ferrite—Rods, strips,
cores, plastic cores, allaudin cores, torroids, micro chokes,
beads, I.F. & R. F. cup and drum cores, thermistors;
hard ferrite (oriented and un-oriented magnets); carbon
brushes, starter dynamo carbon brushes, industrial carbon
brushes.

577. FERROCOILS. Alankar Cinema Building, 2nd
floor, Pune 1. Tel. 58804. Factory: A-40, M.I.D.C., 'H'
Block, Pune 18. Partnership, 1973. Bank: Bank of Baroda.
Cap. Rs.6,00,000. Prod. Rs.12,00,000. Workers 30. Pro-
ducts: AM/FM IF transformers, MW/SW oscillator coils;
MW/SW antenna coils

578. FIBREPLAST INDIA. Plot No. W-15, F-2 Block,
Pimpri Industrial Area, Pune 18. Tel. 83433. Proprietary.
1972. Bank: State Bank of India. Prod. Rs.6,00,000.
Workers 16. Exports: Rs.32,534. Country: Dubai Pro-

ducts· F R P mirror frames, bath tubs, helmets, chair sheets, stools, vessels (F.R.P. thermoplast), pipe and pipe fittings, (out of F.R.P thermoplast). F.R.P. mouldings, thermoplast fabrication, job works, servicing, lining, fittings assembly of customer's equipment with F.R.P thermoplast.

579. **FILTRONICS.** T-170 Bhosari Industrial Estate, Pune 26. Tel. 82055, 83134, 83329 Cable·FILTRONICS Proprietary, 1970. Banks·Bank of Baroda, Bank of India. Cap. Rs.15,00,000. Prod. Rs.25,00,000 Workers 47 Products·AM/FM I F transformers for radio and T.V MW/SW antenna coils, MW/SW oscillator coils, fixed and variable induction and peaking coils, pulse transformers, invertors, convertors, tape-recorder coils

580. **FINOLEX COIL CORD PVT. LTD.** MIDC Industrial Estate, Pune-Nasik Road, Bhosari, Pune 26. Tel 82510 Cable·FINOLEX Estd 1967 Sister concerns Finolex Cables Ltd., Finolex Plastics Pvt. Ltd. Bank Central Bank of India. Cap Rs 7,82,000 Prod Rs.7,36,962. Workers 16 Products: Finolex coiled cords, PVC cordage and moulded plug wires

581. **FINOLEX CABLES LTD.** 26/27 Bombay-Pune Road, Pimpri, Pune 18. Tel. 82163, 82164, 82165, 82800, 82680. Cable·FINOLEX. Telex: 0145-211 Estd 1967 Sister concerns Finolex Plastics Pvt. Ltd., Finolex Coil Cord Pvt Ltd. Banks: Central Bank of India; Bank of India. Cap Rs 164 22 lakhs. Prod Rs 4,17,12,000. Workers 206. Exports Rs 70,00,000 Countries: Middle East, East African countries, U.K., Australia, Singapore, Mauritius, Malaysia, Nicosia, British Honduras. Products PVC insulated electrical cables and wires including house wiring cables, flexible cords, telephone coiled cords, armoured cables, paired telephone cables, automobile cables, battery cables, winding wires, PVC insulated cables for submersible pumps, vinyl hoses for flexible conduiting, vacuum purposes and also for irrigation purpose.

582. **FINOLEX PLASTICS PVT. LTD.** 26/3 Bombay-Pune Rd., Pimpri, Pune 18. Tel.82163/4/5. Cable·FINOLEX. Telex·PN 0145/211. Estd 1971. Sister concerns: Finolex Cables Ltd., Finolex Coil Cord (P) Ltd. Bank·Bank of India. Cap Rs 28 lakhs Prod. Rs.2 lakhs. Workers 62 Products·Rigid PVC pipes and injected moulded fittings, rigid PVC electrical conduits and injection moulded fittings, PVC compound, injection moulded articles in thermoplastic material

583. **FITWELL SEAT CENTRE.** 1050 Raviwar Peth·Pune 2. Tel 448330 Proprietary, 1975 Bank·Indian Bank·

Cap Rs 8,000 Prod 60,000 Workers 4 Products Seat covers for cycle and scooter.

584. **FIVE STARS GARMENTS.** Sevasadan Bldg., 3rd floor, Laxmi Rd., Pune 30. Tel. C/o. 445711. Partnership, 1967. Bank: State Bank of India. Cap. Rs.5 lakhs Prod Rs 4 75 lakhs Workers 10 Products·Readymade garments—frocks, babysuits, maxis, bellbottom, shirts and N shirts and manila, bush-shirts, etc.

585. **FLOUR-TECH INDUSTRIES.** 46 'Vishwas', T.M.V. Colony, Gultekadi Rd., Pune 9. Tel 440325. Factory. 38/39 Hadapsar Industrial Estate, Pune 13. Tel. 7489. Partnership, 1972. Br. Bombay. Bank: Bank of Maharashtra Workers 4. Products·Manufacture of Teflon (P.T.F.E) components, rods, sheets, tapes, gaskets, ball valve spares, rings, machined components, bellows, envelope gaskets, etc.

586. **FLEXO GRAFIKA.** 35/5 Prabhat Road, near Lane No. 8, Pune 4. Tel. 58164. Factory: 70 Hadapsar Industrial Estate, Bijlee Compound, Pune 13. Tel. 7622 Partnership, 1976. Bank Bank of Maharashtra. Cap. Rs 4,00,000. Prod. Rs 6,00,000. Workers 8. Products: Extrusion of polythene film; printed polythene bags

587. **FORBES FORBES CAMPBELL AND CO. LTD.** 658 Shivajinagar, Natraj Compound, Pune 4 Tel. 53376, 50161. Cable: YESTERMORN. Estd. 1967. Brs. Ahmedabad, Baroda, Bangalore, Calcutta, Chandigarh, Cochin, Madras, New Delhi, Secunderabad. Bank: Dena Bank Products: Office equipments—Facit-make typewriters and calculators, Shourie-make duplicators; auto-accessories—spark plugs, spark plugs testing machines and ceramic products; engineering—cutting and threading tools, pneumatic grinders, spring washers, etc.; communications telecommunication components.

588. **FORMICA INDIA LTD.** Sambhaji Mansion, 1260-A Jangli Maharaj Rd., Pune 4. Tel. 53258/9. Cable·FORMICA POONA. Factory: Akurdi, Pune 35 Tel. 82321/2. Cable FORMICA CHINCHWAD Estd. 1962. Brs. Bombay, Delhi, Calcutta, Madras, Bangalore and Ahmedabad Banks: Union Bank of India, American Express International Banking Corpn; Mercantile Bank Ltd. Cap. Rs.2.92 crores. Prod. Rs. 3,30,64,000. Workers 252. Export: Rs.20 46 lakhs Countries: U K , U S A , Australia, Middle East Products: Formica decorative and industrial laminates, including paper phenolic copper clad grades and glass epoxy, unclad as well as copper clad grades

589. **FOUR FIELD.** Plot No.W-14, F-2 Block, M.I.D.C., Pimpri, Pune 18. Cable: WHITROX. Proprietary, 1976. Bank: Bank of Maharashtra. Cap. Rs.1.5 lakhs. Prod Rs.3.7 lakhs. Workers 5. Products: Zirconium silicate opacifier for tablewares, sanitarywares and glazed tiles; fluid energy pulverisers, vibro energy wet grinding mills, vibratory finishing machines, terminal clamps and aluminium braided straps for electric furnace spare accessories.

590. **FOUR STAR CO.** 789 Kasba Peth, Pune 11. Proprietary, 1971. Bank: Poona Peoples Co-op. Bank Ltd. Cap. Rs. 12,000. Prod. Rs.30,000. Worker 1. Products: Pan masala, jarda, kimam, gulkand.

591. **FOUNDERS UNITED PVT. LTD.** 22/3 Hadapsar Industrial Estate, Pune 13. Tel. 7225. Estd. 1968. Bank Bank of Baroda. Cap. Rs.3,00,000. Prod. Rs.1,50,000: Workers 14. Products: C.I. castings, metal and wooden patterns.

592. **FRAM AND CO.** 25 Dr. Ambedkar Rd., Pune 1. Tel. 25034. Partnership, 1923. Banks: Bank of India. Cap. Rs.2.5 lakhs. Prod. Rs.2,63,946. Workers 18. Products: Aerated waters.

593. **FRAM CHEMICAL INDUSTRIES.** 3 M. G. Rd., Pune 1. Tel. 22481. Factory: Shankarshet Rd., Pune. Partnership, 1977. Cap. Rs.1,00,000. Workers 6. Product: Hydrazobenzene.

594. **FREEZ ALL.** 759/19 Deccan Gymkhana, opp. P.Y.C., Pune 4. Tel. 56624. Proprietary, 1970. Br. Freez All Sales, 996 Budhwar Peth, Pune 2. Bank: Bank of Maharashtra. Cap. Rs.10,000, Workers 2. Product: Repairs of refrigeration equipments, i.e. air conditioners, refrigerators.

595. **FUEL INJECTION SERVICE STATION.** 691 A/2 Pune-Satara Rd., Pune 9. Tel. 441331. Proprietary, 1968. Bank: Bank of India. Cap. Rs. 60,000. Prod. Rs.20,000. Workers 4. Product: Repairing of fuel pump and injectors.

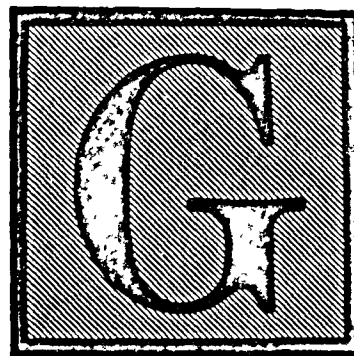

596. **G A K INDUSTRIES.** 759/104 Deccan Gymkhana, Pune 4. Proprietary, 1973. Bank: The New Bank of India Ltd. Cap. Rs.20,000. Prod. Rs.50,000. Workers 4. Export: Rs.12,000. Country: Australia. Products: Thermo-plastic injection moulded industrial components.

597. **G. B. ENGINEERING WORKS.** 378 Shukrawar Peth, Pune 2. Factory: 330 Shukrawar Peth, Pune 2. Proprietary, 1965, Bank: The Poona Co-operative Rupee Bank Ltd. Products: Electric and hand-operated sugarcane crusher.

598. **G. D. WORKS.** 100+92/7, Erandawana Gaothan, Pune 4. Tel. 52126. Partnership, 1974. Bank: Canara Bank. Cap. Rs.80,000. Prod. Rs 45,000. Workers 6. Products: Boiler mountings, gear boxes, fabrication, spares.

599. **G.M.S. ENGINEERING.** MIDC, 'S' Block Plot No. 10, Bhosari, Pune 26. Proprietary, 1974. Bank: Bank of Baroda. Cap. Rs.70,000. Prod. Rs.2,00,000. Workers 6. Products: Cast-iron cock and small gate-valve, diesel engine spares.

600. **G. R. GOKHALE AND CO.** 759/61 Deccan Gymkhana, Pune 4. Tel. 57604. Partnership, 1936. Bank: Bank of Maharashtra. Cap. Rs.1,00,415. Prod. Rs.4,05,337. Workers 4. Product: Steel fabrication.

601. **G. S. DRESSES.** 73 Raviwar Peth, Pune 2. Tel. 444133. Proprietary, 1975. Bank: State Bank of India. Cap. Rs. 15,000. Prod. Rs.25,000. Workers 8. Products: Gents' clothes.

602. **G. S. ENTERPRISES.** 200 Mangalwar Peth, Pune 11. Tel. C/o. 55133. Factory: Visiting Room, Vinayak Ashram,

- 759/15 Deccan Gymkhana, Pune 4 Proprietary, 1970. Bank: State Bank of India Cap. Rs.1,25,000. Prod. Rs. 1,75,000. Workers 12. Products: Cold-storage doors, latches, hinges, ice cans, cooling towers, trolleys, M.S. tanks, ducting work and all types of steel fabrication.
603. G. S. MOGHE AND SONS. 675 Budhwar Peth, Jogeshwari Naka, Pune 2. Tel. 448349. Proprietary, 1938. Bank: Bank of Maharashtra. Cap. Rs.20,000. Prod. Rs. 45,000. Workers 2 Products: Blocks for printing purposes.
604. GAIKWAD ENGINEERING WORKS. 1419 Vithal Nagar, Hadapsar, Pune 28 Proprietary, 1972. Workers 6. Product Jobbing
605. GAIKWAD METAL WORKS. 222 Guruwar Peth, Pune 2. Proprietary, 1960. Workers 4. Product: Charvi.
606. GAJANAN ENGINEERING WORKS. 605 Ghorpade Peth, Pune 2. Proprietary, 1974 Bank: Sangli Bank Ltd. Cap. Rs 15,000 Prod Rs.4,000. Workers 2. Products: Job work.
607. GAJANAN METAL WORKS. 101 Kasba Peth, Pune 11 Tel. C/o. 448915. Partnership, 1963. Bank: Bank of Maharashtra. Cap. Rs. 35,000. Prod. Rs.80,000. Workers 3 Products: Sheet metal parts (machine cover), turning job, fabrication.
608. GAJANAN METAL WORKS. 299 Raviwar Peth, Pune 2. Proprietary, 1956. Bank: Bank of Maharashtra Cap. Rs.1,00,000. Prod Rs 1,25,000. Workers 9. Product Stainless steel polishing
609. GAJANAN P. POTFODE. 276 Kasba Peth, Pune 11. Proprietary. Cap. Rs.22,000 Prod. Rs.1,00,000. Workers 4 Products: Brass and copper handa, tapela, boiler.
610. GAJANAN TEXTILES. 14 Hadapsar Industrial Estate, Pune 13. Tel. 7507, 7497. Proprietary, 1973. Products: Cotton textiles.
611. GAJARE PLASTICS. 125 Budhwar Peth, Junnar. Dist. Pune . Tel. 57. Factory: 38 Bhagat Peth, Junnar, Dist. Pune. Partnership, 1974. Cap. Rs.36,052. Prod. Rs. 5,00,000 Workers 8. Products: Monofilaments from high-density polythelene and their products such as filters, filter cloth, plastic cloth, fishing twine and ropes, etc.
612. GAJENDRA ENGINEERING WORKS. Walchandnagar (Junction), Dist. Pune. Tel. 44. Partnership-1974, Bank: Canara Bank. Cap. Rs 80,000. Prod- Rs 2,00,000. Workers 6, Products: Sugar machinery spares, fabrication and structural work, stud bolt flanges, agricultural implements, etc.
613. GAJRAJ INDUSTRIES. 235 Wanawadi Gaon, Pune 1. Tel. 26975. Partnership, 1972, Banks: Indian Bank. Cap. Rs,36,000. Prod. Rs.1,20,000 Products: Flavouring edible essences
614. GAJRAJ TEXTILES. 15-16 Kaka Halwai Industrial Estate, Pune 9. Tel. C/o. 441917. Proprietary, 1964 Sister concern: Kismat Fabrics. Bank: Bank of Maharashtra. Cap. Rs.20,000. Prod. Rs.30,000 Workers 3 Product: Cotton fabric.
615. GALAXY CHEMICALS AND MINERALS. Plot No. 51, 'S' Block, M.I.D.C., Bhosari, Pune 26 Tel. 82946 Proprietary, 1976. Bank: Punjab National Bank. Cap. Rs. 1,50,000. Prod. Rs 3,00,000. Workers 8. Products: Foundry fluxes, metallurgical chemicals, inflammable refractory dressings.
616. GALAXY ENGINEERING ASSOCIATES. 1684 Sadashiv Peth, Pune 30. Tel. 442149. Proprietary, 1971. Bank: Bank of Maharashtra. Cap. Rs.50,000. Prod. Rs 75,000. Workers 4. Products: High precision components
617. GANDHI FABRICATORS AND COMMERCIALS. 1199/3 Model Colony Rd., above Union Bank of India, Pune 16. Tel. 58611. Partnership, 1973. Bank: Union Bank of India. Cap. Rs 20,000. Prod. Rs 1,00,000. Product: Low-tension pannel boards.
618. GANESH AND COMPANY. 1344 Sadashiv Peth, near Chimanya Ganpati, Pune 30 Tel. 441909. Partnership, 1975. Bank: Bank of Baroda. Cap Rs.60,000. Prod. Rs 35,13,600. Workers 60. Products: Wastepaper collection, sorting, packing and despatching to paper mills for pulping purpose.
619. GANESH CHEMICAL WORKS. Plot No. 21/6 Somwar Peth, Pune 2 Tel 25205 and 27500. Partnership, 1958. Banks: Punjab National Bank; Dena Bank. Cap. Rs.8,00,000. Prod. Rs 15,00,000. Workers 15. Products: Sodium silicate and neutral silicate
620. GANESH ENGINEERING WORKS. 84 New Shukrawar Peth, Pant Sachiv Pichhadi, Pune 2. Tel. 440234. Proprietary, 1954. Bank: Bank of Maharashtra. Cap. Rs. 2,00,000. Prod. Rs.1,25,000. Workers 7. Products Sheet metal works, industrial components, gun-metal choke moulds

- 621. GANESH FOUNDRY.** 127 Telco Rd., Mohan Nagar, Chinchwad, Pune 19. Tel. 83094. Partnership, 1969. Banks: Bank of Maharashtra; United Western Bank Ltd. Cap. Rs.1,42,882. Prod. Rs.5,84,500. Workers 15. Products: Ferrous and non-ferrous casting.
- 622. GANESH INDUSTRIES.** Chinchwad, Pune 19. Partnership, 1967. Cap. Rs.10,000. Prod. Rs 60,000. Workers 2. Product: Job work.
- 623. GANESH PRINTERS.** 693 Budhwar Peth, Pune 2. Tel. C/o. 447365. Proprietary, 1966. Br. 692 Budhwar Peth, Pune 2. Banks: Janata Sahakari Bank Ltd.; Janseva Sahakari Bank Ltd. Cap. Rs.1,00,000. Prod. Rs.50,000. Workers 8. Products: Printing books, magazines, newspapers.
- 624. GANESH WELDING WORKS.** 538 Shukrawar Peth, Shivaji Rd., Pune 2. Proprietary, 1952. Bank: Syndicate Bank. Cap. Rs.50,000. Prod. Rs.13,923. Workers 4. Products: Oil-engine and automobile spare parts.
- 625. GANPAT KESHAV NARBEKAR.** 1371 Shukrawar Peth, Pune 2. Proprietary, 1960. Cap. Rs.2,000. Prod. Rs.6,000. Workers 6. Product: Truck-body repairing.
- 626. GANPATI WEAVING MILLS.** 43/2 Karve Road, Pune 4. Proprietary, 1964. Cap. Rs.28,000. Prod. Rs.18,600. Workers 6. Product: Gray muls.
- 627. GANRAJ TEXTILES.** Plot No. 35, Gultekadi, Pune 9. Proprietary, 1971. Bank: Bank of Maharashtra. Cap. Rs.20,000. Prod. Rs.80,000. Workers 6. Product: Cloths.
- 628. GANRAJ TEXTILES.** 46/A/2 Kaka Halwai Industrial Estate, Satara Rd., Pune 9. Tel. C/o. 441977 Proprietary, 1964. Sister concern: Kismat Fabrics. Bank: Bank of Maharashtra. Cap. Rs.20,000. Prod. Rs.50,000. Workers 3. Product: Cotton fabrics.
- 629. GARAGE EQUIPMENT CORPORATION.** 867 Budhwar Peth, Pune 2. Tel. 445346, 442856. Proprietary, 1970. Bank: Indian Bank. Cap. Rs.35,000. Workers 2. Products: Repairing of accessories, jobbing.
- 630. GARWARE FILAMENT CORPORATION LTD.** Chowpatty Chambers, Sandhurst Bridge, Bombay 7. Tel. 357711. Cable: 'GARFIL' Telex: 011-3201. Factory: (1) Bombay-Pune Rd., Pimpri, Pune 18. Tel. 82241, 82242; (2) 11 M.I.D.C., Akurdi, Pune 19. Tel. 82181, 83162. Estd. 1961. Subsidiary company: Garware Wall Ropes Ltd. Bank: Bank of India. Cap. Rs.52.50 lakhs. Prod. Rs.200 lakhs. Workers 250. Products: Synthetic twine rope, agricultural netting, fish net (nylon) synthetic filter fabrics and knitted fabrics.
- 631. GARWARE NYLONS LTD.** Express Towers, 5th floor, East Wing, Nariman Point, Bombay 21. Tel. 230745, 230807, 230946. Cable: GARNYL. Telex: 011-6020. Regd. Office: Chandramukhi, Nariman Point, Bombay 21. Tel. 259291, 259297, 259299, 258151. Cable: GARNYL. Telex. 011-3201. Factory: Bombay-Pune Rd., Pimpri, Pune 18. Tel. 82241-2-3. 83100, 83200, 83300. Cable: GARNYL Telex: 0145/261. Estd. 1962. Brs. New Delhi, Amritsar, Ahmedabad, Surat. Sister concerns: Garware Motors Pvt. Ltd., Bombay; Garware Plastics Pvt. Ltd., Bombay; Garware Synthetic Bristle Ltd., Garware Filament Corporation, Bombay, Modern Nets Pvt. Ltd., Ahmednagar, Garware Finance Corporation, Bombay; Garware Plastics and Polyester Pvt. Ltd., Aurangabad; Garware Shipping Corporation Pvt. Ltd., Bombay, Garware Fabrics Ltd., Blundell Eomite Paints Ltd., Bombay. Banks: Dena Bank; Bank of India, United Commercial Bank; State Bank of India; Bank of Maharashtra; The United Western Bank Ltd.; The Sangli Bank Ltd. Cap. 17.50 crores. Prod. Rs. 23 crores. Workers 1063. Products: Nylon yarn, polyester yarn, nylon fishnet twines, ropes, nylon texturised yarn, polyester texturised yarn.
- 632. GAS ARC.** 33 Erandawana, Pune 4. Factory: 545 Sadashiv Peth, Pune 30. Tel. 442056. Proprietary, 1966. Banks: Bank of Maharashtra; Dena Bank. Cap. Rs. 45,000. Prod. Rs.70,000 Workers 5. Products: jobbing, fabrication.
- 633. GANPAT MARUTI GAYAKWAD.** 352 Ganesh Peth, Pune. Proprietary, 1976. Prod. Rs.15,000. Workers 4. Products: Brasswares.
- 634. GASEM PVT. LTD.** 83 Shivajinagar, Pune 5. Tel. 53731. Estd. 1966. Bank: State Bank of India. Cap. Rs. 39,000. Prod. Rs.4 lakhs. Workers 10. Products: Gas meters, design development work.
- 635. GASMECO ENGINEERING WORKS.** 83 Shivajinagar, Pune 5. Tel. 58302. Partnership, 1961. Bank: Bank of Maharashtra. Cap. Rs.2,00,000. Prod. Rs.3,00,000. Workers 12. Products: Pneumatic tools, oil pumps, spares for compressors, diesel engines, tools and machine parts.
- 636. GATHANI UDYOG.** 81 'S' Block, M.I.D.C., Bhosari, Pune 26. Partnership, 1974. Bank: Bank of Baroda. Prod. Rs.3,00,000. Workers 10. Products: Bolts, rivets, L and J hooks in M.M.series, B.S.W. UNC. BSF. size 5/16" to 1/2" dia. and 1" to 4" length.

637. **GAVATE BROS.** 14 Budhwar Peth, Pune 2. Tel. 446915. Factory: 662 Narayan Peth, Pune 30. Partnership, 1947. Bank: The Sangli Bank Ltd. Cap. Rs.4,00,000. Prod. Rs. 5,00,000. Workers 10. Products: Gita exercise books, account books, bank account books and all other stationery; supply of all these to schools and colleges.
638. **GAURI FINE CHEMICALS.** T/140 M.I.D.C., Bhosari, Pune 26. Tel. 82789. Cable:GAURI. Proprietary, 1975. Bank: United Commercial Bank: Cap. Rs.10,36,000. Prod. Rs.25lakhs. Workers 30. Products: Oxyphenbutazone BP (basic bulk drug).
639. **GAYLORD DRESSES.** 189 Raviwar Peth, Popatlal Shah Trust Bldg., Bohari Ali, Pune 2. Tel. 449331. Partnership, 1969. Banks: State Bank of India, Union Bank of India Cap. Rs.1,50,000. Prod. Rs.3,00,000. Workers 15 Product: Readymade garments for children.
640. **GAYATRI MUDRANALAYA.** 'Gayatri Sadan', 2060 Sadashiv Peth, Vijaynagar Colony, Pune 30. Tel. 449351. Partnership, 1975. Sister concern: Devlaxmi Prakashan, Pune 30. Bank: Vidya Sahakari Bank Ltd. Cap. Rs.1,85,000. Prod. Rs. 45,000. Workers 5. Export: Rs.15,000. Country: Mauritius. Product: Printing and binding of books, etc.
641. **GEETA DRESS MFG. CO.** 84 Ganesh Peth, Pune 2. P Box No. 570 Tel. 48676. Partnership, 1974. Bank: Canara Bank. Cap. Rs.60,000 Prod. Rs.5,00,000. Workers 13. Products: Frocks, babysuits, baby sets, maxis, etc.
642. **GEETA INDUSTRIES.** 407/2 Geeta Bhavan, Nana Peth, Pune 2. Tel. 26106. Factory: Plot No. 62 Hadapsar Industrial Estate, Pune 13. Partnership, 1976. Sister concern: Geeta Agency Bank. Punjab National Bank. Products: Motor-cycle and scooter accessories.
643. **GEETA MUDRANALAYA.** 1346 Kasba Peth, Pune 11. Est. 1969. Banks: Poona Peoples Co-op. Bank Ltd; Sangli Bank Ltd. Cap. Rs.18,000. Prod. Rs.50,000. Workers 3. Products: Commercial printing, binding.
644. **GEETA PRODUCTS.** 32 Shankarshet Rd., Plot No. 15, Gultekadi, Pune 9. Tel. 446786. Proprietary, 1976. Bank: United Commercial Bank. Cap. Rs.20,000. Prod. Rs.60,000. Products: 'Prakash' fountainpen ink, gum, pad ink, and touch & go.
645. **GEM DRESS MANUFACTURING CO.** 785 Ganj Peth, Pune 2. Tel. 441737. Partnership, 1965. Bank: State Bank of India. Cap. Rs 1,00,000. Prod. Rs.3,50,000. Workers 15. Product: Gents' garments.
646. **GENERAL ELECTRIC AND GAS WELDING WORKS.** 1173 Bhawani Peth, Pune 2. Proprietary, 1970 Bank: Poona Merchants Co-op. Bank. Cap. Rs. 10,000. Prod. Rs.18,000. Worker 1. Product: Stove—general and fabricated.
647. **GENERAL EQUIPMENT MAINTENANCE AND SPARES.** 375 Bhawani Peth, Pune 2 Tel. 27950. Proprietary, 1973 Bank: Bank of Maharashtra. Cap Rs 1,00,000 Prod Rs 70,000. Workers 5. Products: Spare parts for petrol pumps especially substitutes for imported parts, repairing of service station equipment i.e. petrol pumps, vehicle hoists, air compressors, car washers, grease pumps, etc.
648. **GENERAL FURNITURE WORKS.** Plot No 9, Gultekadi Industrial Estate, Pune 9. Tel. 445398. Partnership, 1969. Banks: Bank of India; Muslim Co-op Bank Ltd. Cap. Rs.8,000. Prod. Rs.20,000 Workers 6 Products: Building shutters, brackets, chairs, tables and other furniture.
649. **GENERAL INDUSTRIAL CONTROLS PVT. LTD.** 25/430 Senapati Bapat Rd., Pune 16. Tel. 55400. Cable: GENCON. Estd. 1974. Bank: Indian Bank. Cap. Rs 2,50,000. Prod. Rs.6,00,000 Workers 10. Export: Rs 4,000. Country: Indonesia. Product: Autorest synchronous timers of various ranges.
650. **GENERAL INDUSTRIAL EQUIPMENT PVT. LTD.** 346-D Sadhu Vaswani Nagar, Pune 7. Tel. 54831. Cable: FINEWORK Factory: T-22 Bhosari Industrial Area, Pune 26. Tel 83127. Estd. 1973. Sister concern: Deven Industries, Pune 26 Bank: The United Western Bank Ltd. Cap. Rs 3,46,770. Prod Rs 17,45,273. Workers 45. Export: Rs.25,000. Countries: Sri Lanka, Malaysia. Products: Moulds and dies for glass and plastic industry; glass-making machinery—Lehrs—annealing and decorating; conveyors, stackers, transfer tables, feeders; steel structures, textiles—narrow fabrics and ropes.
651. **GENERAL IRON INDUSTRIES.** 450 New Mangalwar Peth, Pune 11. Cable: KEYZAR. Partnership, 1964. Sister concern: General Hardware Stores, Pune 2. Bank: State Bank of India. Prod. Rs 4,50,000. Workers 7 to 10. Products: Iron and brass articles, agricultural implements such as tipping wheel barrow, rubber wheels, brass spindles, sugar-cane cutting knives, etc.
652. **GENERAL MECHANICAL WORKS.** 187/2/A Shanwar Peth, Pune 30. Tel 54097. Partnership, 1962. Br. 309 Shukrawar Peth, Pune. Bank: Bank of Maharashtra.

- Workers 6. Products: Hand-operated and foot-operated toggle press; electronic hardware (bakelite bobbins); clamps, side (bracket) 'U' clamps, etc.
653. **GENERAL REPAIRING AND WELDING WORKS.** 1370 Shukrawar Peth, Pune 2. Proprietary, 1942. Cap. Rs.25,000. Prod. Rs.15,000. Workers 6. Product: Truck repairs.
654. **GHADGE INDUSTRIES.** 460 Ghorpade Peth, Pune 2. Tel. 441649. Partnership, 1963. Bank: State Bank of India. Cap. Rs.85,000. Prod. Rs.2,40,000. Workers 2. Products: 'Samrat' fuel injection test bench machines.
655. **GHARE AND MANDALI.** 12 Budhwar Peth, Pune 2. Tel. 445342. Partnership, 1937. Banks: Bank of Maharashtra; Cosmos Co-op. Bank Ltd. Cap. Rs.1,00,000. Prod. Rs.4,00,000. Workers 8. Products: Account books, exercise books, supply office stationery.
656. **GHARE DATTATRAYA BALASAHEB.** 717 Guruwar Peth, Pune 2. Tel. 449512. Proprietary, 1969. Cap. Rs.25,000. Prod. Rs.48,000. Workers 3. Product: Electroplating of all metals.
657. **GHOLAP METAL WORKS.** 489 Guruwar Peth, Pune 2. Proprietary, 1962. Bank: Poona Peoples Co-op. Bank Ltd. Cap. Rs. 10,000. Prod. Rs. 1,00,000. Workers 6. Product: Aluminium and brass cutlery.
658. **GIRISH TEXTILES.** 35 Erandawana, off Karve Rd., Pune 4. Tel. 56135. Partnership, 1967. Bank: Bank of India. Cap. Rs.15,000. Prod. Rs.36,00,000. Workers 3. Product: Rough cloth material.
659. **GITA TEXTILES.** 35 Erandawana, Karve Rd., Pune 4. Partnership, 1965. Banks: Bank of Maharashtra; Bank of India. Cap. Rs. 20,000. Prod. Rs.40,000. Workers 8. Products: Rough cotton cloth, loan and knitted cotton, cloth materials.
660. **GITE AND SONS.** 1158 Sadashiv Peth, Pune 30. Partnership, 1953. Bank: Sangli Bank Ltd. Cap. Rs.55,000. Prod. Rs.12,000. Workers 3. Products: Wood-cutting, timber sale, wooden toys, wood-turning, frit work.
661. **GITS FOOD PRODUCTS (INDIA).** 18/3 Hadapsar Industrial Estate, Gits House, Pune 13. Tel. 7104, 7105. Cable: GITS FOOD. Telex: 0145-339 GITS PN. Partnership, 1962. Br. Bombay. Bank: State Bank of India. Cap. Rs.1,55,000. Prod. Rs.16,00,000. Workers 40. Export: (FOB) Rs.18,15,475. Countries: U.S.A., Canada, Australia, Middle East, U.K. Products: Instant and processed foods, pickles and chutneys.
662. **THE GLOBE ELECTRIC STORES.** 68 Mahatma Gandhi Rd., Pune 1. Tel. 23548. Cable: GESTORE. Factory: Globe Electrical Industries, 85-A Hadapsar Industrial Estate, Pune 13. Tel. 7245. Partnership, 1954. Bank: Bank of Maharashtra. Cap. Rs.8,81,825. Prod. Rs.7,50,000. Workers 53. Products: Railway carriage fans, cabin fans, pedestal fans, air circulators, exhaust fans, fractional H.P. motors.
663. **GLOBE TRADING CO.** 55/18 Erandawana, Chip-lunkar Rd., Pune 4. Tel. 58344. Proprietary, 1955. Bank: Bank of India. Cap. Rs.1,00,000. Prod. Rs.2,50,000. Workers 4. Products: Laboratory fine chemicals such as salts of following metals—cadmium, bismuth, nickel, antimony, mercury and molybdenum.
664. **GODBOLE AND SONS.** 719 (new) Budhwar Peth, Pune 2. Proprietary, 1953. Cap. Rs.15,000. Prod. Rs.8 000. Product: Rubber stamps of all sizes.
665. **GODBOLE ENTERPRISES.** 'Jaswandi', Mitra-mandal Colony, Pune 9. Factory: 47/31 Pune-Satara Rd., Pune 9. Tel. 446562. Proprietary, 1974. Bank: Bank of Maharashtra. Prod. Rs.4,00,000. Workers 9. Products: Patterns—wooden, aluminium gunmetal, C.I., etc.
666. **GOODWYN INDUSTRIES CORPORATION (INDIA).** 'Goodwyn House', 95-A Shankarshet Rd., Pune 9. Tel. 447465. Partnership, 1949. Bank: Union Bank of India. Cap. Rs.7.5 lakhs. Prod. Rs.10 lakhs. Workers 30. Products: Fluid energy jet mills I.P. No. 133634. Jupiter micro pulverisers, rotary knife cutters, road unevenness test indicators, rice hullers and grinding mills, universal grinding mills, power transmissions, ferrous and non-ferrous castings.
667. **GOPAL SHIVDAS AND SONS.** 27 New Timber Market, Pune 2. Tel. 441230. Partnership, 1970. Banks: Bank of India; Bank of Maharashtra. Cap. Rs.1,50,000. Prod. Rs.4,00,000. Workers 8. Products: Planks from wooden lays; packing boxes of any size.
668. **GORE JOSHI TOOL (PVT) LTD.** 'Ramanivas', Laxmi Rd., Pune 30. Tel. 444055. Factory: T-159, M.I.D.C., Bhosari, Pune 26. Estd. 1976. Bank: State Bank of India. Cap. Rs.8 lakhs. Prod. Rs.20,000 for three months. Workers 15. Products: Second operation lathes, co-ordinate tables, portable milling machines, special limes required by Defence, special handling equipment, precision tooling items and fixtures, crank presses and press brakes.

669. **GRAFIC ARTS.** 714 Taboot Street, Pune 1 Tel. 26441. Partnership, 1965. Bank Dena Bank. Cap. Rs 50,000. Prod. Rs.1,50,000. Workers 6. Products: Commercial and industrial printed forms, price-lists, any printing job
670. **GRAHA BHARAMAN YANTRA.** 76B/25 Law College Rd., Erandawana, Pune 4. Tel. 54385. Factory. 154 Kasba Peth, Pune 11. Proprietary, 1961. Bank: Bank of India. Cap. Rs.10,000. Prod. Rs 67,550. Workers 5. Product. Graha Bhraman Yantra—geographical apparatus.
671. **GRAND BAKERY.** 59 Ganesh Peth, Pune 2 Tel. 448265 Proprietary, 1963. Bank: Bank of Maharashtra Products: Bread, cake, biscuits, nankatai, toasts
672. **GREAVES FOSECO LTD.** Jolly Bhavan No 2, New Marine Lines, Bombay 20. Tel. 259439, 259276. Cable: FOSECOIND-Bombay. Telex: 011-4113 Factory. Chinchwad, Bombay-Pune Rd., Pune 19. Tel. 82135, 82136. Cable: FOSECOIND-Pune. Telex: 0145-332 Estd. 1958 Br. Calcutta. Bank: Grindleys Bank Ltd Bombay. Foreign collaboration: FOSECO International Ltd., U.K. Cap Rs. 96 lakhs. Prod. Rs.500 lakhs. Workers 100. Export 15 lakhs. Countries: Japan, South East Asia, U.K., West Europe, USSR, East-European countries, Africa and Middle East. Products: Foundry fluxes and chemicals.
673. **GRINDAL.** 33/36 Guruwar Peth, Pune 2 Tel. 442177. Proprietary, 1965. Bank. The Poona Merchants' Co-op. Bank Ltd. Cap. Rs.70,000 Prod. Rs 1,50,000 Workers 7. Products: Centreless grinding, standard dowel pins, gudgeon pins, taper pin and rollers, automobile shafts, pins, etc., measuring pins
674. **GRIND TOOLS.** E-11 (4) Bhosari Industrial Area, Pune 26. Tel. 82471, 83476 Proprietary, 1967 Bank State Bank of India. Cap. Rs 84,000 Prod. Rs.11,00,000 Workers 23. Products: Carbide-tipped tools and tool grinding and lapping machines.
675. **GRIP AGENCY.** 398 Shanwar Peth, Pune. Proprietary, 1966 Cap. Rs. 10,000. Prod. Rs.5,000 Products: Hangers, battery switches.
676. **GULAMHUSEN MOHEMEDBHAI.** 1611 Shukrawar Peth, Pune 2 Tel. 445733. Partnership, 1910 Bank State Bank of India. Cap. Rs.65,000. Prod. Rs.2,25,000 Workers 3. Products: Exercise books, account books and sale of paper.
677. **GULMARG ICE MFG. CO.** 'Saraswati Vilas' Bldg., 1688 Sadashiv Peth, Pune 30. Tel. 441629, 445385. Factory: Vithalwadi, 25/5 Hinge khurd, Pune Proprietary, 1970. Bank: Bank of Maharashtra. Cap. Rs 1,15,000. Prod. Rs.70,000 Workers 4 Product: Ice, preservation of milk.
678. **GUPTA BOX MFG. CO.** 389 Shanwar Peth, Pune 30. Tel. 446502. Proprietary, 1961. Banks: Bank of Maharashtra; Syndicate Bank. Cap. Rs.30,000. Prod. Rs 6,00,000 Workers 8. Product: Cardboard corrugated boxes
679. **GURUDATTA DRESSES.** 1693 Sadashiv Peth, Lodha Niwas, Near S.P. College, Pune 30. Tel. 440158 Partnership, 1961. Bank: Bank of Maharashtra. Products Children wears—frock, baby suit, maxi, etc.
680. **GURUKRIPA ENGINEERS.** Rathod Compound, Mohan Nagar, Chinchwad, Pune 19. Proprietary, 1973 Bank: Bank of Maharashtra. Cap. Rs.85,000. Prod. Rs 1,80,000. Workers 5. Products: Job works, machinery spares.
681. **GURU NANAK INDUSTRIES.** Plot No 87, Bhosari General Block, M.I.D.C., Pune 26. Tel. 82437 Cable: HEATREAT. Proprietary, 1976. Bank: Punjab National Bank. Cap. Rs.5 lakhs. Prod. Rs 2 lakhs Workers 5. Products: Heat treatment—annealing, normalising, stress-relieving, carburising (pack/liquid), hardening and tempering of all plain carbon steels, alloy steels, tool steels, high speed steels, cast-iron, aluminium, brass, etc Heat treatment of high speed steel—speciality
682. **GURSAVE INDUSTRIES.** 29 'S' Block, M I D C., Bhosari, Pune 26. Tel. 82957. Proprietary 1975. Cap. Rs 1,70,000. Prod. Rs.90,000. Workers 5. Products Pinion, flange roller, shaft, lower journal housing (only machining and threading).
683. **GYANANI ENTERPRISE.** M.I.D.C., 'S' Block Plot No. 5, Bhosari, Pune 26 Tel. 83632. Proprietary, 1973 Bank: Bank of Maharashtra. Cap. Rs 2,50,000. Prod. Rs 5,00,000. Workers 13 Products: Steel windows-structural chemical equipments and s.s. fabrication.
684. **GYOTB ENGINEERING COMPANY.** 445 Shukrawar Peth, Talegaon Dabhade, Dist. Pune. Tel. 39 P.C.O. Proprietary, 1973 Cap. Rs.7,000. Workers 2. Products: Wind shields of three wheeler, Vespa, auto rickshaws (side screens); automobile harnesses of Vespa, auto rickshaws.



685. **H. M. VAKHARIA.** 100 Guruwar Peth, Behind Jain Temple, Fulawala Chowk, Pune 2. Tel. 444026. Factory: 817/19 Bhawani Peth, Near Chhaya Talkies, Pune 2. Partnership, 1961. Banks: Bank of Maharashtra; State Bank of India. Cap. Rs.60,000. Prod. Rs.3,63,795. Workers 13. Products: Electric light bulbs (G.L.S.), night lamp frosted, candle clear and colour, pigmy clear and colour, night lamp and candle, decoration lamps, neon lamps.

686. **H.Y.T. ENGINEERING CORPORATION.** 29/10, D-II Block, M.I.D.C., Chinchwad, Pune 19. Proprietary, 1977. Bank: Bank of Baroda. Cap. Rs.3,00,000. Workers 7. Products: Universal mini lathe, Precision mini-drilling machine.

687. **HAIDERY PRINTING PRESS.** 910 Budhwar Peth, Pune 2. Tel. 445045. Partnership, 1930. Bank: Muslim Co-op. Bank Ltd. Cap. Rs.1,00,000. Prod. Rs.1,00,000. Workers 6. Products: Commercial printing, monthly magazine (Gujarathi).

688. **HAKIM SHAIKHADAM ABDULALI.** 1618 Shukrawar Peth, Pune 2. Tel. 445060. Proprietary, 1878. Bank: Bank of Maharashtra. Cap. Rs.25,000. Prod. Rs.15,000. Products: Agarbatti, dhoop.

689. **HALL MARK ENGINEERING CO.** 'West View', Pandita Ramabai Rd., Pune 2. Tel. 24364, 55939. Factory: 21/6 Hadapsar Industrial Estate, Pune 13. Partnership, 1973. Bank: Central Bank of India. Cap. Rs.30,000. Prod. Rs.36,000. Workers 13. Products: Machine shop—jobbing orders comprising turning, drilling, filing etc.; Rubber moulding jobs—oil seals, O rings, gaskets, diaphragms rubber-to-metal bonded jobs, mounts, etc. Instrumenta-

tion—instruments repairs, engineering and medical gauges and all apparatus, micrometers, verniers, bore gauges microscopes and other optical instruments; Auto division—dieselisation of vehicles, and manufacture of accessories.

690. **HAMID HUSSAIN PARANDE.** 237 Ganesh Peth, Pune 2. Proprietary, 1970. Bank: Central Bank of India. Cap. Rs 1,500. Worker 1. Product: Buckets of tin.

691. **HANDMADE PAPER INSTITUTE.** M.S.K. & V.I. Board, Agriculture College Compound, K.B. Joshi Rd., Pune 5. Tel. 56383. Cable: HANDPAPER. A semi-government institute, 1942. Bank: Poona District Central Co-operative Bank Ltd. Cap. Rs.3,31,837. Prod. Rs.7,75,731. Workers 90. Exports: Rs.15,893. Countries: U.S.A, Canada. Products: Handmade high grade papers, especially drawing paper for artists and engineers, degree and diploma certificate papers with watermarks, bond papers, invitation and greeting cards, filter papers of various grammages

692. **HANS PRINTING PRESS.** 474/1 Sadashv Peth, Pune 30. Tel. 443230. C/o. Hans Publications. Partnership, 1964. Bank: Bank of Maharashtra. Cap. Rs.90,600. Prod. Rs.1,04,000. Workers 10. Product: Commercial printing.

693. **HANSA PRINTERS AND STATIONERS.** 65 Navi Peth, Ganjwe Wadi, Pune 30. Tel. 443037. Partnership, 1968. Banks: Central Bank of India; Janata Sahakari Bank Ltd. Cap. Rs.30,000. Prod. Rs.1,50,000. Workers 7. Products: Commercial printing and binding.

694. **HANUMAN PRINTING PRESS.** 718 Sadashiv Peth, Pune 30. Tel. 443514. Proprietary, 1918. Bank: The Sangli Bank Ltd. Cap. Rs.40,000. Prod. Rs.15,000. Workers 5. Products: Commercial printing and book work.

695. **HAPPY TOYS.** 162/C Kasba Peth, Pune 11 Proprietary, 1974. Bank: Bank of Maharashtra. Cap. Rs.12,000. Prod. Rs 30,000. Workers 4. Product: Wooden toys.

696. **HARI BHUJANGRAO CO.** 208 Raviwar Peth, Pune 2. Proprietary, 1871. Cap. Rs.15,000. Prod. Rs 6,000. Products: Repairing works such as turning, fitting, electric welding, electro-plating manufacture of C.I. casting plums.

697. **HARI METAL WORKS.** 446 Ganesh Peth, Pune 2. Proprietary, 1962. Cap. Rs.20,000. Prod. Rs 40,000 Workers 8. Products: Sangli and Satari lotas.

- 698. HARIDAS MADHAVDAS SUGANDHI.** 451 Raviwar Peth, Pune 2. Tel. 448022 Cable: YELLOW ROSE. Partnership, 1860. Bank: Indian Overseas Bank. Cap. Rs.2,00,000. Prod. Rs.14,00,000. Workers 30. Export: Rs.12,00,000 Countries: U.S.A., U.K. Switzerland. Product: Agarbatti.
- 699. HARI PARASHURAM AUSHADHALAYA.** 250-D Shaniwar Peth, Pune 30 Tel. 449618. Proprietary, 1968 Banks: United Western Bank; Poona Co-op. Rupee Bank Ltd. Cap. Rs.1,00,000. Prod. Rs.90,000. Workers 6 Product: Ayurvedic medicines of wide range.
- 700. HARNIK FOOD INDUSTRIES.** A-22, 'H' Block, M.I.D.C., Pimpri, Pune 18 Tel. 82490. Partnership, 1960. Bank: Bank of Maharashtra. Cap. Rs.1,00,000. Prod. Rs.21,00,000. Workers 70. Export: Rs.50,000. Country: Dubai. Products. Confectionery, food products
- 701 HEERA ENGINEERING.** Heera Niwas, 88-E Navi Peth, Pune 30. Tel. 441920. Proprietary, 1968. Bank Bank of Maharashtra. Cap. Rs.58,000. Workers 3 Products: Job work, dowel pin
- 702 HELIUM PRODUCTS (INDIA) PVT. LTD.** 513 Shanwar Peth, Pune 30 Tel. 52036. Cable: HELIUM, Pune. Estd. 1939. Bank: Bank of Maharashtra. Cap. Rs. 48,000. Prod. Rs.1,05,000. Workers 13. Products: Carbon brushes for electrical equipments, carbon rings, carbon seals for pumps, carbon current collectors and other carbon products.
- 703 HEMAL UDYOG.** A-25, 'H' Block, M.I.D.C., Pimpri, Pune 18. Tel. C/o. Balsons 82332. Partnership, 1976- Bank: Bank of Maharashtra Cap. Rs.2,25,000 Prod. Rs.60,000. Workers 8 Product. Engineering job work.
- 704 HEMENT ENGINEERING WORKS.** 526/27 Rasta Peth, Pune 11. Tel. 22210. Proprietary, 1968. Bank: Bank of Maharashtra. Product: Steel furniture and reselling
- 705. HEREKAR TOYS WORKS.** 510 Budhwar Peth, Pune 2. Partnership, 1947. Banks: Dena Bank; Bank of Maharashtra. Cap. Rs.15,000. Prod. Rs.50,000. Workers 9, Product: Wooden toys.
- 706 HERRINGER BRIGHT CO.** 1017/17 Model Colony, Gokhale Nagar Rd., Pune 16. Tel. 58571. Factory: 1105/3, Manas, Model Colony, Pune 16. Tel. 50848. Proprietary, 1964. Bank: Central Bank of India. Cap. Rs. 2 lakhs Prod. Rs.5 lakhs. Workers 10. Product: Pigments of Plastic.
- 707. HEXAGON LABORATORIES (INDIA)** 6/44 Agarkar Nagar, Pune 1 Tel. 25164 Factory 81/82. Ganesh Baug, Mundhwa Road, Pune 36 Tel. 24099, Partnership, 1974. Bank: Bank of Baroda. Cap. Rs.44,000. Prod. Rs.3,00,000. Workers 8 Products: Nicotin, nicotin amide, picolinic acid, N-butyl bromide.
- 708. HI-CLIFF ENGINEERS PVT. LTD.** 29/1 Village Kharadi, Pune-Nagar Road, Pune 14. Tel. 20056, 26985, 26994. Cable: TRUALINE, Pune. Telex: 0145-320. Estd. 1972. Bank: The New Bank of India Ltd. Cap. Rs.2,57,228 Prod. Rs.22,79,506. Workers 6. Product: Trualine flexible geared coupling of various sizes
- 709. HIMALAYA INDUSTRIES.** Sahyadri Park Rd., Kondhawa, Pune 1. Tel. 27238. Partnership, 1970 Bank: Bank of Baroda. Cap. Rs.4,00,000. Workers 20 Products Asbestos cement pipes and fittings, A.C. water tanks.
- 710. HIMALAYA SPUN PIPE INDUSTRIES.** Sahyadri Park Rd., Kondhawa, Pune 1. Tel. 27238. Partnership, 1977. Banks: Bank of Baroda; Indian Bank Cap. Rs. 4,00,000 Workers 20. Product: R.C.C. cement pipes 4" to 48" dia
- 711. HIND CONDENSOR PVT. LTD.** 209 Bombay-Pune Rd., Pimpri, Pune 18. Tel. 82425, 82426 Cable CAPACITOR, Pune. Telex: PN-301 Estd. 1959 Br Calcutta. Banks: Bank of Maharashtra; State Bank of India Cap. Rs.77 lakhs Prod. Rs.129 lakhs Workers 200 Export: Rs.4,13,427. Countries: Malaysia, Bangladesh, Pakistan. Products: Power capacitors, MFD capacitors, HT power capacitors, 3-phase and single-phase air core current limiting reactors up to 22 KV voltages.
- 712. HIND ENGINEERING CO.** 337 Budhwar Peth, Pune 2. Tel. 447892. Factory: 1080 (New) Sadashiv Peth, Pune 30 Partnership, 1957 Bank: Bank of Maharashtra Cap. Rs.50,000 Prod. Rs.1,50,000. Workers 6 Products Industrial heaters for chemical, rubber, plastic, water, air, alkalies, glass and various other industries, air and furnace heaters.
- 713. HINDUSTAN ANTIBIOTICS LTD.** Pimpri, Pune 18. Tel. 82011, 82326, 82327, 82328 Cable: ANTIBIOTIC Pimpri Pune. Telex: 0145-279 Estd. 1954 Depot Offices at Delhi, Bombay, Madras, Bangalore Banks: State Bank of India; Bank of Maharashtra Foreign collaborations: (1) American Home Products Corporation for semi-synthetic penicillin including Ampicillin, (2) Toyo Jozo Co. Ltd, Japan, for Penicillin, (3) Glaxo Laboratories

- Ltd., U.K., for Streptomycin. Cap. Rs.10,90,66,841. Prod. Rs 13,38,16,346. Workers 2528. Export: Rs.55,028. Country: Africa. Products: Penicillin G. first crystals; penicillin V first crystals; bulk penicillin G; bulk penicillin V; Streptomycin, vitamin C, ampicillin, filled vials, packed vials, penicillin v tablets, vitamin c tablets, tetracycline capsules, ampicillin capsules, chlorostrep capsules, penicillin v granules for syrup, ampicillin granules for syrup
- 714. HINDUSTAN BAKERY AND CONFECTIONERY.** 264 Shanwar Peth, Pune 30. Tel. 447002. Partnership. 1948. Bank: Bank of Maharashtra. Products. Bakery products.
- 715. HINDUSTAN CLOCK WORKS.** 215 Shanwar Peth, Pune 30. Tel. 52075. Factory: 264/2 Shanwar Peth, Pune 30. Partnership, 1930. Bank: Bank of Baroda. Cap. Rs.1,00,000. Prod. Rs.1,25,000. Workers 6. Products: Water-level recorders, water meters, hydraulic equipments, repair job work, rain gauge.
- 716. HINDUSTAN ENGINEERING AND PATTERN CORPORATION.** 170 Dnyaneshwar Colony, Akurdi, Pune 35. Proprietary, 1975. Bank: Bank of Maharashtra. Cap. Rs.15,000. Workers 4. Products: All kinds of job work, automobile parts.
- 717. HINDUSTAN ENGINEERING.** 429 Shaniwar Peth, Pune 30. Proprietary. Bank: Cosmos Bank Ltd. Cap. Rs. 10,000. Prod. Rs.10,000. Workers 4. Product: Job work
- 718. HINDUSTAN ENGINEERING CO.** 18 'H' Block, M.I.D.C., Pimpri, Pune 18. Tel. 82127. Cable: HECO TOOLS. Partnership, 1969. Bank: Bank of Baroda. Cap. Rs.2.50 lakhs. Prod. Rs. 8 lakhs. Workers 20. Products: Carbide brazed tools; nuts and bolts.
- 719. HINDUSTAN LEVER LTD.** 190/192 Opp. Chinchwad Railway Station, Pune 33. Tel. 83083. Cable HIND-LEVER. Bank: State Bank of India. Foreign collaboration with England. Prod. Rs.2,00,00,000. Workers 29. Export: Rs.5,00,000. Countries: Middle-East. Products: Animal and poultry feed.
- 720. HINDUSTAN METAL PRESSING WORKS.** 304 Neelam, 108 Worli Sea Face Rd., Worli, Bombay 18. Tel. 378903, 372711. Factory: Plot No. G-92, Bhosari, Pune 26. Tel. 83267, 83268. Partnership. Bank: State Bank of India. Workers 49. Product: Empty steel ammunition boxes for defence.
- 721. HINDUSTAN MUDRAN.** 1365 Shukrawar Peth, Pune 2. Tel. 441750, 441751, 441752 (Reg.). Charitable Trust, 1957. Bank: Janata Sahakari Bank Ltd. Cap. Rs. 7 lakhs. Prod. Rs.7 lakhs. Workers 90. Products: Commercial printing, newspaper compose, book work
- 722. HINDUSTAN PAPER PRODUCTS.** Plot No. 24, Block D-III, M.I.D.C., Bombay-Pune Rd., Chinchwad, Pune 19. Tel. 83052. Partnership, 1974. Bank: United Western Bank Ltd. Cap. Rs.1,35,000. Prod. Rs. 4,60,000. Workers 14. Products. Printed paper cartons, boxes, labels, leaflets and job work printing.
- 723. HINDUSTAN PRINTING PRESS.** 303 Narayan Peth, Pune 30. Tel. 444841. Proprietary, 1938. Bank: Bank of Maharashtra. Cap Rs.2,00,000 Prod. Rs.8,00,000. Workers 50. Product: Newspaper printing.
- 724. HINDUSTAN TYRE RETREADING WORKS.** 1344 Shivajinagar, Pune 5 Tel. 53309. Factory: 17 B-13 Kothrud, Pune 29. Tel. 57122. Partnership, 1971. Bank: Bank of Maharashtra. Cap Rs 2 lakhs. Prod. Rs.2 lakhs. Workers 7 Products Retreading of motor tyres.
- 725. HI-Q ELECTROMECH INDUSTRIES.** 1350 Sadashiv Peth, Pune 30 Tel. 441974, 446028. Partnership, 1974. Bank. The United Western Bank Ltd. Cap. Rs. 50,000 Prod. Rs 3,00,000 Workers 9. Products: Miniature and small transformers for entertainment electronics; mains transformers (small size) of international standard for entertainment and industrial application; sub-assemblies involved in electronic industry.
- 726. HIRA METAL INDUSTRIES.** 119/120 Mahatma Phule Peth, Pune 2. Tel. 444966. Partnership, 1977. Cap. Rs.92,500. Products: 'Star' brand Sangali and Satari brass and copper utensils.
- 727. HIRLEKAR PRECISION ENGINEERING CO-** 18/19 Industrial Estate, Gultekadi, Pune 9. Tel. 440633. Cable: INDBUREAU. Partnership, 1969. Br. Bombay. Bank: Bank of Maharashtra. Cap. Rs.10,45,000. Prod. Rs.15,00,000. Workers 50. Products: Automatic screw machine parts, gears, pinions for instruments and sector mechanisms and can undertake design and development work.
- 728. HIRVEY ENGINEERING WORKS.** 654 Nana Peth, Pune 2. Proprietary, 1973. Bank. Bank of Maharashtra. Cap. Rs.40,000. Prod. Rs.25,000. Workers 2. Products: Roeters, cover plates, bearings, railway brakes special rings, cylinders, bearing huging.

- 729. HODEK ENGINEERING WORKS PVT. LTD.** 227 Rasta Peth, Pune 11. Tel. 20750 Estd. 1976. Bank: Shree Suvarna Sahakari Bank Ltd Cap. Rs 30,000. Prod. Rs.9,00,000 Workers 8 Products: Viscous vibration dampers.
- 730. HOLE G. R.** 590 Ghorpadi Peth, Pune 2. Proprietary, 1969 Bank: Cosmos Co-op. Bank Ltd Cap Rs. 5,000 Prod Rs 3,500 Products Wood turning
- 731. HOLLYWOOD COLOR STUDIO AND LABS.** Laxmi Sadan, Jangali Mahataj Rd., Pune 4 Tel 56565, 57575. Proprietary, 1976 Br Hollywood Studio, Fergusson College Rd., Pune 4 Bank: Bank of Maharashtra Cap. Rs 2,00,000. Prod Rs 80,000 Workers 7 Products: Colour prints and processing of colour films
- 732. HOLLYWOOD DRESSES.** 242 Ganj Peth, Pune 2 Proprietary, 1959. Cap. Rs.17,000. Prod Rs.60,000. Workers 3. Products: Ready garments, shirts for children and gents.
- 733. HONEY PRINTERS AND PUBLISHERS.** 32/1/5 Erandawana, off Karve Road, Pune 4 Tel. 56821 Partnership, 1974. Bank: Canara Bank Cap Rs 1,25,000 Prod Rs.85,000. Workers 6 Products Printing and publishing of all types of books, periodicals, commercial work, etc.
- 734. HOONJAN ENGINEERING CO.** 230 Bhawani Peth, opp Ramoshi Gate, Pune 2 Tel. 24899 Proprietary, 1961 Bank: Bank of India. Cap Rs 75,000 Prod. Rs 1,32,500. Workers 8 Products: Steel furniture and office equipment such as cabinets, chairs, tables, trolleys, racks, filing cabinets, stationery racks, workshop equipment such as work benches, material handling trolleys, control panel cabinets, baking ovens, etc ; data-processing and computer equipment such as trolleys, trays; and magnetic tape storing equipments etc , general sheet metal fabrication work.
- 735. HORSTMANN INDIA PVT. LTD.** 37/40 Nagar Rd, Pune 14 Tel. 23886 (3 lines). Cable: GAUGES Telex: 0145-361. Estd. 1961 Sister concern: Baker Horstmann Mercer India Ltd. Pune. Banks: Union Bank of India; Bank of India. Foreign collaboration: Horstmann Gauges and Metrology Ltd, Bath, England Cap Rs 45.33 lakhs Prod. Rs. 49.35 lakhs. Workers 125. Exports. Rs. 94,000 Country U K. Products: Plain and threaded plug gauges; plain and threaded ring gauges, caliper and special gauges
- 736. HUKUM PRESS.** 80 Mahatma Gandhi Rd, Pune 1 Tel 26028. Proprietary, 1959 Bank: United Commercial Bank. Cap. Rs. 75,000. Prod. Rs 1,00,000. Workers 6. Products: Printing in Sindhi, English, Marathi; book work and job work.
- 737. HUSENSAAB JAFFERSAAB.** 276 Guruwar Peth, Pune Proprietary, 1962. Cap Rs.4,000. Prod. Rs.2,000. Products: Trunks, suitcases
- 738. HYDRO CLAMP ENGINEERS.** 'Prasanna', 55/22 Erandawana, Ashok Path, Pune 4. Tel. 57620. Bank: Bank of Maharashtra. Products: Hydraulic chucks, arbors.
- 739. HYDROLICK TOOLS PRECISION PRESS PART MFG. CO.** 450, Shukrawar Peth, Shivaji Rd., Pune 2. Tel. 446416. Proprietary, 1976. Bank: State Bank of India. Products: Precision press parts, aquarius

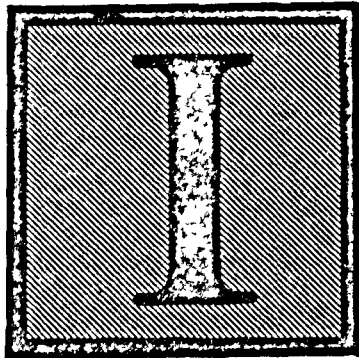

740. **I.E.C. PUMPS AND TOOLS PVT. LTD.** 603 Sadashiv Peth, Pune 30. Tel. 445141. Cable: NUTRUNNER, Factory. 117-118-123 H Block MIDC, Pimpri, Pune 18. Tel. 82348 Estd. 1972. Sister concern: India Engineering Corporation. Bank: Bank of Maharashtra. Foreign Collaboration: Uryu Seisaku Ltd., Osaka, Japan. Cap. Rs.4,03,000. Prod. Rs.15,05,137. Workers 19. Export. Rs 40,000. Countries: Japan, Malaysia. Products: Reciprocating pumps, marine pumps, chemical pumps, impact wrenches, grinders, screw drivers, drills and sanders.

741. **I. F. TALEKAR.** 259 Somwar Peth, Pune 11 Tel 22258. Factory: 149 Somwar Peth, Pune 11. Partnership, 1959. Bank: Bank of Maharashtra. Prod. Rs.80,000. Workers 3 Products: Gaskets for motor, tractor, air compressors, and other packings for industrial valve, etc

742. **I.K.M. INDUSTRIES.** 1679 (New) Shukrawar Peth, Nehru Chowk, Pune 2. Proprietary, 1947. Bank: Bank of India. Cap. Rs.15,000. Products: Fabrication of air conditioning and exhaust ducting works and manufacture of articles made from all kinds of sheet metal, etc.

743. **IDEAL ENGINEERING WORKS.** S-45 Bhosari Industrial Area, Pune 26. Tel. 83295. Partnership, 1974 Bank: Bank of Maharashtra. Cap. Rs.3,65,000. Prod. Rs 10,61,000. Workers 20. Products: Fabrications.

744. **IDEAL MEASURE TAPE PRODUCTS.** 117 Guruwar Peth, Pune 2. Tel. 44872. Factory: 132/29 Parvati, Pune 9. Partnership, 1975. Bank: Bank of Maharashtra Cap. Rs 50,000. Workers 15. Product: Measure tapes.

745. **IDEAL PRINTERS.** 1170/13 A 'Susheel', Shivajinagar, Pune 5. Tel. 52117. Partnership, 1967. Banks: Bank of Maharashtra; Trimurti Sahakari Bank. Cap. Rs. 7,250. Prod. Rs.50,000. Workers 3. Products: Commercial stationery printing.

746. **IDEAL WOOD WORKING MILL.** Plot No. 91 D-3, Bombay-Pune Road, Chinchwad, Pune 19. Tel. 82361. Proprietary, 1970. Bank Poona Co. Rupee Bank Ltd. Cap. Rs 18,000 Prod Rs 15,000. Workers 8 Products: Packing cases and furniture.

747. **IMPERIAL ENGINEERING WORKS.** S.No. 206/4 Station Road, Pimpri, Pune 18 Tel 82886 Proprietary: 1972 Bank: Central Bank of India Cap Rs 50,000. Prod Rs 2,00,000 Workers 15 Products: Plastic and bakelite parts

748. **IMPRINT.** 1047 Shukrawar Peth, Tilak Road, Pune 2 Tel. 443364, 446457, Proprietary 1973. Banks: Central Bank of India; Union Bank of India. Cap. Rs. 45,000. Prod Rs 2,25,000 Workers 7 Products: All kinds of printing

749. **INDIAN CABLE COMPANY LIMITED.** Cable House, Hadapsar Industrial Estate, Pune 13 Tel. 7111 Cable INCAB. Telex. 0145/243 Head Office 9 Hare Street, Calcutta 1 Brs New Delhi, Kanpur, Ahmedabad, Bombay, Secunderabad, Bangalore. Madras, Banks: Grindlays Bank Ltd; Punjab National Bank; American Express International Banking Corporation Cap Rs 1693 81 lakhs. Prod Rs 3938 lakhs Workers 335 Export: Rs 390.34 lakhs (F.O.B.) Products: Electrical cables and wires.

750. **INDIAN CARD CLOTHING COMPANY LTD.** Penicillin Factory P.O., Pimpri, Pune 18. Tel 82738, 83374. Cable: CARDWIRE PIMPRI Telex: 0145-335 INCARD PN. Estd 1955 Brs Ahmedabad, Bombay, Coimbatore, New Delhi. Subsidiary company of. The English Card Clothing Co Ltd, U K Banks: The Chartered Bank; United Commercial Bank; State Bank of India; The Saraswat Co-operative Bank. Cap Rs.3,73,02,988. Prod Rs 4,82,00,000. Workers 468. Export Rs 1,51,462. Countries: Thailand, Sri Lanka, Zambia. Products: Flexible card clothing and tops; flexible and metallic stripping fillets, burnishing, flat cleaning fillets; hand stripping cards, Philipson sheets and strips; woolen, worsted and cotton waste card clothing; fancy sheets, hand cleaning cards, raising fillets and brush sheets; metallic card clothing and tops, steel base wire, lickerin wire, CS4 wire.

751. **INDIAN ELECTRIC.** 1254 Sadashiv Peth, Pune 30. Tel. 441185. Proprietary, 1966. Bank: State Bank of India. Cap. Rs.2,09,575. Prod. Rs. 8,89,786. Workers 9. Products: Transformers for electronic and electrical industries, impedance coils, automatic line voltage corrector, electro-medical equipment, control panels, electro magnets for machine tools, A.C. Voltage stabilisers—single phase and 3 phase, D.C. power supply units.

- 752. INDIA ENGINEERING CORPORATION.** 603 Sadashiv Peth, Pune 30. Tel. 445141. Cable: INCORP. Factory: 117-118-123 H Block, MIDC, Pimpri, Pune 18. Tel. 82348. Proprietary, 1963. Sister concern: I.E.C. Pumps and Tools P. Ltd. Bank: Bank of Maharashtra. Cap. Rs. 1,50,000. Prod. Rs. 8,00,000. Workers 17. Products: Pumps for marine crafts and spares.
- 753. INDIAN INTERNATIONAL LABORATORIES.** 877 Boottee St., Pune 1. Tel. 25163. Proprietary 1947. Bank: Punjab National Bank. Cap. Rs. 10,000. Prod. Rs. 15,000. Products: Fruit products.
- 754. INDIAN HUME PIPE CO. LTD.** 409 Mangalwar Peth, Barne Road, Pune 11. Tel. 22646. Cable: HUME PIPE. Estd. 1935. Brs. All over India. Sister concerns: Hindustan Construction, Cooper Engineering Ltd., Walchandnagar Industries, Ravalgaoon Sugar Farm Bank, State Bank of India. Prod. Rs. 7,00,000. Workers 30. Products: R.C.C. Hume pipe and allied products.
- 755. INDIAN MICRO MOTORS.** Plot E-6 Bhosari Industrial Area, Bhosari, Pune 26. Tel. 83133. Partnership, 1972. Banks: State Bank of India, Bank of Maharashtra. Cap. Rs. 550 lakhs. Prod. Rs. 24 lakhs. Workers 8. Products: Cassette carter motors, electronic timer high frequency and high voltage testers; fibreglass cables, fibreglass sleeveings and tapes—varnished and unvarnished fibreglass cards.
- 756. INDIA POWER LINERS.** S/15 Parvati Industrial Estate, Satara Road, Pune 9. Tel. 442517, 442736. Partnership, 1966. Br. Gultekadi I.E., Pune 9. Bank: Bank of Maharashtra. Cap. Rs. 5,50,000. Prod. Rs. 4,50,000. Workers 35. Products: Automobile repairing, foundry, sleeves and liners for automobiles.
- 757. INDIRA PRINTING PRESS.** 1005 Sadashiv Peth, Pune 30. Tel. 443329. Proprietary, 1958. Banks: Bank of Maharashtra; Poona Peoples Co-operative Bank Ltd. Cap. Rs. 1,50,000. Prod. Rs. 1,60,000. Workers 16. Products: Printing.
- 758. INDIRA PRODUCTS.** 415 Narayan Peth, Pune 30. Proprietary 1958. Cap. Rs. 10,000. Prod. Rs. 7,000. Product: Ayurvedic medicines.
- 759. INDLAB INDUSTRIES.** Block H Plot No. A-65, 66, 67, MIDC, Pimpri, Pune 18. Tel. 82028. Proprietary, 1973. Sister concern: Atlantic General Stores, Pune 1. Bank: Bank of India. Cap. Rs. 3,00,000. Prod. Rs. 8,00,000. Workers 25. Products: Mild steel structural plant and sheet metal fabrication.
- 760. INDOSWE ENGINEERS LIMITED.** 5 Bund Garden Road, Pune 1. Tel. 25334/28807. Cable: INDOSWE. Telex: 0145.342. Factory: Plot No. 4, MIDC, Bhosari, Pune 26. Tel. 82852, 82520. Estd. 1965. Brs. Bombay, Bangalore, Calcutta, Delhi, Madras. Sister concerns: Malcons Engineers Pvt. Ltd., B.D. Malani & Co., Hycarb Process Design Pvt. Ltd., Malani Consultants Pvt. Ltd., Architectural Aluminium Products Company. Banks: Bank of Maharashtra; Dena Bank. Cap. Rs. 25 lakhs. Prod. Rs. 2.15 crores. Workers 205. Products: Copper and copper-alloy tubes and pipes including refrigeration quality tubes; silicon brass tubes, sugar brass tubes, steam and water heater brass tubes; free cutting, forging and riveting high tensile brass rods, sections, profiles and hollow bars; aluminium bronze rods/tubes; nickel silver rods in standard shapes and also profiles; beryllium copper, cadmium copper and tellurium copper rods and profiles, manganese bronze rods in standard shapes and profiles, copper nickel silicon alloy rods; phosphor bronze solid and hollow castings; E.C. copper, copper alloy and brass profiles and sections.
- 761. INDOKEM LABORATORY.** 27/3C/1/1 off Nagar Road, Kharadi, Pune 14. Tel. 25558. Partnership, 1974. Bank: Bank of Maharashtra. Cap. Rs. 7,00,000. Prod. Rs. 3,50,000. Workers 8. Products: Aluminium and magnesium hydronide gel, aluminium chloride.
- 762. INDRAVADAN AGENCIES.** 685 Shukrawar Peth opp. Shrinath Talkies, Pune 2. Tel. 440969. Factory: 282 Mangalwar Peth, Pune 11. Tel. 27171. Partnership, 1967. Bank: Bank of Maharashtra. Cap. Rs. 76,066. Prod. Rs. 1,11,446. Workers 9. Products: Stamp pad ink, fountain-pen ink, fountain-pens ball pens, fountain-pen nibs, file tags, file laces, red paper waffer.
- 763. INDRU INDUR COMPANY.** 43 Hadapsar Industrial Estate, Pune 13. Tel. 7274. Partnership, 1968. Bank: United Commercial Bank. Cap. Rs. 1,00,000. Workers 6. Products: Heat treatment of metals.
- 764. INDU COMMERCIAL CORPORATION.** 1483 Shukrawar Peth, Gadikhana, Pune 2. Tel. 444935. Factory: 691/A/2 Plot No. 4, Bibwewadi, Pune 9. Tel. 448703. Proprietary, 1974. Bank: Bank of Maharashtra. Cap. Rs. 2,00,000. Prod. Rs. 3,00,000. Workers 9. Products: Corrugated and gray board boxes and fitments, interior fitments from second-hand materials.
- 765. INDU TEXTILES.** 10 Kaka Halwai Estate, Satara Road, Pune 9. Tel. 441971. Partnership, 1973. Bank: Bank of Maharashtra. Products: Cotton fabrics.

- 766. INDUSTRIAL ASSOCIATES.** Shed No 31, Parvati Industrial Estate, Pune 9. Tel. 440826. Proprietary, 1964. Sister concern: M/s. Kenjale Bandhoo. Bank: Bank of Maharashtra. Cap. Rs.4,25,000. Prod. Rs 5,50,000. Workers 36. Products: Surface, centreless tools and cutter grinding and turned, pressed, ground and threaded parts, sub-assemblies.
- 767. INDUSTRIAL AND AIRPOWER ACCESSORIES.** 102 A Hadapsar Industrial Estate, Pune 13. Tel. 7306. Partnership, 1970. Sister concern: Vasant Engineering Works. Bank: The Shamrao Vithal Co-operative Bank Ltd. Cap. Rs.91,200. Prod. Rs 3,14,600. Workers 8. Products: Oil filter assembly, air governor assembly, non-return valve for air compressors.
- 768. INDUSTRIAL COLORS AND CHEMICALS.** Ganesh Baug, Mundhwa Road, Poona 36. Tel. 25764. Partnership, 1970. Bank: Bank of Maharashtra. Cap. Rs. 56,000. Prod. Rs. 2,50,000. Workers 8. Products: Extender pigments—(i) Alumina Hydrate, (ii) Gloss white.
- 769. INDUSTRIAL CONTROLS.** 60 Ashok Nagar, Poona 7. Tel. 53931. Partnership, 1969. Sister concern: Instrument and Furnace Engineers. Bank: Bank of Baroda. Cap. Rs.35,000. Prod. Rs.75,000. Products: Temperature indicator and controller, level indicator and controller, custom-built tailor-made process control equipment.
- 770. INDUSTRIAL ELECTRONICS.** 39/27 Karve Road, Poona 4. Tel. 53636. Partnership, 1960. Bank: Bank of Maharashtra, Cap. Rs.1.5 lakhs. Prod. Rs.2.2 lakhs. Workers 6. Products: Transformer, relays, micro-welders, electro-static equipments, pressure switches, electric detonator exploders, electro-magnetic flowmeters, import substitute components and equipments.
- 771. INDUSTRIAL ELECTRONICS CORPORATION.** 324 Narayan Peth, Poona 30. Tel. 446452. Factory: Plot No. T-135, MIDC, Bhosari, Poona 26. Tel. 82429. Partnership, 1965. Bank: Bank of Maharashtra. Cap. Rs.3,50,000. Prod. Rs.1,50,000. Workers 15. Exprot: Rs.5,000. Country: Nigeria. Products: Neon lamps, glow lamps, fluorescent starters, line testers.
- 772. INDUSTRIAL ELECTROPLATERS.** 41/2 D II Block, MIDC, Chinchwad, Poona 19. Partnership, 1977. Bank: Bank of Maharashtra. Cap. Rs.2,25,000. Workers 9. Products: Electroplating, buffing and polishing.
- 773. INDUSTRIAL ENGINEERS AND MANUFACTURERS.** 459 Centre St., Pune 1. Tel. 27744. Proprietary, 1974. Bank: United Commercial Bank. Cap. Rs. 65,000. Prod. Rs. 1,20,000. Workers 8. Products: Spare parts of automobiles, oil engines, cranes, ball mills.
- 774. INDUSTRIAL ENGINEERING.** Gika radiator, Plot No. 5 Gultekadi, Poona 9. Tel. 443595. Factory: Shed 35 Parvati, Poona 9. Partnership, 1965. Bank: Bank of Maharashtra. Workers 15. Products: Radiator, electric transformer.
- 775. INDUSTRIAL ELECTRONIC AND ALLIED PRODUCTS.** 1423 Shukrawar Peth, near Nava Vishnu Chowk, Pune 2. Tel. 441041, 20714. Cable: SEFOTAKE. Partnership, 1965. Banks: Bank of Maharashtra; United Western Bank. Cap. Rs. 1,21,000. Prod. Rs.19,00,000. Workers 35. Export: Rs.1,50,000. Country: U.S.S.R. Products: B P. instrument, 'Thereshel'; 'Fastbond' multicol adhesive, antenna booster, voltage stabilizer, desoldering pump for electronic industry, coupled hoses
- 776. INDUSTRIAL LINKERS.** 847 Raviwar Peth Pune 2. Tel 448094/448010/449660. Cable: INDUSLINK. Factory: B11/12 MIDC Estate, Chikalthana, Aurangabad. Tel. 8429. Partnership, 1974. Sister concerns: Aelora Construction Co., Aelora Associates, Renuka Builders, Aelora Suppliers, Tools Syndicate. Bank: Bank of Maharashtra. Cap. Rs 2,00,000. Products: Welding electrode holders, gas welding (M S.C.C.) rods
- 777. INDUSTRIAL OXYGEN CO. P. LTD.** 38 Vadgaon Sheri, off Nagar Road, Pune 14. Tel. 25546. Telex: 0145-275. Factories: Pune, Bombay, Ahmedabad. Estd. 1963. Bns. Bombay, Thana, Belapur Road, Ahmedabad. Bank: Bank of Maharashtra. Cap. Rs 186 lakhs. Prod. Rs 2 crores. Workers 86. Products: oxygen, acetylene, nitrogen and hydrogen gases and also liquid Oxygen and nitrogen.
- 778. INDUSTRIAL PACKING AND WOODWORKS.** 102/A Hadapsar Industrial Estate, Pune 13. Tel. 7388. Partnership, 1975. Bank: Bank of India. Prod. Rs.40,000. Workers 10-14. Product: Packing cases.
- 779. INDUSTRIAL PAPER CO.** 715 Narayan Peth, Pune 30. Tel. 444093/444849. Cable: NEWSPRINT. Factory: 77/H MIDC, Bhosari, Poona 26. Tel. 82972. Partnership, 1968. Sister concerns: Kohnoor Agencies, Kishor and Co. Bank: Bank of Maharashtra. Workers 10. Product: Waterproof paper.
- 780. INDUSTRIAL PNEUMATIC EQUIPMENT AND CONTROLS.** 452 Ghorpade Peth, Pune 2. Tel. 440266. Partnership, 1973. Bank: State Bank of India. Cap. Rs.

2,50,000. Prod. Rs 3,20,000 Workers 9 Products: Pneumatic friction clutches, torque limiters, torque limiter-cum-coupling, electrodes drying ovens, aluminium embedded heaters

781. INDUSTRIAL SUPPLIERS CORPORATION. 131/7B Hadapsar Industrial Estate, Pune 13 Tel. 7237. Partnership, 1968 Bank Central Bank of India. Cap Rs 8,05,643 Prod. Rs.6,60,000 Workers 22 Products: Engineering components

782. INEX ENGINES VALVES P. LTD. 17B Hadapsar Industrial Estate, Pune 13 Tel 7183, 7283, 7483 Cable: INEXVALVES Telex: 0145-312 Estd 1968 Banks: Bank of Maharashtra; Central Bank of India Foreign collaboration: Markishes, West Germany Cap Rs 81,18,561 Prod Rs 25,00,000 Workers 150. Export Rs.37,62,657 Country: West Germany. Products: Engine valves for combustion

783. INSTITUTE OF VETERINARY BIOLOGICAL PRODUCTS. Maharashtra State, Pune 7. Tel. 57962. Cable BIOLAB Government Institute, 1959 Cap Rs 1 crore. Prod Rs 54,59,159 Workers 197 Products Vaccines for animals.

784. INSTITUTE FOR MICRONUTRIENT TECHNOLOGY. 1-A Kondhwa Khurd, GPO No. 114, Pune 1. Tel 27348/23955 Cable MICNELF Partnership, 1968 Banks Bank of Maharashtra; Central Bank of India Cap. Rs 41,000 Prod. Rs 1,00,000 Workers 9. Products Micronutrient spray and soil application fertilizers in different formulations used for different crops

785. INTEGRATED ELECTRONICS INDIA. 1707 B Sadashiv Peth, Pune 30 Tel 448439 Proprietary, 1970. Bank. United Western Bank. Cap. Rs 8,000 Prod Rs. 10,000. Products: Kishor kit electronics, any other electronic or allied tailor-made product

786. INTERNATIONAL COMPUTERS INDIAN MANUFACTURE LTD. Magnet House, Narottam Morarjee Marg, Bombay 38. Tel. 263264. Factory: Nagar Road, Pune 14. Tel 25317-8-9. Cable: COMPMAN Telex: 0145-204 Estd 1963 Br. Bangalore. Sister concern. International Computers (I) P. Ltd Pune. Banks: Bank of India; State Bank of India; Grindlays Bank Ltd.; United Bank of India. Foreign collaboration: International Computers Ltd, U.K Cap. Rs. 2,64,89,014 Prod Rs 1,78,85,380 Workers 390 Export: Rs.7,31,884 Countries U.K., Malaysia, Burma, Sri Lanka, Bangladesh. Products: Data-processing equipments, tabulating-machine cards, computer system complete with all peripherals

787. INTERMEDIATES INDIA. 101 Mittal Chamber, 228 Nariman Point, Bombay 21. Tel. 252043 Factory: 107/2A MIDC, Bhosari, Pune 26 Tel. 82101. Partnership, 1975. Bank: United Commercial Bank Cap. Rs 40,000. Prod. Rs.8,00,000. Workers 13. Products: N-Butyl Diethyl Malonate, Phenyl Butazone (B.P.), Phenytoin Sodium (B.P.), Diphenyl Hydantoin

788. INTERNATIONAL ENGINEERING WORKS. 704 Budhwar Peth, Pune 2. Tel. 449227. Proprietary, 1955 Bank: Bank of Maharashtra Cap. Rs 1,00,000. Prod. Rs 1,25,000 Workers 2. Products Job work, welding, threading

789. IRON TIN WORKS. 603 Ghorpadi Peth, Pune 2 Proprietary, 1964 Bank Cosmos Co-op. Bank. Cap. Rs. 15,000. Prod. Rs. 20,000. Workers 2 Products: All types of animal cages, fabrication, electric welding

790. ISMAIL AMIR BAGWAN NEW BHARAT HEAD REPAIRING WORKS. Pune-Satara Road, Pune 9. Tel. 449943 Proprietary, 1972. Bank Punjab National Bank Cap Rs 15,000 Products: Automobile job work, turning job

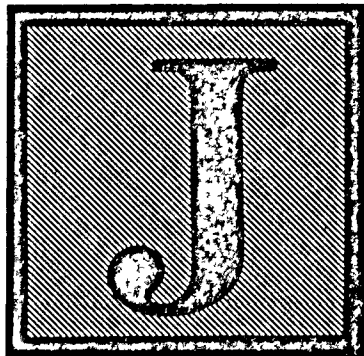

791. **J. ERRANNA AND SONS.** 243-44 Solapur Bazar, Pune 1. Tel. 22086. Partnership, 1898. Br. Bombay. Banks Bank of India; Bank of Maharashtra. Cap. Rs.1,13,555. Prod. Rs. 2,60,000. Workers 20. Products: Brass aldrops, hinges, latches, handles, letters, tower bolts.

792. **J. J. ENGINE RE-POWERING WORKS.** 33/34 Shankarshet Rd., opp. S. T. Depot, Pune 2. Tel. 440433. Proprietary, 1966. Bank: Bank of Maharashtra. Cap. Rs. 6,20,000. Prod. Rs.2,50,000. Workers 8. Products: Sleeves and liners of M.S. and C.I. for all types of engine valves, valve guides, piston rings, connecting rod, crank shafts, gun metal and phosphorus bronze bush, repairs of all types of petrol and diesel engines.

793. **J. K. ENGINEERING (DIAMOND WORKS)** Jivraj Niwas, 408 L.B.S. Marg, Kurla, Bombay 70. Tel. 551543. Factory: 'H' Block, Plot No. B-13, M.I.D.C Industrial Estate, Pimpri, Pune 18 Tel. 82623. Partnership, 1948. Br. Bombay. Banks: The Kurla Nagrik Sahakari Bank Ltd.; Bank of Maharashtra; Algemene Bank, Nederland N. V., Bombay. Cap. Rs 6 lakhs. Prod. Rs.14 lakhs. Workers 10. Exports: Rs.6 lakhs. Countries: U.S.A., Middle East, W. Germany, Philippines, Malaysia, Belgium, Japan, Hong Kong. Products: All types of diamond tools, diamond hand laps, diamond wheels, honing sticks, diamond indenter, diamond powder and pastes, cut and polished diamonds.

794. **J. K. INDUSTRIES.** 739 Rajguru Nagar, Taluka Khed, Dist. Pune. Factory: 1133 Rajguru Nagar, Taluka Khed, Dist. Pune. Tel. 34. Proprietary, 1976. Bank: Rajguru Nagar Urban Co-op. Bank Ltd. Cap. Rs. 33,500. Prod. Rs. 50,500. Workers 6. Products: Jobbing, fabrication-furniture, cots, table, chair, etc.; trusses, beams, grills, sheds and gipsy huts.

795. **J. M. PAREKH.** 95 Amers Rd., Malad, Bombay 64. Tel. C/o. 310606, Cable: MICROAID, Factory: 25 Hadapsar Industrial Estate, Solapur Rd., Pune 13. Tel. 7416 Proprietary, 1960. Bank: Bank of Maharashtra. Prod. Rs 2,50,000. Workers 12. Exports: Rs 50,000. Countries: E. Africa, Singapore, Germany, Malaysia. Products: 'Micro-aid' brand scientific instruments and laboratoryware

796. **J. M. PRODUCTS.** 5/3 Jay-Deep, Erandawana, Karve Rd., Pune 4. Factory No 35, Karve Rd, Pune 4. Proprietary, 1973-74. Cap. Rs 25,000. Workers 3. Surgical and post-mortem handgloves, finger steeps, industrial handgloves, volve tubes, and other letex rubber products.

✓797. **J. N. MARSHALL PVT. LTD.** Bombay-Pune Rd., Pimpri, Pune 18. Tel. 82691. Telex: PN-265. Estd. 1958, Brs. Bombay, Baroda, Calcutta, Delhi, Hyderabad, Bangalore. Sister concerns: Spirax Marshall Ltd., Cambridge Instruments (I) Ltd. Banks: Bank of India; Union Bank of India. Cap. Rs.20 lakhs. Prod. Rs 3.5 crores. Workers 400. Products: Process steam equipments, process control and medical instruments, self-locking fasteners, gauges, valves, pH meters; low air-pressure burners, textile moisture meters, controllers, safety valve metal detectors.

798. **J. R. INDUSTRIES.** Block 3, Plot No. 73, M.I.D.C., Chinchwad, Pune 19. Tel. 83656. Partnership, 1968. Sister concern: Dalvi Engineering Works. Bank: Bank of Maharashtra. Cap. 2,00,000. Prod. Rs 1,80,000. Workers 9. Products Automobile parts and sheet metal fabrication work.

799. **J.R.D. INDUSTRIES.** Block No. D3, Plot No. 73, M.I.D.C., Chinchwad, Pune 19. Partnership, 1968. Bank: Bank of Maharashtra. Cap. Rs 2,00,000. Prod. Rs.1,25,000 Workers 15. Products: Automobile parts, fabrication, sheet metal work, assembly.

800. **J. WINAYAK BOOK BINDERS.** 395 Sadashiv Peth, Pune 30. Tel. 442057. Co-operative Society, 1977. Bank: Janata Sahakari Bank. Cap. Rs.11,000. Workers 14 Product: Book-binding.

801. **JABIECH ENGINEERING WORKS.** 93 Mahatma Gandhi Rd., Pune 1. Tel. 23300. Cable: JABIECH. Factory: 32/4 Nagar Rd., Pune 14. Tel. 28888. Partnership, 1967. Sister concerns: Tufel Pvt. Ltd., 2 Phayre Rd., Pune 1; Hakimjee & Sons, 93 M.G. Rd., Pune 1. Associated concerns: EE Karachiwala and Co. Bombay; Lifting Tackles and Appliance, Bombay. Banks: Bank of Maharashtra; United Commercial Bank; Punjab and Sind Bank Ltd. Prod. Rs.18 lakhs. Workers 25. Products: Lifting

tools and tackles, material-handling equipment, hand-operated winches, board and deck fittings, sheet metal and medium structural fabrication, specialised defence equipments.

802. JADHAV BROTHERS. 417 Shaniwar Peth, Pune 30. Tel 449938. Proprietary. Sister concern: Symbol Arts. Cap. Rs 20,000. Workers 6. Products: Printing, screen printing, advertising layouts, etc

803. JADHAV ELECTRIC WORKS. 1018 Ghorpade Peth, Govt. Industrial Estate, Pune 2. Tel. 443060. Proprietary, 1963 Bank: Central Bank of India Cap. Rs 30,000 Workers 3 Products Electrical and engineering job work

804. JADHAV PRINTING PRESS. 678 Shukrawar Peth, Pune 2 Proprietary, 1964. Bank: Rupee Co-operative Bank Ltd. Cap. Rs 28,000. Prod. Rs.5,000. Workers 2. Products: Job work, ink printing

805. JAGJEEVAN RUBBER INDUSTRIES. C-1-8 Electronic Estate, M.I.D.C., Bhosari, Pune 26. Tel. 83524. Cable: JAGJEEVAN Proprietary, 1976. Bank: Indian Bank. Cap. Rs.1,00,000 Prod. Rs 12,00,000 Workers 40. Products: Moulded industrial rubber products, extruded rubber products, link-v-belts, conveyor belts, hose pipes, rubber sheets, rubber rollers, import substitution items, rubber compounds, moulds and dyes for rubber products, solid rubber tyres, auto parts

806. JAI PRODUCTS. 338 Mahatma Fule Peth, Pune 2. Tel. 446645. Proprietary Bank Indian Bank. Cap. Rs 35,000. Prod. Rs.1,75,000 Workers 9. Products: Chikki, Mysore paak, bobby

807. JAIBHUMI PULVARIZING AND CRUSHING MILL. 156/3 Mangalwar Peth, Pune 11. Proprietary, 1959. Bank: Vidya Sahakari Co-op. Bank Ltd Cap Rs 12,000. Prod. Rs 25,000 Workers 5. Product: Sagol.

808. JAIKISAN TOBACCO COMPANY. 250 Nana Peth, Pune 2. Tel 24212. Factory: 717/1 Bhawani Peth, Pune 2 Tel. 24474. Partnership, 1971 Sister concerns: Delhi Stores, Delhi Sales Corporation Bank: Bank of Maharashtra. Cap. Rs 1,00,000. Prod. Rs 22,00,000. Workers 50. Products: Jaikisan jarda, Milapchand jarda, Janata jarda

809. JAI SANTOSHI MA DEEPAK CANDLE WORKS. 833/54 Wadarwadi, Pune 16. Proprietary, 1976. Bank: Canara Bank. Cap. Rs 3,000. Prod. Rs.15,000. Product: Candles.

810. JALAN CORPORATION. (New) 347 Raviwar Peth, Pune 2. Tel. 449563. Factory: 1520 Shukrawar Peth, Pune 2 Tel. 445399. Partnership, 1967. Bank: Dena Bank Cap. Rs.50,000. Products: Note books, account books, registers.

811. JAL ENTERPRISES. 916 Sadashiv Peth, Pune 30. Tel. 443586 Factory: 46/A/1 Sonawane Estate, Pune-Satara Rd., Pune 9. Partnership, 1976. Bank: Bank of Maharashtra. Cap. Rs 40,000. Prod Rs.80,000 Product: Cast iron powder.

812. JAMTANI STONE INDUSTRIES. Plot No. 61, Akurdi, Chinchwad, Pune 19. Tel. 83563. Proprietary. 1968. Bank: Vijaya Bank. Workers 17. Product: Stone metal

813. JANASEVA MUDRANALAYA. 192 Shukrawar Peth, Pune 2. Tel. 442445. Partnership, 1949. Sister concern. Seva Mudranalaya, Pune 9. Bank: Bank of India. Cap. Rs.2 lakhs. Prod. Rs.3 lakhs. Workers 9. Products: School and college books, periodicals, etc.

814. JANATA LEATHER WORKS. 410 Nana (New) Peth, Pune 2. Proprietary, 1966. Cap. Rs.5,000. Prod. Rs.7,000. Products: Suit cases, brief-cases, hand bags, etc.

815. JANATA PRINTING PRESS. 1089 Shukrawar Peth, Pune 2 Proprietary, 1967. Bank: Bank of Maharashtra Cap. Rs 25,000. Prod. Rs.6,000. Workers 2. Products: Job work, ink printing

816. JANATA STEEL SPRING MANUFACTURERS. 404 New Mangalwar Peth, Pune 11. Proprietary, 1976. Bank. Bank of Maharashtra. Cap. Rs 15,000. Prod. Rs.75,000. Workers 6. Products. All types of springs and strips made in steel, copper and brass and of other metal as per requirements

817. JANATA TRADERS. 223 Ganj Peth, Pune 2 Factory 662 New Guruwar Peth, Pune 2 Proprietary. 1971. Bank. Punjab National Bank. Cap Rs 10,000. Prod. Rs 35,000. Workers 3. Products: 4 wheeler hand carts and all types of wooden furniture

818. JANATA WELDING WORKS. 461 Rasta Peth Pune 11. Proprietary, 1965 Cap Rs 10,000 Prod Rs 15,000 Product Welding.

819. JANAVANI MUDRANALAYA. 45 Budhwar Peth, Pune 2. Proprietary, 1965. Bank: Bank of Maharashtra Workers 16. Products: Book printing and any job work

- 820. JAYESH ENTERPRISES.** 233 Hadapsar, Pune 28. Tel. 7546. Proprietary, 1971. Bank: Mahesh Sahakari Bank Ltd. Cap. Rs.80,000. Prod. Rs.80,000. Workers 8. Product: Job work.
- 821. JAVALEKAR ENTERPRISES.** 113/14 Bhawani Peth, Pune 2. Tel. 22404. Partnership, 1969. Sister concerns: Perfect Engineering, Pune 2; Vipsa Machine Tool, Pune 2. Banks: Central Bank of India; Bank of Maharashtra. Cap. Rs.1,40,000. Prod. Rs.45,000. Workers 9. Products: Oil engines spare parts, coupling and cover, axel and fan, oil body.
- 822. JAVALEKAR METAL WORKS.** 24/25 Somwar Peth, Pune 11. Tel. 28828. Proprietary, 1971. Bank: Central Bank of India. Cap. Rs.65,000. Prod. Rs.1 lakh. Workers 7. Products: Spare parts, job work, machined components, bolts, shafts, adaptor plates, dyes, special nuts, etc.
- 823. JAY BHAWANI METAL WORKS.** 60 Kothrud, Pune 29. Tel. 55834. Partnership, 1968. Bank: Bank of Maharashtra. Cap. Rs.45,000. Prod. Rs.8,50,000. Workers 15. Products: Non-ferrous castings and patterns.
- 824. JAY BHAWANI PRINTING PRESS.** 351 Nana Peth, Pune 2. Proprietary, 1976. Bank: Bank of India. Cap. Rs.8,000. Prod. Rs.5,000. Workers 2. Product: Printing jobs.
- 825. JAYDEEP INDUSTRIES.** F-II Block, Unit A-23, M.I.D.C., Pimpri, Pune 18. Proprietary, 1976. Bank: United Commercial Bank. Cap. Rs.50,000. Prod. Rs.60,000. Workers 6. Product: Job work.
- 826. JAYDEEP PLASTIC PRODUCTS.** 32 Shivaji Housing Society, Pune 16. Factory: Opp. N.D.A. Ahire Gate, Uttamnagar, Pune 4. Proprietary, 1969. Bank: Bank of India. Cap. Rs.15,000. Prod. Rs.65,000. Workers 6. Products: Polythene bags, liners, sheeting rolls in all sizes and thickness.
- 827. JAYA HIND INDUSTRIES LTD.** Bombay-Pune Rd., Akurdi, Pune 35. Tel. 82681. 83473. Cable: NEK-LEPAR. Estd. 1947. Sister concerns: Kinetic Engineering Ltd., Jaya Hind Sciaky Ltd., Bajaj Tempo Ltd. Bank: Central Bank of India. Cap. Rs.111.58 lakhs. Prod. Rs.278.86 lakhs. Workers 462. Products: Dye casting, flywheel magnetos, IC engines, gear box, ignition coils.
- 828. JAYA HIND SCIAKY LTD.** D-1 Block, Plot No. 18/1 Chinchwad, Pune 9. Tel. 82889,83435. Cable: SCIAKY. Telex: 0145-307. Estd. 1974. Bank: Bank of India. Foreign collaboration: Sciaky Intertechnique, S.A, Switzerland. Cap. Rs.44,91,370. Prod. Rs.59,28,597. Workers 196. Export: Rs.93 lakhs. Countries: France, Indonesia. Products: Resistance, friction, fusion, electron beam and other special purpose welding machines for all industries.
- 829. JAYANAND KHIRA AND CO. PVT. LTD.** 71 Bhosari Industrial Estate, Bhosari, Pune 26. Tel. 83402, 83403. Cable: SWAKALA, Pune Estd. 1971. Br Jayanand Khira & Co. Pvt. Ltd., Bombay. Sister concern: Khira Steel Works Pvt. Ltd., Bombay 54. Cap. Rs.37,85,816. Prod. Rs.35 lakhs. Workers 120. Products: All types of automobile bodies, special-purpose vehicle bodies, pre-fabricated body, trailers.
- 830. JAYANT DYES AND CHEMICALS.** 772 (New) Budhwar Peth, Pune 2. Tel. 448173. Factory: Unit 1: 1317/A Kasba Peth, Pune 11. Tel. 447961. Unit 2: S.No. 117/2 Loni Kalbhor (Near Pune), C. Rly. Proprietary, 1961. Sister concern: Meera Agency, Pune 2. Bank: State Bank of India. Prod. Rs.6,00,000. Workers 10. Products: Textile dyes naphthols and bases group, chemicals and intermediates, "Likpruf" waterproofing compound and paste.
- 831. JAIPRABHA ENGINEERING WORKS.** S. No. 15, Vitthal Nagar, Hadapsar, Pune 28. Partnership, 1970. Bank: Central Bank of India. Cap. Rs.97,000. Prod. Rs.60,000. Workers 7. Products: Machinery spare parts.
- 832. JAYASHREE ENTERPRISES.** 2037 B, Tilak Rd., Pune 30. Factory: W-1, F-II Block, M.I.D.C. Industrial Estate, Pimpri, Pune 18. Tel. 82873. Proprietary, 1973. Sister concerns: AG Electric, W-26, 'G' Block, M.I.D.C., Bhosari, Pune 26. Bank: State Bank of India. Cap. Rs.2,00,000. Prod. Rs.5,00,000. Workers 14. Products: Electrodynamical, centrifugal, electronic speed switches, heavy-duty toggle switches, special control panels for automation, hand chrome plating services.
- 833. JAYASHREE ENGINEERING WORKS.** 554 Ghorpade Peth, Pune 2. Proprietary, 1971. Banks: Syndicate Bank; Canara Bank. Cap. Rs.5,000. Prod. Rs.25,000. Workers 4. Product: Job work.
- 834. JAYKAY PRINTERS.** 361 Budhwar Peth, Pune 2. Tel. 448266. Partnership, 1968. Bank: Bank of India. Cap. Rs.20,000. Prod. Rs.72,000. Workers 3. Products: Job work of printing.

- 835. JBROS ENGINEERING WORKS.** Flatted Type Bldg, M I D C. 'C' Block, Chinchwad, Pune 19 Proprietary, 1975 Cap Rs 50,000 Prod. Rs 36,000 (Labour work). Workers 3. Products: Machine components job work, turned components.
- 836. JEETENDRA TEXTILES.** 14 Hadapsar Industrial Estate, Pune 13 Tel 7507. Proprietary, 1973 Sister concern: At Post Velu. Tal Bhor, Dist. Pune. Products: Cotton textiles
- 837. JEKUMA ENGINEERS.** A-19, 'H' Block, M I D C. Pimpri, Pune 18 Tel. 83186, 82131 Partnership, 1976 Bank: State Bank of India Cap Rs 4,85,385. Prod. Rs. 3,00,000 Workers 17. Products: Limit gauges viz. plug, snap, taper, ring, width; setting masters, measuring pins.
- 838. JEMCO RUBBER INDUSTRY.** E-28, M.I.D.C., Bhosari, Pune 26. Tel 83531. Partnership, 1959 Bank: Central Bank of India Cap. Rs 2,75,000. Prod. Rs 3,00,000. Products: Industrial rubber handgloves, surgical gloves, met balloons, medical rubber products, industrial moulded products, adhesives.
- 839. JEMCO PAINTS.** 12 Bombay-Pune Road, Pune 3. Tel. 57993. Partnership, 1975 Bank: Central Bank of India Cap Rs.60,000. Prod Rs 2,50,000 Workers 7. Products: Red oxide, wood primer, industrial primer, decorative paints, varnishes and thinners.
- 840. JEMINI ENGINEERING WORKS.** Opp Backau Wolf, Station Rd., Pimpri, Pune 18. Tel 82653, 82886 Proprietary, 1966. Br Bombay. Sister concern: Imperial Engineering Works, Pune 18. Bank: Central Bank of India. Cap Rs 80,000. Prod. Rs 2,00,000. Workers 12. Products: Machinable, pressed components in bakelite, rubber, plastic and assemblies.
- 841. JETLINE CORRUGATED BOXES PVT. LTD.** 5 Naik Niwas, 793/6 Agarwal Colony, Pune 2 Tel. 24791. Factory: Block D-III, Plot No. 74 and 75, M.I.D.C., Chinchwad, Pune 19. Tel. 83419. Estd. 1975. Bank: Indian Overseas Bank. Cap. Rs 7,50,000. Prod. Rs.10,00,000. Workers 35. Products: Corrugated rolls, sheets, boards and boxes, hessian lined cartons for export.
- 842. JG GLASS INDUSTRIES LTD.** Pimpri, Pune 18. Tel. 82411/12/13, 82535. Cable. GLASS. Telex: 0145-218. Estd. 1956. Sister concerns: Jg Glass Ltd., Virbhadr (Rishikesh) U.P.; Jg Containers (M) Sdn. Bhd., Salangor, Malaysia. Bank: Bank of Maharashtra Cap. Rs 2 crores. Prod. Rs 2.30 crores. Workers 550. Export: Rs.27.02 lakhs. Countries: Australia, Hong Kong, Philippines, Ethiopia, Japan, UAR, Thailand, Burma, Indonesia, Iran. Products: Penicillin vials from 3 ml to 100 ml capacities, pharmaceutical bottles such as balm jars, gripe water bottles, saline bottles, blood transfusion and plasma bottles, etc. conforming to USP type III and II.
- 843. JG VACUUM FLASKS LTD.** S No 142, Akurdi, Chinchwad, Pune 19. Tel. 82911. Cable: JG FLASKS. Telex: 0145-269. Estd. 1970. Sister concern: Thermolab Glass Products Ltd Bank. Bank of Maharashtra Cap. Rs 36,51,960. Prod. Rs 1,18,45,084. Export: Rs 64,14,318. Countries: Russia, Bulgeria, West Germany, Kuwait, Sri Lanka. Products: Vacuum flasks, vacuum flask refills.
- 844. JILBENTS MECHANICAL WORKS PVT. LTD.** T-33, General Block, M.I.D.C. Area, Bhosari, Pune 26. Tel. 83505, 82922. Estd. 1974. Bank: Central Bank of India. Products: Structural steel fabrication, poultry equipments, industrial fabrication
- 845. JINENDRA SMELTING AND ROLLING MILLS.** 357 Raviwar Peth, Pune 2. Tel. 445194. Factory: 25/1-B Kharadi, off Nagar Rd., Pune 14 Tel. 28099. Cable: ALUMINA. Partnership, 1974. Bank: Bank of Baroda. Cap. Rs 8,23,567. Prod. Rs 28,70,245. Workers 45 Products: Aluminium and brass sheets, circles and utensils.
- 846. JINKU RADIATORS PVT. LTD.** Plot No 5, Gultekadi Industrial Estate, Pune 9. Tel 443595, 441773. Estd. 1968. Sister concern: Micro Wires and Insulated Conductors Bank: Bank of Maharashtra. Cap Rs 9,15,000. Prod. Rs 25 lakhs. Workers 32. Products: Pressed steel radiators used for electrical transformer
- 847. JIVHESHWAR PRINTING PRESS.** 594 Ganesh Peth, Pune 2. Tel. 446016. Proprietary, 1968. Banks: Bank of Maharashtra, United Commercial Bank. Cap. Rs.40,000. Prod. Rs 60,000. Workers 4. Products: Printing of books and commercial work.
- 848. JODHPUR TOYS INDUSTRIES.** 91 Ghorpade Peth, Pune 2. Tel. 442032. Partnership, 1970. Banks: Canara Bank. Cap. Rs.1,00,000. Prod. Rs.6,00,000. Workers 15. Products: Aluminium and brass utensils and toys.
- 849. JOG AND SONS.** 13/2 Karve Rd., Pune 4. Proprietary, 1960. Bank: Bank of India Cap. Rs 65,000. Prod. Rs.47,000. Products: Job work, automobile clutch and

brake relining and brake drum cutting, industrial clutch and brake relining.

850. JOGLEKAR PRODUCTS. 131 Shukrawar Peth, Pune 2. Tel. 440165. Factory: S.No. 2421 Wakad, Tal. Mulshi, Dist. Pune. Proprietary, 1951. Bank: Cosmos Co-op. Urban Bank Ltd. Cap. Rs 1,25,000. Prod. Rs. 75,000. Workers 5. Products: R.C.C. flower pots, grills, compound poles, offset blocks.

✓ **851. JOLLY STEEL INDUSTRIES PVT. LTD.** 32/1 Nagar Rd., Pune 14. Tel. 25297. Cable: JOLLY STEEL. Estd. 1961. Sister concerns: Jolly Brothers Pvt. Ltd., Anil Hardboards Ltd., Bombay. Bank: Bank of India. Cap. Rs 60 lakhs. Prod. Rs.80 lakhs. Workers 20. Products: M.S. round bars, torsteel, twiststeel bars, spring washers.

✓ **852. JOSHI PRECISION MACHINES.** Plot E-11, M.I.D.C., Bhosari, Pune 26. Tel. 82358. Cable: JOPRECIJAN. Partnership, 1970. Sister concern: Gore Joshi Tools Pvt. Ltd. Bank: State Bank of India. Cap. Rs. 10,00,000 Prod. Rs.15,00,000. Workers 55. Products: Riksha and taxi fare meters, resistor caps, capacitor tags, anti-vibration mountings, automatic strip feeding device for power presses, automobile door locks, shock mounts, end shields for ball bearings, stainless steel floats, diaphragms for valves, air cooling for diesel engines, press tools and dies, jigs and fixtures, precision pressed parts for all industries.

853. JUPITER PAPER MART. 387 Raviwar Peth, Pune 2. Tel. 447079. Partnership, 1948. Sister concerns: Kanti Press, 387 Raviwar Peth, Pune 2; Tarak Co. 387 Raviwar Peth, Pune 2. Bank: Bank of Baroda. Cap. Rs. 3,00,000. Prod. Rs.20,00,000. Workers 4. Product: Exercise note-books.

854. JYOTI ENTERPRISE. 1804 Sadashiv Peth, Pune 30. Tel. 446235. Proprietary, 1972. Bank: Dena Bank. Cap. Rs.1,00,000. Prod. Rs.85,000. Workers 7. Products: Machinery parts—lock nuts, cap nuts, pistons, piston clutches, throttle valve, throttle stem, sleeves, spacers.

855. JYOTI INDUSTRIES. 368 Nana Peth, Pune 2. Tel. 20631. Partnership, 1967. Sister concern: Savala Enterprise. Bank: Dena Bank. Cap. Rs.3,00,000. Prod. Rs.40,000. Workers 15. Products: Bakelite and plastic moulding, stainless steel, aluminium, brass casting, khal and butta.

856. JYOTI PLASTIC INDUSTRY. 127 Telco Rd., Mohan Nagar, Chinchwad, Pune 19. Partnership, 1977.

Bank: Rupee Bank Ltd. Cap. Rs.30,000. Workers 3. Product: Polythene bags.

857. JYOTI PRINTING PRESS. 16 Somwar Peth, Pune 11. Proprietary, 1948. Bank: Bank of Maharashtra. Worker 1. Product: Commercial printing.

858. JYOTI PRODUCTS. 158 Ganesh Peth, Pune 2. Factory: 545 Ganesh Peth, Pune 2. Tel. 440114. Proprietary, 1976. Bank: United Commercial Bank. Cap. Rs 25,000 Prod. Rs.1,00,000. Workers 11. Products Halad, mirachi, lasoon powder, masala.

859. JYOTI SOAP INDUSTRIES. 588 Guruwar Peth, Pune 2 Tel. 447057. Partnership, 1973. Banks: Bank of Maharashtra; United Commercial Bank. Cap. Rs 15,000. Prod. Rs 80,000. Workers 2. Products: Soap powder, detergent chips and cakes.

✓ **860. JYOTI STONE METAL WORKS.** 10 Oswal Park, Shivajinagar, Pune 5. Tel. 56175. Factories. (i) S.No. 46/A Dhanori, Vishrantwadi, Pune 15. Tel. 27576. (ii) S No. 242/1-B Yerawada, Pune 6. Partnership, 1969. Bank: Bank of Maharashtra. Cap. Rs.1,23,139. Prod. Rs 8,00,000. Workers 45. Product: Stone metal

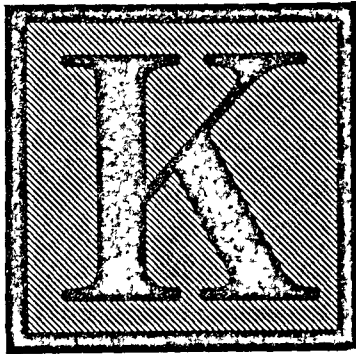

861. KAP ENGINEERING. Avan-Abad, 826-B, Canning Rd, Pune 1 Tel 28890. Factory Shed No. 6, F-II Block, MIDC, Pimpri, Pune 18. Partnership, 1972. Bank: State Bank of India. Cap. Rs 2,00,000. Prod. Rs 1,70,000. Workers 7. Products: Small turned items like bearing rollers, grease nipples, H.T. electrical insulators' inserts, scooter and automobile parts.

862. K. B. METAL AND BUFFING WORKS. 207 Ganj Peth, Pune 2 Tel. 446055. Cap. Rs 6,000. Prod. Rs. 10,000. Workers 11 Products Metal buffing jobs and fabrication.

863. K. D. JOSHI. 429 Narayan Peth, Pune 30. Tel, 442454. Factory: 'A' 83-85, 'H' Block, MIDC, Pimpri, Pune 18 Tel 82170. Cable. MASTERMIND. Partnership, 1950 Bank. Poona Merchants Co-operative Bank Ltd Cap. Rs 3,75,000 Prod. Rs.4,80,000. Workers 7. Products: P.V.C. flexible cum collapsible hoses, rubber squeegees and scrappers for screen printing for textile industry, rubber accessories and components for textile industry, french polish.

864. K. G. BANTHIA BROS. 94 Ganj Peth, Pune 2. Tel. 442578. Factory: 89/1 Bhawani Peth, Pune 2. Tel. 27197. Partnership, 1960. Sister concerns Banthua Trading Corporation, Banthua Enterprises. Bank: State Bank of India. Cap. 2,75,000. Prod. Rs 8,00,000. Workers 18. Export order work done on job contract. Products: Readymade garments

865. K. G. M. ENGINEERING WORKS. S. No. 13/3, A/1-B Bankar Colony, opp. Akashwani, Hadapsar, Pune 28. Partnership, 1974. Bank: Canara Bank. Cap.. Rs70,000. Prod. Rs 1,00,000. Workers 5. Products: Pressed steel components such as cups for oil seals, caps, box spanners, dies, punches, washers.

866. K. K. DANI CONSULTANTS AND ENGINEERS PVT. LTD. 767/9 Shivajinagar, Pune 4 Tel. 55530, 55531. Estd. 1975 Bank Indian Bank. Cap. Rs 1,00,000. Prod Rs 3,00,000 Workers 2. Products: Linear electrical motors/actuators, electronic servo speed control systems, linear actuator system complete with electronic controls, automatic sliding doors for industrial commercial, domestic applications with complete electrical linear motor drive and electronic controls, photocell command units, consultants in cement technology and engineering

867. K. K. ENGINEERING WORKS. 200 Mangalwar Peth, Pune 11 Proprietary, 1966 Bank: Bank of Maharashtra. Cap. Rs.36,000. Prod. Rs 1,00,000. Workers 8 Products: Lathe work, milling and drilling work, job work.

868. K. K. ENGINEERING WORKS. 394 Narayan Peth, Pune 30 Partnership, 1965. Bank Bank of Maharashtra. Cap. Rs.1,00,000. Prod. Rs 80,000. Workers 4. Products Spare parts of oil engines, job work.

869. K. K. NAG PVT. LTD. 23/5-A Bund Garden Rd, Pune 1. Tel 26436 Factory (1) Lead and Plastic Division—Shembekar Industries Compound, Chinchwad, Pune 19. Tel. 82036; (2) Promil Packaging Division—D-3 Bhosari Industrial Estate, Pune 26 Tel. 82875. Cable: KALNAG. Estd. 1965. Banks. State Bank of India; Bank of India, Chartered Bank, Prod. Rs.50,00,000. Workers 200. Products: Lead FRP and PVC fabricated and lined chemical equipments, storage tanks, process vessels, heating/cooling coils, electrodes, ducts, hoods, scrubbers, piping, etc.; Valves—lead valves, FRP valves and C.I. diaphragm valves with lead/FRP/rubber lining, Exhaust system—senofflow ventilating system, 'PROMIL' (thermocole)—packaging and insulation materials.

870. K. JOSHI AND CO. Block Makers and Art Printers, 1745/2 Sadashiv Peth, Pune 30. Tel 441409. Partnership, 1937. Bank Central Bank of India. Cap. Rs Rs 5,00,000. Prod. Rs 6,00,000. Workers 32 Products: Process blocks and printing.

871. K. LALWANI AND CO. K-220 Adinath Co-op Housing Society, Pune-Satara Rd, Pune 9. Tel. 24628, 443339. Factory: 93/1 B Manjri Rd, Dist. Pune. Tel. 7575. Partnership, 1970 Bank: Central Bank of India. Cap. Rs.4,75,000. Prod. Rs 9,25,000. Workers 25. Products: Designing and fabricating, dairy machinery, equipment and kerosene pressure stoves, 'Kanta' brand stove.

872. K. N. VEDPATHAK ENGINEERS. 540 Nana Peth, Pune 2. Proprietary, 1966. Cap. Rs.10,000. Prod. Rs.40,000. Workers 2. Products: Industrial engraving.

- 873. KO—PLASTICS.** Station Rd., Chinchwad, Pune 33. Partnership, 1973. Bank: United Western Bank. Cap. Rs.1,00,000. Prod. Rs.1,00,000. Workers 4. Products: Tip-Top Mixer, Sangam hanger, anti-insect shoe, chess set with board, plastic moulding job work.
- 874. K AND P METAL WORKS.** 119/120 Mahatma Fule Peth, Pune 2. Tel. 444966. Factory: 935 Ganj Peth, Pune 2. Tel. 446765. Partnership, 1972. Cap. Rs. 1,00,000. Prod. Rs. 2,93,734, Workers 15. Product: Sangali, Satara and Rajapuri lotta.
- 875. K. S. ENGINEERS.** 314 Narayan Peth, Pune 30. Tel. 444542. Proprietary, 1964. Sister concern: Vasant Electric Stores, 432 Sadashiv Peth, Pune 30, Banks: Bank of Maharashtra; Central Bank. Cap Rs 20,000. Prod. Rs 1,00,000. Workers 4. Products: Printing machinery, maintenance, spare parts, electric and mechanical rewinding and wiring for electrical installation.
- 876. K S B PUMPS LTD.** Bombay-Pune Rd., Pimpri, Pune 18. Tel. 82006-7. 82686-7 Cable: KAYESBE. Telex: KSBIN PN 228. Estd. 1962 Br. at Vambori, Chinchwad. Bank: Central Bank of India. Foreign collaboration: Klein Schanzlin and Becker AG, West Germany. Cap. Rs. 190.79 lakhs. Prod. Rs.217.35 lakhs. Workers 636. Export: Rs.14,00,000. Countries: Various countries. Products: Submersible pumps, high-pressure pumps, non-clogging pumps, chemical process pumps and mercury pumps.
- 877. K. Y. JAGTAP.** 34/11 Dapodi, Bombay-Pune Rd., Pune 12. Proprietary, 1975. Br. L. K. Kirloskar Rd., Pune 3. Bank: Bank of Maharashtra. Cap. Rs.50,000. Prod. Rs.2,00,000. Workers 7. Product: Wooden cases for packing machinery and spare parts.
- 878. KABIR PRINTING PRESS.** 358 Nana Peth, Pune 2. Tel. 27250. Proprietary, 1974. Bank: Punjab Co-op. Bank. Cap. Rs 25,000. Prod. Rs 25,000. Product: Commercial printing.
- 879. KADAM ENGINEERING WORKS.** 378 Shukrawar Peth, Pune 2. Proprietary, 1961. Bank: Bank of Maharashtra. Cap. Rs.10,000. Prod. Rs. 7,000. Workers 3. Products: Tractor, oil engine and pump repairing, making new parts, heads, crank shafts, flour mill shafting repairs and general repairs.
- 880. KAKADE AND SONS.** 28 Navi Peth, Pune 30. Tel. 441296. Partnership, 1943. Bank: State Bank of India. Cap. Rs.1,00,000. Prod. Rs.3,50,000. Workers 7. Products: 'National' black tooth powder, 'National' Netranjan, 'Nalini' Kajal, Balgoh.
- 881. KAISER ENGINEERING CO.** 'Raynath', 13th Lane, Prabhat Rd., Pune 4. Factory: S.No. 18, Plot No. 14, Etandawana, 1204/24 Shivajinagar, Pune 5. Partnership, 1975. Bank: State Bank of India. Cap. Rs.70,000. Prod. Rs.4,00,000. Workers 15. Products: Ferrous, non-ferrous cast and machine components, instrumentation,
- 882. KALA BHAVAN.** 1847 Sadashiv Peth, Pune 30. Tel. 442188. Proprietary, 1948. Bank: Janata Sahakari Bank. Cap. Rs.1 80 lakhs. Prod. Rs 1.60 lakhs. Workers 8. Product: Block making.
- 883. KALANIKETAN.** 194 Ganesh Peth, Pune 2. Tel. 444774. Public Trust, 1957. Bank: State Bank of India. Cap. Rs.1,50,000. Prod. Rs.4,50,000. Workers 25. Products: Steel and wooden furniture, charkha, saranjam and saranjam equipment.
- 884. KALAVIKAS DECORATED FURNITURE.** 593 Ganj Peth, Pune 2. Tel. 445359. Proprietary, 1970. Bank: Punjab National Bank. Cap. Rs.21,000. Prod. Rs.1,50,000. Workers 5. Product: Furniture.
- 885. KALAVIKAS MUDRANALAYA.** 355 Narayan Peth, Pune 30. Tel. 447220. Proprietary, 1972. Bank: Bank of India. Cap. Rs.90,000. Prod. Rs.1,58,000 Workers 4. Products: Commercial printing, colour printing.
- 886. KALEKAR ENGINEERING WORKS.** 153 Fuge-wadi, Pune 12. Proprietary, 1969. Bank: State Bank of India. Prod. Rs.1,00,000. Workers 6. Product : Oil-engine spare parts.
- 887. KALPAK.** 20/1 Hadapsar Industrial Estate, Pune 13. Tel. 7150, 7339. Partnership, 1972. Bank: State Bank of India. Cap. Rs.1,90,000. Prod. Rs.3,20,000. Workers 35. Products: Automobile spare parts, turned components, assemblies.
- 888. KALPANA ART PRESS.** 1397 (New) Shukrawar Peth, Pune 2. Tel. 440738. Proprietary, 1959. Sister Concern: Kalpro Industries. Bank: Poona Merchants Co-operative Bank. Cap. Rs.30,000. Prod. Rs 40,000. Workers 2. Product: Commercial printing.
- 889. KALPANA DRESSES.** 804 Raviwar Peth, Pune 2. Tel. 448803. Proprietary, 1974. Bank: State Bank of India. Cap. Rs.2,00,000. Prod. Rs 3,00,000. Workers 15. Product: Readymade garments.

- 890. KALPANA INDUSTRIES.** 20/1 Hadapsar Industrial Estate, Pune 13. Tel. 7150, 7339. Partnership, 1968 Sister concern: Kalpak. Banks: Bank of Maharashtra; State Bank of India. Cap. Rs 7,45,785. Prod. Rs 14,13,000. Workers 50. Products: High precision turn parts, heavy turned parts, assembly unit as specification, induction heat treatment to thread rolling
- 891. KALPANA GLASS FABRITEK.** 720/20 Navi Peth, Pune 30. Tel C/o 441810. Partnership, 1975. Bank: Bank of India. Cap. Rs.30,000. Prod. Rs 1,00,000. Worker 1. Products: Mercury switches, laboratory glassware, glass graduation, fibre glass moulding
- 892. KALPANA MUDRANALAYA.** 76-E Block, Bhosari Industrial Estate, Pune 26. Tel 82093. Proprietary, 1960. Br. Kalpana Mudranalaya, Pune 30. Bank: Janata Sahakar Bank Ltd. Cap. Rs 9,00,000. Prod. Rs.7,00,000. Workers 47. Products: Printing books and commercial printing
- 893. KALPANA PLASTIC INDUSTRIES.** 20/3 Industrial Estate, Hadapsar, 'Kalpana House', Pune 13. Tel. 7229. Cable KALPLAST. Partnership, 1965. Bank: Central Bank of India. Cap Rs.5,00,000 Prod. Rs.7,00,000. Workers 7. Product Polythelene bags.
- 894. KALPESH TEXTILES.** 25, S.S I. Estate, Gultekadi, Pune 9. Tel. 441636 Proprietary, 1968. Bank: Bank of Maharashtra. Cap Rs.20,000 Prod Rs 80,000. Workers 6. Product: Cloth.
- 895. KALPRO INDUSTRIES.** 1397 Shukrawar Path, Pune 2 Tel. 440738. Factory: S. No. 97, M.I.D.C, Bhosari, Pune 26. Partnership, 1977. Bank: Bank of Maharashtra. Cap. Rs 95,000. Workers 4. Products: Commercial printing, designing and block making
- 896. KALPUC ENGINEERS.** Commonwealth Colony, Pune 30. Tel. 449134. Factory 39 Parvati Industrial Estate, Pune-Satara Rd., Pune 9. Tel. 449134. Proprietary, 1971. Bank: Bank of Maharashtra. Cap. Rs.80,000. Prod. Rs 1,46,000. Products: Soft and hard jaws for all standard chucks, job work.
- 897. KALYANI APPARELS DRESSES.** 353 Shukrawar Peth, Pune 2. Tel. 440837. Cable.MENAFORM. Partnership, 1971. Sister concern: Kalyani Cloth Merchant. Bank: State Bank of India. Cap. Rs.5,00,000. Prod. Rs. 5,00,000. Workers 18. Products: Brassiers, banians.
- 898. KALYANI CLOTH MERCHANTS.** Opp. Apsara Talkies, 392 Nehru Rd., Pune 9. Tel. 448642. Cable: KALYANIWER. Partnership. Br. Kirkee, Pune 3. Bank: State Bank of India. Prod. Rs.25,00,000. Workers 60. Product Readymade garments.
- 899. KAMAL INDUSTRIES.** S. No. 2, Plot No. 4. Ghorpadi Peth, Pune 1. Tel 27961. Proprietary, 1971. Bank: Bank of Baroda Cap. Rs 2,00,000. Prod Rs 2,11,578. Workers 6 Products: Wax emulsion for textile and paper sizing, pharmaceuticals as defoaming agent, wax candles, wax colour crayons.
- 900. KAMAL TEXTILES.** 14 Hadapsar Industrial Estate, Pune 13. Tel 7288, 7425, 7497. Proprietary, 1967 Br. Saswad, Dist. Pune. Products: Cotton fabrics, voiles, dhotis, mulmul, etc.
- 901. KAMDHENU CHEMICAL AND FERTILISER INDUSTRIES.** 'Krishu Bhavan', 1379 Bhawani Peth, Pune 2 Tel. 26815 Factory: 39 Shankarshet Rd., Pune 9; and Dunkwadi, Pune. Tel. 42843. Cable: KAMDHENU. Partnership, 1969. Sister concerns: Other concerns of Navalakha Group. Bank: Bank of Maharashtra. Cap Rs.8,00,000. Prod. Rs.30,00,000. Workers 17. Products N.P.K. 'Kamdhenu' brand manure, mixtures, micronutrient, 'Plantovit' for all kinds of crops.
- 902. KAMDHENU PESTICIDES.** 1379 Bhavani Peth, 'Krishu Bhavan', Tel. 26815, 26825. Factory: 50/51 A Hadapsar Industrial Estate, Pune 13. Tel. 7201. Cable KAMDHENU. Telex: Kampest 0145-393. Partnership, 1974. Br. Belgaum, Guntur, Baroda, Amravati. Sister concerns: Navalakha group concerns. Bank: Punjab National Bank Cap. Rs 10,00,000. Prod. Rs.1.5 crores Workers 150. Products: Ditox (D.D.T.), Benhexol (B.H.C.), Kamethion (Malathion), Endokam (Endosulfon), Carvin (Carbaryl) Dimethos
- 903. KAMLAPURE DRESSES.** 439 Guruwar Peth, Pune 2. Tel. 440229, 446621. Cable: KALATMAK. Partnership, 1970. Sister concern: Pratubha Dresses, 439 Guruwar Peth, Pune 2. Bank: State Bank of India. Cap Rs.17,000. Prod. Rs 6,00,000. Workers 4. Product: Ready-made garments.
- 904. KANCHAN PRINTERS.** 375/3 Bhawani Peth, Pune 2. 25790. Partnership, 1972. Cap. Rs 20,000. Prod. Rs 10,000. Workers 3. Product: Commercial printing.
- 905. KANHAIYALAL AND COMPANY.** 39 D-2/6 Gultekadi, Shankarshet Rd, Pune 9. Tel. 440803, 449045.

- Partnership, 1970. Br. Pune. Bank: Bank of India. Cap. Rs.2,00,000. Workers 40. Products: Polishing of sesame; rewadi (jaggery and sugar).
906. **KANKARIYA INDUSTRIES.** 152 Mahatma Gandhi Rd., Pune 1. Tel. 25807. Proprietary, 1962. Bank: State Bank of India. Cap. Rs.15,000. Prod. Rs.30,000. Workers 4. Products: Distilled water, battery solution, cotton waste, yellow polish cloth, cleaning solution, white cleaner 'Perfumed', 'Moti' cleaning powder.
907. **KANKOO PAINTS AND VARNISH COMPANY.** 418 R.S. Kedari Rd., Pune 1. Tel. 23836. Factory: 69/1-B/2 Wanowari Industrial Estate, Pune 1. Tel. 22798. Cable: KANKOPAINT. Proprietary, 1975. Sister concerns: Hind General Stores, Naresh Traders. Banks: Bank of India; Bank of Maharashtra. Cap. Rs.3,50,000. Prod. Rs.6.5 lakhs. Workers 5. Products: Ready-mixed paints and synthetic enamel paints, chemical resistant paint, oleo-resinous and bituminous varnishes, stoving paints, all types of primers, paints to defence and other specification, alkyd resins of various types.
908. **KANTA SOAP WORKS.** 464 Ganj Peth, Pune 2. Tel. 441690. Proprietary, 1962. Bank: Bank of Maharashtra. Cap. Rs.25,000. Prod. Rs.1,00,000. Workers 3. Products: Washing soap, bar, cakes, 511 soap bar.
909. **KANTA TEXTILES.** 1150 Bhawani Peth, Pune 2. Tel. 26625. Factory: 30/30 Gultekadi Industrial Estate, Pune 9. Tel. 442812. Cable: KUNDAN SARI. Proprietary: 1974. Banks: Bank of Maharashtra. Cap. Rs.40,000. Prod. Rs.1,79,000. Workers 8. Product: Cotton cloth.
910. **KANTI PRESS.** 387 Raviwar Peth, Pune 2. Tel. 447079. Partnership, 1950. Bank: Bank of Baroda. Cap. Rs.1,00,000. Prod. Rs.1,50,000. Workers 12. Product: Commercial and colour printing.
911. **KANTHAL INDIA LTD.** Plot 33, Block D-2, Pimpri Industrial Estate, Chinchwad, Pune 19. Tel. 82547. 83155, 83156. Cable: KANTHALIND. Telex: 0145-336. Estd. 1971. Bank: Bank of India. Foreign collaboration: Bulten Kanthal AB S 734 01 Hallstahammar, Sweden. Cap. Rs.22.36 lakhs. Prod. Rs.61 lakhs. Workers 118. Product: Precision investment castings.
912. **KAPASI STEEL WORKS.** 56/2 Ganesh Peth, Pune 2. Tel. 449827. Proprietary, 1965. Product: Steel cots.
913. **KAPSONS PRINTERS AND PUBLISHERS.** 736 Bhawani Peth, Pune 2. Tel. 24094. Proprietary, 1972. Bank: Bank of Baroda. Cap. Rs.75,000. Prod. Rs.1,00,000. Workers 5. Products: Commercial printing and designing.
914. **KARANDE INDUSTRIES.** 1018 Shukrawar Peth, Pune 2. Proprietary, 1963. Bank: United Commercial Bank. Cap. Rs.5,000. Prod. Rs.3,500. Product: Leather cushions.
915. **KARANJKAR FOUNDRY.** 106 General Block, M.I.D.C., Bhosari, Pune 26. Partnership, 1974. Bank: Bank of Baroda. Cap. Rs.2,50,000. Prod. Rs.4,50,000. Workers 15. Products: Grey cast iron and jobbing.
916. **KARIGAR.** 110 Rasta Peth, Pune 11. Tel. C/o. 25925. Proprietary, 1974. Bank: State of India. Products: Furniture, interior decorators, engineers.
917. **KARNALA TEXTILES.** 14 Hadapsar Industrial Estate, Pune 13. Tel. 7497, 7507. Proprietary. Product: Cotton textiles.
918. **KARS ELECTRONICS.** 690 Sadashiv Peth, Pune 30. Tel. 446167, 445021. Cable: VISHWADA. Partnership, 1970. Sister concern: Karel Industrial Corporation, Sadashiv Peth, Pune 30. Bank: United Western Bank Ltd. Cap. Rs.1.50 lakhs. Prod. Rs.4.5 lakhs. Workers 8. Export: Rs.20,000. Country: Malaysia. Products: 'Kars' conductivity meters, stabilised power supplies, precision welding machines, radio coils and automatic testing equipment.
919. **KARSONS ENTERPRISES.** 'Pitruchhaya' Bldg., Yerawada, Pune 6. Tel. 28765. Factory: S.No. 22, Vadgaon Sheri, Pune 14. Proprietary, 1975. Bank: United Commercial Bank. Cap. Rs.1,00,000. Prod. Rs.1,20,000. Workers 3. Product: Centerless lapping machine.
920. **KASAMJI EBRAHIMJI NAGARWALA.** 234 Raviwar Peth, Pune 2. Tel. 446464. Partnership. Banks: Bank of Maharashtra; The Muslim Co-op. Bank Ltd. Cap. Rs. 30,000. Prod. Rs.75,000. Workers 2. Products: Account books, exercise books, files, stationery items.
921. **KASCO INDUSTRIES.** 44 Shankarshet Rd., Pune 9. Tel. 448974. Partnership, 1972. Bank: Bank of Maharashtra. Cap. Rs.50,000. Prod. Rs.4,00,000. Workers 12. Products: Humidifiers—centrifugal type, air washer type, evaporative type; de-humidifiers—refrigeration and adsorption type; environmental test chambers.
922. **KASHMIRI PRODUCTS.** Kashmiri Colony, Yerawada, Pune 6. Tel. 25119. Cable: KASHMIRI. Partnership, 1972. Sister concern: New Subhash General Stores,

- Pune 6. Bank: Bank of Maharashtra. Cap. Rs.1,00,000. Rs.3,00,000. Workers 100. Product: Kashmiri sweet fennel (Badishep).
923. **KATARE INDUSTRIES.** 514 Guruwar Peth, Pune 2. Factory: 512 Guruwar Peth, Pune 2. Tel. 446139. Partnership, 1973. Bank: Union Bank of India. Cap. Rs 65,000. Prod. Rs 50,000 Workers 6 Product: Job work.
924. **KAUSHALAYA STEEL WORK.** 1199 Shukrawar Peth, Pune 2. Proprietary, 1957. Cap. Rs.25,000. Prod. Rs.4,500. Product: Scissors for cutting metals.
925. **KAY AND BEE ASSOCIATES.** Wadgaon Sheri, S. No. 22, Pune 14. Tel. 28765. Proprietary, 1973. Subsidiary company: K. K. Mohan Bros., M. G. Rd., Eranakulam, Kerala. Bank: Bank of Maharashtra. Cap. Rs.1,65,000. Prod. Rs 80,000. Workers 12. Products: Domestic electric washing machines, voltage stabiliser, geyser, film racks and negative drier and R.C. drier.
926. **KAYPEE INDUSTRIES.** 383 Shivajinagar, Pune 5. Tel. 58293. Proprietary, 1968. Bank. Bank of Maharashtra. Cap. Rs. 35,000. Prod. Rs.1,00,000. Workers 3. Products: Diesel engine spare parts, job work.
927. **KAYANI BAKERY.** 6 Dr. Koyaji Rd., Pune 1. Tel. 24239. Partnership, 1954. Br. Sales Depot, Sarbatwala Chowk, Pune 1. Bank: Central Bank of India. Workers 21. Products: Bread, butters, biscuits, buns, etc.
928. **KEDAR MUDRANALAYA.** 478 Kasba Peth, Pune 11. Tel. 446529. Proprietary, 1975. Bank: Bank of Maharashtra. Prod. Rs.95,000. Workers 9. Product: Commercial printing.
929. **KEJE ELECTRIC COMPANY.** A-121, 'H' Block, M.I.D.C., Pimpri, Pune 18. Tel. 82092. Cable: KEJEARC. Partnership, 1968. Bank: Bank of Maharashtra. Cap. Rs.2,50,000. Prod. Rs.3,50,000. Workers 10. Products: Arc welding transformers; welding machines spot, butt seam; electric resistance, heating machines, thermal stability test unit for capacitor plants
930. **KELKAR PRINTING PRESS.** 636 Budhwar Peth, Pune 2. Tel. 446229, 444211. Proprietary, 1932. Bank: Bank of Maharashtra. Workers 7. Product: Commercial printing.
- 931 **KESARI MAHRATTA TRUST.** 568 Narayan Peth, Pune 30. Tel. 449250. Public Trust, 1960. Banks: Bank of Maharashtra; The United Western Bank Ltd. Workers 5. Products: Halftone, linetone and colour blocks.
932. **KESHARGULAB ENGINEERING PVT. LTD.** Plot No. E 21 & 22. Bhosari Industrial Estate, Pune 26. Tel. 82217. Estd. 1966. Bank: State Bank of India. Cap. Rs.1,00,000. Prod. Rs 35,00,000. Workers 50. Product: Automobile parts.
933. **KHADILKAR PROCESS STUDIO.** 461/1 Sadashiv Peth, Tilak Rd., Pune 30. Tel. 443059. Proprietary, 1956. Banks: Bank of India; Poona Merchants Co-op Bank Ltd. Cap. Rs. 1,52,900. Prod. Rs 72,400. Workers 8. Product: Block making.
934. **KANTILAL MOHANLAL KHINVASARA.** Mohan Nagar, Chinchwad Station, Pune 19. Tel. 82585. Factory: Khinvasara Industries, S. No. 127, Mohan Nagar, Chinchwad Station, Pune 19. Tel. 82725. Proprietary, 1960. Bank: The United Western Bank. Cap Rs 40,000. Prod Rs 55,000. Workers 25. Product: Bricks.
935. **KHALSA ENGINEERING WORKS.** 170 Dnyaneshwar Colony, Akurdi, Chinchwad, Pune 35. Tel 83449. Partnership, 1966. Banks: Central Bank of India; Dena Bank. Cap. Rs.30,000. Prod. Rs 60,000 Workers 6 Products: Oil-engine spare parts, generators, textile machineries, industrial gears and marine gear boxes, job work.
936. **KHANDELWAL CHIKKI MANUFACTURERS.** Mahatma Gandhi Rd., Lonavala, Dist. Pune. Tel. 705. Partnership, 1970. Sister concern: Vaishali Chikki, Bombay-Pune Rd, Lonavala. Bank: Bank of Baroda. Cap. Rs. 30,000. Prod: Rs.50,000. Workers 6. Product: Chikki.
937. **KHINVASARA INDUSTRIES.** S. No. 127 Mohan Nagar, Chinchwad Station, Pune 19. Tel. 82725. Products: Engineering products and steel fabrication.
938. **KHOSLA ENGINEERING PVT. LTD.** 43 Aundh Rd., Khadki, Pune 3. Tel. 58598, 57077. Factory: 2-B, M.I.D.C., Pimpri, Chinchwad Industrial Area, D-1, Akurdi, Chinchwad East, Pune 19. Cable: KHOSLA, PUNE. Telex: 0145-382. Estd. 1962. Sister concerns: Khosla Plastics: Khosla Metal Works: Khosla Nylons. Pune. Bank: Bank of Maharashtra. Cap. Rs.10,00,000. Prod. 25,00,000. Workers 4. Products: Solder wires and solder sticks, soldering flux and pastes.
939. **KHOSLA METAL POWDERS LTD.** 43 Aundh Rd., Khadki, Pune 3. Tel. 57077, 57496, 57518. Cable: KHOSLA, Pune. Telex: KHOSLA 0145-382. Factory: Plot No. 2, M.I.D.C. Industrial Estate, Akurdi, Pune 19. Tel. 82527, 82390. Estd. 1962. Sister concerns: Khosla

- Plastics; Khosla Engineering Pvt. Ltd., Khosla Nylons Pvt. Ltd., Pune. Bank: Bank of Maharashtra. Cap. Rs. 46,00,000. Prod. Rs.38,08,796. Workers 24. Exports: Rs. 5,52,000. Countries: Singapore; U.S.A. Products: Aluminium powder and pastes, flex, atomised zinc powder, activial zinc paste, magnesium powder, atomised tin powder.
940. KHOSLA NYLONS PVT. LTD. 43 Aundh Rd., Khadki, Pune 3. Tel. 58598. Cable: KHOSLA, Pune. Telex: 0145-382. Factory: 247/c Chichwad gaon, Pune 35. Tel. 82215, 82598. Estd. 1969. Sister concerns: Khosla Engineering Pvt. Ltd., Khosla Plastics Pvt. Ltd., Khosla Metal Powder Ltd. Bank: Bank of Maharashtra. Cap. Rs.3,50,000. Prod. Rs.4,00,000. Workers 15. Product: High-density polyethylene monofilaments in various gauges.
941. KHOSLA PLASTICS PVT. LTD. 43 Aundh Rd., Khadki, Pune 3. Tel. 58598, 57077, 57496. Cable: KHOSLA, Pune. Telex: 0145-382. Factory: 45A, Elphinstone Rd., Khadki, Pune 3. Tel. 57518, 57075. Estd. 1948. Banks: Bank of Maharashtra; Punjab National Bank; Grindlays Bank Ltd., Bombay. Cap. Rs.23,00,000. Prod. Rs.53,86,000. Workers 31. Product: Household electrical wiring accessories.
942. KHOT AND SONS. New 1675 Shukrawar Peth, Pune 2. Proprietary, 1964. Bank: The Poona Co-op. Bank Ltd. Cap. Rs.15,000. Prod. Rs.2,000. Workers 2. Product: Polishing.
943. KINETIC ENGINEERING LTD. Block D-I, Plot No. 18/2, Chinchwad, Pune 19. Tel. 83429, 83430. Cable: KINETIC. Telex: 0145-307. Factory: Dhond-Ahmednagar Rd., Ahmednagar. Tel. 906. Estd. 1970. Sister concerns: Jaya Hind Sciaky Ltd., Bajaj Tempo Ltd.; Jaya Hind Industries Ltd. Bank: State Bank of India. Cap. Rs.1,35,99,000. Prod. Rs.3,06,93,000. Workers: 330. Export: Rs.10,411. Country: U.S.A. Product: Luna Moped.
944. KIRAN COLOUR INDUSTRY: 4 Mithapelli Estate, Shankarshet Rd., Pune 9. Tel. 22108. Factory: 61 Hadapsar Industrial Estate, Pune 13. Tel. 7234. Proprietary, 1970. Bank: Bank of Maharashtra. Workers 20. Product: Colours.
945. KIRAN ENGINEERING WORKS. 408/10/14 Gultekadi Rd., Vir Sawarkar Nagar, Pune 9. Tel. 441079. Partnership, 1964. Br. Walchandnagar (junction). Bank: Bank of India. Cap. Rs.2,50,000. Prod. Rs.8,00,000. Workers 45. Products: Sugar machinery, spare parts and job work
946. KIRAN INDUSTRIES. Chinchwad, Station Rd., Khinvasara Bldg, Pune 19. Proprietary, 1972. Bank: Rupee Bank Ltd. Cap. Rs 20,000. Prod. Rs.25,000. Workers 3. Product: Job work.
947. KIRAN TRADING CO. 937/2 Budhwar Peth, Pune 2. Tel. 446927. Factory: 1520 Shukrawar Peth, Pune 2. Tel. 445399. Partnership, 1967. Sister concern: Ram Vilas Shrinivas. Banks: Bank of Maharashtra; Dena Bank. Cap. Rs 2,00,000. Prod. Rs.8,00,000. Workers 2. Products: Exercise books, account books, papers, etc
948. KIRLOSKAR BROTHERS LTD. Udyog Bhavan, Tilak Rd., Pune 2. Tel. 442116. Cable: KIRLOSKAR. Pune. Telex: 0145-247-KB-PN. Factories Kirloskarwadi, Karad; Dewas (M.P.), Kirloskar Press, Pune 9. Estd. 1910. Brs. Sales regional offices at Ahmedabad, Bangalore, Bhubaneswar, Calcutta, Indore, Jaipur, Madras, New Delhi, Secunderabad, Pune. Banks: Bank of India; Canara Bank; The Sangli Bank Ltd.; The United Western Bank Ltd.; Bank of Maharashtra, Syndicate Bank. Foreign collaboration: International Nickel Co., U.K. Cap. Rs. 16,56,48,386. Prod. Rs 13,25,04,195. Workers 5400. Export: Rs.1,57,96,661. Countries: All over the world. Products: All types of pumps, valves, agricultural implements, machine tools, hermetically sealed compressors, castings.
949. KIRLOSKAR CUMMINS LTD. Kothrud, Pune 29. Tel. 55251-2-3. Cable: CUMKIRK. Telex: 0145-244. Estd. 1962. Subsidiary companies: Cummins Diesel Sales & Service (India) Ltd., Pune. Banks: State Bank of India; Bank of India; Bank of Maharashtra; The New Bank of India; Union Bank of India; The Shamrao Vithal Co-op. Bank; City Bank N. A. Bombay. Foreign collaboration: M/s. Cummins Engine Company, Inc. 1000 Fifth Street, Columbus, Indiana 47201, U.S.A. Cap. Rs.14,18,30,076. Prod. Rs.27,36,18,039. Workers: 2000. Export: Rs. 2,52,66,794. Countries: U.K., U.S.A., Japan, A.R.E., Singapore, Philippines, Kuwait, Iraq, Malaysia and Switzerland, etc. Products: Internal Combustion engines (Diesel engines).
950. KIRLOSKAR ENGINEERING SERVICES PVT. LTD. 134-1A off University Rd., Bhosale Nagar, Plot No. 16, Shivajinagar, Pune 7. Tel. 56845, 52173. Cable: CHANDRAUDAY. Telex: 0145-226. Factory: E-6 Bhosari Industrial Estate, Pune 26. Tel. 82489. Estd. 1971. Cap.

Rs 3,58,565 Workers 75 Products Laminar flow cabinet, LT control panels, motor control centres, fire-fighting, sets (portable), electro-static filters.

951. **KIRLOSKAR FILTERS PVT. LTD.** Kothrud, Pune 29. Tel. 55397-8-9-0. Cable FILTERS. Telex: 0145-316. Estd. 1969. Bank: Indian Bank Cap. Rs 10,33,000. Prod. Rs 70,84,000. Workers 122. Exports: Rs 25,200 Countries: Australia, Abu-Dhabi (U A E). Products All types of fuel, oil and air filters.

952. **KIRLOSKAR KISAN EQUIPMENT LTD.** Karve Rd., Kothrud, Pune 29. Tel. 53211, 53212, 50632, 56593 Cable: KISAN Telex: 0145-316 Estd 1970 Subsidiary company of Kirloskar oil Engines Ltd Banks: Bank of India; Bank of Maharashtra. Cap. Rs 46 18 lakhs. Prod. Rs.40 lakhs Workers 113. Export: Rs 6 83 lakhs Countries: U.K., Singapore, Nigeria, Ghana, etc Products. Internal combustion petrol engines These engines have variety of application as a prime mover such as agriculture sprayer, vehicular bicycle, cycle rickshaw, battery-charging sets, lawn-mower, small river-boats, concrete vibrator, etc

953. **KIRLOSKAR OIL ENGINES LTD.** Laxmanrao Kirloskar Rd., Khadki, Pune 3. Tel 55341 Cable: KOEL. Telex: 0145-245. Estd. 1946. Brs (1) KOEL Sales and Services. Pune; (2) KOEL Bangkok (Thailand), (3) KOEL C/o. KEP Project (Australia) Subsidiary companies: Shivaji Works Ltd. Solapur; Kirloskar Kisan Equipment Ltd., Pune. Banks State Bank of India; Bank of Maharashtra; Bank of India Foreign collaboration: M/s. Glacier Metal Co. Ltd., U.K. for bimetal bearings and bushes Cap. Rs. 22,89,60,000. Prod Rs 33,93,40,000. Workers 3015. Exports: Rs 4,53,56,000 Countries. Various countries in South East Asia, Middle East, Africa, etc Products: Engines between 3 H.P. and 440 H P, 'R' type engines, bimetal bearings, bimetal strips

954. **KIRLOSKAR PNEUMATIC CO. LTD.** Hadapsar Industrial Estate, Pune 13. Tel. 7133, 7341, 7540 Cable SANJAY. Telex: 0145-246 0145-306. Estd. 1958. Brs. Sales offices at Bombay, Calcutta, Madras, New Delhi, Ahmedabad, Bangalore, Cochin, Hyderabad, Margaoon (Goa), Vadodara, Vishakhapatanam. Banks: Bank of Maharashtra; Bank of Baroda; United Western Bank; Canara Bank; State Bank of India; United Commercial Bank; Central Bank of India, Bank of India. Foreign collaboration: Grasso-Stacon B. V. Netherlands; Sutrak Transportkaltte GmbH and Co. KG, West Germany; Hitachi Ltd. Japan; Twin Disc Inc. U.S.A. Cap. Rs. 9,81,59,567. Prod. Rs 9,01,10,347. Workers 2259. Export: Rs.40 18 lakhs. Countries: Mauritius, Kuwait, Thailand,

Zambia, Bahrein, Iraq, Netherlands, U A E, Malaysia, Afghanistan, Nigeria, Sri Lanka, Kenya. Products Compressed air equipments, air conditioning and refrigeration compressors, and power transmission equipment.

955. **KIRTI ELECTRICALS PVT. LTD.** 17/1 and 2, D.S.T.A Compound, Shivajinagar, Pune 5 Tel. 55863 Factory. Shembekar Industries Compound, Bombay-Pune Rd., Akurdi, Pune 35. Tel 82362. Estd 1962 Bank Bank of Maharashtra Cap. Rs 12,47,102. Prod Rs 49 950. Workers 11 Products Distribution transformers, fabrication work, chokes and job work.

956. **KIRTI PRINTERS.** 213 Guruwar Peth, Pune 2 Tel. 446834 Partnership, 1969. Bank: Bank of Maharashtra Cap. Rs 50,000 Prod Rs 50,000 Workers 3. Products Commercial printing, label cartons

957. **KISAN ENGINEERING WORKS.** Opp S T Stand, Baramati, Dist Pune Tel 478 Proprietary, 1972 Bank. Bank of Maharashtra. Cap Rs.50,000 Prod Rs 2,50,000. Workers 5. Product: Trailers (Ajit trailer)

958. **KISHORE FLOUR MILL.** 1537 Sadashiv Peth, Pune 30 Tel 442711. Proprietary, 1946 Bank Bank of Maharashtra Cap Rs 50,000 Prod Rs 75,000 Workers 9 Products: Job work of grinding.

959. **KISHORE PAPERS.** 82/5 Navi Peth, Pune 30 Tel 442696 Proprietary, 1962 Sister concern: Arti Trading Co Banks. Bank of India; Shivajinagar Co-op Bank Cap. Rs. 54,000 Prod. Rs 60,000 Workers 14 Product Grey board

960. **KISHORE PUMPS PVT. LTD.** A-13, 'H' Block, M.I.D.C., Pimpri, Pune 18. Tel 82616, 83373. Cable KISHORPUMP. Telex: 0145-375 Estd. 1963. Bank. The Saraswat Co-op Bank Ltd. Cap. Rs. 9,66,819 Workers 125. Products: Vertical submerged pumps, horizontal chemical pumps, vertical submerged agitator, nonclogg sewage pumps.

961. **K. K. CERAMIC GLASS ART.** 116 Mangalwar Peth, Pune 11. Tel. 24847. Factory: 228 Mangalwar Peth, Pune 11. Proprietary, 1977. Bank: Bank of Maharashtra. Cap. Rs 7,000. Prod. Rs.2,000. Workers 2 Products: Glass dishes and screen printing.

962. **KISMAT FABRICS.** 15/16 Kaka Halwai Estate, Pune 9. Tel. 441971. Partnership, 1972. Bank Bank of Maharashtra Cap. Rs.2,00,000 Workers 3 Products: Textiles clothing (power looms)

- 963. KIWALKAR PRINTERS.** 1380 Kasba Peth, Pune 11. Tel. 448691. Partnership, 1965. Bank: The Cosmos Co-op. Urban Bank Ltd. Prod. Rs 80,000. Workers 5. Products: Commercial printing and binding.
- 964. KODRE INDUSTRIES.** S/6 Parvati Industrial Estate, Pune 9. Tel. 442582. Partnership, 1974. Bank: The Cosmos Bank Ltd. Cap. Rs 60,000. Prod. Rs 1,50,000 Workers 10. Products: Fabrication and press components job work.
- 965. KOHINOOR ELECTRO-PLATINGS.** 468 (New), Sadashiv Peth, Pune 30. Tel. 443660. Partnership, 1965. Cap. Rs 1,10,000 Prod. Rs 1,00,000. Workers 8. Products: All types of electroplating.
- 966. KOHINOOR PROOFING INDUSTRIES.** 13/14 Ganesh Nagar, Chinchwad, Pune 19. Tel. 82511. Partnership, 1964. Bank: Dena Bank. Workers 9 Product: Cotton cloth waterproofing.
- 967. KOHINOOR RUBBER PRODUCTS.** 380 Bhawani Peth, Pune 2. Tel. 26246. Cable: KOHINOOR. Partnership, 1951. Bank: Canara Bank. Cap. Rs 1,50,000. Prod. Rs. 4,56,250. Workers 42. Export: Rs. 1,00,000. Countries: Kenya, Kuwait, U.A.E. Products: All types of rubber toy balloons, rubber play balls.
- 968. KOHINOOR SUPPLIERS.** 874 Sadashiv Peth, Pune 30. Tel. 448804. Proprietary, 1977. Bank: Bank of India. Cap. Rs. 5,000. Products: Commercial printing, binding, blocks, rubber stamps, paper supplying.
- 969. KOHINOOR TIMBER SUPPLYING CO.** 170 Dnyaneshwar Colony, Akurdi, Pune 35. Tel. 82392. Proprietary, 1965. Br. Bombay. Bank: Bank of Maharashtra. Workers 12. Product: Wooden boxes.
- 970. KOKIL PACKING WORKS.** 19-A Timber Market, Bhawani Peth, Pune 2. Tel. 26645. Cable: KOPACK. Partnership, 1958. Sister concern: Jay Deep Packings, Pune; Shri Ram Industries, 127 Mohan Nagar, Chinchwad, Pune 19. Bank: Central Bank of India. Cap. Rs. 3,00,000. Prod. Rs. 10,55,520. Workers 9. Product: Wooden packing cases.
- 971. KOLHATKAR METAL WORKS.** 356-B Ganesh Peth, Pune 2. Tel. 449537. Proprietary, 1965. Bank: Bank of India. Cap. Rs. 35,000. Prod. Rs. 1,25,000. Workers 6. Products: Nut bolts, sheet metal press parts, die punches, etc.
- 972. KOTAK GANDHI AND CO.** 230B Mangalwar Peth, Pune 11. Tel. 26583, 27076, 23220. Partnership, 1954. Sister concerns: Coal & Coke Trading Co; Universal Spring. Bank: Punjab National Bank Cap. Rs. 80,000. Prod. Rs. 25,000. Workers 12. Products: Kandi coal and agarbatti raw material.
- 973. KOTIBHASKAR SMRITI UDYOG.** (Capacitor Division). 510 Sadashiv Peth, Pune 30 Tel. 445632, 442059, 443691. Cable: PRABODHAN. Telex: C/o. 0145-333. Public Trust, 1969. Br. Ahmedabad, Pakli. Sister concerns: Mechanical Division, Electronics Division, Timber Division, Khandsari Sugar Division. Bank: Bank of Maharashtra. Cap. Rs. 12,80,000. Prod. Rs 50,00,000 Workers 135 Products: Condensers, capacitors, H T capacitors.
- 974. KOTIBHASKAR SMRITI UDYOG** (Mechanical/ Fabrication Division) 510 Sadashiv Peth, Pune 30 Tel. 443691, 442059, 445632. Cable PRABODHAN Telex: C/o 0145-333. Factory P O Khed-Shivapur, Tal. Haveli, Dist. Pune-412205. Tel. 31, 38. Public Trust, 1963 Factory: 1968. Sister concerns. Capacitor Division, Timber Division. Banks: Janata Sahakari Bank; United Commercial Bank. Cap. Rs 6,34,650 Prod. Rs 33,38,000 Workers 170. Products: Fabricated bore-well hand-pump, operators chairs and general furniture, gobar gas plants, water circulating pumps.
- 975. KOTHARI INDUSTRIES.** 17 Ganesh Peth, Pune 2. Tel. 444333, 444334. Factory: 155 Ganesh Peth, Pune 2. Tel. 448831. Partnership, 1965 Sister concern: MC & CO. Pune. Bank: Bank of Maharashtra. Cap. Rs. 1,50,000. Prod. Rs. 6,00,000. Workers 20. Products Washing soap, cakes, chips, detergent soap powder and cakes.
- 976. KOTHARI SERVICE CENTRE.** 408/8 Gultekadi, Pune 9. Tel. 440249. Proprietary, 1957. Banks: Cosmos Co-op. Urban Bank. Cap. Rs. 50,000. Workers 9. Products: Diesel engine repairs and welding works.
- 977. KOWLEY CONSULTANTS AND MANUFACTURERS.** 'Ashirwad', 124 Kadolkar Colony, Talegaon Dabhade, Dist. Pune-410506. Tel. T.G.D. 30. Factory: Survey No. 745/1/1 Bombay-Pune Rd., Talegaon Dabhade, Dist. Pune. Proprietary, 1974. Banks: State Bank of India; Syndicate Bank. Cap. Rs. 2,00,000. Prod. Rs. 2,35,971. Workers 4. Products: Polythene white master batch, epoxy powders.
- 978. KOYANA ELECTRIC WORKS.** 1442 Shukrawar Peth, Pune 2. Tel. 443426. Factory: 1450 Shukrawar Peth, Pune 2. Proprietary, 1953. Bank: Bank of India. Prod.

Rs 50,000. Workers 4. Products Repairs and rewinding of motors, fans, transformers; dealing in electric instruments.

979. KRAN RADER PVT. LTD. Industry Manor, Prabhadevi, Bombay 25 DD Tel. 451211 Cable. WESTERMECH. Bombay. Telex 011-2905 Factory: 29/1 Village Kharadi, Pune-Nagar Rd, Pune 14. Tel 26985, 26994, 20056 Cable KRANRADER Telex 0145-320. Estd. 1972 Bank Bank of India Cap. Rs 8,43,764 Prod. Rs. 63,66,970 Workers 70 Products: Wheels and axle sets for transfer cars, cranes, gear boxes, gear couplings, bearing housing

980. KRIPA CHEMICALS. Happy Colony, Kothrud, Pune 29 Tel 50015, 53718, 53971 Factory: W-81, MID.C, Bhosari, Pune 26 Partnership, 1968 Banks: Central Bank of India Cap. Rs 50,000 Prod Rs.2,00,000 Workers 8 Products: Alkyl benzene sulphonate (acid slurry), turkey red oil, detergents—liquid, powder and cakes, cleaning powder, jelly soft soap, perfumed liquid soap, urinal cubes, all other cleaning material

981. KRISHNA-ANANT INDUSTRIES. 1571 Sadashiv Peth, Pune 30. Tel 440295. Proprietary, 1965 Bank: Bank of India Cap. Rs 30,000 Prod Rs 25,000 Workers 4. Products: Job work

982. KRISHNA ENGINEERING WORKS. Jnc Walchandnagar, Dist. Pune—413114 Partnership, 1975. Bank. Dena Bank. Cap. Rs 50,000 Prod. Rs 1,00,000. Workers 5 Products: Cement and sugar plant machinery components, precision jobs, fabrication of platforms, mill house, boiler house, centrifugal starters and beggasse ductings, foundation belts, flanges, air distributors for cement plant, studs for gear boxes, etc

983. KRISHNA INDUSTRIES. 170 Dnyaneshwar Colony, Akurdi, Pune 35. Proprietary, 1968. Bank: Bank of Maharashtra Cap Rs 25,000 Prod Rs 28,000 Workers 2 Products. All kinds of machine job work.

984. KRISHNA INSTRUMENTS. 178 Mira Colony, Salisbury Park, Pune 1. Factory: 427/A-2 Industrial Estate, Gultekadi, Pune 9 Tel. 446109. Proprietary, 1973. Bank. Bank of Maharashtra Cap. Rs.80,000 Prod. Rs.30,000. Workers 2. Products Cylinder bore gauge, spares for precision measuring instruments.

985. KRISHNAKANT AND CO. 76 Bhawani Peth, Pune 2. Tel. 26023 Proprietary, 1970. Bank: Bank of Maharashtra. Cap. Rs 45,000 Prod. Rs 1,00,000. Workers

8. Products: Oil seal metal cups (pressing work); general spare parts as per specimen.

986. KSHIRSAGAR METALS. 65 Vithalwadi, P.O. Wadgaon Bk, Pune 9. Proprietary, 1976 Bank: Cosmos Co-op. Bank Ltd Cap. Rs 15,000. Prod. Rs 35,000. Workers 2. Products: Wooden, aluminium, gun metal and cast iron patterns to any size

987. KULKARNI FOUNDRIES LTD. Hadapsar Industrial Estate, Pune 13. Tel. 7563. Estd. 1957. Subsidiary companies: Kulkarni Patterns Pvt. Ltd. Banks: State Bank of India; Bank of Maharashtra. Foreign collaboration Whiting International & Ontario, U.S.A. (Electric Arc Furnace); Monometer(Ltd.) U.K. for Rotary oil fire furnace Cap Rs.73,47,650. Prod. Rs 41,98,241. Workers 270. Exports: Rs 3,00,000. Country: Nepal. Products: Foundry equipment, C.I. castings for machinery, engineering, C.I. castings—sub contracting, arc furnaces, rotary furnaces, cupolas grinders, mullers, tumbling, bassels, laddles etc, valves, pumps.

988. KULKARNI PATTERNS PVT. LTD. 22/6 Hadapsar Industrial Estate, Pune 13. Tel. 7538 Estd. 1963. Bank: Bank of India. Workers 10. Products: Non-ferrous castings such as aluminium, p b. gun metal, copper, wooden metallic patterns.

989. KULPAK ENGINEERS. 112/113, 'H' Block, MID.C., Pimpri, Pune 18. Tel. 82244, 83501. Proprietary, 1973 Bank: Bank of Maharashtra. Cap Rs 1,24,100. Prod Rs.1,52,534. Workers 11. Products. Wooden and metallic patterns.

990. KUMAR INDUSTRIES. 220/B Parvati, Pune 9. Tel. 442479. Factory: 217 Parvati, Pune 9. Proprietary, 1967. Bank: Bank of Maharashtra. Cap. Rs 1,00,000 Prod. Rs 80,000. Workers 4 Products: Printing boxes, ditching machine work

991. KUMUD INDUSTRIES. 755/1 Ganj Peth, Pune 2. Tel. 441037. Partnership, 1969. Bank: Bank of Maharashtra. Cap. Rs 40,000. Prod. Rs 50,000. Workers 4 Products: Electrical accessories, battery holders, industrial mouldings in plastic and bakelite.

992. KUNDEN INDUSTRIES. 1150 Bhawani Peth, Pune 2. Tel. 26625. Cable: KUNDAN SARI. Factory: 33/40 Gultekadi Industrial Estate, Pune 9. Tel 442812. Partnership, 1970. Bank: Bank of Maharashtra. Cap. Rs. 30,000. Prod. Rs 2,50,000. Workers 8. Products: Twisting of art silk and doubling

993. **KUNDAN TEXTILES.** 'Kundan House', 1150 Bhawani Peth, Pune 2. Tel. 23837, 26625. Cable: KUNDAN SARI. Factory: Plot No. 33/40 Gultekadi Industrial Estate, Pune 9. Tel. 442812. Proprietary, 1970. Sister concern: Narasayya Sayanna Kunden, Pune. Bank: Bank of Maharashtra. Cap. Rs. 27,000. Prod. Rs 1,54,000. Workers 8. Product: Cotton cloth.

994. **KUSUM SERVO COMPONENT.** B-3 Functional Electronics Industrial Estate, Bhosari, Pune 26. Tel. 83128 Proprietary, 1970. Bank: State Bank of India. Cap. Rs 4,50,000. Prod. Rs. 2,50,000. Products: Agricultural and industrial trailers, special-purpose machines.

995. **KWALITY CONFECTIONERY.** 902 Shukrawar Peth, Pune 2. Tel. 446256. Proprietary, 1973. Bank: Syndicate Bank. Cap. Rs. 25,000. Prod. Rs. 50,000. Workers 5. Products: Chikki and confectionery.

996. **KWALITY PLASTIC PRODUCTS.** 423/B Shaniwar Peth, Pune 30. Tel. 55989. Proprietary, 1974. Sister concern: Maneesha Suppliers. Bank: Bank of India. Cap. Rs. 40,000. Prod. Rs. 2,10,000. Products: Files, plastic folders, luxurious photo album, screen printing, spiral binding and punching, golden embossing and thesis binding.

997. **KWALITY PRODUCTS.** 113-14 Bhawani Peth, Pune 2. Proprietary, 1970. Bank: Dena Bank. Cap. Rs 75,000. Prod. Rs. 80,000. Workers 6. Products: Diesel engine spare parts.

998. **KWALITY TIMBERS AND FURNITURES.** S No. 25, Kharadi, Pune 14. Tel. 28952. Proprietary, 1973. Sister concern: Mohit Industries. Bank: Syndicate Bank. Cap. Rs. 3,00,000. Prod. Rs. 4,00,000. Workers 15. Products: Machine-made wooden door and window frames, shutters, furniture, packing-cases, planning, tenoning, chiselling, tung-grooving, chamfering and assembly work.

999. **KWALITY TRADERS.** 658 Ganj Peth, Gaikwad Bldg., Pune 2. Proprietary, 1973. Br. 64 Budhwar Peth, Pune 2. Cap. Rs. 18,000. Prod. Rs. 52,000. Workers 6. Products: Purses, airbags, file cases, suitcases, documentary bags, all travelling goods, presentation articles, keychains, plastic presentation articles, plastic covers.

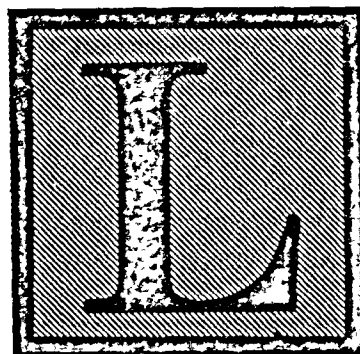

✓ 1000. **LA PRECISION SPRINGS AND ENGINEERING CO. LTD.** 'Kailas' 1103/A-2 Model Colony, Pune 16. Tel. 53634. Factory: Plot No 92, Block D III, MIDC, Bombay-Pune Road, Chinchwad, Pune 19. Tel. 83439. Cable: La Springs. Telex: 0145-319-INDCONS. Banks: Bank of Maharashtra; The Sangli Bank Ltd, Estd 1976. Foreign collaboration with Kato Springs Work Co. Ltd., Japan. Cap. Rs 72 lakhs. Prod. Rs 4 94 lakhs. Products: Precision springs of all types, compression, tension, torsion, wire form and flat springs.

1001. **LA ROZ ELEGANCE** 3 Mira Society, Sslisbury Park, Pune 1. Factory: 37 'S', M I D C , Bhosari, Pune 26. Tel. 82021. Bank: United Bank of India Proprietary, 1977. Cap. Rs. 2,00,000. Prod. Rs. 4,00,000. Workers 13. Products: Flush doors and frames, panel doors, windows and frames, office and household furniture, wooden knobs and handles, wooden flooring and ceiling, wooden cabinets and panelling

1002. **LABORATORY INSTRUMENT AND EQUIPMENT REPAIRS.** Shree Prasad, 1474 Sadashiv Peth, Tilak Road, Pune 30. Factory: Apte Wada, 1811 Deshmukhwadi, Sadashiv Peth, Pune 30. Bank: Bank of Maharashtra, Proprietary, 1969. Cap. Rs. 80,000. Prod. Rs. 1,40,000. Workers 7. Products: Pneumatically operated valves, air conditioning compressor valves, current collector.

1003. **LADGAONKAR INDUSTRIAL WORKS.** 228 Mangalwar Peth, Pune 11. Bank: United Western Bank. Proprietary, 1966. Cap. Rs 40,000. Prod. Rs. 40,000. Workers 5. Products: Governor screw (oil engine), Binza bolt, plugs, drain plugs, fill tank, fresh compounds, turning, milling, and fabrication.

- 1004. LAHOTI EXCELMAN (INDIA).** Head Office: 481/B Kalpana, Parvati Darshan, Pune 9. Tel. 442669, 470371. Office: 1169 Budhwar Peth, Shanpar-Mandai Road, Pune 2. Tel 470880 Partnership, 1977. Sister concerns: Super Gas Appliances, Kalpana Sari Dept., Kalpana Enterprises, etc. Bank: Bank of Baroda, Mahesh Sahakar Bank Ltd. Cap. Rs 2,00,000. Prod. Rs.8,00,000 Workers 12. Products: (manufactured/traded). Sole distribution of multi-purpose LP Gas appliances like gas lamps, portable gas stoves, standby cylinders, room heaters, blow lamps, gas candles; gas, cigarette and domestic electronic lighters.
- 1005 LAKADI KHELNI KARKHANA.** 74 Magar Ah. Hadapsar, Pune 28. Proprietary, 1969. Bank: Bank of Maharashtra, Pune 13 Cap. Rs 6,000 approx. Prod. Rs. 12,000. Products: Wooden articles for domestic purpose, parts of dining tables, chairs, etc.
- 1006. LALA RUBBER PRODUCTS.** MIDC, Area, Block No. S/27, Bhosari, Pune 26 Proprietary, 1977. Bank: Dena Bank Cap. Rs 80,000. Workers 5 Products. All engineering, industrial and automobile parts (rubber), O ring, bushes, packing and dairy rubber parts.
- 1007. LALIT PROFILES AND STEEL INDUSTRIES** Office and Factory: Kasarwadi, Bombay-Pune Road, Pune 18. Tel. 83266 Partnership, 1972 Sister concern: Udyog Chhaya, Kasarwadi, Bombay-Pune Road, Pune 18. Bank: Bank of Maharashtra. Cap. Rs 5,00,000. Prod. Rs.6,63,000. Workers 6 Products. Profile cut MS material of any contour, MS flanges to IS specification, industrial fabrication and allied work, supplying MS plates sheets, structurals, rounds and all industrial materials.
- 1008. LASARIA PLASTICS.** Akurdi, Pune 35. Tel. 83334. Partnership, 1972 Bank: Syndicate Bank. Products: Plastic automobile parts and auto hoods.
- 1009. LATA TEXTILES.** 35 Karve Road, Pune 4. Proprietary, 1971. Bank: Bank of India. Cap. Rs.28,000. Prod. Rs.18,600. Products: 100 x 120 and 80 x 72 50" grey mulls.
- 1010. LAXBRO MFG. CO.** Office: 8 Pallavi, 106 Senapati Bapat Road, Pune 16. Tel. 50893. Cable: LAXBRO. Factory: W-53, MIDC, Bhosari, Pune 26. Proprietary, 1976. Sister concern: R. Bhagwandas and Bros. Bank: Bank of Maharashtra. Cap. Rs 1 lakh. Prod. Rs.30,000. Workers 5. Products: Disposable plastic product for laboratories, plastic petri dishes, storage vial, tissue culture trays, laboratory washing solution, culture tubes.
- 1011. LAXMAN TEXTILES.** Office: 1150 Bhawan Peth, Pune 2. Tel 23837. Cable: KUNDAN SARI. Factory: 33/40 Gultekadi Industrial Estate, Pune 9. Tel 442812. Proprietary, 1966. Bank: Bank of Maharashtra. Cap. Rs. 25,000 Prod. Rs 1,40,000. Workers 8. Products: Cotton cloth on powerlooms.
- 1012. LAXMANDAS GOKULDAS.** 445 Ravivar Peth, Pune 2. Partnership. Bank: Sangli Bank Ltd. Cap. Rs 7,000. Prod. Rs 60,000 Workers 5. Product: Agarbatu
- 1013. LAXMI ELECTRIC.** 103 Rasta Peth, Pune 11. Proprietary, 1977. Bank: State Bank of India. Cap. Rs. 5,000. Prod. Rs 25,000. Products: Miniature, small and medium-size spot welders ranging from 1 to KVA 15 KVA storage energy spot welder for welding dissimilar metals up to 1500 w-sec and custom-built butt welders; general purpose transformers used in electronic instruments; electronic instruments like timers, power packs, school laboratory electric instruments, custom-built control panels.
- 1014. LAXMI ENGINEERING WORKS.** 42/2 Karve Road, Erandawana, Pune 4. Proprietary 1973. Bank: Bank of Maharashtra. Cap. Rs 15,000 Product. All types of engineering jobs.
- 1015. LAXMI HANDLOOM FACTORY.** 571 Ganj Peth, Pune 2. Tel. 442504. Partnership, 1960 Branch. 118 M. Phule Peth, Pune 2. Bank: Bank of Maharashtra. Cap. Rs.3,00,000. Prod. Rs 5,00,000 Workers 60. Product: Handloom sarees.
- 1016. LAXMI INDUSTRIES.** 114 Kasba Peth, Pune 11. Proprietary, 1967. Bank: Bank of Maharashtra. Cap. Rs 30,000. Prod. Rs.3,000. Product: Job work
- 1017. LAXMI IRON WORKS.** 138 Ganesh Peth, Pune 2. Proprietary, 1975. Bank: Bank of Maharashtra. Cap. Rs.50,000. Prod. Rs.1,50,000. Workers 8. Products: Tawa, ghamela, kadai, buckets, milk cans, drums, iron household goods and articles.
- 1018. LAXMI KESHAV INDUSTRIES.** 220/B Parvati, Pune 9. Tel. 442479. Proprietary, 1957. Sister concern: Kumar Industries, 217 Parvati, Pune 9. Bank: Bank of Maharashtra. Cap. Rs.1,50,000. Prod. Rs 1,70,000. Workers 8. Products: Card boxes, office files, all sorts of packing boxes.
- 1019. LAXMI KESHAV UDYOG.** 1348 Sadashiv Peth, near Chumnya Ganpati, Pune 30. Tel. 445820. Proprietary, 1968. Sister concern: Keshav Laxmi Prasadhan

Masalewale, 556/2 Shaniwar Peth, Pune 30. Bank: Shree Suvarna Sahakari Bank. Cap. Rs.30,000. Prod. Rs 3,00,000. Workers 15. Products. Spices, chilly powder, haldi powder, condiments, papads, masala supari and seasonal products.

1020. LAXMI MOTOR WORKS. 587/27 Shukrawar Peth, Pune 2. Proprietary, 1945. Bank. Canara Bank. Cap. Rs.8,000. Prod. Rs.10,000. Workers 10. Product: Spring pata.

1021. LAXMI PAINT WORKS 14 Tadiwala Road, P.O. Box 52, Pune 1. Tel. 27443-27656. Cable: LAXMI-PAINT. Proprietary, 1947. Bank: Syndicate Bank. Cap. Rs.1.5 lakhs. Prod. Rs.10 lakhs. Workers 8. Products: Ammunition paints and varnishes.

1022. LAXMI SAGAR INDUSTRIES. 503/2 Pune-Nasik Road, Bhosari, Pune 26. Proprietary 1974. Bank: Poona Co-operative Rupee Bank Ltd. Cap. Rs 8,000. Workers 4. Product: job work.

1023. LAXMI TYRES. 1342 Shivajinagar, Pune 5. Tel. 57622. Factory:412/1-A Bombay-Pune Road, Dapodi, Pune 12. Tel. 82209. Partnership, 1959. Bank Syndicate Bank. Cap. Rs.4 lakhs. Prod. Rs. 16 lakhs. Workers 11 Products. Repairing and remoulding of tyres.

1024. LAXSONS DYES AND CHEMICALS PVT. LTD. 86/12-13 Vajayashree, Kanchan Galli, Law College Road, Pune 4. Cable: COLOUR. Tel. 57754. Factory: Wadgaon Gupt. Ahmednagar. Tel. 893. Cable: COLOUR. Estd. 1971. Bank: Bank of Maharashtra. Products. Napthols, fast bases, Azoic and Azo dyes.

1025. LECMEC ENGINEERING CORPORATION. 39 Ambedkar Road, Sangam, Pune 1. Tel. 27565. Proprietary, 1965. Bank: Dena Bank. Cap. Rs. 1 lakh. Prod. Rs. 2 lakhs. Workers. 9. Products: Distribution panels, special purpose control panels, switchboards, etc.

1026. LECTROTEK. 33 Parvati Industrial Estate, Pune 9. Tel. 441048, 446953. Cable: LECTROTEK. Proprietary, 1970. Bank: State Bank of India; Bank of Maharashtra. Prod. Rs. 10 lakhs. Workers. 15. Products: Electronic process control instruments and systems: Temperature, pressure controllers/indicators (a) on-off, (b) PI & PID controllers; process value transmitters; electropneumatic transducers; pneumatic to electric transducers; process value sensors—platinum resistance bulbs; digital temperature indicators; programmers; recorders; instrumentation panels and systems.

1027. LEEBA INDUSTRIES. Kadolkarwadi, Talegaon Dabhade Dist. Pune. Tel. TGD 86. Proprietary, 1960. Bank: Bank of Maharashtra, Prod. Rs 2,37,423. Workers 17 Product: White and coloured school chalks.

1028. LEO TEXTILES. 22/5 Hadapsar Industrial Estate, Pune 13 Tel 7194. Partnership, 1968 Sister concerns: (1) Spica Plastic, (2) Jaitha and sons Bank: Bank of India. Workers 42. Product. Quality elastic tapes and webbings.

1029. LIBERTY ELECTRONICS. 233 old Bazar, Khadki, Pune 3. Products Thermal electronic and physical sensing devices.

1030. LIBRA DRUGS (INDIA). 92 Mangalwar Peth, Pune 11. Tel. 27658. Proprietary, 1959. Bank: Bank of India, Rasta Peth. Cap Rs 67,000. Prod. Rs.4,53,283. Workers 7 Products: Cough syrups, carminatives and digestives, anti-worm, antispasmodic, anti-histaminic medicines; vitamin tablets.

1031. LINK CONVEYOR MFG. PVT. LTD. 90 Bhosari Industrial Area, Pune 26. Tel. 83201, 83202, 83203. Telex: 0145-388. Estd. 1970. Sister concern: Deccan Mechanical and Chemical Ind. Pvt. Ltd. 78 Bhosari, Pune 26. Banks: Bank of India; Bank of Maharashtra; Shree Suvarna Sahakari Bank Ltd. Cap Rs 9,05,543 Prod. Rs.5,06,503. Workers 36. Products Printed circuit boards for electronic industries and chemically milled parts.

1032. LIPI BOILERS PVT. LTD. Regd. Office: 16 Phatak Baug, Navi Peth, Pune 30. Tel. 443255. 443265. Cable: COMBUSTION. Factory: E-5, Chukalthana, MIDC Ind. Area, Aurangabad. Tel. 8447. Cable: COMBUSTION AURANGABAD. Estd. 1974. Sister concern: Lipi International. Products: Water tube boilers, both coal and bagasse fired, generating steam for power as well as process applications, soot blowers used for cleaning external heating surfaces of boilers, automatic surplus valves used in sugar industry.

1033. LITAKA PHARMACEUTICALS PVT. LTD. 569/B-5 Shivajinagar, Pune 5. Tel. 52045. Gram: MALTINEE. Factory: 103 Chunawala Chambers, Shivajinagar, Pune 5. Tel. 52151. Estd. 1974. Bank: Bank of Maharashtra. Cap. Rs.4,81,367. Prod. Rs.2,50,000. Workers 9. Products: Cough syrup, Cofcap, Critensin, Diazepam tabs. BP. Febase capsules Ircon-OB, Kinopec, Kaolin mixture with Pectin NF XIII, Litavit capsules, Maltinee, Neo strep-K, Orthogesic.

1034. **LOHARI KAM HOUSE.** 223 Mangalwar Peth, Pune 11. Proprietary, 1960. Bank Bank of Maharashtra. Cap. Rs.2,000. Prod Rs 2 000 Workers 2. Product: Blacksmith work

1035. **LOKA SANGRAHA WORKS.** 1786 Sadashiv Peth, Pune 30. Tel. 441628. Cable LOKAGRAHA. Proprietary 1929. Banks Bank of Baroda; Bank of Maharashtra. Cap. Rs.11 lakhs Prod Rs 10 lakhs Workers 49 Products. Commercial printing, book printing, job printing, type manufacturing, block making.

1036. **LOMBAR INDUSTRIES.** 1180-C kasba Peth, Pune 11. Tel 447278 Proprietary, 1969. Bank Bank of Maharashtra Cap. Rs 30,000 Prod. Rs 25,000. Workers 5. Product: Job work.

1037. **LUBRICARE.** S/114 Bhosari, Pune 26. Tel 83001. Proprietary, 1974 Bank State Bank of India. Cap. Rs.17,72,600. Prod. Rs 14,83,095. Workers 34 Products. Engine cooling water pumps, Lub oil (gear) pumps.

1038. **LUNKAD DRESSES.** 550 Nana Peth, Nana Chawadi Chowk, Pune 2. Tel 26446. Partnership 1974. Bank: State Bank of India. Cap Rs.2,00,000. Prod. Rs. 6,00,000. Workers 16. Products Baba suits, babla suits, manilas, frocks, maxi, punjabi dresses, etc.

1039. **LUNAR CAUSTIC PVT. LTD.** 9/1-A/2 Erandawana, Pune 4. Tel. 57552 Cable LUNAR. Telex LUNAR VIA MCCI PUNE 333. Estd 1952. Banks: The United Western Bank Ltd, Bank of Maharashtra Cap. Rs. 10,10,403. Prod. Rs 23,70,230. Workers 55. Export Rs 25,602. Countries. Japan, Sri Lanka, Bangladesh. Products: Cadmium oxide, Cadmium sulphide, Cadmium Red/Yellow, Cadmium Nitrate, Cadmium Bromide, Cadmium Iodide, Cadmium Carbonate; photo etching chemicals.

1040. **LUNAR GEARS.** 26 Vishwajit Co-op. Housing Society, Pune 16. Tel 57367. Factory: W-31 MIDC, Bhosari, Pune 26. Tel. 82815. Partnership, 1975. Bank: Bank of Baroda. Cap. Rs. 1,50,000. Prod. Rs. 5,00,000. Workers 8. Products: Electrically operated valve actuators, pneumatically operated valve actuators, special spur gear boxes, auto vent (for anaesthesia apparatus), pneumatic damper drives.



1041. **M. A. INDUSTRIES.** 28/2 Safe Colony, B No. 30, Pune 13. Tel. 7132 Factory: 93-A Mahadeonagar, Manjri Road, Pune 412 307. Proprietary, 1976. Bank: Bank of India. Cap. Rs.50,000. Prod. Rs 1,00,000. Workers 7. Products: Brass taper bib cocks (taps) of all sizes used in pipelines, boilers, etc., and non-ferrous castings.

1042. **M A S INDUSTRIES.** 136 Mohannagar, Chinchwad, Pune 19. Tel. 82483. Partnership, 1977. Bank: Bank of Maharashtra. Workers 6. Products: All kinds of fabrication job work.

1043. **M.C. AND CO.** 17 Ganesh Peth, Pune 2. Tel. 444333-34 Factory: 155 Ganesh Peth, Pune 2. Partnership, 1934. Sister concerns: (1) M C. & Co., Ahmednagar, (2) Kothari Industries, Pune 2 Bank: Bank of Maharashtra. Cap. Rs.1,50,000. Prod. Rs 2,50,000. Products: Agarbatti, essence sticks and perfumery compound.

1044. **M C O INDUSTRIES.** 849 Ravivar Peth, Pune 2. Tel. 447384. Proprietary, 1965 Bank: Bank of India; Union Bank of India. Cap Rs 50,000. Prod. Rs 1,44,000. Products: Diesel engine spare parts, press parts, dies and tools.

1045. **M. DWARKADAS AND CO.** 139 Bhavani Peth, Pune 2 Tel. 25199, 27524 Proprietary, 1959. Bank: Bank of India; Union Bank of India; Sangli Bank Ltd. Cap. Rs.5 lakhs, Prod. Rs.22 lakhs. Workers 60. Products: Tables, Chairs, all kinds of furniture, interior decoration

1046. **M. EBRAHIM AND CO.** 967 Ravivar Peth, Pune 2. Tel. 449265. Partnership, 1956. Bank: The Muslim Co-operative Bank Ltd. Cap. Rs 40,000. Prod. Rs.1,00,000. Products: All types of tarpaulins, canvas bags and vehicle covers, etc.

- 1047. M. G. MOHITE AND SONS.** 29 Ganesh Peth, Pune 2. Tel. 444221. Cable: JWALAMUKHI. Partnership, 1904. Branch: Solapur. Sister concern: Mothite Jarda. Banks: Dena Bank; Punjab National Bank; Sangli Bank Ltd. Cap. Rs 4,00,000. Prod. Rs.25,00,000. Workers 178. Products: Bidis and jarda.
- 1048. M. H. PARDESHI AND CO.** 722 Ganj Peth, Timber Market, Pune 2. Tel. 444498. Partnership, 1961. Banks: Bank of India; Union Bank of India. Cap. Rs. 2,00,000. Prod. Rs.4,00,000. Workers 7. Products: Wooden cable drums and wooden packing boxes, packing boxes for engines and other spare parts.
- 1049. M. M. GAIKWAD.** 385 Shukrawar Peth, Pune 2. Proprietary, 1940. Cap. Rs.1,000. Prod. Rs.3,500. Products: Soldering tinsmithy, Blacksmithy and repairing.
- 1050. M. M. ENTERPRISE.** Office: 742/B Bhawani Peth, Pune 2. Factory: 454 Somwar Peth, Pune 11. Tel. 22994. Proprietary, 1972. Bank: Dena Bank. Workers 7. Products: All types of machining jobs, service tools, hub pressing mandrills and fixtures.
- 1051. M. M. INDUSTRIAL CORPORATION.** 170 Dnyaneshwar Colony, Akrudi, Pune 35. Tel. Res. 20496. Partnership, 1976. Sister concern: Yash Industrial Corporation. Bank: Dena Bank, Bombay. Cap. Rs.37,000. Prod. Rs.30,000. Workers 5. Product: All kinds of job work.
- 1052. M M C INDUSTRIES.** 47/30 Pune-Satara Road, Pune 9. Tel. 446333. Partnership, 1973. Bank: Bank of India. Cap. Rs.1,25,000. Prod. Rs 60,000. Product: Engineering job work.
- 1053. M. S. COMPANY.** 189 Ganesh Peth, Pune 2. Tel. 44870. Partnership, 1963. Cap. Rs.17,000. Prod. Rs. 2,00,000. Workers 4. Product: Agarbatti.
- 1054. M. S. C. ENGINEERING.** 297 Bhavani Peth, Pune 2. Tel. 27815. Partnership, 1967. Cap. Rs.70,000. Prod. Rs.70,000. Workers 6. Products: All types of pulleys of oil engine, shafts, nuts, studs, all types of oil engines, collect checks of Capstan machine.
- 1055. M. V. KHULE.** 1354 Kasba Peth, Pune 11 Tel. 449218, 444127. Proprietary, 1957. Banks: Bank of Maharashtra; The Poona Urban Co-operative Bank Ltd. Cap. Rs 1,00,000. Prod. Rs.40,000. Workers 3. Products: Boilers, brass vessels.
- 1056. MACC ENGINEERING CO.** 759/117 Deccan Gymkhana, Pune 4. Factory: 1194/4 Shivajinagar, off Ghole Road, Pune 5. Tel. 56498. Proprietary, 1970. Bank: Bank of Maharashtra. Cap. Rs.50,000. Prod. Rs 4,00,000. Workers 8. Products: Transformer manufacturing for electrical and electronic instruments, control panels etc, offset printing, anodised label manufacturing, block making exposure unit.
- 1057. MACHINEALL PVT. LTD.** 425/55 T M. V. Colony, Nirmal, Gultekadi, Pune 9. Factory: Plot No 28, Poona Small-Scale Co-op. Estate Ltd., Gultekadi, Pune 9. Tel. 441761. Estd. 1963. Bank: Bank of Maharashtra. Cap. Rs.2,72,450. Prod. Rs 12 lakhs Workers 42. Products: Hose couplings and fittings, sealing plus in NPTF, BSP, metric, hydraulic fittings, precision turned and threaded components, pressure relief valve as per requirement.
- 1058. MACHINERY'S COMPONENTS CO.** 573/2 Jangli Maharaj Road, Pune 5. Tel. 55107. Factory: 35 Erandawana, Pune 4. Tel. 56511. Partnership, 1969. Bank: Canara Bank. Cap. Rs 3,00,000. Prod. Rs.3,00,000. Workers 23. Products: All types of machine shaft keys and other turning components, lathe work.
- 1059. MACHINE COMPONENTS.** 507 Gultekadi (F.P. No. 391-A), behind Chakan Oil Mills, Shankarshet Road, Pune 9. Tel. 447840. Proprietary, 1970. Sister concerns: M/S. Shelffoundries, 507 Gultekadi, Pune 9; M/s. Megharaj Sales, 507 Gultekadi, Pune 9. Bank: Central Bank of India. Cap. Rs.1,34,582. Prod. Rs.1,30,000. Workers 30. Products: HMT type quick change toolposts for various sizes of lathes, universal coil-winding machine for fine gauge wires up to 46 swg. (import substitute item), patented animal-drawn agricultural crop-spraying machine, jigs fixture tooling items, precision component and unit assemblies as job work.
- 1060. MACHINOCRAFT.** 15/2 Dhanakawadi, Pune-Satara Road, Pune 9. Tel. Works: 442623. Partnership, 1970. Br. Bombay Metal and Steel Syndicate. Banks: Bank of Maharashtra; Bank of India. Cap. Rs.1,50,000. Prod. Rs.7,00,000. Workers 35 Export: Rs.75,000. Products: Industrial keys and other components, stainless steel flitch plates, machinery components.
- 1061. MACK INDUSTRIES.** F. II Block, Unit A-24, M.I.D.C., Pimpri, Pune 18. Proprietary, 1974. Bank: State Bank of India. Cap. Rs 80,000. Prod. Rs.60,000. Workers 6. Products: All types of machined accessories and revolving centres of floating sockets.

- 1062. MADAN MICROMETAL AND CAST PVT. LTD.** 35 Shivajinagar, Pune 5. Tel 54257. Factory: 27/84 Parvati Industrial Estate, Pune 9 Tel 440721 Estd 1972. Bank: Bank of Maharashtra. Cap. Rs 10,00,000. Workers 7. Products: Shell and sand moulded castings in ferrous and non-ferrous metals such as boiler, scooter, motor-cycle components, etc; metal powders such as aluminium, zinc, copper and copper alloy for chemical reaction, explosives, etc.; ferro-alloys such as ferro-manganese, ferro-chrome, ferro-vanadium, ferro-molybdenum.
- 1063. MADHAV CAPACITORS PVT. LTD.** Bharat Coal Compound, Bel Bazar, Kurla, Bombay 70. Tel. 555317. Cable: CAPACITORS BOMBAY 70. Factory: B-5-2 MIDC, Bhosari, Pune 26. Tel. 82360. Estd. 1962. Bank: State Bank of India. Workers 37. Products: Power factor correction capacitors, LT type 1 to 25 KVAR, HT type up to 11 kv
- 1064. MADHAV PRINTING PRESS.** 1073 Sadashiv Peth, Pune 30 Tel 443596. Partnership, 1935. Bank: Bank of Maharashtra. Prod. Rs.1,50,000. Workers 9. Product: *Printing jobs.*
- 1065. MADHAVSINGH RATANSINGH PARDESHI** 1204 Kasba Peth, Pune 11. Proprietary, 1932. Bank: Central Bank of India. Prod. Rs 20,000. Product: Supply of stones to flour mills, in various sizes
- 1066. MAGNAFIELD CONTROLS.** 1226/7 Apte Road, Deccan Gymkhana, Pune 4 Tel 50135, 53914 Telex 145-398. Partnership, 1972. Bank: State Bank of India. Cap. Rs 1.5 lakhs. Prod. Rs 9,71,019. Workers 9. Products: Electromagnetic crack detector machinery—stationary, mobile, portable models; demagnetising units; standard accessories—dry powder blower—Magnablow DP-200, dry powder spray bottles, fluorescent and non-flourescent magnetic powder for wet and dry application, centrifuge tube with stand, artificial fault test specimens, high current cables, prods and plugs, contact block, residual field indicator, black light assembly, solid state electronic timers and controls.
- 1067. MAGNET ENGINEERS.** 552 Rasta Peth, Pune 11. Tel. C/o. 27899. Partnership, 1969. Bank: Bank of India. Prod. Rs.60,000. Workers 8. Products: Repairs of electric motor, generator, transformers, airconditioners, water coolers, refrigerators.
- 1068. MAHADEO ENGINEERING WORKS:** New 533 Ghorpadi Peth, Pune 2. Proprietary 1964, Bank: Bank of Maharashtra. Cap Rs 20,000. Product: All kinds of job work.
- 1069. MAHADEO NARAYANAPPA RASAL.** 629 Ganesh Peth, Pune 2. Tel. 444398. Partnership, 1922. Banks: Union Bank; Dena Bank. Cap. Rs.40,000. Prod. Rs 50,000. Workers 126. Product: *Bidis.*
- 1070. MAHAJAN ENTERPRISES.** Saikripa, 1205/5 Apte Road end, Pune 4 Tel. 58156. Factory: Plot W-87, M.I.D.C., behind Century Enka, Bhosari, Pune 26. Proprietary, 1977. Bank: State Bank of India. Cap. Rs. 1,63,000. Prod. Rs 5,00,000. Workers 9. Products: Hot forged bolts, rivets and hot forged and pressed components.
- 1071. MAHAJAN PRINTING PRESS.** 651 Narayan Peth, Appa Balwant Chowk, Pune 30. Tel 448580, 50664. Proprietary, 1935. Bank: Bank of Maharashtra. Cap. Rs 1,00,000. Prod. Rs 1,50,000. Workers 13. Product: Commercial printing.
- 1072. MAHALAXMI METAL INDUSTRIES.** 596 Ganj Peth, Pune 2. Tel. 56719, 445705. Partnership, 1973. Banks: Bank of Maharashtra; Dena Bank. Cap. Rs.2 lakhs. Prod. Rs 4,50,000. Workers 6. Products: Copper sheets and circles—commercial quality only; raw materials—copper utensil scrap and brass utensil scrap, melting of scrap and annealing of sheets and circles.
- 1073. MAHALAXMI PRINTING PRESS.** 1156 Budhwar Peth, Pune 2. Proprietary, 1954. Bank: Bank of Maharashtra. Cap. Rs 13,000. Prod. Rs.6,000. Product: Commercial printing.
- 1074. THE MAHARASHTRA AGRO INDUSTRIES DEVELOPMENT CORPORATION LTD.** Rajan House, 3rd fl. Prabhadevi, Bombay 25. Tel. 458211-12-13. Cable: KRUSHIUDYOG. Telex: 011-6044. Factory: Sugras Factory, MIDC Industrial Estate, Plot 52, D. II, Chinchwad, Pune 19. Estd. 1965. Brs. Bombay, Nagpur, Nanded, Cap. Rs 850.19 lakhs. Workers 863. Exports: Rs.63,03,564. Countries: USA, USSR, Canada, Singapore, Gulf countries. Products: Fertilizers under brandname KRUSHIUDYOG, animal feed under brand name SUGRAS, fruit and vegetable products under brand name NOGA.
- 1075. MAHARASHTRA CAPACITORS.** 170 Dnyaneshwar Colony, Akurdi, Pune 35. Tel. 82432. Cable: VAISHALI. Partnership, 1973. Banks: The Poona Co-operative Rupee Bank Ltd.; State Bank of India. Cap. Rs.44,969. Prod. Rs 15,37,293. Workers 35. Products: Power, paper capacitors and condensers in various ranges for fans, tubelights, motors, etc.

- 1076. MAHARASHTRA CYCLE AND SCOOTER SEAT MANUFACTURER.** 458 Somwar Peth, Pune 11. Proprietary, 1969. Cap. Rs.5,000 Prod. Rs.3,000. Workers 2. Products: Cycle and scooter seats and leather works.
- 1077. MAHARASHTRA EDUCATIONAL AIDS.** 383B Shanivar Peth, Prabhune Road, opp. Kanyashala Pune 30. Proprietary, 1974. Bank: Canara Bank. Cap. Rs. 15,000. Prod. Rs.40,000. Workers 2. Products: Scientific geographical and nursery models, apparatus, equipments.
- 1078. MAHARASHTRA ELECTRICAL AND METAL INDUSTRIES.** 21/4 Hadapsar Industrial Estate, Pune 13. Tel. 7406. Partnership, 1962. Bank: State Bank of India. Cap. Rs.5,25,000. Prod. Rs.6,00,000. Workers 15. Products: Machinery required by Electricity Boards, special purpose machinery, diesel, engines, trucks, special-purpose pumps, welding machine, textile machinery, etc.; parts manufactured—cylinder head studs, main bearing studs, various types of threaded components.
- 1079. MAHARASHTRA ENGINEERING WORKS.** 367 Ganj Peth, Pune 2. Tel. 441538. Proprietary 1969. Bank: Bank of Baroda. Cap. Rs 1,00,000. Prod. Rs. 1,00,000. Products: Adjustable floating reamers, tapping attachment, precision instrument repairing reamers for finishing of boring, tapping attachment.
- 1080. MAHARASHTRA FINE CHEMICALS.** 813-14 Bhavani Peth, Pune 2. Tel. 26945/23012. Factory: 58 Hadapsar Industrial Estate, Pune 13. Tel. 7336. Partnership, 1969. Br. Bombay. Bank: Bank of Baroda. Cap. Rs.3,50,000. Prod. Rs.20,00,000. Workers 22. Products: Ammonium Thiocyanate, Barium Chromate, 2-4 Dinotro Alpha Naphthol, EDTA Nafe, Ethyl Silicate, Guanidine Nitrate, Lead Thiocyanate, Potassium Antimonyl Tartrate, Potassium Bicarbonate, Potassium Ferricyanide, Potassium Hydrogen Tartrate, Potassium Nitrate, Potassium Sodium Tartrate, Sodium Para toluene Sulphinat, Tannic Acid, Thio Urea.
- 1081. MAHARASHTRA HANDLOOM FACTORY.** 555 Ganesh Peth, Pune 2. Tel. 444946. Proprietary, 1962. Bank: Bank of Maharashtra. Cap. Rs 2,00,000. Prod. Rs.4,00,000. Workers 9. Product: Handloom sarees.
- 1082. MAHARASHTRA INDUSTRIES WORKS.** 941 Budhwar Peth, Pune 2. Partnership, 1971. Bank: Dena Bank. Cap. Rs.20,000. Prod. Rs.24,728. Workers 2. Product: Wax candle.
- 1083. MAHARASHTRA LEATHER WORKS.** 216 Mangalwar Peth, Pune 2. Proprietary, 1972. Cap. Rs. 2,000. Workers 2. Product: All kinds of suit cases.
- 1084. MAHARASHTRA LEATHER STORE.** Kasarwadi, Pune 18. Partnership, 1972. Bank: State Bank of India. Cap. Rs 2,000. Prod. Rs 50,000. Workers 16. Product: Treating raw hides, and exporting through agent.
- 1085. MAHARASHTRA LIME SUPPLIERS.** 900 Sachapur St., Pune 1. Tel. 24425. Factory: 18/5 Hadapsar Industrial Estate, Pune 13. Tel. 7220. Partnership, 1971. Bank: Bank of Maharashtra Workers 11. Products: Lime and sagol.
- 1086. MAHARASHTRA METAL SHEET WORKS.** 81 Guruwar Peth, Pune 2. Tel. 444195. Partnership, 1939. Bank: Bank of Maharashtra. Cap. Rs 5,00,000. Prod. Rs.10,00,000. Products: Brass circles and non-ferrous strips and stainless steel utensils, cutlery, machinery spare parts, oil lamps, agricultural implements and machinery parts, industrial-quality brass sheets.
- 1087. MAHARASHTRA METAL PRODUCTS.** 402 Guruwar Peth, Pune 2. Proprietary, 1961. Bank: Bank of Baroda. Cap. Rs. 50,000. Prod. Rs 1,50,000. Products: Non-ferrous utensils and machinery parts for laboratory and chemical industries.
- 1088. MAHARASHTRA MODEL WORKS.** Shed No. 37 Parvati Audyogik Vasahat, Pune 9. Tel. 440339. Partnership, 1961, Bank: United Commercial Bank. Cap. Rs.42,534. Prod. Rs.1,10,000. Workers 7. Products: Science models, montessory school toys, wooden furniture.
- 1089. MAHARASHTRA MUDRAN SHALA CHAP-KHANA.** 1786 Sadashiv Peth, Pune 30. Tel. 441628, Factory: 2011 Sadashiv Peth, Pune 30. Tel. 443531. Charitable institutuon, 1928. Sister concern: Loksangraha Mudranalaya. Banks: Bank of Baroda; Bank of Maharashtra. Cap. Rs.10 lakhs. Prod. Rs 1 lakh. Workers 22, Product: Printing.
- 1090. MAHARASHTRA PACKAGING INDUSTRIES.** T-136/137 MIDC, Bhosari, Pune 26. Tel. 82805. Partnership, 1967. Bank: Canara Bank. Cap. Rs.10,23,077. Prod. Rs 12 lakhs. Workers 25. Products: Corrugated paper rolls, boards and boxes.
- 1091. MAHARASHTRA SAFETY GLASS WORKS PVT. LTD.** T-94 Bhosari General Block, Pune 26.

Tel. 83047 Cable: ATULTUF. Telex: 0145-302. Estd. 1973. Sister concern: Atul Glass Industries Pvt. Ltd., Delhi. Bank: Union Bank of India Cap. Rs 18,48,442. Prod. Rs.32,49,951. Workers 46. Products Toughened safety glasses, gauge glasses.

1092. MAHARASHTRA SAW MILLS. 82 New Timber Market, Pune 2. Tel. 444331. Partnership, 1973. Bank: Canara Bank, Bank of India. Cap. Rs.1.5 lakhs. Prod. Rs 10 lakhs. Workers 5. Products: Cutting wooden logs and sleeper into planks and sizes; inland-quality and export-quality boxes

1093. MAHARASHTRA SPUN PIPE INDUSTRY PVT. LTD. 7 Chiplunkar Bhavan, Lal Bahadur Shastri Road, Pune 30. Tel. 443019. Factory .96 MIDC, Bhosari, Pune 26 Tel. 83532. Cable: MAHAPIPE Estd. 1968. Banks: State Bank of India; Bank of Maharashtra. Cap. Rs.8,34,100. Prod. Rs 20,00,000. Workers 80. Products: RCC spun pipes and spigot and socket pipes, RCC water tanks, septic tanks, sentry cabins, dust bins, V shape gutters, precast cement articles.

1094. MAHARASHTRA STEEL INDUSTRIES. E/4/24 Bhosari Industrial Estate, Pune 26 Tel. 82971. Cable: STEELMILL Partnership, 1968. Br. Bombay Bank. State Bank of India Cap. Rs.10 lakhs. Prod. Rs.1 crore. Workers 61. MS flats, angles, rounds, square bars, etc.

1095. MAHARASHTRA SYNTHETICS PVT. LTD. Plot 51, D-2 MIDC, Chinchwad, Pune 19. Tel. 82508. Cable: TENSOR Estd. 1971. Br. Kolhapur. Bank: Syndicate Bank. Cap. Rs.4 lakhs. Prod. Rs 25 lakhs. Workers 40. Products: Designers, producers and erectors of precast prestressed and steel structurals, components for housing industrial bldg. and sugar machinery components.

1096. MAHARASHTRA TIN WORKS. 391/92 Mangalwar Peth, Pune 11. Proprietary, 1963. Bank: Bank of Maharashtra. Cap. Rs 20,000. Product: All types of tin boxes.

1097. MAHARASHTRA TYRE RESOLING WORK. 46/A-1 Pune-Satara Road, Pune 9. Proprietary, 1972. Bank: Syndicate Bank. Cap. Rs.60,000. Prod. Rs.7,500. Workers 2. Product: Tyre resoling, remoulding and repairing.

1098. MAHARASHTRA WELDING AND MECHANICAL WORKS. Solapur Road, At & Post: Indapur, Dist. Pune. Proprietary, 1971. Capital Rs.1,800. Prod.

Rs 9,000. Workers 3 Products: Job work and servicing electric and gas welding, oil engine repairs, plumbing, repairs of steel furniture, window grills.

1099. MAHAVIR ELECTRICAL INDUSTRY. 480 Somwar Peth, Pune 11. Factory: 482 Station Road, Khadki, Pune 3 Tel 50265. Proprietary, 1971. Bank: Bank of Maharashtra. Cap. Rs 55,000. Prod. Rs 30,000. Workers 4. Products: Switches, 3 pin wall sockets, ceiling rose, 15-A 250v and 30A 500v kitkat MEM type, radio type dix.

1100. MAHAVIR PLASTICS. 149 Bhavani Peth, Pune 2. Tel. 25067. Factory: 139 Bhavani Peth, Pune 2. Proprietary, 1975. Br. 667 Ravivar Peth, Pune 2. Bank: State Bank of India. Cap. Rs 35,000. Prod. Rs 1 lakh. Workers 8 Products: Plastic reprocess, plastic bags, bins, etc.

1101. MAHAVIR TEXTILES. 14 Hadapsar Industrial Estate, Pune 13 Tel 7288, 7425, 7497. Proprietary, 1970. Br. Saswad, Dist Pune. Products. Cotton fabrics, voiles, dhotis, mulmul, etc.

1102. MAHENDRAKUMAR MOHANLAL. Station Rd., Baramati, Dist. Pune Tel 388. Partnership, 1967. Bank: State Bank of India. Cap. Rs 2,50,000. Prod. Rs.10,00,000. Workers 8. Products: Organic and inorganic manures.

1103. MAHESH ELECTRICALS AND MANUFACTURERS. 317 Ghorpadi Peth, Pune 2. Tel C/o. 441889. Proprietary, 1974. Banks: State Bank of India; United Commercial Bank. Cap. Rs 46,521. Prod. Rs.2,60,029. Workers 6. Products: Copper and aluminium wires and cables of different sizes, unarmoured wires.

1104. MAHESH ENGINEERING WORKS. 309 Shukrawar Peth, Pune 2 Proprietary, 1971. Bank: Pune Merchants Co-op. Bank Ltd. Cap. Rs 40,000. Prod. Rs. 20,000. Workers 4. Products: Dial gauges for machineries and fabrication, sub-contracting.

1105. MAHESH INDUSTRIES. Raj Chambers, opp. Bajaj Auto Ltd., Akurdi, Pune 35. Tel. C/o. 82667. Partnership, 1977. Bank: The Sangli Bank Ltd. Cap. Rs. 25,000. Product: Job work in pressing, spot welding.

1106. MAHILA UDYOG LTD. Laxmanrao Kirloskar Road, Khadki Pune 3. Tel. 55882. Estd. 1966. Br. Karad. Banks: Bank of Maharashtra; Bank of Karad. Cap. Rs. 3,31,487. Prod. Rs 19,72,878 Workers 201. Products: Processing thin-walled bearings.

1107. **MAHINDRA ELECTRO-CHEMICAL PRODUCTS LTD.** 145 Bombay-Pune Road, Pune 18. Tel. 82771-83177-83178. Cable:EMSEAL PIMPRI PF. Telex: PN-209, PN-250. Estd. 1964. Brs. Delhi, Calcutta and Madras. Wholly owned subsidiary of Mahindra & Mahindra Ltd. Banks: The United Western Bank Ltd.; United Commercial Bank. Cap. Rs.10,88,720. Prod. Rs. 1,25,00,000. Workers 185. Exports: Rs 24,00,000. Countries: Kuwait, Egypt, Mauritius, Tanzania, Zambia, Nigeria, Bahrain, Iraq, Greece, Muscat, Dubai, Pakistan, Ceylon, Nepal, Singapore, Malaysia, Thailand, Hong Kong, Philippines, Australia. Products: M-Seal epoxy cable joining kits for cables up to 33 KV, M-Seal manual crimping tools, M-Seal epoxy compounds, Dovesive & M-Seal super bond epoxy adhesives, M-Seal anti-corrosive paint, FRL tubes, epoxy bushings, etc.
1108. **MAHINDRA INDUSTRIES.** 335/A Ghorpadi Peth, Pune 2. Proprietary, 1975. Bank: Punjab National Bank. Cap. Rs.45,000. Workers 4. Products: Scooter and motor cycle accessories made from ERW pipe (spare parts).
1109. **MAHINDRA OWEN LTD.** 155 Bombay-Pune Rd, Pimpri, Pune 18. Tel. 82445, 82446, 82447 & 82448. Cable: JEEPSTRAIL PIMPRI. Telex: JEEPS 0145-223. Factory: 148 Bombay-Pune Road, Pimpri, Pune 18. Estd. 1958. Brs. Calcutta, New Delhi, Madras, Dharwar, Tiruchirappalli. A subsidiary of Mahindra & Mahindra Ltd. Banks: Bank of Maharashtra; United Commercial Bank; Oriental Bank of Commerce Ltd.; The Sarswat Co-op. Bank Ltd. Foreign collaboration: Rubery Owen Holdings Ltd., England, (Technical and financial collaboration). Cap. Rs. 130.88 lakhs. Prod Rs.302.34 lakhs. Workers 843. Export 1975-76: Rs.1.31 lakhs. Countries: Sri Lanka, Kabul and Mauritius. Products: High and low speed trailers for agriculture, industry and Defence.
1110. **MAHINDRA SINTERED PRODUCTS LTD.** 146 Bombay-Pune Road, Pimpri, Pune 18. Tel. 82632-82931-2. Cable: SINTERED PIMPRI. Telex: 0145-350 SINTER. Estd. 1961. Brs. Bombay, Calcutta, Delhi and Madras. Banks: Canara Bank; Union Bank of India; United Commercial Bank. Foreign Collaboration: GKN Bound Brook Ltd., Lichfield, U.K. Cap. Rs.194.38 lakhs. Prod. Rs.235 lakhs. Workers 368. Export: Rs.15 lakhs. Countries: Iran, Iraq, Kuwait, Singapore, Malaysia, Thailand, Philippines, Hong Kong, Yugoslavia. Products: Sintered bushes and parts and tilters; copper, tin, lead and iron powder for powder metallurgy applications.
1111. **MAK GLIT CHEM.** 686/1-A Chandrika Housing Society, old Bibvewadi Road, Pune 9. Factory: 126, Narhe Vadgaon, Khadakvasla Road, Haveli, Pune. Partnership, 1975. Bank: Bank of Maharashtra. Cap. Rs.10,000. Prod. Rs.55,000. Workers 3. Products: Metal surface treatment chemicals, electroplating chemicals, electroplating plant and machinerie-.
1112. **MALWADKAR INDUSTRIES.** A/22 Flatted Bldg., M.I.D.C., Pimpri, Pune 18. Proprietary, 1975. Bank: State Bank of India. Cap. Rs.50,000. Prod. Rs.30,000. Workers 4. Products: Starch phosphate, Gum Arabic substitute, VIR cleaning powder and allied items.
1113. **MANDA TEXTILES.** 35 Erandawana, Karve Road, Pune 4. Proprietary, 1961. Bank: Bank of India. Cap. Rs.28,000. Prod. Rs.18,600. Workers 6. Product: Grey mulls.
1114. **MANDKE COLD STORAGE.** 707 Sadashiv Peth, Pune 30. Tel. 443234. Factory: 112 Bhosari Industrial Area, MIDC, Pune 26. Partnership, 1972. Bank: Vijaya Bank Ltd. Cap. Rs.9 lakhs. Prod. Rs.1,50,000. Workers 9. Product: Ice, cold storage facilities
1115. **MANDELIA ELECTRONICS PVT. LTD.** Century Bhavan, Dr. A. Besant Road, Worli, Bombay 400 025. Tel. 454833, 464163, 458261. Cable: MANDYTRON. Factory: Plot T-188-B, Electronic Industrial Estate, Bhosari, Pune 26. Tel. 82944. Estd. 1972. Bank: Union Bank of India. Cap. Rs.16.09 lakhs. Prod. Rs.11 lakhs. Workers 40. Products: Entertainment electronic items, professional electronic items, process control instrument for textile industry.
1116. **MANE AUTO WORKS.** 1048 Shukrawar Peth, Subhashnagar, Lane No. 5, Pune 2. Tel. 440582. Partnership, 1956. Bank: Central Bank of India. Cap. Rs.20,000. Workers 2. Products: Scooter and motorcycle repairs, jathe work.
1117. **MANEESHA SUPPLIERS.** 423/B Shaniwar Peth, Pune 30. Tel. 55989. Proprietary, 1968. Sister concern: Kwality Plastic Product. Bank: State Bank of India. Cap. Rs.50,000. Prod. Rs.3 lakhs. Products: All kinds of office files, index files, cardsheet folder, thesis binding, various types of punching, etc.
1118. **MANGAL METAL INDUSTRIES.** 603 Ghorpadi Peth, Pune 2. Proprietary, 1963. Bank: Poona Merchants Co-op. Bank Ltd. Cap. Rs.50,000. Prod. Rs. 10,000. Workers 3. Products: Brass utensils.

- 1119. MANGAL PLASTICS.** Narali Baug, Gultekadi, Pune 9. Tel. 441377. Cable: MANPLAST. Partnership, 1969. Bank: Janata Sahakari Bank. Cap. Rs.50,000. Prod. Rs 10 lakhs Workers 8. Products: Plastic moulded articles, low and high density polythene bags, PVC tubing, sleeving and straps.
- 1120. MANGAL TEXTILES.** 43 Karve Road, Erandawana, Pune 4. Tel. 56135. Partnership, 1962. Bank: Bank of India. Cap. Rs 25,000. Prod. Rs 40,000. Workers 3. Product: 50" mulmul.
- 1121. MANGESH ENTERPRISES.** 259 Rasta Peth, Pune 11. Tel. 22242. Proprietary, 1914. Bank: Bank of India. Cap. Rs.17,000. Prod. Rs 26,000. Product: Office files, speciality in handmade paper files, box files
- 1122. MANKOO AND SONS.** C/o. Hoonjan Engg., 230 Bhavani Peth, Pune 2. Tel. 24899. Proprietary, 1947. Sister concern: Delite Engineering Works. Bank: Punjab National Bank. Cap. Rs 5 lakhs. Prod. Rs 4 lakhs. Workers 10. Products: Electrical engineers and govt licensed contractors, offering complete electrical installations project services, e.g. HT Substations, industrial installations, L.T. control panels, motor winding, cabling services, services on retainer basis.
- 1123. MANIK SOAP WORKS.** 824-B Ganj Peth, Near Ghaseti Bridge, Pune 2. Tel. 444537. Proprietary, 1963. Bank: The Cosmos Co-op. Bank Ltd. Cap. Rs 1,00,000. Prod. Rs 3,00,000. Workers 5. Products: All types of washing soap, liquid soap and jelly soap, detergents, detergent powder, detergent liquid, suppliers of chemicals and oils used in washing soap and detergents, etc.
- 1124. MANICHHA ENGINEERING WORKS.** 136-A Mohan Nagar, Rathod Metal Rolling Mill Compound, Telco Road, Chinchwad, Pune 19. Proprietary, 1974. Bank: United Western Bank. Ltd. Cap. Rs 15,000. Prod. Rs.30,000. Workers 5. Product: Job work.
- 1125. MANISHA ENGINEERING WORKS.** 370-A Somwar Peth, Pune 1. Tel. 27640. Foundry. 170 Bopodi, Pune 3. Proprietary, 1968. Bank: Bank of Maharashtra. Cap. Rs 1,03,558. Prod. Rs.2,13,288. Workers 28. Products: Vehicle parts for defence factories, press parts in CRCA, aluminium and brass for oil seals.
- 1126. MANJIT INDUSTRIES.** 16D Elphinstone Road, Khadki, Pune 3. Proprietary, 1972. Bank: State Bank of India. Cap. Rs.25,000. Prod. Rs.30,000. Workers 2. Products: Hex bolts, shaft sleeves, bevel gear, bush pulley, V belt pulley, flanges and job work.
- 1127. MANOHAR BAKERY.** 1231/2 Sadashiv Peth, Pune 30. Tel. 442410. Partnership, 1957. Br. Navi Peth, Pune. Bank: Bank of Maharashtra. Cap. Rs 20,000. Prod. Rs 2.5 lakhs. Product: Bread.
- 1128. MANOHER ENGINEERS.** 12 NPS Lines, Pune 1. Tel. 25866. Proprietary, 1964. Bank: Bank of India. Cap. Rs 40,000. Prod. Rs.12,000. Workers 2. Products: Electronic control panel, all kinds of electronic cabinets
- 1129. MANOHAR PRINTING PRESS.** 504 Rasta Peth, Pune 11. Proprietary, 1935. Bank: Bank of Maharashtra. Product: Printing.
- 1130. MANOJ DRESS MFG.** 471 Budhwar Peth, Pune 2. Partnership, 1966. Bank: Canara Bank. Cap. Rs 2,50,000. Prod. Rs 6 lakhs. Workers 12. Products: Frocks and maxis, blouses and skirts.
- 1131. MANOJ ENGINEERING WORKS.** 170 Ganesh Peth, Pune 2. Proprietary, 1965. Cap. Rs.3,000. Prod. Rs 8,000. Worker 1. Product: Adapters.
- 1132. MANOJ INDUSTRIES.** 7 Mula Road, Pune 3. Proprietary, 1972. Bank: Mahesh Sahakari Bank Ltd. Cap. Rs 18,000. Prod. Rs. 40,000. Workers 2. Products: Wooden taper blocks for paper industry, steel job work for automobile and sugar machinery.
- 1133. MANOJA UDYOG.** 83 Shivajinagar, Pune 5. Proprietary, 1966. Bank: Central Bank of India. Cap. Rs 25,000. Products: Fabrication of m. s. grills, windows, water tanks, structural columns, trusses, shuttering material, etc
- 1134. MANOWAX.** 105 Shanwar Peth, Pune 30. Tel. 56660. Proprietary, 1967. Bank: Cosmos Co-operative Urban Bank Ltd. Cap. Rs.10,000. Prod. Rs.12,000. Workers 2. Products. Hearing aids, pocket aids, air phone.
- 1135. MARC ZIP INDUSTRY.** 65/62/2 Koregaon Park, Pune 1. Tel. 20261. Factory: Plot S-4 Bhosari Industrial Area, Pune 26. Partnership, 1973. Bank: Punjab National Bank. Cap. Rs 3.5 lakhs. Prod. Rs.2.5 lakhs. Workers 9. Product: Brass and aluminium zip fasteners.
- 1136. MARETS.** 126 Narhe Vadgaon, Sinhadgaon Road, Pune 9. Tel. 448672. Proprietary, 1946. Br. Raviwar Peth,

Pune. Banks: Bank of Maharashtra; Sangli Bank Ltd. Cap. Rs.20,000. Prod. Rs. 5,000. Workers 2. Products: Toffees, Chocolate, Shrikand slabs, Longenzes of all salts.

1137. MARK ELEKTRA. Plot 15, Gultekadi Industrial Estate, Gultekadi, Pune 9. Tel. 441090-441098, 441149. Partnership, 1968. Sister concern: Mark Elektrijs. Bank: Shree Suvarna Sahakari Bank. Cap. Rs.70,000. Prod. Rs. 5 lakhs. Workers 17. Products: Repairs and rewinding of all types of Indian and imported electrical equipment. Electrical engineers and consultants.

1138. MARK ELEKTRIKS. Plot 15, Gultekadi Ind. Estate, Pune 9. Tel. 442090-441090. Cable MARKELEC. Partnership, 1967. Bank: Central Bank of India. Cap. Rs.2,55,000. Prod. Rs.16,71,000. Workers 43. Products: Special purpose and custom built electric motors, Eddy current couplings.

1139. MARS ENTERPRISE ENG. DIV. Malawani Industrial Estate, 228/29 Mangalwar Peth, Pune 2. Tel. 25681. Proprietary, 1972. Bank: Bank of India. Cap. Rs.2 lakhs. Prod. Rs.1 lakh. Workers 35. Products: Various types of trolleys and structural jobs.

1140. MARTINA'S MACHINKRAFT. W-17/S Block, MIDC Area, Bhosari, Pune 26. Tel. 83414, 82887. Cable: MARTINAS. Proprietary, 1974. Sister concern: Martinas' Engineering Works. Banks: Syndicate Bank; Bank of Maharashtra. Cap. Rs. 2.50 lakhs. Prod. Rs. 4 lakhs. Workers 9. Products: Chemical plant and equipments, pharmaceutical equipments, all types of blenders, agitators, reaction vessels and equipment for nuclear, paint, food-processing, plastic and rubber industry.

1141. MARUTIRAO BABAJI JEDHE DESHMUKH. 907/8 Shukrawar Peth, Pune 2. Tel. 444195. Factory: 79 Guruwar Peth, Pune 2. Partnership, 1985. Br. Maharashtra Metal Sheet Works. Banks: Bank of Maharashtra; Dena Bank. Cap. Rs.7 lakhs. Prod. Rs.12 lakhs. Workers 60. Products: Non-ferrous strips, circles, sheets, all kinds of household utensils, stainless steel utensils, cutlery, oil lamps, bells, agricultural implements, ferrous and non-ferrous castings.

1142. MASTER LEATHER WORKS. 307 Narayan Peth, Pune 30. Tel. 449603. Factory: 244 Shanwar Peth, Pune 30. Proprietary, 1964. Bank: Indian Bank. Cap. Rs.70,000. Prod. Rs.1,20,000. Workers 9. Products: Leather bags, travelling-bags, suitcases, purses, belts.

1143. MASTERWHEELS ENGINEERING PVT. LTD. 206 Pleasant Apartments, 15th Lane, Prabhat Road, Pune 4. Tel. 54805. Factory: Plot T-35, MIDC, Bhosari, Pune 26. Tel. 83273 Estd. 1973. Banks: Bank of India; Bank of Baroda. Cap. Rs.3 lakhs. Workers 18. Prod. Rs. 3 lakhs. Products: Machine tool accessories, machine keys as per ISI, DIN or BSS specifications, carbon steels or alloy steel keys in hardened and tempered condition stainless keys, misc precision automobile components.

1144. MASS CHEMICALS. W-24 S Block, MIDC, Bhosari, Pune 26. Tel. 83296. Partnership, 1974. Bank: Bank of Baroda. Cap. Rs 50,000. Prod. Rs.2,50,000. Workers 8. Exports. Rs. 42,000. Country: Indonesia. Products: Fast garnet GBC base, fast scarlet G base, fast red B base, fast scarlet R base, fast scarlet GGS base, naphthol ASG.

1145. MATCHWEL ELECTRICALS (INDIA) LTD. 4/11 Asaf Ali Road, New Delhi. Tel. 28646. Factory: Off. Nagar Road, Pune 1. Tel. 22246. Telex: 0145-365. Estd. 1946. Subsidiary company: Matchwel Electrical (India) Ltd. of Bajaj. Banks: Bank of Maharashtra; Punjab National Bank. Cap Rs.171.73 lakhs. Prod. Rs. 437 lakhs. Workers 980. Export: Rs. 56 67 lakhs. Countries: Iraq, Kuwait, Tripoli, Dubai, Bahrain, Lagos, Nigeria, Muscat, Abu Dhabi. Products: Ceiling fans, table fans, misc. fans, with brand name as Bajaj, Bahar, Kassels, Kohinoor.

1146. MATHER GREAVES LTD. Udyog Bhavan, 29 Walchand Hirachand Marg, Ballard Estate, Bombay 38. Tel. 269661-62-63. Cable: SPRINKLER. Telex: 011-3120. Factory: Bombay-Pune Road, Chinchwad, Pune 19. Tel. 82196-97-98-99. Cable: MATHER. Telex: 0145-351. Estd. 1961. Subsidiary company: Mather & Platt Ltd., Bombay, Calcutta, Madras and New Delhi. Bank: United Commercial Bank. Foreign collaboration: Mather & Platt Ltd., U.K. Cap. Rs.78.83 lakhs. Prod. Rs.292.91 lakhs. Workers 486. Exports: Rs.12.75 lakhs. Countries: Tanzania, Singapore, Malaysia, Canada, U.K. Products: Large and special purpose centrifugal pumps for thermal stations, atomic power plants, industrial applications such as fertilizer complexes, petrochemical industries, mines, refineries and water works; textile processing and finishing machinery, flameproof motors, food-processing and packaging machines.

1147. MAXEL INDUSTRIES. 625 Fugewadi, Pune 12. Proprietary, 1974. Bank: Bank of Maharashtra. Cap. Rs.35,000. Workers 3. Products: Job work, engine spare parts.

- 1148. MAYOOR ENGINEERS.** No. 16 F-2 Block, MIDC, Pimpri, Pune 18. Tel. 82809. Proprietary, 1972. Bank: Bank of Maharashtra. Cap. Rs. 2 lakhs. Prod. Rs. 2.50 lakhs. Workers 12. Product: Job work.
- 1149. MAYOOR PRINTING PRESS.** 649 Budhawar Peth, Pune 2. Tel. 449291. Factory: 187 Kasba Peth, Pune 11. Partnership, 1933. Bank: United Commercial Bank. Cap. Rs. 3 lakhs. Prod. Rs. 6 lakhs. Workers 20. Products: Account books printing, supplying of stationery.
- 1150. McGAY INDUSTRIES.** 16-A Shivajinagar, Pune 5. Tel. 58789. Proprietary, 1969. Bank: Poona Peoples Co-op. Bank Ltd. Cap. Rs.50,000. Prod. Rs.1,92,000. Workers 3. Product: UNIQUE lettering sets.
- 1151. MEBA CHEMICALS.** Deepak Bhavan, Tanajwadi, Pune 5 Tel. 57138-50915. Factory: Bal Patil Estate, Akurdi, Pune 35. Tel. (request) 83487. Proprietary, 1972. Banks: Central Bank of India; Canara Bank. Cap. Rs. 1 lakh. Prod. Rs.1.84 lakhs. Workers 8. Products: Liquor ammonia, in all grades, refrigerant gases and chemicals, heavy or fine.
- 1152. MECOL INDUSTRIES.** 1504 Sadashiv Peth, Pune 30. Tel. 446005. Factory: 691-A Pune-Satara Road, Partnership, 1968. Sister concern: Powercraft Engineers Banks: Cosmos Co-operative Bank; Bank of Maharashtra. Cap. Rs 5,000. Prod. Rs.80,000. Workers 6 Products: Electrical panel boards.
- 1153. MEDITRONICS.** 1433-A Shukrawar (New), Pune 2. Tel. 440735. Proprietary, 1973 Bank: Bank of India. Cap. Rs.30,000. Prod. Rs.2 lakhs. Workers 3. Products: Psychological instruments—Chronoscope, tumers, psychogalvanoscope, electro convulsive therapy apparatus, digital tachometers, digital thermometers, digital clocks and clock systems, automatic line voltage stabilizers.
- 1154. MEELAN HOSPITAL STEEL FURNITURE.** 427/11 Gultekadi Industrial Estate, Pune 9 Tel. 442562. Proprietary, 1963. Bank: Bank of Maharashtra. Cap. Rs 1 lakh. Prod. Rs.2 lakhs. Workers 10. Product: Hospital furniture.
- 1155. MEENA ENGINEERING WORKS.** 61 Mangalwar Peth, Pune 11. Tel. 26437. Partnership, 1970 Bank: Syndicate Bank. Cap. Rs.50,000. Prod. Rs 60,000. Workers 8. Products: All types of gears, chains, wheels, sprockets, industrial and textile parts.
- 1156. MEENA ENTERPRISES.** 565-C Shaniwar Peth, Pune 30. Partnership, 1977. Bank: United Western Bank. Cap. Rs 15,000. Prod. Rs.40,000. Workers 9. Products: Electronic subassemblies, electromechanical assemblies for electronic industry, job work of assemblies.
- 1157. MEENA TEXTILES.** Hadapsar Industrial Estate, Pune 13. Tel. 7288, 7425, 7497. Proprietary, 1971. Br. Saswad, Dist. Pune. Products: Cotton fabrics, voiles, dhotis, mulls.
- 1158. MEERA ENGG. WORKS.** 24-25 Somwar Peth, Pune 11. Tel. 24514. Partnership, 1972. Bank: Central Bank of India. Cap. Rs.14,000. Prod. Rs.1,40,000. Workers 3. Products: Job work.
- 1159. MEHTA CHEMICAL COMPANY.** 1482 Kasba Peth, Daruwala Bridge, Pune 11. Tel. 448204. Factory: 436 Guruwar Peth, Pune 2. Tel. 440179. Partnership, 1971 Bank: Bank of Maharashtra. Cap. Rs 81,570. Prod. Rs 1,66,400. Workers 2. Products: Cleaning powder.
- 1160. MEHTA PACKARD INDUSTRIES PVT. LTD.** 69-B Hadapsar Industrial Estate, Pune 13. Tel. 7265-7510. Cable: PACKARD. Estd. 1975. Br. Bombay. Sister concern: Ms. PAPERSTEQ. Bank: Bank of India. Cap. Rs.6.15 lakhs. Prod. Rs 18 lakhs. Workers 25. Products: Composite containers, paper tubes and paper cores.
- 1161. MEHTA SOAP FACTORY.** 1482 Kasba Peth, Pune 11. Tel. 448204. Factory: 486 Guruwar Peth, Pune 2. Tel. 440179. Partnership, 1962. Bank: Bank of Maharashtra. Cap. Rs 2,47,000. Prod. Rs.7,32,000. Workers 13. Products: Washing soap, industrial soap, acid slurry and industrial liquid detergent, washing detergent powder, dealing in cleaning powders.
- 1162. MEKOS ENTERPRISE.** T. 134 MIDC, Bhosari, opp Jayanand Khira, Pune 26. Tel. 82183-82081. Partnership, 1975. Bank: Syndicate Bank. Workers 42. Products: HDPE monofilament, fishing twine and ropes.
- 1163. MENGJI DRESSES.** 246 Guruwar Peth, Pune 2. Tel. 449853. Partnership, 1974. Bank: State Bank of India. Cap. Rs.50,000. Prod. Rs.2,50,000. Workers 9. Products: Hosiery, children's readymade clothes.
- 1164. METAKAST INDUSTRIES.** Usha Swapna, 10th lane, Prabhat Road, Pune 4. Tel. 55082. Factory: Metal Park, C-15, MIDC area, Chikalthana, Aurangabad. Tel. 8391-8310. Proprietary, 1970. Sister concern: Metakast

Industrial Directory of Pune

Patterns. Banks: Bank of Maharashtra; United Western Bank Ltd. Cap. Rs.6.50 lakhs. Prod. Rs.15.00 lakhs Workers 50. Products: Aluminium and copper alloy based cast components for machine tool, electrical machines for Defence, Navy, sugar machinery, diesel engine, marine engines and railways.

1165. METAL TREAT ENTERPRISES. Plot A-90-91, H Block, MIDC, Pimpri, Pune 18. Tel. 82029. Partnership, 1972. Bank: Bank of Maharashtra. Cap. Rs.2 lakhs. Prod. Rs.2,50,000. Workers 8. Product: Heat treatment and electroplating job work.

1166. METAL COMPONENTS. 335B Shanwar Peth, Pune 30. Tel. 446956. Partnership, 1973. Cap. Rs.60,000. Prod. Rs.4,50,000. Workers 9. Product: All kinds of dowel pins, gudgeon pins, measuring pins (gauge pins), oil-level indicators.

1167. METAL CRAFT ENGINEERING WORKS. 1273 Sadashiv, Pune 30. Proprietary, 1962. Bank: Merchant Co-op. Bank. Cap. Rs.50,000. Prod. Rs.20,000. Workers 4. Products: Electrical goods, agricultural spares and vehicle spares.

1168. METCONS. 32/1/6-A Erandawana, Pune 4. Tel. 53378 (request). Partnership, 1971. Bank: Bank of Maharashtra. Cap. Rs.10,000. Prod. Rs.2 lakhs. Workers 8. Products: Hydraulic control units, hydraulic cylinders, special-purpose machines.

1169. METRO FABRICATION WORKS. 669 Phuge-wadi, Pune 12. Tel. 54301. Proprietary, 1972. Bank: Bank of Maharashtra. Cap. Rs.15,000. Prod. Rs.1,50,000. Workers 7. Products: Steel windows, grills, water tanks, rolling shutters.

1170. METRO GADI KARKHANA. 95-B Shivajinagar, Pune 5. Tel. 56582. Proprietary, 1966. Bank: Indian Bank. Cap. Rs 2 lakhs. Prod. Rs.1,50,000. Workers 5. Product: Bedding equipment.

1171. METRO INDUSTRY. 749 Kasba Peth, Pune 11. Partnership, 1961. Bank: The Poona Co-op. Rupee Bank. Cap. Rs.20,000. Prod. Rs.70,000. Workers 10. Product: Oil-engine spare parts.

1172. METRO PLASTMOLD. 146 Shukrawar Peth, Pune 2. Tel. 446712. Partnership, 1963. Bank: Bank of India. Cap. Rs.1 lakh. Prod. Rs.1,30,000. Workers 8. Products: Plastic bags, plastic injection moulded industrial articles.

1173. MICRO ENGINEERING WORKS. 24/25 Somwar Peth, Pune 11. Proprietary, 1969. Bank: Bank of Maharashtra. Cap. Rs 25,000 Prod Rs 20,000. Workers 3 Products: General repairing.

1174. MICROFINE BRIGHT STEEL CORPORATION. Shiva-Ashirvad, 29-A Sane Guruji Road, Pune 30. Tel. 443956. Factory: Plot 117 General Block, Bhosari, Pune 26. Tel. 82485 Cable: MICROSTEEL. Bank: Bank of Maharashtra. Proprietary, 1974. Cap. Rs 7 lakhs Prod. Rs.7.5 lakhs. Workers 7 Products: Bright bars in EN series, alloy steel, mild steel and other specifications, round, squares, hexagons, flats, rectangles, special profile in steel.

1175. MICRO PISTONS AND RINGS LTD. 8/2 Kharadi, off Pune-Ahmednagar Road, Pune 14. Estd. 1974. Banks: Indian Bank, Bank of Maharashtra. Foreign collaboration: SIM Morges, Switzerland. Cap Rs.30 lakhs. Workers 40. Products: Cylinder liners for diesel engines, cars, trucks, tractors, etc Proposed manufacturing of piston rings, pistons and pins to the same application.

1176. MICRON ENGINEERS. Technicians' Block, Bhosari Industrial Area, Pune 26. Tel. 82760. Proprietary, 1966. Sister concern: Square Deal Enterprises Bank: Bank of India. Cap. Rs 1 lakh. Prod. Rs. 1,20,000. Workers 5 Products: Ancillary products for medium and large scale industries in Pune, fabrication and assembly of special-purpose equipment.

1177. MICRON ENGINEERING WORKS. 380 V. P. Street, Pune 1. Tel. 25283. Factory: 86, S Block, MIDC Industrial Area, Bhosari, Pune 26. Tel. 83618. Partnership, 1968. Bank : State Bank of India. Cap. Rs 2,41,879. Prod. Rs 6,45,424. Workers 15. Products: Highly sophisticated and accurate quick release coupling and various complicated turning components, inlet and exhaust manifold and various heavy and light fabricated components.

1178. MICRON INSTRUMENT CO. 405/5 Narayan Peth, Pune 30. Tel. 448368. Factory: S.NO. 5, Keshavnagar, Mundhwa, Tal. Haveli, Dist. Pune. Proprietary, 1975. Sister concern: Instrument House. Bank: Bank of India. Cap. Rs.75,000. Prod. Rs.60,000. Workers 3. Products: Dial snap gauge, depth micrometer, pattern-maker's marking gauge, master cylinder, gear snap gauge, surface grinding micrometer.

1179. MICROTONE. S. Block, Plot 8, MIDC Industrial Area, Bhosari, Pune 26. Proprietary, 1976. Bank: United

- Commercial Bank. Cap. Rs.6 lakhs. Workers 8. Products: Heat treatment of ferrous and nonferrous metals, specialised in high speed steel, tool steel, bath (liquid) nitriding, general-purpose heat treatment
- 1180. MIDGE GEARS.** Poonam Apartments, Pune-Nasik Road, Bhosari, Pune 26 Tel. C/o 82887. Factory W-16 S Block, MIDC, Bhosari, Pune 26 Products Gears, gear pumps, gear units.
- 1181. MIKROS MILLING PVT. LTD.** F-13 Shanti Kunj, 4 Sadhu Vasvani Road, Pune 1 Tel. 26563 Cable MIKROS Factory 120 Nagar Road, Pune 6 Tel. 24862 Estd. 1971. Sister concern General Glass Machinery P Ltd. Banks: Indian Bank; Janata Sahakari Bank. Cap Rs.60,000. Prod. Rs.2,82,211 Workers 6 Products Machinery and equipments for glass and ceramic industry
- 1182. MIKROTECH.** 1870 Sadashiv Peth, Bhikardas Maruti Road, Pune 30. Tel. 442756. Factory. 38-39 Hadapsar Industrial Estate, Pune 13. Tel 7567. Proprietary, 1974 Bank: Bank of Maharashtra. Cap. Rs. 2 lakhs. Prod Rs.1.75 lakhs Workers 7 Products Dial gauges, dial calibration tester
- 1183. MILAN PRODUCTS.** 170 Ganesh Peth, Pune 2. Tel. 441534. Factory 170 Ganesh Peth, Pune 2 Proprietary, 1966. Bank Bank of Maharashtra. Cap. Rs 50,000 Prod Rs.1,65,210 Workers 7. Product. Plastic bags.
- 1184. MILANSAR BAKERY.** 158 Kharadwadi, Bombay-Pune Road, Pune 18. Tel 82940. Partnership, 1970. Bank: Bank of India. Cap. Rs 30,000. Prod Rs 6 lakhs Workers 14. Product: Bread, cakes, etc.
- 1185. MILAN IRON INDUSTRIES.** 667 Ganesh Peth, Pune 2. Proprietary, 1970. Cap. Rs.10,000. Prod. Rs.30,000. Products: Fabrication and iron work of all types, cupboards
- 1186. MINAKSHI METAL WORKS.** 207 Mangalwar Peth, Pune 11. Tel 26534. Partnership, 1961. Bank: Punjab National Bank. Cap. Rs 2 lakhs. Products: Cooper and brass sheets and circles.
- 1187. MINARA PAINTS.** 1225-D Vinayak Ashram, Shivajinagar, Pune 4. Tel 58572 Factory: Plot 3, Block S, MIDC, Bhosari, Pune 26. Proprietary, 1974. Bank: Bank of Maharashtra. Cap. Rs 60,000. Prod. Rs.5,000. Workers 2. Products: Ready mixed paints, Alkyd resins for paints required by foundry, water-soluble linseed oil for oil bond distemper.
- 1188. MINIATURE ELECTRICALS.** 132-B Ganeshkhind, Pune 7. Tel 57061. Cable MINILEC. Partnership. 1964 Sister concern. Statfield Equipment P Ltd. Bank: State Bank of India. Cap. Rs 63,000. Prod Rs 1 lakh Products Single-phase preventors, phase failure relays, water-level controllers, sensing relays, annunciation systems, supervisory systems, high voltage DC low current systems up to 150 kv infra-red heating systems.
- 1189. MIRAJKAR I. S.** 1056 Budhwar Peth, Pune 2 Proprietary, 1937 Bank Syndicate Bank Prod. Rs 30,000 Products Manufacturing and repairing of Indian musical instruments
- 1190. MITCO GARMENTS.** 403 Ganesh Peth, Laxmi Road, Pune 2. Tel 447390 Partnership, 1975 Bank: State Bank of India Cap. Rs.70,000 Prod Rs.2,25,000. Workers 8 Products Frocks, babysuits, skirts, maxies, bell bottom sets, skirt blouses.
- 1191. MOBSUN PRODUCTS.** 138/B Narayan Peth, N C Kelkar Road, Bhandari Niwas, Pune 30 Factory At Bholavade, Post Bhor, Tal Bhor Dist. Pune. Proprietary, 1977. Bank State Bank of India Workers 7. Products: Industrial leather handgloves, asbestos handgloves, canvas handgloves.
- 1192. MODERN BAG WORKS.** 1047 Raviwar Peth, Pune 2 Proprietary, 1972. Cap. Rs.1,000. Prod. Rs 2,500 Product: Sofa set design, leather work.
- 1193. MODERN ENGINEERING WORKS.** 264 Solapur Bazar, Pune 1. Tel. 27882. Partnership 1974. Bank Syndicate Bank. Cap. Rs.4 0,000 Prod. Rs 55,000. Workers 3 Product: Job work.
- 1194. MODERN ENGINEERS AND COMPANY.** 13/32 B.P. Road, Dapodi, Pune 12 Tel. 58014 Partnership 1959. Bank. United Commercial Bank. Cap. Rs 65,000. Prod. Rs.1,50,000. Workers 8 Products Surface grinder, automobile door hinges and general machinery work.
- 1195. MODERN INDUSTRIES.** 355 Somwar Peth, Pune 11. Factory: 454 Somwar Peth, Pune 11. Proprietary, 1976. Bank Miraj State Bank Cap. Rs 15,000. Prod. Rs. 10,000. Products. Plastic electrical goods, articles, plastic industrial parts, plastic novelties
- 1196. MODERN INDUSTRIAL CORPORATION.** 25. Budhwar Peth, Appa Balwant Chowk, Pune 2 Tel 448957-449457. Factory B. 5 H Block, MIDC, Pimpri, Pune 18.

- Tel. 82921. Partnership, 1965, Sister concern: Modern Paper Stores. Banks: Bank of Maharashtra; State Bank of India. Cap. Rs.10 lakhs. Prod. Rs.60 lakhs Workers: 10. Products: Plain, printed and threadline waterproof packing paper rolls and sheets, plain and folded paper bags, waxed packing paper rolls/sheets, paper coils, silicon release paper rolls and sheets, flexo printed wrappers, for textile mills, bakeries, soap, bidi, cigarette, laundries etc., polythelined hessian cloth, paperlined hessian cloth, bituminised hessian cloth.
- 1197. MODERN MECHANICAL WORKS.** 408/6 Gultekadi, Pune 9. Proprietary, 1959. Cap. Rs 5,000. Prod. Rs.2,500, Worker 1. Product: Automobile repairing.
- 1198. MODERN MOTOR SPRAY PAINTING WORKS.** 1157/3 Sadashiv Peth, Pune 30. Tel. 441888. Proprietary, 1948. Bank: Bank of Maharashtra. Cap. Rs. 10,000. Prod. Rs 60,000, Workers 4. Product: Motor painting.
- 1199. MODERN PACKAGINGS.** Opp. Akashwani. Hadapsar, Pune 28. Tel. 7471 (request). Proprietary, 1977. Bank: Allahabad Bank. Cap. Rs.5,000. Prod. Rs.18,000. Workers 2. Products: Corrugated boxes plain and with printing.
- 1200. MODERN PRINTING SERVICE—BALODYAN PRESS.** 1372 Shukrawar Peth, Natu Bag, Pune 2. Tel. 441034. Proprietary, 1916. Bank: Bank of Maharashtra. Cap. Rs.3 lakhs. Prod. Rs.2 lakhs. Workers 15. Products: Photo blocks, colour and white, offset printing of maps, labels, books, general stationery.
- 1201. MODERN SALES PVT. LTD.** 46/A Dave Industrial Estate Pune-Satara Road, Pune 9. Estd. 1974. Bank: Bank of Maharashtra. Cap. Rs.2 lakhs. Prod. Rs. 3 lakhs. Workers 9. Products: Special-purpose machines, precision components jigs fixtures etc., standard tooling components for toolroom and production shops.
- 1202. MODERN TECHNICAL CENTRE.** 144 Narayan Peth, Pune 30. Tel. 446503. Proprietary 1964. Bns. Satara, Karad. Bank: Bank of Maharashtra. Cap. Rs 2 lakhs. Prod. Rs.80,000. Workers 16. Products: Monolayer roller bottle drum apparatus, inseminating guns for cattle, automobile spare parts, small multi-stream hydraulic valve assembly, conducting various technical courses like Job Inspector, Machinist, Scooter Mechanic, Mechanical Draughtsman and Fitter.
- 1203. MOHAN INDUSTRIES.** 181 Shukrawar Peth, Shinde Ali, Pune 2. Factory: Vithalwadi, Sinhagad Road, Near Temple, Pune Proprietary, 1966. Bank: Bank of Maharashtra. Cap. Rs 10,000. Prod. Rs 6,000. Workers 2. Products: Super sharp single edge blades and cardboard cutter, staple removers
- 1204. MOHAN INDUSTRIES.** 9 Mangalwar Peth, Pune 11. Tel. 23595. Partnership, 1966. Bank: State Bank of India. Prod. Rs 1,25,000. Workers 7. Products: All kinds of spare parts of oil engines
- 1205. MOHAN SLATE DEPOT.** 1482 Shukrawar Peth, Shanipar Chowk, Pune 2 Partnership, 1961. Banks: Rupee Co-op. Bank Ltd, United Commercial Bank. Cap. Rs. 2,000. Prod. Rs 4,000. Product: Beaded slates
- 1206. MOHANKAR TIMBER CO.** 119 New Timber Market, Pune 2. Tel. 443467 Partnership, 1970. Bank: Central Bank of India Cap. Rs 2 lakhs Prod. Rs 5 lakhs. Workers 15 Products Saw milling, wood cutting, packing boxes.
- 1207. MOKAL INDUSTRIES.** S-13-B Parvati Industrial Estate, Pune 9. Proprietary, 1971. Bank: Bank of Maharashtra. Cap. Rs.1,25,000. Prod. Rs 70,000. Workers 8. Products: Machinery spares, oil-engine spare parts.
- 1208. MOKHA ENGINEERING WORK.** 365 Shivajinagar, Pune 5. Tel. 57959. Partnership, 1961, Banks: Bank of Maharashtra; Punjab Sind Bank. Workers 6. Product: Repairing automobile parts, and alteration work.
- 1209. MOHANLAL MANILAL.** 685 Ravivar Peth, Pune 2. Tel. 446894, 449260. Partnership, 1941. Sister concern: Shah Mohanlal Manilal (Retail cloth merchant); Mohanlal Manilal (wholesale cloth merchant), Momshajayant Enterprises (Mechanical Engineers and Manufacturers). Bank: Union Bank of India. Workers 25. Products: Handloom and powerloom sarees, dhotis. Mechanical products—Diaphragm cylinders, booster pumps and allied accessories.
- 1210. MONA DIAL PAINTING WORK.** 1900 Sadashiv Peth, Pune 30. Tel. 446374. Proprietary, 1973. Sister concern: Hindustan Watch Co. Bank: State Bank of India. Cap. Rs.45,000. Prod. Rs.2 lakhs. Export : 50% production is exported through clients. Countries: U.K., U.S.A. and Middle East. Workers 3. Products: Various types of dials required for precision gauges, dial indicators and machine tool dials, specialised in industrial painting of machine tools.

- 1211. MONA STEEL FURNITURE.** 339 Ghorpade Peth, Pune 2 Tel. 441399. Proprietary, 1973. Bank: Bank of Maharashtra Cap. Rs 25,000 Prod Rs 50,000. Workers 7. Product: Steel furniture
- 1212. MONGA ELECTRONICS PVT. LTD.** Arun Bazar, S. V. Road, Post Box 7616, near Bank of India, Malad (West), Bombay 64 Tel. 696662 Cable: MONGA BOMBAY 64 Factory Behind Post Office, Bhosari Industrial Estate, Pune 26 Tel. 82451-83089 Cable: MONGA Pune 26 Estd. 1968. Bank: Bank of India Cap. Rs 2,73,000 Prod Rs 7 lakhs. Workers 15 Product: High-frequency plastic welding machines.
- 1213. MONIR METAL INDUSTRIES.** 1662 Shukrawar Peth, Pune 2. Tel. 444288 Proprietary, 1961. Banks: Bank of India, Union Bank Cap. Rs. 2,30,000 Prod. Rs. 3 lakhs. Workers 6 Products: Stainless steel utensils, stainless steel watch straps, stainless steel cutlery goods, stainless steel hospital wares, aluminium and brass utensils
- 1214. MORE BROTHERS.** 1875 Sadashiv Peth, Pune 30 Proprietary, 1970 Bank: State Bank of India. Cap. Rs. 22,000. Prod Rs 25,000 Workers 4. Product: Structural fabrication.
- 1215. MORESHWAR BOOK BINDING WORKS.** 141 Shukrawar Peth, Shinde Ali, Pune 2. Proprietary, 1965. Bank: United Western Bank Products: Book binding, letter printing, visiting cards, receipt books.
- 1216. MORRIS ELECTRONICS LTD.** Bhosari Industrial Estate, Pune 26. Tel. 82581-83235. Cable: MORITE POONA. Telex: 0145-240 Estd 1965. Bank: Bank of Maharashtra. Cap. Rs 1,45,00,000. Prod. Rs. 65 lakhs Workers 95. Export: Rs. 3,14,000. Countries: UK, West Germany, France Products: Soft and hard ferrites, ferrite antenna rods, screw cores, cup and drum cores, balun cores, sleeve cores, pot cores with bobbins, E cores, U cores, I cores, T oroidal cores, axial lead choke bodies, inductor cores, small tubes, beads and pins etc., loudspeaker magnets, segment magnets, rotor magnets, ring magnets, ante meter magnets, etc.; TV deflection yoke parts, linearity coil parts, flexible magnetic strip, RFI suppressor/fuse holder, high current inductors, round components for electronics, magnetic products for engineering industry
- 1217. MOTOR PRINTING WORKS.** 182 M.G Road, Pune. Tel. 25439. Proprietary, 1974. Bank: Union Bank. Cap. Rs. 35,000. Prod. 1,50,000. Workers 4. Products: Car upholstery, car painting, car accident repair job, alteration job, accessories fitting, car wiring
- 1218. MRUNAL POLYMER ENTERPRISES.** W-33 MIDC, Bhosari, Pune 26. Tel. 82815 (req.) Proprietary, 1976. Bank: Bank of India. Cap Rs 2,50,000. Prod. Rs. 1,15,000. Workers 9. Product: Moulded and extruded rubber articles as per customers' specifications and drawings.
- 1219. MUBARSH ENGINEERING CO.** 62 Somwar Peth, Pune 11. Tel 24665 Proprietary, 1971. Bank: Bank of Maharashtra Cap. Rs. 65,000. Prod. Rs 1,25,000. Workers 7. Products: Spare parts for compressors, generators and oil engines and tractors.
- 1220. MUDRA.** 383 Narayan Peth, Pune 30. Tel. 446836. Proprietary, 1976. Bank: Bank of Maharashtra. Cap Rs 3 lakhs Products: Designing and printing of sales literature, folders, leaflets, posters, packaging material, book covers, books, commercial and advertising printing, stationery and art printing by offset and letterpress processes, complete designing service for printing material and advertising.
- 1221. MUDRAN VIDYA MANDIR.** Vishnupuri, Talegaon Dabhade. 410 507. Tel. 98 (Talegaon). Proprietary, 1967. Banks: Syndicate Bank, Union Bank of India; Jankalyan Sahakar Bank. Cap. Rs. 45,000. Prod. Rs 3,50,000. Workers 60. Products: Printing and binding of annual diaries, bank registers, ledgers etc., ruling and binding of exercise books, different small printing jobs
- 1222. MUDRANKAN.** 205 Shanwar Peth, Pune 2. Proprietary, 1972. Bank: Bank of Maharashtra. Cap. Rs 20,000. Prod. Rs 18,000. Workers 2 Product: Printing job works and colour printing
- 1223. MUDRIKA COMMERCIAL PRINTERS.** 705 Shukrawar Peth, near Globe Talkies, Patwardhan Wada, Pune 2. Tel. 446813. Proprietary, 1973 Bank: Bank of Maharashtra Cap. Rs 30,000. Prod. Rs 40,000. Workers 5. Products: Printing of souvenirs, visiting cards, letterheads, greeting cards, receipt books, etc.
- 1224. MULTI MECH.** 314 Narayan Peth, Pune 30 Tel 444789. Factory: 204 Mangalwar Peth, Pune 11. Tel. 27756. Partnership, 1974. Sister concern: Bachika Enterprises Bank: Bank of Maharashtra. Cap Rs 50,000. Prod. Rs 80,000. Workers 8. Products: All types of machined components and spares, fabricated items, chemical process equipment, special-purpose machines

1225. MULTI TECH. ENGINEERS. Survey No. 19, Vitthalvadi, Hingne Khurd, Pune 9. Proprietary, 1972. Bank: Bank of Baroda. Cap. Rs.40,000. Prod. Rs.50,000. Workers 5. Products: Wooden and metallic patterns, non-ferrous castings, sub-assemblies required for sugar machinery equipment, slipping unit.

1226. MUNGI ELECTRICALS. 118 Bank of Baroda Bldg., Paltan Road, Bombay 1. Tel. 265075. Factory: Plot No. E-10-11(2) Technicians Block, MIDC., Bhosari, Pune 26. Tel. 82850. Partnership, 1966. Bank: Bank of India. Cap. Rs.2,50,000. Prod. Rs.4,35,000. Workers 29. Products: Auto electricals, spring steel components, small forgings, pressed parts for automobiles.

1227. MUTHA AND RATHOD TRADING CO. 123 New Timber Market, Pune 2. Tel. 444948. Proprietary, 1964. Sister concern: Moderncraft. Bank: Union Bank. Cap. Rs.2 lakhs. Prod. Rs.20 lakhs. Workers 25. Export: Rs.4 lakhs. Countries: Germany, Italy, Russia. Products: Wooden boxes, furniture (tables).

1228. MUTHA TEXTILES. 14 Hadapsar Industrial Estate, Pune 13. Tel. 7288-7425-7497. Proprietary, 1970. Br. Saswad, Dist. Pune. Products: Cotton fabrics, voiles, dhotis, mulls, etc.

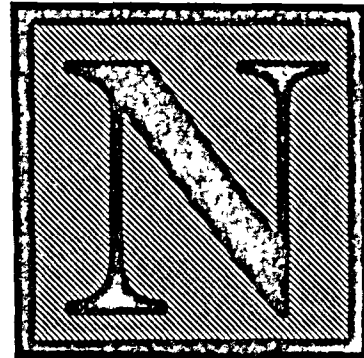

1229. N. B. CHAVAN AND SONS. 335/B Shanwar Peth, Pune 30. Tel. 446603. Proprietary, 1970. Banks: United Western Bank Ltd. Cap. Rs 50,000. Workers 7. Product: Job work

1230. N. B. MORE METAL WORKS. 232 Guruwar Peth, Pune 2. Proprietary, 1965. Cap. Rs 7,000. Prod. Rs.3,000. Worker 1. Product: Brass parat.

1231. N. D. GUPTA ENTERPRISES. 1 'Vijay' Kacharewadi, 39/35 Karve Road, Pune 4. Tel. 56955. Factory: S Block, Plot No. 38, M.I.D.C., Bhosari, Pune 26. Proprietary, 1975. Bank: Bank of India. Cap. Rs.1,90,000. Prod. Rs.1,60,000. Workers 5. Products: Heat treatment processing and other surface treatments like electroplating, blackodising and phosphating.

1232. N. FERNANDES. 19 Frere Road, Khadki, Pune 3. Tel. 55781. Partnership, 1937. Bank: Canara Bank. Cap. Rs.2 lakhs. Prod. Rs.16 lakhs. Workers 16. Export: Rs. 13,00,000. Countries: U.K., Australia, U.S.A. Canada, U.A.E., Singapore, France. Products: Fruit and vegetable pickles, fruit chutneys, condiment pastes.

1233. N. K. ENGINEERING. 615 Shukrawar Peth, Shahu Chowk, Pune 2. Proprietary, 1966. Bank: Bank of India. Cap. Rs.20,000. Prod. Rs 7,000. Worker 1. Products: Sorya, khal-batta (pestle and mortar), mason's plummet.

1234. N. L. VILASAGAR. 752 Ganj Peth, Pune 2. Tel. 441037. Factory: 755 Ganj Peth, Pune 2. Partnership, 1927. Bank: Bank of Maharashtra. Cap. Rs.74,000. Prod. Rs 1,03,000. Workers 15. Product: Handloom sarees.

- 1235. N. N. METAL WORKS.** 113/14 Bhawani Peth, Pune 2. Tel. 27427. Partnership, 1969. Bank: Dena Bank. Cap. Rs 3,00,000. Prod Rs.10,00,000. Workers 10. Products: Aluminium utensils, buckets, vessels.
- 1236. N. P. K. FOUNDERS.** A-92 & 93 'H' Block, M.I.D.C., Pimpri, Pune 18. Tel 82631. Partnership, 1975. Estd. 1962. Bank: State Bank of India Cap. Rs.64,277 Prod. Rs.4,85,695. Workers 9. Export Rs.3,000. Country: Italy. Products: Walk-in-incubators, premature baby incubators, conditioning chambers, B.O.D. incubators, drying ovens, curing ovens (ordinary and explosives), electric furnaces, special industrial heaters, thermo mantles, auto convection type ovens, sherman traps, sugar-cane-seed treatment plants (hot water, hot air and aerated steam type), water baths, electronic temperature and humidity controls, thermostats, level controllers, preset cyclic conditioners, cloud sampling instruments.
- 1237. N. V. SHROFF AND CO.** 17 (old) Shukrawar Peth, Pune 2. Tel 443568. Cable. VISION. Factory: 22 Dhanakavadi, Pune-Satara Rd., Pune 9. Tel. 448305. Proprietary, 1962. Bank: Bank of Maharashtra Cap. Rs. 5,00,000. Prod. Rs.4,00,000. Workers 50. Products: Industrial chemicals and minerals.
- 1238. NAGARKAR INDUSTRIES.** 283 Kasba Peth, Pune 11. Tel. 448483. Factory: 283 Kasba Peth, Pune 11 Estd. 1958. Bank Bank of Maharashtra. Cap Rs.1,65,050. Prod. Rs.1,21,877. Workers 5. Products. Dry type clutches for marine engines, industrial fan guards, spare parts for diesel engines, light and heavy fabrication work.
- 1239. NAGARKAR AND SONS ENGINEERING WORKS.** 384 Raviwar Peth, Pune 2. Tel. 449594. Factory: 663 Kasba Peth, Pune 11. Partnership, 1965. Bank: Bank of Maharashtra. Cap Rs.40,000 Prod. Rs.10,000. Workers 2. Product: Job work.
- 1240. NAGDEO MASALA AND OIL MILLS.** 101 Shivajinagar, Pune 5. Tel 50673. Partnership, 1955. Bank; Bank of Maharashtra. Cap. Rs.30,000. Prod. Rs.40,000. Workers 3. Products: Masala and oil.
- 1241. NAGINA BAKERY.** 830 Bhawani Peth, Pune 2. Partnership, 1963. Cap. Rs 15,000. Prod. Rs.50,000. Workers 5. Products: Bread, toast, etc.
- 1242. NAGMANI PERFUMERY WORKS.** 77 New Raviwar Peth, Kasture Chowk, Pune 2. Tel. 444394. Proprietary, 1955. Bank: Canara Bank Cap Rs.80,000. Prod. Rs.2,20,000. Workers 20. Product: Agarbatties.
- 1243. NAGPURE INDUSTRIES.** 22 kasba Peth, Ganes h Rd., Pune 11. Proprietary, 1962 Cap. Rs 65,000 Prod Rs.60,000. Workers 3. Product: Job work.
- 1244. NAHAR ENVELOPES MFG. CO.** 155 Mangalwar Peth, Pune 11. Tel 27578. Proprietary, 1970 Bank: Bank of India. Products: Paper envelopes and cloth-lined envelopes.
- 1245. NAHAR INDUSTRIES.** 33 Bombay-Pune Rd., Bopodi, Pune 3 Tel. 53048, 53642 Proprietary, 1977. Bank: Central Bank of India. Cap Rs 50,000. Prod. Rs. 1,00,000. Products: Corrugated boxes, sheets
- 1246. NAIK AND CO.** 770/4 Sunanjali, Deccan Gymkhana, Pune 4. Tel. 52191, 54839 Factory: 89 Dhanori, near Vishrantwadi, Pune 15 Partnership, 1975 Sister concern: Ravindra Naik & Co. (Rubbers), Panvel. Bank: State Bank of India Cap Rs. 1,25,000. Prod Rs 3,00,000. Workers 20. Product: Crushed stones of various grades.
- 1247. NAIK WEAVING MILL.** 34/13 Yerandawana-Karve Rd., Pune 4. Tel. 55867. Proprietary, 1964 Bank: Bank of Maharashtra. Cap. Rs 1,32,000 Prod Rs 4,00,000. Workers 20. Product: Industrial cloth, cotton fabrics
- 1248. NAIKO GLASS.** 1206/34 B Leela Nivas, Pune 4. Tel. 57573. Factory: 34/13 Erandawana, Karve Rd., Pune 4. Tel. 55867. Proprietary, 1975 Bank Bank of India. Cap. Rs 50,000. Prod. Rs 1,00,000. Workers 6 Products: Fibre glass for electrical insulation, plastic reinforcent.
- 1249. NAIR BROTHERS.** Survey No. 9, Block 4, near Hadapsar Octroi Naka, Pune 28. Proprietary, 1970. Products. Fabrication, welding, metalising and sand blasting, re-building wornout parts and depositing wear resistant layers on tools and machine parts, lower link of all types of tractors.
- 1250. NAJ DRESSES.** 260 Ganj Peth, Pune 2. Tel 441710. Factory: 261 Ganj Peth, Pune. Partnership, 1961. Bank: Central Bank of India. Cap. Rs 60,000. Prod. Rs. 4,00,000. Workers 11. Product: Readymade garments.
- 1251. NAKHI ENTERPRISES.** 5 Mayur Corporation, Karve Rd., Kothrud, Pune 29. Tel. Office 55300. Tel. Factory: 53647. Partnership, 1971. Bank: Bank of India Cap. Rs 70,000. Prod. Rs.4,00,000. Workers 4. Products: Electronic voltage correctors (for domestic use, T.V., fridges etc.); electronic voltage cut-outs, invertors, single-phase starters, other aid products.

- 1252. NAKODA METAL CORPORATION.** 370 Gurwar Peth, Pune 2. Tel. 444125. Factory: 1098-99 Kasba Peth, Pune 11. Partnership, 1971. Bank: Punjab National Bank. Cap. Rs 1,00,000. Prod. Rs.6,00,000. Workers 5. Product: Aluminium pots.
- 1253. NALANDA DRESSES.** 200 Somwar Peth, near Daruwalla Bridge, Pune 11. Tel. 24403. Partnership, 1970. Bank: State Bank of India. Prod. Rs 4,00,000. Workers 9. Product: Ready-made garments.
- 1254. NANA INDUSTRIES.** 83 Shivajinagar, Pune 5. Tel. 55903. 53702. Partnership, 1964. Bank: Bank of Maharashtra. Cap. Rs.2,00,000. Prod. Rs.4,00,000. Workers 4. Products: Hour run indicators, industrial rectifiers, battery chargers, solenoid switches, fuel off solenoids, control panels.
- 1255. NANAP AND CO.** 414 Narayan Peth, Pune 30. Tel. 440711. Factory: 8/6 Karve Rd., Pune 4. Tel. 56801. Proprietary, 1964. Bank: State Bank of India. Cap. Rs. 50,000. Prod. Rs.15,00,000. Workers 13. Product: Instrument transformers.
- 1256. NANDA CONSTRUCTION CO.** 14-B/4 Boat Club Rd., Pune 1. Tel. 24069. Factory: S. No. 241/2-A, Lohgaon, near Air Force Station, Pune 5. Tel. 20611. Partnership, 1941. Sister concerns: Usha Transport. Bank: United Commercial Bank. Cap. Rs.3,00,000. Prod. Rs 6,00,000. Workers 50. Product: Crushed stone metal.
- 1257. NANDA ENGINEERING WORKS.** 335/B, Shanwar Peth, Pune 5. Tel. req. 446811. Proprietary, 1975. Bank: Bank of Maharashtra. Workers 5. Product: Ferrous and non-ferrous casting.
- 1258. NANDADEEP MUDRANALAYA.** 1250 Deccan Gymkhana, Pune 4. Tel. 50909. Proprietary, 1971. Bank: The Poona Contractors' Co-op. Bank Ltd. Workers 4. Product: Commercial printing.
- 1259. NARASAYYA SAYANNA KUNDEN.** 'Kunden Chamber', 1150 Bhawani Peth, Pune 2. Tel. 23837, 26625. Factory: 113/114 Bhawani Peth, Pune 2. 33/40 Gultekadi Industrial Estate, Pune 9. Tel. 442812. Partnership, 1920. Sister concern: Kunden Industries, 113/114 Bhawani Peth, Pune 2. Bank: Bank of Maharashtra. Cap. Rs.4,50,000. Prod. Rs.15,00,000. Workers 97. Product: Handloom sarees.
- 1260. NARAYAN ENGINEERING WORKS.** 314/2 Mahatma Fule Peth, Pune 2. Tel. 442758. Partnership, 1964. Bank Bank of Maharashtra. Cap Rs 50,000. Prod. Rs.1,20,000 Workers 7 Product Job works
- 1261. NARAYAN FABRICS.** 35 Karve Rd., Pune 4. Proprietary, 1971. Cap. Rs.25,000. Prod. Rs.1,80,000. Workers 3. Products: Grey cotton fabrics, saree voiles, dhotis.
- 1262. NARAYAN TEXTILES.** 1150 Bhawani Peth, Pune 2. Tel. 23837. Cable: KUNDEN SARI. Factory: 33/40 Gultekadi Industrial Estate, Pune 9. Tel. 442812. Proprietary, 1968. Bank Bank of Maharashtra. Cap. Rs. 27,000. Prod. Rs.1,10,000 Workers 8 Prod Cotton cloth.
- 1263. NARENDRA TEXTILES.** 43/2 Erandawana, Pune 4. Proprietary, 1964. Cap. Rs 14,000. Prod. Rs 9,300. Workers 3 Product: Gray mull.
- 1264. NARGOLKAR INDUSTRIES.** Vithalwadi, Khadakawasia Rd., Pune 9. Proprietary, 1973. Bank: Bank of India. Cap. Rs 50,000. Prod. Rs.2,50,000. Workers 10. Product: Pressed components.
- 1265. NARISHOBHA PRODUCTS.** 242-B, Rasta Peth, Pune 11. Tel. 22496. Proprietary, 1971. Banks: Bank of Baroda; Bank of Maharashtra. Cap. Rs.40,000. Prod. Rs.1,50,000. Workers 8. Product: Brassiers.
- 1266. NASA PAINTS AND PRODUCTS.** W 35, M.I.D.C. Bhosari, Pune 26. Tel. 82839. Partnership, 1974. Bank: State Bank of India. Cap. Rs 2,54,000. Prod. Rs. 1,35,000 Workers 4. Products: Red oxide primers, yellow primers, synthetic enamel, thinners.
- 1267. NATH ELECTRICALS.** 303 Ganesh Peth, behind Ganesh Chambers, opp. Alpana Talkies, Pune 2. Proprietary, 1971. Banks: Bank of India; Jai Bhawani Sahakari Bank. Cap. Rs 10,000. Prod. Rs 20,000. Workers 4. Products: Manufacturing and repairing of electrical items, industrial furnaces, driers, ovens, heating mantles, heaters and all types of heating arrangements.
- 1268. NATH ENGINEERING WORKS.** 850 Ganj Peth, Pune 2. Tel. 443923. Proprietary, 1974. Bank: Bank of Maharashtra. Cap. Rs.50,000. Prod. Rs.10,000. Workers 6. Products: Foot suction surgical machine, rolling shutters, welding transformer, plastic machinery, repairing, grill work fabrication, etc.
- 1269. NATIONAL CHEMICALS.** 1142 Shivajinagar, Pune 16. Tel. 53879. Proprietary, 1965. Bank: Union Bank

of India. Cap. Rs.1,50,000. Prod. Rs.4,00,000. Workers 5. Products: Disinfectant, deodorant, liquid soap, cleaning powders, liquid cleaners, detergent powders, soap powder.

1270. NATIONAL CROWN CORKS. 3 Mahatma Gandhi Rd., Pune 1 Tel. 22481. Factory: 882 Boottee Street, Pune 1 Partnership, 1964. Bank: Central Bank of India. Cap. Rs.1,00,000. Prod. Rs.1,04,500. Workers 4 Product: Crown corks

1271. NATIONAL ELECTRONIC INDUSTRY. 333 Shukrawar Peth, Pune 2 Proprietary, 1966. Bank: Cosmos Co-op. Bank Ltd. Cap. Rs 4,000. Product. Wireless receiving sets.

1272. NATIONAL ENGINEERING WORKS. Bombay-Pune Rd., Dapodi, S No 48/1-12 B, Pune 12. Tel. 58448. Proprietary, 1962. Sister concerns: National Battery Builders, Praveen Trading Corporation, Shakti Fuel Injection. Banks: Canara Bank; South Indian Bank; Poona Cantonment Sahakari Bank; Poona Dist. Central Co-operative Bank. Cap. Rs 1,00,000. Prod. Rs.2,50,000. Workers 7. Products: Rewinding of motors, dynamos, starters, transformers, reconditioning of batteries, supply of seat cushions and repairs of fuel injection pumps

1273. NATIONAL GAUGE MANUFACTURING CO. 4 Nana Peth, Pune 2 Tel. 23998 Partnership, 1973. Bank: Union Bank of India. Cap. Rs.6,00,000. Prod. Rs.12,00,000. Workers 49. Products: Sugar machinery spares, copper sockets, cam shaft driving gears of oil engine, revolving centers, dead centres, drill sockets, pipe centres, machinery accessories.

1274. NATIONAL INDUSTRIES. 29 Narayan Peth, Pune 30. Proprietary, 1972. Bank: Bank of Maharashtra Cap. Rs.20,000. Prod. Rs.40,000. Workers 4. Product: Job work.

1275. NATIONAL INK COMPANY. 768 (New) Sadasbiv Peth, Pune 30. Tel. 440372. Proprietary, 1960. Bank: United Commercial Bank. Cap. Rs.5,000. Prod. Rs.16,000. Workers 4 (part time). Products: Ink, chalks.

1276. NATIONAL IRON WORKS. 355 Budhwar Peth, Pune 2. Tel. 447514. Partnership, 1937. Cap. Rs.75,000. Prod. Rs.40,000. Workers 7. Products: Job work, tubewell boring machines and repairs of parts, supply of spare parts.

1277. NATIONAL IRON AND FURNITURE WORKS. 47 Rasta Peth, Pune 11. Factory: 461 Somwar Peth, Pune 2

Estd 1952. Banks: Indian Bank; Poona Urban Co-op. Bank. Cap. Rs.75,000. Prod. Rs 20,000. Workers 5. Products: Rope-making machinery, machinery parts, machinery for coir carpets.

1278. NATIONAL SEEDS CORPORATION. (A Government of India Undertaking). 497/1 Bhawani Peth, Pune 2. Tel. 24297 Cable: RAJBIJ. Estd. 1963. Bns. Amravati, Aurangabad, Akola, Dhulia, Jalgaon, Malkapur, Nagpur, Nasik, Sangli, Shrirampur. Bank: State Bank of India. Cap. Rs.5,93,684. Prod. Rs.76,37,722. Workers 72. Export: Rs.25,000. Countries Maldives, Yemen, Arab Republic, Daker (Senegal). Products: Hybrid seeds, seeds of improved varieties of vegetables, pulses, etc., seed-processing equipments and arranging their import.

1279. NATRAJ ART. 1239 Subhashnagar, Lane No. 4. Shukrawar Peth, Pune 2. Proprietary, 1973. Bank: Central Bank of India. Cap Rs 5,000. Prod. Rs.10,000. Workers 5. Products: Clay models, plaster-of-paris and metal models, life-sketch models, presentation articles, Ganpati idols, ceiling sheets, interior decorative articles, wall plates, grills.

1280. NATRAJ INDUSTRIES. 335/B, Shanwar Peth, Pune 30. Proprietary, 1973. Workers 5. Product: Casting of non-ferrous, ferrous, stainless steel.

1281. NATRAJ PRINTING PRESS. 433 Budhwar Peth, Pune 2. Proprietary, 1970. Cap Rs 20,000. Prod. Rs.30,000 Workers 2. Product. Commercial Printing.

1282. NATSON INDUSTRIES. Plot No. T-130, Bhosari Industrial Estate, Pune 26. Tel. 82486. Proprietary, 1976. Bank: State Bank of India. Cap. R .2,00,000. Prod. Rs. 40,000. Workers 6. Products: Tools and precision machinery parts, light duty fabrication jobs, high tensile bolts.

1283. NAVALAKHA AGRO EQUIPMENT. 1379 Bhawani Peth, Pune 2. Tel. 442843. Cable: KAMDHENU. Factory: 38 Shankarshet Rd., Pune 9. Partnership, 1973. Bank: Punjab National Bank. Cap. Rs 5,00,000. Prod. Rs 10,00,000. Workers 55. Product: Spares and dusters for plant protection.

1284. NAVBHARAT ENGINEERING WORKS. 535 Shukrawar Peth, Shivaji Rd., Pune 2. Tel. 445016. Proprietary, 1965. Bank: Bank of India. Workers 8. Products: Levelling crew nut, spare parts, job work.

1285. NAVA BHARAT UDYOGA KENDRA. 16/4 Erandawana, Karve Rd., Pune 4. Tel. 58735 Partnership,

1962. Banks: Bank of Maharashtra; Bank of India. Cap. Rs.1,50,000. Prod. Rs.2,00,000. Workers 9. Products: Turned components, nuts, bolts, screws and studs, taper pins, rollers for ball bearing, spares of compressors, oil engines.
1286. NAVANITLAL GANDHI. 5 Bhavani Peth, Pune 2. Tel. 25828. Partnership, 1928. Br. Budhwar Peth, Pune 2. Bank: Bank of Maharashtra. Cap. Rs.3,50,000. Prod. Rs. 3,00,000. Workers 3. Product: Account and exercise books.
1287. NAVJIVAN PRINTING PRESS. 2158 New Modkhana, Pune 1. Proprietary, 1972. Bank: Mahesh Co-operative Bank Ltd. Cap. Rs.40,000. Prod. Rs.25,000. Workers 5. Products: Commercial printing, bill books, forms, ledgers, greeting cards.
1288. NAVKETAN ENGINEERING WORKS. 309 Shukrawar Peth, Pune 2. Proprietary, 1968. Bank: Cosmos Co-op. Bank Ltd. Cap. Rs.30,000. Prod. Rs.25,000. Workers 2. Products: Machine spare parts.
1289. NAVRANG PRINTING PRESS. 409 Budhwar Peth, near Pasodya Vitthoba Mandir, Pune 2. Proprietary, 1965. Bank: Central Bank of India. Cap. Rs.70,000. Prod. Rs.18,000. Workers 3. Product: Commercial printing.
1290. NAVSADHANA MUDRANALAYA. 358 Shanwar Peth, Pune 30. Tel. 449985. Partnership, 1971. Bank: Trimurti Sahakari Bank. Cap. Rs.50,000. Prod. Rs.15,000. Workers 8. Product: Commercial printing.
1291. NAV MAHARASHTRA CHAKAN OIL MILLS. 42/43 Shankarshet Rd., Pune 9. Tel. 449449, 447306, 449890. Cable: SHENGA. Telex: 0145-349. Partnership, 1960. Brs. Bombay, Chakan. Sister concerns: Nav Maharashtra Trading Co., Poona Besan Mills, M. P. Sale Purchase Centre, Groundnut Processing Corporation, Chakan Oil Mills Co., Chakan; Nav Maharashtra Protein (P) Ltd. Bank: Central Bank of India. Cap. Rs.56,94,320. Prod. Rs.6,41,75,408. Workers 111. Export: Rs.1,14,25,410. Countries: Japan, Poland, Switzerland, Thailand, U.S.S.R., France, United Kingdom. Products: Edible oils, oil cakes, soaps, dal and besans, de-oiled cake.
1292. NAV MAHARASHTRA METAL INDUSTRIES. 344/46 Ghorpade Peth, Pune 2. Tel. 440035. Partnership, 1961. Bank: State Bank of India. Cap. Rs.75,000. Prod. Rs.4,00,000. Workers 22. Products: Brass utensils, job work.
1293. NAVYUG PRINTERS AND MANUFACTURERS. Nagar Rd., Irani Market Compound, Yeravada, Pune 6. Tel. 27161. Partnership, 1974. Bank: Bank of Maharashtra. Cap. Rs.88,550. Prod. Rs.1,18,000. Workers 6. Products: Commercial printing, binding, stationery.
1294. NAZ BAKERY. 11 Moledina Rd., Pune 1. Tel. 27472. Partnership, 1950. Sister concern: Naz Cafe. Bank: Pune Sahakari Bank. Cap. Rs.2,00,000. Prod. Rs.3,50,000. Workers 15. Products: Cakes, biscuits, bread, toast.
1295. NEAT LOOK. 501 Rasta Peth, Raste Wada, Pune 11. Tel. 28119. Factory: S.No 22/1 Pimpri, Pimpri Station Rd., Pune 18. Partnership, 1976. Bank: Indian Bank. Cap. Rs.5,00,000. Prod. Rs.15,00,000. Workers 30. Product: Paper corrugated boxes.
1296. NEEL PAINTS AND INTERIORS PVT. LTD. 759/55-B, Janseva, Deccan Gymkhana, Pune 4. Tel. 55417. Factory: S No. 248, Plot No. 13, Morya Colony, Chinchwad, Pune 33. Tel. 82333. Estd. 1977. Sister concern: Deccan Decorators. Bank: Indian Bank. Cap. Rs.5,00,000. Prod. Rs.18,00,000. (estimated). Workers 8. Products: Protecting and decorative coating, job work such as wrinkle, hammer, polychromatic and epoxy painting.
1297. NEELAM BRASSIERS CO. 107 Somwar Peth, Pune 11. Partnership, 1971. Tel. 24994. Bank: State Bank of India. Cap. Rs.91,000. Prod. Rs.1,70,000. Workers 4. Product: Brassiers.
1298. NEELAM DRESSES. 667 Raviwar Peth, Pune 2. Tel. 449544. Partnership, 1970. Products: Readymade garments, children wear.
1299. NEELESH INSTRUMENTS. 425/64 Kedar, Tilak Maharashtra Vidyapith, Gultekadi, Pune 9. Tel. 446909. Proprietary, 1975. Bank: State Bank of India. Cap. Rs. 40,000. Prod. Rs.25,000. Workers 3. Products: A.C. and D.C. electro-magnetic relays.
1300. NEEL-SHREE PRODUCTS. 453 Old Somwar Peth, Pune 11. Tel. 27058. Bank: Sangli Bank Ltd. Cap. Rs.30,000. Prod. Rs.40,000. Workers 6. Products: Precision returning (machining) jobs.
1301. NEUROTURN. 47/71 Law College Rd., Pune 4. Partnership, 1977. Bank: Bank of India. Cap. Rs.10,000. Workers 7. Products: Electronic linear measurement, comparison and control instruments—dimensional comparators, in-process grinder controller, electronic micrometers.

- 1302. NEUTROX INKS CO.** 1691 Sadashiv Peth, Pune 30. Tel. 58571. Proprietary, 1975 Bank Bank of Maharashtra. Cap. Rs.1,000. Prod. Rs 250. Product. Stamping inks—red, violet, green, black blue; marking inks.
- 1303. NEVSON PAPER PACKERS.** S-11 Bhosari Industrial Estate, Pune 26. Tel. 82466 Cable NEVSON Partnership, 1976 Bank Bank of Maharashtra. Cap. Rs.6,00,000 Prod. Rs 15,00,000. Workers 32 Product: Corrugated paper boxes.
- 1304. NEW AERIAL BAKERY.** 399 Nana Peth, Pune 2. Tel. 20033. Partnership, 1946 Brs. (i) Mira Society, (ii) Karve Rd. Bank Canara Bank. Cap. Rs.5,00,000 Prod. Rs.4,00,000. Workers 8. Products Bread, cakes, biscuits.
- 1305. NEW AUTO SHOCK ABSORBERS REPAIRING WORKS.** 1314/1 Kasba Peth, Near Gharpure Hospital, Pune 11. Tel. req.448076. Proprietary, 1963. Bank Poona Merchants Co-operative Bank Ltd Cap. Rs 70,000 Prod. Rs 18,000. Workers 2. Product Repairing shock absorbers.
- 1306. NEW BHARAT HEAD REPAIRING WORKS.** 38/1 Pune-Satara Rd., Pune 9 Proprietary, 1969. Bank: Punjab National Bank. Cap Rs 10,000. Prod. Rs 20,000. Workers 3. Products: Cylinder head repairing, cold welding, slives fitting and job works
- 1307. NEW BHARAT CHARCOAL DEPOT.** 466 Somwar Peth, Plot No 27, Pune 11. Tel. 25053. Partnership. Banks: Punjab National Bank; Punjab & Sind Bank. Cap. Rs.1,70,000. Prod Rs 80,000 Workers 5. Products: Charcoal bricks, stocking of charcoal, hard-coke, soft-coke, nut coke.
- 1308. NEW BHARAT SWEET PRODUCTS.** 2158 New Modikhana, Pune 1. Tel. 24905. Proprietary, 1966. Bank. State Bank of India. Cap. Rs.1,00,000. Prod. Rs.3,00,000. Workers 8. Products: Sweets, chikki, sugar candy.
- 1309. NEW DIAMOND WORKS.** 509 Nana Peth, Pune 2. Proprietary, 1957. Cap. Rs 20,000. Prod Rs 12,000 Workers 4. Product: Electro plating.
- 1310. NEW FRIBRO PLASTICS.** 38 Shankarshet Rd., Pune 2. Tel. 26815, 22821. Factory. 442843. Partnership, 1965. Bank: Punjab National Bank. Cap. Rs 2,00,000. Prod. Rs.3,00,000. Workers 20. Products: Rain gauges, industrial moulds, helmets, battery covers, lining work.
- 1311. NEW GANESH FOUNDRY.** S. No. 106-A Solapur Rd., Hadapsar, Pune 13. Tel. 7168. Factory: S.No.1, Plot No. 1, Kondhwa Khurd, Pune 1. Proprietary, 1977. Cap. Rs 25,000. Workers 8. Product: C.I. manual cover (Chamber cover).
- 1312. NEW GANESH METAL WORKS.** 35/36 Kasba Peth, Pune 11 Proprietary, 1970. Bank: Bank of Maharashtra. Cap. Rs 10,000, Prod. Rs.20,000. Workers 4 Product: Metal buff polishing.
- 1313. NEW HASHEMI PRINTING PRESS.** 307 Mahatma Gandhi Rd., Pune 1. Tel. 22651. Partnership, 1930 Brs. Acme Packaging Corporation; Acme Foundry Flux Co. Banks Union Bank of India Cap Rs.10,00,000 Prod Rs 12,00,000. Workers 15. Products: Commercial printing, office stationery.
- 1314. NEW INTERNATIONAL ENGINEERING WORK.** 704 Budhwar Peth, opp. Sakal Press, Pune 2. Tel 449227. Proprietary. Product: Spare parts of diesel oil engines.
- 1315. NEW ITALIAN BAKERY.** 1179 Raviwar Peth, Pune 2. Tel. 447324. Partnership, 1965. Cap. Rs 5,000. Prod. 25,000. Workers 12. Products: Bread, cakes, etc.
- 1316. NEW MAHARASHTRA ENGINEERING WORKS.** 7 Mulla Rd., Khadki, Pune 3. Tel. 56058 Proprietary, 1974. Sister concern. Roopali Engineer. Bank Bank of Maharashtra Cap. Rs.1,50,000. Prod. Rs 2,00,000. Workers 9 Products: Nuts, bolts, bushes.
- 1317. NEW MAHARASHTRA IRON AND STEEL WORKS.** 1075 Sadashiv Peth, Pune 30. Tel. 443624. Partnership, 1947 Bank. Bank of Maharashtra. Cap Rs 1,00,000. Prod. Rs.1,00,000. Workers 6. Products: Fabrication and erection, accessories for P.V.C. plant, trolleys of all sorts.
- 1318. NEW MAHARASHTRA GARAGE.** 205/1 Mangalwar Peth, Barne Rd., Pune 11. Products: All sorts of automobile spare parts, repairing work, transport business.
- 1319. NEW MOTOR HOOD.** 1170/2 Shivajinagar, Pune 5. Partnership, 1962. Bank: Bank of India. Workers 3. Product: Car repairing.
- 1320. NEW NATIONAL ENGINEERS (INDIA).** 33 Old Bazar, Khadki, Pune 3. Tel. 58597. Proprietary, 1973. Bank: Bank of Maharashtra. Cap. Rs.35,000. Prod. Rs.1,15,000. Workers 10. Products: Driving gears, piston pins, banjo special white bit, lub. oil strainer, engraving of steel punches.

- 1321. NEW POONA BAKERY.** 672/C-2 Budhwar Peth, Pune 2. Tel. 448366. Proprietary, 1967. Br. 486 Rasta Peth, Pune 2. Bank: Suvarna Sahakari Bank. Cap. Rs.50,000. Prod. Rs.4,00,000. Workers 9. Products: Bread, cakes, biscuits.
- 1322. NEW POONA HOMOEOPATHIC PHARMACY.** Kakakuva Mansion, Ganpati Chowk, Laxmi Rd., Pune 2. Proprietary, 1953. Bank: Bank of Maharashtra. Products—Homoeopathic and biochemic medicines, etc.
- 1323. NEW POONA INDUSTRIES.** 759/54 Deccan Gymkhana, Pune 4. Tel. 54092. Cable: FILLUNGER, Pune. Factory: Mile 103/1 Bombay-Pune Rd., Pimpri, Pune 18. Tel. 82225. Estd. 1955. Brs. Bombay, Calcutta, Bangalore, New Delhi. Sister concern: Chinchwad Precision Optical Frame Works. Banks: Bank of Maharashtra; Syndicate Bank. Cap. Rs.3,92,500. Prod. Rs.62,900. Workers 10. Products: Spectacle hinges, small ancillary machines, spare parts for tooth brush mfg. machinery and others as per specification.
- 1324. NEW PRECISION ENGINEERING WORKS.** 450 Mangalwar Peth, Pune 11. Proprietary, 1970. Bank: Bank of Maharashtra. Worker 1. Product: Crank shaft turning.
- 1325. NEW PUNJAB MOTOR BODY BUILDERS.** 47/A Pune-Satara Rd., Pune 9. Tel. 447705. Proprietary, 1962. Bank: Bank of Maharashtra. Cap. Rs.8,000. Workers 6. Product: Motor body building and repairing work.
- 1326. NEW STANDARD DIE CASTING.** W-4, 'S' Block, M.I.D.C. Shed, Bhosari Industrial Area, Pune 26. Tel. 82019, 83612. Proprietary, 1975. Sister concern: Die Casting & Tool Room Engineers, Thana. Bank: State Bank of India. Products: Aluminium alloy casting by sand casting, gravity die casting and centrifugal casting process, pressure die castings; electrical motor rotors, dies, tools, jigs and fixtures etc., oil fired furnaces for non-ferrous alloys.
- 1327. NEW SUPREME CALENDARS.** 753 Sadashiv Peth, near Sadashiv Peth Haud, Pune 30. Tel. 443777. Partnership, 1966. Bank: Bank of Maharashtra. Cap. Rs. 2,50,000. Prod. Rs.1,20,000. Workers 4. Products: Calendars, commercial printing, invitations, greeting cards, educational charts.
- 1328. NEW UNIVERSAL ENGINEERING WORKS.** 59 Shivajinagar, Pune 5. Proprietary, 1973. Bank: Muslim Co-operative Bank. Cap. Rs.25,000. Prod. Rs.60,000. Workers 4. Product: Industrial and building fabrication.
- 1329. NEW VYAPARI PRINTING PRESS.** 481 Nana Peth, Pune 2. Proprietary, 1949. Bank: Indian Bank. Cap. Rs.75,000. Prod. Rs.10,000. Workers 3. Products: Commercial printing handbills, bill books, posters, wedding cards, visiting cards.
- 1330. NICHROME METAL WORKS.** 46 Dr. Ambedkar Rd., near Sangam, Pune 1. Tel. 24287. Cable: NICHROME, Partnership, 1947. Bank: Bank of Maharashtra. Cap. Rs. 4,00,000. Prod. Rs 24,65,600. Workers 64. Products: Heavy steel fabrication and erection of sugar, cement and chemical factories, thermal power station; manufacturers of automatic hank yarn mercerising machine; filpack machine for dairies; package testing equipment such as drop test and revolving drum tester; speed sensing and monitoring device for centrifugals.
- 1331. NIRMAL INDUSTRIES.** C/o. Maharashtra Automobiles, Tilak Rd., Hirabag Naka, Pune 2. Tel. 42267. Partnership, 1972. Bank: Bank of Maharashtra. Cap. Rs. 3,00,000. Prod. Rs 2,00,000. Workers 8. Products: Small precision automatic turned components such as bush, plug, screw, tube, pin, shaft and other turned parts.
- 1332. NIRMALA TEXTILES.** 14 Hadapsar Industrial Estate, Pune 13. Tel. 7507, 7497. Proprietary, 1974. Sister concern: At & Post Velu, Tal. Bhor. Dist. Pune. Product: Cotton textiles.
- 1333. NISHAT PRINTING PRESS.** 464 Somwar Peth, Pune 2. Proprietary, 1968. Bank: Muslim Co-operative Bank Ltd. Cap. Rs.15,000. Prod. Rs.6,500. Workers 2. Products: Printing plastic bags, commercial printing.
- 1334. NITIN DIE MAKERS.** 1266 Raviwar Peth, Kachi Ali, Pune 2. Proprietary, 1971. Bank: Syndicate Bank. Cap. Rs.21,000. Workers 4. Products: Die & punches, precision lathe works, bakelite, plastic, injection moulding and die, press parts.
- 1335. NITIN ENTERPRISES.** 150 Shaniwar Peth, Pune 30. Tel. 446271. Proprietary, 1975. Banks: Bank of Maharashtra; Suvarna Sahakari Bank Ltd. Cap. Rs. 1,00,000. Prod. Rs.80,000. Workers 8. Products: Job work; spares for Luna moped, cummins engines.
- 1336. NITIN SCOOTER WORKS.** 21/22 Narayan Peth, Pune 30. Tel. 449086. Proprietary, 1963. Bank: Bank of India. Cap. Rs.3,00,000. Workers 10. Products: Spare parts dealers and service station of M/s. Bajaj Auto Ltd.

- 1337. NITIN WOOD AND STEEL INDUSTRIES.** Bombay-Pune Rd, near Phugewadi Octroi Post, Dapodi, Pune 12. Tel. 82363, 82262. Partnership, 1975. Sister concerns Ratilal Bhagwandas & Associate, near Phugewadi Octroi Post, Dapodi, Pune 12, Rishikesh Fabrication Industries, near Phugewadi, Pune 12, Ratilal Bhagwandas & Sons, Bhagwandas Mansion, Shivaji Chowk, Kalyan; Nitin Traders, Kalyan; Bhushan Trading Corporation, Kalyan. Bank. Bank of Maharashtra. Cap Rs 3,00,000. Prod. Rs 16,00,000. Products Wooden packing cases, T-max cutter boxes, tool kit boxes, wooden furniture, wooden doors and windows, cable drums.
- 1338. NIVRUTTI RAGHUNATH PHALE.** 214-B Gururwar Peth, Pune 2. Proprietary, 1950. Cap. Rs.7,000 Products Job work of pressing, metal parts.
- 1339. N'LEKTRONICS.** 63 Industrial Estate, Hadapsar, Pune 13. Tel. 7253. Proprietary, 1976. Bank Bank of Maharashtra. Cap. Rs 1,00,000. Workers 12. Products: Rectilinears, miniature multi-turn potentiometers variable resistors.
- 1340. NOBLE GARMENT.** 482/63 Budhwar Peth, Pune 2. Tel. C/o 448384. Partnership, 1969. Bank Central Bank. Cap. Rs 60,000. Prod. Rs 4,00,000 Workers 17. Product. Readymade garments.
- 1341. NOBLE IRON AND GENERAL WORKS.** 478 Somwar Peth, Pune 11. Partnership, 1952. Bank: Bank of Maharashtra. Cap. Rs.10,000. Workers 4. Product: Fabrication work.
- 1342. NOBLE PLASTIC INDUSTRIES.** 76 Krishna Kunj, 4th floor, Gen. Thimmayya Rd., Camp, Pune 1. Tel. 25768. Cable: NOBPLAST. Factory: 64 Hadapsar Industrial Estate, Post Box 1224. Pune 13 Tel. 7511. Proprietary, 1974. Bank: Bank of India. Cap. Rs.3,00,000. Prod. Rs.1,00,000. Workers 7. Products Polythene bags, tubes, rolls, sheeting; treated polythene bags, tubing and sheetings; multi-colour polythene bags, tubing and sheeting.
- 1343. NULIFE PHARMACEUTICALS.** 112/3 Erandawana, Pune 4. Tel. 56473. Factory: Plot No. 63, Block No. F-2, Pimpri, Industrial Area, M.I.D.C., Chinchwad, Pune 19. Partnership, 1973. Br Bombay. Bank: Bank of India. Cap. Rs.11,00,000. Prod. Rs.19,00,000. Products: Medicines—tablets, capsules, liquids, lotions, ointments and injections.
- 1344. NURMAHMAD HAJI LALSABEN.** 502 Ghorpadi Peth, near Swargate, Pune 2. Proprietary, 1925. Bank: Canara Bank. Cap Rs 5,000. Prod Rs 3,000. Product: Tin-making, repairs, soldering, etc.
- 1345. NUTAN PLASTICS.** 1527 (New) Shukrawar Peth, near Shukrawar Peth Police Chowky, Pune 2. Tel. 445314. Proprietary, 1965. Bank. Bank of Baroda. Products: P.V.C. plastic, presentation novelties, plastic files, diary cover, bank-pass book cover and polythene bags.
- 1346. NU-TECK ENGINEERING CORPORATION.** Bhosari Industrial Estate, M.I.D.C., Pune 26. Tel. 82103, 83039. Cable FLEXCOUPLE. Telex: NUTECK VIA 0145-333 MCCI. Partnership, 1968. Bank: State Bank of India. Cap Rs. 7,79,430. Prod. Rs.18,00,000. Workers 45. Export Rs.36,441. Country: Iran. Products Sprockets, chain couplings, conveyor chains and industrial machinery.

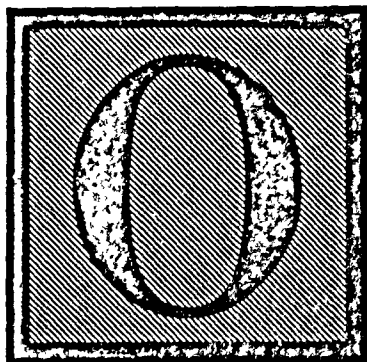

1347. **OAK SUNBREAKERS.** 1524 Sadashiv Peth, Pune 30. Tel. 440323. Factory: S.No. 19 Vithalwadi, Hingane (Khurd), Pune 9. Tel. 445168. Proprietary, 1970. Bank: Shree Suvarna Sahakari Bank Ltd. Cap. Rs.80,000. Prod. Rs.2,50,000. Workers 9. Products: Aluminium sunbreakers-venetion blinds, badminton rackets, plastic presentation articles and plastic moulders.
1348. **O K ENGINEERING WORKS.** 446 Kasarwadi, Pune 11. Proprietary, 1974. Bank: Bank of Maharashtra. Prod. Rs. 1,500. Worker 1. Product: Job work and general repairing.
1349. **O. K. LEATHERS.** 273 Ganesh Peth, Pune 2. Tel. 447774. Partnership, 1970. Br. O. K. Leather Works, 635 Budhwar Peth, Pune 2. Cap. Rs 30,000. Prod. Rs. 60,000. Workers 2. Products: Travelling bags, leather work.
1350. **OJAS ENGINEERING PVT. LTD.** 784 Dr. Chandrachud Bungalow, near Kamla Nehru Park, Deccan Gymkhana, Pune 4. Tel. 54943. Telex: 0145-381. Factory: Shembekar Industries Compound, Chunchwad, Pune 19. Tel. 83120. Estd. 1969. Bank: Bank of Maharashtra. Product: C.T. castings.
1351. **OM KAILAS GRAMODYOGA.** 195 Ganesh Peth, Pune 2. Proprietary, 1970. Cap. Rs.18,000. Prod. Rs.25,000. Workers 3. Product: Wooden work, furniture.
1352. **OM KROME PVT. LTD.** 610 Raviwar Peth, Pune 2. Tel. 446749. Cable: SOMANI. Factory: 410/1 Fugewadi, Pune 12. Estd. 1972. Bank: United Western Bank Ltd. Cap. Rs.4,51,000. Prod. Rs.3,81,000. Workers 27. Product: Leather boards.
1353. **OM MUDRANALAYA.** 250-A Shaniwar Peth, Pune 30. Tel. 449815. Partnership, 1973. Bank: Bank of Maharashtra. Cap. Rs.2,00,000. Prod Rs 1,00,000. Workers 5. Product: Commercial printing.
1354. **OMEGA PAINT INDUSTRIES.** S-40 & S-68, M.I.D.C., Pune 26. Tel. 82583. Proprietary. Bank: Dena Bank. Products: All types of paints and thinners.
1355. **OMEGA PLASTIC INDUSTRIES.** 248 Budhwar Peth, Pune 2. Tel. 445337. Partnership, 1971. Sister concerns: Sona Plastics, Teja Engineering Industries. Bank: Bank of Maharashtra. Cap. Rs.75,000. Prod. Rs. 1,00,000. Workers 9. Products: Plastic injection moulded articles, blow moulded articles, extrusion, colouring and reprocessing, dies manufacturing, hot foil printing and screen printing.
1356. **OPILA MUDRAN KARYALAYA.** 428 Budhwar Peth, Pune 2. Proprietary, 1956. Sister concern: Opila Karya Mandir. Bank: Bank of Baroda. Prod. Rs 10,510. Product: Label printing.
1357. **OPILA KARYA MANDIR.** 428 Budhwar Peth, Pune 2. Proprietary, 1955. Sister concern: Opila Mudran Karyalaya. Product: Perfumery compounds for agarbatties, soaps and other perfumed products.
1358. **OPTICAL AND SCIENTIFIC INSTRUMENTS.** W-18, M.I.D.C. 'S' Block, Bhosari, Pune 26. Proprietary, 1975. Bank: Indian Bank. Cap. Rs 1,00,000. Prod. Rs. 68,000. Workers 5. Products: Astronomical telescopes, optical electronic transducers, optical flats.
1359. **OPTIQUE (INDIA).** 1144 Sadashiv Peth, Pune 30. Tel. 447373. Partnership. 1947. Sister concerns: Ganoo Brothers & Association, Modern Opticians, W.N.E.S. Distributors, Mars Linkers, United Four, Pune. Bank: Bank of Maharashtra. Cap. Rs.1,15,966. Prod. Rs.17,25,800. Workers 46. Export: Rs 65,238. Country: Sri Lanka. Products: Fused bifocal blanks of different varieties, ophthalmic lenses, optical grinding machines, spectacle frames.
1360. **ORBEEY STEEL AND IRON INDUSTRIES.** 37 Hadapsar Industrial Estate, Pune 13. Tel. 7246. Partnership, 1963. Br. H.O. Bombay. Sister concern: R.B. Shivdasani & Sons. Banks: Bank of Maharashtra, Pune; The Chartered Bank, Bombay. Workers 3. Product: Band-saw blades for wood cutting.

1361. ORIENT ELECTRONICS PVT. LTD. W-23, Block F-2, MID C. Industrial Area, Post Bag No. 13, Pimpri, Pune 18. Tel. 83003. Estd. 1972. Bank: Syndicate Bank. Cap. Rs.70,000 Prod. Rs 6,00,000. Workers 5 Product: Capacitors for power factor correction.

1362. ORIENTAL ENGINEERING COMPANY. 540 Kasba Peth, Pune 11. Tel. 446136; and 47/30-C No. 2, Aranyeshwar Cross Road, Pune 9. Tel. 447064. Partnership, 1967. Bank: Bank of Baroda. Cap. Rs.3,00,000. Prod. Rs 4,50,000. Workers 15. Products: Tractor-driven agricultural implements; manufacture and repairs of single-furrow and double-furrow reversible M.B. ploughs.

1363. ORION ENTERPRISES. 363/4 Shivajinagar, Ganga Bhavan, Pune 2. Tel. 441226, 441222. Partnership, 1970. Bank: United Western Bank Ltd. Cap. Rs.16,000. Prod. Rs 60,000 Workers 3 Products: Detergents, cleaning powder, perfumed liquid soap, glass cleaner.

1364. OSWAL AND CO. 105 New Timber Market Pune 2. Tel. 444616 SAWWOOD Telex: 0145-333 MCCI Partnership, 1960 Bank Central Bank of India. Cap. Rs.4,00,000. Prod. Rs 6,00,000. Workers 7. Products: Sawn sizes, doors, windows, packing cases, wooden crates, furniture.

1365. OSWAL WOOD CRAFTS. 929/B Sanas Bungalow, F.C. Rd., Pune 4 Tel. 57697. Proprietary, 1972. Bank: Syndicate Bank. Cap. Rs.40,000. Prod. Rs 2,00,000. Workers 8. Product: Wooden furniture, interior decoration.

1366. OSWAL PLASTIC INDUSTRIES. 332 Shukrawar Peth, Pune 2. Factory: 355 Kasarwadi, Bombay-Pune Rd., Pune 18. Proprietary, 1978 Bank: State Bank of India. Cap. Rs.15,000. Workers 2. Products: Plastic beads and novelty items.

1367. OTOMATS. 11 Ganesh Nagar, Chunchwad, Pune 33. Tel. 82255, 82753. Partnership, 1967. Sister concern: Kohinoor Engineers. Bank: Union Bank of India. Cap. Rs.3,00,000. Prod. Rs.3,50,000. Workers 18. Products: Automobile turned components, nuts, bolts, screws and precision turned components, industrial fasteners, special nut-bolts, radio parts, precisely turned components and automobile ancillaries.

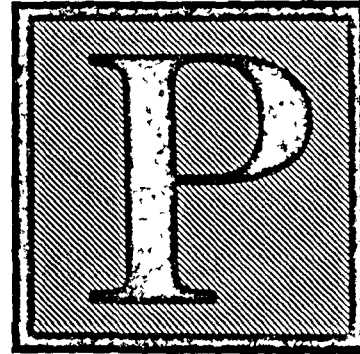

1368. P. A. KOMKAR AND SONS. 1105 Shukrawar Peth, Pune 2 Partnership, 1940. Cap. Rs.20,000. Prod. Rs. 80,000. Workers 7 Product: Brass materials, jobbing.

1369. P. A. PETHKAR ENGINEERING WORKS. 506 Raviwar Peth, Pune 2. Proprietary, 1965. Bank: Bank of Maharashtra. Cap. Rs 60,000 Prod Rs 25,000. Workers 4. Product: Jobbing.

1370. P. BOX WEL. 251 Sadashiv Peth, opp. Bhave School, Pune 30. Tel. 441927. Partnership, 1963. Bank: Bank of Maharashtra. Cap. Rs.80,000. Prod. Rs 6,00,000. Workers 7 Products: Boxes, corrugated rolls, duplex paper, grey board cartons, etc

1371. P. G. HEREKAR. 510 Budhwar Peth, Pune 2 Partnership, 1960. Br. Kasba Peth, Pune Bank: Dena Bank. Cap. Rs.20,000. Prod. Rs.50,000. Products: Wooden toys, wooden turned items, wooden plugs, jobbing.

1372. P. M. CHAVAN. 412 Guruwar Peth, Pune 2. Tel. 444795. Partnership, 1951. Bank: Bank of Baroda. Cap. Rs 2,00,000. Prod. Rs.1,50,000. Workers 10. Products: Aluminium, brass and stainless steel utensils, machinery parts, non-ferrous foundry.

1373. PMS ENTERPRISES. E-13 Bhosari, M.I.D.C., Pune 26. Tel. 82684, 82959. Proprietary, 1969. Bank: State Bank of India. Cap. Rs 3,80,000 Prod. Rs.6,00,000. Workers 20. Products: M S Gratings, chemical plant equipments, trailers, M.S. and S.S. fabrication.

1374. P. M. PATEL AND CO. 61 Timber Market, Pune 2. Tel. 444606, 446744. Partnership, 1959. Sister concern: Sahyadri Enterprises. Banks: Dena Bank;

- Union Bank of India. Cap. Rs.4,00,000. Prod. Rs.3,00,000. Workers 2. Products: Wooden cases, wooden building material, crates.
1375. **P. V. AND CO.** 820/21 Sadashiv Peth, Pune 30. Tel. 53850. Proprietary, 1972. Bank: Bank of Maharashtra. Cap. Rs.13,000. Prod. Rs.8,000. Workers 3. Products: Plastic and bakelite moulding, blowing parts, dial printing on offset machine.
1376. **PAAM INDUSTRIES.** Shed No. 45, Lonavala Industrial Co-operative Estate Ltd., Lonavala, Dist. Pune. Tel. 743. Partnership, 1966. Bank: State Bank of India. Cap. Rs.75,000. Prod. Rs.1,90,000. Workers 7. Products: Flood-light cover glasses, glass reflectors.
1377. **PACKRAFT.** 1971 Madiwale Colony, Sadashiv Peth, Pune 30. Factory: 24 Parvati Industrial Estate, Pune 9. Partnership, 1974. Prod. Rs.50,000. Workers 5. Product: Industrial instrument wooden boxes.
1378. **PACKWELL CORPORATION.** Plot No. 30/A-4, Bombay-Pune Rd., Dapodi, Pune 12. Tel. 56372. Partnership, 1965. Bank: Bank of Maharashtra. Cap. Rs. 1,50,000. Prod. Rs.6,00,000. Workers 12. Product: Wooden boxes.
1379. **PAISA FUND GLASS WORKS.** Talegaon Dabhade, Dist. Pune. Tel. 29, 147. Cable: PAISA FUND. Public Trust, 1908. Br. Shop at Pune. Banks: Sangli Bank Ltd.; Janata Sahakari Bank Ltd.; Bank of Maharashtra. Cap. Rs.4,95,000. Prod. Rs.37,46,436. Workers 380. Export: Rs.5,15,936. Countries: Thailand, Singapore, Kelang. Products: Lenses and roundels for railways traffic signals, road traffic signals and for air-port and naval signals; bottles, refills for thermos flasks, pressed ware, glass rods and refractory-ware.
1380. **PALKAR INDUSTRIES.** 751 Bhawani Peth, Pune 2. Proprietary, 1947. Sister concern: Quadracast Non-ferrous Foundry. Bank: Bank of Maharashtra. Cap. Rs. 50,000. Prod. Rs.50,000. Workers 6. Products: Fork assembly for X-ray equipment, headres for oil heaters, handles of X-ray equipment, oil-engine spare parts, distilled tubes.
1381. **PAN LAMINATES PVT. LTD.** A-108/109, 'H' Block, M.I.D.C., Pimpri, Pune 18. Tel. 82833. Factory: Shembekar's Compound, Chinchwad, Pune 19. Tel. 82366. Estd. 1972. Bank: Bank of Maharashtra. Cap. Rs. 2,00,000. Prod. Rs.6,00,000. Workers 5. Products: Welding accessories and undercarriage assemblies/fabrication.
1382. **PANDE WOOD WORKS.** 15 A/8 Erandawana, off Karve Rd., Pune 4. Tel. 58511. Factory: 171/B Kothrud, Pune 29. Tel. 56583. Partnership, 1974. Bank: State Bank of India. Cap. Rs.1,15,000. Prod. Rs.9,00,000. Workers 110. Products: Wooden furniture for industrial and domestic use, T.V. cases, interior decoration and designing.
1383. **PANDHE FURNITURES.** 603 Ghorpade Peth, Pune 2. Proprietary, 1964. Bank: Cosmos Co-operative Bank Ltd. Cap. Rs.10,000. Prod. Rs.15,000. Workers 2. Products: Type cases, caram boards, presentation articles, wooden furniture.
1384. **PANDIT ENGINEERING WORKS.** Plot No. 2, Shashi Chambers, Satara Rd., Near Swargate, Pune 9. Tel. 441834. Partnership, 1960. Sister concerns: Tej Tools, Gauges Manufacturing Co. Banks: Cosmos Co-operative Urban Bank Ltd.; Bank of Maharashtra. Cap. Rs.3,45,000. Prod. Rs.4,97,600. Workers 23. Products: Hardware components of various defence organisations, jobbing.
1385. **PANDIT LINERS AND MANUFACTURING CO.** 968 (New) Shukrawar Peth, Shivaji Rd., Pune 2. Tel. 440757. Partnership, 1966. Bank: Bank of India. Cap. Rs. 1,00,000. Prod. Rs.2,00,000. Workers 5. Products: All types of gears, parts required for rubber mills.
1386. **PANDURANG BALWANT TADSARE.** 951 Ganj Peth, Pune 2. Tel. 444495. Partnership, 1926. Cap. Rs. 1,00,000. Prod. Rs.2,50,000. Workers 4. Products: Toor dal, chana dal, moog dal, udid dal.
1387. **PANKAJ AND BROTHERS.** Nalband Building, near Post Office, Bombay-Pune Road, Chinchwad East, Pune 19. Partnership, 1969. Bank: Bank of Maharashtra. Cap. Rs.1,25,000. Prod. Rs.1,52,000. Workers 7. Products: Aluminium sliding windows for matadors, jeeps, mini buses, hood covers in canvas for autorikshas, pillion seats for scooters, harnesses for scooters, matadors, trucks.
1388. **PANKAJ PLASTIC INDUSTRIES.** 850 (old) Ganj Peth, Ghaseti Pool, Pune 2. Tel. 444583. Partnership, 1974. Bank: Bank of Maharashtra. Cap. Rs.1,25,000. Prod. Rs.1,75,000. Workers 7. Products: Polythene bags and granules.
1389. **PANKAJ AND SANJIV ASSOCIATED TOOL CO. PVT. LTD.** Block D-1, Plot No. 24, M.I.D.C., Akurdi, Chinchwad, Pune 19. Estd. 1966. Bank: State Bank of India. Cap. 7,00,000. Prod. Rs.4,00,000. Workers

18. Products: Hydraulic and air cylinders and their spares, pistons for hydraulic cylinders used in tractors, automobile spares—front shackle bushes, rear shackle bushes, hyd. jack pistons, swash plate, lock nut and lantern ring, cams for petrol and oil engines.
1390. **PANKAJ PRINTING PRESS.** 790 (New) Shukrawar Peth, Near Jain Mandir, Pune 2. Tel. 444983. Proprietary, 1964. Bank: The Poona Urban Co-op. Bank Ltd. Cap. Rs.50,000. Prod. Rs 30,000. Workers 2. Products: All commercial printing, all types of binding work.
1391. **PANSE CHEMICALS. (P) LTD.** 712/A, Shankarshet Rd., Pune 2. Tel. 22174. Factory: Village Vetore, Tal. Vengurla, Dist Ratnagiri. Estd. 1975 Sister concerns: Panse Agro Industries Corporation, Polyconstructions. Banks: State Bank of India; State Bank of Mysore; Union Bank of India Cap. Rs 8,00,000. Workers 22. Products: Sodium silicate, calcium silicate, cattle mineral supplement.
1392. **PANORAMA AUTOMOTIVE INDUSTRIES PVT. LTD.** 46 A/13 Kaka Halwai Industrial Estate, Satara Rd., Pune 9. Tel. 447185 Estd 1976 Bank Central Bank of India. Cap Rs 1,55,000. Workers 7. Products: Hydraulic jacks, machining jobs and fabrication
1393. **PAP-CON.** 820 Bhawani Peth, Sathe Biscuit Compound, Pune 2. Tel. 27570. Partnership, 1973. Sister concern: Ramesh Fabricators. Banks: Bank of India, Bank of Baroda. Cap. Rs 33,288. Prod. Rs 52,130. Workers 2. Products: Flexographic printing, paper converting and industrial supply.
1394. **PAPAL INDUSTRIES.** 353 Shukrawar Peth, Shivaji Rd., Pune 2. Tel. 440380. Partnership, 1960. Bank: Bank of Maharashtra. Cap. Rs.70,000. Prod. Rs.75,000. Workers 5. Products: Moulds and machineries for glass industries and glass blowing lathe, industrial components
1395. **PAPER AND PULP CONVERSIONS LTD.** 1183 Shivajinagar, Fergusson College Rd., Pune 5. Tel. 55301, 55302. Cable. PAPCOMILLS, Poona Telex: CPM-PM 0145-278. Factory: Papco Mills, Khopoli, Dist. Kolaba. Estd. 1942. Brs. Fort, Bombay; Lower Parel, Bombay. Bank: Bank of Maharashtra. Cap Rs. 220 lakhs. Prod. Rs 553 lakhs. Workers 500. Products. Paper and paper boards, paper and pulp plant machinery and component parts thereof.
1396. **PAPERSTEQ.** 69/B Hadapsar Industrial Estate, Pune 13. Tel. 7265, 7510. Proprietary, 1973. Br. Pune.
- Sister concern: Mehta Packard Industries Pvt Ltd. Bank: Bank of India. Cap. Rs 4,71,121. Prod. Rs.12,00,000. Workers 11. Products: Plain and printed paper bags, printed wrappers.
1397. **PARADKAR AND CO.** 249 M.G. Rd., Pune 1. Tel. 23941. Partnership, 1911. Banks: United Commercial Bank-Bank of India. Cap. Rs.75,000. Prod. Rs 1,00,000. Workers 6. Product. Stationery.
1398. **PARAMOUNT ELECTRICAL AND MECHANICAL INDUSTRIES.** 1587 Sadashiv Peth, Tilak Rd., Pune 30. Tel. 449453. Factory: 1890 Sadashiv Peth, Natu Baug, Pune 30 Proprietary, 1970. Bank: Central Bank of India Cap. Rs.60,000. Prod. Rs.1,25,000. Workers 5. Export: Rs.5,000. Countries: Middle East. Products: Galvanometers, bridges, potentiometers, standard cadmium cells, polarograph units, stabilised supply units for electrical instruments.
1399. **PARAMOUNT PATTERN EQUIPMENT.** 326 Shanwar Peth, Pune 30. Tel. 449912. Cable 'YESH-LAXMI'. Factory: A 24/1 'H' Block, MID.C., Pimpri, Pune 18. Tel 82968, 83579. Partnership, 1969. Bank: Central Bank of India Cap. Rs.88,000. Prod. Rs 1,00,000. Workers 13. Products: All types of patterns, heavy duty glass blowing lathe, small compressor, centrifugal casting machine.
1400. **PARANJPE ENGINEERING AND FOUNDRY CO. PVT. LTD.** E 14 and 15, Bhosari Industrial Area, Pune 26 Tel. 82741, 83311, 83312. Cable: PEFCO, Pune 26. Telex: 0145-330. Estd. 1969. Br. Nagpur. Bank: Punjab National Bank. Cap. Rs 34,02,271. Prod. Rs.42,05,813. Workers 262. Products: Alloy cast iron and alloy steel castings, stainless steel utensils.
1401. **PARANJPE METAL SHAPERS PVT. LTD.** T-141 Bhosari Industrial Area, Pune 26. Tel. 82187. Cable: PAMETS. Estd. 1972. Bank: Bank of Maharashtra. Prod Rs 18 to 20 lakhs. Workers 50. Products: Shell moulded tinned cylinder liners in alloy cast iron, heat resistant and wear resistant iron castings.
1402. **PARAS SOAP FACTORY.** 141 Narayan Peth, Pune 30. Tel 444014. Proprietary, 1952. Bank: The United Western Bank. Cap. Rs.70,000. Prod. Rs 80,000. Workers 3. Product: Soap.
1403. **PARBAT KANJI PATEL AND CO.** 4 New Timber Market, Pune 2. Tel. 23692. Partnership, 1961. Sister concern: Kamala Timber Mart. Bank: State Bank

of India. Cap. Rs. 4 lakhs. Prod. Rs.1,00,000. Workers 4. Products: Building material, doors, windows, furniture.

1404. PAREKH TRADERS. 813 Bhawani Peth, Pune 2. Tel. 23012, 26945. Partnership, 1965. Bank: Bank of Baroda. Cap. Rs.5,00,000. Prod. Rs.20,00,000. Workers 7. Products: Manure mixtures.

1405. THE PARSHURAM IRON AND STEEL ROLLING MILLS. 560 Sadashiv Peth, Laxmi Road, Pune 30. Tel. 444009. Factory: Plot No. 20 D-1, M.I.D.C. Area, Chinchwad, Pune 19. Tel. 82975. Partnership, 1966. Sister concerns: Vinod and Abhyankar; G. K. Abhyankar and Sons; Abhyankar Brothers. Banks: Bank of Maharashtra; Shree Suvarna Sahakari Bank Ltd. Cap. Rs.14,00,000. Prod. Rs.30,00,000. Workers 39. Export: Rs.10,00,000. Countries: Dubai, Kuwait. Products: Hot rolled steel products such as M.S. rounds, M.S. squares, M.S. flats, M.S. angles, H.C. rounds, H.C. octangals, crowbars, chisels, etc.

1406. PARSHURAM PROCESS. 16-A Shivajinagar, Pune 5. Tel. 53855. Proprietary, 1967. Bank: Bank of Maharashtra. Cap. Rs.1,20,000. Prod. Rs.7,50,000. Workers 18. Product: Offset printing.

1407. PASALKAR ENGINEERING WORKS. 108 Shivajinagar, Pune 5. Tel. 56200. Partnership, 1965. Bank: Bank of Maharashtra. Cap. Rs.75,000. Prod. Rs.1,00,000. Workers 7. Product: Semi-finished turning job work.

1408. PATASKAR BROTHERS. 21/1 Hadapsar Industrial Estate, Pune 13. Tel. 7189. Partnership, 1977. Bank: Bank of Maharashtra. Workers 5. Products: Sadha jarda, scented jarda.

1409. PATEL ASBESTOS CEMENT INDUSTRIES. 39 Gultekadi, opp. Apsara Talkies, Pune 9. Tel. 448599, 447599. Cable: PATELGROUP. Telex: 0145-333 MCCI-PATELGROUP. Partnership, 1969. Sister concerns: Poonam Tiles; Swastik Industries. Bank: Bank of India. Cap. Rs.5,50,000. Prod. Rs.7,00,000. Workers 25. Product: Asbestos cement pipes and fittings.

1410. PATEL CEMENT CONCRETE WORKS. Plot No. 42/1 Shivajinagar, Pune 5. Tel. 56975, 53881. Partnership, 1955. Sister concerns: Patel Cement Industries; Patel Agencies. Banks: Bank of Maharashtra; Bank of India. Workers 43. Products: Mosaic flooring tiles, R.C.C. grills and R.C.C. blocks.

1411. PATEL M. R. AND CO. Plot 3 New Timber Market, Pune 2. Tel. 26018. Partnership, 1960. Sister concern: Pragati Ply Centre. Bank: Punjab National Bank. Cap. Rs.2,50,000. Prod. Rs. 4,00,000. Workers 4. Products: All types of wooden work required for the building structure and furniture.

1412. PATEL METAL INDUSTRIES. 1374 Shukrawar Peth, Khadakmal Ali, Pune 2. Tel. 441495, 447745. Partnership, 1951. Sister concerns: Vardhaman Metal Corporation; Hamirnal Mohanlal Poonawala and Co. Bank: Canara Bank Cap Rs 8,00,000. Prod. Rs.19,00,000. Workers 30. Products: All sorts of brass, copper, aluminium and stainless steel household articles, non-ferrous industrial castings, fabrication.

1413. PATEL PARBATBHAI DAHYABHAI AND CO. 61/B New Timber Market, Pune 2. Tel. 444797 Partnership, 1959. Bank: Union Bank of India. Cap Rs. 2,00,000. Prod. Rs 5,00,000. Workers 4. Products: Furniture, door frames and shutters, wooden boxes, wooden crates

1414. PATEL RAJIBHAI S. 118 Mahatma Gandhi Rd, Pune 1. Tel. 22678. Cable SHAKHAND. Partnership, 1910. Bank: Dena Bank. Cap. Rs 6,00,000 Prod. Rs 18,00,000 Workers 600. Product. Handmade bides.

1415. PATEL SAW MILLS. 22 Timber Market, Pune 2. Tel. 444592. Partnership, 1958 Bank: Union Bank of India. Cap. Rs. 4,00,000 Prod. Rs 8,00,000. Workers 6. Products: Wooden sizes for building, doors and windows, packaging boxes, packing wood size.

1416. PATEL SHIVJI KARSAN AND CO. Plot No. 5, New Timber Market, Pune 2. Tel. 24601. Partnership, 1949. Br. Pune Bank: Bank of India. Cap. Rs.3,00,000. Prod. Rs.6,00,000. Workers 3. Exports: Rs.32,000. Country: Muscat. Products: Packing cases, wooden crates.

1417. PATEL SPUN PIPE COMPANY. Plot No. 19, D-1 Block, M.I.D.C., Chinchwad, Pune 19. Tel. 82677. Cable: SPANCO. Partnership, 1966. Bank: Dena Bank. Cap. Rs.3,35,000. Prod. Rs.3,50,000. Workers 25. Products: RCC spun pipe water tanks, septic tanks, half-round gutters, marble mosaic and plain cement tiles, RCC grills and blocks.

1418. PATEL TIMBER TRADING CO. Plot No. 90 New Timber Market, Pune 2. Tel. 444797. Partnership, 1967. Bank: Bank of India. Product: All kinds of wood and packing cases.

- ✓1419. **PATENT TIFFIN CARRIERS SANGHVI CO.** 110 Shivajinagar, Pune 5. Tel 56578, 56579 Cable. SANGHVI CO. Partnership, 1938. Br Bombay. Bank: Bank of Baroda. Cap. Rs. 31,78,000. Prod Rs 1,11,21,350. Workers 153. Products: Brass, copper and stainless steel strips, circles, sheets, etc.
1420. **PATHEJA FORGINGS AND AUTO PARTS MANUFACTURERS PVT. LTD.** E-20 M.I.D.C., Bhosari, Pune 26. Tel. 82639, 83617. Cable. IRRAWADY. Partnership, 1969. Br. office: Bombay Banks: Punjab National Bank; Indian Overseas Bank Workers 280. Products: Steel forgings for scooters and automobiles, job work.
1421. **PATIL INDUSTRIES.** S No. 13/3A/1 C, opp. Akashwani, Solapur Rd., Hadapsar, Pune 28. Tel. 7447 Proprietary, 1971. Bank: Bank of Baroda Cap. Rs. 2,00,000. Prod. Rs. 1,20,000 Workers 8 Products: Spare parts and engineering items
1422. **PAUL CHEMICAL WORKS.** 207/1 Mangalwar Peth, Pune 11. Tel. 25606. Proprietary, 1952. Bank: Bank of Maharashtra. Cap. Rs 50,000. Prod. Rs. 40,000. Workers 7. Products: Black essence of phynyle, white perfumed phenyle, cleaning solution, rat killer, dynamite dust powder.
1423. **PAVA INDUSTRIES.** 167/A Kothrud, Pune 29. Tel. 56611 Partnership, 1966. Bank: Bank of India. Cap. Rs 20,000. Prod. Rs. 1,20,000. Workers 7. Product: Turning, welding, milling job work.
1424. **PAVAN PLASTICS.** 1478 Shukrawar Peth, Pune 2. Partnership, 1976. Bank: Bank of India. Cap. Rs. 20,000. Prod. Rs. 25,000. Products: PVC diary covers, office files, price-list folders, book covers, identity cards, directory covers.
1425. **PAWAGIR POLYMER JUTE MILLS PVT. LTD.** Plot No. 118. M.I.D.C., Bhosari Industrial Area, Pune 26. Tel. 82934. Estd. 1971. Bank: The United Western Bank Ltd. Cap. Rs. 4,00,000. Prod. Rs 3,48,000. Workers 20. Products: H.D.P.E. woven sacks of various sizes, L.D.P.E. liners for industrial and domestic purpose.
1426. **PAWAN RUBBER PRODUCTS.** 1202/3/10 Ghole Rd., Pune 4. Tel. 54850. Cable: 'PAWAN', Pune 18. Factory: 433/2, Pune-Nasik Rd., Kasarwadi, Pune 18. Tel. 83622. Partnership, 1969. Sister concerns: Swati Ice Factory; Rachana Rubber; Shailesh Coal Traders, Car Care Centre Banks: Bank of Maharashtra; The Shamrao Vithal Co-operative Bank Ltd. Cap Rs. 5,25,000. Prod. Rs 10,18,000. Workers 25. Products: Meteorological balloons, dipped and moulded rubber goods
1427. **PAWAR ENGINEERING WORKS.** 408/6 Gultekadi, Swargate, Pune 9 Tel. 440292. Partnership, 1961. Bank: Bank of Maharashtra. Cap. Rs 1,50,000. Prod. Rs 60,000. Workers 8 Product: Job work.
1428. **PAWAR METAL WORKS.** 356/A Ganesh Peth, Pune 2 Proprietary, 1954. Cap. Rs. 40,000. Prod. Rs. 1,60,000. Workers 14 Products: Sangli, Satari and Rajapur lotte.
1429. **PEARL PLASTIC PRODUCTS.** 774 Budhwar Peth, near Bharat High School, Pune 2. Tel. 446296 Partnership, 1969. Bank: Central Bank of India. Cap. Rs. 1,50,000 Prod Rs 2,00,000. Workers 9. Products: Thermo-plastic industrial goods, electronic components, engineering spares, pharmaceutical requirements.
1430. **PERFECT ENGINEERS.** 113/114 Bhawani Peth, Pune 2. Tel. 22404. Proprietary, 1964. Sister concern: Javalekar Enterprises. Banks: Bank of Maharashtra; Central Bank of India. Cap. Rs 90,220. Prod. Rs 3,18,270. Products: Diesel engine spare parts, rear axle tubes.
1431. **PERFECT ENGINEERING WORKS.** 605 Ghorpade Peth, Pune 2 Tel. 444558. Proprietary, 1966. Bank: Bank of Maharashtra Cap Rs 1,50,000. Workers 8. Product: Shafts, jobbing
- ✓1432. **PERFECT OIL SEALS AND INDUSTRIAL RUBBER PRODUCTS.** 84 M.I.D.C. Area, Bhosari, Pune 26. Tel. 82335, 83327. Partnership, 1965. Bank: Bank of Maharashtra. Cap. Rs 10,00,000 Prod. Rs 24,80,000. Workers 64. Products Oil seals, rubber metal bonded parts, auto parts, oil-engine rubber parts, coupling, sugar machinery parts.
1433. **PERFECT SPRING WORKS.** Opp. Century Enka Colony No 2, Bhosari, Pune 26. Partnership, 1974. Bank: Union Bank of India. Cap. Rs. 50,000. Prod. Rs. 88,000. Workers 9. Products: All types of springs, all types of metal parts, auto speedo cables.
1434. **PEST CONTROL (INDIA) PVT. LTD.** 36 Yusuf Bldg, Mahatma Gandhi Rd, Bombay 23. Tel. 251546, 251594. Cable: PESTCIL Factory: Acme Industrial

Estate, Sewree, Bombay 15. Tel. 443216. 440646. Estd. 1954. Brs. Ahmedabad, Allahabad, Bangalore, Baroda, Bhopal, Calcutta, Cochin, Coimbatore, Hyderabad, Kakinada, Lucknow, Madras, Mangalore, New Delhi, Panji, Patna, Pune, Visakhapatnam. Sister concerns: Sahyadri Chemo-Colors Pvt. Ltd., Keetaram Agricultural Services Pvt. Ltd. Bank: Indian Overseas Bank. Cap. Rs. 33,98,000. Prod. Rs. 6,97,000. Export: Rs. 10,144. Countries: Doha, Kuwait, Bahrain, Abu Dhabi, Bangla Desh. Products: Rodafarin pestseal, termiseal, aerosol spray. EDB ampules.

1435. **PETCO ENGINEERS.** 506 Raviwar Peth, Pune 2. Proprietary, 1974. Bank: Bank of Maharashtra. Cap. Rs. 60,000. Prod. Rs. 40,000. Workers 3. Products: Engravers on all sorts of metal and spares for engineering goods.

1436. **PETERS ENGINEERING CO. PVT. LTD.** 74 Bhosari Industrial Estate, Pune 26. Tel. 82393, 83135. Cable: PETERMECH. Estd. 1970. Bank: Bank of Maharashtra. Cap. Rs. 20,28,000. Prod. Rs. 22,11,000. Workers 139. Product: Jobbing of electrical appliances, fabrication.

1437. **PETHE ENGINEERING PVT. LTD.** 69 S.K. Bole Rd., Dagdiwadi, Dadar, Bombay 28. Tel. 454898. Cable: 'MAGBRKE' Bombay 28. Factory: 52/53 Lonavala Industrial Estate, Nagargaon, Lonavala, Dist. Pune. Tel. 570. Estd. 1964. Bank: Bank of India. Cap. Rs. 5,00,000. Prod. Rs. 20,00,000. Workers 100. Products: Electromagnetic clutches, Electromagnetic disc brakes, electromagnetic shoe brakes, electromagnets, demagnetisers.

1438. **PHADKE TOYS.** 1422 Shukrawar Peth, Pune 2. Proprietary, 1950. Bank: Bank of Maharashtra. Cap. Rs. 2,000. Prod. Rs. 3,000. Products: Electric switch board blocks, wooden lettering.

1439. **PHALNIKAR ENTERPRISE.** 427/42 Poona Small Scale Industrial Co-op. Estate Ltd., Gultekadi, Pune 9. Tel. 440408. Proprietary, 1969. Bank: Bank of Baroda. Cap. Rs. 2,56,000. Prod. Rs. 3,19,035. Workers 21. Export: Rs. 1,25,000. Country: Malaysia. Products: Patterns, crank cones, cylinder blocks.

1440. **PHILIPS INDIA LTD.** Loni Kalbhor, Pune 19. Tel. 7581. Cable: PHILIFACTO. Telex: 0145-242. Plot 80, Bhosari Industrial Estate, Pune 26. Tel. 83232. Cable: PHILIFACTO. Telex: 0145-242. Estd. 1930. Br. factories: Calcutta, Kalwa. Offices: Calcutta, New Delhi, Bombay, Madras. Banks: Grindlays Bank Ltd., Algemene Bank;

Bank of India; Punjab National Bank; United Bank of India; Bank of Baroda; Bank of America; American Express International Banking Corporation. Foreign collaboration: N. V. Philips Gloeilampenfabrieken, Eindhoven. Cap. Rs. 3,65,758 thousands. Prod. Rs. 1,95,705 thousands. Workers 3052. Export: Rs. 21,755 thousands. Countries: Holland, Taiwan, Hungary, France, Panama, Bangladesh. Products: Electronic components, piece-parts e.g. capacitors, resistors, condensers, loud-speakers, radio/transistor sets, tape recorders, electronic instruments and scientific instruments, public address systems

1441. **PHOENIX ALUMINIUM PRODUCTS PVT. LTD.** 89/6 Mira Society, 39 Shankarshet Rd., Pune 9. Tel. 447256. Factory. Unit 19, E-2 Block, Plot No 51, M.I.D.C., Pimpri Industrial Estate, Pune 18. Tel. 82528. Estd. 1973. Bank: Syndicate Bank. Cap. Rs. 2,13,195. Prod. Rs. 4,00,000. Workers 10. Products: Aluminium builders' hardware, press components and steel metal fabrication.

1442. **PILLARS PRODUCTS.** 43/2 Karve Rd., Pune 4. Proprietary, 1970. Cap. Rs. 28,000. Prod. Rs. 18,600. Workers 6. Product: Gray mulls.

1443. **PIMPALE MOTORS.** 1408 Kasba Peth, Pune 11. Tel. 449640. Proprietary, 1965. Bank: Bank of Maharashtra. Cap. Rs. 40,000. Prod. Rs. 90,000. Workers 7. Product: Spare parts of oil engines and motor cycles

1444. **PIONEER CO-OP. CONSTRUCTION AND FABRICATION SOCIETY. LTD.** 492 Shanwar Peth, Shanwar Post Office Bldg., Pune 30. Tel. 53066, 443654. Factory: 29/1-C Vadgaon Bdk, Khadakvasla Rd., Tal. Haveli. Dist. Pune. Estd. 1967. Bank: The Poona Dist. Central Co-operative Bank Ltd. Cap. Rs. 1,30,000. Prod. Rs. 20,00,000. Workers 18. Products: Industrial, commercial and domestic wooden items, structural steel fabrication, civil engineering construction and architectural structural designs etc.

1445. **PIONEER ENGINEERING INDUSTRIES.** Plot No. A-41 to 44, 'H' Block, M.I.D.C. Industrial Area, Pimpri, Pune 18. Tel. 83071. Cable: 'PIONEER' Pimpri, Pune 18. Proprietary, 1967. Bank: State Bank of India. Cap. Rs. 2,00,000. Prod. Rs. 4,50,000. Workers 16. Products: Trolley wheels, material handling trolleys, irrigation panel boxes, grinders for chemicals, hose clips.

1446. **PITTIE TOOLS PVT. LTD.** 37/1-B, Vadgaonsheri, off Nagar Rd., Pune 14. Tel. 27311, 27365. Cable: NEWPOWER. Estd. 1974. Br. New Delhi. Banks: Bank

- of India; Vijaya Bank; State Bank of India; Punjab National Bank. Cap. Rs.15,00,000. Prod. Rs.44,00,000. Workers 110. Product: Agricultural tractors.
- 1447. PITRODA INDUSTRIES.** 114 Bhawani Peth, Pune 2. Tel. C/o. 24260. Partnership, 1973. Bank: The Poona Co-operative Rupee Bank Ltd. Cap. Rs.30,000. Prod. Rs.40,000. Workers 4. Products: Induction heating coils, hose pipe clip, hardware jobs, all types of 'v' groove pulleys.
- 1448. PLASTIC MOULDERS.** 5/4 Erandawana, Karve Rd., Pune 4. Tel. 50630, 54706. Proprietary, 1969. Sister concern: Plastic Trading Corporation. Bank: Bank of India. Cap. Rs.50,000. Prod. Rs.2,50,000. Workers 8. Products: Nylon and plastic bobbins, knobs, washers, containers, wheels, sprockets, gears, bulb-holders, bushes, bakelite knobs.
- 1449. PLASTIMOL.** 33/20 Erandawana, Lane No. 4, Prabhat Rd., Pune 4. Factory: 32/1/6-A Erandawana, Pune 4. Partnership, 1972. Bank: Suvarna Sahakari Bank. Cap. Rs.40,000. Prod. Rs.25,000. Workers 4. Products: Plastic moulded goods.
- 1450. PLAST WELD INDUSTRIES.** Survey No. 19, Vithalwadi, Hingne Rd., Pune 9. Proprietary, 1977. Bank: Bank of India. Cap. Rs.25,000. Prod. Rs.10,000. Worker 1. Products: Plastic moulded articles jobbing.
- 1451. PNEU TOOLS CORPORATION.** Plot No. 408/410. Gultekadi, Pune 9. Tel. 440275. Partnership, 1974. Bank: Bank of Maharashtra. Cap. Rs.1,00,000. Prod. Rs.2,43,000. Workers 6. Products: Pneumatic tools, compressor spares, rotar blades, nozzles.
- 1452. POHARKAR BROTHERS.** 271/30 Kothrud, Pune 29. Tel. 54813. Proprietary, 1973. Bank: Bank of India. Products: Wooden packing boxes, furniture.
- 1453. POKALE ENGINEERS.** 666 Ganesh Peth, Pune 2. Tel. 447132. Proprietary, 1969. Bank: Bank of Maharashtra. Cap. Rs.30,000. Prod. Rs.40,000. Workers 7. Products: Oil engine spare parts, compressor spares.
- 1454. POLYCOATS.** Unit No. 1 M.I.D.C., Telco Rd., Chinchwad, Pune 19. Tel. 83143. Proprietary, 1976. Bank: Bank of Baroda. Cap. Rs.20,000. Prod. Rs.36,000. Workers 4. Product: Spray painting.
- 1455. POLYCRAFT INDUSTRIES.** 286 Akurdi, Bombay-Pune Rd., opp. Jayhind Industries, Pune 35. Estd. 1972. Bank: Bank of Maharashtra. Cap. Rs.30,000. Prod. Rs.70,000. Workers 7. Products: Polythene bags, sheets, rolls.
- 1456. POLYMER ENTERPRISE.** Office: 136 Nana Peth, Pune 2. Factory: 36 Hadapsar Industrial Estate, Pune 13. Tel. 7427. Proprietary, 1969. Bank: Ratnakar Bank Ltd. Cap. Rs.1,75,000. Prod. Rs.16,00,000. Workers 65. Products: Rubber hose pipes, rubber tubings, rubber moulded and extruded parts.
- 1457. POLYMER PRODUCTS.** Plot No. 4, Gultekadi Industrial Estate, Savarkarnagar, Pune 9. Tel. 440929, 443235. Cable: POLYPRODS. Partnership, 1961. Bank: Bank of Maharashtra. Cap. Rs.7,50,000. Prod. Rs.10,00,000. Workers 34. Products: Speedometers, drive units, greaved movements, timers, hour meters, restriction indicators, precision gears and precision components.
- 1458. POLYNET INDUSTRIES.** W-49 M.I.D.C., Bhosari Industrial Estate, Pune 26. Proprietary, 1975. Bank: Bank of India. Cap. Rs.1.80 lakhs. Prod. Rs.1.2 lakhs. Workers 6. Products: Wire netting and allied products, general fabrication work.
- 1459. POLYTECHNICAL ENGINEERS.** 630 Ghorpade Peth, behind Khadakmal Ali Ganpati, Pune 2. Tel. 441790. Partnership, 1973. Bank: Canara Bank. Cap. Rs.2,00,000. Prod. Rs.71,000. Workers 7. Products: Jobbing, press work, sheet metal work.
- 1460. POONA ART INDUSTRIES.** 11/1 Erandawana, Karve Rd., Pune 4. Tel. 50385. Factory: 34/11 Erandawana, Karve Rd., Pune 4. Partnership, 1964. Bank: Dena Bank. Cap. Rs.1,50,000. Workers 6. Products: Machine spares, garden implements, lawn mower.
- 1461. POONA AUTO ANCILLARIES PVT. LTD.** W-23 'S' Block, M.I.D.C., Bhosari, Pune 26. Tel. 82887. Estd. 1976. Sister concern: Bharat Automobiles Ancillary Industries. Bank: Punjab National Bank. Cap. Rs.6,00,000. Prod. Rs.3,50,000. Workers 20. Products: Hand honning machines, tool and cutter grinding machines, surface grinding machines.
- 1462. POONA BEVERAGES PVT. LTD.** Plot Nos. E-25, 26 and 27 M.I.D.C., Bhosari Industrial Estate, Pune 26. Tel. 82874, 83401. Cable: POOBEV, Pune. Estd. 1966. Banks: Bank of Maharashtra; Bank of Baroda. Cap. Rs.21,00,000. Prod. Rs.60,00,000. Workers 35. Products: Aerated waters viz. Coca-cola, Fanta orange and Fanta soda.

1463. **POONA BOTTLING COMPANY LTD.** 410/1 411/2 Bombay-Pune Rd., Dapodi, Pune 12. Tel. 82401. Estd. 1959. Banks: Bank of India; Bank of Maharashtra. Workers 14. Products: Gold Spot, Limca, Rimzim, Parle Soda.
1464. **POONA BRUSH CO.** 1294-B, Sadashiv Peth, Pune 30. Tel. 442238. Factory. S.No. 8, P.I.E. Pune 9. Tel. 447818. Partnership, 1952. Bank: Bank of Maharashtra. Workers 15. Products: Industrial and domestic textile brushing.
1465. **POONA CHEMICAL LABORATORY.** 207 Mangalwar Peth, Pune 11. Tel. 27761. Factory: Survey No. 50/5, Village Narhe, Dist. Pune. Tel. 442246. Partnership, 1968. Bank: Bank of Maharashtra. Cap. Rs.2,00,000. Prod. Rs.6,00,000. Workers 10. Products: Laboratory chemicals.
1466. **POONA COVERS.** 594 Sadashiv Peth, Laxmi Rd., Pune 30. Tel. 447060. Partnership, 1974. Bank: Bank of India. Cap. Rs.5,000. Prod. Rs.22,000. Workers 4. Product: Leather cover of transistors.
1467. **POONA CLOSURES.** Kala Basant Society, Plot No. 146, Bhandarkar Rd., Pune 4. Tel. 58415. Factory: S. No. 691/A/2, Shed No. 6, Pune-Satara Rd., Bibwewadi, Pune 9. Tel. 443645. Partnership, 1976. Br. Bombay. Banks: Shree Suvarna Sahakar Bank Ltd. Cap. Rs.2,00,000. Prod. Rs.3,00,000. Workers 5. Product: Aluminium ropp caps.
1468. **POONA COMPLAST PVT. LTD.** F/13 Shanti Kunj, 4 Sadhu Vaswani Rd., Pune 1. Tel. C/o. 26563. Telex: C/o. PN 0145-269. Factory: Plot No. 72, D-III, M.I.D.C. Industrial Area, Akurdi, Chinchwad, Pune 19. Tel. 82911. Estd. 1972. Bank: Bank of Maharashtra. Cap. Rs.8,94,895. Prod. Rs.7,19,064. Workers 36. Products: Plastic components for vacuum flasks, fans, radios.
1469. **THE POONA CRYSTAL ICE WORKS.** 94 Mahatma Gandhi Rd., Pune 1. Tel. 22722, 24891. Cable: **TIMBER.** Factory: 389-D Bhawani Peth, Pune 2. Partnership, 1960. Bank: Canara Bank. Cap. Rs.3,30,643. Prod. Rs.4,10,270. Workers 10. Product: Ice.
1470. **POONA DAL AND BESAN MILLS.** 190 Bhawani Peth, Pune 2. Tel. 22969, 23386. Factory: 71 Hadapsar Industrial Estate, Pune 13. Tel. 7523, 7280. Partnership, 1971. Bank: Central Bank of India. Workers 50. Products: Flour of dal and besan.
1471. **POONA DRUM SUPPLY COMPANY.** 84 Shivajinagar, Pune 4. Tel. 58662. Proprietary, 1970. Cap. Rs.15,000. Worker 1. Products: Reselling and reconditioning of barrels, drums and waste engine-oil.
1472. **POONA ELECTRONICS.** 885/86 Boottee Street, Pune 1. Tel. 23331. Factory: 61 Hadapsar Industrial Estate, Pune 13. Partnership, 1973. Bank: Bank of Baroda. Cap. Rs 1,50,000. Prod. Rs.2,50,000. Product: Printed circuit boards.
- ✓1473. **POONA FIBRE PRODUCTS (PVT.) LTD.** T-29-31 Bhosari Industrial Estate, Pune 26. Tel. 82054, 83469. Estd. 1972. Bank: Bank of Maharashtra. Cap. Rs 10,50,176. Prod. Rs.6,75,467. Workers 48. Product: Filter paper.
1474. **POONA GUT FACTORY.** 29/1 Wanowrie, Pune 13. Tel. 7639. Cable: **GUTS.** Partnership, 1954. Bank: Bank of Maharashtra. Cap. Rs 1,00,000. Prod. Rs. 14,00,000. Workers 22. Export: Rs.14,00,000. Countries: Japan, Europe. Products: Animal casings, sports guts strings for rackets.
1475. **POONA HING SUPPLYING CO.** 200 Ganesh Peth, Pune 2. Tel. 447309. Cable: **HINGWALA.** Factory: 199/A Ganesh Peth, Pune 2. Tel. 446774. Partnership, 1974. Sister concerns: Agarwal Dhanya Bhandar; R. G. Agarwal. Bank: Bank of India. Cap. Rs.2,85,000. Prod. Rs.3,66,000. Workers 9. Product: Asafoetida (Hinga).
1476. **POONA INK INDUSTRIES.** 26-B Main Bazar Pimpri, Pune 17. Tel. C/o.82472. Partnership, 1963. Bank: Bank of Maharashtra. Cap. Rs.50,000. Prod. Rs 1,28,000. Workers 5. Products: Fountainpen ink, writing ink, stamp pad ink, gum, office paste, ink tablets, kumkum.
1477. **POONA ISPAT UDYOG.** 49/4 Budhwar Peth, Laxmi Rd., Pune 2. Tel. 445790. Factory: Plot No. 76,77, 78, Block No. D-III, M.I.D.C., Chinchwad, Pune 19. Tel. 82838. Proprietary, 1975. Bank: Bank of India. Cap. Rs. 3,50,000. Prod. Rs. 2,50,000. Workers 5. Export: Rs. 1,00,000. Country: Dubai. Products: Wire nails, panel pins.
1478. **POONA METAL WORKS.** 26-D-III, M.I.D.C., Bombay-Pune Rd., Chinchwad, Pune 19. Partnership, 1975. Bank: Syndicate Bank. Cap. Rs.2,50,000. Prod. Rs.3,75,000. Workers 12. Products: Castings and non-ferrous castings for various machines, manhole covers, chamber covers, foot-steps, etc.

- 1479. POONA OXI ACETYLENE WELDING WORKS.** 418 Shukrawar Peth, Shivaji Rd., Pune 2 Partnership, 1954. Bank: Bank of Baroda Cap. Rs 25,000. Prod. Rs 10,000. Workers 4 Product Machinery part welding.
- 1480. POONA OXYGEN AND ACETYLENE CO. (P) LTD.** 40/41 Hadapsar Industrial Estate, Post Box No. 1223, Pune 13 Tel. 7223, 7407. Cable: 'POXYGAS'. Estd. 1962. Bns. Bhawani Peth; Pimpri, Pune. Sister concern: United Oxygen Co (P) Ltd Bank of Maharashtra. Cap. Rs.10,00,000 Prod. Rs 20,00,000. Workers 45 Products: Oxygen gas, dissolved acetylene gas, compressed air, medical oxygen.
- 1481. POONA PAPER CONTAINER.** Landewadi, Bhosari, Pune 26. Proprietary, 1975 Sister concerns: United Sales Agency; Vijayashree Enterprises Bank: State Bank of India Cap. Rs 32,000, Prod Rs 36,000 Workers 6. Products Paper boxes, paper tubes
- 1482. POONA PEARLS POULTRY BREEDING FARMS AND HATCHERIES.** Jayajee Mansion, Hadapsar, Pune 28 Tel 7177, 7477 Cable: "PEARLS". Farms at Nandur, Urali, Dist. Pune Partnership, 1969. Bns New Delhi, Andhra Pradesh, Tamilnadu, Gujarat, Karnataka, West Bengal Banks: Bank of Baroda; Bank of Maharashtra Cap Rs.75,00,000 Prod. Rs 70,00,000, Workers 200. Countries: Middle East, Nepal. Products: Day-old chicks of grand parents, parents and commercials of white egg-layer, day-old chicks of golden egg-layer, day-old chicks of grand parent, parent and broilers.
- 1483. POONA PLAST.** 248 'Paramanand' Bldg, Pimpri, Pune 17. Tel 82840. Partnership, 1975. Bank: Syndicate Bank. Cap. Rs 80,000 Prod Rs.2,50,000. Workers 6. Products. L D. and H D polythylene layflat tubing, sheets, rolls and bags.
- 1484. POONA PRESSINGS PVT. LTD.** 39/39 Prabhat Rd, Lane No 9-C Pune 4 Tel 56251. Factory: Plot No. S-50. Bhosari, Pune 26. Tel. 82312. Estd 1976. Bank: State Bank of India Cap Rs.3,18,000 Prod Rs.8,50,000. Workers 13. Products: Press parts, Industrial filters, screen filters.
- 1485. POONA PAPER PRODUCTS.** 1433 Shukrawar Peth, Pune 2. Tel 441808 Partnership, 1947. Bank: Bank of Maharashtra Cap. Rs 1,90,000. Prod Rs 4,00,000. Workers 10. Products: Card board and corrugated boxes.
- 1486. POONA PATTERNS AND FOUNDRIES (P). LTD.** Kala Basant Society, Plot No. 146, Bhandarkar Rd., Pune 4. Tel. 58415. Factory: S No 691/A/2, Shed No. 4. Pune-Satara Rd, Bibwewadi, Pune 9. Tel. 443645. Estd. 1975. Bank: Shree Suvarna Sahakari Bank Ltd Cap. Rs.2,00,000. Prod. Rs. 1,00,000. Workers 7. Products: Wooden and metallic patterns, non-ferrous castings.
- 1487. POONA PHARMCHEM INDUSTRIES.** Laxmi Bldg, Kennedy Bridge, Bombay 4. Factory: Nagar Rd., Pune 14. Tel. 28641, 25274. Partnership, 1963. Bank. State Bank of India. Cap. Rs. 10,00,000. Prod. Rs 30,00,000. Workers 12. Products: Copper sulphate, copper carbonate, cupric chloride, sodium acetate, cuprous chloride, cuprous oxide.
- 1488. POONA PRODUCTS.** 317 Ghorpade Peth, Pune 2. Tel. 441889. Partnership, 1966. Bank: United Commercial Bank. Cap. Rs 36,219. Prod. Rs.1,41,279. Workers 8. Product: Confectioneries.
- 1489. POONA RADIATORS AND OIL COOLERS** 93 Manjri (Br), Pune Tel. 7320, 7330, 7402 Cable: 'RADIATOR', Pune. Telex: 0145-318. Proprietary, 1970. Bank. Central Bank of India Cap. Rs 40,00,000. Prod. Rs 75,00,000. Workers 130. Products: Radiators, oil coolers and heat exchangers.
- 1490. POONA RUBBER MANUFACTURERS PVT. LTD.** 20 Shroff Bhawan, P. D'Mellow Rd, Bombay. Tel. 262336, 267566, 268973. Telex: 0145-305. Factory: Plot 15-A, D-I, Chinchwad, Pune 19. Tel. 83434, 83084, 82293 Estd. 1972. Bns. Delhi, Calcutta, Madras. Sister concerns: Freight Handlers, Short Automobiles, Bank: Canara Bank. Cap. Rs.12,50,000. Prod. Rs.25,00,000. Workers 45. Exports: Rs.50,000. Countries: Middle East Products: Conveyor belts, transmission belts, suction and delivery hose, rubber sheeting, sponge rubber.
- 1491. POONA SAW MILLS.** 126 New Timber Market. Pune 2. Tel. 444281. Partnership, 1935. Sister concern: Prithvi Automobiles. Banks: Punjab Co-operative Urban Bank Ltd.; Bank of India. Cap. Rs.1,00,000. Prod. Rs. 8,00,000. Workers 8. Products. Packing wood, packing boxes, wooden plates.
- 1492. THE POONA SOAP FACTORY.** 129 Bhawani Peth, Pune 2. Tel. 22579 Cable: 'SABOOWALA'. Partnership, 1938. Banks: Union Bank of India; Dena Bank. Cap. Rs 3,75,000. Prod. Rs 12,00,000. Workers 19. Products Washing soap, washing bars, cakes, washing soda.
- 1493. POONA SPRING WORKS.** 274 Shukrawar Peth, Pune 2. Factory: 378 Shukrawar Peth, Shahu Chowk,

- Pune 2. Tel. 441370. Proprietary, 1969. Bank: Bank of India. Prod. Rs.12,000. Workers 2. Product: Various types of springs.
1494. **THE POONA SYNTHETIC COMPANY.** 39/3 Shankarshet Rd., Pune 9. Tel. 449936. Cable: EYECAT-CHER. Telex: MCCI-0145-333. Factory: Supa Rd., Saswad, Tal. Purandhar, Dist. Pune. Tel. 53,88. Proprietary, 1968. Bank: State Bank of India. Cap. Rs.9,00,000. Prod. Rs.41,76,840. Workers 45. Product: Fluorescent pigments.
1495. **POONA TOOLS PVT. LTD.** T 138 Bhosari, M.I.D.C., Pune 26. Tel. 83377. Estd. 1975. Bank: Bank of India. Cap. Rs.6,50,000. Prod. Rs.2,75,000. Workers 30. Products: Jigs, fixtures, gauges, cutting tools, precision items, fabrication.
1496. **POONA TRUNK FACTORY.** Safe Stores, 1101 Budhwar Peth, Pune 2. Tel. 443030. Factory: II 34/36 Raviwar Peth, Pune 2. Tel. 447876. Partnership, 1953. Br. Budhwar Peth, Pune. Banks: Bank of India; Mulsim Co-op. Bank Ltd.; Central Bank of India. Cap. Rs. 1,20,000. Prod. Rs.1,50,000. Workers 7. Products: Trunks, school boxes, all types of boxes.
1497. **POONAM CHEMICALS.** 56/6 Shukrawar Peth, Pune 2. Tel. 441468. Factory: A-81, 'H' Block, M.I.D.C., Pimpri, Pune 17. Proprietary, 1975. Sister concern: Tamari Industries. Bank: Bank of Maharashtra. Workers 4. Products: N-butyl-Di-Ethyl-Malonate, raw material of medicine.
1498. **POONAM ENTERPRISES.** C/o. M/s Kapila Industries. 882 Boottee Street, Pune 1. Tel. 23579. Proprietary, 1975. Br. Phule Peth, Pune. Bank: United Commercial Bank. Cap. Rs 1,40,000. Prod. Rs 3,00,000. Workers 7. Products: Non-ferrous castings—commercial and alloys; patterns—teak wood and metal.
- ✓1499. **POONAM TILES.** 392 G/3 Gultekadi, Jawaharlal Nehru Rd., Pune 9. Tel. 446599, 447599, 448599. Telex: 0145-333 MCCI, PATELGROUP. Partnership, 1965. Sister concerns: Swastik Industries; Patel Asbestos Cement Industries; Patel Cement and Steel Corporation; Bhanji, Bhimji Patel and Co. Banks: Central Bank of India; Bank of India; Sangli Bank Ltd. Cap. Rs.10,00,000. Prod. Rs.12,00,000. Country: Dubai. Products: Mosaic terrazzo flooring tiles, R.C.C. cement grills, R.C.C. kitchen platforms, R.C.C. garden benches, A.C. building pipes, A.C. pressure pipes.
1500. **POORNA POSHAKH BHANDAR.** 853 Budhwar Peth, Laxmi Rd., Pune 2. Tel. 445115. Factory: 350 Budhwar Peth, Pune 2. Proprietary, 1952. Br. Kunte Chowk, Pune. Bank: Dena Bank. Cap. Rs.50,000. Prod. Rs.1,50,000. Workers 8. Products: Readymade garments, uniforms, dresses, etc.
1501. **POPULAR BINDING WORKS.** 495 Shanwar Peth, Pune 30. Tel. 57926. Proprietary, 1935. Bank: Bank of Maharashtra. Cap. Rs 75,000. Prod. Rs 80,000. Workers 10. Products: Note books, account books, ledgers, etc. printing work, and binding work.
1502. **POPULAR ELECTRIC WORKS.** 723 Taboot Street, Pune 1. Tel. 23144. Proprietary, 1958. Bank: Bank of India. Cap. Rs.40,000. Prod. Rs.2,36,000. Workers 9. Products: F.H.P. electric motors, exhaust fans.
1503. **POPULAR LIGHT CO.** 133 Ganj Peth, Pune 2. Proprietary, 1940. Bank: United Commercial Bank. Cap. Rs.30,000. Prod. Rs.15,000. Workers 9. Products: Spare parts for stove and gas light.
1504. **POPULAR PRINTING PRESS.** 693/8 Budhwar Peth, Pune 2. Proprietary, 1962. Banks: Sampada Sahakari Bank; Suvarna Sahakari Bank Ltd. Cap. Rs.25,000. Prod. Rs.30,000. Workers 2. Product: Commercial printing.
1505. **PORWAL AND CO.** 2041 Sadashiv Peth, Tlajk Rd., Pune 30. Tel. 440163. Proprietary, 1943. Banks: Bank of India; United Western Bank Ltd. Cap. Rs.1,57,630. Prod. Rs.6,58,112. Workers 11. Products: Porwal black tooth powder; Porwal kajaal, netranjan.
1506. **PORWAL PORE AND CO.** 330,31 Ghorpade Peth, Pune 2. Tel. 441658. Partnership, 1954. Bank: Dena Bank. Cap. Rs.1,00,000. Prod. Rs.20,00,000. Workers 45. Product: Brass utensils.
1507. **POWER CONTROLS.** 47/21 Law College Rd., Pune 4. Tel. 58935. Partnership, 1974. Bank: Bank of Maharashtra. Cap. Rs.25,000. Prod. Rs.2,50,000. Worker 1. Products: Automatic voltage correctors, alarm panels for diesel engines, regulated D.C. and A.C. power supplies, battery life and performance testing units.
1508. **POWER EQUIPMENTS.** 769/1 Deccan Gymkhana, Pune 4. Tel. C/o. 56827. Partnership, 1973. Bank: Canara Bank. Cap. Rs.75,000. Prod. Rs.25,000. Workers 4. Products: Machining contracts.

- 1509. POWERTEX PRECISION INDUSTRIES.** 3 Shankarshet Rd., Pune 2 Tel 26504 Factory. W-39, M.I.D.C. Shades, Bhosari, Pune 26. Partnership, 1974 Bank: Bank of Maharashtra. Cap Rs.3,60,000 Prod. Rs 3,00,000. Workers 15 Products Precision machined mass production components, jigs, fixtures, tooling accessories, clamping accessories, toggle clamps.
- 1510. PRABHAKAR ENGINEERING WORKS.** A-73 'H' Block, M.I.D.C. Industrial Area, Pimpri, Pune 18 Proprietary, 1971 Bank. United Commercial Bank. Cap. Rs 1,20,000 Prod Rs.96,000. Workers 7. Product: Job work.
- 1511. PRABHAKAR FRAME WORKS.** 200 Mangalwar Peth, Gadital, Pune 11. Proprietary, 1974 Cap Rs 5,000. Prod. Rs 30,000 Worker 1 Product: Frame bundles for photo frames
- 1512. PRABHAT PRINTING WORKS.** 427 Gultekadi, Pune 9. Tel 442587 Partnership, 1944 Sister concern Pradeep Agencies Banks: Bank of Maharashtra; Poona Peoples' Co-operative Bank Ltd Cap Rs 3,00,000. Prod. Rs 3,48,000 Workers 18. Product. Commercial printing
- 1513. PRABHAT TILES AND MARBLE CO.** Survey No 32/1, Plot No 8, Erandawana, Karve Rd., Pune 4. Tel. 53182. Partnership, 1960 Bank. The Shree Suvarna Sahakari Bank Ltd Cap Rs 80,000. Prod. Rs 1,95,000 Workers 17 Products. Plain cement tiles, mosaic and terrazo tiles.
- 1514. PRACHI PROFILES AND SHEET CUTTING AND FRBRICATION.** 990/2 Shukrawar Peth, Tilak Rd., Singh Garage, Pune 2 Tel. C/o. 440238. Partnership, 1977. Bank. Bank of Maharashtra Cap Rs 25,000 Prod Rs 6,00,000. Workers 4 Products.: Profile cutting, sheet cutting, fabrication.
- 1515. PRADEEP AGENCIES.** 427 Gultekadi, Pune 9. Tel. 442587 Partnership, 1952. Sister concern. Prabhat Printing Works Bank. Bank of Maharashtra Cap Rs 2,65,000. Prod Rs 2,50,000. Products. Commercial printing, diaries, calendars, date-pads
- 1516. PRADEEP SURGICAL CO.** 893/3 Anand Chambers, Fergusson College Rd., Pune 4. Tel 58035. Proprietary, 1967. Br. Bombay Bank: Allahabad Bank. Cap. Rs 5,000. Prod. Rs 7,000 Worker 1 Products. Lumbo sacral belt, cervical collars, abdominal belt, spinal jackets and belts, herma trusses, hand splints, surgical boots and shoes for polio, calipers for polio, artificial limbs—legs.
- 1517. PRADEEP METAL WORKS.** 246 Guruwar Peth, Pune 2. Partnership, 1970. Bank: The Poona Merchant Co-op Bank Ltd. Cap Rs.25,000. Prod. Rs.1,00,000. Workers 9. Products Sangli, Satari and Rajapuri lote.
- 1518. PRAKALP PATTERN EQUIPMENTS.** 603 (New) Ghorpade Peth, Pune 2. Tel. 440680. Proprietary, 1977. Bank: Union Bank of India Cap Rs.40,000. Prod. Rs 35,000 Workers 3. Products: Teak-wood and metal patterns.
- 1519. PRAKASH BOOK BINDING.** 639 Sadashiv Peth, Pune Estd. 1950. Product. Book binding.
- 1520. PRAKASH CORRUGATING INDUSTRIES.** Plot No 25, Block D-III, M I D C, Chinchwad, Pune 19. Tel. 82861, 82359. Cable. PRAKASH CORRUGATING, Pune 19. Partnership, 1969. Sister concern: Prakash Medical Stores. Banks. State Bank of India, United Western Bank Ltd. Cap Rs 5,00,000. Prod. Rs 29,00,000. Workers 24. Products: Corrugated boxes and rolls.
- 1521. PRAKASH ENGINEERING WORKS.** 1235 (new) Sadashiv Peth, Pune 30. Tel. 445159. Proprietary, 1971. Bank. Bank of Maharashtra. Cap. Rs 50,000 Prod Rs 1,20,000 Workers 6. Products: Pressed components, die punches
- 1522. PRAKASH INDUSTRIES.** Behind M S E.B. Cash Office, Tanaji Nagar Rd., Chinchwad, Pune 33. Partnership, 1975. Bank: The Poona Co-operative Rupee Bank Ltd. Cap. Rs 25,000. Prod. Rs 25,000. Workers 4. Products. Machining job work.
- 1523. PRAKASH KOLHAPURI MASALA.** 1541 Nehru Chowk, Shukrawar Peth, Pune 2. Tel. 442167. Factory 47/3 Aranyeshwar, Pune-Satara Rd., Pune 9. Partnership, 1947. Br. 959 Shukrawar Peth, Pune. Bank: Bank of India Cap. Rs 1,00,000. Prod. Rs 8,00,000. Workers 19. Products: Chilli powders, turmeric powder, coriander powder, curry powder, kala masala, etc.
- 1524. PRAKASH MUDRANALAY.** 1411 Sadashiv Peth, Pune 30. Tel. 441547. Partnership, 1947. Bank: Bank of Baroda Cap. Rs 60,000. Prod. Rs 1,50,000. Workers 7. Product: Jobbing commercial printing.
- 1525. PRAKASH PLATING INDUSTRIES.** 1158. Sadashiv Peth, Pune 30. Tel. 443766. Partnership, 1948. Bank. Bank. of Maharashtra Cap Rs.1,50,000. Prod. Rs.3,75,000. Workers 21. Product: Nickel and hard chrome plating and anodizing.

- 1526. PRAKASH PRINTING HOUSE.** 360 Budhwar Peth, Pune 2. Tel. 447595. Proprietary, 1947. Bank: The Saraswat Co-op Bank Ltd. Cap. Rs.60,000. Prod. Rs. 1,50,000. Workers 7. Product: Commercial printing.
- 1527. PRAKASH TYPE FOUNDRY.** 250-67 Narayan Peth, Pune 30. Tel. 444636, 444428. Cable: MUDRA. Partnership, 1951. Sister concern: Prakash Process. Banks: Janata Sahakari Bank; Bank of Maharashtra. Cap. Rs.20,000. Prod. Rs 17,60,920. Workers 58. Product: Printing types.
- 1528. PRAKASH TEXTILES.** 1150 Bhawani Peth. Pune 2. Tel. 26625. Cable: KUNDAN SARI. Factory: 33/40 Gulekadi Industrial Estate, Pune 9. Tel. 442812. Proprietary, 1969. Bank: Bank of Maharashtra. Cap. Rs.25,000. Prod. Rs.1,20,000 Workers 8. Product: Cotton cloth.
- 1529. PRAMOD INDUSTRIAL WORKS.** 228/29 Mangalwar Peth, Pune 11. Proprietary, 1975. Bank: The Shamrao Vithal Co-op. Bank Ltd. Cap. Rs.10,000. Workers 2. Products: Panel boards, electronic spares.
- 1530. PRAMOD KAISARY.** 468 Budhwar Peth, Pune 2. Tel. 448190. Proprietary, 1968. Bank: The Bank of Karad Ltd. Prod Rs.15,000. Products: Packaging, blocks and art-work for advertisements.
- 1531. PRAMOD METAL WORKS.** 842 Kasba Peth, Pune 11 Tel. 449942. Proprietary, 1964. Bank: State Bank of India. Cap. Rs.70,000. Prod. Rs.2,00,000. Workers 4. Products: Remote controls and cables.
- 1532. PRAMOD PRINTERS.** 1019 Sadashiv Peth, Pune 30. Tel. 443644. Proprietary, 1970. Bank: Bank of Maharashtra. Cap. Rs.30,000. Prod. Rs.1,20,000. Workers 8. Product: Commercial printing and jobbing.
- 1533. PRANIPRA.** 131 Shukrawar Peth, Pune 2. Tel. 440165. Factory: 242/1 Waked, Tal. Mulshi, Dist. Pune. Proprietary, 1974. Bank: Bank of India. Cap. Rs.10,000. Workers 2. Products: Wooden articles.
- 1534. PRAP ENGINEERING WORKS.** 1228 Shivajinagar, Pune 4. Partnership, 1967. Cap. Rs.40,000. Product: Repairing, jobbing
- 1535. PRASAD INDUSTRIES.** 603 Sadashiv Peth, Pune 30. Tel. 443723. Partnership, 1969. Banks: Bank of Maharashtra; Shree Suvarna Sahakari Bank Ltd. Cap. Rs.1,00,000. Prod. Rs.9,00,000. Workers 8. Product: Components of diesel engines
- 1536. PRASAD GARMENTS.** 1138 Sadashiv Peth, Pune 30. Tel. 44 7813. Partnership, 1967. Bank: Bank of Maharashtra Workers 3 Product: Garments
- 1537. PRASANNA INDUSTRIES.** 21 Hadapsar Industrial Estate, Pune 13 Tel. 7356 Cable: PRASANNA. Telex: MCCI-1045-333 Proprietary, 1958. Bank: Bank of Maharashtra. Products Adhesives, paint removers, clear lacquers
- 1538. PRASHANSA ENGINEERING WORKS.** Plot A-20 'H' Block, M.I.D.C., Pimpri, Pune 18. Tel. 82459, Proprietary, 1967. Bank: Bank of Baroda. Cap. Rs.80,000. Prod. Rs.45,000. Workers 6 Products Machinery spare parts.
- 1539. PRASHANT ENGINEERING WORKS.** 652 Guruwar Peth, Maharana Pratap Rd., Pune 2. Tel. 446114. Proprietary, 1970. Bank State Bank of India. Cap Rs 75,000. Prod. Rs.90,000. Workers 8. Products: STD-O-Lock, engineering goods.
- 1540. PRATAP AUTOMOBILE AND GENERAL ENGINEERING WORKS.** 572 Nana Peth, Pune 2. Tel. 20146 Partnership, 1962 Bank: Bank of Maharashtra Cap. Rs 1,50,000. Prod. Rs 20,000. Workers 3 Product: Air conditioning, automobile repairing.
- 1541. PRATAP ENGINEERING WORKS.** 1206/1 'B' Shivajinagar, Pune 4. Tel. 53546. Factory: 365 Shivajinagar, Pune 5. Proprietary, 1958. Bank: Bank of Maharashtra. Cap. Rs.22,000 Prod. Rs 90,000. Product: Building fabrication.
- 1542. PRATAP LITHO WORKS.** 401 Ganesh Peth, Pune 2 Tel. 446391. Cable: VISHNU BIDL. Factory: 108 M.I.D.C., Bhosari, Pune 26. Tel. 83158. Partnership, 1972. Br. Bhawani Peth, Pune Banks: Union Bank of India; Bank of India. Cap. Rs.20,00,000. Prod. Rs. 9,00,000. Workers 28 Products: Multi-colour printing of bidi labels, packing papers, text books.
- 1543. PRATIBHA PLASTIC INDUSTRIES.** 18-A/2 Bombay-Pune Rd., Pune 3. Tel. 55237, 52094. Cable. SKILLPACK. Partnership, 1960. Bank: United Commercial Bank. Cap. Rs.5,88,000. Prod. Rs 21,78,000. Workers 49. Products: Polythene plain, printing bags, tubings, sheetings, films.

1544. **PRAV ELECTROSPARK PVT. LTD.** 691/1-A Pune-Satara Rd., Pune 9. Tel. 449139, 449167. Estd. 1975. Banks: Shree Suvarna Sahakari Bank Ltd.; Bank of Maharashtra. Foreign collaboration: Agie Industrial Electronics Losone-Lokard, Switzerland. Cap Rs 6,50,000. Prod Rs 2,00,000 Workers 33 Product Spark erosion machines
1545. **PRAVIN INDUSTRIES.** 376 Shukrawar Peth, Pune 2. Tel 440612. Proprietary, 1975 Banks: Rupee Bank; Janseva Sahakari Bank Ltd Cap. Rs.20,000 Workers 10 Products: Lote, brass utensils, jobbing.
1546. **PRAVIN MASALEWALE** 1210 Bhawani Peth, Pune 2 Tel. 22124, 442765. Factory 44 and 55 Industrial Estate, Hadapsar, Pune 13. Tel. 7383, 7411 Partnership, 1974 Sister concern: Dhanyakumar and Co Bank: State Bank of India. Cap Rs 2,50,000 Prod Rs 10,00,000. Workers 40. Products Ground spices, masalas, chilly, turmeric and corriander powders
1547. **PRECIDENCE ART PRESS.** 1220 Raviwar Peth, Pune 2. Tel. 444970. Partnership, 1968. Cap. Rs. 2,00,000 Prod. Rs 30,000 Workers 9 Product Commercial printing
1548. **PRECIFAB.** 133/2-D, Joshu Bungalow, near Sane Guruji Smarak, Pune 30. Factory 88 Vithalwadi, Hingne Khurd, Pune 9 Partnership, 1977. Bank: State Bank of India. Cap. Rs.40,000 Prod Rs 60,000. Workers 4. Products: Instrument boxes, control panels.
1549. **PRECI-MAX INDUSTRIES.** 335/B Shanwar Peth, Pune 30. Tel. 446956 Proprietary, 1970 Bank: Bank of Maharashtra Cap Rs 50,000 Prod Rs 45,000 Workers 4 Product Job work
1550. **PRECISE ELECTRONICS.** 1324 Shivajinagar, Jangali Maharaj Rd., Pune 5 Tel 54780. Factory 83 Shivajinagar, Resane Estate, Pune 5 Proprietary, 1967 Bank: Poona Merchants Co-operative Bank Ltd. Cap Rs 30,000 Prod Rs 1,30,000 Workers 2 Product Loud speakers
1551. **PRECISE INDUSTRIES.** 1/2 Karve Raod. opp S N D T College, Pune 4. Tel. 54717. Proprietary, 1963 Bank: Bank of India. Cap. Rs 15,000. Workers 4. Products: Jobbing, air couplings—pneumatic, time switches.
1552. **PRECISION ENGINEERING CO.** 1517, S No. 17-B Kothrud, Pune 29. Tel 57499. Proprietary, 1973, Bank Bank of Maharashtra Products Point testing instruments and jobbing
1553. **PRECISION ENGINEERING WORKS.** 1-134 North Bombay Society, Juhu Rd., Bombay 54 Tel 579351 Factory: S-46, MIDC, Bhosari, Pune 26 Tel C/o. 83295. Partnership, 1973 Bank State Bank of India. Workers 6. Products Heavy duty machines, steel cutters
1554. **PRECISION ENGINEERING WORKS.** 472 Fugewadi, Pune 12 Proprietary, 1968 Bank Bank of Maharashtra Cap. Rs 15,000 Prod Rs.10,000. Product. Job work.
1555. **PRECISION INSTRUMENTS.** 'Sunder Niwas', Kothrud, Pune 29. Proprietary, 1972. Bank: Bank of India. Cap Rs.10,000 Prod. Rs 15,000 Product: Electrical instruments and jobbing
1556. **PRECISION INDUSTRIES.** Plot No A-77, 'H' Block, M.I.D.C., Pimpri, Pune 18. Tel. 82484. Partnership, 1964. Sister concern: Sanmati Sintered Metal and Alloys. Bank: Central Bank of India Cap Rs 4,00,000 Prod. Rs.7,50,000. Workers 40. Products: Scooter components, diesel engine components, tempo vehicle components, other precision engineering components
1557. **PRECISION PRESSING MANUFACTURERS.** Plot No. W-11, Block F-2, M.I.D.C. Industrial Estate, Pimpri, Pune 18. Partnership, 1975. Bank Bank of India Cap. Rs.1.2 lakhs. Prod. Rs.6,00,000. Workers 9 Products. Electrical stampings and laminations of all types.
1558. **PRECISION STEEL FASTENERS.** S No 209 Bombay-Pune Rd., Pimpri, Pune 18 Tel. 83220, 83248. Cable: 'PREFAST' Partnership, 1967 Sister concerns: Kwalty Steel Products; K.B Chinchanakar and Co. Super Grip Fasteners. Bank: United Commercial Bank Prod. Rs.18,00,000. Workers 35. Export Rs 5,80,000 Countries: U.S.A., South East Asia, Dubai, A.R.E. Products: Mild steel hex cap screws, foundation bolts, high tensile fasteners, carriage bolts, other fasteners items
1559. **PRECISION TOOLS.** 81/82 Ganesh Baug, Mundhwa, Pune 36. Tel. 7796. Proprietary, 1975 Bank: Bank of India. Cap. Rs. 8,40,000. Prod. Rs.5,00,000 Workers 25. Products: High speed steel form tools, high speed steel special cutters, templates, jigs and fixtures, ancillary items.

1560. PRECISION TOOLS AND ACCESSORIES. T-133, M.I.D.C., Bhosari, Pune 26. Partnership, 1975. Bank: Bank of Maharashtra. Cap. Rs.3,50,000. Prod. Rs.,75,000. Workers 8. Products: Machine tool accessories, tool holding equipments.
1561. THE PREMIER CO-OP. PRINTERS LTD. 915/1 Shivajinagar, Pune 4. Tel. 56813. Estd. 1975. Sister concern: The Maharashtra Sahakari Mudranalaya Banks: Janata Sahakari Bank; The Maharashtra State Co-operative Bank Ltd.; Pune Zilla Madhyawarti Sahakari Bank Maryadit. Cap. Rs.13,70,000. Prod. Rs.13,60,000. Workers 100. Products: Book work, job work, statistical work, magazines, annual reports, pamphlets, folders and other commercial printing.
1562. THE PREMIER GARAGE. Chhatrapati Shivaji Pool, opp. Pune Municipal Corporation Building, Shivajinagar, Pune 5. Tel. 56043. Workshop: Tel. 54149. Tractor Dept. Tel. 58182. Partnership, 1947. Bns. Solapur, Shrirampur, Sangli. Sister concerns: Mysore Auto Distributors; Indian Electrical and Engineering Corpn.; V.M. Shah and Co. Banks: Bank of Maharashtra; The Sangli Bank Ltd. Cap. Rs.2,41,000. Workers 87. Product: Automobile repairing and maintenance.
1563. PREMIER TIMBER MART. 81/82 Ganesh Baug, Mundhwa, Pune 36. Tel. 20487. Partnership, 1969. Bank: Central Bank of India. Workers 14. Products: Packing cases, planks timber.
1564. PRESTO INDUSTRIES. 1099 Shivajinagar, Model Colony, Pune 16. Tel. 58559. Factory: 200 Mangalwar Peth, Gadital, Pune 11. Tel. 27661. Partnership, 1974. Sister concern: Presto Ions. Bank: Union Bank of India. Cap. Rs.2,00,000. Prod. Rs.3,50,000. Workers 8. Products: Base frames, base guards, ductings, rolling tubes, eye bolts, silencers, heavy fabrication.
1565. PRIMA PAPER AND ENGINEERING PVT. LTD. 'Prima', 942/2 Gokhale Rd., Pune 16. Tel. 50180. Factory: Plot No. 'T' 73, M.I.D.C., Bhosari, Pune 26. Estd. 1974. Bank: Bank of Baroda. Cap. Rs.5,60,000. Prod. Rs.1,80,000. Workers 27. Products: Handmade paper and boards, packaging boxes and box files.
1566. PRINCE GARMENTS. 894 Raviwar Peth, Pune 2. Tel. 448167. Proprietary, 1963. Bank: Dena Bank. Workers 8. Products: Ladies' wear.
1567. PRINCI PRODUCTS. 459 Narayan Peth, Pune 30. Factory: Survey No 5, Patil Vasti, Mundhwa, Pune 36. Proprietary, 1975. Bank: Bank of Maharashtra. Prod. Rs.10,000. Workers 3. Products: Red oxide, red oxide glossy, thinner, varnish.
1568. PRINT ART ENTERPRISES. 1121 Shivajinagar, Pune 16. Tel. C/o. 54153. Partnership, 1976. Bank: Bank of India. Cap. Rs.70,000. Prod. Rs.1,25,000. Workers 6. Product: Commercial printing, binding work.
1569. PRINT ORIGIN COMPANY. Shed No. 5, Lonavala Co-op. Estate Ltd., Nagargaon, Lonavala, Dist. Pune. Tel. 756. Partnership, 1972. Bank: Bank of Maharashtra. Cap. Rs.2,15,700. Prod. Rs.1,09,500. Workers 21. Products: Metal labels, name plates, dials, instrument panels, printed circuit boards, lettering set; jobbing—screen printing, anodising, offset printing.
1570. PRINTEXT PRESS. 461/1 Sadashiv Peth, Pune 30. Tel. 443362. Proprietary, 1964. Cap. Rs.42,585. Prod. Rs.2,19,145. Product: Commercial printing.
1571. PRINTOP. 3 Ganeshnagar, Chinchwad, Pune 33. Proprietary, 1971. Banks: Bank of Maharashtra; Shree Suvarna Sahakari Bank Ltd. Cap. Rs.50,000. Workers 5. Products: Printing of bill books, vouchers and commercial stationery.
1572. PRINTRAJ. 310 Rasta Peth, Pune 11. Tel. 20640. Proprietary, 1977. Bank: State Bank of India. Cap. Rs. 10,000. Workers 3. Products: Bill books, letter-heads, visiting-cards, posters, greeting-cards, printing work.
1573. PRISM PROCESS. 461/1 Sadashiv Peth, Pune 30. Tel. 443362. Proprietary, 1974. Cap. Rs.19,900. Prod. Rs.87,700. Products: Block-making.
1574. PRITHVI AUTOMOBILES. 857 Bhawani Peth, Pune 2. Tel. 25166. Partnership, 1953. Sister concern: Poona Saw Mills. Bank: Punjab Co-operative Urban Bank Ltd. Cap. Rs.2,00,000. Prod. Rs.60,000. Workers 6. Products: Cylinder sleeves and liners, casting bars.
1575. PRITHVI TEXTILES. 1205/2/4 Shirole Rd., Shivajinagar, Pune 4. Tel. 55755. Factory: 9 Erandawana, Pune 4. Tel. 54074. Proprietary, 1963. Sister concerns: Prithvi Traders; Prithvi Services. Bank: Bank of Maharashtra. Cap. Rs.1,25,000. Prod. Rs. 3,00,000. Workers 5. Product: Mulmul.
1576. PRITHVI TEXTILES. 35 Erandawana, Pune 4. Tel. 56135. Partnership, 1961. Bank: Bank of India. Cap. Rs.20,000. Prod. Rs.50,000. Workers 3. Product: Dyeing of cotton fabrics.

- 1577. PRIYA TEXTILES.** 35 Erandawana, Pune 4. Tel. 56135. Partnership, 1964. Bank: Bank of India Cap. Rs.20,000. Prod. Rs 50,000 Workers 3. Product: Cotton fabrics
- 1578. PROCESS EQUIPMENTS.** Unit No 2, F-II Block, Pimpri Industrial Area, Pimpri, Pune 18 Tel. 82130, 82567. Proprietary, 1972 Bank State Bank of India. Cap. Rs 6,00,000 Prod. Rs. 8,00,000 Workers 40 Products: Dairy machinery, chemical machinery
- 1579. PROCKAGE SOAPERY ENTERPRISES.** 538 Centre Street, Pune 1. Tel. 22119 Cable: PROCKAGE. Factory. 35/1-2 Pimpri, Pune 18. Tel. 82268. Partnership, 1971. Bank: Bank of India Cap. Rs 8,00,000 Workers 98. Product: Washing soap
- 1580. PRODUCTION ENGINEERS CORPORATION.** Behind Matchwel Electricals (I) Ltd Vadgaon Sheri, Pune 14. Tel. 28915 Proprietary, 1954. Bank Bank of Maharashtra Prod. Rs 10,00,000. Workers 55 Product: Ferrous castings
- 1581. PROFILOFORMS.** Plot 64, 'S' Block, M.I.D.C., Bhosari, Pune 26. Tel. 83315 Cable PROFILTOOL Proprietary, 1974. Bank. United Commercial Bank Cap. Rs.8,90,000. Prod. Rs 6,15,000. Workers 20. Export. Rs.35,000. Country: Malaysia Products: High speed steel and tungston carbide tipped profile tools, flat form tools, dove-tail form tools, multi-point special cutters, form relieved cutters, etc
- 1582. PROGRESSIVE WELDING WORKS.** 458/5 Sadashiv Peth, opp. Alka Talkies, Pune 30. Tel. 443864. Factory: S-9/A, Parvati Industrial Estate, Pune-Satara Rd, Pune 9 Tel. 440186 Proprietary, 1957 Cap. Rs 1,00,000. Prod. Rs 2,50,000 Workers 7 Product: Automobile repairing
- 1583. PROTECTIVE PACKAGINGS.** 39/24 Erandawana, Karve Rd., Pune 4 Tel. 53803. Factory. B-3, M.I.D.C. Industrial Estate, Bhosari, Pune 26. Tel. 82288 Proprietary, 1975. Bank: The Poona Co-operative Rupee Bank Ltd. Cap. Rs 2,84,000 Workers 3 Product: Volatile corrosion and jugal inhibitor paper
- 1584. PROTEIN KINGS.** C-7-8 (2) Functional Electronic Industrial Estate, Bhosari, Pune 26. Tel. 83148. Cable: KINGS. Partnership, 1974. Bank: Punjab National Bank. Cap. Rs 7,00,000 Prod. Rs 6,60,000 Products: Bread, cakes, biscuits, cookies.
- 1585. PUDUMJEE PULP AND PAPER MILLS CO.** 60 Dr V. B Gandhi Marg, Bombay 23. Tel. 274485, 274529, 274532 Cable: 'STRAWPULP' Bombay. Telex: PPML 011-5362 Factory: Thergaon, Pune 33. Tel. 82540, 82090, 82070. Cable: 'STRAWPULP' Pune Telex. GPGL PN 0145-325. Estd. 1964. Br. Calcutta. Subsidiary company: P. Pudumjee and Co Ltd. Bombay-23 Banks: Bank of Maharashtra; The United Western Bank Ltd.; Bank of India. Cap. Rs.583.94 lakhs Prod. Rs. 656 57 lakhs. Workers 680. Products: Speciality papers such as greaseproof, glassine, natural tracing paper, sulphites, calendered kraft, teleprinter tape paper, etc.
- 1586. PUNE METAGRAPH.** T-113 Bhosari, 'C' Block, M.I.D.C. Industrial Area, Bhosari, Pune 26. Tel. 82060. Cable: LABLEKING. Partnership, 1976. Sister concern: Metagraph Pvt. Ltd. Bank: Bank of Maharashtra Cap. Rs 4,50,000. Prod. Rs.10,00,000. Workers 12. Products: Decorative grills and plates for radio, aluminium anodised embossed itched name plates
- 1587. PUNJAB FURNISHERS.** 55/56 Somwar Peth, Pune 11 Tel. 27690, Proprietary, 1975. Sister concern: Punjab Furniture Works. Bank: Union Bank Cap. Rs. 1,50,000. Prod. Rs.2,50,000 Workers 8. Products: Wooden furniture, meteorological instruments
- 1588. PUNJAB FURNITURE WORKS.** 309 Nana Peth, Pune 2. Proprietary Bank Punjab Urban Co-operative Bank Ltd. Cap. Rs 1,00,000. Prod. Rs.50,000 Workers 4 Products: Tables, chairs, cupboards, jobbing
- 1589. PURANDARE ELECTRIC LABORATORIES.** 572-A Shanwar Peth, Pune 30. Proprietary, 1970. Bank: Bank of Maharashtra. Workers 5. Product: Electrical equipments.
- 1590. PURNA PRINTING PRESS.** 236 Ganj Peth, Pune 2 Proprietary, 1972 Cap. Rs 8,000 Prod. Rs 8,000 Workers 2. Products. Printing of bill books, letter-heads, wedding invitations, jobbing.
- 1591. PURNIMA TEXTILES.** 35 Erandawana, Pune 4 Tel. 56135. Partnership, 1961. Bank. Bank of India Cap. Rs 20,000 Prod. Rs 50,000. Workers 3. Product: Cotton fabrics
- 1592. PUROHIT AND PUROHIT.** 1206/27-B Shivajinagar, Pune 4 Cable: SCIENTIFIC, Pune. Factory. 820 Bhawani Peth, Pune 2. Tel. 442919, 441673 Partnership, 1956. Sister concerns. Woodcraft Mfg Co ; Vaman

D. Purohit and Sons; Die Castings and Forgings. Bank: Bank of Maharashtra. Products: Precision Woodwares for laboratories, laboratory hard wares, fine furniture.

1593. PUSHPA TEXTILES. 1150 Bhawani Peth, Pune 2. Tel. 26625. Cable: KUNDAN SARI. Factory: 33/40. Gultekadi Industrial Estate, Pune 9. Tel. 442812. Proprietary, 1973. Bank: Bank of Maharashtra. Cap. Rs 40,000. Prod. Rs.1,75,000. Workers 8. Product: Cotton cloth.

1594. PUSHPA TEXTILES. 14 Hadapsar Industrial Estate, Pune 13. Tel. 7288, 7425, 7497. Proprietary, 1970. Br. Saswad, Dist. Pune. Products: Cotton fabrics, voiles, dhotis, mulmul.

1595. PUSHPANJALI DRESSES. 782 Ganj Peth, Pune 2. Tel. 444992. Partnership, 1973. Bank: State Bank of India. Cap. Rs.25,000. Prod. Rs 2,60,000. Workers 8. Product: Readymade garments.

1596. PUSHPASHAYYA GADI KARKHANA. 461-1 Sadashiv Peth, Tilak Rd., Pune 30. Tel. 449089. Proprietary, 1958. Bank: Bank of Maharashtra. Cap. Rs.25,000. Prod. Rs. 70,000. Workers 4. Products: Mattresses, pillows, quilts, cushions.

1597. PYROTREAT. 8/5 Karve Rd., Pune 4. Tel. 58634. Proprietary, 1972. Bank: State Bank of India. Cap. Rs 1,25,000. Prod. Rs.1,60,000. Workers 4. Product: Heat treatment to machine components.

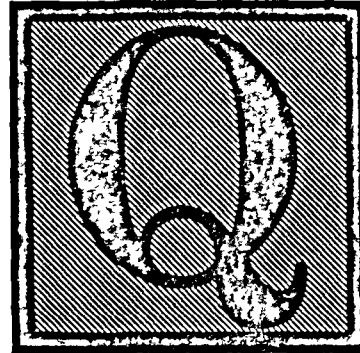

1598. QUAD ENGINEERS. 850/3 Shuvajinagar, opp B.M. Commerce College, Pune 4. Tel. C/o. 50933. Partnership, 1974. Bank: Dena Bank. Cap. Rs 20,000. Prod. Rs.2,50,000. Workers 4. Products: Automatic voltage regulators; electronic timers, custom built; ampere hour metres; magnetisers, demagnetisers and other test equipments; custom built controls for automatisations; import substitution projects

1599. QUALITY BRIGHT STEEL. 32/A Darekar Heights, Karve Rd., opp. M.E.S. College, Pune 4. Tel. 57208. Factory: 32/1-D-3 Block, M.I.D.C. Industrial Estate, Chinchwad, Pune 19. Partnership, 1974. Sister concerns: Quality Sales Corporation; Quality Cement Pvt. Ltd. B. N. Shah; Shah & Co. Prod. Rs.5,00,000. Products: Mild steel commercial bright bars and wire drawing.

1600. QUALITY ENGINEERING. 430/2 Mangalwar Peth, Pune 11. Partnership, 1967. Bank: Bank of Maharashtra. Cap. Rs.75,000. Prod. Rs.1,00,000. Workers 6. Products: Micromachine tools—lathe, drilling, millers, tapping, special-purpose machines, precision jigs and tools.

1601. QUALITY PRINTERS. Paper box manufacturers and stationers. 399 Ganesh Peth, Pune 2. Tel. 444529. Proprietary, 1890. Cap. Rs.20,000. Prod. Rs. 25,000. Workers 4. Product: Commercial printing.

1602. QUALITY STEEL CASTINGS. 45 Dr. Ambedkar Rd., Pune 1. Tel. 22429, 24901. Partnership, 1971. Bank: Bank of Baroda. Cap. Rs.8,63,000. Prod. Rs. 19,89,000. Workers 37. Products: Stainless steel of various grades and nickel-base and cobalt-base superalloy castings.

1603. QAMAR INDUSTRIES. 540/3 Nana Peth, Pune 2. Proprietary, 1973. Sister concern: Auto Field Industries. Bank: Dena Bank. Cap. Rs 1,25,000. Prod. Rs 50,000. Workers 4. Products: Gears of all types, all types of moulds—automatic and machine mould bakelite, block boring machine for automobile repowering purpose.

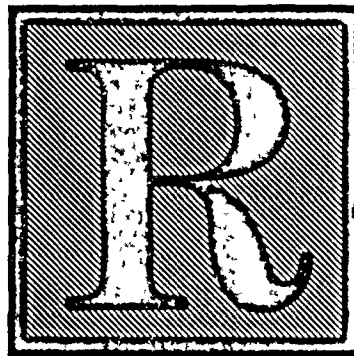

1604. R AND D ENGINEERS. F-2 Block, Unit A 10, M.I.D C., Flatted Bldg., Pimpri, Pune 18. Proprietary, 1974. Bank: United Commercial Bank. Prod. Rs 50,000. Workers 6. Product: All types of turning and drilling work

1605. R. K. ENGINEERS. No. 1 Khivasara Bldg., Bombay-Pune Rd, Chinchwad, Pune 19. Proprietary, 1973. Bank: Pune Ruby Co-operative Bank Ltd. Workers 3. Product: Job work.

1606. R. K. FURNITURES. 743 Guruwar Peth, Pune 2. Partnership, 1977. Cap. Rs.2,500. Products: Sofa-cum-beds and cushions, wooden furnitures.

1607. R. K. INDUSTRIES. 131 Bhawani Peth, Pune 2. Tel. 22122. Cable: RATTNADIP. Partnership, 1965. Bank: Bank of Maharashtra Cap. Rs.1,10,000. Prod. Rs. 22,00,000. Workers 10. Products: Manure mixtures, dealing in fertilizers.

1608. R. K. INDUSTRIES. 445 New Sadashiv Peth, Pune 30. Tel. 445776. Proprietary, 1967. Sister concern: M.K. Transport, 433 New Sadashiv Peth, Pune 30. Bank: Bank of India. Cap. Rs 10,000. Product: Automobile maintenance.

1609. R. K. MENGJL 610 Guruwar Peth, Pune 2. Proprietary, 1973. Bank: State Bank of India. Cap. Rs. 10,000. Prod. Rs. 1,50,000. Workers 5. Product. Ready-made garments

1610. R. K. RADIO ENGINEERING WORKS. 912 Shukrawar Peth, Pune 2. Proprietary, 1962. Bank: Bank of Maharashtra. Cap. Rs 25,000. Products: Radio electronics and miniature lamps.

1611. **R. N. MISTRY.** 769 Budhwar Peth, Pune 2. Proprietary, 1963. Bank: Punjab National Bank. Cap. Rs. 7,000. Prod. Rs.50,000. Workers 3. Products: Tables for sewing machine.
1612. **R. P. PRODUCT.** 530 Kasba Peth, Pune 11. Proprietary, 1971. Cap. Rs.5,000. Prod. Rs.25,000. Workers 2. Product: Chikki.
1613. **R. P. WADKE AND BROS.** 1150 Kasba Peth, Pune 11. Tel. 445736. Partnership, 1958. Bank: Bank of India. Cap. Rs.60,000. Prod. Rs.6,00,000. Workers 7. Products: Hunda, Kalshi.
1614. **R. P. DHOOT AND SONS.** 423 Budhwar Peth, Pune 2. Tel. 446032. Partnership, 1951. Sister concern: Dhoot Pharmacy, 5 Bhawani Peth, Pune 2. Bank: The Sangli Bank Ltd. Cap. Rs.25,000. Prod. Rs.10,000. Workers 7. Products: Agarbatties, dashonga, dhoops, cones, ashtagandha.
1615. **R. P. DRESSESS.** 291-92 Ganj Peth, Pune 2. Partnership, 1974. Bank: State Bank of India. Cap. Rs.80,000. Prod. Rs.2,00,000. Workers 15. Product: Readymade garments.
1616. **R. V. JOGLEKAR.** 474/1 Sadashiv Peth, Tulak Rd., Pune 30. Proprietary, 1954. Workers 5. Products: Duplicating stencil paper, inks, correcting fluid and litho offset paper masters.
1617. **R. Y. RAJU AND CO.** 2nd floor, Alankar Cinema Bldg., Pune 1. Tel. C/o. 28933. Partnership, 1973. Sister concern: Yadav Brothers, Pune 1. Banks: Vijaya Bank; Syndicate Bank. Cap. Rs.10,00,000. Prod. Rs.9,00,000. Workers 250. Products: Sugar machinery erection, turn-key project and expansion plants.
1618. **RACHANA RUBBER.** Post Shahapur, Dist. Thana. Factory: 433/2 Pune-Nasik Rd., Kasarwadi, Pune 18. Tel. 82119. Partnership, 1971. Bank: The Shamrao Vitthal Co-operative Bank Ltd. Cap. Rs.70,107. Prod. Rs. 1,17,527. Workers 7. Products: All types of rubber products, 'O' ring, bushings, gaskets, grommets.
1619. **RACHANA PATTERN WORKS.** 339 Shukrawar Peth, Pune 2. Factory: B-5 Bhosari, M.I.D.C., opp. Philips India, Pune 26. Partnership, 1977. Bank: Bank of Maharashtra. Cap. Rs.20,000. Prod. Rs.16,000. Workers 2. Products: Wooden and metal patterns.
1620. **RACOLD APPLIANCES PVT. LTD.** Bombay-Pune Rd., Pimpri, Pune 18. Tel. 82295, 82587. Cable: 'RACOLD' Pimpri P.F. Estd. 1946. Brs. Vandhana, New Delhi, Bombay. Banks: Bank of Maharashtra; Canara Bank; First National City Bank. Cap. Rs.49,07,827. Prod. Rs.97,00,000. Workers 200. Export: Rs.1,36,847. Countries: Middle East countries. Products: Domestic electrical appliances such as water heaters, washing machines, ovens, toasters, irons, etc
1621. **RADHA TEXTILES.** 1150 Bhawani Peth, Pune 2. Tel. 23837. Cable: KUNDAN SARI. Factory: 33/40 Gultekadi Industrial Estate, Pune 9. Tel. 442812. Proprietary, 1973. Bank: Bank of Maharashtra. Cap. Rs. 40,000. Prod. Rs 1,85,000. Workers 8 Product: Cotton cloth.
1622. **RADHAN INDUSTRIES.** Radhika Deep, 239/302 Sind Society, Aundh, Pune 7. Tel. 50193. Factory: Plot No. W-10, F-II Block, M.I.D.C. Pimpri Industrial Area, Pimpri, Pune 18. Tel. 83150. Partnership, 1972. Bank: Bank of Maharashtra. Cap. Rs.1,43,091. Prod. Rs.8,27,102. Workers 8. Products: Polythene sheets, bags, rolls, rectangular covers.
1623. **RADIANCE.** 46 Shukrawar Peth, Pune 2 Tel. 445446. Proprietary, 1972. Bank: Dena Bank. Workers 14. Product: Interior decoration and furniture making.
1624. **RADIUM ELECTRICAL INDUSTRIES.** 1605 (new) Shukrawar Peth, behind Jumma Masjid, Pune 2. Proprietary, 1974. Bank: Central Bank of India. Cap. Rs.30,000. Prod. Rs.50,000. Workers 3, (part time). Products: Transformers, free-lamps, moon lamps, electrical night lamp novelties, battery eliminators, fluorescent chokes, cigarette lighters.
1625. **RAGHOBAN GANPATRAO KAD.** 376 Ganesh Peth, Pune 2. Partnership, 1955. Bank: Merchants Co-operative Bank Ltd. Workers 6. Products: Niranjana, tal, zanzh.
1626. **RAGHURAJ MUDRANALAYA.** 517 Narayan Peth, Pune 30. Tel. 448084. Proprietary, 1970. Banks: Bank of Maharashtra; Bank of India. Workers 6. Product: Commercial printing.
1627. **RAGHUVIR PRINTERS.** 169 Budhwar Peth, Pune 2. Tel. 445261. Proprietary, 1958. Bank: Bank of Maharashtra. Cap. Rs.13,000. Prod. Rs.30,000. Workers 3. Products: Commercial printing, book binding and composing.

- 1628. RAHIM SERVICE STATION.** 9-B Synagogue Street, Pune 1. Tel. 25535 Products: Petroleum, purchase and sell of cars
- 1629. RAHUL DRESS MFG. CO.** 310-B Narayan Peth, Pune 30 Partnership, 1975. Bank: State Bank of India Cap. Rs.25,000. Prod. Rs 2,00,000 Workers 8 Product: Readymade garments.
- 1630. RAHUL ENGINEERING CORPORATION.** 587/12 Shukrawar Peth, Tilak Road, Pune 2. Tel. 440448. Factory: S/30 Parvati Industrial Estate Co-operative Society Ltd, Pune-Satara Rd., Pune 9. Tel. 441484. Proprietary, 1972 Bank: Bank of Maharashtra. Cap. Rs. 4,00,000. Prod Rs 5,50,000. Workers 13. Products: Bi-metallic bushings, steel and bronze bushings; hand priming pump; vacuum indicator, pressure control safety device; temperature control safety device, right angle drive; two speed adapter drive; thrust rings for heavy engine crankshaft thrust, engine starting gear box; valve head body complete assembly with valves, zinc electrodes assembly; various components like pump shafts, special washers, special thread caps, etc.
- 1631. RAHUL ENTERPRISES.** 610 Shanwar Peth, Pune 30 Tel. C/o. 440837. Partnership, 1974. Bank: State Bank of India. Product: Readymade garments
- 1632. RAHUL INDUSTRIES.** 416 Mangalwar Peth, Pune 11. Proprietary, 1973 Bank: Bank of Maharashtra Cap. Rs.18,000. Workers 4 Product: Job works
- 1633. RAI ELECTRICAL INDUSTRIES.** 88-A Hadapsar Industrial Estate, Pune 13. Proprietary, 1954. Bank: Bank of Maharashtra. Cap. Rs.30,000. Prod. Rs.65,000 Workers 9. Products: Fabricate component parts for fans
- 1634. RAJ ENGINEERING WORKS.** 882 Boottee Street, Pune 1. Tel. 23173. Partnership, 1961. Banks: Bank of India; Punjab & Sind Bank Ltd. Cap. Rs.40,000. Prod Rs 5,00,000. Workers 18. Products: Fabrication in mild steel—structural works, sheds, water tanks, steel windows, grills, gates and job works
- 1635. RAJ ENGINEERING WORK.** 844 Sadashiv Peth, Pune 30. Tel. 443322. Partnership, 1969. Bank: Bank of India. Cap. Rs.45,000. Prod Rs 60,000. Workers 5. Product: Job work.
- 1636. RAJ INTERNATIONAL TRADING CO.** 724 Bhawani Peth, Pune 2. Tel. 26009. Proprietary, 1952. Banks: Bank of Baroda; Muslim Co-operative Bank Ltd. Cap. Rs.40,000. Prod. Rs 1,00,000. Workers 8 Products: Paper tubes, rolls, agarbatti containers, cones, composite containers
- 1637. RAJ PLASTIC INDUSTRIES.** 206/1 Behind Hotel Roxy, Pimpri, Pune 18. Tel. 82424. Proprietary, 1970 Bank: Bank of Maharashtra. Cap. Rs.2,00,000. Prod Rs. 3,00,000 Workers 8. Products: Polythene bags, sheets, rolls and industrial items
- 1638. RAJA ARTS.** 820 Sadashiv Peth, Pune 30. Tel. 443719. Proprietary, 1960. Bank: Rupee Bank Ltd. Prod. Rs 5,000 Products: Commercial art, screen printing, stoving process
- 1639. THE RAJA BAHADUR MOTILAL POONA MILLS LTD.** Haman House, Ambalal Doshi Marg, Bombay 23. Tel. 274278. Cable: RAMOPOON. Telex: 011 3596. Factory: 5 Raja Bahadur Motilal Rd., Pune 1. Tel. 27201/2/3/4/5. Cable: SILKO. Telex: 0145-304 Estd. 1926. Subsidiary company: The Raja Bahadur Motilal Export Import Ltd. Banks: Bank of India; State Bank of India; Union Bank of India, Central Bank of India; New Bank of India Ltd.; Saraswat Co-op. Bank Ltd. Cap. Rs.3,45,33,000. Prod. Rs.9,00,00,000. Workers 2700. Export: Rs 4,40,00,000. Countries: Denmark, Norway, Sweden, Switzerland, Austria, W. Germany, Iran, Australia. Products: Cloth, yarn, drafting machines, internal grinding machines, ammonia printing machines, machine tools, accessories, jigs, fixtures, etc.
- 1640. RAJA INDUSTRIES.** 65 Navi Peth, Ganjave Wadi, Pune 30. Tel. 442860. Proprietary, 1965. Bank: Bank of India. Cap. Rs.75,000. Prod. Rs.1,93,000. Workers 6. Products: Various items for explosive research and development laboratory
- 1641. RAJA PROCESSORS.** 363/3 Shivajinagar, Pune 5 Tel. 53763. Factory: 804 Deccan Gymkhana, Bhandarkar Institute Rd., Pune 4. Proprietary, 1973. Sister concern: Technoport, W-50 Bhosari Industrial Area, Pune 26. Bank: Bank of Maharashtra. Cap. Rs.30,000. Prod. Rs. 12,000. Workers 4. Products: Plastic injection moulding, small electronic components and industrial items from L.D. polythene, polystyrenes, high impact, nylon, polypropylene materials, sheet metal press work; light fabrication work—steel window, grills, collapsible gates, tanks and structures; plastic moulds and press tools, jigs and fixtures; turning and various types of precision machining.

1642. **RAJA STEEL INDUSTRIES.** Plot No. 8, Kaka Halwai Industrial Estate, Pune-Satara Rd., Pune 9. Tel. 442980. Partnership, 1969. Bank: Bank of Maharashtra. Cap. Rs.4,48,450. Prod. Rs.10,50,000. Workers 20. Products: Industrial trailers for diesel generating sets, air compressors, fire lighting sets, pump sets; agricultural trailers—tractor trailer, tiller trailers; sheet metal canopies both in mild steel and aluminium required for air compressors and diesel generating sets, diesel engines and pumps etc.; material handling equipments—trolleys, belt conveyors, slat conveyors; steel furniture—cupboards, tables, chairs etc.
1643. **RAJENDRA CEMENT PRODUCTS.** 718 Sadashiv Peth, Pune 30. Tel. 443514. Factory: At & Post Koregaon Mul, Tal. Haveli, Dist. Pune. Tel. 60. Partnership, 1966. Bank: State Bank of India. Cap. Rs.2,00,000. Prod. Rs.1,57,340. Workers 40. Products: R.C.C. pipes and allied products like septic tanks, water tanks, etc.
1644. **RAJENDRAKUMAR AND CO.** 359 Mangalwar Peth, Pune 11. Proprietary, 1972. Bank: Syndicate Bank. Cap. Rs.12,500. Prod. Rs.41,000. Workers 6. Product: Wooden packing cases.
1645. **RAJESH TRANSPORTS.** 517 Sadashiv Peth, Pune 30. Tel. 443671. Proprietary 1970. Sister concern: Air Carriers. Bank: Indian Bank. Cap. Rs.2,50,000. Workers 20. Products: Transporting—local and outstation.
1646. **RAJKAMAL ART FURNITURE.** 141 Shilpakala Society, Sahakar Nagar, No. 1. Pune 9. Proprietary, 1971. Cap. Rs.20,000. Prod. Rs.25,000. Workers 4. Products: All furnitures, wooden works.
1647. **RAJKAMAL DRESSES.** 1105 Raviwar Peth, Mukund Bhuvan, Pune 2. Tel. 446305/449420. Cable: AMBER. Proprietary, 1952. Sister concerns: Veracity Wear; Geeta Dress Mfg. Co., Makos Enterprise. Bank: State Bank of India. Cap. Rs.5,00,000. Prod. Rs.6,50,000. Workers 35. Product: Readymade garments.
1648. **RAJKAMAL SOAP FACTORY.** 199 Ganesh Peth, Pune 2. Tel. 448982. Proprietary, 1976. Br. Daund. Workers 5. Products: Washing soap and powder.
1649. **RAJKUMAR TEXTILES AGENCIES.** 552 Raviwar Peth, Pune 2. Tel. 449696. Cable: RAJTEX. Proprietary, 1969. Bank: State Bank of India. Cap. Rs.50,000. Prod. Rs.1,50,000. Workers 2. Products: Readymade garments.
1650. **RAJANIKANT V. KAMBLE.** 562 Ganesh Peth, Pune 2. Proprietary, 1974. Bank: State Bank of India. Cap. Rs. 2,000. Prod. Rs.9,000. Products: Plastic bag, P.V.C. bags, baby toilet bags, shopping bags.
1651. **RAJPUT BROTHERS.** 345 Budhwar Peth, Pune 2. Partnership, 1959. Bank: Bharati Sahakari Bank. Cap. Rs.15,000. Prod. Rs 10,000. Product: Book binding and ruling.
1652. **RAJ RATAN PLASTIC INDUSTRIES.** 785 Bombay-Pune Rd., Chinchwad, Pune 19. Partnership, 1974. Bank: Bank of Baroda. Cap. Rs.75,000. Prod. Rs 2,40,000. Workers 6. Product: polythene layflat tubing, sheets, bags, and processing powder
1653. **RAJSHREE ENGINEERING CORPORATION.** Raj Chambers, opp. Bajaj Auto Ltd., Bombay-Pune Rd., Akurdi, Pune 35. Proprietary, 1977. Bank: State Bank of India. Workers 6. Product: Precision job work.
1654. **RAKESH BULB INDUSTRIES.** Office: 19 Elphinstone Rd., Pune 1. Tel. 20764. Cable: RAKESH BULB. Factory: 20/4 Hadapsar Industrial Estate, Pune 13. Tel. 7184. Partnership, 1960. Bank: State Bank of India. Cap. Rs.5,00,000. Prod. Rs.12,50,000. Workers 75. Products: Electric lighting bulbs of all types, general lighting lamps, auto lamps, miniature and decoration lamps.
- ✓1655. **THE RAM AGENCY.** 461/2 Sadashiv Peth, Tilak Rd., Pune 30. Tel. 443040. Cable: RAMSEVA. Proprietary, 1936. Brs. 458/2 Tilak Rd., Pune 30; East Street, Pune 1; Dapodi, Pune 12; Shree Auto Works, Kaka Halwai Estate, Pune-Satara Rd., Pune 9. Banks: Bank of Maharashtra; Janata Sahakari Bank Ltd. Cap. Rs.20,000—investment as tools, machinery, etc. Workers 8. Products: Premier Padmini cars servicing, car accident job and repairing, painting, etc.
1656. **RAM G. DEO AND BROS.** 506 Shaniwar Peth, Mehunpura, Pune 30. Tel. 58563, 57317. Factory: 457 Shaniwar Peth, near Shaniwar Wada, Pune 30. Proprietary, 1951. Bank: Central Bank of India. Cap. Rs. 55,000. Prod. Rs.5,00,000. Workers 5. Products: Kerosene pressure stoves, machinery spare parts, industrial heating equipments, M.S. tanks
1657. **RAMAYYA CHINNAPPA MITHAPELLI.** 1151 Bhawani Peth, Pune 2. Tel. 23511. Factory: Tel. 444694. Partnership. Bank: Bank of Maharashtra. Cap. Rs. 2,25,000. Prod. Rs.4,60,000. Workers 70. Product: Handloom sarees.

- 1658. RAMDAS PLASTIC MFG. CO. PVT. LTD.** A-47 'H' Block, M.I.D.C., Pimpri, Pune 18. Tel. 82247, 83058. Estd. 1970. Sister concern: Indira Sales Corporation Bank: State Bank of India Cap. Rs.3,50,000. Prod. Rs. 10,00,000. Workers 17. Products: PVC tubings, PVC lay flat tubing in crystal clear colours like brown, green, red, yellow, blue, etc., PVC rigid sheets, PVC caps for food storage, PVC tarpaulins, PVC machine covers, PVC liner bags, for chemical packaging, ramphane reams in place of cellophane
- 1659. RAMESH FABRICATORS.** 'Venunad', Plot No. 24, Mukund Nagar, Pune 9. Factory. 820 Bhawani Peth, Sathe Biscuit Compound, Pune 2. Tel. 26876. Partnership, 1968. Sister concern: PAP-CON Flexographic Printers. Bank: Bank of India. Cap. Rs.1,25,000. Prod. Rs.7,00,000. Workers 17. Export: Rs.9,300. Countries: United Arab Emirates. Products: Round and square tin containers of various sizes; industrial wet grinders for grinding soaked food-grain and masala for industrial canteens and hotels, and Ayurvedic medicines etc; drawing instruments for engineering students; bakery equipments such as bread moulds, trolleys, etc.; industrial special types of filters buyer to buyer; sheet metal pressed parts, poultry feeder and cages and any light fabrication jobs.
- 1660. RAMESH FURNITURE MART.** 378 (New) Rasta Peth, Pune 11. Tel. 28823. Partnership, 1947. Cap. Rs.3,00,000. Prod. Rs.2,00,000. Workers 7. Products: Teak wood furniture for schools, offices, etc. Government contractors
- 1661. RAMKRISHNA FOOD PRODUCTS PVT. LTD.** 96, T.P.S. Sub-1, Shivajinagar, Pune 5. Tel. 54116, 56250. Cable: RAMFOOD. Estd. 1970. Bank: Bank of Maharashtra. Cap. Rs.3,00,000. Prod. Rs.25,40,000. Workers 35. Products: Confectionery—toffee, sugar candy, etc
- 1662. RAMKRISHNA STEEL INDUSTRIES.** 170 Dnyaneshwar Colony, Akurdi, Pune 35 and Plot No.84, D-III Block, M.I.D.C., Pune 35. Proprietary, 1973. Bank: Syndicate Bank. Cap. Rs.2,30,000. Prod. Rs.2,00,000. Workers 8. Products: Structural fabrication—columns, trusses windows, grills; machining of fabricated machine components; fabrication of machine components.
- 1663. RAMESH PRODUCTS.** 141 Narayan Peth, Pune 30. Tel. 444014. Proprietary, 1970. Cap. Rs.15,000. Prod. Rs.35,000. Worker 1. Products: Chikki, mysore pak.
- 1664. RAMILA ENTERPRISE.** 288 Mahatma Gandhi Rd., Pune 1. Tel. 22657. Factory: M.I.D.C. 'S' Block, Plot No. 103, Bhosari, Pune 26. Proprietary, 1976. Bank: Syndicate Bank. Cap. Rs.1,00,000. Prod. Rs.4,00,000. Workers 18. Products: Fabrication of heavy steel vessels, tanks, pressure vessels, steel structurals, windows, M S gratings, plate bending, etc., sugar-cane machinery.
- 1665. RAMINDS ENTERPRISE.** 10/A N.P.S. Lines, East Street, Pune 1. Tel. 24696. Proprietary, 1972. Bank: Punjab National Bank. Cap. Rs.2,00,000. Prod. Rs. 2,00,000. Products: Manufacturers of chemical plant and machinery, storage tanks, traders for minerals, chemicals, solvents.
- 1666. RANA PRINTERS.** 943 (old) Ganj Peth, 598(New) Ganesh Peth, Pune 2. Tel. 444332, 444262. Proprietary, 1967. Cap. Rs.10,000. Prod. Rs.15,000. Workers 4. Products: Plastics, polythene bags printing, screen printing
- 1667. RANADEY MICRONUTRIENTS. (PVT.) LTD.** 1-A Kondhwa Khurd, G.P.O. Box No. 118, Pune 1. Tel. 27348/23955. Cable: NUTRIENTS. Estd. 1974. Banks: Bank of Maharashtra; Bank of India. Cap. Rs. 50,000. Prod. Rs.4,00,000. Workers 5. Export: Rs.20,000. Country: Nigeria. Products: Micronutrient spray fertilizers; soil application fertilizers.
- 1668. RANADE TIME INSTRUMENTS.** 352 Narayan Peth, Near Vijay Talkies, Pune 30. Tel. 443115. Factory: 576/10 Dattawadi, Pune 30. Tel. 447811. Proprietary, 1976. Banks: The United Western Bank Ltd.; The Vysya Bank Ltd. Cap. Rs.50,000. Workers 3. Products: Spare parts of time recorders; time recorders; repairs of time recorders and various instruments; sales and service of time recorders, clocks, stop watches, watches and alarm clocks.
- 1669. RANJAN TILES.** 'Devkunj', 119 Prabhat Road, Pune 4. Tel. 57472. Factory: Plot No. B-6, 'H' Block, M.I.D.C., Pimpri, Pune 18. Tel. 83085. Partnership, 1969. Sister concerns: Kohinoor Construction Co., Vasant Corporation. Bank: State Bank of India. Cap. Rs.2,50,000. Prod. Rs.4,00,000. Workers 15. Products: Plain cement tiles, cement mosaic and terrazo tiles and alike other pre-cement products
- 1670. RAPICUT TOOLS PVT. LTD.** Plot No. T-144, M.I.D.C. Estate, Bhosari, Pune 26. Tel. 82320. Cable: RAPICUT, Pune 26. Estd. 1973. Bank: Bank of Maharashtra. Cap. Rs.12,42,610. Prod. Rs. 14,20,665. Workers 51. Products: Single-point tungsten carbide tipped form tools both flat form type and form relieved type; tungsten carbide tipped tools for single and multi-spindle automats;

tangential turning tools; truncated and full form threading tools; serrated tungsten carbide-tipped cutter blades for gultonna meller, wickman etc.; tungsten carbide-tipped reamers, counter bores, spot facers, end mills, multi-step cutters, etc.; solid carbide slitting saws and boring tools; tungsten carbide-tipped form cutters; work rest and tungsten carbide-tipped centres.

1671. RAPID ELECTROPLATORS. 552 Rasta Peth, Pune 11. Tel. 25906. Factory: 170 Bopodi, Pune 3. Proprietary, 1966. Bank: Syndicate Bank. Cap. Rs.1,74,500. Prod. Rs.2,65,000. Workers 8. Products: Aluminium nails in various sizes for siporex building construction.

1672. RATAN ENTERPRISES. 93/1A Mahadevnagar, Manjari Rd., Dist. Pune. Tel. 7684. Partnership, 1975. Bank: Bank of Maharashtra. Cap. Rs.77,500. Prod. Rs. 20,000. Workers 5. Products: Paper tubes, taper tubes, composite containers and paper sleeves, development work in paper tube technology.

1673. RATAN INDUSTRIES. Chinchwad Gaon, Chinchwad, Pune 33. Proprietary, 1971. Bank: Bank of Maharashtra. Cap. Rs.10,000. Prod. Rs.15,000. Workers 4. Products: Chalks white and coloured, plaster of paris.

1674. RATHI ENGINEERING WORKS. 27 Shankarshet Rd., Pune 9. Tel. 440585. Cable: LOVEJOY. Telex: 0145-210 RATHI PN. Partnership, 1948. Sister concerns: Sudarshan Chemical Industries Ltd.; Sudarshan Textiles & Chemicals Ltd.; Marathwada Chemical Industries Pvt. Ltd. Bank: Bank of Maharashtra. Foreign collaboration: Lovejoy International Corporation, U.S.A. Cap. Rs. 35,000. Prod. Rs.25,00,000. Workers 100. Products: Lovejoy couplings, U-blenders, drying ovens, complete range of material handling equipments, laboratory equipments i.e. automatic pigment muller, vibro paint shaker, plant and machinery and rubber moulded and metal bounded items in nitrile, natural and viton rubber.

1675. RATIONAL PRINTERS. 216 Narayan Peth, N. C. Kelkar Rd., Pune 30. Tel. 449825. Partnership, 1966. Bank: United Commercial Bank. Cap. Rs.60,000. Prod. Rs.1,50,000. Workers 7. Product: Commercial printing.

1676. RAUT BROTHERS FOOTWEAR INDUSTRIES. 543 Ganesh Peth, Pune 2. Tel. 444541. Proprietary, 1970. Bank: The Poona Co-operative Rupee Bank Ltd. Cap. Rs.50,000. Prod. Rs.1,27,324. Workers 8. Products: Manufacturers and wholesale suppliers of quality chappals and exportable leather articles.

1677. RAVI MARBLE AND STONE CUTTING AND POLISHING INDUSTRIES. 19/4-5 Somwar Peth, Pune 11. Tel C/o 24457. Proprietary, 1975. Bank: Bank of Baroda. Cap. Rs.7,500. Workers 3. Products: Cutting and polishing of stones, marble, granite.

1678. RAVI PEN INDUSTRIES. 1482 New Shukrawar Peth, Pune 2. Proprietary, 1973. Bank: Bank of India. Cap. Rs 30,000. Prod. Rs.50,000. Workers 5. Products: Pens and ball pens.

1679. RAVI PRINTERS. 213 Guruwar Peth, Pune 2. Tel. 440671. Partnership, 1967. Bank: Mahesh Sahakari Bank Ltd. Cap. Rs.60,000. Prod. Rs.1,00,000. Workers 5. Products: Commercial printing and art printing.

1680. RAVI UJWAL CO. 1018 (old) Shukrawar Peth, 605 (new) Ghorpade Peth, Pune 2. Proprietary, 1970. Bank: Bank of India. Cap. Rs 5,000. Prod. Rs.20,000. (order) & Rs. 8,000. (sale). Workers 7. Products: Toys, school instruments.

1681. RAVINDRA BROTHERS. 726 Sadashiv Peth, Pune 30. Proprietary, 1957. Bank: Vjaya Bank. Cap. Rs.10,000. Prod. Rs 8,000. Product: Machine repairing, lathe turning.

1682. RAVINDRA INDUSTRIES. 24/25 Somwar Peth, Pune 11. Tel. C/o. 26630. Partnership, 1973. Bank: State Bank of India. Cap. Rs 40,000. Prod. Rs 10,000. Workers 7. Product: Job works.

1683. RAVINDRA METAL WORKS. 52 Ganesh Peth, Pune 2. Proprietary, 1953. Bank: Poona Merchant Co-operative Bank. Cap. Rs.40,000. Prod. Rs.25,000. Workers 8. Product: Metal works.

1684. REDYWEAR DRESS MFG. CO. 172 Budhwar Peth, Pune 2. Tel. 445521. Partnership, 1966. Bank: State Bank of India. Cap. Rs.20,000. Prod. Rs.2,00,000. Workers 11. Product: Readymade manila.

1685. REENA FABRICS. 43/2 Karve Rd., Pune 4. Proprietary, 1970. Cap. Rs.28,000. Prod. Rs.18,600. Workers 6. Product: Super fine gray mulls.

1686. REFLEX INDUSTRIES. 353 S. V. Patel Street, Pune 1. Tel. 24563. Factory: (1) 463/B Somwar Peth, Pune 11; and (2) 848 Nana Peth, Pune 2. Partnership, 1969. Sister concern: Eastern General Stores, 353 S.V.Patel St., Pune 1. Bank: Bank of India. Products: All types of sheet

metal jobs, steel fabrications, structural work, machining, steel furniture and industrial fabricating jobs, racks, grills, windows, water tanks, and wooden articles

1687. REFRACTORY SHAPES. 1223 Raviwar Peth, Pune 2. Tel. 446445 Factory S-7 M.I.D.C Industrial Estate, Bhosari, Pune 26. Tel. 82372. Partnership, 1973. Bank: Bank of India. Cap Rs 1,20,000. Prod. Rs.1,38,000 Workers 8. Products: Special shaped sillimanite refractories, special shaped fused alumina and fused mullite refractories.

1688. REKHA ENGINEERS. D-2 Block, 28/6 M.I.D.C., Telco Road, Chinchwad, Pune 19. Tel. 83465. Proprietary, 1975. Bank: Bank of Maharashtra Cap. Rs.1,00,000. Prod. Rs.2,00,000. Workers 7. Products: Moulds and dies, (labour jobs), automobile ancillaries, forged components

1689. REKHA PRINTERS. 919 Shukrawar Peth, Pune 2. Partnership, 1967. Bank: Central Bank of India. Cap. Rs. 27,000. Product: Commercial printing.

1690. REKHA TEXTILES. 14 Hadapsar Industrial Estate, Pune 13 Tel. 7288, 7425, 7497. Proprietary, 1971. Products: Cotton fabrics, dhotis, voiles and mulmul.

1691. REKHA TEXTILE. 35 Erandawana, Pune 4. Tel. C/o.54074. Proprietary, 1961. Cap Rs.14,600 Prod. Rs. 28,000. Workers 6. Product: Grey muls

1692. RELEKAR ENGINEERING. 38/39 Hadapsar Industrial Estate, Pune 13. Tel. 7495. Cable: SOFT JAW. Estd. 1974. Bank: Bank of India. Cap. Rs 1,50,000. Prod. Rs.1,80,000. Workers 7. Products: Soft jaws for scroll operating chucks; top soft jaws suitable for coventry chuck and GMT chuck; SRM reishauer chucks Sunil independent lathe chuck.

1693. RELIABLE ENGINEERING WORKS. 368 Nana Peth, Pune 2. Tel. 26575. Partnership, 1965. Bank: Janata Sahakari Bank. Cap. Rs.50,000. Prod. Rs.4,00,000. Workers 13. Products: Steel fabrication, structural steel, factory shed, gantry and crane fabrication, steel window, boiler and impregnating plant Government contractors and erection contractors

1694. RELIANCE ELECTRONICS. 767 Sadashiv Peth, Pune 30. Tel. 443970. Partnership, 1967. Sister concerns: Kavel Industrial Corporation, 767 Sadashiv Peth, Pune 30; Reliance Sales Corporation, 236 Kasba Peth, Pune 11. Bank: Bank of India. Cap. Rs 50,000. Prod. Rs 2,25,000.

Workers 10. Products: Time lag, slowblow fuses, all types of transformers, quick-acting fuses, control panels, furnaces

1695. RENUKA ENGINEERING WORKS. 453 Nana Peth, Pune 2. Factory: 389 Nana Peth, Pune 2. Partnership, 1974. Bank: Muslim Co-operative Bank. Cap. Rs. 65,000. Prod. Rs 35,000. Workers 3 Product: Machining of parts

1696. RESCON MANUFACTURING CO. PVT. LTD 226 S.V Rd., Moray House, 2nd floor, Near Bandra Talkies, Bombay 50. Tel. 538481. Cable: NO FAMINE. Bandra. Telex: 011-4077. Factory: 43/1 Karve Rd., Pune 4. Tel. 57253-54. Cable: RESCON, Pune. Estd. 1955. Sister concerns: FERTIPLANT ENGINEERING CO. PVT. LTD.; Deccan Sales Corporation Ltd.; Swati Industries; Plant Food Mfg. Co. Bombay. Banks: Bank of Maharashtra, Pune; Indian Overseas Bank, Bombay Cap Rs.35,00,000. Prod. Rs.35,00,000. Workers 120. Products. Carbon fixed resistors, carbon potentiometers and preset pot-meters, electrolytic capacitors

1697. REVINGTON INDUSTRIES. 533 Ghorpade Peth, Pune 2. Proprietary, 1970. Bank: Central Bank. Cap Rs.12,000. Prod. Rs.24,000 Workers 3 Products: Job work, machining of parts.

1698. RODGE CARPET FACTORY. 73 (new) Raviwar Peth, 30(old) Ganj Peth, Pune 2. Tel. 444133 Factory 329-B Ghorpade Peth, Pune 2. Tel. 440326 Partnership, 1905. Sister concern: 329-B Ghorpade Peth, Pune 2. Bank: Bank of Maharashtra. Cap. Rs.1,00,000. Prod. Rs 5,00,000 Workers 50. Product: Carpets.

1699. ROHINI ENTERPRISES. 667 Budhwar Peth, Near Sakal Office, Pune 2. Factory: C/o. Pamb's Typewriting Institute, 555 Budhwar Peth, Pune 2. Partnership, 1974. Cap. Rs.20,000. Prod. Rs 5,000 Workers 2. Products. Envelopes and stationery.

1700. ROPLAS (INDIA) LIMITED. 145, Bombay-Pune Road, Pimpri, Pune 18 Tel. 82783/83495. Cable ROPLAS, Pimpri P.F. Telex: 0145-350. Estd. 1965 Associate of M/s. Mahindra & Mahindra Ltd. Banks. United Commercial Bank; Union Bank of India. Foreign collaboration. M/s. Rubery Owen Holdings, U.K. Cap Rs.14,12,347. Prod. Rs.58,78,320. Workers 212. Products: Jeep body kit, galley carts—food and beverage carts; scooter sidecar; consumer items like chair, mixi base, helmets, etc., tanks for storage and transportation of chemicals; industrial items like equipment covers, tube-light covers, etc.

- 1701. ROSY PLASTICA.** 2 New Shukrawar Peth, Rameshwar Chowk, Pune 2. Tel. 443706. Proprietary, 1974. Bank: Shri Adinath Sahakari Bank Ltd. Cap. Rs 20,000. Prod. Rs.45,000. Workers 5. Products: Injection moulding screw cap, plugs and industrial products.
- 1702. ROYAL CROWN ICE FACTORY.** 2158 New Modikhana, Pune 1. Tel. 27804. Partnership, 1930. Bank: Dena Bank. Cap. Rs.2,00,000. Prod. Rs.1,25,000. Workers 3. Product: Ice.
- 1703. ROYAL BAKERY.** 200 Mahatma Gandhi Rd., Pune 1. Tel. 25241. Partnership. Banks: Dena Bank; Union Bank. Prod. Rs 8,50,000. Workers 17. Products: Bread, buns biscuits, cakes.
- 1704. ROYAL PROFILES.** 173 Ganj Peth, Near Macca Mosque, Pune 2. Tel. 445606. Factory: 335-A Ghoipade Peth, opp. Police Chowky, Poonawala Compound, Pune 2. partnership, 1974. Sister concern: Royal Industrial Steel, 173 Ganj Peth, Pune. Bank: State Bank of India. Cap. Rs.3,00,000. Prod. Rs 6,00,000. Workers 4. Product: Profile-cutting job work.
- 1705. ROYAL TURNING WORKSHOP.** 1370 Shukrawar Peth, Natu Baug, Pune 2. Tel. 441124. Proprietary, 1938. Br. Vijay Turning Workshop, Shivajinagar, Pune. Bank: Dena Bank. Cap. Rs.1,52,000. Prod. Rs.65,000. Workers 10. Products: Repairs of automobiles and oil engines; printing machinery turning, milling and grinding jobs, overhauling of water pumps, electric motors, shafts etc.
- 1706. RUBY CAST.** 335/B Shanwar Peth, Pune 30. Partnership, 1976. Bank: Bank of India. Workers 5. Product: Casting ferrous and non-ferrous
- 1707. RUBI-ROSE PACKING INDUSTRIES.** Gyaneswar Colony, Akurdi, Pune 35. Tel. 83037. Partnership, 1977. Bank: Janata Sahakari Bank Ltd. Cap Rs.3,000. Products: Corrugated boxes, gray-board boxes.
- 1708. RUPALI DRESS MANUFACTURING COMPANY.** 887 Shukrawar Peth, Punch Mukhi Maruti, Pune 2. Partnership, 1977. Bank: Dena Bank. Cap. Rs. Rs.1,00,000. Workers 8. Product: Readymade garments.
- 1709. RUSSEL FABRICATORS.** 32 Pune-Sholapur Rd., Pune 1. Factory: 11 Joddmulla Rd., Pune. Proprietary, 1967. Bank: Bank of India. Workers 4. Products: All kinds of fabrication, grills, steel window, rolling and sheet metal.
- 1710. RUPAM ELECTRICALS.** 32 Karve Rd., Pune 4. Tel. 56354. Factory: S No. 19 Vithalwadi, Pune 9. Partnership, 1974. Bank: Bharati Sahakari Bank. Cap. Rs. 60,000. Prod. Rs 1,00,000. Workers 7. Products: Bakelite electrical accessories like round switch, ceiling rose, socket, plugs, etc.
- 1711. RUSEKA PRODUCTS.** 307 Narayan Peth, Munjabacha Bole, Pune 30. Factory: 413 Narayan Peth, Pune 30. Proprietary, 1955. Bank: Cosmos Co-op Bank. Prod. Rs.5,000. Products: Pickles, chikki.
- 1712. RUSHI DIE CAST PRODUCTS.** 3/4 Vadgaonsheri, Pune 14. Proprietary, 1974. Bank: State Bank of India. Cap. Rs.40,000. Prod. Rs.1,00,000. Workers 4. Products: Non-ferrous casting, die cast rotors, fabrications, set makers, machine job work
- 1713. RUSTON AND HORNSBY (INDIA) LTD.** 1 Dr. V. B. Gandhi Marg, Bombay 23. Tel. 271524. Cable: GREAVES, Bombay. Telex: 011-2517. Factory: Chinchwad, Pune 19. Tel. 82601/06. Cable: RUSTONIND. Telex: 0145-303 GREAVES PN. Estd. 1939. Banks: Oriental Bank of Commerce; State Bank of India. Foreign collaboration: Ruston & Hornsby Ltd. U.K. Cap. Rs. 438 lakhs. Prod. Rs 1217 81 lakhs. Workers 2300. Export: Rs.114.19 lakhs. Countries: U.K., USA., Australia, Ghana, Far East, Middle East countries, etc. Products: 5 to 150 HP diesel engines for various applications like generating sets, marine, agricultural, industrial.

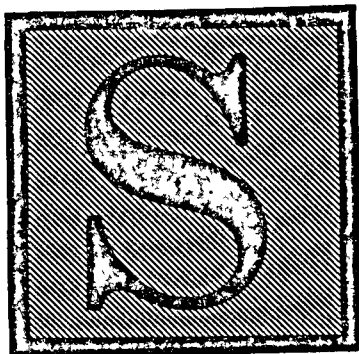

1714. **S.A.J. STEELS PVT. LTD.** 12 Kaka Halwai Industrial Estate, Pune-Satara Rd, Pune 9 Tel 445308, 440227. Cable: DYNASTEEL. Estd. 1969. Bank: Bank of Baroda. Cap. Rs 3,83,723. Prod. Rs 13,64,609 Workers 40. Products: Dynamometers for testing prime movers, gear boxes etc, engine mounting test-beds, instrument panel boards for engine testing, special variety of alloy steels—melting and rolling, iron ingots (soft iron) for magnets and remelting application

1715. **S. B. ELECTRO-MECHANICALS.** Plot No 4, 691/A-2 Pune-Satara Rd., Bibwewadi, Pune 9. Tel 447237. Cable: LEVELSET. Partnership, 1975 Bank: The Vijaya Bank Ltd. Cap. Rs 1,00,000. Prod Rs 4,00,000 Workers 7 Products: Complete range of level indicators and level controllers, flame proof and explosion proof certified equipments, design and supply of complete level control loops in process control.

1716. **S. B. PRODUCTS.** 1971 Gaffar Beg Street, Pune 1. Tel. 23497 Proprietary, 1940 Bank: Bank of Maharashtra Cap. Rs 5,000 Prod Rs.30,000. Products Synthetic syrup, orange, lemon squashes, Woestershire sauce, synthetic vinegar

1717. **S. B. SCIENTIFIC CO.** 41/5 Karve Rd, Tarte Colony, Pune 4 Tel 55518 Proprietary, 1970. Bank Bank of Baroda. Cap Rs.70,000. Prod Rs 1,60,000. Workers 5. Products. Glass apparatus for chemical and research laboratories, distillation units from 50 ml to 50 litre capacity, condensers, vacuum cocks etc., and other apparatus as per drawings for special research.

1718. **S. B. SONAR.** 909 Shukrawar Peth, Pune 2. Proprietary, 1955. Bank: Bank of Maharashtra. Cap. Rs

1,000. Prod Rs 3,500. (Labour). Products: Wrist-watch cases, watermarks, badges, statues and other metal art works

1719. **S. B. S. INDUSTRIES.** 564 Shivajinagar, Pune 5. Proprietary, 1965. Bank: Bank of Baroda. Cap. Rs 25,000 Prod. Rs 30,000. Workers 2 Product: Jobbing

1720. **S. GOPAL ENGRAVERS.** 360 Budhwar Peth, Pune 2. Tel. 447677. Proprietary, 1950. Cap. Rs 1,25,000. Prod. Rs 80,000 Workers 2. Product: Engraving jobbing.

1721. **S. G. GOKHALE AND CO.** (Furniture). Plot No. 21, Somwar Peth, near 15th August Lodge, Pune 11 Tel. 22471. Partnership, 1970. Bank: Bank of Maharashtra. Prod. Rs 9,00,000. Workers 50 Products: All types of wooden and steel furniture

1722. **S. G. P. INDUSTRIES.** 27/3-A Somwar Peth, Kanade Bldg., Pune 11. Factory: 181 Fugewadi, Bombay-Pune Rd, Pune 12. Proprietary, 1971. Bank: Bank of Maharashtra. Cap Rs 55,000. Prod Rs 90,000. Workers 5. Products: Tractor implements and other agricultural implements such as cultivator, levelling blade etc, jobbing

1723. **S. K. ENGINEERS.** Plot No. 109 New Timber Market, Pune 2. Tel. 444244. Partnership, 1963. Bank: Canara Bank Cap. Rs 20,000. Prod. Rs.1,00,000. Workers 6 Products: Structural steel fabrication, steel motor-body builders, steel furniture.

1724. **S. K. ENTERPRISES.** 1206/4-B Shivajinagar, Pune 4 Tel 58277. Factory: 497/A Kasarwadi, Pune 18. Estd. 1975 Bank: Janata Sahakari Bank Ltd. Cap. Rs. 1,50,000. Prod. Rs 2,15,000. Workers 5. Products: Beater additives for paper and leather board industries, wet-end additives, sizing gum and adhesives for paper, and consultancy services for preparing project reports of small and medium-scale industries, inventory control, O & M studies and assessment of workload

1725. **S. K. PACKWELL INDUSTRIES.** 180 Budhwar Peth, Laxmi Rd, Pune 2. Tel. 445305. Cable. PAPER-PACK. Factory: Plot No T/142, M.I.D.C., Bhosari, Pune 26 Tel. 82864. Partnership, 1976. Sister concerns: Sharat and Co, Tarula Paper Co. Bank: Bank of Maharashtra. Prod. Rs.10,68,000. Workers 23. Products: Corrugated paper rolls, boards and boxes, duplex cartons, wax-coated cartons.

1726. **S. K. B. MACHINE TOOLS.** 95 Ganj Peth, 609 Guruwar Peth, Pune 2. Proprietary, 1970. Bank: Bank of

- Maharashtra. Cap. Rs 40,000. Prod Rs 50,000. Workers 3. Product: Jobbing.
1727. S. L. TRADING CO. 69/1 E, Wanawadi, Pune 1. Tel. 27983, 26050. Partnership, 1955. Brs. Bombay, Delhi. Banks: Canara Bank; Mercantile Co-op. Bank Ltd. Cap. Rs.5,00,000. Prod. Rs.30,00,000. Workers 45. Export: Rs. 50,000. Countries: U.K., Singapore, Japan, Sweden, U.S.A., Canada, Middle East. Products: Leather wallets, money clips, writing sets, machine sets, passport cases, key chains in rexine and plastic.
1728. S. M. GAWAI AND SONS. 905 Budhwar Peth, Pune 2. Proprietary, 1953. Bank: The Poona District Central Co-op. Bank Ltd.; The Muslim Co-op. Bank Ltd. Cap. Rs.10,000. Prod. Rs.40,000. Workers 3. Products: Galvanised iron drums, buckets and some steel furniture.
1729. S. N. GHARPURE. Shops and offices building, Unit No. 8, C Block, M.I.D.C., Chunchwad, Pune 19. Tel. 82726. Factory: 35/1 D-2, Block, M.I.D.C., Chinchwad, Pune 19. Proprietary, 1972. Bank: Bank of Maharashtra. Products: Structural fabrication.
1730. S. P. ELECTRONICS. 6/1 Erandawana, Karve Rd., Pune 4. Tel. 58734. Proprietary, 1972. Sister concern: Pradeep Enterprises. Bank: United Commercial Bank. Cap. Rs.10,000. Prod. Rs.60,000. Workers 5. Products: Liquids and solids level controllers and indicators, other electrical and custom-built electronic equipments
1731. S. R. SHINDE. S-29 Parvati Industrial Estate, Pune 9. Tel. 440616. Proprietary, 1964. Bank: Canara Bank. Cap. Rs.2,50,000. Prod. Rs 5,00,000. Workers 20. Products: Sewing and other machines, accessories thereof required for hosiery, garment and leather goods industries.
1732. S. S. AND COMPANY, 1226/5 Hariniwas, off Apte Rd., Deccan Gymkhana, Pune 4. Proprietary, 1977. Bank: Bank of Maharashtra. Cap. Rs.9,000. Prod. Rs. 10,000. Products: Crack dejecting powders for ferrous and non-ferrous metals.
1733. S. S. INTERNATIONAL. 1187/62-2 Shivajunagar, Pune 5. Tel. 58190. Cable: MONALISA. Partnership, 1975. Bank: Bank of India. Cap. Rs.50,000. Prod. Rs. 5,00,000. Workers 10. Export: Rs.5,00,000. Countries: U.S.A., West Germany, Middle East. Products: Ladies fashion garments, shirts for ladies and gents.
1734. S. S. S. ENTERPRISES. 23-A, Napier Rd., Pune 1. Tel. 26128. Factory: S-47, M.I.D.C., Bhosari, Pune 26. Tel. 82124. Proprietary, 1973. Sister concern: Ahura Mazda Saw Mill, Pune. Bank: Bank of Maharashtra. Cap. Rs.2,00,000. Prod. Rs.4,00,000. Workers 8. Products: Wooden packing cases, crates, cut timber sizes.
1735. S. U. SOMVANSHI AND BROTHERS. 161 (New) Guruwar Peth, Pune 2 Tel' 445105 Partnership, 1954. Bank: Bank of Maharashtra. Cap. Rs 30,000. Prod. Rs.1,00,000. Workers 8. Products: Brass water-cocks, brass buckets, electrical contacts.
1736. S. V. ENGINEERING WORKS. S. No. 170 Dnyaneshwar Colony, Akurdi, Pune 35 Proprietary, 1968. Bank: Bank of Maharashtra. Workers 22. Products: Ferrous and non-ferrous castings, patterns, jobbing.
1737. SAAA ENGINEERS. 8 Chiplunkar Bhavan, L.B. Shastri Rd, Navi Peth, Pune 30. Tel. 443890. Factory: 34/11 Erandawana, Ganeshnagar Rd, Pune 4. Tel. 54333. Partnership, 1973. Banks: The Pune Peoples' Co-op. Bank Ltd. Cap Rs.3,00,000. Prod. Rs 15,00,000 Workers 9 Products. Ferrous and non-ferrous castings, patterns.
1738. SABLE WAGHIRE AND CO. LTD. 105 Bhawani Peth, Pune 2 Tel 23139. Cable: CHHATRAPATI. Factories: Sholapur, Nizamabad. Estd. 1967. Brs. Bombay, Rajkot, [Sholapur, Nizamabad, Ahmednagar. Banks: Union Bank of India; State Bank of Hyderabad. Cap. Rs.70,00,000. Prod. Rs 9 crores. Workers 22,000. Export: Rs.16,00,000 Countries: Middle East. Product: Bids.
1739. SACHIN ENGINEERING. 492/93 Shukrawar Peth, Pune 2. Tel. 441058. Factory: 1478 (old) Shukrawar Peth, 1736 (new) Shukrawar Peth, Pune 2. Proprietary, 1973. Bank: Union Bank of India. Cap. Rs.50,000. Products: Socket head grub screw, cap screw, precision machinery parts, all types of fasteners.
1740. SACHIN ENGINEERS. 53/B Mukund Nagar, Pune 9. Tel. 448894. Factory: 46-A Sonavane Industrial Estate, Satara Rd., Pune 9. Proprietary, 1975. Bank: Bank of Maharashtra. Cap. Rs 85,000. Prod. Rs.2,25,000. Workers 8. Products: Bowl spindles for marine separators, cream separators, mining equipment accessories for Volts Ltd. separators.
1741. SACHIN MUDRANALAYA. 1162 Sadashiv Peth, Pune 30. Proprietary, 1964. Br. 983 Sadashiv Peth, Pune 30. Bank: Poona Merchants' Co-op. Bank. Cap. Rs.40,000. Prod. Rs 22,000. Workers 6. Products: Commercial printings.

1742. **SACHIN PLASTICO**, 188/2 Shaniwar Peth, Pune 30. Tel. 54836. Factory: Survey No. 5, Patil Vasti, Keshavnagar, Mundhwa, Tal. Haveli, Dist. Pune Proprietary, 1974. Bank Bank of India. Cap. Rs 40,000. Prod Rs 30,000. Workers 3. Products: Low density reprocessed plastic granules (powder) from scrap, L.D polythene film, pipe grade L.D. polythene granules (natural colour); tubing grade L.D polythene granules, moulding grade L.D. polythene granules (natural colour).
1743. **SADANAND ENGINEERING WORKS**, 38 (new) Shukrawar Peth, near Mandai, Pune 2. Tel. 448314. Proprietary, 1971. Bank: Poona Merchants' Co-op Bank Ltd Cap. Rs.50,000. Prod Rs.8,000 Products: Spindle, ratchet rings, air compressor parts, wooden brush
1744. **SADANAND TEXTILES AND CALICO PROCESSORS**, 69/A, Hadapsar Industrial Estate, Pune 13. Tel. 7197, 7296 Proprietary, 1964 Bank: State Bank of India Products: Hosiery cloth, hosiery, industrial threads, quality textile processors.
1745. **SADHANA ARTS**, Agarkar High School Bldg., Somwar Peth, Station Rd, Pune 11 Tel 26351. Proprietary, 1972. Bank: Bank of Maharashtra. Prod Rs 4,00,000. Workers 19. Products: Aluminium anodised labels, name-plates, brass name-plates, labels, boards, badges, stainless steel labels and boards, engraving on bakelite materials and on aluminium, brass and stainless steel plates
1746. **SAFETY INDUSTRIAL OPTICIANS**, 870 D M Rd, Pune 1. Tel. 20207 Partnership, 1970. Bank: Union Bank of India. Products: Industrial safety products, optical and safety items.
1747. **SAGAR DRESSES**, 398 first floor, Ganesh Peth, Pune 2. Tel. 449504. Partnership, 1968. Bank: State Bank of India. Cap. Rs.1,20,000. Prod. Rs 3,25,000. Workers 17 Product: Readymade garments
1748. **SAGAR PAINTS CO**, 808 Bhandarkar Institute Rd, Pune 4. Tel. 55653. Factory: Plot 16, 'S' Block, M.I.D.C., Bhosari, Pune 26. Proprietary, 1977. Bank: Bank of Maharashtra Cap. Rs.2,70,000. Workers 5. Products: Red oxide and ready mixed paints, bituminous black paints, glass moulds, quenching oils, rust preventives series, wood pink primer, distemper dry paints.
1749. **SAGAR PRODUCTS**, 221 Sahajeevan Nagar, Parvati, Pune 9. Tel. 441820. Proprietary, 1977. Bank: Bank of India. Cap. Rs.3,000. Workers 2. Products: White and coloured chalk sticks, fountainpen ink, shri-khandwadi, jumbo (lolak).
1750. **SAHAR ART PRESS**, 5 Nana Peth, Pune 2. Tel 27969 Proprietary, 1967. Bank: Muslim Co-op. Bank Ltd Cap Rs 40,000 Prod Rs.25,000 Workers 4 Products Arabic, Persian and Urdu art work, litho and type printing
1751. **SAHAKAR MUDRANALAYA**, 540 Ganesh Peth, Pune 2 Tel. 444611. Co-operative institute. Bank: Pune Zilla Madhyawarti Sahakari Bank Ltd, Workers 37. Products: Commercial printing
1752. **SAHASRABUDHE INDUSTRIES**, 1904 Sadashiv Peth, Bajrao Rd., Pune 30. Tel. 440628 Partnership, 1967. Sister concern: Drilling and Constructional Engineers, Pune. Banks: Janata Sahakari Bank Ltd.; Bank of India Cap. Rs 1,00,000 Prod. Rs.3,00,000. Workers 20. Products: Service Industry, undertake contracts for bore wells, rock cutting work with air compressor; well excavation works
1753. **SAHAYOG UDYOG**, S. No. 12 Parvati Industrial Estate, Pune 9. Tel 447453 Partnership, 1965. Bank: Bank of India. Workers 9 Product: Job work
1754. **SAHITYA MUDRANALAY**, 1263 Sadashiv Peth, L. B Bhopatkar Rd, Pune 30. Tel. 441171 Partnership, 1971 Bank: Bank of Karad Ltd Cap. Rs 40,000. Workers 4 Product Commercial Printing.
1755. **SAHYADRI DYESTUFFS AND CHEMICALS**. (Division of Mafatlal Industries Ltd) H O. at Bombay Pune Office and Factory. 117 Vithalwadi Rd., Pune 9 Tel 440868, 440875. Estd. 1960. Sister concern: Mafatlal Industries Ltd, Bombay. Bank: Bank of Maharashtra Workers 500. Exports to all countries. Product: Vat dyes and intermediates
1756. **SAHYADRI ENGINEERING CORPORATION**, 91/1 Parvati, Pune 9. Proprietary, 1971. Bank: Bank of Maharashtra. Cap Rs 25,000 Workers 6 Product: Job work.
1757. **SAHYADRI TIMBERS**, 7 New Tumber Market Pune 2. Tel. 25595. Partnership, 1973 Bank: Union Bank of India Cap Rs.1.5 lakhs. Prod Rs.2.5 lakhs. Workers 5 Products: All sizes in tumber, teak wood, jungle wood, ain wood, sal wood, packing wood, packing boxes, wooden crates and wooden pelets
1758. **SAHYADRI UDYOG**, Preet Chambers, 36 Bombay-Pune Rd., Pune 3. Tel. 50490, 50498, 50499 Cable: MATFUR. Telex 0145-396. Partnership, 1969

- Sister concerns: Western India Erectors Ltd.; Western India Industries Ltd.; Western India Sales and Services and Allied Companies; Western India Service Centre, Western India Co.; Western India Sales and Services; Sahyadri Structural Pvt. Ltd.; Sahyadri Constructors Pvt. Ltd.; Sahyadri Sales and Service; Nandan and Nandan; U.P. Sales and Service Ltd.; Tests, Inspection and Services and Allied Companies; S.M.M.S. Transports; Poly Plastics. Banks: Bank of Maharashtra; United Western Bank. Foreign collaboration: Sunbeam Equipment Corporation, U.S.A. for special purpose and various types of sophisticated furnaces for heat treatment, and protective atmosphere generators. Cap. Rs 25,50,000. Prod. Rs. 55,00,000. Workers 50. Products: All types of forging and heat treatment furnaces, including sealed quench, vacuum, potary hearth, bogie hearth, pusher, alumigium heat treatment etc; protective atmosphere generators, recuperators, parts washing equipment; are melting furnace; material handling equipment associated with furnaces; foundry equipment.
- 1759. SAINATH AGARBATTI.** 488 Narayan Peth, Pune 30. Proprietary, 1950. Bank: Bank of Maharashtra. Cap. Rs.3,000. Prod. Rs.9,000. Product: Agarbatti.
- 1760. SAI ENTERPRISE.** W-5, 'S' Block, Bhosari, Pune 26. Tel. 83560. Partnership, 1975. Sister concern: Sai Industries. Bank: Punjab National Bank. Cap. Rs. 4,00,000. Prod. Rs 2,00,000. Workers 10. Products: Tool die, gauges and machine components.
- 1761. SAI INDUSTRIES.** 156 [Bombay-Pune Rd., Pimpri, Pune 18. Tel. 83102. Partnership, 1973. Sister concern: Sai Enterprises, Plot W-5, S Block, Bhosari, Pune 26. Bank: Punjab National Bank. Cap. Rs 1,00,000. Prod. Rs.5,00,000. Workers 30. Products: Celluloid products.
- 1762. SAINATH TIMBER CORPORATION.** Mohan Nagar, 126 Chinchwad, Pune 19. Partnership, 1977. Cap. Rs.10,000. Products: Timber supply and packing cases.
- 1763. SAIFEE ELECTRO PLATING WORKS.** 1141 Saifee St., Mahatma Gandhi Rd., Pune 1. Tel. 26072. Partnership, 1948. Br. T-64 M.I.D.C., Pimpri Industrial Area, Bhosari, Pune 26. Banks: Bank of India; The Muslim Co-operative Bank Ltd. Cap. Rs. 75,000. Prod. Rs.1,25,000. Workers 6. Products: Bright nickel, chromium, cadmium, zinc (with passivation) silver, oxydizing and barrel plater.
- 1764. SALES WIN (INDIA).** 925/D-1 Shivajinagar, Pune 4. Tel. 55845. Factory: D-6, M.I.D.C., Bhosari, Pune 26 Partnership, 1968. Bank State Bank of India. Cap. Rs.1,75,000. Prod. Rs 20,61,000. Workers 38. Products: Aluminium containers for medicines, pesticides, perfumes, etc.
- 1765. SALIM WELDING AND AUTOMOBILES MANUFACTURING WORKS.** 900 Sachapur Street, Pune 1 Estd. 1968 Bank Bank of India. Cap. Rs.7,900. Prod. Rs 8,000. Workers 3 Export Rs.7,900. Products: Running board, door pieces, mudguard pcs. silver boxes, flooring, vespa tool box, cross numbers, jeep body.
- 1766. SALUNKHE IRON AND STEEL WORKS.** 114 New Mahatma Phule Peth, Pune 2. Tel. 449171. Partnership, 1955. Br. 264/65 Shivajinagar, Pune. Bank: Bank of Maharashtra. Cap Rs 50,000. Prod.Rs.70,000. Workers 5. Products: Water tanks, window grills, welding, turning, fabrication work.
- 1767. SAMADHAN PRINTING PRESS.** Indapur, Dist. Pune. Tel. 42 Proprietary, 1973. Cap. Rs.25,000. Prod. Rs. 20,000. Workers 2. Product:Commercial printing.
- 1768. SAMARTHA ART PRESS.** Opp. Perugate, Brahman Karyalaya, 969/1 Sadashiv Peth, Pune 30. Tel. 443164. Proprietary, 1955. Bank: Janata Sahakari Bank Ltd. Cap. Rs.70,000. Prod. Rs.50,000 Products: Colour cartons, magazine covers, labels, commercial printing.
- 1769. SAMBI ENGINEERS PVT. LTD.** 57 Shivajinagar, Pune 5. Tel. 58257. Estd. 1965. Banks: State Bank of India; The United Western Bank Ltd. Cap. Rs 1,50,000. Prod. Rs.4,50,000. Workers 18. Products:Hand-milling machine, machinery and automobile spares, job works.
- 1770. SAMMCO MACHINERY PVT. LTD.** Kantilal Mansion, V. Mehta Rd., Vile Parle (West), Bombay 56. Tel. 572995 Factory:38/39 Hadapsar Industrial Estate, Post Box. 1220, Pune 13. Tel. 7413. 7474. Estd. 1955. Br. C 3/27 G.I.D.C. Industrial Area, Nadiad. Bank: Bank of India. Cap. Rs.4,47,711. Prod. Rs 6,84,541. Workers 32. Products: Pressure and chemical vessels and heat exchangers in mild steel, stainless steel, monel aluminium, copper, etc.
- 1771. SAMPATTI SOAP FACTORY.** 184 Guruwar Peth, Fulwala Chowk, Pune 2. Tel. 444855. Partnership, 1938. Bank: Dena Bank. Cap. Rs.75,000. Prod. Rs.1,00,000. Workers 6. Products: Soaps and detergents, soap grains,

soap chips, soap powder, liquid soap, jelly soap, liquid detergent and cleaning materials.

1772. SAMRAT INDUSTRIES. 'Adhar', 244 Narayan Peth, Laxmi Rd, Pune 30. Tel. 444112, 449368 Proprietary, 1974 Bank: Central Bank of India Cap Rs 20,000 Prod. Rs 40,000. Products: Venetian blinds and car blinds.

1773. SAMRAT THERMO PLASTIC INDUSTRIES. 'S' Block, Plot No 33/34, Bhosari Industrial Area, Pune 26. Tel. 83322 Proprietary, 1974. Bank: State Bank of India. Workers 16. Product: 'Samrat' 2 speed mixer-grinder.

1774. SANCHETI INDUSTRIES. 19/2 Industrial Estate, Hadapsar, Pune 13. Tel. 7192, Partnership, 1968 Bank: Bank of Maharashtra. Cap. Rs 5 lakhs Prod Rs 5 lakhs Workers 20. Products: Petrol cock assembly, breather, nuts, bolts, washers, electronic components, chucking leavers for automats, coolant improver and sever of 57%, cam blanks, drum cams, cam shafts, job work; wood itching by chemical, chemical coating on drill for glass and hard metal, marbling process on any material, wooden articles from wood dust, b/2 photo to colour photograph bychemical.

1775. SANDISH COMBINE. 84 Shivajinagar, Topkhana, Pune 5. Tel 58214. Factory: Plot No. 28/1, Block D-II, M.I.D.C. Industrial Estate, Chinchwad, Pune 19. Partnership, 1965. Bank: State Bank of India. Cap. Rs. 2,75,153 Prod Rs.8,96,033. Workers 22. Products: Sheet steel pressed components, electrical accessories, control panel and special purpose machinery component, light fabrication of ventilation ducts, cydones

1776. SANDEEP ENGINEERING WORK. S. No. 19, Vithalwadi, Pune 9. Proprietary, 1976. Bank: Syndicate Bank. Cap. Rs.25,000. Prod. Rs.20,000. Workers 2. Products: Job work, precision, turning, machine components.

1777. SANDVIK ASIA LTD. Bombay-Pune Rd, Pune 12. Tel. 82491 (6 lines) Cable: COROMANT. Telex: 0145-225. Estd. 1960. Bns. Bangalore, Bombay, Calcutta, Delhi, Jabalpur, Hyderabad and Madras. Banks: City Bank, NA; Bank of Maharashtra; Canara Bank; Bank of America; Bank of India; Indian Overseas Bank. Foreign Collaboration. Sandvik Aktiebolag, Sandviken, Sweden. Cap. Rs.7,78,28,168. Prod. Rs 8,47,82,000. Workers 882. Export: Rs 77,14,470. Countries: Australia, Sri Lanka, Sweden. Products: Tungsten carbide products

including integral rock drill steels, bits, detachable bits, extension drill steel equipment, inserts, tips, dies, nuts, studs and other applications; tools—TC tipped; Sandvik coromant tools, milling cutters, carbide burners, scrappers, wear resisting parts, twist drills and similar products; hydrogen gas

1778. SANES VARICON PVT. LTD. A-2, M I D C. Bhosari Industrial Estate, Pune-Nasik Rd, Pune 26. Tel 83197. Cable. SANESACON. Estd 1965. Bank: State Bank of India Foreign collaboration: San-Esu Electronic Co. Ltd, Japan Cap Rs 3,00,000. Workers 40. Product. P.V.C gang condensers.

1779. SANGAM GANDHI CAP DEPOT. 312 Guruwar Peth, Pune 2 Partnership, 1967. Bank: State Bank of India Cap Rs 7,000 Prod. Rs 70,000 Workers 6. Product: Gandhu caps

1780. THE SANGAM METAL AND ENGINEERING PVT. LTD. Gowardhan Wadi, Gultekadi, Pune 9. Tel. 441506, 440036 Estd 1947. Bank. Bank of India. Cap. Rs 4,00,000 Prod Rs 15,00,000. Workers 50. Products: Grey iron castings, chrome-molybdenam alloy iron castings, nickel chrome alloy iron casting, undertake development of castings

1781. SANGAM PRESS LTD. 17B Kothrud, Pune 29. Tel. 56745. Cable SUNPRESS. Estd. 1947. Parent company: Orient Longman Ltd Bank: Bank of Maharashtra Cap Rs 10,23,778 Prod. Rs 10,00,000. Workers 115. Products Text books, magazines and periodicals, booklets, sales and promotional materials.

1782. SANGAM TEXTILES. 14 Hadapsar Industrial Estate, Pune 13 Tel 7288, 7425, 7497. Proprietary, 1967. Products: Cotton fabrics, voiles, dhotis, mulmul

1782A. SANGEET AND SANDEEP. D-12 Shanti Kunj, opp. G.P.O, Pune 1. Tel 20805. Factory: W-57, M.I.D.C., Bhosari, Pune 26. Proprietary, 1975. Banks: State Bank of India. Cap. Rs. 1,00,000. Prod. Rs 1,00,000. Workers 8. Products: Designers, screen printers, industrial and advertising stickers, plastic files and folders, fine art printers.

1783. SANGHVI METAL CORPORATION. 129/2 Bombay-Pune Rd, Chinchwad, Pune 19. Tel. 82449, 83208. Cable: SANGHVICOP. Partnership. 1962. Bank: Bank of Baroda. Cap. Rs.8,50,415. Prod. Rs 57,01,181. Workers 170. Products: Industrial and commercial sheets, strips and circles; and copper, brass, aluminium and stainless steel sheets and strips.

- 1784. SANGHVI MULTI-METAL PRODUCTS.** Bombay-Pune Rd., Chinchwad, Pune 19. Tel. 83207, 83642. Partnership, 1969. Bank: Bank of Baroda. Cap. Rs.10,01,638. Prod. Rs.41,46,788. Workers 160. Products: Industrial sheathing, strips, circles of copper, brass, aluminium, steelium and re-rollers of stainless steel.
- 1785. SANGHVI NON-FERROUS METAL INDUSTRIES.** 160 Bombay-Pune Rd., Chinchwad, Pune 19. Tel. 82847, 83206. Cable: SANGHVIMET. Partnership, 1960. Bank: Bank of Baroda. Cap. Rs.15,77,523. Prod. Rs.54,60,530. Products: Quality non-ferrous metals and stainless steel sheets and strips, aluminium canisters and utensils.
- 1786. SANJAY AUTO CENTRE.** 740 Guruwar Peth, Pune 2. Tel. 448182. Proprietary, 1967. Bank: Bank of India. Cap. Rs 30,000. Prod. Rs.45,000. Workers 2. Product: Brake and clutch repairing works.
- 1787. SANJAY AUTO WORKS.** Bombay-Pune Rd., Kasarwadi, Pune 18. Proprietary, 1972. Bank: State Bank of India. Cap. Rs.35,000. Prod. Rs.48,000. Workers 6. Product: Job works.
- 1788. SANJAY AUTOMOBILE ENGINEERS.** 26 Wellesley Rd., Pune 1. Proprietary, 1969. Bank: Bank of Maharashtra. Workers 5. Product: Reconditioning of automobiles.
- 1789. SANJAY HOSIERY.** 637 Shivajinagar, Pulachiwadi, Pune 4. Proprietary, 1971. Bank: State Bank of India. Cap. Rs.20,000, Prod. Rs.1,10,330. Workers 2. Product: Hosiery.
- 1790. SANJIVAN INDUSTRIES.** S/4-B Parvati Industrial Estate, Pune 9. Tel. C/o. 441833. Proprietary, 1967. Bank: Bank of Maharashtra. Cap. Rs.23,000. Prod. Rs. 30,000. Workers 5. Product: Instrument boxes.
- 1791. SANJAY TEXTILES.** 14 Hadapsar Industrial Estate, Pune 13. Tel. 7288, 7425, 7497. Proprietary, 1967. Br. Saswad, Dist. Pune. Products: Cotton fabrics, voiles, dhotis, mulmul, etc.
- 1792. SANKALP PRINTERS.** 1165 Sadashiv Peth, Tilak Rd., Pune 30. Proprietary, 1976. Bank: Suvarna Sahakari Bank Ltd. Cap. Rs.40,000. Workers 3. Product: Commercial printing.
- 1793. SANTOSH LAGHU UDYOG.** 219 Ghorpade Peth, Pune 2. Tel. C/o. 449984. Proprietary, 1970. Bank: State Bank of India. Cap. Rs. 7,000. Prod. Rs.75,000. Workers 6. Products: Rubber chappels, leather shoes, sandals, bags and other articles.
- 1794. SANTOSH PRINTING PRESS.** 1744 Shukrawar Peth, Pune 2. Partnership, 1964. Bank: Central Bank of India. Cap. Rs.50,000. Prod. Rs.27,500. Workers 3. Products: Commercial printing.
- 1795. SANTOSH RAKSHABANDHAN.** (Prop. Popatlal Raghunath Bora), 1153 Raviwar Peth, Pune 2. Tel. 448751. Factory: 1129 Raviwar Peth, Pune 2. Cable. FATAKA KING. Proprietary, 1974. Sister concerns: Bansiwala Fireworks; Sari Centre, 1153 Raviwar Peth, Pune 2. Banks. State Bank of India; The Poona Merchants Co-op. Bank; Canara Bank; Mahesh Sahakari Bank, Pune. Cap. Rs 30,000. Prod. Rs 1,07,000. Product: Rakhi.
- 1796. SANYAM PRINTING PRESS.** 57/2 Bombay-Pune Rd., Bopodi, Pune 3. Tel. 52105. Proprietary, 1967. Bank: Cosmos Co-operative Urban Bank Ltd. Cap. Rs. 30,000. Prod. Rs.36,000 Workers 5. Product: Commercial printing.
- 1797. SAPHALYA PRINTING PRESS.** 461/1 Sadashiv Peth. Tilak Rd, Pune 30. Proprietary, 1968. Bank: Bank of Maharashtra. Cap. Rs.70,000. Prod. Rs.10,000. Workers 4. Product: Commercial printing.
- 1798. SAPKAL ENGINEERING WORKS.** Station Rd., Pimpri, Pune 18. Proprietary, 1968. Bank: United Commercial Bank. Cap Rs. 60,000. Prod. Rs 45,000. Workers 7. Product: Machine job work (preturning only).
- 1799. SAPTAHIK MUDRAN.** 1025 Sadashiv Peth, near Nagnath Par, Pune 30. Tel. 446218, 443459. Partnership. 1969. Bank: Bank of Maharashtra. Cap. Rs. 1,00,000. Prod. Rs.2.5 lakhs. Workers 15. Products: Colour catalogues, job works, commercial printing.
- 1800. SAR INDUSTRIES.** 45 A-9 Prakash Colony, opp. Formica Factory, Akurdi, Pune 35. Tel. C/o. 82159. Partnership, 1977. Bank: Poona Co-op. Rupee Bank Ltd. Cap. Rs.22,000. Workers 4. Product: Job work.
- 1801. SARADA LITHO PRESS.** 513 Shanwar Peth, Pune 30. Tel. 56784. Partnership, 1939. Banks: The Sangli Bank Ltd., Bank of Maharashtra. Workers 50. Products: Labels and wall papers, commercial printing.
- 1802. SARDAR METAL PRESSING WORKS.** 31-32 Bombay-Pune Rd., Dapodi, Pune 12. Proprietary, 1964.

- Bank· Cosmos Co-op Urban Bank Cap Rs 13,000. Prod. Rs.1,000 Workers 2. Product: Tile moulds, general repairing.
- 1803. SARASWATI TYPE FOUNDRY.** 301 Sadashiv Peth, near Navi Peth Vithal Mandir, Pune 30 Proprietary, 1969 Cap Rs 2,300 Product Job work of type foundry.
- 1804. SARLA TEXTILES.** 35 Erandawana, Pune 4. Tel 56135 Partnership, 1964 Bank of India Cap. Rs 20,000. Prod Rs 50,000. Workers 5 Product: Cotton fabrics.
- 1805. SAROJINI TEXTILES.** 14 Hadapsar Industrial Estate, Pune 13. Tel. 7288, 7425, 7497 Proprietary, 1977 Products: Cotton fabrics, dhotis, mulmul, voiles.
- 1806. SARVODAYA MUDRANALAYA.** 450 Budhwar Peth, Pune 2 Tel. 447694 Partnership, 1945 Sister concern *Imprint*, 1047 Shukrawar Peth, Pune 2. Banks. Central Bank of India, Bank of Maharashtra. Cap Rs. 2,00,000. Prod Rs. 3,85,450. Workers 22 Product Commercial printing
- 1807. SARVODAYA TRADING CO.** 1047 Sadashiv Peth, Pune 30. Partnership, 1972. Bank. Bank of India. Cap Rs 1,50,000 Prod. Rs.3,00,000 Workers 9 Product· Readymade garments.
- 1808. SARVOTTAM CALENDAR CO.** 711 Budhwar Peth, Pune 2. Tel 449098 Partnership, 1971 Sister concern: Sarvottam Mudranalaya Bank: Bank of Maharashtra Cap. Rs.30,000. Prod Rs 40,000 Workers 2 Products *Calendars, wedding cards, invitations, greetings, board calendar, stationery suppliers.*
- 1809. SARVOTTAM MUDRANALAYA.** 711 Budhwar Peth, near Sakal Office, Pune 2 Tel. 449098 Factory· S/38 Parvati Industrial Estate, behind Swargate Octroi Naka, Pune 9. Tel. C/o 440339, 440625 Partnership, 1966. Sister concern: Sarvottam Calendar Co Bank: Bank of Maharashtra Cap. Rs 40,000. Prod. Rs 70,000. Workers 8 Products· Forms, registers, books, wedding and greeting cards, pictorial office and board calendars, office files, envelopes, inland letters
- 1810. SASANE PRINTING PRESS.** 377 Hadapsar, Pune-Sholapur Rd., Pune 28. Tel. 7549. Proprietary, 1964. Bank: Bank of Maharashtra. Workers 5. Product: Commercial printing, book binding work.
- 1811. SATCHIDANAND MUDRANALAYA.** 590 Sadashiv Peth, Laxmi Rd, Pune 30. Tel. 56467. Partnership, 1976. Bank: Bank of India. Cap. Rs 1,00,000. Workers 5. Product. Commercial printing, binding
- 1812. SATHE BAKERIES LTD.** 820 Bhawani Peth, Pune 2. Tel. 22158 Estd 1971. Bank· Bank of Maharashtra Cap. Rs 81,341. Workers 35. Products. Bread and bakery products.
- 1813. THE SATHE BISCUIT AND CHOCOLATE CO.** Ltd. 820 Bhawani Peth, Post Box No 597, Pune 2 Tel 22158 Telex C/o. PN 0145-333. Factory S. No. 44/45 Pune-Alandi Rd, Dhanori, Pune 15 Tel 25357. Estd. 1949 Bns Delhi, Bombay, Kanpur and Kagwad. Bank· Bank of Maharashtra Cap Rs 61,24,476. Prod. Rs 1,63,21,591 Export Rs 2,37,085 Countries Abu Dhabi, Dubai, Muscat Sallah, Seychelle Products Food products, biscuits, cocoa powder, chocolate, Dr chocolate powder, chocolate powder.
- 1814. SATHE DATAR ASSOCIATES.** 9 Sahavihar, 1194/5 Shivajinagar, Pune 5. Tel. 55054. Factory Plot 61, S Block, MIDC Pimpri Estate, Bhosari, Pune 26. Partnership, 1977 Bank Bank of India Cap Rs 1,00,000 Prod Rs 10,00,000 approx. (new unit). Workers 8 Products Fine chemicals for perfumery and pharmaceutical industry like Amyl Salicylate, amyl esters, gualacol, potassium gualacol sulfonate, glyceryl gualacol ether, vanillin, etc.
- 1815. SATHE GADI KARKHANA.** 418 Narayan Peth, Pune 30 Tel 443556 Partnership, 1935 Bns Kolhapur, Ratnagiri, Baroda Bank. Poona Peoples' Co-op Bank Ltd Prod. Rs 2,18,000. Workers 11 Products. Cotton and coir mattresses and repairs
- 1816. SATHE PRINTING PRESS.** 820 Bhawani Peth, Pune 2 Tel 26744 Partnership, 1971. Bank Bank of Maharashtra Cap. Rs 56,980 Prod. Rs 57,486 Workers 4. Product Job work, box punching.
- 1817. SATHIDAR PRINTERS.** 461/1 Tilak Rd, Sadashiv Peth, Pune 30. Tel. 443691. Partnership, 1956 Bank: Bank of India Cap. Rs 50,000. Prod Rs 1,12,000. Workers 10. Product· Processes and job work
- 1818. SATISH TEXTILES.** 14 Hadapsar Industrial Estate, Pune 13. Tel. 7288, 7425, 7497. Proprietary, 1971. Products: Cotton fabrics, dhotis, mulmul, voiles, etc.
- 1819. SATVIR MOHANLAL GUPTA AND CO.** 1582 Shukrawar Peth, Pune 2. Tel. 445147. Proprietary, 1959.

- Bank: United Commercial Bank. Foreign collaboration: Oriental Handicrafts Ltd. London. Cap. Rs.60,000. Prod. Rs.2,00,000. Workers 8. Export: Rs.2,00,000. Countries: U.K. Products: Handloom cotton readymade garments.
- 1820. SATYAWATI VILASRAO RAKATE.** 219 Guruswar Peth, Pune 2. Proprietary, 1977. Bank: The Poona Urban Co-operative Bank Ltd. Cap. Rs.15,000. Workers 4.
- 1821 SANT PRINTING PRESS.** 421 Budhwar Peth, Pune 2. Tel. C/o. 447743. Office: 405 Budhwar Peth, Pune 2. Proprietary, 1972. Bank: Poona Merchants' Co-operative Bank. Cap. Rs.25,000. Workers 4. Product: Commercial printing job work.
- 1822. SAVITA INDUSTRIES.** 247 Shanwar Peth, Pune 30. Tel. 449049. Factory: 688 Kasba Peth, Pune 11. Proprietary, 1970. Bank: Sangli Bank Ltd. Cap. Rs. 25,000. Prod. Rs. 1,00,000. Workers 5. Products: TV antenas, metal capillaries, die punches, electrical instruments.
- 1823. SAVITA RASIKLAL GANDHI.** 536 Centre Street, Pune 1. Tel. 23820. Proprietary, 1965. Bank: State Bank of India. Cap. Rs 35,000. Prod. Rs.25,000. Workers 4. Product: Scented supari.
- 1824. SAVLEY AND COMPANY.** 1290 Shukrawar Peth, Subhashnagar, Pune 2. Tel. 441440. Proprietary, 1929. Banks: Bank of Maharashtra; The United Western Bank Ltd. Cap. Rs.1,75,000. Rs 3,00,000. Workers 15 to 20. Products: All sorts of envelopes and packets, cloth lined and silk lined envelopes, window envelopes, exercise books, office files, lever index files, guard books, signature pads and other paper stationery
- 1825. SAWAN INDUSTRIES.** 199-A Ganesh Peth, Pune 2. Tel. 447512. Partnership, 1973. Sister concerns: Delhi Stores; Jaikisan Tobacco Co. Bank: Central Bank of India. Cap. Rs.43,000. Prod. Rs 43,500. Workers 4. Product: Rajhans candles.
- 1826. SAYAJEE PRINTING PRESS.** 254 Shukrawar Peth, Pune 2. Proprietary, 1976. Bank: Punjab National Bank. Cap. Rs. 30,000. Worker 1 Product: Commercial printing
- 1827. SEALOL HINDUSTAN LIMITED.** F-27 Shanti Kunj, opp. G.P.O., Pune 1. Tel. 23801/2. Cable: HIN-DSEALOL, Pune. Telex: 0145-216. Factory: Atlas House, Hadapsar Industrial Estate, Pune 13 and Plot 57, GIDC Vapi, Dist. Bulsar, (Gujarath). Estd. 1974. Brs. Bombay Baroda. Service Centres at Bangalore and Madras Banks: Bank of Baroda; Bank of India. Foreign collaboration: Sealol Inc, Providence, Rhode Island, USA. Export countries: New Zealand, Malaysia Product: Mechanical seals and allied items.
- 1828. SEEMA COSMETICS.** 280 (new) Raviwar Peth, Pune 2 Proprietary, 1976. Bank: Muslim Co-operative Bank. Cap. Rs 10,000. Prod. Rs 24,000. Workers 2. Products: Cleaning powder, liquid soap, soft soap, shaving cream, shaving soap, snow.
- 1829. SEEMA METAL PRESSING WORKS.** 518 Ganesh Peth, opp Vithal Mandir, Kasture Chowk, Pune 2. Tel. C/o. 444332. Proprietary, 1969. Sister concerns: Pinky Engineering & Pressing Industries; Sham Industries. Bank: Bank of Maharashtra. Cap. Rs.2,00,000. Prod. Rs.3,90,000. Workers 8. Products: Sheet metal parts, oil seal metal cups, filter caps, cover, bearing covers, sealing rings, auto parts in sheet metal for Vijaya, Vespa, Luna and Greaves Lombardini; stainless steel parts in sheet metal, electronic parts.
- 1830. SELECTRON ENGINEERS.** F-II Block, Shed No. 3, M.I.D C., Pimpri, Pune 18. Tel. 83457. Proprietary, 1972. Bank: Bank of Baroda. Cap. Rs 2,00,000. Prod. Rs 1,50,000. Workers 7. Products: Electroplating and metal finishing, electro-galvanising, cadmium plating, phosphating, etc.
- 1831. SEMICONDUCTORS LIMITED.** 4th Floor, Ador House, 6 K. Dubash Marg, Fort, Bombay 1. Tel. 293667, 293493. Cable: 'TRANSDUCER'. Telex: 011-2781. Factory: 4/5 Mile Ahmednagar Rd., Ramwadi, Pune 14. Tel. 27361/2/3. Cable: 'TRANSDUCER'. Telex: 0145-362. Estd. 1961. Brs. Delhi. Calcutta. Banks: Bank of India; Canara Bank. Foreign collaboration: Associated with Raytheon Co. Lexington, Mass, USA. Cap. Rs. 84,00,000. Prod. Rs. 1,96,00,000. Workers 450. Products: Transistors, diodes, silicon rectifiers, silicon control rectifiers, ferrites, thermistors, VDRs, electronic musical instruments, etc.
- 1832. SERSON INDUSTRIES PVT. LTD.** Pimpri, Pune 18. Tel. 82379. Cable: ETCHFOIL. Estd. 1961. Bank: Central Bank of India. Cap. Rs.52,53,000. Workers 53. Product: Electrolytic capacitors.
- 1833. SERUM INSTITUTE OF INDIA.** 283 Mahatma Gandhi Rd., Pune 1. Tel. 26725, 26959, 26964. Cable: BLOODHOUSE. Telex: Serum-0145-317. Factory:

- S. No. 212/2 Hadapsar, Pune 28. Tel. 7325, 7625, 7149. Partnership, 1966. Bank: Bank of India Cap. Rs. 24,40,116. Prod. Rs.91,00,000. Workers 150. Products: Pharmaceutical (injections)—triple antigen, tetanus anti-toxin, diphtheria antitoxin, tetanus toxoid, dual antigen.
1834. SETU ENGINEERS. 24/25 Somwar Peth, Pune 11. Tel. 52071. Proprietary, 1967. Bank: Bank of Maharashtra. Cap. Rs.25,000 Prod. Rs 30,000. Workers 2 Product: Job work.
1835. STAR PRINTING PRESS. 250 Shivajinagar. Pune 5. Tel. 56314. Proprietary, 1970. Bank Bank of Maharashtra. Cap. Rs.30,000. Prod Rs 85,000. Workers 7. Product: Commercial printing.
1836. SHA SUGANDHI WORKS. 83 Ganj Peth, Pune 2. Tel 444770. Partnership, 1947. Bank: Bank of Maharashtra. Prod Rs 10,00,000. Workers 50. Export countries: Saudi Arabia, Kuwait. Product: Agarbatti.
1837. SHAH PREMJI VELJI, 1536 Shukrawar Peth, Pune 2. Tel. 449231. Factory. 1683 Shukrawar Peth, Pune 2. Partnership, 1956. Bank: Dena Bank. Cap. Rs. 1,50,000. Prod. Rs.2,50,000. Products: Brass and aluminium kitchen set (toys).
1838. SHAH PRODUCTS. 259 Guruwar Peth, Pune 2. Tel. 441247. Partnership, 1964. Bank: Bank of Maharashtra. Cap. Rs.25,000. Prod. Rs 1,25,000. Workers 6. Product: Chikki.
1839. SHAIKH USMAN SHEIKH HASAR BALDI-WALA. 4 Nana Peth, Pune 2. Proprietary, 1967. Cap. Rs.1,000. Prod. Rs 10,000. Worker 1. Products: Badli and other.
1840. SHAHEEN PRINTERS. 18 Ghorpade Peth, Pune 2. Tel. C/o. 442610. Proprietary, 1972. Bank: Canara Bank. Cap. Rs.15,000. Prod. Rs.10,000. Product: Commercial printing, stationery, bookbinding.
1841. SHAILESH INDUSTRIES. 1412 (New) Sadashiv Peth, Pune 30 Tel. 446984. Proprietary, 1974. Bank: The United Western Bank Ltd. Pune 30. Cap. Rs 10,000. Prod. Rs.5,000. Products: Marking ink on hard irons and steel, glass marking ink, magnetic ink, rust remover, rustproof compounds and other surface treatment chemicals.
1842. SHAKABH ENGINEERING. Plot 29, D-III Block, M.I.D.C., Chinchwad, Pune 19. Partnership, 1967. Bank: Allahabad Bank Workers 4. Products: Metal press parts for electronic industries; press tools—jigs, fixtures; machinery fabrication.
1843. SHAKTI AUTOMOBILES. 65 Navi Peth, Pune 30. Proprietary, 1977. Bank: United Western Bank. Cap Rs 15,000. Product. High pressure greasing.
1844. SHAKTI UDYOG. 'S' Block, Plot No. 30, M.I.D.C., Bhosari, Pune 26. Tel. 82683. Proprietary, 1972. Bank: Bank of Maharashtra. Cap. Rs 16 lakhs. Prod. Rs.26 lakhs Workers 28 Products: Pressed parts, complete range of filters, relief valves, chemical plants in stainless steel, fabrication and assembly, unit toolings, jigs and fixtures.
1845. SHALMALI AUTO ANCILLARY INDUSTRIES PVT. LTD. 431/195-96, Tilak Rd., Pune 2 Tel. C/o 441119, 441216. Factory: Plot No T-139, M.I.D.C., Bhosari, Pune 26 Tel 83095. Estd. 1971. Banks: Vijaya Bank; State Bank of India Cap. Rs 4,05,000. Prod. Rs. 6,42,000. Workers 23. Products: Oil filter cartridges, reclamation of waste oil, fabrication of dumper and easy ride chair.
1846. SHALICO PAPER BOX CO. 88 Kasarwadi, Pune 18 Partnership, 1973. Bank: Central Bank of India. Prod. Rs 1,26,000. Workers 3 Products: Corrugated and card board boxes.
1847. SHAM PRINTING PRESS. 676 Budhwar Peth, Pune 2. Tel. 447252. Press: 650/2 Budhwar Peth, Pune 2. Proprietary, 1947. Bank: Dena Bank. Cap Rs 1,00,000. Prod. Rs 1,50,000 Workers 13 Product: Commercial printing
1848. SHAMALA TEXTILES. 14 Hadapsar Industrial Estate, Pune 13. Tel. 7288, 7425, 7497. Proprietary, 1972. Products. Cotton fabrics, dhoties, mulmul, voiles.
1849. SHANDAR FURNITURE. 180 Narayan Peth, opp. L.I.C. Building, Kelkar Rd., Pune 30. Partnership. 1969. Bank: State Bank of India. Product: Wooden furniture.
1850. SHANKAR KRISHNAJI WADKE. 1392 Kasba Peth, Pune 11. Proprietary, 1927 Bank: Bank of India. Workers 2 Products: Hande, tapeli, brass utensils.
1851. SHANKAR TEXTILES. 'Kunden House', 1150 Bhawani Peth, Pune 2. Tel 26625 Cable-KUNDAN SARI.

- Factory:** 33/40 Gultekadi Industrial Estate, Pune 9. Tel. 442812. Proprietary, 1966. Bank: Bank of Maharashtra. Cap. Rs. 24,500. Prod. Rs.1,15,000. Workers 9. Product: Cotton cloth.
- 1852. SHANKAR UDDHAV TAMBE.** 232 Guruwar Peth, Pune 2. Proprietary, 1974. Cap. Rs.14,000. Prod. Rs.44,000. Workers 3. Products: Grills, windows, water tanks, gates.
- 1853. SHANKARRAO GOPALRAO BHUJBAL.** 447 Ghorpade Peth, Zagade Wadi, Pune 2. Proprietary, 1969. Bank: Poona Urban Co-op. Bank Ltd. Workers 4. Product: Utensils.
- 1854. SHANTARAM ELECTRIC WORKS.** 561 Rasta Peth, Pune 11. Tel. 25039. Partnership, 1948. Br. 520 Rasta Peth, Pune 11. Sister concern: Ramakant Electricals, 519 Rasta Peth, Pune 11. Bank: Bank of Maharashtra. Cap. Rs. 1,37,000. Prod. Rs.2,70,000. Workers 9. Products: Rewinding and repairs of all types of D.C. and A.C. motors, armatures, rotors, stators, welding transformers, generators, plating, rectifying, battery charging.
- 1855. SHANTI INDUSTRIES.** 994/1 Chinchwad, near Hindustan Lever Ltd. Pune 33. Proprietary, 1976. Bank: Bank of Baroda. Cap. Rs.80,000. Prod. Rs.40,000. Workers 4. Products: Automobile spares and machinery components.
- 1856. SHANTILAL REYCHAND SHAH.** 1282, Kasba Peth, Pune 11. Proprietary, 1972. Cap. Rs.10,000. Prod. Rs.10,000. Worker 1. Product: Hair oil.
- 1857. SHARAD FURNITURE.** 1158 Sadashiv Peth, Pune 30. Tel. 440591. Proprietary, 1956. Bank: Bank of Maharashtra. Cap. Rs.20,000. Prod. Rs 4,000. Workers 4. Product: Wooden furniture.
- 1858. SHARAD PRINTING PRESS.** 643 Sadashiv Peth, Pune 30. Tel. 444041. Partnership, 1958. Bank: Poona Merchants Co-op. Bank. Cap. Rs.40,000. Prod. Rs.12,000. Workers 4. Product: Commercial printing.
- 1859. SHARDA BOOK MANUFACTURING CO.** 413 Narayan Peth, Pune 30. Tel. 444828. Partnership, 1970. Bank: Bank of Maharashtra. Cap. Rs.1,50,000. Prod. Rs.6,00,000. Workers 9. Products: Exercise books, bound books, examination papers, registers, ledger and journal books, files (office and box).
- 1860. SHARADA ENGINEERING WORKS.** 197 Ganesh Peth, Pune 2. Proprietary, 1973. Bank: Central Bank of India. Cap. Rs 8,000. Prod. Rs.40,000 Workers 6. Products: Cots, cradles, racks etc.
- 1861. SHARADA ENTERPRISES.** 11/1 Erandawana, Karve Rd, Pune 4. Tel. 56299. Partnership, 1969. Bank: Sangli Bank Ltd. Cap. Rs.1,20,664. Prod. Rs 6,90,000. Products: Chemical plants—reaction kettles, condensers, heat exchangers, sigma mixers, rotary-drum dryers, vacuum receivers, evaporators, nutsch filters, filter presses, etc. specialisation in tig argon welding, ms transformer tanks, storage tanks, elliptical tube radiators.
- 1862. SHARADA INDUSTRIES.** 1927 Sadashiv Peth, Pune 30 Factory: Khadakwasala Rd., Vithalwadi, Pune 9. Partnership, 1973. Banks: Shree Suvarna Sahakari Bank Ltd.; Bank of Maharashtra. Cap Rs.75,000. Prod. Rs. 3,00,000. Workers 18. Product: Industrial fabrication.
- 1863. SHARDA METAL WORKS.** Plot No. 39 Industrial Co-op. Estate, Gultekadi, Pune 9. Tel. 442808. Partnership, 1969. Br. Sales Dept., 245 Raviwar Peth, Pune 2. Bank: Bank of India. Cap. Rs 1,70,000. Prod. Rs.14,00,000. Workers 14. Products: Brass waterpots, brackets.
- 1864. SHARDA MOTOR WORKS.** Opp. Vulcan Laval Ltd, Bombay-Pune Rd., Pune 12. Tel. 83179. Proprietary, 1974. Bank: Bank of India. Cap. Rs.1,75,000. Prod. Rs. 2,40,000. Workers 17. Product: Repairing of automobiles.
- 1865. SHARADA PRINTING PRESS.** Opp. Buckau Wolf Ltd., Station Rd., Pimpri, Pune 18. Tel. 83282. Proprietary, 1967. Bank: Syndicate Bank. Cap. Rs.55,000. Prod. Rs. 2,00,000. Workers 9. Products: Commercial printing, stationery.
- 1866. SHREYAS PLASTIC INDUSTRIES.** Vithalwadi, P.O. Wadgaon, Pune. Proprietary, 1973. Worker 1. Product: Plastic paper.
- 1867. SHARMA MECHANICAL WORKS.** Plot No. T-28, M.I.D.C., Bhosari, Pune 26. Tel. 83044. Cable: SHARMA MECHANICAL. Proprietary, 1972. Sister concerns: Manoj Glass Mould & Co.; Pratik Industries. Bank: Bank of Maharashtra. Cap. Rs.2,00,000. Prod. Rs.2,50,000. Workers 9. Products: Glass moulds and glass-ware machines, I.S. machine parts, round bottle moulds, vacuum bottles.

- 1868. SHARMA ENGINEERING WORKS.** 1316 Kasba Peth, Pune 11. Proprietary, 1972. Bank. Bank of Maharashtra. Cap Rs 40,000. Prod. Rs.7,500 Workers 5 Products: Plastic moulding dies, lathe work, brass, bronze, aluminium moulds, etc.
- 1869. SHASHIKIRAN CHEMICALS PVT. LTD.** 470-A Phugewadi, Bombay-Pune Rd., Pune 12. Tel 83344, 82322. Estd. 1975. Cap. Rs. 5,00,000 Workers 15 Products: Paints, thinners, pigments, zinc oxide, zinc hydroxide, zinc stearate, manganese carbonate, titanium dioxide, red oxide, whiting, carbon black, silicone emulsion, stearic acid, magnesium oxide, industrial solvents, rubber chemicals and rust preventives.
- 1870. SHEETAL INDUSTRIES.** Nalini-Chaya, 11 Shivaji Housing Society, Shivajinagar, Pune 16 Tel. 55983. Factory: Block F-2, Plot No 41, MIDC, Pimpri, Pune 18. Partnership, 1976 Bank Bank of Baroda Cap. Rs 8,00,000. Prod Rs 3,31,300 Workers 30 Products Metal laundry, shot blasting and settling of various castings and forgings, finishing of oil engine parts for diesel engine.
- 1871. SHEKHAR TRADING CO.** 1958 Sadashiv Peth, Pune 30, Tel. C/o. 443022. Partnership, 1974. Sister concern: Joshi Bros, 160 Budhwar Peth, Pune 2 Bank. Dena Bank. Cap. Rs 20,000. Prod Rs.1,30,000. Workers 4. Products: Exercise books, registers, account books, flap files, plastic files, binding work.
- 1872. SHELFFOUNDRIES.** 507 Gultekadi (F P. No. 391-A), behind Chakan Oil Mills, Shankarshet Rd., Pune 9. Tel. 447840 Partnership, 1973. Sister concern: Machine Components, 507 Gultekadi, Pune 9 Bank: Cosmos Urban Co-operative Bank Ltd Cap. Rs 20,000. Products: Non-ferrous and ferrous shell moulded castings, non-ferrous castings, high grade and alloy cast iron castings, chemical pumps and valves.
- 1873. SHEMBEKAR INDUSTRIES.** Bombay-Pune Rd., Chinchwad, Pune 19. Tel. 82366, 82172. Cable: KARIN. Partnership, 1963. Bank: Bank of Maharashtra Products: AC electric motors, pumps
- 1874. SHENDE PRODUCTS.** S.No. 41/6 "Guru Prasad", Pratibha Co-op. Housing Society, Parvati, Pune 9. Partnership, 1971. Bank: Bank of Maharashtra. Cap. Rs.25,000. Prod. Rs.70,000. Workers 4. Products: Detergent washing powder, cleaning powder, liquid soap detergent.
- 1875. SHILPA ENGINEERS.** 1137/11 Parag, Shivajinagar, Pune 16 Tel. 57231. Factory: A-87 'H' Block, MIDC, Pimpri, Pune 18 Proprietary, 1976. Bank: United Commercial Bank Cap Rs 40,000. Prod. Rs. 10,000 Workers 9 Products: Angle plates, surface plates, tool room accessories, plumber blocks and valves.
- 1876. SHILPA ENGINEERING WORKS.** 3/5 Erandawana, Pune 4 Tel 57013 Partnership, 1961 Bank Bank of India. Cap. Rs 1,00,000. Prod Rs 1,50,000. Workers 4. Products: Welding and turning work, window grill, structural work, sugar factory, textile, chemical machinery.
- 1877. SHILPA PAINT INDUSTRIES.** 'H' Block, Plot No B-20, MIDC, Pimpri, Pune 18. Tel. 83190. Office: 5/2/3 State Bank Colony, 'Priya' Housing Society, Tadiwala Rd, Pune 1 Prod Rs 2,00,000 Products. Industrial and domestic paints, varnishes, thinners.
- 1878. SHINDE SPORTS.** 458/3 Sadashiv Peth, Tilak Rd., Pune 30 Tel 443469. Proprietary, 1961. Br Ahmednagar Sister concern Shinde Sports, Ahmednagar Bank: Bank of Maharashtra Cap. Rs.1,00,000 Workers 4. Products Tennis, badminton, squash, racket gutting, rackets.
- 1879. SHINDE SURGICAL AND METAL WORKS.** 72 Rasta Peth, Pune 2. Tel 24519 Proprietary, 1967. Bank: Canara Bank Cap Rs 10,000 Prod. Rs 10,000 Products: Surgical appliances, walking callipers spinal braces tractions, tricycle, medical equipments
- 1880. SHINGANIA SERVICES.** 1205-1-11 Deccan Gymkhana, Pune 4 Tel 50320. Factory. B-18 'H' Block, MIDC, Pimpri, Pune 18 Tel 82892 Partnership, 1972. Banks Bank of Maharashtra, Sangli Bank Cap. Rs. 1,47,278. Prod Rs 2,37,261 Workers 20. Products Moulds for rubber, plastic, glass articles; dies for sheet metal parts; jigs for ferrous and non-ferrous articles; fixtures for ferrous and non-ferrous articles
- 1881. SHINDE BABURAO GANOJI.** 205 Ghorpade Peth, Pune 2. Proprietary, 1972. Bank: Bank of Maharashtra. Cap. Rs 2,400 Prod Rs.36,838 Workers 4 Products: Leather shoes and boots, straps, finger guards, belts and washers; Leather-rexine-asbestos bellows
- 1882. SHINGOTE PROCESSED FOODS PVT. LTD.** 636/6 Vijaynagar Colony, near Peshave Park, Pune 30 Tel. 448989/441114. Cable: 'ROONAA'. Telex: Anxious' PN-0145-290. Factory: B-2 M.I.D.C. Industrial Area

- Ahmednagar 1. Tel. 37. Estd. 1976. Br. Bombay. Sister concern: K. B. Shingote & Co. Bank: Bank of Baroda. Cap. Rs.10,00,000. Workers 150. Export: Rs.24,000. Country: Kuwait. Products: Canned and bottled fruits and vegetables, jams, squashes, syrups, pickles, tomato products.
1883. SHIRODKAR PACKINGS. 783/2 Shivajinagar, Old Tophkhana, Pune 5. Tel. 54952. Proprietary, 1960. Bank: Bank of Maharashtra. Cap. Rs.1,50,000. Prod. Rs 8,00,000. Workers 8. Product: Wooden packing boxes.
1884. SHIRISH TEXTILES. 14 Hadapsar Industrial Estate, Pune 13. Tel. 7288, 7425, 7497. Proprietary, 1971. Products: Cotton fabrics, dhotis and mulmul.
1885. SHIRISH TEXTILES. 35 Erandawana, Karve Rd., Pune 4 Tel. 56135. Partnership, 1961 Bank of India Cap. Rs. 20,000. Prod. Rs.50,000 Workers 3 Product: Cotton cloth.
1886. SHIV PRECISION ENGINEERING WORKS-F II Block, A-9 Unit, M.I.D.C., Pumpri, Pune 18. Proprietary, 1974. Bank:Bank of India. Cap. Rs 1,25,000. Prod. Rs.1,35,000. Workers 7. Products: Pneumatic cylinders for machine tools, auto spares, clamping and tooling units and job work.
1887. SHIVDAS MANJI AND CO. Plot No. 11 New Timber Market, Pune 2. Tel. 23383, 27299. Partnership, 1947. Sister concern: Todian Timbers Bank: Punjab National Bank. Cap. Rs.3,00,000. Prod. Rs 8,00,000 Products: Timber sawn sizes, timber articles, wooden crates, wooden packing cases.
1888. SHIVAJI ENGINEERING WORKS. 8 Elphinstone Rd., Khadki, Pune 3. Proprietary, 1976. Cap. Rs. 20,000. Prod. Rs.25,000. Workers 3. Products: Bushes, shafts, aluminium plates, pulleys, plugs, job work.
1889. SHIVAJI LAXMAN GORADE. Plot No. 9 New Timber Market, Pune 2. Tel. 27399. Proprietary, 1961. Cap. Rs.25,000. Prod. Rs.80,000. Workers 5. Products:Wooden packing cases, timber supply and saw milling.
1890. SHIVAJI KARSAN PATEL AND CO. Plot No. 5 New Timber Market, Bhawani Peth, Pune 2. Tel. 24601. Partnership, 1949. Sister concern: S.K. Wood Works and Timber Mart. Bank:Bank of India. Cap. Rs. 4,00,000. Prod. Rs.9,00,000. Workers 4. Export: Rs.35,000. Country: Muscat. Products: Wood cutting, packing material, wooden articles, wooden furniture, wooden crates, wooden meter box and batten paties
1891. SHIVAJI LALJI PATEL AND CO. 102-A New Timber Market, Pune 2. Tel 444913. Partnership, 1954. Workers 6. Products: Teak wood size and furniture, boxes, jangli wood size and furniture and boxes.
1892. SHIVSAGAR PRESS. Plot No 391-B, Survey No. 507-509, behind Meera Co-op. Housing Society, Shankarshet Rd., Pune 9 Tel 442276. Partnership, 1966 Bank. Bank of Baroda Cap Rs.75,000 Prod Rs 2 50 lakhs Workers 18 Product: Bidi labels
1893. SHIVSHAKTI ENGINEERING WORKS. 751 Bhawani Peth, Pune 2 Tel C/o. 22508. Proprietary, 1968. Bank: Bank of Maharashtra. Cap Rs 50,000. Prod. Rs 1 lakh. Workers 3. Products: General repairing, repairing of oil engines, oil expellers and all type of machinery.
1894. SHIVSHAKTI OIL MILL. 72 Nana Peth, Pune 2. Tel. 26022. Partnership, 1958. Bank: Bank of Maharashtra. Cap. Rs 10,000. Prod. Rs 10,000. Workers 5. Product: Oil.
1895. SHIV-SHAKTI PRINTING PRESS. 653 Ganj Peth, Pune 2. Proprietary, 1971. Bank: Poona Urban Co-op Bank Ltd. Cap. Rs 8,000 Prod Rs.7,000. Worker 1. Product: Commercial printing
1896. SHOBHA FARM. (Horticulturists and Nurserymen). 1206/20-A Srirang, Shivajinagar, Pune 4. Tel. 57643. Cable: SHOBHA FARM. Nursery: Yerawada, next to National Model School, Yerawada, Pune 14. Proprietary, 1952. Sister concerns: Associated Designers; Landscape Architects. Bank: Bank of Maharashtra Ltd. Cap. Rs. 2,00,000. Prod. Rs.2,00,000 Workers 4. Export country: Kuwait. Products: Plants, seeds, garden lay-outs and consultancy agri-horticulture, ornamental plants, roses, orchids, cacti, succulents, dehalias, clads, tube roses, seeds ornamental seasonable and bulbs and rhizomes; garden maintenance, and sell of potted plants.
1897. SHOBHA TOY WORKS. 99/B Mangalwar Peth, Barne Rd., Pune 11. Proprietary, 1963. Bank:State Bank of India. Cap. Rs.47,000. Prod. Rs 45,000. Workers 7. Products: Wooden toys, electric blocks, job work.
1898. SHONAN PRODUCTS. 49 Vijayanagar Colony, behind S. P. College, Pune 30. Tel. 440964. Partnership, 1955. Banks: Central Bank of India; Bank of Mahara-

- shtra. Cap. Rs.3,00,000. Workers 6. Products: Veterinary medicines and petroleum jelly, mineral feed supplement for cattle.
- 1899. SHRAM SAHAKAR MAHILA SANGH NIYAMIT.** 250 New Shanwar Peth, Pune 30. Society, 1961. Br. Suruchi canteen, Gultekadi Industrial Area, Pune 9. Bank: Poona Jhila Dist Central Co-operative Bank. Cap. Rs 65,000 Workers 40. Products: Wooden toys, job work, masala, chilly powder, metkut.
- 1900. SHREE BHASKARANAND FACTORY.** 504/A/1, Shaniwar Peth, Pune 30. Tel. 53567. Proprietary, 1910. Bank: Bank of India. Cap. Rs 1,50,000. Prod. Rs.1,10,000. Workers 20 Products: Sugar-cane crusher, Rasawant charak, juice pump, washing machine, hydro extractors, type casting machine, backing machine, flour mills, block making machine, foundry shop.
- 1901. SHRI BHAWANI METAL WORKS.** Industrial Co-operative Society, Plot No. 12, Gultekadi, Pune 9. Tel. 442506. Co-operative, 1959. Bank: Bank of Maharashtra. Cap. Rs 4,11,080 Prod. Rs 15,67,715 Workers 22. Product: Brass utensils.
- 1902. SHRI DATTA ELECTRIC PLATING AND BRASS WORKS.** 909 Budhwar Peth, Pune 2. Tel. 445473. Factory: 161 Guruwar Peth, Pune 2. Partnership, 1968. Bank: Bank of Maharashtra. Cap. Rs 3,00,000. Workers 18. Products: Job work, all types of plating, hard chrome plating speciality.
- 1903. SHREE DATTA TRUNK AND UMBRELLA MART.** New 1099 Budhwar Peth, Pune 2 Tel. 443997. Factory: New 1101 Budhwar Peth, Pune 2. Proposed factory: S No. 34/9 Erandawana, Pune 4. Tel. 52181. Proprietary, 1957. Sister concern: Hira, 249 Budhwar Peth, Pune 2. Bank: Bank of India. Products: Steel trunks, buckets, sheet metal products, umbrellas.
- 1904. SHRI DATTA ELECTRIC PLATING AND BRASS, WORKS.** 909 Budhwar Peth, Pune 2. Tel. 445473. Factory: 161, Guruwar Peth, Pune 2. Partnership, 1938. Cap. Rs.36,388. Prod. Rs 2,55,000. Workers 18. Products: Electroplating, hardchrome plating, heavy silver plating.
- 1905. SHRI DATTA MUDRANALAYA.** 335 Shanwar Peth, Pune 30. Tel. 446811. Partnership, 1952. Banks: Bank of Maharashtra; The Karad Bank Ltd. Cap. Rs. 7,50,000. Prod. Rs 4,50,000. Workers 20. Product: Commercial printing.
- 1906. SHREE ENTERPRISES.** 41/2 Vadgaon Sheri, Pune 14. Tel. 22892. Partnership, 1972. Sister concerns: Jain Industries, Dugar Industries. Bank: Bank of Maharashtra. Cap Rs.1,00,000. Prod. Rs 3,25,000. Workers 25. Products: Components for ceiling fans and table fans.
- 1907. SHREE ELECTRICALS.** A-132, 'H' Block, M.I.D C., Pimpri, Pune 18. Tel. 82453. Cable: COIL. Partnership, 1968. Sister concern: Elemec Industries, A-119-122 'H' Block, M.I.D C., Pimpri, Pune 18. Bank: Central Bank of India. Cap. Rs.1,50,000. Prod. Rs 9,80,000. Workers 19. Products: Magneto coils, magnetising equipments, ignition testers, solenoid valve coils.
- 1908. SHREE ENGINEERING WORKS.** 161 Ghorpade Peth, Pune 2. Proprietary, 1976. Bank: Dena Bank. Cap Rs.42,000. Prod. Rs 36,000. Workers 4 Products: Job works like rough and finishing casing, finish spacer pipe, rigid casing, bush rough and finish, spare parts.
- 1909. SHREE ENGINEERING.** 677 Kasba Peth, Pune, 11. Tel. 447196. Factory: Opp. Atlas Capco, Bombay-Pune Rd., Dapodi, Pune 12. Tel. 82635. Partnership, 1968. Bank: Bank of Maharashtra. Cap. Rs 1,00,000. Prod. Rs. 5,00,000. Workers 9. Product: All kinds of fabrication works.
- 1910. SHREE ENGINEERING.** 665 Narayan Peth, Appa Balwant Chowk, Pune 30. Tel. 446998. Proprietary, 1963. Bank: Suvarna Sahakari Bank. Cap Rs 20,000. Prod. Rs 8,000. Workers 2. Product: Shock absorbers of all kinds and repairing.
- 1911. SHREE GANESH CHILDREN'S GARMENTS.** 507 Guruwar Peth, Pune 2. Proprietary, 1967. Bank: Sangali Bank. Cap. Rs.40,000. Prod Rs.70,000 Workers 4. Product: Readymade garments for children.
- 1912. SHREE GANESH MECHANICAL REPAIRING WORKS.** 115 Ganesh Peth, Pune 2. Proprietary, 1964. Cap. Rs.10,000. Products: All kinds of turning and drilling job work.
- 1913. SHREE GANESH PLASTIC INDUSTRY.** 549 Guruwar Peth, Pune 2. Tel. 449061. Factory: 197 Mahatma Phule Peth, Pune 2. Proprietary, 1969. Bank: United Commercial Bank. Cap. Rs.20,000. Prod. Rs.25,000. Workers 4. Products: Industrial plastic articles, buttons.
- 1914. SHRI GANESH CONFECTIONERY WORKS.** 1453 Kasba Peth, Pune 11. Tel. 448077. Partnership,

1971. Bank: Bank of Maharashtra. Cap. Rs.1,60,000. Prod. Rs.5,50,000. Workers 8. Products: Lemon drops, chocolates, khari sakhar, papermint tablets, pithi sakhar,
1915. SHRI GANESH ELECTRO PLATERS. 294 Kasba Peth, Pune 11. Tel. 448853. Proprietary, 1966. Bank: Pune Merchants' Co-operative Bank. Cap. Rs. 15,000. Prod. Rs.30,000. Workers 5. Product: Electroplating.
1916. SHRI GANESH ENGINEERING WORKS. "Sumati" Hemkant Housing Society, Dattawadi, Pune 30. Factory: 200 Mangalwar Peth, Kudale Estate, Gadital Pune 11. Tel. C/o. 20043. Proprietary, 1969. Bank: Bank of Maharashtra. Cap. Rs.40,000. Prod. Rs.1,20,000. Workers 8. Products: Job work, washers, sheet metal work, ductings, panels, filters and fabrication work.
1917. SHRI GANESH INDUSTRIES. S. No. 13, opp. Akashwani, Sholapur Rd., Hadapsar, Pune 28. Partnership, 1975. Bank: Canara Bank. Cap. Rs.65,000. Prod. Rs.1,00,000. Workers 6. Products: Job work for rickshaw and taxi meters.
1918. SHRI GANESH FABRICATORS. Opp. Bajaj Tempo, Akurdi, Pune 35. Partnership, 1973. Bank: Rupes Co-op. Bank Ltd. Cap. Rs.20,000. Prod. Rs.40,000. Product: job work.
1919. SHRI GANPATI SAW MILL. Plot No. 100, New Timber Market, Bhawani Peth, Pune 2. Tel. 444523. Partnership, 1957. Banks: Central Bank of India; Union Bank of India; Bank of India. Cap. Rs.1,50,000. Prod. Rs.3,00,000. Workers 6. Products: Building materials (wooden), all kinds of timber.
1920. SHREE GURUDATTA SAW MILLS. Plot No. 26, Gultekadi, Pune 9. Tel. 444104. Proprietary, 1967. Bank: Bank of Maharashtra. Cap. Rs.1,00,000. Prod. Rs.25,000. Workers 7. Products: Saw mill job working and package boxes.
1921. SHRI JALARAM TIMBER DEPOT. 415/1 A Kasarwadi, Pune 18. Partnership, 1973. Bank: Bank of Maharashtra. Cap. Rs.50,000. Prod. Rs.1,00,000. Workers 5. Product: Wooden packing boxes.
1922. SHRI INDUSTRIES. S. No. 45, Erandawana, Karve Rd., Pune 4. Tel. 55779. Factory: 45/5C/3 Erandawana, Karve Rd., Pune 4. Proprietary, 1974. Bank: Bank of India. Cap. Rs.15,000. Prod. Rs.3,000. Workers 3. Product: Cabinet boxes of sheet metal.
1923. SHREE INDUSTRIES. 596 Ganj Peth, Pune 2. Tel. 442447. Partnership, 1972. Bank: State Bank of India. Cap. Rs.80,000. Prod. Rs.2,50,000. Workers 15. Products: Aluminium utensils, pots.
1924. SHREE J. PRINTERS. 1416 Sadashiv Peth, Datta Kuti, Pune 30. Tel. 443269. Proprietary, 1971. Sister concerns: Shree Suppliers; Shree Cyclostyling. Banks: Shree Suvarna Sahakari Bank Ltd.; Cosmos Co-op. Urban Bank Ltd. Prod. Rs.80,000. Workers 6. Products: Commercial printing, binding, cyclostyling, supply of stationery, paper, etc.
1925. SHREE 'K' INDUSTRIES. Plot No. 85, 'S' Block, M.I.D.C., Bhosari, Pune 26. Partnership, 1974. Bank: Bank of Maharashtra. Products: Jobbing and fabrication, machine tool accessories—stub and long arbour and hob arbour, chemical machineries, dies, special toolings.
1926. SHREE KAMALA TIMBER MART. 170/176, Plot No. 12, Chinchwad, Pune 33. Telephone 82538. Partnership, 1965. Bank: Bank of India. Cap. Rs.24,000. Prod. Rs.1,00,000. Product: Packing boxes.
1927. SHRI KARNAVAT SAW MILL. 48 New Timber Market, Bhawani Peth, Pune 2. Tel. 23343. Proprietary, 1963. Bank: Bank of India. Cap. Rs.50,000. Prod. Rs.1,00,000. Workers 4. Product: Packing boxes.
1928. SHRI LAXMAN SAVLARAM SALGAR. Small Scale Industrial Estate, Gultekadi, General furniture Works, Plot No. 9. Pune 9. Tel. 445398. Partnership, 1961. Bank: Bank of India, Cap. Rs.2,00,000. Prod. Rs.15,000. Workers 4. Products: Wooden furniture, windows, doors, ceiling, partitions, etc.
1929. SHRI LAXMI MECHANICAL WORKSHOP. 1377 Shukrawar Peth, Pune 2. Tel. 442168. Proprietary, 1923. Banks: State Bank of India; Bank of India. Cap. Rs.60,000. Prod. Rs.1,10,000. Workers 10. Products: Cast iron foundry and structural iron work, c.i. manhole covers, c.i. specials for water connections such as fire hydrants, duck foot bends, tail pieces etc.; soil and concreting equipment such as post hole augers, liquid limit device, proctor, cylinder, permeameters, c.b.r. moulds, etc.
1930. SHRI LAXMINARAYANA TYPE FOUNDRY. 1089 Sadashiv Peth, Bajirao Rd., Pune 30. Proprietary 1945. Cap. Rs.5,000. Workers 4. Product: Printing types.

- 1931. SHRI LAXMI SAW MILL.** 240/A-1 Bombay-Pune Rd., Chinchwad, Pune 19 Tel 82774 Partnership, 1975. Cap Rs 2,50,000. Prod Rs 5,00,000 Products Timber, saw milling, packing boxes
- 1932. SHRI MAHILA GRUHA UDYOG LIJJAT PAPAN.** 33/16 Prabhat Rd., Lane No 4, Pune 4 Tel 53007. Co-operative Society, 1968 Head Office Bombay Bank Bank of India Cap Rs 1,00,000 Prod Rs 2,00,000 Workers 350. Product Papad
- 1933. SHRI MUDRAN.** 418 Shanwar Peth, Pune 30 Tel 56033 Proprietary, 1969 Bank Bank of Maharashtra. Workers 3 Product: Commercial printing
- 1934. SHRI MUDRAN MANDIR.** 914 Sadashiv Peth, Pune 30 Tel 443360 Partnership, 1960 Bank Bank of Maharashtra Cap Rs 1,15,361 Prod Rs 1,35,800 Workers 11 Products. Commercial printing, composing binding
- 1935. SHRI MAHAVIR TEXTILES.** Plot No 14, Industrial Estate, Hadapsar, Pune 13 Tel 7507, 7497 Proprietary, 1973. Product Cotton fabrics
- 1936. SHREE METAL PRODUCTS.** Industrial Shed No. 5, 691 Pune-Satara Rd., Bibwewadi, Pune 9 Tel 54979 Partnership, 1974, Bank. Bank of India Cap. Rs 2,00,000. Prod Rs 10,00,000 Workers 9 Products Mobile racks, plain roller conveyors, trollies, rolls stands
- 1937. SHREE PLASTICS.** 167/A Happy Colony, Kothrud, Pune 29 Tel 58440 Cable KOPLAST Proprietary, 1964. Br. Gandhidham, Kutch. Bank. Dena Bank. Cap. Rs 2,00,000 Prod. Rs 9,00,000. Workers 9 Export: Rs 9,00,000 Countries Middle East countries. Products: Polyethelene sheets, tubing, films, moulded articles and reprocs sed material
- 1938. SHREE PLASTIC COVERS AND BOOK SELLERS.** 742(A), Sadashiv Peth, Pune 30 Proprietary, 1976. Bank Sangli Bank. Cap Rs 1,000 Prod Rs 1,500. Worker 1 Products: Plain stickers for industrial purpose, transparent and non-transparent covers for books and maps, p v c. welding.
- 1939. SHREE PRODUCTS LTD.** 'Swastik House', behind Khadki Rly. Station, Khadki, Pune 3 Tel. 55201-5 Cable: SWASTIRUB. Factory: H.A. Ltd Compound, Bombay-Pune Rd., Pimpri, Pune 18. Tel 82958, 83366, 83367. Cable: SHRICAP. Tels x 0145-338 Estd. 1961. Subsidiary company: Swastik Rubber Products Ltd. Khadki, Pune 3 Banks Canara Bank; Indian Overseas Bank Cap Rs 78 03 lakhs Prod Rs 184 02 lakhs Workers 300 Export Rs 6 70 lakhs Country Bangladesh Products Packaging material of rubber for pharmaceutical industry, rubber stoppers of various properties for injection vials, T V, solution bottle stoppers, b.t. bangs, wads etc, feeding bottle nipples, medical tubing
- 1940. SHRI RAM ENGINEERS.** 1204/24 Bapusaheb Purandare Rd., Shivajinagar, Pune 4. Tel 54147. Proprietary, 1961. Bank Janata Sahakari Bank Ltd. Cap Rs 30,000 Prod Rs 15,000 Workers 3 Products. Job work, repairing of engines, pumps.
- 1941. SHRI RAM HOSIERY.** 264/4 Shanwar Peth, Pune 30 Tel 447203 Proprietary, 1965 Bank Bank of Maharashtra Workers 13 Product: Banyans
- 1942. SHREE RAM INDUSTRIES.** 1316 Kasba Peth, Pune 11 Tel 449521 Proprietary, 1965 Bank: Bank of Maharashtra Cap. Rs 75,000 Prod. Rs 75,000 Workers 7. Products Saloon chairs, job work, spare manufacturers and suppliers
- 1943. SHRI RAM SAW MILLS.** 21 New Timber Market, Pune 2. Tel 444588 Partnership, 1964 Workers 6 Products Teak wood sizes, furnitures, boxes
- 1944. SHRI RENUKA PRINTING PRESS.** 425 Narayan Peth, Bhat Lane, Pune 30. Tel 444307 Proprietary, 1970. Cap Rs 15,000 Prod Rs 70,000 Workers 6 Products Commercial printing and binding
- 1945. SHREE ROLLING MILLS,** Pune. 186 Chinchwad. Pune 19. Tel 83269 Partnership Sister concern Shree Steel Traders, 399 Nana Peth, Pune 2 Banks: Bank of Maharashtra, Punjab National Bank. Products. MS bar and cast iron products.
- 1946. SHREE SHESHADREE PLASTICS.** 9 Mangalwar Peth, Pune 11. Tel. 26150 Proprietary, 1966. Banks Bank of Maharashtra; Mahesh Sahakari Bank Ltd. Products: Polythene tubings, bags, injection moulding, blow mouldings, industrial items
- 1947. SHRI TECHNICIANS.** 61/51 Ketkar Rd., Bharati Niwas Colony, Pune 4. Tel. 50583. Factory: S No. 19/1 Vithalwadi, Hingne Khurd, Tal. Haveli Dist. Pune Partnership, 1974. Bank. Bank of Baroda. Cap Rs.1 lakh.

- Prod. Rs 1.5 lakhs. Workers 7 Products. Mechanical seals for compressors, oil pumps, material handling equipment.
- 1948. SHREE VASUDEO INDUSTRIES.** 31 Mangalwar Peth, Pune 11. Proprietary, 1972 Bank: Bank of Maharashtra. Workers 7 Product. Spare parts for various industries.
- 1949. SHREE VENKATESH BOX WORKS.** 1573 Shukrawar Peth, Pune 2. Tel. 446923 Proprietary, 1968. Cap. Rs. 15,000. Prod. Rs.30,000. Workers 3 Product Carton boxes including printing.
- 1950. SHREE VENKATESHWAR INDUSTRIES.** 371/380 Kothrud, Pune 29 Proprietary, 1972. Banks Bank of Maharashtra; Bank of India Cap Rs 1,00,000 Prod. Rs 36,000. Workers 8. Products Ancillary suppliers of machined spare parts for diesel engine automobile products and allied assembly equipments of other engineering concerns
- 1951. SHREE VENKATESH PRINTING PRESS.** 567 Raviwar Peth, Pune 2 Tel. 447397. Partnership, 1963. Sister concerns: Bhutada Trading Corporation; Shri Venkatesh Calendar Mfg Co. Bank: Bank of Maharashtra Cap. Rs 1,50,000. Prod. Rs.2,50,000 Workers 9. Product: Commercial printing
- 1952. SHRIDHAR MACHINE TOOLS PVT. LTD.** 27/1 L. Kirloskar Path, Khadki, Pune 3. Tel. 54079 Factory. E-12-17 (7), MID.C., Bhosari, Pune 26 Tel. 83535. Estd. 1975. Bank: Union Bank of India Cap. Rs. 60,000. Prod. Rs.1,85,154. Workers 18 Products: 3 D.P. pantograph milling machine, 2 D.P. pantograph engraving machine, single lip grinder.
- 1953. SHRI JIVESHWAR PRINTING PRESS.** 594 Ganesh Peth, Pune 2. Tel. 446016. Proprietary, 1968. Bank: Bank of Maharashtra. Cap. Rs.55,000. Prod. Rs 50,000. Workers 4. Products: Commercial printing, binding, stationery suppliers.
- 1954. SHRIKANT AND CO.** 77 Rasta Peth, Pune 11. Tel. 27456. Factory: 77/1/1 Mundhwa, Industrial Estate, Pune 36. Partnership, 1966. Bank: The Poona Contractors Co-op. Bank Ltd. Cap. Rs 1,15,000. Prod. Rs.7,00,000. Workers 12. Products: Ground spices—chilli powder, turmeric powder, coriander powder, curry powder, kandasoon chatney.
- 1955. SHRIKANT ENGINEERING CORPORATION.** 41 Industrial Estate, Gultekadi, Pune 9 Tel. 445371. Proprietary, 1962 Bank Bank of Maharashtra. Cap. Rs. 1,04,852 Prod. Rs 6,80,000. Workers 22 Products: Fabrication work, steel windows.
- 1956. SHRIKANT MUDRANALAYA.** 610 Sadashiv Peth, Kunte Chowk, Pune 30. Proprietary, 1973 Workers 7. Product: Job work.
- 1957. SHREEKESHAR PRINTERS AND PUBLISHERS.** Block D-III, Plot No. 79, MID.C., Chinchwad, Pune 19 Tel 83553 Partnership, 1972. Sister concern: Shreekeshar Trading Agencies. Bank: The Poona Co-op. Rupee Bank Ltd Cap Rs 45,000. Prod Rs 75,000. Workers 4 Product: Commercial printing.
- 1958. SHRIKRISHNA BAKERY.** 1333 Raviwar Peth, Pune 2. Partnership, 1939 Bank: Bank of Maharashtra. Cap Rs 15,000 Prod Rs 1,40,000. Workers 6. Products: Butter, toast, khari, bakery products.
- 1959. SHRIKRISHNA DRESSES.** 520 New Ghorpade Peth, Khadak Mal Ali, Pune 2 Partnership, 1974. Cap. Rs 10,146 Prod Rs 1,06,780. Workers 6 Product: Readymade garments.
- 1960. SHRIKRISHNA ENGINEERING WORKS.** 31/1 Karve Rd, Pune 4. Tel. 54077 Factory: 12 Kothrud Industrial Area, Pune 29. Tel. 53552. Proprietary, 1963. Bank: Bank of Baroda Cap. Rs 1,50,000. Prod. Rs. 10,00,000. Workers 22. Products: Water gates, M.S. pipes and specials, jib cranes and overhead cranes, filter plants and chemical plants.
- 1961. SHRIKRISHNA HOMOEOPHARMACY.** D-2, 67-B, MID.C., Chinchwad, Pune 19. Tel. 83105. Partnership, 1911. Brs. Bombay, Bangalore. Bank: Bank of Maharashtra Prod. Rs 10,00,000. Workers 35. Products: Homoeopathic and biochemic medicines, globules, alfalfa tonic, family tonic, arnica hair oil, biochemic tooth-powder, etc.
- 1962. SHRIKRISHNA METAL WORKS.** 100 Guruwar Peth, Pune 2. Tel. 444469. Partnership, 1947. Bank: Bank of Maharashtra. Cap. Rs.2,00,000. Prod. Rs.3,00,000. Workers 15. Products: Stainless steel, cutlaries, surgical and hospital wares.
- 1963. SHRI NATH PRINTING PRESS.** 335 Shanwar Peth, Pune 30. Tel. 447852. Proprietary, 1959. Bank:

- Poona Merchants Co-op. Bank Ltd. Cap. Rs 1,00,000. Prod. Rs.1,20,000. Workers 10. Product: Commercial printing.
1964. SHREENATH TEXTILES. 14 Hadapsar Industrial Estate, Pune 13. Tel 7507, 7497 Proprietary, 1974. Sister concern: At & post Velu, Dist. Pune. Tal. Bhor. Product: Cotton fabrics.
1965. SHRINGAR DRESS MFG. CO. 361-62 Budhwar Peth, Pune 2. Tel 447036. Factory. 412 Budhwar Peth, Pune 2. Partnership, 1958 Bank: Canara Bank Cap. Rs. 4,00,000. Prod. Rs. 10,00,000. Workers 18. Product: Children wear.
1966. SHRINAGAR HANDLOOM FACTORY. 593 Ganj Peth, Pune 2. Tel 444694 Partnership, 1964. Bank: Bank of Maharashtra. Cap. Rs 1,50,000. Prod. Rs. 2,70,000. Workers 60. Product. Handloom sarees.
1967. SHRINIWAS ENGINEERING WORKS. 546 Ganj Peth, Pune 2. Partnership, 1968. Cap. Rs 15,000. Prod. Rs.20,000. Workers 2. Product. Electronic parts for convertor assembly parts.
1968. SRINIWAS CARDS. 1167 Raviwar Peth, Pune 2. Tel. 446849. Proprietary, 1977. Bank: Bank of India. Cap. Rs.10,000 Products: Wedding cards, greeting cards, stationery.
1969. SHRINIWAS FURNITURE. 108 Ganesh Peth, Pune 2. Tel. 446703. Proprietary, 1965. Bank: Union Bank of India. Cap. Rs 5,000. Product: Furniture and repairs.
1970. SHRINIWAS PRINTING PRESS. 1167 Raviwar Peth, Pune 2. Tel. 446849. Cable: SHRIPRINT. Proprietary, 1949. Bank: Bank of India. Cap. Rs 1,00,000. Prod. Rs 1,50,000. Workers 6. Product: Commercial printing.
1971. SHRINIWAS UDYOG. 151-A Shaniwar Peth, Pune 30. Tel. 53726. Factory: 34/13 Erandawana, Pune 4. Tel. 55116. Proprietary, 1969. Bank: Bank of Maharashtra. Cap. Rs. 50,000. Prod. Rs.3,98,000. Workers 8. Products: Conveyors of all types, belt, screw and slat type elevators, material handling equipment, base plates for maintaining motor/pump, or engine/pump, engine/generator, etc. tool-boxes including collapsible tool-boxes.
1972. SHRIPAD METAL WORKS. 377 Shukrawar Peth, Shivaji Rd., Pune 2. Partnership. Bank: Bank of Baroda. Cap. Rs 25,000. Workers 2. Product: Machinery repairing.
1973. SHRIPAD MUDRANALAYA. 208/209 Mangalwar Peth, Pune 11. Tel. 27839. Partnership, 1969. Bank: Central Bank of India Cap. Rs.9,000. Prod. Rs 60,000. Workers 4 Product: Commercial printing.
1974. SHRIRAM MUDRAN MANDIR. 218/223 Shukrawar Peth, Pune 2. Proprietary, 1971. Bank: Bhagini Nivedita Sahakari Bank Ltd. Cap. Rs 60,000. Prod. Rs. 1,30,000. Workers 6. Product: Commercial printing.
1975. SHRIRAM RUBBER PRODUCTS. W-41 Technician Shed, M.I.D.C., Bhosari, Pune 26. Proprietary, 1976. Bank: Bank of Maharashtra. Cap. Rs 50,000. Prod. Rs. 1,10,000. Workers 9 Products: Moulded rubber components such as 'O' rings, grommets, washers, flat rings, gaskets, packings, etc; synthetic rubber compounds, such as Neoprene, Nitrile, Silicone, Butyl. etc; metal to rubber bonded components such as mountings, shock absorbers.
1976. SHREEYASH PLASTIC INDUSTRIES. 27/375 Lokmanya Nagar, Pune 30. Factory. Vithalwadi. At & Post: Vadgaon, Tal. Haveli, Dist. Pune Proprietary, 1973. Bank: Bank of Maharashtra. Cap. Rs 17,000. Workers 3. Products: Low density polythelene bags, sheets, rolls and tubing, reprocessed tubing and bags, coloured sheets for rainy season.
1977. SHUBH NEEL CHEMICALS. 38/18 Erandawana, Vinayak-1, off Prabhat Rd., Lane No. 10, Pune 4. Tel. 54939. Factory: M.I.D.C. F-2, Block, Shed No. 24, behind Telco (Pumpri), Pumpri, Pune 18. Proprietary, 1975. Bank: Shree Suvarna Sahakari Bank Ltd. Cap. Rs.40,000. Prod. Rs 25,000. Workers 4. Products: Metal primers (oil paints), wood primers (oil paints) syn-enamel paints.
1978. SHUBHALAXMI METAL WORKS. 69-B Hadapsar Industrial Estate, Pune 13. Tel. 7213. Partnership, 1976. Bank: Bank of India. Workers 25. Product: Brass utensils.
1979. SHUBHRATA CHEMICALS. C-41 Adinath Society, Pune-Satara Rd., Pune 9. Tel. 442347. Partnership, 1974. Bank: Adinath Sahakari Bank Ltd. Cap. Rs.10,000. Prod. Rs.1,00,000. Workers 3. Products: Detergent powder, liquid soap, cleaning powder, oil-base liquid soap, jelly soap, liquid solution, etc.

- 1980. SHYAM ENGINEERING CO.** Unit No. 6, M.I.D.C. 'C' Block, Chinchwad, Pune 19. Tel. C/o. 82726. Factory: Shop No. 5, M.I.D.C. 'C' Block, Chinchwad, Pune 19. Partnership, 1976. Bank: Bank of Maharashtra. Cap. Rs.25,000. Prod. Rs.36,000. Workers 4. Products: Job work for engineering, sugar, chemical and glass industries.
- 1981. SIDDHA LAXMI ENGINEERING INDUSTRIES PVT. LTD.** Plot No. A-128, 'H' Block, M.I.D.C., Pimpri, Pune 18. Tel. 82668. Estd. 1967. Bank: Bank of Baroda. Cap. Rs. 2.5 lakhs. Prod. Rs.5 lakhs. Workers 8. Products: Spot film devices for 'X' rays (tables) rays, tele-therapy simulator, machined spare parts for marine engines, electro-medical equipment and jobbing work.
- 1982. SIDHESHWAR AND CO.** 480 Budhwar Peth, Pune 2. Tel. 448877. Partnership, 1928. Sister concerns. Sidheshwar Electric Co., Shah International. Bank: State Bank of India. Cap. Rs.1,75,000. Prod. Rs.2,00,000. Workers 9. Products: Lamps, miniature and auto lamps, decoration, cycle dynamo, projection, exciter, neon, radio dial, aircraft torch, flashlight bulb, instrument and indicator, surgical and medical, optic, electric and special type lamps; glass fuses—quick acting fuses, time lag (slow blow) fuses, carbon brushes—copper carbon brushes, geyser plates, carbon plate and rods.
- 1983. SIGMA ENGINEERS.** Plot No. W-2, 'S' Block, M.I.D.C., Bhosari Industrial Area, Pune 26. Tel. 83544. Cable: SIGMAENG. Partnership, 1972. Bank: State Bank of India. Cap. Rs.4,00,000. Prod. Rs.8,00,000. Workers 35. Products: Electronic components, power electronic equipment, process control panels and process instrument accessories.
- 1984. SIGMA INDUSTRIES.** 230 Kasba Peth, Pune 11. Tel. 449931. Factory: W-92, 'S' Block, M.I.D.C. Industrial Area, behind Century Enka, Bhosari, Pune 26. Proprietary, 1978. Bank: State Bank of India. Cap. Rs.2.5 lakhs. Workers 4. Product: Wire nails.
- 1985. SIGNAL ELECTRONICS AND ELECTRICALS.** 6/14 Erandawana, Pune 4. Proprietary, 1976. Bank: State Bank of India. Cap. Rs.15,000. Prod. Rs.80,000. Products: Water-level controllers, timers, neon sign, street light controllers, solid state automatic car light dimmers, non-conducting liquid level controllers, boiler fuel saver attachment.
- 1986. SILVER BRIGHT.** 19 Karve Rd., Pune 4. Tel. 52114. Factory: 67-A Block, D-2, M.I.D.C., Chinchwad, Pune 19. Tel. 82900. Partnership, 1973. Bank: Bank of Baroda. Cap. Rs.5,58,115. Prod. Rs.7,43,000. Workers 10. Products: Bright steel bars and shaftings, general fabrication and steel structural works, sugar machinery and spares, chemical equipments, job work.
- 1987. SINDHU ART PRINTERS.** 317 Ajit Bhavan, Hemoo Kalani Marg, Pimpri, Pune 17. Tel. 82943. Proprietary, 1971. Bank: Seva Vikas Co-operative Bank Ltd., Vijaya Bank. Cap. Rs.30,000. Prod. Rs.50,000. Workers 5. Product: Commercial printing.
- 1988. SINGH PRINTERS.** Unit A-20, Block F-2, M.I. D.C., Pimpri, Pune 18. Tel. 82766. Partnership, 1974. Bank: Bank of India. Cap. Rs 60,000 Prod. Rs 1,44,000. Workers 6. Product: Commercial printing.
- 1989. SHIRKE CONSTRUCTION EQUIPMENTS PVT. LTD.** 1205 Apte Rd., Pune 4. Tel. 56712, 58947. Telex: 0145-280. Cable: EQUIPMENT. Factory, sales and other offices: 72-76 Industrial Estate, Mundhwa, Pune 36. Tel. 7151-54. Telex: 0145-258. Cable: EQUIPMENT. Foreign collaboration: Richier International of France. Product: Tower cranes.
- 1990. SHIRKE PRIVE REIMBERT SILOS PVT. LTD.** 1205 Apte Rd., Pune 4. Tel. 56712, 58947. Telex: 0145-280. Cable: BUILDALL. Factory, sales and other offices: 72-76 Industrial Estate, Mundhwa, Pune 36. Tel. 7151-54. Telex: 0145-258 Cable: BUILDALL. Foreign collaboration: Prive S.A. of France, and Mr. Reimbert, International Silos Consultant. Products: Corrugated galvanised metal sheet silos for storage of food grains, fertilisers, granular materials and equipment for bulk handling and preservation of food grains etc. as also structures like garages, ware-houses, stores, workshops etc. using corrugated metal sheeting and fabricated frames.
- 1991. MINATO SHIRKE CONCRETE MACHINES PVT. LTD.** 1205 Apte Rd., Pune 4. Tel. 56712, 58947. Telex: 0145-280. Cable: MINATO. Factory, sales and other offices: 72-76 Industrial Estate, Mundhwa, Pune 36. Tel. 7251-54. Telex: 0145-258. Cable: MINATO. Estd. 1970. Foreign collaboration: Minato S.A. of France. Products: Moderately priced Minato-Shirke dense concrete layer to layer closed cavities 'Cellular' building block-making machines run on electricity with high vibration simultaneous tamping used for construction of housing and drains and culverts and pavements of roads, ideal for starting small-scale industries in both urban and rural areas.

- 1992. SIPOREX INDIA LTD.** 72-76 Industrial Estate, Mundhwa, Pune 36 Tel 7284, 7318-19, Cable. SIPOREX Estd 1969. Banks: Central Bank of India, Pune, Bank of Baroda, Pune & Bombay; *Syndicate Bank*, *Yadgiri* Foreign collaboration: *Internationella Siporex AB*, Malmoe, Sweden. Products: Light weight autoclaved cellular concrete reinforced slabs and panels for roofs, floors and walling and lintels and unreinforced blocks for partitions and walls and insulation
- 1993. SIRAJ S. MULLA.** 343 Raviwar Peth, Pune 2. Tel 446279. Factory 1583 Shukrawar Peth, Pune 2 Partnership, 1946 Br 1573 Shukrawar Peth, Pune 2 Bank: Bank of Maharashtra; The Muslim Co-op Bank Ltd Cap. Rs 2,50,000. Prod. Rs 4,00,000. Workers 40 Products: Iron ghamellas, galvanised buckets, trunks, tawas, kithoxes, and other household articles
- 1994. SIRAZ FRAME WORKS.** 234 Budhwar Peth, Tel. 445860 445593 Partnership, 1930 Bank The Muslim Co-op. Bank Ltd Cap. Rs 1,00,000 Workers 6 Products: Glass, frame-making, building glass fitting.
- 1995. SIRONA CO.** Prabhat Rd, Pune 4 Tel 55403 Factory 6/20 Karve Rd, Pune 4 Tel 55041 Partnership, 1942. Sister concern: Madhav & Co Pune. Bank: Bank of Maharashtra Cap Rs 10,000 Prod Rs 16,00,000 Workers 28. Products: Sirona sanitary towels, compressed pads, toilet paper rolls.
- 1996. S K VISHWAS ENGINEERING WORKS.** 110/17 Shivajinagar Pune 5. Partnership, 1976. Bank: Bank of Maharashtra Cap. Rs 25,000 Prod. Rs.36,000 Workers 4 Products: Spares and mould equipments for I. S. glass forming machines and for engineering, chemical and sugar industries.
- 1997. S-KEL AUTO.** 'Furaha' 796-A/2 Bhandarkar Rd, Shivajinagar, Pune 4 Tel 56879 Proprietary, 1971 Cap. Rs 15,000. Prod Rs 25,000 Workers 4. Products: Repairs of auto vehicles, servicing, painting of scooter and motor cycles.
- 1998. SKEY PRODUCTS.** 24/25 Somwar Peth, Pune 11 Tel C/o. 24514 Proprietary, 1973 Bank: Bank of Maharashtra Cap Rs 80,000 Prod Rs.84,000. Workers 9 Products: Axle shaft, king pin tubes for tractors, brake crankshafts.
- 1999. SLING INDUSTRIES.** 37 Kadolkar Wadi, Talegaon Dabhade 410 405. Tel. 93. Partnership, 1966. Banks: Sangli Bank Ltd., Talegaon Dabhade; Shree Suvarna Sahakari Bank Ltd, Pune Cap Rs 50,000 Prod Rs 2,25,000 Workers 9 Products: AU types of printed and plain corrugated boxes, grey board boxes and duplex cartons.
- 2000. SLING PRINTERS.** 37 Kadolkar wadi, Talegaon Dabhade Tel 93 Partnership, 1975 Banks Sangli Bank Ltd, Talegaon Dabhade, Shree Suvarna Sahakari Bank Ltd, Cap Rs 25,000 Prod. Rs. 1,25,000 Workers 7 Products: Commercial printing, tracing paper printing
- 2001. SMALL PARTS REPETITIONS.** Station Rd., 186 Chinchwad, Pune 33 Tel 82386 Proprietary, 1962 Bank Bank of Maharashtra Products. Job work, nuts
- 2002. SMEVS ENGINEERING WORKS.** 27/1 L Kirloskar Rd, Khadki, Pune 3 Tel 54079 Partnership, 1961 Bank. Bank of Maharashtra Cap Rs 2,81,922 Prod Rs 3,38,800. Workers 8 Export Rs 50,000 (not directly) Products: Smevs 3 dimensional pantograph milling machine, super single lip cutter grinder, 2 dimensional pantograph engraving machine, dies, moulds, jigs and fixtures
- 2003. SNOW WHITE CLEANERS AND DYERS.** 374 M. G Rd, Pune 1 Tel 24047 Partnership, 1950 Bns J M Road; Khadki, Pune Bank: Canara Bank. Cap Rs 60,000. Workers 10. Products: Washing and dyeing
- 2004. SOARES ENGINEERS.** 59 Small Ghorpuri, Pune 1 Proprietary, 1972 Bank: Bank of Baroda Cap Rs 70,000 Prod Rs 1,25,000 Workers 8. Products: Precision machine components, pipe union and ancillary units
- 2005. SODHI ENGINEERING WORKS.** 31-32 Bombay-Pune Rd, Dapodi, Pune 12 Proprietary, 1967 Bank: The Punjab Co-op. Urban Bank Ltd Cap Rs 30,000 Product: Job work
- 2006. SOLITRONICS.** Ram-Kunj, 108/7 Erandawana, Pune 4. Tel. 50926. Cable. SOLITRONICS. Factory Plot No 7, Happy Colony, Kothrud, Pune 29. Tel. 55854. Proprietary, 1969. Bank: Bank of Maharashtra Cap. Rs. 60,000. Prod Rs.2,00,000. Workers 5. Products. PTC thermistors for electric motor protection, current limiting, temperature sensing, etc, low-melting glass for glass/metal seals of semiconductors devices, feed through connectors, ceramic metalizing (solderable).

- 2007. SOLID PACKAGING INDUSTRIES.** 786 Budhwar Peth, Pune 2. Factory: 20/42 Industrial Estate, Gultekadi, Pune 9. Tel. 445647. Partnership, 1976. Sister concern: Western Paper Box Syndicate. Bank: State Bank of India. Cap. Rs. 2,00,000. Prod. Rs.1,00,000. Workers 5. Products: Corrugated rolls, corrugated sheets.
- 2008. SOLID STATE ELECTRONICS.** 784 Shivajinagar, Pune 4. Tel. 56320, 52084. Proprietary, 1970. Sister concern: Metronika. Bank: Bank of Baroda. Cap. Rs. 35,000. Prod. Rs.2,00,000. Workers 2. Products: Industrial control panels, power suppliers, precision timers and time delay relays, etc.
- 2009. SOMWANSHI BROTHERS AND CO.** 32 Shankarshet Rd., Gultekadi, Plot No. 15, Pune 9. Tel. 446786. Partnership, 1973. Sister concern: Somwanshi Rolling Mills, 82 Shankarshet Rd., Gultekadi, Plot No. 15, Pune 9. Banks: State Bank of India; Bank of India. Cap. Rs.5,00,000. Prod. Rs. 4,32,000. Products: Brass, aluminium and copper sheets, circles, non-ferrous domestic utensils, job works.
- 2010. SONA DRESS MFG. CO.** 1480 Kasba Peth Daruwala Bridge, Pune 11. Tel. 449654. Proprietary, 1970. Bank: Bank of Maharashtra. Cap. Rs.20,000. Prod. Rs.4,00,000. Workers 12. Product: Readymade garments.
- 2011. SONA PLASTICS.** 565C Shanwar Peth, Pune 30. Tel. 445337. Partnership, 1977. Bank: United Western Bank Ltd. Cap. Rs.25,000. Prod Rs.35,000. Workers 5. Products: Plastic reprocessing and colouring.
- 2012. SONALKAR ENGINEERING.** 65 Hadapsar Industrial Estate, Pune 13. Tel. 7216, 7316. Partnership, 1961. Sister concerns: Unity Gauges and Tool Co., 101 Rasta Peth, Pune 11; Sonalkar Tools Works (P) Ltd. Harihar. Bank: Bank of Maharashtra. Cap. Rs. 2.5 lakhs. Prod. Rs. 6 lakhs. Workers 35. Products: Machine vices, gear pumps, revolving centres, dead centres, soft jaws, hydraulic dynamometers, gauges, precision components.
- 2013. SONAWANE BUFF MFG. WORKS.** 1667 Shukrawar Peth, Pune 2. Tel. 440681. Factory: 489 Ganesh Peth, Pune 2. Partnership, 1964. Bank: Bank of Baroda. Cap. Rs 25,000. Prod. Rs.2,00,000. Products: Cloth buff, sisal buff, leather cover wheel.
- 2014. SONIS AND CO.** 570 Rasta Peth, Near Daruwala Bridge, Pune 11. Proprietary, 1977. Bank: Bank of Maharashtra. Product: Agarbatti.
- 2015. SONNENFLEX ABRASIVES.** 706 (108) Sind Co-op. Housing Society, Pune 7. Tel. 54809. Factory: T-98, M.I.D.C., Bhosari, Pune 26. Tel. 82278. Partnership, 1974. Bank: Union Bank of India. Foreign collaboration: Sonnenflex Schleiprittwerte, West Germany. Cap. Rs.1,35,000. Prod. Rs 5,50,000. Workers 4. Export: Rs.15,000. Country: Thailand. Products: Resin-bonded grinding wheels, resin-bonded re-inforced depressed centre wheels, resin-bonded reinforced cut-off wheels, resinoid non-reinforced wheels.
- 2016. SONO-RIKA.** 501 Ghorpade Peth, Swargate Corner, Pune 2. Tel. 441120. Partnership, 1974. Bank: State Bank of India. Cap. Rs.50,000. Prod. Rs.1,50,000. Workers 6. Product: Readymade garments.
- 2017. SOUDAMINI ASSOCIATES.** 402 Shanwar Peth, Pune 30. Tel. 57236. Partnership, 1970. Bank: Bank of Maharashtra. Workers 7. Products: Precision industrial parts, corrugated paper boxes, bakelite and plastic moulding and plating
- 2018. SOUDAMINI INSTRUMENTS.** 17/1B/2 Kothrud, Pune 29. Tel. 56464. Cable:Relays. Partnership, 1963. Sister concerns: Soudamini Wiring Works; Soudamini Associates Bank: Bank of Maharashtra. Cap. Rs 4,00,000. Prod. Rs.7,50,000. Workers 45. Products: Electro-magnetic relays, pin hole tester, abrasion tester, elec. etching equipment, tacho generator, relay unit of electronic control, micro amps relays, electronic programmer, h.v. tester.
- 2019. SOUND ELECTRONICS.** 86/2 Erandawana, Pune 4. Tel. 55982. Proprietary, 1970. Bank: Bank of Maharashtra. Cap. Rs.55,000. Prod. Rs.2,10,000. Workers 7. Product: Power transformers.
- 2020. THE SOUTHERN MACHINE INDUSTRIES.** Gultekadi Rd., Pune 9. Tel. 441172, 441423. Cable: SOU-MACHINE. Partnership, 1948. Sister concern: Supanekar Machine Industries Pvt. Ltd. Bank: Bank of Maharashtra. Cap. Rs.1,00,000. Prod. Rs.10,00,000. Workers 50. Products: Industrial keys, cans, camshaft machinery.
- 2021. SPACE AGE PRECISION TOOLS PVT. LTD.** 13/1 Vishwajit Housing Society, Ganeshkhind, Pune 16. Tel. 56480. Cable: SPACEAGE. Telex: SPACEON PN-0145-354. Factory: T-96 Bhosari Industrial Estate, Bhosari, Pune 26. Tel. 82031, 83114. Estd. 1973. Bank: Syndicate Bank. Cap. Rs.6,85,000. Prod. Rs.11,25,000. Workers 50. Products: Belt conveyors, barge loaders, apron feeders, reciprocating conveyors, twinboom stacker reclaimers, screw conveyors bucket elevators, crushers (double roll, double toggle, etc.), screen—single, double, triple deck,

- 2022. SPACO CARBURETTORS (INDIA) LTD.** Post Box 13, Chinchwad, Pune 19. Tel. 84482, 82728, 82729. Cable: SPACOCAR-CHINCHWAD Telex: 0145-347 SPACO PN Estd 1970 Banks: United Commercial Bank; State Bank of India Foreign collaboration: Associated Industrial Development Holding S A, Switzerland. Cap. Rs 1,04,48,642 Prod. Rs.1,76,68,403. Workers 196 Export: Rs 57,833. Country Italy Products: Carburettors and parts thereof for scooters, mopeds, motor-cycles, three wheelers, etc
- 2023. SPAN ENTERPRISES.** 115 Harivansh, Sahakar Nagar No 2, Pune 9. Tel. 441113. Factory: 46/A-1 Sonawane Estate, Satara Rd, Pune 9. Tel 446678 Partnership, 1974. Bank: United Commercial Bank. Cap. Rs. 35,000. Prod. Rs 1,60,000. Workers 8 Products: Shell core blower machine for foundries, paper-testing equipments, sand coating plant for shell moulding sand.
- 2024. SPAR PLASTICS PVT. LTD.** T-184 Bhosari Industrial Estate, Nasik Rd., Pune 26. Tel 83326. Estd 1973. Bank: Bank of Maharashtra. Cap. Rs.2,06,000. Prod. Rs 2,20,000. Workers 12. Product: Patterns, dies (all types), fibreglass reinforced plastic mouldings, epoxy castings for high voltage insulation.
- 2025. SPARC.** S. No. 117-A, Vithalwadi Rd, Pune 30. Tel. 440068, 447164. Partnership, 1960. Bank: Bank of Maharashtra. Cap. Rs.14,00,000. Prod. Rs 25,00,000. Workers 150. Products: Parts for compressors, sugar machineries, centrifuges, driers, r.c.an washers, chemical plants and equipments.
- 2026. SPARK ENGINEERS.** Nirmal, 425/55 TMV Colony, Pune 9. Tel. 443182 Factory: Dadawadi Jain Mandir, Near Saras Baug, Pune 2. Tel. req. 441221. Proprietary, 1967. Banks: Bank of India; Bank of Maharashtra. Cap. Rs.25,000. Prod. Rs.1,00,000 Workers 5. Products: L.P. pressure switches, automobile engine plates, handles and levers for two-wheelers; job works—camshaft turning, hand and power pressing.
- 2027. SPARKLERS.** 1225/1 Shivajinagar, Fergusson College Rd, Pune 4. Tel. 55286. Proprietary, 1970. Br. Bhosari, 'S' Block M.I.D.C., Pune 26. Sister concern: Fabrica. Bank: Bank of Maharashtra. Cap. Rs.2,00,000. Prod. Rs.2,50,000. Workers 18. Products: Industrial painting (job work) of various electronics and electrical equipments, medical, optical, scientific instruments, and out-casting required by manufacturers.
- 2028. SPARKO ENGINEERING WORKS.** Sonawane Estate, 46/A-1 Pune-Satara Rd, Pune 9. Tel. 446847. Proprietary, 1973. Bank: Bank of India. Cap. Rs 80,000. Prod. Rs.1,00,000. Workers 15. Products: Steel fabricators and manufacturers of steel windows, grills, m.s. tanks, collapsible gates, sheet metal works, tubular structural works and heavy structural works.
- 2029. SPARKONIX (INDIA).** 1103, A-15, Shivajinagar, Pune 16. Tel. 441968. Cable: SPARKONIX. Factory: A-82, M I D C., 'H' Block, Pimpri, Pune 18. Tel. 83236. Partnership, 1968 Sister concern: Dr N R. Damle & Co, Pune 9. Bank: Bank of India. Cap. Rs.3,00,000. Prod. Rs 8,00,000 Workers 6. Products: Spark erosion and special purpose machines, geophysical special purpose machines—earth resistivity meters, electric loggers, etc.
- 2030. SPICA PLASTIC.** 99 Vithalwadi, Bombay 2. Cable SPICATAPES Factory 22/2 Hadapsar Industrial Estate, Pune 13. Tel. 7194. Cable: SPICATAPES. Telex: 0145-322 Partnership, 1965. Sister concerns: Leo Textiles, Jaitha and Sons Bank: Bank of India. Product: Narrow elastic tapes
- 2031. SPINDER STEEL SPRINGS MFG. CO.** 24/25 Somwar Peth, Pune 11. Tel. 26630. Partnership, 1975 Bank: State Bank of India. Cap. Rs 30,000 Prod. Rs. 1,20,000. Workers 8. Product: All kinds of springs.
- 2032. SPINN INDIA.** 867. Budhwar Peth, Sonya Maruti Chowk, Pune 2. Tel. 445346. Factory: W-37, Bhosari General Block, M.I.D.C., Bhosari, Pune 26. Partnership 1976. Bank: Dena Bank. Cap. Rs 2,50,000. Prod. Rs. 1,75,000. Workers 6. Products: Mechanical comparators, textile bearings.
- 2033. SPIRAX MARSHALL LTD.** Bombay-Pune Rd., Pimpri, Pune 18. Tel. 82691-2-3. Cable ELEKTRON Telex: 0145-265 PN. Estd. 1959. Sister concerns: J. N. Marshall Pvt. Ltd.; Cambridge Instruments (India) Ltd. Banks: Bank of India; Union Bank of India; Bank of India, Pimpri. Foreign collaboration: Spirax Sarco Ltd. Cheltenham, U.K. Cap. Rs 23,96,744. Prod. Rs 51,92,064. Workers 115. Export: Rs.3,81,159. Countries: Switzerland, Mauritius, Aden, Burma, Tanzania, England, Canada, Kuwait, Bangladesh, Ceylon, Malaysia, Iran. Products: Spirax thermostat steam trap, thermodynamic steam trap, open bucket trap, float trap, strainer, sight glass, system unit, air vent, air vent assembly, air eliminator, compressed air trap, ogden automatic pump, steam or air separator, temperature regulator with SB and NS type control

valves, flash condenser, DP reducing valve, relief valve, flash vessels, monnitors, air filters, regulators and lubricators.

2034. **SPRAY METAL (P) LTD.** Manjari Rd., Post: Manjari Farm, Pune 411 307. Tel. 7565, 7361. Cable: **SPRAYMETALS**. Telex : 0145-326. Proprietary, 1972. Sister concern: Shot Blasting and Metal Spraying (P) Ltd, Bombay. Bank: Bank of Maharashtra. Cap. Rs. 40,00,000. Prod. Rs.77,00,000. Workers 204. Export: Rs. 5,00,000. Countries: Abu Dhabi, Kuwait. Products: Shot blasting machines, sand blasting machines, airless spray painting machines, paper plants on turnkey basis; welding rotators, storage tanks, pressure vessels, spherical vessels, general fabrication job work.

2035. **SPRINGOWELL INDUSTRIES.** Flatted Type Bldg., F-2 Block, Unit No. A-21, M.I.D.C., Pimpri, Pune 18. Tel. C/o. 82766. Proprietary, 1974. Bank: Indian Bank. Cap. Rs.1,30,000. Prod. Rs.84,000. Workers 4. Product: Wire springs, transformer spare parts (breather) shaft keys, wood roof keys, machining, turning, milling, shaping-surface grinding, etc.

2036. **SQUARE DEAL ENTERPRISES.** Bhosari Industrial Area, Pune 26. Tel. 82760. Partnership, 1976. Bank: United Western Bank Ltd. Cap. Rs.20,000. Prod. Rs. 5,00,000. Products: Workshop machines, sheet metal machines, power presses, moulding presses, electric motors, machine tool accessories, bench and machine vises, air compressors, material handling equipments, heat treatment furnaces, etc.

2037. **SRIJAN CONTROL DRIVES.** 39/38 Erandawana, Kachare Wadi, Pune 4. Tel. 58272. Factory: 47-B Shivajinagar, Juna Tophkhana, Pune 5. Tel. 50863. Partnership, 1976. Bank: Bank of India. Cap. Rs.1,00,000. Prod. Rs. 68,000. Workers 2. Products: SRI-SYN A.C. synchronous motors, SRI-SYN D.C. stepping motors, stepping translators and indexers.

2038. **SRINIWAS ENGINEERS PVT. LTD.** 6 Pallavi Co-op. Housing Society, Pune 16. Tel. 55513. Factory: 81/82 Ganesh Baug, Mundhwa, Pune 36. Estd. 1978. Bank: Bank of Maharashtra. Cap. Rs.15,00,000. Prod. Rs. 20,00,000. Workers 30. Products: Gear pumps, hydraulic powder packs, precision engineering components.

2039. **STANDARD DYES AND INTERMEDIATES MFG. CO. A-1,** Krishi Society, Gokhale Nagar, Pune 16. Factory: Plot No. S-105, Bhosari Industrial Estate,

Pune 26. Partnership, 1975. Bank: Syndicate Bank. Cap. Rs.1,35,000. Prod. Rs.95,000. Workers 7. Products: Alkyl benzene sulphonate (acid slurry), synthetic detergents, (powder, liquid, cake), black disinfectant fluid.

2040. **STANDARD ENGINEERING CO.** 22/3 Hadapsar Industrial Estate, Pune 13. Tel. 7275. Partnership, 1961. Bank: State Bank of India. Cap. Rs.4,75,000. Prod. Rs. 6,00,000. Workers 25. Products: Parts for diesel engine, marine engines, generators, compressors of various types, reduction gear boxes, textile machinery and automobiles, bolts, studs, nuts, flanges, washers, pins, screws, etc.

2041. **STANDARD LEATHER WORKS.** 759 Deccan Gymkhana Corner, Pune 4. Proprietary, 1966. Sister concern: Satish Leather Works. Worker 1. Product: Repairing auto bags, seat covers.

2042. **STANDARD METALLURGICAL LABORATORY.** No. 4, Shops and Office Building, 'C' Block, M I. D.C., Pune 26. Tel. req. 83602. Partnership, 1977. Bank: State Bank of India. Cap. Rs 85,000. Workers 3. Products: Analysing of ferrous and non-ferrous metals, alloys, minerals and inorganic chemicals.

2043. **STANDARD METER MANUFACTURING CO.** S. No. 9 Hadapsar, Pune 28. Tel. 7505, 7699. Cable: **FAREMETER.** Partnership, 1971. Bank: Union Bank of India. Cap. Rs.1,50,000. Prod. Rs.20,00,000. Workers 58. Products: Faremeters for auto-rickshaws, taxis and tempos.

2044. **THE STANDARD PROCESSORS.** 170 Akurdi, Pune 35. Tel. 83487, 46686. Partnership, 1970. Sister concern: Arjunwadkar Associates, Plot A-21 'H' Block, Pimpri, M.I.D.C., Pune 18. Bank: The Cosmos Co-op. Urban Bank Ltd. Cap. Rs. 1,00,000. Prod. Rs.4,00,000. Workers 11. Products: Foundry chemical and fluxes.

2045. **STANDARD RUBBER LININGS PVT. LTD.** 4-A Chikalwadi, Bopodi, Pune 3. Factory: Chinchwad, Pune 19. Tel. 83384. Cable: 'LININGS' Pune 19. Estd. 1972. Banks: Bank of Maharashtra; Sharmrao Vithal Co-operative Bank Ltd, The United Western Bank Ltd. Cap. Rs.8,32,000. Prod. Rs.36,56,060. Workers 33. Products: Rubber lining of equipments for chemical industries viz. tanks reaction vessels, pipes, pumps, centrifuges, valves, etc.; special rubber parts required for assembly in the equipments rubberlined, solid rubber dock fenders.

2046. **STANDARD SPORTS AND STEEL INDUSTRIES.** No 4 Bahiroba Rd., Wanawadi, Pune 1. Tel.

26024. Partnership, 1969 Sister concern: Rovers (India), 273 M.G. Rd., Pune 1 [Bank: Bank of Maharashtra. Cap. Rs. 170,000 Prod Rs 3,00,000. Workers 3. Products: Gymnastics and sporting equipment, trampolines, weight training equipment.
2047. STAR ENTERPRISES. 1823 Sadashiv Peth, Deshmukhwadi, Deshpande Bungalow, Pune 30. Tel. 447810. Factory: Unit I—79 Ganjave Wadi, Pune 30 Unit II—232 Kachare Baug, Kothrud, Pune 29. Partnership, 1973. Bank: Bank of Maharashtra Cap Rs 24,000 Prod Rs 80,000. Workers 7 Product: Job work of brake lining equipments
2048. STAR RUBBER PRODUCTS. B/23 'H' Block, M.I.D.C., Pune 18 Tel. 82314 Partnership, 1975. Bank: United Western Bank Ltd. Cap. Rs 13,98,934 Prod. Rs 21,75,608. Workers 44. Products: Gumboots, boot rubber knee; surgeon, hunter and jungle boots, combat, m.c. sheet, rubberised fabric, cushion felt, moulded articles like disc, stud, stars, etc.
2049. STATFIELD EQUIPMENTS PVT. LTD. 132/B Ganeshkhund Rd., Pune 7. Tel. 57061. Cable STATFIELD. Factory. A-54-55, 'H' Block, M I D C, Pimpri, Pune 18. Tel. 82950 Estd 1973 Brs Bombay, Delhi, Calcutta, Madras, Bangalore Sister concerns. Miniature Electricals; Ansuya Udyog Bank: Bank of Maharashtra. Foreign collaboration Ernst Mueller, KG, F.R. Germany. Cap. Rs. 7,10,844. Workers 50. Products: Equipments and systems for electrostatic surface coating, manual and automatic spray guns, air assisted, airless, powder, disc, bell and the A.E.G. system; inter-connected equipment such as spray booths, ovens, conveyors, turnkey projects of new paint shops and the expansion/renovations of existing ones
2050. STEEL AND CO. 365 Shivajinagar, Pune 5. Tel. 55496. Partnership, 1964. Bank: Canara Bank. Cap. Rs. 1,20,000 Prod. Rs 85,000. Workers 7. Products: All types of fabrication (sheet metal) jobs.
2051. STEEL STRUCTURES. 19 Karve Rd., Pune 4. Tel. 57404. Partnership, 1975. Bank: Bank of Baroda. Cap. Rs. 2,08,465. Prod. Rs 6,87,086. Workers 24. Products: Structural steel work, water tanks, steel windows, grills, gates, doors, etc
2052. STEELMET INDUSTRIES. 327 Ghorpade Peth, Near Police Chowky, Pune 2. Tel. 442864. Proprietary, 1961. Bank: State Bank of India Cap. Rs 80,024. Prod. Rs 2,00,000. Workers 9. Products: Machine tool accessories (lathe), tailstock turret, carriage stoppers (micrometer and 5 position stoppers) laboratory shakers—light duty and heavy duty shaker.
2053. STEEL ARTS. Plot No. 6, 'S' Block, Bhosari Industrial Estate, Pune 26. Tel. 82700, 83578. Partnership, 1972. Sister concern: Amar Construction. Bank: Dena Bank. Cap. Rs 5,50,000. Workers 30. Products: Rolling shutters, steel window, industrial grilling, steel structures.
2054. STRONGFIELD ENGINEERS. 458/5 Sadashiv Peth, opp. Alka Talkies, Pune 30. Tel. req. 443864. Partnership, 1977. Bank: Vijaya Bank Ltd. Cap. Rs. 50,000. Workers 4. Products: Cylinder reboring machines, main line reboring machines, connecting rods reboring machines.
2055. SUBHASH PRINTING PRESS. 390 Shanwar Peth, Pune 30. Tel. 446002. Proprietary, 1969. Bank: Poona Merchants' Co-op Bank Cap Rs 37,000. Prod. Rs 50,000 Workers 8. Product Commercial printing.
2056. SUBHASH FABRICATORS. 23/3 Hadapsar Industrial Estate, Pune 13. Tel. 7231. Proprietary, 1968. Bank: Bank of Baroda Cap Rs 10,00,000. Prod Rs 9,00,000. Workers 40 Products Foundry equipment, material handling equipments, plants and ancillary machines for sugar, cement, dairy, chemical and refrigeration, air conditioning industries, turnkey assignments for erection and commissioning including the supply of various principle plant and equipments.
2057. SUBHAJAY ELECTRONICS AND METAL PROCESSORS PVT. LTD. B-22, H Block, M I D C. Estate, Pimpri, Pune 18. Tel. 82657, 82057, 83163. Cable: SUBHAJAY. Telex. 0145-340. Estd. 1970. Bank: The United Western Bank Ltd. Cap. Rs 16,62,500. Prod. Rs 21,28,600. Workers 135. Export Rs 54,452. Countries: Metronex, Poland. Products: Aluminium anodised components for electronic industry, electronic tuning indicators.
2058. SUBHASH TEXTILES. 1150 Bhawani Peth, Pune 2. Tel. 26625. Cable: KUNDAN SARI. Factory: 33/40 Gultekadi Industrial Estate, Pune 9. Tel. 442812. Proprietary, 1966. Bank: Bank of Maharashtra. Cap. Rs 24,000. Prod. Rs 1,20,000. Workers 8. Product: Cotton cloth.
2059. SUDHIR ENGINEERING WORKS. 749 Gurwar Peth, Pune 2. Proprietary, 1951. Cap. Rs 25,000. Prod. Rs. 15,000. Workers 3. Product: Job works—buffing, welding, lathe work and general repairing.

- 2060. SUBODH CHROME PLAST.** 75-A, M.I.D.C., Bhosari, Pune 26. Tel. 82185. Cable: TUSHAR. Partnership, 1969. Sister concern: D. Subodh & Co., 371 Raviwar Peth, Pune 2. Banks: Bank of Maharashtra; Bank of India. Cap. Rs.7,00,000. Prod. Rs.12,00,000. Workers 17. Export: Rs.6,00,000. Countries: Dubai, Bahrain, Nigeria, Zambia and Ghana. Products: Chrome plast modern bathroom fittings; industrial products such as automobile parts, fan, radio and T.V. parts.
- 2061. SUCHETA INDUSTRIES.** 2164 Sadashiv Peth, Vijayanagar Colony, Parvati Rd., Pune 30. Tel. 440869. Factories: (1) 691/A Bibwe Wadi, Pune 9; (2) 46 Sonawane Estate, Pune-Satara Rd., Pune 9. Tel. 449778, 441219. Proprietary, 1972. Sister concern: Deccan Engineering Co., Pune 30. Bank: Bank of India. Cap. Rs.1.7 lakhs. Prod. Rs.1.33 lakhs. Workers 18. Products: Hose couplings of different sizes, job work.
- 2062. SUDARSHAN CHEMICAL INDUSTRIES LTD.** 162 Dr. Ambedkar Rd., Pune 1. Tel. 27323. Cable: Rangundar, Telex: 0145/210 Rathi PN. Factory: 46, M.I.D.C. Industrial Area, Roha, Dist. Kulaba. Estd. 1951. Sister concerns: Marathwada Chemical Industries (P) Ltd., Sudarshan Textiles & Chemicals Ltd.; Rathi Engineering Works; Rathi Industrial Equipment Co. Ltd., Rathi Dye Chem Pvt. Ltd. Bank: Bank of Maharashtra. Foreign collaborations: Sericol Group Ltd., U.K.; Sanyo Colour Works Ltd., Japan; Allied Chemical Corporation, U.S.A. Cap. Rs. 624.87 lakhs. Prod. Rs.970.93 lakhs. Workers 700. Export: Rs.1,42,07,834. Countries: U.K., U.S.A., P.D.R., Australia, Denmark, Greece, Hong Kong, Malaysia, Philippines, Sri Lanka, Tanzania, Middle East, etc. Products: Organic and inorganic pigments and dyes intermediates, fluorescent pigment, pearl essences, 3:3 dichlorobenzidine dihydrochloride, beta naphthol, printext pastes, cosmetic colours, etc.
- 2063. SUDARSHAN ENGINEERS.** Housing Board 23/8, Saraswati Sadan, Pimpri Colony, Pune 17. Tel. 82194. Factory: B-11 H Block, M.I.D.C., Pimpri, Pune 18. Tel. 82709. Cable: 'SUDENG' Pimpri P.F. Partnership, 1970. Banks: Central Bank of India; Syndicate Bank. Cap. Rs.6,00,000. Prod. Rs.5,77,000. Workers 9. Products: Sugar machinery spares, centrifugal machine parts and accessories, automation of centrifugal machines, baggage carrier chains and spares, solenoid valves, pneumatic control two-way and three-way valves, import substitution for electrical equipments.
- 2064. SUDARSHAN GENERAL REPAIRING WORKS.** 857 Budhwar Peth, Laxmi Rd., Kedari Chowk, near State Bank of India, Pune 2. Factory: 563 (New) Guruwar Peth, Kasture Chowk, Pune 2. Tel. 446885. Proprietary 1942. Bank: State Bank of India. Cap. Rs.1,19,000. Prod. Rs.1,00,000. Workers 4. Products: Sprayers (spray pumps) such as sturup pumps, hand compression sprayers, foot sprayers and rocking sprayers; Sudarshan automatic bread slicer.
- 2065. SUDARSHAN RUBBER WORKS.** 184/13 Shaniwar Peth, Pune 30. Tel. 56408. Factory. Plot No. 83, M.I.D.C., Bhosari, Pune 26. Tel. 83440. Partnership, 1964. Banks: Bank of Maharashtra; Shree Suvarna Sahakari Bank Ltd. Cap. Rs.2,00,000. Prod. Rs.1,50,000. Workers 15. Products: Grommets, origins for scooters, solid rubber tyres, rubber seats, gaskets for electronic parts, bonded rubber articles.
- 2066. SUDARSHAN STATIONERY MART.** 1482 Shukrawar Peth, Pune 2. Tel. 443081. Factory: 1710 Sadashiv Peth, Pune 30. Tel. 440138. Partnership, 1952. Bank: Bank of Maharashtra. Cap. Rs.4,32,000. Prod. Rs.20,88,000. Workers 30. Products: Exercise books, note books, registers, foolscap books, account books, writing pads, duplicate and triplicate books, examination papers, office files.
- 2067. SUDARSHAN TEXTILES AND CHEMICALS LTD.** 27 Shankarshet Rd., Pune 9. Tel. 440585, 441036, 446233. Cable: 'LOVEJOY' Pune. Telex: 0145-210 Rathi. Estd. 1968. Sister concerns: Sudarshan Chemical Industries Ltd.; Rathi Engineering Works. Bank: Bank of Maharashtra. Cap. Rs.3,65,300. Prod. Rs.48,00,000. Workers 125. Products: Sodium bichromate, sodium chromate, potassium-biochromate, sodium sulphate.
- 2068. SUDARSHAN THREAD CO.** 780 Budhwar Peth, Pune 2. Proprietary, 1955. Bank: The Sangli Bank. Cap. Rs.10,000. Prod. Rs.50,000. Product: Sewing thread.
- 2069. SUDEP PRECISION.** No. 2, M.I.D.C. Flatted Bldg., Block 'C', Chinchwad, Pune 19. Proprietary, 1974. Bank: Bank of Maharashtra. Cap. Rs.60,000. Prod. Rs.50,000. Workers 8. Product: Job work.
- 2070. SUDHA FURNITURES.** 686 Kasba Peth, Pune 11. Partnership, 1965. Bank: Bank of Maharashtra. Cap. Rs.30,000. Prod. Rs.40,000. Products: Steel furniture, fabrication.
- 2071. SUDHEER TEXTILES.** 14 Hadapsar Industrial Estate, Pune 13. Tel. 7288, 7425, 7497. Proprietary, 1967. Br. Saswad, Dist. Pune. Products: Cotton textiles, dhotis, voiles, mulmul, etc.

2072. **SUDHAKAR TOYS WORKS.** 705 Kasba Peth, Pune 11. Proprietary, 1964. Bank: State Bank of India. Cap. Rs. 10,000. Prod. Rs 20,000 Workers 3. Products: Wooden toys, carom boards.
2073. **SUDHIR ENGINEERING WORKS.** 1340 Shukrawar Peth, Pune 2. Proprietary, 1975. Bank: Muslim Bank Cap. Rs.50,000. Workers 4. Products: Spare parts of stove, job works.
2074. **SUGANDHI HARIDAS MADHAVDAS.** 451 Raviwar Peth, Pune 2. Tel 448022. Cable: Yellow Rose Factory: 467 Raviwar Peth, Pune 2. Partnership, 1860. Bank. Indian Overseas Bank. Cap. Rs.2,00,000. Prod. Rs 11,00,000. Workers 30. Export: Rs 9,00,000 Countries: U S A., U K., Germany, Switzerland, France. Products: Agarbatti and perfumery compounds
2075. **SUJATA ELECTRONICS CORPORATION.** 427/A-2 Gultekadi Industrial Estate, Pune 9. Tel C/o. 446100. Proprietary, 1977. Bank. Bank of Maharashtra. Cap. Rs.32,000. Prod. Rs.22,000. Workers 2 Product: All types of transformers.
2076. **SUJATA SOAP WORKS.** 856 Kasba Peth, Pune 11. Proprietary, 1973. Cap Rs 20,000. Prod Rs 50,000 Workers 2. Products: Washing soaps, cakes and choora.
2077. **SUJATA TEXTILES.** 14 Hadapsar Industrial Estate, Pune 13. Tel 7288, 7425, 7497. Proprietary, 1971. Products: Cotton fabrics, dhotis, mulmuls, vodes, etc.
2078. **SUJANIL CHEMO INDUSTRIES.** 434/8 Kamfnath Bhawan, Salisbury Park, Pune 1. Tel. 445525, 445747, 449788. Factory: Ganesh Nagar, Chinchwad, Pune 33. Tel. 82177. Partnership, 1967. Bank: Dena Bank Products: Agricultural industrial and household insecticides and pesticides.
2079. **SUKRUT UDYOG.** 9/1A Erandawana, Pune 4. Tel. 55914, 58828. Cable: SUKRUT. Partnership, 1967 Bank: Bank of Maharashtra. Cap. Rs.1,85,000. Prod. Rs.10,00,000. Workers 27 Export: Rs.10,000 Countries: Sri Lanka, Mauritius Products: Sukrut single phasing preventors, Sukrut magnetic oil level indicator, float switch, Sukrut liquid controller, Sukrut magnetic flow indicator; automatic control panel for fire fighting pump-set; solid state linear servo amplifier.
2080. **SULABHA MUDRANALAYA.** 291 Shanwar Peth, Pune 30. Tel. 55037. Proprietary, 1963. Bank: Bank of Maharashtra. Workers 10. Product: Commercial printing.
2081. **SULECTRONS.** 507 Narayan Peth, Pune 30. Proprietary, 1976. Bank: United Commercial Bank Cap Rs.10,000. Prod. Rs 30,000. Products: All types of standard thermocouples, special type of thermocouples and platinum resistance bulb, non-indicating and indicating temperature controllers, timers, custom built instruments, temperature indicator.
2082. **SULEKHA PRINTERS.** 759/94 Prabhat Road, Pune 4. Tel. 56268. Partnership, 1970. Bank: Indian Bank. Cap. Rs. 70,000. Prod. Rs 1,71,000. Workers 6. Product. Commercial printing.
2083. **SULSHANK APPLIANCES (PVT) LTD.** A-104 M.I.D.C. 'H' Block, Pimpri, Pune 18. Tel. 83638. Estd. 1971. Bank: State Bank of India. Cap. Rs.1,50,000. Workers 4. Products: Sheet folding machines, gas indicator, other fabrication of special purpose machines.
2084. **SUMA SOPHISTICATED INDUSTRIAL EQUIPMENT.** C/o. Impression Engineer, 834 Sadashiv Peth, Pune. Tel. 443437. Partnership, 1976. Sister concern: Impression Engineers, M.I.D.C. H Block, Pune. Cap. Rs. 25,000. Workers 3. Products: Die manufacturing, plastic moulding dies, other toolroom engineering work.
2085. **SUMMIT PRECISION ENGINEERING WORKS.** Plot No. A 24, H Block, M.I.D.C. Pimpri, Pune 18. Partnership, 1969. Bank: Bank of Maharashtra. Cap Rs.1,25,000. Prod. Rs.18,000. Workers 4. Products: Manufacture of precision gauges, machining of machine parts, fabrication of structural work fixture, tools and special purpose devices.
2086. **SUN AUTOMOBILE CO.** 2425 East Street, Pune 1. Tel. 22761. Partnership, 1948. Sister concerns: Standard Automobiles; Super Automobiles Bank: Bank of India. Workers 6. Product: Automobile repairs.
2087. **SUNAKO ENTERPRISES.** C-11 Devankush, 64/C Ashwini Society, Wakadewadi, Pune 5. Tel. 56257, 55418. Factory: 102, 'S' Block, Bhosari Industrial Area, Pune 26. Tel. 83261. Cable: SUNAKO Bhosari. Proprietary, 1975. Sister concerns: Sunako Enterprises (Chemicals Sales Division); Monachem Industries. Bank: Bank of Maharashtra. Cap. Rs.4,00,000. Workers 14. Products: Aero-matics chemicals—yara-yara, coumarin, hydroxy; Engineering Division—job work.
2088. **SUNDEEP BULB INDUSTRIES.** 471 More Ali, Bhor, Dist. Pune. Tel. 73. Cable: SUDNEEP LAMP.

- Proprietary, 1971. Bank: State Bank of India; Bank of Maharashtra. Cap. Rs.60,000. Prod. Rs.20,000. Workers 9. Products: Miniature and auto lamps, torch and flashlight lamps, cycle dynamo lamps, decoration lamps, radio dial lamps, night lamps.
2089. SUNDOWNERS. 34/13 Erandawana, Ganesh Nagar Rd., off Karve Rd., Pune 4. Tel. 56271. Proprietary, 1972. Bank: Bank of India. Cap. Rs 2,00,000. Prod. Rs. 5,00,000. Workers 25. Products: Pressed parts, sheet metal components, engineering fabrication, die punches, grooved pins, etc.
2090. SUNDOWN FABRICS. 35 Erandawana, Pune 4. Tel. 56135. Partnership, 1964. Bank: Bank of India. Cap. Rs. 20,000. Prod. Rs.60,000. Workers 5. Product: Fabrics.
2091. SUN METAL INDUSTRY. 307 Guruwar Peth, Pune 2. Tel. 445085. Partnership, 1966. Workers 12. Products: Aluminium canisters of various sizes and specifications, brass ornaments, etc.
2092. SUNIL ENGINEERING WORKS. 830 Bhawani Peth, Pune 2. Tel. 27965. Partnership, 1969. Banks: Janseva Bank; Rupee Bank; Vijaya Bank. Cap. Rs.1,50,000. Prod. Rs.1,50,000. Workers 12. Product: Building material.
2093. SUNIL ENGINEERING WORKS. 228/29 Mangalwar Peth, Pune 11. Tel. 28154. Partnership, 1970. Bank: Cosmos Bank. Cap. Rs.50,000. Prod. Rs.1,50,000. Workers 5. Product: Job work.
2094. SUNIL INDUSTRIES. 691 Raviwar Peth, Pune 2. Tel. 449175. Proprietary, 1970. Bank: Central Bank of India. Cap. Rs.1,00,000. Prod. Rs.2,50,000. Workers 12. Products: Stainless steel dairy fittings, flow diversion valve for dairy, refrigeration compressor parts, pneumatic compressure parts.
2095. SUNITA RULERS AND BINDERS. 123 Ganesh Peth, Pune 2. Proprietary, 1969. Bank: Bank of Maharashtra. Cap. Rs.5,050. Prod. Rs 8,050. Product: All kinds of paper ruling.
2096. SUNJEEV MUDRANALAYA. 469 Sadashiv Peth, Pune 30. Tel. 445082. Proprietary, 1962. Bank: Syndicate Bank. Cap. Rs 80,000. Prod. Rs 90,000. Workers 8. Product: Commercial printing.
2097. SUNRISE PAPER BOX SYNDICATE. 708 (New) Guruwar Peth, Pune 2. Partnership, 1976. Bank: Bank of Maharashtra. Cap. Rs.15,000. Prod. Rs.24,000. Products: Grey board, straw board, cardboard, corrugated boxes hardware and engineering materials
2098. SUPADMA DRESSES. 340 Ganj Peth, Pune 2. Proprietary, 1971. Bank: Poona Merchants' Co-op. Bank Ltd. Cap. Rs.20,000. Prod. Rs 35,000. Workers 4. Product: Readymade garments.
2099. SUPANEKAR MACHINE INDUSTRIES (PVT.) LTD. Gultekadi Rd., Swargate, Pune 9. Tel. 441172, 441423. Estd. 1972. Sister concern: The Southern Machine Industries. Bank: Bank of Maharashtra. Export: Rs. 6,00,000. Country: Sri Lanka. Products: Paper machinery, electromagnetic chucks and defence equipments.
2100. SUPER BRIGHT MANUFACTURING CO. 227 Nana Peth, Pune 2. Tel. 24715, 27960. Factory: Plot No. A-101, 'H' Block, M.I.D.C., Pimpri, Pune 18. Tel. 82115. Proprietary, 1975. Sister concern: Tool Crib, Print Well, Medi-centre. Bank: Canara Bank. Cap. Rs 2,50,000. Prod. Rs 1,50,000. Workers 8. Products: Bright steel bars of alloy steels, open forgings, etc
2101. SUPER CAN MANUFACTURERS AND REPAIRERS PVT. LTD. K-220 Adinath Society Ltd., Pune-Satara Rd., Pune 9. Tel. 443339. Factory: 93/1-B Manjari Road, Dist. Pune Tel. 7575 Estd. 1976. Bank: Dena Bank. Cap. Rs 5,00,000. Prod. Rs 18,00,000. Workers 24. Products: Designers, fabrication engineers, dairy machinery equipments, chemical containers and drums, barrels.
2102. SUPER DRY CLEANERS. 'Super House' 408/9A, Gultekadi, Swargate, Pune 9. Tel. 442540. Partnership, 1957. Brs. Seven branches in Pune. Bank: Bank of Maharashtra. Cap. Rs.6,33,000. Prod. Rs 10,28,000. Workers 95. Product: Dry cleaning.
2103. SUPER ENGINEERS. 23/3 Hadapsar Industrial Estate, Pune 13. Tel. 7493. Partnership, 1963. Bank: Bank of Maharashtra. Cap. Rs.1,00,000 Workers 10. Product: Job work.
2104. SUPER GAS APPLIANCES. 1169 Budhwar Peth, Shanpar-Mandai Rd., Pune 2. Tel. 470880. Partnership, 1978. Sister concern: Lahoti Excelman (India). Banks: Bank of Baroda, Mahesh Sahakari Bank Ltd. Cap. Rs 2,00,000. Prod. Rs 6,00,000. Workers 5. Product: Distributors for L.P. Gas appliances like instant lighting gas lamps, portable gas stoves, standby cylinders, room heaters, blow lamps, gas candles, cigarette and domestic gas lighters.

- 2105. SUPERB PRODUCTS.** 2163/26 Sane Guruji Marg, Pune 30. Tel. 446004. Partnership, 1968. Bank: Central Bank of India. Cap. Rs.1,50,000 Prod. Rs 3,75,000. Workers 8. Products: Soldering equipments, low-voltage soldering irons, solder bars, deep solder machines, automatic wave soldering machine under development, all types of transformers and control panels
- 2106. SUPRAHI PATTERN WORKS.** 46 Sonawane Estate, Pune-Satara Rd., Pune 9. Tel. 446214 Proprietary, 1972. Bank: Bank of Maharashtra. Cap. Rs 30,000. Prod. Rs.2,14,000. Workers 9. Products: Wooden, metal and shell moulding patterns
- 2107. SUPRANIL CHEMICAL INDUSTRIES.** 70 Hadapsar Industrial Estate, Bujlee Compound, Pune 13. Tel. 7641. Partnership, 1976. Bank: United Commercial Bank. Cap. Rs.2,00,000 Prod. Rs 1,50,000. Workers 13. Products: Phenyl acetic acid, benzyl cyanide, benzyl chloride, perfumery chemicals—ethyl phenyl acetate, propyl phenyl acetate, benzyl benzoate, benzyl acetate, benzyl alcohol, etc.
- 2108. SUPREME INDUSTRIES.** Plot No. 102 Bhoosar Industrial Estate, Century Enka to Telco Rd, Pune 26. Tel. 83565. Partnership, 1967. Bank: Bank of India. Cap. Rs 4,00,000. Prod Rs.3,50,000 Workers 2 Product: Pressure switches.
- 2109. SUPER RUBBER WORKS.** Kharadwadi, Pune 18. Tel. 82252. Partnership, 1973. Bank: Bank of India. Cap. Rs.50,000. Prod. Rs.3,00,000. Workers 8. Products: Rubber and plastic goods.
- 2110. SUPREME METALLIC INDUSTRIES.** 908 Budhwar Peth, Pune 2. Tel. 445460. Cable: SUMIL. Factory: 21/4 Somwar Peth, Pune 11. Tel. 24327 Partnership, 1969. Bank: Punjab National Bank. Cap. Rs. 90,000. Prod. Rs 1,50,000 Workers 7. Products: Castor wheels, steel furniture, sheet metal work, light fabrication work.
- 2111. SUPREME CHEMICALS.** 1684 Shukrawar Peth, Pune 2. Tel. 22450. Cable: SUMIL. Factory: 21/4 Somwar Peth, Pune 11. Tel. 24327. Proprietary, 1969. Bank: Union Bank of India. Cap. Rs 1,92,867. Prod. Rs.75,509. Workers 4. Products: Soap hard, soft and liquid, detergent liquid and powder, Deokem white cleaning fluid, Visa cleaning powder, french polish varnish, thinner, turpentine, Visa cleaning solution (hydrochloride acid).
- 2112. SURANJANA INDUSTRIES.** Plot No. 36, Poon^a Small Scale Industries Co-op. Society Ltd., Gultekadi, Pune 9. Tel. 442171. Partnership, 1967. Banks: State Bank of India, Bank of Maharashtra. Cap. Rs.1,00,000. Prod. Rs.5,80,000. Workers 26. Products: Cast iron manhole cover and c.i. sanitary fittings.
- 2113. SURAY DRESSES.** 1450 Kasba Peth, near Gaokos Maruti, Pune 11. Partnership, 1972. Bank: Bank of India. Cap. Rs 25,000. Prod Rs 1,82,000 Product: Readymade garments.
- 2114. SURYAKIRAN WORKS.** 143 (Old) Narayan Peth, Kelkar Rd., Pune 30. Tel. 444373. Proprietary, 1964. Bank: The Sangli Bank Ltd. Cap. Rs.10,000. Prod. Rs. 1,50,000. Workers 4. Products: Seal Grip Brand black insulation tape with polythelene, black insulation cotton tape, p.v.c. self-adhesive.
- 2115. SUREKH MUDRAN.** Office: 2040 Sadashiv Peth, Pune 30. Tel. 442229. Factory: 46/2 Parvati, Kaka Halwai Industrial Estate, Pune-Satara Rd., Pune 9. Proprietary, 1976. Br. Pragati jMudranalaya, 108-A Parvati Village, Pune 9. Bank: United Commercial Bank. Workers 20. Products: Commercial printing, binding
- 2116. SUREKH MUDRANALAYA.** 1525 Sadashiv Peth, Near R.S.M. High School, Pune 30. Proprietary, 1969. Bank: The Poona Merchants Co-op. Bank Ltd. Cap. Rs.20,000. Prod. Rs 18,000. Workers 3. Product: Commercial printing.
- 2117. SUREKHA FABRICATORS.** 32/641 Karve Rd., Pune 4. Office: 1264 Sadashiv Peth, Pune 30. Proprietary, 1968. Bank: Bank of Maharashtra. Cap. Rs 22,000. Prod. Rs 36,000. Workers 6. Products: Mixers for glass and ceramic industry, magnetic separators and general fabrication.
- 2118. SURENDRA TRADERS.** 374 Budhwar Peth, Pune 2. Tel 447371. Partnership, 1970. Bank: State Bank of India. Cap. Rs.50,000. Prod. Rs.2,50,000. Workers 8. Product: Readymade garments.
- 2119. SURESH INDUSTRIES.** 20/6 Hadapsar Industrial Estate, Pune 13. Tel. 7278 and 7578. Cable: INDOTOOL. Proprietary, 1972. Brs. Indo Machine Tools, Bombay; Pune Maharashtra Machine Tools; Maharashtra Industrial traders, Pune. Bank: Bank of Maharashtra. Cap. Rs. 6,60,000. Prod. Rs.7,50,000. Workers 11. Products: Welding transformers, air cooled; hacksaw machines, special purpose machinery.

- 2120. SURESH METAL WORKS.** 603 Ghorpade Peth, Pune 2. Proprietary, 1976. Bank: Canara Bank. Cap. Rs.13,000. Prod. Rs.7,000. Workers 2. Product: Cornel machine of tin.
- 2121. SURESH MUDRANALAYA.** 635 Sadashiv Peth, Abhyankar Wada, opp. Sweet Home, Pune 30. Br. 457 Sadashiv Peth, Tilak Rd., opp. Alka Talkies, Pune 30. Proprietary, 1977. Bank: United Western Bank Ltd. Cap. Rs.20,000. Prod. Rs.40,000. Workers 6. Product: Commercial printing.
- 2122. SURESH MOHANLAL GANDHI.** 536 Central St. Camp, Pune 1. Tel. 23820. Proprietary, 1925. Cap. Rs.40,000. Prod. Rs.35,000. Workers 8. Products: Bonolip, dhanvantari powder, ayurvedic products.
- 2123. SURESH PRESS WORKS.** Plot No. 50, D-III Block, M.I.D.C., Pimpri Industrial Area, Akurdi, Pune 29. Tel. 83694. Proprietary, 1970. Sister concern: Suresh Press Metal Works, Kalas. Bank: Bank of Maharashtra. Cap. Rs.1,70,000. Prod. Rs.4,00,000. Workers 15. Products: Copper gasket, washers, press parts and sheet metal parts.
- 2124. SURESH RULING AND BINDING WORKS.** 383 Shanwar Peth, Pune 30. Tel. 447096. Proprietary, 1972. Bank: Vidya Sahakari Bank. Cap. Rs.25,000. Products: Note book, ruling, ledger, accounts, binding, papers, etc.
- 2125. SURESH TEXTILES.** 14 Hadapsar Industrial Estate, Pune 13. Tel. 7507, 7497. Proprietary, 1973. Sister concern: At & Post Velu, Tal. Bhor, Dist. Pune. Product: Cotton textiles.
- 2126. SURYAVANSHI P. K.** 2431 East Street, Camp Pune 1. Tel. 27820. Partnership. Banks: Bank of Maharashtra; State Bank of India. Cap. Rs.50,000. Prod. Rs.2,00,000. Workers 2. Product: General repairing, job work.
- 2127. SUSHEEL INDUSTRIES.** 484/93 Mitra Mandal Colony, Pune 9. Tel. 440342. Factory: 1089 Shukrawar Peth, Shivaji Rd., Pune 2. Tel. req. 442633. Partnership, 1975. Bank: Central Bank of India. Cap. Rs.1,75,000. Prod. Rs.2,80,000. Workers 8. Products: Hose couplings, hydraulic pressure pipes, N.P.T. threaded jobs and other SAE standard jobs.
- 2128. SUSHIL BALWANT MUDRANALAYA.** 34 Parvati Industrial Estate, Pune 9. Tel. 443987. Proprietary, 1967. Bank: Bank of Maharashtra. Cap. Rs.30,000. Prod. Rs.70,000. Workers 12. Product: Commercial printing.
- 2129. SUVARNA PATTERN AND ENGINEERING WORKS.** 308 Shuvajinagar, Pune 5. Tel. C/o. 445470. Proprietary, 1971. Bank: Bank of Maharashtra. Products: Metal and wood patterns.
- 2130. SUVARNA TEXTILE.** 14 Hadapsar Industrial Estate, Pune 13. Tel. 7288, 7425; 7497. Proprietary, 1971. Products: Cotton fabrics, voiles, dhotis, mulmul, etc.
- 2131. SUYOG INDUSTRIES.** 847 Sadashiv Peth, Pune 30. Partnership, 1969. Bank: Rupee Co-operative Bank Ltd. Cap. Rs.8,000. Prod. Rs.8,200. Worker 1. Products: Mechanical components for gear boxes, repairs to fractional h.p. motors.
- 2132. SUYOG PRINTERS** 861/1 Sadashiv Peth, behind Training College, Pune 30. Proprietary, 1973. Bank: Mahesh Sahakari Bank Ltd. Cap. Rs.75,000. Prod. Rs.1,25,000. Workers 6. Product: Commercial printing.
- 2133. SWAMINATHAN AND SONS.** 482 M.G. Rd, Khadki, Pune 3. Partnership, 1961. Bank: Bank of Maharashtra. Cap. Rs.50,000. Prod. Rs.57,000. Workers 6. Products: All kinds of precision, turning and job work.
- 2134. SWAN RUBBER CHEMICALS PVT. LTD.** Girijatmak Co-op. Housing Society, Flat No. 1, 3/11 Erandawana, Pune 4. Factory: 385 Narayan Peth, Pune 30. Tel. 447243. Estd. 1975. Banks: Bank of Maharashtra; Sampada Sahakari Bank. Cap. Rs.32,000. Prod. Rs.40,000. Product: Rubber blowing agent.
- 2135. SWANAND MUDRANALAYA.** 203 Shanwar Peth, Pune 30. Tel. 58074. Partnership, 1963. Banks: Rupee Co-op. Bank; Cosmos Co-operative Bank. Cap. Rs.1,50,000. Prod. Rs.1,50,000. Workers 12. Product: Commercial printing.
- 2136. SWAPNA FABRICATORS.** 1358 Sadashiv Peth, Pune 30. Proprietary, 1970. Bank: Central Bank of India. Cap. Rs.20,000. Prod. Rs.1,50,000. Workers 7. Products: Cummins and diesel engine components, parts.
- 2137. SWAROOP MUDRAN.** 687 Narayan Peth, Pune 30. Tel. 447204. Partnership, 1971. Sister concern: Studio Salkar. Pune. Banks: Bank of Maharashtra; Shri Suvarna Sahakari Bank Ltd. Cap. Rs.1,00,000. Prod. Rs.2,50,000. Product: Colour printing.

- 2138. SWASTIK AUTO ELEC. WORKS.** 408/6 Gultekadi Rd., Pune 9. Tel. 441607 Partnership, 1967. Bank: The Poona Merchants' Co-op Bank Ltd. Cap. Rs 25,000 Prod. Rs.10,000. Workers 3 Product Repairing work.
- 2139. SWASTIK ENGINEERS.** Plot No. 5, Kaka Halwai Estate, Swargate, Pune 9. Tel. 443232. Cable: CRANKHOUSE Proprietary, 1968. Sister concerns: Swastik Engineering, Sangli; Crankwel, Pune 9. Banks Bank of Maharashtra Central Bank of India. Cap. Rs 2,50,000 Prod. Rs 10,00,000. Workers 25. Products. Crankshafts for International Tractors, reclamation of any types of crankshafts, generating sets crankshafts, air compressor crankshafts, diesel loco crankshafts and any other rotating parts by submerging and re-building with hardness, and many other rebuilding jobs.
- 2140. SWASTIK FUEL INJECTION SERVICE.** Pune-Satara Rd., near Dena Bank, Lalwai Estate, Pune 9. Proprietary, 1976 Bank Shri Adinath Sahakar Bank Ltd. Cap. Rs 50,000. Prod. Rs 24,000 Worker 1 Product: Job works of vehicular, industrial and agricultural diesel fuel injection pumps and nozzles.
- 2141. SWASTIK INDUSTRIES.** Swastik House, 39 Gultekadi, Pune 9. Tel. 446599, 447599/448599. Cable: PATELGROUP. Telex: 0145-333 MCCI. Factory: MIDC Block D-III, Plot No. 46 to 49 Chinchwad, behind Dr. Mehta Hospital, Pune 19. Tel. 82982, 83368. Proprietary, 1975 Sister concerns Poonam Tiles, Patel Asbestos Cement Industries. Bank. The Sangli Bank Ltd. Cap. Rs 12,00,000. Prod. Rs 25,00,000. Workers 40. Products: Asbestos cement (A C) pressure pipes, mosaic and plain cement flooring tiles, cement product.
- 2142. SWASTIK LABORATORY AND INDUSTRIAL CHEMICALS PVT. LTD.** 217 Sadashiv Peth, Pune 30 Tel 441140. Cable: LABCHEM Factory: 29 Hadapsar Industrial Estate, Pune 13 Tel 7175 Estd. 1962. Banks: The United Western Bank Ltd., Bank of Maharashtra, Shree Suvarna Sahakar Bank Ltd Cap Rs. 11,69,000. Prod Rs 8,50,000. Workers 51 Products: Amyl alcohol, nickel carbonate, nickel oxide, cobalt oxide, copper oxide, cadmium sulfide orange, calcium oxalate, strontium oxalate, barium nitrate, lead nitrate, triacetate, amyl acetate, methyl acetate, methyl iodide, dimethyl glyoxime, diethyl oxalate.
- 2143. SWASTIK MUDRANALAYA.** 439 Shanwar Peth, Pune 30. Tel. 55797. Factory: 446 A/2 Shanwar Peth, Pune 30. Proprietary, 1948. Bank: Bank of Maharashtra. Cap. Rs. 2,00,000. Prod. Rs.1,70,000. Workers 20 Product: Commercial printing.
- 2144. SWASTIK PLASTIC PRODUCTS.** 513 Shanwar Peth, Pune 30 Tel. 57704 Cable: PLASTICS. Proprietary, 1948. Bank: State Bank of India Cap Rs 6,00,000. Prod Rs 4,20,000 Workers 38 Products: Medical electrical/ electronic and industrial and defence plastic components
- 2145. SWASTIK RUBBER PRODUCTS LTD.** Swastik House, behind Khadki Railway Station, Pune 3. Tel. 55201-5. Cable: SWASTIRUB. Estd. 1947. Br. Chinchwad, Pune 19. Sister concern Shree Products Ltd., Pimpri, Pune 18. Banks: Bank of Maharashtra; State Bank of India, Canara Bank; Bank of India, Syndicate Bank, Sangli Bank, The United Western Bank. Foreign collaboration: U.S.A., U.K. Prod Rs 6 crores 20 lakhs Workers 2173. Products: All types of tool wear rubber PVC canvas, hoses, latex gloves, refracting bags, rubber band, gum boots, jungle boots, minor boots, combat boots, oil seals, auto parts, moulded goods, latex tubing, water proof fabric, life jackets, life rafts, race boats, water tank, gemini craft, oil mattress, c. nuts, erasers, teflon articles, plastic moulded goods, PVC boots, rubber lining, rubber sheets, MC sheets, crash helmets, protecto helmets
- 2146. SWATEE SHRICHAND BATHIJA.** 867 Budhwar Peth, Sonya Maruti Chowk, Pune 2 Tel. 445346 Factory: W-37, Bhosari General Block, MIDC, Bhosari, Pune 26 Partnership, 1976. Bank: Dena Bank Cap. Rs 2,00,000. Prod. Rs.1,50,000. Workers 6. Products. Mechanical components and other instruments for checking the bearings, needle roller bearing
- 2147. SWATI TEXTILE.** 81/82 Ganesh Bag, Mundhwa, Pune 36. Proprietary, 1973 Sister concern Ashok Textiles; Ajit Textiles. Bank: Central Bank of India Cap. Rs. 30,000. Prod. Rs 1,00,000. Workers 3 Products: Mulmul, cambric cloth and cotton fabrics.
- 2148. SWATI ICE FACTORY.** P.O. Shahapur, Dist. Thana. Factory: 433/2 Pune-Nasik Rd., Kasarwadi, Pune 18. Tel. 82119. Partnership, 1971. Bank: Bank of Maharashtra. Cap. Rs.65,186. Prod. Rs 1,26,452. Workers 7. Product: Ice.
- 2149. SWISS WATCH HOUSE AND OPTICIANS.** 298 M.G Rd., Pune 1. Partnership, 1930. Bank: Dena Bank. Products: Opticians and watch makers, work of lences, eagraving work.

2150 SWITCHGEAR CORPORATION. 2-A/7/2 Bhau Patil Rd., Khadki, Pune 3. Tel. 50136. Partnership, 1961. Bank: Bank of Maharashtra. Prod. Rs 2,58,000. Workers 75. Product: Assembling, household electrical wiring, accessories.

2151. SYMTRONICS. Plot S-1, Electronics Zone, Bhosari Industrial Area, Bhosari, Pune 26. Tel. 82716. Partnership, 1969. Subsidiary companies: Symtronics; Sales. Bank: Bank of Maharashtra. Cap. Rs 5,00,000. Prod. Rs.10,00,000. Workers 13. Products: Industrial electronic controls.

2152. SYNCHROPAN ELECTRONICS PVT. LTD. 314 Narayan Peth, Kale Bldg., 1st floor, Vjay Cinema Lane, Pune 30. Tel. 448778, 53563. Estd. 1969. Bank: Bank of Maharashtra. Cap. Rs.1,10,000. Workers 9. Products: Insulation testers, earth testers, cabin indicators, high voltage breakdown tester, voltage stabilizers, power packs, non-conductive liquid level controllers, sound and indication systems.

2153. SYNTHETIC DYESTUFF INDUSTRIES. 52/13 Hadapsar Industrial Estate, Pune 13. Tel. 7242. Cable: SCARLET. Partnership, 1962. Bank: Bank of Maharashtra. Prod. Rs. 20,00,000. Workers 20. Export countries: Bangladesh, Pakistan, France. Products: Dyestuffs, fast garnet GBC base, fast scarlet g. base, fast scarlet (RC) base.

2154. SYSTECH INTERNATIONAL. Bombay Mutual Chambers, Hamam St., Bombay 400 023. Tel. 270065. Cable: CLINCHER. Factory: 61/16 Erandawana, Income Tax Lane, Pune 4. Tel. 54509. Partnership, 1972. Bank: Bank of Baroda. Cap. Rs.1,06,708. Prod. Rs.6,00,000. Workers 15. Products: Digital speed instruments—tachometer, speed trips, analog tachometer, hand head tachometers, instrument tachometers; Digital test and measuring equipment—word generators, logic analyzers Q meters; Digital time standards, special purpose test equipment.

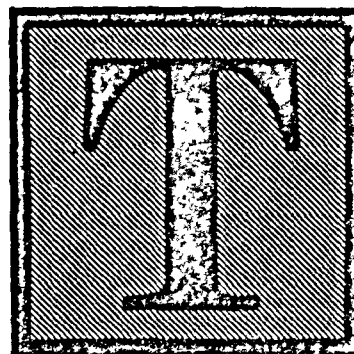

2155. T. K. STEEL INDUSTRIES PVT. LTD. 229 Sant Tukaram Rd, Lokhand Jatha, Bombay 9. Factory: M.I.D.C. Plot No. 9, D-I Block, Akurdi, Chinchwad, Pune 19. Tel. 83090, 82909. CABLE: GIRDERS. Estd. 1964. Banks: Union Bank of India, Bombay and Pune. Cap. Rs. 29,07,741 Prod Rs 19,34,975 Workers 249. Products: M.S. bars, angles, flats etc., cold-rolled strips, box strappings, stainless steel strips

2156. T. K. KARANDE AND SONS. Vikrant, 8 Budhwar Peth, Laxmi Rd, Pune 2. Factory: 714 Ganesh Peth, Dhor Ali, Pune 2. Partnership, 1972 Products: Ankle boots, high ankle boots, all kinds of safety shoes, chappals.

2157. T. WALKER'S PHARMACEUTICAL LABORATORIES. 92/10 Navi Peth, Pune 30. Tel. 441238. Partnership, 1916. Bank: Bank of Maharashtra. Cap. Rs.1,00,000. Prod. Rs.10,00,000. Workers 30. Products: Pharmaceuticals like injectables, infusion solutions, liquid orals and tablets.

2158. TABASSUM CHEMICAL INDUSTRIES (INDIA). 366 Ganj Peth, Pune 2. Proprietary, 1947. Cap. Rs.2,500, Prod. Rs.6,000. Products: Eczemomal ointment, cornointment, piles ointment, influenza powder, purgative pills, green eye drops, gastric pills, cough pills, face cleaner cream.

2159. TALATHI SOAP INDUSTRIES. 542 (New) Ganesh Peth, Pune 2. Tel. 444045. Partnership, 1956. Sister concern: Rajesh Trading Co. Banks: State Bank of India; Bank of Maharashtra. Cap. Rs.1,50,000. Prod. Rs 5,00,000. Workers 11. Products: Washing soap, detergent powder, cakes, soap choora etc.

- 2160. TAMARI INDUSTRIES.** 56/6 Shukrawar Peth, Pune 2 Factory: 592 Budhwar Peth, Pune Tel. 449932. Proprietary, 1969. Sister concerns: S.M. Munge & Co; Poonam Chemicals, A/81 MID.C., Pimpri, Pune 18. Banks: State Bank of India; Bank of Maharashtra. Cap Rs.60,000. Prod. Rs.20,000 Workers 3 Products: Marking ink, pens, industrial ink.
- 2161. TAMBE INDUSTRIES.** (Bhawana Steel Works) 232 Guruwar Peth, Pune 2. Proprietary, 1975. Bank: Shri Suvarna Sahakar Bank Cap. Rs. 13,000 Prod. Rs 8,000 Workers 3. Product: Indo grill D
- 2162. TAMCO TUBE CO.** 208 E.M.M Rd., Near Pydhonie Police Station, Bombay 3. Tel 347447, 339989 Factory: Gulamally Compound, 'H' 76, Raiwood, Lonavala, Dist. Pune. Partnership, 1962. Bank: Bank of Baroda. Prod. Rs 15,00,000 Workers 25. Products: Seamless ERW and high pressure tubes, bi-metal bearings and bushes, non-ferrous castings and bushes.
- 2163. TAMHANE SAFETY EQUIPMENTS.** 848-B New Sadashiv Peth, Pune 30. Tel 444631. Proprietary, 1976. Sister concern: Tamhane Autocars, 1760 Sadashiv Peth, Pune 30 Bank: Bank of India Cap. Rs 16,000. Prod. Rs.25,000. Workers 2. Products: Reflective car and scooter number plates, reflective road signs, red cross and hospital signs, railway signs and signals, reflective road repairing signs.
- 2164. TANKALKAR AND CO.** C-1, Technician's shed, M.I.D.C. Bhosari Industrial Estate, Pune 26. Tel. 82966. Proprietary, 1965 Bank: Central Bank of India Cap. Rs.4,00,000. Prod. Rs 1,25,000 Workers 6. Products: Ferrous and non-ferrous castings; C.I pipes specials, ferrous and non-ferrous alloy castings.
- 2165. TAPASWI PACKING CASE FACTORY.** Opp. Ruston & Hornsby (I) Ltd. Chinchwad, Pune 19. Tel. 82740. Partnership, 1960 Banks: Rupee Bank; Syndicate Bank. Workers 8 Product: Wooden packing boxes
- 2166. TAPASWI AND D. D. ASSOCIATES.** Bombay-Pune Rd., S. No. 150 Akurdi, Chinchwad, Pune 19 Tel. 82740. Partnership, 1976 Bank: Bank of India Cap. Rs 60,000. Prod. Rs 1,20,000 Product: Wooden and metal patterns.
- 2167. TARA TEXTILES.** 141 Hadapsar Industrial Estate, Pune 13 Tel 7507, 7497. Proprietary, 1974. Sister concern: At Post Velu, Tal. Bhor, Dist. Pune Product: Textiles.
- 2168. TARKAR PRODUCTS.** 58/30 Hadapsar Industrial Estate, Pune 13. Tel. 7182. Cable: 'TAR PRODUCTS'. Partnership, 1965 Bank: Dena Bank. Cap. Rs 8,00,000. Prod.Rs.1,00,000. Workers 19. Products: Matador door hinges, headlights, tappet cover, oil-engine gear covers, sprayer pump cover, magneto cover, filter covers.
- 2169. TAS PRODUCTS.** Plot No. 4, Somwar Peth, Pune 11 Tel. 27808. Cable: TASPRODUCTS. Proprietary, 1969. Sister concern: Irrigation Engineers and Consultants, Plot No 4 Somwar Peth, Pune 11 Bank. Central Bank of India. Cap. Rs 2,00,000. Prod. Rs. 8 to 9 lakhs Workers 9. Products: Industrial parts and irrigation works
- 2170. TATA ENGINEERING AND LOCOMOTIVE CO. LTD.** Bombay House, 24 Homi Mody Street, Bombay 23 Factory. Pimpri P F., Pune 18. Tel. 82061 (5 lines). Cable. 'TELCO', Pimpri Telax: 0145-323 Estd. 1945 Bra. Jamshedpur, Thana. Sister concerns: TISCO, Nelco, Tomco, Tata Chem, Tata Elec., Tata Finlay, Tata Textiles, T R F., Tata Yodogawa, Tata Merlin, Lakme, Voltas, Tata Press, Indian Hotels Banks: State Bank of India, Central Bank of India; Indian Bank, Bank of Baroda; United Bank of India, Allahabad Bank, The Punjab & Sind Bank Ltd; Grindlays Bank Ltd, Bank of Maharashtra, Mercantile Bank Ltd, The Chartered Bank; State Bank of Indore, Bank of India. Foreign collaboration: Tatab Industries, Sdn Bhd. Cap Rs 1,79,77,25,581 Prod 285 73 crores Workers 29,990. Export: Rs 25 crores Countries: Middle East South East Asia, African and European countries. Products Truck and bus chassis, excavators, vehicle spare parts, excavator spare parts.
- 2171. TATIYA SOAP FACTORY.** 67 Bhawani Peth, Pune 2. Tel 27974. Partnership, 1950 Sister concern: Rameshchandra Sobhachandra Tatiya. Bank Canara Bank. Workers 4 Product. Washing soap
- 2172. TAWADE ENGINEERING AND FABRICATION CO.** Shop No. 6, Flatted Building, 'C' Block MID.C., Chinchwad, Pune 19. Tel. C/o 82726 Proprietary, 1975. Sister concern: Marketing organisation (proposed). Bank: Bank of India. Cap. Rs 1,25,000. Prod Rs 2,50,000. Workers 9. Products: Carbide tools—standard and special hospital furniture and equipments, transmission flanges and couplings and gear blanks and shaftings etc., pipeline and chemical vessels flanges, turnkey projects in fabrication for chemical and sugar factories, structural fabrication and construction of fabrication, job work.

- 2173. TECHNICAL PRODUCTS.** Plot No. 204, New Timber Market, Pune 2. Tel. 444919. Partnership, 1973. Bank: Bank of Maharashtra Cap. Rs. 2.5 lakhs. Prod. Rs.5,00,000. Workers 16. Products: Press tools, jigs, fixtures, safety devices for pressure and temp. for diesel engines, industrial knives, tooling acids.
- 2174. TECHNO INDUSTRIES.** D-4, Technicians Block, M.I.D.C., Pune 16. Tel. 82592. Partnership, 1968. Bank: State Bank of India. Cap. Rs.3,43,054. Prod. Rs 3.1 lakhs. Workers 15. Products: Plastic, polythene bags, tubings, polythene sheets, valves, cocks, tap and 4-colour printing.
- 2175. TECHNO CRAFTS.** M.I.D.C. 'H' Block, Plot No. A 79, Pimpri, Pune 18. Tel. 83284. Partnership, 1969. Bank: Bank of India. Cap. Rs.1,00,000 Prod Rs 1,15,000. Workers 7. Product: Job work.
- 2176. TECHNOCRAFT.** 200 Mangalwar Peth, Pune 11. Proprietary, 1974. Bank: Bank of India. Cap. Rs.15,000. Prod. Rs.35,000. Workers 6. Product: Machinery spares.
- 2177. TECHNOFOUR.** 841 Budhwar Peth, Laxmi Rd., Pune 2. Tel. 445018. Cable: TEEFOUR, Pune. Telex: MCCI-0145-333. Factory: A-4 Mayurban, 1100/A Model Colony, Pune 16. Tel. 56373. Partnership, 1972. Bank: Canara Bank. Cap. Rs. 2,00,000. Prod. Rs.4,80,000. Workers 8. Products: Eddy current tester-727, multifect, flawmark test system, conductivity meter-757, crack detector.
- 2178. TECHNOLEC.** 336 Shivajinagar, Pune 16. Tel. 58043. Factory: 336 Shivajinagar, 'Chandra Prakash', Wada,wadi, Pune 16. Tel. 50859. Proprietary, 1969. Sister concern: Atul Trading Corporation. Banks: State Bank of India; Bank of Maharashtra. Cap. Rs 60,000. Prod. Rs.2,00,000. Workers 8. Export: Rs.10,000 (casual). Product: Hot spring geyser.
- 2179. TECHNOMAT INDUSTRIES.** 'Ujwal', Plot No. 29, Adarsha Co-operative Society, Satara Rd., Pune 9. Tel. 446795. Factory: W-10, 'S' Block, M.I.D.C., Bhosari, Pune 26. Proprietary, 1974. Bank: Bank of India. Cap. Rs.89,000. Prod. Rs.1,30,000. Workers 5. Products: All sorts of high precision turned parts for radio, electronic, telephone and other units; electronic connector parts.
- 2180. TECHNOPERT.** Shed No. W-50, Bhosari Industrial Area, Pune 26. Partnership, 1976. Sister Concern: Raja Process, 804 Deccan Gymkhana, Pune 4. Cap. Rs.2,00,000. Workers 9. Products: Turning and allied machined components, job work.
- 2181. TEJ TOOLS AND GAUGES MFG. CO.** Plot No. 2, Satara Rd., 'Shashi Chambers', near Swargate, Pune 9. Tel. 440359, 441834 Sister concern: Pandit Engineering Works, Shashi Chambers, near Swargate, Pune 9. Bank: Bank of India. Cap Rs 3,00,000 Prod Rs.6,00,000. Workers 6. Products: H.S.S. cutting tools, form tools, chamfering tools, centre drills, dies, revolving centres, plain plug gauges, snap gauges etc.
- 2182. TEJA ENGINEERING INDUSTRIES.** 248 Budhwar Peth, Pune 2. Tel. 445337 Proprietary, 1974. Bank: State Bank of India Cap. Rs 20,000. Prod. Rs. 40,000. Workers 5. Products: Plastic and rubber dies, moulds and jobbing work.
- 2183. TEKNIKRAFT.** 8-6 Karve Rd., Pune 4. Tel. 54684. Cable: TEKNIKRAFT. Proprietary, 1967 Bank: Bank of India. Cap. Rs 59,000. Prod Rs 6,11,618. Workers 17. Products: Regulated power supply units, emergency lighting units, automatic line voltage correctors, digital instruments, industrial control panels
- 2184. TEMP CONTROLS.** Racold Compound, Bombay-Pune Rd., Pimpri, Pune 18 Tel 82295, 82587 Cable: RACOLD, Pimpri P. F. Partnership, 1964. Bank: Canara Bank. Cap. Rs.2,92,580. Prod. Rs.4,00,000. Workers 19. Products: Thermostats both stem type and surface type, cut-outs and relays.
- 2185. TENACITY ADHESIVES (PVT.) LTD.** 21/6 Hadapsar Industrial Estate, Pune 13. Tel. 7529, 7522, 7218. Cable: ADHESIVES. Telex: C/o. PN 0145-288 CONFIL. Estd. 1975. Sister concern: Tenacity Filters Pvt. Ltd. Banks: Bank of Baroda; Indian Bank. Cap. Rs.3,30,496. Prod. Rs.6,15,403. Workers 47. Products: All types of foams, adhesive, pencil erasers.
- 2186. TENACITY FILTERS PVT. LTD.** 21/6 Hadapsar Industrial Estate, Pune 13. Tel. 7218, 7403. Cable: CONFIL. Telex: PN 0145-288. Estd. 1975. Sister concern: Tenacity Adhesives Pvt. Ltd. Bank: Bank of Baroda. Cap. Rs.2,00,000. Prod. Rs.18,00,000. Workers 30. Products: Absolute filters required by pharmaceutical, automobile, food and drug industries.
- 2187. TESTO ENGINEERING WORKS.** 1423 Shukrawar Peth, Pune 2. Tel. 445581. Factory: 46/2 Kaka Halwai Industrial Estate, Pune 9. Partnership, 1975. Bank: State Bank of India. Cap. Rs 1,00,000. Prod. Rs.5,00,000. Workers 17. Products: Job work, centre lathe, surface grinding.

- 2188. THAKUR SAVADEKAR AND CO. LTD.** 377 Guruwar Peth, Pune 2 Tel 444730 Factory: 111 Nana Peth, Pune 2. Tel. 25409. Estd. 1930 Brs Ahmednagar, Sangamner, Sholapur, Barsi, Vajapur, Gulbarga and Nizamabad Banks. Bank of Maharashtra, Punjab National Bank, Canara Bank, State Bank of India Cap. Rs.33,14,888. Prod. Rs 4,25,21,824. Workers 17,000 Product: Bidis.
- 2189. THERMO ELECTRICALS.** 202/1 opp Aghakhan Palace, Nagar Rd, Pune 14. Tel. 24690 Factory: 245 New Khadki, Pune 6 Tel 24776 Partnership, 1970. Bank: Central Bank of India Cap Rs 15 lakhs Prod. Rs 6,00,000 Workers 8 Products: All types of industrial electrical heaters and heating elements, control panels, muffle furnaces, oil fired furnaces, thermocouples cromel, alamel and iron—constantan type
- 2190. THERMOLAB GLASS PRODUCTS LTD.** Akurdi, Chinchwad, Pune 19 Tel 82311 Cable: TEELAB. Sister concern: Jg Vacuum Flask Ltd Bank: Janata Sahakari Bank Ltd Cap. Rs 5,59,688. Prod. Rs 44,09,818. Workers 300. Products Glass shells for vacuum flasks.
- 2191. THERMODORS PVT. LTD.** M.I.D.C. Industrial Estate, Plot No A 3-4 'H' Block, Pimpri, Pune 18 Tel 82539. Cable. "THERMODORS" Estd 1966 Banks: Bank of Maharashtra, Indian Bank Cap Rs 5 lakhs. Prod. Rs 19 73 lakhs. Workers 35 Export: Rs 6,41,533. Countries: Dubai (U A E) Products: Fibreglass reinforced plastic beats of various types, defence equipment such as missile containers, warhead holders, aircraft equipment, water tanks, bath tubs, shower trays, sanitary elements, moulds, jgs and fixtures and other allied products. vacuum formed products (thermoplastic products); International Division: specialised in turn-key projects for construction oriented products.
- 2192. THETA CONTROLS.** 1161/10 Ganeshkhind Rd., Pune 5. Tel 57560, 50838 Factory: Plot No 10 (New) Sind Society, Pune 7 Tel 55633. Proprietary, 1976. Bank: Bank of Maharashtra Cap Rs 50,000 Prod Rs 1,20,000. Workers 4. Products Electronic timers, automatic voltage stabilizer, high-voltage breakdown testers, motor-speed controllers; regulated DC power supplies, high-frequency meters.
- 2193. TIKHE TILES AND MARBLE CO.** 32/1 Plot 6 Erandawana, Karve Rd, Pune 4 Tel. 57385. Proprietary, 1970. Sister concern T. K. Products. Bank: Bank of India. Cap. Rs. 25,000. Prod Rs 3,60,000. Products: Marble mosaic, plain and terrazo tiles.
- 2194. TIKSHOW ENGINEERING INDUSTRIES** 136 A Mohan Nagar, Rathod Metal Rolling Mills Compound, Telco Road, Chinchwad, Pune 19. Partnership, 1974. Bank: United Commercial Bank. Cap. Rs.45,000. Prod Rs 90,000. Workers 7. Products: Axle assemblies for trailers, gears, spur, helical, job work.
- 2195. TILAK AND COMPANY.** Near Ram Agency, Tilak Rd, Pune 30. Tel. 446088 Proprietary, 1961. Bank: Bank of Maharashtra. Cap. Rs.15,000 Prod. Rs 35,000. Workers 3. Products: Steel furniture and hospital furniture.
- 2196. TILAK PACKAGING INDUSTRIES.** 209 Mangalwar Peth, Pune 11 Tel. 28864 Proprietary, 1977 Brs Pune, Bombay. Sister concerns. Book Sellers Publication Co. 54 Budhwar Peth, Pune 2, and Girgaum, Bombay. Datta Agency; Industrial & Commercial Services, D. Tilak & Sons Banks: Bank of Maharashtra; Saraswat Co-op Bank. Cap. Rs 2,00,000 Worker 1. Product: Paper bags.
- 2196A. TIP TOP DRY CLEANERS.** 211/12 M. G. Road, Pune 1 Tel. 26179 Factory: 363/1 Shivajinagar, Pune 5. Tel 54516. Proprietary, 1961 Brs 12 shops all over Pune Banks: Syndicate Bank, Bank of Maharashtra, Punjab & Sind Bank. Products: Cleaning of carpets, sofas, chairs and other upholstery, tapestry; dry cleaners, laundry, dyers, darners, tailors.
- 2197. TIRUPATI WIRE WORKS.** 382/2 Bhawanı Peth, near Juna Motor Stand, Pune 2. Tel 20631. Proprietary, 1974. Bank: Punjab National Bank. Cap Rs 12,297. Prod. Rs.3,94,290 Workers 7. Export: Rs.1,10,000. Countries: Arab Gulfs Product: Hard bright wire nails.
- 2198. TOKO ELECTRONIC COMPONENTS (P) LTD.** S-24 Electronic Block, M.I.D.C., Bhosari, Pune 26 Tel. 83197. Cable: 'TOKO'. Estd 1974. Bank: State Bank of India. Workers 41. Products: P.V.C gang condensers and trimmers.
- 2199. TRANS ELECTRONICS (P) LTD.** 'A' 108/109, 'H' Block, Pimpri, M.I.D.C., Pune 18 Tel. 82833. Cable: TRANSDUCER. Factory: 'Adore' House, 6K Dubash Marg (Rampart Row), Bombay 1. Tel 293667, 293493 Estd 1972. Bank: Bank of India. Cap. Rs 4,00,000 Prod. Rs.10,00,000. Workers 5. Products: Silicon rectifiers, blocking rectifiers, rectifier stack.
- 2200. TRANSTRONIC INDUSTRIES.** 527 Narayan Peth, Pune 30. Factory: Tarkar Compound 38-39 Hadapsar

- Industrial Estate, Pune 13. Tel. req. 7182, 7428. Partnership, 1972. Br. Bombay. Bank: Canara Bank. Cap. Rs. 55,000. Prod. Rs.1,21,780. Workers 5. Products: Special purpose transformers—Austin, inventor, rectifier; process control equipment for fermentors and other microbiological plants; rectifiers and inventors; power control equipments, control punches, welding controls, industrial measuring equipment; voltage stabilizers in kw range.
2201. **TRANSAGE**. Saraswati Vilas Bldg. Laxmi Rd., Pune 30. Tel. C/o. 445323. Partnership, 1972. Bank: Bank of India. Cap. Rs.46,000. Product: Transistor clocks.
2202. **TRANS INDIA LTD.** Bell Bldg., Sir P. M. Rd., Fort, Bombay 1. Factory: Pimpri P.F. Post Bag No. 2. Pune 18. Tel. 82344, 82345, 82346. Cable: TRAOMBAT. Telex: Pn-0145-217. Estd. 1961. Banks: United Commercial Bank; Banque Nationale de Paris, Bombay. Foreign collaboration: Hermann Traub Maschinenfabrik GmbH, West Germany. Cap. Rs.50,24,761. Prod. Rs 81,91,843. Workers 263. Export: Rs.30,08,777. Countries: Japan, Malaysia, West Germany, U.S.A., New Zealand, Ceylon, Singapore. Products: Single spindle automatic lathe and accessories
2203. **TRIBOLETICS**. Plot No. 115, 'S' Block, Bhosari, Pune 26. Tel. 83001. Partnership, 1976. Bank: United Western Bank Ltd. Cap. Rs.7,01,748. Workers 32. Products: Engine-cooling water pumps for diesel engines, cast iron pistons.
2204. **TRIDAL RUBBER**. 32/1/6-A Erandawana, behind Mehendale Garage, Pune 4. Tel. req. 53378. Partnership, 1977. Sister concern: Alcop Enterprises, 32/1/6-A Erandawana, Pune. Bank: The Cosmos Co-operative Urban Bank Ltd. Cap. Rs.1,30,000. Workers 6. Products: Natural and synthetic moulded rubber industrial components such as washers, hydraulic seals, gaskets; extruded rubber components like beading industrial gaskets; radiator hoses, solid rubber trolley wheel tyres.
2205. **TRIFORT ELECTRONIC AND METERS COMPANY PVT. LTD.** 52 Shivaji Housing Society, Pune 16. Tel. 58150. Cable: TRIFORT. Factory: 81 Bhosari Industrial Estate, Pune 26. Estd. 1971. Bank: Union Bank of India. Products: Autorickshaw and taxi fare meters.
2206. **TRIMURTHI ENGINEERING WORKS**. 2A/25 Somwar Peth, Pune 11. Tel. C/o. 24514, 28828. Partnership, 1975. Bank: Bank of Maharashtra. Cap. Rs.28,000. Workers 3. Product: Job work.
2207. **TRIMURTI MOTOR BODY GARAGE**. At & post Chakan, Tal. Khed, Dist. Pune 410501. Proprietary, 1976. Bank: Bank of India. Cap. Rs 5,000. Workers 6. Product: Motor repairing works.
2208. **TRINITY ENTERPRISES**. 249 Shanwar Peth, Pune 30. Tel. 449779. Factory: 19 Vithalwadi, Pune 9. Tel. req. 445168. Proprietary, 1972. Subsidiary company: Leak Proofers. Bank: Bank of Maharashtra. Cap. Rs. 50,000. Prod. Rs.1,00,000. Workers 2. Products: Industrial paints, decorative paints, water proofing compounds.
2209. **TRINITY ENGINEERS PVT. LTD.** United Bank of India Bldg, 6th Floor, Sir P. M. Rd., Bombay 1. Cable: TRIFORGE. Factory: 14, D-1 MID C. Area, Chinchwad, Pune 19. Tel. 83536, 83388. Telex: 0145-327. Estd. 1973. Bank: Union Bank of India. Cap. Rs 10,05,000. Prod. Rs. 1,54,69,103. Workers 270. Products: Closed die forgings for autos, tempos, tractors and automobiles; crankshafts, connecting rods, camshafts for oil engines.
2210. **TRINITY FASTENERS AND FORGINGS CO.** 65 Shivaji Co-op. Housing Society, Padma-Kunj, Pune 16. Tel. 50471. Factory: 'S' Block, Plot No 43, Bhosari Industrial Area, Pune 26. Tel. 83380., 82893. Partnership, 1974. Bank: Bank of Baroda. Cap. Rs.14,20,000. Prod. Rs. 25,00,000. Workers 82. Products: Closed die forgings of M.S. carbon steel and alloy steel, stainless steel for automobile, diesel general engineering and tractor industries.
2211. **TRIO AND COMPANY**. 1414/3 Sadashiv Peth, Pune 30. Tel. 440436. Partnership, 1937. Sister concern: Flour Mill. Bank: Bank of Maharashtra. Cap. Rs.35,000. Prod. Rs.2,00,000. Workers 8. Products: Office furniture school furniture, wooden furniture
2212. **TRISON INSTRUMENTS**. 200 Mangalwar Peth, Pune 2. Tel. 27141. Proprietary, 1965. Workers 8. Products: All types of parts of Kirloskar Oil Engines Ltd.
2213. **TRIUMPH INDUSTRIES**. 125/7 Prabhat Nagar, Pune 4. Tel. 57600. Proprietary, 1966. Sister concern: Triumph Traders. Bank: Central Bank of India. Cap. Rs. 55,000. Prod. Rs.2,20,000. Workers 9. Products: Job work of machining—nut bolts, flanges, various shafts, axle tubes, Khandasari sugar project; gutters, crystallisers, settling tanks, pans, tanks, sulphatation tanks etc., structural fabrication—trusses, columns, tanks, grills, windows, doors and flower stands, lamp shades.

- 2214. TRULENGTHS.** 47/A Pune-Satara Rd. Pune 9. Tel. 447705. Partnership, 1975 Br. Roha. Bank: Bank of Maharashtra. Cap. Rs.15,000. Workers 8. Products: Fabrication and erection.
- 2215. TRY-O-SPARK ENGINEERS.** 353/1 Narayan Peth, Pune 30. Factory. 184-B Shanwar Peth, Pune 30 Tel. 56408. Partnership, 1968 Bank: Bank of Baroda. Cap. Rs.1,31,000. Prod. Rs 1,84,753 Products Rubber and plastic moulding dies, components for synthetic and nylon yarn machinery and precision job work.
- 2216. TUBE WELL ENGINEERING CORPORATION.** 343/6 Bhawani Peth, 1/2 Bhawani Society, Pune 2 Tel. 22541, 23513. Proprietary, 1965. Bank. Dena Bank. Cap. Rs.4,00,000 Prod. Rs.10,00,000 Workers 60 Products Construction of tube wells, drilling and grouting work of govt. projects and assembly of 'Krishikar' boring machine and oil engine
- 2217. TUGA BIOCHEMICALS LABS.** 7 E/2 Sadashiv Peth, Tilak Rd, Pune 30 Tel. 443593 Factory: 70 Hadapsar Industrial Estate, Bijlee Compound, Pune 13. Tel. 7641. Partnership, 1976 Bank. Bank of India Cap. Rs 25 lakhs. Prod Rs 0.5 lakhs Workers 8. Exports: Rs.21,200 Countries: U S A. Products: Pancreatin, Papain
- 2218. TULSI FINE CHEMICAL INDUSTRIES PVT. LTD.** 1196 Ghole Rd, Shivajinagar, Pune 5 Tel 53135. 57555. Cable: TULSION. Telex PN 0145-364 Factory: 97-E General Block, Bhosari, Pune 26 Tel. 83169. Cable. TULSION Estd. 1960. Bank: Bank of Maharashtra Cap. Rs 15,50,000. Prod. Rs.40,00,000 Workers 50. Products: Ion exchange resins such as cation and anion resins and polyelectrolytes
- 2219. TURNWEL.** 129 Shanwar Peth, Pune 30. Tel. 50239. Proprietary, 1965. Bank Bank of Maharashtra. Cap. Rs 50,000. Prod. Rs 1,00,000 Workers 2 Product Job work.
- 2220. TUSHAR ENGINEERING WORKS.** 22/A Nagar Rd., Gadiya Estate, Pune 14 Tel. 23909. Proprietary, 1969. Banks: United Commercial Bank; Poona Contractors Co-operative Bank. Cap. Rs 1 to 1.5 lakhs Workers 6 Products: Sugar machinery spare parts and other spare parts, tractor parts such as brak pedals, clutch fidal, fuel tank supporters, selectors; other tooling and jig, fixture work.
- 2221. TULSO FURNISHERS.** 929/1 Shivajinagar, F.C. Rd, Pune 4. Tel. 53134. Factory: 927 F.C. Rd, Shivajinagar, Pune 4. Proprietary, 1974. Subsidiary company: Lottkiar and Associates, Pune Bank: Bank of India. Cap. Rs.60,000. Prod. Rs 4,00,000. Workers 24. Product: Wooden furniture.
- 2222. TWINCO ENGINEERING.** 390 Sadashiv Peth, Pune 30. Tel. 440730. Partnership, 1970. Bank: Bank of Maharashtra. Cap. Rs 30,442. Prod Rs.41,289. Workers 3 Products: All types of lead-cutting machines, life testing machines, special purpose machines required for electronic industries, assembly tools/fixtures for radio and tv, machine spare parts.

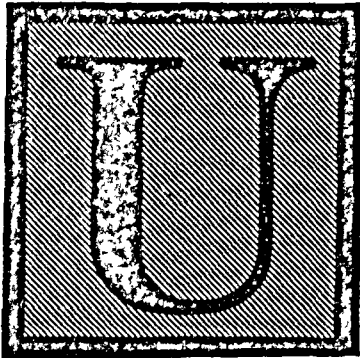

- 2223. U D INSTRUMENTATION.** W-20 'S' Block, Bhosari Industrial Area, Pune 26. Tel. 83216. Partnership, 1973. Bank: State Bank of India. Cap. Rs.3.5 lakhs. Workers 8. Product: Constant speed, permanent magnet D.C. micromotors, magnetisers and magnet calibrators, mini/micro spot welding machines, gaussmeters, torque-meters.
- 2224. U. K. MULLA AND CO.** 403 Old Bazar, Khadki, Pune 3. Tel. 55062. Partnership, 1945. Bank: Bank of Maharashtra. Cap. Rs. 40,000. Prod. Rs.80,000. Workers 6. Product: Shewaj (vermicelli).
- 2225. U P M INDUSTRIES.** 392/1/7 Shivajinagar, Pune 16. Tel. 54225, 54155, 440779. Proprietary, 1973. Subsidiary company: Ramesh & Co., 209 Narayan Peth, Pune 30. Bank: Bank of India. Cap. Rs.50,000. Prod. Rs. 3,00,000. Workers 4. Products: De-greasing solutions, N. C. cleaners, engine cleaning, solutions, thinners.
- 2226. U. S. INDUSTRIES.** 719 Shivajinagar, Deccan Gymkhana, Pune 4. Tel. 58006. Proprietary, 1965. Bank: Bank of Maharashtra. Cap. Rs.20,000. Prod. Rs.45,000. Workers 8. Products: Filters, hand gloves, dust collectors, centrifugal bags.
- 2227. UBIQUE ENTERPRISES.** 46/2 Satara Road, Kaka Halwai Ind. Estate, Plot No. 6. Pune 9. Tel. 448511. Partnership, 1972. Bank: Bank of Baroda. Cap. Rs. 80,000. Prod. Rs.5,00,000. Products: Oil seal lip tester, bursting strength tester, puncture resistance tester, substance indicator, box compression tester.
- 2228. UDAY INDUSTRIES.** 16/1 Shivajinagar, Pune 5. Tel. 55704. Partnership, 1972. Bank: Bank of Baroda.
- Workers 9.** Products: Spare parts of machine tools, assemblies, casting, fabrication.
- 2229. UDAY STATIONERY MART.** 1622 Shukrawar Peth, Pune 2. Tel. 447893. Proprietary, 1954. Bank: State Bank of India. Cap. Rs. 40,000. Prod. Rs.75,000. Products: Exercise and account books.
- 2230. UDAY BOX MANUFACTURING CO.** 1020 Bhavani Peth, Pune 2. Tel. 27750. Partnership, 1962. Bank: Bank of India. Cap. Rs.75,000. Prod. Rs 2,50,000. Workers 9. Products: Wooden packing cases, cable drums of various sizes.
- 2231. UDAY POLISHING WORKS.** 66 Hadapsar Industrial Estate, Pune 13. Tel. C/o. 7597. Partnership, 1972. Bank: Bank of India. Cap. Rs.1,500. Prod. Rs.80,000. Workers 7. Product: Hand polishing.
- 2232. UJWALA ENGINEERING WORKS.** 446 Nana Peth, Pune 2. Tel. 28045. Factory: 536 Nana Peth, Pune 2. Partnership, 1967. Bank: Bank of Baroda. Cap. Rs.1,15,000. Prod. Rs.2,00,000. Workers 9. Products: Various types of washers and other press parts.
- 2233. ULHAS ENGINEERING WORKS.** Sur. 30L,A, Kothrud, Pune 29. Proprietary, 1969. Bank: Bank of Maharashtra. Cap. Rs.1,00,000. Prod. Rs 40,000. Workers 8. Product: Machine spare parts.
- 2234. UMA PLASTIC INDUSTRIES.** 247 Ganesh Nagar, Chinchwad, Pune 33. Tel. 82750. Partnership 1974. Bank: The Poona Co-operative Rupee Bank Ltd. Cap. Rs.1,50,000. Prod. Rs.4,00,000. Workers 6. Products: Polythene bags, sheetings, rolls of low density and high density polythene, reprocessing and colouring all kinds of plastic.
- 2235. UMCO WORKS.** 1002/2 Rajendra Nagar, Pune. 30. Tel. 448524. Factory: 19 Vithalwadi, Pune. Proprietary, 1977. Bank: Bank of Maharashtra. Cap. Rs.2,50,000. Workers 4. Product: Electrical laminations.
- 2236. UNIK FURNISHERS.** 899 Boottee Street, Pune 1. Tel. 27526. Partnership, 1967. Bank: The Muslim Co-op. Bank Ltd. Workers 5. Products: Wooden furniture.
- 2237. UNIMECH ENGINEERING.** 463B Somwar Peth, Pune 11. Proprietary, 1973. Bank: Rupee Bank. Cap. Rs. 60,000. Prod. Rs.30,000. Workers 3. Product: All kinds of turning jobs.

- 2238. UNIMECH INDUSTRIES.** 722 A-B-17 Laxmi Park colony, Navi Peth, Pune 30. Factory: MIDC Plot 95, Bhosari, Pune 26. Tel. 83116. Partnership, 1973. Sister Concern: United Erectors. Bank: Bank of Baroda. Prod. Rs 10 lakhs Workers 50. Products: Structural and other fabrication.
- 2239. UNION STEEL INDUSTRIES.** 23/1 Hadapsar Industrial Estate, Post Box 1213, Pune 13. Tel. 7227. Cable: UNISTEEL Partnership, 1964. Sister concerns: Poonawalla and Co., Union Traders. Bank: Central Bank of India. Cap. Rs 4,00,000. Prod. Rs.6,00,000 Workers 15. Export: Rs 20,000. Countries: Abu Dhabi, U.A.E., Australia. Products: Ghamellas, slotted angles, cable trays, bubble caps, elevator buckets
- 2240. UNIQUE TOOLS AND PRESSCOMPS (P) LTD.** A-78 H Block MIDC, Pimpri, Pune 18 Tel 82294. Estd. 1971. Bank: Bank of India Cap. Rs 1,25,000. Prod Rs. 10,00,000. Workers 25. Products: Sheet metal pressed components, engineering goods, service tools and garage tools, deep drawing jobs, washers, clips, brackets, fuel tank caps, jigs and fixtures, light fabrication jobs.
- 2241. UNITED AUTO WORKS.** 103 Shivajinagar, Chanawala Chambers, Pune 5. Tel 55066 Proprietary, 1961. Bank: Bank of Maharashtra Cap Rs 50,000. Prod. Rs.30,000. Workers 5. Product: Machining and labour works.
- 2242. UNITED ERECTORS.** 722-A-B-17 Laxmi Park Colony, Navi Peth, Pune 30. Tel. 443193. Telex:0145-333. Partnership, 1973. Sister concern: Unimech Industries Bank: Bank of Baroda Prod. Rs.33,00,000. Workers 250. Products: Erection of sugar plant and fabrication of incidental sugar plant.
- 2243. UNITED ENTERPRISES.** 74 Budhwar Peth, Pune 2. Tel. 446161. Factory: 1124 Sadashiv Peth, Nimbalkar Talim Chowk, Pune 30. Tel. 441490. Partnership, 1970. Bank: Bank of Maharashtra. Cap. Rs 40,000. Prod Rs.72,000. Workers 8. Products: Springs, strips and wire forms
- 2244. UNITED ENGINEERS.** 83 Shivajinagar, Pune 5. Tel. 50721. Partnership, 1975. Bank: Bank of India. Cap. Rs 1,50,000. Prod. Rs.1,50,000. Workers 7. Product: Lathe work, structural construction, industrial fabrication
- 2245. UNITED HOSIERY WORKS.** 264/4 Shanwar Peth, Pune 30. Tel. 447702, 441190. Partnership: 1956. Bank: Bank of Maharashtra. Cap. Rs 4.5 lakhs. Prod. Rs 34 lakhs. Workers 90 Product: All sorts of hosiery.
- 2246. UNITED METAL INDUSTRIES.** Sir Vithaldas Thakersey Memorial Bldg. 9 Bake House Lane, Fort, Bombay 1. Factory: Technicians Block, Bhosari Ind. Estate, Pune 26 Tel. 82572 Partnership, 1967. Branch Amar Brass Company Bank: Bank of Maharashtra. Cap Rs 3.95 lakhs. Prod. Rs 9,00,000. Workers 22. Product: Heat treatment salts, heat treatment plant.
- 2247. UNITED METACHEM P. LTD.** 784 Deccan Gymkhana, Pune 4 54943 Cable: METACHEM. Telex: 0145-381. Factory: 72/76 Mundhwa, Pune 1. Estd. 1973. Sister concerns Ajay Metachem P. Ltd, Ojas Engg P. Ltd. Bank: Bank of Maharashtra. Products: Metallurgical and industrial chemicals
- 2248. UNITED STEEL WORKS.** 561 Nana Peth, Pune 2 Proprietary, 1972 Bank Bank of India. Cap. Rs 30,000. Prod Rs 4,00,000. Products: Industrial fabrication, trolleys, grills, steel windows, main gate, louvre, collapsible gate, section windows, rolling shutters, oriental type table and chair, repairing of motor wheels
- 2249. UNITED TYREKRAFTS.** 327 Nana Peth, Pune 2. Tel 440122 Factory: Shed No. S/5, Parvati Industrial Estate, Pune 9. Partnership, 1958. Sister concern. Royal Rubber Works. Bank: Dena Bank. Cap. Rs 1,00,000. Prod. Rs 5,00,000. Workers 18. Products: Tyre retreading equipments, retreading of tyres.
- 2250. UNITY GAUGE AND TOOL COMPANY.** 101 Rasta Peth, Pune 11. Tel. 27697. Cable: UNITGAUGE. Factory: Plot No. 109, MIDC Industrial Area, Bhosari, Pune Partnership, 1970. Sister concern. Sonalkar Engineering. Bank: Central Bank of India. Cap Rs 5 lakhs. Prod. Rs 11 lakhs Workers 30. Products: Standard gauge. non-standard gauge, jigs and fixtures. special tooling items, comparator stand.
- 2251. UNIVERSAL ENGINEERING.** Plot No. A-62, 63, 64, H Block Pimpri Industrial Area, MIDC, Pune 18. Tel. 56175. Partnership, 1977. Bank: State Bank of India. Cap. Rs 1,00,000. Workers 4. Products: Magnetic 'V' blocks, magnetic bases, dial stands, etc.
- 2252. UNIVERSAL ENGINEERING AND MANUFACTURING INDUSTRY.** 5-8 Block F.2 MIDC Ind. Estate, Pimpri, Pune 18. Tel. 83230. Cable: UNISAL-TOOL. Proprietary, 1972. Bank: State Bank of India.

- Cap. Rs.9,00,000. Prod. Rs.30,00,000. Workers 62. Export: Rs.1,00,000. Countries: U.S.A., U.K., Germany and Europe. Products: Milling cutters, reamers, drills, core drills, endmills, counter bores, and other tools.
- 2253. UNIVERSAL ENGINEERING WORKS.** 648 Shukrawar Peth, Shivaji Road, Pune 2. Proprietary. 1947. Bank: Bank of Maharashtra. Cap. Rs.25,000. Workers 4. Product: Oil engine repairing.
- 2254. UNIVERSAL INDUSTRY.** 1284 Kasba Peth, Pune 11. Proprietary, 1972. Cap. Rs. 80,000. Prod. Rs. 25,000. Workers 3. Product: Job work.
- 2255. UNIVERSAL GASKETS AND COMPONENTS.** 830 Bhavani Peth, near Bhawanimata Mandir, Pune 2. Tel. 27963. Partnership, 1972. Bank: Bank of Maharashtra. Cap. Rs.1,75,739. Product: Gaskets and components.
- 2256. UNIVERSAL SPRINGS.** 230-B Mangalwar Peth, Pune 11. Tel. 23220, 26583. Partnership, 1973-74. Sister concern: Kotak Gandhi & Co. Bank: Punjab National Bank. Cap. Rs.1 lakh 50 thousand. Prod. Rs.3 lakhs 50 thousand. Workers 11. Product: All kinds of springs.
- 2257. UNPA ENGINEERING.** 83 Shivajinagar, Pune 5. Tel. 57824. Partnership, 1975. Bank: Bank of Maharashtra. Cap. Rs.2 lakhs. Prod. Rs.3.28 lakhs. Workers 7. Product: Special duty pumps as per order.
- 2258. USHA DOMESTIC CONSUMER PRODUCTS.** C-6 Century Enka Colony No. 2, Nasik Road, Bhosari, Pune 26. Factory: 513/1 In front of Atlas Metal Industries, Pune-Nasik Road, Bhosari, Pune 26. Proprietary, 1975. Bank: Bank of India. Cap. Rs.40,000. Prod. Rs. 30,000. Workers 2. Products: Detergent powder, liquid detergent.
- 2259. USHA INDUSTRIES.** "Ushakkal", 999 Navi Peth, Pune 30. Tel. 440509. Factory: 35 Parvati Industrial Estate, Pune 9. Tel. 441497. Proprietary, 1975. Partnership, 1977. Bank: Union Bank of India. Cap. Rs. 3,00,000. Prod. Rs. 5,00,000. Workers 12. Product: Polythene bags.
- 2260. USHA TEXTILES.** 14 Hadapsar Industrial Estate, Pune 13. Tel. 7288, 7425, 7497. Proprietary, 1971. Product: Cotton fabrics, dhotis, mulmal, voiles.
- 2261. URSAMAJOR.** 631-A Sadashiv Peth, Post Box 747, Pune 30. Proprietary, 1977. Bank: Sampada Sahakari Bank Ltd. Sister concern: Sunandan Enterprises. Cap. Rs.2,000. Prod. Rs. 4,000. Workers 2. Products: Cleaning powder, washing powder.
- 2262. USHA PRINTERS.** 434 Sadashiv Peth, Pune 30. Tel. 443877. Partnership, 1966. Bank: Bank of India. Prod. Rs.80,000. Workers 4. Product: Printing on paper.

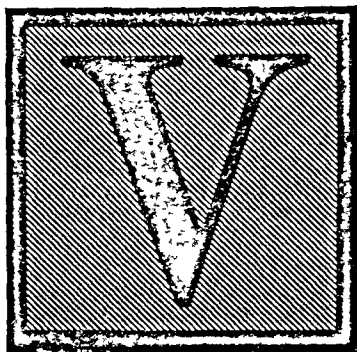

2263. V. B. & Co. 2083 Sadashiv Peth, Vijaynagar Colony, Pune 30. Tel. 440225. Cable: VIBICO. Show Room: Jeevan Darshan, Laxmi Road, Pune 411 030. Tel. 444631. Proprietary, 1958. Products: Xerox, photostat, micro-filming, colour processing, mini offset, bromides, flash photography, industrial photography, developing and printing, cinema slides, clinical photography, model, fashion and product photography and dealers.

2264. V. JOSHI AND CO. 1447/48 Shukrawar Peth, near Shanpar Janata Sahakari Bank, Shevade Lane, Pune 2. Tel. 443188. Partnership, 1960. Banks: Bank of India; Bank of Maharashtra. Prod. Rs. 4 to 5 lakhs. Workers 30. Products: Blocks for advertisement, colour photograph blocks, cover printing.

2265. V. K. ENGINEERING SERVICE. 537 Shukrawar Peth, Shivaji Rd., Pune 2. Proprietary, 1965. Bank: Bank of Maharashtra. Workers 3. Product: Job work.

2266. V. K. SAMAK AND CO. 637 Budhwar Peth, Pune 2. Partnership, 1922. Bank: United Western Bank. Cap. Rs.15,000 Prod. Rs.1,63,000. Workers 5. Products: Shop Act forms, stationery, printing, maps, exercise books, account books.

2267. V. K. GARUD AND SONS. Charholi Budruk, Tal. Haveli, Dist. Pune. Proprietary, 1969. Bank: Bank of Maharashtra. Cap. Rs 10,000. Prod. Rs.5,000. Product: Agricultural implements.

2268. V. L. ENGINEERING. 861/2 Sadashiv Peth, behind Training College, Pune 30. Tel. 443709. Partnership, 1969. Banks: United Western Bank; Bank of Maharashtra. Cap. Rs.1,00,000. Prod. Rs.1,17,000. Workers 8. Products: Nut bolts, studs.

2269. V. M. ENGINEERING CO. PVT. LTD. Plot No. A-102- 'H' Block, M.I.D.C. Area, Pumpri, Pune 18. Tel. 82323. Estd. 1969. Bank: The Saraswati Co-operative Bank Ltd., Pune 1. Cap. Rs 5,50,000. Prod. Rs 7,00,000. Workers 18. Products: Control panels, relay panels, L.T. & H. T. switchgear panels, fabrication and manufacture of machine components, jigs and fixtures; job work like milling, turning, grinding, drilling, erection work, testing and commissioning of L.T. and H.T. switchgear.

2270. V. M. ENGINEERING WORKS. S. No. 440/A/2 Pune-Satara Rd., Pune 9. Tel. 440547 Partnership, 1972. Bank: Bank of Maharashtra. Cap. Rs.1,75,000. Prod. Rs 1,50,000. Workers 6. Products: Shafts, oil seal housing, gear blanks, flanges, crankshafts etc., job work.

2271. V. RAJENDRA ART PRESS. 1437 Sadashiv Peth. Jadhav Niwas, Pune 30. Tel. 441562. Proprietary, 1959, Bank: Bank of Maharashtra. Cap Rs 2,50,000. Products. Art printing

2272. V. R. KARANJKAR AND SONS. 26 Ghorpade Peth, Pune 2. Tel. 441861. Partnership, 1925. Bank: Union Bank of India. Cap. Rs 30,000. Prod. Rs 2,12,128. Workers 10 Products: 1" brass flush cocks and brass hose couplings

2273. V. S. AND COMPANY. 753 Budhwar Peth, Pune 2. Tel. 448004. Factory: 562 Budhwar Peth, Pune 2. Partnership, 1940. Bank: Bank of Maharashtra. Cap. Rs.30,000. Prod. Rs 48,000. Products: Black liquid disinfectant (phenyle) grade III R.W.C. 5; white perfumed deodorant.

2274. V. S. ENGINEERS. Bapuchi Krupa Bungalow, Bhonde Colony, 102/103/T Erandawana, Pune 4. Tel: 52071. Factory: 24/25 Somwar Peth, Pune 11. Proprietary, 1960. Bank: Bank of Maharashtra. Cap Rs.25,000. Prod. Rs. 30,000. Workers 9. Product: Job works.

2275. V. S. INDUSTRIES. 127 Telco Rd., Chinchwad, Pune 19. Tel. 82731. Partnership, 1968. Bank: Bank of Maharashtra. Cap. Rs.1,00,000. Prod. Rs 66,000. Workers 7. Products: Job work, manufacturing of bend type drafting machine.

2276. V. S. INDUSTRIES. 39/47 Prabhat Rd., Lane No. 9, Pune 4. Factory: 17/2 Erandawana, opp. Dav Bindu Society, off Karve Rd., Pune 4. Partnership, 1975. Banks: State Bank of India; Bank of Maharashtra. Cap. Rs.

- 20,000. Prod. Rs.1,50,000. Workers 2. Products: Geoelectronic instruments, control panels cubicals (CT), hydrogen monitoring system, tailor-made process control electronic equipment, custom built electronic instruments.
- 2277. V. V. DHOTRE AND SONS.** 300-B Narayan Peth, Pune 30. Tel. 444249. Proprietary, 1946. Banks: Indian Bank; United Western Bank Ltd. Cap. Rs.1,00,000. Prod. Rs.4,00,000. Workers 19. Products: Wooden furniture, internal decoration, doors and windows, office furniture, hospital furniture, shop furniture, education department's requirements etc.
- 2278. V. V. PRODUCTS.** 52 Shivaji Housing Society, Pune 16. Tel. 58150. Proprietary, 1975. Bank: State Bank of Mysore. Prod. Rs.40,000. Product: Special types of spices and chatanys, cooking masala.
- 2279. V-PLA PRODUCTS.** 4/1 Erandawana, 'Parijat', Karve Rd., Pune 4. Tel. 57577. Proprietary, 1971. Bank: Bank of India. Cap. Rs.80,000. Prod. Rs.1,20,000. Workers 8. Products: Plastic moulding articles, machinery—hand press, injection moulding machine, semi-automatic injection moulding machine, all types of caps, packing boxes.
- 2280. VACUUM PLANT AND INSTRUMENTS MFG. CO. PVT. LTD.** 48/A Mundhwa, Pune 36. Tel. 7535/7258. Telex: PN 0145-366. Estd. 1965. Br. Vacuum Pump unit at Ahmednagar. Bank: Bank of Maharashtra. Foreign collaboration: Leybold Heraeus GmbH & Co., W. Germany. Cap. Rs.79.46 lakhs. Prod. Rs.120 lakhs. Workers 283. Products: High vacuum degassing, drying and filtering plants; vacuum impregnating plant, epoxy mixing and casting plant, vapour degreasing plant, vacuum degassing plant, complete paper capacitor manufacturing plant, vacuum and pressure impregnating plant, capacitor winding machine, filament winding machine, coil winding machine, capacitor testing instruments, special vacuum valves.
- 2281. VAHIDY AND CO.** 100 Guruwar Peth, behind Jain Temple, Fulwala Chowk, Pune 2. Tel. 444026. Factory: 817/18 Bhawani Peth, near Padamji Gate, Farshibaug, Pune 2. Partnership, 1962. Bank: Bank of Maharashtra. Cap. Rs.1,00,000. Prod. Rs.4,00,000. Workers 17. Product: Electric lighting bulbs.
- 2282. VAIBHAV ENGINEERING WORKS.** 38 Pune-Satara Rd., Pune 9. Tel. 446145. Partnership, 1965. Bank: Bank of India. Cap. Rs. 50,000. Prod. 50,000. Workers 6. Product: Grill work and fabrication.
- 2283. VAIBHAV PRINTING PRESS.** Pune-Nasik Rd., Bhosari, Pune 26. Tel. C/o. 82906. Proprietary, 1974. Bank: Bank of Maharashtra. Cap. Rs.40,000. Prod. Rs. 15,000. Products: Commercial printing, stationery and binding.
- 2284. VAIBHAV PRINTERS.** 203 (New) Narayan Peth, Pune 30. Tel. 444099. Proprietary, 1977. Bank: Bank of Maharashtra. Cap. Rs.25,000. Workers 3. Product: Book printing.
- 2285. VAIDYA INDUSTRIES.** 32/1 Karve Rd., Pune 4. Tel. 56549. Partnership, 1959. Bank: The Karad Bank Ltd. Cap. Rs.1,13,940. Prod. Rs.3,00,000. Workers 24. Products: Plant protection equipment, fibreglass reinforced plastic articles, machining job work, non-ferrous castings.
- 2286. VAISHALI DRESSES.** 641 Guruwar Peth, Pune 2. Partnership, 1974. Bank: State Bank of India. Cap. Rs.15,000. Prod. Rs.90,000. Workers 3. Products: Hosiery, readymade garments.
- 2287. VAISHALI ENTERPRISES.** 1362 Sadashiv Peth, Pune 30. Tel. 449675. Proprietary, 1975. Bank: Shri Suvarna Sahakari Bank Ltd. Cap. Rs.5,000. Prod. Rs. 8,000. Workers 2. Products: Printed circuits and screen printing.
- 2288. VAKIF INDUSTRIES.** 7 Mulla Rd., Khadki, Pune 3. Tel. 55802. Partnership, 1976. Sister concern: Vakif Tin Works. Banks: Bank of Maharashtra; Sangli Bank. Cap. Rs. 70,000. Prod. Rs.70,000. Workers 3. Product: Die punches for manufacturing containers.
- 2289. VAKIF TIN WORKS.** 35 Ganesh Peth, Pune 2. Tel. 444318. Partnership, 1960. Sister concern: Vakif Industries, 7 Mulla Rd., Pune 3. Banks: Bank of Maharashtra; Muslim Co-op. Bank Ltd. Cap. Rs.75,000. Prod. Rs.3,07,586. Workers 6. Products: Tin containers—round and square type, calendar metal strips, tin cans for condenser manufacturers, fabrication works, aluminium belts, hangers and caps.
- 2290. VALCO INDUSTRIES.** 427 Ghorpade Path, Shankarshet Rd., Pune 2. Tel. 440126. Cable: IMAGE. Factory: S 4/A Parvati Industrial Estate, Pune-Satara Rd., Pune 9. Partnership, 1972. Sister concern: Valco Industries (Instrument Division). Bank: United Commercial Bank. Products: Cinema laboratory equipments for editing such as flat-bed editing tables; synchronisers, winders, viewers, vertical rewind arm, super 8 mm loop cassette silent projectors.

- 2291. VALJI KHIMAJI PATEL AND CO.** 124 Timber Market, Pune 2. Tel. 444188. Partnership, 1960. Banks: Bank of India; Dena Bank Cap. Rs 3,00,000. Prod Rs 3,00,000. Workers 5. Products: Packing boxes, wood cutting, saw milling
- 2292. VAMAN D. PUROHIT AND SONS.** 1206/27-B Shrivajunagar, Pune 4. Cable: INTIGRITY Factory: C/o Woodcraft. Mfg. Co. Plot No. S-I, S-II, S-III, Parvati Industrial Estate, Swargate, Pune 9 Tel 441673. 442919. Cable: INTIGRITY. Proprietary, 1971. Sister concerns: Purohit and Purohit; Woodcrafts Mfg Co.; Die Castings & Forgings, Pune. Bank: Bank of Maharashtra. Products: Scientific instruments, laboratory equipments, laboratory woodwares metal fabrication and erection, scale models, fine furniture, wooden and metal patterns, die casting and forgings small weight, engraving, hardware garden tools, corrugated paper, board, containers, packing material all sorts, paper products, office stationery.
- 2293. VANAZ ENGINEERING PVT. LTD.** 396 Veer Savarkar Marg, Prabhadevi, Bombay 25. Factory: Unit 2, 85/1, Poud Rd., Pune 29. Tel. 57244 (3 lines). Cable. VANAZENG. Pune. Telex: 0145-379. Estd. 1949. Sister concern: Arudyog Engineers Pvt. Ltd., 18/6 Hadapsar Industrial Estate, Pune 13. Banks: Bank of Maharashtra, Pune and Bombay. Cap. Rs.48,20,326. Prod. Rs 1,98,46,056. Workers 421. Export. Rs. 1,30,545. Countries: United Kingdom, West Germany, Malaysia, Ceylon. Products: High pressure cylinder valves for industrial and medicinal gases. L.P.C./natural gas pressure regulators (domestic and industrial type) and other low pressure gauges; caliper brakes, coaster brake hubs and 3-speed hubs for bicycles; pressure vacuum valves, emergency vents and fusible links for tank lorries: non-ferrous forgings up to 4 kgs.; die-castings, swing forgemachines.
- 2294. VANDE MATARAM PRESS.** Raviwar Peth, Moti Chowk, Pune 2. Tel. 448032. Partnership, 1976. Bank: Bank of Maharashtra. Cap. Rs 60,000. Prod Rs.85,000. Workers 6 Products: Commercial printing and job work.
- 2295. VANITA SNUFF WORKS.** Plot No. 21/1 Hadapsar Industrial Estate, Pune 13. Tel. 7189. Partnership, 1949. Br. Saswad, Tal. Purandhar, Dist Pune Sister concern: Pataskar Brothers Bank: Bank of Maharashtra. Cap. Rs. 2,25,000. Prod. Rs 6,00,000. Workers 9. Products: Scented snuff, jarda.
- 2296. VANITA TEXTILES.** 35 Karve Rd., Erandawana, Pune 4. Tel. 56135. Partnership, 1961. Bank: Bank of India. Cap. Rs.25,000. Prod. Rs.50,000. Products: Mulmul, dhoti, khatav dyes and fabrics.
- 2297. VARDHAMAN METAL INDUSTRIES.** 580 New Guruwar Peth, Pune 2. Tel. 444941. Proprietary, 1947. Sister concern: Surana Industries, 647 Raviwar Peth, Pune 2. Bank: Bank of Maharashtra. Cap. Rs 2,00,000. Prod. Rs.50,000. Workers 9. Products: Polshing, finishing of all types of utensils.
- 2298. VARDHAN WORKS.** Pardi No. 1, Erandawana, Pune 4. Tel. 54086. Proprietary, 1961. Bank: State Bank of India. Cap. Rs 2,00,000. Prod. Rs 2,00,000. Workers 6. Products: Metallurgical microscopes, polshing machines, optical flats, optics of special types.
- 2299. VARDHAMAN TEXTILES.** 14 Hadapsar Industrial Estate, Pune 13. Tel. 7288, 7425, 7499. Proprietary, 1970. Br. Saswad, Dist. Pune. Products: Cotton fabrics, dhotis, voles, and mulmul.
- 2300. VARIETY AGENCIES.** 461/1 Sadashiv Peth, Tilak Rd., Pune 30. Tel. 443493. Cable: VARIETY. Partnership, 1961. Bank. Bank of Maharashtra. Cap. Rs.2,50,000. Prod. Rs. 10,00,000. Workers 7. Products: Paper products, binding.
- 2301. THE VARMA PHARMACY PVT. LTD.** 59 Hadapsar Industrial Estate, Pune 13. Tel. 7251. Estd. 1950. Banks: The United Western Bank Ltd; Bank of Maharashtra. Products: Allopathic medicines, ayurvedic medicines, cosmetics and household insecticides.
- 2302. VARSHA STEEL FURNITURE.** 1227 Raviwar Peth, Pune 2. Tel 441358 Proprietary, 1972. Bank: Bank of Maharashtra. Cap. Rs.25,000. Prod. Rs.70,000. Workers 3. Products: Kitchen table, racks, steel furniture.
- 2303. VARSHA TEXTILES.** 14 Hadapsar Industrial Estate, Pune 13. Tel 7288. 7425, 7997. Proprietary, 1970. Br. Saswad, Dist. Pune. Products: Cotton fabrics, dhotis and mulmul.
- 2304. VARTAKI TAPKIR KARKHANA.** 520 Shanwar Peth, Pune 30. Tel. 58023. Factory: 259 Shanwar Peth, Pune 30. Tel. 447202. Partnership. Banks: Bank of India; Central Bank of India. Cap. Rs 10,00,000. Prod. Rs.14,00,000. Workers 14. Product. Spuff.
- 2305. VASANT CHEMICAL WORKS.** 564 Budhwar Peth, Pune 2. Factory: 123 Kasba Peth, Pune 11. Proprietary, 1972. Sister concern: Swati Chemical Works, Bombay. Banks: Canara Bank; Poona Co-op. Rupee Bank Ltd. Cap. Rs 11,000. Prod. Rs 6,800. Workers 3. Products: Liquid detergent, and detergent powder.

- 2306. VASANT ENGINEERING WORKS.** Plot No. 102-A Hadapsar Industrial Estate, Pune 13. Tel. 7306. Partnership, 1963. Sister concern: Industrial and Air-power Accessories. Bank: The Shamaro Vithal Co-op. Bank Ltd. Cap. Rs.59,800. Prod. Rs.1,09,500. Workers 7. Products: Air compressor accessories like moisture separators, speed control assembly, blow down valve assembly, die grinder (pneumatic) and machine components.
- 2307. VASANT INDUSTRIES.** 27/2 Somwar Peth, Pune 11. Tel. 23916. Partnership, 1965. Bank: State Bank of India. Prod. Rs.2,00,000. Workers 9. Products: Diesel engine parts, machinery parts, material handling equipment, job work.
- 2308. VASANT PRAKASH.** 232-B Shukrawar Petha Hule Wada, Pune 2. Factory: S.No. 32/1/6-A Erandawana, behind Mehendale Garage, Pune 4. Proprietary, 1970. Bank: Bank of Maharashtra. Cap. Rs.26,000. Prod. Rs. 23,600. Workers 8. Products: Hollow and solid blocks of vibrated concrete, allied precast products like lintels, jalis, column blocks, planks.
- 2309. VASANT P. KOMKAR BROS.** 715 Guruwar Peth, 1374 Old Shukrawar Peth, Pune 2. Partnership, 1965. Cap. Rs. 35,000. Prod. Rs.80,000. Workers 8. Products: Job work of brass materials.
- 2310. VASANT PRINTING PRESS.** 1112 Budhwar Peth, Babu Genu Chowk, Pune 2. Tel. 443143. Proprietary, 1964. Bank: Poona Merchants' Co-op. Bank Ltd. Cap. Rs. 75,000. Prod. Rs.10,000. Workers 7. Product: Commercial printing.
- 2311. VASANT TAILORS.** 1013/16 Shivajinagar, Pune 16. Tel. 55449. Factory: 19 Kasba Peth, Ganesh Rd., Pune 11. Partnership, 1945. Sister concerns: Vasant, 1010 Shivajinagar, Pune 16; Industrial Suppliers, 1013/16 Shivajinagar, Pune 16. Banks: Bank of India; Central Bank of India. Cap. Rs.75,000. Prod. Rs.3,50,000. Workers 10. Products: Dealing in Binny Mills cloth, industrial workers' uniforms.
- 2312. VASCO INDUSTRIES** 81/82 Ganesh Bag, Mundhwa, Pune 36. Partnership, 1976. Bank of Maharashtra. Cap. Rs.60,000. Products: Wire nails, rivets.
- 2313. VASWANI DRESSES.** 957 Budhwar Peth, Pune 2. Tel. 445410. Proprietary, 1967. Bank: State Bank of India. Cap. Rs 1,00,000. Prod. Rs 10,00,000. Workers 30. Product: Readymade garments.
- 2314. VED-VIDYA MUDRANALAYA.** 41 Budhwar Peth, Pune 2. Tel. 445983. Proprietary, 1964. Banks: Poona Co-op. Rupee Bank; Bank of Maharashtra. Cap. Rs. 80,000. Prod. Rs.30,000. Workers 6. Product: Printing.
- 2315. VEE PRINTERS.** 601/1 Rasta Peth, Pune 11. Proprietary, 1968. Bank: Indian Bank. Cap. Rs 30,000. Workers 4. Products: Commercial printing, binding and stationery.
- 2316. VEEDEET ENTERPRISES.** 115 Shanwar Peth, Pune 30. Tel. 52085. Proprietary, 1972. Sister concern: Veeheet Enterprises. Bank: Bank of Maharashtra. Cap. Rs.1,50,000. Prod. Rs.2,00,000. Workers 14. Products: Sheet metal enclosures and control panels for electronic and electrical instruments and fabricated components.
- 2316A. VEEGO INSTRUMENTS CORPORATION.** 67-68 Parleshwar Society, Vile Parle (E), Bombay 57. Tel. 563299. Factory: 654 Shukrawar Peth, Pune 2. Proprietary, 1976. Sister concern: Thermolab Equipment Co. Bombay. Banks: United Western Bank Ltd. Cap. Rs. 28,000. Prod. Rs 80,000. Workers 4. Products: Scientific instruments and laboratory equipment, custom built equipments, and projects.
- 2317. VEENEET ENTERPRISES** 115 Shanwar Peth, Pune 30. Tel. 52085. Proprietary, 1976. Bank: Bank of Maharashtra. Cap. Rs 25,000. Prod. Rs 80,000. Workers 9. Products: Control panels and metal boxes for electronic and electrical instruments.
- 2318. VEERASHRI ENTERPRISES.** 15/16 Kaka Halwai Estate, Pune 9. Tel. 441971. Proprietary, 1976. Bank: Central Bank of India. Cap. Rs.50,000. Prod. Rs. 60,000. Workers 5. Products: Electrical suction apparatus, foot suction pumps, orthopaedic implants, hospital furniture.
- 2319. VEGUS ENGINEERING WORKS.** 461 Rasta Peth, Pune 11. Tel. 27978. Factory: 238-C Somwar Peth, Pune 11. Partnership, 1966. Bank: State Bank of India. Cap. Rs. 50,000. Prod. Rs.1,20,000. Workers 6. Products: Machinery spare parts, laundry washing machine, open kiers, dyeing jiggers and textile machinery spares.
- 2320. VENKATESWAR HATCHERIES PVT. LTD.** 13/6 Milestone, Pune-Panshet Rd., Gorbh Budruk, Girinagar Post Office, Pune 25. Tel. 442244. 445064. Cable: BABCOCK, Pune. Telex: 0145-329. Estd. 1971. Brs. Village Inzapur, P.O. Saroornagar, Hyderabad 35. Banks:

Union Bank of India; Bank of Baroda, Bank of India. Cap. Rs.101.47 lakhs. Prod. Rs 118 37 lakhs Workers 217. Export: Rs.65.83 lakhs. Countries Dubai, Bahrain, Damascus, Kuwait, Saudi Arabia and Gulf countries. Products: Day-old chicks, hatching eggs, poultry feed.

2321. VENKO INDUSTRIAL PACKAGERS. (Vyankatesh Trading Co.) Mukund Bhavan, 1105 Raviwar Peth, Pune 2. Tel. 446664. Factory: 102-B Hadapsar Industrial Estate, Pune 13. Tel. 7310. Partnership, 1973. Bank: Union Bank of India. Cap Rs 8 lakhs. Prod. Rs. 5,00,000. Workers 15. Products: All types of duplex, pulp board, mill board, multi-colours cartons, Vip exercise books, specialisation in varnishing.

2322. VENTILE COMPANY PRIVATE LIMITED. 692/1/6 Pune-Satara Rd, Kosa Roadways Compound, Pune 9. Tel. 441747. Estd. 1961. Bank: Dena Bank. Cap. Rs.1,50,000. Products: Dealership of International Tractor, agricultural implements, reversible plough, veterinary medicines and vitamin supplements, zolone EC pesticides and sellers of spares for tractors, ITCI implements, trailers and ploughs, service station of tractors.

2323. VENUS ENGINEERS. 362 Shukrawar Peth. Shivaji Rd., Pune 2. Proprietary, 1960. Bank: Bank of Maharashtra. Cap. Rs.1,00,000. Workers 7. Products: Water pump, oil engine repairing and spare parts.

2324. VENUS RUBBER INDUSTRIES. 5 Smbai Nivas, 382/2 Gokhale Nagar Rd, Shivajinagar, Pune 16. Factory: No. 5 F-2 Block, M.I.D.C., behind Telco. Pimpri Industrial Estate, Pune 18. Proprietary, 1974. Bank: Bank of Maharashtra. Cap. Rs.35,000. Prod. Rs 60,000. Workers 7. Products: Rubber goods such as oil seals, 'O' rings, other rubber parts for industrials and automobile industries, and all kinds of special quality rubber parts from natural and synthetic rubbers like neoprene, nitrile rubbers.

2325. VENUS WOODEN WORKS. 235 Mahatma Gandhi Rd., Pune 1. Partnership, 1971. Bank: Dena Bank. Cap. Rs.25,000. Prod. Rs.15,000. Workers 2 Product: Wooden blocks for electrical equipments.

2326. VERTEX CHEMICAL INDUSTRIES. 20 Plot No. Mayur Colony, Karve Rd., Kothrud, Pune 29. Tel. 54608. Cable: VERTEX. Head Office and Works at Krishna Nagar, G. T. Rd., Kanpur 7. Partnership, 1962. Bank: State Bank of India. Cap. Rs.2,00,000. Prod. Rs. 15,00,000. Workers 10. Products: Light camthoreinene, pyridine bases, antifoam, turkey red oil, linseed oil, thinners,

suppliers—crotonaldehyde, methanol, acetone, benzene, toluene, ethyl acetate, amyl acetate, butyl acetate, turpentine oil, castor oil and other industrial chemicals.

2327. VICTOR METER MFG. CO. 433 Centre Street, Pune 1. Tel. 28830. Proprietary, 1967. Bank: State Bank of India. Cap. Rs.1,00,000. Prod. Rs 60,000. Workers 2. Products: Fare Meters for auto rikshaws, taxi and tempo.

2328. VIDYADHAR METAL WORKS. 1231/3 Kelkar Wada, Near Shivaji Mandir, Peru Gate, Pune 30. Tel. 446338. Proprietary, 1948. Bank: Bank of Maharashtra. Cap. Rs.20,000. Prod. Rs.90,000. Workers 3. Products: All kinds of moulding, casting in ferrous and non-ferrous metals, job work.

2329. VIDYUT BLADE SHARPENING WORKS. 198 (old) Shukrawar Peth, 603 (new) Ghorpade Peth, Pune 2. Tel. C/o. 440680. Proprietary, 1962. Br. Bombay. Bank: Shri Suvarna Sahakari Bank Ltd. Cap. Rs 5,000. Prod. Rs.12,000. Worker 1. Product: Cutting-machine-blade sharpening, and plastic-cutter and metal-cutter sharpening.

2330. VIJAY BOX MFG. CO. B-5 Prakash Colony, Opp. Formica (I) Ltd, Bombay-Pune Rd., Aqurdi, Pune 35. Partnership, 1975. Bank: Bank of India. Workers 6. Products: All kinds of boxes for sweets, boxes for shoes.

2331. VIJAY DAL MILLS. 526 Ganesh Peth, Pune 2. Tel. 444262, 444644, 444728. Cable: VIJAYDAL. Factory: 597 Ganesh Peth, Pune 2. Partnership, 1976. Sister concern: Vithal Gangaram Menkar. Bank: Bank of Maharashtra. Workers 9. Products: Toordal, gramdal, moongdal, urid-dal, masoordal, mathdal, waldal, etc.

2332. VEEJAY ENGINEERS. 36 Pushpanjali, Panmala, Pune 30. Tel. 442285. Factory: S-94 Bhosari, M.I.D.C., Pune 26. Proprietary, 1975. Bank: State Bank of India. Cap. Rs.1,50,000. Prod. Rs.60,000. Workers 7. Products: Press components, filters, etc.

2333. VIJAY ENGINEERING. 55-A/4 Hadapsar Industrial Estate, Pune 13. Tel. 7315. Cable: PRECIBORE. Partnership, 1963. Bank: Bank of Maharashtra. Cap. Rs.9,00,000. Prod. Rs. 12,00,000. Workers 32. Products: Precibore tools, precision boring heads, preciboring bars, dial snap, gauges; comparator stands, precision vices, round boring tools, sip jig boring tools.

2334. VIJAY ENGINEERING WORKS, 228/29 Mangalwar Peth, Pune 11. Tel. 28154. Proprietary, 1962. Bank:

- Bank of Maharashtra. Cap. Rs.1,50,000. Prod. Rs.1,00,000. Workers 4. Products. All kinds of job work.
- 2335. VIJAY INDUSTRIES.** 1011 Sadashiv Peth, Pune 30. Factory: 201 Mangalwar Peth, Pune 11. Proprietary, 1969. Bank: Bank of India. Cap. Rs.70,000. Workers 4. Products: Water heaters, industrial heaters, electric stove, storage water boiler, electrical junction boxes, panel boards, concealed board, buffing, welding, heat treatments.
- 2336. VIJAY KADBA KUTTI.** 58 Mangalwar Peth, Barne Rd., Pune 11. Tel. 27174. Proprietary, 1971. Sister concern: Mangal Agency, 58 Mangalwar Peth, Pune 11. Banks: Janata Sahakari Bank; Sangli Bank. Cap. Rs. 10,000. Prod. Rs.30,000. Workers 4. Product: Kadaba cutting.
- 2337. VIJAY METAL INDUSTRIES.** 1199 Shukrawar Peth, 716 (new) Guruwar Peth, Khadak Mal Ali, Pune 2. Tel. 441284. Partnership, 1961. Banks: Bank of Maharashtra; Vidya Sahakari Bank Ltd. Cap. Rs.2,00,000. Prod. Rs.4,00,000. Workers 10. Products: Parts of filter covers and other industrial jobs.
- 2338. VIJAY PRINTING PRESS.** 170 Akurdi, Pune 35. Tel. 82630. Proprietary, 1967. Bank: State Bank of India. Cap. 1,00,000. Prod. Rs.1,25,000. Workers 8. Product: Commercial printing.
- 2339. VIJAY SEAT COVER WORKS.** 584 Nana Peth, Pune 2. Tel. 27730. Cable: KING SEAT. Partnership, 1969. Sister concern: Pawar Auto Accessories, 591 Nana Peth, Pune 2. Banks: The Corporation Bank; Bank of Maharashtra. Cap. Rs. 80,998. Prod. Rs. 5,41,022. Workers 12. Products: Seat, seat covers, bags of scooters, motor cycles and mopeds, pillion seats.
- 2340. VIJAY TEXTILES.** 35 Karve Rd., Erandawana, Pune 4. Proprietary, 1961. Bank: Bank of Maharashtra. Cap. Rs.28,000. Prod. Rs.18,600. Workers 6. Product: Grey Muls.
- 2341. VIJAY TURNING AND WELDING WORKS.** 370 Shivajinagar, Pune 5. Proprietary, 1965. Cap. Rs. 1,00,000. Workers 3. Products: Motor spare parts repairing and welding.
- 2342. VIJAY METAL INDUSTRIES.** 338 Ghorpade Peth, Pune 2. Tel. 446867. Proprietary, 1973. Bank: Bank of Maharashtra. Cap. Rs. 25,000. Prod. Rs. 70,000. Workers 9. Products: Non-ferrous castings, patterns, dies, die castings, machining, etc.
- 2343. VIJAYANAND ENGINEERING WORKS.** 24/25 Somwar Peth, Pune 11. Tel. req 24514. Proprietary, 1969. Bank: Central Bank of India. Cap. Rs.10,000. Prod. Rs. 1,50,000. Workers 6. Product: Job work.
- 2344. VIKAS ENGINEERING WORKS.** 38 Bopodi, Bombay-Pune Rd., Pune 3. Tel. 54263. Proprietary, 1967. Bank: Cosmos Co-operative Bank Ltd. Cap. Rs.25,000. Prod. Rs.16,000. Workers 4. Products: Turning, die punch work, pentagraph (wiper) type electric windscreen wiper, welding, etc.
- 2345. VIKAS INDUSTRIES.** 430 Kasba Peth, Pune 11. Proprietary, 1970. Bank: Miraj Bank. Cap. Rs.30,000. Prod. Rs.11,000. Products: Rickshaw horns, spare parts, side tank stoves and other charging articles of two and three wheelers.
- 2346. VIKAS INDUSTRIES.** 'Abhyudaya' Nissen Hut, Co-op. Housing Society, Building No. 2, Pune 30. Tel. 446189. Factory: A-106, 107 'H' Block, M.I.D.C. Industrial Area, Pimpri, Pune 18. Proprietary, 1976. Cap. Rs.21,000. Prod. Rs.50,000. Workers 4. Products: All sorts of transformers—single phase for varying voltages, currents, wattages required for electrical and electronic equipments; D.C. power packs and battery eliminators.
- 2347. VIKAS MASALA DEPOT.** 853 Bhawani Peth, near Chhaya Talkies, Pune 2. Tel. 26787. Proprietary 1964. Bank: Laxmi Bank. Cap. Rs.50,000. Prod. Rs. 50,000. Workers 2. Products: Masala, chatney powder, haldi powder, dhana powder, pickles, papad, etc.
- 2348. VIKAS PRECISION WORKS.** 568 Sadashiv Peth, near Gokhale Hall, Laxmi Rd., Pune 30. Tel. 443035. Factory:1875 Sadashiv Peth, Pune 30. Partnership, 1974. Bank: The Poona Co-op. Rupee Bank Ltd. Cap. Rs. 10,000. Prod. Rs 42,000. Workers 5. Products: Machinery and fabrication work.
- 2349. VIKRAM BELTS LTD.** 12-G Shanti Kunj, Opp. G.P.O., Pune 1. Tel. 23109, 25611. Cable: VEEBELTS. Factory: E-4 M.I.D.C. Industrial Area, Ahmednagar. Estd. 1976. Banks: Syndicate Bank; Vijaya Bank Ltd. Cap. Rs. 54,00,000. Workers 125. Products: Industrial Vee belts and fan belts.
- 2349A. VIKRAM TILES.** Plot No. 45, Shivajinagar, Pune 5. Tel. 52074, 52269. Banks: Bank of Maharashtra. Workers 45. Prod. Rs. 10,00,000. Products: Mosaic Terrazo, plain cement and multy marble tiles.

- 2350. VILAS ENGINEERING WORKS.** 132-B Mangalwar Peth, Pune 11 Tel. 28980 Proprietary, 1969. Bank: Bank of India Cap. Rs 50,000 Prod. Rs 10,000. Workers 4. Products: Job work, lock nuts, cap nuts, pistons, piston clutches, flanges, bushes, shafts.
- 2351. VILAS STEEL FABRICATORS.** 1260 Bhawani Peth, Pune 2. Tel. 26353, 440299. Factory: 34 Gultekadi Industrial Estate, Pune 9 Partnership, 1963 Bank: Central Bank of India. Cap. Rs.3,00,000. Prod. Rs 8,00,000. Workers 20. Products: Grill steel windows, steel doors, water tanks, compound gates, steel structures.
- 2352. VIMAL TEXTILES.** 14 Hadapsar Industrial Estate, Pune 13. Tel. 7288, 7425, 7497. Proprietary, 1971. Products: Cotton fabrics, dhotis, mulmul
- 2353. VIMULKAR ENGINEERING WORKS.** 335/B Shanwar Peth, Pune 30. Proprietary, 1973 Bank: State Bank of India. Cap. Rs 15,000 Prod Rs 15,000 Product. Sugarcane crushers.
- 2354. VINASHRI ENTERPRISES.** 1167 Raviwar Peth, Pune 2. Tel 446849 Proprietary, 1975. Banks: Bank of India; Dena Bank. Cap. Rs. 25,000. Prod. Rs 60,000. Workers 4. Products: Stickers, P.V.C. sticker paper, transfer labels, tin printing of display and advertisement boards.
- 2355. VINAY BULBS INDUSTRIES.** 156/2-B Hadapsar Industrial Estate, Pune 28 Tel 7559 Proprietary, 1969. Bank: Bank of India. Workers 12 Products: Electric lighting bulbs for decoration
- 2356. VINAY INDUSTRIES.** 14/10-A opp. Akashwani, Hadapsar, Pune 28. Tel 7415. Partnership, 1965. Bank: Bank of Maharashtra. Cap. Rs 60,000. Prod. Rs. 2,25,000. Workers 7. Products: Ferrous and non-ferrous castings and panels of rickshaw and taxi meters
- 2357. VINAYAK BHASKAR PATOLE.** 365 Raviwar Peth, Pune 2. Tel. C/o. 445969. Proprietary, 1921 Prod. Rs.30,000. Products: Lazim, wooden dumb-bells, Indian club, lagori set, skipping ropes, all types of physical exercise instruments.
- 2358. VINAYAK ENGINEERING WORKS.** 200 Mangalwar Peth, Pune 11. Tel. 27366. Proprietary, 1965. Sister concern: Vinayak Engineering Works, 97/98 Somwar Peth, Pune 11. Bank: Bank of Maharashtra. Cap. Rs.3,00,000. Prod. Rs 4,00,000. Workers 18. Product: Oil engine spare parts.
- 2359. VINAYAK INDUSTRIES.** 1243/1 'Samadhan, Apie Rd., Pune 4. Tel. 58254. Factory. 22/1 Hadapsar Industrial Estate, Pune 13. Tel. 7109. Partnership, 1966. Bank: Bank of Maharashtra. Cap Rs. 2,00,000. Workers 8 Products: Process control instruments—gelation timer, coulomb meter; process control equipment—electro chemical milling; control panel; size reduction equipment—vibratory ball mill, micronuser; environmental test chambers.
- 2360. VINAYAK PAPER BOX CO.** 1712 Sadashiv Peth, Pune 30. Factory: 1708 Sadashiv Peth, Pune 30. Partnership, 1973. Bank: Bank of India. Cap. Rs.20,000. Prod. Rs.50,000. Workers 2. Product: Paper boxes.
- 2361. VINEET LAGHU UDYOG.** 1038/4 Gokhale Rd., Shivajinagar, Pune 16 Tel. 53597. Partnership, 1969. Bank: Janata Sahakari Bank Ltd. Cap. Rs 43,250. Prod. Rs. 87,000 Workers 4 Product Turning and milling components.
- 2362. VINAYAK UDYOG NIWAS.** 107 Budhwar Peth, Jogeshwari Lane, Pune 2. Factory: 262 Nana Peth, Pune 2 Proprietary, 1968 Sister concern: Deodhar Brothers. Bank: Bank of Maharashtra. Cap. Rs 20,000 Prod. Rs 60,000 Workers 5. Products Blocks and wooden batton for electrical fittings.
- 2363. VINOD BOOK MANUFACTURER.** 207 Mangalwar Peth. Wellesley Rd., Pune 11. Tel. 24473 Partnership, 1963 Sister concerns N.A. Gandhi, Madras, National Paper Mart, Pune. Bank: Canara Bank Cap. Rs 60,000. Prod. Rs 2,50,000 Workers 8. Products Exercise books, account books, office files, commercial printing.
- 2364. VIPIN INDUSTRIES.** 153 Kasba Peth, Near Kasba Ganpati, Pune 11. Tel. 446788 Proprietary, 1969. Sister concern: Sangita Transport, 153 Kasba Peth, Pune 11. Bank: Bank of Maharashtra. Cap Rs 50,000. Prod. Rs 1,00,000 Workers 8. Products: Wooden and steel furniture, fabrication and job works
- 2365. VIPUL CHEMICAL CORPORATION.** Western Petrol Dept, opp. Shivaji Statue, Shivajinagar, Pune 5. Tel. 56809. Factory: 43/1 F-II Block, MID C., Pimpri, Pune 18. Tel. 83108. Partnership, 1977. Sister concern: M.M. Enterprises. Bank: Bank of Maharashtra. Prod. Rs. 10,00,000. Workers 8. Products. Nigrosine spirit soluble oil soluble, water soluble.
- 2366. VISH ENGINEERS.** 117A/2 Vijay Bhavan, Lakaki Rd., Pune 16. Tel. 54134. Factory. S.No. 32-B,

- Hissa No. 6, Hutatma Narayan Dabhade Rd., Dapodi, Pune 12. Proprietary, 1974. Banks: Bank of Maharashtra; Central Bank of India. Cap. Rs.28,650. Prod. Rs.75,000. Workers 6. Products: Steel windows, grills, structural steel works such as trusses, columns, collapsible gates, compound gates, railings, industrial gratings etc.
- 2367. VISHAL ENGINEERING WORKS.** 200 Mangalwar Peth, Kadba Bazar, Kudle Estate, Pune 11. Proprietary, 1969. Bank: State Bank of India. Products: Machinery components, swivel end fittings for hose pipes.
- 2368. VISHAL PACKING INDUSTRIES.** 312 Mahesh Chambers, Hemu Kedari Rd., Pimpri, Pune 17. Tel. 82049. Cable: WISHALL. Partnership, 1975. Sister concerns: Radhika Medical & General Stores; Radhika Chemicals. Bank: Syndicate Bank. Cap. Rs.1,00,000. Prod. Rs. 3,50,000. Workers 8. Products: Corrugated and cardboard boxes plain and printed, suppliers of packing materials.
- 2369. VISHWA METAL INDUSTRIES.** 557 Guruwar Peth, Kasturi Chowk, Pune 2. Tel. 444655, 447046. Partnership, 1972. Sister concerns: B.C. Mehta & Co., Kirti Metal Rolling Mill. Bank: State Bank of India. Cap. Rs.2,00,000. Prod. Rs.9,00,000. Products: Aluminium utensils, kitchen wares and spare parts.
- 2370. VISHWAS ENGINEERS.** 603B Sadashiv Peth, Pune 30. Tel. 443612. Proprietary, 1958. Banks: The Cosmos Co-op. Urban Bank Ltd.; Bank of Maharashtra. Cap. Rs.13,282. Prod. Rs.82,600. Workers 2. Products: Air compressor (small type cycle air compressor), refrigeration, air conditioning valve assembly.
- 2371. VISHWAJIT ENGINEERING WORKS.** 228/29 Mangalwar Peth, Pune 11. Proprietary, 1969. Bank: Poona Merchants' Co-op. Bank Ltd. Cap. Rs.11,000. Workers 3. Products: Fabrication, steel windows, grills, water tank.
- 2372. VISHWAKARMA MUDRANALAYA (PVT.) LTD.** 405 Narayan Peth, Pune 30. Tel. 444118. Estd. 1946. Sister concern: Vishwakarma Sahityalaya. Bank: Bank of Maharashtra. Workers 15. Products: Commercial printing, publishers and job work.
- 2373. VISHNU METAL INDUSTRIES.** Vadgaon Sheri, Pune 14. Tel. 26654. Cable: BRASS. Partnership, 1969. Bank: Dena Bank. Cap. Rs.9,00,000. Prod. Rs.20,00,000. Workers 35. Products: Non-ferrous (brass) circles, sheets and utensils.
- 2374. VISHNU TIMBER MART.** 110 New Timber Market, Pune 2. Tel. 446842. Partnership, 1969. Sister concern: Naw Durga Saw Mills. Bank: Union Bank of India. Cap. Rs.2,00,000. Prod. Rs.2,50,000. Workers 4. Export: Rs.10,000. Country: Dubai. Products: Wooden cases, wooden cut size.
- 2375. VISHRAM.** 399 Budhwar Peth, Pune 2. Tel. 447736. Partnership, 1963. Bank: Bank of Baroda. Cap. Rs. 50,000. Prod. Rs.1,00,000. Workers 3. Products: Mattresses, pillows.
- 2376. VISHWAKARMA SAW MILL.** Vadgaon Numbalkar, Tal Baramati, Dist. Pune. Proprietary, 1975. Bank: Bank of India. Cap. Rs.47,771. Prod. Rs.35,000. Workers 6. Products: Wooden boxes for grapes, saw mill.
- 2377. VISHWAKARMA SAW MILLS.** Plot 29, New Timber Market, Pune 2. Tel. 24593. Proprietary, 1954. Sister concern: Vishwakarma Saw Mills. Banks: Central Bank of India; Punjab National Bank. Cap. Rs.30,000. Prod. Rs. 1,00,000. Workers 6. Products: Packing boxes, teak wood, wooden furnitures.
- 2378. VISHWAKARMA WORKSHOP.** Bombay-Pune Rd., 446/4 Kasarwadi, Pune 18. Proprietary, 1972. Bank: Miraj. State Bank Ltd. Cap. Rs.20,000. Prod. Rs.60,000. Workers 6. Products: Machinery and auto spares and job work.
- 2379. VITHAL TEXTILES.** 'Kunden House', 1150 Bhawani Peth, Pune 22. Tel. 23837. Cable: KUNDAN SARI. Factory: Plot No. 33/40 Gultekadi Industrial Estate, Pune 9. Tel. 442812. Proprietary, 1968. Bank: Bank of Maharashtra. Cap. Rs.25,000. Prod. Rs.1,30,000. Workers 9. Product: Cotton cloth.
- 2380. VITHALDAS NARAYANDAS AND SONS.** 755/56, Budhwar Peth, Phadke Haud, Pune 2. Tel. 448587. Cable: UDBATTI. Partnership, 1883. Banks: State Bank of India; Punjab National Bank; Bank of Maharashtra. Cap. Rs.4,10,314. Prod. Rs.6,14,935. Workers 45. Export: Rs.1,31,810. Countries: Iraq, U.S.A., Qatar, U.K., Holland. Product: Agarbatties.
- 2381. VITRONICS.** 296 Shanwar Peth, Bapatwadi, Pune 30. Tel. 446482. Proprietary, 1976. Cap. Rs.2,000. Prod. Rs.10,000. Worker 1. Products: Loud-speaking intercom sets, transformers, voltage stabilisers for TV, freeze, power supplies, battery eliminators for tape recorders, radios and calculators, electronic timers, burglar alarms, temperature controllers.

2382. VIVEK ENTERPRISES. 42 Ashok Nagar, Pune 7. Tel. 54561. Partnership, 1969. Br. Bombay. Bank: Bank of Maharashtra. Cap. Rs 2,00,000. Prod. Rs.5,00,000. Workers 10. Products: Industrial heavy duty surfacings; viz. acid-alkali resistant, heavy duty shock and impact proof wear resistant; oil resistant; industrial insulations of all types, bridge and road wear resistant toppings, frictional surfacings, industrial water proofings.

2383. VIVIDH YANTRA. 1370 Shukrawar Peth, Natu Baug, Pune 2. Tel. 50151. Proprietary, 1964 Bank: Cosmos Co-op. Bank Ltd. Cap. Rs 60,000. Prod. Rs.2,00,000. Workers 7. Products: Poultry equipments viz. laying cages, broiler cages, brooding cages, calponion cages, feeders, waterers, etc draftsman's revolving chairs.

2384. VORA MACHINERY WORKS. 358 Shukrawar Peth, Shivaji Rd., Pune 2. Tel. 440025. Partnership, 1940. Bank: Dena Bank. Cap. Rs 3,00,000. Prod. Rs 2,00,000. Workers 20. Products: Split pulley, V groved pulleys, flour mills, hullar, pulveriser, etc.

2385. VRINDA PRINTERS. 635 Sadashiv Peth, Abhyankar Wada, Pune 30. Proprietary, 1977. Bank: Central Bank of India. Cap. Rs 30,000 Prod. Rs 70,000. Workers 7. Products: Commercial printing, book printing, stationery.

2386. VULCAN LAVAL LTD. Bombay-Pune Rd. Dapodi, Pune 12. Tel. 82521, 82522, 82523. Cable: NORDIC. Telex: 0145-219. Registered Office, Mustafa Bldg, 74 Sir P. M. Road, P. O. Box. No. 735. Bombay 1. Tel. 260386, 265661, 267056, 269161. Cable: NORDIC. Telex: By 4108. Estd. 1937. Brs. Bombay, New Delhi, Calcutta, Bangalore, Madras. Banks: Bank of India; Grindlays Bank; Vjaya Bank. Foreign collaboration: Arenco AB, Sweden; ALFA-LAVAL AB, Sweden; ANHYDRO, Denmark; Lurgi (India) Ltd; Skoda India Ltd. Cap. Rs. 53.34 lakhs. Prod. Rs.10 crores. Export: Rs.20 lakhs. Countries: U.S.A, Iran, Iraq, Sri Lanka, South-east countries. Products: Development, manufacture and erection of complete range of machineries for dairy, brewery, cattle feed, refrigeration, spray dryer plants. Product range also covers match-making machines, ice-cream machine, immersion cooler, stainless steel pump, plate heat exchanger, industrial separator and refining units, refrigeration compressor, milk chilling units, road and rail milk tankers, S. S. vessels.



2387. WADAKE R. P. 817 Budhwar Peth, Pune 2. Tel. 445736. Factory: 1150 Kasba Peth, Pune 11. Partnership, 1957. Br. Sales Depot at 817 Budhwar Peth, Pune 2. Bank: Bank of India. Cap. Rs.25,000. Prod. Rs.6,00,000. Workers 6. Product: Brass utensils.

2388. WAHGURU ENTERPRISES. 2406 East Street, Pune 1. Tel. 27887. Factory: 715 Bhawani Peth, near Poona College, Pune 2. Partnership, 1974. Banks: Punjab National Bank, Pune, Bombay. Cap. Rs.1,00,000. Prod. Rs.1,00,000. Workers 2. Products: Printing types, leads, lead rules spaces, borders etc., material for printing presses.

2389. WAIKAR ENGINEERING WORKS. 31 Bombay-Pune Rd., Bopodi, Pune 3. Partnership, 1964. Bank: Bank of Maharashtra. Cap. Rs.45,000. Prod. Rs.80,000. Workers 6. Products: Water oblate manifold of oil engine, stud for clutwheel, hand press items, driving gear of oil engines, job work.

2390. WALCAR CHEMICALS. S-40-B Government Industrial Estate, Parvati, Pune-Satara Rd., Pune 9. Tel. 443008. Cable: CHEMWALCAR. Proprietary, 1973. Banks: Bank of Maharashtra; Central Bank of India. Cap. Rs 65,000. Prod. Rs.1,32,000. Workers 3. Products: Pesticides and insecticides—endosulfan, D.D.T., malathion, B.H.C., carbaryl.

2391 WANDLESIDE NATIONAL CONDUCTORS LTD. Nagar Road, Pune 14. Tel. 25211, 25212, 25213. Cable: WANDLESIDE. Telex: Wencee PN 0145-241. Estd. 1961. Br. H. O. Bombay. Sister concerns: The National Electrical Industries Ltd., Crescent Iron and Steel Co. Ltd., Bombay. Banks: United Bank of India. Canara Bank. Cap. Rs. 19.99 lakhs. Prod. Rs. 2.83 crores,

Workers 230. Products: Varnish bonded glass braided rectangular and round copper conductors; enamelled and glass lapped rectangular and round copper conductors; enamelled rectangular copper conductors; cotton-covered rectangular and round copper conductors; silk/rayon covered round copper wires; kapton insulated rectangular and round copper conductors; PTFE—insulated copper wires, paper covered bunched and rope-stranded flexible copper conductors for use in transformers as leads; bare copper conductors; flexible insulating sleeveings for electrical use; terminal lead wires for hermetic motor services; woven tapes; tinned copper-strips/foils/round wire; nomex covered conductors; teflon moulded components; flexible braids; PVC winding wires; resi-glass tapes, stage 'B' (semi-cured).

2392. WANDREKAR ELECTRONICS. 917/5 Ganesh Wadi, Fergusson College Rd., Pune 4. Tel. 55450. Proprietary, 1977. Bank: Bank of Baroda. Cap. Rs.25,000. Prod. Rs. 1,00,000. Workers 2. Products: Automatic voltage regulators—single phase, three phase; precision electronic timers; ampere hour meters; preset module for ampere hour meters.

2393. WANSON (INDIA) PVT. LTD. M.I.D.C. Plot No. 13, Chinchwad, Pune 19. Tel. 83550, 83303, 83304, 83305, 83062, 83063. Cable: 'VAPORAX' Poona-Chinchwad, Telex: 0145-334. Estd. 1966. Brs. Bombay, Delhi, Madras, Calcutta and Bangalore. Sister concern: Thermax (India) Pvt. Ltd. Banks: Union Bank, Bank of Baroda, Canara Bank, Pune; and Dena Bank, Bombay. Cap. Rs.1,54,77,487. Prod. Rs.4,73,63,700. Workers 324. Export: Rs.1,43,92,759. Countries: USSR, Canada, Iran, Mauritius, Bangladesh, Nepal, Kuwait, Iraq, Kenya, Australia, West Germany, Nigeria, Thailand. Products: 'Vaporax' packaged fully automatic instant steaming boilers, multitherm—multifunctional boilers; thermopac—thermic fluid heaters; thermobloc—hot air generators; incinex—incinerators; hydrobloc—hot water generators; vapor jet—steam cleaners; dal dryers; grain/seed dryers; seed/grain drying/storage systems; seed processing centres; cars spray painting and drying booths.

2394. WATERLOO DIESEL FUEL INJECTION SERVICE. 461/2 Sadashiv Peth, Pune 30. Tel. 443148. Proprietary, 1969. Bank: State Bank of India. Workers 12.

2395. WAVELINE SERVICES. 1st floor, Sewasadan Bldg., Laxmi Rd., Pune 30. Tel. 444625. Proprietary, 1971. Bank: Bank of Maharashtra. Cap. Rs.60,000. Prod. Rs. 1,20,000. Workers 8. Export: Earned Canadian dollars through indirect sales (through an agent). Products:

Pocket size electronic thermometers; portable type and panel mounting type electronic thermometers; temperature controllers; rocket size r p m. meters; R. F. chokes and coils covering almost full range of inductances.

2396. WEIGHTSCALE COMPANY. Bombay-Pune Rd., Kasarwadi, Pune 18. Tel. 82780. Cable: 'TARAZU'. Partnership, 1963 Br. Secunderabad. Bank: Bank of Maharashtra. Cap. Rs.8,00,000. Prod. Rs.12,00,000. Workers 30. Products: Spring balances, platform scales, dormant scales, weigh bridges.

2397. WEIKFIELD PRODUCTS CO. (INDIA) PVT. LTD. Weikfield Estate, Nagar Rd., Pune 14. Tel. 23963, 20744. Cable: WEPROCO. Telex: Pn 0145-285 AB: Weproco. Estd. 1956 as partnership and 1972 as Ltd. Co. Br. Associate marketing Offices in Bombay, Ahmedabad, New Delhi, Chandigarh, Calcutta, Madras, Bangalore. Banks: Dena Bank; Bank of India; State Bank of India. Export countries: United Arab Emirates, Sultanate of Oman, Qatar, Bahrain, Kuwait, Saudi Arabia, Iran, Iraq, Ethiopia, Sudan, Kenya, Tanzania, Malaysia, Singapore, Thailand, Indonesia and Philippines. Products: Baking powder; baker's hoppe mix; vanilla concentrated powder, aljofoma, ice cream freeze, custard powder, variety custard powder (six flavours); cornflour, blanc-mange powder, jelly crystals; mustard powder (superfine); ice cream mix powder, glucose-d powder, arrowroot powder, wep cleanser, laundry starch powder.

2398. WELDONE ENGINEERS. 59/2 Bharatnivas Colony, off Karve Rd., Erandawana, Pune 4. Tel. 54021. Factory: W-7, M.I.D.C., Bhosari, Pune 26. Proprietary, 1973. Bank: Bank of Baroda. Workers 5. Product: Turned components.

2399. WEST INDIA CHEMICALS LTD. No 7 Modibag, Ganeshkhind Rd., Pune 16. Tel. 54009. Cable: SULPHACID. Factory: P O. Lonikalbhor, Tal. Haveli, Dist. Pune. Tel. 7408, 7409. Estd. 1949. Banks: Bank of Maharashtra; Central Bank of India. Cap. Rs.112.35 lakhs. Prod. Rs.217.52 lakhs. Products: 16% P 205 single superphosphate (fertiliser); 99% sulphuric acid.

2400. WESTERN INDIA CERAMICS. 505 Kalbadevi Rd., Bombay 2. Tel. 311874. Factory: E/16 Bhosari Industrial Area, Pune 26. Tel. 83126. Partnership, 1972. Bank: State Bank of India.

2401. WESTERN INDIA ERECTORS LIMITED. Sahyadri Sadan, Tilak Rd., Pune 30. Tel. 440072, 440118, 440319. Cable: 'ERECTORS'. Telex: 0145-221. Estd.

1971. Sister concerns: Western India Industries Ltd.; Western India Sales and Service, Sahyadri Udyog, Sahyadri Constructors P. Ltd. Sahyadri Structural P Ltd. Banks: Bank of Maharashtra, United Commercial Bank. Cap. Rs.196 lakhs. Prod. Rs 469 50 lakhs. Workers 1683. Export: Rs. 1.83 crores. Country: Kuwait Products: Industrial Engineers and constructors

2402. WESTERN INDIA FLOUR MILLS. Props. Alsales Ltd, 103/104 Hadapsar Industrial Estate, Pune 13. Tel. 7236, 7101 Cable: Alsales, Pune. Estd. 1964. Bank: Dena Bank. Cap. Rs.15,00,000 Prod Rs 3,50,00,000. Workers 77 Products: Wheat products i.e wheat flour, atta, rawa and bran

2403. WESTERN MICRO FERTILIZERS PVT. LTD. 1223 Shivajinagar, 'Madhuban', Pune 4 Tel. 56569. Estd 1975 Bank: Bank of Maharashtra. Cap Rs 1,00,000. Prod Rs. 2,80,000. Workers 6. Products: Nitro-ne-AZ; nitro-ne-RH; Bacterial cultures micromin—micronutrients.

2404. WESTERN PAPER BOX SYNDICATE. 786 Budhwar Peth, Pune 2 Tel. 24347. Factory: Tel 445647. Partnership, 1959. Br Solid Packaging Industries, Gultekadi Industrial Estate, Pune 9. Sister concern: Western India Services (I) Pvt Ltd. Pune 1 Bank. State Bank of India. Prod. Rs.10,00,000 Workers 9 Products: Corrugated sheets, rolls, boxes, cardboard, duplex and export boxes and other packing material.

2405. THE WHITE CLOUD PAPER MILLS. 412 Gultekadi Rd., Pune 9. Tel. 441078 Cable: WHITECLOUD. Partnership, 1963. Bank: Bank of Maharashtra. Cap Rs. 8,64,150. Prod. Rs.9,27,780. Workers 136 Export: Rs.74,245. Countries: Iraq, Baghdad. Products: Various filter papers, pads for pharmaceuticals, breweries, distilleries, antibiotics, electroplating, paint and varnishes, rayon and tyre cord, industries and electricity boards for filtering transformer oil etc.

2406. WHITE CLOUD TRADING CORPORATION. 412 Gultekadi Rd, Pune 9. Tel C/o. 441078. Cable: C/o. WHITECLOUD. Partnership, 1976. Sister concerns: The White Cloud Paper Mills; The White Cloud Hand-made Pulp and Paper Manufacturers Bank. Bank of Maharashtra.

2407. WOOD-CRAFTS MFG. CO. Plot No. S-I, S-II, S-III, Parvati Industrial Estate, Swargate, Pune-Satara Rd., Pune 9. Tel. 441673 Cable-INTIGRITY. Proprietary, 1946. Sister concerns: Purohit and Purohit; Vaman D.

Purohit and Sons; Die Castings & Forgings, Pune. Bank: Bank of Maharashtra. Products: Corrugated paper, corrugated board and containers, paper boxes, general paper products, office files, stationery, wood-boxes, novelties.

2408. WOOD CRAFT. Plot No. 9, 'S' Block, Pune 26. Tel. 25925. Partnership, 1974. Sister concern: S B. Traders and Fabricators. Bank: Dena Bank. Cap Rs.2,00,000. Prod Rs 4,50,000. Workers 9. Products: Wooden packing cases, wooden planks of all sorts of jungle wood.

2409. WOOD PRODUCTS MANUFACTURING COMPANY. 104 M.I.D.C., P. B No. 20, Bhosari, Pune 26. Tel. 82457. Proprietary, 1968. Bank: Bank of Baroda. Cap. Rs 1,00,000. Prod. Rs 12,00,000. Workers 40. Products: Wooden packing cases, wooden furniture, wood-wool, wooden pallets, wooden crates, etc

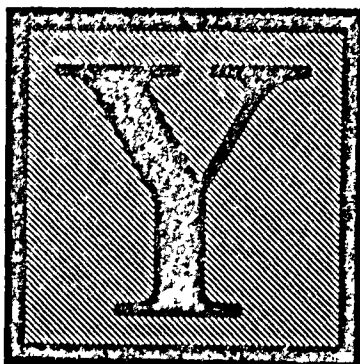

- 2410. YAD AUTO VENTURE.** 62A Somwar Peth, Pune 2. Tel. 24585. Partnership, 1971. Bank: State Bank of India. Cap. Rs 25,000. Workers 6 to 10. Products: Plant protection machinery, power sprayers operated by small petrol engine for insecticides and pesticides sprayings, complete power sprayer and its accessories replacement parts.
- 2411. YANTRIK.** Gowardhanwadi, Pune 9. Tel. 441506. Partnership, 1970. Bank: Bank of Maharashtra. Cap. Rs.45,300. Prod. Rs.1,75,000. Workers 7. Products: Axles pinions, trolley wheels, gear blanks for handling equipment, jobs of close tolerances and intricate profiles.
- 2412. YANTRA-NIRMAN.** 707 Narali Baug, Gultekadi Rd., Pune 9. Tel. 442819. Partnership, 1970. Bank: Bank of Maharashtra. Cap. Rs.1,25,000. Prod. Rs 3,00,000. Workers 9. Products: Engine cooling water circulating pumps for diesel engines; furnace oil lineat flow control valves; special machines.
- 2413. YAPISHIKA CHEMICALS PVT. LTD.** T-24-27, M.I.D.C., Bhosari, Pune 26. Tel. 82727, 55432. Estd. 1970. Bank: Sangli Bank. Cap. Rs.10,00,000. Prod. Rs. 4,00,000. Workers 25. Products: Sodium hydro sulphite, zinc hydro oxide, zinc sulphite.
- 2414. YASHASHRI PLASTICS.** 167 Happy Colony, Kothrud, Pune 29. Tel. req. 58440. Proprietary, 1973. Bank: Bank of Maharashtra. Cap. Rs 10,000. Prod. Rs. 35,000. Workers 3. Products: plastic moulding, plastic moulds making sheet metal press parts.
- 2415. YASHODA TEXTILES.** 1150 Bhawani Peth, Pune 2. Tel. 23837. Cable: KUNDAN SARI. Factory: 33/40 Gultekadi Industrial Estate, Pune 9. Tel. 442812. Bank: Bank of Maharashtra. Cap. Rs.26,000. Prod. Rs. 1,96,000. Workers 8. Product: Cotton cloth.
- 2416. YESHWANT ENGINEERING WORKS.** 3 Sarvadarshan Society, Karve Rd., Pune 4. Tel. 57280. Factory: A-114, 'H' Block, M.I.D.C., Pumpri, Pune 18. Tel. 83099. Proprietary, 1974. Bank: Bank of Maharashtra. Cap. Rs. 1,50,000. Prod. Rs.3,80,000. Workers 15. Products: Automobile spares; M.S. tanks—circular, rectangular etc.; lead lined tanks; M.S. pallets, partitions, gates, heavy fabrication as trusses, etc.
- 2417. YASHWANT INDUSTRIES.** 16/3 Erandawana, Karve Rd., Pune 4. Tel. 58331. Partnership, 1963. Bank: Bank of Maharashtra. Cap. Rs.56,363. Prod. Rs.2,34,514. Workers 6. Products: Turning, welding, plate bending, pipe bending and structural work.
- 2418. YASHAWANT MUDRANALAYA.** 1835 Sadashiv Peth, Pune 30. Tel. 440495. Proprietary, 1966. Bank: Janata Sahakari Bank Ltd. Cap. Rs.30,000. Prod. Rs. 50,000. Workers 9. Products: Commercial printing and stationery.
- 2419. YASHWANT TRADING CO.** 191 Kasba Peth, Pune 11. Tel. 447441. Partnership, 1968. Bank: United Western Bank Ltd. Cap. Rs.10,000. Product: Rubber stamps.
- 2420. YESHWANT WELDING WORKS.** 16/236 Lokmanya Nagar, Pune 30. Factory: 408/6 Gultekadi Rd., Pune 30. Tel. 449566. Proprietary, 1964. Br. Block No. B-22, M.I.D.C., Satara. Bank: The United Western Bank Ltd. Cap. Rs.15,000. Prod. Rs.30,000. Workers 5. Products: Automobile spare parts, sheet metal work, trolleys, tanks, pallets, gates, general fabrication.
- 2421. YUNUS TIN FACTORY.** 46 Ganesh Peth, Pune 2. Tel. 448645. Proprietary, 1965. Bank: Indian Overseas Bank. Cap. Rs.55,000. Prod. Rs.25,000. Workers 3. Products: Tin containers and calendar tin mounting, allied products.

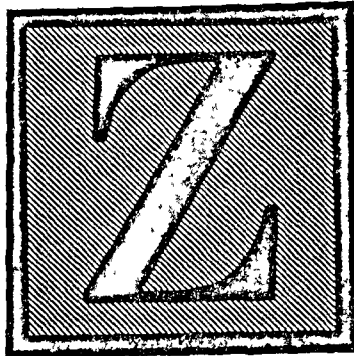

2422. ZENITH INDUSTRIAL CORPORATION.

Kusum Bhawan, Nasik Phata, Shop No. 5, Kasarwadi, Pune 18. Tel. 82501. Factory: General Block, T-100, Telco Rd., Bhosari, Pune 26. Tel. 82947 Estd. 1977. Bank: Bank of Baroda. Cap. Rs. 1,00,000. Workers 10. Products: Job work, chemically pickling and phosphering rust remover and other sand jobs.

2423. ZENITH CEMENT UDYOG.

28 Shivajinagar, Pune 5. Tel. 54008, 57772. Proprietary, 1970. Sister concerns: Zenith Tiles Manufacturers; Zenith Paper Industries. Bank: State Bank of India. Cap Rs.35,000. Prod. Rs. 1,13,000. Workers 6. Products: Folding kitchen platforms, mosaic garden benches, decorative cement grills, high polished and machine-cut black cuddapa and marble for paneling, kitchen otta, flooring, window sills, steps etc., decorative R C C hollow blocks.

2424. ZENITH TILES MANUFACTURERS.

28 Shivajinagar, Pune 5. Tel. 57772, 54008. Proprietary, 1959. Sister concerns: Zenith Cement Udyog; Zenith Paper Industries. Bank: State Bank of India. Cap. Rs 1,06,000. Prod. Rs. 3,29,000. Workers 15. Products: Flooring tiles, cement, coloured cement tiles, cement and coloured mosaic, ferrozo and marble tiles, paving and industrial tiles, steps and chequered tiles.

SERUM INSTITUTE OF INDIA

283, Mahatma Gandhi Road, Pune 411 001

Telephones : 26959, 36725, 26964

Telex : 145-317 SERA IN

Manufacturers of life-saving biologicals :

TRIPLE ANTIGEN B.P.

DUAL ANTIGEN B.P.

TETANUS TOXOID FT I.P.

TETANUS TOXOID PTAP B.P.

TETANUS ANTITOXIN I.P.

DIPHThERIA ANTITOXIN I.P.

Sole Distributors :

INTERFARMA DISTRIBUTION

806, 8th floor, Prasad Chambers,

Opera House, Bombay 400 004

Telephones : 369961, 364889.

Telex : 11 3460 VAC IN

Bharat Forge Company Limited

**Mundhwa
Pune 411 036**

Manufacturers of
**Quality Steel Forgings,
Ring Rolled Flanges
and
Finish Machined Crankshafts
for
Automobiles, Defence, Railways,
Diesel Engines, Shipbuilding
and
Petrochemical Industries**

DO YOU KNOW ?

MSFC can help you in many attractive ways.

Here are some of them :

- * Technicians can get loans upto Rs. 5 lakhs for starting their own industrial projects on 15% margin.
- * Young technicians can get loans upto Rs. 1.50 lakhs for starting industrial projects, on 15% margin.
- * Financial assistance upto Rs. 5 lakhs for acquisition of Generating sets available to our clients on 35% margin.
- * We give seed capital assistance to meet the gap in equity to be brought in by the promoters.
- * Units assisted by us which are in existence atleast for last 5 years can get concessional finance under our scheme for modernisation of machinery.
- * We assist industries to import plant and machinery from any of the World Bank countries, under the World Bank Loan Scheme.
- * Industrial units in backward districts of Maharashtra and Goa, Daman and Diu can obtain loans at concessional rates.
- * Limited companies and co-operatives can get finance upto Rs. 30.00 lakhs and proprietary and partnership firms can get finance upto Rs. 15.00 lakhs.

Maharashtra State Financial Corporation

New Excelsior Building
Amrit Keshav Nayak Marg,
Fort, Bombay - 400 001.

Regional Offices at Bombay, Pune, Kolhapur, Nasik,
Aurangabad, Nagpur and Panaji, Goa.

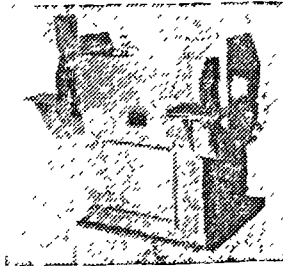

Manufacturers of :

Full Range of Foundry Equipment

- Melting Furnaces Shell Moulding Plant
- Sand Mills Core Sand Mixers
- Grinders Core Ovens Tumbling Barrels etc.

Material Handling Equipments :

- All Types of Conveyors Elevators
- Screw Conveyors Idlers etc.

Chemical Plant Equipment

- Pressure Vessels Stirrers Mixers & Kneaders Ball Mills
- Dryers Heat Exchangers, etc.

Manufacturers:

ABLE ENGINEERING CO.

38/579, Lokmanyagar, Pune 411 030.

People of Fastidious Taste

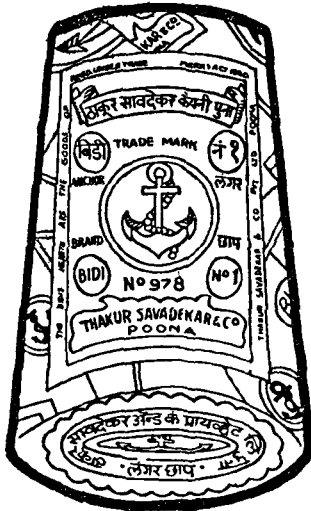

Always Smoke.....

ANCHOR Brand BIDIS

- A Super Fine Product
- Made of Highclass Tobacco and Tendu Leaves

Other Brands :

Shankar, Horse, Lion, Lantern, Bombay Langar, Pari etc.

Manufacturers :

THAKUR SAVADEKAR & CO. LTD.

377 Guruwar Peth,
Pune 411 002.

Phone : 444730 ■ Telex : DHUMRAPAN

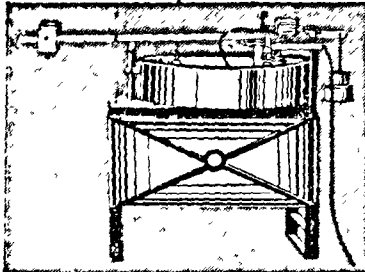

Abrasion Testing Machine

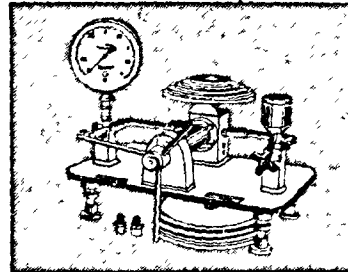

Pressure Gauge Tester

Research Polariscope

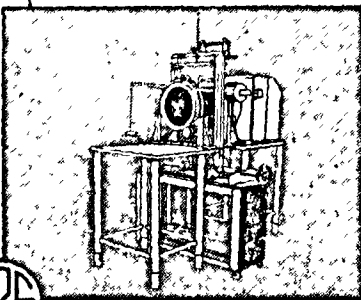

Glass Polarimeter

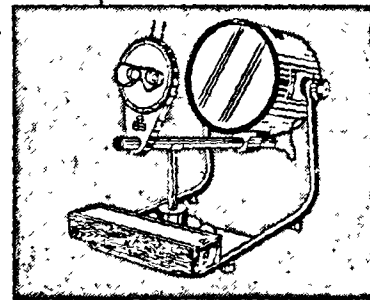

EQUIPMENT FOR RESEARCH & DEVELOPMENT, QUALITY CONTROL & TESTING

Indispensable to progressive R & D Establishments, Laboratories and Industries, the range of equipment is developed by India's pioneers in the field.

Besides in-built precision and complete reliability, it is backed by our prompt service-after-sales.

Wide choice offered.

Product Range Covers:-

- Stress Analysis Equipment
- Heat Transfer equipment
- Tile Testing machine
- Pressure Gauge Testers
- Teaching Equipment for training divisions of Industries.
- Equipment for Glass testing



ERCC

Bringing the Best in Modern Technology at your doorsteps

For details, please contact :-

ERCC Instruments

A-1/25, Rambag colony
POONA-411 030.
(INDIA)
Phone No. 440603

APPLIED RESEARCH AND ENGINEERING PVT. LTD., SANGLI.

**PANKAJ
ENGINEERING
WORKS**

Manufacturers of
REVOLVING CENTRE,
SPECIAL TAPS,
THREADING ATTACHMENTS.

We Undertake

GENERAL REPAIRING & ENGINEERING
JOB WORKS

Address

2431 East Street
Camp, Pune 411 001

Tel. No. 27820

*With Best
Compliments from*



**T. Walker's
Pharmaceutical Laboratories**

**92/10 Navi Peth,
Pune 411 030.**

Manufacturers of
Quality Injectables, Liquid Orals
and Tablets

For Quality Meehanite Castings
Of Different Grades & Ranging From
1/2 kg to 1000 Kg Apiece
And Also For Sugar Mill Requirements of
Magma & Molasses Pumps, Trash Plates &
Scraper Plates, Mill Square Couplings
& Mill Roller Flanges etc.
All Discerning Buyers
First Approach Us
Yashwant Iron & Steel Works Ltd.
Shivaji Udyamnagar, Kolhapur.

Phone : 3855

Grams : " IRONSTEEL "

A WHOLESOME TRIO!



**SATHE
ORANGE CREAM
BISCUITS**

**SATHE
MALTex
BISCUITS**

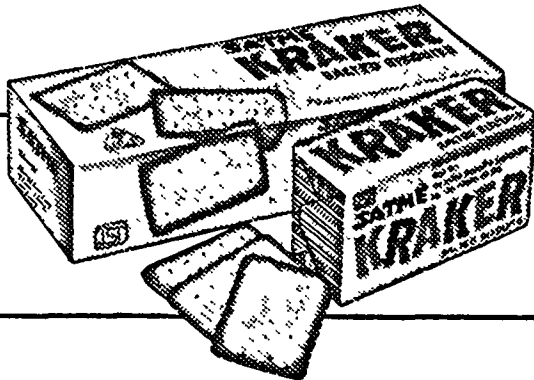

**SATHE
KRAKER
BISCUITS**

heros' SBC-76

SATHE BISCUITS



Retirement in Sight

The approaching shadows of old age will soon overtake us. The lingering memories of the past-however pleasant they may be, alone will not solve burning problems of retirement. The South Indian Bank's ANASWARA NIDHI helps you to relax.

Please contact our nearest branch.

THE SOUTH INDIAN BANK LTD.

(Regd. Office : Trichur)

AUTHORISED DEALERS IN FOREIGN EXCHANGE

Hindustan Engineering Works

1328/2, Jawahar Nagar,
Kolhapur 416 002 (India)

*Manufacturers of sophisticated
Tanning Machines in India.*

 *Band Knife Splitting Machine
Pin-Wheel Measuring Machine.*

(Import -Substitute)

*For
Purity
& Quality*



LIBRA DRUGS (INDIA)

**Manufacturing Chemists,
92, Mangalwar Peth,
Pune 411 011**

चार वर्षांचे 'विद्या' जर्न



तसं पाहिलं तर चार वर्षांत आम्ही बरंच काही मिळवलं आहे।
पण आम्ही तेवढ्यावरच समाधान मानून घेत नाही.
आम्हाला अजून खूप खूप मोठं व्हायचय !

विद्या सहकारी बँक लि.

लक्ष्मीरोड, पुणे ४११०३०. दूरध्वनी: ४४४२३६

- सहर्ष निवेदन : आजपासून बँकेच्या खातेदारासाठी महाराष्ट्र बँकेच्या सहकार्यानि प्रमुख शहरांतोल त्याच्या शाखांवर डिमांड ड्राफ्ट देण्याची सोय करण्यात आली आहे.
- बँकेच्या भागधारकानी व ठेवीदारांनी वाढदिवसानिमित्त बँकेस भेट द्यावी ही विनंती.

| | | | | |
|------------|-----------------------------------|--------|----------------------|------------------------|
| अध्यक्ष | प्रा. प. वि. तथा भाऊसाहेब फटवर्धन | संचालक | प्रा. शि. श्री. काळे | प्रा. वि. रा. शिरगुरकर |
| उपाध्यक्ष | प्रा. वि. ज. जोशी | | हॉ. जानंद नाडकर्णी | श्री. अ. व्ही. भट |
| व्यवस्थापक | श्री. ज. ग. नलावडे | | प्रा. श्री. ग. बापट | प्रा. नि. तु. किटेकर |
| | | | प्रा. सु. पुं. पाठक | श्री. विक्रम मेहता |
| | | | प्रा. मा. तु. पवार | श्री. हेमंत जोशी |
| | | | प्रा. एच. के. देशमुख | |

स्थापना : ९ जून १९७४

M/s Vishwamitra & Rathi

Successful Engineers, Builders & Promoters
of Ownership Buildings who have built in
hundreds of Flats, Shops, Godowns & Offices.

FOR YOUR REQUIREMENTS

CONTACT

**103, 'SUYASH' Chambers, 1149, Sadashiv Peth,
Perugate Chawk, Pune 411 030.**

(Tel. : 440816)



UMESH TRADERS

1182, Sadashiv, Pune 411 030

Manufacturers

and

Dealers

in

**Electrical and Mechanical
Spare Part**

With Best Compliments From :

Tuga Biochemical Labs.,

485, Sadashiv Peth,

Tilak Road,

Pune 411 030.

Phones :

Office : 443593 Works : 7641

Cable : TUGALABS

*Manufacturers of Enzymes and
Biochemicals.*

With Best Compliments From :

Tele : 470142
Gram : SAWWOOD

N. M. NIMANI
Chairman

105, New Timber Market
Pune 411 002

**THE
POONA
TIMBER
SMALL
SCALE
INDUSTRIES
ASSOCIATION**

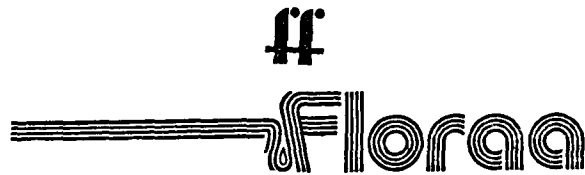

UNDERTAKES

All types of Printing Work, Wedding Cards, Greeting Cards,
and all types of stationery by Letter Press Method,
Screen Printing, Dye Stamping, Gold Embossing.

FLORAA-P

Manufacturers of : Anodised, Etched, Embossed Metal Lables,
Momentos, Novelties & Stickers

AT 'Suyash' Chambers, 1149 Sadashiv Peth,
Near Peru Gate, Pune 411 030.

**Now available
in Poona and Nasik**

PROGRAF ADVIC

Rods Tubings, Sheets Tapes,
Filter Fabric Ropes, Twine
Coiled Tubing Hollow Rods
made out of Nylon, Plastic,
Teflon (Polytetrafluoroethy-
lene P T F E) Polypropylene,
Acrylic Fibreglass,
Molybdenum Disulphide
(Mos₂-Black)

Asbestos Packaging Tape
metallic and non-metallic
Gatstrap Non-metallic
Plastic Box Strapping Packing
Seals Tensioner, Sealer
(Sealing Plier) Packing Strap
Stand, Gumtape Cello-Tape,
Marking Pens Marking Ink
Fishing line

Agricultural Nettings

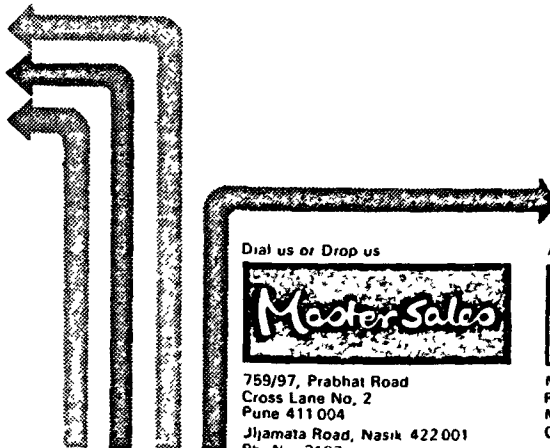

Dial us or Drop us



759/97, Prabhat Road
Cross Lane No. 2
Pune 411 004
Jijamata Road, Nasik 422 001
Ph. No. 3187.

Authorised Stockists of



M/s Garware Synthetics
Pvt Ltd
M/s, Garware Filament
Coopn Ltd

**The widest range
of trailers
in the world**

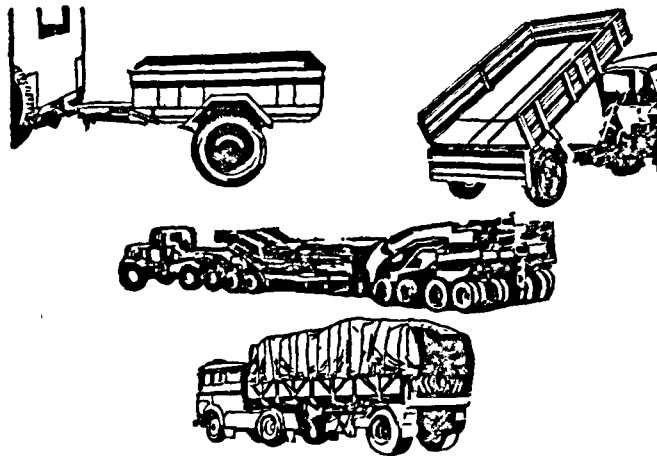

All made at



Mahindra Owen

LEADERS IN TRAILERS

155, Bombay Poona Road, Pimpri, PUNE 411018 INDIA
Telephone: 82445 Telex: JEEPSN-0145223 Telegram: 'JEEPSTRAIL' Pimpri

Ashwini / 650

D. E. SOCIETY'S
Institute of Management
Development And Research

Pune 411 004

(**Founders : Dr. R. T. Doshi, M. Com., LL. B., Ph. D.**
and Shri. S. M. Shah)

This Management Institute conducts full-time MBA and DBM courses and also offers short duration programmes in various areas of business administration for companies in the private, public and the co-operative sector in English as well as in Marathi. The information brochure is available for Rs. 5/-.

P. C. Shejwalkar
 Director

**Achieve Maximum Fuel Economy &
 Save Lacs in Your Boilers & Furnaces
 By Using Our Well Designed**

● 'Suparna' Manual Coal Firing Systems ● 'Anjali' Mechanical Stokers For Coal Firing ● 'Sameer' Induced Draft and Forced Draft Fans & Blowers ● 'Ulka' Economisers & Air Preheaters ● 'Hiverclone' Multi-Clone Dust Collectors ● We Also Undertake, Design and Supply of Any Special Purpose Machine ● Energy Conservation Studies ● Pollution Control System Design and Supply ● Coal & Ash Handling Systems ● Pneumatic & Other Conveyors.

Phones : 54685, 55848

DEEPAK ENGINEERING CO.

**3B, 'Lajwanti' Erandavana,
 Karve Road, Pune 411 004**

For All Your Pest Problems
 Please Contact—

**Messrs Topaz
 Anti Pest Service
 Private Limited**

"Successors to the Anti-Pest-Division of
 Anglo-Thai Corpn. Ltd."

**3/18, 11th Floor Navjivan Society,
 Lamington Road, Bombay 400 008.**

Branch :

Krishnai
 23 Onkareshwar
 Co-op. Society
 Sahakar Nagar
 Pune 411 009

Branch :

Tara Niwas
 Opp Jinning Press
 Society, Kiradpura
 Aurangabad 431 001

The Muslim Co-operative Bank Limited

" Saifee Mahal," 633, Raviwar Peth, Pune 411 002

Estd. 25-5-1931.

Telephone No. 444215/444177.

BRANCHES

Camp Branch

48, Mahatma Gandhi Road,
Pune-411 001
Phone : 23924

Ladies Branch

935, Budhwar Peth,
Pune-411 002
Phone : 445635

Khadki Branch

184, Old Bazar, Khadki,
Pune-411 003
Phone : 54441

* * *

Financial position as on 31.3.1978

| | | | | |
|----------------------|------------------------|-----|-----|---------------|
| Share Capital | ... | ... | ... | 21,35,600/- |
| Owned Funds | ... | ... | ... | 20,30,100/- |
| Deposit | ... | ... | ... | 1,31,70,700/- |
| Working capital | ... | ... | ... | 1,85,09,000/- |
| Investment | ... | ... | ... | 58,78,400/- |
| Loans and advances | ... | ... | ... | 1,13,14,000/- |
| No. of Members: 7300 | Net Profit: 5,93,800/- | | | |

* * *

Deposits are insured under the Deposit Insurance Scheme.

Highest rate of interest is allowed on Deposits.

Lowest rate of interest is charged on loans and advances.

A Bank of traders, professionals, artisans, self-employed persons and small scale industries.

Visit for all Banking business promptly.

Talib Khambata
Vice-Chairman

A. Maroof A. Rauf Khan
Chairman

Esoof A. Adib
Secretary

Pune-Phone Nos. : 55486 / 54701 / 58630 / 56486 Telex : 0145-387 NANAKJI

M/s. G. S. ANAND & COMPANY

Hd. Office : 198 / 1 Shivaji Nagar, Pune 411 005

Government Transport Contractors

Specialists in

**Transporting, Loading, Unloading Heavy & Over Dimensional
Consignments All Over India. We Always Keep Our Wheels
Moving to Ensure Prompt & Safe Delivery of Stores at the
Owner's Doors. Our Motto "Effeciency At All Costs"**

Branches :

Bombay:

Atur Park,
Bldg. No. 2,
Flat No. 4,
Sion Trombay Road,
Chembur,
Bombay 400 071.

Kasarwadi:

S. No. 421/1 A & B,
Bombay-Pune Road,
Kasarwadi,
Pune 411 018.

Nagpur:

Branch Office,
Chaurasia Bldg.,
Ghat Road,
Nagpur.

Bhusawal:

Deepnagar,
Thermal Power
Station,
Bhusawal.

ATUR INDIA PVT. LTD.

CIVIL ENGINEERS & CONTRACTORS

**Specialised in : Dams, Bridges,
Aqueducts, Residential and Office Buildings.**

Atur Foundation House
4 Dr. Ambedkar Road
Pune 411 001.
Cable : PRESTCON
Phone : 23811.



Atur House
87 Dr. Annie Besant Rd.
Worli, Bombay 400 018.
Cable : PRESTCON
Phone : 378561-2.



With Best Compliments from:



FINOLEX CABLES LIMITED

26-27 Bombay-Pune Road,
Pimpri, Pune 411 018.



**Manufacturers of Quality Cables & Conductors, Auto Cables,
Flexibles, AAC/ACSR etc.**



Estd. 1884 Gram : "SEEDS" Telex 0145 - 373 PN

POCHA SEEDS PVT. LTD.

NEAR SHOLAPUR BAZAR, PUNE, 411 001. Phone : 23563



The ONLY trustworthy dealers in :-

- * **Roses, Cacti and Succulents,
Roadside, Avenue & Forest Trees,
Ornamental and Shade-Loving
Plants**
- * **Vegetable and Flower Seeds**
- * **Fertilizers and Pesticides**
- * **Garden Implements**
- * **Plastic Pots**
- * **Landscape Designing**
- * **and Everything for the Gardens
and Farms**

DRYMET

- The Unconventional Dynamic Dehydrator.
- Modern technic of drying any free flowing material in the form of Grains, Leaves Powders and Flakes.
- The most useful Indoor Dryer for Dal, Oil & Rice Mills.
- We design, manufacture & install custom built dryers to entire satisfaction.

Please Contact :

ESSAR ASSOCIATES

105 Shukrawar Peth, Pune 411 002. Tel. 445875

SILCO SILVER BRAZING ALLOYS

Manufacturers of :

- Low Temperature Silver Brazing Alloys*
- Copper Brazing Strip*
- Brazesil Flux*
- Gas Welding Rods*
- Brass Solder Sticks and Solder Wire*
- Bronze Antifriction Bearing Alloys*
and
- Other Non Ferrous Alloys.*

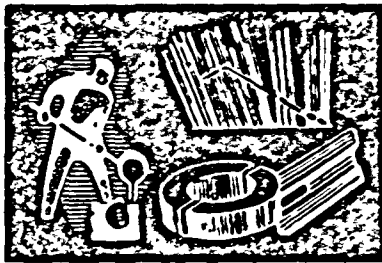

BRAZESIL ENTERPRISE

Office : 51, Shamseth Street, 2nd Floor, Bombay 400 002

Factory : 33, Agarwal Industril Estate, 2nd Floor,
S. V. Road, Dahisar (East), Bombay 400 068.

Phone : Office 344723

Phone : 470866

Deepa Electronics

1149 Sadashiv Peth
Sayash Chambers, Perugate
Pune 411 030

Manufacturers of
AUTOMATIC VOLTAGE
STABILIZERS
DC POWER SUPPLIES
QUALITY TRANSFORMERS

With Best Compliments From

M/s RAJ ENGINEERING WORKS

882, Boottee Street
Pune 411 001

ENGINEERS & CONTRACTORS

Manufacturers of
STEEL WINDOWS, GRILLS,
WATER TANKERS, GATES &
STRUCTURAL WORKS

Phones : Office · 23173
Residence : 26731

**Pursuit of Excellence
Is a way of life with us.**

**Be it
Deposits
Advances**

or

**Foreign exchange.
Speedy service with a
smile is our motto.**



500 CC

THE NEW BANK OF INDIA LIMITED

(Regd. Office : 1, Tolstoy Marg, New Delhi-1)

D. R. Fandotra
Chairman

Elektrodyne Industries

Office : " Asha-kiran ", 75-76/44 Erandavana, Pune 411 004
(Telephone : 56651, 55135)

Factory : W-25, MIDC, Bhosari, Pune 411 026
(Telephone : 82625)

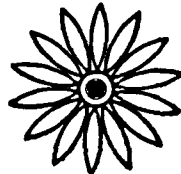

**Manufacturers of All types of Electrical
Dynamometers including :**

- 1. Eddy Current Dynamometers**
- 2. A. C. Absorption Dynamometers**
- 3. A. C. Motoring Dynamometers**
- 4. Complete Engine Test Stands**

Rapicut



Plot No. T-144 M.I.D.C. Estate,
Bhosari, Pune 411 026.

Phone : 82320
Gram : RAPICUT, Pune 26

Manufacturers of :

- Tungsten Carbide Tipped Tools
- Reamers
- Side & Face Cutters
- Brazed End Mills
- Spot Facing Cutters
- Drills
- Form Tools Etc.

**ALSO COMPLETE ENGINEERING FROM TOOLING DESIGN TO MANUFACTURE
UNDERTAKEN TO MEET ANY SPECIFIC REQUIREMENTS**

With best compliments from :

JAMS

Manufacturers of
**Alloy Steel Castings
&
Furnace Equipments**

**JAMS ENGINEERING
(INDIA)**

**406, Arun Chambers, Tardeo
Main Road, Bombay 400 034**

Telephone : 395520—372781

Telex : JAMS 011—5113

Grams : JAMSCAST

Regional Office : Tel. : 57620

'Prasanna', 55/22, Erandwana,

Ashok Path, Pune 411 004

Come one !

Come all !!

With Best Compliments From :

**JAIN
TRADING COMPANY**

1646, Tilak Road, Pune 411 030 (INDIA)

Dealers & Stockist of :

- Killick Caribonum Ltd.
- Camlin Pvt. Ltd.
- Topcel Tapes
- Ammonia Sensitized Products
- Stationery & Drawing Material
- Engineering & Surveying Instruments

Gram : 'BAGESHAN' - Phone : 449774

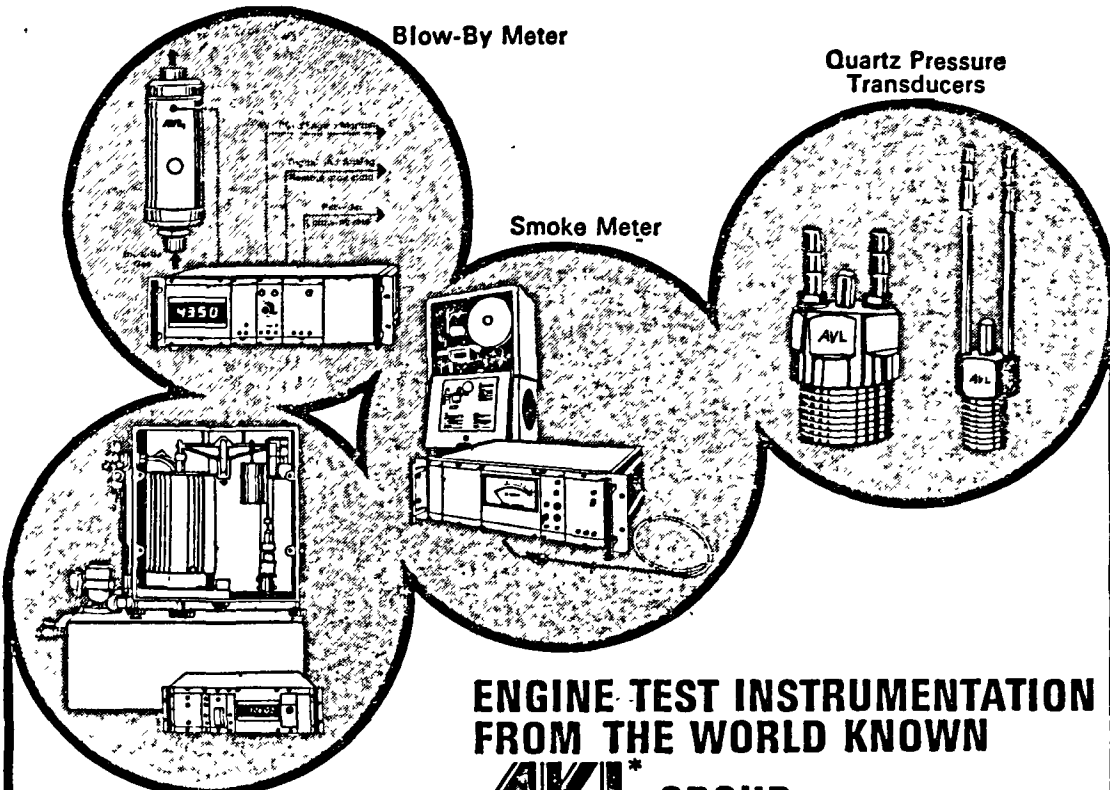

Blow-By Meter

Quartz Pressure Transducers

Smoke Meter

Fuel consumption Measuring Equipment

ENGINE TEST INSTRUMENTATION FROM THE WORLD KNOWN

AVL* GROUP

"AVL, Ltd." Graz, (Austria) are undoubtedly world leaders in design and manufacture of most sophisticated Engine Test Instrumentation.

Here is the wide range for your selection :-

- Pressure Transducers
- Blow-by meter
- Fuel consumption measuring equipment
- Diesel Diagnostic system
- Injection system Tester
- Complete Instrumentation ... & Many more Control consoles ...
- Smoke meter
- Exhaust Gas Analyser
- Engine Monitor
- Compression Tester system
- Research Engines

For details please write to :-

Spot/78



RCG instruments

Bringing the Best in Modern Technology at your doorsteps.

A-1/25, Rambag colony
POONA-411 030. (INDIA)
Phone No. 440603

* AVL Gesellschaft für Verbrennungskraftmaschinen und Messtechnik m. b. H.

**Only
BRITISH
AIRWAYS**
can offer you a daily
Rolls Royce 747 non-
stop service to London
and back. One-stop to
Europe, USA & Canada.

**Saaa engineers and
foundry pvt. ltd.**

8, Chiplunkar Bhavan,
L. B. Shastri Marg,
Pune 411 030.

Phone : 4433890/447062

'सा' for Patterns, Ferrous &
Non-ferrous CastingS

Works : 34/11, Erandwana, Ganeshnagar Road,
Pune 411 004

Phone : 54333



**Academy of
Marketing and
Management Science**

Prabhat Chambers, 685, Budhwar Peth,
Bajirao Road, Pune 411 002.

Phones : 442487/470290

Activities :

- Management Consultations* *Management Training*
- Project Reports* *Research & Survey*
- Personnel Selection* *Management Efficiency Check-up*

Serving the cause of Industrial & Economic Development
of the Country since 1969

Director : S. M. Jewadekar,

M. Com. (Business Administration) B. A LL. B. M I M. M

**HIGH-TEMPERATURE
AIR-SETTING
FIRECEMENT
ACCOSET-50**
Excellent for jointing, repairing
and patching * Bonding and
laying firebricks of any shape
* Monolithic and rammed
linings * Gunning * Protecting
furnace walls and floors
High-temperature
ramming mass—
ACCOSET SUPER
is also
available

**HOT-FACE
INSULATING
FIREBRICKS**
For all types of
reheating and
forging furnaces
• Reduce fuel
consumption
• Help maintain a
constant temperature
inside the furnace
• Ensure rapid
heating resulting in
larger output
• Help distribute
heat evenly

**CASTABLE
REFRACTORIES
FIRECRETE AND
FIRECRETE SUPER**
Can be used for repairs
of furnace linings. They
can be cast in any shape
and size are strong and
durable, resist spalling,
abrasion and thermal
shocks
Tailor-made castables
to suit customer needs
can also be supplied.

**ACID-PROOF
CEMENT
ACCOCID**
An excellent bedding
and jointing cement
for acid-proof bricks
and tiles and acid-
resisting natural
stone slabs for
construction of acid
storage tanks, reaction
vats, acid towers
fume stacks, etc
Supplied in two parts—
• power and a mixing liquid

**HIGH
ALUMINA
REFRACTORY
CEMENT
CALUNDUM**
Hydraulic setting
and rapid hardening
basic refractory
cement for
manufacture
of castable
refractories

**SPECIAL
ACC
PRODUCTS FOR
INDUSTRIAL
USE**

Contact—

CHANEY & COMPANY

343, Raviwar Peth, Poona 411 002, Phone. 446445

Gram : ZEBRABRAND

Phone : Shop 27316

Factory : 82511

Resi. : 23550

D. CHHAGANLAL & COMPANY
TARPAULINE HOUSE

1377, Bhawani Peth, Burudi Pool Chowk, Puna 411 002

**Manufacturers of Zebrabrand
Tarpauline & Tents**

Wholesale Dealers in Grey, Wax & Chemical
Waterproof Canvas, Filter Canvas & Belting Cloth

Estd. 1865

Phone : 24614

**WITTUL
SHAMSETT
AND
SONS**

Jewellers & Diamond Setters

Dealers in Gifts & Sport Trophies
Government Approved Valuers

2433, East Street, Pune 411 001

Leading Manufacturers of

All kinds of Quality Edible Oils
De-oil Cakes and
Washing Soaps

**Nav Maharashtra
Chakan Oil Mills**

Importers and Exporters

42-43, Shankarsheth Road, Pune 411 009

Phones : 449449 - 449890

Telex : 0145 - 349

Grams : SHENGA -- PUNE.

Branch Office :

75, Mittal Chambers, Nariman Point
BOMBAY 400 021

With Best Compliments from :

The Pioneers in the manufacture of Card Clothing and Card Clothing Accessories of perfection — both Metallic & Flexible — and also

- * Lickerin Wire — Different Types — Hardened & Tempered
- * Special Stripping Fillet for Metallic Card Clothing
- * Standard Stripping Fillet
- * Standard Burnishing Fillet
- * Philipsons Sheets & Top Clearer Strips
- * Special Flat Cleaning Fillet
- * Hand Stripping Cards and Hand Cleaning Cards
- * Special type of Card Clothing for Woollen, Worsted, Silk & Cotton Waste Cards & Raising Fillets and Raising Brush Sheets
- * CS4 Wire for Stripping & Redirecting Rollers of Crosrol Varga Attachment
- * 505 Wire for Tandem Card.

THE INDIAN CARD CLOTHING CO. LTD.,

Bombay - Poona Road, Pimpri, Pune 411 018

Telephones:
82738 & 83374

Telegrams:
Cardwire, Pimpri.

Telex:
145 - 335 ICCO IN

Branches and Service Stations:

Bombay Sales Office
J. K. Building,
Ballard Estate,
Bombay-400 001.
Coimbatore Branch:
Kamaraj Road,
Coimbatore-641 018.

Bombay Service Station:
Saki-Vihar Road,
Powai,
Bombay-400 072.
Delhi Branch:
6-B, Atma Ram House,
1, Tolstoy Marg,
New Delhi-110 001.

Ahmedabad Branch:
Opp: Kankaria Loco Shed
Rajpur Gomtipur,
Ahmedabad-380 021.
Madurai Branch:
55 Ponmeni Narayan St.,
S. S. Colony,
Madurai-625 016.

With also a network of Technical Sales Representatives in all textile centres and Service Engineers attached to each Branch.

Our Motto:

"WE HELP THE TEXTILE WORLD TO CARD WELL & SPIN WELL"

WANSON INDIA

Associate Company : Thermax India

Designers, manufacturers and suppliers of
standard packaged units to
complete turnkey projects
for
process heating, waste heat recovery,
waste incineration, water and effluent treatment,
and post harvest treatment systems.

PROCESS HEATING EQUIPMENT

Vaporax — oil fired packaged boilers
Multitherm — coal fired boilers
Thermopac — thermic fluid heaters
Water Tube Drum Type Boilers
Waste Heat Boilers

WASTE TREATMENT EQUIPMENT

Incinex — waste incinerators
Effluent Treatment Systems

WATER TREATMENT EQUIPMENT

Pressure Filters * Base Exchange Softeners * Dosers
Ion Exchange Demineralisers * Deaerators * Reverse
Osmosis Systems

AGRICULTURAL EQUIPMENT

For Post Harvest Treatment —
Grain Dryers * Seed Dryers * Groundnut Dryers * Dal
Dryers
Seed Processing and Storage Centres



Wanson (India) Private Limited

Chinchwad, Pune 411 019

Branches : BOMBAY * Delhi * Calcutta * Madras
* Bangalore

ADDENDA

Guide to Manufacturers

The Chamber had sent special investigators to visit each industrial unit in Pune region and collect data required for the Directory. The proformas were specially mailed to the industries with a request to them to send the information. Special press advertisement was also issued and a general appeal was made to all the industries to give information for publishing in the Directory. But in spite of our best efforts some industries did not respond at all and some gave information very late. This necessitated us to issue an addenda to the original compilation. In this addenda we have given detailed information in respect of those who gave information to us. But in some cases we could not get this information in spite of our continuous persuasion. We have, therefore, given only names and products manufactured by such companies. In respect of certain industries like garments, hosiery, stone crushers, brick manufactures, bakeries classified lists along with their addresses have also been given. Economic data in respect of them have not been collected.

In the Product Index, however, we have covered all these lists. In preparing statistical tables also information in respect of all those units who have supplied their economic data has been included. These tables are presented in the statistical section of the Directory.

ADDENDA

- 2425. A. T. NUTS.** S-52 M.I.D.C., Bhosari, Pune 26 Tel. No. 83260. Cap. Rs. 80,000. Workers 9 Products: Steel and brass nuts.
- 2426. AARTI INDUSTRIES.** 441 Nana Peth, Laxmi Road, Pune 2 Tel. No 24443. Cap Rs.50,000 Workers 8. Products: Steel fabricators, industrial goods
- 2427. AJAY ENGINEERING WORKS.** Yashomala 1194/27-A Shivajinagar, Pune 5 Partnership, 1968 Tel. C/o. 57776. Factory: 15/A Poona-Bombay Road, Wakde-wadi, Pune 3. Tel. 58871. Bank: Bank of Maharashtra Workers 18. Prod. Rs. 3 lakhs. Cap. Rs. 50,000. Products: Air cleaners, fuel and lub. oil filters, shells, fabrication and job work.
- 2428. AMEET LUBRICANTS AND CHEMICALS.** 15-A Bombay-Poona Road, Bhale Estate, Pune 3. Tel. 58871. Proprietary, 1977 Cap. Rs. 1,50,000. Workers 6. Products: Automotive and industrial lubricants reslaimers and processors.
- 2429. ANANDKUMAR PAPER MILLS.** Girme Garden, Sholapur Road, Pune 1. Product: Handmade paper.
- 2430. ARBOR ACRES FARM INDIA LTD.** Post Box No. 81, G.P.O. Pune 1. Tel. 25257 Cable: ARBORACRES. Telex 0145-293. Factory: P.O Talegaon General Hospital, Talegaon 410 507. Dist. Pune. Tel. 23 & 54. Cable: ARBORACRE Talegaon. Estd. 1963. Brs. Dehradun, New Delhi, Lucknow. Sister concerns: Arambagh Hatcheries Ltd., Calcutta; Armahatch, Calcutta; Micky Broiler Pvt Ltd, N Delhi; R S. Hatcheries, Jullunder; K. S. Broilers, Kathmandu, Nepal. Banks: Central Bank of India, Pune; American Express International Banking Corporation, Bombay, Sangli Bank, Talegaon Dabhade. Foreign collaboration: Arbor Acres Farm Inc Connecticut 06033, U.S.A. Cap. Rs. 41,15,006. Prod Rs. 56,10,915. Workers 135. Exports: Rs 1,00,000 Countries: Middle-East, Malaysia. Products: One-day-old broiler chicks, one-day-old layer chicks.
- 2431. ARC ELECTRONICS RESEARCH CORPORATION.** 1895 Sadashiv Peth, Pune 30. Products: Fibreglass core resistors. Pneumatic differentials.
- 2432. ARCO ENGINEERS.** 46A/13 Kaka Halwai Industrial Estate, Satara Road, Pune 9. Tel. 440696. Partnership, 1967. Bank: Bank of Maharashtra. Cap. Rs 5 lakhs. Prod. Rs 24 lakhs. Workers 100. Products: Bus and coach building, fabrication of structure for passenger bus, delivery van, precision fabricators.
- 2433. ATLAS STEEL ERA.** 95-A Shankarshet Road, Pune 9 Tel. 25967. Partnership, 1950. Bank: Central Bank of India. Prod. Rs 13,00,000. Cap. Rs.3,67,766. Workers: 70. Products: Furniture, rolling shutters.
- 2434. ATUL GUMS.** 3/3 Shylendra Society, Senapati Bapat Road, Pune 16. Tel. 50302. Products: Adhesive and gum.
- 2435. ATUR RUBBER PRODUCTS.** Atur Foundation House, 4 Dr. Ambedkar Road, Pune 1. Tel. 23811. Cable: ATURUBBER. Factory: 29/2 Kharadi Village, Nagar Road, Pune 14. Tel. 27321. Partnership, 1973. Br. Bombay. Bank: Union Bank of India. Cap. Rs. 4,00,000. Prod. Rs. 3,50,000 Workers 30. Products: Cycle tubes, rubber tubing, rubber moulded parts and rubber compounds
- 2436. BAKER HORSTMAN MERCER (I) LTD.** 401 Jolly Bhavan No. 2, 7 New Marine Lines, Bombay 20 Tel 298912. Factory. Nagar Road, Pune 14. Tel. 25277. Cap. Rs. 19,93,100. Workers 41. Products: Air gauges, dial gauges, electronic gauges and accessories.
- 2437. BAKRE INDUSTRIES.** 8 New Timber Market, Bhavan Peth, Pune 2. Tel. 27441. Factory : 63, D-2, M.I.D.C., Pune 19. Tel. 82324. Partnership, 1969. Bank: Central Bank of India. Cap. Rs. 1,00,000 Workers 12. Products: Wooden fancy cases, doors, windows, job work.
- 2438. BALBIRSINGH AND CO.** Shankarshet Road, Pune 9. Tel. No. 447504, 447488. Workers 15. Cap Rs. 25 lakhs Products: Automobile repairing, spare parts.
- 2439. BALSONS.** Leather Division. A-26 'H' Block, M.I.D.C., Pimpri, Pune 18. Tel. 82332. Cable: BALSONS PIMPRI. Partnership, 1965. Banks: Bank of Maharashtra; Sangli Bank Ltd. Cap. Rs. 3 lakhs. Workers 19. Products: Polythene sheets, machine covers, bags, rolls and lay-flat tubes etc.
- 2440. CHAMPION ELECTRONICS (P) LTD.** 'Patanjali', Survey No. 83/3, off Baner Road, Aundh, Pune 7. Tel. 50790. Cap. Rs. 45,800. Workers 9. Products: Solder terminals, insulated terminals, terminal boards, capa-

- citors, coils, I.O. sockets, panel hardware, miniature connectors, coil forms, chokes, thermometers devices, N. C. machines, integrated circuits, assemblies, accessories.
- 2441. CREATIVE CHEMICALS PVT. LTD.** 39/3 Shankarshet Road, Pune 9. Tel. 449936. Cable: CREATIVE Pune. Telex: C/o 0145-333. Estd. 1977. Bank: State Bank of India. Cap. Rs. 5,00,000. Workers 40. Products: Organic and inorganic pigments for paints, printing ink, plastic, rubber lacquer, varnish and allied industries; complete range of pigment emulsions for textile industry.
- 2442. DECCAN PAPERMINT MANUFACTURING CO.** 972 (New) Budhwar Peth, Pune 2. Tel. 25639. Partnership, 1927. Workers 7. Products: Boiled confectionery and allied products.
- 2443. DEEPA ELECTRONICS.** Suyash Chambers, 1149 Sadashiv Peth, Peru Gate, Pune 30. Tel. 470866. Partnership, 1977. Bank: Bank of India. Cap. Rs. 8,000. Products: Automatic voltage stabilizers, DC power supplies, transformers.
- 2444. DHANANJAY PAINTS AND PROTECTIVE COATINGS PVT. LTD.** 246 Narayan Peth, Laxmi Road, Pune 30. Tel. 444890. Factory: Ahmednagar. Cap. Rs. 1,50,000. Products: Paints, varnishes and allied products.
- 2445. DILNAWAZ ENGINEERING WORKS.** 161 Yera-vada, Pune 6. Tel. 23634, 25856, 26291. Partnership, 1948. Bank: Bank of Maharashtra; Central Bank of India. Cap. Rs. 5 lakhs. Workers 16. Products: Stainless steel, brass and aluminium utensils.
- 2446. DURGA DYECHEM INDUSTRIES.** 1517 Sadashiv Peth, Pasalkar Nivas, Pune 30. Factory: Solapur. Cap. Rs. 2.13 lakhs. Products: Sulphur black dyes, sodium teosulphate.
- 2447. ENGINEERS SKILL CRAFTS.** 1007 Sadashiv Peth, Pune 30. Tel. 52124. Factory: C/o. Micron Engineers, 86 M.I.D.C., Bhosari, Pune 26. Tel. 82760. Cap. Rs. 50,000. Workers 4. Products: Control panels and sheet metal fabrication.
- 2448. EUREKA ENGINEERS.** 63, 'S' Block, Bhosari Industrial Area, Pune 26. Tel. 82714. Br. Bombay. Cap. Rs. 95,000. Workers 20. Products: Process control instruments, thermocouples etc.
- 2449. FIBREALL.** 23 Sahney Sujan Park, Pune 1. Tel. 22416. Cable: MANGKUKU. Proprietary, 1976. Bank: Bank of Maharashtra. Products: Fibreglass reinforced plastics tanks, tank linings, containers, pipes, pipe linings, ductings, acid pumps, machinery guards, covers and cowls, battery boxes, equipment casing, cabinets etc., crash helmets, leather riding gloves and other accessories in fibreglass for motor cycles and cars.
- 2450. FLORAA-P.** Madhu Moti, Phatak Baug, Navi Peth, Pune 30. Factory: Suyash Chambers, 1149, Sadashiv Peth, Pune 30. Partnership, 1977. Sister concern: Floraa. Bank: The Ratnakar Bank Ltd. Cap: Rs. 80,000. Prod. Rs. 1,35,000. Workers 10. Products: Printing jobs, stationery, screen printing, dye stamping, gold embossing.
- 2451. FOUR EYES.** 1233A Apte Road, Deccan Gymkhana, Pune 4. Cap. Rs. 7,500. Workers 9. Products: Tree-guards. Research and development of new product and export of organic manure.
- 2452. GARWARE WALL ROPE.** D-1/11 Chinchwad Pune 19. Tel. 83769. Products: Nylon ropes.
- 2453. GLASS MINERALS.** Paise Fund Glass Works Compound, Talegaon Dabhade, Dist. Pune. Tel. 82. Partnership, 1977. Bank: Sangli Bank Ltd. Cap. Rs. 14,00,000. Prod. Rs. 26,00,000. Workers 10. Export: Rs. 2,15,000. Countries: Ceylon, Iraq. Products: Vacuum flasks and vacuum refills, glass shells for vacuum refills.
- 2454. GUJARAT METAL FACTORY.** 589 Rasta Peth, Pune 11. Tel. 22188. Products: Brass utensils, domestic electrical appliances.
- 2455. HAFKINE BIO-PHARMACEUTICAL CORPORATION LTD.** Acharya Donda Marg, Parel, Bombay 12. Cable: RESEARCH. Factory: Pimpri, Pune 18. Tel. 446341. Products: Antiserum against tetanus, diphtheria gangrene and snake bites.
- 2456. INDIAN ELECTRICAL ENGINEERING CORPN.** Premier Garage, Lloyds Bridge, Pune 5. Factory: Survey. No. 31/32 Poona-Bombay Road, Pimpri, Pune 18. Tel. 82869. Estd. 1960. Bank: Bank of Maharashtra. Cap. Rs. 80,000. Workers 10. Products: Electrical equipments, solenoid valves for sugar mfd. and job work.
- 2457. J. M. ARTS.** 1244 Shivajinagar, Deccan Gymkhana, Pune 4. Tel. 58578. Partnership, 1977. Bank: Bank of Maharashtra. Cap. Rs. 1,200. Prod. Rs. 10,000.

- Workers 2. Products: Screen printing on paper, plastic, cloth etc; commercial design jobs.
- 2458. J. P. HANDMADE PAPER AND BOARDS MANUFACTURING CO.** Durga Shankar, K. P. Kulkarni Road, 1206/4-B Shivajinagar, Pune 4 Tel. 58277. Factory-Shed W-90 MIDC 'S' Block, Bhosari, Pune 26. Partnership, 1978. Banks: Bank of Maharashtra; Vysya Bank. Cap. Rs. 4,00,000. Products: Handmade paper and boards, special leather quality handmade boards and insulation boards.
- 2459. JAYANT ENGINEERING WORKS.** 1344 Shivajinagar, Pune 5. Tel. 56236. Cable: AUTOSTORES, Poona. Factory: Pune-Satara Road, Pune 9. Tel. 27057. Sister concern: Swastik Auto Stores, Pune. Bank: Bank of Maharashtra. Workers 70. Products: Water pump assembly, oil pump assembly and components for trucks and tractors.
- 2460. JAYDEEP ENGINEERS.** 'S' 24, MIDC, Bhosari, Pune 26. Products: Trailer, cranes, special machinery.
- 2461. K. C. BHIDE BLOCK MAKERS.** 1977 Sadashiv Peth, Madiwale Colony, Pune 30 Tel. 442338. Cap. Rs.1,00,000. Workers 9. Product: Block making.
- 2462. K. L. PLASTICS.** 63 Bombay-Pune Road, Dapodi, Pune 12 Partnership, 1978. Bank: Bank of Maharashtra. Cap. Rs. 1,50,000. Products Plastic colouring, processing and extrusion.
- 2463. K. T. AND CO.** 'Hrishikesh', Savarkar Nagar, Pune 9. Factory: S No. 691-A-1-B, Plot No. 9, Pune-Satara Road, Pune 9. Cap. Rs.1,50,000. Workers 5. Product: Job work.
- 2464. KAPUR ENGG. WORKS.** 124 Budhwar Peth, Jogeshwari Lane, Pune 2. Tel. 449727. Factory: 14 Parvati Industrial Estate, Pune 9 Tel. 28613. Proprietary, 1962. Sister concern: Kapur Electroplating & Polishing Works. Banks: State Bank of India; Bank of Maharashtra. Products: Drilling machine, toggle presses, turned components, special steel fasteners
- 2465. KARACHI SWEET MART.** 544 Centre Street, Pune 1. Tel. 23303. Cable: TARSON. Factory: 1510 Bhimpura, Galli No. 14, Pune 14. Products: Food products.
- 2466. KASAT CHEMICALS PVT. LTD.** 153 Kothrud, Karve Road, Pune 29. Tel. 58258. Br. Bombay. Cap. Rs. 15,00,000. Products: Dyes, pigments and other textile auxiliaries.
- 2467. KHIRA ASDEC CONTAINERS (INDIA) LTD.** 71 MIDC, Bhosari, Pune 26. Products: Containers.
- 2468. KIRLOSKAR PRESS.** Swargate, Pune 9. Tel. 24700, 24851. Cable: KIRLOMAGS, Pune. Estd. 1920. Banks: Bank of Maharashtra; Sangli Bank Ltd. Products: Offset and letterpress commercial printing
- 2469. KRISPEE FOODS PVT. LTD.** Plot E 25-26-27, MIDC, Bhosari, Pune 26. Sister concern: Poona Beverage Pvt Ltd., Pune. Products: Snack foods, potato wafers etc.
- 2470. KUSUMA ARTS.** 484/17 Mitra Mandal Colony, Pune 9 Tel. 58324 Cap. Rs.10,000 Workers 6. Products: Printed circuits, instruments dials, panels and display articles, screen printing.
- 2471. KWALITY STEEL PRODUCTS.** S. No. 209, Bombay-Pune Road, Pimpri, Pune 18. Tel. 82824. Products: Nuts and bolts.
- 2472. LAXMI SOAP FACTORY.** 767/961 Ganj Peth, Pune 2. Tel. 444761, 447039. Cable: WASHWONDER Partnership, 1959. Br. Bombay. Bank: Bank of India. Cap. Rs. 1,78,000. Product: Washing soap.
- 2473. M G INDUSTRIES.** B 1/38 Shree Agrasen Society, 8 Koregaon Road, Pune 1. Cable: WOODWOOL. Proprietary, 1978. Banks: Bank of Maharashtra; Central Bank of India. Cap. Rs. 5,00,000 Prod. 3,00,000. Workers 8. Products: Wood wool, packing cases. (proposed expansion in plastic goods for Defence use only).
- 2474. MAALTA PRODUCTS.** 1266 Shukrawar Peth, Lane No 6, Subhash Nagar, Pune 2. Tel. 442428. Proprietary, 1968. Bank: Bank of Maharashtra. Cap. Rs. 70,000. Prod. Rs 1,30,000. Workers 3. Products: Soft drinks, aerated drinks and fruit juices.
- 2475. MANEESHA AMBROSIAL.** 11 Alakanand, 158/159 Mukundnagar, Pune 9. Tel. 470078. Cable: VAN-CHIEF. Proprietary, 1977. Bank: Union Bank of India. Cap. Rs. 8,000. Prod. 96,000. Workers 6. Product: Scented agarbatti.
- 2476. MATRU CHHAYA.** M.I.D.C. 'S' Block, Plot No. 103, Bhosari, Pune 26. Products: Fabrication jobs.
- 2477. MEELAN SHOE CO. PVT. LTD.** M.I.D.C., Chinchwad, Pune 19. Tel. 83649. Product: Rubber shoes.

- 2478. MICRO-CHECK GAUGES AND INSTRUMENTS.** 26/19 Vithalwadi, Khadakwasla Road, Hingane Khurd, Pune 9. Tel. 442231. Partnership, 1976. Bank: Indian Bank. Cap. Rs.65,000. Prod. Rs.50,000. Workers 7. Products: Plain plug gauges, plain snap gauges, measuring pins, sine bars, sine centre, special gauges, gauge blocks, adjustable snap gauges.
- 2479. MODULAR SYSTEMS.** 17A/3 Karve Road, Ganesh Chamber, Pune 4. Tel. 57875. Factory: Ashirwad, Prabhat Road, Pune 4. Partnership, 1977. Sister concern: Electromark Associates. Bank: State Bank of India. Cap. Rs. 50,000. Workers 3. Products: Electronics components—IC Sockets, IC pins, electronics hardware, gaussmeter, custom-built electronic equipments.
- 2480. MOSH INDUSTRIES.** 'S' 101 M.I.D.C., Bhosari, Pune 26. Bank: The Poona People's Co-op. Bank Ltd. Workers 14. Products: Structural fabrications.
- 2481. NAND INDUSTRIES.** 324 Raviwar Peth, Pune 30. Tel. 447311. Cap. Rs. 50,000. Workers 4. Products: Printers' roller composition and printing rollers.
- 2482. NANDAN AND NANDAN.** Krishi, 1144 Shukrawar Peth, Pune 2. Tel. 443639. Telex: 0145-221. Factory: (1) Plot No. 103 M.I.D.C., Bhosari, Pune 36. (2) 116 M.I.D.C., Ahmednagar 1. Partnership, 1975. Products: Letter embossing gun, tape, cigarette holders.
- 2483. NEW BALL BEARING COMPANY.** Opp. Shivaji Statue, Shivajinagar, Pune 5. Tel. 50312. Cap. Rs. 2,00,000. Workers 3. Products: Ball and roller bearings, V-belts and other machinery parts.
- 2484. NEW POONA PLASTIC.** 1693 Sadashiv Peth, Pune 30. Factory: 311/26-A/2 Hadapsar, Mahamodwadi Road, Pune 28. Products: Polythelene tubing, sheets, bags.
- 2485. NIRMAL FOODS.** Alandi Road, Pune 5. Tel. 22018. Products: High protein beverage - PROTIVIN.
- 2486. NU POINT INSTRUMENT.** 1065 Shukrawar Peth, Pune 2. Tel. 440170. Estd. 1970. Products: Speed controls for slipping and D. C. motors.
- 2487. P M T MACHINE TOOL AUTOMATIC LTD.** P.O. Box. No. 2, Pimpri, P. F., Pune 18. Tel. 82344, 82345, 82346. Cable: TRAUBOMAT, Pune. Telex: 0145-217. Estd. 1961. Banks: Banque Nationale De Paris; United Commercial Bank; Bank of India. Cap. Rs. 47,91,000. Products: Single spindle automatic lathe and its accessories.
- 2488. PACKWELL INDUSTRIES.** 180 Budhwar Peth, Pune 2. Estd. 1972. Products: Polythene bags and tubing.
- 2489. PANKAJ ENGINEERING WORKS.** 2431 East Street, Pune 1. Tel. 27820. Partnership, 1971. Banks: Bank of Maharashtra, State Bank of India. Cap. Rs. 1,00,000. Prod. Rs. 25,000. Products: Revolving centre, special taps, threading attachments, general repairing and engineering job works.
- 2490. PERFECT INDUSTRIES.** 37/2 C, Shankarshet Road, Pune 9. Tel. 441879. Products: Scooter and motor cycle accessories.
- 2491. POCHA SEEDS PVT. LTD.** Post Box 55, 1A-Middle Road, Pune 1. Tel. 23563. Cap. 1.70 lakhs. Products: Seeds, plants.
- 2492. POLYPLASTICS.** 1144 Shukrawar Peth, Pune 2. Tel. 443639. Telex: 0145-221. Factory: Plot No. 103, M.I.D.C., Bhosari Industrial Area, Pune 26. Tel. C/o. 83565. Partnership, 1969. Sister concern: Western India Erectors. Bank: Bank of Baroda. Cap. Rs.1,34,700. Prod. Rs.70,000. Workers 5. Products: Letter embossing tape, quality engineering plastic components, supply of plastic components to defence.
- 2493. PRABHAKAR ENGINEERING (P) LTD.** 'Indira', 1011/19 Mitranagar, Shivajinagar, Pune 16. Tel. 53092, 55906. Factory: Plot No. 116, Bhosari Industrial Estate, Pune 26. Tel. 82793. Workers 18. Products: Sugar machinery spare parts and IBR piping and boiler plant.
- 2494. PRECISION ENGINEERING.** 92 Mitra Mandal, Pune 9. Tel. 446062. Cable: FREEWHEEL. Factory: B-48, MIDC, Satara 1. Proprietary, 1977. Bank: Bank of Maharashtra. Cap. Rs.75,000. Prod. Rs.1,50,000. Workers 10. Export: DM 311. Country: West Germany. Products: Mechanical power transmission devices such as one-way roller clutches, back-stops, multi-use clutches, spray clutches and special purpose machines.
- 2495. PRINTON.** 22 M.G. Road, Pune 1. Tel. 25425. Estd. 1970. Products: Screen printing.
- 2496. PROTECTION ENGINEERING CORPN.** 27 Saraswat Colony, Pune 26. Tel. 28977. Factory: 'S' Block Plot No. W 22, MIDC, Bhosari, Pune 26. Tel. 82887. Cable: MATCHLESS. Products: Anti-rust and anti-fungal preparations in liquid, powder and trace-paper form.

- 2497. QUEEN MARY'S TECHNICAL SCHOOL** (for disabled Indian soldiers) Park Road, Khadki, Pune 20 Tel. 56799 Private charitable institution, 1917. Products: Clothing and uniforms made to measure, hosiery and tapestry articles, dyeing and printing on cloth and garments, grijs and minor workshop jobs.
- 2498. R. S. INDUSTRIES.** 32/3 Nagar Road, Pune 14. Estd 1962 Tel. 23881 Bank: Bank of Maharashtra Products: Ferrous and non-ferrous castings, sewing machine cast iron stand
- 2499. RAJ POWER PARTS AND ENGINEERING COMPANY (P) LTD.** 11 Galaxy Garden, Koregaon Park, Pune 1. Tel. 26171. Cable: RAPPCO-POONA. Factory: Plot A-23 Block D-1, MIDC, Chinchwad, Pune 19. Tel. 82469. Products: Industrial rubber products and engineering goods, V-belts, fan belts, rubber moulding transmission and conveyer belts, machinery parts.
- 2500. RAMKALA.** 22 Sadashiv Peth, Pune 30. Partnership, 1958. Bank: Bank of India. Cap. Rs 60,000 Prod. Rs.3,00,000. Products: Meteorological instruments, rain-gauge, windwave, Stevenson's screen, pan evaporimeters etc.
- 2501. SAHYADRI STRUCTURAL (P) LTD.** Preet Chambers, 36 Bombay-Poona Road, Pune 3. Cable: MATFUR. Telex: 0145-396 Factory: E-1, M.I.D.C Industrial Area, Post Bag No. 073, Ahmednagar, Tel 24. Estd. 1974 Banks: The United Western Bank Ltd, Bank of Maharashtra. Foreign collaboration: Authorised representative of M/s C.S. Johnson & Co., U.S.A. for concrete batching and mixing plant Cap. Rs 12,92,000 Prod. Rs. 40,00,000. Workers: 150. Export: Rs 7,28,000 Country: Kuwait. Products: Design, fabrication and erection of major structural work at remotest sites, design and manufacture of non-pressure parts, ducting, chimneys; tanks and vessels; heavy piping etc. for heavy industrial installations; evaluators; screw conveyors and bulk handling equipment; heat-exchangers as per IS, BS, TEMA and other codes; fabrication of jacketted and non-jacketted pressure vessels and other chemical vessels as per ASME, IS and other codes; fabrication and carbon steel piping; expansion joints; piping specials; feed tanks and dampers etc., manufacture of plant components of customers design; vacuum pans, clarifiers, electrostatic precipitators, mechanical separators, dust collectors, grit separators, and any other steel fabricated items; agitators, centrifuges, evaporators; gas holders; coolers; hoppers; kettles; mixers; blenders; dryers etc. in mild and stainless steel.
- 2502. SAKAL PRESS PVT. LTD.** 595 Budhwar Peth, Pune 2 Tel. 448403, 448550, 448901. Estd 1948 Br. Bombay Cap Rs 69,69,636. Workers 240 Products: Printing of newspaper and printing job work.
- 2503. SERVOLEC.** Girya, 4/3 Karve Road, Pune 4 Tel C/o 54448. Workers 6 Cap. Rs 1,00,000. Products: Electronic equipments
- 2504. SHANKAR RAMCHANDRA AND BROTHERS.** 131 Hadapsar Industrial Estate, Pune 13. Tel. 7185. Workers 70. Cap Rs 40,00,000. Product: Factory made panel doors, furniture, interior decorators and designers.
- 2505. SHINDE INDUSTRIES.** 691/A/2 Pune-Satara Road, Pune 9 Tel. 441331. Products: Job work.
- 2506. SHREE METAL CONTAINERS MANUFACTURING CO.** 44 Karve Road, Pune 4. Tel. 50322. Proprietary, 1977. Bank: Bank of India. Cap. Rs. 20,000. Prod. Rs. 1,50,000. Workers 8. Products: Sheet metal fabrication, instrument cabinets, control panels, sheet metal pressed parts—electro plated, oven baked painted.
- 2507. SHRIKANT ENGINEERING WORKS.** Plot No. A-95-96, 'H' Block, M.I.D.C., Pimpri, Pune 18. Estd. 1969. Workers 30. Products: Job work, auto parts.
- 2508. SHRINIWAS FABRICO (P) LTD.** Plot No. 80, Block 'S', M.I.D.C., Bhosari, Pune 26. Tel. 83645. Cable: DEKMACHIN. Cap Rs. 1,10,000. Workers 14. Products: Deck machinery and marine equipments such as stirring gears, material handling equipments, special purpose equipments.
- 2509. SHRIPAD INDUSTRIES.** 2075 Krishna Niwas, Vjayanagar Colony, Pune 30. Factory. 19/20 Parvati Industrial Estate, Pune 9. Cap. Rs. 3,00,000. Workers 110. Products: Magnetic tools, engineering tools and measuring instruments and accessories.
- 2510. SHRIRAM CHEMICALS (POONA).** 43 Budhwar Peth, Ganpati Chowk, Pune 2. Tel. 57577. Factory: 28/7 Kharadi, Nagar Road, Pune 14. Tel. 27277. Products: Dyes and intermediates and fine chemicals.
- 2511. SPECTRONICS.** 28 Prasad Chambers, 17 A/2 Karve Road, Pune 4 Tel. C/o 50905. Partnership, 1978. Bank: State Bank of India. Cap. Rs. 93,000 Workers 5. Products: Electronic measuring instruments and control systems
- 2512. SPEYS INDUSTRIAL SERVICES.** 118 Shukrawar Peth, behind Fule Market, Pune 2 Tel. 470347. Cable: SPEYS. Proprietary, 1974. Bank: United Com-

- mercial Bank. Prod. Rs. 10,000. Products: Tailor-made electroplating equipment plants.
- 2513. SUPER RUBBER AND ENGINEERING CO.** Telco Road, Chinchwad, Pune 19. Bank: Syndicate Bank. Cap. Rs. 3,50,000. Prod. Rs. 6,50,000. Workers 10. Products: Moulded rubber components.
- 2514. SUYASH DYES AND INTERMEDIATES (P) LTD.** 249 Shaniwar Peth, Pune 30. Tel. 449779. Factory: 197/2 Nimblak, Nagar-Manmad Road, near M.I.D.C., Nagar. Cap. Rs. 6,38,000. Products: Dyes and mainly dye intermediate
- 2515. SWASTIK METAL ROLLING MILLS.** 114-A Bhawani Peth, Pune 2. Tel. 27427. Estd. 1972. Cap. Rs. 2,00,000. Products: Aluminium circles, sheets and utensils.
- 2516. T.F.D. AND SONS.** 59 Elphinstone Road, Khadki, Pune 3. Tel. 58730. Estd. 1964. Products: All kinds of fabrication and sheet metal work.
- 2517. TECHNICAL PRODUCTS.** 20-A New Timber Market, Pune 2. Tel. 444919. Products: Precision Parts.
- 2518. THERMAX (INDIA) PVT. LTD.** Chinchwad, Pune 19. Tel. 83303, 83550. Products: Boilers.
- 2519. THERMO-CHEM REFRACTORY INDUSTRIES (INDIA).** 19 Mukund Nagar, Bhagyashri Building, Pune 9. Tel. 441903. Factory: 30/10-D/II Block, M.I.D.C., Pimpri, Pune 18. Workers 20. Products: Refractory basic products and thermal insulation.
- 2520. THERMOTOUCH.** 507 Shankarshet Road, behind Mira Society, Pune 9. Tel. 447426. Workers 20. Cap. Rs. 1,25,000. Product: Heat treatment.
- 2521. TILAK SPORTS CO.** Fergusson College Road, Deccan Gymkhana, Pune 4. Tel. 55632. Workers 18. Cap. Rs. 50,000. Products: Sport goods, retail and wholesale merchants.
- 2522. ULTRAMATIX.** Plot No. 10, opp. Lokmanya Hospital, Erandawana, Karve Road, Pune 4. Tel. Res. 449205. Partnership, 1976. Bank: Bank of Maharashtra. Prod. Rs. 4,00,000. Workers 6. Products: Digital instruments; process control instruments; instruments for telephone exchange maintenance and testing.
- 2523. UMA TOOLS (P) LTD.** S-17 Parvati Industrial Estate, Pune-Satara Road, Pune 9. Tel. 55375, 442374. Workers 26. Cap. Rs. 2.5 lacs. Products: Circular thread mills, N.S.S. milling cutters, tools.
- 2524. UMESH TRADERS.** 1182 Sadashiv Peth, Pune 30. Partnership, 1976. Bank: Bank of Maharashtra. Cap. Rs. 20,000. Prod. Rs.3,15,000. Products: Slipping units for electrical machines.
- 2525. UNITED ENGINEERING WORKS.** 333 Shukrawar Peth, Pune 2. Tel. 440385, Cap. Rs.40,000. Workers 7. Products: Jigs, fixtures, dies and various types of sheet metal components.
- 2526. UNITED INDUSTRIES.** Plot No. A-78, H Block, M.I.D.C., Pimpri, Pune 18. Cap. Rs. 1,75,000. Workers 18. Products: Press Components, tool room work.
- 2527. VIJAY CHEMICAL INDUSTRIES.** 4/4 Sahakari Vasahat, Karve Road, Pune 4. Tel. 56831. Factory: 155-A Phursungi, Pune-Saswad Road, Dist. Pune. Tel. 7187. Partnership, 1975. Bank: Bank of Maharashtra. Cap. Rs. 1,00,000. Prod. Rs. 6,00,000. Workers 8. Products: Potassium carbonate anhydrous.
- 2528. VIJAY OIL MILLS.** H/46 Adinath Housing Society, Pune-Satara Road, Pune 9. Factory: Chakan, Taluka Khed, Tel. 25, 36. Estd. 1970. Cap. Rs. 2,00,000. Workers 10. Products: Groundnut oil and oil cake.
- 2529. VIJAY TILES.** 691/A-1 Pune-Satara Road, Pune 9. Tel. 442767. Cap. Rs. 3,00,000. Workers 15. Products: Plain, mosaic cement tiles and grills.
- 2530. VILSO ENGINEERING CO.** S.No. 22/1 Pimpri, Pune 18. Cap. Rs. 1,50,000. Workers 9. Products: Pressed tools and pressed components
- 2531. VITHAL VALVES MFG. CO. (P) LTD.** Flat No 2, Kamal Niwas, Guru Nanak Nagar, Pune 2. Factory: D-54, MID C., Ahmednagar, Cap. Rs. 9.20 lakhs. Products: Industrial valves and castings.
- 2532. WESTERN INDIA RADIATORS AND ENGINEERING CO. PVT. LTD.** Bank of India Bldg., 4th floor, Laxmi Road, Pune 30. Tel. 445438, 443572. Cable: WIRECO. Estd. 1974. Bns. Bhopal, Chandigarh, Cochin, Hyderabad, Goa. Cap. Rs. 10,00,000. Workers 6. Products: Engineering goods like hose fittings, radiators, heat exchangers, assembling generating sets.
- 2533. YESHWANT SAHAKARI SAKHAR KARKHANA LTD.** At & Post Theur, Tal. Haveli, Dist. Pune. Estd. 1966. Tel. 7282. Cable: SECOSYFAL. Banks: Pune District Central Co-op. Bank; Bank of India; M.S.C. Bank. Products: Sugar, raw sugar.

BAKERIES**A. G. PRODUCTS**

Pimpri Colony, Pune 17.

AMAR BAKERY

464 Somwar Peth, Pune 11.

AMBALA BAKERY

557 Nana Peth, Pune 2.

AMBIKA BAKERY

451/455 Yerawada, Pune 6.

AMERICAN BAKERY

70 Naya Bazar, Khadki, Pune 3.

AMIR BAKERY

327 Taboot Street, Camp, Pune 1

ANAND BAKERY

113/114 Nana Peth, Pune 2

ANSAR BAKERY

801 Bhawani Peth, Pune 2

APSARA BAKERY

207 Ganj Peth, Pune 2

ARANYESHWAR BAKERY

970 Shukrawar Peth, Pune 2.

ASANDAS BAKERY

B Block, Pimpri Colony, Pune 17

ASHOK BAKERY

712 Guruwar Peth, Pune 2.

AUSTEIN BAKERY

Gol Market, Khadakwasla, N. D. A., Pune.

AZAD BAKERY

Kasarwadi, Pune 17,

AZAD HIND BAKERY

369A Koregaon Park, Pune 1.

AZAD HIND BAKERY

417 Hadapsar, Pune 28.

BHARAT BAKERY

Morwadi, Pimpri, Pune.

BHOLE SHANKAR BAKERY

434 Hadapsar, Pune 28.

BIBVE BAKERY

955 Shukrawar Peth, Pune 2

BLUE DIAMOND BAKERY

Koregaon Park, Pune 1.

BOMBAY BAKERY

460 Somwar Peth, Pune 11.

BREADWAY BAKERY

523 Nana Peth, Pune 2.

C.M.E. BAKERY

Dapodi, Pune 12.

CENTRAL PRISON BAKERY

Yerawada, Pune 6.

CHANDBI BAKERY

1012 Raviwar Peth, Pune 2

CROWN BAKERY

845 Bhawani Peth, Pune 2.

D'NOBELEE COLLEGE

Ramwadi, Pune

D'SOUZA BAKERY

Bhosari, Pune 26.

DARBAR BAKERY

463/467 Yerawada, Pune 6.

EDWARD BAKERY

983 Raviwar Peth, Pune 2.

EHASAN BAKERY

Old Bazar, Khadki, Pune 3,

EMPIRE BAKERY

Sachapir Street, Camp, Pune 1.

EMPIRE BAKERY

59 Khadki, Pune 3.

ENGLISH BAKERY

2008 St. Vincent St., Camp, Pune 1.

FAMOUS BAKERY

635 Nana Peth, Pune 2.

FERNANDEZ BAKERY

2145 New Modikhana, Camp, Pune 1.

GAJANAN BAKERY

715 Kasba Peth, Pune 11.

GANESH BAKERY

129 Mangalwar Peth, Pune 11.

GANESH BAKERY

Nana Peth, near Ghodepir, Pune 2.

GOOD LUCK BAKERY

14 Sassoon Road, Pune 1.

GOOD LUCK BAKERY

Old Bazar, Khadki, Pune 3

GOPALKRISHNA BAKERY

946 Bootee Street, Camp, Pune 1.

GOPAL BISCUITS

B. Block, Pimpri Colony, Pune 17

GRAND BAKERY

59 Ganesh Peth, Pune 2.

GULBAHAR BAKERY

703 Shukrawar Peth, Pune 2.

GUPTA BAKERY

Pimpri, Pune 17.

GURUNAN BAKERY

Pimpri Colony, Pune 17.

GURU NANAK BAKERY

1270 Bhawani Peth, Pune 2.

- HANUMAN BAKERY**
Shivajinagar, Pune 5.
- HEERA BAKERY**
Survey No. 47, Plot No 39, Akurdi,
Pune 35.
- HILTON BAKERY**
715 Nana Peth, Pune 2
- HINDUSTAN BAKERY**
264 Shaniwar Peth, Pune 30.
- HINDVIJAY BAKERY**
Vithalwadi, Pune.
- HINDUSTAN BAKERY**
Chinchwad, Pune 19.
- HUSENI BAKERY**
662 Taboot Street, Camp Canton-
ment, Pune 1.
- HUSHANGI BAKERY**
95 M. G. Road, Camp, Pune 1.
- IMPERIAL BAKERY,**
12 N.P.S. Line, Sholapur Nagar,
Pune 1.
- INDIA BAKERY**
112B Block, Pimpri Colony, Pune 17.
- INDIA BAKERY**
78 Raviwar Peth, Pune 2.
- J. A. CASTILINO BAKERY**
329 Sachapir Street, Camp, Pune 1.
- J. D. ASHOK BISCUITS
FACTORY**
Pimpri, Pune 17.
- JAJ BAKERY**
234 Hadapsar, Pune 13.
- JANATA BAKERY**
85 Rasta Peth, Pune 2.
- JAY BHARAT BAKERY**
482 Khadki, Pune 3.
- JAYHIND BAKERY**
1226 Kasba Peth, Pune 11.
- JAY KISAN BAKERY**
291 New Khadki, Pune 6.
- JOHREHIND BAKERY**
1558 Shukrawar Peth, Pune 2.
- K. L. KAMAL BAKERY**
C Block, Pimpri Colony, Pune 17.
- KALYAN BAKERY**
B Block, Pimpri Colony, Pune 17.
- KALYANI BAKERY**
6 Elphinston Rd., Pune 1.
- KAYANI BAKERY**
6 East Street, Camp, Pune 1.
- KHADI MEROTAR BAKERY**
Nana Soma Landagechi Landge
Wadi, Pune.
- KOHINOOR BAKERY**
422 Nana Peth, Pune 2.
- LAXMI NARSIMHA BAKERY**
1377 Kasba Peth, Pune 11.
- LAXMI NARSIMHA BAKERY**
Chinchwad, Pune 19.
- LOBO BAKERY**
1136 Bhawani Peth, Pune 2.
- LUCKY BAKERY**
1227 Shukrawar Peth, Pune 2.
- MADAN BAKERY**
Kharadwadi, Pune.
- MAHARASHTRA BAKERY**
629/30 Ganj Peth, Pune 2.
- MAHARASHTRA BAKERY**
Bombay-Poona Road, Pimpri,
Pune 17.
- MAJDOOR BAKERY**
B Block, Pimpri Colony, Pune 17.
- MANOHAR BAKERY**
150 Navi Peth, Pune 30.
- MILANSAR BAKERY**
Kharadwadi, Pune 18.
- MIRA BAKERY**
53 Narayan Peth, Pune 30.
- MODERN BAKERY**
458 Nana Peth, Pune 2.
- MOONLIGHT BAKERY**
64 Shivajinagar, Pune 5.
- MURLIDHAR BAKERY**
228 Guruwar Peth, Pune 2
- MY FRIEND BAKERY**
901 Shukrawar Peth, Pune 2.
- N. R. PRAKASH BAKERY**
B Block, Pimpri Colony, Pune 17.
- NAGINA BAKERY**
830 Bhawani Peth, Pune 2.
- NASEMAN BAKERY**
Kundan Nagar, Phugewadi, Pune.
- NATIONAL BAKERY**
815 Bhawani Peth, Pune 2.
- NAV MAHARASHTRA BAKERY**
215-B Budhwar Peth, Pune 2.
- NAV MAHARASHTRA BAKERY**
534 Phugewadi, Pune.
- NAZZ BAKERY**
M. G. Road, Camp, Pune 1.
- NAAZ BAKERY**
803 Bhawani Peth, Pune 2.
- NAZRATH BAKERY**
72 Elphinstone Road, Khadki, Pune 3.
- NEW AERIAL BAKERY**
399 Nana Peth, Pune 2.

- NEW BOMBAY BAKERY**
444 Rasta Peth, Pune 2.
- NEW DATTA BAKERY**
73 Ganesh Peth, Pune 2.
- NEW ITALIAN BAKERY**
1195 Raviwar Peth, Pune 2.
- NEW MAHARASHTRA BAKERY**
Dapodi, Pune 12.
- NEW NAZZ BAKERY**
1733 Shukrawar Peth, Pune 2.
- NEW POONA BAKERY**
672/C/2 Budhwar Peth, Pune 2.
- NEW RAMDAS BAKERY**
733 Raviwar Peth, Pune 2.
- NEW ROSHAN BAKERY**
742 Nana Peth, Pune 2.
- NEW SINDH BAKERY**
107 M.G. Road, Pune 1
- NEW STANDARD BAKERY**
12 P.M.T. Stop, Sholapur Road,
Pune 1.
- NEW TAJ BAKERY**
751 Bhawani Peth, Pune 2
- NEW TAJ BAKERY**
Kharadwadi, Pune.
- NILKAMAL BAKERY**
Pimpri Colony, Pune 17.
- NOVELTY BAKERY,**
22-B Somwar Peth, Pune 11.
- PARADISE BAKERY**
Chunchwad, Pune.
- PASTURE BAKERY**
6 Main Street, Camp, Pune 1.
- PATEL BAKERY**
1064 Raviwar Peth,
Pune 2.
- PERSIAN BAKERY**
383 Kolse Galli, Camp,
Pune 1.
- PERSIEN BAKERY**
369 Nana Peth,
Pune 2.
- POONA BAKERY**
405 Central Street, Camp,
Pune 1.
- PRATAPGAD BAKERY**
205 Somwar Peth,
Pune 11.
- PROTEIN KINGS BAKERY**
Bhosari Functional,
Electronic Industrial Estate,
Pune 26.
- PUNJAB BAKERY**
2158 Sholapur Road,
Camp, Pune 1
- RADIO BAKERY**
1957 Dr Saldhana Street, Camp,
Pune 1
- REELEX BAKERY**
329/2 Ghorpadi Peth,
Pune 2
- RAHIMAT BAKERY**
115/1 Khadki, Pune 3.
- RAJENDRA BAKERY**
189 Ganesh Peth, Pune 2.
- RAJESHWARI BAKERY**
Khadakwasla South, Pune
- RAJKAMAL BAKERY**
254 Mangalwar Peth, Pune 11.
- ROYAL BAKERY**
200 M. G Road, Camp, Pune 1.
- ROYAL HIND BAKERY**
B. Block, Pimpri Colony,
Pune 17.
- SAIBABA BAKERY**
Alandi Road, Kalas, Pune 15.
- SAMBHAJI BAKERY**
N.D.A, Khadakwasla, Pune.
- SANGITA PRODUCTS**
Pimpri Colony, Pune 17.
- SHAHANI BAKERY**
722 Nana Peth, Pune 2.
- SHAMSUNDAR BAKERY**
802 Bhawani Peth, Pune 2.
- SHANTARAMA BAKERY**
320 Nana Peth, Pune 2.
- SHERALA BAKERY**
1198 Bhawani Peth, Pune 2.
- SHIVSHAKTI BAKERY**
Morwadi, Pune 17.
- SHRI DATTA BAKERY**
1255 Shuvajinagar, Pune 5.
- SHRIKRISHNA BAKERY**
1333 Raviwar Peth, Pune 2.
- SILVER BAKERY**
726 Kasba Peth, Pune.
- SPICER COLLEGE**
Ganeshkhund, Aundh, Pune.
- STAR BAKERY**
710 Shukrawar Peth, Pune 2.
- SUNRISE BAKERY**
2128 A.H.P. Road, Camp, Pune 1.
- SURAT BAKERY**
82 Sholapur Bazar Road, Camp,
Pune 1.

SWASTIK BAKERY

262 Raviwar Peth, Pune 2.

TAJ BAKERY

858 Bhawani Peth, Pune 2.

U. P. BAKERY

515 Khadki, Pune 3.

U. P. EXPRESS BAKERY

Dehu Road, Tal. Haveli, Dist. Pune.

U. P. NAGINA BAKERY

Dehu Raod, Tal. Haveli, Dist. Pune.

U. P. TAVKAL BAKERY

Dapodi, Pune 12.

U. P. YADGAR BAKERY

328 Ghorpadi Peth, Pune 2.

USMANIA BAKERY

1875 Bhipura Line No. 29, Pune 1.

VAIBHAV PRODUCTS

802 Sadashiv Peth, Pune 30.

VARMA BAKERY

Dehu Road, Tal. Haveli, Dist. Pune.

VASANT BAKERY

1337 Raviwar Peth, Pune 2.

VAZ BAKERY

1941 Dr. Saldhana St., Camp, Pune 1.

VENUS BAKERY

1354 Raviwar Peth, Pune 2.

VIJAY BAKERY

290 Somwar Peth, Pune 11.

VOLGA BAKERY489/2 Satara Road,
Parvati Darshan, Pune 9.**BRICK FACTORIES****ASHOK & CO.**10 Oswal park, Shivajinagar,
Pune 5.**ABHIMANNU SHANKAR KEDARI
BRICK FACTORY**

7 Pashan, Pune 8.

**BABAN DHONDIBA SATPUTE
VEET BHATTI**

Pashan, Pune 8.

**BALOBA KONDIBA NIMHAN
BRICK FACTORY**

S. No. 11, Pashan, Pune 8.

BAM & CO.P. N. 355, S.No. 120 A/B
Vithalwadi Road, Pune 30.**BHIGWANKAR NARAYAN
EKNATH**Plot No. 31, Navi Veet Vasahat,
Parvati, Pune 30.**BHIKOPA GOVIND GHODNADI-
KAR BRICK FACTORY**Plot No. 36, Survey No 120,
Vithalwadi, Sinhagad Rd.,
Pune 9.**CHOPDA & SONS BRICK
FACTORY**

146/2 Pashan, Pune 8.

**D. S. DHADAPHALE BRICK
FACTORY**

64 Navi Peth, Pune 30.

**DAGDU BABU BANEKAR
BRICK FACTORY**

H. No. 22 Pashan, Pune 8.

**DATTATRAYA AVADAJI SHINDE
BRICK FACTORY**

545/2 Parvati, Pune 30.

DESAI & DESAI

196/18 Sadashiv Peth, Pune 30.

DHUMKE VASANT MAHADEV

89 Sadashiv Peth, Pune 30.

**GOVIND EKNATH NIMHAN
BRICK FACTORY**

5 Pashan, Pune 8.

**GOVIND RAMBHAU PASHAN-
KAR BRICK FACTORY**1187/7 Gora Kumbhar Sadan,
Shivajinagar, behind Modern High
School, Pune 5.**HANUMANT VITHAL PATIL
BRICK FACTORY**S. No. 11, Dhankawadi,
Pune-Satara Road, Pune 9.**JANARDAN NIVRUTTI ADMANE
BRICK FACTORY**

H. No. 190, Pashan, Pune 8.

**KONDIRAM VISHNU KUMBHAR
VEET KARKHANA.**

1004 Kasaba Peth, Pune 11.

**M. D. KALE VEETACHA
KARKHANA**

19 Pashan, Pune 8.

M. P. ATTAR BRICK FACTORY

Chinchwad, Pune 19.

**M. S. ATTAR & CO. VEET
BHATTI**

Pashan, Pune 8.

**MANIKBHAI PAPUBHAI ATTAR
BRICK FACTORY**

Varje, Tal. Haveli, Dist. Pune.

**MANIKBHAI PAPUBHAI ATTAR
BRICK FACTORY**

Dapodi, Pune 12.

**MAHADEO EKNATH NIMBANI
BRICK FACTORY**

At & Post Pashan, Pune 8.

N. V. DEOKAR
S. N. 133, Parvati, Pune 30.

**NARAYAN EKNATH BHIGWAN-
KAR & CO.**
Dhankawadi, S. No. 11, H. No. 10,
Pune 9.

**NAMDEO NARAYAN
GHODNADIKAR VEET
KARKHANA**
S. No. 120, Plot No. 33, Vithalwadi,
Pune 30.

**NIMHAN BABAN BALAJI BRICK
FACTORY**
1/18 Pashan, Pune 8.

**NIMHAN BALKRISHNA PANDU-
RANG**
S. No. 1/3, At & Post Pashan,
Pashan, Pune 8.

NIMHAN LAXMAN PANDURANG
S. No. 1/6, Pashan, Pune 8.

NIMHAN LAXMAN SOPANRAO
Pashan, Pune 8.

NIMHAN NIVRUTTI VITHAL
H. No. 52, Pashan, Pune 8.

NIMHAN SHANKAR EKNATH
S. No. 138, Pashan, Pune 8

NIMHAN SOPAN RAMU
214 Pashan, Pune 8.

NIMHAN VASUDEV NIVRUTI
Pashan, Pune 8.

NIMHAN VITTAL DNYANOBA
89 Pashan, Pune 8.

**NIVRUTTI DAGDOBA KUMBHAR
BRICK FACTORY**
27 Pashan, Pune 8.

**PARINCHEKAR TARABAI
SHANKARRAO**
S.N. 120, Plot No. 28, Parvati,
Pune 30.

PARAKHE KRISHNA VISHNOO
H. No. 6, Pashan, Pune 8.

**PUNDLIK RAMBHAU PASHAN-
KAR BRICK FACTORY**
S. No. 144, Pashan, Pune 8.

PAWAR NIMHAN AND CO.
Pashan, Pune 8

R. G. NAIK BRICK FACTORY
342/43 Guruwar Peth, Pune 2.

R.M. WANJARI VEET KARKHANA
Kasarwadi, Pimpri, Pune 18.

**R. J. K. INDUSTRIES BRICK
FACTORY**
S. No. 114, Pashan, Pune 8.

S. RANPISE AND CO.
S. No. 146/2, Pashan, Pune 8.

**SAHDEO EKNATH NIMHAN
BRICK FACTORY**
31/3 Pashan, Pune 8.

SATHE KANTILAL NARAYAN
S No, 64, Aundh Camp, Tal. Haveli,
Dist. Pune.

**SHANKAR DAGDOBA KUMBHAR
BRICK FACTORY**
27 Pashan, Pune 8.

**SHANKAR DHONDIBA PASHAN-
KAR BRICK FACTORY**
Plot No 75, Pashan, Pune 8.

SHREE DEALERS
46/A Dhanori, Vishrantwadi,
Pune 15.

**SITARAM RAMCHANDRA PA-
SHANKAR BRICK FACTORY**
Pashan, Pune 8.

SURESH BRICK FACTORY
345/14 Parvati, Pune 9.

SWASTIK BRICK FACTORY
146/2/2 Pashan, Pune 8.

**T. K. KOTASTHANE BRICK
FACTORY**
1611 Sadashiv Peth, Pune 30.

**UMESH AND CO. BRICK
FACTORY**
434/2, Narayan Peth, Pune 30.

GOVERNMENT & SEMI-GOVERNMENT UNDERTAKINGS

A. F. M. S. D.
Elphinston Road, Pune 1.

A.V.B. SHOP AND SICK SIDING
Head Train Examiner, Central
Railway, Pune 1.

**AGRICULTURAL ENGINEERING
WORKSHOP**
College of Agriculture Compound,
Shivajinagar, Pune 5.

AMMUNITION DEPOT
Dehu Siding, Dehu Road, Pune.

AMMUNITION FACTORY
Khadki, Pune 3.

**ARMAMENT RESEARCH AND
DEVELOPMENT ESTATE**
Armament Post, Pashan, Pune 21.

ARMAMENT STORES DEPOT
Khadki, Pune 3.

512, ARMY BASE WORKSHOP
Khadki, Pune 3.

ARTIFICIAL LIMB CENTRE
Wanawadi Road, P. B. No. 86,
Pune 1.

- BAHIROBA PUMPING STATION**
Koregaon Park, Pune 1.
- BEAM WIRELESS STATION**
Dighi, Pune 15.
- BHARAT PETROLEUM CORPORATION LTD.**
40/41 Dr. Ambedkar Rd.,
Opp. R.T.O., Pune 1.
- BARRACK OFFICE AND STORE YARD**
Air Force Work, Yerawada, Pune 6.
- C. A. F. V. D.**
Khadki, Pune 3.
- CANTONMENT MOTOR WORKSHOP**
2015 John Mohmad Street, Pune 1.
- CENTRAL A. F. V. DEPT.**
Khadki, Pune 3.
- CENTRAL A. F. V. DEPOT (Stores Sub-Depot)**
Khadki, Pune 3.
- CENTRAL ORDINANCE DEPOT (DEHU SIDING)**
Dehu Road, Pune 1.
- CENTRAL RAILWAY TRACTION**
Sub-Station, Khadki, Pune 3.
- CENTRAL RAILWAY TRACTION**
Sub-Station, Dehu Rd., Pune.
- CENTRAL VEHICLE WORKSHOP M.S.E.B., Rasta Peth, Pune 11.**
- COLLEGE OF MILITARY ENGINEERING**
West Khadki, Pune 3.
- COMMAND SUB-DEPOT**
Ordnance Depot, Talegaon Dabhade, Pune,
- CONTROLLERATE OF INSPECTION**
Khadki, Pune 3,
- CONTROLLERATE OF INSPECTION (Ammunition)**
Powder Works Rd., Khadki, Pune 3.
- CONTROLLERATE OF INSPECTION (Engineering Equipment)**
Dighi, Pune 15.
- CONTROLLERATE OF INSPECTION (Special Vehicles), C. I. S. V**
Dehu Rd., Dist. Pune.
- CUSROW WADIA INSTITUTE OF TECHNOLOGY**
Pune 1.
- D G I INSPECTION AND PROOF TEAM**
Project Mayflower. C/o CI (A).
Khadki, Pune 3.
- DETACHEMENT AIR**
Armament Inspection
C/o Ammunition Factory, Khadki,
Pune 3.
- DET STATION WORKSHOP**
E.M.E. Dehu Rd., Dist. Pune.
- ENGINEERING WORKSHOP**
Dapodi, Pune 12.
- ENGINEERS STORES DEPOT**
Dehu Siding, Pune.
- EXPLOSIVES RESEACH AND DEVELOPMENT LABORATORY**
Sutarwadi, Pashan, Pune 21.
- E/M T & P YARD**
Within IAF Area, Pune 6.
- FURNITURE REPAIR WORKSHOP M.E.S.**
Barrack & Stores Office, Dehu Rd.,
Pune.
- FURNITURE REPAIR WORKSHOP M.E.S.**
Kahun Rd., Pune 1.
- FURNITURE REPAIR WORKSHOP M.E.S.**
Khadki, Pune 3.
- FURNITURE YARD**
B. E. & G. Centre, Khadki,
Pune 3.
- GANESHKHIND RECEIVING STATION M.S.E.B.**
S.No. 109, Ganeshkhind, Chaturshringi Rd., Pune 16.
- GHORPADI SICK SIDING GOODS**
Ghorpadi, Pune 1.
- GOVT. CENTRAL DAIRY**
Near Mari Aai Gate,
Bombay-Pune Rd., Pune 3.
- GOVT. CENTRAL WORKSHOP**
Dapodi, Pune 12.
- GOVT. PHOTO REGISTRY OFFICE**
5 Finance Rd., Pune 1.
- GOVT. PHOTO ZINCOGRAPHIC PRESS**
5 Finance Rd., Pune 1.
- HAFFKINE BIO-PHARMACEUTICAL CORPORATION LTD.**
Pimpri, Pune 18.
- HIGH EXPLOSIVES FACTORY**
Khadki, Pune 3.
- HINDUSTAN ANTIBIOTICS LTD.**
P.O. Pimpri, Pune 18.
- HOIST MFG. DIVISION**
Dapodi, Pune 12.
- HINDUSTAN PETROLEUM CORPORATION LTD.**
11 Raja Bahadur Rd.,
Pune 1.
- HOLKAR BRIDGE WATER WORKS**
1940 Khadki Works, 1943
46 Elphinstone Rd., Pune 1.

INDIAN OIL CORPORATION LTD.

Aviation Service Station,
Air Force Station, Pune 6

INSPECTORATE OF ARMAMENTS

Khadki, Pune 3.

INSPECTORATE OF MILITARY EXPLOSIVES

Khadki, Pune 3.

INSTITUTE OF ARMAMENT TECHNOLOGY

Training Workshop, Girinagar,
Pune 25.

INSTITUTE OF VETERINARY (Biological Products)

Ganeshkhind, Poona University Rd.,
Pune 7.

LOW LEVEL PUMPING STATION

934 Kasba Peth, Pune 11.

M.A.I.D.C. SUGARS FACTORY

D-II, 52 M.I.D.C. Industrial Estate,
Chinchwad, Pune 19.

M.E.S. TOOL AND PLANT YARD

No. 1, 'H' Lines, Wanawadi,
Pune 1.

M.S.E.B. WORKSHOP

S. No. 387, St. Mary, Pune 1.

MAFCO LTD.

Mafco Cold Store, Gultekdi, Pune 9.

MAHARASHTRA AGRO INDUSTRIES DEVELOPMENT CORPORATION LTD.

Plot No. 52, D-II, M.I.D.C. Industrial
Estate, Chinchwad, Pune 19.

MANGALWAR PETH PUMPING STATION

233 Mangalwar Peth, Pune 11.

METEOROLOGICAL OFFICE

Instrument Sector, Shivajinagar,
Pune 5.

MILITARY FARM

Near Holkar Bridge, Khadki,
Pune 3.

NEW POWER HOUSE

G. E. Air Force Works,
Pune 6.

PARVATI JAL SHUDHIKARAN KENDRA

Sinhagad Rd., Pune 30

PIMPRI PANI PURAVATHA CENTRE

Pimpri, Pune 18.

POLICE CENTRAL MOTOR TRANSPORT WORKSHOP

Near Body Guard Police Line,
Aundh, Pune 7.

POONA CANTONMENT WATER WORKS

Near St. Mary's Church, Stavely Rd.,
Pune 1

POONA COACHING SICK SIDING

Pune 1

PUNE JILHA SAHAKARI DOODH UTPADAK SANGH LTD.

Katraj, Pune 9.

PUNE MAHANAGARPALIKA MUDRANALAYA

'J' Plot, Ghole Road, Shivajinagar,
Pune 5.

PUNE MAHANAGARPALIKA VAHAN VYAVHAR GENERAL WORKSHOP

Shankarshet Road, Swargate, Pune 9.

PUNE MUNICIPAL CORPORATION VAHAN VYAVHAR

Narveer Tanaji Wadi,
Shivajinagar, Pune 5.

POONA MUNICIPAL CORPORATION VEHICLE DEPOT

Near Swargate, 1198 Shankarshet
Road, Pune 2.

POONA MUNICIPAL TRANSPORT WORKSHOP

High level tank compound, Near
Swargate, Pune 9.

POONA MUNICIPAL WATER WORKS

Swargate, Pune 9.

POONA MUNICIPAL CORPORATION WORKSHOP

410 Ghorpade Path, Pune 2.

POONA UNIVERSITY PRESS

Ganeshkhind, Pune 7.

R.D.E. (ENGINEERS)

Research & Dev. Estt., Pioneer Lines,
Dighi, Pune 15.

REGIONAL WORKSHOP SUB-DIVISION

Dapodi, Pune 12.

SLUICE GATE MFG. DIVISION

Dapodi, Pune 12.

STATE TRANSPORT CENTRAL WORKSHOP

Dapodi, Pune 12.

S. T. DIVISIONAL WORKSHOP

Shankarshet Rd., Pune 9.

S. T. SHIVAJINAGAR DEPOT

22/2 Narveer Tanaji Wadi,
Shivajinagar, Pune 5.

S. T. SWARGATE DEPOT

Swargate, Pune 9.

STATE TRANSPORT WORKSHOP TALEGAON DEPOT

Station Road, General Hospital,
Dist. Pune.

STATION WORKSHOP E. M. E.

Khadakwasla, N.D.A. Depot,
Pune 23.

STATION WORKSHOP E. M. E.
Khadki, Range Hill, Pune 3.

STATION WORKSHOP E. M. E.
Napier Lines, Pune 1.

**SUB-DEPOT OF BEGADEWADI
RLY. STATION**
Talegaon Dabhade, Pune.

**VEHICLE DEPOT WORKSHOP
E. M. E.**
Chikhalwadi, Near Swastik Rubber
Factory, Kadki, Pune 3.

VEHICLE SUB-DEPOT
Khadki, Pune 3.

YERAWADA PRISON PRESS
Yerawada, Pune 6.

HOSIERY MANU- FACTURERS

AMOLAK HOSIERY
298 Somwar Peth,
Pune 2.

**BHARAT KNITTING WORKS
LTD.**
524 Budhwar Peth, Pune 2.

DHAKATE HOSIERY
240 Guruwar Peth, Pune 2.

MANGAL HOSIERY
25 Kasba Peth, Pune 11.

MAYUR HOSIERY WORKS
1162 Raviwar Peth, Pune 2.

POONA HOSIERY MILLS
1684 Shukrawar Peth, Pune 2.

PRAKASH HOSIERY
820 Raviwar Peth, Pune 2.

R. C. MOTIWALE AND SONS
247 Budhwar Peth, Pune 2.

RAJKAMAL TEXTILES
552 Raviwar Peth, Pune 2.

SADANAND TEXTILES
Hadapsar, Pune 13.

**SHA. MULUKCHAND DAULAT-
RAM**
Raviwar Peth, Pune 2.

SHRIRAM HOSIERY
810 Raviwar Peth, Pune 2.

SHRIRAM HOSIERY WORKS
264/4 Shanwar Peth, Pune 30.

UNITED HOSIERY WORKS
264/4 Shanwar Peth, Pune 30.

VIJAY HOSIERY WORKS
308 Narayan Peth, Pune 30.

READYMADE GARMENT MANUFACTURERS

ALLWIN GARMENTS
436A/1 Narayan Peth, near
Lokhande Talim, Pune 30.

APSARA DRESS MFG. CO.
720 Budhwar Peth, Pune 2.

AROON TRADERS
1038 Raviwar Peth, Pune 2.

C. K. C. DRESSERS
587 Guruwar Peth, Pune 2.

C. M. KUKKAR BROS.
499 Guruwar Peth, Pune 2.

CHANDAN GARMENTS
613/614 Sadashiv Peth, Sevasadan
Bldg., Laxmi Road, Pune 30.

**CHAVAN READYMADE CLOTH
STORES**
337 Budhwar Peth, Pune 2.

CHETANA CHILDREN CHOICE
183 Guruwar Peth, Fullwala
Chowk, Pune 2.

CRESSWELL TAILORS
5 Coyaji Road, Pune 1.

**DECCAN EMBROIDERY MFG.
CO.**
39/1-A Ambedkar Rd., Pune 1.

DELTA ENTERPRISES
W-40 (MIDC), Bhosari Industrial
Area, Bhosari, Pune 26.

GEETA DRESS MFG. CO.
84 Ganesh Peth, Pune 2.

GEM DRESS MFG. CO.
312 Ganj Peth, Pune 2.

HIMALAYAN TRADING CORP.
152 St. Patricks Town, Pune 13.

HINDUSTAN DRESSES
22 Mahatma Phule Peth, Pune 2.

K. G. BANTHIA BROS.
94 Ganj Peth, near Police Gate,
Pune 2.

KALYANI APPARELS
353 Shukrawar Peth, Pune 2.

KALYANI CLOTH MERCHANTS
392 Pandit J. N. Road, opp. Apsara
Talkies, Pune 9.

KAMLAPURE DRESSES
439 Guruwar Peth, near Ahlyadevi
Mandal, Pune 2.

LUNKAD DRESSES
550/B Nana Peth, Pune 2.

MADHUKAR VISHNU TILEY
437 Budhwar Peth, near Shri Pasodya
Vithoba Mandir, Pune 2

**MADHU-VISHWA DRESS MFG.
CO.**
437 Budhwar Peth, Pune 2.

MANSUKH DRESS MFG. CO.
350 Budhwar Peth, Pune 2.

MITCO GARMENTS
403 Ganesh Peth, Laxmi Road,
Pune 2.

NAJ DRESSES
260 Gunj Peth, near Police Chowki,
Bhoi Ali, Pune 2.

NOBLE GARMENTS
482/83 Budhwar Peth, Pune 2.

PARAG DRESSES
507 Guruwar Peth, near Gunj Peth
Police Chowki, Pune 2.

POONA CLOTHING CO.
New 1255 Bhawani Peth, near
Mahesh Bank, Pune 2.

PRAKASH ENTERPRISES
501 Budhwar Peth, Pune 2.

PRASAD GARMENTS
1138 Sadashiv Peth, Pune 30.

RAJKAMAL DRESSES
1105 Raviwar Peth, Pune 20.

S. S. INTERNATIONAL
1187/62-2 Shivajinagar, Pune 5.

SAGAR DRESSES
398 Ganesh Peth, Pune 2.

SHRINAGAR DRESS MFG. CO.
361/62 Budhwar Peth, Pune 2.

SONA DRESS MFG. CO.
1480 (New) Kasba Peth, Pune 11.

SONO-RIKA
501 Ghorpade Peth, Swargate Corner,
Pune 2.

SURENDRA TRADERS
372 Budhwar Peth, Pune 2.

SWEETOO GARMENTS
1255 Bhawani Peth, Pune 2.

TAPADIYA AND COMPANY
693 Raviwar Peth, Pune 2.

TEJWANAY BROTHERS
966 Raviwar Peth, Gurudwar Road,
Pune 2.

VAISHALI DRESSES
641 Guruwar Peth, Pune 2.

VASWANI DRESSES
957 Budhwar Peth, opp. Vijayanand
Talkies, Pune 2

VERACITY WEAR
94 Raviwar Peth, near Railway
Booking Office, Pune 2.

STONE CRUSHERS

AMARDEEP ASSOCIATES
S. No. 8 Akurdi, near Khandoba
temple, Pune 19.

APTE CONSTRUCTION CO.
1635 Sadashiv Peth, Pune 30.

**ARJUNDAS M. KRIPLANI
STONE METAL WORKS**
Pimpri, Bombay-Pune Road, Pune 18.

**ARJUNDAS M. KRIPLANI
STONE METAL WORKS**
Chunchwad, Bombay-Pune Road,
Dist. Pune.

**M/S. ASIAN INDUSTRIES STONE
CRUSHER**
S. No. 16B Yerawada, Pune 6.

ATUR INDIA PVT. LTD.
Atur House, 16/A Dr. Ambedkar Rd.,
Pune 1.

**BRILLIANT STONE METAL
WORKS**
No. 2 Vishrantwadi, Alandi Rd.,
Dhanori, Pune 15.

**CHINCHWAD STONE CRUSHING
WORKS**
S. No. 73/2/2, Nigadi, Pune 19.

**D. A. BHILLARE STONE CRUSH-
ING WORKS**
C/o Shapoorji Palaji & Co. P. Ltd.,
Pimpri Telco Works, Pune 18.

D. C. POTNIS STONE CRUSHER
S. No 10/A Yerawada, Pune 6.

**DIAMOND STONE METAL
WORKS**
154 Vishrantwadi, Dhanori, Pune 15.

ELEPHANT STONE CO.
S. No. 12 Dhanori, Pune 15.

G. S. NARANG & SONS
S. No. 10/A Yerawada Quarters,
Pune 6.

**HAJARE & SONS (STONE CRU-
SHER)**
S. No. 119-A Nigadi, Chinchwad,
Pune 19.

J. D. PANDAY STONE CRUSHER
S. No. 16/B, 12/B, Yerawada,
Pune 6.

JAIHIND STONE CRUSHING CO.
S. No. 12A Yerawada, Pune 6.

JAMTANI STONE INDUSTRIES
Akurdi, Chinchwad, Pune 19.

M/S. JYOTI STONE INDUSTRY
S. No. 154/B Dhanori, Vishrantwadi,
Pune 15.

JYOTI STONE METAL WORKS
10 Oswal Park, Shivajinagar,
Pune 5.

L. K. AGARWAL
S. No. 231 Lohgaon, Pune 6.

MAHARASHTRA MINERALS
S. No. 154/1/B Yerawada, Vishrant-
wadi, Pune 15.

**MAHENDRA STONE METAL
WORKS**
7/5 Erandawana, Anil colony,
Pune 4.

PRAVIN STONE METAL WORKS
S. No. 152 Pimpri, Waghire, Pune 18.

R. P. Y. GERA
Lohagaon, 8/352 Boat Club Rd.,
Pune 1.

**RAMESH METHRANI SUPPLI-
ERS OF BUILDING & ROAD
MATERIALS**
Plot No. 242 Vishrantwadi, Dhanori,
Pune 15.

RECONDO LTD.
282/84 Sadhu Waswani Nagar,
Pune 7.

**S. DAYALSINGH KKISHNASING
& SONS**
Chinchwad, Pune 19,
I. D...14

**SHRI GANESH STONE METAL
WORKS**
Suvarnadeep Bungalow, 38/12
Prabhat Rd., Galli No. 10, Pune 4.

**SUBHASH STONE METAL
WORKS**
S. No 152 Pimpri, Waghire,
Pune 18.

VIJAY CONSTRUCTION CO.
Opp. Cooper Factory, Chinchwad,
Pune 19.

**VIJAY STONE CRUSHING
WORKS**
282 Sahakar Nagar, Pune 9.

WOOD-WORKING INDUSTRIES

**ARJUNBHAI KARSANBHAI
PATEL**
691/A/1 Pune-Satara Road, Pune 9.

ASAPURA SAW MILLS
24 New Timber Market, Pune 2.

BAND SAW BLADES MFG. CO.
39/32 Karve Road, Pune 4.

BHANAJI BHIMAJI PATEL & CO.
2 New Timber Market, Pune 2.

BHIKAMCHAND KASTURCHAND
76 New Timber Market, Pune 2.

BOMBAY TIMBER SYNDICATE
23 New Timber Market, Pune 2.

D. G. DESHPANDE & SONS
715 Sadashiv Peth, Pune 30.

D. M. JANGADA
16 New Timber Market, Pune 2.

**DATTUSING GANPATSING
PARDESI**
30 New Timber Market, Pune 2.

DHANAJI SHIVAJI PATEL
122 New Timber Market, Pune 2.

DILIP SAW MILLS
99 New Timber Market, Pune 2.

**DINKAR YESHWANT
PATANKAR**
106 New Timber Market, Pune 2.

G. H. KIRAD
109 New Timber Market, Pune 2.

GANESH SAW MILLS
12 New Timber Market, Pune 2.

GAJANAN SAW MILLS
120 New Timber Market, Pune 2.

GANPATI SAW MILLS
100 New Timber Market, Pune 2.

GEETA UDYOG
121 New Timber Market, Pune 2

**GIRJAPPA NARAYAN CHINCH-
AWALE**
New Timber Market, Pune 2.

GIRISH BHAIRU BAKARE
8 New Timber Market, Pune 2.

GODAJI MOTILAL & CO.
37/B New Timber Market, Pune 2.

GODAVARMAL KASTURCHAND
76 New Timber Market, Pune 2.

GOPAL SHIVDAS & SONS
27 New Timber Market, Pune 2.

GOVIND TRIMBAK LOHOTEKAR
99 New Timber Market, Pune 2.

- GUJRATH TIMBER SYNDICATE**
8 New Timber Market, Pune 2.
- H. GOPALBHAI & CO.**
104 New Timber Market, Pune 2.
- HANUMAN SINGH & SONS**
30/4 New Timber Market, Pune 2.
- HAREKAR TOYS WORKS**
510 Budhwar Peth, Pune 2.
- HARISCHANDRA HARIJEEVAN KIRAD**
77 Nana Peth, Pune 2.
- HIRAK STEEL CRAFT**
78 Nana Peth, Pune 2
- JAGDISH BALDEOPRASAD GUPTA**
41 Shukrawar Peth, Pune 2.
- JAIN TIMBER TRADING CO.**
84 New Timber Market, Pune 2.
- JESVANT TIMBERS**
46 New Timber Market, Pune 2.
- K. S. PATEL & CO.**
122 New Timber Market, Pune 2.
- KALIDAS VITHALDAS KIRAD**
356 Nana Peth, Pune 2.
- KARNATAK SAW MILLS**
New Timber Market, Pune 2.
- KOKIL PACKING WORKS**
19-A Timber Market, Pune 2.
- KOTHARI TRADERS**
77 New Timber Market, Pune 2.
- N. G. PATEL**
2 New Timber Market, Pune 2.
- N. K. OSWAL & CO.**
6 New Timber Market, Pune 2.
- NITINKUMAR & CO.**
39/32 Late Bldg, Karve Road,
Pune 4.
- OSWAL & CO.**
105 New Timber Market, Pune 2.
- M. D. PATEL**
22 New Timber Market, Pune 2.
- M. DWARKADAS**
139 Bhawani Peth, Pune 2.
- H. M. PARDESHI**
722 Ganj Peth, Pune 2.
- N. K. PATEL & SONS**
100 New Timber Market, Pune 2.
- M. R. PATEL & CO.**
3 New Timber Market, Pune 2
- MAHARASHTRA ENTERPRISES**
266/B New Timber Market, Pune 2
- MAHIMA TIMBER TRADERS**
75 New Timber Market, Pune 2.
- MAJESTIC TRADERS**
266/B New Timber Market, Pune 2
- MAWAJI PREMAJI PATEL**
110 New Timber Market, Pune 2.
- MODERN CRAFT**
123 New Timber Market, Pune 2.
- MOHANKAR TIMBER CO.**
119 New Timber Market, Pune 2.
- MUKESH TIMBER TILES CO.**
80 New Timber Market, Pune 2.
- MUTHA RATHOD TIMBER TRADING CO.**
123 New Timber Market, Pune 2.
- P. M. PATEL & CO.**
61 New Timber Market, Pune 2.
- PARBHATBHAI KANJI PATEL & CO.**
4 New Timber Market, Pune 2.
- PATEL PRABHATBHAI DAYA-BHAI & CO.**
61/B New Timber Market, Pune 2.
- PATEL SAW MILLS**
22 New Timber Market, Pune 2.
- PATEL TIMBER TRADING CO.**
90 New Timber Market, Pune 2.
- PRADIP TIMBER MART**
7 New Timber Market, Pune 2.
- PRAGATI GENDABHAI PARMAR**
116 New Timber Market, Pune 2.
- PRAMOD SHALIGRAM BAKARE**
8 New Timber Market, Pune 2.
- PUNJAB SAW MILLS**
36 New Timber Market, Pune 2.
- PURUSHOTTAM GOVIND BAKARE**
8 New Timber Market, Pune 2.
- R. R. KIRAD**
Plot No 12 New Timber Market,
Pune 2.
- RAGHWOANSHI SAW MILLS**
7 New Timber Market, Pune 2.
- RAJ FURNITURES**
630 Narayan Peth, Pune 30.
- RAJA STEEL INDUSTRIES**
Plot No. 8 Kaka Halwai Estate,
Pune 9.
- RAMANI & CO.**
266 New Timber Market, Pune 2.
- RAMJIBHAI VISHRAM PATEL**
121 New Timber Market, Pune 2.

| | | |
|---|---|--|
| RANUN ENGINEERING CORPORATION 587/12 Shukrawar Peth, Pune 2. | SARDAR SUKHASING TIMBER MART 113 New Timber Market, Pune 2. | SOMNATH GOPAL PATEL 27 New Timber Market, Pune 2. |
| RAVAJI LALJI PATEL 102/B New Timber Market, Pune 2. | SHAHA RIKHABCHAND MULCHAND BHANDARI 49 New Timber Market, Pune 2. | SURESH LAXMAN KALEKAR 208/8 Gunj Peth, Pune 2. |
| RAVAJI SHIVAJI PATEL & CO. 5 New Timber Market, Pune 2. | SHAILENDRA & CO. 103 New Timber Market, Pune 2. | TIMBER AGENCY (Dealers only) 321/5 Mahatma Phule Peth, Pune 2. |
| RAVINDRA & CO. 524/525 Gunj Peth, Pune 2. | SHANKAR MANIRAM 98 New Timber Market, Pune 2. | TIMBER IMPORTERS SYNDICATE 99 New Timber Market, Pune 2. |
| S. S. H. B. INDUSTRIES 75 New Timber Market, Pune 2. | SHARADA TIMBER TRADING CO. 75 New Timber Market, Pune 2. | TIMBER TRADING CO. 120 New Timber Market, Pune 2. |
| SATISH PRABHAKAR BAKARE 8 New Timber Market, Pune 2. | SHIRODKAR SAW MILLS 127/B New Timber Market, Pune 2. | TODIYAN TIMBERS 11 New Timber Market, Pune 2. |
| SANGHAVI JATAJI SAKALJI OSWAL & CO. 58-A-B New Timber Market, Pune 2. | SHIVAJI KARSAN PATEL & CO. 5 New Timber Market, Pune 2. | TRIBHUVAN VITHALJI KIRAD 103 New Timber Market, Pune 2. |
| SARDAR M. KIRAD 108 New Timber Market, Pune 2. | SHIVDAS MANJI & CO. 11 New Timber Market, Pune 2. | UNIVERSAL GASKETES & CO. 830 Bhawani Peth, Pune 2. |
| SAHYADRI TIMBERS 7 New Timber Market, Pune 2. | SHRI LAXMI SAW MILLS 116 New Timber Market, Pune 2. | VISHNU TIMBER MART 110 New Timber Market, Pune 2. |
| SARASWATI TIMBER TRADERS 102/B New Timber Market, Pune 2. | SHRIRAM SAW MILLS 21 New Timber Market, Pune 2. | WALJI KHIMJI PATEL & CO. 124 New Timber Market, Pune 2. |
| SARASWATI SAW MILLS 116 New Timber Market, Pune 2. | SOHANSING AMARSINGH New Timber Market, Pune 2. | WOOD CRAFT 238 Nana Peth, Pune 2. |

**EXPLANATORY
NOTES
FOR
PRODUCT
INDEX**

1. Names of the products in this Index are arranged in alphabetical order.
2. Serial numbers used in the 'Guide to Manufacturers' are used as code numbers in this Index.
3. Names of the products are followed by these serial numbers which are given to the respective manufacturers. On the corresponding serial number one will get detailed information of the manufacturer in the 'Guide to Manufacturers'.
4. This Index includes bakeries, brick manufacturers, stone crushers, hosiery and readymade garment manufacturers and wood-working units.

PRODUCT INDEX

- ACETYLEN GAS**
777.
- ACIDS**
560, 2111, 2399.
- ACIDS—SLURRY**
1161, 2039.
- ACCESSORIES, MACHINE**
1061, 1273, 1509, 1731, 1740, 1875, 2063.
- ACTUATORS, VALVE**
1040.
- ADAPTERS**
822, 1131.
- ADDITIVES**
1724.
- ADHESIVES**
142, 352, 775, 838, 1107, 1537, 1724, 2114, 2185, 2434.
- AERATED WATER**
592, 1462, 1463, 2474.
- AGARBATTIES**
14, 279, 318, 402, 421, 688, 698, 972, 1012, 1043, 1053, 1242, 1614, 1759, 1836, 2014, 2074, 2380, 2475.
- AGRICULTURAL EQUIPMENTS AND IMPLEMENTS**
36, 48, 112, 184, 190, 289, 419, 492, 612, 651, 948, 1059, 1086, 1141, 1283, 1362, 1642, 1722, 2267.
- AGITATORS**
1140, 2501.
- AIR CIRCULATOR**
662.
- AIR CLEANERS**
60, 2427.
- AIR CONTROL EQUIPMENT**
45, 437.
- AIR CONDITIONING EQUIPMENT AND COMPONENTS**
44, 954, 2056, 2370.
- AIR POLLUTION EQUIPMENT**
2501.
- AIR VENT**
2033, 2293.
- ALCOHOL, INDUSTRIAL**
313.
- ALUMINA-HYDRATE**
768.
- ALUMINIUM PARTS**
399, 1441, 1467.
- ALUMINIUM CONTAINERS**
1764.
- ALUMINIUM POWDER AND PASTE**
939.
- ALUMINIUM SHEETS, STRIPS AND CIRCLES**
845, 1783, 1784, 1785, 2009, 2515.
- ALUMINIUM WIRES & CABLES**
1103.
- AMONIA, LIQUOR**
1151.
- AMONIA PRINTING MACHINE**
1639.
- AMPLIFIER**
27, 2079.
- ANGLES**
1405.
- ANGLES, SLOTTED**
2239.
- ANALYSERS**
197, 2042.
- ANODISING**
1525, 1569, 2057.
- ANTENNA BOOSTER**
775.
- ANTENNAS, TV**
1822.
- ANTIBIOTICS**
713.
- ANTI-RUST PREPARATIONS**
2496.
- AUDIO-EQUIPMENTS**
27, 1440.
- ATOMIC POWER PLANTS**
1146.
- AUTOMOBILES**
222, 223, 2170.
- AUTOMOBILE ACCESSORIES**
243, 335, 396, 587, 642, 684, 689, 852, 1008, 1108, 1765, 1772, 1845, 2065, 2168, 2339, 2345, 2490.
- AUTOMOBILES SPARE PARTS**
100, 124, 185, 198, 199, 200, 222, 223, 243, 265, 269, 272, 289, 368, 392, 466, 469, 539, 562, 624, 647, 673, 716, 773, 798, 799, 805, 821, 861, 879, 887, 932, 1078, 1125, 1143, 1202, 1226, 1318, 1320, 1335, 1336, 1367, 1389, 1420, 1432, 1433, 1443, 1574, 1630, 1688, 1769, 1829, 1845, 1855, 1886, 1950, 1998, 2022, 2026, 2040, 2060, 2145, 2170, 2220, 2345, 2378, 2416, 2459, 2507.
- AXLES**
265, 979, 1998.

- AUTOMOBILE CHASIS AND BODIES**
152, 829, 1700, 1723, 1765, 2432.
- BAGS**
63, 814, 999, 1046, 1100, 1142, 1172, 1349, 1650, 1658, 2339.
- BAKELITE PARTS AND MOULDINGS**
194, 457, 527, 652, 747, 840, 854, 991, 1334, 1375, 1448, 1603, 1710, 2017.
- BAKERY PRODUCTS**
544, 572, 671, 714, 927, 1127, 1184, 1241, 1294, 1304, 1315, 1321, 1584, 1703, 1812, 1958. Please also see Addenda for a detailed list.
- BALANCING MACHINES**
528.
- BAND SAWS**
1360.
- BARs**
232, 760, 851, 1599, 1986.
- BASE PLATES**
1971.
- BATTERIES**
367.
- BATTERY CHARGER**
68, 288, 412, 1254, 1854.
- BATTERY PARTS**
191, 1310.
- BATTERY SOLUTIONS**
906.
- BEARINGS**
117, 182, 368, 728, 953, 1106, 2032, 2162, 2483.
- BEARING PARTS**
852, 1285, 1829.
- BELTS, INDUSTRIAL**
235, 342, 805, 1490, 1971, 2349, 2483, 2499.
- BENCHES, R.C.C.**
1499, 2423.
- BICHROMATES**
2067.
- BICYCLE SPARES**
319.
- BIDIES**
458, 1047, 1069, 1414, 1738, 2188.
- BIMETAL STRIPS**
6, 953
- BISCUITS**
1321, 1813.
- BLADES, SINGLE EDGE**
1203.
- BLENDERS**
1140.
- BLOOD-PRESSURE APPARATUS**
775.
- BLOWERS**
1032.
- BOILERS & BOILER PARTS**
137, 316, 1693, 1985, 2393, 2581.
- BOILERS, WATER TUBE**
1032.
- BOLTS, FOUNDATION**
229, 1558.
- BOOK BINDING**
260, 454, 462, 493, 640, 643, 693, 800, 968, 996, 1117, 1215, 1221, 1293, 1390, 1501, 1519, 1568, 1651, 1810, 1811, 1840, 1871, 1924, 1934, 1944, 1953, 2095, 2115, 2124, 2283, 2300, 2315.
- BOOK DISPLAY RACKS**
247
- BORING EQUIPMENTS**
2333.
- BORING MACHINE**
380.
- BRAIDS, ELASTIC**
2391.
- BRAKES, ELECTROMAGNETIC**
1437.
- BRAKE LINERS**
37, 2047.
- BRAKE PIPES**
37.
- BRASS STRIPS AND CIRCLES**
429, 816, 845, 1086, 1186, 1419, 1783, 1784, 2009, 2373
- BRASSWARES**
633, 791, 1368, 2091, 2272.
- BREWERY MACHINES**
2386.
- BRICKS**
934. Please also see Addenda for a detailed list.
- BRUSHES**
256, 1464, 1743.
- BUCKETS**
218, 302, 467, 506, 510, 690, 1017, 1235, 1728, 1735, 1839, 1903, 1993.
- BUFF**
2013.
- BUFFING**
772, 862, 1312, 2059, 2335.
- BUILDING MATERIAL**
208, 258, 259, 377, 469, 794, 807,

- 850, 1000, 1085, 1095, 1133, 1374, 1403, 1411, 1444, 1671, 1919, 1992, 2092, 2308, 2401, 2501.
- BUSHES**
22, 792, 1006, 1110, 1316, 1331, 1389, 1448, 1888, 2162, 2350.
- BUSHINGS**
100, 1107, 1618, 1630.
- C. I. CASTING PLUMS**
696.
- C. T. C. SEGMENTS**
290.
- CABLES**
581, 749.
- CABLES, COILED CORD**
580, 581.
- CABLES ELECTRICAL**
581, 749.
- CABLES, GLASSFIBRE**
755.
- CADMIUM COMPOUNDS**
1039.
- CAGES**
43, 789, 1659.
- CALCULATORS**
587
- CALENDARS (OF PAPER)**
1808.
- CALIPER BRAKES**
2293.
- CAMS**
1389, 1774, 2020.
- CAM SHAFTS**
265, 1774, 2020, 2209.
- CANDLES**
440, 809, 899, 1082, 1825.
- CANISTERS, ALUMINIUM**
2091.
- CANS**
1017.
- CAPACITORS**
357, 359, 518, 711, 973, 1063, 1075, 1361, 1696, 1832, 2440.
- CARBON BRUSHES & CARBON PRODUCTS**
6, 576, 702, 1982.
- CARBURETTORS**
2022.
- CARDBOARD BOXES**
1018, 1485, 1846, 2097, 2330, 2368, 2404.
- CARD CLOTHING**
750.
- CARPETS**
1698.
- CARTON BOXES**
164, 722, 841, 1370, 1707, 1725, 1949, 1999, 2097, 2321.
- CASTER WHEELS**
2110.
- CASTINGS, EPOXY**
549, 2024.
- CASTINGS, INVESTMENT**
911.
- CATTLE FEED**
143, 351, 489, 719, 1391, 1898, 2336.
- CELLULOID PRODUCTS**
1761.
- CEMENT ARTICLES**
350, 2141.
- CERAMIC COMPONENTS**
333.
- CERAMIC FILTER CANDLES**
332
- CHAIRS, SALOON**
1942.
- CHALKS**
1027, 1275, 1673, 1749.
- CHEMICALS**
33, 39, 141, 236, 271, 315, 353, 371, 398-A, 450, 560, 593, 707, 830, 1039, 1080, 1111, 1151, 1237, 1391, 1422, 1487, 1492, 1497, 1819, 1869, 2067, 2087, 2107, 2142, 2217, 2247, 2326, 2399, 2413, 2430, 2463, 2510, 2527.
- CHEMICALS, LABORATORY**
619, 663, 761, 787, 1465, 2142.
- CHEMICALS, OFFSET**
1039.
- CHEMICAL PROCESSING**
1774, 1830.
- CHLORINATION PLANTS**
129, 517.
- CHOKES**
576, 955, 1624, 2395, 2440.
- CHROMIUM-PLATING**
832, 1525, 1902, 1904, 2060.
- CHUCKS**
1, 1054, 1692, 2099.
- CINEMATOGRAPHIC EQUIPMENTS**
2290.
- CIRCUIT BOARDS, PRINTED**
336, 1031, 1472, 1569, 2287.

- CLEANING POWDERS/SOLUTIONS**
130, 906, 980, 1112, 1159, 1269, 1363, 1422, 1771, 1828, 1874, 1979, 2111, 2225, 2261.
- CLOCKS, DIGITAL**
1153.
- CLOCKS, TRANSISTORS**
2201.
- CLOTH, HESSIAN**
1196
- CLOTH INDUSTRIAL**
264, 1247.
- CLOTH, POLISH**
906.
- CLUTCHES AND CLUTCH ASSEMBLY**
780, 849, 853, 1238, 1437, 2494.
- COAL AND COAL PRODUCTS**
373, 972, 1307
- COAL PRESS MACHINE**
211.
- COILS**
324, 546, 577, 579, 1447, 1907, 2395, 2440.
- COIL WINDING MACHINE**
96, 1059.
- COLD-STORAGE**
1114.
- COLOUR FILMS PROCESSING**
731, 2263.
- COMMODITY DISPLAY STANDS**
247.
- COMPONENTS TEXTILE**
182.
- COMPRESSORS, AIR**
187, 954, 2036, 2370.
- COMPRESSORS AND PARTS**
109, 492, 948, 954, 1399, 1451, 1453, 1743, 2025, 2040, 2094, 2306, 2386.
- COMPUTER SYSTEM**
786.
- CONCRETE BLOCK MAKING MACHINE**
1991.
- CONCRETE BUILDING PARTS, REINFORCED**
1992.
- CONCRETE BUILDING PARTS, PRECAST**
16, 1093, 1410, 1499, 2308, 2423
- CONCRETE TESTING APPARATUS**
1929.
- CONDENSERS**
518, 973, 1075, 1440, 1717, 1861.
- CONDENSERS, GANG**
31, 336, 1778, 2198.
- CONDENSERS, PAPER**
357, 1075.
- CONDUCTORS, COPPER**
2391.
- CONFECTIONERY**
119, 217, 244, 248, 284, 334, 362, 366, 700, 806, 936, 995, 1308, 1488, 1612, 1661, 1663, 1749, 1813, 1838, 1914, 2442.
- CONNECTING RODS**
265, 792, 2209.
- CONSTANT OIL LEVELLER**
138.
- CONTACT BREAKER POINTS**
205.
- CONTACT POINT, ELECTRICAL**
1735
- CONTROL PANELS**
197, 545, 832, 950, 1025, 1122, 1128, 1254, 1548, 1694, 1775, 1983, 2008, 2079, 2105, 2183, 2189, 2269, 2276, 2316, 2317, 2359, 2447, 2506.
- CONTROLLING EQUIPMENTS**
31, 649, 769, 866, 1066, 1236, 1531, 1598, 2081, 2151, 2200, 2395, 2486.
- CONVEYORS, CHAIN**
3, 1346.
- CONVEYORS**
3, 650, 1642, 1936, 1971, 2021, 2049.
- COOLERS, OIL**
35, 852, 1489.
- COPPER POWDER**
1110.
- COPPER STRIPS AND CIRCLES**
816, 1072, 1186, 1419, 1783, 1784, 1785, 2009.
- COPPER WIRES & CABLES**
1103.
- CORDS**
580, 581.
- CORDS, GLASS FIBRE**
755.
- CORES, FERRITE**
1029, 1216.
- CORRECTING FLUID**
1616.
- CORRUGATED BOXES**
164, 268, 309, 310, 311, 321, 382, 431, 678, 764, 841, 1090, 1199, 1245, 1295, 1303, 1370, 1485, 1520, 1707, 1725, 1846, 1999, 2017, 2097, 2292, 2368, 2404, 2407.

CORRUGATED SHEETS

309, 382, 431, 841, 1090, 1245, 1370, 1520, 1725, 2007, 2292, 2404, 2407.

CORRUGATED METAL SHEETS

1990.

COSMETICS

93, 880, 1505, 1856, 2301

COTTON WASTE

906.

COUPLINGS

1674, 2172.

COUPLING, PNEUMATIC

151, 1551.

COUPLINGS, FLEXIBLE

73, 363, 417, 708, 1346, 1432.

COUPLINGS, HOSE

775, 1056, 2061, 2127, 2272.

COVERS, INDUSTRIAL

2168, 2439, 2449.

CRANES

1989, 2460.

CRANK SHAFTS

265, 383, 491, 822, 879, 1054, 1324, 1431, 1888, 1998, 2139, 2209, 2270,

CRAYONS

899.

CROWN CORKS

1270.

CRUSHERS

3, 1900, 2021, 2352.

CURRENT COLLECTORS

1002.

CUTLERY ITEMS

144, 657, 1086, 1141, 1213, 1962.

CUTOOUTS

1251, 2184

CUTOOUTS, HIGH TENSION

538.

CUTTERS

307, 924, 1553, 1559, 1581, 1670.

CUTTING TOOLS

7, 307, 452, 1495, 2181, 2222

CUTTING TORCHES

124.

CYLINDERS

728, 1389, 1886.

CYLINDER-BLOCKS

1439.

CYLINDER DIAPHRAGMS

1209.

CYLINDER LINERS

201, 1175, 1574.

DAL AND FLOUR MILLS

1291, 1470, 2331, 2402

DATA PROCESSING**MACHINES**

786.

DEAD CENTRES

1273, 2012.

DECORATIVE ARTICLES

144, 1279, 1382, 1383, 1718.

DEFENCE EQUIPMENTS

561, 2191

DEMAGNETISING UNITS

1066, 1437, 1598.

DEODORANT

1269, 2273.

DETECTOR, CRACK

1066, 2177.

DETERGENTS

89, 141, 859, 975, 980, 1123, 1161, 1269, 1363, 1771, 1874, 1979, 2039, 2111, 2159, 2258, 2305.

DETONATOR EXPLODERS, ELECTRIC

770.

DHOTIS

90, 120, 900, 1101, 1157, 1209, 1228, 1261, 1594, 1690, 1782, 1791, 1805, 1818, 1848, 1884, 2071, 2077, 2130, 2260, 2296, 2299, 2303, 2352

DIALS

1210.

DIAMOND, CUT & POLISHED

793

DIAMOND GRINDING WHEELS

456, 793

DIAMONDS, POWDER & PASTES

456, 793

DIAMOND TOOLS

456, 793.

DIE CASTING

1326, 2292, 2293, 2342.

DIE PUNCHES

477, 865, 971, 1334, 1521, 1822, 2089, 2288, 2344.

DIES

67, 355, 401, 457, 464, 650, 805, 822, 827, 1044, 1326, 1334, 1355, 1760, 1868, 1880, 1925, 2002, 2024, 2084, 2181, 2182, 2215, 2342, 2525.

DIESEL ENGINES

949, 953, 1713.

DIGITAL INSTRUMENTS

96, 482, 1153, 2154, 2183, 2522.

DIODES

519, 1831.

| | | |
|--|--|---|
| DISINFECTANTS 1239, 1269, 2273. | 1030, 1033, 1322, 1343, 1833, 1961, 2157, 2158, 2301, 2455 | ELECTRICAL MOTORS, RE- PAIRING 24, 978, 2131. |
| DISTILLATION UNITS 1717. | DRUMS AND OTHER STEEL CONTAINERS 34, 286, 467, 720, 1017, 1471, 1728, 2101, 2467. | ELECTRIC MOTORS, WINDING 83, 159, 413, 875, 978, 1122, 1272 1854. |
| DISTILLED WATER 906. | DRUMS, CABLE 1337 | ELECTRICAL ACCESSORIES 122, 451, 526, 542, 861, 941, 991, 1025, 1099, 1167, 1195, 1448, 1700, 1710, 1775, 2150. |
| DOMESTIC APPLIANCES 451, 873, 925, 1620 | DRYERS 552, 925, 1267, 2393. | ELECTRICAL EQUIPMENTS 40, 96, 197, 336, 525, 929, 1167, 1188, 1398, 1507, 1555, 1589, 1620, 1624, 1730, 1822, 1854, 1985, 2063, 2152, 2335, 2381, 2454, 2456 |
| DOORS, AUTOMATIC SLIDING 866. | DRY CLEANING 2, 455, 2102 | ELECTRICAL FITTINGS 582, 2362. |
| DOOR FITTINGS 791, 1000, 2168. | DUCTING 2501. | ELECTRICAL INSTALLATION 875, 1122, 1330, 2269. |
| DOORS AND WINDOWS, WOODEN 998, 1000, 1337, 1364, 1403, 1413, 1415, 1444, 2277, 2504 | DUST BINS 1093. | ELECTRICAL REPAIRS 24, 444, 978, 1067, 1122, 1137, 1267, 1272, 1436, 1705, 1854. |
| DOWEL PINS 200, 210, 673, 701, 1166 | DUST COLLECTOR 43, 45, 2226. | ELECTRO-CHEMICAL PRO- DUCTS 1107. |
| DRAFTING MACHINES 1639. | DYERS 2003. | ELECTRO-MAGNETS 1437. |
| DRAWING MATERIALS 548. | DYES AND DYESTUFFS 85, 140, 179, 180, 422, 830, 839, 907, 1040, 1266, 1748, 1755, 2062, 2153, 2365, 2446, 2466, 2510, 2514 | ELECTRO-MEDICAL EQUIP- MENTS AND PARTS 86, 281, 320, 538, 751, 1153, 1981. |
| DRESS MATERIALS 169, 675, 873, 1913. | DYNAMOMETERS 521, 1714, 2012. | ELECTRO-PLATING 10, 99, 151, 214, 314, 463, 504, 571, 656, 696, 771, 965, 1165, 1231, 1309, 1763, 1830, 1902, 1904, 1915. |
| DRILLING MACHINE, PRECI- SION—MINI 686, 2464. | ELECTRIC HOISTS 378. | ELECTRO-STATIC EQUIP MENTS 770, 2049. |
| DRILLS 307, 1777, 2181, 2252. | ELECTRIC MOTORS AND PARTS 29, 30, 1138, 1502, 1873, 2036. | |
| DRILL, BITS 1777. | ELECTRIC MOTORS, FRACTI- ONAL 662. | |
| DRILLS, ROCK 187. | ELECTRIC MOTORS, SYNCHRO- NOUS 29, 2037. | |
| DRUGS AND PHARMACEUTI- CALS 17, 308, 351, 515, 638, 713, 899, | | |

ELECTRONIC INSTRUMENTS AND COMPONENTS (N.E.S.)
30, 31, 54, 68, 79, 95, 220, 240, 364, 412, 435, 482, 518, 519, 524, 652, 734, 751, 755, 770, 775, 785, 866, 918, 1026, 1029, 1031, 1066, 1128, 1153, 1156, 1216, 1251, 1301, 1339, 1429, 1440, 1529, 1641, 1730, 1774, 1829, 1831, 1967, 1983, 1985, 2018, 2057, 2081, 2154, 2179, 2276, 2381, 2392, 2431, 2436, 2440, 2443, 2479, 2503, 2511.

ELEVATORS
1971, 2021, 2239.

EMBOSSING
510, 996, 1580, 2450.

EMBROIDERY WORK
32, 80.

EMERGENCY LIGHTING UNITS
482, 2183.

EMULSIFIERS, INDUSTRIAL
398A.

EMULSION WAX
899.

ENGINES, I. C.
827, 949, 952, 953, 1713.

ENGRAVING
292, 872, 1320, 1435, 1720, 1745, 2149, 2292.

EPOXY-COMPOUNDS
977.

ESSENCES
613.

ETCHING POWDER
1039.

EXCAVATORS & PARTS
1270.

EXERCISE AND ACCOUNTS BOOKS
156, 655, 676, 810, 853, 920, 947, 1286, 1501, 1859, 1871, 2066, 2124, 2229, 2266, 2321, 2363.

EXHAUST SYSTEM
869.

FABRICATION EQUIPMENTS
134.

FABRICATION WORKS
36, 40, 52, 59, 73, 152, 159, 160, 161, 173, 184, 208, 211, 268, 298, 304, 349, 359, 386, 404, 428, 473, 487, 530, 551, 566, 568, 570, 598, 600, 602, 607, 612, 632, 646, 683, 734, 742, 743, 759, 789, 798, 799, 801, 844, 862, 871, 937, 955, 964, 974, 982, 1003, 1007, 1042, 1094, 1104, 1174, 1176, 1177, 1185, 1214, 1224, 1238, 1249, 1268, 1282, 1317, 1328, 1330, 1341, 1373, 1392, 1412, 1436, 1441, 1458, 1495, 1514, 1541, 1564, 1633, 1659, 1662, 1686, 1693, 1709, 1729, 1766, 1775, 1842, 1844, 1862, 1876, 1909, 1916, 1925, 1955, 1986, 2034, 2056, 2070, 2085, 2089, 2101, 2110, 1217, 2213, 2214, 2228, 2238, 2240, 2244, 2248, 2269, 2289, 2292, 2348, 2364, 2371, 2426, 2427, 2432, 2476, 2480, 2501.

FABRICS, COTTON
57, 90, 120, 153, 175, 176, 230, 340, 341, 348, 407, 485, 503, 610, 614, 626, 627, 628, 658, 659, 765, 836, 894, 900, 909, 917, 962, 993, 1011, 1101, 1157, 1209, 1228, 1247, 1261, 1262, 1332, 1528, 1577, 1591, 1593, 1594, 1621, 1639, 1690, 1782, 1791, 1804, 1805, 1818, 1848, 1851, 1884, 1885, 1935, 1964, 2058, 2071, 2077, 2090, 2125, 2130, 2147, 2167, 2260, 2296, 2299, 2303, 2352, 2379, 2415.

FABRICS, HANDLOOM
438, 1015, 1081, 1209, 1234, 1259, 1657, 1966.

FANS AND FAN PARTS
43, 45, 220, 662, 1145, 1468, 1906, 2060.

FANS, EXHAUST
1502.

FASTENERS
75, 539, 797, 854, 1135, 1367, 1558, 1739, 2464.

FEEDER, PRESS AUTOMATIC
852

FEEDERS
3, 650.

FERRITES AND FERRITE RODS
519, 538, 576, 1216, 1831

FERTILIZERS
219, 784, 901, 1074, 1102, 1607, 1667, 2399, 2403.

FIBRE GLASS MOULDING
891, 2024

FIBRE GLASS PRODUCTS
2449

FILMS AND SLIDES
369.

FILTERS
45, 129, 170, 185, 344, 368, 514, 951, 1484, 1659, 1844, 1861, 1916, 2186, 2226, 2332.

FILTERS, AIR AND OIL
951, 2033, 2427.

FILTERS, ELECTROSTATIC
950.

FIRE BRICKS
2400.

FIRE CLAY
2400.

- FIRE-FIGHTING EQUIPMENT, PORTABLE**
950.
- FITTINGS, BOARD AND DECK**
801.
- FLAME PROOF & EXPLOSION PROOF EQUIPMENTS**
1715
- FLANGES**
75, 265, 982, 1007, 1126, 2270, 2350
- FLITCH PLATES, STAINLESS STEEL**
1060.
- FLY WHEEL MAGNETOS**
827.
- FOOD PRODUCTS**
128, 334, 391, 399, 436, 501, 511, 590, 661, 700, 753, 858, 905, 922, 1019, 1074, 1136, 1232, 1291, 1711, 1716, 1813, 1882, 2224, 2397, 2465, 2469, 2485
- FOOTWEAR**
115, 509, 1676, 1793, 1881, 2048, 2145, 2156, 2477.
- FORGED ITEMS**
265, 1070, 1226, 1420, 1688, 2100, 2209, 2210, 2292, 2293
- FOUNDRY CHEMICALS**
26, 42, 52, 53, 615, 672, 1732, 2044.
- FOUNDRY EQUIPMENT**
987, 1758, 2023, 2034, 2056.
- FOUNDRY, FERROUS**
55, 81, 137, 290, 299, 324, 591, 621, 666, 881, 915, 948, 987, 1062, 1141, 1257, 1280, 1350, 1400, 1401, 1478, 1580, 1706, 1736, 1737, 1780, 1872, 1929, 2164, 2328, 2356, 2498.
- FOUNDRY FLUXES**
26, 42, 266, 615, 672, 2044.
- FOUNDRY, NON-FERROUS**
9, 22, 55, 81, 105, 108, 113, 139, 186, 188, 227, 299, 324, 330, 415, 435, 468, 555, 621, 666, 756, 760, 823, 881, 948, 988, 1041, 1062, 1141, 1164, 1225, 1257, 1280, 1326, 1372, 1400, 1401, 1412, 1486, 1498, 1602, 1706, 1712, 1736, 1737, 1872, 2162, 2164, 2228, 2285, 2328, 2342, 2356, 2498
- FOUNDRY, TYPE**
1035, 1527, 1803, 1930, 2388.
- FRACTION COLLECTOR**
541
- FRAME WORKS, PHOTO**
1511, 1994
- FRENCH POLISH**
328, 863, 2111.
- FREQUENCY EQUIPMENT**
1212.
- FRUIT PRODUCTS**
753, 2474
- FUNGICIDES**
2496.
- FURNACES**
372, 568, 987, 1267, 1694, 1758, 2036, 2189.
- FURNACES, ELECTRIC**
1236.
- FURNITURE, HOSPITAL**
1154, 2172, 2195, 2277, 2318.
- FURNITURE, OFFICE**
241, 1000, 1045, 1660, 2211, 2277.
- FURNITURE, STEEL**
78, 91, 234, 286, 298, 473, 545, 704, 734, 794, 883, 884, 912, 916, 974, 1045, 1185, 1211, 1642, 1686, 1721, 1723, 1728, 1860, 2070, 2110, 2195, 2248, 2302, 2364, 2433.
- FURNITURE, WOODEN**
78, 88, 150, 172, 298, 338, 410, 425, 531, 648, 746, 817, 883, 884, 916, 998, 1001, 1005, 1045, 1088, 1227, 1337, 1351, 1364, 1365, 1382, 1383, 1403, 1411, 1413, 1452, 1587, 1588, 1592, 1606, 1611, 1623, 1646, 1660, 1721, 1849, 1857, 1890, 1891, 1943, 1969, 2211, 2221, 2236, 2277, 2302, 2364, 2437, 2504.
- FUSES**
1694
- GALVANOMETERS**
54, 1398.
- GARDEN IMPLEMENTS**
415, 1460, 1896, 2292.
- GAS BURNERS**
40.
- GAS, HYDROGEN**
777.
- GAS PRESSURE REGULATORS**
2293.
- GASES, INDUSTRIAL**
777, 1480.
- GASKETS**
689, 741, 1618, 1975, 2065, 2123, 2204, 2255.
- GATES, WATER**
1960.
- GAUGES**
25, 100, 158, 210, 735, 837, 984, 1104, 1178, 1182, 1495, 1760, 2012, 2085, 2181, 2250, 2293, 2436, 2478.
- GAUGE GLASSES**
1091.
- GEARS**
265, 417, 491, 540, 553, 727, 935, 1126, 1155, 1180, 1273, 1320, 1385, 1448, 1457, 1603.

| | | |
|---|---|--|
| GEAR BOXES 827, 933, 979, 1039, 2040. | GRATINGS 1664, 2366. | HEARING AIDS 1134. |
| GEYSERS 925, 2178. | GRILLS, CEMENT 1410, 2423, 2529. | HEAT EXCHANGER 6, 35, 73, 529, 1489, 1770, 1861, 2386, 2501, 2532. |
| GENERATORS 935, 953, 1854, 2018. | GRINDERS 740, 587, 1194, 1359, 1445, 1461, 1659, 1952, 2035. | HEAT TREATMENT 403, 508, 681, 763, 890, 1165, 1179, 1231, 1267, 1597, 2335, 2520. |
| GENERATORS, WELDING 31. | GRINDING MACHINES 322, 1639. | HEAT TREATMENT SALTS 2246. |
| GHAMELLAS 1017, 1993, 2239. | GRINDING MATERIALS 958. | HEATERS 372, 436, 538, 712, 780, 1236, 1267, 1620, 2189, 2335, 2393. |
| GLASS, WARES 1379. | GRINDING MILLS 666. | HEAT TREATMENT PLANT 2246. |
| GLASS BOTTLES 842, 1379. | GRINDING STONES 1065. | HEATING EQUIPMENTS 451, 929, 1267, 1656, 2189, 2335 2393 |
| GLASS JARS 842, 1379. | GRINDING WHEELS 2015. | HEAVY-DUTY MACHINES 1553. |
| GLASS, FIBRE 1248. | GUIDES, VALVE 792. | HELMETS 578, 1310, 1700, 2145, 2449. |
| GLASS, LOW-MELTING 2006. | GUM 1476, 1724, 2434. | HIDES 1084. |
| GLASS MOULDS 1394, 1748, 1867, 1880. | GUNS, LETTER EMBOSSING 2482. | HOBBING MACHINES 380. |
| GLASS, OPTICAL 1359. | GUNS, SPRAY 2049. | HONING MACHINES 1461. |
| GLASS PANELS 144. | GUTS, TENNIS AND BADMINTON 74, 1474. | HOOKS, ROOFING 636. |
| GLASS PLATES 961. | HACKSAWING MACHINES 2119. | HORNS 2345. |
| GLASS RODS 1379. | HAND-GLOVES 1191, 2226. | HOSE CLIPS 1445, 1447. |
| GLASS VIALS 42. | HANGERS, FOLDING 65. | HOSE FITTINGS 2532. |
| LOSS WHITE 8. | | |

- HOSIERY**
46, 101, 157, 267, 897, 1265, 1297,
1744, 1789, 1941, 2245, 2286, 2497.
Please also see Addenda for a detailed list.
- HOSPITAL WARES, EQUIPMENT**
376, 395, 1962
- HOUSEHOLD ARTICLES**
405, 463, 1017, 1055, 1233, 1412, 1993, 2369.
- HULLERS, RICE**
2384.
- HUMIDIFIERS & DEHUMIDIFIERS**
921.
- HYDRAULIC CYLINDERS**
1389.
- HYDRAULIC EQUIPMENTS**
134, 715, 738, 1168, 2038.
- HYDRAULIC JACKS**
75, 1392.
- ICE**
677, 1114, 1469, 1702, 2148.
- ICE PLANTS**
954.
- INCUBATORS**
1236.
- INDICATING DEVICES**
320, 482, 543, 666, 715, 769, 1026, 1166, 1254, 1330, 1457, 1715, 2079, 2081, 2083, 2152, 2227.
- INDICATOR, TEMPERATURE**
543, 769, 1026
- INDICATOR, UNEVENNESS**
666.
- INDUSTRIAL GUARDS**
1238, 2449
- INDUSTRIAL SAFETY WEARS**
19, 796, 1746
- INDUSTRIAL UNDER-CARRIAGES**
112, 149, 234, 1381
- IMMERSION COOLERS**
2386
- INK, DUPLICATING**
1616.
- INK, MARKING**
1302, 1841, 2160
- INK, WRITING**
446, 644, 762, 1275, 1476, 1749, 2160.
- INSECTICIDES**
2078, 2301, 2390.
- INSTANT FOOD**
661, 2397
- INSTRUMENT BOXES, WOODEN**
1377, 1548
- INSTRUMENT CABINETS**
2506.
- INSTRUMENT PANEL BOARDS**
1569, 1714, 2470.
- INSULATION MATERIAL**
2114, 2382, 2519.
- INSULATOR**
549.
- INTERCOM SETS**
220.
- INVERTORS**
523, 579, 1251.
- JAWS, SOFT AND HARD**
1, 7, 11, 896, 1692, 2012.
- JIGS & FIXTURES**
259, 452, 528, 559, 1059, 1201, 1326, 1495, 1509, 1559, 1600, 1639, 1661, 1842, 1844, 1880, 2002, 2173, 2191, 2220, 2240, 2250, 2269, 2525.
- JOBGING WORKSHOPS**
1, 5, 13, 20, 21, 41, 47, 67, 69, 72, 84, 87, 92, 94, 104, 105, 107, 109, 118, 131, 145, 154, 163, 166, 177, 181, 184, 185, 190, 195, 198, 212, 213, 237, 245, 249, 251, 252, 263, 268, 272, 287, 293, 294, 300, 306, 317, 327, 356, 360, 392, 404, 414, 439, 442, 445, 452, 459, 461, 468, 470, 483, 484, 513, 529, 555, 558, 567, 573, 578, 604, 606, 607, 622, 623, 625, 629, 632, 673, 680, 682, 689, 696, 701, 703, 715, 716, 717, 766, 781, 788, 790, 794, 803, 820, 822, 825, 833, 835, 849, 867, 868, 881, 890, 896, 915, 923, 926, 935, 945, 946, 955, 981, 983, 1003, 1014, 1016, 1022, 1034, 1036, 1049, 1050, 1051, 1052, 1058, 1068, 1104, 1105, 1116, 1124, 1126, 1131, 1147, 1148, 1156, 1158, 1173, 1193, 1229, 1239, 1243, 1249, 1260, 1274, 1276, 1282, 1284, 1292, 1300, 1306, 1334, 1335, 1338, 1348, 1368, 1369, 1371, 1384, 1407, 1420, 1423, 1427, 1431, 1450, 1459, 1508, 1510, 1522, 1534, 1545, 1549, 1551, 1552, 1554, 1555, 1604, 1605, 1632, 1634, 1635, 1641, 1653, 1681, 1682, 1683, 1695, 1697, 1704, 1705, 1712, 1719, 1722, 1726, 1736, 1753, 1756, 1769, 1774, 1776, 1787, 1798, 1800, 1816, 1834, 1868, 1870, 1880, 1888, 1908, 1912, 1916, 1918, 1925, 1940, 1942, 1956, 1980, 1981, 1986, 2001, 2005, 2009, 2026, 2059, 2061, 2069, 2073, 2085, 2087, 2093, 2103, 2126, 2127, 2133, 2139, 2140, 2172, 2175, 2180, 2182, 2187, 2194, 2206, 2212, 2216, 2219, 2237, 2241, 2244, 2254, 2265, 2270, 2269, 2274, 2275, 2285, 2307, 2309, 2334, 2337, 2341, 2343, 2350, 2361, 2364, 2378, 2389, 2411, 2417, 2422, 2426, 2427, 2456, 2459, 2463, 2489, 2497, 2505, 2507.
- KEYS, INDUSTRIAL**
1058, 1060, 1143, 2020, 2035.

| | | |
|---|---|---|
| KITCHEN PLATFORM 2423. | LAMPS, SURGICAL 4, 1982. | LIQUOR 313. |
| KNIVES, INDUSTRIAL 2173. | ✓ LAPPING MACHINE 674, 919. | LOCKS, INDUSTRIAL 1539. |
| LABELS & STICKERS 426, 2354. | ✓ LATHES, AUTOMATIC AND PARTS 668, 2202, 2487 | ✓ LOOMS AND ACCESSORIES 148, 167. |
| LABELS, ANODISED 1056, 1569, 1745. | ✓ LATHES, UNIVERSAL-MINI 374, 686. | LOUD SPEAKERS 27, 1440, 1550. |
| LABORATORY EQUIPMENTS 206, 295, 296, 499, 1010, 1077, 1592, 1640, 1674, 2052. | ✓ LAUNDRY EQUIPMENTS 2319. | LUBRICANTS 2428. |
| LABORATORY FERMENTOR 541, | LEAD LINING 869 | M.S. BARS, PIPES 1945, 1960, 2155. |
| LABORATORY GLASSWARE 891, 1717. | LEATHER GOODS 106, 814, 914, 1076, 1142, 1192, 1349, 1352, 1466, 1676, 1727, 1881. | ✓ MACHINE TOOLS 948, 1600, 1639, 1952, 2002, 2036. |
| LACQUERS 490, 1040, 1537. | LEATHER, TANNING 1084. | ✓ MACHINE TOOL RECONDITIONING 563. |
| LAMINAR FLOW CABINETS 930. | LENSES 565, 1359. | ✓ MACHINE TOOL ACCESSORIES 11, 256, 1143, 1560, 1639, 1925, 2036, 2052. |
| LAMINATES 588. | LETTERING SETS 1150, 1569. | ✓ MACHINE TOOL SPARES 61, 374, 563, 1059, 1164. |
| LAMP AND LAMP COMPONENTS 505, 771, 1654, 1982. | LEVEL CONTROLLERS AND INDICATORS 517, 769, 1188, 1236, 1715, 1730, 1985 2079, 2152. | ✓ MACHINERY, CATTLE-FEED 2386. |
| LAMP AND SCALE 54. | LIBRARY STATIONERY 257. | ✓ MACHINERY, CEMENT PLANT 337, 982. |
| LAMPS, AUTO 1654, 1982, 2088. | LIGHTNING ARRESTERS 538. | ✓ MACHINERY, CHEMICAL INDUSTRY 36, 400, 499, 683, 1140, 1224, 1373, 1578, 1665, 1844, 1861, 1925, 1960, 1986, 2025, 2172. |
| LAMPS, ELECTRIC 486, 685, 1624, 1654, 1982, 2088, 2281, 2355. | LIME 479, 1085. | ✓ MACHINERY, CERAMIC INDUSTRY 1181. |
| LAMPS, GLOW 770. | LINERS 792, 826, 1425, 2449. | ✓ MACHINERY, DAIRY 871, 1330, 1578, 2094, 2101, 2386. |
| LAMPS, MINIATURE 685, 1610, 1654, 1982, 2088. | LINSEED OIL 2326. | |
| LAMPS AND SIGNS, NEON 771, 1982, 1985. | | |

| | | |
|---|---|--|
| MACHINERY, DECK 2508. | MACHINERY, RUBBER INDUSTRY 1674 | 801, 1642, 1674, 1758, 1971, 1991, 2021, 2036, 2056, 2307, 2501, 2508. |
| MACHINERY, ELECTRO- PLATING 1111, 2512. | MACHINERY AND PARTS, SAW-MILL 1360 | MATRICES 564. |
| MACHINERY, FLOUR MILLS 1900, 2384 | MACHINERY, SPRAY DRYERS PLANT 2386 | MATTRESSES 132, 1170, 1596, 1815, 2375 |
| MACHINERY, FOUNDRY 1399 | MACHINERY AND PARTS, SUGAR INDUSTRY 3, 72, 149, 316, 337, 428, 498, 597, 612, 945, 982, 1095, 1132, 1225, 1432, 1617, 1900, 1986, 2021, 2063, 2172, 2220, 2242, 2493 | MEASURING EQUIPMENTS 25, 673, 744, 837, 1166, 1301, 2145, 2478, 2509, 2511. |
| MACHINERY, FOOD-PRO- CESSING 1146 | MACHINERY, TEXTILE INDUSTRY 400, 935, 1078, 1146, 1330, 2032 | MEDICAL INSTRUMENTS 775, 1879 |
| MACHINERY, GLASS INDUSTRY 464, 650, 1181, 1394, 1399, 1367 | MACHINERY, TYRE RETREADING 2249 | MEDICINES AYURVEDIC 202, 203, 278, 699, 758, 880, 2122, 2301 |
| MACHINERY, ICE-CREAM MAKING 2386 | MAGNESIUM POWDER 939, 1669. | MEDICINES, VETERINARY 783, 1898 |
| MACHINERY, MATCH MAKING 2386 | MAGNETIC MATERIALS 1066, 1216, 2223, 2251 | METAL CASES AND BOXES 473, 567, 2317. |
| MACHINERY, PAPER AND BOARD MILLS 207, 1395, 2034, 2099. | MAGNETS, INDUSTRIAL 538, 575, 1216 | METAL NAME PLATES AND SIGNS 257. |
| MACHINERY, PHARMACEUTI- CAL INDUSTRY 400, 1140 | MAGNETISING EQUIPMENTS 1907, 2223. | METER REPAIRING 1917. |
| MACHINERY, PLASTIC INDUSTRY 1317, 2279. | MANHOLE COVERS 1311, 1478, 1929, 2112. | METERS 482, 517, 519, 2223, 2395 |
| MACHINERY, PRINTING 1900. | MAN-MADE FIBRES 331, 631, 940. | METERS, FLOW 770. |
| MACHINERY, PROCESS INDUSTRY 1146. | MARINE EQUIPMENTS 2508 | METERS, GAS 634. |
| MACHINERY, REFRIGERATION 2386. | MATERIAL-HANDLING EQUIPMENTS 3, 112, 286, 376, 378, 428, 498, 545, | METERS, CONDUCTIVITY 918, 2177. |
| MACHINERY, ROPE & COIR MAKING 1277. | | METERS, HOUR 1457, 1598, 2392. |
| | | METERS, RIKSHAW AND TAXI 476, 852, 2043, 2205, 2327. |

- METERS, WATER**
715.
- MICROSCOPES**
2298.
- MILK TANKERS**
2386.
- MILLING CUTTERS AND MACHINES**
387, 668, 1669, 1777, 1952, 2002, 2035, 2252, 2523.
- MINERAL, INDUSTRIAL**
1237.
- MINING MACHINERY**
187.
- MISCELLANEOUS INSTRUMENTS**
517, 1202, 1236, 2064, 2146, 2298, 2359, 2522.
- MITICIDES**
1422.
- MIXER**
1773, 2117.
- MODELS, SCIENTIFIC**
557, 1077, 1088, 2292.
- MONOFILAMENTS, POLYETHYLENE**
940.
- MOTOR CONTROL CENTRES**
950.
- MOTORS, FLAMEPROOF**
1146.
- MOPEDS**
943.
- MOULDING, SAND**
1062.
- I. D...15**
- MOULDS**
291, 457, 464, 554, 559, 805, 1310, 1603, 1802, 1868, 1880, 2182, 2191.
- MOULDS, FOR CHALKS**
620.
- MULMUL AND GREY MULLS**
57, 90, 103, 120, 176, 242, 488, 900, 1009, 1101, 1113, 1120, 1157, 1228, 1263, 1442, 1575, 1594, 1685, 1690, 1961, 1782, 1791, 1805, 1818, 1848, 1884, 2071, 2077, 2130, 2147, 2260, 2296, 2299, 2303, 2340, 2352.
- MUSICAL INSTRUMENTS**
1189, 1625, 1831.
- NAPHTHOLS AND BASES**
830, 1024, 1144, 2062, 2153.
- NIGROSINE**
2365.
- NIRANJAN**
1625.
- NITROGEN GAS & LIQUID**
777.
- NOVELTIES**
575, 2407.
- NOZZLES**
1451.
- NYLON**
331, 631, 940.
- NYLON ROPES**
2452.
- NUT-BOLTS**
84, 125, 151, 196, 229, 403, 612, 636, 718, 822, 971, 1054, 1282, 1285, 1316, 1367, 1774, 2001, 2268, 2350, 2425, 2471.
- OIL CAKES**
1291, 2528.
- OIL CIRCUIT BREAKERS**
387.
- OIL MILLS**
1240, 1291, 1894, 2528.
- OIL SEALS**
1432, 2145, 2324.
- OIL SEAL CUPS**
985, 1829.
- OFFICE EQUIPMENTS**
587, 734.
- OPTIC DEVICES**
19, 1358, 1359, 1746, 2149, 2298
- OSCILLATORS AND NULL POINT DETECTORS**
577.
- OVENS**
372, 568, 780, 1236, 1267, 1620, 1674, 2049.
- OXYGEN GAS & LIQUID**
777, 1480.
- P.V.C. CABLES**
581.
- P.V.C. COMPOUNDS**
582.
- P.V.C. LEATHER CLOTH**
427.
- P.V.C. PRODUCTS, FABRICATED**
520, 869, 1658, 1778, 2198, 2354.
- P.V.C. SHEETINGS**
427, 1658.
- P.V.C. TUBING**
60, 1119, 1658.
- PACKING MATERIALS**
264, 741, 764, 869, 1069, 1160,

- 1196, 1393, 1396, 1530, 1565, 1583, 1672, 1939, 1975, 2097, 2279, 2292, 2321, 2404.
- PACKAGE TESTING EQUIPMENTS**
1330.
- PAINTS AND THINNERS**
26, 85, 315, 447, 450, 574, 907, 944, 1021, 1107, 1187, 1296, 1354, 1567, 1748, 1869, 1877, 1977, 2111, 2208, 2225, 2326, 2444.
- PAINT REMOVERS**
1537
- PANEL BOARDS, ELECTRICAL**
1152, 1529, 2335.
- PANEL BOXES, IRRIGATION**
617, 1445.
- PAPAD**
1932, 2347.
- PAPER**
329, 430, 1395, 1585.
- PAPER BAGS**
1196, 1396, 2196, 2300.
- PAPER BOARD**
959, 1395.
- PAPER BOXES**
1481, 2360, 2407.
- PAPER CONES**
1636.
- PAPER ENVELOPES**
1244, 1699, 1824, 2300.
- PAPER, FILTER**
1473, 2405.
- PAPER, HANDMADE**
691, 1565, 2429, 2458.
- PAPER PULP**
329.
- PAPER, SPECIAL**
1583, 1585, 1616, 1866.
- PAPER, STENCIL**
1616.
- PAPER TUBES & ROLLS**
1636, 1672
- PATTERNS**
665, 2024, 2106, 2129, 2342.
- PATTERNS, METAL**
555, 591, 823, 986, 988, 989, 1225, 1399, 1439, 1486, 1498, 1518, 1619, 1736, 1737, 2106, 2166, 2292
- PATTERNS, WOODEN**
555, 591, 986, 988, 989, 1225, 1399, 1439, 1486, 1498, 1518, 1619, 1737, 2106, 2166, 2292.
- PENS, FOUNTAIN**
762, 1678.
- PERFUMERIES**
1357, 2074.
- PESTICIDES**
902, 1434, 2078, 2390.
- PETROL ENGINES**
952.
- PHYNYL, WHITE**
1422.
- PHOTOCELL COMPOUND UNITS**
866.
- PHOTO ENGRAVING CHEMICALS**
1040
- PHOTOGRAPHIC MATERIAL**
384, 731, 925, 1774.
- PIGMENTS**
475, 768, 1869, 2062, 2441, 2466.
- PIGMENTS, FLUORESCENT**
1494, 2062
- PINIONS**
682, 727, 2411
- PIPES AND PIPE FITTINGS**
520, 1041, 2127, 2164, 2367.
- PIPES, ASBESTOS CEMENT**
709, 1409, 1499, 2141.
- PIPES, COPPER AND COPPER ALLOY**
760.
- PIPES, F.R.P.**
578.
- PIPES, FUEL INJECTION**
37
- PIPES, P.V.C.**
582, 863.
- PIPES, R.C.C. SPUN**
465, 469, 710, 754, 1093, 1643.
- PIPES, SEAMLESS**
76.
- PISTONS AND PISTON RINGS**
324, 792, 853, 1389, 2203.
- PLANING MACHINE**
380.
- PLANT PROTECTION EQUIPMENT**
2285, 2410.
- PLASTER OF PARIS**
1673.
- PLASTIC ARTICLES/COMPONENTS**
29, 93, 194, 228, 376, 457, 840, 996,

- 999, 1008, 1010, 1100, 1195, 1345, 1347, 1355, 1364, 1424, 1468, 1913, 1938, 2011, 2109, 2144, 2174, 2462, 2492.
- PLASTIC GRANULES, REPROCESSED**
1742.
- PLASTIC MOULDINGS**
220, 478, 500, 855, 873, 991, 1119, 1172, 1334, 1347, 1355, 1375, 1448, 1450, 1499, 1641, 1701, 2017, 2024, 2145, 2279, 2414.
- PLASTIC PIGMENTS**
706.
- PLASTICS, REINFORCED**
2191, 2285.
- PLUGS**
542, 575, 1003, 1331.
- PNEUMATIC EQUIPMENTS**
187, 954, 2306.
- PNEUMATIC TOOLS**
635, 1039, 1451.
- POLISHING**
571, 668, 772, 942, 1830, 1870, 1908, 2231, 2297.
- POLISHING MACHINES**
2298.
- POLYESTER RESINS**
497.
- POLYTHYLENE OR POLYTHENE**
189, 532, 1387.
- POLYTHYLENE GRANULES**
1742.
- POLYTHYLENE BAGS**
60, 174, 586, 824, 855, 893, 1119, 1183, 1342, 1345, 1388, 1455, 1483, 1543, 1622, 1637, 1650, 1652, 1946, 1976, 2174, 2234, 2259, 2439, 2484, 2488.
- POLYTHYLENE FILMS**
586, 1543, 1937.
- POLYTHYLENE LAYFLAT TUBINGS**
270, 1483, 1652, 2439.
- POLYTHYLENE PRODUCTS**
60, 77, 174, 977, 1622, 1637, 1641, 1937, 1946.
- POLYTHYLENE SHEETS & ROLLS**
60, 174, 270, 826, 1342, 1455, 1483, 1543, 1622, 1637, 1652, 1937, 1976, 2174, 2234, 2439, 2484.
- POLYTHYLENE TUBING**
174, 532, 1342, 1543, 1937, 1946, 2174, 2484, 2488.
- PORCELAIN PARTS**
2400.
- POTENTIOMETERS**
54, 96, 220, 1339, 1398, 1696.
- POTENTIOMETERS, CARBON**
1696.
- POTENTIOMETER-RECORDER**
240.
- POULTRY**
38, 1482, 2320, 2430.
- POULTRY EQUIPMENTS**
38, 844, 1659, 2383.
- POULTRY FEED**
719, 2320.
- POWER PACKS**
2346.
- POWER SUPPLIERS**
482, 523, 1507, 2008, 2075, 2183, 2192, 2443.
- POWER TRANSMISSION EQUIPMENT**
68, 666, 954.
- POWDER, METAL**
811, 939, 1062, 1110.
- PRECISION MACHINE COMPONENTS**
7, 23, 158, 193, 196, 210, 252, 259, 457, 484, 528, 616, 668, 739, 852, 890, 982, 1057, 1059, 1060, 1143, 1201, 1224, 1282, 1331, 1367, 1457, 1495, 1509, 1556, 1641, 1739, 1760, 1776, 2004, 2012, 2017, 2038, 2179, 2464, 2517.
- PRESSES**
134, 668, 2036.
- PRESSED COMPONENTS**
865, 964, 971, 1044, 1070, 1125, 1226, 1264, 1334, 1338, 1441, 1484, 1521, 1775, 1829, 1842, 1844, 2089, 2123, 2232, 2240, 2332, 2414, 2506, 2526, 2530.
- PRESSURE RINGS**
464.
- PRESSURE VESSELS**
35, 1770.
- PREVENTORS**
1188, 2079.
- PRINTED CIRCUITS**
2470.
- PRINTING, AMONIA**
443.
- PRINTING, ART**
147, 301, 1393, 1679, 1809, 1865, 1968, 2137, 2264, 2271.
- PRINTING, BLOCKS**
226, 282, 603, 870, 882, 895, 933, 1035, 1056, 1200, 1530, 1573, 2264, 2461.

- PRINTING, COMMERCIAL**
18, 28, 62, 64, 70, 102, 111, 114, 123, 155, 164, 204, 224, 226, 250, 346, 358, 375, 381, 397, 398, 426, 434, 441, 449, 454, 462, 480, 493, 494, 623, 640, 643, 669, 687, 692, 693, 694, 721, 722, 723, 733, 736, 745, 748, 757, 802, 804, 813, 815, 819, 824, 834, 847, 857, 870, 878, 885, 888, 892, 895, 904, 910, 913, 928, 930, 931, 956, 963, 968, 1035, 1064, 1071, 1073, 1089, 1129, 1149, 1200, 1215, 1220, 1221, 1222, 1223, 1258, 1281, 1287, 1289, 1290, 1293, 1313, 1327, 1329, 1333, 1350, 1363, 1390, 1501, 1504, 1512, 1515, 1520, 1524, 1532, 1547, 1561, 1568, 1570, 1571, 1572, 1590, 1601, 1626, 1627, 1675, 1679, 1689, 1741, 1750, 1751, 1754, 1767, 1768, 1781, 1792, 1794, 1796, 1797, 1799, 1801, 1806, 1809, 1810, 1811, 1817, 1821, 1826, 1835, 1840, 1847, 1858, 1865, 1895, 1905, 1924, 1933, 1934, 1944, 1951, 1953, 1957, 1963, 1970, 1973, 1974, 1987, 1988, 2000, 2055, 2080, 2082, 2096, 2115, 2116, 2121, 2128, 2132, 2135, 2143, 2262, 2266, 2283, 2284, 2294, 2310, 2314, 2316, 2338, 2363, 2372, 2385, 2418, 2450, 2468, 2502
- PRINTING, LITHO**
273, 426, 1542, 1750, 1801, 1892.
- PRINTING, METAL**
165, 277, 990, 2354
- PRINTING, OFFSET**
226, 1056, 1200, 1220, 1375, 1406, 1569, 2468.
- PRINTING, PLASTIC**
1355, 1666, 2174.
- PRINTING, POLYTHENE**
1666, 2174.
- PRINTING ROLLERS**
2481.
- PRINTING, SCREEN**
221, 420, 441, 802, 961, 996, 1355,
- 1569, 1638, 1666, 1865, 2287, 2450, 2457, 2470, 2495
- PROCESS CONTROLLING INSTRUMENTS**
31, 330, 769, 797, 1026, 1115, 1715, 2200, 2276, 2359, 2448, 2522
- PUBLICITY FILMS**
369.
- PULVERISERS**
589, 666, 2384
- PULLEYS**
491, 1054, 1126, 1447, 1888, 2384,
- PUMPS**
131, 159, 472, 525, 537, 541, 740, 876, 948, 974, 987, 1037, 1078, 1630, 1872, 1873, 1900, 2012, 2038, 2203 2257, 2318, 2386
- PUMPS, ACID**
2449
- PUMPS, BARREL OIL**
635.
- PUMPS, CENTRIFUGAL**
1146
- PUMPS, CHEMICAL PROCESS**
876, 960
- PUMPS, CIRCULATING**
2412.
- PUMPS, MARINE**
740, 752.
- PUMPS, NON-CLOG**
876, 960.
- PUMPS, STAINLESS STEEL**
2386.
- PUMPS, SPRAY**
492, 2064, 2410.
- PUMPS, SUBMERSIBLE**
876, 960.
- PUSHERS**
187.
- RACKS & STANDS, INDUSTRIAL**
1936.
- RADIATORS**
387, 774, 846, 1489, 2532
- RADIO AND RADIO COMPONENTS**
918, 1367, 1440, 1468, 1586, 1610, 1982, 2060, 2179.
- RAIN GAUGES**
1310
- RAKHI**
1795.
- REACTION KETTLES**
1861.
- REACTION VESSELS**
1140.
- READYMADE GARMENTS**
49, 121, 146, 178, 339, 344, 347, 350, 361, 451, 556, 584, 601, 639, 641, 645, 679, 732, 864, 889, 898, 903, 1038, 1130, 1163, 1190, 1250, 1298, 1340, 1500, 1536, 1566, 1595, 1609, 1615, 1629, 1631, 1647, 1649, 1684, 1708, 1733, 1747, 1779, 1807, 1819, 1911, 1959, 1965, 2010, 2016, 2098, 2113, 2118, 2311, 2313, 2286, 2497, Please also see Addenda for a detailed list.
- REAMERS**
1079, 1670, 2252
- REAMERS, FLOATING**
1079.
- REBORING MACHINES**
2054.

| | | |
|--|--|---|
| RECORDERS 54, 1026. | REPAIRING, INSTRUMENTS 281, 689, 1668. | RUBBER BALLOONS 838, 967. |
| RECORDING INSTRUMENTS 30. | REPAIRING, MACHINES 159, 213, 245, 547, 595, 647, 875, 976, 1098, 1249, 1268, 1276, 1681, 1705, 1802, 1893, 1910, 1940, 1972, 2126, 2138, 2253, 2323. | RUBBER BANDS 2145. |
| RECTIFIERS 31, 288, 536, 1254, 1831, 1854, 2199. | RESINS 42, 497, 907, 1187, 2218. | RUBBER COMPONENTS 2499. |
| REFLECTORS, GLASS 1376. | RESISTORS 1339, 1440, 1696, 2431. | RUBBER COMPOUNDS, SYNTHETIC 1975, 2134 |
| REFRACTORIES 1687. | REVOLVING CENTRES 1273, 2012, 2181, 2489. | RUBBER, FOAM 1490, 2185 |
| REFRACTORY PRODUCTS 2519. | RIVETS 636, 760, 1070, 2312. | RUBBER, GLOVES 796, 838, 2145. |
| REFRIGERANT GASES & CHEMICALS 1151. | ROCK DRILLING RIGS 539. | RUBBER HOSES 805, 1456, 1490, 2145, 2204. |
| REFRIGERATION EQUIPMENT 954. | RODS & PROFILES 760. | RUBBER LINING 2045, 2145. |
| REGULATORS 124, 2033. | RODS, GAS WELDING 776. | RUBBER MOULDED ARTICLES 323, 354, 533, 689, 796, 805, 838, 1006, 1218, 1426, 1618, 1674, 1939, 1975, 2045, 2048, 2109, 2145, 2204, 2324, 2435, 2499, 2513. |
| RELAYS 569, 770, 1188, 1299, 2008, 2018, 2184. | ROLLED FIN TUBES 6. | RUBBER, PRESSED ARTICLES 840, 2145. |
| REPAIRING, AIR CONDITIONING AND REFRIGERATION APPLIANCES 594, 1067, 1540, 2370. | ROLLING MILL 404, 1405, 1714, 1784, 1945, 2155. | RUBBER SHEETS 805, 1490, 2145. |
| REPAIRING, AUTOMOBILES 98, 126, 133, 168, 192, 199, 255, 283, 365, 370, 383, 390, 393, 408, 409, 413, 471, 495, 502, 629, 653, 689, 756, 790, 792, 849, 879, 1020, 1023, 1116, 1197, 1208, 1217, 1272, 1305, 1306, 1318, 1319, 1325, 1540, 1562, 1582, 1608, 1628, 1655, 1705, 1786, 1788, 1843, 1864, 1997, 2086, 2207, 2438. | ROLLING SHUTTERS 1268, 2053, 2248, 2433. | RUBBER STAMPS 292, 664, 2419. |
| REPAIRING, BOSH PUMPS 326. | ROTARY KNIFE CUTTERS 666, 1451. | SACKS 1425. |
| | ROTARY SHAKERS 541. | SAFETY DEVICES 2173. |
| | ROUTER 553. | SAFETY EQUIPMENTS 19, 106, 168, 171, 1091, 1630, 2145, 2163. |
| | RUBBER ACCESSORIES 194, 289, 863, 1006, 1432, 1618, 2065, 2145, 2324. | |

| | | |
|---|---|---|
| SAGOL 162, 579. | SEPARATORS 1740, 2033, 2117, 2501. | SILICA GEL 389. |
| SALTS, GEL 356. | SEPARATORS, MAGNETIC 575 | SILK YARN TWISTING 343. |
| SANITARY FITTINGS 589, 1093, 2060, 2112. | SEPTIC TANKS 1093, 1643 | SILO 1990. |
| SAW MILLS 660, 667, 1206, 1411, 1413, 1415, 1416, 1491, 1734, 1757, 1887, 1889, 1890, 1891, 1919, 1920, 1931, 1943, 2291, 2374, 2376, 2377, 2408. Please also see Addenda for a detailed list. | SEWING MACHINE 1731 | SINTERED PRODUCTS 1110. |
| SCALES, WEIGHING 2396. | SEWING MACHINE ACCESSORIES 135. | SLATES 1205. |
| SCENTED BETEL-NUT, SWEET FENNEL ETC. 1823. | SEWING THREAD 216, 423, 2068. | SLEEVES, GLASS FIBRE 755. |
| SCIENTIFIC INSTRUMENTS 40, 96, 97, 670, 795, 1153, 1440, 1587, 1659, 2292, 2316 A, 2500. | SHAPING MACHINE 380. | SLEEVES, METAL 792, 853, 1574, 2391. |
| SCOOTERS 222 | SHARPENING 2329. | SLEEVES, PLASTIC 1119. |
| SCOOTER—SIDE CARS 1700. | SHEARING MACHINE 134. | SLIPRING UNITS 1225, 2524. |
| SCREENS 3, 191. | SHEET METAL PARTS 2525. | SLOTING MACHINE 380. |
| SCREENS, FLUROSCOPIC AND INTENSIFYING 538. | SHEET METAL WORKS 52, 160, 161, 191, 206, 401, 405, 530, 607, 620, 742, 759, 798, 799, 801, 971, 1086, 1141, 1459, 1514, 1641, 1686, 1709, 1829, 1903, 1916, 1922, 2028, 2050, 2110, 2316, 2447, 2506, 2516. | SNOFF 225, 2295, 2304. |
| SCREWS 151, 1285, 1331, 1367, 1558, 1739. | SHELL MOULDERS 1062, 1401, 1872. | SOAP 50, 56, 141, 231, 246, 275, 379, 490, 859, 908, 975, 1123, 1161, 1269, 1291, 1402, 1492, 1579, 1648, 1771, 1828, 1979, 2076, 2111, 2159, 2171, 2261, 2472. |
| SEALS, MECHANICAL 1827, 1947. | SHOCK ABSORBERS 1910. | SOAP, LIQUID 89, 379, 490, 980, 1123, 1269, 1363, 1771, 1828, 1874, 1979, 2111. |
| SEAT COVERS 583, 1076, 2041, 2339. | SHOES, SAFETY 873, 2048, 2145, 1256. | SOCKETS 7, 542, 1273. |
| SEEDS 1278, 1896, 2491. | SILENCERS 401, 1564. | SODIUM SILICATE 274, 1391. |
| | | SOIL-TESTING APPARATUS 40, 1929. |

- SOLDER WIRES & STICKS**
938, 2105.
- SOLDERING FLUXES & PASTES**
938.
- SOLDERING EQUIPMENTS**
2105.
- SOLENOIDS**
1254.
- SOLID RUBBER TYRE WHEELS**
2065, 2204.
- SORYA**
218.
- SPARE PARTS**
37, 75, 100, 124, 185, 198, 229, 289, 291, 297, 337, 368, 401, 448, 457, 460, 472, 495, 496, 514, 522, 563, 620, 635, 647, 680, 727, 728, 766, 773, 821, 822, 831, 835, 852, 853, 868, 875, 879, 886, 926, 935, 945, 984, 985, 997, 1003, 1044, 1054, 1058, 1060, 1085, 1086, 1125, 1126, 1147, 1155, 1164, 1167, 1171, 1177, 1194, 1204, 1207, 1219, 1238, 1273, 1277, 1284, 1285, 1288, 1314, 1323, 1331, 1372, 1380, 1386, 1389, 1421, 1429, 1430, 1432, 1433, 1435, 1443, 1453, 1460, 1535, 1538, 1539, 1564, 1656, 1662, 1743, 1769, 1855, 1867, 1942, 1948, 1950, 1981, 2025, 2035, 2040, 2063, 2131, 2136, 2169, 1276, 2180, 2215, 2220, 2222, 2228, 2233, 2307, 2319, 2323, 2337, 2358, 2367, 2369, 2378, 2389, 2398, 2438, 2493.
- SPARK EROSION MACHINE**
1544.
- SPECIAL PURPOSE MACHINES**
96, 380, 668, 801, 994, 1078, 1168, 1201, 1224, 1600, 1758, 1775, 2029, 2083, 2119, 2222, 2412, 2460, 2494, 2508.
- SPECTACLE FRAMES**
524, 1359.
- SPEEDOMETERS**
1457.
- SPICES**
858, 1019, 1240, 1475, 1523, 1546, 1899, 1954, 2278, 2347.
- SPORTS GOODS**
1347, 1383, 1878, 2046, 2357, 2521.
- SPRAY PAINTING**
370, 1198, 1217, 1454, 1655, 1997, 2027.
- SPRAY PAINTING BOOTH**
45, 257, 2049, 2393.
- SPRAY PAINTING MACHINE**
2034, 2049.
- SPRINGS**
816, 1000, 1433, 1493, 2031, 2035, 2243, 2256.
- SPROCKETS**
1155, 1346, 1448.
- STAINLESS STEEL STRIPS, CIRCLES & SHEETS**
1419, 1783, 1784, 1785, 2155.
- STAINLESS STEEL BARS**
2100.
- STAMPINGS, ELECTRICAL**
1557, 2235.
- STARCH PHOSPHATE**
1112.
- STARCH POWDER (LAUNDRY)**
2397.
- STARTERS**
576, 1251, 1272.
- STATIONERY**
257, 303, 418, 637, 655, 762, 810, 920, 996, 1018, 1117, 1121, 1203, 1293, 1313, 1397, 1424, 1476, 1565.
- 1571, 1809, 1824, 1859, 1871, 1968, 2066, 2185, 2266, 2283, 2292, 2315, 2363, 2385, 2407, 2418.
- STEEL DOORS, WINDOWS, GATES, GRILLS ETC.**
51, 208, 258, 298, 335, 406, 473, 683, 794, 1098, 1133, 1169, 1634, 1641, 1686, 1693, 1709, 1766, 1852, 1955, 2028, 2051, 1053, 2161, 2213, 2248, 2282, 2351, 2366, 2371.
- STEEL STRUCTURES**
52, 208, 258, 794, 1095, 1133, 1139, 1444, 1541, 1634, 1662, 1664, 1641, 1693, 1723, 1729, 1876, 1929, 1986, 2028, 2051, 2053, 2172, 2213, 2238, 2248, 2351, 2366, 2416, 2417, 2501.
- STEAM CLEANERS**
2393.
- STOKERS, MECHANICAL**
137.
- STONE CRUSHERS**
Please see Addenda for a detailed list.
- STONE CUTTING & POLISHING**
1677.
- STONE METAL**
136, 312, 812, 860, 1246, 1256.
- STORAGE TANKS**
400.
- STOVES, KEROSENE PRESSURE**
871, 1656.
- STOVES, PARTS**
646, 1503.
- STUDS**
612, 982, 1054, 1078, 1285, 2268.
- SUCTION MACHINE**
525.

| | | |
|--|---|---|
| SUGAR MILLS 313, 2533 | TAPER PINS 1285. | TESTING MACHINES AND EQUIPMENTS 561, 654, 1552, 1714, 1907, 2023, 2154, 2177, 2192, 2222, 2359. |
| SUITCASES 1083, 1142. | TAPESTRY 2497 | TEXTILE PROCESSING 534, 992, 1576, 1744. |
| SURFACE ACTIVE AGENTS 398A. | TAPPING ATTACHMENTS 1079. | THERMISTORS 1029, 1831, 2006 |
| SURFACINGS & RESISTANTS 2382 | TARPAULIN COVERS & BAGS 1046, 1658. | THERMOCOUPLES 2081, 2189, 2448. |
| SURGICAL CLOTH 1995. | TEFLON COMPONENTS 585, 2145, 2391. | THERMO MANTLES 1236 |
| SURGICAL EQUIPMENTS 1268, 1516, 1879, 1962, 2318. | TELECOMMUNICATION COMPONENTS 587. | THERMOMETERS 2395 |
| SURGICAL SHADOWLESS LIGHTS 4. | TELESCOPES 1358 | THERMOPLASTIC 2191. |
| SWITCHES 291, 519, 675, 832, 891, 1099, 1254, 1551. | TEMPLATES 452, 1559. | THERMOPLASTIC POWDERS AND MOULDED ARTICLES 578, 582, 596, 1429. |
| SWITCHES, PRESSURE 770, 2108, 2026. | TERMINALS AND TERMINAL BOARDS 2440. | THERMOSTATS 1236, 2184. |
| TACHO METERS 2154. | TESTERS 771, 2227. | THREAD, INDUSTRIAL 1744. |
| TAIL STOCK TURRET 2052. | TESTERS, ABRASION 2018 | THREE-WHEELERS 2349 A, 222. |
| TANKS 602, 1641, 1656, 1664, 2028, 2416, 2449, 2501. | TESTERS, EARTH 54, 2152 | TILES 15, 325, 377, 432, 535, 550, 589, 1410, 1499, 1513, 1669, 2141, 2193, 2349A 2424, 2529. |
| TAPES, ADHESIVE 264, 2114. | TESTERS, FREQUENCY 755. | TILES, ASBESTOS 1669. |
| TAPES, ELASTIC 516, 1028, 2030. | TESTERS, INSULATION 54, 2152. | TIMERS 482, 541, 1066, 1153, 1457, 1598, 1668, 1985, 2008, 2081, 2192, 2392. |
| TAPES, GLASS FIBRE 755, 2391. | TESTERS, PINHOLE 2018. | TIN-WARE 416, 1096, 1344, 1659, 2120, 2289, 2421. |
| TAPES, LETTER EMBOSING 2492. | TESTERS, VOLTAGE 755, 2152. | |

| | | |
|--|--|--|
| TOBACCO PRODUCTS 215, 590, 808, 1047, 1408, 2295. | TRAILERS 829, 957, 994, 1109, 1373, 1642. | TUBES, METAL 760, 2162. |
| TOGGLE PRESS AND CLAMPS 234, 652, 1509, 2464. | TRANSFORMERS 288, 336, 394, 486, 523, 546, 577, 579, 725, 751, 770, 774, 1013, 1056, 1255, 1272, 1624, 1694, 2075, 2105, 2200, 2346, 2381, 2443. | TUNGSTEN CARBIDE MIXED POWDER PRODUCTS 1777. |
| TOOL-BOXES 1971. | TRANSFORMERS, CURRENT AND POWER 254, 288, 394, 2019. | TYPE FOUNDRY 277, 1527. |
| TOOL GRINDING MACHINES 674. | TRANSFORMERS, DISTRI-BUTION 394, 955 | TYPEWRITERS 587 |
| TOOLS 307, 322, 401, 415, 456, 528, 559, 587, 635, 740, 793, 1044, 1107, 1282, 1495, 1559, 1581, 1600, 1670, 1760, 1777, 1886, 1925, 2085, 2181, 2240, 2250, 2252, 2509, 2523. | TRANSFORMERS, ONLOAD TAP CHANGING 387 | TYRE RETREADING 433, 724, 1023, 1097, 2249 |
| TOOLS, CARBIDE TIPPED 7, 452, 674, 718, 1581, 1670, 1777, 2172. | TRANSFORMERS, POTENTIAL 254, 394. | UMBRELLAS 1903. |
| TOOLS, LIFTING 801. | TRANSFORMERS, WELDING 31, 929, 1268, 1854, 2119. | UTENSILS 110, 209, 253, 302, 388, 474, 605, 609, 697, 726, 845, 848, 854, 874, 1055, 1086, 1087, 1118, 1141, 1213, 1230, 1235, 1252, 1292, 1372, 1400, 1412, 1428, 1506, 1517, 1545, 1613, 1785, 1850, 1853, 1863, 1901, 1923, 1978, 2009, 2369, 2373, 2387, 2445, 2454. |
| TOOLS, MAGNETIC 2509. | TRANSISTORS 519, 1831. | UTENSILS, SILVER PLATED 463. |
| TOOLS, PRESS 413, 559, 1842, 2173, 2530. | TRAPS, AIR 2033. | VACUUM DE-GASSING PLANTS 2280. |
| TOOTH POWDER 880, 1505. | TRAPS, FLOAT 2033. | VACUUM FLASKS 507, 843, 2453. |
| TORCH 675. | TRAPS, STEAM 2033. | VACUUM FLASK, REFILLS 507, 843, 1379, 2190, 2453. |
| TORQUE CONVERTORS AND TORQUE LIMITERS 780. | TREE-GUARDS 2451. | VACUUM INDICATORS 1630. |
| TOYS 58, 71, 405, 660, 695, 705, 848, 967, 1088, 1371, 1680, 1837, 1897, 1899, 2072, 2357 | TROLLIES 530, 602, 734, 1139, 1317, 1445, 1642, 1700, 1936, 2248. | VACUUM PLANT 2280. |
| TRACTORS 1446. | TRUNKS 737, 1496, 1903, 1993. | VALVES 127, 188, 233, 297, 324, 599, 767, 782, 852, 853, 869, 948, 987, 1002, |

1032, 1057, 1844, 1872, 1875, 2033, 2063, 2174, 2280, 2293, 2412, 2456, 2531.

VANS
152.

VARNISH
85, 447, 497, 512, 574, 839, 907, 1021, 1567, 1877, 2111, 2444, 2501.

VESSELS
234, 386, 1664, 1770, 2034, 2386, 2501.

VENETIAN BLINDS
1347, 1772.

VICES
2012, 2036.

VISCOUS VIBRATION DAMPERS
729.

VITAMIN PREPARATIONS
351.

VOILES
90, 120, 900, 1101, 1157, 1228, 1261, 1594, 1690, 1782, 1791, 1818, 2296.

VOLTAGE CORRECTORS
197, 1507, 2183.

VOLTAGE REGULATORS, AUTOMATIC
1598, 2392.

VOLTAGE STABILISERS
220, 288, 412, 442, 546, 775, 925, 1153, 2152, 2192, 2200, 2381, 2443.

WASHERS, METAL
851, 1916, 2123, 2232, 2240.

WASHERS, RUBBER
2204.

WATCH CASES
1718.

WATER BATHS
1236

WATER MARKS
1718.

WATERPROOFING MATERIALS
179, 180, 352, 779, 830, 966, 1196, 2145, 2208, 2382.

WATER AND OTHER LIQUID STORAGE TANKS
149, 152, 238, 302, 405, 469, 510, 709, 1093, 1133, 1169, 1634, 1643, 1665, 1686, 1700, 1766, 1852, 1861, 2034, 2051, 2145, 2191, 2351, 2371.

WATER TAPS
8, 1735.

WEIGHT-BRIDGES
2396.

WELDERS, MICRO
770, 2223.

WELDERS, SPOT
1013.

WELDING ELECTRODES
31.

WELDING EQUIPMENTS
31, 124, 776, 1381.

WELDING MACHINES
31, 406, 828, 918, 929, 1078, 1212, 2280.

WELDING WORKS
305, 345, 409, 788, 789, 818, 976, 1098, 1105, 1249, 1479, 1766, 1861, 1876, 2059, 2335, 2341, 2344.

WHEELS
66, 265, 979, 1155, 1445, 2015, 2411.

WINCHES
801.

WIPERS
2344.

WIRE, ELECTRICAL
581, 749, 2391.

WIRE, STEEL
1599.

WIRELESS RECEIVING SETS
1271.

WIRE MESHES & WIRE PRODUCTS
247, 551.

WIRE NAILS
276, 1477, 1984, 2197, 2312.

WOODEN PACKING CASES
12, 172, 261, 285, 385, 453, 481, 667, 746, 778, 877, 969, 970, 998, 1048, 1092, 1206, 1227, 1337, 1364, 1374, 1378, 1413, 1415, 1416, 1418, 1452, 1491, 1563, 1644, 1734, 1757, 1762, 1883, 1887, 1889, 1890, 1891, 1920, 1921, 1926, 1927, 1931, 1943, 2165, 2230, 2291, 2374, 2376, 2377, 2407, 2408, 2409, 2473.

WOODEN PARTS & ARTICLES
1438, 1444, 1533, 1592, 1686, 1757, 1774, 1887, 1890, 1897, 2292, 2325, 2357, 2362, 2409, 2473.

WOOD TURNING
730.

WOOD TURNING MACHINE
23.

X-RAY EQUIPMENTS
538, 1380, 1981.

YARN
1639.

ZINC POWDER AND PASTE
939, 1869.

At Agarwal Containers, Quality Comes In Barrels.

We manufacture barrels to meet every need.

*Oil Barrels, *Epiccoated Barrels *Drums,
*Grease Barrels *Galvanized Barrels.

Our Barrels store and handle chemicals, pesticides, semi-solids greases, alcohol, etc. Large and small orders are executed at the correct delivery schedules.

Manufactured under strict quality control, each barrel is tested before it rolls out of our factory. That's why our barrels are your safest bet to store and transport all your liquids and fluids

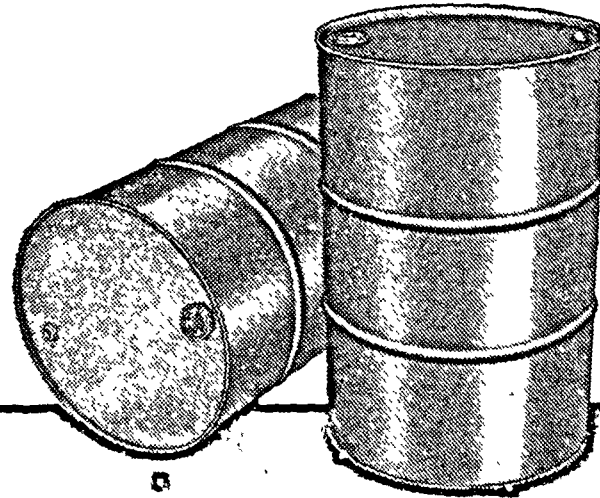

AGC agarwal containers pvt.ltd.
799/5, Bhawani Peth, Poona 411 002
Phone nos: 26058, 26611

sunbeam299

Complete Export Service

To Small and Medium Scale Manufacturers

- * LOCATE OVERSEAS MARKETS.
- * CARRY OUT SALES PROMOTION.
- * ADVISE ON EXPORT AND SHIPMENT FORMALITIES.



Sapphire Exports Private Limited

Bombay Office :
38, Mittal Chambers,
Nariman Point,
Bombay - 400 021.

Tele : 232393
Telex : 011 - 5866

Registered Office :
882, Bhandarkar,
Institute Road,
Pune - 411 004

Tele : 7151
Telex : 0145 - 258

Exporters

Manufacturer Exporters
Merchant Exporters

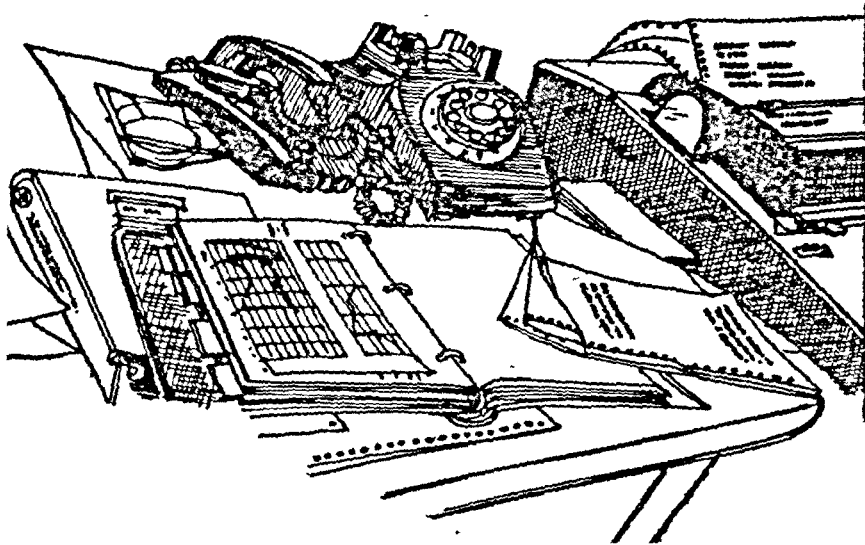

**EXPORTERS
FROM
PUNE**

In the following pages we have compiled lists of exporters from Pune. The first list comprises manufacturer-exporters from this city and the second list comprises merchant-exporters from Pune. Detailed information regarding manufacturer-exporters has not been given in this list because this has already been published in the section Guide to Manufacturers. The figures in bracket at the end of each name indicate the number against which the information of manufacturer-exporter appears in the section Guide to Manufacturers. Readers can find detailed information about these exporters from this section.

MANUFACTURER- EXPORTERS

- M/S. ABLE TOOL ROOM**
32/119 Erandawana, Pune 4. (21)
- M/S. ACCURATE ENGINEERING COMPANY LIMITED**
67 Hadapsar Industrial Estate, Pune 13. (25)
- M/S. ADVANI OERLIKON LTD.**
Chinchwad, Pune 9. (31)
- M/S. AGARWAL CONTAINERS PVT. LTD.**
34/35, F-2 Block, MIDC, Pimpri, Pune 18. (34)
- M/S. AGARWAL FABRICATIONS (PVT.) LTD.**
3 Wilson Gardens, Pune 1. (36)
- M/S. AGRO SCIENTIFIC INDUSTRIES**
207/3 Mangalwar Peth, Pune 11. (40)
- M/S. AJAY METACHEM (P) LTD.**
784 Deccan Gymkhana, Opp. Kamala Nehru Park, Pune 4. (53)
- M/S. ALL-INDIA SPORTS INDUSTRIES**
1032 Shivajinagar, Pune 16. (74)
- M/S. ALLOVERS & LACE PVT. LTD.**
78 MIDC Industrial Area, Bhosari, Pune 26. (80)
- M/S. AMPHETRONIX LTD.**
Plot 105, Bhosari Industrial Area, Pune 26. (95)
- M/S. ANALOGUE & DIGITAL MEASUREMENT COMPANY**
A-6 Functional Electronic Estate, Bhosari, Pune 26. (96)
- M/S. AQUA PURA CORPORATION**
1170/11 Shivajinagar, Pune 5. (129)
- M/S. ARBOR ACRES FARM INDIA LTD.**
G.P.O., Box No. 81, Pune 1. (2430)
- M/S. ARROW DEVELOPMENT CORPORATION**
Narali Baug, Gultekdi Road, Pune 9. (144)
- M/S. ARTI ENGINEERS**
'Sonali', 5 Prabhat Road, Lane No. 6, Pune 4. (149)
- M/S. ASSOCIATED BEARING CO. LTD.**
Chinchwad Gaon, Pune 33. (182)
- M/S. ATLAS COPCO (INDIA) LTD.**
Bombay-Pune Road, Dapodi, Pune 12. (187)
- M/S. AUTOMATIC CONTROL EQUIPMENT**
8/6 Karve Road, Pune 4. (197)
- M/S. B. G. SHIRKE & CO.**
72/76 Industrial Estate, Mundhwa, Pune 36. (208)
- M/S. BAFE LAB. PVT. LTD.**
37/9B Prabhat Road, Pune 4. (219)
- M/S. BAGGA ELECTRONICS**
Bhosari Industrial Area, Pune 26. (220)
- M/S. BAJAJ AUTO LTD.**
Akurdi, Pune 35. (222)
- M/S. BAJAJ TEMPO LTD.**
Akurdi, Pune 35. (223)
- M/S. BAKER HORSTMANN MERCER (I) PVT. LTD.**
31/1 Nagar Road, Pune 14. (2436)
- M/S. BETTER LIVING**
8/352 Boat Club Road, Pritam Villa, Pune 1. (241)
- M/S. BHARAT FORGE CO. LTD.**
Export Division, 16 Mahatma Gandhi Road, Pune 1. (265)
- M/S. BIOTECH LABORATORIES**
397/7 Senapati Bapat Road, Pune 16. (296)
- M/S. BOMBAY BOOK MFG. CO.**
1105 Raviwar Peth, Pune 2. (303)
- M/S. BRIHAN MAHARASHTRA SUGAR SYNDICATE LTD.**
980 Sadashiv Peth, Pune 30. (313)
- M/S. BUCKAU WOLF NEW INDIA ENGINEERING WORKS LTD.**
Pimpri, Pune 8. (316)
- M/S. C.T.R. MFG. INDUSTRIES LTD.**
Nagar Road, Pune 14. (387)
- M/S. CAMBRIDGE INSTRUMENTS (INDIA) LTD.**
Bombay-Poona Road, Pimpri, Pune 18. (320)
- M/S. CENTRAL PULP MILLS LTD.**
1183 Shivajinagar, Pune 5. (329)
- M/S. CENTURY ENKA LTD.**
Bhosari, Pune 26. (331)
- M/S. CHLORIDE INDIA LTD.**
D-2 MIDC Estate, Chinchwad, Pune 19. (367)

- M/S. CONSOLIDATED HOISTS (PVT.) LTD.**
29-30 Industrial Estate, Gultekdi, Pune 9. (378)
- M/S. COOPER ENGINEERING LTD.**
658 Jangali Mahataj Road, Pune 4. (380)
- M/S. DAMODARDAS BHAGWANDAS PVT. LTD.**
761 Raviwar Peth, Pune 2. (402)
- M/S. DAMWELL INDUSTRIES**
1901 Sadashiv Peth, Sharda Niwas, Pune 30. (403)
- M/S. DATSONS ELECTRONICS**
482 Shaniwar Peth, Pune 30. (412)
- M/S. DATTATRAYA INDUSTRIES PVT. LTD.**
69A Pune-Satara Road, Pune 9. (415)
- M/S. DAVID BROWN GREAVES LTD.**
Park Gear Works, Chinchwad, Pune 19. (417)
- M/S. DECCAN DYES & CHEMICAL INDUSTRIES**
38 Vijaynagar Colony, Pune 30. (422)
- M/S. DECCAN EMBROIDERY MANUFACTURING CO.**
Sangam, 30/1 Wellesley Road, Pune 1. (423)
- M/S. DELTA ENTERPRISES**
W-40 MIDC, Bhosari Industrial Area, Pune 26. (451)
- M/S. DEVAL UTENSILS FACTORY**
15/5 Karve Road, Pune 4. (463)
- M/S. DIAMOND CLOCK MFG. CO. PVT. LTD.**
1180 Budhwar Peth, Pune 2. (476)
- M/S. DR. BECK & CO. (I) LTD.**
Pimpri, Pune 18. (497)
- M/S. EAGLE FLASKS PVT. LTD.**
Talegaon, Tal. Maval, Dist. Pune. (507)
- M/S. EISEN PHARMACEUTICAL CO. PVT. LTD.**
1246 Apte Road, Pune 4. (515)
- M/S. ELECTRODYNE INDUSTRIES**
'Asha-Kiran', 75-76/44, Erandawana, Pune 4. (521)
- M/S. ELEKTROMIN**
277 Narayan Peth, N. C. Kelkar Road, Pune 30. (526)
- M/S. ELITE PLASTIC INDUSTRIES**
'Alankar', 25 Mukundnagar, Pune 9. (532)
- M/S. ELPRO INTERNATIONAL LTD.**
Chinchwad Goan, Pune 33. (538)
- M/S. ESCO (POONA) PVT. LTD.**
2432 East Street, Pune 1. (550)
- M/S. FIBREALL**
23 Sahney Sujan Park, Pune 1. (2449)
- M/S. FIBRE PLAST INDIA**
Plot No. W-15, D-2 Pimpri, Pune 18. (578)
- M/S. FINOLEX CABLES LTD.**
26-27 Bombay-Poona Road, Pimpri, Pune 18. (581)
- M/S. FINOLEX PLASTIC INDUSTRIES**
Bombay-Pune Road, Pimpri, Pune 18. (582)
- M/S. FORMICA INDIA LTD.**
'Sambhaji Mansion', 1260-A Shivajinagar, Pune 4. (588)
- M/S. G.A.K. INDUSTRIES**
759/104 Deccan Gymkhana, Pune 4. (596)
- M/S. GARWARE FILAMENT CORPORATION PVT. LTD.**
Pimpri, Pune 18. (630)
- M/S. GAYATRI MUDRANALAYA**
'Gayatri Sadan', 2060 Sadashiv Peth, Vijaynagar Colony, Pune 30. (640)
- M/S. GENERAL INDUSTRIAL CONTROLS (P) LTD.**
25/430 Senapati Bapat Road, Pune 16. (649)
- M/S. GENERAL INDUSTRIAL EQUIPMENT PVT. LTD.**
T-22 Bhosari Indl. Estate, Pune 26. (650)
- M/S. GITS FOOD PRODUCTS (INDIA)**
18/3 Hadapsar Industrial Estate, Pune 13. (661)
- M/S. GREAVES FOSECO LTD.**
'Chinchwad, Bombay-Poona Road, Pune 19. (672)
- M/S. GRIND TOOLS**
Bhosari Indl. Area, Pune 26. (674)
- M/S. GUJARAT METAL FACTORY**
589 Rasta Peth, Pune 11. (2454)
- M/S. HANDMADE PAPER INSTITUTE**
M.S.K. & V.I. Board, Agricultural College Compound, K. B. Joshi Road, Pune 5. (691)
- M/S. HARIDAS MADHAVDAS SUGANDHI**
451 Raviwar Peth, Pune 2. (698)
- M/S. HARNIK FOOD INDUSTRIES**
A-22, 'H' Block, M.I.D.C., Pimpri, Pune 18. (700)

- M/S. HIND CONDENSOR PVT. LTD.**
209 Bombay-Poona Road, Pimpri,
Pune 18. (711)
- M/S. HINDUSTAN ANTIBIOTICS LTD.**
Bombay-Poona Road, Pimpri,
Pune 18. (713)
- M/S. HINDUSTAN LEVER LTD.**
190/192 Opp. Chinchwad Railway
Station, Pune 33. (719)
- M/S. HIRLEKAR PRECISION ENGINEERING CO.**
18-19 Gultekadi, Industrial Estate,
Pune 9. (727)
- M/S. HORSTMAN INDIA P. LTD.**
Nagar Road, Pune 14. (735)
- M/S I. E. C. PUMPS & TOOLS PVT. LTD.**
603 Sadashiv Peth, Laxmi Road,
Pune 30. (740)
- M/S. INDIAN CABLE CO. LTD.**
Hadapsar Industrial Estate, Pune 13.
(749)
- M/S. INDIAN CABLE INDUSTRIES (Machinery Division)**
26-27 Bombay-Poona Road, Pimpri,
Pune 18.
- M/S. THE INDIAN CARD CLOTHING CO. LTD.**
Pimpri, Pune 18. (750)
- M/S. INDIA ENGINEERING CORPORATION**
603 Sadashiv Peth, Pune 30. (752)
- M/S. INDUSTRIAL ELECTRONIC & ALLIED PRODUCTS**
1423 (New) Shukrawar Peth, Near
Nava Vishnu Chowk, Pune 2 (775)
- M/S. INDUSTRIAL ELECTRONICS CORPORATION**
324 Narayan Peth, Pune 30. (771)
- M/S. INEX ENGINE VALVES LTD.**
17-B Hadapsar Industrial Estate,
Pune 13. (782)
- M/S. INSTITUTE FOR MICRO-NUTRIENT TECHNOLOGY**
1-A Kondhava Khurd, P. B. No.
114, G.P.O., Pune 1. (784)
- M/S. INTERNATIONAL COMPUTERS LTD, INDIAN MANUFACTURE, Nagar Road, Pune 14. (786)**
- M/S. J. K. ENGINEERING (Diamond Works)**
'H' Block, Plot No. B-13 M.I.D.C.
Industrial Estate, Pimpri, Pune 18.
(793)
- M/S. J. M. PAREKH**
25 Hadapsar Industrial Estate,
Solapur Road, Pune 13. (795)
- M/S. J. N. MARSHALL P. LTD.**
Pimpri, P.F., Pune 18. (797)
- M/S. JABIECH ENGG. WORKS**
93 M. G. Road, Pune 1. (801)
- M/S. JAYAHIND SCIACKY LTD.**
D-1 Block, Plot No. 18/1 Chinchwad,
Pune 19. (828)
- M/S. JEMCO RUBBER INDUSTRIES**
MIDC, Bhosari, Pune 26. (838)
- M/S. JG GLASS INDUSTRIES LTD.**
Pimpri, Pune 18. (842)
- M/S. JG VACUUM FLASKS LTD.**
Akurdi, Pune 35. (843)
- M/S. JAYA HIND INDUSTRIES LTD.**
Bombay-Poona Road, Akurdi,
Pune 35. (827)
- M/S. K. K. NAG PVT. LTD.**
Shembekar Industrial Compound,
Chinchwad, Pune 19. (869)
- M/S. K S B PUMPS LTD.**
104th Mile Stone,
Bombay-Poona Road, Pimpri,
Pune 18. (876)
- M/S. KARS ELECTRONICS**
690 Sadashiv Peth, Pune 30. (918)
- M/S. KHOSLA ENGINEERING PVT. LTD.**
43 Aundh Road, Khadki, Pune 3. (938)
- M/S. KHOSLA METAL POWDERS LTD.**
43 Aundh Road, Khadki, Pune 3.
(939)
- M/S. KHOSLA PLASTICS PVT. LTD.**
43 Aundh Road, Khadki, Pune 3.
(941)
- M/S. KINETIC ENGINEERING LTD.**
D-1 Block, Plot 18/1 Chinchwad,
Pune 19. (943)
- M/S. KIRLOSKAR BROS. LTD.**
Udyog Bhavan, Tilak Road, Pune 2.
(948)
- M/S. KIRLOSKAR CUMMINS LTD.**
Kothrud, Pune 29. (949)
- M/S. KIRLOSKAR FILTERS P. LTD.**
Kothrud, Pune 29. (951)
- M/S. KIRLOSKAR KISAN EQUIPMENT LTD.**
Kothrud, Karve Road, Pune 29.
(952)
- M/S. KIRLOSKAR OIL ENGINES LTD.**
Khadki, Pune 3. (953)
- M/S. KIRLOSKAR PNEUMATIC CO. LTD.**
Hadapsar Industrial Estate, Pune 13.
(954)

- M/S KISHOR PUMPS PVT. LTD.**
A-13, H Block MIDC Industrial Area, Pimpri, Pune 18. (960)
- M/S. KOHINOOR RUBBER PRODUCTS**
380 Bhawani Peth, Pune 2. (967)
- M/S. KRISPEE FOODS PVT. LTD.**
Plot E-25-26-27, MIDC, Bhosari Industrial Estate, Pune 26. (2469)
- M/S. KULKARNI FOUNDRIES LTD.**
Hadapsar Industrial Estate, Pune 13. (987)
- M/S. KWALITY STEEL PRODUCTS**
S. No. 209 Bombay-Poona Road, Pimpri, Pune 18. (2471)
- M/S. LEO TEXTILE**
Hadapsar Industrial Estate, Pune 13. (1028)
- M/S. LUNAR CAUSTIC P. LTD.**
Off Karve Road, P. Box 806, Pune 4. (1039)
- M/S. MAHARASHTRA AGRO-INDUSTRIES DEVELOPMENT CORPORATION LTD.**
MIDC Industrial Estate, Plot No. 52, D-II, Chinchwad, Pune 19. (1074)
- M/S. MAHINDRA ELECTRO-CHEMICAL PRODUCTS LTD.**
145 Bombay-Poona Road, Pimpri, Pune 18. (1107)
- M/S. MAHINDRA OWEN LTD.**
Bombay-Poona Road, Pimpri, Pune 18. (1109)
- M/S. MAHINDRA SINTERED PRODUCTS LTD.**
146 Bombay-Poona Road, Pimpri, Pune 18. (1110)
- M/S. MARK ELEKTRIKS**
15 Gultekadi Industrial Estate, Pune 9. (1138)
- M/S. MATCHWEL ELECTRICALS (INDIA) LTD.**
Off Nagar Road, Pune 14. (1145)
- M/S. MATHER GREAVES LTD.**
Bombay-Poona Road, Chinchwad, Pune 19. (1146)
- M/S. McGAY INDUSTRIES**
16 A Shivajinagar Pune 5. (1150)
- M/S. MEELAN SHOE CO. PVT. LTD.**
Chinchwad, Pune 19. (2477)
- M/S. MICROFINE BRIGHT STEEL CORPORATION**
Plot 117 Bhosari, General Block, Pune 26. (1174)
- M/S. MINATO SHIRKE CONCRETE MACHINES PVT. LTD.**
Mundhwa, Pune 36. (1991)
- M/S. MORRIS ELECTRONICS LTD.**
Bhosari, Pune 26. (1216)
- M/S. MUTHA & RATHOD TRADING CO.**
123 New Timber Market, Pune 2. (1227)
- M/S. N. FERNANDES**
19 Frere Road, Khadki, Pune 3. (1232)
- M/S. N. P. K. FOUNDERS**
A-92 and 93, 'H' Block, MIDC, Pimpri, Pune 18. (1236)
- M/S. NARASAYYA SAYANNA KUNDEN**
Kunden House, 1150 Bhawani Peth, Pune 2. (1259)
- M/S. NATIONAL SEEDS CORPN.**
497/1 Bhawani Peth, Pune 2. (1278)
- M/S. NAV MAHARASHTRA CHAKAN OIL MILLS**
42-43 Shankarshet Road, Pune 9. (1291)
- M/S. NU TECK ENGG. CORPN.**
Bhosari Industrial Estate, MIDC, Pune 26. (1346)
- M/S. OJAS ENGINEERING PVT. LTD.**
784 Deccan Gymkhana, opp. Kamala Nehru Park, Pune 4. (1350)
- M/S. OPTIQUE (INDIA)**
1144 Sadashiv Peth, Pune 30. (1359)
- M/S. PAISA FUND GLASS WORKS**
Talegaon, (Dist. Pune) (1379)
- M/S. THE PARSHURAM IRON & STEEL ROLLING MILLS**
560 Sadashiv Peth, Laxmi Road, Pune 30. (1405)
- M/S. PERFECT INDUSTRIES**
37/2C Shankarshet Road, Pune 9. (2490)
- M/S. PHALNIKAR ENTERPRISES**
427-42 Poona Small-Scale Industrial Co-operative Estate, Gultekadi, Pune 9. (1439)
- M/S. PHILIPS INDIA LTD.**
Loni Kalbhor, Pune, (1440)
- M/S. PMT MACHINE TOOL AUTOMATICS LTD.**
P.O. Pimpri Penicillin Factory, Post Bag No. 2, Pune 18. (2487)
- M/S. POLY PLASTICS**
63 MIDC, Bhosari, Pune 26. (2492)
- M/S. POONA GUT FACTORY**
29/1 Wanowari, Pune 13. (1474)
- M/S. POONA ISPAT UDYOG**
49/4 Budhwar Peth, Laxmi Road, Pune 2. (1477)

- M/S. POONA PEARLS**
POULTRY BREEDING FARM
AND HATCHERIES, Hadapsar,
Pune 13. (1482)
- M/S. POONA RADIATORS &
OIL COOLERS**
Plot No. 93, Manjari Branch, Pune.
(1489)
- M/S. POONA RUBBER MANU-
FACTURERS (PVT.) LTD.**
Plot No. 15-A, D-I, MIDC,
Chunchwad, Pune 19 (1490)
- M/S. POONAM TILES**
392-G-3 Gultekadi, Pune 9. (1499)
- M/S. PRATIBHA PLASTIC IN-
DUSTRIES**
18-A/2 Bombay-Poona Road, Pune 3.
(1543)
- M/S. PRECISION STEEL
FASTENERS**
Survey No 209, Pimpri, Bombay-
Poona Road, Pune 18. (1558)
- M/S. PROFILO FORMS**
64 'S' Block, MIDC, Bhosari,
Industrial Area, Pune 26. (1581)
- M/S. RACOLD APPLIANCES PVT.
LTD.**
Pimpri, Pune 18. (1620)
- M/S. THE RAJA BHADUR
MOTILAL POONA MILLS LTD.**
Engineering Division, 5 R.B. Motilal
Road, Pune 1. (1639)
- M/S. RAMESH FABRICATORS**
820 Bhawani Peth, Pune 2. (1659)
- M/S. RANADEV MICRONUTRI-
ENTS PVT. LTD.**
1-A Kondhwa Khurd, G.P.O
Box 118, Pune 1. (1667)
- M/S. RESCON MFG. CO. PVT.
LTD.**
43/1 Karve Road, Pune 4. (1696)
- M/S. ROPLAS INDIA LTD.**
145 Bombay-Poona Road, Pimpri,
Pune 18. (1700)
- M/S. RUSTON & HORNSBY (I)
LTD.**
Chunchwad, Pune 19. (1713)
- M/S. S.A.J. STEELS PVT. LTD.**
12 Kaka Halwai Industrial Estate,
Pune 9. (1714)
- M/S. S. L. TRADING COMPANY**
69/1 E Wanowrie, Pune 1. (1727)
- S. S. INTERNATIONAL**
1187/62/2 Shivajinagar, Pune 5.
(1733)
- M/S. SAHYADRI DYESTUFF &
CHEMICAL INDUSTRIES**
117 Parvati, Vitthalwadi Rd., Pune 9.
(1755)
- M/S. SAHYADRI STRUCTURALS
(P) LTD.**
Preet Chambers, Bombay-Pune
Road, Pune 3. (2501)
- M/S. SAHYADRI UDYOG**
D-226, MIDC Industrial Area,
Pune 19. (1758)
- M/S. SANDVIK ASIA LTD.**
Bombay-Poona Road, Dapodi,
Pune 12. (1777)
- M/S. SANGHVI NON-FERROUS
METAL INDUSTRIES**
160 Bombay-Poona Road, Pune 19.
(1785)
- M/S. THE SATHE BISCUIT &
CHOCOLATE CO. LTD.**
820 Bhawani Peth, Post Box No. 597,
Pune 2. (1813)
- M/S. SATVIR GUPTA & CO.**
1582 Shukrawar Peth, Pune 2. (1819)
- M/S. SEALOL HINDUSTAN LTD.**
F-27 Shantikunj, opp G.P.O.,
Pune 1. (1827)
- M/S. SERSON INDUSTRIES P.
LTD.**
Pimpri PF PO, Pune 18. (1832)
- M/S. SERUM INSTITUTE OF
INDIA**
283 M. G. Road, Pune 1. (1833)
- M/S. SHA SUGANDHI WORKS**
83 Gunj Peth, Pune 2. (1836)
- M/S. SHINGOTE PROCESSED
FOODS (P) LTD.**
636/6 Vijaynagar Colony, Pune 30
(1882)
- M/S. SHIRKE CONSTRUCTION
EQUIPMENTS PVT. LTD.**
Mundhwa, Pune 36. (1989)
- M/S. SHIVJI KARSAN PATEL
AND CO.**
Plot No. 5, New Timber Market,
Bhawani Peth, Pune 2 (1890)
- M/S. SHOBHA FARM**
1206/20-A 'Shrirang', Shivajinagar,
Pune 4. (1896)
- M/S. SHREE PLASTICS**
167/A Happy Colony, Kothrud,
Pune 29. (1937)
- M/S. SHREE PRODUCTS LTD.**
Antibiotic Compound, Bombay-
Poona Road, Pimpri, Pune 18.
(1939)
- M/S. SHRINIWAS FABRICO
PVT. LTD.**
Plot No 80, 'S' Block MIDC
Bhosari, Pune 26. (2508)
- M/S. SIPOREX INDIA LTD.**
72-76 Mundhwa Industrial Estate,
Pune 36. (1992)
- M/S. SONNENFLEX ABRASIVES**
706 (108) Sind Co-op. Housing
Society, Pune 7. (2015)

- M/S. SPACO CARBURETTORS (I) LTD.**
Post Box No. 13, Chinchwad,
Pune 19. (2022)
- M/S. SPICA PLASTIC**
22/5 Hadapsar Industrial Estate,
Pune 13. (2030)
- M/S. SPIRAX MARSHALL LTD.**
Bombay-Poona Road, Pimpri,
Pune 18. (2033)
- M/S. SPRAY METAL PVT. LTD.**
93/1 Manjri Road, P.O. Manjri
Farm, Pune 1. (2034)
- M/S. STANDARD METER MFG. CO.**
Survey No. 9, Hadapsar, Pune 28.
(2043)
- M/S. SUBHAJAY ELECTRONICS & METAL PROCESSORS P. LTD.**
MIDC Estate, Pimpri, Pune 18.
(2057)
- M/S. SUBODH CHROME PLAST**
75-A MIDC, Bhosari, Pune 26.
(2060)
- M/S. SUDARSHAN CHEMICAL INDUSTRIES LTD.**
162 Dr. Ambedkar Road, Pune 1.
(2062)
- M/S. SUGANDHI HARIDAS MADHAVDAS**
451 Raviwar Peth, Pune 2. (2074)
- M/S. SUJANIL CHEMO INDUSTRIES**
Ganeshnagar, Chinchwad, Pune 33.
(2078)
- M/S. SUKRUT UDYOG**
9/1-A Erandavana, Pune 4. (2079)
- M/S. SUPANEKAR MACHINE INDUSTRIES PVT. LTD.**
Gultekadi, Pune 9. (2099)
- M/S. SWASTIK INDUSTRIES**
Block D-3, Plots 46-49, MIDC
Industrial Area, Chinchwad, Pune 19.
(2141)
- M/S. SWASTIK LABORATORY & INDUSTRIAL CHEMICALS PVT. LTD.**
176-7 Sadashiv Peth, Phule Baug,
Pune 30. (2142)
- M/S. SWASTIK RUBBER PRODUCTS LTD.**
Swastik House, Khadki, Pune 3.
(2145)
- M/S. SYNTHETIC DYESTUFF INDUSTRIES**
52/13 Hadapsar Industrial Estate,
Pune 13. (2153)
- M/S. TATA ENGINEERING & LOCOMOTIVE CO. LTD.**
Pimpri, Pune 18. (2170)
- M/S. TECHNOFOUR**
A/4 Mayurban, 1100/A Model
Colony, Pune 16. (2177)
- M/S. TECHNOLEC**
336 Shivajinagar, Pune 16.
(2178)
- M/S. TEKNIKRAFT**
8/6 Karve Road, Pune 4. (2183)
- M/S. TENACITY ADHESIVES PVT. LTD.**
21/6 Hadapsar Industrial Estate,
Pune 13. (2185)
- M/S. THERMAX (INDIA) PVT. LTD.**
Chunchwad, Pune 19. (2518)
- M/S. THERMODORS PVT. LTD.**
Pimpri, Pune 18. (2191)
- M/S. TIRUPATI WIRE WORKS**
382/2 Bhawani Peth, Pune 2.
(2197)
- M/S. TRANS INDIA LTD.**
Pimpri Penicillin Factory, Post
Box No. 2, Pune 18. (2202)
- M/S. TUGA BIOCHEMICAL LABS.**
7E/2 Sadashiv Peth, Tilak Road,
Pune 30. (2217)
- M/S. UNION STEEL INDUSTRIES**
23/1 Hadapsar Industrial Estate,
Pune 13. (2239)
- M/S. UNIVERSAL ENGINEERING & MANUFACTURING INDUSTRY**
5-8 Block F/2, MIDC, Pune 19.
(2252)
- M/S. VANAZ ENGINEERS PVT. LIMITED**
85/A Paud Road, Pune 29. (2293)
- M/S. VENKATESHWARA HATCHERIES PVT. LTD.**
P. Box. No. 1, I.A.T., Girinagar,
Pune 25. (2320)
- M/S. VISHNU TIMBER MART**
110 New Timber Market, Pune 2.
(2374)
- M/S. VITHALDAS NARAYAN-DAS & SONS**
Phadke Haud, Pune 2. (2380)
- M/S. VULCAN LAVAL LTD.**
Bombay-Poona Road, Dapodi,
Pune 12. (2386)
- M/S. WANSON (INDIA) P. LTD.**
Chinchwad, Pune 18. (2393)
- M/S. WEIKFIELD PRODUCTS CO. (INDIA) PVT. LTD.**
Nagar Road, Pune 14. (2397)
- M/S. WESTERN INDIA ERECTORS LTD.**
Sahyadri Sadan, Tilak Road, Pune 30.
(2401)
- M/S. WHITE CLOUD PAPER MILLS**
412 Gultekadi Road, Pune 9.
(2405)

MERCHANT-EXPORTERS

ASSOCIATED DISTRIBUTORS 8 Prince of Wales Drive, Wanawadi, Pune 411 001. Tel. 22581. Cable: **WORLDWIDE**. Partnership, 1973. Bank : Bank of Maharashtra Products: Machine spare parts, garments, textiles, pre-packed food.

BHARAT TRADING COMPANY. 30 M. G. Road, Pune 411 001 Tel 27155, 27156. Cable: **TEJSONS**. Telex ATEJ-368. Partnership, 1977. Bank: Union Bank of India. Products: Fresh chilled meat (sheep/goat), live animals (sheep/goat), vegetables, fruits, potatoes canned vegetables, mango juice, mango slices and Indian groceries.

D. J. DAMANI & CO 25/2 Shivajinagar, Pune 411 005. Tel 57076 Cable: **DAMANISEED**. Partnership, 1955. Bank: Indian Overseas Bank. Products: Vegetable seeds specially onion, radish, ladyfinger and other items. Also condiments and spices required for sowing purpose.

DIMPEX INTERNATIONAL. 1 Kamal Bagh, 1062 Gokhale Road, Pune 411 016. Tel 54146 Cable **BATIK**. Proprietary, 1972 Bank: State Bank of India. Products: Genuine hand-made batik, painted articles, dolls and handicrafts

ELEPHANTA. 69 Koregaon Park, Pune 411 001 Tel-24273. Proprietary, 1968. Bank: Bank of Baroda. Products Handloom cotton fabrics, handloom silk fabrics.

FANCY FOODS SALES CORPORATION. 17 Lawrence Colony, Solapur Road, Pune 411 001. Tel. 7607. Partnership, 1976. Bank : Bank of India. Products: Chatanics, curry powders, papad, pickles.

FIBREALL. 23 Sahney Sujan Park, Pune 411 001. Tel. 22416 Cable: **MANGKUKU**. Proprietary, 1976. Bank: Bank of Maharashtra. Products: Fibreglass helmets, fibreglass motor cycle and car accessories, leather goods.

GITS INTERNATIONAL. 18/3 Hadapsar Industrial Estate, Pune 411 013. Tel. 7104, 7105. Cable: **GITS-FOOD**. Partnership, 1962. Bank: State Bank of India. Products: Instant foods, condiments, papads, canned mango products etc.

JAITHA & SONS. 22/5 Hadapsar Industrial Estate, Pune 411 013 Tel. 7194. Bank: Bank of India. Products: Elastic tape (containing rubber thread).

JAYANTILAL MANGALDAS & SONS. Sanghar Apartments, Opp. Laxminarayan Theatre, Pune-Satara Road, Pune 411 009. Tel 443879, 442721. Cable: **DHARMIK**, Telex 0145-239 Partnership, 1965. Banks: Bank of Maharashtra, Bank of India, Canara Bank, Indian overseas Bank. Products : Onions and garlics.

JOSEL CORPORATION. Rama Nivas, Laxmi Road. Pune 411 030. Tel. 444055. Cable: **JOSEL**, Telex: MCCI PN 333. Proprietary, 1970. Bank: Sangli Bank, Products: Lovejoy flexible couplings.

K. B. SHINGOIE AND COMPANY. 636/6 Vijaynagar Colony, Pune 411 030. Tel. 441114, 448989. Cable: **KAYBEECO**. Telex: **ANXOUS PN 290**. Partnership, 1968. Bank: Bank of India. Products: Indian spices, processed food, grocery items.

MEHER EXPORTS. Meher Mohalla, 841 Dastur Meher Road, Pune 411 001. Tel 28026 Bank: Central Bank of India. Proprietary, 1976. Products: Footwear, household linen.

MAILIMPEX 768 Sadashiv Peth, Phadatare Chowk, P.M.C.S. Bank Bldg, Pune 411 030. Tel. 443218. Cable. **MIMPEX**. Estd 1970. Banks: Bank of Maharashtra, Indian Overseas Bank. Products: Kolhapuri chappals, silver ornaments, laundry machinery.

MISTRY EXPORTS. D 6/7, Commonwealth Building, Bund Garden Road, Pune 411 001. Tel. 27702. Cable: **BEST SERVE POONA**. Telex: MCCI PN 333 Products: Building materials, steel structures, machine tools and equipments, aluminium and steel doors and windows.

NIKAS CORPORATION. 2/7 Sadhu Vasvani Kunj, Pune 411 001. Tel. 27543. Cable: **HOTSTUFF**. Partnership, 1971. Bank: Bank of India. Products: Processed foods of all kinds, spices and Indian groceries, hair oil, soap, cosmetics, leather goods footwear etc.

POCHA SEEDS. 1A Middle Road, Near Solapur Bazar, Pune 411 001. Tel. 23563. Cable: **SEEDS**. Telex: 0145-373. Estd 1884. Banks: Bank of India, Bank of Maharashtra. Products: All kinds of horticultural/agricultural inputs, plants, seeds, bulbs, agricultural implements, pesticides, fertilisers, fumigants, weedkillers, 'Hasti' pipes, 'Voltas' pumpsets, power tillers etc.

PRATIBHA EXPORTS PVT. LTD. 58 Mira Society, Salisbury Park Road, P. B. No. 128. Pune 1,

RAJNEESH FOUNDATION. 17 Koregaon Park, Pune 411 001. Tel. 28127. Products : Books.

S. S. INTERNATIONAL. 1187/62 Shivajinagar, Chinchankar Building, J. M. Road, Pune 411005, Tel. 58190. Readymade garments.

SAPPHIRE EXPORTS PVT. LTD. 881 Bhandarkar Institute Road, Pune 411 004. Tel. 58825. Telex: 0145-280. Estd. 1974. Banks: United Western Bank, The Chartered Bank. Products: Garage machinery and equipment, auto spares, timber for construction, finished leather goods, handicrafts, marine products, etc.

STERLING OVERSEAS CORPORATION. G-8 Gita, P. O. 58, Pune 411 001. Tel. 22071/28084. Cable: ESKAY. Proprietary, 1977. Bank: Bank of India.

UNI AKSHAE INTERNATIONAL. 116 Koregaon Park, Pune 411 001. Tel. 23963. Products: Food products, custard powder.

UNIVERSAL AGENCIES. 5/4 Geetanjali Kunj, Opp. Nehru Memorial Hall, Pune 411 001. Tel. 28092. Cable: UNIHARMONY. Partnership, 1974. Products: Spares and accessories of all kinds, hand tools and other allied items of motor vehicles.

WADKEY INTERNATIONAL. 735 Sadashiv Peth, Pune 411 030. Tel. 445631, 444160. Cable: WADEXPO. Proprietary, 1976. Bank: Bank of Baroda. Products: Pharmaceutical products.

WEIKFIELD INTERNATIONAL. Weikfield Estate, Nagar Road, Pune 411 026. Tel. 23963, 20744. Cable: WEPROCO. Telex: 0145-285. Bank: State Bank of India. Products: Instant food products, custard powder, corn flour, jelly crystals etc.

Statistics

General
Industrial
Commercial
Employment
Transport
Communication
Finance
Education
Health
Electricity

Statistical tables Nos. 2.1 to 2.3 are based on the data collected by the Maharashtra Chamber of Commerce and Industries and the figures relating to production, employment, investment etc. relate to the year 1977.

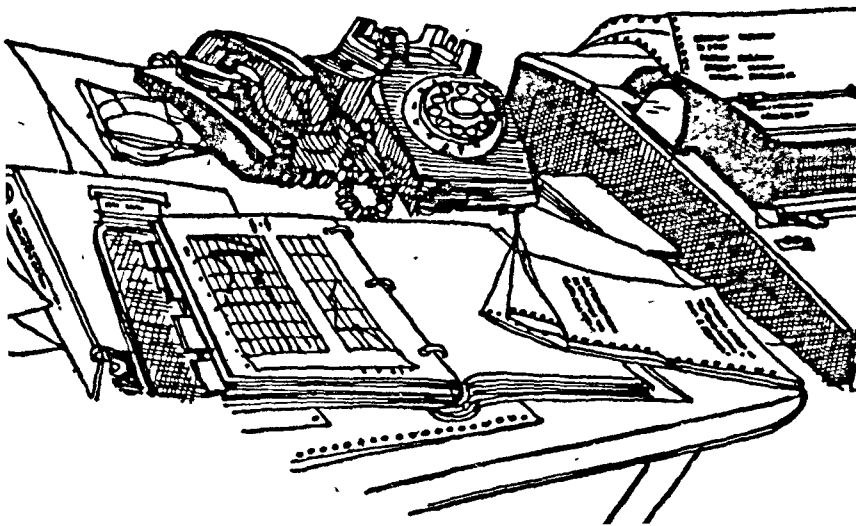

**INDEX TO
STATISTICAL TABLES**

| | |
|---|-----|
| 1. GENERAL | |
| 1.1 Climatological Table | 246 |
| 1.2 General Information | 250 |
| 1.3 Population Growth of Pune City | 251 |
| 1.4 Pune Municipal Corporation Population (1971 census) | 252 |
| 1.5 Comparative figures of Population | 254 |
| 1.6 Population of Greater Pune | 254 |
| 1.7 Pune District at a Glance | 255 |
| 2. INDUSTRIAL | |
| 2.1 Statistics relating to Industries in Pune Metropolitan Region | 258 |
| 2.2 Areawise Distribution of Industries in Pune | 260 |
| 2.3 Distribution of Industries in Pune Metropolitan Region according to their Capital Investment | 264 |
| 3. COMMERCIAL | |
| 3.1 Total Number of Establishments in Pune City | 265 |
| 3.2 Total Number of Establishments in P. C. M. C. Area | 265 |
| 4. EMPLOYMENT | |
| 4.1 Number of applicants registered, placements effected, vacancies notified and filled during 1-1-1977 to 31-12-1977 | 266 |
| 4.2 Employment statistics of Shops and Establishments in Pune City | 267 |
| 5. TRANSPORT | |
| 5.1 Total Number of Vehicles Registered (Pune Region) | 267 |
| 5.2 Number of Vehicles on Road (Pune Region) | 268 |
| 6. COMMUNICATION | |
| 6.1 Telephone Statistics of Pune Telephone District | 269 |
| 7. FINANCE | |
| 7.1 Statement showing the Actuals of Income from 1951-52 to 1977-78 of the Pune Municipal Corporation | 270 |
| 7.2 Statement showing the Income from Octroi for 1976-77 of the Pune Municipal Corporation | 271 |
| 7.3 Statement showing the Receipts of the Pimpri-Chinchwad Municipal Council | 272 |
| 7.4 Statement showing the Expenditure of the Pimpri-Chinchwad Municipal Council | 273 |
| 8. EDUCATION | |
| 8.1 Statistics relating to students of University of Poona | 274 |
| 9. HEALTH | |
| 9.1 Govt. Hospitals in Pune City | 275 |
| 10. ELECTRICITY | |
| 10.1 Actual Consumption of Electricity by Industrial Consumers | 276 |

Table 1 1

CLIMATOLOGICAL

| Station | | Poona | | Lat 18° 32' N. Long. 75° 51' E. | | | | | | | | |
|----------------------|---------------|-------|-----------|---------------------------------|------------|------------|----------------------|---------------------|-----------------------|------|----------------------|------|
| AIR TEMPERATURE | | | | | | | | | | | | |
| Month | Station Level | | Mean (of) | | | | Extremes | | | | | |
| | Pressure | | Dry bulb | Wet bulb | Daily Max. | Daily Min. | Highest in the Month | Lowest in the Month | Date and Highest Year | | Date and Lowest year | |
| | * | mb | C° | C° | C° | C° | C° | C° | C° | C° | C° | C° |
| January | I | 952 2 | 15 2 | 12 7 | 30 7 | 12 0 | 33.3 | 7 4 | 35 0 | 30 | 1 7 | 17 |
| | II | 948 4 | 28 2 | 17 4 | | | | | | 1938 | | 1935 |
| February | I | 951 1 | 17 1 | 13 2 | 32 9 | 13 3 | 36.0 | 8 3 | 38.9 | 28 | 3 9 | 1 |
| | II | 947.2 | 30 9 | 17 7 | | | | | | 1953 | | 1934 |
| March | I | 949 8 | 21 5 | 15.4 | 36 1 | 16.8 | 39.3 | 11 9 | 42 8 | 28 | 7 2 | 2 |
| | II | 945 6 | 33.9 | 18 8 | | | | | | 1892 | | 1908 |
| April | I | 948 3 | 25.7 | 18 8 | 37 9 | 20 6 | 41 1 | 16 3 | 43 3 | 30 | 10 6 | 2 |
| | II | 944 0 | 34.9 | 20 7 | | | | | | 1897 | | 1903 |
| May | I | 946 0 | 27.2 | 21 0 | 37 2 | 22 6 | 40 9 | 19 4 | 43.3 | 7 | 13 9 | 7 |
| | II | 942 2 | 34 0 | 22 3 | | | | | | 1889 | | 1888 |
| June | I | 943 2 | 26.0 | 22 3 | 31 9 | 23 0 | 36 6 | 21 0 | 41 7 | 6 | 17 2 | 6 |
| | II | 940.6 | 28.4 | 22.9 | | | | | | 1897 | | 1920 |
| July | I | 942 5 | 24 4 | 21 9 | 27 8 | 22 0 | 31 1 | 20 7 | 35 6 | 6 | 18 9 | 6 |
| | II | 940 9 | 25 2 | 22 3 | | | | | | 1915 | | 1920 |
| August | I | 943 9 | 23.7 | 21 6 | 27 7 | 21 5 | 30 8 | 19 9 | 35 0 | 23 | 17 2 | 9 |
| | II | 941 9 | 24 9 | 22 1 | | | | | | 1950 | | 1920 |
| September | I | 946 3 | 23.7 | 21 3 | 29 2 | 20 8 | 32 9 | 18 7 | 36 1 | 29 | 16 1 | 27 |
| | II | 943 5 | 25.8 | 22 2 | | | | | | 1915 | | 1901 |
| October | I | 949 3 | 22 9 | 20.2 | 31 8 | 19 3 | 34.3 | 14.4 | 37 8 | 8 | 11 1 | 23 |
| | II | 945.8 | 28.7 | 21 2 | | | | | | 1899 | | 1910 |
| November | I | 952 2 | 19.3 | 16.3 | 30 8 | 15 0 | 33 2 | 10 3 | 36.1 | 7 | 7 2 | 29 |
| | II | 947.8 | 28.3 | 19.1 | | | | | | 1896 | | 1939 |
| December | I | 952 6 | 15.8 | 13.2 | 30 1 | 12.0 | 32 5 | 7 8 | 35 0 | 23 | 4.4 | 23 |
| | II | 948 9 | 27.5 | 17 5 | | | | | | 1896 | | 1940 |
| Annual Total or Mean | I | 948 1 | 21 9 | 18.2 | 32 0 | 18.2 | 41.6 | 6 2 | 43 3 | | 1.7 | |
| | II | 944.7 | 29.2 | 20.3 | | | | | | | | |
| Number of years | I | 30 | 30 | 30 | 30 | 30 | 30 | 30 | 80 | | 80 | |
| | II | 28 | 28 | 28 | | | | | | | | |

* I means 0830 hrs. IST.

II means 1730 hrs. IST.

TABLE

| Height about M. S. L. 559 Metres. | | | | Based on Observations from 1931 to 1960. | | | | | | |
|-----------------------------------|-----------------|---------------|------------|--|-------------------|----------------------------------|---------------------------------|---------------------------|---------------|-----------------|
| HUMIDITY | | CLOUD AMOUNT | | RAINFALL | | | | | | |
| Relative Humidity | Vapour Pressure | All Clouds | Low Clouds | Monthly Total | No. of Rainy Days | Total in Wettest Month with Year | Total in Driest Month with Year | Heaviest Fall in 24 Hours | Date and Year | Mean wind speed |
| % | mb. | Okto's of 'ky | | mm. | | mm. | mm. | mm. | | Km ph |
| 74 | 11.4 | 1.5 | 0.3 | 1.9 | 0.2 | 35.1 | 0 | 22.3 | 23 | 2.9 |
| 30 | 11.6 | 1.8 | 0.8 | | | 1948 | | | 1948 | |
| 64 | 12.1 | 0.9 | 0.2 | 0.3 | 0.1 | 26.4 | 0 | 16.3 | 8 | 3.6 |
| 23 | 9.9 | 1.3 | 0.5 | | | 1917 | | | 1892 | |
| 52 | 13.0 | 0.9 | 0.1 | 3.1 | 0.3 | 38.1 | 0 | 35.1 | 17 | 4.2 |
| 20 | 10.0 | 1.8 | 1.0 | | | 1954 | | | 1954 | |
| 50 | 16.1 | 1.6 | 0.3 | 17.6 | 1.3 | 70.4 | 0 | 51.1 | 4 | 5.4 |
| 26 | 13.4 | 2.6 | 1.6 | | | 1907 | | | 1896 | |
| 58 | 20.0 | 2.4 | 0.6 | 34.7 | 2.4 | 181.6 | 0 | 82.5 | 31 | 7.3 |
| 36 | 17.7 | 2.7 | 1.6 | | | 1933 | | | 1927 | |
| 74 | 24.0 | 5.6 | 2.7 | 102.8 | 6.9 | 384.3 | 1.3 | 97.0 | 7 | 9.0 |
| 63 | 23.2 | 5.8 | 3.4 | | | 1893 | | | 1906 | |
| 83 | 24.7 | 7.1 | 3.8 | 186.8 | 13.9 | 508.5 | 31.0 | 130.4 | 19 | 9.2 |
| 78 | 24.6 | 7.2 | 4.2 | | | 1907 | | | 1918 | |
| 85 | 24.4 | 6.9 | 3.8 | 106.4 | 9.0 | 277.4 | 19.3 | 108.7 | 3 | 7.6 |
| 77 | 24.1 | 6.9 | 4.2 | | | 1956 | | | 1904 | |
| 82 | 23.7 | 5.5 | 2.5 | 127.3 | 7.8 | 309.6 | 10.2 | 132.3 | 21 | 5.9 |
| 71 | 23.5 | 6.1 | 3.6 | | | 1955 | | | 1905 | |
| 79 | 21.5 | 3.4 | 0.9 | 91.9 | 5.8 | 440.7 | 3.6 | 149.1 | 24 | 3.5 |
| 52 | 19.3 | 4.4 | 2.3 | | | 1892 | | | 1942 | |
| 73 | 16.1 | 2.3 | 0.6 | 37.0 | 2.0 | 208.8 | 0 | 96.8 | 2 | 2.9 |
| 40 | 14.9 | 3.0 | 1.1 | | | 1948 | | | 1934 | |
| 75 | 13.2 | 1.7 | 1.3 | 4.9 | 0.4 | 71.4 | 0 | 42.4 | 22 | 2.7 |
| 35 | 12.2 | 2.0 | 0.7 | | | 1942 | | | 1942 | |
| 71 | 18.3 | 3.3 | 1.3 | 714.7 | 50.1 | 1242.3 | 268.5 | 149.1 | | 5.3 |
| 46 | 17.0 | 3.8 | 2.1 | | | 1892 | 1918 | | | |
| 30 | 30 | 30 | 20 | 30 | 30 | 80 | 80 | 80 | | 30 |
| 28 | 28 | 28 | 20 | | | | | | | |

Source—Meteorological Department, Pune.

Table 11

| MONTH | WEATHER PHENOMENA * | | | | | | | | WIND | | | | | | | | | | | | | |
|----------------------|-----------------------------------|---------------|------------|----------|---------------|---|--------------------|------|--------------------------------------|------|-------------------------------------|-----|----|----|----|----|----|----|----|-----|----|----|
| | No. of Days with | | | | | | | | No. of Days with wind speed (Km p h) | | Percentage No. of Days of wind from | | | | | | | | | | | |
| | Precipitation 0 3mm or more | Thun- Hail | der Fog | 0.4 0 | Dust storm | 0 | 62 Or squall | more | 20-61 | 1-19 | 0 | N | NE | E | SE | S | SW | W | NW | Cal | | |
| January | I | 0 | 5 | 0 | 0 | 1 | 0.4 | 0 | 0 | 0 | 6 | 25 | 1 | 1 | 1 | 1 | 5 | 7 | 4 | 0 | 80 | |
| | II | | | | | | | | 0 | 0 | 21 | 10 | 4 | 5 | 12 | 6 | 2 | 6 | 22 | 10 | 33 | |
| February | I | 0 | 1 | 0 | 0 | 2 | 0 | 0 | 0 | 0 | 10 | 18 | 1 | 1 | 1 | 2 | 18 | 15 | 8 | 0 | 64 | |
| | II | | | | | | | | 0 | 1 | 20 | 7 | 6 | 5 | 9 | 4 | 2 | 6 | 27 | 18 | 23 | |
| March | I | 0 | 9 | 0 | 2 | 1 | 5 | 0 | 0 | 4 | 0 | 12 | 19 | 0 | 1 | 1 | 2 | 10 | 12 | 8 | 2 | 64 |
| | II | | | | | | | | 0 | 1 | 25 | 5 | 5 | 6 | 6 | 2 | 2 | 6 | 34 | 25 | 14 | |
| April | I | 3 | 0 | 3 | 4 | 0 | 0 | 1 | 1 | 2 | 0 | 15 | 15 | 0 | 0 | 1 | 3 | 9 | 16 | 14 | 5 | 52 |
| | II | | | | | | | | 0 | 1 | 26 | 3 | 6 | 3 | 2 | 2 | 2 | 6 | 37 | 33 | 9 | |
| May | I | 4 | 0 | 8 | 5 | 0 | 0 | 1 | 0 | 1 | 23 | 7 | 1 | 0 | 1 | 1 | 4 | 12 | 42 | 14 | 25 | |
| | II | | | | | | | | 0 | 4 | 26 | 1 | 5 | 2 | 1 | 1 | 6 | 50 | 30 | | | |
| June | I | 13 | 0 | 3 | 0 | 0 | 0 | 5 | 0 | 1 | 25 | 4 | 1 | 0 | 0 | 1 | 4 | 18 | 54 | 8 | 14 | |
| | II | | | | | | | | 0 | 6 | 23 | 1 | 0 | 0 | 1 | 0 | 2 | 18 | 66 | 11 | 2 | |
| July | I | 24 | 0 | 0 | 3 | 0 | 0 | 1 | 0 | 2 | 25 | 4 | 0 | 0 | 0 | 0 | 1 | 15 | 64 | 5 | 15 | |
| | II | | | | | | | | 0 | 4 | 27 | 0 | 0 | 0 | 0 | 0 | 0 | 14 | 77 | 7 | 2 | |
| August | I | 23 | 0 | 0 | 9 | 0 | 0 | 1 | 0 | 1 | 23 | 7 | 0 | 0 | 0 | 0 | 0 | 11 | 59 | 7 | 23 | |
| | II | | | | | | | | 0 | 3 | 27 | 1 | 0 | 0 | 0 | 0 | 0 | 10 | 78 | 8 | 4 | |
| September | I | 14 | 0 | 4 | 0.1 | 0 | 0 | 6 | 0 | 0 | 19 | 11 | 0 | 0 | 0 | 1 | 1 | 13 | 40 | 7 | 38 | |
| | II | | | | | | | | 0 | 1 | 27 | 2 | 1 | 1 | 1 | 0 | 1 | 8 | 62 | 18 | 8 | |
| October | I | 8 | 0 | 5 | 1 | 5 | 0 | 1 | 0 | 3 | 0 | 11 | 20 | 1 | 2 | 7 | 3 | 3 | 10 | 9 | 1 | 64 |
| | II | | | | | | | | 0 | 0 | 21 | 10 | 3 | 9 | 14 | 5 | 1 | 6 | 18 | 12 | 32 | |
| November | I | 3 | 0 | 1 | 8 | 0 | 5 | 0 | 0 | 0 | 7 | 23 | 1 | 3 | 7 | 2 | 2 | 5 | 1 | 0 | 79 | |
| | II | | | | | | | | 0 | 0 | 18 | 12 | 3 | 8 | 28 | 11 | 2 | 1 | 3 | 2 | 42 | |
| December | I | 0.6 | 0 | 0 | 3 | 0 | 2 | 0 | 0 | 0 | 6 | 25 | 0 | 2 | 3 | 2 | 3 | 5 | 2 | 0 | 83 | |
| | II | | | | | | | | 0 | 0 | 19 | 12 | 2 | 10 | 25 | 9 | 1 | 3 | 6 | 4 | 40 | |
| Annual Total or Mean | I | 94 | 1 | 3 | 26 | 3 | 0.2 | 4 | 0 | 5 | 182 | 178 | 1 | 1 | 2 | 1 | 4 | 12 | 25 | 4 | 50 | |
| | II | | | | | | | | 0 | 21 | 280 | 64 | 3 | 4 | 8 | 3 | 1 | 8 | 40 | 15 | 18 | |
| Number of years | I | 22 | | | | | | | | 26 | | | | | 28 | | | | | | | |
| | II | | | | | | | | | 26 | | | | | 28 | | | | | | | |

* No. of days 2 and above are given in whole/numbers.

Table 1 2

GENERAL INFORMATION

| | | | | |
|-------|---|-----------------------------|---------------------------|----------------------|
| (I) | 1 | Height above the sea level | | 570 Meters |
| | 2 | Distance from the sea shore | | 107.25 km. |
| | 3 | Latitude | | 18° 31' North |
| | 4 | Longitude | | 43° 51' East |
| | 5 | Population and area | Population 1971 Census | Area Sq. km |
| | | Pune Municipal Corporation | 8,56,105 | 138.85 |
| | | Pune Cantonment | 77,774 | 13.99 |
| | | Khadki Cantonment | 65,497 | 13.20 |
| | | PC MC | 83,542 | 42.00 |
| | | Dehu Road Cantonment | 24,709 | |
| (II) | | Pune District | Population | Total Area Sq. km |
| | | | 31,78,029 | 15,600 |
| (III) | | Languages spoken : | | |
| | | (1) Marathi | | |
| | | (2) Hindi | | |
| | | (3) English | | |
| | | (4) Gujrathi | | |

Table 1.3

POPULATION GROWTH OF PUNE CITY

| Year | Population | Increase-Decrease | In % |
|------|------------|-------------------|---------|
| 1740 | 40,000 | — | — |
| 1780 | 1,50,000 | + 1,10,000 | 275% |
| 1818 | 1,05,000 | — 45,000 | — 30% |
| 1822 | 78,915 | — 66,085 | — 62.9% |
| 1851 | 73,209 | — 5,706 | — 7.23% |
| 1864 | 80,000 | + 6,691 | 9.27% |
| 1872 | 90,346 | + 10,436 | 13.05% |
| 1881 | 99,622 | + 9,186 | 10.15% |
| 1891 | 1,18,790 | + 19,168 | 19.25% |
| 1901 | 1,11,341 | — 7,359 | — 6.19% |
| 1911 | 1,17,456 | + 6,115 | 5.49% |
| 1921 | 1,33,227 | + 15,771 | 13.42% |
| 1931 | 1,62,001 | + 28,774 | 21.6% |
| 1941 | 2,37,546 | + 75,545 | 46.63% |
| 1951 | 4,80,942 | +2,43,396 | 102.5% |
| 1961 | 5,97,562 | +1,16,620 | 24.24% |
| 1971 | 8,56,105 | +2,58,543 | 43.20% |

Table 1 4

PUNE MUNICIPAL CORPORATION POPULATION

Census of India 1971

| Sr. No | Ward | Population | | |
|-----------|---------------------------|------------|--------|--------|
| | | Men | Women | Total |
| 1 | Hingane Kothrud | 9,671 | 9,068 | 18,739 |
| 2 | Hingane Kethrud | 7,363 | 6,804 | 14,167 |
| 3 | Shivajinagar | 2,695 | 2,548 | 5,243 |
| 4 | Shivajinagar | 7,321 | 5,718 | 13,039 |
| 5 | Shivajinagar A, B, C | 19,154 | 17,310 | 36,464 |
| 6 | Shivajinagar | 5,130 | 4,535 | 9,665 |
| 7 | Shivajinagar | 4,452 | 3,491 | 7,943 |
| 8 | Shivajinagar | 6,931 | 5,596 | 12,527 |
| 9 | Shivajinagar-Aundh-Pashan | 7,499 | 5,678 | 13,177 |
| 10 | Aundh-Pashan | 7,813 | 6,729 | 14,542 |
| 11 | Bopodi-Dapodi-Bhosari | 3,978 | 3,527 | 7,505 |
| 12 | Bopodi-Dapodi-Bhosari | 7,969 | 7,116 | 15,085 |
| 13 | Bopodi-Dapodi-Bhosari | 9,153 | 7,775 | 16,928 |
| 14 | Sadashiv-Parvati | 10,900 | 9,816 | 20,716 |
| 15 | Sadashiv-Parvati | 4,660 | 3,903 | 8,563 |
| 16 | Sadashiv-Parvati | 5,281 | 4,773 | 10,054 |
| 17 | Sadashiv-Parvati | 5,437 | 4,832 | 10,269 |
| 18 | Sadashiv-Parvati | 4,671 | 4,455 | 9,126 |
| 19 | Sadashiv-Parvati | 5,232 | 4,560 | 9,792 |
| 20 | Shaniwar | 4,745 | 4,282 | 9,127 |
| 21 | Shaniwar | 3,930 | 3,512 | 7,442 |
| 22 | Shaniwar-Narayan | 4,529 | 4,164 | 8,693 |
| 23 | Narayan | 4,280 | 4,007 | 8,287 |
| 24 | Shukrawar | 4,648 | 4,067 | 8,715 |
| 25 | Shukrawar | 4,894 | 4,293 | 9,187 |
| 26 | Shukrawar | 5,192 | 4,639 | 9,831 |
| 27 | Shukrawar | 4,017 | 3,482 | 7,499 |
| 28 | Shukrawar | 5,851 | 5,256 | 11,107 |
| 29 | Shukrawar-Parvati | 9,381 | 8,203 | 17,584 |
| 30 | Shukrawar | 9,832 | 8,738 | 18,570 |
| 31 | Guruwar | 4,319 | 4,067 | 8,386 |
| 32 | Guruwar | 5,200 | 4,726 | 9,926 |
| 33 | Guruwar | 4,365 | 4,009 | 8,374 |
| 34 | Ganesh | 5,499 | 4,774 | 10,273 |
| 35 | Ganesh | 5,041 | 4,460 | 9,501 |
| 36 | Raviwar | 4,823 | 4,365 | 9,193 |
| 37 | Raviwar | 4,539 | 3,891 | 8,430 |
| 38 | Raviwar | 4,480 | 3,845 | 8,325 |
| 39 | Raviwar | 4,486 | 4,398 | 8,884 |
| 40 | Budhwar | 3,660 | 3,473 | 7,133 |
| 41 | Budhwar | 4,699 | 4,110 | 8,809 |

Table 1-4—(Contd.)

| Sr. No. | Ward | Population | | |
|------------|------------------------|-----------------|-----------------|-----------------|
| | | Men | Women | Total |
| 42. | Budhwar-Kasba | 3,780 | 3,368 | 7,148 |
| 43. | Kasba | 4,940 | 4,417 | 9,357 |
| 44. | Kasba | 6,090 | 5,723 | 11,813 |
| 45. | Kasba | 4,456 | 4,079 | 8,535 |
| 46. | Kasba | 4,630 | 4,149 | 8,779 |
| 47. | Somwar-Mangalwar | 7,477 | 6,725 | 14,202 |
| 48. | Somwar-Mangalwar | 5,574 | 4,976 | 10,550 |
| 49. | Somwar-Mangalwar | 4,689 | 4,146 | 8,835 |
| 50. | Somwar-Mangalwar-Rasta | 5,313 | 4,711 | 10,024 |
| 51. | Rasta | 4,154 | 3,776 | 7,930 |
| 52. | Rasta-Nana | 5,071 | 4,595 | 9,666 |
| 53. | Nana | 5,637 | 5,260 | 10,897 |
| 54. | Nana | 4,256 | 3,942 | 8,198 |
| 55. | Nana | 4,452 | 3,911 | 8,363 |
| 56. | Nana | 3,973 | 4,198 | 8,171 |
| 57. | Bhawani | 6,034 | 5,983 | 12,017 |
| 58. | Bhawani | 5,636 | 5,001 | 10,637 |
| 59. | Bhawani | 5,631 | 5,261 | 10,892 |
| 60. | Bhawani | 4,350 | 3,823 | 8,173 |
| 61. | Ghorpade-Bhawani | 9,215 | 8,307 | 17,522 |
| 62. | Ganj | 6,755 | 6,337 | 13,092 |
| 63. | Ghorpade Peth | 6,815 | 6,267 | 13,082 |
| 64. | Ghorpade Peth | 10,703 | 9,513 | 20,216 |
| 65. | Hadapsar | 10,679 | 8,475 | 19,154 |
| 66. | Hadapsar | 7,649 | 6,971 | 14,620 |
| 67. | Mundhwa, Ghorpadi | 5,585 | 5,217 | 10,802 |
| 68. | Civil Sides | 6,803 | 5,903 | 12,706 |
| 69. | Civil Sides | 8,680 | 7,506 | 16,186 |
| 70. | Lohgaon | 10,049 | 8,244 | 18,293 |
| 71. | Yerawada | 6,861 | 6,501 | 13,362 |
| 72. | Yerawada | 7,196 | 6,299 | 13,495 |
| 73. | Yerawada | 13,423 | 9,145 | 22,568 |
| | Total | 4,54,281 | 4,01,824 | 8,56,105 |

Source: D. S. O., Pune.

Table 1 5
COMPARATIVE FIGURES OF POPULATION
 (1971 Census)

| | Men | Women | Total |
|-----------------------------|-----------------|-----------------|-----------------|
| According to Census of 1961 | 3,15,715 | 2,83,070 | 5,98,785 |
| According to Census of 1971 | 4,54,281 | 4,01,824 | 8,56,105 |
| | Men | Women | Total |
| Pune Municipal Corporation | 4,54,281 | 4,01,824 | 8,56,105 |
| Pune Cantonment | 42,495 | 35,279 | 77,774 |
| Khadki Cantonment | 37,938 | 27,559 | 65,497 |
| Total | 5,34,714 | 4,64,662 | 9,99,376 |

Source : District Statistical Officer, Pune

Table 1 6
POPULATION OF GREATER PUNE
 (1971 Census)

| | Male | Female | Total | Literate Male | Literate Female | Total |
|---------------------------------------|----------|----------|----------|---------------|-----------------|----------|
| 1. Pune Municipal Corporation | 4,54,281 | 4,01,824 | 8,56,105 | 3,21,596 | 2,13,668 | 5,35,264 |
| 2. Pune Cantonment | 42,495 | 35,279 | 77,774 | 31,880 | 20,832 | 52,712 |
| 3. Khadki Cantonment | 37,938 | 27,559 | 65,497 | 28,424 | 14,106 | 42,530 |
| 4. Lohogaon | 7,077 | 5,424 | 12,501 | 4,718 | 2,556 | 7,274 |
| 5. Pimpri-Chinchwad Municipal Council | 45,742 | 37,800 | 83,542 | 29,445 | 16,390 | 45,835 |
| 6. Dehu | 2,895 | 2,741 | 5,636 | 1,807 | 919 | 2,726 |
| 7. Dehu Cantonment | 13,560 | 11,149 | 24,709 | 8,542 | 4,231 | 12,773 |

Source : D. S. O., Pune

Table 1 7
PUNE DISTRICT AT A GLANCE
 Statistical Abstract, 1975-76

| Sr. No. | Item | Unit | Pune Dist | Mahara- shtra State |
|------------|--|-------------------|--------------|---------------------------|
| 1 | 2 | 3 | 4 | 5 |
| 1 | Location | | | |
| 1.1 | North Latitude | Degree | 17 5 to 19 2 | 16 4 to 22 1 |
| 1 2 | East Longitude | Degree | 73 1 to 75.0 | 72 6 to 80,9 |
| 2. | Area & Population (According to 1971) | | | |
| 2.1 | Area | Sq. Km | 15640 | 307762 |
| 2.2 | No. of Towns | No. | 22 | 282 |
| 2 3 | Total No of Villages | No | 1498 | 38661 |
| | (i) Inhabited | No. | 1481 | 35778 |
| | (ii) Uninhabited | No. | 17 | 2883 |
| 2 4 | Rural Population | No' in '000 | 1848 | 34701 |
| 2.5 | Urban Population | " | 1330 | 15711 |
| 2.6 | Total Population | " | 3178 | 25041 |
| 2 7 | Population of Scheduled Castes & Scheduled Tribes | " | 284 | 5980 |
| 2 8 | Total Workers | " | 1036 | 18390 |
| | (i) As Cultivators & Agri Laboures | " | 541 | 11930 |
| | (ii) Others | " | 495 | 6460 |
| 2 9 | Non-workers | " | 2142 | 32020 |
| 2 10 | Literacy Percentage | Percentage | | |
| | (i) Male | " | 56 30 | 51 04 |
| | (ii) Female | " | 32 10 | 26 43 |
| | (iii) Persons | " | 44 62 | 39 18 |
| 3 | Climate | | | |
| 3 1 | Rainfall (1975) Average (In Selected Centres) | mm | 983.5 | 1587 2 |
| 3 2 | Temperature (1975) | | | |
| | (a) Maximum (absolute) (in Selected Centres) | Centigrade | 42 8 | 46 0 |
| | (b) Minimum (absolute) (in Selected Centres) | Centigrade | 4 8 | 3 6 |
| 4 | Agriculture 1974-75 | | | |
| 4 1 | Cultivable Area | Thousand Hectares | 1131 | 21116 |
| 4.2 | Area not available for Cultivation | " | 191 | 2668 |
| 4 3 | Area sown | | | |
| | (a) Net | " | 979 | 18206 |
| | (b) Gross | " | 1092 | 18506 |

Table No 1 7—(Contd)

| 1 | 2 | 3 | 4 | 5 |
|------------|---|-------------|-------|----------|
| 4 4 | Area Irrigated | | | |
| | (a) Net | .. | 140 | 1612 |
| | (b) Gross | .. | 171 | 1933 |
| 4 5 | Area under Forests | .. | 184 | 5348 |
| 4 6 | Cropped Area under food grains | .. | 698 | 13498 |
| 4 7 | Land Revenue Collection (1975-76) | Rs. '000 | 4837 | 156000 |
| 5. | Animal Husbandry | | | |
| 5.1 | Livestock | No. in '000 | 1498 | 26361 |
| 5.2 | Cattle | .. | 639 | 14705 |
| 5.3 | Buffaloes | .. | 161 | 3301 |
| 5 4 | Sheep | .. | 306 | 2128 |
| 5 5 | Goats | .. | 377 | 5911 |
| 5.6 | Horses & Ponies | .. | 2 | 58 |
| 5 7 | Other livestock | .. | 12 | 258 |
| 5 8 | Poultry | .. | 1217 | 12217 |
| 5 9 | No of Veterinary Hospitals & Dispensaries (1975-76) | .. | 25 | 359 |
| 6. | Industries (1975) | | | |
| 6 1 | Working Factories | No. | 1056 | 10975 |
| 6 2 | Average daily employment | No. | 91993 | 10388868 |
| 7. | Electricity (1975-76) | | | |
| 7 1 | Electricity consumed | Million KWH | 603 | 9392 |
| 7 2 | No of villages & towns electrified at the end of March '76 | No. | 777 | 20112 |
| 8. | Co-operation (1975-76) | | | |
| 8 1 | Co-operative societies (all types) | No. | 3226 | 49659 |
| 8 2 | Membership | '000 No. | 556 | 11383 |
| 8.3 | Working Capital | Lakhs Rs. | 9662 | 270221 |
| 8 4 | Loan advanced | .. | 2766 | 244264 |
| 8 5 | Loans advanced by Agr. Credit societies | .. | 1140 | 17011 |
| 9. | Medical & Public Health (1978) | | | |
| 9 1 | Hospitals | No. | 21 | 353 |
| 9 2 | Dispensaries | No. | 51 | 1395 |
| 9 3 | No. of beds in hospitals and dispensaries | No. | 6829 | 54769 |
| 9.4 | Birth rate (1975) | per '000 | 22 | 24 |
| 9 5 | Death rate (1975) | .. | 7 | 8 7 |
| 9.6 | No of sterilisation operations done (75-76) | No. | 45415 | 611588 |
| 10. | Education (as on 15-7-1975) | | | |
| 10 1 | Primary Education | | | |
| | (i) Institutions | No. | 3044 | 48018 |
| | (ii) Students | in '000 | 528 | 7367 |
| | (iii) Teachers | .. | 16 | 220 |

Table No. 1.7—(Contd.)

| 1 | 2 | 3 | 4 | 5 |
|-------|--|----------|------|--------|
| 10.2 | Secondary Education | | | |
| | (i) Institutions | No. | 344 | 5897 |
| | (ii) Students | in '000 | 187 | 2513 |
| | (iii) Teachers | " | 6 | 94 |
| 10.3 | Higher Education | | | |
| | (i) Institutions | No. | 45 | 682 |
| | (ii) Students | in '000 | 43 | 474 |
| | (iii) Teachers | " | 2 | 20 |
| ✓ 11. | Transport & Communication | | | |
| 11.1 | Total Railway length (31-3-76) | Km. | 311 | 5232 |
| 11.2 | Total extra municipal roads (31-3-1976) | Km. | 8746 | 178768 |
| 11.3 | (a) No. of post offices for State & 75-76 for Dist. | No. | 570 | 9414 |
| | (b) No. of telegraph offices for State 1973-74/Dist. 1975-76 | " | 119 | 1119 |
| 12. | Local Self Govt. | | | |
| 12.1 | Village panchayats (31-3-75) | No. | 1050 | 23552 |
| 12.2 | Municipalities (including Corpn. 1976) | No. | 13 | 227 |
| 13. | Community Development | | | |
| 13.1 | C.P.A. Pattern Blocks | No. | 2400 | 44250 |
| 13.2 | Village included in | No. | 1498 | 38904 |
| 13.3 | Population covered | Lakh No. | 19 | 402 |
| ✓ 14. | Plan | | | |
| 14.1 | Total Expenditure incurred during 4th Plan | Lakh Rs. | 1938 | 100451 |
| 14.2 | Expenditure incurred during 5th Plan exp. for 1975-76 | " | 517 | 37398 |
| ✓ 15. | Miscellaneous | | | |
| 15.1 | Joint Stock Companies (31-3-75) | No. | 392 | 9691 |
| 15.2 | Banking offices (as on 31-3-74) | No. | 367 | 3603 |
| 15.3 | Employment Exchange (1975-76) | | | |
| | (1) Registration | '000 No. | 35 | 456 |
| | (2) Placement | " | 3 | 35 |
| | (3) Live register at the end of the year (as on 31-3-76) | " | 67 | 795 |

Note : The figures for items 3,4,6 to 15 in Col. 5 are provisional.
Source : District statistical office, Pune.

Table 2.1

STATISTICS RELATING TO INDUSTRIES IN PUNE METROPOLITAN REGION

| | No. of units | % to total | Workers | % to total | Capital employed (Rs. in lakhs) | % to total | Value of production (Rs. in lakhs) | % to total | Exports Rs. (in lakhs) | % total Exports (Rs. in lakhs) |
|--|--------------|------------|---------------|------------|---------------------------------|------------|------------------------------------|------------|------------------------|--------------------------------|
| 1 | 2 | 3 | 4 | 5 | 6 | 7 | 8 | 9 | 10 | 11 |
| Food Products | 86 | 3.42 | 2243 (13) | 2.00 | 437.40 (14) | 1.08 | 1724.73 (13) | 2.51 | 220.11 | 2.71 |
| Beverages, Tobacco, Tobacco Products | 16 | 0.64 | 2485 (1) | 2.22 | 187.90 (3) | 0.46 | 1625.41 (3) | 2.36 | 16.00 | 0.20 |
| Cotton Textiles | 93 | 3.70 | 3366 (34) | 3.01 | 378.07 (38) | 0.93 | 978.23 (38) | 1.42 | 440.00 | 5.42 |
| Wool, Silk, Synthetic Fibre Textiles, Jute, Hemp & Mesta Textiles | 4 | 0.16 | 43 (3) | 0.04 | 5.05 (1) | 0.01 | 6.54 (1) | 0.01 | — | — |
| Textile Products (Including Wearing Apparel other than Foot Wear) | 87 | 3.46 | 1613 (6) | 1.44 | 104.69 (15) | 0.26 | 4039.45 (14) | 5.87 | 22.05 | 0.27 |
| Wood & Wood Products Furniture & Fixtures | 109 | 4.33 | 982 (12) | 0.88 | 122.48 (15) | 0.30 | 300.74 (19) | 0.44 | 4.00 | 0.05 |
| Paper & Paper Products Printing & Allied Industries | 300 | 11.93 | 5373 (41) | 4.80 | 1340.44 (40) | 3.29 | 1936.44 (57) | 2.82 | 36.87 | 0.45 |
| Leather & Leather Goods and Fur Products (Except Repairs) | 23 | 0.91 | 404 (6) | 0.36 | 22.53 (3) | 0.06 | 119.95 (4) | 0.17 | 21.50 | 0.26 |
| Rubber, Plastic, Petroleum and Coal Products | 120 | 4.77 | 3822 (20) | 3.41 | 324.21 (15) | 0.80 | 1365.00 (24) | 1.98 | 17.52 | 0.22 |
| Chemical & Chemical Products (Except Products of Petroleum & Coal) | 194 | 7.71 | 10012 (39) | 8.94 | 7300.98 (36) | 17.95 | 9284.23 (35) | 13.50 | 720.02 | 8.87 |
| Non-Metallic Mineral Products (Cement, Glass, Crockery etc.) | 71 | 2.82 | 4964 (10) | 4.43 | 896.20 (13) | 2.20 | 1556.28 (15) | 2.26 | 373.34 | 4.60 |
| Basic Metal and Alloys Industries | 106 | 4.21 | 5602 (14) | 5.00 | 2253.13 (21) | 5.54 | 3487.63 (25) | 5.07 | 43.09 | 0.53 |

Table 2.1 Contd.

| 1 | 2 | 3 | 4 | 5 | 6 | 7 | 8 | 9 | 10 | 11 |
|--|------|-------|-----------------|--------|-------------------|--------|-------------------|--------|---------|-------|
| Metal Products and Parts (Except Machinery & Transport Equipments) | 267 | 10.62 | 7199 (35) | 6.43 | 927.77 (29) | 2.28 | 2399.86 (44) | 3.49 | 256 98 | 3 16 |
| Machinery, Machine Tools & Parts, Except Electrical Machinery | 576 | 22 90 | 33066 (60) | 29.53 | 13376.50 (64) | 32.88 | 19227.22 (109) | 27 96 | 1656 40 | 20 40 |
| Electrical Machinery, Apparatus, Appliances, Supplies & Parts | 207 | 8.23 | 11868 (20) | 10.60 | 9397.67 (18) | 23.10 | 12075.96 (38) | 17.56 | 1263 23 | 15.55 |
| Transport Equipment & Parts | 66 | 2.62 | 17132 (7) | 15.30 | 3066.87 (5) | 7 54 | 7907.32 (15) | 11.50 | 2863.39 | 35.26 |
| Other Manufacturing Industries | 77 | 3.06 | 1064 (20) | 0.95 | 441.49 (16) | 1.09 | 614.83 (23) | 0.89 | 166 78 | 2 05 |
| Repair Services | 113 | 4.51 | 727 (12) | 0.66 | 100.74 (15) | 0.23 | 116.34 (33) | 0.19 | — | — |
| | 2515 | 100% | 111965 (353) | 100.00 | 40684.12 (361) | 100.00 | 68766.16 (510) | 100 00 | 8121 28 | 11.81 |

- NOTES: (1) The industry classification adopted in this table for classifying industries is the National Industrial Classification (NIC) 1970.
- (2) Statistical information in this table has been compiled only in respect of units having their factories located in the Pune Metropolitan Region.
- (3) Figures in respect of industrial units having Registered Office in Pune Metropolitan Region but whose factories are located outside Pune Region have been excluded.
- (4) Figures in the bracket indicate number of non-reporting units.
- (5) Figures of number of units as well as workers exclude Government and semi-government undertakings, brick manufacturers, stone crushing units and workers employed therein.
- (6) Figures of capital employed and production do not include figures of TELCO in respect of which figures of Pune Plants were not available separately. However, figure of workers includes workers employed at Pune Plants of TELCO.
- (7) Export figures exclude exports by merchant exporters.
- (8) Figure of exports includes exports of TELCO, Pune, as well as Jamshedpur.

(Source : Data collected by Mahratta Chamber of Commerce & Industries, Pune.)

Table 2 2

AREAWISE DISTRIBUTION OF INDUSTRIES IN PUNE

| Pune Postal Zones | Area | 1 | 2 | 3 | 4 | 5 | 6 | 7 | 8 | 9 | 10 | 11 | 12 | 13 | 14 | 15 | 16 | 17 | 18 | 19 |
|-------------------|---|----|---|---|---|----|----|----|----|----|----|----|----|----|----|----|----|----|----|-----|
| | Food Products | 1 | | | | | | | | | | | | | | | | | | |
| | Beverages, Tobacco & Tobacco Products | 2 | | | | | | | | | | | | | | | | | | |
| | Cotton Textiles | 3 | | | | | | | | | | | | | | | | | | |
| | Wool Silk, Synthetic Fibre Textiles, Jute, Hemp & Mesh Textiles | 4 | | | | | | | | | | | | | | | | | | |
| | Textile Products (Including Wearing Apparel other than Footwear) | 5 | | | | | | | | | | | | | | | | | | |
| | Wood & Wood Products Furniture & Fixtures | 6 | | | | | | | | | | | | | | | | | | |
| | Paper & Paper Products, Printing & Allied Industries | 7 | | | | | | | | | | | | | | | | | | |
| | Leather & Leather Goods & Fur Products Except Repairs | 8 | | | | | | | | | | | | | | | | | | |
| | Rubber, Plastic, Petroleum & Coal Products | 9 | | | | | | | | | | | | | | | | | | |
| | Chemicals & Chemical Products (Except Products of Petroleum and Coal) | 10 | | | | | | | | | | | | | | | | | | |
| | Non-Metallic Mineral Products (Cement, Glass, Crockery etc.) | 11 | | | | | | | | | | | | | | | | | | |
| | Basic Metal & Alloys Industries | 12 | | | | | | | | | | | | | | | | | | |
| | Metal Products and Parts Except Machinery and Transport Equipments | 13 | | | | | | | | | | | | | | | | | | |
| | Machinery, Machine Tools & Parts Except Electrical Machinery | 14 | | | | | | | | | | | | | | | | | | |
| | Electrical Machinery Apparatus, Appliances Supplies & Parts | 15 | | | | | | | | | | | | | | | | | | |
| | Transport Equipments and Parts | 16 | | | | | | | | | | | | | | | | | | |
| | Other Manufacturing Industries | 17 | | | | | | | | | | | | | | | | | | |
| | Repair Services | 18 | | | | | | | | | | | | | | | | | | |
| | Total | 19 | | | | | | | | | | | | | | | | | | |
| | | | | | | | | | | | | | | | | | | | | |
| 1. | Camp Area, Sassoon Hospital till Hadapsar, Race Course till Bund Garden Bridge | 14 | 2 | 1 | — | 1 | 3 | 8 | 1 | 2 | 10 | 5 | 4 | 4 | 17 | 5 | 4 | 11 | 4 | 96 |
| 2. | Laxmi Road, Bhawani Peth, Ganesh Peth, Shukrawar Peth, Nana Peth, Raviwar Peth, Gururwar Peth, Ganji Peth, Vetal Peth, Chorprade Peth | 28 | 8 | 9 | 1 | 47 | 51 | 95 | 12 | 13 | 39 | 7 | 9 | 86 | 90 | 21 | 12 | 13 | 36 | 577 |
| 3. | From Mhasoba Gate upto Bopodi Bridge, Ranghulls, Area of Khadki Cantonment Board | 1 | — | — | — | 1 | 1 | 2 | — | 6 | 1 | — | 1 | 2 | 16 | 3 | — | — | 5 | 39 |

Table -2.2 Contd.

| | 1 | 2 | 3 | 4 | 5 | 6 | 7 | 8 | 9 | 10 | 11 | 12 | 13 | 14 | 15 | 16 | 17 | 18 | 19 |
|---|---|---|----|---|---|---|----|---|---|----|----|----|----|----|----|----|----|----|-----|
| 4. Beyond Sambhaji Bridge, Erandwana, Deccan Gymkhana, Karve Road, Prabhat Road, Apte Road, Fergusson College Road, Bhandarkar Inst. Road, Jangli Maharaj Road till Bal Gandharva Rang Mandir | 1 | — | 25 | — | 5 | 3 | 7 | — | 9 | 9 | 7 | 9 | 12 | 25 | 37 | 1 | 9 | 4 | 163 |
| 5. Shivajinagar, beyond Bal Gan- dharva Rang Mandir, Corporation, Engineering College, Ganesh- khind Road | 2 | — | — | — | 3 | 1 | 6 | — | 1 | 1 | 7 | 3 | 7 | 13 | 7 | 1 | 2 | 12 | 66 |
| 6. Yeravada, Mental Hospital, Jail Area till Aga Khan Palace Dunkirk Lines | 1 | — | — | — | — | — | — | — | — | — | — | — | 1 | 2 | 2 | — | — | — | 6 |
| 7. University Area (Whole), Aundh | — | — | — | — | — | — | — | — | — | 2 | — | — | — | — | 4 | — | — | — | 6 |
| 9. Parvati Darshan, Saras Baug, Satara Road, Katraj, Bibwe Wadi, Half of Gultekadi, Shankarshet Road | 3 | — | 21 | — | 4 | 8 | 17 | — | 7 | 15 | 10 | 9 | 23 | 56 | 15 | 12 | 8 | 18 | 226 |

Table 2.2 Contd.

| | 1 | 2 | 3 | 4 | 5 | 6 | 7 | 8 | 9 | 10 | 11 | 12 | 13 | 14 | 15 | 16 | 17 | 18 | 19 |
|--|---|---|----|---|---|---|----|---|-----|----|----|----|----|----|----|----|----|----|-----|
| 11. Kasba Peth, Mangalwar Peth, Rasta Peth, Somwar Peth, Phadke Haud | 5 | 1 | — | — | 8 | 6 | 17 | 1 | 9 | 12 | 4 | 4 | 27 | 57 | 7 | 4 | 4 | 8 | 174 |
| ✓ 12. Dapodi | — | — | — | — | — | 4 | 1 | 1 | 1 | 1 | — | — | 6 | 14 | — | — | 1 | 3 | 32 |
| 13. Hadapsar Industrial Estate | 4 | 2 | 32 | — | 2 | 3 | 2 | — | 7 | 15 | 2 | 7 | 4 | 24 | 9 | 3 | 3 | — | 119 |
| 14. Dunkirk Lines | 2 | — | — | — | — | 1 | 1 | — | 2 | 4 | 1 | 3 | 5 | 8 | 4 | 2 | 1 | 2 | 36 |
| 15. Dighi Camp | 1 | — | — | — | — | — | — | — | — | 1 | 3 | — | — | — | — | — | — | — | 5 |
| 16. Model Colony, Wadar Wadi, Gokhalenagar, Chaturshringi | 1 | — | — | — | — | — | 1 | — | 2 | 4 | 1 | 1 | 1 | 2 | 2 | — | 4 | — | 19 |
| ✓ 17. Pimpri Colony | — | — | — | — | — | — | 2 | — | 1 | — | — | — | — | — | — | — | 1 | — | 4 |
| ✓ 18. Pimpri | 4 | — | — | 1 | — | 3 | 7 | 1 | 16 | 28 | 4 | 9 | 16 | 53 | 23 | 5 | — | 3 | 173 |
| ✓ 19. Chinchwad (East) | — | — | 1 | 1 | — | 5 | 4 | 1 | 11 | 5 | 5 | 13 | 11 | 32 | 7 | 6 | — | 2 | 104 |
| 23. Khadakwasla | — | — | — | — | — | — | — | — | — | — | — | — | 1 | — | — | — | — | — | 1 |
| 25. I.A.T. | 1 | — | — | — | — | — | — | — | 188 | — | — | — | — | — | — | — | — | — | 1 |
| ✓ 26. Bhosari Industrial Estate | 4 | 1 | — | 1 | 3 | 9 | 17 | 2 | 16 | 24 | 8 | 20 | 26 | 56 | 30 | 1 | 4 | 3 | 225 |
| 28. Hadapsar | — | — | — | — | — | 1 | 3 | — | 1 | 2 | — | 1 | — | 10 | 1 | — | — | — | 19 |

Table 2.2 Contd.

| | 1 | 2 | 3 | 4 | 5 | 6 | 7 | 8 | 9 | 10 | 11 | 12 | 13 | 14 | 15 | 16 | 17 | 18 | 19 |
|---|-----------|-----------|-----------|----------|-----------|------------|------------|-----------|------------|------------|-----------|------------|------------|------------|------------|-----------|-----------|------------|-------------|
| 29. Kothrud | — | — | — | — | — | 2 | 1 | — | 2 | 3 | — | 3 | 1 | 12 | 5 | — | — | 2 | 31 |
| 30. Sadashiv Peth, Narayan Peth, Tilak Road, Shaniwar Peth | 10 | 2 | 1 | — | 12 | 5 | 95 | 4 | 7 | 8 | 2 | 8 | 31 | 55 | 19 | 7 | 15 | 10 | 291 |
| 33. Chinchwad Gaon | 1 | — | — | — | 1 | 1 | 5 | — | 2 | 1 | 1 | — | 6 | 5 | 2 | 2 | — | — | 21 |
| 35. Akurdi | — | — | — | — | — | 1 | 4 | — | 2 | 3 | 1 | 1 | 3 | 21 | 2 | 4 | — | — | 42 |
| 36. Mundhwa | 1 | — | 3 | — | — | — | 1 | — | 1 | 3 | 1 | 1 | — | 5 | — | 2 | — | — | 18 |
| Total for Pune Postal Zones | 84 | 16 | 93 | 4 | 87 | 108 | 296 | 23 | 118 | 191 | 69 | 106 | 267 | 573 | 205 | 66 | 76 | 112 | 2494 |
| Industries in Pune Metropolitan Re- gion but outside Pune Postal Zones | 2 | — | — | — | — | 1 | 4 | — | 2 | 3 | 2 | — | — | 3 | 2 | — | 1 | 1 | 21 |
| | 86 | 16 | 93 | 4 | 87 | 109 | 300 | 23 | 120 | 194 | 71 | 106 | 267 | 576 | 207 | 66 | 77 | 113 | 2515 |

Industrial Directory of Pune

NOTES : (1) The table shows physical distribution of industries located in Pune postal zones.

(2) 21 units located elsewhere in Pune Metropolitan Region are as follows:

Narhe—2. Loni—3. Talegaon—6. Wadgaon—2. Urali—1. Manjri—2. Hingne—1. Koregaon Mul.—1. Wakad—1. Khadakwasla—1. Theur—1.

(3) 23 units are located outside Pune Metropolitan Region at places like Lonavala, Baramati, Walchandnagar, Chakan, Khedshivapur etc. They are not included in this Table. However, information in respect of these units has been given in the Guide to Manufacturers.

(Source—Data Collected by Maharashtra Chamber of Commerce & Industries, Pune)

Table 2.3

DISTRIBUTION OF INDUSTRIES IN PUNE METROPOLITAN REGION ACCORDING TO THEIR CAPITAL INVESTMENT

| Capital investment in Rs. | No. of units | % to total | Workers | % to total | Capital in lakh Rs. | % to total | Production in lakh Rs. | % to total | Exports in lakh Rs. | % to total |
|---------------------------|--------------|------------|---------|------------|---------------------|------------|------------------------|------------|---------------------|------------|
| Rs. 0 to 2 lakhs | 1787 | 71.05 | 28870 | 25.78 | 1978.97 | 4.86 | 7229.88 | 10.51 | 119.95 | 1.48 |
| Rs. 2 to 10 lakhs | 428 | 17.02 | 10761 | 9.61 | 1758.02 | 4.32 | 4478.19 | 6.51 | 54.95 | 0.68 |
| Rs. 10 to 15 lakhs | 38 | 1.51 | 3549 | 3.17 | 636.48 | 1.56 | 1298.59 | 1.89 | 47.24 | 0.58 |
| Rs. 15 lakhs to 1 crore | 73 | 2.90 | 10273 | 9.18 | 3071.36 | 7.55 | 8798.71 | 12.80 | 485.24 | 5.97 |
| Rs. 1 crore to 3 crores | 25 | 0.99 | 14218 | 12.70 | 3862.55 | 9.49 | 7513.00 | 10.93 | 1090.98 | 13.43 |
| Rs. 3 crores and above | 25 | 0.99 | 44294 | 39.56 | 29376.74 | 72.22 | 39447.79 | 57.36 | 6322.92 | 77.86 |
| Non-reporting units | 139 | 5.54 | — | — | — | — | — | — | — | — |
| | 2515 | 100.00 | 111965 | 100.00 | 40684.12 | 100.00 | 68766.16 | 100.00 | 8121.28 | 100.00 |

About 71% of the industries in Pune Metropolitan Region have investment below Rs. 2 lakhs, but their share in total production is only 10.51%. They employ about 25% of total industrial workers in Pune.

On the contrary only 50 units representing only 2% of total industrial units, provide employment to 52% of industrial working population. Their share in total production is also significant (68% of total production). However, capital investment per worker in this group is as high as Rs. 56,800 as compared to Rs. 6,854 in the group of industries having capital investment up to Rs. 2 lakhs.

Industrial output per worker in the group of industries having capital investment from 0 to 2 lakhs is Rs. 25,000 as compared to Rs. 80,000 in the group of Rs. 1 crore and above.

(Source—Data collected by Mahratta Chamber of Commerce & Industries, Pune).

Table 3.1

TOTAL NUMBER OF ESTABLISHMENTS IN PUNE CITY

| | 1973 | 1974 | 1975 | 1976 | 1977 |
|----------------|-------|-------|-------|-------|-------|
| 1. Shops | 24507 | 26210 | 27744 | 29116 | 31429 |
| 2. Com, Estts. | 6310 | 5982 | 6833 | 7713 | 7679 |
| 3. Hotels | 2173 | 2623 | 2023 | 2075 | 2289 |
| 4. Theatres | 28 | 28 | 29 | 33 | 36 |
| | 33018 | 34843 | 36629 | 38937 | 41433 |

Source : Chief Inspector of Shops & Establishment, Pune Municipal Corpn.

Table 3.2

TOTAL NUMBER OF ESTABLISHMENTS IN P. C. M. C. AREA

| Area | No. of Shops and Hotels etc. | No. of Industries |
|----------------|---------------------------------|----------------------|
| Pimpri Waghire | 204 | 130 |
| Bhosari | 213 | 222 |
| Chinchwad | 197 | 83 |
| Akurdi | 125 | 76 |
| Pimprinagar | 76 | 27 |
| Total | 815 | 538 |

(Source—Pimpri-Chinchwad Municipal Council)

Table 4-1

266

**NUMBER OF APPLICANTS REGISTERED, PLACEMENTS EFFECTED, VACANCIES NOTIFIED AND FILLED DURING
1-1-1977 TO 31.12.1977 BY SUB-REGIONAL EMPLOYMENT EXCHANGE, PUNE; EMPLOYMENT EXCHANGE,
PIMPRI; AND UNIVERSITY EMPLOYMENT INFORMATION AND GUIDANCE BUREAU, PUNE**

| MONTHS | REGISTRATION | | | | PLACEMENTS | | | | VACANCIES NOTIFIED | | | | VACANCIES FILLED | | | |
|--------------|---------------|-------------------|-------------|--------------|---------------|-----------------|------------|-------------|--------------------|------------------|-------------|-------------|------------------|-----------------|-------------|-------------|
| | SREE, Pune | E. Ex., Pimpri | UEI &GB | Total | SREE, Pune | E Ex, Pimpri | UEI &GB | Total | SREE, Pune | E Ex., Pimpri | UEI & GB | Total | SREE, Pune | E Ex, Pimpri | UEI & GB | Total |
| JANUARY 77 | 2370 | 317 | 110 | 2797 | 236 | 54 | 14 | 304 | 266 | 328 | 25 | 619 | 236 | 54 | 14 | 304 |
| FEBRUARY 77 | 1990 | 233 | 112 | 2335 | 211 | 36 | 14 | 261 | 313 | 173 | 12 | 428 | 208 | 36 | 14 | 258 |
| MARCH 77 | 1924 | 234 | 72 | 2230 | 257 | 53 | 15 | 325 | 636 | 306 | 48 | 990 | 257 | 53 | 15 | 325 |
| APRIL 77 | 2557 | 222 | 70 | 2849 | 217 | 48 | 2 | 267 | 615 | 330 | 13 | 958 | 217 | 48 | 2 | 267 |
| MAY 77 | 2778 | 362 | 95 | 3235 | 213 | 61 | 4 | 278 | 588 | 231 | 37 | 856 | 212 | 61 | 4 | 277 |
| JUNE 77 | 3254 | 358 | 228 | 3840 | 208 | 31 | 10 | 249 | 701 | 231 | 92 | 1024 | 208 | 31 | 10 | 249 |
| JULY 77 | 4200 | 295 | 289 | 4784 | 241 | 69 | 6 | 316 | 415 | 252 | 23 | 690 | 241 | 69 | 6 | 316 |
| AUGUST 77 | 3437 | 736 | 134 | 4307 | 503 | 57 | 12 | 572 | 668 | 97 | 24 | 789 | 503 | 57 | 12 | 572 |
| SEPT. 77 | 2128 | 373 | 92 | 2593 | 258 | 36 | 11 | 305 | 375 | 128 | 50 | 553 | 258 | 33 | 11 | 302 |
| OCT. 77 | 2643 | 302 | 69 | 3014 | 413 | 65 | 19 | 497 | 447 | 237 | 74 | 758 | 413 | 65 | 19 | 497 |
| NOV 77 | 1781 | 244 | 47 | 2072 | 282 | 43 | 11 | 336 | 333 | 126 | 63 | 522 | 280 | 43 | 11 | 334 |
| DEC. 77 | 1470 | 197 | 65 | 1732 | — | 3 | 9 | 12 | 168 | 141 | 17 | 326 | — | 3 | 9 | 12 |
| TOTAL | 30532 | 3873 | 1383 | 35788 | 3039 | 556 | 127 | 3722 | 5525 | 2580 | 478 | 8583 | 3033 | 553 | 127 | 3713 |

Source : Sub-Regional Employment Exchange Office, Pune

Industrial Directory of Pune

Table 4.2

EMPLOYMENT STATISTICS OF SHOPS AND ESTABLISHMENTS IN PUNE CITY

| | 1973 | 1974 | 1975 | 1976 | 1977 |
|---------------|--------------|--------------|--------------|--------------|--------------|
| 1. Shops | 18624 | 19024 | 19600 | 19594 | 22656 |
| 2. Com. Estt. | 15640 | 16634 | 20914 | 21619 | 18865 |
| 3. Hotels | 9055 | 8196 | 7757 | 9628 | 10167 |
| 4. Theatres | 556 | 547 | 655 | 557 | 616 |
| Total | 43875 | 44401 | 48826 | 51398 | 52304 |

Source: Chief Inspector of Shops & Establishment, Pune Municipal Corporation.

Table 5.1

TOTAL NUMBER OF VEHICLES REGISTERED (PUNE REGION)

| Category | Years | | | | 1 4.77 to 31.12.77 |
|--------------------------------|--------------|--------------|--------------|---------------|-----------------------|
| | 1973—74 | 1974—75 | 1975—76 | 1976—77 | |
| 1. Motor cycles | 3,017 | 5,633 | 6,594 | 7,612 | 8,119 |
| 2. Motor cars | 712 | 556 | 925 | 688 | 567 |
| 3. Taxi cabs | 58 | 18 | — | — | 16 |
| 4. Auto rickshaws | 646 | 451 | 215 | 863 | 1,131 |
| 5. Stage carriages | 454 | 628 | 597 | 704 | 512 |
| 6. Contract carriages | — | — | — | — | — |
| 7. Lorries: public and private | 381 | 377 | 210 | 528 | 656 |
| 8. Ambulances | — | — | — | 12 | — |
| 9. School buses | — | — | — | — | — |
| 10. Trailers | 130 | 131 | 109 | 94 | 187 |
| 11. Tractors | 201 | 101 | 172 | 42 | 294 |
| 12. Private service vehicles | — | — | — | 54 | — |
| 13. Others | — | — | — | — | 19 |
| Grand Total | 5,599 | 7,895 | 8,822 | 10,597 | 11,712 |

Source : Regional Transport Officer, Pune.

Table 5.2

NUMBER OF VEHICLES ON ROAD (PUNE REGION)

| Vehicles | As on 1 1.1961 | As on 1 1 1971 | As on 1 1 1972 | As on 1 1 1973 | As on 1 1 1974 | As on 1 1.1975 | As on 1.1.1976 | As on 1.1.1977 | As on 1.1.1978 |
|--------------------------------|-------------------|-------------------|-------------------|-------------------|-------------------|-------------------|-------------------|-------------------|-------------------|
| Motor cycles, Scooters etc. | 5,381 | 26,196 | 28,190 | 30,826 | 33,667 | 37,828 | 43,622 | 50,866 | 61,438 |
| Motor cars | 7,606 | 17,143 | 18,723 | 18,905 | 19,498 | 19,467 | 20,237 | 20,815 | 21,669 |
| Taxi cabs | 434 | 761 | 837 | 856 | 433 | 531 | 518 | 526 | 543 |
| Auto rickshaws | 347 | 2,308 | 2,563 | 3,234 | 3,763 | 4,381 | 4,829 | 5,531 | 6,948 |
| Stage carriages | | | | | | | | | |
| i) Diesel | 1,153 | 4,309 | 4,489 | 4,717 | 1,753 | 1,372 | 1,384 | 1,635 | 2,536 |
| ii) Petrol | 14 | 9 | 9 | 9 | — | — | — | — | — |
| Contract carriage lorries | | | | | | | | | |
| a) Private carriers | | | | | | | | | |
| i) Diesel | 5,163 | 11,099 | 14,586 | 3,051 | 5,776 | 4,943 | 2,033 | 2,138 | 6,234 |
| ii) Petrol | 1,065 | 991 | 996 | 412 | 1,629 | 1,606 | 1,378 | 1,389 | 1,650 |
| b) Public carriers | | | | | | | | | |
| i) Diesel | | | | 11,339 | 7,815 | 7,308 | 8,181 | 8,395 | 8,907 |
| ii) Petrol | | | | 945 | 684 | 546 | 801 | 801 | 801 |
| Ambulances | 15 | 104 | 105 | 109 | 109 | 102 | 102 | 112 | 114 |
| School Buses | 23 | 53 | 102 | 105 | 45 | 42 | 42 | 42 | 42 |
| P. S. V. | 70 | 201 | 333 | 345 | 377 | 373 | 379 | 395 | 514 |
| Trailers | 518 | 1966 | 2,112 | 2,129 | 2,236 | 2,303 | 2,627 | 2,805 | 3,088 |
| Tractors | 441 | 2,053 | 2,233 | 2,350 | 2,413 | 1,988 | 2,176 | 2,392 | 2,779 |
| Motorised cycle- rickshaws | — | — | — | — | — | — | — | — | — |
| Others | 17 | 39 | 39 | 39 | 39 | 36 | 3,857 | 3,956 | 114 |
| Grand total | 22,252 | 67,234 | 75,317 | 79,441 | 80,137 | 82,835 | 92,266 | 1,01,798 | 1,17,377 |

Source : Regional Transport Officer, Pune.

Table 6.1

TELEPHONE STATISTICS OF PUNE TELEPHONE DISTRICT AS ON 1-11-1978

Industrial Directory of Pune

| | Cantonment | Shivajinagar | City | Pimpri | Hadapsar | Loni | Dehu Road | Total |
|---|--------------------------|--------------|----------|---------|----------|----------|-----------|-------|
| Installed capacity | 7800 | 7800 | 11000 | 1900 | 700 | 100 | 100 | 29400 |
| Working connections | 7546 | 7598 | 10175 | 1845 | 642 | 52 | 99 | 27957 |
| O. Y. T. W. List | 70 | 21 | 7 | 27 | 1 | — | 4 | 70 |
| Special waiting list | 23 | 46 | 41 | 54 | 5 | — | 1 | 170 |
| General waiting list | 751 | 538 | 913 | 191 | 31 | 4 | 4 | 2432 |
| Date up to which waiting list cleared : | Total waiting list 2672. | | | | | | | |
| | Cantonment | Shivajinagar | City | Pimpri | Hadapsar | Loni | Dehu Road | |
| O. Y. T. W. | 9-10-78 | 13-10-78 | 18-10-78 | 31-5-78 | 30-10-78 | — | 30-6-78 | |
| Special | 31-5-78 | 31-5-78 | 31-5-78 | 18-3-78 | 31-7-78 | 30-10-78 | 30-9-78 | |
| General | 30-9-77 | 30-9-77 | 30-9-77 | 31-3-77 | 30-6-78 | 31-8-78 | 8-8-77 | |

Table 7.1

**STATEMENT SHOWING THE ACTUALS OF INCOME FROM 1951-52 TO 1977-1978
OF THE PUNE MUNICIPAL CORPORATION**

| Year | General tax | Water tax | Street-cleaning, conservancy & road watering | Octroi | Other taxes Educational tax, Hotel tax, Theatre tax, etc | Wheel tax | Other receipts | Govt grant | Total |
|--------------------|-------------|-----------|--|--------|---|-----------|----------------|------------|---------|
| 1951-52 | 25 51 | 5 21 | 5 63 | 42 62 | 1 72 | 3 47 | 16 79 | 8 75 | 109 73 |
| 1952-53 | 29 15 | 5 62 | 6 44 | 40 48 | 1 88 | 3 72 | 14 49 | 8 37 | 110 18 |
| 1953-54 | 31 20 | 5 94 | 4 23 | 40 01 | 1 82 | 3 18 | 21 21 | 8 11 | 115 73 |
| 1954-55 | 29 63 | 6 15 | 6 70 | 46 78 | 1 84 | 3 22 | 19 31 | 8 01 | 126 06 |
| 1955-56 | 29 49 | 6 45 | 7 43 | 47 62 | 1.82 | 3 20 | 21 50 | 9 33 | 121 66 |
| 1956-57 | 31.47 | 6 80 | 8 26 | 52 47 | 1 87 | 3 55 | 23 57 | 9 76 | 137 80 |
| 1957-58 | 30.63 | 6 78 | 7 48 | 56.10 | 1 88 | 3.56 | 28 20 | 11 82 | 146 55 |
| 1958-59 | 32.70 | 6.90 | 8.19 | 62.23 | 1.87 | 3 70 | 27.39 | 11.27 | 154 36 |
| 1959-60 | 30.48 | 7.00 | 9.17 | 64.40 | 1.87 | 3.43 | 34.94 | 13 97 | 165 28 |
| 1960-61 | 35.90 | 7.02 | 8.71 | 71.26 | 1.93 | 3 38 | 27 37 | 15 20 | 170 81 |
| 1961-62 | 40.57 | 6.70 | 8.62 | 85 52 | 1 92 | 3 36 | 27 69 | 20 56 | 194 98 |
| 1962-63 | 46.45 | 7 81 | 9 36 | 88 81 | 1 99 | 3 85 | 32 56 | 17 46 | 203 32 |
| 1963-64 | 54 97 | 8 40 | 9.74 | 87 17 | 2 17 | 4 12 | 35 41 | 16 91 | 218 93 |
| 1964-65 | 64 15 | 8 96 | 10 51 | 104.47 | 2 38 | 4 38 | 40 71 | 18 18 | 253 78 |
| 1965-66 | 70.10 | 9 67 | 11 46 | 125 93 | 3.10 | 4 72 | 46 58 | 26 32 | 297 91 |
| 1966-67 | 78 51 | 10 50 | 12 93 | 154 85 | 4 64 | 4 52 | 61 35 | 30 93 | 358 27 |
| 1967-68 | 91 91 | 11 40 | 14 69 | 170 17 | 4 84 | 4 85 | 75 41 | 30 58 | 403 80 |
| 1968-69 | 120 35 | 12 18 | 15 86 | 195 57 | 5.04 | 4 87 | 75 43 | 33 83 | 463 43 |
| 1969-70 | 141 34 | 13 13 | 19 12 | 224 70 | 5 43 | 4 11 | 76 25 | 52 68 | 636 70 |
| 1970-71 | 129 53 | 20.07 | 18 88 | 266 48 | 6 00 | 3 52 | 65 73 | 65 38 | 575 50 |
| 1971-72 | 130.37 | 23.17 | 21.44 | 296 71 | 18 52 | 3 62 | 102 49 | 54 73 | 651 20 |
| 1972-73 | 152 82 | 26 58 | 22.81 | 342 20 | 22 91 | 5 26 | 94.06 | 69 98 | 736 40 |
| 1973-74 | 158.73 | 28 59 | 27 22 | 436 17 | 25.05 | 4 86 | 100 58 | 80 22 | 861 42 |
| 1974-75 | 159.18 | 26 46 | 23 94 | 522.68 | 29 34 | 5 22 | 120 15 | 91 86 | 978 83 |
| 1975-76 | 208.00 | 37.80 | 33 91 | 568 53 | 23 63 | 6 91 | 150 04 | 113 98 | 1142 80 |
| 1976-77 (Approved) | 232.18 | 35 51 | 28 50 | 712.00 | 48 80 | 12.26 | 147 67 | 110.14 | 1327 06 |
| 1977-78 (Budgeted) | 233 08 | 37 89 | 36 10 | 806.78 | 47 07 | 12 70 | 180 37 | 115 29 | 1469 28 |

Source : Pune Municipal Corporation.

Table 7.2

**STATEMENT SHOWING THE INCOME FROM OCTROI FOR THE YEAR 1976-77
OF THE PUNE MUNICIPAL CORPORATION**

| Sr. No. | Kind of goods | Octroi duty charged on | Weight in Metric Tonnes | Value in Rs | Octroi levied Rs. |
|---------|---|------------------------|-------------------------|--------------|-------------------|
| 1. | Grains | Weight | 1027280 | — | 51,36,400 |
| 2. | Grocery and articles used as food and drink for men and animals | Weight | 108570 | — | 43,42,800 |
| | —do— | Value | — | 5,87,34,000 | 23,49,360 |
| 3. | Vegetables and fruits | Weight | 316097 | — | 22,12,679 |
| 4. | Food for animals | Weight | 481802 | — | 24,09,010 |
| 5. | Animals for slaughter | Weight | 9760 | — | 5,95,600 |
| 6. | Articles for fuel | Weight | 109009 | — | 21,80,180 |
| 7. | Oil & Oil seeds | Weight | 792584 | — | 23,77,753 |
| | —do— | Value | — | 21,69,11,000 | 86,76,440 |
| 8. | Articles for washing | Weight | 7984 | — | 79,840 |
| | —do— | Value | — | 10,31,20,400 | 20,62,408 |
| 9. | Building materials | Weight | 1501010 | — | 30,02,020 |
| | —do— | Value | — | 17,28,62,000 | 51,85,880 |
| 10. | Drugs | Weight | 110020 | — | 16,50,300 |
| | —do— | Value | — | 29,63,49,000 | 59,26,980 |
| 11. | Perfumes | Value | — | 6,01,13,000 | 30,05,650 |
| 12. | Tobacco | Weight | 622660 | — | 24,93,670 |
| 13. | Cigar, Cigarettes, Snuff etc. | Value | — | 6,05,63,000 | 30,28,150 |
| 14. | Cloth piece goods & articles of clothing | Value | — | 38,65,70,000 | 77,31,400 |
| 15. | Metals & articles of metal | Weight | 1940200 | — | 38,80,400 |
| | —do— | Value | — | 17,67,18,000 | 53,01,550 |
| 16. | Miscellaneous | Weight | 18190 | — | 72,770 |
| | —do— | Value | — | 17,70,10,000 | 53,10,300 |
| | | | | Total | 7,90,08,540 |

Source : Pune Municipal Corporation, Octroi Dept.

Table 7.3

272

STATEMENT SHOWING THE RECEIPTS OF THE PIMPRI-CHINCHWAD MUNICIPAL COUNCIL

| Year | Municipal Rates & Taxes (other than octroi) | Octroi | Income from Muni. properties, utility service and powers | Grants & contribution from State Govt. | Deposits & Advances | Misc. | Total |
|---------|---|-------------|--|--|---------------------|-----------|-------------|
| 1971—72 | 7,85,027 | 73,35,446 | 22,228 | 1,17,548 | 5,99,425 | 90,857 | 89,50,532 |
| 1972—73 | 10,09,423 | 1,25,55,201 | 29,896 | 1,96,676 | 4,70,547 | 5,23,445 | 1,47,83,685 |
| 1973—74 | 11,47,623 | 1,50,28,514 | 84,466 | 3,75,678 | 13,51,734 | 9,35,790 | 1,89,23,805 |
| 1974—75 | 18,05,990 | 1,96,02,981 | 9,86,989 | 12,36,333 | 42,94,461 | 13,07,653 | 2,92,34,407 |
| 1975—76 | 30,84,436 | 2,38,47,562 | 23,71,707 | 44,22,724 | 1,19,06,549 | 26,26,764 | 4,82,59,742 |
| 1976—77 | 34,47,417 | 2,71,42,479 | 33,33,181 | 29,56,651 | 87,47,976 | 18,40,875 | 4,74,68,590 |
| 1977—78 | 44,81,805 | 3,20,97,422 | 35,37,496 | 46,38,190 | 62,66,273 | 29,77,589 | 5,39,98,776 |

(Source—Pimpri-Chinchwad Municipal Council, Pimpri, Pune 18.)

Table No. 7.4

STATEMENT SHOWING THE EXPENDIURE OF THE PIMPRI-CHINCHWAD MUNICIPAL COUNCIL

| Year | Gen. Admn. & Collection charges | Public safety | Public Health & Convenience | Public Works | Public Instruction | Debts Deposit & Advances | Misc. | Total |
|---------|---------------------------------------|------------------|--------------------------------|-----------------|-----------------------|--------------------------------|----------|-------------|
| 1971—72 | 6,21,726 | 1,98,883 | 22,32,426 | — | 20,306 | 49,698 | 1,24,427 | 32,47,466 |
| 1972—73 | 10,29,624 | 3,55,361 | 44,66,172 | — | 9,16,925 | 35,440 | 60,972 | 68,64,495 |
| 1973—74 | 11,20,488 | 7,21,600 | 61,42,427 | — | 14,23,345 | 12,88,658 | 9,245 | 1,07,05,764 |
| 1974—75 | 23,51,905 | 10,44,889 | 1,00,15,438 | — | 28,12,994 | 68,43,475 | 17,458 | 2,30,86,159 |
| 1975—76 | 24,57,226 | 11,46,459 | 1,96,32,974 | 46,80,455 | 37,10,558 | 2,40,79,776 | 1,54,358 | 4,68,61,806 |
| 1976—77 | 29,73,559 | 6,62,873 | 1,62,52,893 | 58,02,657 | 51,88,989 | 71,32,076 | 41,301 | 3,80,54,351 |
| 1977—78 | 16,18,511 | 3,39,340 | 1,15,07,612 | 30,27,744 | 39,29,508 | 52,49,959 | 89,070 | 2,57,96,745 |

Table 8.1

STATISTICS RELATING TO STUDENTS OF UNIVERSITY OF POONA (1976—77)

| Sr. No. | Name of the College | Year of Establishment | Total No. of Students on roll during 1976—77 | | |
|---------|---|-----------------------|--|-------|-------|
| | | | Boys | Girls | Total |
| 1. | College of Engineering, Pune 5. | 1854 | 1850 | 37 | 1887 |
| 2. | Fergusson College, Pune 4. | 1885 | 1583 | 798 | 2381 |
| 3. | S. P. College, Pune 30. | 1914 | 1292 | 1153 | 2445 |
| 4. | Law College, Pune 4. | 1924 | 1744 | 114 | 1858 |
| 5. | N. Wadia College, Pune 1. | 1932 | 2234 | 812 | 3046 |
| 6. | Tilak College of Education, Pune 30. | 1941 | 232 | 159 | 391 |
| 7. | Brihan Maharashtra College of Commerce, Pune 4. | 1943 | 1769 | 317 | 2080 |
| 8. | Abasaheb Garware College, Pune 4. | 1945 | 1447 | 685 | 2132 |
| 9. | B. J. Medical College, Pune 1. | 1946 | 1158 | 275 | 1433 |
| 10. | Tilak Ayurved Mahavidyalaya, Pune 1. | 1933 | 480 | 83 | 543 |
| 11. | Shri Shahu Mandir Mahavidyalaya, Pune 9. | 1960 | 474 | 34 | 508 |
| 12. | St. Mira College for Girls, Pune 1. | 1962 | — | 559 | 559 |
| 13. | Armed Forces Medical College, Pune 1. | 1948 | 529 | 101 | 630 |
| 14. | M. E. S. Garware College of Commerce, Pune 4. | 1967 | 1265 | 1140 | 2405 |
| 15. | Ness Wadia College of Commerce, Pune 1. | 1969 | 1566 | 513 | 2079 |
| 16. | Poona College of Arts, Science & Commerce, Pune 1. | 1970 | 465 | 128 | 593 |
| 17. | Modern College of Arts, Science & Commerce, Pune 5. | 1970 | 1176 | 458 | 1634 |
| 18. | St. Vincent College, Pune 1. | 1970 | 102 | 10 | 112 |
| 19. | Adarsha Comprehensive College of Education, Pune 4. | 1970 | 213 | 95 | 308 |
| 20. | Adhyapak Mahavidyalaya, Pune 9. | 1970 | 112 | 30 | 142 |
| 21. | P. D. E. Association's Arts & Comm. College, Hadapsar, Pune 28. | 1971 | 324 | 56 | 380 |
| 22. | Shri Jain College, Pune 19. | 1971 | 196 | 55 | 251 |
| 23. | Astang Ayurved College, Pune 30. | 1936 | — | — | — |

(Source— University of Poona)

Table 9.1

GOVT. HOSPITALS IN PUNE CITY

| Govt. of Mah. | | Govt. of India | | Municipal Corporation | | Others Aided | | Private | |
|---------------|------|----------------|------|-----------------------|-----|--------------|-----|---------|-----|
| H | B | H | B | H | B | H | B | H | B |
| 9 | 4944 | 3 | 1249 | 3 | 422 | 5 | 394 | 6 | 376 |

H = Hospitals

B = Beds.

The figures are as on 1—1—1976.

Patients admitted

| Name of the Hospital | 1975 | 1976 | 1977 |
|-------------------------------|-------|-------|------|
| (1) Chest Hospital, Aundh | 2615 | 2985 | 2851 |
| (2) Mental Hospital, Yerawada | 2719 | 2839 | 2629 |
| (3) Sassoon General Hospital | 44789 | 48612 | — |

Source : Directorate of Health Services, Pune Office.

Table 10

**ACTUAL CONSUMPTION OF ELECTRICITY BY THE INDUSTRIAL CONSUMERS IN
PUNE URBAN AREA INCLUDING PIMPRI-CHINCHWAD INDUSTRIAL AREA**

| Year | Supply at | Consumption in million KWH |
|---------|-----------|----------------------------|
| 1973-74 | L.T. | 25.58 |
| | H.T. | 286.39 |
| 1974-75 | L.T. | 26.24 |
| | H.T. | 289.82 |
| 1975-76 | L.T. | 29.33 |
| | H.T. | 276.38 |
| 1976-77 | L.T. | 31.23 |
| | H.T. | 332.04 |
| 1977-78 | L.T. | 33.41 |
| | H.T. | 365.60 |

Source : Dy. Chief Engineer (Pune Urban Circle), Maharashtra State Electricity Board, Pune.

Industrial and Allied Services

Technical Testing, Research
& Development
and Consultancy Services
Professional Services
Allied Services

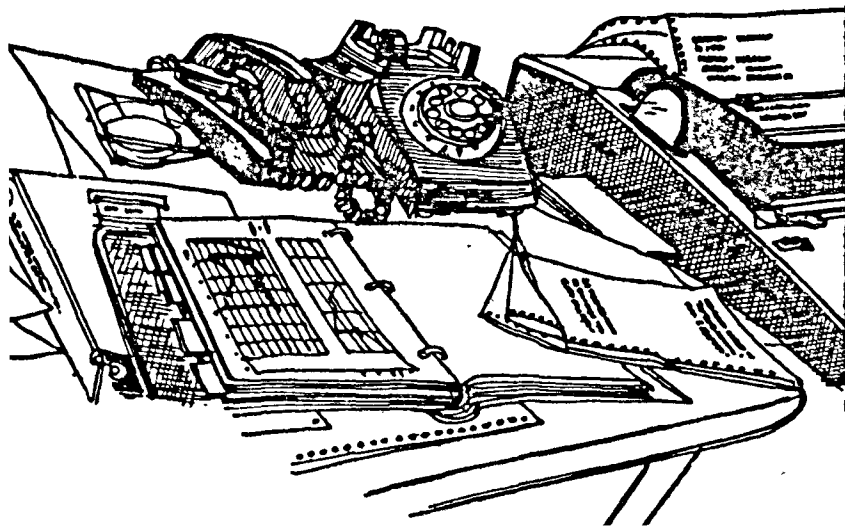

INDUSTRIAL AND ALLIED SERVICES

I. Technical Testing, Research and Development, and Consultancy Institutions

II. Professional Services

Architects

Banks

i State Bank Group

ii Notionalised Banks

iii Commercial Banks

iv Co-operative Banks

Builders and Contractors

Chartered Accountants

Chartered Engineers

Cost Accountants

Income Tax and Sales Tax Consultants

Industrial and Management Consultants

Insurance Companies

Stock Brokers

Valuers

III. Allied Services

Ammonia Printing and Xerox Copying

Cleaning, Plumbing and Sanitary

Clearing and Forwarding

Colour Contractors and Interior Decorators

Disinfection

Erection Work and Maintenance

Gardening and Landscape Designing

Intercom, Telephone and Automatic

Telephone Exchange

Parcel Services

Repairing and Maintenance

Security

Transport Operators

I. TECHNICAL TESTING, RESEARCH AND DEVELOPMENT, AND CONSULTANCY INSTITUTIONS

In this Section an effort has been made to list various institutions in Pune which render services such as testing of raw material and finished products, research and development of processes and products and technical consultancy in their respective areas of activity. An endeavour has been made to make the list as comprehensive and useful as possible by including all the major institutions in this field in the city and also to give as many relevant details about their services as would be found necessary by those desirous of availing of them. The list includes government, semi-government and private institutions of national and regional stature.

All the above services are available to industries, individuals and entrepreneurs on charge basis details of which could be obtained from the respective institutions.

ABASAHEB GARWARE COLLEGE, DEPARTMENT OF MICROBIOLOGY

Address : Karve Road, Pune 4. *Tel.* 56311. *Head of the Department* : Dr. A. D. Agate. *Nature of management* : The College is run by the Maharashtra Education Society, which is registered under the Societies Act and also as a Public Trust. It renders the following services.

1. **Testing** : Analytical facilities are available for microbiological examination of food such as *masala*, pickles, dehydrated meat and meat products, milk and milk products, and other materials such as air, water, soil, effluent sewage, etc. The department also provides for examination of raw, stored, contaminated, preserved or spoiled food and food products such as (a) sugar and sugar products like honey, candy etc.; (b) cereals and cereal products like grains, meals, flours, bread, cakes etc.; (c) vegetables and fruits and allied products like pickles, juices, sauces, fermented products etc.; (d) meats and meat products, including poultry; (e) fish and sea foods including shellfish; (f) eggs and egg powder, including products like egg noodles etc.; (g) milk, milk products like condensed milk, dry milk, frozen milk, butter, ghee, ice-cream etc.; (h) miscellaneous foods like oils, bottled beverages, spices, condiments, salts, fermented and non-fermented prepared food and food products; and (i) canned foods like meats, fish, vegetables etc.

2. **Standards** : Microbiological standards are available for (i) starch, (ii) sugar, (iii) liquid sugar, (iv) dairy products, (v) frozen products, (vi) tomato products, (vii) precooked foods, (viii) drinking water, (ix) eggs, (x) preserved and also frozen jams, (xi) juices, (xii) raw meats (precooked), and (xiii) fish (including shellfish).

3. **Consultancy** : The Department of Microbiology renders technical advice on the products mentioned above and processes allied to them.

4. **Library** : The Department has a well-equipped library on Microbiology, and books are available for reference purposes.

THE AUTOMOTIVE RESEARCH ASSOCIATION OF INDIA

Address : Survey No. 102, Vetal Hill, off Paud Road, Kothrud, Pune 29. *Tel.* 55546, 50816, 52423. *Director* : Shri. B. S. V. Rao. *Nature of management* : Co-operative Research Association with the Council of Scientific & Industrial Research and assisted by the Government of India and the United Nations Development Programme. The Association renders the following services.

1. Testing

Materials Laboratory: The laboratory provides for (i) complete chemical analysis of metal and alloys; (ii) physical and mechanical tests such as tension, compression, bend, shear, impact, hardness including micro-hardness, cupping test for sheet material etc.; (iii) determination of hardness of rubbers and plastics; (iv) detection and determination of depth of coated surfaces; (v) tests on fuel, lubricating oils and grease; (vi) ultrasonic-flaw detection and magnetic-flaw detection of ferro-magnetic materials; and (vii) precision metallographic examination with stereo microscope and metallographic microscope. Sophisticated and precision equipment for torsion test, tensile, bend and compression tests on small test pieces of metals and alloys is under installation.

Metrology Laboratory: This is equipped with (i) measuring projector with max. magnification of 100, co-ordinate measuring facility with $1/\mu\text{m}$ accuracy; (ii) universal measuring microscope with least count $0.2/\mu\text{m}$ for measuring any type of dimensions in two planes, external and internal, and checking of threads and gear profiles; (iii) camshaft tester for linear measurements of profiles of camshafts and any other component with least count $1/\mu\text{m}$ and bed-length 1600 mm.; (iv) precision instruments for measurement of internal and external features of any component including gauges, gears, gauge blocks etc., all linear measurements and measurement of angles, profiles, radial, thread etc.; (v) gear base pitch measuring instrument and cavity inspection device; and (vi) surface roughness measuring and concentricity checking equipment for checking roundness, concentricity, particulellism, straightness, squareness, alignment, etc. including those of multi-trow crankshafts.

Environmental Laboratory : To create different conditions under which components are to be tested, it has (i) a dry heat chamber up to 300°C ; (ii) a cold chamber for sub-zero conditions up to -53°C ; (iii) a damp heat chamber with max. humidity 99.5% R.H. temp. 10°C — 90°C ; (iv) a salt mist chamber for accelerated corrosion test under up to 90°C ; (v) a mould growth chamber to assess growth and sustainability of moulds, particularly electrical and electronic; (vi) a dust chamber; and (vii) a vibration table system capable of producing vibration accelerations up to 100 and accommodating components up to 300 N for testing vibration sustainability and transmissionability characteristics of components over a wide range of 0—5000 Hz. Impact and drop testing facilities are being planned.

Engine-testing Laboratory : ARAI is recognised by

the Indian Standards Institution for ISI certification marking scheme for automotive, industrial and agricultural engines. The laboratory provides for (i) performance and life test on all automotive and industrial I. C. engines up to 150 h. p.; (ii) testing of low-speed stationary diesel engines; and (iii) testing of engines up to 350 h.p., engine-analyser, pressure-volume diagram recorder, exhaust gas analyser.

Vehicle-testing Laboratory : It has (i) a precision fuel consumption meter which can also be used on board vehicle; and (ii) on-the-road brake test and pedal pressure gauge, Fifth wheel, Tapley meter, steering torque meter, head-light beam tester, wheel alignment equipment and a chassis dynamometer are under procurement.

Instrumentation Laboratory : This laboratory is equipped with (i) precision transducers for stress, strain, pressure, displacement, linear and angular acceleration and angular velocity; (ii) temperature amplifying and indicating instruments; (iii) X-Y recorder; (iv) oscilloscope; (v) multi-channel ultraviolet recorder; (vi) load cells; (vii) torque and angular displacement transducers; (viii) digital indicators; and (ix) programmable calculator with printer.

Test Rigs: The Association has facilities for performance and endurance tests of the following as per ISI and other international standards: (i) air filter, (ii) fuel filter, (iii) shock absorber, (iv) horns and horn relay, (v) oil-pressure switches, (vi) on frictional material like brake and clutch liner, (vii) crash helmet, (viii) friction liners, and (ix) horn switches.

The Association has also planned to provide, in the near future, for more testing facilities such as (i) installation of test rigs for various automotive components; (ii) oil-seal test; (iii) endurance and performance trials on dynamos and alternators, starter motors, magnetos and distributors; (iv) propeller shaft and crank shaft testing; and (v) valve spring fatigue test.

2. Research and Development, and Consultancy : The Association has facilities for (i) designing and drawing and their blue printing, (ii) development, (iii) prototype experimentation including precision manufacturing, (iv) product analysis and improvement projects, (v) value engineering, and (vi) investigational studies.

3. Library of Technical Information: Publications and technical reports on automotive engineering and allied fields are available for reference. Information and data contained in these are constantly abstracted and monitored for the benefit of technologists.

BEHRAM WADIA AND ASSOCIATES

Address : 77 Koregaon Park, Pune 1. *Tel.* 23134.
Laboratory : 44/2 Sassoon Road, Pune 1 *Tel.* 26961.
Managing Director : Dr. B. H. Wadia. *Nature of management* : Private. The following services are rendered.
 1. *Testing* : A well-equipped laboratory is available for testing components and circuits. 2. *Consultancy*.
 3. *Research and Development*. For details please see "Consultancy Services" section.

THE BHARATIYA AGRO INDUSTRIES FOUNDATION

Address : 'Kamadhenu', Senapati Bapat Road, Pune 16. *Tel.* 50526-7. *Director* : Dr. Manibhai Desai
Nature of management : A non-profit non-governmental voluntary organisation, registered as a public trust. The activities of BAIF are divided into four groups : (i) The BAIF Research Institute for Cattle and Agricultural Development (BRICAD) consisting of Central Research Station at Uruli-Kanchan; (ii) Cattle Development Programme; (iii) The BAIF Research Institute of Animal Health (BRIAH), Briahnagar, near Poona and (iv) Rural Development Programme. The foundation renders the following services.

1. *Testing* : The Foundation has various laboratories where facilities for testing cattle progeny and testing veterinary preventive medicines are available.

2. *Research and Development* : The Foundation has the following laboratories and sections for research and development facilities at BRICAD : (i) Genetics Section; (ii) Semen-freezing Laboratory; (iii) Semen Bank; (iv) Liquid Nitrogen Plant; (v) Nutrition Laboratory; (vi) Disease Investigation Laboratory and (vii) BAIF's Research Institute for Training in Economic Milk Production. Studies are conducted on utilisation of by-products like sugar-cane, jowar, etc. for production of cattle-feed. The following laboratories carry on research work in their respective fields at BRIAH : (i) Independent Epidemiological Surveillance Laboratory with foot and mouth disease virus-typing facilities; (ii) Cell Culture Feed Bank Laboratory; (iii) Virus Culture Seed Bank Laboratory; (iv) Viral Bio-chemical Research Laboratory; (v) Cell Culture Research and Production Laboratory; (vi) Experimental Virus Fermentation Laboratory; (vii) Tissue Culture Media Production Laboratory on Industrial Scale; (viii) Virus Fermentor Battery Laboratory which is capable of producing 5000 litres of viruses per week—the biggest of its kind in India; and (ix) Bio-engineering Laboratories for virus inactivation and vaccine production. The BRIAH has commenced large

-scale production of Foot and Mouth Disease Vaccine of international standards for the first time in India.

3. *Training* : BAIF is recognised by (a) The Indian Council of Agricultural Research; (b) Department of Science and Technology, Ministry of Scientific Affairs, Government of India; (c) Mahatma Phule Agricultural University, Rahuri, Maharashtra, to which it is affiliated for Post-Graduate Programmes; and (d) The Revenue and Forests Department, Government of Maharashtra, for research in Agriculture. It imparts training in the following fields : (a) Exotic Dairy Cattle Management (b) Economic Milk Production—to Veterinary and Agriculture graduates and also to farmers; (c) Fodder Crop Cultivation Strategies and Designing of efficient minimum cost cattle-feed; (d) Animal Health Management; and (e) Exotic Cattle Breeding.

CENTRAL BEE RESEARCH INSTITUTE

Address : 839/1 Decean Gymkhana, Pune 4. *Tel.* 54019. *Director* : Shri S. V. Thakar, *Nature of management* : Semi-government; managed by the Khadi and Village Industries Commission (an autonomous body of the Government of India).

The Institute has carried out exhaustive research on bees and bee-keeping and has evolved standards for various bee productions, processes and bee management. The Indian Standards Institution has laid down ISI standards and specifications based on the standardisation evolved by this Institute. The Institute is a member of the Honey and Wax Sub-Committee of the ISI, Central Agmark Organisation and the Central Committee of Food Standards, Ministry of Health, Government of India. It renders the following services :

1. *Analysis and Testing* : The Institute carries on (a) physico-chemical studies on nectars of major bee plants, composition of unifloral and multi-floral honeys, waxes secreted by different species of bees, and other bee products like royal jelly, bee venom, etc ; (b) Fische's Test on honey as prescribed by the Food Adulteration Act and Rules; (c) synthesization of Hydroxy-methyl-furfural; and Sucrose-octo-acetate; and (d) finer analysis of different ingredients in honey, wax and other bee products.

2. *Research and Development, and Consultancy* : This wing of the Institute caters to the needs of institutions and individual bee-keepers in India and individuals in Asian and African countries on all aspects of bees and science of bee-keeping, viz. (a) comparative studies on Indian honey bees; (b) bee botany; (c) melitto-palynology (pollen study as related to honey bees; (d) pollination of agricu-

lural crops; (e) cyto-genetics and breeding of bees; (f) chemistry of bee products; (g) bee management comprising optimum brood chamber capacity, optimum bee space, and optimum width of top bar; (h) honey processing; (i) methods for extraction and purification of bee's wax; (j) techniques for manufacture of good-quality comb foundation sheets; (k) designing of honey house for storage, testing, processing and packing of honey and wax; (l) pollen bee research; and (m) bee pathology.

3. Library and Publications : The Institute's library is recognised by the International Bee Research Association and the Association has established its Regional Library for Asia at this Institute. The Institute has 115 papers on various aspects of bee-research and bee-keeping, published in international journals. Its library has over 800 books on bees, bee-keeping and bee research; over 1500 reprints of papers on apiculture and apiculture research published all over the world; and periodicals, journals, back volumes of journals and other literature.

4. Central Museum : The Institute has developed a museum for bees and bee-keeping at its central laboratory. A collection of about 300 colour and black-and-white transparencies, hundreds of photographs, beeboxes and other bee equipments, charts and colour panels on bee research is maintained in the museum.

5. Training : This is the only institute in India which imparts advanced training in Apiculture. The following courses are conducted : (i) Apiarist Course, (ii) Apiarist Refresher Course, (iii) Fieldman Training Course, (iv) Beekeeper's Training Course, (v) Amateur's Course, and (vi) Special course for service personnel. A post-graduate diploma course is intended to be started soon.

CENTRAL INSTITUTE OF ROAD TRANSPORT (TRAINING & RESEARCH)

Address: Pune-Nasik Road, Bhosari, Pune 26. *Tel.* 83671-72. *Director :* Brig. Lokesh Dhar (Retd.). *Nature of management:* The Institute is an organ of the Association of State Road Transport Undertakings with the Secretary, Ministry of Shipping and Transport, as its President. The Institute is to be assisted by the United Nations Development Programme for its further development. The services rendered are:

1. Testing as per ASRTU/ISI Standards

Metallurgical Laboratory : In this laboratory there are facilities for measurement of hardness by Vickers, Brinell, Rockwell, Shore; micro-hardness test; Izod and Charpy impact test; magnetic or fluorescent flow detec-

tion test of machined parts, welded joints, castings and forgings; tensile test; compression test; bend test; torsion test; metallographic examination; ultrasonic flow detection test of castings and forgings, welded joints, small machined components; dimensional measurement of small, medium and large items or components; sheet metal testing on Erichson Sheet Metal Tester; rubber hardness test—Shore A & D; rubber tensile test; adhesion test; abrasion test; and flex resistance test for rubber and PVC.

Automobile Laboratory : The laboratory has provided for diesel fuel filter test; lubricating oil filter test; load-rate deflection test for coil spring and leaf spring assembly up to 100 Kg. load; fuel injection pump test; nozzle injection test; dead weight pressure gauge test; and complete testing of hydraulic vehicle jack up to 15-ton capacity, hydraulic trolley jack up to 6-ton capacity, hydraulic trolley jack up to 15-ton capacity, self-locking nuts, nylon washer used in self-locking nuts, piston rings, fuel flexible hoses, fuel pressure pipes, fan belt, oil seal, burst test of rubber hoses up to 350 Kgs/cm², brake chamber diaphragm, brake hose, and shock absorbers.

Electrical Laboratory : The laboratory carries on the following numerous tests. (i) Battery testing comprising capacity test, air pressure test, high rate discharge test, and life cycle test; (ii) Cable testing comprising Kelvin Wheatstone bridge test, spark test, electric oven test, high voltage breakdown test, fire resistance test, hot deformation test, diesel and lubricating oil bath test, insulation test, and measurement of capacitance, inductance and resistance; (iii) Carbon brush testing comprising coefficient of friction and contact drop test, hardness, transverse strength and pulling-strength test, and specific resistance and milli-volt drop test; (iv) Auto bulb testing comprising torsion test, life cycle test, and potentiometric integration; (v) Environmental testing comprising vibration test, humidity test, damp heat cycling, dry heat test, salt spray test, water spray test, and hot air oven; and (vi) complete testing of dipper switch, dynamo 6, 12, 24 volts, field coil, fuse box, horn switch, wiper motor, horn relay, electric horn, speedometer cables, ammeter, taper terminal battery connectors, head light switch, fuel gauge and tank unit, stop light switch, and voltage regulator.

Chemical Laboratory : This laboratory has facilities for (i) ferrometal analysis of (a) carbon steels and cast iron, (b) alloy steels and cast iron; (ii) non-ferrous metal analysis; and (iii) complete testing of oils and lubricants such as brake fluid, diesel fuel and engine oil; and of paints and greases.

2. Research and Development : The Institute conducts management research studies concerning organisational problems, operations, road transport economics, engineering, and transportation problems. It envisages to lay down standards, specifications and norms for various materials used by the road transport industry and will have its own testing facilities. The Engineering Research Centre of the Institute will help small-scale industries in developing quality product of prescribed specifications with indigenous raw materials and encourage import substitution. A test track incorporating different types of severe operating conditions and provision for acceleration, braking, steering, skidding tests etc is also planned for testing passenger vehicles. The Engineering Research Centre will carry out defect and failure analysis of parts having frequent failures and evolve methods to reduce such failure. The centre is working on methods for achieving optimum use of fuel, lubricants, tyres, brake liners and other important components.

3. Consultancy : The services rendered by the Institute are mostly in the areas of organisation, traffic management, production planning and control, and maintenance management.

4. Training : Training programmes are conducted in the following fields for personnel from road transport undertakings : (a) Automotive Engineering, (b) Traffic Management, (c) Stores Management, (d) General Administration, and (e) Industrial Relations.

CENTRAL WATER AND POWER RESEARCH STATION

Address : P. O. Khadakwasla Research Station, Pune 24. *Tel.* 445550-51-52. *Director :* Shri P. C. Saxena
Nature of management : Under the Ministry of Agriculture & Irrigation. Government of India. *Estd.* 1916.

The CWPRS is a unique research institution with a staff of about 800 professional engineers and scientists, many of whom are trained and educated abroad, and over 800 technicians and workers. The Station has an assured supply of about 90 million cubic metres of water, which is used for operating a large number of hydraulic models. Currently, the CWPRS has 450 research projects and 200 models on hand. The Station is recognised as a Regional Laboratory by the United Nations Economic and Social Commission for Asia and the Pacific and it has carried out research and advisory projects for Africa, Sri Lanka, Egypt, Iraq, Philippines, Singapore, Afghanistan, Malaysia, Burma, Nepal and several other countries. Its main activities are : (1) Testing, and (2) Research and Development, and Consultancy.

1. Testing

River and Canal Hydraulics : Instrumentation and special equipment is available for rapid and accurate measurement of current velocities and water levels. There is an arrangement for automatic control of water supply, detritus feeding, photographic recording of flow pattern, and simultaneous measurement of water temperature at a number of locations.

Coastal and Harbour Engineering : Sophisticated equipment is available for measurement of waves, tides, salinity, temperature, silt charge, currents, and pressure in hydraulic models.

Ship Model Testing : The 'Station has a unique testing tank, 228 metres long, 3.65 metres wide and 0.66 to 2.13 metres deep for testing models of ships. The following tests are conducted on ship models, fishing trawlers, passenger launches, barges, tugs, cargo vessels and high-speed specialised crafts, hopper dredger and landing craft: (i) Resistance of a hull to determine effective horsepower of a hull; (ii) Open-water test for propeller thrust and torque; (iii) Self-propulsion test to predict speed and power of a vessel; (iv) Tow rope and Ballard pull for tugs and trawlers; and (v) Pitching and heaving of ships in head-on waves.

Hydraulic Machines & Equipment : The multi-test water tunnel at the Cavitation Research Centre of the Station caters to industrial testing of homologous models of machines. There are equipments for establishing their performance and cavitation characteristics in their complete operating range. Turbine and pump models are tested as per international test code. The other tests include field efficiency tests of prototype water turbines, testing of models of Kaplan & Francis turbines of hydel projects, and NPSH tests on barrel pumps.

Geomechanics and Construction Materials : This section carries out geotechnical investigation of hydraulic and maritime structures such as dams, barrages, breakwaters and quays. Evaluation of engineering characteristics of construction materials such as soil, rock, concrete, cements, stone, steel, bricks, tiles etc., and evaluation of shear strength of concrete and masonry are also carried out.

Structural Engineering : There are facilities for stress analysis of structural models made of plastic materials, micro-metals, gelatine, plaster of Paris etc., and analysis of structural models for their resistance to heavy water pressure, forces due to self-weight wind, temperature and earth-quake stresses.

Earth Sciences: Facilities are available for dynamic tests to study response of lightning arrestors to earthquakes; testing of sub-surface material for capability to bear load, safety against stresses caused by vibration, explosion and earth-quakes; testing to avoid geological faults in the periphery of a reservoir; geophysical surveys and investigations with sophisticated instruments using isotope and other tracers; and study of prototype and model behaviour with the help of seismographs, large vibrators, accelerographs, spectrum analysers, etc.

Applied Sciences: Two major aspects that are dealt with are (i) mechanical, chemical and biological analysis; and (ii) determination of quality of river, reservoir and sea water to establish pollution levels.

Mobile Laboratory: The Station has two air conditioned mobile laboratories on shock resistant vans and are equipped with computer-based data loggers for off-line data acquisition and prototype measurements. The equipment includes analog and digital magnetic tape recorders, transducers, level recorders, and real time analysers for vibration measurement and analysis, telemetry systems, etc.

2. Research and Development, and Consultancy

River and Canal Hydraulics: There are facilities for (i) study of river processes and methods of river improvement, control and utilization; (ii) potamological studies, river morphology and stability; (iii) flood protection works; (iv) bank protection measures; (v) flood routing studies; (vi) cofferdam and diversion work; (vii) barrages and weirs; (viii) bridge design; (ix) sediment control and exclusion devices (desilting basins); (x) siting cooler water intakes and warm water outlets for thermal power plant; (xi) vortex prevention at intakes; (xii) design of canals and canal structures; and (xiii) basic studies.

Coastal and Harbour Engineering: Facilities include a number of tidal and wave basins and a set of wave flumes of varying sizes for practical experimentation in coastal engineering, ports and harbours, and maritime structures of tidal hydraulics. Consultancy and R & D facilities are available in the following fields : (i) location and layout of harbours, docks and jetties; (ii) estimation of siltation in harbours and navigation channels; (iii) design of marine structures such as breakwater and seawalls; (iv) measurement of wave and wave impact forces; (v) navigation channels in estuaries; (vi) dredging methods and location of dumping grounds; (vii) surging in harbours; (viii) reclamation of deltaic

areas; (ix) littoral drift and stability of coastal inlets; (x) coastal protection; (xi) navigation locks, docks and gates; (xii) erection of offshore oil-drilling platforms; (xiii) cooling water intakes and hot water outlets for power stations; (xiv) hydraulic design of tidal power schemes; (xv) hindcasting and forecasting of wind waves and storm surges in the ocean; (xvi) field data collection on oceanographic parameters; (xvii) radioactive and fluorescent tracer studies for sediment movement in models and prototypes; (xviii) behaviour of cohesive sediments in marine environment; (xix) pollution problems of coastal areas due to thermal discharges, oil spills and effluents; (xx) development of fishery harbours; (xxi) coastal erosion; (xxii) navigation locks; (xxiii) sediment transport studies using tracers; and (xxiv) coastal reclamation.

Reservoir Control and Appurtenant Structures : The Station has so far evolved hydraulic designs for nearly 100 river valley projects. Model trays for models of spillways and appurtenant structures, glass-sided flumes for models of spillways and conduits and free-surface and pressure chambers for models of gates and valves are available for these studies. Consultancy and R & D facilities are available in the following fields : (i) profiles and energy dissipators for spillways and outlets; (ii) approaches and exit channels of spillways; (iii) protective works for adjacent structures; (iv) highhead gates and valves and free surface control gates; (v) siphons, tunnels, conduits and intake structures; (vi) power house inlet, outlet manifolds and surge tanks; (vii) hydel and irrigation projects; (viii) water supply schemes; (ix) lift irrigation schemes; and (x) pump intake.

Hydraulic Machines and Equipment : This section deals with (i) NPSH characteristics and their improvement for condensate extraction pump, (ii) cavitation problems, (iii) design of small water tunnel systems, and (iv) rectification of cavitation damage.

Geomechanics and Construction Materials : It deals with (i) assessment of engineering characteristics of soil and rock mass *in situ* and in the laboratory; (ii) foundation studies; (iii) stability of embankments; (iv) determination of stresses in rock mass for tunnels and underground structures; (v) suitability of construction materials such as cement, aggregate, stones, steel, bricks, tiles etc., and (vi) use of epoxy polyester resins for repairing cracks in concrete and other civil engineering works. The Station has investigated several dams and barrages, tunnels, ports and harbours, aerodromes, satellite stations etc. for the above.

Structural Engineering : The Station has undertaken and completed investigations for nearly all major river

valley projects in India and substantial economy has been achieved by improvement in design. Analysis and design of the following structures are undertaken: (i) foundations, (ii) dams, (iii) galleries, (iv) sluiceways, (v) intake and outlet structures, (vi) power house structures, (vii) tunnels, (viii) conduits, (ix) sheet piles, (x) bridges, (xi) surge tanks, (xii) maritime structures, (xiii) space frames, and (xiv) aqueducts.

Earth Sciences : The facilities include (i) estimation of borrow area capacity; (ii) delineation of bed rock profile; (iii) underwater geophysical survey; (iv) detection of sources of seepage and leakage by tracers (chemicals, electrolytes and isotopes); (v) location of fissures, solution channels, shear and fault zones, permeable seams and deep seated river courses; (vi) study of efficacy of grouting and diaphragm walls; (vii) resistivity measurements for earthing of electrical systems and apparatus; (viii) determination of aquifer characteristics; (ix) *in situ* dynamic modulus of elasticity; (x) location of machinery buried during floods; (xi) slide area studies; (xii) seismo-tectonic investigations of project sites; (xiii) evaluation of earthquake co-efficients for design of engineering structures; (xiv) vibration characteristics of machine foundations; (xv) safe charge determination; (xvi) model studies on vibration table; (xvii) non-destructive studies for quality of concrete etc.; and (xviii) crack detection studies in large structures like dams.

Hydrology : It incorporates (i) statistical studies, correlation and analysis of hydrological data for development of river valley basins and planning of river valley projects; (ii) field study to assess the water balance as governed by soil conservation methods and watershed management; (iii) rainfall-runoff studies; (iv) estimation of peak values of hydrological and meteorological parameters with various return periods; (v) assessment of effects of soil conservation measures; (vi) estimation of wasteload and soil erosion; (vii) estimation of seepage and evaporation losses; (viii) synthetic generation of hydrological information; (ix) investigation into trend periodicity and seasonal variation in data on hydrological, hydraulic and meteorological characteristics and (x) study of changes in river beds by specific discharge gauge curves.

Mathematical Modelling : This branch covers (i) transformation of mathematical formulation describing the behaviour of physical systems into numerical form and processing the same on computer to yield static and dynamic characteristics; (ii) data reduction and analysis of hydraulic, oceanographic and seismographic data; (iii) analysis of behaviour of physical systems—hydrodynamic, structural and seismologic; (iv) mathematical modelling—flood and tidal propagation in rivers, estu-

aries etc.; (v) wave data analysis; (vi) analysis of earthquake data; (vii) cubature; (viii) tidal propagation and salinity intrusion; (ix) flow resulting from collapse of dam; (x) hydraulic transients in water conducting systems of hydel projects; (xi) systems analysis of water resources; (xii) slope stability of earth dams; (xiii) slope stability of breakwaters; (xiv) hydroturbine design; (xv) spectral levels and solidstate physics; and (xvi) tidal oscillations; (xvii) two-dimensional tidal circulation.

Applied Sciences : Electrical and electronic analogues have been developed to study sub-soil and open channel flow, characteristics of seepage under dams, aquifer problems and flood routing. The other studies comprise determination of uplift pressures, effect of deep scour on exit gradient, quantity of seepage, flood routing, inundation, backwater effects, fluorescent tracer studies, flocculation of sea bed material and salinity and silt charge of sea waters.

Instrumentation : The main work constitutes design, development, fabrication, installation and maintenance of instruments and systems for measurement of hydraulic and other parameters such as water levels and bed profiles, current-speed and direction, wave heights, salinity, temperature and depth, static and transient pressures, force and vibration, strain and deflection, torque, precipitation, wind speed and direction, evaporation and evapotranspiration, and water stage. The Instrumentation Division has so far designed a number of sophisticated instruments and systems for measurement of the above hydraulic parameters, besides transmitting and recording coastal data from on-shore and off-shore locations through telemetry systems. Computer based flood forecasting system using multi-channel telemetry systems for transmission of hydrometeorological data is proposed.

3. Library : The excellent technical reference library houses 60,000 items comprising books, journals, and publications. The library subscribes to over 450 journals and technical publications.

COLLEGE OF ENGINEERING

Address : Shivajinagar, Pune 5. **Tel.** 56835, 55466.
Principal : Prof. M. G. Shah. **Nature of management :** Under the Government of Maharashtra. The following services are rendered.

1 Testing

Civil Engineering : This department has facilities for testing water, sewage and industrial effluents.

Structural Engineering : Facilities include finite element analysis of pump heads and end fitting tubes;

dynamic response of flexible couplings; analysis of water supply pipes on saddle supports; and soil testing.

Mechanical Engineering : This branch has arrangements for pressure gauge and pressure vessel testing; taxi and auto-rickshaw fare meter testing; engine and pump testing; dynamic balance testing, fuel and lubricant testing; and pressure vessel testing.

Metallurgy : This section carries out physical, mechanical and chemical testing of metals and metallography.

Electrical Engineering : The department provides for instrument calibration; and testing for electrical and magnetic properties.

Telecommunication Electronics : There are facilities for electronic component testing; radio frequency cable testing; testing of industrial electronic controls; test on electronic instruments; test on electronic material; and field strength testing.

Instrumentation : This wing has provided for the testing of pneumatic pressure, gauges, control valves, transmitters, PID controllers, control relays, timers, thermocouples, flow meters, level meters, Ph meters, recorders, electronic components, digital instruments, oscilloscopes, frequency meters, amplifiers, industrial and electronic controllers, electro cardio-gram machines, health monitor, all types of surgical and chemical instruments, and industrial speed regulators.

Geology : In this department there is a facility for testing stability of cuts and tunnels.

Meter Testing : All types of meter testing in all departments is undertaken.

2. Consultancy

Civil Engineering : Consultancy services are available in matters of bridges, contour bunding, flow indicators, legal advice, and valuation.

Structural Engineering : Services are available in matters of design of bus body; finite element analysis of fuel pump heads and end fitting tubes; military equipment, bridges and structures; structural design of bridges; river improvement schemes; investigation in cases of structural failures; computer programmes for finger prints; computer solution of cylinder heads; dynamic response of flexible couplings; computer programmes for examination results; structural design of various buildings; and analysis of water supply pipes on saddle supports.

Mechanical Engineering : Consultancy services in matters of testing are available for all the aspects mentioned under this head earlier under testing. Such services are also available in matters relating to refrigeration.

Metallurgy : Facilities exist in matters of selection and specification of materials for automobile components from the point of view of import substitution; development of heat treatment—schedule for high-speed steels and spring steels; investigation of failures in heat treatment, corrosion and casting; designing and development of tensometer; design and development of cup testing machine; foundry; and failure analysis.

Electrical Engineering : Services are available in connection with machines and transformers, instruments calibration, electrical and mechanical properties, and lighting and illumination.

Electrical Communication (Telecommunication Electronics) : Services available in this field are mostly in aspects described under this head earlier under testing.

Instrumentation : Here also the items of consultancy are the same as described under this head under testing.

Geology : Services are available in matters of engineering geology investigations, irrigation projects, hydro-electric projects, stability of cuts and tunnels, alignment of road highways and railways, and construction materials.

Town Planning and Architecture : The assistance is mostly in connection with traffic analysis, urban design models, master plan and regional plans, architectural designs, and valuation of properties.

Computer Programming : The College owns ICL 1904 S Computer. For details please see Structural Engineering above.

Environmental Engineering : The laboratory is equipped for (1) analysis of waste water samples; (2) preparation of designs and drawings for water treatment plants, sewage treatment plants and industrial effluent treatment plants; (3) technical scrutiny of tenders for the type of works mentioned; and (4) improving the operation of existing treatment plants.

3. Research and Development

Civil Engineering : This division renders facilities in matters of pollution problems of rivers, energy dissipations, seepage losses in canals, strengthening of dams, seepage problems in connection with earthen dams, and piled foundation.

Structural Engineering : The facilities available are in connection with Shell Lamella roofs, prestressed trussed beams, optimization of various structures, finite element analysis applied to structural and soil machines, analysis of water supply pipes, military bridges and structures, numerical analysis of wall-panel action, selective

energy approach in isoparametric element, soil testing, and pile foundation and soil mechanics.

Mechanical Engineering : The services pertain to internal combustion engine development, compressor valve development, machine tool structures and joints, heat transfer, and machine elements.

Metallurgy : The services relate to superplasticity and creep; development of high-speed steels by powder metallurgy; development of manganese, zinc and nickel zinc ferrites; machinability—evaluation and assessment; fluid sand process, and development and continuous anodising of aluminium.

Electrical Engineering : The aspects include special machines design, machine transients and stability, power system computerized design, and servosystems and control.

Telecommunication Electronics : It includes electronic instrumentation, digital communication, and television antennae.

Instrumentation : In connection with silicon controlled rectifier power control

Geology : The studies pertain to basalt petrography, Deccan trap studies—field characters, and nature of volcanicity—engineering aspects.

Town Planning and Architecture : The services available are in matters of physical planning of towns and cities, slums removal and low-cost housing, traffic and transport in metropolitan areas and cities, and its impact on civic design, and urban aesthetics.

4. Training

There are full-fledged courses leading to graduation and Master's degrees in (i) Civil Engineering, (ii) Structural Engineering, (iii) Mechanical Engineering, (iv) Metallurgy, (v) Electrical Engineering, (vi) Telecommunication Engineering, (vii) Instrumentation, and (viii) Geology. The College imparts vocational/vacational training through evening courses of 6-week duration, for self-employment in repairs and maintenance of scooter and motor-cycles; repairs and maintenance of domestic refrigerators; T. V. receiver servicing; domestic use of electricity; operation and maintenance of automatic electrical equipment, surveying methods and practice; ferrocement technology; CPM/PERT for project planning, implementation and monitoring; water and waste water treatment; building supervision; building surveying; masonry; plumbing; carpentry; and legal aspects pertaining to civil engineering.

CONTROLLERATE OF INSPECTION (ENGINEERING EQUIPMENT)

Address : Dighi, Pune 15. **Tel.** 27936. **Controller** : Col. S. B. Ghorpade. **Nature of management** : Under Ministry of Defence (DGI), Government of India. It is recognised by the Indian Standards Institution, New Delhi, as approved laboratory for I. S. I. certification mark scheme for steel wire ropes, link chains, fibre ropes etc. It renders valuable services in testing jobs through its following laboratories.

(1) **Engine-testing Laboratory** : There are facilities for testing CI/SI engines up to 75-KW capacity as per ISS 1601, JSS 20,000. Facilities for engines up to 270 KW are to be installed shortly.

(2) **Pneumatic Laboratory** : This has facilities for testing compressors, pneumatic tools and rock drills etc. as per ISS and Defence specifications.

(3) **Horizontal Testing Machine** : This is available for proof load and tensile test on chains, steel ropes, bars, flats, conduit pipes, etc. It has capacity to apply load up to 1000 KN with accuracy better than Grade I of German Standards DIN 51220.

(4) **Material Testing Laboratory** : It helps physical testing of ferrous and non-ferrous metals like textiles, rubber, plastic, timber etc. as per ISS, BS, ASTM; non-destructive testing for detection of cracks, blow-holes, etc.

(5) **Metrological Laboratory** : It undertakes fine precision measurements of inspection gauges, cutting tools, fasteners, gudgeon pins, cylinders, rings, pistons, etc.

(6) **Electrical and Climatic Testing Laboratory** : It has facilities for (i) trial and test on charging sets, welding generator, welding transformer, motor-operated hand tools etc; (ii) electrical tests for high voltage, insulation resistance, power voltage, current, etc; and (iii) humidity test, salt spray test, and cold condition test.

(7) **Hydraulic Laboratory** : It does fullscale testing of outboard motors, car washers, pumps, etc. There are facilities for testing as per I. S. S., protable fire-extinguishers.

CONTROLLERATE OF INSPECTION (MILITARY EXPLOSIVES)

Address : Kirkee, Pune 3. **Tel.** 54349, 56736, 58746
Director : Dr. Surjit Singh. **Nature of management** : Under Department of Defence Production, Ministry of Defence, Government of India.

Its services are mainly in the field of testing. Tests are carried out on materials such as chemicals, rubber, plastics, certain packages, adhesives, cements, lutings, textiles, paper and boards, and allied materials pertaining to the Controllerate's AHSP responsibility. This work is done with a view to helping the prospective manufacturers who are interested in supplying raw materials or products conforming to Defence specifications.

CONTROLLERATE OF INSPECTION (SPECIAL VEHICLES)

Address: Bombay-Pune Road, Dehu Road, Pune 412 101. *Tel.* 83255/56. *Controller*: Brig. P. K. Pant, S. M. *Nature of management*: Under the Department of Defence Production, Ministry of Defence, Government of India. Services rendered are mostly in the field of testing.

1. *Testing of metals*: (i) Chemical composition; (ii) hardness; (iii) tensile properties; (iv) fatigue properties; (v) torsion properties; (vi) spring rating; (vii) piston and piston-ring testing; (viii) sulphur print and micro examination; (ix) metallographic examination—Universal microscope (X 10 to X 2000) and stereo microscope (X 4 to X 100); (x) magnetic particle inspection for cracks; (xi) fluorescent dye inspection for cracks; (xii) impact test; (xiii) ultrasonic inspection—flaw detection; and (xiv) surface finish tests.

2. *Testing of rubber and plastics*: (i) Tensile properties; (ii) elasticity test; (iii) permanent set in compression tension; (iv) adhesion test; and (v) cold chamber and ageing oven test.

3. *Testing of automobile assemblies/components on Test Rigs*: (i) Oil seals, (ii) fan belt, (iii) hoses for burst test, (iv) fuel and oil filter, (v) bond strength test on rubber-bonded tyres, and (vi) radiator and radiator caps etc.

Direct Reading Spectrometer is being installed and shortly chemical composition of metals will be done on the spot. Testing on payment is being undertaken at standard government rates at par with National Test House. Schedule of test charges and other details can be obtained on request from the above address directly.

DECCAN EDUCATION SOCIETY'S TECHNICAL INSTITUTE

Address: Servants of India Society Road, Near Gokhale Institute of Politics & Economics, Pune 4. *Tel.* 55573. *Principal*: Mrs. Tara S. Deo. *Nature of management*: Semi-government. It renders the following services.

1. *Testing*: The Institute has a well-equipped laboratory for analysis and testing of paints, varnish, pigments, printing inks, synthetic resins, lacquers, etc.

2. *Training*: The Institute conducts a full-time six-semester (Sandwich Pattern) Diploma Course in Surface Coating Technology, recognised by the Director of Technical Education, Government of Maharashtra. The Course is covered by the Apprenticeship Act, 1973.

DECCAN SUGAR INSTITUTE

Address: Project Office, 270 Senapati Bapat Road, Pune 16. *Tel.* 55963, 56328. *Adviser*: Shri. S. N. Gundu Rao. *Chief Project Officer*: Shri. N. C. Varna. *Nature of management*: Private, managed by Trust and registered under the Societies Act. The Maharashtra State Government has allotted 535.25 acres to the Institute at village Naigaon, Taluka Haveli, situated about 30 Kilometres from Poona City on the Pune-Solapur Road, for construction of the Institute's buildings and research laboratories. The total project cost is estimated at Rs. 5 crores with an annual expenditure of Rs. 40 lakhs. The Institute will start its full-fledged activities and services by the end of 1980.

I. *Services rendered*: (1) Consultancy service to the member sugar-factories in day-to-day problems; (2) Assistance to them in developing by-product industries; (3) Extension service in regard to sugar-cane development work; and (4) Survey and information service.

II. *Services proposed*: The Institute will provide the following facilities after its building and research laboratories are ready in 1980.

1. *Testing of products of the sugar industry and products allied to sugar and sugar-cane.*

2. *Research and Development*: (i) Time-bound result-oriented applied research of the problems of sugar industry in the field and factory in Maharashtra; (ii) research on utilization of by-products of the sugar industry including trials of known or evolved processes on pilot plant or commercial scale.

3. *Advisory, extension and information services to member-factories.*

4. *Training in* (i) scientific methods of sugar-cane cultivation; (ii) sugar technology; (iii) sugar engineering and instrumentation; (iv) sugar industry management; and (v) other required disciplines.

The Institute will be organised into 3 divisions; (1) Sugarcane Research Division, for research on agronomy, cane physiology, plant breeding, soil science, plant protection, agricultural engineering, and extension and

field service 2. Technological Research Division for research on by-product utilisation, sugar technology, chemical engineering, sugar engineering, organic chemistry, physical chemistry, and bio-chemistry and microbiology 3. Technical Services Division for (i) analysis and testing, (ii) economic evolution and process release, (iii) *ad hoc* consultancy and extension services, (iv) planning and development, (v) documentation, (vi) publication, (vii) statistical compilation and data processing, (viii) liaison and co-ordination, and (ix) technical audit, of factory performance.

ELECTRONICS TESTING AND DEVELOPMENT CENTRE

Address: College of Engineering Campus, Pune 5. *Tel* 56835. *Officer-in-Charge:* Prof. K. L. Joshi, *Nature of management:* Under the Government of Maharashtra, with the help of grants from the Department of Electronics, Government of India. It is proposed that this Centre will be taken over by the Maharashtra Electronics Corporation Ltd. and the facilities will be augmented by procuring environmental and mechanical test equipment. It is also envisaged to maintain echelon III calibration facilities, traceable to echelon II calibration facilities at the Regional Testing Centre at the Bhabha Atomic Research Centre, Bombay.

The services rendered are mainly in Testing and calibration. The following equipment is available at the Centre for testing and calibration: (i) Aplat A. C. stabiliser, L V, H V (up to 3 KW) supplies; (ii) ECIL pulse generator (10 MHz); (iii) Yamuna Digital DVM DM (0.01%); (iv) ECIL oscilloscopes—50 MHz with plugins; (v) Curve tracer units; (vi) storage CRO; (vii) BPL capacitance bridge (1%) and component comparator; (viii) Marconi AM/FM generator 220 MHz; (ix) R. F. attenuator (1000 MHz); (x) Distortion factor meter; (xi) RFT Sweep frequency set—wobbulo-scope (0.3—1000 MHz); (xii) Radart decade R, L, C boxes; (xiii) Teletronix oscilloscope—581 A (100 MHz); (xiv) 502 double beam (1 MHz); (xv) 459 storage (30 MHz) with plugin sampling (1000 MHz); (xvi) Spectrum analyser (1200 MHz); (xvii) R & S field strength meter (47-225 MHz); (xviii) Systron Donnor counter 50 MHz (1 in 107); (xix) Bontoon RI mv meter; (xx) Metrimpex wobbulo-scope (1-220 MHz); (xxi) Marconi Q Meter (50 KHz-300 MHz); (xxii) RFT sound level meter.

FOOD CRAFT INSTITUTE

Address: Engineering College Campus, opp. 'Lok-mangal', Shivajinagar, Pune 5. *Tel.* 58298. *Principal:*

Mrs. V. A. Gangolli. *Nature of management:* Managed by Trust and jointly sponsored by the Government of India and the Government of Maharashtra. The following services are rendered.

1. **Testing:** The Institute has a well-equipped and modern laboratory where the following testing facilities are available: (i) Fermentation test for juices and beverages; (ii) Bacterial count in tomato products; (iii) Water analysis—colony count; (iv) Microbiological examination of canned foods; (v) Examination of raw material for food and fruit products; (vi) Examination of can ream, (vii) Determination of brix by hydrometer, refractometer, and by indirect method; (viii) Determination of acidity in fruit and vegetable products, (ix) Determination of salt; (x) Detection and determination of sulphur-dioxide and benzoic acid; (xi) Determination of reducing sugar, (xii) Detailed cut-out analysis of fruits and vegetable products.

2. **Consultancy:** The services are available in the following fields of (i) bakery and confectionery; (ii) hygiene in hotels etc, (iii) storage of food; (iv) care of premises and equipment; (v) canning and bottling processes; (vi) fruit and vegetable beverage preparation and preservation; (vii) preparation of jams, jellies, marmalades, fruit preserve candies, cheese, butter and other confectionery; (viii) preparation of tomato products, pickles, sauces, chutneys and vinegar; (ix) drying and dehydration; (x) utilisation of fruit and vegetable waste; (xi) food packing; (xii) microbiology, sanitation and quality control; (xiii) source and control of contamination in preserved food; (xiv) food poisoning—causes and control; (xv) control of insects and rodents in factories; (xvi) food toxicology; (xvii) food grades and standards; (xviii) product evaluation and marketing techniques; (xix) cookery; (xx) hotel reception; (xxi) housekeeping; and (xxii) use, service and maintenance of large-scale equipment used in bakery, confectionery, canning and food preservation, and cookery.

3. **Training:** The Institute conducts the following courses which are recognised by the Board of Technical Examinations, Government of Maharashtra: (i) Craftsmanship course in Bakery and Confectionery—1 year; (ii) Craftsmanship course in Canning and Food Preservation—1 year; (iii) Craftsmanship course in Cookery—6 months; (iv) Craftsmanship course in Restaurant and Counter Service—6 months; (v) Craftsmanship course in Reception and Book-keeping—6 months; (vi) Craftsmanship course in House-keeping—6 months; (vii) Housewives course in Bakery and Confectionery—13 weeks; (viii) Housewives course in Cookery—13 weeks; (ix)

Housewives course in Canning and Food Preservation—13 weeks.

GOVERNMENT POLYTECHNIC

Address : Poona University Road, Pune 16. *Tel.* 57907. *Principal* : Prof. M. S. Srikantiah. *Nature of management* : State Government institution. The following services are rendered.

1. **Testing** : It includes : (i) Testing of materials for strength; (ii) Testing of taxi and auto-rickshaw meters; (iii) Metallurgical testing; and (iv) Testing of I. C. engines up to 10 h. p. on behalf of the Indian Standards Institution, New Delhi. It also carries out repairs to survey instruments.

2. **Consultancy** : This service is available in heat treatment, metal forming and material selection problems.

3. **Training** : The Polytechnic conducts full-time courses for (i) Diploma in Mechanical Engineering; (ii) Diploma in Electrical Engineering; (iii) Diploma in Civil Engineering; (iv) Diploma in Telecommunications Engineering; and (v) Diploma in Metallurgical Engineering. It also conducts part-time diploma courses for candidates sponsored by industries; and a post-diploma course in Production Engineering. The latter is a part-time course conducted for working-engineers.

HANDMADE PAPER INSTITUTE

Address : K. B. Joshi Road, Agriculture College Campus, Pune 5. *Tel.* 56383. *Director* : Shri D. C. Nadaph. *Nature of management* : Semi-government, under the Maharashtra State Khadi and Village Industries Board. It renders the following services.

1. **Testing** : The Institute possesses a well-equipped laboratory for conducting all physical and chemical tests on paper and board as per ISI specifications.

2. **Research and Development** : Facilities exist for research and development on all aspects of handmade paper and board.

3. **Consultancy** : On all aspects of production, standardization and processing of handmade paper and board.

4. **Training** : The Institute imparts training in production of handmade paper and board.

INDIAN DRUGS RESEARCH ASSOCIATION DRUG RESEARCH LABORATORY

Address : 561-B Shivajinagar, Pune 5. *Tel.* 55018. *Hon. Director* : Dr. G. S. Pende. *Nature of management* : I.D....19

ment : Society and Trust. The following services are rendered.

1. **Testing** : The laboratory has facilities for testing drugs, pharmaceuticals, cosmetics, fats, oils, etc.]

2. **Research and Development** : The Institution undertakes research and development programme on behalf of industries which may have some problems of their own and also of those who wish to diversify to other important industrial enterprise, on certain terms and conditions to be mutually agreed upon.

3. **Consultancy Services** : These services are available on a limited scale in the fields mentioned above.

4. **Training** : Students are provided research facilities in their study for M.Sc. and Ph.D. degrees of the University of Poona and Bombay University. Training facilities are also available for analysts and commercial apprentices.

INDUSTRIAL CHEMICAL LABORATORY

Address : Poona University Campus, opp. Raj Bhavan, Ganeshkhind Road, Pune 7. *Tel.* 56853. *Industries Officer (Laboratory)* : Shri N. M. Chudgar. *Nature of management* : Under the Government of Maharashtra. The following services are rendered.

1. **Testing** : The Laboratory has facilities for testing chemicals, raw material, and finished products such as adhesives, soap oil, inks, acids, alkalis, minerals, ores, clays, non-ferrous metals, spirits, solvents, etc.

2. **Research and Development** : Facilities for conducting initial experiments and trials are available for technical entrepreneurs who desire to start a new chemical industry but do not have sufficient funds and time to establish a well-equipped laboratory. This Laboratory is well equipped with many quick-fit glass assemblies and instruments for conducting such experiments and trials. Facility for conducting experiments in the Laboratory is provided at nominal fees. The Laboratory also undertakes to carry out experiments for technical entrepreneurs on a limited scale.

3. **Training** : Short-duration practical training courses of 3 to 7 days and demonstration are arranged for specific small and cottage industries for the manufacture of products such as inks, gum, adhesive, washing soap, liquid soap, candles, crayons, detergents, incense sticks (agarbatties), phenyl, etc.

INDUSTRIAL TECHNICAL INSTITUTE

Address : 3B, Lajwanti, 9/62 Erandawana, Karve Road, Pune 4. *Tel.* 55848, 54685. *Proprietor* : Shri

Shashikant D. Mahulikar, Chartered Engineer, Approved Valuer, Insurance Surveyor, Technical Consultant. *Nature of management*: Private. The following services are rendered.

1. *Testing*: The facilities include (i) testing of equipment as per Factories Act; (ii) oil tanker testing and inspection as required by the Explosives Inspector; and (iii) inspection and testing of pressure vessels, lifting tackles etc. as per Factories Act. For other services please see under "Consultancy Services" section.

INSECTICIDES TESTING LABORATORY

Address: Administrative Building, Agriculture College Campus, Shivajinagar. Pune 5. *Tel.* 58413. *Chemist*: Shri U. D. Thakare. *Nature of management*: Under Department of Agriculture, Government of Maharashtra. The services rendered are mostly testing of insecticides and pesticides.

INSPECTORATE OF ELECTRONICS WING

Address: CIA Campus, Khadki, Pune 3. *Tel.* 57520, 58176. *Inspector-in-Charge*: Lt. Col. J. S. Brar. *Nature of management*: Branch Office of Inspectorate of Electronics, Bombay, under Controllerate of Inspection (Electronics), Bangalore, and Directorate of Production and Inspection Electronics, New Delhi. It renders valuable services in the field of testing.

The Wing has the following imported and indigenous equipment for providing testing facilities: (i) Power-measuring set multi-range of voltage, current power, and reactive power; (ii) Voltmeter AC/DC, PR, 0-600 V for measurement of voltage; (iii) Voltmeter D. C., 0-150 V accuracy 0.5 for measurement of voltage; (iv) Ammeter AC with CT, PR, 0-100A accuracy 0.5 for measurement of current; (v) Ammeter D. C. with shunt 75 mV, 20-100A accuracy 0.5 for measurement of current; (vi) Universal LCR bridge. Freq. 1 KHZ, 10 micro H to 100 H, 10 PF to 100 MF, 1 Ohm to 10 M Ohms for measurement of resistance, inductance and capacitance; (vii) Multimeter model 8 X MK III multi-ranges for measurement of electrical parameters, (viii) Breakdown tester RM 215 0-5 KV A.C 0-10 KV D. C., 100 MA for voltage proof test; (ix) Electronic megger 500 V. D. C., 100 M Ohm for insulation test; (x) Insu-tester for insulation test; (xi) Oscilloport with universal rheostat for measurement of transient changes, voltage and current; (xii) VTVM AC/DC EM 201/C for precise AC/DC voltage and resistance measurement; (xiii) Frequency meter for measurement of frequency; (xiv) Wattmeter AC/DC single phase PR for measurement of

power; (xv) Multi-meter for measurement of electrical parameters.

Tests as per I.S.I. Standards are also taken of electric hot plate, electric irons, and electric kettles.

INSTITUTE OF ARMAMENT TECHNOLOGY

Address: Girinagar, Pune 25. *Tel.* 440050, 440501, 440701-2-3. *Director and Dean*: Air Commodore S. K. Nair, AVSM. *Nature of management*: Under the Research and Development Organisation, Ministry of Defence, Government of India. The services rendered are mostly in Research and Development. Applied research is undertaken in (i) Physics, (ii) Chemistry, (iii) Mathematics (Mechanism and Ballistics), (iv) Telecommunications, and (v) Metallurgy.

KIRLOSKAR CONSULTANTS LIMITED

Address: 917/19-A Shivajinagar, Fergusson College Road, Pune 4. *Tel.* 56495-96-97/54211-12 *Managing Director*: Shri D.V. Tikekar. *Nature of management*: Public Limited Company. Services rendered by Laboratory Division (Manager: Shri I. S. Kirad):

1. *Testing*: The Company has a well-equipped laboratory for chemical analysis of (i) metals and its alloys, (ii) ores and minerals, (iii) limestone and soapstone, (iv) soil and fertilizers, (v) cattle and poultry feed, (vi) oil-seeds and cakes, (vii) rice bran and rice polish, (viii) fish meal, (ix) water for industrial uses, and (x) waste water and effluents. These services are as per requirements of clients, and charges vary accordingly.

2. Fixation of quality control standards for internal use.

3. Study of process of manufacture for various metallic and alloy components.

4. For consultancy and other services, please see "Consultancy Services" section.

KIRLOSKAR FOUNDATION

Address: 13 Laxmanrao Kirloskar Road, Khadki, Pune 3. *Tel.* 58334. *Chairman*: Shri S. L. Kirloskar, *Holding Trustees*: Shri C. S. Kirloskar and Shri V. B. Kirtane. *Nature of management*: Managed by Trust and registered under the Societies Registration Act 1860 and the Bombay Public Trust Act 1950. The Foundation has been established in the memory of Late Shri Laxmanrao K. Kirloskar who founded the Kirloskar Group of Companies and who was a pioneer in the industrialisation of Maharashtra. The Foundation aims at continuing the spirit and work of Late Shri L. K.

Kirloskar to encourage new entrepreneurs and thereby reduce unemployment in the country. It renders the following services to entrepreneurs for starting small and large industries.

1. **Technical and Management Advice :** These services include (i) technical advice, (ii) management advice, (iii) technical and management information, (iv) practical assistance based on experience for the improvement of production and management techniques, and (v) assistance in securing bank loans for starting an industry by standing as guarantor for such loans; no commission is charged for the guarantee by the Foundation.

2. **Training:** Small courses of 1 to 2 days' duration are arranged at various places in the State on subjects like labour legislation, costing, financing, income-tax and sales tax, and other government laws, rules and regulations affecting industry, in order to educate small-scale entrepreneurs on these vital subjects. The Foundation organises these courses in co-operation with Chambers of Commerce and local Associations of Industries.

MAHARASHTRA ASSOCIATION FOR CULTIVATION OF SCIENCE—Research Institute

Address: Law College Road, Pune 4. Tel. 56357/53683. *Director :* Dr. G. B. Deodikar. Estd. 1946. *Nature of management :* Autonomous, private institution registered as a Public Trust and aided by the Department of Science and Technology, Government of India and the Government of Maharashtra. The Institute is devoted to both basic and applied research in Science and has on its rolls, about 70 scientists apart from post-graduate research students, post-doctoral fellows, visiting scientist, pool scientists and casual research workers. The Institute has unique distinction of utilising valuable services of eminent retired scientists from various fields of sciences who work full-time but in an honorary capacity. It renders the following services.

1. **Research and Development, and Consultancy :** The MACS Research Institute has well equipped laboratories in its various departments. Research and development facilities are available in the fields of : (i) Biometry, (ii) Botany, (iii) Chemistry, (iv) Genetics and Plant Breeding, (v) Geology and Palaeontology, (vi) Instrumentation, (vii) Microbiology, (viii) Mycology and Plant Pathology, (ix) Zoology and Agricultural Entomology, and (x) Quantitative Biology.

2. **Training :** The Institute is recognised by the University of Poona for research leading to M.Sc. and Ph.D. degrees of the University in the following

subjects : Botany, Cytogenetics, Plant Breeding, Entomology, Zoology, Mycology, Microbiology, Chemistry, Biochemistry, and Agricultural Chemistry. The Mahatma Phule Agricultural University has recognised the Institute as a Centre for post-graduate research leading to the M.Sc. and Ph.D. degrees of the University in Agricultural Chemistry, Soil Science, Entomology, Mycology, Bacteriology, Plant Pathology, Agricultural Microbiology, Agricultural Botany, Genetics, and Plant Breeding.

3. **Library :** The Institute has an excellent library which houses 10,739 books and 19,364 other publications on the subjects mentioned above. It receives 117 Indian and foreign journals on the related subjects. It also has a collection of microfilms on the above subjects. Scientists of the Institute have so far published* over 700 research papers in Indian and foreign journals. The Institute publishes a monthly *Biovigyanam*.

MECHANICAL ENGINEERING RESEARCH AND DEVELOPMENT ORGANISATION

Address: National Chemical Laboratory Campus, Pashan, Pune 8. Tel. 58224, 50743. *Scientist-in-Charge:* Shri N. C. F. Shah. *Nature of management:* Autonomous, under the Council of Scientific and Industrial Research, New Delhi. The following services are rendered.

Testing and Evaluation: This includes (i) Destructive testing comprising tensile tests, compression tests, transverse tests, impact tests—Brinell, Rockwell, Vickers and Shore—, bend tests, hydraulic pressure tests, spring tests, and special testing such as piston ring tests etc.; (ii) Non-destructive testing comprising ultrasonic testing, ultrasonic thickness survey and detection of corrosion in vessels, pipelines, heat exchangers etc.; radiography of welds etc., surface crack detection—metallic and non-metallic, survey of radioactive contaminants on surface and radiation working areas, and surface and sub-surface magnetic crack detection in ferrous materials; (iii) Metallurgy and Metallography covering macro and micro structures of ferrous and non-ferrous metals and alloys, determination of ASTM grain size, thickness measurement, micro hardness, sulphur printing, and heat treatment; (iv) Chemical analysis of ferrous and non-ferrous metals and alloys; and (v) Metrology covering surface roughness measurement, pitch measurement of screws, calibration of micrometers, calibration of dial gauges and test indicators, plane tapers, indexing of any parts into any number of equal parts, flatness surface plates, and concentricity and eccentricity measurements.

NATIONAL INSTITUTE OF VIROLOGY

Address: 20-A Dr. Ambedkar Road, Post Box No. 11, Pune 1. *Tel.* 23471-2. *Director:* Dr. N. P. Gupta.

Nature of management: Under the Indian Council of Medical Research, Ministry of Health and Family Welfare, Government of India. The Institute was established in 1952 under the joint auspices of the I. C. M. R. and the Rockefeller Foundation, U. S. A., and is now recognised by the World Health Organisation as a Reference Centre on Arboviruses. It renders the following services.

1. **Testing:** There are facilities for (i) the testing of all the field specimens by virological and serological techniques; (ii) physico-chemical and biological characterisation and pathogenicity studies of the isolated viruses and rickettsiae; (iii) interaction of viruses and other parasites or micro-organisms in different host systems; and (iv) testing and development of effective control measures through the use of insecticides for certain vectors of arboviral and rickettsial diseases.

2. **Research and Development:** Facilities exist in the fields of (i) arbo and respiratory viruses; (ii) immunology; (iii) tissue culture and cell biology; (iv) medical entomology and zoology; (v) rickettsiology; (vi) laboratory animals; (vii) development of newer techniques for quicker and efficient diagnosis of viral diseases; (viii) experimental studies on viral genetics for developing "candidates" for viral vaccines; (ix) development of newer cell lines from vertebrate and non-vertebrate; and (x) designing, fabrication and modification of laboratory equipment employing indigenous materials to minimise imports.

3. **Supplies:** The Institute maintains and supplies laboratory animals, Swiss mice, arthropods, mammalian and arthropod cell lines to different research institutes in India and abroad. It also prepares and supplies standard serological reagents and prototype viruses.

4. **Training:** The Institute is affiliated to the University of Poona and is recognised by several other universities in India. It has training facilities for Ph.D. and M.Sc. students, partly by research and partly by thesis. It gives Diploma in Virology in the fields of Virology, Medical Zoology and Entomology, and Viral Epidemiology including Tissue Culture and Immunology. The Institute conducts short-duration practical training courses of 6 months to one year in the fields of (a) Serological Diagnosis, (b) Tissue Culture, (c) Virus Isolation and Identification, (d) Epidemiology, and (e) Medical Zoology and Entomology. It also conducts post-graduate certificate courses in virology sponsored by

I. C. M. R.; technicians' training courses in virology (12 months' duration); and inter-country courses in virology sponsored by the World Health Organisation.

NATIONAL CHEMICAL LABORATORY

Address: Pashan, Pune 8. *Tel.* 56451/2/3. *Director:* Dr. L. K. Doraiswamy. *Nature of management:* Constituent laboratory under the Council of Scientific and Industrial Research, New Delhi, an autonomous body registered under the Societies Act.

The NCL has been quite successful in transferring its technology to small, medium and large scale private and public sector industries. The cumulative value of industrial production based on the NCL technology for the last decade (1965-75) was Rs. 33.4 crores of which Rs. 13.4 crores can be claimed as foreign exchange saving, as most of these products were being imported. As against this contribution to national economy, the CSIR has spent only Rs 13 crores on the NCL since its inception. The value of production based on NCL technology is Rs. 15 crores annually. Out of a total of 139 processes developed by the NCL so far, presently 6 processes are in production in public sector undertakings, 23 processes in other large-scale companies and 42 processes in medium and small-scale industries. The NCL has to its credit 22 Indian patents sealed, out of which 7 have been released for commercial exploitation, 17 Indian patents filed, and 3 foreign patents in force in the USA and Cuba. The research work at the NCL is recorded in the publication of about 3000 papers in India and foreign journals. The NCL has on its staff 392 scientists, 78 research fellows and graduate trainees, 380 technical personnel and 190 other personnel. Major beneficiaries of the NCL technology have been the public sector enterprises: Hindustan Organic Chemicals Ltd., Indian Drugs and Pharmaceuticals Ltd., Hindustan Antibiotics Ltd., Indian Petrochemicals Ltd., Hindustan Insecticides Ltd., Ministry of Finance, and the Railways. Several industries in the small and medium sectors have also benefited from the NCL technology. As an objective and a feasible target, the NCL hopes to generate technology which is expected to lead to industrial production worth around Rs. 200 crores per year within the next five to ten years. Major areas of thrust for the NCL's efforts in the decade 1975-85, would be: (a) development of technology which will promote agricultural production and economic utilization of forests; (b) utilization of regenerative resources such as cellulose materials; (c) development of much needed technology

for critical sectors such as health-care (drugs and pharmaceuticals), defence, petrochemicals, polymers and elastomers; (d) utilization of mineral resources; (e) projects expected to bring economic benefits to the economically backward sections of our society such as rural, backward and tribal population, e. g. assistance in the development of Chandrapur, a backward district in Maharashtra; (f) development, absorption and improvement of technology in public sector enterprises with the view for its diffusion within India and eventual export, and development of closer links with public sector manufacturing and engineering companies for the above purposes; and (g) contributions to frontiers of science and technology in areas such as (i) application of plant tissue culture to horticulture, agriculture and forestry, (ii) development and use of immobilized enzymes as industrial catalysts, (iii) use of solar energy in association with other CSIR laboratories, (iv) exploitation of renewable resources, (v) catalysis and catalytic processes, and (vi) development of new production techniques based on the use of fluidized bed techniques.

Testing: The NCL has modern sophisticated equipment for structural elucidation such as (i) Mass Spectrometer, (ii) Vapour Phase Chromatograph, (iii) Gas Liquid Chromatograph, (iv) High Pressure Liquid Chromatographs, (v) Ultra Violet, (vi) Infra Red, (vii) Nuclear Magnetic Resonance, (viii) Gamma Ray and Mossbauer Spectrometers, (ix) X-Ray and Electron Diffraction Equipment, (x) Analytical and Preparative Ultra-Centrifuges, (xi) Amino Acid Analyser, (xii) Impedance Bridge, (xiii) LUVA Evaporimeter, (xiv) Printing Digital Analogue Indicator (Rikadenki Model Padal-1), etc. The following facilities for testing and analysis are available: (i) physico-chemical analysis of raw materials, intermediate and finished products; (ii) microanalysis of organic and organo-metallic compounds for various elements and functional groups; (iii) other estimations like molecular weight determination; (iv) thermogravimetric analysis. (v) X-Ray powder patterns; (vi) optical microscopy; (vii) spectrophotometric estimation; (viii) inorganic analysis of special nature; (ix) determination of surface area by BET technique; (x) measurement of capacitance, inductance and resistance at different frequencies; (xi) removal of moisture, residual solvents from organo-phosphorous pesticides. An entomology unit is available for testing various compounds like pesticides and hormones; and a separate laboratory is available for studying high pressure chemical reactions.

Research and Development, and Consultancy: The NCL undertakes projects from industries on sponsorship basis

is for the development of technology and on specific problems faced by industries, and also offers consultancy services. These facilities are available in the following subjects: (i) petrochemicals and bulk organic chemicals, (ii) chemical engineering, (iii) pesticides and agro-chemicals, (iv) agro-chemicals based on natural products, (v) drugs, dyestuffs and fine chemicals, (vi) organic intermediates, (vii) utilization of agricultural, plant, forest and marine products, (viii) organic chemistry, (ix) industrial polymers, elastomers and resins, (x) polymer chemistry, (xi) utilization of mineral sources. (xii) industrial inorganic and organo-metallic chemistry, (xiii) solid state materials including materials for electronic industry, (xiv) physical chemistry, (xv) plant tissue culture, (xvi) fermentation technology, (xvii) enzyme technology, (xviii) biochemistry, (xix) development of instruments, and (xx) water management. In addition to the above areas of industrial and socio-economic relevance, senior NCL scientists are also working on problems of a basic nature in their own fields of interest.

Technology for new industries : The NCL has developed various technological processes which are available for commercial exploitation in existing industries and for starting new industries in the large, medium and small-scale sectors. The process of transfer of this technology for actual production depends upon the level of technology development. The NCL develops technology on three distinct levels:—Level 1: For low volume/value products prepared by one or two simple chemical steps, only laboratory work is carried out, i.e. on 1-5 kg/batch scale. This level of transfer meets the needs of companies which are already in the manufacturing line or the entrepreneurs who have the necessary expertise. Level 2: At this level, in addition to laboratory work pilot plant trials on a scale of 10-100 kg/batch or 2-20 kg/hour (in the case of continuous operations) are carried out. The required design data are collected and complete process engineering package (PEP) is prepared, usually in collaboration with a project engineer. Based on the PEP, the entrepreneur can erect a plant either with the help of their own engineers or with the assistance of a project engineer of their choice. Level 3: A complete turn-key offer with guarantees of commercial plant performance is made to entrepreneurs through a firm of reputed project engineers. This level of transfer is similar to foreign turn-key offers. In this level of transfer, the NCL's responsibility is only to the project engineering firm, while the client deals with the project engineers. However, the NCL actually associates with the project engineers in designing, commissioning and guaranteeing runs.

Consultancy: The NCL can enter into agreements with firms/groups of firms and public sector undertakings for rendering technological support to industry in the fields of (i) development, (ii) planning, (iii) programming, (iv) feasibility studies, (v) designs, (vi) start-up help and commissioning of the plant, (vii) research and development establishment, and (viii) trouble shooting. Such institutional consultancy is operated through the NCL scientist/s particularly desired by the industry with the concurrence of the NCL/Council of Scientific Industrial Research.

Ad hoc Assistance: The NCL can render assistance to industry in (i) standardization, (ii) optimization, (iii) analysis and testing, and (iv) trouble shooting, on *ad hoc* payment basis depending upon the nature of the problem and provided the necessary facilities and expertise are available and can be spared.

Pilot Plant Work: Based on the laboratory data obtained elsewhere, pilot plant work on agreed terms could be undertaken on behalf of industry, either on sponsorship basis or on *ad hoc* basis.

Feasibility Studies: The NCL offers assistance on payment to project engineering firms for the preparation of feasibility reports or turn-key proposals for NCL technology.

R & D Collaboration with Industry: In projects which are engineering intensive or technically complex and involving high capital investment or high risk factors and necessitating establishment of semi-commercial units for large-scale proving runs, the NCL is keen to collaborate with interested industry on such joint development programmes. Such units could be established at the site of the industry and run at the cost of the industry. The National Research and Development Corporation may also participate in the financing of these semi-commercial plants.

Import of Foreign Technology : The NCL can participate with industries in their negotiations for importing foreign technologies so as to choose proper technology from the various foreign technologies available. The NCL scientists could also be associated with training abroad and commissioning of the plants in India, as an integral part of foreign collaboration agreements, so as to help in assimilation and further improvement of foreign technology.

Miscellaneous Services: (i) The NCL has a National Collection of Industrial Micro-organisms (NCIM) of non-pathogenic yeasts, bacteria and fungi. These are supplied to industries and other institutions on nominal charges. (ii) Glass Blowing—An excellent glass-blowing

section undertakes fabrication of glass assemblies and repair of glass apparatus for research and development work in the laboratory.

Training: The NCL is recognised for post-graduate research leading to the M.Sc. and Ph.D. degrees, by a number of Indian universities. A limited number of scholarships financed by the Council of Scientific and Industrial Research, New Delhi, are available for doctoral and post-graduate work. The NCL also imparts technical training to representatives from industries, in various subjects such as (a) Thin Film Physics, (b) Mass Spectrometry, (c) Microbiological Technique, (d) Electrophoresis, and (e) Glass Blowing.

Library: The library which is one of the finest of its kind in India, maintains an impressive collection of 75,000 books, periodicals, patents, standards, technical reports etc. on chemistry and chemical technology. Library facilities are available to industries. Micro-films and Xerox copies of references available in the library, are supplied to outside parties on payment. The library also compiles bibliography on special subjects of interest to the NCL.

OFFICE OF THE INSPECTING OFFICER (ENGINEERING)

Address: D. G. S. & D., "Surad", 1st floor, 106/13 Erandawana, Dr. Ketkar Road, Pune 4. *Tel.* 55164. **Inspecting Officer-in-Charge:** Shri S. K. Gautam. **Nature of management:** Under the Director General of Supplies and Disposals, Department of Supply, Government of India. The services rendered are inspection and testing of stores against government or semi-government orders.

RESEARCH & DEVELOPMENT ESTABLISHMENTS (ENGINEERS)

Address: Dighi, Pune 15. *Tel.* 27221, 20427, 20428, 25387 **Director:** Brig. P. N. Kapoor. **Nature of management:** Under Research and Development Organisation, Ministry of Defence, Government of India. The following services are rendered.

1. Type testing of IC Engine.
2. Environmental Tests. These tests comprise cold test, dry heat test, damp heat (accelerated), mould growth test, salt spray test, dust test, rapid change of temperature test, rain test, ultra violet radiative test (100-hr. test or part thereof), bump and jolt test DEF-133, vibration test DEF-133, rubber strength test DIN 5904, and thermal conductivity test.
3. Metallurgical Tests : These tests include tensile

test; bending test; shear test; hardness test—Rockwell, Brinell, Vickers, and Shore Scleroscope; torsion test; X-Ray radiography and interpretation; flow-detection by ultrasonic method; flow-detection by magnetic particle.

4. Fabric Tests : There are facilities to test breaking strength of fabrics; tearing-strength of fabrics; bursting-strength of coated fabrics; waterproofness of basic and coated fabrics—cone test, pressure head test, Bundes-mann test; flexing-strength of fabrics; and flame-proofness of fabrics.

5. Soils and Civil Engineering Tests : These include: (i) Cement testing as per IS-269-1958 for fineness, soundness, setting time, comprehensive strength, heat of hydration, and chemical requirements as per clause 3.1 and 3.2. (ii) Concrete testing as per I. S. I. specification, for workability, comprehensive strength, flexural strength, and modulus of elasticity by electrodynamic method. (iii) Aggregates testing as per IS 2386 (Part I to V only) 1963 for grading, soundness, water absorption, specific gravity, bulk density, hardness in Moh's scale, aggregate abrasion value, adhesion of aggregates to tar, and aggregate impact test. (iv) Tar and bitumen testing for specific gravity IS 1202-1958, penetration IS-1203-1958, softening point IS-1205-1958, ductility IS-1208-1958, viscosity IS-1206-1958, and flash point and fire point IS-1209-1958. (v) Soil testing as per IS-2780 Part I to XXXI for moisture content, specific gravity, particle size analysis, shrinkage factor, moisture content—dry density relation using light and heavy compaction, unconfined compressive strength, consolidation properties, laboratory determination of CBR, field determination of California Bearing Ratio, field moisture equivalent, laboratory determination of permeability, organic matter, calcium carbonate, PH value, dry density by core cutter method, and laboratory vane-shear test.

SHEEP BREEDING FARM

Address: Gokhale Nagar, Pune 16. *Tel.* 54862.

Manager : Shri. G. R. Potnis. *Nature of management:* Under the Government of Maharashtra. The following services are rendered.

1. Testing : It includes testing and analysis of raw wool, and proximate analysis of cattle-feed samples.
2. Processing of raw wool into thread through scouring, carding, spinning, dyeing, sizing, winding and warping of woollen yarn.
3. Consultancy in sheep-breeding, and manufacture and processing of wool and wollen products.

SMALL INDUSTRIES DEVELOPMENT INSTITUTE

Address: Agriculture College Campus, Shivajinagar, Pune 5. *Tel.* 56368. *Asstt. Director in-charge:* Shri V. B. Diwakar. *Nature of management:* Under the Industries Commissioner, Government of Maharashtra. It renders the following services.

1. Testing: The Institute has the following equipment for testing of various engineering products: (1) Sine Protractor, (2) Parallelism Tester, (3) Three-point Internal Micrometer, (4) Cylinder Bore Gauge, (5) Co-ordinate Table, (6) Magnetic Base 48×2×49, (7) Magnetic Base 70×46×64, (8) Magnetic Base flexible post, (9) Magnetic Holder, (10) Adjustable Links, (11) Dial Test Indicator 38 mm dial 0.01, (12) Dial Test Indicator 38 mm dial 0.002, (13) Dial Bevel Protractor, (14) Magnetic V Blocks, (15) Indicator Stand 250×51 base, 200×18 column, (16) Indicator Stand 300×100 base, 300×40 column, (17) Universal Surface Gauge 80×65×300, (18) Universal Surface Gauge 125×95×600, (19) Dial Indicator Lever type, (20) Vernier Calliper 600 mm, (21) Vernier Calliper 200 mm, (22) Mini Bench Centre, (23) Screw Pitch Gauge 4×160, TPI, (24) Screw Pitch Gauge 0.25 to 2 mm, (25) Straight Edge, (26) Combination Square Set, (27) Telescopic Gauge, (28) Vernier Depth Gauge, (29) Column Measuring Support, (30) Outside Micrometer, (31) Vernier Height Gauge, (32) Micrometer, (33) Slip Gauge, (34) Surface Plate, (35) Height Master Gauge, (36) Optical Flat, (37) Hardness Tester, (38) Profile Projector, and (39) Universal Tester.
2. Research and Development: Facilities are available to small-scale industries through the Institute's Workshop and Tool Room.
3. Training: 18 months' full-time training courses in the manufacture of scientific glass apparatus for boys who have passed the SSC Examination.

SMALL INDUSTRIES SERVICE INSTITUTE —INDUSTRIAL EXTENSION CENTRE

Address: Shankarshet Road, Swargate, Pune 9. *Tel.* 440594. *Assistant Director-in-Charge:* Cap. T. D. Srinivasan. *Nature of management:* Under the Small Industries Development Organisation, Ministry of Industry, Government of India. It renders the following services.

1. Workshop facilities: They include (i) machine, and (ii) electroplating.
2. Training: The Centre imparts training to artisans and small industrialists. Short-term courses are arranged for new and prospective entrepreneurs.

3. **Consultancy:** The Centre helps new entrepreneurs in preparing project reports and also provides brief project reports on various types of small-scale industries. It provides technical information, management advice, economic information, and marketing advice.

UNIVERSITY OF POONA

Address: Ganeshkhind Road, Pune 7. *Tel.* 56061.
Vice-Chancellor: Dr. R. G. Takawale. *Nature of*

management: Autonomous, under the Government of Maharashtra. It renders the following services.

1. **Testing:** The University has modern and well-equipped laboratories in its various departments, such as Biology, Botany, Chemistry, Physics, Microbiology, Zoology, etc., and testing facilities are available in these laboratories.

2. **Training:** The University imparts advanced education in all the above disciplines. It also runs various other courses of study through the colleges and technical commercial, and management institutes affiliated to it

Phone : 443686

Gram : 'CARAVAN'

**MAJOR INDUSTRIES ARE NOW
CHANGING OVER TO**

caravan

OIL SEALS

**INDUSTRIAL RUBBER COMPONENTS
AND
ANY RUBBER MOULDED ARTICLES**

*Manufactured out of Viton, Silicone, Polyacrylic,
Neoprene, Nitrile and Natural Rubbers*

CARAVAN ENGINEERS

36, GULTEKDI INDUSTRIAL ESTATE

PUNE 411 009

STAR ENTERPRISES

Industrial Development
Engineers

Office : 1823 Sadashiv Peth
Pune 411 030

Tel. Office : 447810

Works : 16/2/B Kachare Bag
Kothrud, Pune 411 029

WE UNDERTAKE

- (A) Job-work for turned components.
- (B) Job-work for Relining of brake lining Equipments.
- (C) Sub assemblies of various components under development projects.

For Meteorological Instruments

**Evaporimeters and Frp. Rain
Gauges with ISI Mark**

Contact

M/s. RAMKALA

**22 Sadashiv (Navi) Peth
Pune 411 030 (India)**

*(Suppliers to the Government
of India)*

Wood house

Phadtare Chowk, 768, Sadashiv
Peth, Pune-411 030

Phone : 443943



DEALERS IN :

**Plywood-Block Board, Hard
Board, Flush Doors, Sunmica,
Aluminium Section, & Fevicol.**

DAY LONG

XEROX

PHOTOCOPYING SERVICE



QUICK PRINTS

465 SADASHIV PETH.
OPP. ALAKA TALKIES.
POONA 30. PHONE 446808.
QUICK SERVICE IS OUR TRADITION.

ALPHA

**The safest way to travel—
on business or pleasure.**

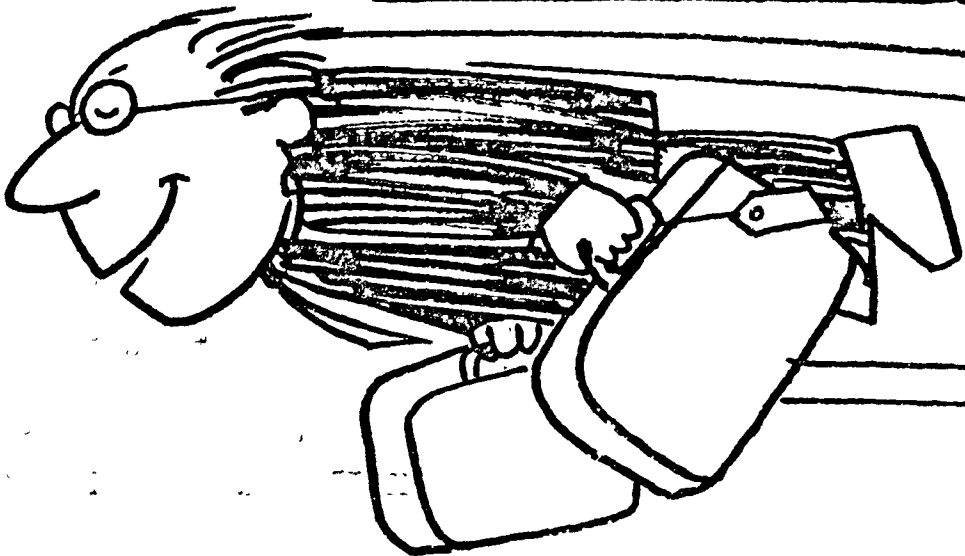

Carry Bank of Baroda Travellers' Cheques.

With Bank of Baroda's Travellers' Cheques, you can take as much money as you wish without any of the risks or worries of carrying cash.

Our Travellers' Cheques are :-

- **Safe**—only your signature can encash a Travellers' Cheque in your name. Even if it is lost or stolen, no one else can use it.
- **Convenient**—available in denominations of Rs. 25, Rs. 50, Rs. 100 and Rs. 250. You can encash only what is immediately required.
- **Accepted everywhere**—in leading hotels, stores, restaurants, shops, at our branches all over India; and at branches of all other nationalised banks.
- **Issued free of charge.**



Bank of Baroda

(A Government of India Undertaking)

A network of over 1100 branches in India and abroad—in Belgium, Fiji Islands, Guyana, Kenya, Mauritius, Sultanate of Oman, U.A.E. and U.K.

आपला नवीन गाडी घेण्याचा निर्णय सिद्ध क्यतो की, आपण उत्तम दर्जाचे चाहते आहात...

म्हणूनच मोटर सायकल, स्कूटर अॅक्सेसरीज घेतांना सर्वोत्कृष्ट
 ❶ परफेक्ट अॅक्सेसरीज हीच आपली निवड राहिल.

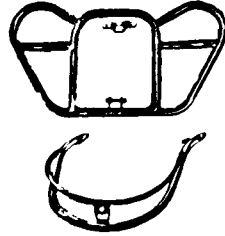

भारतातील सर्वाधिक खपाच्या
 ❷ 'परफेक्ट' स्कूटर, मोटर सायकल अॅक्सेसरीज

३३ मे ७८ च्या उत्पादनापासून

परफेक्ट इंडस्ट्रीज

मोदी मॅन्शन, शंकरशेठ रोड, पुणे-४११००९,
 फोन: ४४१८१८-९, ग्रॅम: परफेक्ट, टेलेक्स: पीएन १४५-२२४



KALPAKPI 789

Make your Conference a success

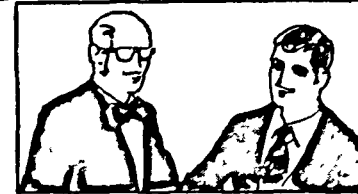
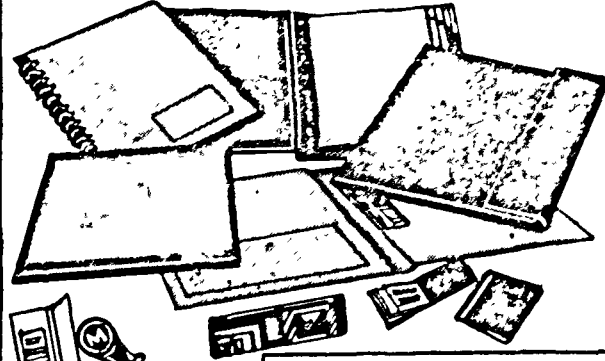

See yourself as millionaire ... feel other people admiring your keep sakes ... with your initials in gold. The quality and a very thoughtful design sense ... with your status in mind... and even as perfect gift idea. The quality is matchless!

KWALITY PLASTIC PRODUCTS

423/B Shanwar Peth, oppo. Rajmachkar Flour mill, Poona-30
 Phone : 470589

Fire ! Fire ! Fire Contact : Phone : 28298 Resi. : 55127

For Your Fire Fighting Problems

M/s. PRAVIN ENTERPRISES

398, New Mangalwar Peth
Narpatgir Chowk, Station Road
Pune 411 011

Dealers & Exporters of

**'Zenith' Brand Fire Extinguishers, Fire Engine,
Fire Pumps, Fire Appliances as per I. S. I. : Also
Available New Brand Imported CO₂, Nitrogen,
Oxygen, Air, Orgon Gas Cylinders.**

We also undertake repairing, recharging and
servicing contracts of all types of
FIRE EXTINGUISHERS.

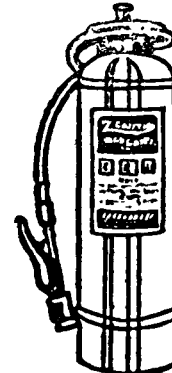
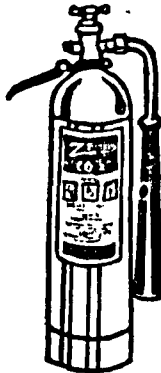

**'ZENITH' Brand Fire Extinguishers are Approved by Tariff Advisory
Committee of General Insurance**

This information will prove invaluable to your relations residing abroad

Now Indians residing abroad have an opportunity to deposit their savings as fixed deposit in India. This opportunity to earn Tax-free interest is open to the persons of Indian origin as well. State Bank of Saurashtra accepts fixed deposits from Non-Resident Indians for a period of 12 months

to 60 months. Such deposits are accepted in pounds sterling or US dollars. The deposits earn interest repayable in the currency in which they are deposited.

- These deposits are not affected by exchange risks.
- Prior approval of the Reserve Bank of India is not needed for the repatriation of deposits and interest.
- Deposits earn Tax-free interest in foreign currency.

For instant, personalised and smiling service

**STATE BANK OF
SAURASHTRA**



For further details contact :
**Public Relations Officer,
STATE BANK OF
SAURASHTRA**

*P. B. No. 51, Bhavnagar, 364 001.
(Gujarat) India.*

Labour Research and Consultancy Bureau

The Labour Research and Consultancy Bureau, Pune, is a registered body under the Societies Registration Act of 1860, and the Bombay Public Trust Act of 1950.

The objectives of the Bureau, since the registration in November 1972, are to provide education and training for leadership to industrial workers, and to provide some supportive and consultancy services to trade unions and industrial workers in relation to industrial disputes and various kinds of grievances.

The Bureau is a non-fee charging body, and is supported by well-wishers and donations.

The Bureau functions from the main office at St. Ignatius Church, 45, Burr Road, Khadki, Pune 3. (Phone No. 57179) and also from the branch at 631, Sachpir Street, Pune 1. (Phone No. 23733)

The Bureau runs the Kamgar Sadan Library and also has a special Law Library. The annual subscription is only Rs. 10/—. The Library has got a wide range of books to cater to various tastes.

STAR RADIO & ELECTRONICS

Near S. T. Depot, Sangli

Phone No. 2200

SPECIALIST IN SERVICING OF

- ELECTROMEDICAL APPARATUS X-RAY, CARDIOGRAM ETC.
- TIMER AND TEMPERATURE CONTROL
- ELECTRONIC SPEED CONTROL FOR SUGAR FACTORIES
- ELECTRONIC AUTOMATIC VOLTAGE REGULATOR FOR TURBO ALTERNATER
- TAPERECORDER AND ELECTRONIC INSTRUMENTS

"A Bank for Progress and Prosperity"

JANASEVA SAHAKARI BANK LTD.

Gandhi Chowk, Hadapsar,
Pune 411 028

Contact personally for all types
of attractive deposit scheme,
according to your needs.

| | |
|------------------------|------------------------|
| Hadapsar Branch | Shanipar Branch |
| Time | Time |
| From 2-30 to 6-30 p.m. | 9-00 to 11-00 a.m. |
| Except Saturday | 5-30 to 7-50 p.m. |
| Tel. 7481 | Tel. 449579 |

J. N. MARSHALL PRIVATE LIMITED

PUNE 411 018

**Process Steam
and
Instrumentation Engineers
We Undertake
Complete Study of Your Plant
and Help to
Design—Construct—Commission
Process Steam Generation Plants
Distribution and Condensate Systems
Fuel Economy Measures
and
Industrial Process Control
Instrumentation
Consult Us for Your Problems**

DECCAN EMBROIDERY MANUFACTURING CO.

**39/1 A, Wellesley Road, Sangam Bridge,
PUNE 411 001**



Manufacturers of
**Sewing Thread
Cotton Yarns**



**Phone : 26316
20741**

**Grams : VALCORD
Branches at : Delhi,
Calcutta, Hyderabad.**

II. PROFESSIONAL SERVICES

ARCHITECTS

- APTE PRAKASH U.**
658 J. M. Road, Pune 4.
- APTE V. S.**
1635 Sadashiv Peth, Gopal Gayan Samaj Road, Pune 30.
- ARANKALE R. V.**
772 Deccan Gymkhana, Pune 4.
- ARCHITECTS UNITED**
31/1 Karve Road, Pune 4.
- BADVE V. V.**
891 Bhandarkar Institute Road, Pune 4.
- BANEY K. P.**
'Devi Nivas', 1161/10 Shivajinagar, Pune 5.
- BAPAT ASHOK N.**
1194/4 Shivajinagar, Pune 5.
- BHARUCHA & CO.**
Kutika, 31/3 Pune-Solapur Highway, Pune 1.
- B. H. BAGBAN & ASSOCIATES**
2nd floor, Alankar Cinema Building, 16 Waswani Road, Pune 1.
- BHAGAT VASANT R.**
19 Wilson Garden, Pune 1.
- BHENDE U. V.**
204 Parvati, Pune 9.
- BODHANI RATNAKAR S.**
33/6 Erandawana, Pune 4.
- CHANDAN ARCHITECTS**
436 Shaniwar Peth, Pune 30.
- CHANDRACHUD Y. R.**
'Ratnaprabha',
1102 Shukrawar Peth, off Tilak Road, Pune 2.
- CHAVARE S. B.**
458/3 Chitrakuti, 2nd floor, Tilak Road, Pune 30.
- CHIMBALKAR VILAS R.**
31 Savarkar Nagar, Pune 9.
- CREATORS**
216 Rasta Peth, Pune 11.
- DANDEKAR ANIL S.**
Alhad, 767/4 Bhandarkar Institute Road, Pune 4.
- DATE SHARAD D.**
9A/2 Budhwar Peth, Bajirao Road, above Vaibhav Sadi Centre, Pune 2
- DEO VINAYAK G.**
115 Budhwar Peth, Pune 2.
- DEODHAR BALWANT G.**
'Vastu Kalp', 1607 Sadashiv Peth, Pune 30.
- DESHMUKH N. L.**
452 Gokhale Road, Pune 16.
- DESHMUKH V. K.**
623/5-A Deshmukhwadi, Sadashiv Peth, Pune 30.
- DESHPANDE C. B.**
1243/4 Shivajinagar, Pune 4.
- DESHPANDE MAKARAND P.**
637 Shukrawar Peth, Pune 2.
- DHAIRE SURESH M.**
32/3 Avinash Smriti, Shuvajinagar, Pune 5.
- DHARNE SURESH V.**
2145 Sadashiv Peth, Vijayanagar Colony, Pune 30.
- DIGHE SUHAS**
32/464 Lokmanyagar, Pune 30.
- DONGRE & DONGRE ASSOCIATES**
'Manik Jyoti', Jangli Maharaj Road, Pune 4.
- DONGRE RAJIV U.**
'White Lotus', opp: Kamla Nehru Park, Pune 4.
- DONGRE UMAKANT W.**
'White Lotus', opp. Kamala Nehru Park, Pune 4.
- D. P. NAGARKAR & CO.**
759/45 Deccan Gymkhana, Pune 4.
- GANDHE J. V.**
'Indraprastha', 1134/1 Shivajinagar, Pune 16.
- GESOTA M. J.**
1243/3 Apte Road, 'Saroj Sadan', Pune 4.
- GHAYAL L. R.**
302 Jail Road, Pune 6.
- GHOCALE RANJIT T.**
10/A Shivajinagar, opp. Akashwani, Pune 5.
- GHOTING & DONGRE**
Manik Jyoti, J. M. Road, Pune 4.
- GHOTING M. P.**
Suyog, 101/3 Bhamburda, off Chaturshringi Road, Pune 16.
- GODSE ASILATA G.**
1206/1 B Shivajinagar, opp. Sambhaji Park, Pune 4.

- GOLE DILIP G.**
34 Vijaynagar Colony, Sadashiv Peth,
Pune 30.
- JOHN C. I.**
Southern Asia Division of Seventh-
day Adventists Office, Salisbury Park,
Post Box 15, Pune 1
- JOSHI ARCHITECTS**
123/4 A Radhakrishna, Erandawana,
Pune 4.
- K. B. MAHINDRAKAR & ASSO-
CIATES**
52/53 Ghorpuri Bazar, Pune 1.
- KADAM HEMANT M.**
75 Shivaji Housing Society, Pune 2.
- KARANDIKAR V. V.**
101 Shivajinagar, Pune 5
- KELKAR MOHAN R.**
25 Budhwar Peth, Appa Balwant
Chowk, Pune 2.
- KELUSKAR MOHAN M.**
12 Budhwar Peth, Pune 2.
- KHADILKAR M. D.**
543/2 Sadashiv Peth, Laxmi Road,
Pune 30.
- KHAIRE KENJALE**
'Surshee', 146 Lakaki Road, Pune 16.
- KHANDEKAR ARUN**
50 (New) Narayan Peth, Pune 30.
- KHANDEKAR G. K.**
613/14 Sadashiv Peth, Pune 30.
- KHANDEKAR SUBHASH V.**
1574 Sadashiv Peth, Tilak Road,
Pune 30.
- KOPARKAR S. V.**
8/29 Mira Society,
Shankarshet Road, Pune 9.
- K. S. TANDALE & ASSOCIATES**
11 (Old) Narayan Peth, Pune 30.
- KULKARNI R. M.**
143 Shukrawar Peth, Shinde Ali,
Pune 2
- KULKARNI S. N.**
683 A B. Chowk, Budhwar Peth,
Pune 2
- LIMAYE D. R.**
'Kanchanganga',
1187/4 B, Shivajinagar, Pune 5.
- M. M. D. R. ARCHITECTS &
ENGINEERS**
132 Shaniwar Peth, Pune 30.
- MALWAD R. N.**
133 D, Plot No. 7, Parvati,
Pune 30.
- MANGALE BHANDARI & ASSO-
CIATES**
'Shradha', 813-B Bhandarkar Institute
Road, Shivajinagar, Pune 4.
- MARATHE SASHIKANT B.**
405/9 Harihar Niketan, Narayan
Peth, Pune 30.
- MASTER ZAHIR**
931 New Budhwar Peth, 2nd floor,
Pune 2.
- MODERN ARCHITECTS**
13 (old) Narayan Peth, Pune 4.
- MULAY MORESHWAR P.**
21/B 'Akshar', Laxmi Park, Pune 30.
- MULGUD SHRIKANT V.**
465 Shanwar Peth, Pune 30.
- NACHIKET & JAYOO PATWAR-
DHAN**
'Sitaram', Prabhat Road, Pune 4.
- NAGRAJ S. R.**
3D Bank of India Colony, Dattawadi,
Pune 30.
- NAGARKAR ACHYUT P.**
1204/12 Shivajinagar, Pune 4.
- NAGARKAR V. G.**
461 Narayan Peth, Pune 2.
- NANAL ARUN N.**
24 Mane Mansion, F. C. Road,
Pune 4.
- PADHYE VIJAY B.**
759/94C, Prabhat Road, Pune 4.
- PAGADIWALA NAWAL P.**
27 Main Street, Pune 1.
- PAJNIGER D. J.**
873 Dastur Meher Road, Pune 1.
- PALSHIKAR MADHAV G.**
425/30 T. V. Colony,
Veer Sawarkar Nagar, Pune 9.
- PARADKAR R. S.**
1614 V. V. Gadkari's Bunglow,
Sadashiv Peth, Pune 30.
- PATIL P. P.**
61/A New Timber Market, Pune 2.
- PERSPECTO INTERIOR DESI-
GNERS**
2038 Sadashiv Peth, Tilak Road,
Pune 30.
- PESHAVE & ASSOCIATES**
339/C Rasta Peth, Pune 11.
- PINGLE SHRIKANT N.**
1202/2-B, Apte Road, Pune 4.
- P. H. KUBER & CO.**
'Adwait', 9/2 Erandawana, Karve
Road, Pune 4.
- PRAGAT SHILPI**
379 Shaniwar Peth, Near Kanya
Shala, Pune 30.
- PUNDLIK & PUNDLIK**
'Purti', 1304/19 Shukrawar Peth,
Pune 2.

- PUNDLIK AVINASH R.**
'Sam', 425/11 Tilak Vidyapeeth Colony, Pune 9.
- RANADE A. M.**
'Chitrashala Bhuwan',
354 Narayan Peth, Laxmi Road,
Pune 30.
- RAWAT RAJPATHAK**
479 Sadashiv Peth, Tilak Road,
Pune 30.
- RAWAT SHRIKANT S.**
69/B Parvati, Pune 30.
- SALUNKHE SHAM A.**
78 Nana Peth, Pune 2.
- SALVI SURESH A.**
943 Bootee Street, Pune 1.
- SANE Y. S.**
'Renuka Apartments',
135/5 Erandawana, Pune 4.
- SANT P. V.**
573/6 Jangli Maharaj Road,
Pune 4.
- SARDAR ABHAYKUMAR G.**
1243/2 Apte Road, Pune 4.
- SARDESAI VAJKUNTH R.**
'Sutung', 1206/A/23 Shivajinagar,
Pune 4.
- S. B. THORAT & PARTNERS**
1258 Jangli Maharaj Road, Pune 4.
- SETHNA H. K.**
22 Sahney Sujan Park, Pune 1.
- SHAH ARVIND C.**
Kashi Krupa, 1085 Shukrawar Peth,
Pune 2.
- SHARMA ABHAYA B.**
Architects United
31/1 Karve Road, Pune 4.
- SHASHIKANT CHAVAN & ASSO-
CIATES**
2152 Sadashiv Peth, opp. Neelayam
Theatre, Pune 30.
- SHILPA RATNA**
30 Guru Nanak Nagar,
Shankarshet Road, Pune 2.
- SHILPAREKHA**
90 Kasaba Peth, Pune 11.
- SONTAKKE SHASHIKIRAN S.**
1038/9 Chaturshringi Road,
Pune 16.
- STRUCTURES**
766/2 P. Y. C. Gymkhana Colony,
'Suyash', Deccan Gymkhana,
Pune 4.
- STUDIO COLLABORATIVE**
1246 Apte Road,
Deccan Gymkhana, Pune 4.
- STUDIO UNITED**
620 Sadashiv Peth, Pune 30.
- SULE SUBODH G.**
1794 Sadashiv Peth, Pune 30.
- S. V. NATEKAR & SONS**
1206, 13/15 Shivajinagar, D. G.,
Pune 4.
- TAMARCH**
719-20 Narayan Peth,
Motiwale Apte Building, 1st floor,
Umbrya Ganapati Chowk,
Laxmi Road, Pune 30.
- TAMBE JAGDISH T.**
1616 Erandawana, Pune 4.
- TANDALE K. S.**
11 Narayan Peth, opp. Post Office,
Pune 30.
- THITE LAXMAN S.**
18 Shivajinagar, Pune 5.
- TRIO ARCHITECTS**
603 Sadashiv Peth, Laxmi Road,
Pune 2.
- UPLEKAR ANAND R.**
940 Model Colony, Canal Road,
Pune.
- VAIDYA SUDHAKAR DINKAR**
603 Sadashiv Peth, Laxmi Road,
Pune 2.
- VARTAK RAMESH S.**
38/582 Lokmanya Nagar, Pune 30.
- VASTU-VIKAS**
Gangavataran Dashbhuj Ganesh
Society, near Poud-Fata, Karve Road,
Pune 4.
- V. A. TAMHANKAR & CO.**
481/3 Shree Prasad Society, Parvati,
Pune 9.
- V. B. DESHPANDE &
ASSOCIATES**
462/2 New Sadashiv Peth,
opp. Vithal Mandir (Alka Theatre),
Pune 30.
- VIKASARCH ASSOCIATES**
'Saakar', 30 Shailesh Society,
Maharshi Karve Nagar, Pune 29.
- V. M. Ghaisas & Co.**
425 Sadashiv Peth, Khajina Mahal,
Pune 30.

BANKS**STATE BANK GROUP****STATE BANK OF INDIA**

DECCAN GYMKHANA BRANCH
Post Box No. 4,
Jangali Maharaj Road, Pune 4.

DEHU ROAD BRANCH
Post. Dehu Road,
Near Radway Station, Pune

THIMMAYYA ROAD BRANCH
Thummayya Road,
Opp. Poona Herald Office, Pune 1.

ERANDAWANA BRANCH
Patwardhan Baug,
Col. Araj's Bungalow, Pune 4.

N.D.A. KHADAKWASLA BRANCH
Khadakwasla, Pune.

PIMPRI BRANCH
Pimpri P. B. No. 5, Pune 18.

CITY BRANCH
Laxmi Road, P. B. No 5, Pune 2.

TILAK ROAD BRANCH
Commercial Building, Pune 2

CAMP BRANCH
29 Dr Ambedkar Road,
P. B. No. 6, Pune 1.

KHADKI BRANCH
3 Napier Road, Pune 3.

N. C. L. CAMPUS SUB-OFFICE
N. C. L. Campus, Pune 8.

I. A. T. SUB-OFFICE
Institute of Armament Technology
Campus, Girinagar, Pune 25.

STATE BANK OF MYSORE

SHANKARSHET ROAD BRANCH
322/1 Shankarshet Road, Pune 9.

GOKHALE NAGAR BRANCH
390 Gokhalenagar, Pune 16.

STATE BANK OF SAURASHTRA

SADASHIV PETH BRANCH
618 Sadashiv Peth, Pune 30.

STATE BANK OF BIKANER & JAIPUR

SADASHIV PETH BRANCH
954 Sadashiv Peth, Pune 30.

STATE BANK OF HYDERABAD

NARAYAN PETH BRANCH
360/369 Narayan Peth, Pune 30.

NATIONALISED BANKS**ALLAHABAD BANK**

MAIN BRANCH
613 Sadashiv Peth, Pune 30.

MANJARI BRANCH
Pune 1.

BANK OF BARODA

CITY BRANCH
Post Box No. 503, Nagar Wachan
Mandir Bldg., Laxmi Road, Pune 2.

SADASHIV PETH BRANCH
Pune Vidyarthi Griha Bldg.,
1786 Sadashiv Peth, Pune 30.

SENAPATI BAPAT ROAD BRANCH
Senapati Bapat Road, Pune 16.

SHIVAJINAGAR BRANCH

1303 Jangali Maharaj Road,
Shivajinagar, Pune 5.

STATION ROAD BRANCH
Post Box No. 26, 15-A Sadhu
Vaswani Peth, Pune 1.

N. WADIA COLLEGE BRANCH
N. Wadia College, Pune 1.

SUBHASHNAGAR BRANCH
1302 Sanas Estate, Subhashnagar
Colony, Shukrawar Peth, Pune 2.

KARVE ROAD BRANCH
Darekar Heights, 32 Karve Road,
Pune 4.

CHINCHWAD BRANCH
Post Box No. 20, Olympic House,
Bombay-Poona Road, Pimpri, Pune
18.

M. S. A. CELL BRANCH
Pune Vidyarthi Griha Bldg.,
1786 Sadashiv Peth, Pune 30.

CAMP BRANCH
Post Bag No. 39, 2 Moledina Road,
Camp, Pune 1.

BANK OF INDIA

CAMP BRANCH
8/A Dr. Coyaji Road,
Post Box No. 56, Pune 1.

BHAWANI PETH BRANCH
Final Plot No. 259-B/1,
Opp. Timber Market, Pune 2.

DASHABHUJA GANAPATI BRANCH
Plot No. 4, C.T.S. 584, Parvati,
Pune 9.

FERGUSON ROAD BRANCH
1201 C/A Shivajinagar, Pune 4.

- HADAPSAR BRANCH**
Hadapsar Industrial Estate,
Post Box No. 1, Pune 13.
- KARVE ROAD BRANCH**
65/1/B Erandawana,
Karve Road, Pune 4.
- KHADKI BRANCH**
New Bazar, M. G. Road, Khadki,
Pune 3.
- KOREGAON PARK BRANCH**
Hotel Blue Diamond, 11 Koregaon
Road, Pune 1.
- NAVI PETH BRANCH**
Ravi Building, 8/2 Sadashiv Peth,
Near Alka Talkies, Pune 30.
- LAXMI ROAD BRANCH**
592 (New) Sadashiv Peth,
Post Box No. 541,
Laxmi Road, Pune 30.
- PASHAN ROAD BRANCH**
Plot 3, Bhuvaneshwar Co-op. Housing
Society, Pashan Road, Pune 8.
- PIMPRI BRANCH**
Pimpri P. F., P. B. No. 1, Pune 18.
- CITY BRANCH**
181 Budhwar Peth, Post Box No.
508, Pune 2.
- RASTA PETH BRANCH**
Apollo Talkies Compound, 594
Rasta Peth, Pune 11.
- SHANIPAR BRANCH**
1439 Shukrawar Peth, Pune 2.
- SHIVAJINAGAR BRANCH**
F P. No. 36/1 Bombay-Poona Road,
Wakadewadi, Pune 3.
- SWARGATE BRANCH**
34/35 Parvati Darshan Road,
Swargate, Pune 9.
- TILAK ROAD BRANCH**
431/112 Shukrawar Peth,
Tilak Road, Pune 9.
- BANK OF MAHARASHTRA**
- AKURDI BRANCH**
Bombay-Poona Road,
Akurdi, Pune 35.
- BHOSARI BRANCH**
Landgewadi, Landge Building,
Bombay-Poona Road,
Bhosari Gaon, Pune 26.
- LONI KALBHOR BRANCH**
H. No. 86, Poona-Sholapur Road,
Loni-Kalbhori, Tal. Haveli (412 201).
- AUNDH BRANCH**
Jayanand Patil Building,
Ganeshkhind Road, Aundh, Pune 7.
- BAJIRAO ROAD BRANCH**
Mahabank Building,
1177 Budhwar Peth, Pune 2.
- BHAWANI PETH BRANCH**
Sanas Building, 122 Bhawani Peth,
Gul Ali, Mahatma Phule Road,
Pune 2.
- KASARWADI BRANCH**
opp. S. T. Bus Stop,
Bombay-Poona Road,
Kasarwadi, Pune 18.
- CAMP BRANCH**
Khudamurd, 628-29 Sachapir St.,
Camp, Pune 1.
- CHINCHWAD BRANCH**
Satish Chambers, opp. Post Office,
Station Road, Chinchwad,
Pune 33.
- DAPODI BRANCH**
35/B Bombay-Poona Road,
Dapodi, Pune 12.
- DECCAN GYMKHANA BRANCH**
Dawar Building, 1257 Shivajinagar,
Deccan Gymkhana, Pune 4.
- ERANDAWANA BRANCH**
Opp. Kamala Nehru Park,
Erandawana, Pune 4.
- MAHATMA PHULE PETH
BRANCH**
Dr. Dillal Building,
103 Mahatma Phule Peth, Pune 2.
- GURUWAR PETH BRANCH**
R. K. Madiwale Building,
193/94 Guruwar Peth,
Phulwale Chowk, Pune 2.
- HADAPSAR BRANCH**
Mahabank Building,
Hadapsar Industrial Estate, Pune 13.
- KARVE ROAD BRANCH**
Ayurved Rasashala Bldg.,
25 Karve Road, Pune 4.
- KASBA PETH BRANCH**
Allanapadas House, Ganesh Road,
19 Kasba Peth, Pune 11.
- KHADKI BRANCH**
'Deepshri', 156 Old Bazar,
Khadki, Pune 3.
- KOTHRUD BRANCH**
Borse Building, 1/2 Karve Road,
Pune 29.
- LAXMI ROAD BRANCH**
Mahabank Building,
93/2 Budhwar Peth,
Laxmi Road, Pune 2.
- MUNDHWA BRANCH**
59/B Mundhwa, Pune 36.
- NANA PETH BRANCH**
Khan Building, 550 Nana Peth,
Laxmi Road, Pune 2.

- NARAYAN PETH BRANCH**
Kesari Wada, 568 Narayan Peth,
Pune 30.
- NAVI PETH BRANCH**
Plot No 720/16, 'Yogchandra',
104 Navi Peth, Pune 30.
- PADMAVATI BRANCH**
'Sushil Dulta',
Sangam Co-op. Housing Society,
Padmavati, Pune 9
- PARVATI BRANCH**
'Indira', Pradhan Building,
84 Parvati, Pune 9.
- PAUD ROAD BRANCH**
48 Ex-Servicemen Colony,
Paud Road, Pune 4.
- PIMPRI BRANCH**
Bombay-Poona Road,
Pimpri, Pune 18
- RAVIWAR PETH BRANCH**
D. D. Khinvasara Bldg,
367 Raviwar Peth, Pune 2.
- SAHAKARNAGAR BRANCH**
Pune Vidyarthi Griha Bldg,
Sahakarnagar, Pune 9.
- SALISBURY PARK BRANCH**
548/17 Salisbury Park Road,
Pune 1.
- SHANKARSHETH ROAD
BRANCH**
290/17 Pandit Jawaharlal
Nehru Marg,
Shankarsheth Road Chowk,
Pune 9.
- SHIVAJINAGAR BRANCH**
Kashinath Prasad,
Pashankar Building,
364/65 Shivajinagar, Pune 7.
- AUNDH BRANCH**
Hare Ram Hare Krishna Sadan,
436 Sindh Co-op. Hsg. Society,
Aundh, Pune 7.
- SOMWAR PETH BRANCH**
Agarkar High School Bldg,
444 Somwar Peth, Station Road,
Pune 11.
- SATARA ROAD BRANCH**
Shashi Chambers, Plot No. 2,
Pune-Satara Road, Pune 9.
- TILAK ROAD BRANCH**
S P. College Compound,
Tilak Road, Pune 30.
- GULTEKDI BRANCH**
Trimurthi Building,
425/88 T.M.V. Building,
Veer Savarkar Marg,
Gultekdi, Pune 9
- UNIVERSITY ROAD BRANCH**
132B Plot No. 2.
University Road, Pune 7.
- VISHRANTWADI BRANCH**
Dattaram Bhavan, Survey No 113/4
Vishrantwadi, Pune 15.
- YERAWADA BRANCH**
Gugle Building,
1137/D Pune-Nagar Road,
Yerawada, Pune 6
- GHORPADI BRANCH**
L. G. Gupta Building,
54 Ghorpadi Bazar, Pune 1.
- PUNE UNIVERSITY
CAMPUS SUB-OFFICE**
Pune 7.
- CANARA BANK**
- BHAWANI PETH BRANCH**
Post Box No. 509, Pune 2.
- CAMP BRANCH**
Post Box 21, Pune 1.
- DECCAN GYMKHANA BRANCH**
Pune 4.
- GHORPADI BRANCH**
Pune 1.
- HADAPSAR BRANCH**
Pune 28.
- KHADKI BRANCH**
Pune 3.
- CITY BRANCH**
Laxmi Road, P. B. No. 524,
Pune 2.
- MODEL COLONY BRANCH**
Post Box No. 1, Pune 16.
- RAMWADI BRANCH**
Pune 14.
- SADASHIV PETH BRANCH**
Pune 30.
- SWARGATE BRANCH**
Pune 2.
- LOHOGAON BRANCH**
Pune 32.
- PIMPRI BHOSARI BRANCH**
Industrial Estate, Pune 18.
- CENTRAL BANK OF INDIA**
- CAMP BRANCH**
P. B. No. 41,
317 M. G. Road, Pune 1.
- CITY BRANCH**
1768 Shukrawar Peth,
Laxmi Road, P. B. 576, Pune 2.
- PIMPRI BRANCH**
S. No. 210/12, Station Road,
Post Box 18, Pimpri, Pune 18.
- DECCAN GYMKHANA BRANCH**
759/5 Deccan Gymkhana, Pune 4.
- BHAWANI PETH BRANCH**
1209 New Chanduseth Oswal Bldg,
Pune 2.

- TILAK ROAD BRANCH**
Sahyadri Sadan, Pune 30.
- SWARGATE BRANCH**
Plot No. 3. Mukundnagar, Pune 9.
- SHANKARSHET ROAD BRANCH**
37/2 Shankarshet Road, Pune 9.
- SHIVAJINAGAR BRANCH**
Post Box 21, 529/2-A Lakaki Road,
Pune 16.
- SHUKRAWAR PETH BRANCH**
P. B. 625, Kenjale Building,
345 Shukrawar Peth, Pune 2.
- RASTA PETH BRANCH**
K.E.M. Hospital Bldg.,
Sardar Mudaliar Road, Pune 11.
- HADAPSAR BRANCH**
79/2 Pune-Solapur Road,
Opp. A.S.P.T., Pune 13.
- YERAWADA BRANCH**
161 Yerawada, Pune 6.
- FERGUSON COLLEGE BRANCH**
Fergusson College,
Near Amphi Theatre, Pune 4.
- ARANYESHWAR BRANCH**
S. No. 47, Bakre's Building,
Parwati, Pune 9.
- AKURDI BRANCH**
Shah Chambers, S. N. 169,
Pune 35.
- REGIONAL OFFICE**
3/7 M. G. Road, Pune 1.
- DENA BANK**
- MAIN BRANCH**
840 Budhwar Peth, Pune 2.
- BHAWANI PETH BRANCH**
266/A Bhawani Peth, Pune 2.
- BUDHWAR PETH BRANCH**
615 Budhwar Peth, Pune 2.
- CAMP BRANCH**
31/32 M. G. Road, Pune 1.
- DECCAN GYMKHANA BRANCH**
Pune 4.
- RAVTWAR PETH BRANCH**
Pune 2.
- SWARGATE BRANCH**
Pune 2.
- LAXMI ROAD BRANCH**
Pune 2.
- INDIAN BANK**
- LAXMI ROAD BRANCH**
734 Budhwar Peth, Laxmi Road,
Pune 2.
- NANA PETH BRANCH**
614 Nana Peth, Pune 2.
- DECCAN GYMKHANA BRANCH**
759/61 Prabhat Road, Pune 4.
- SADASHIV PETH BRANCH**
1025 Sadashiv Peth, Pune 30.
- INDIAN OVERSEAS BANK**
- LAXMI ROAD BRANCH**
840 Laxmi Road, Pune 2.
- A. F. M. C. CAMP BRANCH**
Pune 1.
- PUNJAB NATIONAL BANK**
- CAMP BRANCH**
M. G. Road, Camp, Pune 1.
- CITY BRANCH**
Laxmi Road, Pune 2.
- KHADKI BRANCH**
New Bazar, Khadki, Pune 3.
- C.M.E. CAMP BRANCH**
Bhopakbede, Pune 13.
- PASHAN BRANCH**
Pashan, Pune 8.
- BHOSARI BRANCH**
Bhosari Industrial Estate,
Pune 26.
- SYNDICATE BANK**
- SHIVAJINAGAR BRANCH**
1216/7 Fergusson College Road,
Post Box No. 818,
Shivajinagar, Pune 4.
- LAXMI ROAD BRANCH & CITY
H. O.**
Laxmi Road, Pune 30.
- PHULE MARKET BRANCH**
578 Shukrawar Peth, Pune 2.
- CAMP BRANCH**
Hotel Amir Bldg., Pune 1.
- GULTEKDI MARKET YARD
BRANCH**
Pune 9.
- CHINCHWAD BRANCH**
202 Bombay-Poona Road, Pune 19.
- UNION BANK OF INDIA**
- VADGAON BRANCH**
Survan Building, Bombay-Poona
Road, Vadgaon (Maval), Pune.
- CAMP BRANCH**
284 M. G. Road, Pune
Cantonment, Pune 1.
- MODEL COLONY BRANCH**
1099/182 Model Colony,
Ganeshkhind, Pune 16.
- LAXMI PARK BRANCH**
F. P. No. 989, Laxmi Park,
Lal Bahadur Shastri Marg,
Navi Peth, Pune 30.

- BHAWANI PETH BRANCH**
290/1 New Timber Market Road,
Bhawani Peth, Pune 2.
- PIMPRI BRANCH**
414/3 Kasarwadi, Bombay-Poona
Road, Pimpri, Pune 18.
- PAUD BRANCH**
P. O. Paud, Tal Mulshi, Pune
- RAVIWAR PETH BRANCH**
189 Raviwar Peth, Pune 2
- TILAK ROAD BRANCH**
Udyog Bhavan, Block C, Tilak
Road, Pune 2.
- KARVE ROAD BRANCH**
21/2 Karve Road, Deccan
Gymkhana, Pune 4.
- UNITED BANK OF INDIA**
15 Waswani Road, Pune.
- UNITED COMMERCIAL
BANK**
- CAMP BRANCH
AND PUNE OFFICE**
79 off M G. Road, Pune 1.
- CITY BRANCH**
659 Sadashiv Peth, Laxmi Road,
Pune 30.
- SHIVAJINAGAR BRANCH**
S.S.C. Board Bldg., Pune 10.
- RAVIWAR PETH BRANCH**
80 (New) Raviwar Peth, Pune 2.
- DECCAN GYMKHANA BRANCH**
891 Bhandarkar Institute Road,
Pune 4.
- YERAWADA BRANCH**
1237 Yerawada Nagar, Pune 6.
- PIMPRI BRANCH**
Bombay-Poona Road, Pimpri,
Pune 18.
- HADAPSAR BRANCH**
Jiyaji Mansion,
225/9/A Solapur Road, Pune 28.
- GANESHKHIND BRANCH**
Shivasagar Apartments, Pune 16
- COMMERCIAL BANKS**
- BANK OF KARAD LTD.**
Budhwar Peth, Branch,
24 Budhwar Peth, Pune 2
- CORPORATION BANK LTD.**
Nana Peth Branch,
582 Nana Peth, Pune 2
- LAXMI COMMERCIAL
BANK LTD.**
Budhwar Peth Branch,
176 Budhwar Peth, Pune 2.
- LAXMI VILAS BANK LTD.**
Narayan Peth Branch,
658 Narayan Peth, Pune 30.
- MIRAJ STATE BANK LTD.**
Somwar Peth Branch,
27/2 Somwar Peth, Pune 11.
- NEW BANK OF INDIA LTD.**
Camp Branch,
17 M. G. Road, Pune 1.
- ORIENTAL BANK OF
COMMERCE LTD.**
Nana Peth Branch,
329 Nana Peth, Pune 2.
- PUNJAB & SIND BANK LTD.**
Camp Branch,
1156 Exhibition Road, Pune 1.
- THE SANGLI BANK LTD.**
- RAVIWAR PETH BRANCH**
455 Raviwar Peth, Pune 2.
- BUDHWAR PETH BRANCH**
179/B Budhwar Peth, Pune 2.
- SADASHIV PETH BRANCH**
361 Sadashiv Peth, Pune 30.
- DECCAN GYMKHANA BRANCH**
54 Deccan Gymkhana, Pune 4.
- SHIVAJINAGAR BRANCH**
1123/B Shivajinagar, Pune 5.
- SWARGATE BRANCH**
692/9/1 Satara Road, Pune 9
- KARVE ROAD BRANCH**
66 Karve Road, Pune 4.
- SOUTH INDIAN BANK LTD.**
13 M. G Road, Pune 1
- VIJAYA BANK LTD.**
Regional Office,
241 Thimmayya Road, Pune 1.
- SADASHIV PETH BRANCH**
5 Sadashiv Peth, near Alka Talkies,
Post Box No. 710, Pune 30.
- CAMP BRANCH**
5 M. G Road, Pune 1.
- PIMPRI BRANCH**
1 Phiso Commercial Centre,
Station Road, Pimpri Chinchwad,
Pune 18.
- THE UNITED WESTERN
BANK LTD.**
- LAXMI ROAD BRANCH**
Ganapati Chowk,
6/1 Budhwar Peth, Pune 2.
- LOKMANYANAGAR BRANCH**
Dandekar Bridge, Pune 30.
- DECCAN GYMKHANA BRANCH**
Gokhale Chowk, Pune 4.
- TILAK ROAD BRANCH**
Santosh Bhuvan Chowk, Pune 30.
- PIMPRI CHINCHWAD BRANCH**
127 Telco Road, Chinchwad,
Pune 19.
- SADASHIV PETH BRANCH**
Chitrashala Chowk, Pune 30.
- TALEGAON DABHADE BRANCH**
Talegaon Dabhade, Dist. Pune.

अल्पावधीत सर्वांचा संपूर्ण विश्वास संपादन करून समाजकार्याच्या दृष्टिकोनातून
चालविलेली आदर्श बँक



भगिणी निवेदिता सहकारी बँक मर्यादित, पुणे

राष्ट्रभाषा भवन, ३८८ नारायण पेठ, पुणे ४११ ०३०

फोन : ४४४ ६३५

कामाच्या वेळा

गुरुवार ते सोमवार दुपारी २ ते ६ : मंगळवार दुपारी २ ते ४.

रविवारी बँक चालू राहिल : बुधवार साप्ताहिक सुट्टी.

बँकेची मे १९७८ अखेरची प्रगती

- स्थापना : गुढी पाडवा, २४ मार्च १९७४. खातेदार : २० हजारांचे वर.
 महिला सभासद : ३३००, पुरुष सभासद : १४०० शेअर भांडवल : ४,८०,००० रु.
 स्त्री-पुरुष सभासदांना कर्जवाटप ९० लाखांपेक्षा जास्त ठेवी ३५ लाख रु.

मुदत ठेव योजना, सेविंग्ज ठेव व दैनंदिन बचत योजना, मासिक आवतक ठेव योजना,
रामदुप्पट ठेव योजना या बचतीच्या आकर्षक फलदायी योजना

संचालक मंडळ

सौ. मीनाक्षी दाढे-अध्यक्ष, सौ. मालिनी बोडस-उपाध्यक्ष, सौ. सुलोचना बापट,
सौ. निर्मला चांदोरकर, सौ. शीला काळे-कार्यवाह, श्रीमती सरला रेगे,
सौ. नीला वासवानी, सौ. मंगला आदमणे, सौ. सुमित्रा गोवईकर,
सौ. सुलोचना पुरंदरे, सौ. प्रमिला गरुड, सौ. मोरा देशपांडे, सौ. विमल वाडेकर,
सौ. शुभदा वावळे, सौ. नलिनी आदमणे.

मॅनेजर : कु. नंदिनी बेडेकर जनरल मॅनेजर : व. प. गुंदेचा

सल्लागार मंडळ

श्री. वि. ग. दाढे, श्री. पु. म. बोडस, श्री. य. गो. जोशी

- रिझर्व बँकेचे लायसेन्स डिपॉझिट इन्शुरन्स कॉर्पोरेशनचे सभासदत्व
 कोणत्याही खात्यातील रु. २०,००० पर्यंतची ठेव विमा योजनेने सुरक्षित.

■ ठेवीवर १% अधिक व्याज !

■ नोकरवर्गांना पगाराच्या हमीवर कर्जाची सुविधा !

BEARING !

Thy name is 'NEW BALL BEARING !'

Here you will get all types, in all sizes, of all makes—

BALL, ROLLER & TAPER ROLLER BEARINGS !

THE NEW BALL BEARING COMPANY

Opp. Shivaji Statue, Shivajinagar, Pune 411 005.

Phone : 50312 & 52598

* The only source for getting quality Bearings of
SKF, NORMA, NBC, FAG & TIMKEN *

Also for 'Fenner V Belts', 'Nylon Leather Sandwich
Belts' contact us please !

PUNE : 444873 ←Telephones→ BOMBAY : 663404

Please Contact—

MAK CORPORATION

353/2 (Old) Narayan Peth, Pune 30.
3, Dandekar Bldg., Natakwala Lane,
Borivli (W), Bombay 400 092.

for

*Reliable Quality & Prompt Deliveries
of*

TRANSFORMER MATERIAL—

Plastik Bobbins, Bakelite Bobbins,
M. S. Clamps, Laminations,
Stampings.

PRESS TOOL JOBS—

Bakelite & M. S. Fabrication Jobs,
Plastic Moulding Items for
Electronics Industry

NEON-BULB(NE-2) & JEWEL LAMPS

CERAMIKA

21, Gultekdi Ind. Estate
Pune 411 009



Manufacturers of
Miniature Ceramics
for
Electronics
and
Electrical Use

EMENVEE SCIENTIFIC INSTRUMENTS PVT LIMITED

**Regd. Office & Factory : 'EMENVEE HOUSE'
14, Poona Small Scale Industrial Co-op. Estate Ltd.,
Gultekdi, Pune 411 009. (INDIA)**

Phone : 441323 & 441324

Telegram : 'EMENVEE' Pune



**Manufacturers of Specialised Scientific Apparatus
and Precision Instruments.**

EMENVEE PRODUCTS

**Rotary Shaker, Reciprocating Shaker, Incubator Rotary Shaker,
Automatic Fraction Collector, & Timer, Laboratory Fermentor,
Pilot Plant Fermentor, Peristaltic Pump, Bio-Flow Pump,
Roller Drum Apparatus,**



Phone : 440359

**M/s. TEJ TOOLS & GAUGES
MFG. COMPANY**

Shashi Chambers, 1st Floor,
2, Satara Road, Pune 411 009

Manufacturers of
Centre drills, chamfering
cutters, tools and plain and
taper plug gauges, plain and
taper ring gauges, gap and
width gauges, also various
other gauges.

With Best Compliments from

**LAXMI
ENTERPRISES**

Laxmi Road, next to Vijay Talkies
PUNE-30- Tel. 445107

Stockists of

**KARACHI
SWEET MART**
PUNE-1.

Try our Specialities

Kaju Pista Barfi—Malai Barfi
Fruit Barfi—Bengali Sweets
Shreekhand—Dry Fruits
Farsan—Pan Masala
Orders for Marriages-Parties
also accepted.

NICHROME METAL WORKS

46, Dr. Ambedkar Road, Pune 411 001

'Meet the new Member of Family'

After successfully putting more than 20 FILPACK-2500 & 5000 machines in various dairies throughout the country Nichrome Metal Works announce with pleasure their newest & latest MINI-FILPACK having a capacity of 800/1000 pouches/hour which will be most useful for medium sized Dairy.

For further information please write to :

**Commercial Manager,
Nichrome Metal Works,
46, Dr. Ambedkar Road, Pune 411 001.**

HELD UP? on Account of Carrying Problem?

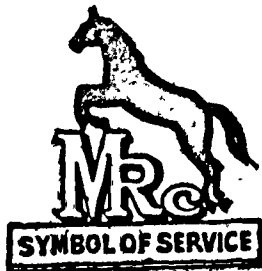

MAHARASHTRA ROAD CARRIER

**Nasik Phata, Bombay-Poona Road,
Pune 411 018.**

Phone : 83061

Gram : "ROADKING" PIMPRI

**Transport is our Business—Business With a Difference
Where the Individuals Behind the Business are
More Important and Matter More to Us
: We Say This and We Mean it :**

Modesty prevents us from claiming that we are the best in business, because we know our business and we can appreciate your business.

A trial order will convince you completely that we are the best.

If absolutely necessary, you may refer to :

1. M/s. Sandvik Asia Ltd.
2. M/s. K. S. B. Pumps Ltd.
3. M/s. Protos Engineering Co. Pvt. Ltd.
4. M/s. Kirloskar Group of Industries
5. M/s. Ajay Metachem Pvt. Ltd.
6. M/s. Emenvue Engineers

Service before self is our motto.

Avail our prompt services for the :

Stations :—Ahmedabad, Amritsar, Bangalore, Bokaro, Calcutta, Ernakulam, Gauhati, Hyderabad, Jaipur, Jammu, Jodhpur, Kanpur, Madras, Patna, Ranchi Etc.

Area Offices :

DELHI

97, Khanna Market
Tis Hazari, Delhi-110 054
Phone: 225887
Gram : "SAFESOUND"

CALCUTTA

3-B, Gangahdar Babu Lane
Calcutta-700 012
Phone : 347869
Gram : BIRAMKA"

MADRAS

20/21-A, Malayappan
Street, Mannady,
Madras 600 001
Phone : 27208

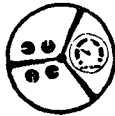

Industrial Electronics and Instruments

209, Narayan Peth, Pune 411 030

Phone : 444006

Authorised Sales & Service Centre for
 "YENKAY" Speedo-meters,
 Tachographs, Temperature, Fuel &
 Pressure gauges, Ammeters
 Specialists in Industrial Panel Instru-
 ments, Precision Instruments & ASCO
 Optical Instruments.

Speys Industrial Services

Regd. Office : 118 Shukrawar Peth
 Behind Fule Market, Pune 411 002,
 Phone 470347 Grams : 'Speys'

RUSH!



- For
- Chemicals
 - Plant and Equipment
 - Analytical Control
 - Supplies
 - Services IN
- Electroplating
 Metal Pretreatment
 Surface Finishing
 Anodising
 Electropolishing
 ...etc...etc.

“MARK ELEKTRA”

Rewinding & Repairing of Electric Motors,
 Transformers & Generators.
 Elec. Engineers & Consultants

Plot 15,
 Gultekadi Industrial Estate,
 Gultekdi, Pune 411 009
 Phones : 441090, 441098, 441149.

VAIRMA STUDIO

12, Moledina Road,
Pune 411 001

Tel. : 23404

**Industrial & Commercial
Photographers**

**QUICK DOCUMENT COPIES
BY XEROX PROCESS
ELECTRONIC STENCILING
& CYCLOSTYLING**

Phone : 83789 / 82868

STAR DYES & CHEMICAL INDUSTRIES

Plot No. A-27, 'H' Block
M. I. D. C. Pimpri,
PUNE 411 018

Manufacturers of :

- i) Cyanolgen Brill. Blue 3GX
(for cloth dyeing)
- ii) Cyanolgen Brill. Blue 3GK
(for yarn dyeing)
- iii) Colour Paste for FRP Polyester
- iv) Colour Paste for Leather
- v) STAR-22 (equivalent to NA-22) an
accelerator for Neoprene Rubber
- vi) Colours for Plastics.

With best wishes from



Star Rubber Products

B 23, H-Block, M. I. D. C. Pimpri, Pune 411 018

With best compliments from :



LUBRICARE

S—114, Pune 411 026

Tele. : 83510, 83548.

With best compliments from :

Sealoflex Rubber and Plastic Industries

Manufacturers of :

Quality Automobile, Electrical and Industrial Rubber and Plastic Components such as Oil Seals, Washers, Chevron Packings "O" Rings and Bushes and any other Components as per Customers' Requirements and Specifications.

| | |
|---|--|
| Head Office : | Pune Branch : |
| A37/39A, Industrial Estate, Ambedkar Road, Wadala, Bombay 400 031 | Plot No. 1, 'S' Block M I D C, Bhosari. Pune 411 026 |
| Tel. : 447412 | Tel : 83815 |

'M/S LA ROZ ELEGANCE'

37, 'S' M. I. D. C. Bhosari,
Pune 411 026.



**Products : (a) Wooden Parquet Flooring
(b) Panel Doors.
(c) Furniture.**

**Phone Nos : Office—448297
Factory—82021**

SONNENFLEX ABRASIVES

T-98, MIDC, Bhosari, Pune 411 026

Tel. : 83797, 82278

Manufacturers of

**Resine Bonded Reinforced Depressed
Centre and Cut-off Grinding wheels
For electrical and pneumatic hand tools**

In Technical Collaboration with

SONNENFLEX OF WEST GERMANY

We are

**Original Equipment with M/s. RALLIWOLF LTD
Manufacturers of Famed Electrical
Grinding Equipment.**

With Best Compliments From

Box Fab

**"S" 36 MIDC. Ind. Area, Bhosari,
Pune 411 026.**

**Mfgrs. of Corrugated Paper
Rolls, Sheets and Boxes,
Corrugated Boxes, Paper Board
Containers, Composite Tubes.
Etc.**

PLATRONICS

The Metallic Processors

**Plot W-1, S-Block
M. I. D. C. Estate, Bhosari
Pune 411 026**

**Plating and Processing to
I. S. I. and Defence
Specifications.
Quality Control from start to
finish.**

**Well equipped, modern
plant.**

HOLLYWOOD STUDIO and COLOR LABS

**Fergusson College Road,
Pune 411 004
Phone : 57575
Jangli Maharaj Road,
Pune 411 004
Phone : 56565**

AJAY ENGINEERING WORKS

**15-A, Pune-Bombay Road,
'Bhale Estate' Pune 411 003.**

Phone : Factory - 58871
Residence - 56673

*Manufacturers of Air and Fuel
Oil Filters to Customers'
Specification.*

UBIQUE ENTERPRISES

**462 Kaka Halwai Industrial Estate, Satara Road. Pune 411 009
(India)
Phone Nos. Works : 448511 Res. 56753**

Manufacturers of

- (1) Bursting Strength Tester (Hand Operated or Power Operated) for Paper, Corrugated boards etc.
- (2) Puncture Resistance Tester for Paper, Corrugated Boards etc.
- (3) Substance Indicator for determining the substance of Paper in direct g. s. m.
- (4) Packaging Testing Equipment
- (5) Oil Seal Lip Opening Pressure Test Rig.
- (6) Drill Grinding Attachments.
- (7) Metallurgical Polishing Machines and many other products.

**Used Petroleum Oils Refined to Original Standard.
You Can Save Wonderfully on Your Oil Costs**

Try

**Ameet
Lubricants
& Chemicals**

**Reclaimers, Processors and Dealers of Automotive and
Industrial Lubricants.**

15, A, Bombay-Poona Road, Pune 411 003

Telephone : FACTORY : 58871
RESIDENCE : 56140

Estd : 1920

Phone : 449174

**Painter
BEDEKAR A. G.**

GOLD MEDALLIST

**HOARDING CONTRACTORS
Sign Board Painter, Plastic
Glow signs, Screen Printing and
Rubber Stamps Suppliers.**

Budhwar Chowk, Pune (City)

No Branch Any Where.

With Best Compliments from :

QUALITY STEEL CASTINGS

**45, Dr. Ambedkar Road
Pune 411 001**

Manufacturers of :

- Spare components for Shot Blasting Machines of various makes
- Stainless Steel Unions for Dairies, Pharmaceuticals etc.
- Alloy Steel Castings
- Heat Resistant Steel Castings
- Wear/Abrasion Resistant Castings

We fabricate Plants and Equipments for Chemical, Pharmaceutical and Textile Industries out of

Stainless Steel, Mild Steel, Aluminium, Monel etc.

Welding is done by Argon Arc Process.

For details

Please contact

DALCO ENGINEERING PVT. LTD.

H. A. LTD. Compound, Pimpri, Pune 411 018

Phones : 82315, 82817

SUBHAJAY

ELECTRONICS & METAL PROCESSORS (PVT.) LTD.

B 22, H block, m. i. d. c. estate, pimpri, pune INDIA 411 018.

Phone 82657, 82057, 83163

Cable SUBHAJAY

Telex 0145-340 Stempel

Manufacturers of Precision Aluminium
Anodised components in Various
Colours, Finishes, Off-set printed,
Silk screen printed, as per Customers'
Specification.

Serson Industries Pvt. Ltd.

Pimpri, P. F. P. O., Pune 411 018 (India)

Manufacturers of Electrolytic Capacitors

Phone : Pimpri 82379

Cable: "ETCHFOIL Poona 18"



JEKUMA ENGINEERS

JEKUMA LIMIT GAUGES

Telegrams : JEKUMA

Telephone : 83186 / 82131

- | | |
|--|---|
| <input type="checkbox"/> PLUG GAUGES | <input type="checkbox"/> SNAP GAUGES |
| <input type="checkbox"/> MEASURING PINS | <input type="checkbox"/> SPECIAL GAUGES |
| <input type="checkbox"/> SETTING MASTERS | <input type="checkbox"/> TAPER GAUGES |

The entire resources of 'JEKUMA' have been devoted to the manufacture of Limit Gauges and allied products to cater to the modern production technology, 'JEKUMA GAUGES' are produced by craftsmen using specialised equipments in a sophisticated plant and the quality is controlled in a well equipped standards room. Our Gauges are manufactured to ISI, DIN, BSS or to Customer's Drawing.

EISEN PHARMACEUTICAL CO. PVT. LTD.

1246-A, Apte Road,
Pune 411 004 (INDIA)

*Manufacturers and Exporters of
Ethical Pharmaceutical Specialities.*

ON THE APPROVED LIST

- ★ D.G.S. & D.
- ★ INDIAN RAILWAYS
- ★ E.S.I.C.
- ★ RAJASTHAN GOVERNMENT &
- ★ SULTANATE OF OMAN,
MUSCAT.

A Wide range of fine
furniture for your Office &
Home

- STRONG
- STURDY
- GOOD-LOOKING
- VERY ECONOMICALLY PRICED

We also deal in Electrical Gadgets like
mixers, fans, appliances and cooker etc

M/s. RAVINDRA

759/52, Deccan Gymkhana,
PUNE 4.

Phone : 57624
Showroom

Phone : 50773
Furniture Dept

Tel. 23923

**NEVER COMPROMISE
WITH QUALITY**



ENGINEERS & FABRICATORS
Plot 101, 'S' Block, M.I.D.C. Bhosari,
PUNE 411 026

**Pioneers in structural fabrication
& steling procedures.**

- * Our Associates-
1. M/s Vesta Incorporation
Engineers & Industrial Suppliers.
 2. M/s Vesta Automotive
Automobile Engineers

Member Of Super Honesty

With Best Compliments from:

**P M T
MACHINE TOOL
AUTOMATICS
LIMITED**

**P. O. Pimpri PF., Post Bag No. 2,
PUNE 411 018**

Manufacturers of :

**PMT -- Traub Single Spindle
Automatic Lathe**

Models - A15, A25, A42/A60 & TC15.

**PRECISION STEEL
FASTENERS**

Pimpri, Pune 411 018

Tel. : 83220

Gram : PREFAST



**Manufacturer and Exporter
of Industrial Fasteners**

With Best Compliments From:



Mehta Packard Industries Pvt. Ltd.

69/B Hadapsar Industrial Estate, Pune 411 013.

CABLE : PACKARD

PHONE : 7265 and 7510



Manufacturers of
COMPOSITE CONTAINERS
i.e. PAPER CONTAINERS,
PAPER TUBES AND CORES.

WITH BEST COMPLIMENTS FROM :



**INDUSTRIAL OXYGEN
COMPANY (PVT.) LTD.,**

Off. Nagar Road, PUNE 411 014

Manufacturers of : OXYGEN, NITROGEN, ACETYLENE AND
HYDROGEN GASES

ALSO

LIQUID OXYGEN AND NITROGEN

Distributors of : ARGON GAS, WELDING ELECTRODES &
EQUIPMENTS

| | PUNE | BOMBAY | DELHI | THANA | AHMEDABAD |
|---------|-------------|---------------|--------------|--------------|------------------|
| Phone : | 25546/47/48 | 527236 | 343293 | Vashi-304 | 87580 |
| Telex : | 0145-275 | 011-3552 | 031-2926 | 011-5004 | 012-447 |

**On the path of progress
-The helping hand...**

COSMOS BANK

Pune

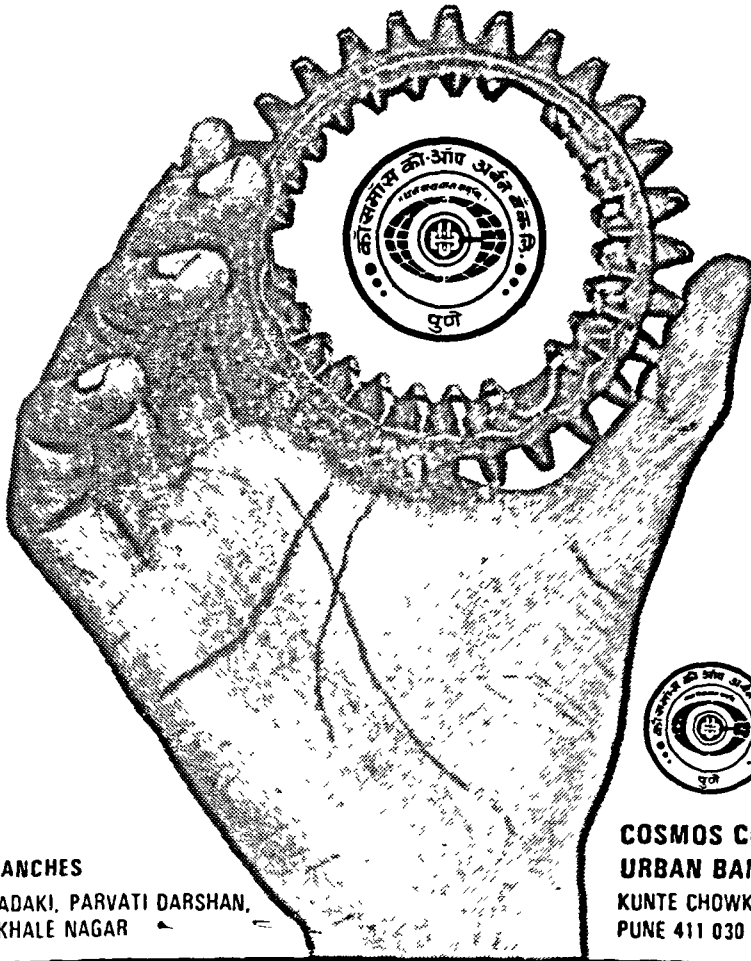

BRANCHES
KHADAKI, PARVATI DARSHAN,
GOKHALE NAGAR

**COSMOS CO-OPERATIVE
URBAN BANK LTD.**
KUNTE CHOWK, LAXMI ROAD,
PUNE 411 030

CO-OPERATIVE BANKS**ABBREVIATIONS**

Estd.=Year of establishment; Ch.=Chairman, Mgr.=Manager; Sh. Cap.=Share Capital (paid up); Loans=Loans distributed; Inv.=Investment; Dd.=Dividend; Br.=Branch. Dps.=Deposits.

BHAGINI NIVEDITA SAHAKARI BANK LTD. Rahrabhasha Bhavan, 388 Narayan Peth, Pune 30. Estd. March 1974. Ch. Mrs. Meenakshi Vivek Dadhe; Mgr. Miss Nandini Dattatraya Bedekar. Sh. Cap. Rs. 4,80,000. Dps. Rs.35,00,000. Loans : Rs.90,00,000. Inv. Rs.6,60,000.

BHARATI SAHAKARI BANK LTD. 434 Sadashiv Peth, Pune 30. Estd. 1971. Ch. Shri Namdevrao Devaji Badhe. Mgr. Shri Baburao Laxmanrao Pokale. Sh. Cap. 3,03,000. Dps. Rs. 1,40,000. Loans: Rs. 1,20,000. Inv. Rs. 10,000. Dd. 6%.

THE COSMOS CO-OPERATIVE URBAN BANK LTD. 12 Sadashiv Peth, Cosmos Bank Building, Kunte Chowk, Axmi Road, Pune 30. Ch. Shri V. R. Pingale. Mgr. Shri V. Pujari. Sh. Cap. Rs. 20,00,000. Dps. Rs. 2,87,00,000. Loans: Rs.2,19,04,000. Inv. Rs.74,59,000. Brs. Parvati, Marshan, Gokhale Nagar, Khadaki.

THE DECCAN CO-OPERATIVE URBAN BANK LTD. 139 Raviwar Peth, Hamjekhan Chowk, Pune 2. Estd. 1971. Ch. Shri Shaikh Nadim Janmohamed. Mgr. Shri A. Tajamal. Sh. Cap. Rs. 1,36,675. Dps. Rs. 2,07,756. Loans: Rs. 2,52,752.

THE DIAMOND JUBILEE CO-OPERATIVE BANK LTD. 13 Vaswani Road, Pune 1. Estd. 1947. Ch. Shri M. Sajanali. Sh. Cap. Rs. 2,92,440. Dps. Rs. 8,56,891. Loans: Rs. 9,15,678. Inv. Rs. 85,749.

ANATA SAHAKARI BANK LTD. 1444 Shukrawar Peth, Bajirao Road, Pune 2. Estd. 1949. Telex:JSBPL 203. Ch. Shri. A. K. Phadke. Sh. Cap. Rs. 14,57,000. Dps. Rs. 9,21,30,000. Loans: Rs.3,68,73,000. Inv. Rs.4,63,17,000. Dd. 12%. Br. Shivajinagar; Bhawani Peth; Karve Road; Ghodnadi; Engineering College; Chinchwad; Talegaon Dabhade; Talegaon Station; Chinchwad Station, Urangabad; Latur; Junnar; Tilak Road; Shaniwar; ...20

Narayan Peth; Dadar, Bombay; Fort, Bombay; Ambajogai; Vileparle, Bombay; Girgaon, Bombay; Shivajinagar; Ratnagiri; Deorukh; Pawas; Makhajan; Sakharpa.

JANSEVA SAHAKARI BANK LTD. 6-A Hadapsar, Pune 28. Estd. 1972. Ch. Shri Deoramji Dhondiba Lonkar. Mgr. Shri Vasant Narayan Deodhar. Sh. Cap. Rs. 1,84,000. Dps. Rs. 15,86,000. Loans: Rs. 10,18,000. Inv. Rs.9,35,000. Dd. 4%. Br. Budhwar Peth, Pune 411 030.

JAY BHAWANI SAHAKARI BANK LTD. 1228 Bhawani Peth, Pune 2. Estd. 1972. Ch. Shri Namdevrao Tatyaba Suryavanshi. Mgr. Shri. M. G. Soman. Sh. Cap. Rs. 1,67,700, Dps. Rs. 3,97,400. Loans: Rs. 5,51,100. Inv. Rs. 1,13,600. Dd. 5%.

JIJAMATA MAHILA SAHAKARI BANK LTD. 411 Shaniwar Peth, Kakasaheb Gadgil Marg, Sardar Natu Wada, Pune 30. Estd. 1974. Ch. Mrs. Malatibai M. Shirole. Mgr. Mrs. Aditi V Ambade. Sh. Cap. Rs. 3,32,625. Dps. Rs.1,74,157. Loans: Rs. 3,36,899. Inv. Rs. 1,94,508.

KUNBI SAHAKARI BANK. 180 Navi Peth, Pune 30

MAHESH SAHAKARI BANK LTD. 1255 Bhawani Peth, Pune 2. Cable: MAHESH Bank Poona. Estd. 1972. Ch. Shri V. B. Maniar. Mgr. Shri M. B. Modani. Sh. Cap. Rs. 5,00,000. Dps. Rs. 46,000. Loans: Rs. 39,00,000. Inv. Rs. 12,00,000. Dd. 9%. Br. Narayan Peth, Pune 411 030.

THE MUSLIM CO-OPERATIVE BANK LTD. 633 Raviwar Peth, Pune 2. Estd. 1931. Ch. Shri Abdul Maroofkhan Abdul Raufkhan. Mgr. Shri Esuf A. Adib. Sh. Cap. Rs. 25,00,000. Dps. Rs. 1,30,78,000. Loans: Rs. 1,06,83,000. Inv. Rs. 59,74,000. Dd. 9%. Brs. Camp, Budhwar Peth, Khadki, Pune.

NO. 1 DEFENCE ACCOUNTS CO-OPERATIVE CREDIT BANK LTD. 2013 Sadashiv Peth, Pune 30. Estd. 1906. Ch. Shri V. K. Kolhatkar. Mgr. Shri R. R. Kulkarni. Sh. Cap. Rs. 5,09,360. Dps. Rs. 12,60,740. Loans: Rs. 24,29,829. Inv. Rs. 15,57,000. Dd. 12%.

PAVANA SAHAKARI BANK LTD. 7/244 Chinchwad Station, Pune 19. Vice Ch. Shri D. S. Pimple. Mgr. Shri H. S. Kondare. Sh. Cap. Rs. 1,92,450. Dps. Rs. 28,10,000. Loans: Rs. 10,00,000. Inv. Rs. 20,000. Dd. 9%.

POONA CANTT. SAHAKARI BANK LTD. Shastri Apartments, 4 Moledina Road, Pune 1. Ch. Shri Shivajirao A. Dhere. Mgr. Shri R. G. Keskar. Sh. Cap. Rd.

Rs. 2,72,400 Dps Rs. 20,66,000. Loans: Rs 15,19,000
Inv. Rs. 36,000. Dd 7%.

THE POONA CONTRACTORS' CO-OPERATIVE BANK LTD. 867 Budhwar Peth, Laxmi Road, Sonya Maruti Chowk, Pune 2. Estd. 1953. Ch. Shri B. R. Gupta
Mgr. Shri S. S. Degaonkar Sh. Cap Rs. 4,59,600. Dps. Rs. 33,45,717. Loans: Rs. 30,98,046 Inv Rs 15,87,137
Dd. 9%

THE POONA CO-OPERATIVE RUPEE BANK LTD. 110 Budhwar Peth, Pune 2 Estd. 1912. Ch Dr K N Bada. Mgr. Shri S. K. Patki. Sh Cap Rs. 6,94,570. Dps. Rs. 1,85,92,140. Loans Rs 1,41,08,280. Inv Rs 58,65,000. Dd. 9%. Br Chunchwad, Bhawani Peth, Market Yard. Branch.

THE POONA MERCHANTS CO-OP. BANK LTD Saraswati Vilas Bldg, Laxmi Road, Pune 30. Estd. 1924
Ch. Shri M. B. Kale. Mgr. B. G. Sabane Sh. Cap Rs. 4,22,480 Dps. Rs. 1,12,72,959 Loans Rs. 1,10,53,365.
Inv. Rs. 71,84,402 Dd 6%

PUNE MUNICIPAL CORPORATION SERVANTS' CO-OP. URBAN BANK LTD. 768 Sadashiv Peth, Phadtare Chowk, Pune 30 Estd 1914. Ch Shri Baburao Laxmanrao Hirulkar. Mgr. Shri S. A. Chitre. Sh Cap. Rs 18,76,910. Dps. Rs. 1,57,13,394. Loans : Rs. 1,45,61,947. Inv Rs 28,84,800 Dd 9%. Rs 1,72,000

THE POONA PEOPLE'S CO-OP. BANK LTD. 606 Sadashiv Peth, Pune 30 Estd 1952 Mgr. Shri S G. Joshi Sh Cap. Rs 6,72,550. Dps Rs. 1,40,00,000 Loans Rs 1,04,00,000. Inv. Rs. 12,87,000. Dd. 9%. Brs 3

THE POONA URBAN CO-OPERATIVE BANK LTD 25 Shukrawar Peth, Mahatma Fule Market, Pune 2 Est. 1927. Ch Shri S. D. Dhamadhare Mgr Shri P B Gaikwad Sh. Cap. Rs. 11,52,540 Dps. Rs 74,04,558. Loans: Rs. 51,67,614 Inv Rs 42,55,752 Dd 7%

PUNE ZILLA MADHYAWARTI SAHAKARI BANK MARYADIT. 855 Budhwar Peth, Laxmi Road, Pune 30 Cable: CENCOBANK. Est. 1917. Ch. Shri R B. Gholap Mgr Shri B V. Inamdar Sh. Cap Rs 202 21 (lakhs) Dps. Rs. 2420 85 lakhs Loans: Rs 2185 50 lakhs Inv Rs. 731 45 lakhs Dd 7% Brs. 80

THE PUNJAB CO-OP. URBAN BANK LTD. 440 Nana Peth, Pune 2. Estd. 1954. Ch. Sardar Tarloksingh Sarana. Mgr. Shri A. M. Mane. Sh. Cap. Rs. 7,62,700. Dps. Rs. 22,51,783 Loans: Rs 35,13,428 Inv Rs 83,400 Dd 12%

SADHANA SAHAKARI BANK LTD. Hadapsar, Pune 28-

SAMPADA SAHAKARI BANK LTD. D.I.C. Building, 717 Budhwar Peth, Ganesh Road, Pune 2. Estd. 1974 Ch. Shri A G. Bhopatkar. Mgr. Shri S V. Khare Sh Cap Rs 2,97,500. Dps. Rs. 22,30,852. Loans Rs 20,58,670 Inv Rs 2,24,000. Dd. 6%

SANMITRA SAHAKARI BANK LTD. 407 Hadapsar, Pune 28. Estd 1972. Mgrs. Shri Shaikh H. G. Sh. Cap. Rs. 1,02,500. Dps Rs 21,000. Loans: Rs. 72,000 Inv Rs. 22,100.

THE SEVA VIKAS CO-OP. BANK LTD. Dodawani Bldg., 244 Pimpri, opp. Fish Market, Pune 18. Estd. 1971. Ch. Shri Kishanchand Arya. Mr. Shri H. R. Belsare Dps. Rs 15,00,000 Loans Rs. 12,000. Inv Rs. 3,00,000. Dd 6%

SHARADA SAHAKARI BANK LTD. 692-A/2 Sub^oplot No 1, Pune-Satara Road, Pune 9. Estd. 1978. Ch. Shri M K Kulkarni

SHIVAJINAGAR SAHAKARI BANK. 94-A Narveer Tanajiwadi, Pune. Estd. 1972. Ch. Shri Shuvajirao J Bhosale. Mgr. Shri P S More. Sh. Cap. Rs. 2 94 lakhs Dps. Rs. 8.54 lakhs. Loans: Rs. 9.76 lakhs. Inv. Rs 1.45 lakhs. Dd. 6%

SHRI ADINATH SAHAKARI BANK LTD. 234 Budhwar Peth, Pune 2. Estd. 1972. Ch. Shri Jayant Babulal Shah Mgr Shri S G. Bhavsar. Sh. Cap. Rs. 1,90,350. Dps Rs 10,63,500 Inv. Rs. 8,99,300. Inv. 2,30,000. Br. Pay Office Shri Adinath Sahakari Graha Rachana Society, Pune 411009.

SHRI GANESH SAHAKARI BANK LTD. 680 Shukrawar Peth, Pune 30. Estd 1952. Ch. Shri S. V. Chandane. Mgr Shri R. R. Sontakke. Sh. Cap. Rs. 7,25,000. Dps Rs. 28,00,000 Loans Rs 31,00,000. Inv Rs 5,25,000. Dd. 7%

SHRI LAXMI CO-OPERATIVE BANK LTD. 2140 Vijayanagar Colony, Sadashiv Peth, Pune 30 Estd. 1972. Ch Shri Shripad Vishnu Deshpande. Mgr. Mrs. Sulabha S. Sadashiv Deshpande. Sh. Cap. Rs. 1,20,000. Dps Rs 900,000. Loans Rs 5,20,000. Inv. Rs 1,25,000

SHRI SADGURU JANGLI MAHARAJ CO-OP. BANK LTD. Jangli Maharaj Road, Pune 4. Ch. D. K. Shirole Mgr. V. M. Shirole. Sh. Cap. Rs. 88,000. Dps Rs. 2,15,000 Loans: Rs. 2,60,000. Inv. Rs. 20,000

SHREE SUVARNA SAHAKARI BANK LTD. 759/51 Deccan Gymkhana, Fergusson College Road, Pune 4. Estd. 1969. Ch. Shri Jagdish Chandrashekhar Agashe. Mgr. Shri Vasant Gopal Chinchalkar. Sh. Cap. Rs. 3,57,200. Dps. Rs. 3,53,49,467. Loans: Rs. 2,40,43,409. Inv. Rs. 1,10,49,912. Dd. 9%. Brs. Budhwar Peth, Sadashiv Peth, Shreepur.

SUVARNAYUG SAHAKARI BANK LTD. 215/216 Budhwar Peth, Pune 2. Estd. 1973. Ch. Shri Ulhasrao Shedge. Mgr. Shri D. A. Kulkarni. Sh. Cap. Rs. 1,89,500. Dps. Rs. 9,73,643. Loans: Rs. 10,68,223.

TRIMURTI SAHAKARI BANK LTD. 1909 Sadashiv Peth, Yashwant Niwas, Bajirao Road, Natubag. Pune 30. Estd. 1971. Ch. Shri K. G. Soman. Mgr. Shri M. B. Kulkarni. Sh. Cap. Rs. 1,40,000. Dps. Rs. 30,00,000. Loans: Rs. 18,00,000. Dd. 8%. Br. T.M.V. Nagar, Pune 9.

VIDYA SAHAKARI BANK LTD. 596 Sadashiv Peth, Laxmi Road, Pune 30. Estd. 1974. Ch. Prof. P. V.

Patwardhan. Mgr. Shri J. G. Nalawade. Sh. Cap. Authorised: Rs. 5,00,000 & Subscribed Rs. 4,00,000. Dps. Rs. 60,50,000. Loans: Rs. 43,70,000. Inv. Rs. 15,00,000. Dd. Rs. 9%.

THE VISHWESHWAR SAHAKARI BANK LTD. 523 Ganesh Peth, Pune 2. Estd. 1972. Ch. Shri Namdeorao V Rukari. Mgr. Shri K. K. Gabbane. Sh. Cap. Rs. 2,75,000. Dps. Rs. 34,00,000. Loans: Rs. 27,00,000. Inv. Rs. 7,00,000. Dd. 6% Br. Fursungi, Tal. Haveli, Dist. Pune.

There are following 3 Urban Co-operative Banks having their branches in Pune.

BOMBAY MERCANTILE CO-OP. BANK LTD. 22 M. G. Road, Pune.

SARASWAT CO-OP. BANK LTD. City H. O 991 Shukrawar Peth, Tilak Road, Pune 2.

THE SHAMRAO VITHAL CO-OP. BANK LTD. 1274 Shivajinagar, opp. Deccan Gymkhana Post Office, Pune 4.

BUILDERS & CONTRACTORS

ADEPT CONSTRUCTION CO.
Ganesh Sadan, Prabhat Rd.,
759/63 Deccan Gymkhana, Pune 4.

AGARWAL L. K. ENGINEERS AND CONTRACTORS
No. 64 Mahatma Gandhi Rd.,
Pune 1.

AGARWAL P. K.
M/s. Uttam Bros. & Co, No. 27,
Stavely Rd., Pune 1.

AHUJA B. G.
No. 2 Shivdham, Pudumjee Rd.,
Pune 2.

AJANTA BUILDERS
569/48 Ganga-Yamuna, Shivajinagar,
Pune 4

AJIT CONSTRUCTION CO.
No 775/2 Deccan Gymkhana,
Opp. Kamla Nehru Park, Pune 4

AJIT SINGH DAYALSINGH
No. 33-A/7,8,9 Bombay-Pune Rd,
Dapodi, Pune 12.

AJWANI B. K.
No. 3 Laxmi Niwas, Padumjee
Compound, 815/4 Bhavani Peth,
Pune 2.

AKOLKAR PRAKASH
Excel Engineers

Tilak Bhavan, L. B. Shastri Rd.,
Near Alka Talkies, Pune 30.

AMAR ASSOCIATE ENGINEERS, CONTRACTORS AND SUPPLIERS
178 Deccan College Rd. Yeravada,
Pune 6.

AMAR CONSTRUCTION CO.
Engineers and Contractors,
No 471 Baner Rd., Sind Co-op.
Housing Society, Aundh, Pune 7

ARUNACHALAM
Engineers and Contractors,
No. 20 Vishram Baugh Society,
Senapati Bapat Rd., Pune 16.

ATUR INDIA PVT. LTD.
Civil Engineers, 'Atur House',
No. 16 Dr. Ambedkar Rd., Pune 1.

AVINASH ENGINEERS
'Rajyog', Narekar Park, Pune 4.

B. G. SHIRKE AND CO.
Engineers and Contractors,
No. 1205 Rao. B. Apte Rd.,
Pune 4.

BAGADIA CONSTRUCTION CO.
Engineers and Contractors,
No. 356 Budhwar Peth, Pune 2.

**On the path of progress
-The helping hand...**

COSMOS BANK

Pune

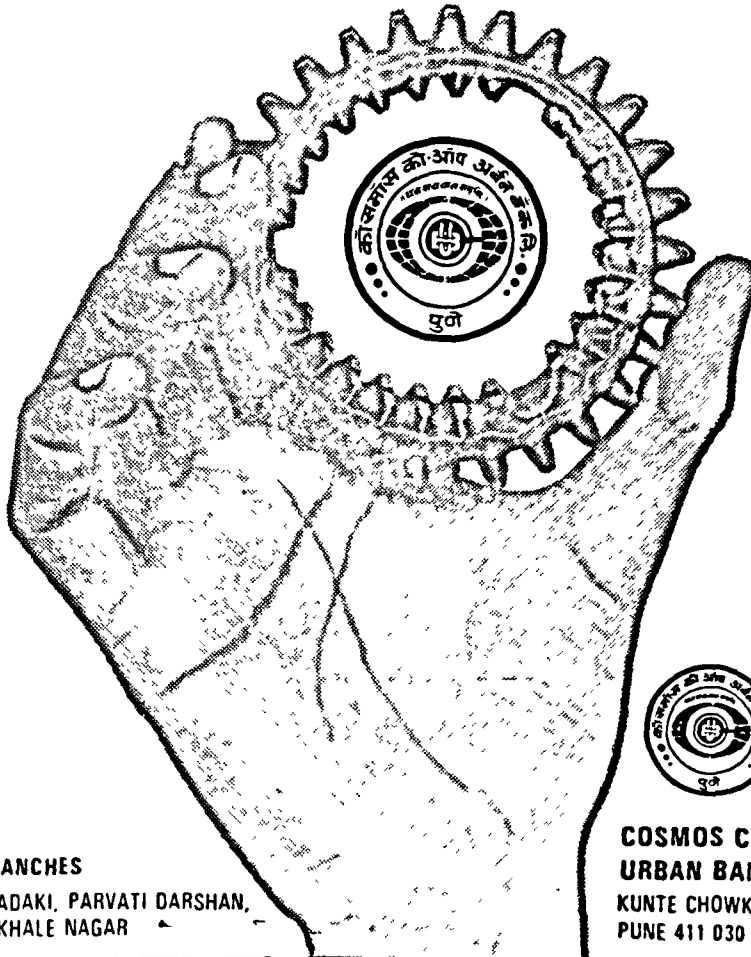

BRANCHES

**KHADAKI, PARVATI DARSHAN,
GOKHALE NAGAR**

**COSMOS CO-OPERATIVE
URBAN BANK LTD.**

**KUNTE CHOWK, LAXMI ROAD,
PUNE 411 030**

CO-OPERATIVE BANKS**ABBREVIATIONS**

Estd.=Year of establishment, Ch.=Chairman, Mgr.=Manager; Sh. Cap.=Share Capital (paid up); Loans=Loans distributed; Inv.=Investment; Dd.=Dividend; Br.=Branch. Dps.=Deposits

BHAGINI NIVEDITA SAHAKARI BANK LTD. Rashtrabhasha Bhavan, 388 Narayan Peth, Pune 30 Estd. March 1974. Ch. Mrs. Meenakshi Vivek Dadhe, Mgr. Miss Nandini Dattatraya Bedekar. Sh. Cap Rs. 4,80,000. Dps. Rs.35,00,000. Loans Rs 90,00,000. Inv. Rs.6,60,000

BHARATI SAHAKARI BANK LTD. 434 Sadashiv Peth, Pune 30. Estd. 1971. Ch. Shri Namdeorao Devaji Badhe. Mgr. Shri Baburao Laxmanrao Pokale. Sh. Cap. 3,03,000 Dps. Rs. 1,40,000. Loans: Rs. 1,20,000. Inv Rs 10,000. Dd. 6%.

THE COSMOS CO-OPERATIVE URBAN BANK LTD. 612 Sadashiv Peth, Cosmos Bank Building, Kunte Chowk, Laxmi Road, Pune 30 Ch. Shri V. R. Pingale. Mgr. Shri G. V. Pujari. Sh. Cap. Rs. 20,00,000. Dps. Rs. 2,87,00,000. Loans: Rs.2,19,04,000. Inv. Rs.74,59,000 Brs. Parvati Darshan, Gokhale Nagar, Khadaki.

THE DECCAN CO-OPERATIVE URBAN BANK LTD. 1039 Raviwar Peth, Hamjekhan Chowk, Pune 2 Estd. 1971. Ch. Shri Shaikh Nadim Janmohamed. Mgr. Shri R. A. Tajamal. Sh. Cap. Rs. 1,36,675. Dps. Rs 2,07,756. Loans: Rs. 2,52,752.

THE DIAMOND JUBILEE CO-OPERATIVE BANK LTD. 13 Vaswani Road, Pune 1. Estd. 1947. Ch. Shri G. M. Sajanali. Sh. Cap. Rs. 2,92,440. Dps. Rs. 8,56,891. Loans. Rs. 9,15,678. Inv. Rs. 85,749.

JANATA SAHAKARI BANK LTD. 1444 Shukrawar Peth, Bajirao Road, Pune 2. Estd. 1949. Telex:JSBPL 203. Ch. Shri. A. K. Phadke. Sh. Cap. Rs. 14,57,000. Dps Rs.9,21,30,000. Loans: Rs.3,68,73,000. Inv. Rs.4,63,17,000. Dd. 12%. Br. Shivajinagar; Bhawani Peth; Karve Road; Bhor; Ghodnadi; Engineering College; Chinchwad; Talegaon Dabhade; Talegaon Station; Chinchwad Station, Aurangabad; Latur; Junnar, Tilak Road, Shaniwar, I.D....20

Narayan Peth; Dadar, Bombay; Fort, Bombay; Ambajogai; Vileparle, Bombay; Girgaon, Bombay; Shivajinagar; Ratnagiri; Deorukh; Pawas; Makhajan; Sakharpa.

JANSEVA SAHAKARI BANK LTD. 6-A Hadapsar, Pune 28. Estd. 1972. Ch. Shri Deoramji Dhondiba Lonkar. Mgr. Shri Vasant Narayan Deodhar. Sh. Cap. Rs. 1,84,000. Dps. Rs. 15,86,000 Loans: Rs. 10,18,000. Inv. Rs.9,35,000. Dd 4%. Br. Budhwar Peth, Pune 411 030.

JAY BHAWANI SAHAKARI BANK LTD. 1228 Bhawani Peth, Pune 2. Estd. 1972. Ch. Shri Namdevrao Tatyaba Suryavanshi. Mgr. Shri. M. G. Soman. Sh. Cap. Rs. 1,67,700, Dps. Rs. 3,97,400. Loans: Rs. 5,51,100. Inv. Rs. 1,13,600. Dd. 5%.

JIJAMATA MAHILA SAHAKARI BANK LTD. 411 Shaniwar Peth, Kakasaheb Gadgil Marg, Sardar Natu Wada, Pune 30. Estd. 1974. Ch. Mrs. Malatibai M. Shirole Mgr. Mrs. Aditi V. Ambade. Sh. Cap. Rs. 3,32,625. Dps. Rs.1,74,157. Loans: Rs. 3,36,899. Inv. Rs. 1,94,508.

KUNBI SAHAKARI BANK. 180 Navi Peth, Pune 30

MAHESH SAHAKARI BANK LTD. 1255 Bhawani Peth, Pune 2. Cable: MAHESH Bank Poona. Estd. 1972. Ch. Shri V. B. Maniar. Mgr. Shri M. B. Modani. Sh. Cap. Rs. 5,00,000. Dps. Rs. 46,000. Loans: Rs. 39,00,000. Inv. Rs. 12,00,000. Dd 9%. Br. Narayan Peth, Pune 411 030.

THE MUSLIM CO-OPERATIVE BANK LTD. 633 Raviwar Peth, Pune 2. Estd. 1931. Ch. Shri Abdul Maroofkhan Abdul Raufkhan. Mgr. Shri Esuf A. Adib. Sh. Cap. Rs. 25,00,000. Dps. Rs 1,30,78,000. Loans: Rs.1,06,83,000. Inv. Rs. 59,74,000 Dd. 9%. Brs. Camp, Budhwar Peth, Khadki, Pune

NO. 1 DEFENCE ACCOUNTS CO-OPERATIVE CREDIT BANK LTD. 2013 Sadashiv Peth, Pune 30. Estd. 1906. Ch. Shri V K Kolhatkar. Mgr. Shri R. R. Kulkarni. Sh. Cap. Rs. 5,09,360. Dps. Rs. 12,60,740. Loans Rs. 24,29,829. Inv. Rs. 15,57,000. Dd. 12%

PAVANA SAHAKARI BANK LTD. 7/244 Chinchwad Station, Pune 19 Vice Ch Shri D. S. Pimple. Mgr. Shri H. S. Kondare. Sh. Cap. Rs. 1,92,450. Dps. Rs. 28,10,000. Loans: Rs 10,00,000. Inv. Rs. 20,000 Dd. 9%

POONA CANTT. SAHAKARI BANK LTD. Shastri Apartments, 4 Moledina Road, Pune 1. Ch. Shri Shivajirao A. Dhere. Mgr. Shri R. G. Keskar. Sh. Cap. Rd.

Rs. 2,72,400. Dps. Rs 20,66,000. Loans: Rs 15,19,000.
Inv. Rs 36,000 Dd. 7%.

THE POONA CONTRACTORS' CO-OPERATIVE BANK LTD. 867 Budhwar Peth, Laxmi Road, Sonya Maruti Chowk, Pune 2. Estd. 1953. Ch. Shri B. R. Gupta Mgr Shri S. S. Degaonkar. Sh. Cap. Rs. 4,59,600. Dps. Rs. 33,45,717. Loans: Rs. 30,98,046. Inv. Rs. 15,87,137. Dd. 9%.

THE POONA CO-OPERATIVE RUPEE BANK LTD 110 Budhwar Peth, Pune 2. Estd. 1912. Ch Dr. K. N. Bade. Mgr. Shri S. K. Patki. Sh. Cap. Rs. 6,94,570. Dps. Rs. 1,85,92,140 Loans: Rs. 1,41,08,280. Inv Rs 58,65,000. Dd. 9%. Br Chinchwad, Bhawani Peth, Market Yard. Branch.

THE POONA MERCHANTS CO-OP. BANK LTD. Saraswati Vilas Bldg., Laxmi Road, Pune 30. Estd. 1924. Ch. Shri M. B. Kale. Mgr. B. G. Sabane Sh. Cap. Rs. 4,22,480. Dps. Rs. 1,12,72,959. Loans: Rs 1,10,53,365 Inv Rs. 71,84,402 Dd. 6%

PUNE MUNICIPAL CORPORATION SERVANTS' CO-OP. URBAN BANK LTD. 768 Sadashiv Peth, Phadtare Chowk, Pune 30. Estd. 1914. Ch. Shri Baburao Laxmanrao Hirulkar. Mgr. Shri S. A. Chitre. Sh. Cap. Rs. 18,76,910 Dps. Rs 1,57,13,394. Loans : Rs. 1,45,61,947. Inv Rs 28,84,800. Dd 9%. Rs. 1,72,000

THE POONA PEOPLE'S CO-OP. BANK LTD. 606 Sadashiv Peth, Pune 30 Estd 1952 Mgr. Shri S. G. Joshi Sh. Cap. Rs. 6,72,550. Dps. Rs. 1,40,00,000 Loans: Rs 1,04,00,000. Inv. Rs 12,87,000 Dd. 9% Brs 3

THE POONA URBAN CO-OPERATIVE BANK LTD 25 Shukrawar Peth, Mahatma Fule Market, Pune 2 Est. 1927. Ch Shri S. D. Dhamadhare Mgr Shri P. B. Gaikwad. Sh. Cap. Rs. 11,52,540. Dps. Rs. 74,04,558. Loans: Rs. 51,67,614 Inv. Rs 42,55,752. Dd. 7%.

PUNE ZILLA MADHYAWARTI SAHAKARI BANK MARYADIT. 855 Budhwar Peth, Laxmi Road, Pune 30 Cable: CENCOBANK. Est. 1917. Ch. Shri R. B. Gholap Mgr. Shri B. V. Inamdar. Sh. Cap. Rs 202.21 (lakhs) Dps. Rs. 2420.85 lakhs. Loans: Rs 2185 50 lakhs Inv Rs. 731 45 lakhs Dd 7% Brs. 80

THE PUNJAB CO-OP. URBAN BANK LTD. 440 Nana Peth, Pune 2. Estd. 1954 Ch Sardar Tarloksingh Sarana Mgr. Shri A. M. Mane. Sh. Cap. Rs. 7,62,700. Dps. Rs. 22,51,783 Loans: Rs. 35,13,428 Inv. Rs. 83,400. Dd. 12%.

SADHANA SAHAKARI BANK LTD. Hadapsar, Pune 28-

SAMPADA SAHAKARI BANK LTD. D I C. Building, 717 Budhwar Peth, Ganesh Road, Pune 2. Estd 1974 Ch. Shri A. G. Bhopatkar. Mgr Shri S. V. Khare Sh. Cap. Rs 2,97,500 Dps. Rs. 22,30,852 Loans: Rs. 20,58,670 Inv Rs 2,24,000. Dd. 6%

SANMITRA SAHAKARI BANK LTD. 407 Hadapsar, Pune 28. Estd. 1972. Mgrs. Shri Shaikh H. G. Sh. Cap Rs. 1,02,500. Dps Rs. 21,000. Loans: Rs 72,000 Inv Rs. 22,100.

THE SEVA VIKAS CO-OP. BANK LTD. Dodawani Bldg., 244 Pimpri, opp. Fish Market, Pune 18. Estd. 1971. Ch. Shri Kishanchand Arya. Mr. Shri H. R. Belsare Dps. Rs 15,00,000. Loans: Rs. 12,000. Inv Rs. 3,00,000. Dd 6%

SHARADA SAHAKARI BANK LTD. 692-A/2 Subplot No 1, Pune-Satara Road, Pune 9. Estd 1978. Ch. Shri M K Kulkarni

SHIVAJINAGAR SAHAKARI BANK. 94-A Narveer Tanajiwadi, Pune. Estd. 1972 Ch Shri Shrivajirao J. Bhosale Mgr. Shri P. S. More. Sh. Cap. Rs. 2 94 lakhs Dps. Rs. 8.54. lakhs. Loans: Rs. 9.76 lakhs Inv Rs 1.45 lakhs. Dd. 6%

SHRI ADINATH SAHAKARI BANK LTD. 234 Budhwar Peth, Pune 2. Estd. 1972. Ch. Shri Jayant Babulal Shah Mgr Shri S. G. Bhavsar. Sh. Cap. Rs. 1,90,350. Dps. Rs 10,63,500. Inv Rs. 8,99,300. Inv. 2,30,000. Br. Pay Office Shri Adinath Sahakari Graha Rachana Society, Pune 411009.

SHRI GANESH SAHAKARI BANK LTD. 680 Shukrawar Peth, Pune 30. Estd 1952. Ch. Shri S. V. Chandane. Mgr Shri R. R. Sontakke. Sh. Cap. Rs. 7,25,000. Dps. Rs., 28,00,000 Loans: Rs. 31,00,000. Inv Rs 5,25,000 Dd. 7%

SHRI LAXMI CO-OPERATIVE BANK LTD. 2140 Vijaynagar Colony, Sadashiv Peth, Pune 30 Estd. 1972. Ch Shri Shripad Vishnu Deshpande. Mgr. Mrs. Sulabha S. adashiv Deshpande. Sh. Cap. Rs. 1,20,000. Dps Rs 900,000 Loans Rs 5,20,000 Inv Rs. 1,25,000

SHRI SADGURU JANGLI MAHARAJ CO-OP. BANK LTD. Jangli Maharaj Road, Pune 4. Ch. D. K. Shirole Mgr. V. M. Shirole. Sh. Cap. Rs. 88,000. Dps Rs. 2,15,000 Loans: Rs. 2,60,000. Inv. Rs. 20,000.

SHREE SUVARNA SAHAKARI BANK LTD. 759/51 Deccan Gymkhana, Fergusson College Road, Pune 4. Estd. 1969. Ch. Shri Jagdish Chandrashekhar Agashe. Mgr. Shri Vasant Gopal Chinchalkar. Sh Cap Rs. 3,57,200. Dps. Rs. 3,53,49,467. Loans: Rs. 2,40,43,409 Inv. Rs. 1,10,49,912. Dd. 9%. Brs. Budhwar Peth, Sadashiv Peth, Shreepur.

SUARNAYUG SAHAKARI BANK LTD. 215/216 Budhwar Peth, Pune 2. Estd. 1973. Ch. Shri Ulhasrao Shedge. Mgr. Shri D. A. Kulkarni. Sh. Cap. Rs. 1,89,500 Dps. Rs. 9,73,643. Loans: Rs. 10,68,223.

TRIMURTI SAHAKARI BANK LTD. 1909 Sadashiv Peth, Yashwant Niwas, Bajirao Road, Natubag. Pune 30 Estd. 1971. Ch. Shri K. G. Soman, Mgr. Shri M. B. Kulkarni. Sh. Cap. Rs. 1,40,000. Dps. Rs. 30,00,000. Loans: Rs. 18,00,000. Dd. 8%. Br. T M V Nagar, Pune 9.

VIDYA SAHAKARI BANK LTD. 596 Sadashiv Peth, Laxmi Road, Pune 30. Estd. 1974. Ch. Prof. P. V.

Patwardhan. Mgr. Shri J. G. Nalawade. Sh. Cap. Authorised: Rs. 5,00,000 & Subscribed Rs. 4,00,000. Dps. Rs. 60,50,000. Loans: Rs. 43,70,000. Inv. Rs. 15,00,000 Dd Rs 9%

THE VISHWESHWAR SAHAKARI BANK LTD. 523 Ganesh Peth, Pune 2. Estd. 1972. Ch. Shri Namdeorao V. Rukari. Mgr. Shri K. K. Gabhane. Sh. Cap. Rs. 2,75,000. Dps Rs. 34,00,000. Loans : Rs. 27,00,000. Inv. Rs 7,00,000. Dd. 6% Br. Fursungi, Tal Haveli, Dist. Pune.

There are following 3 Urban Co-operative Banks having their branches in Pune.

BOMBAY MERCANTILE CO-OP. BANK LTD. 22 M. G. Road, Pune.

SARASWAT CO-OP. BANK LTD. City H O 991 Shukrawar Peth, Tilak Road, Pune 2.

THE SHAMRAO VITHAL CO-OP. BANK LTD. 1274 Shivajinagar, opp. Deccan Gymkhana Post Office, Pune 4.

BUILDERS & CONTRACTORS

ADEPT CONSTRUCTION CO.
Ganesh Sadan, Prabhat Rd.,
759/63 Deccan Gymkhana, Pune 4.

AGARWAL L. K. ENGINEERS AND CONTRACTORS
No. 64 Mahatma Gandhi Rd,
Pune 1.

AGARWAL P. K.
M/s. Uttam Bros. & Co, No 27,
Stavely Rd., Pune 1.

AHUJA B. G.
No. 2 Shivdham, Pudumjee Rd,
Pune 2.

AJANTA BUILDERS
569/48 Ganga-Yamuna, Shivajinagar,
Pune 4

AJIT CONSTRUCTION CO.
No 775/2 Deccan Gymkhana,
Opp. Kamla Nehru Park, Pune 4

AJIT SINGH DAYALSINGH
No. 33-A/7,8,9 Bombay-Pune Rd,
Dapodi, Pune 12.

AJWANI B. K.
No. 3 Laxmi Niwas, Padumjee
Compound, 815/4 Bhavani Peth,
Pune 2

AKOLKAR PRAKASH
Excel Engineers
Tilak Bhavan, L. B. Shastry Rd,
Near Alka Talkies, Pune 30

AMAR ASSOCIATE ENGINEERS, CONTRACTORS AND SUPPLIERS
178 Deccan College Rd, Yeravada,
Pune 6,

AMAR CONSTRUCTION CO.
Engineers and Contractors,
No 471 Baner Rd, Sind Co-op.
Housing Society, Aundh, Pune 7

ARUNACHALAM
Engineers and Contractors,
No 20 Vishram Baugh Society,
Senapati Bapat Rd., Pune 16

ATUR INDIA PVT. LTD.
Civil Engineers, 'Atur House',
No 16 Dr Ambedkar Rd., Pune 1.

AVINASH ENGINEERS
'Rajyog', Narekar Park, Pune 4

B. G. SHIRKE AND CO.
Engineers and Contractors,
No. 1205 Rao. B Apte Rd,
Pune 4

BAGADIA CONSTRUCTION CO.
Engineers and Contractors,
No 356 Budhwar Peth, Pune 2.

BEEJAY ASSOCIATES (CONTRACTS) PVT. LTD.
No 29-30 M G Rd., Pune 1

BHARAT TRADING CORPORATION
No 94 Sahaney Sujan Park,
Pune 1.

BHARUCHA AND MOTIWALA
No. 14 Boat Club Rd., Pune 1.

BHATE AND KELKAR
1223 'Madhuban', Shivajinagar,
F C Road, Pune 4

BHATIA L. M.
Dr. Kelkar Park, Bhandarkar Institute Rd., Pune 4

BOMBAY CONSTRUCTION CO.
Engineers and Contractors,
No 2 Koregaon Park, Pune 1

CHAI BROTHERS
No. 18 Lulla Nagar, Pune 1.

CHEMAN CONSTRUCTION CO.
Engineers and Contractors,
No. 8, Hadapsar Industrial Estate,
Pune 13

CHUNKHARE S. J.
Engineers and Contractors,
No 368 Wanawadi, Pune 1

DIAMOND CONSTRUCTION
Engineers and Contractors,
1423 (New) Shukrawar Peth,
Off Bajrao Rd, Pune 2

DIXIT AND APTE
Engineers and Contractors
'Apnagar', No 1238/1 Apte Rd.
Pune 4

E. C. ENGINEERING SERVICES
S. No 273/1, Shridhar Nagar,
Chinchwad, Pune 33.

G. K. SHOTRI AND CO.
Engineers and Contractors,
39/33 Erandwana, Karve Rd.,
Pune 4

GADRE A. H.
Consultant for Structural Engineering,
1025/B Sadashiv Peth,
Pune 30

GAURIMAL MAHAJAN AND SONS
Engineers and Contractors,
12 Solapur Rd, Pune 1

GERA RAISAHIB PRITAMDAS
'Pritam Villa', 8/352 Boat Club Rd.,
Pune 1

GHARPURE S. N.
Shops and Office Building
'C' Block Unit No 8,
Chinchwad, Pune 19

GUPTA CONSTRUCTION CO.
Engineers and Contractors,
Kashmir Colony, 1000 Yerawada,
Pune 6

INDIA CONSTRUCTION AND SUPPLY CO.
8A Parvati Villa, Pune 1

INDO FOREIGN ELECTRIC CO.
Engineers and Contractors,
No 12-A/3 Boat Club Rd., Pune 1

JOLLY KASTURILAL
Jolly Bros Pvt Ltd.,
No. 23 Bund Garden Rd
Pune 1

JOSHI AND CO.
Engineers and Contractors
1967 Gatterbeg Street, Pune 1

JOSHI BUILDERS
759/107/2 Deccan Gymkhana,
Pune 4.

JOSHI CONSTRUCTION
1319/2 Sadashiv Peth, Pune 30

JOTUMAL K. LULLA AND SONS
Engineers and Contractors,
322/17 Shankarshet Rd., Pune 9

JUPITER CONSTRUCTION CO.
Engineers and Contractors,
Mobo's Hotel, No 20 Bund Gadren
Rd., Pune 1.

KANT CONSTRUCTION CO.
R/344 Adinath Housing Society,
Satara Rd., Pune 9.

KASHVIL CONSTRUCTION CO.
Engineers and Contractors,
(Electrical Engineers)
'Parag', 1137/11 Shivajinagar,
Pune 16.

KASTURILAL RAMNARAYAN
Engineers and Contractors,
2420 Thimmayya Road, Pune 1.

KAVNDAL R. R.
11-B Gita Co-op. Housing Society
Ltd., Pune 1

KELKAR, DANDEKAR AND PHADKE
106 (New) Shukrawar Peth, Pune 2.

KHUBSON BUILDERS
Engineers and Contractors,
212 Sind Co-operative Housing
Society, Pune 7

KHURANA CONSTRUCTION CO.
Engineers and Contractors,
7 Gurunanak Nagar, Pune 2

KOHINOOR CONSTRUCTION CO.
'Dev Kunj', 119 Prabhat Rd.,
Pune 4.

KRISHNA ELECTRICALS
Engineers and Contractors,
'Prem Kutu', Sadhu Vaswani Rd.
Pune 1.

ULKARNI AND KULKARNI
025 B Sadashiv Peth, Pune.

U. G. CONSTRUCTION CO.
Engineers and Contractors,
Elphinston Rd., Khadki, Pune 3.

UABHUBANI P. T.
161/105 Shivajinagar, Pune 5.

UAKWANA BROS.
11 Somwar Peth, Pune 11.

UANGIA D. M.
Engineers and Contractors,
5 Duncan Rd., Khadki, Pune 3.

UAHASKE B. K.
Engineers and Contractors,
59/4 New Sadashiv Peth, Pune 30.

UULCHANDANI A. K.
Mar Construction,
73 Shankarshet Rd., Pune 9.

UUTHA R. P.
/36 Agarkar Nagar, Pune 1.

UAHATA S. J.
Structural and Civil Engineers,
12 Shaniwar Peth, Pune 2.

URETHVI BROS.
Engineers and Contractors,
18 Hadapsar Industrial Estate,
Pune 13.

URWAL BUILDERS
16 Bhavani Peth, Pune 2.

UNJABI H. B.
Engineers and Contractors,
1 Park View, Pudumjee Park,
Pune 2.

U. M. JILKAR AND CO.
9-A Jilkar Baugh,
Aarekrishna Path, Shivajinagar,
Pune 16.

RANGA CONSTRUCTION CO.
Engineers and Contractors,
1170/27 Revenue Colony, Pune 5.

RATANLAL P. JAIN AND CO.
Engineers and Contractors,
64 Mahatma Gandhi Rd., Pune 1.

RATILAL BHAGWANDAS
Bombay-Pune Rd.,
Near Garsungi Post Office,
Dapodi, Pune 12.

RUPANI H. A.
Engineers and Contractors,
790/1 Bhavani Peth, Pune 2.

S. C. AMBALAL AND CO.
927 Budhwar Peth, Pune 2.

S. S. GADHOKE AND SONS
1214 Fergusson College Rd.,
Pune 4.

S. Y. SAMAL AND CO.
Gharpure Colony,
1160-61/12 Shivajinagar, Pune 5.

SANGHVI BROS.
Engineers and Contractors,
B-34 Adinath Society,
Pune-Satara Rd., Pune 9.

SANGHVI ENGINEERING
B-34 Adinath Society,
Pune-Satara Rd., Pune 9.

SANGHVI C. S.
Engineers and Contractors,
318-19 Chaturringi Rd., Pune 16.

SANGHVI R. S.
Engineers and Contractors,
No. 36 Bombay-Pune Rd.,
Wakdewadi, Pune 3.

SANT RAM & SONS
Engineers and Contractors,
91 Koregaon Park, Pune 1.

SATHE M. K.
98 Shivajinagar, Pune 4.

SETH C. S.
Civil Engg. Construction Co.,
257 Narayan Peth, Pune 30

SETH D. M.
'Gitanjali', Vijayanagar Colony,
Pune 30.

SHAH BUILDERS
Engineers and Contractors,
403 Sardar V. Patel Rd.,
Pune 1.

SHAH CONSTRUCTION CO.
Engineers and Contractors,
95/96 Somwar Peth, Pune 11

SHARADA CONSTRUCTION CO.
Engineers and Contractors,
1/3 Guru Prasad, Bund Garden Rd.,
Pune 1.

UNITED CONSTRUCTION CO.
Bldg. No. 44, Block No 703,
Lokmanya Nagar, Pune 30.

V. M. JOG AND CO.
Engineers and Contractors,
2047 Sadashiv Peth, Pune 30.

VEEJAY CONSTRUCTION CO.
Engineers and Contractors,
55/2 Salisbury Park, Pune 1.

VISHWAMITRA AND RATHI
Karad Bank Wada,
761 Sadashiv Peth, Pune 30.

**WESTERN INDIA ERECTORS
LTD.**
Sahyadri Sadan, Tilak Rd.,
Pune 30.

Y. B. BHIDE
Waterproofing Specialist,
763 Sadashiv Peth, Pune 30.

CHARTERED ACCOUNTANTS

- ALVA AMUNJE SRINIVASA**
C/o. G M. Oka & Co Swapnanagari,
Karve Rd, Pune 4.
- ANGAL GOVIND NARAYAN**
2137 Sadashiv Peth,
Vijaynagar Colony, Pune 30
- APTE CHANDRASHEKHAR
GOPAL**
'Shruti', 1236 R B Apte Road,
Deccan Gymkhana, Pune 4
- BAFNA MOTILAL BANDULAL**
M/s M B BAFNA & Co
245 Narayan Peth, Laxmi Road,
Chopra Mansion, Pune 30
- BAGUL SUBHASH DIGAMBER**
46 Rasta Peth, Pune 11
- BAL GAJANAN RAMCHANDRA**
G R Bal & Co
48 Budhwar Peth, Pune 2
- BANGAD SHRINIVAS BANSILAL**
Flat No A-8, Adinath Society,
Satara Road, Pune 9
- BAPAT ANANT NARAYAN**
M/s. Bapat & Co.
5 Sadashiv Peth, Near Alka Talkies,
Tilak Road, Pune 30.
- BARVE DHANANJAY
RAMKRISHNA**
741 Budhwar Peth, Pune 2
- BASALE VASANT DATTATRAYA**
Hanuman Society, Senapati Bapat
Rd., Pune 16
- BASARKAR SURESH RAM-
CHANDRA**
1170/31/II Revenue Cly Magikai
Bldg., Shivajinagar, Pune 3
- BATHIA SUWALAL
CHANDANMAL**
G R Bal & Co,
48 Budhwar Peth, Pune 2
- BEHEDE VISHWANATH BHA-
GIRATH**
Vishwanath Maheswary & Co
Chitrashala Bhawan, II Floor,
Laxmi Road, Pune 30.
- BHAGWAT TRIMBAK NARAYAN**
70 Budhwar Peth, Near Tulsibag,
Pune 2.
- BHALERAO ASHOK YESHWANT**
A Y Bhalerao & Co,
Mohini, 94/11 Prabhat Road,
Lane No 11, Erandawana, Pune 4
- BHALGAT NEMICHAND
CHANDANMAL**
Patankar & Associates, 185/3-4,
"Anand", Prabhat Road, Pune 4
- BHAT ARUN ATMARAM**
A. A. Bhat & Co. 60-61, Saraswati
Vilas Bldg., 2nd floor, Laxmi Road,
Pune 30.
- BHATIA MANOHAR K.**
M. K. Bhatia & Co., 791 Sadashiv
Peth, near Seva Sadan, Laxmi Rd,
Pune 30.
- BHAVE MADHUSUDAN
RAMCHANDRA**
1221 B/1 Chitalewadi, Poona 4.
- BHIDE ARVIND SHANKAR**
4-A Parvati Villa Road,
Camp, Pune 1
- BHIDE KRUSHNAJI NARAYAN**
1187/12 Shivajinagar,
Ghole Road, Pune 5.
- BHIDE VAMAN GANESH**
Gadre & Bhide, Pratibha, 759/104
Gymkhana Road, Deccan Gymkhana,
Opp P Y C Gymkhana, Pune 4
- BHIDE VAMAN SHANKAR**
Bhide, Palnikar & Shah,
1025 Sadashiv Peth, 5th Floor,
Opp Shivaji Mandir, Pune 30.
- BHUTADA SHAMSUNDAR
JAYANARAYAN**
M/s S. J. Bhutada & Co., 98 Budhwar
Peth, Ganpati Chowk, Laxmi Road,
Poona 2
- BOTHARA GHEVARCHAND
MOTILAL**
M/s. G. M. Bothara & Co, Arun-
odaya Society, Bungalow No 9,
Kaka Halwai Estate, Pune 9
- CHACKO M. L.**
Flat No. 21 Gulati Mansion,
799/A Bhawan Peth,
Pudumjee Park, Pune 2
- CHHALLANI BHAGCHAND
ZIPARULAL**
467 Sadashiv Peth, Sambhaji Bridge
Corner, Pune 30
- CHITALE ARVIND
PURUSHOTTAM**
N P. Chitale & Co, Pariyat Block
No 2, Sane Guruji Road,
Opp. Peshwe Park, Pune 30
- CHOPADA MANIKLAL
PANNALAL**
M/s. M. P. Chopada & Co.,
976 Sadashiv Peth, Laxmi Road,
Near Hotel Jashan,
Pune 30.
- DABAKE VISHWANATH PRA-
BHAKAR**
603 Sadashiv Peth, Laxmi Road,
Pune 30
- DALAL MARAZBAN NARIMAN**
B-3 Park View Apartments,
55/8, A/2 Salisbury Park, Pune 1.

DAMLE DILIP KUMAR
1460 Sadashiv Peth, Hari-Prasad,
Pune 30.

DANAWE PURUSHOTTAM ANANTRAO
Tara-Bhuvan, 1966 Sadashiv Peth,
Madiwale Colony, Pune 30.

DAVAR MINU SAVAKSHAH
S. No. 247-148, Yeravada,
Pune 6.

DAVIERWALA MINOO PESTONJI
661A Shivajinagar, 2nd Floor,
Above Agurti Corner, Pune 4.

DESHMUKH SHIVRAM VISHWANATH
573/5 Jangli Maharaj Road, Pune 4.

DESHPANDE ANILKUMAR GOVINDRAO
M/s. A. G. Deshpande & Co.,
852 Bhandarkar Road, Pune 4.

DESHPANDE ARVIND ACHYUT
48/4 Post & Telegraph Colony,
Gultekadi, Pune 1.

DESHPANDE DIPAK JANARDAN
C/o. P. G. Bhagwat, Kohinoor,
2094 Vijayanagar Colony, Sadashiv
Peth, Pune 30.

DESHPANDE SHARAD NARAYAN
S. N. Deshpande & Co.,
179-A Budhwar Peth, Pune 2.

DISA RAVINDRA GOVARDHAN-DAS
A-2/9 Rambaug Colony, Kalpana,
Navi Peth, Pune 9.

DIXIT CHINTAMAN MAHADEO
Laxmi Niwas, 759/122 Deccan
Gymkhana, Pune 4.

DOSHI ARVINDKUMAR UTTAMCHAND
M/s. A. V. Doshi & Co.
826/27 New Budhwar Peth, Sonya
Maruti Chowk, above Punjab
National Bank, Pune 2.

DOSHI CHANDRAKANT GOVINDAS
Chandrakant G. Doshi & Co.
Chadda Mansion, 206/4, Office No
7, 1st Floor, Pimpri 18.

DOSHI SHASHIKANT NEMCHAND
S. N. Doshi & Co. 41 Shivajinagar,
Juna Tophkhana, Pune 4.

DUDHEDIA VIJAYKUMAR AMOLAKCHAND
V. A. Dudhedia & Co., 826/27
Budhwar Peth, Sonya Maruti Chowk,
Laxmi Road, Pune 2.

FIRKE DAVIDAS HARI
D. H. Firke & Co., 1195-4 Gokhale
Road, Pune 5.

G. D. APTE & CO.
United Western Bank Bldg., Laxmi
Rd., Pune 2.

GADGIL ASHOK GOVIND
A. G. Gadgil & Co., A/6 Madhuban
Apts., F. C. Road, Deccan
Gymkhana, Pune 4.

GADGIL RAGHUNATH GOVIND
R. G. Gadgil & Co., 23/24A
Erandawana, Prabhat Road,
Lane No. 4, Pune 4.

GADGIL SHRINIVAS RAMCHANDRA
56/18 Bhonde Colony, Erandavana,
Pune 4.

GADRE K. S.
Vidya Dhan, Plot 1227, Near
M. S. E. B. Colony,
Ashoknagar, Pune 7.

GANDHI RAMESH KHIVARAJ
Alankar Cinema Bldg., 1st Floor,
Pune 1

GANOO SUNIL RAMCHANDRA
41 Phule Market, Shukrawar Peth,
Pune 2

GHATPANDE SATISH SHRIRAM
Satish Ghatpande & Co., 1277,
Vishvas, Subhash Nagar, Lane No. 6
Pune 2.

GHATPANDE SUNIL MADHUKAR
Madhukosh, H.A.E. Co-op. Housing
Society, Karve Rd., Pune 4.

GODBOLE MADAN SHRIDHAR
M. S. Godbole & Co.,
841 Budhwar Peth, Pune 2.

GODBOLE NARASINHA KRISHNAJI
V. K. Godbole & Co., 23/2-A Budh-
war Peth, Laxmi Road, Bank of
Maharashtra Bldg., Pune 2.

GODBOLE SHRIKRISHNA HANMANT
C/o. C. D. Phadke, 527 Narayan
Peth, Pune 30.

GODBOLE VASUDEO KRISHNAJI
V. K. Godbole & Co. Sevasadan
Bldg., Laxmi Road, Pune 30.

GOEL SANTOSHKUMAR SURAJBHAN
S. S. Goel & Co., 2nd Floor, Geeta
Bhawan, 407/2 Nana Peth, Pune 2.

GOGATE SHRIRAM NARAYAN
4037 B, Narayan Smriti Sadashiv
Peth, Tilak Road, Pune 30.

GOKHALE ACHYUT ATMARAM
A. A. Gokhale, 565 Narayan Peth,
Pune 2.

GORE ARVIND BHALCHANDRA
A. B. Gore & Co., 1/8, Jeevan
Sangeet, Erandawana, Pune 4.

GOSAVI VASANT DINKAR
V. D Gosavi & Co. 209 Narayan
Peth, Adhar, Laxmi Road, Pune 30

**GUJAR UDAYKUMAR BHANU-
DAS**
Tilak Road, Abhinav Kala Maha-
vidyalaya Chowk. Pune 30

**HARNESSWALA MUBBASSHIR
AKBERHUSEIN**
6 Murtazavi Society, 363/2 Bhavani
Peth, Pune 2

HEGDE B. RATNAKAR
27/4 Bhavani Co-op. Hsg. Scty ,
343/6 Bhavani Peth, Pune 2

**HOZDAR ADARBAD
TEHMURASP**
A. T Hozdar & Co. Bungalow No.
826 Dastur Meher Road, Camp,
Pune 1

IRANI GUSTAD JEHANGIR
590 Sachapir Street, Pune 1

**JAIN RAMCHANDRA
CHANDRARAO**
820/3 B. J. Road, Pune 4

**JAIN SUDHIR RAMESH-
CHANDRA**
696 Narayan Peth, Kunte Chowk,
Laxmi Road, Pune 30.

JAYARAMAN V.
269 Mahatma Gandhi Road, Pune 1

JOSHI ARUN HARI
A. H. Joshi & Co., Neelam, 1907
Sadashiv Peth, Natu Baug, Pune 30.

JOSHI ARUN MADHAV
498 Narayan Peth, Pune 30.

**JOSHI CHANDRASHEKHAR
HARI**
562 Narayan Peth, Pune 30

JOSHI DILIP PRABHAKAR
1144 Krish. Shukrawar Peth,
Pune 2.

JOSHI JAGDEEP SURESH
C/o. Poonawala Investments, 283
Mahatma Gandhi Road, Pune 1

JOSHI PRAKASH SHIVRAM
1246 Sadashiv Peth, Karve Wada,
Pune 30

JOSHI RAGHUNATH NARAYAN
R. N. Joshi & Co., Abhyankar
Chawl, 2nd Floor, Sadashiv Peth,
Fadtare Chowk, Pune 30

JOSHI YESHWANT GOVIND
711 Sadashiv Peth, Nimbalkar Talim
Chowk, Pune 30

JOSHI Mrs. SHEELA BAL
S B. Joshi & Co., Jaydeo, 20 Prashant
Nagar, Navi Peth, Pune 30.

**KAMDAR JALALUDIN
JAFFERALI**
Guru-Chaya, 2nd Floor, 66 Karve
Road, Pune 4

**KARACHIWALA YUSUF F.
Y F. Karachiwala & Co.**
908 Deccan Gymkhana, Pune 4

**KARNAVAT NEMICHAND
FULCHAND**
M/s. N. F Karnavat & Co .
Junnarkar Datta Mandir Bldg ,
2nd Floor , near Commonwealth
Bldg , 596 Sadashiv Peth, Pune 30

**KAVATHEKAR CHANDRAKANT
VINAYAK**
C. V Kavathekar & Co , Phadtare
Chowk. P.M.C. Bank Bldg , 3rd
Floor, Pune 30.

KELKAR ARUN GOVIND
603 Sadashiv Peth, Pune 30.

KETKAR PRABHAKAR GANESH
P. G. Ketkar & Co . 148/A. Kasha
Peth, Pune 11

**KHADILKAR ASHOK BALKRI-
SHNA**
466 Shanwar Peth, Waman Niwas,
Pune 30

**KHADILKAR PURUSHOTTAM
DAMODAR**
1627 Sadashiv Peth, Dadhe's
Bungalow, Pune 2

**KHANDELWAL CHANDRAKANT
VITHALDAS**
Khandelwal Jain & Co 1st Floor.
Alankar Cinema Bldg , Pune 1

KHANDKAR ARVIND GAJANAN
A. G. Khandkar & Co , 1106, Shukra-
war Peth, Subhash Nagar Colony,
Opp Club of Maharashtra, Pune 2,

KHARE BALKRISHNA GOVIND
1236 & 1306 New Sadashiv Peth.
Pune 30

**KHATAVKAR SHRIKANT
RAGHUNATH**
184 Somwar Peth, Near Daruwala
Bridge, Pune 11

KIRTANE VITHAL BHAGWANT
253/9 Sadashiv Peth, Limayewadi,
Pune 2

KITEKAR NIWRATI TUKARAM
Shiv Prasad Co-op. Hsg. Society
Ltd., Plot No. 54, Panamala, Vithal-
wadi Road, Pune 30

KOSHE ARUN HARI SIVIDHA
Plot No. 15, Vikas Nagar, Navi
Peth, Pune 30.

KOTHARY ASHOK NATWARLAL
G. M. Oak & Co. 32 Swapna Nagari,
Karve Road, Pune 4

- KRISHNAMURTHY R.**
253/254 Rasta Peth, Pune 11
- KRISHNASWAMY A. R.**
Internal Auditor, Bajaj Auto Ltd.,
Akurdi, Pune 35.
- KSHIRASAGAR BHASKAR
NARAYAN**
1236 Shivajinagar, Apte Road,
Deccan Gymkhana, Pune 4.
- KUDCHE VASANT S.**
V. S. Kudche & Co., Thorat Estate,
1275 Deccan Gymkhana, Pune 4.
- KUDVA SUDHAKAR**
C/o. Sri K. S. Kudva, Flat No. A/8,
Suhrud Co-op. Hsg. Scy., Opp.
Mehendale Garage, Erandawana,
Pune 4
- KULKARNI DHANANJAY
RAMCHANDRA**
558/4 Tilak Road, Swargate, Pune 2.
- KULKARNI DNYANESHWAR
RAMCHANDRA**
M/s. D. L. Kulkarni & Co., 255
'Shriram Niwas', Sahakar Nagar,
Pune 9
- KULKARNI RAMESH SONOPANT**
1330 Shukrawar Peth, Pune 2.
- KULKARNI VENKTESH GOPAL**
D.B.M. V. G. Kulkarni & Co.,
1444 Sadashiv Peth, Pune 30.
- KULKARNI VIJAYKUMAR
SADASHIV**
876 Mardhekar Banglow, Bandarkar
Road, Gali No. 4, Deccan Gym-
khana, Pune 4,
- LADDA LAXMINIVAS
BALAPRASAD**
F5/1, Bajaj Auto Colony, Akurdi,
Pune 35.
- LATIF FIROZE NOMAN**
5 Napier Road, Pune 1.
- LIMAYE GIRIDHAR YASHWANT**
G. Y. Limaye & Co., Pitru Chhaya,
1258/2 Jangli Maharaj Road, Pune 4.
- LODHA BANKATLAL MOTILAL**
B. M. Lodha & Co., 286 Ganesh
Chambers, Opp. Alpana Talkies,
Laxmi Road, Pune 2.
- LOHADE PUNAMCHAND
PREMCHAND**
Jain Lohade & Co., 708 Narayan
Peth, Laxmi Road, Opp. Common-
wealth Bldg., Pune 2.
- MADANE GOPAL VISHWANATH**
G. V. Madane & Co., 9-B, Budhwar
Peth, Laxmi Road, Pune 2.
- MADHEKAR WAMAN
DATTATRAYA**
348 Rasta Peth, Pune 11
- MAITRI VIJAYKUMAR
MALLIKARJUN**
M/s. V. M. Maitri & Co., Alankar
Cinema Bldg., Floor 1st, Pune 1.
- MANDKE SHRADDHA VITHAL**
1257 Shukrawar Peth, Subhash
Nagar, Lane No. 5, Pune 2.
- MARATHE MADHUKAR
PURUSHOTTAM**
G. M. Oak & Co., 32 Swapna
Nagari, Karve Road, Pune 4.
- MARATHE SHIRISH NILKANTH**
G. M. Oak & Co., 32 Swapna
Nagari, Karve Road, Pune 4.
- MARSHIYA GIRDHARILAL
BANSILAL**
Amrit, 31/1 Karve Road, Pune 4.
- MEDHEKAR RAVINDRA VASANT**
1420 Shukrawar Peth, Near Nava
Vishnu, Pune 2.
- MEDADKAR SHRIKRISHAN
DATTATRAYA**
S. D. Medadkar & Co., 611
Sadashiv Peth, Datt Nivas, Kunte
Chowk, Pune 30.
- MEHENDALE MUKUND
RAMCHANDRA**
Vaishampayan & Associates, 354
Narayan Peth, Laxmi Road, Pune 30
- MEHENDALE PRAMOD
HEMKANT**
Mehendale & Shah, Ganesh
Chambers, Karve Road, Pune 4
- MEHTA MAHASUKHRAY
KEVALCHAND**
M. K. Mehta & Co. Hakim
Mansion, 917/18 Budhwar Peth,
Pune 2.
- MERCHANT RAJENDRALAL
BHOJILAL**
R. B. Merchant & Co.,
691 Budhwar Peth, Opp. Daxin-
mukhi Maruti, Pune 2.
- MAAIGI ARUN DATTATRAYA**
A. D. Mhalgi & Co., 1454 Kasba
Peth, Pune 11
- MOHITE GULAB RAGHUNATH-
RAO**
M/s. Mohite & Deshpande, 377 New
Sadashiv Peth, Laxmi Road, Pune 30.
- MOTE RAMCHANDRA
BAPURAO**
R. B. Mote & Co., 534 Budhwar
Peth, Pune 2
- MUNAGEKAR R. R.**
Patankar & Associates, 'Anand',
Prabhat Rd., Pune 4.
- NADPUROHIT SHRIKANT
RAMDAS**
S. R. Nadpurohit & Co., 1211/1A,
Shukrawar Peth, Subhash Nagar,
Pune 2.
- NAKHATE SAGAR RAMKRISHNA**
Santosh, 1226/2 Deccan Gymkhana,
Pune 4.

NANAL MOHAN MADHUKAR
Mohan M. Nazal & Co., 1440
Shukrawar Peth, Shevade Lane,
Pune 2

NARASIMHAN S.
C-8, Commonwealth Bldg., Opp
Bund Garden, Pune 1.

NAYAK ULLHAS ANAND
Ullhas Nayak & Co., 416/11 Krishna
Kunj, Raghuvir Housing Society,
Mukund Nagar, Pune 9

OSWAL GEVARCHAND
CHANDMAL
G. C. Oswal & Co., 399 Nana Peth,
Near Quarter Gate, Pune 2

OSWAL PRITHVIRAJ
BHICKAMCHAND
P. B. Oswal, 501 Centre street,
Pune 1.

PADHYE SHREEDHAR
VASANTRAO
2061 Vijaynagar Colony, Behind
S P College, Pune 30

PALNITKAR HARI GANESH
Bhide Palnitkar & Shah, 1025
Sadashiv Peth, 5th floor, Shivaji-
mandir, Pune 30.

PANDIT BALKRISHNA
RAMCHANDRA
Kirtane & Pandit, 955 Sadashiv
Peth, Laxmi Road, Near Gokhale
Hall, Pune 30.

PANDIT SASHISHEKHAR
BALKRISHNA
Kirtane & Pandit, 576 Sadashiv
Peth, Pune 30.

PARANJPE GOVIND KESHAV
G. K. Paranjpe & Co.,
993 Sadashiv Peth, Pune 30.

PARASNIS SHASHIKANT
S. P. Parasnisi & Co. C/o Ram
Agency, 458/2 Sadashiv Peth,
Tilak Road, Pune 30.

PAREKH UMESH SHANTILAL
2 Shukrawar Peth, 2nd floor, Pune 2.

PARMAR PUNAMCHAND
CHANDULAL
P. C. Parmar & Co., 945 Bootee
Street, Pune 1

PATANKAR MANOHAR KESHAV
Patankar & Associates,
185/3-4 Budhwar Peth, Laxmi Road,
Pune 2

PATEL POLLY BHIKHAJI
P. B. Patel & Co., 2/24 Guru Prasad,
Bund Garden Road, Pune 1.

PATKI ANANT RAMKRISHNA
Patki & Soman, 639 Sadashiv Peth,
Pune 30

PATWARDHAN ASHOK
MADHAV
M/s. A. M. Patwardhan & Co.,
711 Narayan Peth, Laxmi Road,
Pune 30.

PEWAR RAJARAM DUTTAPPA
R. D. Pawar & Co., 12 Sadhu
Waswani Road, Pune 1

PETHE MADHUKAR JANARDAN
Plot No. 1000/3, Navi Peth, Anupam
Society, Pune 30.

PHADKE PANDURANG
NARAYAN,
P. N. Phadke & Co., 23 Shukrawar
Peth, Phule Market, Pune 2,

PHATAK BALKRISHNA LAXMAN
B. L. Phatak & Co., Kakakuwa
Mansion, 54 Budhwar Peth, Laxmi
Road, Pune 2.

PITALE WALCHAND MOTILAL
Pitale & Associates, 206 B Shivaji-
nagar, Pune 5.

PITHAWALLA BOMANSHAW
MUCHERSHAW,
B. M. Pithawala & Co.,
405/2 Ardeshir Irani Road, Pune 2.

PURANIK SHRIRAM NARA-
YANRAO
10/127 Lokmanya Nagar, Pune 30

RANADE AJIT VISHNU
484/53 Jaevan Jyoti, Mitra Mandal
Colony, Parvati, Pune 9

RANADE JAYANT KRISHNA
64/4 Parijatak, Karve Road, Pune 4

RANADE SURESH VASANT
1993 Sadashiv Peth, Madiwale
Colony, Pune 9

RANADE YESHWANT MADHAV
Ranade & Co., Meenal Apts. Karve
Road, Near Nul Stop, Pune 4

RATHI JUGALKISHOR
SHRINIWASJI
B-103 Prabhat Chambers, Appa
Balwant Chowk, 685 Budhwar Peth,
Pune 2.

RATHI RATANKUMAR
LAXMINARAYAN
R. L. Rathi & Co., 789 Deccan
Gymkhana, Bhandarkar Road,
Pune 4.

SABNE DILIP BHAGWANT
586 Budhwar Peth, Pune 2

SABNE SUDHIR BHAGWAN
Flat No. 1-B, 1244 Sadashiv Peth,
L. B. Bhopatkar Road, Pune 30.

SAHNEY RAVINDRA
Joshi & Sahney, 1913 Sadashiv
Peth, Natu Bag, Pune 30.

SALVEKAR SHASHIKANT
RAMCHANDRA
341 Narayan Peth, Commonwealth
Colony, Pune 30.

SAMPATHKUMAR D.
775/1 Park View, Opp. Kamala
Nehru Park, Pune 4.

**SANCHETI JAWAHARLAL
MANIKCHAND**
M/s. Century Enka Ltd.,
Bhosari, Pune 26.

SARAD BALKRISHNA C.
B. C. Sarad & Co., 1688 Sadashiv
Peth, Pune 30

**SARPOTDAR SHRIKANT
GOVIND**
C/o. Sri V. G. Palsule,
664-B Shaniwar Peth, Pune 30.

SATBHAI DILIP VASANTRAO
34/3 Suvas Mansion, Prabhat Road,
Pune 4.

SATHE ANIL MADHUKAR
M/s. A. M. Sathe & Co., C/o. Dr.
B. B. Gokhale, 17 Sadhu Vaswani
Road, Pune 1.

SATHE DINKAR VISHWANATH
D. V. Sathe & Co., Sathe Chambers,
678 Shukrawar Peth, Pune 2.

SATHE SANJIV ANANT,
S. A. Sathe & Co. Shriphal,
1187/25 Ghole Road, Pune 5.

SATHE SHANKAR GOVIND,
892 Sadashiv Peth, Near Tulsi bagh,
Pune 2.

SEWAK ANANT DATTATRAYA
83 Ganesh Peth, Laxmi Road,
Pune 2.

SHAH BHARAT KANAIYALAL
C/o. B. C. Oswal & Co., 399 Nana
Peth, Pune 2.

SHAH BHARAT VISHNUDAS
Bhide Palnitkar & Shah, 1025
Sadashiv Peth, 5th floor, Opp.
Shivaji Mandir, Pune 30.

SHAH B. K.
1423 New Shukrawar Peth,
Near Nava Vishnu, Pune 2.

SHAH DEEPAK SURENDRALAL
M/s. D. Shah & Co 217 Nana Peth
Pune 2.

**SHAH DWARKANATH
DHARAMDAS**
D. D. Shah & Co. 95/96 Somwar
Peth, Ramnarayan Niwas, Pune 11.

SHAH JAGDISH MOHANLAL
1074 Shukrawar Peth,
Bhagyatara Bunglow, Pune 2

SHAH JAYSUKHLAL SOMCHAND
Block No. 14, 550 B, 3rd floor, Nana
Peth, Pune 2.

**SHAH MAHENDRAKUMAR
MOTICHAND**
Mahendrakumar Shah & Co., 720/20
Navi Peth, Lal Bahadur Shatri
Path., Pune 30.

SHAH NALIN SAKALCHAND
Nalin S. Shah & Co., C/o. Indo-
Foreign Stores, 292 Mahatma Gandhi
Road, Pune 1.

**SHAH PRAVINCHANDRA
CHHANALAL**
148 Shastri Apts., 4 Moledina Road,
Pune 1.

SHAH RAJAN MANILAL
Rajan M. Shah, 635/84 Vijay
Nagar Colony, Sadashiv Peth,
Siddharth Bunglow, Pune 30.

SHAH SHARAD ANANDLAL
C/o. C. T. Shah & Co., Sachapir
Street, Pune 1.

SHAH SHEKHAR SHANTILAL
626 Sachapir Street, Pune 1.

SHAH SURESH KANTILAL
101/29 Erandawana, Uday Society,
Karve Road, Pune 4.

**SHAH SURYAKANT
MANIKCHAND**
Suraykant M. Shah & Co., 1835/111
Sadashiv Peth, Flat No. 8, Desh-
mukhwadi, Pune 30.

SHAHA PRAKASH HARAKCHAND
P. H. Shaha & Co., 786 Sadashiv
Peth, Fadtare Chowk, Pune 30

SHAHA VIJAY RAMCHANDRA
Shri Ganesh Chambers, 286A
Ganesh Peth, Laxmi Road, Pune 2.

**SHARMA PURUSHOTTAM
GOPILAL**
Parashuram Kuti, 106/9 Erandawana,
Pune 4

SHARMA RAJA RAM
Sharma Associates,
Vishnu Bhawan, 1216 Subhash
Nagar, 4th Crosslane, Pune 2.

**SHENOY LAXMINARAYAN
SARVOTHAM**
Janki, 189 Bhandarkar Institute
Road, Deccan Gymkhana, Pune 4

SHETTY A. SADANANDA
Sadananda Shetty & Co., 2nd floor,
Alankar Cinema Bldg., Pune 1.

**SHUKLA GOPALPRASAD
SHIVPRASAD**
7 Tridal Apartment, Dr. Ketkar
Road, Erandawana, Pune 4.

**SHUKLA YESHWANT
PRABHAKAR,**
7 Shivaji Housing Society Pune 16.

SOMAN NARAHARI KRISHNAJI
Patki & Soman, 639 Sadashiv Peth,
Pune 30.

**SOMAN SATISHCHANDRA
MAHESHWAR**
1986 Sadashiv Peth, Madwale
Colony, Pune 30.

SURAF NEMICHAND
550 Narayan Peth, Pune 30.

TAMBE SUHAS PRABHAKAR,
M/s. Suhas Tambe & Co., 6 Mrun-
mayee, 65/6 Karve Road, Eranda-
wana, Pune 4

TANKSALE RAJARAM GOVIND
C/o. P. G. Bhagwat, Kohinoor,
2094 Vijaynagar Colony, Sadashiv
Peth, Pune 30

THORAT GORAKH SONABA
G. S. Thorat & Co., 354 Narayan
Peth, Chitrashala Bhavan, Room
No 30, Pune 30.

TORVI RAGHAVENDRA
RANGRAO
R. R. Torvi & Co., 128 Jangli
Maharaj Road, Pune 4.

UMARANI BHALCHANDRA
GANGADHAR
Sudbanshu Co-op. Housing Society,
1000/5 Navi Peth, Flat No. 9,
Pune 30.

UMBARKAR NARAYAN
DATTATRAYA
N. D. Umbarkar & Co. Shiva-
shaktrupa, 1030 Shukrawar Peth,
Tilak Road, Pune 2.

UPADHYE ANIL PRABHAKAR
Patankar & Associates, 185/3-4
Budhwar Peth, Pune 2.

VENKATARAMAN ERDDE
SUBRAMANINA
269 Mahatma Gandhi Road, Pune 1

WALIMBE AWDHUT
RAMCHANDRA
Argade Shyam & Co., 768 Sadashiv
Peth, Phadtare Chowk, Pune 30

YERAVDEKAR MADHAV
DATTATRAYA,
49 Sangamnagar, Poona-Satara Rd.,
Bibwewadi, Pune 9.

ZAWARE SHIWAJI BHIKAJI
M/s. S. B. Zaware & Co., 112A/1
Ambica Prasad, Prabhat Road,
Pune 4.

CHARTERED ENGINEERS

MAHULKAR SHASHIKANT D.
3-13 Lajwanti, 9/62 Erandavana,
Karve Road, Pune 4.

MEHENDALE, V. G.
217 Sadashiv Peth, Pune 30.

SHAH, HASMUKHLAL
AMBALAL
927 Budhwar Peth, Pune 2

COST AND WORKS ACCOUNTANTS (Practising)

ABHYANKAR GAJANAN
KASHINATH
10 Sunim Apartments, Prabhat
Road, Lane No. 7, Pune 4.

APTE MANOHAR DATTATRAY
'Kailash', 1103/A-2 Adarsh
Colony, Pune 16

KALE DAMODAR GANESH
D. G. Kale & Co. Cost Account-
tants, 'Purfi', Govardhan Society,
559/19 Maharshi Nagar, Pune 9

PARKHI PROMOD DATTATRAYA
P. D. Parkhi & Co. Cost Accountants,
563/A Budhwar Peth, Ganesh Road,
Pune 2.

PANDIT MADHUSUDAN
PURUSHOTTAM
'Shree', Sangam Nagar, Pune-
Satara Road, Pune 9

SHAH CHANDRAKANT
RIKHABDAS
661-A Shivajinagar, 2nd Floor,
Pune 4.

The following members have the
certificate of practice, but the
members are in employment also

CHAVARE MUKUND BAPURAO
A5, Malkans Society, 41/5
Erandawana, Paud Phata, Pune 4

DAFTARDAR SHARAD
SHANKAR
C/o. G. K. Umrani, 441/3 Somwar
Peth, Pune 11.

DANDAWATE AVINASH
JANARDAN
501 Narayan Peth, Pune 30

GUPTA JAGANNATH
Century Enka Colony No 1,
Bhosari, Pune 26.

JAYARAMAN, S.
Bajaj Tempo Ltd, Akurdi, Pune 35

LADHA GOVINDPRASAD
BALAPRASAD
F1/2 Bajaj Auto Colony, Akurdi,
Pune 35

TAMHANE RATNAKAR
SHRINIWAS
R. S. Tamhane & Co. Cost Account-
tants, Umrani Bungalow, Plot 12,
Anand Baug Society, 725/1/C Navi
Peth, Pune 30.

WAIIDYA NARAYAN SHANKAR
'Vijay', 1137/15 Shivajinagar,
Pune 16.

CONSULTANCY SERVICES

INDUSTRIAL AND FINANCIAL MANAGEMENT

AEON ASSOCIATES. 83 Koregaon Park, Pune 1. Industrial management consultants for marketing, exports and general administration etc.

AMBADE VASANT. 1027 Sadashiv Peth, Pune 30. Consultancy in stores management and purchase to small industries.

AURO MANAGERIAL SERVICES PVT. LTD. 2038-Tilak Road, Sadashiv Peth, Pune 30. Management consultancy services.

CENTRE FOR PSYCHOLOGICAL SERVICES- Chandrapurna, 7/1 Karve Road, Pune 4. The Centre offers consultancy services in the areas of personnel management and consumer psychology through job design and job analysis, selection of personnel, performance evaluation and promotion, exit interviews, counselling, organization planning and design, consumer surveys, and training. The Centre provides service to the financing agencies in three ways—entrepreneurial selection, entrepreneurial development programme and entrepreneurial counselling for sick units

DASS ASSOCIATES. ASHA 1, Block No. 31, Guru Nanak Nagar, Pune 2. Management consultants

DESHPADE & ASSOCIATES. 6-A. Padmanabh Housing Society, Near Church, Erandawana, Pune 4. Import & Export.

GEMINI CONSULTANCY SERVICE. 464/9 Suyog Colony, Ganeshkhind Road, Pune 7. Financial services.

HABIB H. DATTOOBHAL 4/12 Canopus Apartments, Boat Club Road, Pune 1. Management consultancy.

INDUSTRIAL & MANAGEMENT CONSULTANTS ADVANCE INDUSTRIAL SERVICES.

B-1 Shamkripa, behind S. T. Stand, Shivajunagar, Pune 5. Project reports and technical feasibility report, assistance in finance creation, plant erection, liaisoning, marketing, taxation, management, labour and process consultancy.

INDUSTRIAL AND MANAGEMENT CONSULTANCY SERVICE (PVT) LTD. 1103/A-2 Model Colony, Pune 16. Managerial, technical, financial consultancy and services; feasibility and project reports; and counselling in foreign collaboration proposals.

JAL MODI AND ASSOCIATES. 2 Kasturba Samadhi Road, Off Nagar Road, Pune 14. Management consultancy services in the field of corporate planning, marketing, market research, personnel, production.

KARKHANIS VASANT. 1402 Kasba Peth, Pune 11. Import, Export, Investment Accounts.

KALYANI CONSULTANTS PVT. LTD. 1 Manali Apartments, 100-A/4, 15th Lane, Prabhat Road, Erandawana, Pune 4. Management and technical consultancy services such as feasibility studies, project profiles, techno-economic studies, plant design and erection, marketing research, industrial surveys, technical/process know-how, quality control, turnkey installation. Specialisation in forging technology, metallurgical problems, mini steel plants engineering, electrical and chemical products and plants; management services in industrial engineering, production engineering, design and development and O & M, financial management, market research, personnel selection

KIRLOSKAR G. S. 1078/D, Harekrishna Mandir Path, Pune 16. Management consultants.

KIRLOSKAR CONSULTANTS LTD. 917/19/A, Shivajunagar, Fergusson College Road, Pune 4. Consultancy services rendered—market research and economic studies, feasibility studies and project reports; civil, electrical and electronic engineering services; environmental, production and industrial engineering; chemical analysis, agricultural advisory services and agricultural engineering; management services, computer services, commercial information and language services, placement; specialisation in sugar, engineering, brewery, aluminium, diesel engine etc.

KULKARNI V. S. Mardhekar Bungalow, Off Bhandarkar Institute Road, Pune 4. Consultancy in project planning & tax planning.

MAHRATTA CHAMBER OF COMMERCE & INDUSTRIES. Tilak Road, Near Swargate, Pune 2. The Chamber provides consultancy services in labour problems, taxation, import-export procedures and special guidance to small-scale industries.

MODERN MANAGEMENT CONSULTANCY SERVICES. 692 Bombay-Pune Road, Kasarwadi, Pune 18 Management consultancy services in financial, materials and production management; general administration, company formation; project reports; market surveys etc Nagpur office & H O—Dhanawate Chambers, Sitaburdi, Nagpur 12.

N. N. KSHIRSAGAR AND CO. 384 Narayan Peth, Near Rashtrabhasha Bhavan, Pune 30. Industrial consultancy in imports and exports; new project and other related services for industry and trade.

P. D. PARKHI & CO. Chitrashala Bhavan, Laxmi Road, Pune 30. Consultancy in finance, costing; project reports and feasibility studies; materials management; import-export.

PARR CONSULTANTS. Ishkripa, 773/6-A Shuvajinagar, Pune 4

POONA DIVISIONAL PRODUCTIVITY COUNCIL. Maharashtra Chamber of Commerce & Industries Building, Tilak Road, Pune 2. Special assignments on production planning and control, stores reorganisation, work study, cost reduction, plant layout and such other assignments are undertaken by the industrial engineers of the Council

PROMPT MARKETING SERVICES. 596 Sadashiv Peth, Near Commonwealth Building, Laxmi Road, Pune 30 Manufacturer's representation, publicity and consultancy

PURUSHOTTAMDAS GOKALDAS. Kanchangalli, Law College Road, Pune 4 Consulting Engineers and Patent Attorneys.

PURANIK S. N. 10/127 Lokmanyagar, Pune 30 Consultant in tax planning.

R. D. APTE & CO. 58 Sheela Vihar Colony, Karve Road, Erandawana, Pune 4. Consultants in foreign collaborations, industrial licences, D G T D registration, drawback claims etc

R. G. JOSHI & ASSOCIATES. 198/22 Tilak Road, Patil Building, Pune 30. Management and technical consultants, prepare feasibility and project reports, undertake investigation and advise on plant/management; specialisation in medium and small units in chemical engineering and textile industry,

S. V. DEODHAR AND ASSOCIATES. 938 Sadashiv Peth, Laxmi Road, Pune 30. Management consultants.

S R G CONSULTANCY. Ram Kripa, 17 Deccan Gymkhana Colony, Pune 4. Management advisory services for project planning, financial appraisal, administrative management, organisational development and railway transport.

SERVIELEC. Gurja, 4/3 Karve Road, Pune 4. Consultants, distributors, representative and service engineers.

SHARMA ASSOCIATES
1216 Subhashuagar, 4th Crosslane, Pune 2,
Business and management consultants,

STATISTICAL CONSULTANCY SERVICES. 1410 Sadashiv Peth, Pune 30 Market survey, project report, analysis

THE COMMERCIAL CONSULTANTS' BUREAU. 994-B, Sadashiv Peth, Opp. Sweet Home, Pune 30 Consultation in Sales Tax, Income Tax, Professional Tax, guidance in making applications for import, raw materials, hire purchase, finance from banks, S.F.C etc maintenance of accounts; new projects, registration.

UNIQUE SYSTEMS. 713 Sadashiv Peth, Near Chitra Shala, Pune 30. Management and technical consultants rendering services such as electronic data processing; industrial engineering; project engineering; project reports; feasibility reports; costing systems; technical and financial advisers for small and medium scale industries on retainer basis; inplant training courses in financial management, costing and industrial engineering.

INDUSTRIAL RELATIONS

DASHRATH S. N. 'Rimzim', Vijayanagar Colony, Pune 30

DEO N. B. 376 Narayan Peth, Laxmi Road, Pune 30

DESHPANDE S. A. Nandadeep, 365/15 Shivajinagar, Pune 5

HAGAWANE M. S. 630 Narayan Peth, Pune 30.

JANA CONSULTANTS. 38/576 Lokmanyagar, Pune 30.

JOSHI Y. D. Panchshri, 67/68/11 Karve Road, Pune 4.

MAHRATTA CHAMBER OF COMMERCE AND INDUSTRIES Tilak Road, Pune 2.

SOHONI P. D. Dipalee, 720/18 Navi Peth, Shastri Road, Pune 30.

EXCISE, CUSTOMS & GOLD CONTROL

BARVE D. D. (Retired Assistant Collector—Central Excise & Customs). 55/23 Nav Sahyadri Co-op. Housing Society, Ganeshnagar, Pune 29.

CHIPALKATTI P. B. 3/15 Mukundnagar, Pune 9.

DESHMUKH B. D. (Retired Collector of Central Excise and Customs). 1165 Shukrawar Peth, Pune 2.

JOSHI KAMALAKAR. P. 3 Bhawani Peth, Pune 2.

KHOSLA N. D. (Retired Dy. Collector—Central Excise & Customs) 22 Kahun Road, Pune 1.

PETHKAR R. V. 432 Sahakar Nagar, Pune 9.

SONALKAR V. R. (Retired Collector of Central Excise & Customs) 1194/7-A Ghole Road, Pune 5.

SPECIALISED

BHATE & PONKSHE. 1423 Shukrawar Peth, Off. Bajirao Road, Pune 2. Patents, design, trade mark attorneys and industrial consultants.

BOPARDIKAR M. V. 50 Vijaynagar Colony, Behind S. P. College, Pune 30. Consulting Engineer for environmental pollution; expert in water treatment and waste treatment plants.

BOPARDIKAR S. M. 50 Vijayanagar Colony, Behind S. P. College, Pune 30. Consultation in industrial and occupational health.

CENTRE FOR DEVELOPMENT STUDIES AND ACTIVITIES. 86/15 Kanchan Galli, Pune 4. Advice in planning and financing of low cost housing; socio-economic surveys; integrated rural development.

HASABNIS GOVIND S. 42 Budhwar Peth, Laxmi Road, Ganpati Chowk, Pune 2. General and life insurance consultancy services to industries.

JALSEVA. 1475 Sadashiv Peth, Shreedham, Opp. S. P. College, Tilak Road, Pune 30. Design, execution and consultancy in irrigation and water supply schemes, ground water survey, bore wells, diamond core drilling, marine diesel services, boat building, instrumentation, ferro-cement products.

KADU L. M. 379 Shaniwar Peth, Pune 30. Consultant in graphic designing, exhibition planning etc.

KHANDEKAR N. G. 'Shreekar', Sarang Society, 83/1 Parvati, Pune 9. Consultant in Co-operative laws.

LINK. 925/D-3, Shivajinagar, Kinara, Pune 4. Consultants in public relations, mass media, and visual communications

MAHULIKAR SHASHIKANT D. 3B, Lajwanti, 9/62 Erandawana, Karve Road, Pune 4. Chartered Engineer, registered valuer for plant and machinery, estates etc, testing of equipments as per the Factories Act, oil tanker testing and inspection as required by the Explosives Inspector; designing and development of special equipments, machines and products; trouble shooting in plants; licenced insurance surveyor; economic feasibility and project reports, valuation reports for banks, M.S.F.C., I.D.B.I etc.

MULAY A. N. 1281 Shivajinagar, Pune 5. Consultancy in provident fund & E.S.I. matters.

PANCHWAGH M. S. 1206/A-32, Deccan Gymkhana, Shirole Road, Pune 4. Technical library consultants, assistance in solving any problem in technical libraries, and prepare and execute schemes of new technical projects.

PARANJPE ENGINEERING AND FOUNDRY CO. (PVT.) LTD. E 14 & 15 Bhosari Industrial Estate, Pune 26. Offers I B M unit record system services such as card punching and verification, financial accounting, stores accounting, pay-roll accounting and implementation of mechanised accounting system.

PATEL V. K. 399/2 Raviwar Peth, Sonya Maruti Chowk, Pune 2. Trade marks and patent attorneys.

PHILIPS (INDIA) LTD. Bhosari Industrial Estate, Pune 26. Computer services.

PRATIBHA ADVERTISING. Cosmos, Prabhat Road, Pune 4. Business services

SYSTEMS RESEARCH INSTITUTE. 6 Parvati Villa Road, Pune 1. The Institute performs applied systems analysis and designing as well as training in systems analysis and computer methods. Institute's Computer Centre collaborates with firms and public agencies in doing applied research on decentralised data processing, micro-processing, data banks and simulation modeling.

VAIKUNTH MEHTA NATIONAL INSTITUTE OF CO-OPERATIVE MANAGEMENT. R.B.I. Buildings, Ganeshkhind Road, Pune 7 Economic services.

TATA ENGINEERING AND LOCOMOTIVE CO. LTD. Chinchwad, Pune 19. Computer services

TECHNICAL

A. D. HATE & ASSOCIATES. 1380 New Shukrawar Peth, Pune 2 Consulting Engineer

ARKEY ENGINEERING SERVICES. 37/4/A, 6th Cross Lane, Prabhat Road, Pune 4. Project feasibility reports on turn-key basis, techno management services, design and development of new products.

ARVIND SURANGE. 5 Pawar's Block, Laxami Sadan, 1263/1 J. M. Road, Pune 4. Specialist's technical services, management consultancy, project consulting engineers in refrigeration and allied fields

B. D. MALANI AND CO. 5 Bund Garden Road, Pune 1. Management and technical consultants; project reports, technical, economic and financial services

BEHRAM WADIA AND ASSOCIATES. 77 Koregaon, Park, Pune 1 Technical consultants and offer specialists technical services in electronics such as market services, product knowhow, project engineering, computational facilities, technical information and testing

BHANDARI M. K. 23 Yashwant Nagar, Rane Circle, Ganeshkhind Road, Pune 7. Technical services in chemicals, dyes, pharmaceuticals, glass and ceramic industries; project reports

CHEM-E-CON. 994/9 Shivajinagar, Pune 16. Consulting chemical engineers and chemical technologists;

undertake feasibility studies, project reports, plant design etc.; specialists in intermediates for dyes and pharmaceuticals, perfumery chemicals, organic fine chemicals, effluent treatment etc.

CHAKRABORTY M. R. 12 Floriana Estate, Boat Club Road, Pune 1 Consultancy in foundry (ferrous), foundry (alloy and steel)

D. D. OWSAL & ASSOCIATES. 1642, Shukrawar Peth, Pune 2. Engineering and management consultants.

DATA SYSTEM SERVICES. Hotel Amir, Pune 1 E. D. P. consulting services.

DECCAN INDUSTRIAL PROCESS CONSULTANTS. 14 Ganeshwadi, Pune 4. Process control consultants

DESHPANDE M. V. Vinayak Cottage, 1170/24 Shivajinagar, Pune 5. Consulting engineer; specialised in electrical power problems; training for industrial personnel

GAJENDRAGADKAR M. H. 55/15 Pachadri, Near F.T.I.I. Erandawana, Pune 4 Technical services in refractories such as design, supply and installation of refractories; installing refractory bricklinking, analysing furnace problems and executing necessary remedial means

GODBOLE M. S. 3 Manali Co-op. Housing Society, 100/4 A, 15th Lane, Prabhat Road, Erandawana, Pune 4 Consultancy in foundry (non-ferrous), rolling mills, electronics

GOOD & SUITABLE RADIO CLASSES. 170 Budhwar Peth, Opp. Faraskhana Tank, Pune 2. Consultancy in manufacturing electronic instruments

HAWKEY TECHNICAL & BUSINESS CONSULTANTS. 22 Shahaney Sujan Park, Kondhwa Road, Pune 1 Programming for engineering projects.

INDUSTRIAL DESIGNERS. Post Box No. 741, Pune 30 Industrial machinery and equipments designing, drafting and estimation service for industrial units.

INDUSTRIAL TECHNICAL INSTITUTE. 3-B Lajwanti, 9.62 Erandawana, Karve Road, Pune 4. Technical services on the starting up of new industry; economy studies; production studies; energy conservation studies, increasing efficiency; industrial services for economic feasibility and project reports; turnkey project consultancy service

KARNIK RAO AND ASSOCIATES. 12-B Wasvani Road, Pune 1. Technical and management consultants.

KARVE P. R. A/11 Swapnanagari, Karve Road, Pune 4. Consultancy in chemical engineering and water pollution problems; valuation of equipments and chemicals in chemical industry.

KHATRI B.D. 46/A1 Dave Industrial Estate, Pune-Satara Road, Pune 9. Consultancy services in biscuit and confectionery manufacture, tooth paste and allied toiletries.

KIRTEE AGRO VET SERVICES. 11/1 Someshwarwadi, Pashan, Pune 8. Technical and management consultancy in poultry and dairy farming; technical poultry services offered such as debeaking, vaccination, supply of feed and cages etc.

KOWLEY CONSULTANTS AND MANUFACTURERS. 'Ashirwad', 124 Kadalakar Colony, Talegaon Dabhade, Dist. Pune. Consultants for rubber and plastic products.

KULKARNI A. H. 21 Matruchhaya Society, Near Agakhan Palace, Nagar Road, Pune 14. Consultancy in electrical engineering; specialisation in conductors, wires and cables, electrical insulating system etc.

MEHTA M. K. Mehta Packard Industries Pvt. Ltd. 69-B Hadapsar Industrial Estate, Pune 13. Consultancy in paper and allied products specialisation in paper conversion; project reports for paper mills and other allied industries.

NABAR S. M. B-1/4, Jilkar Baug, Hare Krishna Mandir Path, Pune 16. Consultancy in communication electronics.

NATRAJ R. C. Doctors' Quarters, Cantonment General Hospital, Khadki, Pune 3. Consultancy in forgings, plastics and allied industries.

NATIONAL HEAVY ENGINEERING CO-OPERATIVE LTD. 16 M G. Road, Pune 1. Services rendered—designing and manufacture of heavy engineering machinery, undertake turn-key assignments and consultancy.

NATIONAL SUGAR INSTITUTE. (Government of India), Pune Advisory Cell, 17 Shivaji Housing Society, Pune 16. Advisory service to sugar industry.

NEW PRODUCT DEVELOPMENT CO. 27 Shivaji Society, Pune 16. Consultancy in development of new I.D., 21

products; merchandising (P.O.P.) display; industrial engineering work and computer applications.

OAK R. P. Elektromin. 276/277 Narayan Peth, N. C. Kelkar Road, Pune 30. Consultancy in electronics.

PADHYE R. S. Chhaya Colony, 73/1/9 Law College Road, Pune 4. Technical and management consultants; technical services for electrical and electronic industries.

PAKNIKAR KANCHAN K. 1166 Sadashiv Peth, Tilak Road, Pune 30. Consultancy services in the field of printing and packaging, technical guidance, project reports, valuation of printing machinery.

PATIL G. K. Vimal Sadan, 11th Lane, Prabhat Road, Pune 4. Consulting engineers (civil) and management consultants.

POONAWALLA Z. A. 55/6-2 Salisbury Park, Pune 1. Consultancy in foundry technology, industrial metallurgy and management techniques.

PESTOKEM INDUSTRIES PVT. LTD. Pune Branch Office: 7 Sugandhi, Opp. Law College, Pune 4. Consultants on timber and wood decay.

PISHAROTI N. R. Systech International, 90/124-C, Erandawana, Pune 4. Consultancy in digital electronic equipment, computers, medical electronics.

SAILGARKAR S. N. Transtronic Industries, 5 Progressive Model Housing Society, Vaiduwadi, Solapur Road, Pune 13. Consultancy in manufacture of special purpose transformers and electronic equipments for industries.

SARAF J. K. 248 Budhwar Peth, Pune 2. Consultancy services in plastics such as setting up of new plastic units, valuation of machinery in plastic industry etc.

SATHE-DATAR ASSOCIATES. 9 Sabvihar, 1194 Shivajinagar, Pune 5. Consultants in chemical engineering, paper and allied products, khandsari manufacture.

SPEYS INDUSTRIAL SERVICES. 118 Shukrawar Peth Behind Phule Market, Pune 2. Shop and industrial services such as analytical control of baths, trouble shootings, maintenance, consultancy, development and technological assignments.

SWASTIK LABORATORY & INDUSTRIAL CHEMICALS PVT. LTD. 29 Hadapsar Industrial Estate, Pune 13. Consultancy in chemical industry.

THAKARSONS. 1206 B/31 Shivajinagar, Pune 4. Industrial Consultancy and development in electronics components field.

TECHNICAL CONSULTANTS ASSOCIATES. P. Box No. 10., Pune 18 Technical consultancy, project reports.

UNNIKRISHNAN P. N. 1st floor, Crown Restaurant, Khadki, Pune 3. Consultancy in ferrous and non-ferrous foundries.

INCOME-TAX & SALES-TAX CONSULTANTS

ADVANI MOTIRAM D.
Old Pool Galli, end of Thimayya Rd., Pune 1.

AKHEGAONKAR S. K.
1393 Shukrawar Peth, Bajirao Rd., Pune 30.

ASAR S.
865 Budhwar Peth, Laxmi Rd., Pune 30.

ATRE S. V. 163 Shukrawar Peth, Pune 2.

BAGMAR P. C. 570 Narayan Peth, Pune 30.

BAL G. R. 48 Budhwar Peth, Pune 2.

BALDOTA R. V.
391 Raviwar Peth, Sonya Maruti Chowk, Pune 2.

BAPAT A. N.
5 Sadashiv Peth, Near Alka Talkies, Pune 30.

BEHEDE V. B. Chitrashala Bhavan, Laxmi Rd., Pune 30.

BHAGWAT K. R.
180 Budhwar Peth, City Post Chowk, Pune 2.

BHAGWAT R. P.
1895 Sadashiv Peth, Natu Bag, Pune 30.

BHAGWAT V. R.
780 Budhwar Peth, City Post Chowk, Pune 2.

BHALGAT N. C.
'Anand', 38/1 Prabhat Rd., Near Gali No. 10, Pune 4.

BHIDE V. G.
Near P.Y.C. Gymkhana, Pune 4.

BHOJWANI L. R.
12 Wonderland, M. G. Rd., Pune 1.

BHOJWANI V. R.
12 Wonderland, M. G. Rd., Pune 1.

BHOSALE P. K.
47 Rasta Peth, Pune 11.

BIRAJDAR P. S.
9/3 Sane Guruji Rd., Pune 30.

BIRAJDAR S. A.
9/3 Sane Guruji Rd., Pune 30.

BOKAPHODE S. N.
318 Narayan Peth, Pune 30.

BOTHRA K. V.
826/27 Budhwar Peth, Sonya Maruti Chowk, Pune 2.

CHANDWANI K. H.
334 Sachapir Street, Pune 1.

CHANLECE K. M.
93/2 Budhwar Peth, Bank of Maharashtra Bldg., Pune 2.

CHASTWE C. H.
Laxmi Chambers, 840 Budhwar Peth, Pune 2.

DADHE V. G.
1627 Sadashiv Peth, Pune 30.

DEO N. B.
376 Narayan Peth, Pune 30.

DESAI D. S.
Sanchay, 25 Somwar Peth, Pune 11.

DESAI S. G.
34 Budhwar Peth, Pune 2.

DESAI S. S.
125 Budhwar Peth, Pune 2

DESHPANDE R. K.
180 Budhwar Peth, Pune 2.

DESHPANDE S. N.
City Post Chowk, Pune 2.

DESHPANDE V. M.
543 Shivajinagar, Pune 5.

DOMALE G. H.
865 Budhwar Peth, Pune 2.

- DOSHI A. V.**
826/27 Budhwar Peth, Pune 2.
- DOSHI B. N.**
77/1 Shivajinagar, Pune 5.
- DOSHI C. G.**
1/7 Chaddha Comm. Centre, Pimpri,
Pune 18
- DUDHEDIA V. A.**
826/27 Budhwar Peth, Sonya-
Maruti Chowk, Pune 2.
- GHANEKAR P. D.**
466 Raviwar Peth, Pune 2.
- GODBOLE V. K.**
Sevasadan Building, Laxmi Rd.,
Pune 30.
- GOEL S. S.** 407/2 Nana Peth,
Quarter Gate, Pune 2.
- GOGATE S. N.**
945 Bootee Street, Pune 1.
- GOSAVI V. D.**
'Adhar', 209 Narayan Peth, Pune 30.
- GUGALE D. K.**
3 Bhavani Peth, Pune 2.
- GUJAR V. B.**
'Jeevan Wadi', opp. Police Gate,
Narayan Peth, Pune 30.
- GURJAR V. M.**
1315 Sadashiv Peth, Pune 30.
- JAMADAR C. H.**
830 Budhwar Peth, Pune 2.
- JAYRAMAN P.**
269 M. G. Rd., Pune 1.
- JEDHE V. R.** 52/403 Maharshi-
nagar, Pune 9.
- JOGLEKAR G. N.**
177 Budhwar Peth, Pune 2.
- JOSHI A. G. & CO.**
88 Shukrawar Peth, Pune 2.
- JOSHI M. K.**
528 Raviwar Peth, Laxmi Rd.,
Pune 2.
- JOSHI V. N.**
55 Budhwar Peth, Pune 2.
- JOSHI & SAHNEY**
1913 Sadashiv Peth, Pune 30.
- KADAM S. S.**
304 Shukrawar Peth, Pune 2
- KATARIYA A. O.**
Shri Ganesh Chambers,
286-A Ganesh Peth, Pune 2.
- KATARIYA M. B.**
3 Bhavani Peth, Pune 2.
- KAVLE C. G.**
938 Sadashiv Peth, Laxmi Rd.,
Pune 30.
- KAVTHEKAR C. V.**
768 Sadashiv Peth, Pune 30.
- KHINVASARA S. S.**
528 Raviwar Peth, Laxmi Rd.,
Pune 2.
- KUDCHE V. S.**
1275 Thorat Estate, Deccan
Gymkhana, Pune 4.
- KULKARNI K. H.**
1487 Shukrawar Peth, Bajrao Rd.,
Pune 30.
- KULKARNI M. K.**
310 Narayan Peth, Pune 30.
- KULKARNI P. S.**
568 Narayan Peth, Gaikwad Wada,
Pune 30.
- KULKARNI R. K.**
1839 Sadashiv Peth, Pune 30,
- LALWANI V. P.**
414 Raviwar Peth, Pune 2.
- LIMAYE G. Y.**
1258/A J. M. Rd., Pune 4.
- LODHA B. M.**
Shri Ganesh Chambers,
280-A, Ganesh Peth, Pune 2.
- LOHADE P. P.**
708 Narayan Peth, Pune 30.
- LUNKAD H. N.**
867 Budhwar Peth, Pune 2.
- MADANE C. V.**
9-B Budhwar Peth, Pune 2.
- MALPANI R. L.**
1652 Shukrawar Peth, Pune 2.
- MEDIWALE R. K.**
129-B Guruwar Peth, Pune 2.
- MEHTA M. K.**
918 Budhwar Peth, Pune 2.
- MODI B. N.**
1770 Shukrawar Peth, Laxmi Rd.,
Pune 2.
- MODI B. N.**
C/o. Babula & Co.
215 Budhwar Peth, Pune 2.
- MODI C. N.**
14 M. G. Rd., Pune 1.
- MODY R. B.**
398 Raviwar Peth, Sonya Maruti
Chowk, Pune 2.
- MUNAGEKAR R. R.**
'Anand', Prabhat Rd., Near Galli
No. 10, Pune 4.
- MUNDADA C. R.**
1167 Raviwar Peth, Pune 2,

- NAGARKAR D. R.**
378 Shanwar Peth, Pune 30
- NAGORI C. H.**
74 Ganesh Peth, Pune 2.
- NAIK B. L.**
Shri Ganesh Chamber,
286-A Ganesh Peth, Pune 2.
- OSWAL G. C.**
399 Nana Peth, Pune 2.
- OZA R. J.**
942 Budhwar Peth, Pune 2.
- PANGARKAR J. G.**
354 Narayan Peth, Laxmi Rd.,
Pune 30.
- PARANJAPE S. H.**
994-B Sadashiv Peth, Pune 30.
- PARDESHI R. J.**
833 Budhwar Peth, Laxmi Rd.,
Pune 2.
- PAREKH MAHENDRA**
1285 Haffine Lane, M. G. Rd.,
Pune 1.
- PARMAR P. C.**
945 Bootee Street, Pune 1.
- PATANKAR M. K.**
'Anand', 38/1 Prabhat Rd.,
Near Galli No. 10, Pune 4.
- PATKI S. D.**
444 Shivajinagar, Pune 5.
- PATNIS M. L.**
13 Rajendranagar, Pune 30.
- PATWA I. C.**
Shri Ganesh Chambers,
286-A Ganesh Peth, Pune 2.
- PATWARDHAN A. N.**
705 Shukrawar Peth, Near Shrinath
Talkies, Pune 2.
- PAYGUDE D. M.**
351 Guruwar Peth, Pune 2.
- PHATAK B. L.**
Kakakuwa Mansion, Laxmi Rd.,
Pune 2.
- PISE D. M.**
95 Shinde Wadi, Shivajinagar,
Pune 5.
- RANADE J. K.**
1339 Sadashiv Peth, Pune 30.
- SADAR A. H.**
1313 Jan Mohamed Street, Pune 1
- SATHE P. V.**
1225/8 Prashat, Awatewadi, Pune 4.
- SAVANT D. V.**
840 Budhwar Peth, Pune 2.
- SETHIA S. K.**
1-A 23 Rambag Colony, Navi Peth,
Pune 30.
- SHAH B. V.**
1025 Sadashiv Peth, Pune 30.
- SHAH P. H.**
768 Sadashiv Peth, Pune 30.
- SHAH P. M.**
14 M. G. Rd., Pune 1.
- SHAH R. D.**
865 Budhwar Peth, Laxmi Rd.,
Pune 2.
- SHAH R. N.**
14 M. G. Rd., Pune 1.
- SHAH R. P.**
177 Guruwar Peth, Phulwala Chowk,
Pune 2.
- SHAH R. S.**
C/o Nandlal & Co. Rameshwar
Chowk, 23 Shukrawar Peth, Pune 2.
- SHAH S. C.**
1278 Subhashnagar Lane, Pune 2.
- SHAH S. C.**
1278 Subhashnagar Lane No. 6,
Pune 2.
- SHAH V. P.**
Shri Ganesh Chambers,
286-A Ganesh Peth, Pune 2.
- SHAH V. P.**
1428 Kasaba Peth, Pune 11.
- SHAH V. R.**
1156 Shukrawar Peth, Opp. Shivaji
Maratha High School, Pune 2
- SHAIKH & SHAIKH**
628 Raviwar Peth, Pune 2.
- SHARMA G. D.**
393 Mangalwar Peth, Pune 11.
- SHARMA N. J.**
840 Budhwar Peth, Pune 2.
- SHARMA P. G.**
393 Mangalwar Peth, Pune 11.
- SHARMA S. G.**
393 Mangalwar Peth, Pune 11.
- SHIVADEY V M.**
1963 Madiwale Colony, Pune 30
- SHROFF M. P.**
14 M. G. Rd, Pune 1.
- SOMAN N. K.**
993 Sadashiv Peth, Pune 30.
- TADGE B. N.**
'Rajlaxmi', 569/3-B, Shivajinagar,
Pune 5.
- TAMNA P. C.**
791 (new), Budhwar Peth, Pune 2.
- THAKAR N. C.**
354 Narayan Peth, Pune 30.

THOMBARE M. C.
172 Shanwar Peth, Pune 30.

TRIVEDI
Shri Ganesh Chambers,
286-A Ganesh Peth, Pune 30.

TRIVEDI H. C.
582 Raviwar Peth, Kapadganj,
Pune 30.

UPADHYA
840 Budhwar Peth, Pune 2.

UPADHYE A. P.
'Anand', 38/1 Prabhat Rd., Near
Galli No. 10, Pune 4.

UPLENCHWAR N. D.
85 New Bazar, Khadki, Pune 3.

VANKATRAMAN F. S.
269 M. G. Rd., Pune 1.

VARMA IYER
Shri Ganesh Chambers,
286-A Ganesh Peth, Pune 2

VELHAL D. G.
1571 Sadashiv Peth, Tilak Rd.,
Pune 30.

ZIRPE M. G.
569 Narayan Peth, Pune 30.

INSURANCE COMPANIES

GENERAL INSURANCE

**NATIONAL INSURANCE CO.
LTD.**
11 M. G. Road, Pune 1.

**NEW INDIA ASSURANCE CO.
LTD.**
Area Office: 2 Molodina Road,
Pune 1.

**ORIENTAL FIRE AND GENERAL
INSURANCE CO. LTD.**
'Jeevan Darshn' Bldg., 278/1
Narayan Peth, Pune 30.

**UNITED INDIA FIRE AND
GENERAL INSURANCE CO. LTD.**
15 Waswani Road, Pune 1.

LIFE INSURANCE

**LIFE INSURANCE CORPORA-
TION OF INDIA**
Divisional Office: Jeevan Prakash,
University Road, Pune 5.

STOCK BROKERS

KANE K. K.
179B Karve Sadan, Laxmi Road,
Budhwar Peth, Pune 2.

LELE K. V.
Sub-broker with A. B. Pandit &
Co., 1434 Sadashiv Peth, Madiwale
Colony, Pune 30.

R. R. NABAR & CO.
Bank of Maharashtra Bldg., Bajirao
Road, Pune 2.

SABNIS A. A.
1040 Shukrawar Peth, Tilak Road,
Pune 2.

VALUERS

AGRICULTURAL LANDS

BHOSALE S. A.
296 Shukrawar Peth, Pune 2.

DESHPANDE D. G.
23/333 Lokmanya Nagar, Pune 30.

DIXIT S. B.
'Dixit Paramdham',
28A (New), Narayan Peth, Pune 30.

MAHAJAN K. D.
484/17 Mitra Mandal Colony,
Parvati, Pune 9.

MODY H. N.
1187/12, Behind Modern High
School, Pune 5.

NEURGAONKAR R. S.
1444 Sadashiv Peth, Pune 30.

PATASKAR G. B.
316 Somwar Peth, Pune 11.

PATEL B. A.
Vidhate Colony, Block No. 1,
Area No. 15, Hadapsar, Pune 29.

PATWARDHAN R. S.
1311 Shukrawar Peth, Pune 2.

PHAVDE A. N.
'Laxmi', 517/32 Ghorpade Peth,
Pune 2.

RAJPUT B. G.
978, Block No. 4, Shankya Housing
Society, Model Colony, Pune 16.

RANE J. B.
'Ashirwad', 89 Shri Shivaji Housing
Society, Pune 16.

TEJWANI K. H.
25/8 P. W. D. Quarters, Pimpri
Colony, Pune 17.

IMMOVABLE PROPERTY

AGASHE V. V.
183-B Shukrawar Peth, Pune 2.

ARANKALE R. V.
772 Deccan Gymkhana, Pune 4.

BADAVE V. V.
891 Bhandarkar Inst. Road, Pune 4.

BAPAT K. N.
1194/4 Shivajinagar, Pune 5

BHANDEKAR V. G.
13 Narayan Peth, Pune 30.

BHIDE C. M.
19-A/7 Erandawana, Karve Rd.,
Pune 4.

BHIDE G. K.
43/16 Erandawana, 'Nanda Deep',
Pune 4.

BHOSEKAR H. D.
47 Ganesh Prasad, Tilak Rd.,
Vijayanagar Colony, Pune 30.

BODHANI R. S.
33/6 Erandawana, Pune 4.

BRAGANZE V.
37 St. Patricks Town, Solapur
Rd., Pune 1.

CHANDRACHUD Y. R.
1102 Shukrawar Peth, "Ratna-
prabha", Pune 2.

CHAPHALKAR V. B.
427/1 Shivajinagar, Pune 5.

CHAVAN D. F.
12 Yeshwant Nagar, Pune 7.

CHIKTE D. R.
766/14 P. Y C Gymkhana Colony,
Pune 4.

DALAYA J. B.
331 Sachapir Street, Pune 2.

DATE S. D.
9/A/2 Budhwar Peth, Pune 2

DATEY D. K.
860 Deccan Gymkhana, 'Mandai,
Bhandarkar Rd., Pune 4.

DEVDHAR V. S.
'Kiran', 786 Deccan Gymkhana,
Pune 4.

DESHPANDE V. B.
462/2 (New) Sadashiv Peth, Pune 30

DEORE J. M.
'Susangat, Mitra Mandal Colony,
Pune 4

DEO S. V.
48 Narayan Peth, Pune 30.

DONGRE U. W.
'Manikjyoti', J M Rd., Pune 4.

GANDHE J. V.
1134/1 Shivajinagar, 'Indraprasta',
Pune 16.

GHAISAS S. T.
1167 Shukrawar Peth, 'Kusumshree',
Pune 2.

GUMPHEKAR B. S.
38/17 'Chandan', Bhrat Kung
Vasahat, Pune 4.

HATE A. D.
1390 (New), Shukrawar Peth, Pune 2

JAVDEKAR B. Y.
Gangavatrana', Deshbuja Ganesh
Society, Pune 4.

JOGLEKAR K. S.
1210/C Shivajinagar, Pune 4

JOGLEKAR M. V.
1311 Shivajinagar, Pune 5

KALE K. G.
314 (New), Narayan Peth, Pune 30

KARIA B. L.
Bombay-Pune Rd., Near Phugewadi
Pune 12.

KARMARKAR H. G.
127/7 'Parijat', Erandawana, Pune 4

KHAROTE N. V.
471 Budhwar Peth, Pune 2.

KHOLAKAR M. V.
'Priya', 76-83 Mukund Nagar,
Pune 9.

KOTWAL D. B.
318 Sadashiv Peth, Pune 30

KULKARNI H. B.
52/2 By lane off Dr. Ketkar Rd.,
Erandawana, Pune 4

KULKARNI V. V.
40/12 Erandawana, 'Kripa', Bhone
Colony, Pune 4.

LELE R. D.
36 Shukrawar Peth, Pune 2.

LIMAYE D. R.
1877/4B Shivajinagar, 'Kanchan-
ganga', Pune 5.

MAHINDRAKAR K. B.
53/53 Ghorpuri Bazar, Pune 1

MEHALA S. M.
15/114 Agarkar Nagar, Pune 1

MEHENDELEY V. G.
720/13 Navi Peth, Pune 30

MONE V. T.
109/5 Erandawana, "Shrishaarda".
Pune 4.

NADGAUDA A. S.
161-A/3 Modibag, Ganeshkhind Rd.,
Pune 16.

NAGARKAR D. P.
759/45 Deccan Gymkhana, Pune 4.

NAGARKAR G. P.
492 Narayan Peth, Pune 30.

NAGARKAR R. D.
66/3 Erandawana, Pune 4.

NAROHNA A. N.
1 Middle Rd., Pune 1.

NAVARE V. V.
Rambag Colony, 8/6 Navi Peth,
Pune 30.

PALSIKAR B. G.
31/9 'Gulmohar', Sano Guruji Marg,
Pune 30.

PATIL R. S.
1258 J. M. Rd., Pune 9.

PATWARDHAN R. S.
131 Shukrawar Peth, Sathe Colony,
Bajirao Rd., Pune 2.

PUNDALIK R. G.
1931 Sadashiv Peth, Pune 30.

RANADE A. M.
354 Narayan Peth, Chitrashala
Bhawan, Pune 30.

RANADE K. S.
759/11 D. G. Colony, Pune 4.

RATHI R. H.
766/2 PYC Gymkhana Colony,
Pune 4.

SANE Y. S.
135/5 Erandawana Pune 4.

SANT P. V.
573/6 J. M. Rd., Pune 4.

SARASHIYA A. N.
96 Kothrud, Pune 29.

SARDAR A. G.
1243/2 Apte Rd., Pune 4.

SHAH B. N.
8 Satara Rd., Pune 9.

SWAMY S. K.
4 Abhilasha Housing Society,
Pune.

TALIM B. T.
36 Shukrawar Peth, Pune 4.

TALWALKAR M. G.
1233A Apte Rd., D. G., Pune 4.

TAMBE J. P.
5 Shri Vithal Rd., Near Alka
Cinema, Pune 30.

TAWADE N. B.
1187/4B Shivajinagar, Pune 5.

TELLIS C. S. J.
3 Middle Rd., Cantonment, Pune 1.

THORAT S. B.
1258 J. M. Rd., "Matruchhaya",
Opp. Natraj, Pune 4.

TULPULE H. K.
780/5 Shivajinagar, Pune 4.

VAIDYA S. D.
603 Sadashiv Peth, Pune 30.

VISHAMPAY Y. N.
294-A Shanwar Peth, Pune 30.

JEWELLERY

ASHTEKAR C. W.
824 Budhwar Peth, Pune 2.

DAHIWADEKAR L. B.
Shamsett Building, 2433 East Street,
Pune 1.

DAHIWADKAR S. B.
Shamsett Building, 2433 East Street,
Pune 1.

PARMAR N. C.
379 Rasta Peth, Pune 11.

SATHE K. V.
957 (Old) Sadashiv Peth, Pune 30.

LIFE INTEREST, REVER- SIONS ETC.

GADGIL G. M.
'Sayantara', Tilak Rd.,
479-16 Sadashiv Peth, Pune 30.

MACHINERY AND PLANT

JOSHI A. V.
713 Sadashiv Peth, Pune 30.

MAHULIKAR S. D.
671 Shukrawar Peth, Pune 2.

MEHENDELEY V. G.
720/13 Navi Peth, Pune 30.

REGE S. R.
108/27 Erandawana, Pune 4.

SHAH H. A.
927 Budhwar Peth, Pune 2.

STOCKS-SHARES AND DEBENTURES

DADHE V. G.
1627 Sadashiv Peth, Pune 30.

III. ALLIED SERVICES**CLEANING, PLUMBING & SANITARY****COLOUR CONTRACTORS & INTERIOR DECORATORS****AMMONIA PRINTING & XEROX COPYING**

ASMITA ELECTRONICS
824 Deccan Gymkhana, Swagat Bungalow, Pune 4

D. G. COPIERS
750 Sadashiv Peth, Pune 30

INSTANT COPYING CENTRE
Pimpri-Chinchwad Municipal Bldg, Pimpri, Pune 18.

MAHRATTA CHABER OF COMMERCE & INDUSTRIES
Tilak Road, Pune 2.

QUICK PRINTS
465 Sadashiv Peth, Opp Alka Talkies, Pune 30.

SAPRE BROTHERS
Near Gokhale Hall, Laxmi Road, Pune 30.

V. B. AND CO.
'Rangvarsha', 2083 Sadashiv Peth, Pune 30.

VAIDYA ROHINI
22 Mukund Nagar, Pune 9.

VARMA STUDIO
12 Moledina Road, Pune 1

BHARAT ENGINEERING & TRADERS
Station Road, Pimpri, Pune 18.

CROWN CARPET CLEANING CO.
Shop No. 35A, Arun Chambers, Tardeo, Main Road, Bombay 34.

D. A. CHINOY & CO.
Mahatma Gandhi Road, Pune 1.

DEORAJ ENTERPRISES
Samant Bungalow, Lokesh Co-op Housing Society, Bibavewadi, Pune 9.

INDUSTRIAL CLEANING SERVICES
No. 3 Dhondiba Lande's Chawl, Bombay-Pune Road, Pune 18.

JADHAV Y. S.
1182 Sadashiv Peth, Pune 30.

VISHWANATH & CO.
1053 Budhwar Peth, Pune 2

CLEARING & FORWARDING

THE NAV BHARAT CO-OP. FORWARDING CLEARING AND TRANSPORT SOCIETY LTD.
776 Sadashiv Peth, Pune 30.

POONA OCTROI CLEARING AGENT
29 Bopodi Jakat Naka, Pune 3.

A. A. NAIK & CO.
1 Govardhan Co-operative Housing Society, Gultekdi, Pune 9

APTE S. G.
Opp. Sambhaji Park, Pune 5

CHINDHE E. A.
Dastoor Meher Road, Pune 1

COLOUR KINGS
Near daily Prabhat Office, Narayan Peth, Pune 30.

COLOUR-MASTER
78 Rasta Peth, Pune 11

COLOUR TONER
(Decorative Painters)
B-6 Ushakal, 'Deep Bunglow', 1010 Shivajinagar, Pune 16

COOPER DESIGNERS
21/A Ambedkar Road, Pune 1.

DOLLS STUDIO
990/2 Shukrawar Peth, Pune 2.

HAIDERBHAI KADARBHAI & SONS
(Colour Contractors), 935 Budhwar Peth, Pune 2.

HULLICAR S. B.
Near Gultekadi Industrial Estate, Pune 2.

INDECOR
Opp. Jyoti Photo Studio, Shanwar Peth, Pune 30.

INTERDECOR
454 Somwar Peth, Pune 11.

INTERIOR DECOR

Laxmi Road, Opp. Bank of India,
Pune 30.

MIRACLE MAKERS

Ashok Vaidya, 1187/20 Ghole Road,
Pune 5.

MULTIAK PAINT & VARNISH CO.

8 Mundhwa Road, Pune 36.

N B M DECORATORS

Madiwale Colony, Tilak Road.
Pune 30.

N. R. ANARKAT

247 D 'Nilgiri', Near Railway Cross-
ing, Chinchwad. Pune.

NEEL DECORATORS

441/5 Somwar Peth, Pune 11.

PANSE J. D.

Near Shanipar, 1073 Sadashiv Peth,
Pune 30.

Mrs. PRABHA THAKAR

(Interior decorator & Batik Artiste)
C/o Dimpex International (Exporters)
1 Kamalabaug, 1062 Gokhale
Road, Pune 16.

PRATIBHA DECORATORS

N. A. Saokar, 'Cosmos', Prabhat
Road, Pune 4.

RAVAL & ASSOCIATES

Laxmi Road, Pune 30.

S. J. NAHATA

492 Shaniwar Peth, Pune 30.

**VASANTI DANDEKAR & ASSO-
CIATES**

Deccan Gymkhana, Pune 4.

**WANDERING ART GALLERY
SERVICES**

'Yashonand', 17 Shyamsunder
Society, Near Dattawadi Bridge,
Pune 30.

DISINFECTION**MINI ENTERPRISES**

63 Somwar Peth, Pune 11.

NAV BHARAT PEST CONTROL

351 Shukrawar Peth, Pune 2

**PEST CONTROL (INDIA) PVT.
LTD.**

Attar Building, Bombay-Poona Road,
Chinchwad, Pune 19.

**PESTOKEM INDUSTRIES PVT.
LTD.**

Pune Branch Office: 7 'Sugandh',
Opp. Law College, Pune 4.

POONA PEST CONTROL CORPN.

No. 5 Parvati Villa, Opp Golibar
Maidan, Pune 1.

**ERECTION WORK
& MAINTENANCE****AERAM ENGINEERING
SERVICES**

Flatted Type Building, C-2, M.I.D.C.
Chinchwad, Pune 19.

**BAHAR ELECTRICAL
ENTERPRISE**

Shirole Baug, 1108/2 Ganeshkhind
Road, Pune 16.

CRYSTAL ELECTRIC CO.

Bombay-Pune Road, Near Railway
Station, Chinchwad, Pune 19.

FLAG TRADING CORPORATION

332/B Shukrawar Peth, Soman Bldg.,
Pune 2.

JANATA ELECTRIC STORES

Shanti Kunj, Sadhu Wasvani Road,
Opp. H. P. Office, Pune 1.

&

6 Moledina Road, Pune 1

KAMAL ELECTRICALS

Decorators & Contractors, Near
Dnyaneshwar Paduka Chowk,
Pune 5.

**LECMEC ENGINEERING PVT.
LTD.**

39 Dr. Ambedkar Road, Pune 1.

MAHATI ELECTRICS

79 Bhawani Peth, Pune 2.

MADHAV & CO.

C/o. Radio Service Association,
459 Sadashiv Peth, Tilak Road,
Pune 30.

POONA ELECTRIC HOUSE

Laxmi Road, Pune 2.

S. B. ELECTRICALS

484/37 Mitra Mandal Colony,
Pune 9.

SHRI SAI SERVICES

Shop No. 4, 'C' Block, Flatted
Building, Chinchwad, Pune 19.

ESTATE BROKERS**GANESH AGENCY**

257C Budhwar Peth, Opp. Fire
Brigade Pune 2.

GLAMOUR ESTATE AGENTS

1703 Kedari Road, Pune 1.

**INTERNATIONAL ESTATE
AGENTS**

211 M. G. Road, Pune 1.

ISHWARLAL SHAHA

H-143 Adinath Society, Pune 9.

P. D. DIKSHIT AND CO.
Dikshit Compound, 12-B Wasvani
Road, Pune 1

R. G. PHATAK
428/1 Narayan Peth, Pune 30

WADEKAR ENTERPRIZERS
725B Deccan Gymkhana, Pune 4

GARDENING AND LANDSCAPE DESIGN- ING

**ANIL GARDEN MATERIAL
SUPPLIERS**
8/3 Solapur Road, Pune 1

**BUNGALOW GARDEN SERVICE
CENTRE**
Parvati-Darshan, Near Chawl No
113, Pune 9

FOUR EYES
1233A Apte Road, Pune 4

GARDEN ASSOCIATES
861/1 Sadashiv Peth, Pune 30.

**KIRLOSKAR CONSULTANTS
LTD.**
Farm Services & Agri Studies Divn.
Post Box No 803, Pune 4

**MEDICO INDUSTRIAL GARDEN
SERVICES**
Post Box No 826, Pune 4.

MURTHY K. G. N
C/o. Shobha Farm, 1206/20-A, Shri
Rang, Shivajinagar, Pune 4

POCHA SEEDS PVT. LTD.
1/A, Middle Road, Near Solapur
Bazar, Post Box No. 55, Pune 1.

STUDIO BLOSSOM,
Post Bag 6, Pimpri, Pune 18.

&
513 Rear Bldg, Ground Floor, 15th
Road, Khar, Bombay 52

INTERCOM, TELEPH- ONE AND AUTO- MATIC TELEPHONE EXCHANGE

AMBIKA TELE-COM
78 Hanuman Bhavan, Maheshwari
Society, Sanjeevan Nagar, Pune 9

**INDIAN TELEPHONE INDUS-
TRIES**
Pune Sub-Office, 6/1 Prabhu Krupa,
Ashok Nagar, Pune 7

**INDUSTRIAL TELEPHONE
SERVICES**
79A/2, 15th Cross Lane, Prabhat
Road, Pune 4.

POONA SALES & SERVICES
L I C Building, Laxmi Road, Pune 2

S. K. RADIOS & ELECTRICALS
T S 7, Old Bazar, Khadki, Pune 3

**SWASTIK TELEPHONE & ELE-
CTRIC CO.**
1396 Shukrawar Peth, Pune 2

PARCEL SERVICES

ANANT PARCEL SERVICE
301 Shanwar Peth, Pune 30.

GANESH PARCEL SERVICE
Narayan Peth, Pune 30.

GIRISH PARCELS
161 Narayan Peth, Pune 30.

INDUSTRIAL CARRIER SERVICE
2148 Vijayanagar Colony,
Pune 30

INDUSTRIAL PARCEL SERVICE
4 Budhwar Peth, Pune 2

JOSHI BROTHERS
Near Jogeshwari, Budhwar Peth,
Pune 2.

K. B. K. TRANSPORT
Raviwar Peth, Pune 2.

KHAKU TRANSPORT
10-A Tadiwalla Road, Pune 1.

KIRAN PARCEL SERVICE
Phuge Chawl, Nasik Phata,
Kasarwadi, Pune 19.

LAXMI PARCEL SERVICE
198/7 Sadashiv Peth, Pune 30.

M. K. TRANSPORT
Narayan Peth, Pune 30.

M. R. GHORPADE & CO.
Ayodhya, Tilak Vidhyapith Nagar,
Pune 9.

M. S. DIXIT & CO.
482 Shaniwar Peth, Pune 30.

MEENA TRANSPORT
416/21 Savarkar Nagar, Pune 9

NITIN TEMPO SERVICE
15/6 Shukrawar Peth, Nehru
Chowk, Pune 2.

OSA PARCEL SERVICE (S K OAK)
76 Budhwar Peth, Pune 2.

PARDESHI TRANSPORT SERVICE
1148 Saifee Street, Pune 1.

PAVAN ENTERPRISES
'Vasant Vihar', Near. Congress
House, Shivajinagar, Pune 5.

SPEEDER PARCEL SERVICE
Opp. Sambhaji Park, Pune 4.

REPAIRING AND MAINTENANCE

**AIR CONDITIONERS, WATER
COOLERS, ICE PLANTS,
REFRIGERATORS, CHILL-
ING PLANTS**

AIRTEMP & ALLIED AGENCIES
458/2 Sadashiv Peth, Tilak Road,
Pune 30.

BLUE STAR LTD.
15 Wellesley Road, Pune 1.

CLIMATE ENGINEERS
33/41 Karve Road, Pune 4.

G. B. TRADERS & ENGINEERS
S-11 M.I.D.C. Bhosari, Pune 26.

IDEAL TRADERS
Shirole Baug, 1108/2 Ganeshkhind
Road, Pune 16.

**PARIKH ENGINEERING CORPO-
RATION**
243 Ganesh Bhuvan, Bombay-Poona
Road, Chinchwad, Pune 19.

POONA SALES & SERVICES
L.I.C. Building, Laxmi Road,
Pune 2.

**R. R. REFRIGERATION AND AIR
CONDITIONING SERVICES**
Preet Chambers, Wakadewadi, Pune 3.

POCKET SERVICE CENTRE
438 Sadashiv Peth, Behind Ram
Agency, Pune 30

**SHEETAL REFRIGERATION &
AIR CONDITIONING SERVICES**
478 Narayan Peth, Kunte Chowk,
Pune 30.

COMPRESSORS

ARVIND ENGINEERING WORKS
481/B, 'Shreekrupa, Manorama,
Shahu College Road, Pune 9.

DIAL GAUGES

P. G. KANITKAR & CO.
Chimanbag, Opp. Maharashtra
Mandal, Tilak Road, Pune 30

DUPLICATING MACHINES

BHARAT REPAIRING WORKS
1244 Shukrawar Peth, 5th Lane,
Subhashnagar, Pune 2.

ELECTRICAL CALCULATORS

ASSOCIATED AGENCY
Preet Chambers, F P. No. 36/2,
Bombay-Pune Road, Wakadewadi,
Pune 3.

DCM DATA PRODUCTS
Marketing Dept., Hotel Blue
Diamond, 11 Koregaon Road, Pune.

G. K. ELECTRONICS
1160/61/7, Gharpure Colony, Shivaji-
nagar, Pune 5.

**INTERNATIONAL MARKETING
CORPORATION**
Olympic House, 1st Floor, 157, D/4
Bombay-Poona Road, Pimpri,
Pune 18.

SUPER TECHNICO
231 Pitrakul, Opp. Parvati Poultry
House, Pune 9.

FIRE FIGHTING EQUIP- MENTS

**FIRE EQUIPMENT CORPORA-
TION**
6 Bund Garden Road, Pune 1

PRAVIN ENTERPRISES
398 (New) Mangalwar Peth, Near
Zilla Parishad, Narpatgir Chowk,
Pune 11.

RAMA TRADERS
7 Deccan Mansion, Nagar Road,
Pune 6.

FRANKING MACHINES

A. SAMAD AND SONS
197 M. G. Road, Pune 1

FURNACES

THERMO ELECTRICALS
Asara, 202/1 Nagar Road, Opp.
Agakhan Palace, Pune 14.

INDUSTRIAL ELECTRICAL MACHINERY AND REWINDING OF MOTORS

**ACCURATE ELECTRICAL
WORKS**
1034 Nana Peth, Opp. Padamji Police
Gate, Pune 2.

IDEAL TRADERS
'Shirole Baug', 1108/2 Ganeshkhind
Road, Pune 16.

MARTIN FRANK & CO.
University Road, 1162/2 Shivaji-
nagar, Pune 5.

MEHENDALE ELECTRIC CO.
8/19 Erandawana, Off Karve Road,
Pune 4.

REPOWER MOTORS
Bombay-Poona Road, Opp. Burmah.
Shell Pump, Chinchwad, Pune 19-

UNIQUE ELECTRICALS

Office: 584 Shukrawar Peth, Pune 2
Works: 317 Hemu Kalani Road,
Pimpri, Pune 17.

VINKI ENGINEERS

Datir Chawl, Opp. David Brown
Greaves, Bombay-Poona Road,
Chinchwad, Pune 19.

**INDUSTRIAL
INSTRUMENTS**

NECTOR RADIO ELECTRONICS
312 Narayan Peth, Vijay Talkies,
Laxmi Road, Pune 30

PURANDARE INSTRUMENTS

11/90 Maharshi Nagar, Pune 9.

NEON SIGNS**PRABHAT NEON SIGNS**

2088 Vijaynagar Colony, Sadashiv
Peth, Pune 30.

TIME RECORDERS

RANADE TIME INSTRUMENTS
Near Vijay Talkies, Laxmi Road,
Pune 30.

SUNIL WATCH HOUSE

Fugewadi, Bombay-Pune Road,
Pune 12.

TYPEWRITERS**B. P. SHORTHAND AND TYPE-
WRITING INSTITUTE**

14 Connaught Road, Pune 1.

LIMAYE TYPEWRITING ROOM
1257 Sadashiv Peth, Pune 30.

**POONA TYPEWRITER REPAIR-
ING WORKS**

691 Narayan Peth, Pune 30.

WEIGHING MACHINES**AVERY INDIA LTD.**

No. 2, Satara Road, Swargate,
Pune 9.

NEW WEY-WELD INDIA

'C' Block, M.I.D.C., Chinchwad,
Pune 19.

WEIGHTSCALE COMPANY

417, R-5 Kedari Road, Pune 1.

WELDING EQUIPMENT**SAHALI AND SANGHAVI**

3 Mukundnagar, Swargate, Pune 9.

SECURITY**ARMED FORCES EX-ARMY
OFFICERS, MULTI-SERVICE CO-
OPERATIVE SOCIETY LTD.**

Smeet Apartments, 457/6 Gokhale
Road, Pune 16 (Supply multi-
purpose security personnel.)

**DECCAN SECURITY CONSUL-
TANTS**

87 Abhiman Apartments, Lane No.
5, Prabhat Road, Pune 4

JYOTI SECURITY

Dapodi, Pune 12

**THE PROMPT SECURITY
SERVICES**

Pimpri, Pune 18.

**THE SECURITY MANAGEMENT
CONSULTANTS**

108/30 Erandwana, Pune 4.

TOP SERVICES

H.3, Flat No. 5, Kundannagar,
Opp. Sandvik Asia Ltd., Pune 12.

**TRANSPORT
OPERATORS****A. C. TRANSPORT CO.**

392 Guitekadi, Shankar Road,
Pune 9.

AHER N. G. TRANSPORT CO.

124 Somwar Peth, Pune 11.

ALL INDIA TRANSPORT CO.

Bhawani Peth, Pune 2.

**AMAR BHARAT MOTOR TRANS-
PORT CO.**

239A Nana Peth, Pune 2.

**AMAR TRANSPORT CORPORA-
TION**

Bombay-Pune Road, Kasarwadi,
Pune 18

**AMBADAS NARAYAN DAVARE
HUNDEKARI TRANSPORT
AGENCY**

9/10 Bhawani Peth, Pune 2.

AMRUTLAL A SHAHA

1211 Raviwar Peth, Pune 2.

ANAND ROADWAYS

1019 Shivajinagar, Pune 16.

ANIL TRANSPORT

1254 Bhawani Peth, Pune 2

ARCO ROADWAYS PVT. LTD.

Chinchwad, Pune 19

**ARYA'S CENTRAL TRANSPORT
OF INDIA PVT. LTD.**

Chinchwad, Pune 19.

**ASHOK KUMAR GOODS
TRANSPORT CO.**

50A Bhawani Peth, Pune 2.

- ASHOK LUGGAGE LORRY AGENCY**
671 Shukrawar Peth, Pune 2.
- ASHOK ROADWAYS**
202/1 Ganesh Peth, Pune 2.
- ASSAM BENGAL ROADWAYS (P) LTD.**
Nasik Phata, Pune 26.
- ASSOCIATED ROAD CARRIERS PVT. LTD.**
Akurdi, Pune 35.
- ASSOCIATED TRADERS & ENGINEERS LTD.**
319 Somwar Peth, Pune 11.
- ASSOCIATED TRANSPORT CORPORATION**
Nasik Phata, Pune 26.
- ATAR GOODS TRANSPORT**
620 Sachapeer Street, Sarbatwala Chowk, Pune 1.
- BABAJI TRANSPORT CO.**
578 Nana Peth, Pune 2.
- BABURAVAN TRANSPORT**
503 Guruwar Peth, Pune 2.
- BAGAI GOLDEN TRANSPORT CO.**
Kasarwadi, Pune 18.
- BANDHU TRANSPORT SERVICE**
No. 10 Ramtekdi Road, Pune 13.
- BAFNA MOTOR TRANSPORT CO.**
280/ANTM, Timber Market, Pune 2.
- BALURGHAT TRANSPORT CO.**
Akurdi, Pune 35.
- BHADARI ROADWAYS**
365/9 Shivajinagar, Pune 5.
- BHARATI TRANSPORT**
161 Budhwar Peth, C/o. S. D. Shinde, Pune 2.
- BHARAT ROADWAYS ORGANISATION**
Nasik Phata, Pune 26.
- BHARAT TRANSPORT OFFICE**
3 Bhawani Peth, Pune 2.
- BHORUKA ROADLINES PVT. LTD.**
Bhosari, Pune 26.
- BHOSALE MOTOR TRANSPORT SERVICE**
108 Bhawani Peth, Pune 2.
- BID TRANSPORT SERVICE**
180 Bhawani Peth, Pune 2.
- BOMBAY ANDHRA TRANSPORT CO.**
Chinchwad, Pune 19.
- BOMBAY GOODS TRANSPORT**
46/2 Kaka Halwai Industrial Estate, Pune 9.
- BORA TRANSPORT CO.**
156 Ganesh Peth, Pune 2.
- BORKAR BROTHERS TRANSPORT SERVICE**
8/1 Mukund Nagar, Block No. 5, Gultekdi, Pune 9.
- CENTRAL TRANSPORT OF INDIA**
Chinchwad, Pune 19.
- CHANDRAKANT ROADLINES**
1041 Shukrawar Peth, Near Hirabaug, Tilak Road, Pune 2.
- CHANDRARAO DHAMDHERE**
47 Shukrawar Peth, Pune 2.
- CHAWLA TRANSPORT CO.**
Kasarwadi, Pune 18.
- CHAYYA TRANSPORT**
344 Ganesh Peth, Pune 2.
- D. R. AMBAVALE & SONS GOODS TRANSPORT**
1326 Raviwar Peth, Pune 2.
- DASTUR DAVE & CO.**
460 Somwar Peth, Pune 11.
- DECCAN QUEEN TRANSPORT CO.**
Kasarwadi, Pune 18.
- DHAMDHARE BROTHERS GOODS TRANSPORT**
47 Shukrawar Peth, Pune 2.
- DHANLAXMI TRANSPORT CO.**
237 Nana Peth, Pune 2.
- DOOARS TRANSPORT CO.**
Kasarwadi, Pune 18.
- EAGLE TRANSPORT (MADRAS) LTD.**
Nasik Phata, Pune 26.
- ECONOMIC TRANSPORT ORGANISATION**
Dapodi, Pune 12.
- EXPRESS ROAD TRANSPORT PVT. LTD.**
Nasik Phata, Pune 26.
- G. S. ANAND & CO.**
198/1 Shivajinagar, Pune 5.
- GAVAKAR TRANSPORT CO.**
Swargate, Pune 2.
- GAYAKWAD BROTHERS TRANSPORT**
258 Nana Peth, Pune 2.
- GHATGE PATIL TRANSPORT LTD.**
703 Budhwar Peth, Pune 2.
- GOPALKRISHNA HUNDEKARI CO.**
750 Ganesh Peth, Pune 2.
- GOYAL ROADWAYS**
Nasik Phata, Pune 26.
- GOYAL TRANSPORT CO.**
Nasik Phata, Pune 26.

- HARI ROADWAYS CORPORATION**
Nasik Phata, Pune 26.
- HASBEL TRANSPORT**
Somwar Peth, Pune 11
- HIGHWAY CARGO MOVERS**
Dapodi, Pune 12.
- HINDUSTAN CORPN. (HYD) PVT. LTD.**
Akurdi, Pune 35.
- HUNDEKARI GOODS TRANSPORT SERVICE**
408/1 Gultekdi, Pune 9.
- INDIAN ROADWAYS CORPN.**
Nasik Phata, Pune 26.
- INDIAN ROADWAYS ORGANISATION**
Nasik Phata, Pune 26.
- INDIAN TRANSPORT ORGANISATION**
Nasik Phata, Pune 26
- INDIRA MOTOR PVT. LTD.**
Nasik Phata, Pune 26.
- IRANI & CO.**
882 Bootee Street, Pune 1.
- J. J. & CO.**
879 Shukrawar Peth, Pune 2
- JAIN ROADWAYS,**
231/2 Nana Peth, Ashok Chowk,
Pune 2.
- JAY BHARAT GOODS TRANSPORT SERVICE**
183 Bhawani Peth, Pune 2.
- JAYHIND MOTOR MALTRUCK AGENCY**
180 Bhawani Peth, Pune 2.
- JAY MAHARASHTRA MOTOR TRANSPORT SERVICE**
1272 Bhawani Peth, Pune 2.
- JAY MAHARASHTRA TRANSPORT SERVICE**
71 Nana Peth, Pune 2
- JAYSHANKER TRANSPORT CO.**
77 Nana Peth, Pune 2
- JETHABHAI DONGARSI TRANSPORT & CO.**
228 Nana Peth, Pune 2
- KAHANE TRANSPORT SERVICE**
84 Bhawani Peth, Gul Ali, Pune 2.
- KAILASH TRANSPORT CORPN.**
Dapodi, Pune 12.
- KAKADE PATIL & SONS GOODS TRANSPORT SERVICE**
556 Ganesh Peth, Pune 2
- KALES GOODS CARRIERS**
1366 Sadashiv Peth, Pune 30.
- KALPANA GOODS TRANSPORT SERVICE**
1/1 Gultekdi, Pune-Satara Road,
Pune 9.
- KAMAL TRANSPORT CO.**
53 Bhawani Peth, Pune 2.
- KAMAL TRANSPORT CORPN.**
Nasik Phata, Pune 26.
- KAMATHE GOODS TRANSPORT SERVICE**
Flat No. 8, Mukund Nagar, Pune 9.
- KAPIL ROADWAYS**
Nasik Phata, Pune 26.
- KARNATAK ROADLINES**
Nana Peth, Pune 2.
- KARVE TRANSPORT SERVICE**
Kasarwadi, Pune 17.
- KASHMIR ROADLINE**
Nasik Phata, Pune 26.
- KERALA TRANSPORT CORPN**
Nasik Phata, Pune 26.
- KHANDESH TRANSPORT CO.**
809 Shukrawar Peth, Pune 2
- KHANNA TRANSPORT CORPN.**
Nasik Phata, Pune 26.
- KIRTI TRANSPORT CO.**
241 Ganesh Peth, Pune 2.
- KOHLI MOTORS**
Pimpri, Pune 18
- KOHLI TRANSPORT CORPN.**
30/1A Bombay-Poona Road,
Dapodi, Pune 12.
- KOSA ROADWAYS**
692/1/6 Pune-Satara Road, Pune 9.
- KUNJIR GOODS TRANSPORT**
199 Ganesh Peth, Pune 2.
- KUWAD TRANSPORT CO.**
537 (New), Ganesh Peth, Pune 2.
- LALCHAND TRANSPORT CO.**
75 Nana Peth, Pune 2.
- LALWANI GOODS TRANSPORT**
1198 Shukrawar Peth, Pune 2.
- LALWANI TRANSPORT CO.**
Prop. M. P. Lalwani, 314/2 Gunj
Peth, Pune 2.
- LALWANI TRANSPORT CO.**
Nana Peth, Pune 2
- LODHA TRANSPORT SERVICE**
1198 Shivajinagar, Pune 4
- LUGGAGE LORRY OFFICE**
773 Ganesh Peth, Pune 2.
- LUNKAD TRANSPORT**
39 Shankarshet Road, Pune 2
- M. NUSSERWANJI & CO.**
94 M. G Road, Pune 1
- M. B. T. CO.**
Bhawani Peth, Pune 2.

- M. H. KOTHARI**
Swargate, Pune 2.
- M. K. MEHANDALE TRANSPORT PVT. LTD.**
31/1 Erandawana, Karve Road, Pune 4.
- M. K. TRANSPORT**
433 New Sadashiv Peth, Pune 30.
- M. M. TRANSPORT CO.**
Nigadi, Pune 35.
- M. S. DIXIT & CO.**
Shaniwar Peth, Pune 30.
- MADRAS BANGLORE TRANSPORT CO.**
122 Bhawani Peth, Gul Ali, Pune 2.
- MAHARASHTRA CARGO MOVERS**
Nasik Phata, Pune 26.
- MAHARASHTRA ROAD CARRIER**
Nasik Phata, Bombay-Poona Road, Pune 18.
- MAHARASHTRA ROAD LINES**
Nasik Phata, Pune 26.
- MAHESH ROAD WAYS**
139 Nana Peth, Pune 2.
- MANISHA TRANSPORT CO.**
520 Centre Street, Pune 1.
- MANOJ ROADWAYS**
1596 New Shukrawar Peth, Pune 2.
- MEENA TRANSPORT**
2 Ganesh Peth, Pune 2.
- MHASVADKAR (TRANSPORT) ROAD LINES**
50A Bhawani Peth, Pune 2.
- MILAN TRANSPORT CO.**
Nasik Phata, Pune 26.
- MOHITE GOODS TRANSPORT SERVICE**
Pune-Satara Road, Pune 9.
- MOIEN TRANSPORT**
593 Phule Market, Pune 2.
- NAGNATH TRANSPORT CO.**
160 Ganesh Peth, Pune 2.
- NANDKUMAR & BROS.**
S. No. 31/A1 Bomby-Poona Road, Dapodi, Pune 12.
- NATIONAL TRANSPORT SERVICE**
47 Gultekdi, Pune 9.
- NAVAL TRANSPORT CO.**
346 Nana Peth, Pune 2.
- NAVBHARAT ROADWAYS**
168 Bhawani Peth, Pune 2.
- NAVLAKHA TRANSPORT**
38 Shankarshet Road, Pune 9.
- NEW BALAJI MOTOR SERVICE**
3 Bhawani Peth, Pune 2.
- NEW BATAKALA TRANSPORT SERVICE**
Nana Peth, Pune 2.
- NEW BHAWANI LUGGAGE LORRY OFFICE**
1380/3 Bhawani Peth, Pune 2.
- NEW FRIENDS TRANSPORT CO.**
3 Ganesh Peth, Pune 2.
- NEW KAKADE PATIL GOODS TRANSPORT**
1101 Shukrawar Peth, Pune 2.
- NEW KANEHEYA ROAD LINES**
48 Bhawani Peth, Pune 2.
- NEW KASHMIR ROADLINES**
Nasik Phata, Pune 26.
- NEW MALU TRANSPORT CO.**
Chinchwad, Pune 19.
- NEW NIGADE TRANSPORT AGENCY**
352 Shukrawar Peth, Pune 2.
- NEW SHRI GAJANAN GOODS TRANSPORT**
742 Ganesh Peth, Pune 2.
- NEW SHRINATH ROAD LINES**
47/2 Sardar Building, Pune.
- NEW TRANSPORT CO.**
Plot No. 36, Somwar Peth, Pune 11.
- NEW UNITED TRANSPORT**
3 Bhawani Peth, Pune 2.
- NEW VIJAYKUMAR GOODS TRANSPORT**
241 Gunj Peth, Pune 2.
- NIGADE LUGGAGE LORRY MOTOR TRANSPORT AGENCY**
353 Shukrawar Peth, Pune 2.
- NORTH CALCUTTA ROADWAYS**
Kasarwadi, Pune 17.
- NUTAN GUJARATH TRANSPORT**
137 Nana Peth, Pune 2.
- OLD MAHABALESHWAR TRANSPORT**
Shukrawar Peth, Pune 2.
- P. D. SHAHA**
251/1 Nana Peth, Pune 2.
- PADMAVATI GOODS TRANSPORT SERVICE**
Shukrawar Peth, Pune 2.
- PARDESHI GOODS TRANSPORT SERVICE**
62 Nana Peth, Pune 2.
- PATEL ROADWAYS**
Chinchwad, Pune 19.
- PATOSHA TRANSPORT CO.**
M. Gandhi Bag Road, Pune.
- PENOSH TRANSPORT**
13 Moledina Road, Pune 1.
- PERFECT ROAD LINES**
Nasik Phata, Pune 26.

- POONA DISTRICT MOTOR TRANSPORT CO-OP. SOCIETY LIMITED**
Tilak Road, Pune 30
- POONA GOLDEN TRANSPORT CO.**
- POONA MAHABALESHWAR TRANSPORT**
1544 Shukrawar Peth, Pune 2.
- POONA ROADWAYS,**
43 Bhawani Peth, Pune 2.
- PRAKASH ROAD LINES PVT LTD.**
230/2 Bombay-Poona Road, Pimpri, Pune 18.
- PUNE KOHLAPUR PARCEL & GOODS SERVICE**
163 Budhwar Peth, Pune 2.
- PUROHIT ROAD LINES**
Nasik Phata, Pune 26.
City Booking Office, 234A Shivajinagar Pune 4.
- PUROHIT ROADWAYS**
108 Bhawani Peth, Pune 2.
- RADIANT KERALA ROADWAYS**
31/A Bombay-Poona Road, Dapodi, Pune 12
- RAJ ROADWAYS**
17 Ganesh Peth, Pune 2
- RAJ TRANSPORT CO.**
Nasik Phata, Pune 26
- RAJASTHAN ROADWAYS**
847 Gunj Peth, Pune 2
- RAJENDRA ROAD LINES**
83 Bhawani Peth, Pune 2
- RAJENDRA ROADWAYS CORPORATION**
50A Bhawani Peth, Pune 2.
- RAJKUMAR ROADWAYS**
266/7 Bhawani Peth, Pune 2.
- RAJPAL ENTERPRISE TRANSPORT**
365 Shivajinagar, Pune 5.
- RAJU GOODS TRANSPORT**
53 Bhawani Peth, Pune 2.
- RANPISE GOODS TRANSPORT SERVICE**
228 Shivajinagar, Pune 5.
- RASKAR TRANSPORT CO.**
421 Hadapsar, Pune 28.
- REDE GOODS TRANSPORT SERVICE**
442 Shukrawar Peth, Pune 2.
- ROAD BIRD PVT. LTD.**
Nasik Phata, Pune 26.
- ROAD TRANSPORT CORPN.**
Bombay-Poona Road, Pimpri, Pune 18.
- SAHYADRI TRANSPORT CO.**
138 Nana Peth, Pune 2.
- SAMRAT TRANSPORT**
446 Bombay-Poona Road, Kasar-4adi, Pune 18.
- SANMITRA TRANSPORT**
76 Nana Peth, Pune 2.
- SARDAR TRANSPORT**
Mangalwar Peth, Pune 11.
- SASWAD LUGGAGE PARCEL SERVICE**
23 Ganesh Peth, Pune 2
- SATYA TRANSPORT SERVICE**
No. 10, Ramtekdi Road, Pune 13.
- SAVANI TRANSPORT PVT. LTD.**
613 Nana Peth, Pune 2.
- SHAHA GOODS TRANSPORT**
3 Mukund Nagar, Satara Road, Pune '9.
- SHAHA ROAD LINES**
1 Ganesh Peth, Pune 2.
- SHAHA TRANSPORT**
1881 Sadashiv Peth, Pune 30.
- SHALMALI TRANSPORTS**
Tilak Road, Pune 2
- SHINDE GOODS TRANSPORT**
735 Ganesh Peth, Pune 2.
- SHINGAVI GOODS MOTOR TRANSPORT CO.**
49B Bhawani Peth, Pune 2.
- SHIVRAU TRANSPORT**
Rasta Peth, Pune 2.
- SHRI AHIRESHWAR TRANSPORT SERVICE**
1824B Sadashiv Peth, Pune 2
- SHRI BALAJI TRANSPORT SERVICE**
139 Bhawani Peth, Pune 2.
- SHRI DATTA PARCEL & GOODS TRANSPORT CO.**
237 Nana Peth, Pune 2.
- SHRI GURUKRUPA GOODS TRANSPORT**
1436 Shukrawar Peth, Pune 2.
- SHRI LAXMI MOTOR TRANSPORT**
70 Nana Peth, Pune 2
- SHRI MANGAL TRANSPORT**
194 Ganesh Peth, Pune 2.
- SHRI NADALAL PARCEL & TRANSPORT CO.**
738 Ganesh Peth, Pune 2.
- SHRINATH TRANSPORT CORPORATION**
614/1 Nana Peth, Pune 2.
- SHRIRAM TRANSPORT CO.**
Shukrawar Peth, Pune 2.

M/s
A. J. ELECTRONICS

39/55. Erandavana, 9/B Prabhat Road, Pune 411 004



Manufacturers of
COPPER ALUMINIUM BIMETAL STRIPS &
WASHERS,
INTIGRAL FIN TUBES
'BONDUCT' EVAPORATOR PANELS
'BONDUCT' SOLAR ENERGY COLLECTOR PANELS
CARBON BRUSHES—INDUSTRIAL AND AUTOMOBILE.



Phone : 53060 / 52652
Gram : 'CLADMETAL'
TLX. : 0145-370 Bonduct

Winners of the Highest National Invention Award
for the year 1975.

With Best Compliments from

Capacitor Manufacturing Company

A/7, Functional Electronic Industrial Estate

M I D C, Bhosari

PUNE 411 026

Telephone : 82960

Telegram : PLYCAP

***Manufacturers of Corrugated Paper Rolls,
Board and Boxes and Press Components.***

DRILLCO METAL CARBIDES LIMITED

Manufacture in their modern plant at Ahmednagar

Tungsten Intermediates

Tungsten Metal & Carbide Powders

Tungsten Carbide Tips for Metal Cutting, Forming, Mining and
Wear Part applications to all specifications.

Tungsten Carbide Wire, Bar & Tube Drawing Die Pellets

Mining Products including Integral Drill

Steels upto 4.8 mtrs. long

Extension Steels

Drilling Bits in all sizes

Drillco Metal Carbides Ltd.

Motwani Chambers,

1187/59, Jangli Maharaj Road, Shivajinagar, Pune 411 005

Grams : Drillco

Tel. Nos. : 53954, 54232

Telex : 0145 - 394

Vineet Profile Industries

We can cut gas-cut Profile
in any design & shape as
per customer's drawings.

Factory :
Bombay-Poona Road
Nasik Phata

Opp. Dai-ichi
Pune 18.

Tel. : 83022

Head Office :
202, Steel Centre
Carnac Bunder
Bombay 9.

Tel. : 328644
521142

SUNAKO ENTERPRISES

*Manufacturers & Suppliers of
Acids, Solvents, Chemicals &
Liquid Chlorine*

| | |
|---|---|
| Factory : | Office : |
| Plot No. 102 'S' Block Bhosari Industrial Area, M.I.D.C. Pune 411 026 Phone : 83261 | C11 'Devankush' 64/C, Ashwini Society Wakadewadi Bombay-Pune Rd Pune 411 005 |
| Gram: SUNAKO, Bhosari | Phones : 56257/55418 |

*With Best Compliments
From*



POONA PRESSINGS PRIVATE LIMITED FILTERS-PRESS PARTS- SHIMS

**PLOT NO. S-50
BHOSARI, Pune 411 026
TEL : 82312**

SYMTRONICS

Electronic Control Systems
Plot No. S-1, M.I.D.C. Industrial Area
Behind Bhosari Post Office
Pune 411 026
Tel. No. 82716



Manufacturers of :
Industrial Electronic Controls and
Special Purpose Control Panels for
Process Industry.

The end of daily grinding drudgery

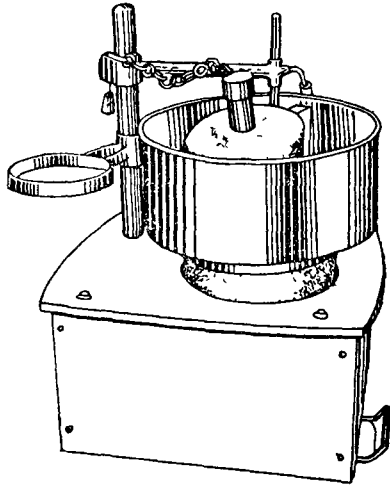

It Saves Time and Labour.
Guaranties Uniformity of Product
Adds digits of your Profits.
Is Very Easy to operate
Suitable for any type of wet grinding.
For Idli, Dosa, Chutany & Aurvedic Medicines.

ANITA

INDUSTRIAL WET GRINDER

Mfgrs.-Ramesh Fabricators, Poona 2.

Sathe Biscuit Compound,
820, Bhawani peth, Poona 2
Telephone-26876

Available in 4 different models.

BOMBAY TRADERS

Shop No. 4, Baldota House, Laxmi Narayan Lane,
Matunga, Bombay-19. Telephone : 474682.

If You Must Have
The Most Advanced Servo Controlled
AC Voltage Stabilisers

DATSONS
LEVEL TRON 'CLPS'
IS THE RIGHT ANSWER!

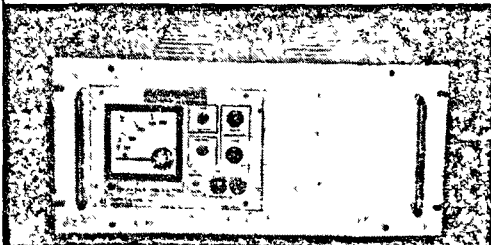

PERFECT STABILITY, 230 V \pm 1%
CORRECTION SPEED 40 V/SEC.

DATSONS ELECTRONICS
PUNE PHONE: 446543

Official Agent



TIME KEEPERS TO THE NATION

WATCHES

In Factory Price



Authorised Sales and
Service Agent

JAI WATCH CO.

836 Budhawar, Opp. Bombay Vihar
Laxmi Road, Pune 411 002
Tel. : 445010

BIJLEE

Main Dealers :

- USHA ● ORIENT ● BAJAJ
- KASSEL ● ALMONARD ● CINNI
- RALLIES ● RAVI ● RACOLD
- ANCHOR ● KHOSALA ● KETCO
- HOMA

Dealers in : **EVERYTHING IN ELECTRICAL GOODS**

Distributors for Pune Dist. :

G.E.C.

Crompton Greaves

Bijlee Chambers, 337 Budhwar Peth,
Pune 411 002
Phone : 447430

Also Visit **ANURADHA** House of
Sarees, Kunte Chowk, Laxmi Road,
Pune 411 030.

Phone : Office - 447270

Resi. - 441024

DYE CHEM CORPORATION

741, Budhwar Peth, Pune 411 002

CHEMICALS

- * SODA ASH
- * BLEACHING POWDER
- * CAUSTIC SODA FLAKES
- * SODIUM NITRITE
- * SODIUM SULPHATE
- * TITANIUM DIOXIDE
- * AMMONIUM NITRITE
- * T.S.P. O.STBP.

SOLVENTS

- * ACETONE
- * TOLUENE
- * XYLENE
- * ANILINE OIL
- * BENZENE
- * METHANOL
- * D.M.A.
- * PHENOL

DYES

- * INK BLUE
- * TURQUOISE BLUE
- * G.B.C.
- * MAGENTA
- * NAPHTHOL ASG

With Best Compliments From :

I.E.C. PUMPS & TOOLS PVT. LTD.

Manufacturers of :

- Pneumatic Tools Chemical Dozing Pumps
- Reciprocating Pumps Marine Pumps etc.

Registered Office :

603, Sadashiv Peth,
Laxmi Road, Pune 411 030.
Phone : 445141

Factory :

117, 118, 123, H-Block,
MIDC, Pimpri, Pune 18.
Phone : 82348

Sales & Service

KIRLOSKAR BROTHERS LTD.

Udyog Bhavan, Tilak Road,
PUNE 411 002.

MACHINALL PRIVATE LIMITED

POONA SMALL SCALE INDUSTRIAL ESTATE,
PLOT NO. 28, GULTEKDI,
PUNE 411 009.
PHONE : 441761

Manufacturers of precision turned & threaded components in NPTF & BSP and Metric. Hydraulic hose assemblies as per customer's requirements.

With Compliments from



**WESTERN INDIA
FLOUR MILLS**
PROPS : ALSALES LTD.

PLOT No. 103/104

Hadapsar Industrial Estate

PUNE 411 013

Telephone : 7236

Telegrams : 'ALSALES' Poona

*Manufacturers of 'SCALE' Brand
Flour, Rawa, Atta, Soji & Bran*

SUPER DRY- CLEANERS

**Next Day Dry-Cleaning
Delivery Centre**

- Branches**
- Tilak Road
 - Natu Bag
 - Bajirao Road
 - Karve Road
 - Mahatma Gandhi Road
(Poona Camp)

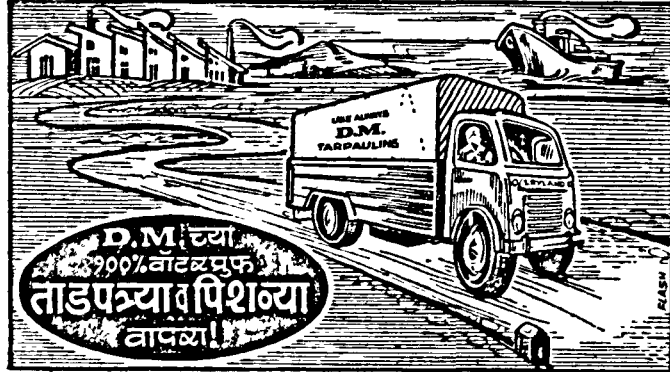

ठा. देवकरण मूलजी ताडपत्रीवाला
 १०७३ भिवानी पेठ, हुमाळ ताळमीजवळ, पुणे ४२. फोन: २६७७६

**साधं मैत्रिणीकडे जायचं म्हणजे सुद्धा
 अनेक अडचणी...**



आता अडचणी... स्वतः!
 लूना मोपेड घेतल्या पासून
 सारं काही सोपच झालं आहे.

स्वरोस्वरीच अडचणीत
 मदत करणारी ती
 स्वरी मैत्रिण
 लूना मोपेड



बी.यू.भंडारी
 सेल्स-सर्विस

बाळुडवाडी, बाँबे-मुंबई रोड
 पुणे ४११००३
 फोन: ३३२११२३

Ashok (INDIA)

Regd Office: 832, Dastur Meher Road, Pune-411 001 Tel: 25345, 23265
 Branch Office: F-24, Shanti Kunj, 2nd Floor, Opp G P O Pune-411 001 Tel: 22060



AUTHORISED STOCKIST OF
LARSEN & TOUBRO LIMITED

For,

L&T Switchgear & EUTECTIC

LOW TEMPERATURE WELDING ALLOYS

Precision resistors
 for measuring
 instruments
 Professional resistors
 for defence
 applications
 Special resistors
 for aircraft,
 radar & Computers
 Industrial resistors
 for TV & other
 electronic equipment



**PEC Wire Wound
 RESISTORS**

**Ensure
 Stable & Reliable
 Performance
 of your Equipment**

Approved by LCSO

Available At -

ELECTROMARK ASSOCIATES,

17A/3 Ganesh Chambers, Karve Road, Pune-411 004

Phone No: 57875

PAPCO MILLS

KHOPOLI

A Leading Mill in Western India



*Specialised in the manufacture of all kinds of
Industrial Wrappings and Packings.*

**PAPER AND PULP
CONVERSIONS, LIMITED.**

Registered Office :
1183, Shivajinagar,
Fergusson College Road,
Pune 5.

Mills :
Khopoli,
(Dist : Kolaba),
Maharashtra State.

**Super Bright
Manufacturing Co.**

227, Nana Peth, Pune 411 002



**Makers of Quality Bright Bars in all
sizes and sections as per the
orders of customers.**

*Also Manufacturers of Bright Bar
Machinery.*

Contact : 24715 - 27960 - Office
82115 - Factory

WE
LEAD
THE
MACHINERY DEALERS IN
PUNE

MIS. Kelkar Brothers

777, Sadashiv Peth
Opp. Bank of Maharashtra
Pune 411 030

(Phone Nos. : 444211, 444213, 444912)
(Distributors of Kirloskar Products)

711, Narayan Peth,
Laxmi Road,
Pune 411 030.

45, G. H. Deshpande Road,
Nasik 422 001,
Dist : Nasik.

For your requirement of
Organic and Inorganic Pigments and Intermediates
(For Paint, Printing Ink, Plastic, Rubber and
Other Industries)

Please Contact :

**Sudarshan
Chemical Industries Ltd.**

162, Wellesley Road, Pune 411 001

Selling Agents at :

Bombay - Delhi - Calcutta - Madras - Ahmedabad
Hyderabad - Kanpur - Indore - Jodhpur - Tirur

" Small Business Men Rely On Us For
Timely Help "

**SHREE SUVARNA
SAHAKARI
BANK LTD.**

Head office : 759/51, Fergusson College Road,
Deccan Gymkhana, Pune 411 004.

Phone : 54529/58154

Grand Success—

Working Capital Over Rs. 4,00,000,00.

J. C. Agashe
Chairman

V. G. Chinchalkar
Manager

With best Compliments from

**D'Rona Rohitra
Pvt. Ltd.**

Manufacturers of :

**Power, Distribution, Current & Potential
Transformers, Electronic & Electrical Components.**

Regd. Head Office : 'Suyash', 882/A, 4th Cross Lane, Bhandarkar Road,
Shivaji Nagar, Pune 411 004.

Works : C. 1., Functional Electronics Industrial Estate,
Bhosari, Pune 411 026.

Gram : ROHITRA, Pune 26 • Phone : Office : 57169

Works : 83180

For the small scale industry:

MSSIDC keeps pace with the growing needs of the small scale sector: Procurement and distribution of industrial raw materials, marketing, imports, exports. MSSIDC has a model warehousing facility in Bombay. It also has undertaken development of Handicrafts and Leather Industry besides management of certain production centres.

And to help you wherever you are, MSSIDC has decentralised its functions and widened its network of Divisional/Regional Offices and Depots. There is one in your area. Step in and

discuss your problems with us any time.

We'd be glad to help.



MSSIDC

Maharashtra Small Scale Industries Development Corporation Ltd.

(A Government of Maharashtra Undertaking)
Krupanidhi, Ballard Estate,
P. B. No. 311 A, Bombay-400 038
Phone: 261121 Telex 011-3399
Cable: MASSIDCORP

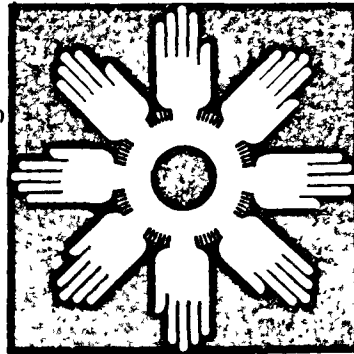

RADICAL/MSSIDC/4-78

A helping hand in every direction

LOOK FOR BETTER MACHINERY

MANWANI MACHINE TOOLS
QUARTER GATE, NANA PETH,
POONA - 411 002
PHONE : 22534-83259

The advertisement for Manwani Machine Tools features a central text block surrounded by ten circular frames, each containing a different piece of industrial machinery. The machines include various types of lathes, mills, and presses. Two circular frames contain the 'MMT' logo. The entire advertisement is enclosed in a decorative border with the name 'MANWANI' written diagonally in the corners.

**Serving Indian Sugar Industry
for more than 20 years
with
Sugar Plants of advanced designs
and
Quality Workmanship**

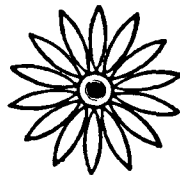

**Buckau Wolf New
India Engineering
Works Limited**

**Sugar Machinery Manufacturers
Pimpri, Pune 411 018.**

Telex : 0145 267 ■ Gram : "DEVCORP" ■ Phone 83265-66

**TRANSFORMERS
From
ELECTRONIC
LABORATORIES**

- * For Electronic & Electrical Industries up to 25 KVA.

Made to order units to suit your specific requirements.

- * Solid State Invertors, Convertors, D. C. Power Suppliers, and other Electronic Products.

Phone : 443854 or Contact at :
1265, Shukrawar Peth, 6th Lane,
Subhash Nagar, Pune 2.

**Hind Condensor
Private Limited**

Plot No. 209, Bombay-Poona Road
Pimpri, Pune 411 018

Pioneer Manufacturers of
Capacitors for Fans, Tubelight,
Motor as well as L.T. and H.T.
Capacitors.

Telephones : 82425/26 Telex : PN/301
83012 Telegram : Capacitor
83712

**ET YOUR
MENTS :**

All Modern Industries Rely On Us For



V. B. & Co.

- * Microfilming
- * Xerox and Photostats
- * Industrial Photography
- * Multi Copies
- * Statfile DRG Reductions
- * Colour and B & W Developing Printing

Office : "Rangvarsha" 2083 Sadashiv Peth, Pune 411 030
Showroom : 278/79, Narayan Peth, Laxmi Road, Pune 411 030
Phone Nos. Office : 44 02 25 Show Room : 44 46 31

*The Only Complex In India Have All Photographic
Departments Under One Roof.*

INDUSTRIAL ELECTRIC

- OVENS
- FURNACES
- DEGREASING UNITS
- WASHING BOOTHS



Manufactured by

CLEAN ENERGY SYSTEMS

24, Gultekdi Industrial Estate, Pune 9.

Tel : 440136
448736

CONTACT

**M/s Kiran Engineering
Works**

10/14, Gultekdi Road, Pune 411 009
Telephone No. 441079

For

Sugar Machinery Spares
Job Work and Design &
Development Work



Guru Nanak Industries

Heat Treatment Division

Plot No. 87, Bhosari General

Pune 411 026

Phone : 82437

Gram : HEATREAT



do it good
is dg's motto

D.G. COPIERS
EXPERTS IN XEROX COPYING

- 750, New Sadashiv Peth,
Near Sadashiv Peth Houd,
Poona 411 030.

● Phones Office: 445088 Res. · 54325

A J ADVT

TIC WIRE WOUND POTENTIOMETERS

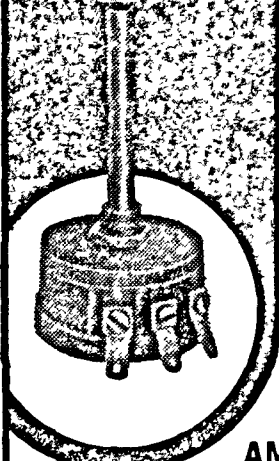

BIG RANGE TO MEET YOUR ALL REQUIREMENTS :

- PRECISION POTENTIOMETERS FOR BRIDGES AND INSTRUMENTS
- POTENTIOMETERS WITH LINEAR LAW, LOG-ANTI-LOG AND SPECIAL CURVES
- POTENTIOMETERS WITH HIGH RESOLUTION
- POTENTIOMETERS AS PER DEFENCE SPECIFICATIONS,

ANALOGUE & DIGITAL MEASUREMENT CO.

A-6, FUNCTIONAL ELECTRONIC ESTATE, POONA-26 INDIA

WE

OFFER YOU
THE FOLLOWING SERVICES

Labour Contract for

- ★ Material Handling
- ★ Cleaning and Maintainance of shop floors and offices
- ★ Sand/Shot Blasting Work
- ★ Cleaning of Drinking/Raw Water tank, Colling towers, Street Lights, Fans, Statues, Fountains.
- ★ Any type of Labour/Job Contracts,

Please Write to or call on

DEORAJ ENTERPRISES

Gammatt Bungalow, Lokesh Co-op. Housing Socieyt, Bibve Wadi, Pune 9
Phone : 44 67 05

With best Compliments from :



MANGAL PLASTICS

Manufacturers :

Plastic Sheeting, Plastic Tubing and Plastic Moulding Articles

**Narali Baug, Gultekadi Road
Pune 411 009**

Phone No. 441377

We, a group of graphic designers, journalists, photographers, printers, financial and marketing consultants offer you :

A COMPLETE INDUSTRIAL INFORMATION SERVICE

For example, we will help you to organize press conferences, design and print sales promotion literature, buyers and sellers meets, industrial tours, translations and copywriting and obtain any other information you may need for your industry.

Contact



Consultants in Public Relations, Visual Communication & Industrial Information

925/D 3, Shivajinagar, 'Kinara', Pune 411 004

THE DECISIONMAKERS

YOU

Your Home
Your Office
The Environment
you live in.
Make them pleasant
and useful.
It's your decision.



WE

To make your decision a practical reality, is in our hands. We have experienced and efficient craftsmen to execute these decisions. And what's more We plan just the right interiors and exteriors to your convenience.

Unique Designers

Interior Decorators & Furnishers
1205/5, Saikripa, Apte Road,
Deccan Gymkhana, Pune-411 004.
Phone - 56591.

BETWEEN THE TWO OF US WE CAN MAKE IT

THREEJA

| | | |
|--|--|---|
| SHRI SADGURU GOODS TRANSPORT HUNDEKARI 3 Bhawani Peth, Pune 2. | SURILAL H. OHARA No. 10, Ramtekdi Road, Pune 13 | TRANS-INDIA Tilak Road, Pune 2. |
| SOMANATH GOODS TRANSPORT 30A Bhawani Peth, Pune 2. | SURYODAYA TRANSPORT CO. 1249B (New), Bhawani Peth, Pune 2. | UNION ROAD LINES CORPORATION Nasik Phata, Pune 26. |
| SOUTH EASTERN CARRYING LTD. Nasik Phata, Pune 26. | SUSHIL TRANSPORT Pro. S. N. Lalvani, 434/8 Gultekadi, Pune 9. | UNION ROADWAYS Nasik Phata, Pune 26 |
| SOUTH EASTERN ROADWAYS Pimpri, Pune 18. | SUYOG TRANSPORT 1087 Sathe Colony, Pune 2. | UNIVERSAL TRANSPORT SERVICE Bombay-Poona Road, Dapodi, Pune 12 |
| SOUTH FREIGHT CARRIERS Kasarwadi, Pune 17. | SWASTIK TRANSPORT CO. 217 Nana Peth, Pune 2. | V. P. TRANSPORT 62 Bhawani Peth, Pune 2. |
| SUDARSHAN TRANSPORT CO. 1377 Bhawani Peth, Pune 2. | TARUN TRANSPORT CORPORATION Nasik Phata, Pune 26. | V. LUGGAGE LORRY (OFFICE) SERVICE 59 New Shukrawar Peth, Pune 2. |
| SUKHWANI MOTOR TRANSPORT Pimpri, Pune 18. | TATANAGAR TRANSPORT CORPORATION Akurdi, Pune 35. | VIJAY LAXMI TRANSPORT CORPN. Nasik Phata, Pune 26. |
| SANGAM TRANSPORT 189B Ganesh Peth, Pune 2. | TATA TRANSPORT COMPANY Plot No. 100, Senapati Bapat Road, Pune 16. | VIJAY TRANSPORT CO. 436 Somwar Peth, Pune 11. |
| SURANA TRANSPORT CORPORATION 595 (New), Guruwar Peth, Pune 2. | THE DECCAN TRANSPORT SERVICE 5 Bhawani Peth, Pune 2 | VIJAY TRANSPORT CORPORATION 480/1A Rasta Peth, Pune 11. |
| SURAT GOODS TRANSPORT SERVICE Dapodi, Pune 12. | THE POONA MOTOR GOODS TRANSPORT CO. 780 Sadashiv Peth, Pune 30. | VILAS TRANSPORT SERVICE 42 Shaniwar Peth, Pune 2. |
| SURESH SHAHA TRANSPORT CO. Nana Peth, Pune 2. | TRANSPORT CORPORATION OF INDIA 33A/1 Dapodi, Pune 12. | WARVANDEKAR DAILY GOODS TRANSPORT SERVICE 3 Bhawani Peth, Pune 2. |
| | | YEWALE GOODS TRANSPORT Chinchwad, Pune 19. |

Dealers

Automobiles/Spare Parts
& Accessories,
Bardan, Brass & Copper,
Cement, Chemists & Druggists,
Consumer Cooperative Stores,
Cycles, Electrical Goods,
Fertilisers, Manures & Pesticides,
Furniture & Furniture Hirers,
Grain, Hardware, Industrial Suppliers,
Iron & Steel,
Jewellery, Machinery, Optics,
Paper, Photographic
Material & Photographers,
Sanitarywares, Seeds,
Shahabad Stone & Tiles,
Stationery & Cutlery,
Televisions, Textiles, Watches,
Miscellaneous

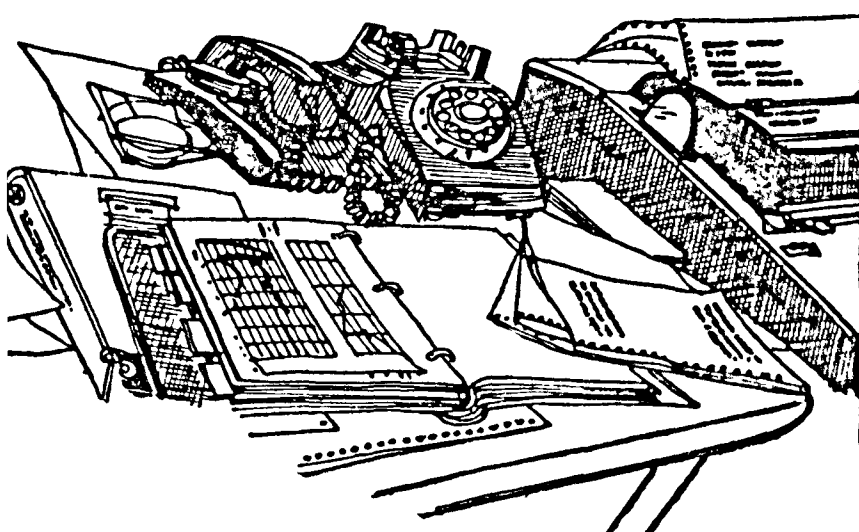

DEALERS

Automobiles/Spare Parts & Accessories
Bardan
Brass & Copper
Cement
Chemists & Drugists
Consumer Co-operative Stores
Cycles
Electrical Goods
Fertilisers, Manures & Pesticides
Furniture & Furniture Hirers
Grain
Hardware
Industrial Suppliers
Iron & Steel
Jewellery
Machinery
Optics
Paper
Photographic Material & Photographers
Sanitarywares
Seeds
Shahabad Stone & Tiles
Stationery & Cutlery
Televisions
Textiles
Watches
Miscellaneous

AUTOMOBILES / SPARE PARTS & ACCESSORIES

- AHMEDNAGAR AUTOMOBILES** 134 D Shivajinagar, Pune 5. Auto parts & lubricants.
- AMALGAMATED AGENCIES** 2/2 Krishna Niwas, Padamjee Compound, Bhawani Peth, Pune 2. Automobile spare parts
- AMEET LUBRICANTS & CHEMICALS** 15A Bhale Estate, Bombay-Pune Road, Pune 3. Dealers in lubricants.
- ASIAN TRADERS** Poonam Apartments, Swargate, Pune 9. Automobile spare parts.
- AUTOMOTIVE MANUFACTURERS LTD.** 10 Pune-Satara Road, Pune 9. Trucks.
- AUTOMOTIVE SERVICES** 431/195, 196 Shukriawar Peth, Pune 2. Trucks.
- B. U. BHANDARI.** Bombay-Poona Road, Wakdewadi, Pune 3. Scooters, matadors & Luna mopeds.
- B. U. BHANDARI AUTOMOBILES** 63/64/65 Dapodi, Pune 2. Scooters, matadors & Luna mopeds.
- BAFNA AUTOMOBILES** 280/3 Mahatma Phule Peth, Pune 2. Luna moped and scooters.
- BHARAT AUTOMOBILES** 582 Nana Peth, Pune 2. Automobile spare parts.
- BHAVKAR GARAGE** 726/27 Shivajinagar, Pune 5. Automobile dealers & repairs
- BOMBAY MOTOR STORES** 563 Nana Peth, Pune 2
- CEAT TYRES OF INDIA LTD.** 2420 Thimayya Road, Pune 1. Tyres & tubes
- CENTRAL AUTO CENTRE** 1500 Shukrawar Peth, Pune 2. Fit-tight bolts & nuts.
- CENTRAL AUTOMOBILES** 1017 Tilak Road, Pune 2 Automobile spare parts.
- CITY MOTOR STORES** 185 Laxmi Road, Pune 30 Automobiles.
- DEEPAK AUTOMOBILES** 408/1 Gultekdi, Swargate, Pune 9 Automobile spareparts.
- EASTERN TYRE CO.** 14 Coyaji Road, Pune 1 Automobile spare parts
- EXCELL MULTI AGENCY** Block No. 56, Khanna Ware House, Nasik Phata, Kasarwadi, Pune 18. Atlas lubricants.
- GEETA AGENCY** 407 Nana Peth, Pune 2. Automobile spare parts.
- GEETA AUTOMOBILES** 1206/18-B Shivajinagar, Pune 4. Automobile Spare parts.
- HINDUSTAN MOTORS (INDIA) AUTOMOBILES** 322 Nana Peth, Pune 2. Automobiles.
- INTERNATIONAL TYRES** 391 Raviwar Peth, Pune 2 Automobile spare parts.
- J. WILLIAM & CO.** 2422 East Street, Pune 1 Ambassador cars.
- JAGDIP AUTO STORES** Mukund Nagar, Pune 9 Automobile spare parts & accessories.
- JASWANT MOTOR STORES** 586 Nana Peth, Pune 2 Automobile spare parts & accessories.
- JOSHI GARAGE** 405 Narayan Peth, Pune 30. Cars
- KAMDAR AUTOMOBILES** 46/2-1 B Satara Road Pune 9. Automobile spare parts.
- KARACHIWALA UNITED AUTOMOBILE** 546 Sada-shiv Peth, Pune 30. Automobile spare parts.
- KIRAN AUTOMOBILES** 381 Nana Peth, Pune 2 Automobiles
- LATIFALIYA MOTOR STORES** 219 Shivajinagar, Pune 5. Automobiles spare parts and accessories
- LAXMI TYRES** 1342-43 Shivajinagar, Pune 5. Automobile spare parts.

- MAHARASHTRA AUTOMOBILES** 7 Mukundnagar, Pune 9. Automobile spare parts & accessories.
- MARATT AGENCIES** Bombay-Poona Road, P. B No. 9, 157/D-4 By. Rd., Pimpri, Pune 18. Tyres, retreading materials, rumafoam latest products, cycle & cycle-riksha tyres.
- MEGHRAJ & CO.** 1263/1 Jangli Maharaj Rd., Pune 4 Automobiles spare parts accessories.
- METRO MOTORS** 2418 Timayya Road, Pune 1. Automobile spare parts.
- MITHASING & SONS** Nana Peth, Pune 2. Automobiles.
- MODEL MOTORS** 252/8 Narayan Peth, Pune 30. Automobiles.
- NATIONAL AUTO STORES** Plot No. 6 Pune Station Road, Mukund Nagar, Pune 9. Automobile spare parts.
- NIRMAL AUTOMOBILES** 365/9 Shivajinagar, Pune 5. Automobile spare parts.
- NEW BALL BEARING CO.** Opp: Shivaji Statue Pune 5.
- ORIENT AUTOMOBILES** 32 Karve Road, Pune 4. Automobile spare parts.
- P. CHOUDHARI & CO.** 7 Thimayya Road, Pune 1. Automobile spare parts.
- PADIYAR & PADIYAR** Shriram Bhavan, Tilak Road, Shukrawar Peth, Pune 2. Automobile spare parts.
- PERFECT MOTOR CO.** Modi Mansion, 37/26 Shankarshet Road, Pune 9. Motor-cycles.
- POONA AUTOMOBILES** 177 Laxmi Road, Pune 30. Automobiles.
- POONA AUTOMOBILE CONSUMER'S CO-OP. SOCIETY LTD.** Udyog Bhavan, Tilak Rd., Pune 2. Automobile spare parts.
- POONA DIST. TRANS. CO-OP. SOCIETY LTD.** 431-12 Tilak Road, Pune 30. Automobile spare parts & accessories.
- POONA KACHHI MOTOR STORES** 563 Nana Peth, Pune 2. Automobile parts & accessories.
- POONA MOTOR SERVICE STATION** 1256A D Gymkhana, Pune 4. Automobile spareparts & accessories.
- POONA TYRE COMPANY** 259/61 Ganesh Peth-Laxmi Road, Pune 2. Tyres.
- PRABHAT VULCANISING WORKS** P.M.C Building, Shivajinagar, Pune 5. Tyres.
- PREMCHAND RATANCHAND** 122 Bhawani Peth-Pune 2. Tyres, tubes and automobile accessories, industrial & automotive lubricating oils and greases & all types of petroleum products.
- TYRES DIVISION** Udyog Bhavan, Pune 2. Tyres, tubes and automobile accessories, industrial & automotive lubricating oils and greases & all types of petroleum products.
- PREMIER GARAGE** Lloyds Bridge, Pune 5. Fiat cars & Fargo trucks.
- PREMIER SUPPLY CO.** Laxmi Road, 544/1 Sadashiv Peth, Pune 30. Lub. oil and petrol pump.
- PREMIER TYRES LTD.** 692/1/6 Satara Road, Pune 9. Tyres.
- RAJPAL AUTO CORPN.** Pune-Satara Road, Pune 9. Automobile parts & accessories.
- RAM AGENCY** 458/2 Sadashiv Path, Pune 30 Scooters, cars, batteries, tyres, automobile spares & accessories
- REGAL MOTORS** 545 Sadashiv Peth, Laxmi Road, Pune 30. Automobile spare parts & accessories.
- S. B. AUTOMOBILES** 117 Narayan Peth, Pune 30. Automobile spare parts & accessories.
- SARAS AUTOMOBILES** 7 Parvati Darshan Rd., Near Bank of India, Swargate, Pune 9. Automobile spare parts & accessories.
- SANDHYA AUTO AGENCY** 6 Satara Road, Pune 9. Automobile spare parts and accessories
- SANGHAVI AUTOMOBILES** Pune-Satara Road, Pune 9. Tractors, motorcycles, scooters, power tillers and mopeds.

- SANTOKH AUTO CENTRE** 309 Nana Peth, Laxmi Road, Pune 2 Automobile parts.
- SAWHNEY AUTOMOBILES** 27/2 Mira Society, Pune 9 Automobile spare parts & accessories
- SAWHNEY AUTOMOBILES** Shivajinagar, Pune 5. Automobile spare parts & accessories.
- SAWHNEY SALES CORPN.** Pune-Satara Road, Pune 9. Automobile spare parts and accessories.
- SCOOTER ACCESSORIES** Indra Bhavan, 1205/3 J. M. Road, Pune 5. Automobile spare parts & accessories.
- SCOOTERS INDIA LIMITED** Regional Sales Office, Plot No. 38C, Opp. Sarasbag, Pune 9. Sales and service of 'Vijay' scooters, three wheelers, moped.
- SHREERAM AUTOMOBILES** 691/A-25 Satara Road, Pune 9. Automobile spare parts & accessories
- SHREE BHAWANI TRADING CORPORATION** 1366A Kasba Peth, Pune 11. Motorcycle & scooter accessories.
- SILVER JUBILEE MOTORS PRIVATE LTD.** 12 Moledina Road, Pune 1 Automobile spare parts & accessories.
- SINGH AUTOMOBILES** 341 Nana Peth, Pune 2 Automobile spare parts
- SOUTHERN AUTOMOBILES** 691/28 Narayan Peth, Pune 30. Automobile spare parts.
- STANDARD AUTOMOBILES** 2426 Thimayya Road, Pune 1 Automobile parts
- SUN AUTOMOBILES** 2425 Thumayya Road, Pune 1. Automobile parts.
- SUPER AUTOMOBILES** 1258/A J M Road, Pune 4. Automobile parts
- SUSHIL AUTOMOBILES** 1339 Shivajmagar, Pune 5 Jeep parts
- SWASTIK AUTOMOBILES** 1344 Shivajinagar, Pune 5 Automobile parts & accessories
- TAMHANE AUTOMOBILES** Thimayya Road, Pune 1 Automobile spare parts & accessories.
- UNION AUTOMOBILES** 456 Nana Peth, Pune 2. Automobile spare parts & accessories
- UNITED AUTOMOBILES** 546 Sadashiv Peth, Laxmi Road, Pune 30 Automobile spare parts & accessories.
- UNITED TYRE CRAFTS** S-5 Parvati Indl. Estate, Pune 9. Tyres
- UNIVERSAL AUTOMOBILES** 815 Pune-Satara Road, Pune 9. Automobile spare parts & accessories.
- UNIVERSAL AUTO TRADING CO.** 407/1 Nana Peth, Quarter Gate, Pune 2 Automobile accessories & spare parts
- VIJAYA AUTOMOBILES** 110/2 Shivajinagar, Pune 5. 1215/21 Shirole Road, Pune 5 Automobile spare parts & accessories
- VOHRA AGENCIES** 47/2 Pune-Satara Road, Pune 9 Automobile spare parts & accessories.
- WATERLOO DIESEL FUEL** Injection Service, 461/2 Sadashiv Peth, Tilak Road, Pune 30. Automobile parts & accessories.
- UNITED TRADERS** Pune-Satara Road, Pune 9. Automobile spare parts & accessories.

BARDAN

- ASHOK KUMAR SHYAMJI & CO.** 111 Bhawani Peth, Pune 2.
- BABULAL ISHWARDAS THAKKAR** Bhawani Peth, Pune 2.
- BHAVANJI PITAMBAR THAKKAR** 1122 Bhawani Peth, Pune 2.
- CHANDRAKANT KHAJI & CO.** 110 Nana Peth, Pune 2.

- CHANDAN TRADING CO. 110 Nana Peth, Pune 2.
- CHANDRAKANT CHATRABHUJ PAUWUA 1011 Bhawani Peth, Pune 2.
- CHATRABHUJ RATANSI 1122 Bhawani Peth, Pune 2.
- DEAJI NENASI THAKKAR 1112 Nana Peth, Pune 2.
- DEOKARAN MULAJI THAKKAR 1071 Bhawani Peth, Pune 2.
- DINESHCHANDRA VITTHALDAS & CO. 142 Nana Peth, Pune 2.
- G. T. THAKKAR 55/56 Somwar Peth, Pune 11.
- GAJANAN BARDAN DEPOT 75 Nana Peth, Pune 2.
- GHANSHYAMDAS KHEMJI & CO. 168 Bhawani Peth, Pune 2
- GOVINDAJI NATHURAM THAKKAR Tambakhu Ali, Bhawani Peth, Pune 2.
- H. P. PATANI & CO. 1296 Bhawani Peth, Pune 2.
- HARISCHANDRA HARIRAM & CO. 1379 Bhawani Peth, Pune 2.
- ISHWARDAS KORAJI THAKKAR 1374 Bhawani Peth, Pune 2.
- JAYANTILAL TULSIDAS & CO. 1021 Bhawani Peth, Pune 2.
- JAYRAM VALLABHDAS THAKKAR Bhawani Peth, Pune 2.
- JAY YOG TRADERS 24/25 Somwar Peth, Pune 11.
- JALARAM GUNNY DEPOT 98/182 Bhawani Peth, Pune 2.
- JOY TRADING CO. 466 Nana Peth, Pune 2.
- JAMANADAS RATANSI THAKKAR 1305 Bhawani Peth, Pune 2.
- JETHAMAL THAKKAR & CO. Bhawani Peth, Pune 2.
- KAMAL BARDAN DEPOT 73 Nana Peth, Pune 2.
- KHIMAJI JETHAMAL THAKKAR 1079 Bhawani Peth, Pune 2.
- LALAJI CHAMAJI TANNA & CO. 1305 Bhawani Peth, Pune 2.
- MADHAVAJI JAYRAM THAKKAR 1305 Bhawani Peth, Pune 2.
- MANGALDAS DAMAJI & CO. Bhawani Peth, Pune 2.
- MOHANLAL PREMAJI & CO. 111 Bhawani Peth, Pune 2.
- MORARAJI HIRAJI NARAM 78 Bhawani Peth, Pune 2.
- NAMDEO SADASHIV MANKAR 1096 Nana Peth, Pune 2.
- NANJI DAYARAM & CO. 1225 Budhwar Peth, Pune 2
- PATHAI LADARAM THAKKAR Bhawani Peth, Pune 2.
- PRATAP NANJI THAKKAR 1122 Bhawani Peth, Pune 2.
- PURUSHOTTAMDAS TIKAMDAS THAKKAR & CO. 55/56 Somwar Peth, Pune 11.
- SATYAWAN SAMAJI & CO. 114/A Bhawani Peth, Gul Ali, Pune 2.
- SHANTILAL VALLABHADAS KAMANI 1122 Nana Peth, Pune 2.
- TULASIDAS CHATRABHUJ & CO. 1122 Bhawani Peth, Pune 2.
- TULASIDAS RAMJI & CO. 1071 Bhawani Peth, Pune 2.
- WALJI PURUSHOTTAMDAS & CO. 183 Nana Peth, Pune 2.

BRASS & COPPER

- AWATE MADHUKAR MAHADEV 55 Guruwar Peth, Pune 2.
- AWATE ANANT RAGHUNATH 223 Raviwar Peth, Pune 2
- BHAGYALAXMI METAL CORPORATION 229 Raviwar Peth, Pune 2
- BHAI DHULICHAND JAVAHARMALJI PORWAL 298 Raviwar Peth, Pune 2
- BHARATKUMAR & CO. 1146 Raviwar Peth, Pune 2.
- BHARAT METALICA 295 Raviwar Peth, Pune 2.
- BHIMRAJ & CO. 245 Guruwar Peth, Pune 2.
- D. SHRIKANT & CO. 1106 Budhwar Peth, Pune 2.
- DAGADE BHIKABA BAPUJI 1106 Budhwar Peth, Pune 2.
- DANGRE A. J. Budhwar Peth, Sonya Maruti Chowk, Pune 2.
- DECCAN STAINLESS STEEL MART 883 Guruwar Peth, Pune 2.
- DINESH METAL INDUSTRIES 1671 Shukrawar Peth, Pune 2.
- FULCHAND TEJMAL & CO. 181 Guruwar Peth, Pune 2.
- GANDHI METAL CORPORATION 650 Raviwar Peth, Pune 2.
- GUJARATH METAL FACTORY 21 Nahal Peth, Near Apollo Theatre, Pune.
- GURBOMAL TAHILRAM 657 Raviwar Peth, Pune 2.
- JEDHE MARUTRAO BABAJI 207 Shukrawar Peth, Pune 2.
- JITENDRA SMELTING & ROLLING MILLS 308 Raviwar Peth, Pune 2
- JODHPUR METAL INDUSTRIES Ghorpade Peth, Pune 2.
- KADU B. M. 1106 Budhwar Peth, Pune 2.
- KAKUBHAI & SONS 234 Raviwar Peth, Pune 2.
- KASAWA METAL CORPORATION 195 Guruwar Peth, Pune 2.
- KHOPDE BROS. 1106 Budhwar Peth, Pune 2.
- KHULE MARUTRAO VITTHAL 534 M. Phule Market Gala, Shukrawar Peth, Pune 2.
- KRISHNARAO & SONS 1670 Shukrawar Peth, Pune 2.
- LANJEKAR DIGAMBAR NARAYAN 219 Raviwar Peth, Pune 2.
- LOMBAR GOVIND ABAJI Budhwar Peth, Sonya Maruti Chowk, Pune 2.
- MAHADEVIA METAL MART 192 Guruwar Peth, Pune 2.
- MAHALAXMI METAL INDUSTRIES 1598 Gunj Peth, Pune 2.
- MAHAVIR METAL CORPORATION 684 Shukrawar Peth, Pune 2.
- B. C. MEHTA & CO. 1106 Budhwar Peth, Pune 2.
- M. K. MEHTA & CO. 11 Shukrawar Peth, Pune 2.
- MEHTA METAL MART 317 Raviwar Peth, Pune 2.
- MURALE KRISHNAJI VISHNUPANT 243 Raviwar Peth, Pune 2.
- NAGORI & CO. 1627 Shukrawar Peth, Pune 2.
- NANCHAND NARSAJI & CO. 319 Raviwar Peth, Pune 2.
- NARENDRA METAL CORPORATION 1669 Shukrawar Peth, Pune 2.
- NATIONAL METAL MART 284 Raviwar Peth, Pune 2.

| | |
|---|--|
| NAVAYOG METAL INDUSTRIES 1652 Shukrawar Peth, Pune 2. | SHAH AJABAJI JESAJI JAIN 1659 Shukrawar Peth, Pune 2. |
| NEETIN METAL WORKS 1626 Shukrawar Peth, Pune 2. | SHAH AMRITRAJ BADANMAL 1106 Budhwar Peth, Pune 2. |
| NJAMPURKAR NARAYAN SAVLARAM Budhwar Peth, Pune 2. | SHAH ASLAJI BABULAL RATHOD & CO. 315 Raviwar Peth, Pune 2. |
| NON-FERROUS METAL DISTRIBUTORS Shivajinagar, Pune 5. | SHAH ASLAJI KHAMCHAND 1667 Shukrawar Peth, Pune 2. |
| PANDYA NARAYAN HIRAJI 1142 Budhwar Peth, Pune 2. | SHAH ASLAJI LALAJI 1218 Raviwar Peth, Pune 2. |
| PANDYA SHANKAR HIRAJI 1140 Budhwar Peth, Pune 2. | SHAH B. M. JAIN 1536 Shukrawar Peth, Pune 2. |
| PARMAR BROTHERS 393 Guruwar Peth, Pune 4. | SHAH BABULAL DEVICHAND 313 Raviwar Peth, Pune 2. |
| PATEL METAL INDUSTRIES Shukrawar Peth, Pune 2. | SHAH BHABUTAMAL KASTURJI & CO. 270 Raviwar Peth, Pune 2. |
| PRAKASH METAL INDUSTRIES 289 Raviwar Peth, Pune 2. | SHAH BHABUTMAL NAMICHAND & CO. 192 Guruwar Peth, Pune 2. |
| POONA METAL INDUSTRIES 223 Raviwar Peth, Pune 2. | SHAH BHABUTMAL SAREMAL 295 Raviwar Peth, Pune 2. |
| POONAWALA KUNDANMAL VENICHAND 549 Guruwar Peth, Pune 2. | SHAH BHABUTMAL TILOKCHAND 311 Raviwar Peth, Pune 2. |
| PORWAL METAL MART 238 Raviwar Peth, Pune 2. | SHAH BHERUMAL & CO. 1623 Raviwar Peth, Pune 2. |
| PUNAMCHAND SURTINGJI 226 Raviwar Peth, Pune 2. | SHAH BHIMAJI PHULCHAND 236 Raviwar Peth, Pune 2. |
| PURANDARE SHANKAR RAMCHANDRA 1142 Budhwar Peth, Pune 2. | SHAH CHANDANMAL PUKHRAJ 226 Raviwar Peth, Pune 2. |
| RAMANLAL NAROTTAMDAS & CO. 380 Guruwar Peth, Pune 2. | SHAH CHANDULAL MOHANLAL 1106 Budhwar Peth, Pune 2. |
| RASANE KRISHNAJI GOVIND 207 Guruwar Peth, Pune 2. | SHAH CHATRIJI MAGANLAL 287 Raviwar Peth, Pune 2. |
| RASNE PURSHOTTAM MAHADEV Budhwar Peth, Pune 2. | SHAH CHIMANLAL NAROTAMDAS 222 Raviwar Peth, Pune 2. |
| RASNE SURYAKANT VITHAL 218 Raviwar Peth, Pune 2. | SHAH CHUNILAL AMRUTLAL 306 Raviwar Peth, Pune 2. |

- SHAH DALICHAND KASTURJI RATHOD 300 Raviwar Peth, Pune 2
- SHAH DANMAL HUKUMAJI 638 Raviwar Peth, Pune 2
- SHAH DEVICHAND GEMRAJ JAIN 224 Raviwar Peth, Pune 2.
- SHAH DEVICHAND KESARIMAL & CO. 308 Raviwar Peth, Pune 2.
- SHAH DEVRAJ PARASMAL 402 Guruwar Peth, Pune 2.
- SHAH DHARAMCHAND KAPURCHANDJI 291 Raviwar Peth, Pune 2.
- SHAH DHARAMCHAND MOTAJI 236 Raviwar Peth, Pune 2.
- SHAH DOLAJI AMBALAL 317 Raviwar Peth, Pune 2
- SHAH DUDHAJI PADMAJI 1668 Shukrawar Peth, Pune 2.
- SHAH GENMAL VELLAJI 300 Raviwar Peth, Pune 2.
- SHAH GHANSHAMDAS GOPALDAS 1658 Shukrawar Peth, Pune 2.
- SHAH GHELABHAI JADHAVJI 230 Raviwar Peth, Pune 2.
- SHAH GULABJI NATHAJI 238 Raviwar Peth, Pune 2
- SHAH GUNDECHA METAL CORPORATION 633 Raviwar Peth, Pune 2.
- SHAH HAKAMCHAND ISHWARDAS 246 Raviwar Peth, Pune 2.
- SHAH HAMIRMAL MOHANLAL 298 Raviwar Peth, Pune 2
- SHAH HIRACHAND PRAGAJI 1668 Shukrawar Peth, Pune 2.
- SHAH HIRACHAND RAYCHAND & CO. 286 Raviwar Peth, Pune 2.
- SHAH JAYCHAND KALURAM & CO. 141 Raviwar Peth, Pune 2.
- SHAH JUGRAJ OTARMAL SURANA 643 Raviwar Peth, Pune 2
- SHAH KANTILAL KASTURCHAND 033 Raviwar Peth, Pune 2
- SHAH KAPURCHAND JAVANMALJI 1104 Budhwar Peth, Pune 2.
- SHAH KAPURJI SHANKARLAL 1661 Shukrawar Peth, Pune 2
- SHAH KASTURCHAND TARACHAND 225 Raviwar Peth, Pune 2.
- SHAH KESARIMAL LAKHMICHAND & CO. 299 Raviwar Peth, Pune 2
- SHAH KORINGJI RAMLAL 314 Raviwar Peth, Pune 2
- SHAH LADHAJI LUMBAJI 213 Raviwar Peth, Pune 2.
- SHAH LAKHAMAJI KHANGARMAL & CO. 300 Raviwar Peth, Pune 2
- SHAH LALUBHAI NIHALCHAND 214 Raviwar Peth, Pune 2
- SHAH LUMBAJI BABHUTALMAL 294 Raviwar Peth, Pune 2.
- SHAH MAGANLAL & SONS 1669 Shukrawar Peth, Pune 2
- SHAH MAGANRAJ UMEDMAL 11 Shukrawar Peth, Pune 2.
- SHAH MALAJI BHAGAVANJI 290 Raviwar Peth, Pune 2
- SHAH MANIKCHAND RATANCHAND 1748 Shukrawar Peth, Pune 2.
- SHAH MANIKCHAND LAKHAMAJI 420 Guruwar Peth, Pune 2.
- SHAH MISHRIMAL GULABCHAND & SONS 606 Guruwar Peth, Pune
- SHAH MITHALAL TEJMAL JAIN 118 Guruwar Peth, Pune 2.

- SHAH MULCHAND BHURMAL & CO. 376 Guruwar Peth, Pune 2.
- SHAH MULCHAND NARSAJI GANDHI 202 Guruwar Peth, Pune 2.
- SHAH MULCHAND SWAROOPCHAND 185 Guruwar Peth, Pune 2
- SHAH NAGRAJ MAGNIRAM 1614 Raviwar Peth, Pune 2
- SHAH NANCHAND ONKARAMAL & SONS 1748 Shukrawar Peth, Pune 2.
- SHAH NARSAJI MOHANLAL JAIN & CO. 298 Raviwar Peth, Pune 2.
- SHAH NATHAJI CHUNILAL 307 Raviwar Peth, Pune 2.
- SHAH NATHAJI RIKABCHAND 314 Raviwar Peth, Pune 2.
- SHAH NAVALMAL DALICHAND 1666 Shukrawar Peth, Pune 2.
- SHAH NEMAJI ONKARMAL 381 Guruwar Peth, Pune 2.
- SHAH PHULCHAND DANMAL 297 Raviwar Peth, Pune 2
- SHAH PHUTARMAL AMICHAND 11 Shukrawar Peth, Pune 2.
- SHAH PREMJI VELJI 1536 Shukrawar Peth, Pune 2.
- SHAH PREMRAJ SARUPCHAND 179 Guruwar Peth, Pune 2.
- SHAH PUKHRAJ SUKANRAJ 215 Raviwar Peth, Pune 2.
- SHAH PUNAMCHAND VIRAJI 312 Raviwar Peth, Pune 2.
- SHAH RAMLAL CHATRAJI 185 Guruwar Peth, Pune 2.
- SHAH PREMAJI SAJAJI 382 Guruwar Peth, Pune 2.
- SHAH SAKALCHAND ROPCHAND 224 Raviwar Peth, Pune 2.
- SHAH SAMANAJI MALAJI 325 Raviwar Peth, Pune 2
- SHAH SAMANIRAM BHAGANI & CO. Bhopale Chowk, Pune 1
- SHAH SURTHINGJI VANECHAND 321 Raviwar Peth, Pune 2.
- SHAH SONMAL MOTAJI 549 Guruwar Peth, Pune 2.
- SHAH TAJAMAL VANNAJI 1652 Shukrawar Peth, Pune 2.
- SHAH TILOKCHAND DOLAJI 229 Raviwar Peth, Pune 2.
- SHAH VARDHAJI NAVAMAL 1668 Shukrawar Peth, Pune 2.
- SHAH VARDICHAND DOLAJI 303 Raviwar Peth, Pune 2.
- SHAH WADILAL NAROTAMDAS 231 Raviwar Peth, Pune 2.
- SHARADA METAL WORKS C/o. Bhmraj & CO. 245 Guruwar Peth, Pune 2.
- SHRI CHANDAN STEEL HOUSE 684 Shukrawar Peth, Pune 2
- SURJAMAL K. SANGHVI & CO. Shivajinagar, Pune 5.
- TULSIDAS AND SONS 210 Raviwar Peth, Pune 2.
- VARDHAMAN METAL CORPORATION 298 Raviwar Peth, Pune 2.
- VISHANDAS LALCHAND 300 Raviwar Peth, Pune 2.
- VISHNU METAL INDUSTRIES Laxmi Nagar Market, Raviwar Peth, Pune 2.
- WADKE RAMCHANDRA PANDHARINATH Sonya Maruti Chowk, Budhwar Peth, Pune 2.

WADKE BABURAO RAMCHANDRA Sonya Maruti Chowk, Budhwar Peth, Pune 2.

YAVANKAR SHASHIKANT HIRACHAND Shivajinagar, Pune 5.

CEMENT

ARIHANT AGENCIES 4 New Khadki Bazar, Khadki Pune 3.

ANJUNA MIRCHANDANI C/o. N. K. Joshi, 205 Shukrawar Peth, Pune 2.

B. B. PATEL New Timber Market, Pune 2.

B. B. TRADER 110 Nana Peth, Pune 2.

BHARAT ENTERPRISES S. No. 732/B Satara Road Pune 9.

DARGE AGENCIES 1061 Shukrawar Peth, Pune 2.

DIAMOND LIME 103S Shivajinagar, Chunawala Bldg. Pune 5,

E. DINSHAW & CO. Gen. Thimayya Road, Pune 1.

GODAJI MANAJI & CO. 37/8 New Timber Market, Pune 2.

J. K. & SONS 669 Guruwar Peth, Phulwala Chowk, Pune 2.

JASWANT TIMBERS 52 New Timber Market, Pune 2.

KACHRADAN MANULAL 332 Raviwar Peth, Pune 2.

L. EBRANIM & CO. 343 Raviwar Peth, Pune 2.

LAXMI CEMENT SUPPLIERS 39/A, G-62, Gultekdi, Pune 9.

LAXMI SALES AGENCIES 459 Kasba Peth, Pune 11.

LUNAWAT AGENCIES 584 Nana Peth, Pune 2.

M. LALWANI & CO. 883 Budhwar Peth, Pune 2.

MADHAV & CO. 204 Mangalwar Peth, Pune 11.

MAHALAXMI AGENCIES 39 New Timber Market, Pune 2.

MANIK TIMBERS 139 Bhawani Peth, Pune 2.

NITIN ENTERPRISES 613/14 Laxmi Road, Pune 30

NITIN SALES CORPORATION 524/25 M. Phule Peth, Opp. Sonmarg Theatre, Pune 2.

NIVEDITA TRADERS 76/32 Prabhat Road, Shanti Sheela Society, Pune 4

P. K. G. AGENCIES 1281 Shivajinagar, Opp. Rang Mandir Bridge, Pune 5.

PARMAR AGENCIES 393 Guruwar Peth, Pune 2.

PATEL SALES AGENCIES 33 Gultekdi, Pune 9.

PILANI TRADERS 997/2 Navi Peth, Pune 30.

R. B. SHINDE 725/2 Sadashiv Peth, Near Shanipar Chowk, Pune 30.

S. M. KIRAD 107/108 Timber Market, Pune 2.

S & S ENTERPRISES 485 Shukrawar Peth, Pune 2

SANCHETI SALES CORPORATION 389 Narayan Peth, Pune 30.

SHANKAR MERCHANTILES CORPORATION (AGENCIES) 401 Ganesh Peth, Near Arya Bhusban Theatre, Pune 2.

SUSHIL & GO. Deepatkar, G-94/2 Navi Peth, Pune 30.

CHEMISTS and DRUGGISTS

- AFRICA DRUG HOUSE** 547 Sadashiv Peth, Pune 30.
- ALLIED MEDICAL STORES** 1526 Sadashiv Peth, Pune 30.
- AMAR MEDICAL & GENERAL STORES** 1045 Shukrawar Peth, Tilak Rd, Pune 2.
- AMBIKA MEDICAL STORES** 1152/A Raviwar Peth, Pune 2.
- AMIT MEDICALS** 1759 Shukrawar Peth, Pune 2.
- AMOD MEDICAL & GENERAL STORES** 1505 Sadashiv Peth, Pune 30.
- ANAND DRUG HOUSE** Opp. Ladkat Petrol Pump, 356 Somwar Peth, Pune 11.
- ANAND MEDICO** Lal Bahadur Shastry Marg, 181 Navi Peth, Pune 30.
- ANAND MEDICAL & GENERAL STORES** 884/7 Karve Road, Pune 4.
- ANIL MEDICAL & GENERAL STORES** Vishrantwadi, Alandi Road, Pune 15.
- ANUP CHEMISTS** 436 Somwar Peth, Pune 11.
- ANUP MEDICAL STORES** 263 Gadi Tal, Hadapsar, Pune 22.
- ANUP MEDICAL STORES** 433/7/A Saraswat Colony, Pune 11.
- ARCINES DISTRIBUTORS** 735 Sadashiv Peth, Pune 30.
- ARIHANT MEDICALS** 259 New Raviwar Peth, Opp Jain Temple, Pune 2.
- ARVIND MEDICALS** 135/3 Opp. Bank of India, Sahakar Nagar, Pune 9.
- ASHOK MEDICO** 1278 Sadashiv Peth, Pune 30.
- ATLANTIC MEDICAL STORES** Shivsadan, 499 'B', Rasta Peth, Pune 11.
- AVINASH ENTERPRISES** 92 Ganesh Peth, Laxmi Road, Pune 2.
- AVI MEDICO** 1010 Shivaji Nagar, Opp. Deep Bungalow, Pune 16.
- BAFNA SUPPLIERS** 286 Ganesh Peth, Pune 2.
- BATAVIA MEDICO** 893/8 Deccan Gymkhana, Gokhale Chowk, Pune 4.
- B. J. MEDICALS** 1340 Shivajinagar, Pune 5.
- BHAGAT BROS** 250 Budhwar Peth, Pune 2.
- BHARAT DRUG HOUSE** 77 Budhwar Peth, Pune 2.
- BHOGILAL & CO.** 849 Budhwar Peth, Laxmi Road, Pune 2.
- BHOGILAL & CO.** Tilak Road, Pune 30.
- BOMBAY MEDICAL AGENCY** 1107 Sadashiv Peth, Pune 30.
- BORA & BORA** 156 B Ganesh Prema Chambers, Pune 2.
- CENTRAL DRUG HOUSE** 923/A Sadashiv Peth, Laxmi Road, Pune 30.
- CENTRAL MEDICAL STORES** 217 Budhwar Peth, Pune 2.
- CHANDULAL R. MEHTA** 735 Shukrawar Peth, Pune 2.
- CHEMI CENTRE** 614 Guruwar Peth, Pune 2.
- CHEMPAK INDUSTRIES** 244 Narayan Peth, Pune 30.
- CHIMANLAL D. MEHTA** 21 New Bazar, Khadki, Pune 3.
- CITY MEDICALS** 19 Kasba Peth, Pune 11.
- CIVIC DRUG HOUSE** 100 Budhwar Peth, Pune 2.

- COLONIAL CHEMISTS** 759/59 Deccan Gymkhana, Pune 4.
- D. MACEDO & CO.** 251 Bhudhwar Peth, Pune 2.
- D. MACEDO & CO.** 250/51 M. G. Road, Pune 1.
- D. V. DIKE & SONS** 678 Sadashiv Peth, Pune 30
- DATTA MEDICAL STORES** 361/62 Budhwar Peth, Pune 2.
- DECCAN STORES** 645 Sachapeer Street, Camp Pune 1.
- DEEPAK MEDICALS** 339 Ganesh Peth, Pune 2
- DEFENCE ACCOUNTS DRUG STORES** No 1 Finance Road, Office of CDASC, Pune 1.
- DELHI STORES** 199 Ganesh Peth, Pune 2
- DEOKAR MEDICAL STORES** 6 Mukund Nagar, Pune-Satara Road, Pune 9.
- DEVENDRA MEDICAL CENTRE** 49 Gunj Peth, Pune 2
- DEVENDRA MEDICAL STORES** No 1 Rasta Peth, Pune 11.
- DHANPAL & CO.** 1609 Shukrawar Peth, Pune 2
- DIAMOND DRUG STORES** 603 Sadashiv Peth, Pune 30.
- DIAMOND DRUGGISTS** 153 Kasarwadi, Pune 24
- DILIP MEDICAL CENTRE** 1712/1 B Sadashiv Peth, Pune 30.
- DORABJEE & CO.** 1-B Moledina Road, Pune 1
- FLORENCE TRADERS** 625 Sachapeer Street, Pune 1
- FREE INDIA STORES** 233 M G Road, Pune 1.
- GANESH MEDICAL & GENERAL STORES** 1164 Budhar Peth, Pune 2.
- GANESH MEDICAL STORES** Opp: K.E.M. Hospital, 354 Rasta Peth, Pune 11.
- G. BAL & CO.** 378 Shaniwar Peth, Pune 30.
- GIRIDHARLAL COMPANY** Seva Sadan Building, 789 Laxmi Road, Pune 30.
- GODBOLE JOSHI & CO.** 596 Sadashiv Peth, Pune 30. and 172, Shaniwar Peth Pune 30.
- GUJAR & COMPANY** 311/2 Kasba Peth, Pune 11.
- GUJAR MEDICO** 501 Ghorpadi Peth, Swargate, Pune 2.
- HIND MEDICO** 552 Guruwar Peth, Kasture Chowk, Pune 2.
- HIRALAL MEHTA** 375 Narayan Peth, Pune 30.
- HIRALAL MEHTA & CO.** Pharmaceutical Distributors 569 Sadashiv Peth, Pune 30.
- INDUSTRIAL & ALLIED SUPPLIERS** 209 Narayan Peth, Laxmi Road, Pune 30.
- J. L. MARTYRES & CO.** 93/2 Laxmi Road, Pune 2.
- JAI HIND DRUG STORES** 391 Mangalwar Peth, Pune 12.
- JANATA MEDICAL STORES** 768 Sadashiv Peth, Phadtare Chowk, Pune 30.
- JASPAL MEDICALS** 5 Sasson Road, Pune 1.
- JAYANT & COMPANY** 721 Budhwar Peth, Laxmi Road, Pune 2
- JEEVAN SALES CORPORATION** 570 Nana Peth, Laxmi Road, Pune 2.
- JEEVAN MEDICALS** 298 Market Road, Khadki, Pune 3
- JEEVEN MEDICO** Hadapsar, Pune 28.

- KHEMCHAND DAYALJEE & SONS** 538 Sardar Patel Street, Pune 1.
- KIRAN MEDICALS** C-1/115 Pimpri Colony, Pune 17
- KIRAN MEDICAL SERVICE** Umbrya Ganpati Chowk, Laxmi Road, Pune 30.
- KOSHI MEDICO** 1321/1 Shivaji Nagar, Pune 5.
- KUNDAN MEDICAL & GENERAL STORES** Chinchwad Station, Pune 19.
- L. EBRAHIM & CO.** 343 Raviwar Peth, Pune 2.
- LIBERTY MEDICALS** 1539 Sadashiv Peth, Pune 30.
- M. D. PENDSE** 568 Sadashiv Peth, Laxmi Road, Pune 30.
- MADAN DRUG STORES** 323 Mahatma Gandhi Road, Pune 1.
- MADAN MEDICALS** 9/4B Pitru-chohaya, Kashmiri Colony, Yerawada, Pune 6.
- MADHAV & CO.** 759/5 Deccan Gymkhana, Pune 4.
- MADHUSUDAN DRUG STORES** 363 Narayan Peth, Opp. Gokhale Hall, Laxmi Road, Pune 30.
- MAHARASHTRA DRUG HOUSE** 88 Yerawada, Pune 6.
- MAHARASHTRA MEDICAL & GENERAL STORES** Hotel Amir Bldg., 15 Cannaugat Road, Pune 1.
- MAHARASHTRA SURGICAL HOUSE** 550 B Nana Peth, Pune 2.
- MAHESH MEDICAL** 52/53 Ghorpadi Bazar, Pune 1
- MAJITHIA MEDICAL STORES** 1878 Sadashiv Peth, Pune 30.
- MANIK STORES** Gandhi Peth, Chinchwad, Pune 33.
- MANOHAR DRUG STORES** 197 Pimpri Colony, Pimpri, Pune 17.
- MEDECO DISTRIBUTORS** 1051 Sadashiv Peth, Pune 30.
- MEDI CENTRE** 513/3 Shivajunagar, F C. Road, Pune 5
- MEDICAL DISTRIBUTORS** 775/3 Sunrise Apartments, Pune 4
- MEDI SALES** 354/4 Rasta Peth, Pune 11.
- MILAFF MEDICAL STORES** 841 Budhwar Peth, Pune 2.
- MITRA MEDICALS** 484/31/1 Mitra Mandal Colony, Parvati, Pune 9.
- MODAK & CO.** 20/1A Somwar Peth, Pune 11.
- MODERN DRUG HOUSE** 371 Nana Peth, Pune 2.
- N. MAHADEO & CO.** (1) 851 Budhwar Peth, Pune 2. (2) 759/55-D. Gymkhana Pune 4.
- NAIK BROTHERS (Day & Night Service)** 574 Rasta Peth, Pune 11.
- NANDADEEP MEDICAL STORES** 23 Mukund Nagar, Pune 9.
- NARENDRA MEDICALS** 5/6 Gultekdi, Apsara Apartments, Pune 9
- NATRAJ MEDICAL & GENERAL STORES** 456 Nana Peth, Laxmi Road, Pune 2.
- NATRAJ MEDICAL STORES** 374, Nana Peth, Pune 2.
- NEELU & CO.** 612/6 Nana Peth, Pune 26.
- NEW INDIA PHARMACY** 25 Budhwar Peth, Appa Balwant Chowk, Pune 2.
- NEW INDIA MEDICAL STORES** 56 Yerawada, Pune 6.
- NEW LIFE MEDICAL & GENERAL STORES** 426 Ganesh Peth, Pune 2.

- NEW MEDICAL STORES** 627 Budhwar Peth, Pune 2
- NIRMAL MEDICALS** Chadda Mansion, Bombay-Pune Road, Pimpri, Pune 18.
- NISHAT MEDICAL HALL** 4 M. G. Road, Pune 1.
- NOVELTY MEDICAL & GENERAL STORES** Pimpri Colony, Pune 17.
- NUTAN MEDICAL & GENERAL STORES** 1/1 Navi Peth, Pune 30.
- PASHUPAKSHI AUSHADHALAYA** 693 Budhwar Peth, Pune 2
- PATIL & CO.** 433/23, Somwar Peth, Pune 11.
- PHARM DEAL** 286 Ganesh Peth, Opp. Alpana Talkies, Pune 2.
- PHARMA SALES** 205 M. G. Road, Pune 1
- PIONEER MEDICAL STORES** J. M. Road, Pune 5
- POONA MEDICAL STORES** 90 Budhwar Peth, Pune 2.
- POONA SURGICAL & GENERAL AGENCIES** 972, Sadashiv Peth, Laxmi Road, Pune 30.
- POONAM MEDICALS** 33 Bombay-Poona Road, Pune 3.
- PRAFULLA MEDICALS** 1531 Tilak Road, Pune 30.
- PRAKASH AGENCY** 41 Shukrawar Peth, Pune 2.
- PRAKASH PHARMACEUTICALS** Shop No 7, Yeshwant Market, 599 Budhwar Peth, Pune 2
- PRAKASH MEDICAL STORES** Opp. Poona Railway Station, 14 Cannought Road, Pune 1
- PRAKASH MEDICALS** 1187/66 Shivajinagar, Opp. Bal Gandharva RnggaMandir, J. M. Road, Pune 5
- PRAKASH MEDICAL STORES** Chunchwad, Pune 19.
- PRAMOD DISTRIBUTORS** 1st Floor, 386 Guruwa, Peth, Pune 2.
- PRASAD AGENCY** 1019 Sadashiv Peth, Near Nagnath Par, Pune 30.
- PRAVIN MEDICALS** 622 Ganesh Peth, Pune 2.
- PREMPRAKASH MEDICAL & GENERAL STORES** 386/5 New Timber market, Poona 2.
- PUNDOL MEDICAL STORES** 561 V. P. Street, Pune 1.
- RADHIKA MEDICAL & GENERAL STORES** Arya Samaj Bhavan, Shop No. 142, Pune 18.
- RAHUL MEDICAL STORES** 1132/3 F C. Road, Pune 4.
- RAJ & CO.** 4 National Defence Academy, Khadakwasla, Pune 23
- RAJIV MEDICAL & GENERAL STORES** 180 Navi Peth, Pune 30.
- RASANE MEDICAL SERVICE & GENERAL STORES** 816, Budhwar Peth, Pune 2.
- RATHOD MEDICALS** Opp: Apollo Talkies, Pune 1.
- RECIPE DRUG HOUSE** 311 Nana Peth Laxmi Road, Pune 2
- RELIEF DRUG HOUSE** 100 Raviwar Peth, Pune 2.
- S. V. GUPTA & Co** 405/6, Narayan Peth, Pune 30
- S. GOKULDAS** 1764 Laxmi Road, Sonya Maruti Chowk, Pune 2.
- S. A. HAKIM** 1618 Shukrawar Peth, Pune 2.
- SACHIN MEDICALS** 842 Sahakar Nagar, Pune 9
- SAMS MEDICO** 39/A G2, 62 Shankarshet Road, Pune 9.
- SANDEEP MEDICAL & GENERAL STORES** Sainler Building, Chinchwad, Pune 33.

- SANGHVI MEDICALS** Opp: Nehru Memorial Hall, Soona 1.
- SANJIVANI MEDICAL** 160 Hadapsar, Pune 28.
- SANJIVANI MEDICAL & GENERAL STORES** Sindh Housing Society, Aundh, Pune 7.
- SANJIYESH AGENCY** 365 Narayan Peth, Laxmi Road, Opp, Gokhale Hall, Pune 30.
- SATGURU MEDICAL & GENERAL STORES** Mira Housing Society, Pune 9.
- SAYAR MEDICO** 975 Shukrawar Peth, Pune 2.
- SHAH VITHALDAS SAKALCHAND** 1557, New Shukrawar Peth, Pune 2.
- SHANTI MEDICAL & GENERAL STORES** FA, Shanti Kunj Bldg. Opp: G.P.O., Poona 1.
- SHREE MEDICAL & GENERAL STORES** 1010 Ushakkal Apartments, Deep Bungalow, Pune 16.
- SHREEYASH MEDICALS** 1087 Sadashiv Peth, Pune 30
- SHRI MEDICAL STORES** 664/A, Shukrawar Peth, Pune 2.
- SHRIRAM MEDICAL & GENERAL STORES** 943 Shukrawar Peth, Pune 2.
- STANDARD GENERAL STORES** 734 Sadashiv Peth, Pune 30.
- SUNIL MEDICAL STORES** 1223 Madhuban, F. C. Road, Pune 4.
- SUNITA MEDICAL & GENERAL STORES** 815/16/10 Padamjee Compound, Bhawani Peth, Pune 2.
- SUPER PRODUCTS MFG. CO. PVT. LTD.** 640 Narayan Peth, Pune 30.
- SUVIDHA DISTRIBUTORS** 120 Raviwar Peth, Moti Chowk, Pune 2.
- SUYASH MEDICALS** Shop No. A/5, Swapna Nagari, 20 Karve Road, Pune 4.
- SUYOG MEDICAL STORES** 585/86 Shukrawar Peth, Pune 2.
- SWASTIK MEDICAL STORES** (1) 177/78, Laxmi Road, Pune 30. (2) 499 C Rasta Peth, Pune 11.
- THE CENTRAL AGENCIES** 952 Sadashiv Peth, Laxmi Road, Pune 30.
- UNIK MEDICALS** 89 M. G. Road, Pune 1.
- UNITY MEDICALS** Dapodi, Nehru Chowk, Pune 12.
- UTTAM MEDICALS** 17A Ganesh Chambers, Karve Road, Poona 4
- V. B. KHARE & SONS** 726 Budhwar Peth, Laxmi Road, Opp. City Post, Pune 2.
- VAIBHAV MEDICO** 1154 Sadashiv Peth, Near Perugate, Pune 30.
- VARDHAMAN MEDICAL CENTRE** 660 Raviwar Peth, Pune 2.
- VLJAY MEDICAL & GENERAL STORES** 566 Sadashiv Peth, Pune 30.
- VLJAY MEDICAL** 216 M. G. Road, Pune 1.
- VLJAYA MEDICAL & GENERAL STORES** 30 Sassoon Road, Pune 1.
- YASHDEEP MEDICALS** 661 Narayan Peth, Pune 30v.
- YOGESH MEDICALS** 108/7 Vaibhav Building Ganeshkhind Road, Pune 16.
- YOGESH MEDICAL & GENERAL STORES** 117 Kailas, Opp. R.D.E. Quarters, Alandi Road, Pune 15.

AURVEDIC MEDICINES SHOPS

AMBADAS RANADE Tulasi Bag, Pune 2.

APHALI PHARMACEUTICALS LTD. Budhwar Peth, Datta Mandir, Pune 2.

AYURVED RASASHALA, PUNE (1) 95 Laxmi Road, Pune 30. (2) Rasta Peth, Apollo Talkies, Pune 11.

AYURVEDIK ARKASHALA VIKRI KENDRA
Tilak Road, Pune 30.

AYURVEDIK AUSHADH BHANDAR Shani Par Chowk, Pune 2.

BIDHYALOK AYURVEDIK AUSHADH KENDRA
Bombay-Poona Road, Chinchwad, Pune 19.

DHOOTPAPESHWAR 726 Budhwar Peth, Opp. City Post, Pune 2.

HARI PARASHURAM AUSHADHALAYA 716 Sadashiv Peth, Pune 30.

KERAL AYURVED PHARMACY Rasta Peth, Near Apollo Talkies, Pune 11.

I. C. HAKIM (UNANI) Raviwar Peth, Pune 2.

POONA AYURVED AUSHADHA BHANDAR
420 Budhwar Peth, Pune 2.

SAHYADRI AUSHADHA BHANDAR Budhwar Peth, Pune 2.

SANDU BROTHERS Laxmi Road, Near Gokhale Hall, Pune 2.

SHRINATH CHEMICAL & PHARMACEUTICALS
Raviwar Peth, Moti Chowk, Pune 2.

TRIPATHI & CO. Ganapati Chowk, Laxmi Road, Pune 2.

CONSUMERS' CO-OPERATIVE STORES

AMMUNITION FACTORY CO-OP. CONSUMER STORES Powder Rd, Khadki, Pune 3.

ASHOK SAHAKARI SANSTHA LTD. Pach Pandav Sah Gruh Rachana Sanstha, Pune 16.

BHARATI MADHYAVARTI SAHAKARI GRAHAK BHANDAR LTD. 13 Sadashiv Peth, Pune 30.

CENTRAL EXCISE CO-OP. CUTTING STORES
Tilak Rd, Corporation Bldg., Pune 5.

COLLEGE OF AGRICULTURE CO-OP. CONSUMERS SOCIETY Fergusson Rd., Pune 4.

COLLEGE OF COMMERCE CO-OPERATIVE STORES LIMITED B.M.C. College, Pune 4.

CO-OP. TRAINING COLLEGE CONSUMERS STORES
43/16 Gunadhar Banglow, Pune 4.

ERANDWANA SRAVADYA GRAHAK SANSTHA LTD.
44 Erandwana, Karve Rd., Pune 4.

FERGUSSON COLLEGE CONSUMERS STORES
Fergusson College, Pune 4.

GOPAL SAHAKARI MANDAL LTD. 1028 Raviwar Peth, Pune 2.

GOVT. POLYTECHNIC CO-OP. CONSUMERS SOCIETY Ganesh Kbind Road, Pune 6.

GUNJ PETH SAHAKARI GRAHAK BHANDAR LTD.
23 Gunj Peth, Pune 2.

INDUSTRIAL TRAINING INSTITUTE CO-OP. CONSUMERS STORES I.T.I. Aundh Camp, Pune 27.

JANASEVA SAHAKARI GRAHAK SANSTHA LTD.
531 Budhwar Peth, Pune 2.

JANATA GRAHAK MADHYAVARTI SAHAKARI SANGH LTD. Opp. S. P. College, Tilak Rd., Pune 30.

- KESHAV SAHAKARI GRAHAK SANSTHA LTD.** 'Ratnaprabha', 1204/2A, Pune 5.
- M.E.S. COLLEGE CO-OP. SOCIETY** M.E.S. College, Pune 4.
- MAHARSHINAGAR PRATHMIK SAHAKARI GRAHAK BHANDAR** Maharshinagar, Pune 9.
- MANGALWAR PETH SAHAKARI GRAHAK BHANDAR LTD.** 232 Mangalwar Peth, Pune 2.
- MITRA SAHAKARI MANDAL CO-OP. CONSUMERS STORES LTD.** 1735 Shukrawar. Peth, Pune 2.
- MODERN COLLEGE STUDENTS' CO-OP. STORES** Modern College, Pune 5.
- N. C. L. CO-OP. STORES LTD.** N.C.L. Pashan, Pune 8.
- NAGRIK SAHAKARI GRAHAK BHANDAR LTD.** 551, Nana Peth, Pune 2.
- PANSHET PURGRASTA SAHAKARI NITYOPAYOGI GRAHAK BHANDAR LTD.** Laxmi Nagar, Pune 9.
- PARIJAT DEPARTMENTAL STORES** 2011 Sadashiv Peth, Tilak Road, Near S. P. College, Pune 30.
- POONA AUTOMOBILES CONSUMERS CO-OPERATIVE SOCIETY** Udyog Bhavan, Pune 2.
- POONA-BOMBAY ROAD SAHAKARI GRAHAK SANSTHA LTD.** 14 Poona-Bombay Road, Khadki, Pune 3.
- POONA DISTRICT KHADI GRAHODYOG SAHAKARI SOCIETY** Laxmi Road, Pune 2.
- POONA DIST. MOTOR TRANSPORT CO-OP. CONSUMERS STORES LTD.** 587/24 Shukrawar Peth, Pune 2.
- POONA LAWYERS' CO-OP. CONSUMERS STORES** District Court, Pune 5.
- POONA RETAILERS' CO-OP. CONSUMERS STORES LIMITED** 205 Ganesh Peth, Pune 2.
- POONA TAXIMEN CONSUMERS' CO-OP. SOCIETY LTD.** Sassoon Road, Pune Station, Pune 1.
- POONA TELEPHONE EMPLOYERS CO-OP. CONSUMERS SOCIETY LTD.** Divisional Engineers' Home, Pune.
- PUNCH-HOUD SPORTS CLUB CONSUMERS SOCIETY** 1216 Shukrawar Peth, Pune 2.
- PUNE CONTRACTOR CO-OP. CONSUMERS SOCIETY** 613 Nana Peth, Pune 2.
- PUNE DHOBI SAMAJ CO-OP. CONSUMERS SOCIETY** 265 Somwar Peth, Pune 11.
- PUNE MAHANAGARPALIKA KAMGAR PRATHMIK SAHAKARI GRAHAK BHANDAR LTD.** 640 Narayan Peth, Pune 30.
- PUNE NORTHERN WADAR SAMAJ CO-OP. CONSUMERS SOCIETY** 382 Shivajinagar, Pune 5.
- PUNE ZILLA BAKERY MAL UTPADAK SAHAKARI CO-OP. CONSUMERS SOCIETY** 301 Mangalwar Peth, Pune 11.
- PUNJAB CO-OP. CONSUMERS STORES LTD.** 440 Nana Peth, Pune 2.
- PURV VIBHAG SAHAKARI GRAHAK BHANDAR** 206 Rasta Peth, Pune 2.
- RAJYA SAHAKARI NAKAT GRAHAK VASTU BHANDAR** Central Bldg. Pune 1.
- RESEARCH DEVELOPMENT CO-OP. CONSUMERS STORES LTD.** A.R. & D. L., Pune 1.
- REVENUE COMMISSIONERS CO-OP. CONSUMERS STORES** Commissioner's Office, Council Hall, Pune 9.
- REVENUE DEPARTMENT EMPLOYEES' CO-OP. CONSUMERS SOCIETY LTD.** Near Court, Pune 5.
- S. P. COLLEGE CO-OP. CONSUMERS STORES** S. P. College, Tilak Road, Pune 30.
- SANJIVANI SAHAKARI GRAHAK SANSTHA LTD.** 132 Shukrawar Peth, Pune 2.
- SHIVAJINAGAR SAHAKARI GRAHAK SANSTHA LTD.** 93 Narvur Tanaji Wadi, Pune 2.

- SHOBHECHI DARU UTPADAK CO-OP. CONSUMERS STORES LTD.** 445 Raviwar Peth, Pune 2.
- SHRI ADINATH DEPARTMENTAL CONSUMERS CO-OP. SOCIETY LTD.** Adinath Society, Pune 9.
- SHRI GANESH SAHAKARI GRAHAK SANSTHA LTD.** 12 Ganesh Peth, Pune 2.
- SOUTH INDIA CO-OP. WHOLESALE CONSUMERS SOCIETY** 206 Rasta Peth, Pune 11.
- SWASTIK CO-OP. CONSUMERS STORES** 643 Ghorpade Peth, Pune 2.
- THE DEFENCE ACCOUNT CO-OP. CONSUMERS SOCIETY** 2013 Sadashiv Peth, Pune 30.
- TRIVENI SAHAKARI GRAHAK BHANDAR LTD.** 247/2 Navi Peth, Pune 30.
- YESHWANT SAHAKARI GRAHAK SANSTHA LTD.** 149 Mukundnagar, Gultekadi, Pune 9.
- HARBANS CYCLE TRADING CO.** 995 Raviwar Peth Pune 2
- HIND RUBBER & CYCLE CO.** 727 Budhwar Peth, Ganesh Road, Pune 2.
- J. K. CYCLE CO.** 657 M. G. Road, Camp, Pune 1.
- JOSHI GARAGE** 405 Narayan Peth, Pune 30.
- KULKARNI & SONS** 680 Budhwar Peth Pune 2
- MAHARASHTRA CYCLE & MOTOR CO.** 261 Budhwar Peth, Pune 2.
- MASTER CYCLE TRADING CO.** 616 Budhwar Peth-Pune 2.
- MODERN CYCLE CO.** 38/1 New Bazar, Khadki, Pune 3.
- NATIONAL AGENCIES** Poona-Bombay Road, Chinchwad, Pune 19.
- NEELAM TRADERS** 579 Nana Peth, Pune 2.
- NEW STANDARD CYCLE TRADING CO.** Main Road, Khadki, Pune 3.
- P. K. CYCLE INDUSTRIES CORPN.** 262 Budhwar Peth, Pune 3.
- PATEL CYCLE TRADING CO.** 16 Kasba Peth, Pune 2.
- PIONEER CYCLE STORES** 984 Raviwar Peth, Laxmi Road, Pune 2.
- POONA CYCLE STORES** 603 Budhwar Peth, Pune 2.
- POPULAR CYCLE & MOTOR CO.** 602 Budhwar Peth, Pune 2.
- PORWAL CYCLE & MOTOR CO.** Laxmi Road, 185 Budhwar Peth, Pune 2.
- PRASHANT BROTHERS** Shukrawar Peth, Pune 2.
- PUBLIC CYCLE INDUSTRIES** 1000 Raviwar Peth, Laxmi Road, Pune 2.
- AMICO CYCLE CO.** Poona-Bombay Road, Dapodi, Pune 12.
- AVRAT CYCLE CO.** 635 Budhwar Peth, Pune 2.
- CENTRAL CYCLES** 430 Budhwar Peth, Pune 2.
- DANGO CYCLE MART** 685 Budhwar Peth, Pune 2.
- ENGLISH CYCLE CO.** 88 M. G. Road, Poona, Camp, Pune 1.
- GANESH CYCLE STORES** 472, Budhwar Peth, Ganesh Road, Pune 2.
- GULATI & CO.** Nagar Road, Yeravada, Pune 2.

CYCLES

RAJNAREN AGENCY 330/31 Kasba Peth, Phadke Chowk, Pune 11.

RAMESH CYCLE STORES 93 Old Bazar, Khadki, Pune 3

RAVINDRA CYCLE STORES 286 Ganesh Peth, Pune 2.

RELIABLE CYCLE & MOTOR CO. 779 Budhwar Peth, Pune 2.

RELIANCE CYCLE & MOTOR CO. 608 Budhwar Peth, Pune 2.

SINGH CYCLE & MOTOR CO. 756 Budhwar Peth, Phadke Chowk, Pune 2.

SONAR AGENCIES 155/7 Old Bazar, Khadki, Pune 3.

STANDARD CYCLE TRADING CO. 723 Nana Peth, Pune 2.

SUDARSHAN CYCLE & MOTOR CO. 261 Budhwar Peth, Pune 2.

SURANA CYCLE CO. 112 M. G. Road, Camp, Pune 1.

SURENDRA CYCLE STORES 40/25 Karve Road, Pune 4.

UBERAI CYCLE TRADING CO. 591 Budhwar Peth, Pune 2.

UNITED CYCLE CO. 607 Budhwar Peth, Pune 2.

VASANT & CO. 667 New Narayan Peth, Pune 30.

VIJAY CYCLE & MOTOR CO. 594 Budhwar Peth, Pune 2.

VIJAY CYCLE TRADING CO. 1001 Raviwar Peth, Pune 2.

ELECTRICAL GOODS

ACTIVE ELECTRONICS 985/15 Navi Peth, L. B. Shastri Marg, Pune 30.

AGENTS CORNER 661/A Shivajinagar, Pune 4.

AJANTA ELECTRICALS 126 Budhwar Peth, Pune 2.

ALURKAR BROS. Mithapeli Estate, Shankarshet Road, Pune 9.

AMRAPALI DEPARTMENTS 229 M. G. Road, Pune 1.

ANAND ELECTRICALS 7 Waswani Road, Pune 1.

ASHOK ELECTRIC CORPORATION 337 Budhwar Peth, Pune 2.

ASHOK (INDIA) 832 Dastur Meher Road, Pune 1.

ATLAS ELECTRICALS Budhwar Peth, opp. Vasant Talkies, Pune 2.

BAJAJ ELECTRICALS LTD. 2 Gen Thimayya Road, Pune 1.

BHARAT ELECTRIC STORES Near Arya Samaj Mandir, Pimpri Colony, Pune 17.

BHARATKUMAR & BROS. 267 Budhwar Peth, Pune 2.

BHOPATKAR ELECTRICALS 1032 Shukrawar Peth, Pune 2.

BIJLEE 337 Budhwar Peth, Pune 2.

DAS ELECTRIC TRADING CO. 337 Budhwar Peth, Pune 2.

DASS ELECTRIC AND TRADING CO. 483 Budhwar Peth, Pune 2.

DASSON INDUSTRIES 337 Budhwar Peth, Pune 2.

- DAULAT ELECTRICALS** 613 Shukrawar Peth, Pune 2.
- DEEP ELECTRIC HOUSE** 2135 New Modikhana, Pune 1.
- DEEPAK ELECTRICAL INDUSTRIES** 1482 New Shukrawar Peth, Near Shanipar, Pune 2.
- DEEPAK ELECTRIC STORES** 569/48 Shivajinagar, Pune 5.
- DEODHAR ELECTRIC STORES** 722/3 Laxmi Park, Pune 30.
- DEODHAR ELECTRIC WORKS** 413 Sadashiv Peth, Pune 30.
- DIAMOND ELECTRIC STORES** 628 Budhwar Peth, Pune 2.
- DILIPKUMAR LIGHT HOUSE** 416 Raviwar Peth, Pune 2.
- DORABJEE & CO.** (a) 1B, Moledina Road, Pune 1.
(b) 12/95 Agarkar Nagar, Pune 1.
- DUGAL BROTHERS** 610 Budhwar Peth, Pune 2.
- ELECTROMARK ASSOCIATES** Ganesh Chambers, 17/A/B Karve Road, Pune 4.
- ELITE ELECTRICAL INDUSTRIES** 482/483 Budhwar Peth, Gopinath Sadan, Pune 2
- ELMEC TRADING CO.** 303 New Sadashiv Peth, Pune 30.
- ENSECO** A-1/23 Rambag Colony, Navi Peth, Pune 30.
- FLAG TRADING CORPORATION** 332/B, Shukrawar Peth, Soman Bldg., Pune 2.
- G. C. ELECTRIC & RADIO CO.** 458 Budhwar Peth, Pune 2.
- G. V. PUNTAMBEKAR & CO.** 473 Budhwar Peth, Pune 2.
- GADKARI AGENCIES** Hindu Mahilashram Bldg., Laxmi Road, Pune 30.
- GHAISAS AND CO.** 100 Budhwar Peth, Pune 2. Natraj Cinema Compound, Pune 4.
- GLAMOUR ASSOCIATES** F-3 Shanti Kunj, Opp. G.P.O. Pune 1.
- GLOBE ELECTRIC AND TRADING CO.** Shankarshet Road, Pune 9.
- GLOBE ELECTRIC & TRADING CO.** 550/51, Narayan Peth, Pune 30.
- GLOBE ELECTRIC STORES** Hadapsar Industrial Estate, Pune 13.
- GLOBE ELECTRIC STORES** 68 M. G. Road, Pune 1.
- HAKAMCHAND ISHWARDAS** (a) 488 Budhwar Peth, Pune 2. (b) 246 Raviwar Peth, Pune 2
- H. M. VAKHARIA** 100 Guruwar Peth, Pune 2.
- H. PAREKH & CO.** 358/17 Mira Co-op Housing Society, Shankarshet Road, Pune 9.
- HIND ENGINEERING CO.** 337 Budhwar Peth, Pune 2.
- HINDUSTAN ELECTRIC & RADIO CORPN.** (a) 577 Rasta Peth, Daruwala Bridge, Pune 11. (b) 17/5, Gitanjali, 5 Dr. Ambedkar Road, Pune 1.
- INDIAN ELECTRIC** 1254 Sadashiv Peth, Pune 30.
- INTERNATIONAL ELECTRONICS** 544 V. P. Street, Pune 1.
- JAIN ELECTRIC WORKS** 467 Rasta Peth, Pune 11.
- JAYANTILAL & CO.** 644 Shukrawar Peth, Pune 2
- JAYASHREE ELECTRICALS** 483 Budhwar Peth, Pune 2.
- JAYDAN ENGINEERS** 8/2 Gultekadi, opp. Laxminarayan Theatre, Pune 9.
- JOSHI ELECTRICALS** 230 M G. Road, Pune 1.
- JYOTI ELECTRIC & TRADING CO.** 1342 Shivajinagar, Pune 5.

- K. M. BEHERAY & CO.** 354 Narayan Peth, Laxmi Road, Pune 30.
- KARVE BROTHERS** 598 Sadashiv Peth, Laxmi Road, Pune 30.
- KHODE RADIO & ELECTRIC CORPN.** 794 Sadashiv Peth, Pune 30.
- KINGS ELECTRONICS** 461 Budhwar Peth, Pune 2.
- KOHINOOR ELECTRIC STORES** 336 Budhwar Peth, Pune 2.
- KRISHNA ELECTRICALS** 9 Sadhu Vaswani Road, Pune 1.
- KUMAR ELECTRIC & RADIO CO.** 361/62 Budhwar Peth, Pune 2.
- KUNVARJI NESHI DHAROD** 1029 Sadashiv Peth, Near Vijay Talkies, Pune 30.
- LAXMI ELECTRIC STORES** 348 Budhwar Peth, Pune 2.
- LAXMI TRADERS** 77 New Bazar, Khadki, Pune 3.
- LOKMANYA GEN. & ELECTRIC STORES** 899 Sadashiv Peth, Pune 30.
- LORD ELECTRICALS CO.** 229/A, Raviwar Peth, Pune 2.
- LECMEC ENGINEERING PVT. LTD.** 39 Ambedkar Road, Sangam Bridge, Pune 1.
- LUKHME CORPORATION** 613-B Nana Peth, Pune 2.
- M. T. & CO.** 'Keshav Smriti', 1172 Budhwar Peth, Pune 2.
- MADHU ELECTRIC & TRADING CO.** 421 Budhwar Peth, Pune 2.
- MADHUKAR RADIO AND ELECTRIC CORP.** 479 Budhwar Peth, Pune 2.
- MAHESH ELECTRICAL & MANUFACTURING** 317 Ghorpade Peth, Pune 2.
- MAHARASHTRA ELECTRIC CORPN.** 714 Budhwar Peth, Pune 2.
- MAHAVIR ELECTRICAL INDUSTRIES** 482 M. G. Road, Khadki, Pune 3.
- MANGAL ELECTRIC STORES** 266 Budhwar Peth, Pune 2.
- MANOHAR ELECTRICALS** 599 Budhwar Peth, Super Market, Pune 2.
- MEHENDALE ELECTRIC CO.** 8/19 Erandawana Pune 4.
- MEHTA ELECTRICALS** 600 Budhwar Peth, Super Market, Pune 2.
- METRO LIGHT** 349 Budhwar Peth, Pune 2.
- MONARCH ELECTRICALS** 577 Sachapoor Street, Pune 1.
- MOTI ELECTRIC STORES** 352 Budhwar Peth, Pune 2.
- MURPHY BATTERY CORPN.** 330 Nana Peth Pune 2.
- N. S. JAIN & CO.** 629 Raviwar Peth, Pune 2.
- NATRAJ LIGHT HOUSE** 789 Budhwar Peth, Pune 2.
- NEW INDIA ELECTRIC HOUSE** 350 Budhwar Peth, Pune 2.
- NEW MAHARASHTRA ELECTRICAL CO.** 219 Kasba Peth, Pune 11.
- P. J. ELECTRICALS** 983/2 Shukrawar Peth, Pune 2.
- P. K. ELECTRICALS** 285 Mangalwar Peth, Pune 11.
- PARESH INDUSTRIAL ENTERPRISES** 359 Budhwar Peth, Pune 2.
- POONA ELECTRIC HOUSE** 691 Narayan Peth, Pune 30.
- POPULAR ELECTRICALS** 600 Budhwar Peth, Super Market, Pune 2.

- PRAKASH ELECTRICALS** 240 Budhwar Peth, Pune 2.
- PRAVINKUMAR & BROS.** 456 Budhwar Peth, Pune 2.
- PUROHIT ELECTRICALS** 413A Shaniwar Peth, Pune 30.
- RADIUM ELECTRICAL INDUSTRIES** 1605 Shukrawar Peth, Pune 2.
- RAJ ELECTRIC & RADIO STORES** 21/B-14 M. G. Road, Main Bazar, Pimpri, Pune 17.
- RAJAN TRADERS** 25/2 Shivajinagar, opp. Tanajiwadi, PMT Depot, Pune 5.
- RAMCHANDRA BHAGWANDAS & CO.** 484 Budhwar Peth, Pune 2.
- RAMESH ELECTRIC & TRADING CO.** 461 Budhwar Peth, Pune 2.
- RATTAN ELECTRICALS** 551 Narayan Peth, Pune 30.
- REGAL RADIO & ELECTRICALS** 440 Budhwar Peth, Pune 2.
- RETCO CABLE CORPORATION** 54 Budhwar Peth, Kakakuvva Manson, Pune 2.
- S. K. RADIO & ELECTRICALS** 7 Old Bazar, Khadki, Pune 3.
- SADHANA ELECTRICALS** Ursekar Chambers, Ganesh Road, Kasba Peth, Pune 11.
- SAMARTH RADIO AGENCY** Laxmi Road, Pune 2.
- SAMPAD SALES CORPORATION** 1025 Nana Peth, Pune 2.
- SANJAY SALES CORPORATION** 19 Elphinston Road, Pune 1.
- SANGHAR ENTERPRISES** 8/2 Gultekadi, opp. Laxminarayan Talkies, Pune 9.
- SANJAY LIGHT** Gandhi Chowk, Hadapsar, Pune 28.
- SEHGAL TRADING CO.** 482 Budhwar Peth, Pune 2.
- SENIOR ELECTRICALS** 478 Budhwar Peth, Pune 2.
- SHAH INTERNATIONAL** Post Box No. 527, Pune 2.
- SHAM ELECTRICALS** 871 Ganj Peth, Pune 2.
- SHYAM RADIO ELECTRONICS** C/4 Rani Market Nagar Road, Yerwada, Pune 6
- SIDHESHWAR ELECTRIC CO.** 480 Budhwar Peth, Pune 2.
- SIND TRADING AGENCIES** 667 Raviwar Peth, Ramsukh Market, Pune 2
- SINGH LIGHT HOUSE** 794 Budhwar Peth, Pune 2.
- SHREE ELECTRICALS** 1229 Bhawan Peth, Pune 2.
- SONI ELECTRICALS** 267 Budhwar Peth, Pune 2.
- SUPER ELECTRONICS** 348 Budhwar Peth, Pune 2.
- SUPRAVI SALES** 8/2 Ravi Bldg., Near Alka Talkies, Pune 30.
- SURAJ ENTERPRISES** 418 Somwar Peth, Pune 11.
- SWASTIK ELECTRIC STORES** 433 Raviwar Peth, Pune 2.
- SWITCHGEAR HOUSE** 610 Shaniwar Peth, Pune 30.
- THAKUR SHROFF & ELECTRIC CO.** 467 Budhwar Peth, Pune 2
- TRIO RADIO & ELECTRONICS** 468 Budhwar Peth, Pune 2.
- UMESH TRADERS** 1182 Sadashiv Peth, Pune 30.
- VENUS ELECTRICALS** 589 Budhwar Peth, Old Tapkeer Galli, opp. Vasant Talkies, Pune 2.
- VERSATILES** 31 Laxmi Park, Navi Peth, Pune 30.
- VIJAY ELECTRICALS** 474 Budhwar Peth, Pune 2.
- WAVE LIGHT RADIOS** 59 M. G. Road, Pune 1.

FERTILISERS, MANURES & PESTICIDES

AGRO AGENCIES Tilak Road, Pune 2

AYURVEDIC AGRI. FERTILISER INDUSTRIES LTD.
4/2 Sahakar Nagar, Pune 9.

E I D PARRY (INDIA) LTD., 618 Sadashiv Peth
Pune 30.

GREENFIELD FERTILISER PVT. LTD. Pune Office:
8/2 Ravi Bldg., Near Alka Talkies, Sadashiv Peth,
Pune 30.

INDIAN FARMERS FERTILISER CO-OP. LTD. 6th
Lane Prabhat Road, Pune 4.

INSTITUTE FOR MICRONUTRIENTS TECHNOLOGY
1-A Kondhwa Khurd Pune 1.

JYOTI KRISHI UDYOG 1609 Shukrawar Peth, Pune 2.

KAMDHENU CHEMICALS & FERTILISERS
INDUSTRIES 'Krishi Bhavani', 1379 Bhawani Peth,
Pune 2

L. U. NAVALAKHA & SONS 1379 Bhawani Peth,
Pune 2.

MADRAS FERTILISERS, MADRAS Pune Office.
425/40 Tilak Vidyapeeth Nagar, Pune 9.

MARSONS FERTILISERS & PESTICIDES (Stockists
of M/s. Indofil Chemicals, Bombay) 439 Raviwar Peth,
Pune 2.

POCHA SEEDS PVT. LTD. 1-A Middle Road, Near
Sholapur Bazar, Post Box No. 55, Pune 1.

R. K. INDUSTRIES 122 Bhawani Peth, Pune 2.

SHAH MOTEJEE MEGHAJEE 131 Bhawani Peth,
Pune 2.

SHAW WALLACE & CO. Pune Office: 8-A Tarapur
Road, Pune 1.

SHRI MANGAL BONE MEALS & FERTILISERS (PVT.)
LTD. 530/2 Gokhale Road, Pune 16.

SUNRISE MANURES & CHEMICALS 813/114 Bhawan
Peth, Pune 2.

WEST INDIA CHEMICALS LTD. Factory: Lon
Kalbhor., Sales Office: 7 Modibag, Ganeshkhind Road,
Pune 16.

ZUARI AGRO CHEMICALS LTD. Pune Office: Ravi
Bldg., Near Alka Talkies, Tilak Road, 8/2 Sadashiv
Peth, Pune 30.

FURNITURE & FURNITURE HIRERS

AJANTA FURNITURE 252 Guruwar Peth, Pune 2.

AMCO SAFE 339 Ghorpade Peth, Pune 2.

ANIL AGENCIES 592 Budhwar Peth, Pune 2.

ANKUSH AND CO. 11 Nana Peth, Pune 2.

ARIHANT AGENCIES New Bazar Road, Khadki,
Pune 3.

ATLAS AGENCY 80/25 Nana Peth, Pune 2.

AZIZBHAI CUTTWALA 480 Nana Peth, Pune 1.

B. NITESH AND CO. 1278 Sadashiv Peth, Pune 30.

CHALLENGE FURNITURE WORKS 178 Shukrawar
Peth, Pune 2.

CHITRAMANGAL FURNITURES 1390 Shukrawar
Peth, Pune 2.

DECCAN FURNITURES Prabhat Road, Pune 4.

DINDAYAL ENGINEERING CO. 562 Sachapur Street,
Pune 1.

- DORABJEE & CO.** 1-B Moledina Road, Pune 1
- G. J. GHASIAS AND CO.** Deccan Gymkhana, Pune 5.
- GOPAL AGENCIES** 379/2 Shukrawar Peth, Pune 2.
- H. K. CHHAJED** 86 Ganesh Peth, Pune 2.
- HAPPY HOUSE** Lal Bahadur Shastri Marg, Navi Peth, Pune 30.
- J. WILLIAMS** East Street, Camp, Pune 1.
- JANATA FURNITURES** 776 Sadashiv Peth, Pune 30.
- JAYCO** 890 Raviwar Peth, Pune 2.
- KALA FURNITURE WORKS** 73 Nana Peth, Pune 2.
- KALANIKETAN** 194 Ganesh Peth, Pune 2.
- KAMALAKAR STEEL FURNITURES** 593 Gunj Peth, Pune 2.
- KHYATI FURNITURES** Lal Bahadur Shastri Marg, Pune 30.
- KINGS FURNITURES** 2405 Sir Ebrahim Jaffer Road, Pune 1.
- LADHA AND CO.** Z. P. Bldg., Somwar Peth, Pune 11.
- M. DWARKADAS** 139 Bhawan Peth, Pune 2
- MADHAV FURNITURE** Tilak Road, Pune 30.
- MAJESTIC FURNITURE MART** 2401 Gen. Thimayya Road, Pune 1.
- METRO FURNITURES** 514/B Nana Peth, Sant Kabir Chowk, Pune 2.
- MILAN IRON INDUSTRIES** 667 Ganesh Peth, Pune 2.
- MILAN HOSPITAL STEEL FURNITURES** Jondhale Chowk, Sadashiv Peth, Pune 30.
- MODERN FURNISHERS** 23 Budhwar Peth, Pune 2.
- MODERN FURNITURE MART** Gen. Thimayya Road, Pune 1.
- N. S. RAJURKAR AND SONS** Opp. Bal Gandharva Rang Mandir, Jangali Maharaj Road, Pune 5
- NANDKISHORE FURNITURES** 771 Raviwar Peth, Pune 2.
- NEW SWASTIK AGENCY** 763 Raviwar Peth, Pune 2.
- NILAM FURNITURES** 332 Ghorpade Peth, Pune 2.
- PANKAJ GENERAL TRADING CO.** Laxmi Road, Pune 30.
- POONA CHEAP STORES (STEEL DEPT).** 1374 Bajirao Road, Natu Baug, Pune 2.
- PRASAD FURNITURES** 1443 Shukrawar Peth, Pune 2.
- RAJESH FURNITURES** 802/4 Sadashiv Peth, Pune 30.
- RAJKAMAL ART FURNITURE** 141 Shipkala Society, Sahakarnagar, No. 1, Pune 9.
- RAVI FURNITURES AND DECORATORS** 1878 Sadashiv Peth, Pune 30.
- RAVINDRA** Deccan Gymkhana, Pune 4.
- RAVINDRA AGENCIES** Sonya Maruti Chowk, Pune 2.
- S. A. HANNURE FURNITURE WORKS** 357 Ghorpade Peth, Pune 2.
- SAJAWAT STEEL FURNITURES** 1278 Sadashiv Peth, Pune 30.
- SHAKTI STEEL FURNITURES** Shivajinagar, Pune 5.
- SHARADA ENGINEERING WORKS** Ganesh Peth, Pune 2.
- SHRIKANT ART FURNITURE** 141 Sahakar Nagar, Pune 9.
- SUDHA FURNITURES** 1249 Deccan Gymkhana, Pune 4.
- SUKHADA FURNITURES** 1443 Shukrawar Peth, Pune 2.

SUREKH AND CO. 87/2 Modi Mansion, Shankarshet Road, Pune 9.

TILAK AND CO. Tilak Road, Pune 30.

TRIO & CO. 1414/3 Sadashiv Peth, Pune 30.

VARSHA STEEL FURNITURES 227 Raviwar Peth, Pune 2.

VASANT FURNITURES 888 Sadashiv Peth, Gadgū Street, Pune 30.

VISHRAM GADI KARKHANA Budhwar Peth, Pune 2.

VISHWAKARMA ARTISTIC FURNITURE 1654 Sadashiv Peth, Near Tilak Smarak Mandir, Pune 30.

WESTERN TRADERS 1392 Shukrawar Peth, Bajirao Road, Pune 2.

FURNITURE HIRERS

BHARAT FURNITURE Station Road, 433/B-2 Somwar Peth, Pune 11.

DECCAN FURNITURE 1286-B Shivajinagar, Jangali Maharaj Road, 'Dilip' Building, Pune 5.

MADHAV FURNITURE WORKS Opp. Alka Talkies, 461/3 Tilak Road, Pune 30.

S. G. GOKHALE & CO. 1375 Shukrawar Peth, Natu Baug, Pune 2.

TILAK AND CO. Near Ram Agency, Tilak Road, Pune 30.

VOGUE FURNISHERS 313 M. G. Road, Pune 1.

GRAIN

A. N. SOMAJI 122 Bhawani Peth, Pune 2.

AMOLAKCHAND BHERUDAS CHUTTAR 83 Bhawani Peth, Pune 2.

ASHOKKUMAR BALCHAND RAYSONI 167 Ganesh Peth, Pune 2.

ASHOKKUMAR INDRABHAN CHAJED 122 Bhawani Peth, Pune 2.

BABANLAL BANWARILAL KOREGAONWALE 1380/1 Bhawani Peth, Pune 2.

BABULAL KANTILAL 1379 Bhawani Peth, Pune 2.

BABULAL UTTAMCHAND BHANDARI 133 Nana Peth, Pune 2.

BABUSING HASTIMAL 75/76 Nana Peth, Pune 2.

BAFANA SANCHETTI & CO. 89/1 Bhawani Peth, Pune 2.

BALRAM CHOTUMAL 110 Nana Peth, Pune 2.

BALARAM RAMCHANDRA & CO. 20 Ganesh Peth, Pune 2.

BALCHAND JEEVRAJ & CO. 168 Bhawani Peth, Pune 2.

BALKRISHNA VAMAN SALVEKAR 26 Bhawani Peth, Pune 2.

BANSILAL PANNALAL & BROS. 748 Ganesh Peth, Pune 2.

BANSILAL UMEDMAL CHORDIYA 138 Nana Peth, Pune 2.

BHAGAT GENERAL STORES 1374 Bhawani Peth, Pune 2.

BHAGWANDAS & SONS 86 Bhawani Peth, Pune 2.

- BHARATKUMAR TRADING CO. 270 Nana Peth, Pune 2. DEVECHAND MULTANCHAND 1221 Bhawani Peth, Pune 2.
- BHIKAMDAS KISANDAS 208 Nana Peth, Pune 2. DHANRAJ CHAGANLAL & CO. 1359 Bhawani Peth, Pune 2.
- BHIKUMAL CHANDULAL NANAWATI 184 Guruwar Peth, Pune 2. DHANRAJ PRAVINCHANDRA & CO. 1262 Bhawani Peth, Pune 2.
- BHIMAJIBHAI HIRALAL & CO. 107 Bhawani Peth, Pune 2. DHANRAJ SUBHASHCHANDRA SANCHETI 1238 Bhawani Peth, Pune 2.
- BHOGILAL M. VYAS 351/25 Somwar Peth, Pune 11. DHANRAJ TARACHAND SAKALA 1267 Bhawani Peth, Pune 2.
- CHAGANLAL AMBARAM RAWAL 18 Bhawani Peth, Pune 2. DHANYAKUMAR & CO. 1210 Bhawani Peth, Pune 2.
- CHANDRAKANT HASTIMAL MUTHA 1201 Nana Peth, Pune 2. GANESH YESHWANT & CO. Bhawani Peth, Pune 2.
- CHANDRAKANT TARACHAND & CO. 19 Ganesh Peth, Pune 2. GAVADE & CO. 1380 Bhawani Peth, Pune 2.
- CHAJED & CO. Nana Peth, Pune 2. GENMAL MANIKCHAND 1271 Bhawani Peth, Pune 2.
- CHAMPALAL KANTILAL & CO. 1218 Bhawani Peth, Pune 2. GHEVARCHAND CHUNILAL 31 Bhawani Peth, Pune 2.
- CHANDAK TRADING CO. 125 Nana Peth, Pune 2. GOPICHAND & CO. 125 Nana Peth, Pune 2.
- CHIMANMAL RANCHODDAS 70 Bhawani Peth, Pune 2. GOUTAMCHAND SUKHARAJ SETHIYA 159 Bhawani Peth, Pune 2.
- CHORDIYA BROS. 138 Nana Peth, Pune 2. GOVINDDAS GOPILAL DOSHI 10B Ganesh Peth, Pune 2.
- CHUNILAL BIRDICHAND PHULPHAGAR 1234 Bhawani Peth, Pune 2. GOVINDLAL BHOGILAL 76 Bhawani Peth, Pune 2.
- CHUNILAL KANTILAL & CO. 1235 Bhawani Peth, Pune 2. GULABCHAND MOTILAL & CO. 80 Nana Peth, Pune 2.
- CHUNILAL MOTILAL GANDHI 81 Nana Peth, Pune 2. H. B. TRADING CO. 239 Nana Peth, Pune 2.
- DAGDOBA LAXMAN KHANDRE 109 Bhawani Peth, Pune 2. H. V. TRADING CO. 774 Ganesh Peth, Pune 2.
- DAMODAR BIRDICHAND 230 Nana Peth, Pune 2. HAPSE BROS. 1377 Bhawani Peth, Pune 2.
- DEVECHAND UTTAMCHAND SANCHETI 91 Bhawani Peth, Pune 2. HANMANT MADHUKAR & CO. Ganesh Peth, Pune 2.
- DEVECHAND UTTAMCHAND SANCHETI 91 HAKKACHAND KEWALCHAND CHORADIY 1254 (New) 1380/2 Bhawani Peth, Pune 2.

- HARKHACHAND LUNAKARAN 76'B' Bhawani Peth, Pune 2.
- HARSHEDKUMAR RAMANLAL Bhawani Peth, Pune 2.
- HASHAMBHAI JAVARBHAI & CO. 1239 Bhawani Peth, Pune 2.
- HEMANT DATTATRAYA SHETYE & CO. 83 Bhawani Peth, Pune 2.
- JAYANTILAL & CO. 1174 'B' Raviwar Peth, Pune 2.
- JAYANTILAL WADILAL 22 Bhawani Peth, Pune 2.
- JAYKUMAR & BROS. 124 Nana Peth, Pune 2.
- JAYRAJ & CO. 1250 Bhawani Peth, Pune 2.
- JHODHAJI KUPAJI 1220 Bhawani Peth, Pune 2.
- KAPURCHAND DHUALJI KHATER 1362 Bhawani Peth, Pune 2.
- KESHARMAL PUNAMCHAND 1380/2 Bhawani Peth, Pune 2.
- KHERAJ MANAJI & CO. 25 Bhawani Peth, Pune 2.
- KHIVSARA LUNKAD & CO. 181 Nana Peth, Pune 2.
- KHUMCHAND LUMBAJI 1220 Bhawani Peth, Pune 2.
- KISANDAS BHAGWANDAS 27 Bhawani Peth, Pune 2.
- KISANDAS POPATLAL KAG. 234 Nana Peth, Pune 2.
- KONDIBA HANMANTRAO 630 Ganesh Peth, Pune 2.
- LACHAMANDAS MANUMAL 17 Bhawani Peth, Pune 2.
- LALITKUMAR SURYAKANT & CO. 91 Bhawani Peth, Pune 2.
- LUNKAD BROS. 221 Nana Peth, Pune 2.
- M. A. SOMAJI 122 Bhawani Peth, Pune 2.
- MADANLAL MISHRILAL 209 Nana Peth, Pune 2.
- MAHAVIR TRADERS 1220 Bhawani Peth, Pune 2.
- MAHESHWARI CO. 1380 Bhawani Peth, Pune 2.
- MAHINDRAKUMAR & CO. 1258 Bhawani Peth, Pune 2.
- MANIKCHAND MOTICHAND PHALTANKAR 164 Bhawani Peth, Pune 2.
- MANIKCHAND RAMESHWARDAS & CO. 223 Nana Peth, Pune 2.
- MANIKCHAND MOTILAL & CO. 21 Bhawani Peth, Pune 2.
- MANILAL P. SAWALA & CO. 24 Bhawani Peth, Pune 2.
- MATHURADAS TULJARAM 72'A' Bhawani Peth, Pune 2.
- MEHTA BROTHERS Kritartha Co-op. Society, Satara Road, Pune 9.
- MITTAL & CO. 217 Nana Peth, Pune 2.
- MOHANLAL RAMCHANDRA & SONS 13 Bhawani Peth, Pune 2.
- MOHANLAL UMEDMAL BHANDARI & CO. 1258 Bhawani Peth, Pune 2.
- MOTIJI VIRCHANJI 68 Bhawani Peth, Pune 2.
- MOTILAL EKNATH RATHI & CO. 226 Nana Peth, Pune 2.
- MOTILAL MOHANLAL 7 Bhawani Peth, Pune 2.
- MOTILAL PANNALAL LUNAWAT 1090 Nana Peth, Pune 2.
- MOTILAL TARACHAND NAHAR 118 Bhawani Peth, Pune 2.
- MULCHAND BHAGCHAND MAVADIKAR 1356 Bhawani Peth, Pune 2.

- MUTTHA & CO. 80 Nana Peth, Pune 2.
- NAHAR BROS. 80 Nana Peth, Pune 2.
- NAMICHAND GULABCHAND SANGHAVI 1090
Nana Peth, Pune 2.
- NANDKUMAR & CO. 507 (New) Ganesh Peth, Pune 2.
- NANDRAM KANIRAM BAJAJ 135 Nana Peth, Pune 2
- NANIKCHAND AGARCHAND & CO. 1247 Bhavani
Peth, Pune 2.
- NARAYANDAS B. BARSHIKAR 71 Bhawani Peth,
Pune 2.
- NARAYANDAS GOVINDAS 5 Bhawani Peth, Pune 2.
- NAROTTAMDAS GHANASHAMDAS 77 Bhawani
Peth, Pune 2.
- NAROTTAMDAS PREMCHAND & BROS. 1240
Bhawani Peth, Pune 2.
- NAVLAKHA & SONS 1379 Bhawani Peth, Pune 2.
- NITINKUMAR MISHRILAL LALVANI 114 Bhawani
Peth, Pune 2.
- NOULAKHA BROS. 207 Nana Peth, Pune 2.
- P. V. GORE & CO. 16 Bhawani Peth, Pune 2.
- P. VITTALDAS & CO. 105 Bhawani Peth, Pune 2.
- PANDIT MURLIDHARRAO P. PAWAR 106 Bhawani
Peth, Pune 2.
- PANDIT PANDURANGRAO P. PAWAR 107 Bhawani
Peth, Pune 2.
- PANNALAL DHANRAJ BORA 733 Ganesh Peth,
Pune 2.
- PATKI BROS. 112 Nana Peth, Pune 2.
- POONA DAL MILLS 190 Bhawani Peth, Pune 2.
- PREMJI NANJI & CO. 1227 Bhawani Peth, Pune 2.
- POPATLAL DHANRAJ DUGAD 1043 Bhawani Peth,
Pune 2.
- POPATLAL HARILAL NAHAR 1045 Bhawani Peth,
Pune 2.
- POPATLAL MOHANLAL KASWA Nana Peth, Pune 2.
- PRAMODKUMAR PRAVINCHANDRA KATARIYA
220 Nana Peth, Pune 2.
- PRAKASHKUMAR TARACHAND NAHAR 138
Bhawani Peth, Pune 2.
- PREMRAJ MANIKCHAND & BROS. 182/83 Nana
Peth, Pune 2.
- PUNAMCHAND KACHARADAS BHALGAT 231
Nana Peth, Pune 2.
- RAMAJI DAYAJI 126 Nana Peth, Pune 2.
- RAMANLAL SUKHARAJ SATTIYA 87 Bhawani Peth,
Pune 2.
- RAMBHAGAT SOMANI 12 Bhawani Peth, Pune 2.
- RAMDHAN BADRINARAYAN BHATTAD 132 Nana
Peth, Pune 2.
- RAMESHCHANDRA SHOBHACHANDRA TATTIYA
67 Bhawani Peth, Pune 2.
- RAMESHLAL & CO. 1218 Bhawani Peth, Pune 2.
- RAMESHWARDAS KAILASCHANDRA & CO. 1272
Bhawani Peth, Pune 2.
- RAMKRISHNA MANURAM AGARWAL 22 Ganesh
Peth, Pune 2.
- RATILAL DURLABHDAS 1296 Bhawani Peth, Pune 2
- RATILAL MULCHAND & CO. 1296 Bhawani Peth,
Pune 2.
- RIDKIRAN BANSILAL MUNDADA 129 Nana Peth,
Pune 2.
- RUPCHAND DAGADURAM 134 Nana Peth, Pune 2.

| | |
|---|--|
| RUPCHAND LALCHAND TALEGAONKAR 17 Ganesh Peth, Pune 2. | SHA MOTIJI VIRCHANDJI & SONS 69 Bhawani Peth, Pune 2. |
| RUPCHAND UTTAMCHAND KOYALIKAR 23 Bhawani Peth, Pune 2. | SHA MOTIJI VIRCHANDAJI & CO. 33 Bhawani Peth, Pune 2. |
| SAHIYA & CO. 77 Nana Peth, Pune 2. | SHA PRAVINCHANDRA MOHANLAL & CO. 72 'B' Bhawani Peth, Pune 2. |
| SANCHETI BROS. 89/2 Bhawani Peth, Pune 2. | SHAH RAJARAM AMARCHAND 163 Bhawani Peth, Pune 2. |
| SANCHETI & CO. 19 Bhawani Peth, Pune 2. | SHAM TRADING CO. 1243 Bhawani Peth, Pune 2. |
| SATYANARAYAN GIRIDHARILAL PARTANI 118 Nana Peth, Pune 2. | SHANKARLAL BHAGWANDAS 224 Nana Peth, Pune 2. |
| SHA ASHOKKUMAR JASWANTLAL 87 Bhawani Peth, Pune 2. | SHANTILAL POPATLAL & CO. 1044 Bhawani Peth, Pune 2. |
| SHA BABULAL HARGOVANDAS 143 Bhawani Peth, Pune 2. | SHASHIKANT MANILAL SHAH 232 Nana Peth, Pune 2. |
| SHA BHARATKUMAR GOUTAMLAL 74 Bhawani Peth, Pune 2. | SHRIKANT KABARA & CO. 331/1 Nana Peth, Pune 2. |
| SHA DHANRAJ JAVANMAN JAIN 74 Bhawani Peth, Pune 2. | SHRIKANT SADASHIV HAPASE 153 Bhawani Peth, Pune 2. |
| SHA DHIMAJI PREMJI & CO. 936 Ganesh Peth, Pune 2. | SHRIKISAN SURAJMAL 219 Nana Peth, Pune 2. |
| SHA KESHAVAL RAMDAS 1177 Govind Halwai Chowk, Pune 2. | SHRINIWAS NANDKUMAR DAGA 1369 Bhawani Peth, Pune 2. |
| SHA LALLUBHAI KEWALDAS & SONS 14 Bhawani Peth, Pune 2. | SHRINIWAS SITARAM LADDHA 1092 Bhawani Peth, Pune 2. |
| SHA NAVINCHANDRA MANSUKHLAL 159 Bhawani Peth, Pune 2. | SIDHESHWAR TRADING CO. 231/1 Nana Peth, Pune 2. |
| SHA POPATLAL CHANDMAL 87 Bhawani Peth, Pune 2. | SOMNATH SITARAM SATE 111/114'A' Bhawani Peth, Pune 2. |
| SHAH BHUPENDRAKUMAR HIMATLAL 176 Bhawani Peth, Pune 2. | SONRAJ RAGHUNATH TOSANIWAL 225 Nana Peth, Pune 2. |
| SHAH MOTIJI BABHUTMAL & SONS 80 Bhawani Peth, Pune 2. | SUBHASHCHANDRA RAJENDRAKUMAR CO. 1090 Nana Peth, Pune 2. |
| SHANTILAL MOHANLAL LALWANI 160 Bhawani Peth, Pune 2. | SURAJMAL MOHANLAL & SONS 121 Nana Peth Pune 2. |

SUWALAL VINODKUMAR BOTHARA & CO. 122 Bhawani Peth, Pune 2.

TARACHAND BHIVRAJ & CO. 1229 Bhawani Peth, Pune 2.

TRIMBAKLAL KESHAVJI 32 Ganesh Peth, Pune 2.

ULHASCHANDRA & CO. 155/56 Bhawani Peth, Pune 2.

UTTAMCHAND DEEPCHAND & CO. 160 Bhawnai Peth, Pune 2

V. V. SUUANNA 123 Nana Peth, Pune 2.

VASANT AGENCY 1339 Raviwar Peth, Pune 2.

VASANT & CO. 752 Ganesh Peth, Pune 2.

VIJAYKUMAR VIMALCHAND 106 Bhawani Peth, Pune 2.

VINODCHANDRA KUBERDAS 1231 Bhawani Peth, Pune 2.

VISHNU RAVAJI KULKARNI 21 Bhawani Peth, Pune 2.

VITTHAL GANGARAM MENKAR 876 Ganj Peth, Pune 2.

VITTHALDAS GHANASHAMDAS 81 Bhawani Peth, Pune 2.

VITTHAL PARVATRAO DIVEKAR 1263 Bhawani Peth, Pune 2.

ZUMBARMAL CHANDMAL & CO. 1273 Bhawani Peth, Pune 2.

HARDWARE

A. ESUFALLY & CO. 883 Budhwar Peth, Pune 2. Dealers in hardware A/u Section & oil paint soil and other minerals.

A. K. ABDUJEE 915 Budhwar Peth, Pune 2. Dealers in hardware, nut bolts, pipe fittings, valves etc. Dealers of Unbrako socket head cap screws; Fit-tight nuts & bolts

A. K. SANTRAMPURWALA & SONS 878 Budhwar Peth, Pune 2.

ABBASBHAI KADARBHAI 931 Budhwar Peth, Pune 2. Dealers in paints pipes, hardware, fittings, G. 1 cast iron, cement & S. W. pipes. Distributor: Gricon Welding Rods.

ABDULHUSEN ABDULLY HAKIM 342 Raviwar Peth, Pune 2. Dealers in paints and allied products. Stockists for Asian, Garware, Asco Paints etc. Distributors of Esdee paints pilot spray gun.

AJANTHA CORPORATION 443 Raviwar Peth, Pune 2. Dealers in sanitaryware, glazed tiles, Fordham & C. 1. cistern and plastic seat. Distributors for Hindustan Santaryware Industries Ltd.; Somani Pilkingtons Ltd., Dealers in Plumbing Fixtures, Jhonson Glazed Tiles.

AKIL HARDWARE STORES 884 Budhwar Peth, Pune 2. Dealers in Garware paints & Decolite distemper, mercury paints, William brushes.

ASGARBHAI MOHAMADBHAI 929 Budhwar Peth, Pune 2. Dealers in building materials, iron, hardware pipe fittings.

B. A. TRADERS 686 Raviwar Peth, Pune 2. Dealers in hardware materials and industrial suppliers

BABULAL & SONS 888 Budhwar Peth, Pune 2. Dealers in hardware, paints, tools, wire nettings, building fittings, and furniture decorative fitting. Stockist for M/s. Bombay Paints.

- BAFNA HARDWARE & STEEL SUPPLIERS** 1162/8 Raviwar Peth, Pune 2. Dealers in nut bolts, full thread bolts, G.I. buckets and all hardware goods.
- BARAMATI HARDWARE** 912 Budhwar Peth, Pune 2. Dealers in hardware materials.
- BHANPURA TOOLS STORES** 988 Raviwar Peth, Pune 2. Dealers in tools.
- BHARAT ENGINEERS & TRADERS** Station Road, Pimpri, Pune 18. G. I. & M. S. pipe fittings, valves, sanitarywares and Capstan water meters.
- BHARAT HARDWARE DEPOT** 96 Mahatma Gandhi Road, Pune 1. Dealers in hardware and paints manufacturers of French polish. Stockist of "Diamond" brand cement, Asian paints and Johnson tiles.
- BHARAT TUBE AND SANITARY STORES** 789 Budhwar Peth, Pune 2. Dealers in pipe fittings and sanitarywares.
- BHARAT TOOLS & HARDWARE STORES** 653 Raviwar Peth, Pune 2. Dealers in hardware and tools.
- BOMBAY SANITARY STORES** 961 New Budhwar Peth, Pune 2. Dealers in G. I. pipes and C. I. pipes and fittings.
- BOMBAY TOOLS STORES** 978 Raviwar Peth, Pune 2. Dealers in engineering machinery and garage tools. Distributors for Bahco Taparia Tools Ltd. Nasik. Dealers in Asian, Sigma, & British paints.
- BRITER CORPORATION** 1032, Raviwar Peth Pune 2. Dealers for Carborundum Universal Ltd. hardware, tools and abrasive goods.
- BRITEX CORPORATION** 1032 Raviwar Peth, Pune 2. Dealers in cutting tools, precision tools, hardware, pipe fitting and general items, M. S. slipon and blank flanges. Stockists of 'PAT' nylon and copper hammer; 'Rabro' number and letter punch; 'Unbrako' Allencaps; 'Gedore tools, 'Champion' tool-bits.
- C. AMBALAL & CO.** 927 Budhwar Peth, Pune 2. Dealers in hardware, sanitaryware paints, G. I. pipes, C. I. pipes, S. W. pipes and fittings.
- CENTRAL HARDWARE STORES** 923 Budhwar I.D....24
- Peth, Pune 2. Dealers in machinery, tools, hardware, Electric tools, Carborundum products, I.T. Drills. Distributors: Rallis India Ltd. for electric tools.
- CHANDRAKANT SHAH & CO.** 390 Ganesh Peth, Pune 2. Dealers in grinding wheels, Emery cloth, water-proof papers, Emery paper and all types of abrasive goods. Distributor for M/s. Carborundum Universal, Madras.
- CHOICE & CO.** 550/B Nana Peth, Pune 2. Dealers in hardware & other household materials.
- D. SUBODH & CO.** 371 Raviwar Peth, Pune 2. Dealers in hardware, tools, pipe and pipe fittings, milling stores, boxes, strappings and chrome plast bath-room fittings. Distributor for Kamani Metals and Alloys Ltd.; Hindustan Everest Tools Ltd., New Delhi; Hindustan Ferodo Ltd. Bombay; Warrior India Ltd.; Leader Engineering Works.
- DAWOODBHAI ESMALIJE & SONS** 41-42 M.G. Road, Pune 1. Dealers in hardware, paints, sanitary-ware etc.
- DEEPAK STEEL TRADERS** 544 Raviwar Peth, Pune 2. Dealers in iron, steel hardware, tools & alloy steel. Stockists of J. K. box strappings.
- DESAI HARKISHANDAS T.** 398 Adinath Society, Pune 9. Commission Agent.
- EBRAHIM & SONS** 863 Sadashiv Peth, Pune 30. Dealers in general hardware, electrical appliances, refrigeration equipment. Govt. & M.E.S. Contractors & Suppliers.
- ESHAK & CO.** 360 Raviwar Peth, Pune 2. Dealers in iron and hardware.
- F. ABDUL RASUL & BROS.** 883 Budhwar Peth, Pune 2. Dealers in paints and hardware. Distributors of I.C.L. paints, Emperol paints. Agents of Asian paints.
- F. ALIHUSAIN & CO.** 977 Raviwar Peth, Pune 2. Dealers in machinery tools, ball bearing & hardware. Stockists of Addison's cutting tools.
- R. H. TAYEBALI** 919 Budhwar Peth, Pune 2. Dealer in hardware, paints, tools, asphalt accessories, G.I. & C.I. pipes & fittings. Distributors for Goodlass Nerolac Paints; British Paints (I) Ltd.; Jenson & Nicholson (I) Ltd. Sto-

ckists of Everite Hyd. door closers & other door devices; Amar paints brushes, Osnar waterproofing materials.

FAZ-AL HARDWARE STORES 924 Budhwar Peth, Pune 2. Dealers in welded wire mesh & pan metal & hardware sundries.

GENERAL HARDWARE STORES 368 Raviwar Peth, Pune 2. Dealers in hardware, tools, steel etc.

GUJRAT HARDWARE STORES 883 Budhwar Peth, Pune 2. Dealers in building materials, hardware & sanitaryware.

H. FAKHRUDDIN & CO. 958 Budhwar Peth, Pune 2. Dealers in hardware and paints.

HAIDERBHAI KADERBHAI & SONS 935 Budhwar Peth, Pune 2. Dealers in paints & hardwares.

HAKIMUDDIN EBRAHIM ALLANABANDA 'Banda House', 378 Raviwar Peth, Pune 2. Dealers in hardware, iron and steel; paints and pipes and pipe fittings; mill gin stores & nuts and bolts; tools, sanitarywares, box strapping wixnails, Agnizo tools etc.

HARDWARE AND GENERAL STORES SUPPLYING CO. 327 Nana Peth, Pune 2. Dealers in alloy tool steel, ferrous bright shafting, silver steel and mill steel, etc.

HONESTY TRADING COMPANY 306 Raviwar Peth, Pune 2. Dealers in hardware, tools and general suppliers.

IDEAL GENERAL STORES 1437 Kasba Peth, Pune 11. Dealers in hardware, paints and tools etc. Government suppliers and contractors.

INDUSTRIAL ASSOCIATES Parvati Industrial Estate, Shed No. 31, Pune 9. Dealers in spares and industrial components mfg.; marketing of pressed parts, special studs, bolts and h.t. fasteners.

INDUSTRIAL TRADE CORPORATION 573/3 Jangli Maharaj Road, Pune 4. Dealers in abrasives. Agents of Cutfast Abrasive Tools Pvt. Ltd., Supreme Carbide Tip Tools, Industrial Abrasive Co-op. Society Ltd.

J. K. LALWANI & BROS. 899 Budhwar Peth, opp. Gujrat Lodge, Pune 2. Dealers in glazed tiles and sanitary-wares. Distributors of Lakaki dry distemper. Stockists of Parryware & sanitarywares.

JANATA HARDWARE STORES 912 Raviwar Peth, Pune 2. Dealers in C.I. pipe & pipe fitting, S.W. pipe & S.W. pipe fitting, C.M. cocks etc. Govt. & Military contractors & suppliers.

JAIGRIS ENTERPRISES 371 Nana Peth, Pune 2. Dealers in general hardwares.

JAYANTILAL AND CO. 926 Budhwar Peth, Pune 2. Dealers in tools, nut-bolts, welding rod etc. Stockists: Power Cable welding rod.

K. ASGARALLY & CO. 361 Raviwar Peth, Pune 2. Dealers in engineering, precision and measuring tools, cutting tools, hardware and pipe fittings. Distributors of AARVY portable electric tools.

K. S. NAGORI 872 Budhwar Peth, Pune 2. Dealers in steel tubes and tube fittings, C.I. spun pipes and specials, Kirloskar, G.G. Leader make valve and water meters, H.B.wires, pipes and fittings. Agents and stockists of A.P.J. valves, Capstan meters and Kirloskar make valves

KALA INDUSTRIES Block No. 20, 1st floor, Seva Sadan Building, Laxmi Road, Pune 30. Dealers in cutting tools.

KANTILAL D. BOBRA 1425 Shukrawar Peth, Pune 2. Dealers in Grindwell Norton wheel, Sandvik tools, Miranda Tools, Accurate gauges, Unbrako bolts and other tools required for factory.

KISHOR PAINTS HOUSE 893 Budhwar Peth, Pune 2. Dealers in quality paints.

M. LALWANI & CO. 883 Budhwar Peth, Pune 2. Dealers in hardware, paints, sanitarywares etc. Distributors of Colorcem cement paints.

M'LA SALES CORPORATION 661/D Deccan Gymkhana, Pune 4. Dealers in cutting tools, manufacturing accessories. Distributors for Indian Tool Mfg. Ltd., Sonalkar Tool (P) Ltd. Agents of Forbes Campbell & Co. Ltd., The Raja Bahadur Motilal Poona Mills Ltd.

MAHARASHTRA TRADERS 617 Raviwar Peth, Pune 2. Government suppliers and contractors.

MALWA TRADING CO. 1573-74 Shukrawar Peth, Pune 2. Dealers in tools hardware, brassware. Commission agents.

- MASTER HARDWARE STORES** 916 Budhwar Peth, Pune 2. Dealers in hardware, oil paints, aluminium section and all sorts of furniture fixtures and fancy Ajanta handles. Stockists of Victor paints & Fevicol.
- MOHSIN & SONS** 359 Raviwar Peth, Pune 2. Dealers in hardware.
- N. FAKHRUDDIN BROS.** 356 Raviwar Peth, Pune 2. Dealers in paints, hardware and brushes. Distributors for I.C.I. Paints Ltd. ACCI India Ltd. Stockists for Asian Paints Ltd., Mercury Paints & Varnishables Ltd., Asco Paints Industries, Amar Brushes, Deoraj Brushes.
- N. PORWAL & CO.** 369 Raviwar Peth, Pune 2. Dealers in paints, hardware, tools, pipe fittings. Distributors: Sigma Paints Ltd., Jenson & Nicholson (I) Ltd.
- NAVNITLAL & SONS** 655 Sachapir Street, Pune 1. Dealers in paints. Distributors: Goodlas Nerolac Paints, Snowcem India Ltd., Mercury Paints.
- NECET TRADING** 866 Raviwar Peth, Pune 2. Dealers in: C.I. pipes, specials and valves.
- THE NEW BALL BEARING COMPANY** Opp. Shivaji Statue, Pune 5. Dealers in Ball bearings and 'V' bolts. Distributors: S.K.F. Norma, NBC Ball Roller and Tape Roller Bearing & Fenner, Cockills' 'V' Bolts.
- NOBLE HARDWARE STORES** 383 Raviwar Peth, Pune 2. Dealers in hardware, oil paints, tubes, dis-temper, nails.
- NOMANBHAI S. ABDULALI** 370 Raviwar Peth, Pune 2. Dealers in hardware and nut bolts and Agrico tools. Distributors: Mysore Implements Factory, Kumar Industries.
- P. KESHAVLAL SHAH** 1661/1 Shukrawar Peth, Pune 2. Manufacturer's representative; Industrial and government suppliers for iron, hardware, paints, sanitaryware, screws, nuts, bolts, washers, pipes and pipe fittings, wire nails, wire gauges, wire nettings, wire fencing.
- PATEL PAINTS CORPORATION** 904 Budhwar Peth, Pune 2. Dealers in Paints, varnishes and turpentine.
- POONA COMMERCIAL CORPORATION** 371 Raviwar Peth, Pune 2. Dealers in Iron, steel pipes, hardware, plywood hardboards.
- PARDA HARDWARE & CO.** 984 Raviwar Peth, Pune 2. Dealers in machinery and garage tools. Distributors: Miranda Tools, Sharpedge Tools, Ambo-make Tools.
- PATEL ASBESTOS CEMENT INDUSTRIES** 39 D Gultekadi, Shankarshet Road, Pune 9. Dealers in Asbestos cement products and hardware materials.
- POONAWALA & COMPANY** 655 Raviwar Peth, Pune 2. Dealers in General hardware, phawadas and slotted angles.
- POONA HARDWARE CORPORATION** 6 M.G. Road, Pune 1. Dealers in Sanitarywares, fancy bathroom fittings, C.I. & G.I. pipes and fittings etc. Distributors, Agents: E.I.D. Parry Ltd., 'Penguin' brand CP fittings, 'East annia' flush cisterns.
- POONAM HARDWARE** F.P. 270/2 Bhawani Peth, Pune 2. Dealers in Hardware, sanitaryware and paints.
- PREMIER IRON & HARDWARE STORES** 927 Budhwar Peth, Pune 2. Dealers in Hardware tools, oil, paints, pipes, pipe fittings and industrial goods.
- RAMANLAL MANILAL SHAH** 328 Nana Peth, Pune 2. Dealers in Paints, weldmesh, wire nettings and other hardware fittings. Distributors: Shalimar Paints, Welmesh and Wire Netting Company, Shalimar Tar Products Ltd.
- RAMANLAL & SONS** 926 Budhwar Peth, Bhoari Ali Pune 2. Dealers L. Looks & J. Looks foundation bolts staring bolts.
- REGAL HARDWARE** 975 Raviwar Peth, Pune 2. Dealers in: Special and precision tools.
- REKHA HARDWARE STORES** 387 Raviwar Peth, Pune 2. Dealers in Hardware, tools, bolts & nuts, industrial materials, machine screws.
- THE RELIABLE IRON AND HARDWARE STORES** 925 Raviwar Peth, Pune 2. Dealers in Hardware and paints sanitarywares, bolts and nuts, nails etc. G.I. C.I. pipes, S.W. pipes and specials.
- ROSHANALI AND SONS** 883 Budhwar Peth, Pune 2. Dealers in Iron & hardware.

- S. PANDURANG & CO.** 467/2 Budhwar Peth, Pune 2. Dealers in : Plywoods, laminates, hardwares, aluminium section. Distributors : Disulitre, Weldecare Indecore, Fevicol.
- SAIFY HARDWARE MART** 181 Raviwar Peth, Pune 2. Dealers in : Furniture materials and hardware, decorative materials and door closer.
- SAIFEE STORES** 544 Centre Street, Pune 1. Dealers in : Hardware tools paints and iron & steel, G.I.M.S. & seamless pipes & pipe fittings, welding accessories sanitaryware.
- SANGHAVI BROTHERS** 884 Budhwar Peth, Pune 2. Dealers in : Hardware & paints.
- SATHE BROTHERS** 678 Shukrawar Peth, Pune 2. Dealers in : Building materials, G. & C.I. pipes.
- SARABHAI & BROS.** 1678 Shukrawar Peth, Pune 2. Dealers in : Hardware paints and building materials.
- SHAH RAVINDRA R.** 528 Nana Peth, Pune 2. Dealers in : Cement, paint.
- SHAH THANMAL HIRACHAND CHHAJED** 733 Raviwar Peth, Pune 2. Dealers in : Hardware brass-ware. Commission Agent.
- SHAHABAD CEMENT DEPOT** 655 Sachapir Street, Pune 1. Dealers in : Hardware and sanitaryware. Authorised stockists : A.C.C. cement, Asian Paints, Good lass Nerolac Paints.
- SHAH TRADERS** 889 Raviwar Peth, Pune 2. Dealers in : Sanitary and pipe fittings, G.I. fittings, brass cocks, C.F. bathroom-fittings and plastic cocks etc. Distributors : Jaypee Enterprises, Bombay. Stockist : Gem Sanitary App. Pvt. Ltd.; Jaypee Enterprises, Bombay; G.T.C. Bombay; 'A.A.A.' C.P. Fittings, Delhi.
- SHRI BALKRISHNA AGENCIES** 812 Raviwar Peth, Pune 2. Dealers in : G.I. pipes and fittings, C.I. pipes and fittings.
- SIRAJ S. MULLA** 343 Raviwar Peth, Pune 2. Dealers in : Bucket, ghamellas, tawa, hardware.
- STANDARD HARDWARE STORES** 883 Budhwar Peth, Pune 2. Dealers in Hardware, paints, tools, asbestos packings, jointing sheets, sanitaryware pipes and fittings, mill gin stores etc. Stockists : Leader cocks, Unbrako fasteners, Wolf electric tools, sugar factory items.
- SWASTIK HARDWARE STORES** 897 Budhwar Peth, Pune 2. Dealers in : Hardware and paints.
- TAHERALI ABDULHUSAIN CHHIL** 198 Raviwar Peth, Pune 2. Dealers in : Hardware and paints.
- TAIYEBBHAI ABBASBHAI** 236 Raviwar Peth, Pune 2. Dealers in : General hardware & oil paints.
- UNION TRADERS** 655 Raviwar Peth, Pune 2. Dealers in : Pipes and pipe fittings and mill gin stores.
- U P M INDUSTRIES** 392/1 Shivajinagar, Pune 5. Dealers in : Thinners and turpentines.
- V. M. PORWAL & CO.** 369 Raviwar Peth, Pune 2. Dealers in : Mill gin stores, hardwares, box strapping, paints, pipes & pipe fitting, bolts and nuts.
- V. R. KARANJKAR & SONS** 26 Ghorpade Peth, Pune 2. Dealers in : Cocks.
- VARIETY TOOLS STORES** 988 Raviwar Peth, Pune 2. Dealers in : Tools. Authorised Regd. Dealers : Comet bench vice, Miranda Tools, bits, metal cutting bandsaw hacksaw blades, Sharpedge end mill slot drill, sleeves — revolving center, Netro and Ships hand tools.
- VENUS HARDWARE AND PAINT MART** 38 Pune-Satara Road, Pune 9.
- VINAYAK INDUSTRIES** 1243/1 Samadhan, Apte Road, Pune 4. Dealers in : Door fittings, aldrops, latches-hinges etc.
- VORA TRADING CO.** 950 Budhwar Peth, Pune 2s Dealers in : E.R.W. Ad & square tubes, Zenith mak.. G.I. & M.S. pipes, Seam pipes and fittings, Seam bare tubes and other fittings.
- YAKUBALI & SONS** 878 Budhwar Peth, Pune 2 Dealers in : Hardware and pipe fitting.

INDUSURIAL SUPPLIERS

ARVIND CHEMICALS 'Ratnakar', 8/16 Karve Road, Pune 4. Factory : A-115, 'H' Block, M.I.D.C., Pimpri, Pune 18. Partnership, 1972. Sister concerns : Poona Gas & Chemical Co., Mate's Goods Carriers. Banks : Shri Suvarna Sahakari Bank Ltd. Dealers in industrial gases.

BAJAJ AUTOMOBILES Opp. Mahindra and Mahindra Building, Bombay-Poona Road, Pimpri, Pune 18. Suppliers of automotive, industrial lubricants and grease. Dealers for the Indo-Burma Petroleum Co. Ltd.

BHARAT AGENCIES 'Adhar,' 244 Laxmi Road, Near Sambhaji Bridge, Pune 30. Suppliers of intercom telephones, slotted angles, venetian blinds, safety helmets, calculators, office equipment and systems, photo copiers and cinema carbon.

CHANEY & CO. 1223 Raviwar Peth, Pune 2. Cable : LECO. Suppliers of ACC refractories, Gujrat sagol.

D. D. SAVLA AND CO. 123 Nana Peth, Pune 2. Cable : CHAWAL. Partnership, 1950. Sister concerns : Jyoti Industries, Bharat Grain Crushing and Flour Mills. Banks : State Bank of India, Central Bank of India, Dena Bank, Cap. Rs. 50,000. Workers 50. General merchants; Commission agents for bakelite and plastic moulding parts, stainless steel household utensils.

DEEPAK ENGINEERING CO. 3B Lajwanti, Erandawana, Karve Road, Pune 4. Distributors of all types of industrial and allied goods. Designers and suppliers of special machinery plants, parts and tools.

DELUXE TRADING CO. 3, Mukundnagar, Pune-Satara Road, Swargate Pune 9. Dealers in industrial gases, welding material, safety wares.

DHANASHREE METALS 321/4 Timber Market Road, Shantinagar Society, Pune 2. Dealers and stockists of non-ferrous metals.

EVEREST Rashid Khodadad (Asbestos Dept.) and Co. 1 East Street, Pune 1. Suppliers of asbestos cement products.

GRAFIS 'Smriti', Rambaug Colony, Pune 30. Distributors for 'Colorama' photographic chemicals.

HERAMB ENTERPRISES Narali Baug, Gultekadi Road, Swargate, Pune 9. Proprietary, 1976. Bank : Bank of India. Industrial suppliers.

INTERNATIONAL PRODUCTS. 346-D Sadhu Vaswani Nagar, Aundh, Pune 7. Factory : T-22 M.I.D.C., Bhosari, Pune 26. Cable : "FINEWORK". Proprietary. Government contractors and suppliers of tapes, webbings, ropes, cords, twines, bags, etc.

JAMS ENGINEERING (INDIA) 55/22 Erandawana, Pune 4. H.O. : 406 Arun Chambers, Tardeo, Bombay 34. Suppliers of special-purpose alloy steel castings and furnace equipments in heat-resisting sheets.

JURIA TRADING CO- Juria Niwas, behind Buckau-Wolf, Pimpri, Pune 18. Distributors for Bharat Refineries Ltd. and Tide Water Oil Co. Suppliers of lubricating oil and greases.

K. S. JITE AND SONS. Krishnashram, Dapodi, Pune 12. Government contractors.

KANTILAL D. BOBRA 1425 Shukrawar Peth, Gadikhana, Pune 2. Proprietary, 1962. Br. Kasarwadi, Pune 18. Sister concern : Indore. Bank : Bank of Maharashtra. Dealers in all abrasive products, engineering tools (cutting, threading & grinding).

KIRTI GOVARDHANDAS THAKKAR 518 Rasta Peth, Pune 11. Dealers in all types of chemicals, dyes and acids.

L. EBRAHIM AND CO. 343 Raviwar Peth, Pune 2. Cable : LECO. Partnership, 1900. Sister concern : Solapur. Banks : Bank of India. Suppliers of ACC Cement. Distributors for Reckitt and Coleman of India Ltd.; Corn Product Co. (India) Pvt. Ltd.

LUNKAD TRANSPORT CO. 348 Lunkad Road, Dapodi, Pune 12. Suppliers of sand and transport contractors.

MADHURI ENTERPRISES 573/1 J. M. Road, Pune 4. Suppliers of industrial cleaning material.

MAK CORPORATION 353/2 Narayan Peth, Pune 30. Distributors of transformer material, bakelite bobbin,

plastic bobin, various types of clamp side brackets, electrical stampings, neon bulb (NE-2) Jewel light, terminal strip.

MAMATA AGENCY 321 Shantinagar Society, Timber Market Road, Near Sonmarg, Pune 2. Cable: MAMATA Distributors of 'Literoff' asphaltic roofing sheets; Sun Arc welding electrodes; 'Cutwel', 'Janata' hacksaw blades and tools.

MASTER SALES & SERVICES 759/97 Prabhat Road, Lane No. 2, Deccan Gymkhana, Pune 4. Proprietary, 1976. Br. 1460 Jijamata Road, Nasik 1. Sister concern: C/o. Shri Offset Press, Satpur Industrial Area, Nasik 7. Bank : Indian Bank. Cap. Rs. 40,000. Prod. Rs. 3,50,000. Workers 5. Products : Master filter bags for chemicals, all types of liquid filtration packing seals for plastic and steel, stampings, packing machines like tensioner, sealer and packing stand for steel and plastic strapping, textile nylon and tuflon parts.

MEGHJI MANJI & CO. 200 Mangalwar Peth, Gadital, Pune 11. Cable : RANACOAL. Partnership, 1973. Sister concern : Panvel. Bank : Bank of Baroda. Coal and coke merchants.

MODI STEEL YARD Chadda Mansion, opp. Mahindra and Mahindra, Pimpri, Pune 18. Yard : Plot No. 208, S. No. 12, Pimpri Station Road, Pimpri, Pune 18. Partnership, 1974. Sister concern : Shri Nath Hardware. Banks : Bank of India. Cap. Rs. 2,00,000. Workers 2. Dealers in M.S. round bars, flats, angles, sections and industrial steel.

NIRMAL TEXTILES 629 (New) Sadashiv Peth, Phadtare Chowk, Pune 30. Suppliers of all kinds of uniforms and fabrics.

NIRMALA TRADING CORPORATION 768 New Sadashiv Peth, Phadtare Chowk, Pune Municipal Servants Bank Bldg., Pune 30. Proprietary, 1970. Sister concern : M N CIMPEM. Bank : Bank of Maharashtra. Cap. Rs. 50,000. Prod. Rs. 4,50,000. Dealers in tapioca starch, maize starch, textile dyes and laundry chemicals.

ORIENTAL SCIENTIFIC INSTRUMENTS CORPORATION 52 Vivekanand Nagar, opp. Ram Tekdi, Solapur Road, Pune 13. Showroom : 277 Narayan Peth, opp. Nighojkar Karyalaya, Pune 30. Dealers in laboratory instruments, chemicals, glassware, audio visual equipments, etc.

POONA CHEAP STORES 255-56 Mahatma Gandhi Road, Pune 1. Cable : CHEAPSTEEL. Partnership, 1922. Sister concerns : Poona Cheap Stores (Steel Dept); Allied Agencies; M.J. Transport; M. Vipin & Co.; Shan-Hira Entreprises. Banks : Bank of India; Bank of Baroda; Dena Bank; Union Bank of India. Wholesalers and retailers in crockery, cutlery, glassware, plasticware, enamelware etc.

PROMPT MARKETING SERVICES 596 Sadashiv Peth, near Commonwealth Bldg., Laxmi Road, Pune 30. Suppliers of technical and non-technical products : Laboratory and heavy chemicals, solvents, acids and general chemicals; fastener, nut bolts, screws, angles, gauges, types of V-belt fan belts, stationery, calculators, P.V.C. pipes, electrical appliances, electroplating and sundry chemicals, clay, scrap etc., corrugated boxes and sheets, welding rods, automobile accessories, miscellaneous engineering tools, printing and stickers, hydrated lime, gypsum-powder, plaster of paris etc.

R C G INSTRUMENTS A 1/25 Gurukripa, Rambag Colony, New Sadashiv Peth, Pune 30. Cable : PLATRI-SCOP. Telex:0145-333. Partnership, 1975. Sister concern: Applied Research & Engg. Co. Pvt. Ltd., Sangli. Bank: Bank of Maharashtra. Cap. Rs. 50,000. Distributors of equipment for engineering, education, research, quality control, testing from imported and indigenous source.

RAJAN TRADERS 25/2 Shivajinagar, Pune 5. Distributors of corrosion resistant polyurethane coatings, paint and rust removers.

SHALEYA SAHITYA BHANDAR (Educational Aids) 882 Shanwar Peth, Pune 30. Partnership, 1956. Bank : Bank of Maharashtra. Cap. Rs. 25,000. Dealers in school and college equipments, roll-up black-boards, maps, charts, science apparatus and montessory school materials.

SHRINATH HARDWARE Chadda Mansion, opp. Mahindra & Mahindra, Pimpri, Pune 18. Dealers in G.I. pipes and fittings, all types of paints, sanitary fittings, Duco products.

SUSHITO TRADERS Dhanakawadi Nagar, Pune-Satara Road, Pune 9. Suppliers of acids, caustic soda, chemicals-retail and tanker loads.

UNIVERSAL AGENCIES 5/4 Geetanjali Kunj, opp. Nehru Memorial Hall, Pune 1. Box 72 G.P.O., Pune 1. Tel. 28092. Cable: UNIHARMONY. Bank : Dena Bank. Suppliers of engineering, automobile, electrical, hardware goods, sanitarywares, food products; general

merchandise, general suppliers of consumer and other allied products.

V. D. DASTUR AND CO. 16-C Wellesley Road, Pune 1. Proprietary, 1906. Sister concern : Bombay. Bank : Central Bank of India. Workers 25. Dealers in Laboratory and industrial chemicals.

VALICO ENTERPRISES 660 Taboot Street, Pune 1. Suppliers of industrial products, paints, cutting tools, electrodes, foundry chemicals.

VISHWANATH AND CO. 1053 Budhwar Peth, behind C P O, Pune 2. Cable : 'PAINTILE'. Factory and Godown : 19 K/2 Somwar Peth, Pune 11. Godown : 408 Mangalwar Peth, Ambedkar Marg, Pune 11. Tel. 23261 Partnership, 1929. Cap. Rs. 2,00,000. Prod. Rs. 12,00,000. Workers 2. Dealers in Shahabad, Tandur, Cudappa, Kota paving stones, marble, asbestos cement roofing sheets, manufacturers of processed paving stones, sills, steps, kitchen otta, etc. Agents for water meters.

IRON & STEEL

A. EBRAHIM 368 Nana Peth, Pune 2.

ABBAS ALI BROTHERS 216 Mangalwar Peth, Juna Bazar, Pune 11.

AKBAR HUSSAIN CO. 218 Bhawani Peth, behind Ramoshi Gate, Pune 2.

AMBIKA CEMENT & STEEL TRADERS 840/41 Bhawani Peth, near Chhaya Talkies, Pune 2.

BHARAT STEEL TRADERS 213 Bhawani Peth, near Ramoshi Gate, Pune 2.

BOMBAY IRON & STEEL 1050 Nana Peth, Pune 2.

C. GOMRAJ AND SONS 199 Bhawani Peth, Pune 2.

CHATURMAL UDAJI & CO. 1237 Bhawani Peth, near Ramoshi Gate, Pune 2.

COMMERCIAL STEEL CORPORATION 324 Ghorpade Peth, Pune 2.

ESAK & CO. 360 Raviwar Peth, Bohari Lane, near Muslim Bank (Mahila Shakha), Pune 2.

G. K. ABHYANKAR AND SONS 560 Sadashiv Peth, near Vijay Talkies, Laxmi Road, Pune 2.

HAJI ALIMOHAMED YAKUB & SONS 150 Nana Peth, A. D. Camp Chowk, Pune 2.

HAKIMCHAND HANSAJI JAIN 857 Bhawani Peth, Pune 2.

HARDWARE AND GENERAL STORES 327 Nana Peth, Pune 2.

HARUN AYUB & CO. 985 Bhawani Peth, Pune 2.

HIRACHAND DARGAJI New 1202 Bhawani Peth, Pune 2.

INDUSTRIAL STEEL AND TOOLS 330 Nana Peth opp. Kaka Halwai, Pune 2.

J. J. STEEL CORPORATION 981 Bhawani Peth, Pune 2.

JAFERANI & CO. 149 Nana Peth, A.D. Camp Chowk, Pune 2.

JAHALI STEEL TRADERS Vijay Appartments, Gultekadi Road, Pune 9.

JAI HIND STEEL CENTRE 857 Bhawani Peth, Pune 2.

JAVANMAL ASLAJEE OSWAL 1251 Bhawani Peth, Pune 2.

JETHMAL SAYAJEE OSWAL 1251 Bhawani Peth, Pune 2.

JETHMAL SOMAJI HIRAJI 1237 Bhawani Peth, near Ramoshi Gate, Pune 2.

K. S. NAGORI 872 Budhwar Peth, Sonya Maruti Chowk, Pune 2.

KANTILAL DHARAMJI SHARMA 196 Bhawani Peth, Pune 2.

- KARNAVAT STEEL TRADERS 532 Shivajinagar, near Congress House, Pune 2.
- KASTURCHAND TEJMAL 1249 Bhawani Peth (New 1197), Pune 2.
- LALAJI VANAJI OSWAL 979 Bhawani Peth, Pune 2.
- LALAJI WALAJI BHANDARI 957 Bhawani Peth, Pune 2.
- LALCHAND KESAJI 1247 Bhawani Peth, Pune 2.
- LALIT STEEL TRADERS 857 Bhawani Peth, Pune 2.
- LILACHAND GHUDAJI JAIN 225/2 Bhawani Peth, Pune 2.
- MAHARASHTRA IRON STEEL TRADERS 449 Mangalwar Peth, near Tourist Hotel, Pune 11.
- MANILAL MULCHAND BHANDARI 1255 Bhawani Peth, Pune 2.
- MENON STEEL CENTRE 161 Nana Peth, Pune 2.
- MODERN STEEL TRADERS 1077 Nana Peth, A.D. Camp Chowk, Pune 2.
- MOHAMADEE STEEL YARD 819 Bhawani Peth, Pune 2.
- MOHMED GALIB ABDUL-HAKEEM 368 Nana Peth, Pune 2.
- MOTI STEEL CENTRE 57 New Timber Market, Pune 2.
- N. AJIT STEEL TRADERS 191 Bhawani Peth (3rd floor), Pune 2.
- N. PITHAWALA & BROTHERS 840/41 Bhawani Peth, near Chhaya Talkies, Pune 2.
- N. POPATLAL & CO. C-6 New Timber Market, Pune 2.
- NEW BHARAT STEEL CENTRE 51 New Timber Market, Pune 2.
- OSWAL AND CO. 979/82 Bhawani Peth, Pune 2.
- PREM STEEL 229 Bhawani Peth, near Ramoshi Police Chowki, Pune 2.
- RAJENDRA STEEL TRADERS 857 Bhawani Peth, Pune 2.
- S. M. STEEL TRADERS 11 Boat Club, Narangi Bagh, Pune 2.
- S. V. IRANI 267-A New Timber Market, Pune 2.
- SAMANJI DHARMAJI 1258 Bhawani Peth, Pune 2.
- SANJAY STEEL CORPORATION No. 266/B/2 Bhawani Peth, Pune 2.
- SHANTILAL GOMANJI OSWAL 857 Bhawani Peth, Pune 2.
- SOGMAL JASAJI KHIVSARA 857 Bhawani Peth, Pune 2.
- STANDARD HARDWARE STORES 883 Budhwar Peth, Pune 2.
- STEEL STOCK HOLDERS SYNDICATE 198 Ganesh Peth, Pune 2. Office : 915 Budhwar Peth, Pune 2.
- TARACHAND LALCHAND JAIN 856 Bhawani Peth, Pune 2.
- VIRANI STEEL 259 New Timber Market, Pune 2.

JEWELLERY

- AMBICA JEWELLERY 35 M.G. Road, Pune 1.
- ASHOKKUMAR INDRARAJ & CO. 411 Raviwar Peth, Pune 2.
- ASHTEKAR SARAF 604 Sadashiv Peth, Pune 2.
- B. B. GHODKE 956-B Sadashiv Peth, Pune 30.
- BABURAO NIMBAJI ASHTEKAR 828 Budhwar Peth, Pune 2.

- BADRAJ PUNAMCHAND SOLANKI** 459 Centre Street, Pune 1.
- BAHUTMAL VAKTAJI** 531 Centre Street, Pune 1.
- BASTIMAL LAKHIMACHAND** 158 Main Bazar, Dehu Road, Dist. Pune.
- BHAGAJI DEVAJI** 541 Centre Street, Pune 1.
- BHAGWANDAS DAMODHARDAS** 823 Budhwar Peth, Pune 2.
- BHANUDAS RAMSHETH WAIKAR** 5 Shukrawar Peth, Pune 2.
- BHAT & CO.** 257C Budhwar Peth, Pune 2.
- BHAU CHINGUSETH SHIVARKAR** 582 Narayan Peth, Pune 30.
- BHIKHALAL VELSIBHAI SONI** 523 Raviwar Peth, Pune 2.
- MADANRAJ PUKHRAJ KAWEDIA** 1187 Raviwar Peth, Pune 2.
- BHURKE SARAF** Tulshibag, 1140 Budhwar Peth, Pune 2.
- CHAMPALAL GULABCHAND VARMA SARAF** Post Chinchwad, Dist. Pune.
- CHANDULAL KRISHNAJI WAIKAR** 413 Raviwar Peth, Pune 2.
- CHIMANLAL BABHUTMAL & CO.** 399 Raviwar Peth, Pune 2.
- CHOKSE SARDARMAL ASUJI & SONS** 872 Budhwar Peth, Pune 2.
- CHUNILAL NAVALJI** 11 Yerawada, Pune 6.
- CHUNILAL PUNAMCHAND OSWAL** 88 Yerawada, Pune 6.
- D. B. GHODKE** 148 Shukrawar Peth, Pune 2.
- D. B. PAWAR** 717 Raviwar Peth, Pune 2.
- D. D. PARAKHI** 986 Sadashiv Peth, Pune 30.
- DANMAL HARI BANSOD** 458 Shaniwar Peth, Pune 30.
- DANMAL RAJMAL BALDOTA** 386 Raviwar Peth, Pune 2.
- DINDORIKAR SARAF** 458 Shaniwar Peth, Pune 30.
- DAVECHAND KANAJI** 371 Centre Street, Pune 1.
- DEVRAJ VIRCHAND** 2-B New Bazar, Khadki, Pune 3.
- DHIRAJMAL CHUNILAL KAWADIYA** 410 Raviwar Peth, Pune 2.
- DHONDIRAM DALICHAND KHIVASARA** 400 Raviwar Peth, Pune 2.
- DNYANOBA MARUTI MAGAR** 517 Raviwar Peth, Pune 2.
- F. MANIKLAL BALDOTA** 389 Raviwar Peth, Pune 2.
- GANESHMAL B. SOLANKI** 463 Centre Street, Pune 1.
- GANPAT VITHAL NAGARKAR** 386 Raviwar Peth, Pune 2.
- GANPAT ZUMBARLAL VARMA** Post Chinchwadgaon, Dist. Pune.
- GOVINDAS RADHAKISAN** 543 Raviwar Peth, Pune 2.
- GULABCHAND CHATRIGANJI** 1183 Raviwar Peth, Pune 2.
- GUNDECHA JEWELLERS** 365 Centre Street, Pune 1.
- H. A. HAJJUSUB MOTIWALE** 826-27 Budhwar Peth, Pune 2.
- HANSAJI JITAJI SARAF** 1139 'B' Sadashiv Peth, Pune 30.
- HASTIMAL & CO.** 1308/6 Sainkar Bldg., Chinchwad, Pune 18.
- HIMATLAL P. & BROS.** 63 Ganesh Peth, Pune 2.
- HIRACHAND KHATAJI & CO.** 809 Budhwar Peth, Pune 2.

- J. BABULAL 3-B M. G. Road, Khadki, Pune 3.
- JAMNADAS RAGHAVJI SONI 823 Budhwar Peth, Pune 2.
- JASRAJ KUNDANMAL 2 New Bazar, Khadki, Pune 3.
- JAYANTILAL RATANCHAND SAND 1185 Raviwar Peth, Pune 2.
- JATHALAL BABULAL 359 Centre Street, Pune 1.
- JOHARMAL HAMAJI 1334 Raviwar Peth, Pune 2.
- KANAYALAL P. & BROS. 868-69 Budhwar Peth, Pune 2
- KANAYALAL V. SHROFF 558 Centre Street, Pune 1.
- KANTILAL & BROS. 412 Raviwar Peth, Pune 2.
- KASARIMAL DHANRAJ SONIGRA 204 Main Bazar, Post Dehu Road, (Pune).
- KASHINATH V. SATHE 417 Raviwar Peth, Pune 2.
- KHARI PEDHI Centre Street, Pune 1.
- KISAN JEWELLERS Pune 1.
- KISHOR D. DANTALE 403 Raviwar Peth, Pune 2.
- KRISHNAJI ANANT PALKAR 383 Raviwar Peth, Pune 2.
- KRISHNAJI RAICHANDJI 374 Centre Street, Pune 1.
- KRISHNAJI L. TAPARE 417 Raviwar Peth, Pune 2.
- KUNDANMAL GUMNAJI & SONS New Bazar, Khadki, Pune 3.
- KUNDANMAL KHIVRAJ 620 Ganesh Peth, Pune 2.
- LALCHAND OTARMAL 593 Ganesh Peth, Pune 2.
- LAXMAN G. KULKARNI 5 Shukrawar Peth, Pune 2.
- LAXMAN RAMNATH & CO. 401 Raviwar Peth, Pune 2.
- LAXMINARAYAN K. RATHI 391 Raviwar Peth, Pune 2.
- M. SHRIKRISHNA VARMA 690 Raviwar Peth, Pune 2
- M. U. MOTIWALE 868-69 Budhwar Peth, Pune 1.
- MADANLAL PRAYASHMAL 34-35 Ganesh Peth, Pune 2.
- MADHAVRAO BABURAO ASHTEKAR Pune 2.
- MANE & CO. 498 Raviwar Peth, Pune 2.
- MANGILAL & SONS 1672 Shukrawar Peth, Pune 2.
- MANMAL PHUTARMAL & CO. 382 Centre Street, Pune 1.
- MEHTA JEWELLERS 557 Centre Street, Pune 1.
- MODERN JEWELLERS 3 New Bazar, Khadki, Pune 3.
- MOHANLAL SHANTILAL SARAF 408 Raviwar Peth, Pune 2.
- MOTHALAL JEVRAJ 540 Centre Street, Pune 1.
- MOTILAL JAVAHARMAL BAPHANA 826-27 Budhwar Peth, Pune 2.
- MOTILAL JOSHI 950 Sadashiv Peth, Pune 30.
- MOTIWALE APTE 719-20 Narayan Peth, Pune 30.
- MOTIWALE DEODHAR 932 Laxmi Road, Pune 2.
- MOTIWALE PATWARDHAN 1482 Shukrawar Peth, Pune 2.
- MULCHAND BHAGVANDAS 1 M. G. Road, Khadki, Pune 3.
- MURLIDHAR BHIKAJI PIMPALGAONKAR 875 Budhwar Peth, Pune 2.
- MURLIDHAR GANESH TALEGAONKAR 876 Budhwar Peth, Pune 2.
- NAGRAJ GUJRAJ SARAF 1153 Raviwar Peth, Pune 2.
- NAKODA BHAIKAV JEWELLERS Bombay-Poona Road, Kasarwadi, Pune 18.
- NARAYAN BABURAO JUNNARKAR 390 Raviwar Peth, Pune 2.

- NARAYAN MARUTI KATKAR** 807 Budhwar Peth, Pune 2.
- NIHALCHAND CHANDULAL PARMAR** 379 Rasta Peth, Pune 11.
- NILKANTH BAPU GODBOLE** 1301 Sadashiv Peth, Pune 30.
- NENMAL BISAJI** 89 Yerawada, Pune 6.
- NAMICHAND & BROS.** 416 Raviwar Peth, Pune 2.
- NAMICHAND SESMAL** 409 Centre Street, Pune 1.
- PADMAKAR GAJANAN KANASKAR** 1137 Budhwar Peth, Pune 2.
- PADMAKAR BABURAO WAIKAR** 946 Sadashiv Peth, Pune 30.
- PHOJMAL JITAJI** 374 Centre Street, Pune 1.
- PIMPALDAS SITARAM GHODKE** 820 Budhwar Peth, Pune 2.
- POPATLAL GHISULAL SOLANKI** 733/2 Raviwar Peth, Pune 2.
- POPATLAL PHUTARMAL BALDOTA** 397 Raviwar Peth, Pune 2.
- PRABHAKAR DATTATRAYA DEOGAONKAR** 405 Raviwar Peth, Pune 2.
- PRAVINKUMAR SASTIMAL** 519 Centre Street, Pune 1.
- PRUTHVIRAJ JUHARMAL** 49 Ganesh Peth, Pune 2.
- PUNAM JEWELLERS** 365 Centre Street, Pune 1.
- PURUSHOTTAM NARAYAN GADGIL,** Kunte Chowk, Laxmi Road, Pune 30.
- R. B. DABHADE** 388 Raviwar Peth, Pune 2.
- R. N. TAPARE** 678 Shukrawar Peth, Rameshwar Chowk, Pune 2.
- R. V. DEVKAR** 808 Budhwar Peth, Pune 2.
- RAJABHAU DHONDIBA SALUNKHE** 873 Budhwar Peth, Pune 2.
- RAJMAL PUKHARAJ** 101 Yerawada, Pune 6.
- RAJMAL JAYRAJ SAND** 1185 Raviwar Peth, Pune 2.
- RAKA JEWELLERS** 1142 Raviwar Peth, Pune 2.
- RAMCHAND LALBUBHAI SARAF** 826-27 Budhwar Peth, Pune 2.
- RAMCHANDRA SHANKAR NAGARKAR** 403 Raviwar Peth, Pune 2.
- RAMCHANDRA N. YEWALEKAR** 273 Kasba Peth, Pune 11.
- RAMESHWARLAL LALCHAND VARMA** Telco Road, Post Chinchwad, Pune.
- RATANCHAND DALICHAND & CO.** 406 Raviwar Peth, Pune 2.
- RATHANCHAND DEVCHAND PAREKHI** 11 Raviwar Peth, Pune 2.
- SAKALCHAND MAGHANRAJ** 414 Raviwar Peth, Pune 2.
- SANTOSHI PEDHI** 559 Centre Street, Pune 1.
- SATYA PEDHI** 557 Centre Street, Pune 1.
- SESMAL DHIRAJI** 522 Centre Street, Pune 1.
- SESMAL KUPAJI** 622 Ganesh Peth, Pune 2.
- SHANKAR R. JABADE** 420 Raviwar Peth, Pune 2.
- SHANTILAL MESHRILAL** 6 M. G. Road, Pune 3.
- SHAVANTILAL GOWARDHANDAS** 555 Centre Street, Pune 1.
- SHIVLAL DALICHAND SARAF** 44 Bopodi, Pune 12.
- SHRIKANT C. BAGUL** 82 Budhwar Peth, Pune 2.
- SHRIPAD S. NAGARKAR** 886 Sadashiv Peth, Pune 2.
- SITARAM N. DEOKAR** 539 Raviwar Peth, Pune 2.
- SUKHANRAJ S. PARMAR** 624 Ganesh Peth, Pune 2.

- SUKHARAJ SHOBHACHAND 826-27 Budhwar Peth, Pune 2.
- SURESH L. DABHADE 1136 Budhwar Peth, Pune 2.
- SURESHCHAND DALICHAND 419 Raviwar Peth, Pune 2.
- SURESHCHAND LAKHMICHAND 40 Yerawada, Pune 6.
- SURESHMAL HIMATLAL PARMAR 1182 Raviwar Peth, Pune 2.
- SWASTIK ALANKAR 1128 Budhwar Peth, Pune 2.
- T. G. SAINKAR 999 Sadashiv Peth, Pune 30.
- T. V. ABHONKAR 391-B C Raviwar Peth, Pune 2.
- TIKHE SARAF 584 Shaniwar Peth, Pune 30.
- TOTARAM MAHADU SARAF 170-B Budhwar Peth, Pune 2.
- TULARAM DHONDIRAM 361 Centre Street, Pune 1.
- UDHAV BALKRISHNA NIPHADKAR 823 Budhwar Peth, Pune 2.
- UMEDMAL PUNAMCHAND OSWAL 88 'A' Yerawada, Pune 6.
- UMESHKUMAR T. SANCHETI 42/43 Ganesh Peth, Pune 2.
- V. G. RANADE 1524 Sadashiv Peth, Oak Wada, Pune 30.
- VANNAJI GANESHLAL 545 Centre Street, Pune 1.
- VARDHAMAN JEWELLERS 59 M. G. Road, Khadki Pune 3.
- VARDICHAND RAMCHAND 374 Centre Street, Pune 1.
- VARMA RATANLAL GOVINDRAJ 1150 Raviwar Peth, Pune 2.
- VASANT MARUTI KATURKAR 447 Raviwar Peth, Pune 2.
- VASANT A. YEWALEKAR 404 Raviwar Peth, Pune 2.
- VASUDEO NARAYAN PARAKHI 823 Budhwar Peth, Pune 2.
- VASUDHA V. GODBOLE 1301 Sadashiv Peth, Pune 30.
- VIJAYKUMAR DEORAJ 514 Centre Street, Pune 1.
- VINAYAK M. SAINKAR 419 Raviwar Peth, Pune 2.
- VINAYAK R. SHIVARAİKAR 514 Narayan Peth, Pune 30.
- VIPUL JEWELLERS 554 Centre Street, Pune 1.
- VISHNU L. TALEGAONKAR & SONS 390 Raviwar Peth, Pune 2.
- VITHAL M. BANSODE 388 Raviwar Peth, Pune 2.
- VITHAL SAHMSHETH 2433 East Street, Pune 1.
- VITHAL TATYABA DEOKAR 823 Budhwar Peth, Pune 2.
- WALCHAND JASRAJ 1135 Raviwar Peth, Pune 2.
- WALCHAND NIHALCHAND 347 Centre Street, Pune 1.
- WAMAN NIMBAJI ASHTEKAR 824 Budhwar Peth, Pune 2.
- WAMAN M. RAIKAR 879 Boottee Street, Pune 1.

MACHINERY

ABHIJIT ENTERPRISES 712 Sadashiv Peth, Pune 30.
Dealers in electronic gadgets, paper shredding machines.

AIRTEMP & ALLIED AGENCIES 458/2 Sadashiv Peth, Thak Road, Pune 30. Authorised dealers of 'Airtemp room air conditioners; 'Shriram' hermetic sealed compressors; 'A.C.E.' voltage stabilisers, 'Ruttonsha' battery

chargers; 'Gulmarg' appliances; 'Godrej' refrigerators; and 'Krish' television sets. Sales, service & repairing workshop.

ARWIND ENGINEERING WORKS 481/B Shreekrupa-Shahu College Road, Pune 9. Dealers in Compressor spares for Kirloskar, Atlas, C.P.T. and other types of compressors and accessories for any type as per customer's specification; carbon brushes, brush holders, sliprings, metallic contacts to electrical machines.

ASMITA ELECTRONICS 824 Deccan Gymkhana, Bhandarkar Institute Road, Pune 4. Dealers of NELCO business machines.

AUTO ENGINEERS 655 Shukrawar Peth, Pune 2.

B. G. SHIRKE & CO. 1205 Apte Road, Pune 4.

BARDAI (P) LTD. 440 Nana Peth, Pune 2.

BOBRA KANTILAL D. 1425 Shukrawar Peth, Gadikhana, Pune 2.

CENTRAL ENGINEERS 353 Shukrawar Peth, Pune 2.

CENTRAL HARDWARE STORES 923 Budhwar Peth, Bohri Ali, P. O. Box 530, Pune 2. Showroom & service station: Opp. East Street Post Office, Pune 1. Distributors for Wolf Electric Tools—drills, grinders, sanders, etc.

CERATRONICS 'Goras', 1170/1 Shivajinagar, J. M. Road, Pune 5. Distributors of semiconductor devices by Semiconductors Ltd., & Transelectronics.

CUMMINS DIESEL & SALES SERVICE (I) LTD. 32B Karve Road, Pune 4.

DE-LUXE SALES & SERVICE 3 Mukundnagar, Swargate, Pune 9. Dealers in 'TIRFOR' lifting and pulling machines; 'Wolf' electrical tools; 'RMT' Machine tools.

ESBEE INDUSTRIAL COMBINES 14A Shastri Road, Pune 30. Distributors of electrical motors, pumps, switchgears, workshop machinery & accessories.

FORWARD ENGINEERS 718 Sadashiv Peth, Pune 30.

GADKARI AGENCIES 'Adhar', Laxmi Road, Pune 30. Dealers in 'KSB' submeride pump, heavy duty fuse switches contactor, starters, capacitors, star delta starters, 'Minilec' type NSV-2.

HALWARD ENGINEERS Chitrakuti, Tilak Road, Pune 30. Dealers in industrial electrical equipments.

IBM WORLD TRADE CORPORATION 11 Koregaon Park, Pune 1. Dealers in machines & computers.

INDIA ENGINEERING CORPORATION 603 (New) Sadashiv Peth, Laxmi Road, Pune 30.

INDO MACHINE TOOLS Bhawani Peth, near Padamjee Gate, Pune 2.

INDUSTRIAL ELECTRONICS & INSTRUMENTS 209 Narayan Peth, Pune 30. Tel. 444006. Sales & service for 'YENKAY' speedometers, tachographs; temperature, fuel and pressure gauges; ammeters, industrial panel and precision instruments, electric ovens.

ISPAT TRADING CO. 1976 Gafar Beg street Pune 1

J. BRACEWELL (P) LTD. 1881-B Sadashiv Peth, Pune 30.

J. D. COMPANY 23 Napier Road, Pune 1.

JAY ENGINEERING & MACHINERY CO. 377 Shukrawar Peth, Pune 2.

JAYEMS ENGINEERING CO. 407/6 Nana Peth, Quarter Gate, Pune 2.

JOSEL CORPORATION Laxmi Road, Pune 30. Dealers in pneumatic clutch, D. C. motor controllers, special pumps.

K. S. NAGORI 872 Budhwar Peth, Pune 2. Authorised stockists for 'Kirloskar' sluice valves, 'Capstan' water meters, I. T. C. Tata steel tubes, A.P.J. leader, 'GG' valves etc.

KAMALASHANKAR P. JOSHI & CO. Shivajinagar, Pune 5.

KELGA TECHNO SALES PVT. LTD. 8/2 Sadashiv Peth, Near Alka Talkies, 'Ravi' Bldg., Pune 30. Distributors of Calma-Pleuger submersible pumps & 'Calma' chemical process pumps; generating sets & DC motors; 'Sureseal' valves; and control panels. Dealers of starters.

KELKAR BROTHERS (1) 777 Sadashiv Peth, Pune 30. (2) 711, Narayan Peth, Pune 30. Distributors of Kirloskar Products for Poona & Nasik districts.

- KOHINOOR ENGINEERS** 11 Ganeshnagar, Chinchwad, Pune 33. Dealers & stockists of Unbrako make socket head cap screws, socket set screws & Hi-titan wrenches, & hardware items.
- KRISHNA TRADING CORPORATION** 563 Nana Peth, Pune 2.
- M. JEDHE & CO.** 907 Shukrawar Peth, Pune 2
- MAHARASHTRA AGRO-INDUSTRIAL CORPORATION** 613 Shukrawar Peth, Pune 2.
- MAHARASHTRA INDUSTRIAL GAUGES** 'Chetak' House, 2nd Floor, 715 Narayan Peth, Laxmi Road, Pune 30. Agency for plug gauges, snap gauges, ring gauges, taper gauges, spl. gauges.
- MAHARASHTRA MACHINERY STORES** 636/1 Shukrawar Peth, Pune 2.
- MITHAPELLI TRADING CORPORATION** 49/3 Budhwar Peth, Pune 2.
- N. MEHTA & CO.** 648 Shukrawar Peth, Pune 2. Dealers in machinery, machine spares & electrical goods.
- NATIONAL ENGINEERING WORKS** 220 Kasba Peth, Pune 11.
- NEW PRAVIN AGENCY** 741 Budhwar Peth, Pune 2.
- NEW VARDHAMAN MACHINERY STORES** 639 Budhwar Peth, Pune 2.
- NIRMALA TRADING CORPORATION** 768 Sadashiv Peth, Phadtare Chowk, Pune 30. Dealers of hot water boilers, laundry machinery.
- PATASKAR & CO.** 46/2 Saraswati Vilas, Laxmi Road, Pune 30. Sale of 'PATCO' sewing machines.
- PHOENIX TRADING COMPANY** 1347 Shivajinagar, Pune 5. Dealers in engineering goods, Fenner, Helicord FIL 'V' belts. Distributors of 'Rapplon' nylon sandwich leather belts & flat endless belts.
- POCHA SEEDS PVT. LTD.** 1-A Middle Road, Near Solapur Bazar, P. Box No. 55, Pune 1. Agricultural equipments, Hasti pipes, Voltas pump sets, power tillers
- POONA DISTRICT CO-OPERATIVE PURCHASE AND SALE UNION LTD.** 125 Bhawani Peth, Pune 2.
- POONA ENGINEERS** 18 Bhawani Peth, Pune 2.
- POONA MACHINERY AGENCIES** LIC Bldg., Block No. 8, Laxmi Road, Pune 30.
- POONA SALES & SERVICE** Jeevan Darshan, Laxmi Road, Pune 30. Dealers of 'Blue Star Ltd. speedex; slotted angles, refrigerators spare parts, steel furniture, 'Solutron' calculators, 'Usha' water coolers, 'Dolphin' intercoms.
- RADIANT ENGINEERING & MANUFACTURING WORKS** 'Prasanna', 55/22 Erandwana, near Film Institute of India, Pune 4. Heavy duty exhaust & propeller fans, industrial blowers, roof extractors, fireproof doors & rolling shutters, pallet trucks & trolleys, geared motors.
- RAGHUNATH LAXMAN KHIRE** 351 Shukrawar Peth, Shivaji Road, Pune 2.
- RAJENDRA & CO.** 718 Sadashiv Peth, Pune 30.
- RAMESH ELECTRIC & TRADING AGENCIES** 461 Budhwar Peth, Near Pasodya Vithoba, Pune 2. Dealers of SIEMENS electric equipments.
- RELIABLE MACHINERY STORES** 568 Nana Peth, Pune 2.
- S. MACHINE TOOLS** Alka Talkies Compound, Tilak Road, Pune 30.
- SALES CORNER** 530 Sadashiv Peth, Jondhale Chowk, Pune 30. Dealers in bearings and V belts; cutting, hardening and precision tools; machine accessories and engineering goods.
- SALEX** Motwani Chambers, J. M. Road, Pune 5. Air conditioners, Water coolers, Deepfreezers, weighing machines, inter communication system, typewriters, fire extinguishers.
- SHEELAN ENTERPRISES** 1137/11 'Parag', Shivajinagar, Pune 16. Dealers of welding electrodes, Unbrako fasteners.
- SHOUNAK ENGINEERING** 596 Sadashiv Peth, Laxmi Road, Pune 30. Sole selling agents for 'Chetana' capacitors.

SHRIRAM ENGINEERING CORPORATION 715 Narayan Peth, Laxmi Road, Likhite Ram Mandir. Pune 30.

SIMCO BALL BEARING CORPORATION East Street, Pune 1.

SOUTHERN ENGINEERS Shivaji Road, 346 Shukrawar Peth, Pune 2.

TECHNO SALES PVT. LTD. Ravi Bldg., 8/2 Sadashiv Peth, Near Alka Talkies, Pune 30. Sales & Service.

TEXCON 'Chetak House' 715 Narayan Peth, Laxmi Road, Pune 30. Precision machine tools, machinery for watch industry, special purpose machines, machine tool accessories, metrological equipment, cutting tools & gauges.

TWIN ENGINEERS 1187/27, 'Bhagirathi Niwas', Shivajinagar, Pune 5. Suppliers of power Tools, redrawn seamless & ERW Steel pipes. Designers & fabricators.

VORA MACHINERY WORKS 358 Shukrawar Peth, Pune 2.

VYMAN & CO. 428 (New No. 133), Sadhu Waswani Nagar, Pune 7. Water treatment plants & resins, metal powder, mass flow meters, ventilating equipments, fabricated pipe works, Mowatrise circuit breakers.

WESTERN ENGINEERS 652/53 Shukrawar Peth, Pune 2.

OPTICS

ABHYANKAR OPTICAL CO. Shivaji Road, Pune 2.

ABHYANKAR OPTICIANS Bhanuvilas Chowk, Pune 30.

BRIGHT OPTICIANS Opp. Ratan Cinema, Budhwar Peth, Pune 2.

DEEPAK OPTICAL CO. Laxmi Road, opp. Hindustan Bakery, Pune 30.

DINSHAW AND CO. 2 M.G. Road, Pune 1.

ELITE OPTICAL CO. Shivdarshan Lodge, Garware Chowk, Pune 4.

F. HOMI DASTOOR Meher Road, Pune 1.

GOGATE AND CO. 120 Sadashiv Peth, Near Umbarya Ganpati Chowk, Pune 30.

HOMI AND CO. 909 Sadashiv Peth, Pune 30.

JANATA OPTICAL CO. Budhwar Peth, Budhwar Chowk, Pune 2.

JYOTI OPTICAL CO. 27 Rajendra Nagar, 2nd floor, Pune 30

KELKAR OPTICIANS Near Datta Mandir, Budhwar Peth, Pune 2.

MODERN OPTICAL CO. Karve Road, Pune 4.

MODERN OPTICIANS 1144, Sadashiv Peth, Laxmi Road Pune 30.

PARANJAPE OPTICIANS Opp. Prabhat Cinema, Pune 30.

POONA OPTICAL 1 M. G. Road, Pune 1.

R. N. GOGATE AND CO. 920 Sadashiv Peth, Laxmi Road, Pune 30.

RELIABLE OPTICAL CO. 178 Budhwar Peth, Budhwar Chowk, Pune 2.

SUNDER AND CO. Opp. Ratan Cinema, Budhwar Peth, Pune 2.

SWASTIK OPTICAL HOUSE 160 Budhwar Peth, Pune 2.

SWASTIK OPTICIANS 160 Budhwar Peth, Pune 2.

PAPER

- ABHIJIT AGENCIES 157 Budhwar Peth, Pune 2.
- B. G. DESAI & CO. 495 Shaniwar Peth, Pune 30.
- BHARAT KAGAD BHANDAR 25 Budhwar Peth, Pune 2.
- CHANDRAKANT PAPER CO. 176 Shaniwar Peth, Pune 30.
- DECCAN PAPER MILLS CO. LTD. Laxmi Road, Pune 2.
- DESAI PATEL PAPER CO. 1436 Kasba Peth, Pune 11.
- DIAMOND PAPER MART 50 Parvati, Pune 9.
- GHARE & CO. 12 Budhwar Peth, Pune 2.
- HARIHAR PAPER MART 943 Budhwar Peth, Pune 2.
- INDUSTRIAL STATIONERY MART 634 Shaniwar Peth, Pune 30.
- JAWAHAR TRADING CO. 495 Shaniwar Peth, Pune 30.
- JUPITER PAPER MART Shroff Bazar, 387 Raviwar Peth, Pune 2.
- KOHINOOR AGENCIES 715 Narayan Peth, Laxmi Road, Pune 2
- L. B. BHANDARI & CO. 47 Somwar Peth, Pune 11.
- M. R. JOSHI Laxmi Road, 569 Sadashiv Peth, Pune 30.
- M. Y. GHARPURE & CO. 500 Narayan Peth, Pune 30.
- MAHARASHTRA PAPER CO. 394 Guruwar Peth, Pune 2.
- MAHARASHTRA SALES ANTARBHARATI 1392 Shukrawar Peth, Bajirao Road, Pune 2.
- MAYUR PAPER CO. 768/785 Shukrawar Peth, Pune 2.
- MODERN PAPER STORES 25 Budhwar Peth, Appa Balwant Chowk, Pune 2.
- MUDRAN BHANDAR 1331 Sadashiv Peth, Pune 30.
- MUDRAN SAHITYA BHANDAR 1078 Sadashiv Peth, Pune 30.
- NATIONAL PAPER MART 867 New Budhwar Peth, Laxmi Road, Pune 2.
- NATVARLAL & CO. 659 Narayan Peth, Pune 30.
- NIKO TRADING CO. 1049/50 Sadashiv Peth, Pune 30.
- PAPCHEM 23 Yeshwant Nagar, Pune 7.
- PAPER & PULP CONVERSIONS LTD. 1183 Shivajinagar, Pune 5.
- PAPER TRADE (INDIA) 383B Shaniwar Peth, Pune 30.
- POPULAR BINDING WORKS 495 Shaniwar Peth, Pune 30.
- PROVINCIAL PAPER CO. 693/7 Budhwar Peth, Pune 2.
- R. S. RATHI 841 Ganj Peth, Pune 2.
- RAMANLAL PAPER CO. 724 Raviwar Peth, Pune 2.
- RAMBHAGAT PACHHANDAS SOMANI 610 Raviwar Peth, Pune 2.
- ROYAL PAPER MART P.M.C. Bldg., 802 Sadashiv Peth, Pune 30.
- SHARAT & CO. 180 Budhwar Peth, Laxmi Road, Pune 2.
- SHARDA BOOK MFG. CO. 413 Narayan Peth, Pune 30.
- SHREE GANESH PAPER CO. 493 Shaniwar Peth, Pune 30.
- SHRIKRISHNA PAPER CO. 457 Budhwar Peth, Pune 2.

SUBODH TRADERS 581 Sadashiv Peth, Pune 30.

SWASTIKKO B-305 Preet Apartments, Bombay-Poona Road, Pune 3.

THAKUR BROTHERS 495 Shaniwar Peth, Pune 30.

UNITED AGENCIES 5 Bhawani Peth, Pune 2.

Y. L. THATTE & CO. 844 Sadashiv Peth, Pune 30.

ASHWINI PHOTO STUDIO 23 Laxminagar, Room No. 11, Parvati, Pune 9.

ASSOCIATED PHOTOGRAPHIC ENTERPRISE 427 Ghorpade Peth, Pune.

B. G. PARGE AND CO. 240 Budhwar Peth, Pune 2.

BALAJI STUDIO 84 Budhwar Peth, Pune 2.

BHARAT PHOTO STUDIO Near B.E.G. Post Office, Pune.

BHARAT PHOTO STUDIO 68 Shukrawar Peth, Pune 2.

BHARAT PHOTO STUDIO 47 Shukrawar Peth, Pune 2.

BRIGHT PHOTO STUDIO 354 Rasta Peth, Pune 11.

C. T. PANDOL AND SONS 262 Mahatma Gandhi Road., Pune 1.

PHOTOGRAPHIC MATERIAL AND PHOTOGRAPHERS

ABHINAV PHOTO STUDIO 426 Shukrawar Peth, Pune 2.

AJANTHA PHOTO STUDIO 538 Shukrawar Peth, Pune 2.

AJIJ ART 1221 Raviwar Peth, Pune 2.

AMAR PHOTO STUDIO Poona Camp, Pune 1.

ANANT PHOTO STUDIO 1119 Budhwar Peth, Pune 2.

ANIL PHOTO STUDIO 1482 Shukrawar Peth, Pune 2.

ART CENTRE 67 Mahatma Gandhi Road, Pune 1.

ART COLOUR PHOTO STUDIO 4 Mahatma Gandhi Road, Pune 1.

ART GALLERY, 1553 West East, Pune

ARTIST AND PHOTOGRAPHERS 691 Narayan Peth, Pune 30.

ASHA ART STUDIO Near Apsara Talkies, Pune 9.

ASHA PHOTO STUDIO 7 Modi Mansion, 37/2 Shankarshet Road, Pune 9.

CHHAGNANI PHOTO MATERIALS PVT. LTD. Plot No. 16, Kothrud, Pune 4.

CHHAYA PHOTO STUDIO 582 Shaniwar Peth, Pune 30.

CHHAYA STUDIO 583 Narayan Peth, Pune 30.

CHIANG PHOTO STUDIO 70 Nava Bazar, Khadki, Pune 3.

CHINESE PHOTO STUDIO 1 Market Road, Pune 1.

CHITRALAXMI PHOTO STUDIO 454 Dapodi, Pune 12.

CHROMAX PHOTO STUDIO 1201/A-12 Shivajinagar, Pune 5.

D. D. BAPAT ART STUDIO 318 Narayan Peth, Pune 30.

D. T. BHOSALE PHOTO STUDIO 1660 Budhwar Peth, Pune 2.

DECCAN CAMERA HOUSE 684 Shivajinagar, Pune 4.

DECCAN PHOTOGRAPHIC HOUSE 462 Budhwar Peth, Pune 2.

- DEEPA PHOTO STUDIO 1 Yerawada, Pune 6.
- DEEP ART STUDIO 27 Cannought House, Pune
- DESHPANDE PHOTO STUDIO 1650 Sadashiv Peth, Pune 30.
- DIAMOND PHOTO STUDIO 661/B Shivajinagar, Pune 5.
- DILIP PHOTO STUDIO 23 Mukundnagar, Pune 9.
- DIVEKAR ARTS 12 Budhwar Peth, Pune 2.
- DREAM FLASH Dapodi, Pune 12.
- EXCELSIOR 849 Budhwar Peth, Pune 2.
- EXCELSIOR PHOTO STUDIO Opp. City Post, Pune 2.
- FINE ART PHOTO STUDIO 697 Guruwar Peth, Pune 2.
- FLASH STUDIO 906 Booty Street, Pune 1.
- FRANKELS 288 Mahatma Gandhi Road., Pune 1.
- FRIENDS PHOTO STUDIO 744 Sadashiv Peth, Pune 30.
- G. G. WELLING 2430 East Street, Pune 1.
- GIRISH PHOTO STUDIO 768 Sadashiv Peth, Pune 30.
- GRAND PHOTO STUDIO 580 Narayan Peth, Pune 30.
- GRAFIS L. B. Shastri marg, Pune 30.
- GREEN STUDIO 352 Somwar Peth, Pune 11.
- GUJARAT ARTS 617 Jai Corpn. Housing Society, Bhawani Peth, Pune 2.
- GUJRAL ARTS 771 Bhawani Peth, Pune 2.
- GUJRATH ARTS 2128 Centre Street, Pune 1.
- HARISH RADIO AND PHOTO 3 Rajmahal Hotel, Dada Vasvani Road, Pune.
- HIND PHOTO STUDIO 189 Hadapsar, Pune 28.
- HOLLYWOOD COLOR STUDIO AND LAB. 1632 Shivajinagar, Pune 5.
- HOLLYWOOD PHOTO STUDIO 759/75/9 Deccan Gymkhana, Pune 4.
- HUPRIKAR PHOTOGRAPHERS 1806 Sadashiv Peth, Pune 30.
- JANATA PHOTO STUDIO 280 Ganesh Peth, Pune 2.
- JOY PHOTO STUDIO 391/92 Mangalwar Peth, Pune 11.
- JYOTI PHOTO STUDIO 184 Shaniwar Peth, Pune 30.
- K. K. & CO. 2428 East Street, Pune 1.
- KALASAGAR PHOTO STUDIO 1114 Budhwar Peth, Pune 2.
- KALASAGAR PHOTO STUDIO 725 Shivajinagar, Pune 4.
- KALAVAIBHAV PHOTO STUDIO Survey No. 163, Hadapsar, Pune 28.
- KALPANA PHOTO STUDIO Khadki, Pune 3.
- KANHERE PHOTO STUDIO 310 Narayan Peth, Pune 30.
- KARAVANDE PHOTO STUDIO 181 Navi Peth, Pune 30.
- KIRTI STUDIO 1386 Kasba Peth, Pune 11.
- KOHINOOR PHOTO STUDIO 95 Ganesh Peth, Pune 2.
- KULKARNI PHOTO STUDIO 1144 Budhwar Peth, Pune 2.
- KULKARNI PHOTO STUDIO Near Tulsibag, 4 Shukrawar Peth, Pune 2.
- L. K. DESOUZA AND SONS 105 Mahatma Gandhi Road, Pune 1.

- LAXMI CHHAYA PHOTOS** 527 Shaniwar Peth, Pune 30.
- MADHAV PHOTO STUDIO** 500 Rasta Peth, Pune 11.
- MADHAVI PHOTO STUDIO** 1350 Nana Peth, Pune 2.
- MADHU ART** 382 Narayan Peth, Pune 30.
- MALJAR PHOTO STUDIO** 172 Shriram Society, Sahakaragar, Pune 9.
- MANISHA PHOTO STUDIO** 509/510 Ghorpade Peth, Pune 2.
- MANMOHAN PHOTOGRAPHER** 993 Sadashiv Peth, Pune 30.
- MANOHAR AWSARE PHOTOGRAPHERS** 1828/2 Sadashiv Peth, Ravi Bldg., Pune 30.
- MAYUR STUDIO** 607 Budhwar Peth, Pune 2.
- MILAN STUDIO** 25 Budhwar Peth, Pune 2.
- MILTON AND CO.** 1 Mahatma Gandhi Road, Pune 1.
- MINERVA PHOTO STUDIO** 23 Shukrawar Peth, Pune 2.
- MODERN ART** 1170/2 Shivajinagar, Pune 5.
- MOON PHOTO STUDIO** 607 Budhwar, Pune 2.
- N. S. DATE** 240 Narayan Peth, Pune 30.
- NANDKISHORE PHOTO STUDIO** 702 Deccan Gymkhana, Pune 4.
- NATIONAL PHOTO STUDIO** 106 Yerawada, Pune-6.
- NATRAJ PHOTO STUDIO** 728 Shivajinagar, Pune 4.
- NAVRANG PHOTO STUDIO** Pimpri Waghire, Pune 17.
- NEPALI PHOTO STUDIO** Yerawada, Pune 6.
- NEW KALPANA PHOTO STUDIO** 245 Budhwar Peth, Pune 2.
- NILAM PHOTO STUDIO** Kasaba Peth, Pune 11.
- NILAYAM PHOTO STUDIO** 484/12 Mitramandal Colony, Pune 9.
- NILKAMAL PHOTO STUDIO** 630 Budhwar Peth, Pune 2.
- NOVELTY PHOTOS** 893/8 Shivajinagar, Pune 4.
- OPERA PHOTO STUDIO** 1199 Budhwar Peth, Pune 2.
- ORIENTAL PHOTO SERVICE** Sarswati Vilas, Laxmi Road, Pune 2.
- PAHINYAAR PHOTO CINE** 382/383 Shukrawar Peth, Pune 2.
- PARASHAR** 2427 East Street, Pune 1.
- PARGE PHOTO STUDIO** 829 Budhwar Peth, Pune 2.
- PARGE PHOTO STUDIO** 1060 Budhwar Peth, Pune 2.
- PHOTO CENTRE** 815/4 Bhawani Peth, Pune 2.
- PHOTO CENTRE STUDIO** 11 Koregaon Park, Pune 1.
- PHOTO CENTRE STUDIO** 14 Cannought Road, Pune 1.
- PHOTOGRAPHIC SCHOOL & STUDIO** 1300 Sadashiv Peth, Pune 30.
- PHOTO STUDIO** 1261 Shivajinagar, Pune 5.
- POORNIMA PHOTO STUDIO** 629/4 Shivajinagar, Pune 5.
- PRABHAT PHOTO STUDIO** 691 Sadashiv Peth, Pune 30.
- PRABHAT PHOTO STUDIO** 1027 Sadashiv Peth Pune 30.
- PRADIP PHOTO STUDIO** 500 Budhwar Peth, Pune 2.
- PRAKASH JADHAV** Near Nagnathpar, Sadashiv Peth, Pune 30.
- PRAKASH STUDIO** L. P. 477 B/X/A Bldg. No. 2, Near Shahu College, Pune 9.
- PRAMOD PHOTO STUDIO** Commercial Building, Pune, 2.

- PRATIBHA STUDIO** 1649 Sadashiv Peth, Pune 30.
- PRINCE PHOTO STUDIO** 34/1 Yasin Manzil, Erandawana, Pune 4.
- R. K. PHOTO STUDIO** 14 Cannought Road, Pune 1.
- R. R. ARTS** 646 Narayan Peth, Pune 30.
- RAGHUVIR PHOTO STUDIO** 23 Shukrawar Peth, Pune 2.
- RAHUL PHOTO STUDIO** Rambag, Navi Peth, Pune 30.
- RAJESH PHOTO STUDIO** Survey No. 163, Hadapsar, Pune 28.
- RAJKAMAL STUDIO** 577 Budhwar Peth, Pune 2
- RAJPUT ART STUDIO** 93/2 Budhwar Peth, Pune 2,
- RASHMI PHOTO STUDIO** 1157 Budhwar Peth, Pune 2.
- RATAN PHOTO STUDIO** 461/1 Sadashiv Peth, Pune 30
- RUPKALA PHOTO STUDIO** 1169 Sadashiv Peth, Pune 30.
- SADHANA STUDIO** Sonya Maruti Chowk, Laxmi Road, Pune 2.
- SAPPHERS PHOTO STUDIO** 759/102 Shivajinagar, Pune 5.
- SAGAR PHOTO STUDIO** Survey No. 163, Hadapsar, Pune.
- SAINATH COMMERCIAL SERVICE** 246 Narayan Peth, Pune 30.
- SANGAM PHOTO STUDIO** 245 Budhwar Peth, Pune 2.
- SANJIV STUDIO** 494 Budhwar Peth, Pune 2.
- SHARADA PHOTO STUDIO** 1128 Bhawani Peth, Pune 2.
- SHASHANK PHOTO STUDIO** Blue Diamond, Pune 1.
- SHIRISH PHOTO STUDIO** 265 Kasba Peth, Pune 11.
- SHISODE PHOTO STUDIO** 1158 Budhwar Peth, Pune 2.
- SHIVAJI PHOTO STUDIO** S.N.M. Lime Bazar, East Khadki, Pune 3.
- SHRIRAM PHOTO STUDIO** 2248 Gokhale Chowk, Deccan Gymkhana, Pune 4.
- SHYAM PHOTO STUDIO** 1265 Shukrawar Peth, Pune 2.
- SIDHARAJ PHOTO STUDIO** 388 Budhwar Peth, Pune 2.
- SKY LINE PHOTO STUDIO** 1251 Shukrawar Peth, Pune 2.
- SOUZA PHOTO STUDIO** Sunny Dala, 949 Ardeshir Irani Road, Pune 1.
- STUDIO AMIN** 1225/8 Shivajinagar, Pune 5.
- STUDIO DELIGHT** 36 Shukrawar Peth, Pune 2.
- STUDIO DE-LUX** 1650 Sadashiv Peth, Pune 30.
- STUDIO HIMLAND** 667 Sadashiv Peth, Pune 30.
- STUDIO INTIMATE** 931/A Shivajinagar, Pune 4.
- STUDIO JAMUNA** 97 Mangalwar Peth, Pune 11.
- STUDIO MODERN ART** 22/A Somwar Peth, Pune 11.
- STUDIO PARAGON** 152 Narayan Peth, Pune 30.
- STUDIO RUPALI** 608 Budhwar Peth, Pune 2.
- SUN ART STUDIO** 548 Sadashiv Peth, Pune 30.
- SUVARNA BHARAT PHOTO STUDIO** 280 Ganesh Peth, Pune 2.
- SWASTIK PHOTO ART STUDIO** 851 Budhwar Peth, Pune 2
- TECHNICOLOUR PHOTO STUDIO** 635 Ganj Peth, Pune 2.

THE NEW ROYAL PHOTO STUDIO Elphinstone Rd., Khadki, Pune 3.

UNIQUE PHOTOGRAPHERS 1020 Nana Peth, Pune 2.

V. B. AND CO. 278/79 Narayan Peth, Pune 30.

VAISHALI PHOTO STUDIO 27/2 Somwar Peth, Pune 11.

VAISHALI PHOTO STUDIO 42/9 Erandwana, Pune 4.

VARMA STUDIOS 12 Molodina Road, Pune 1.

VENUS PHOTO STUDIO 788 Cantonment Bldg., 1st floor, M. G. Road., Khadki, Pune 3.

VALIAI PHOTO ART STUDIO 243 Budhwar Peth, Pune 2.

VISHWAS COLOURS 255 Somwar Peth, Pune 11.

WAIKAR PHOTO STUDIO 336 Budhwar Peth, Pune 2.

WAMAN AND DASTUR 18 Arsenal Road, Pune 1.

SANITARYWARES

AJANTHA CORPORATION 443 Raviwar Peth, Pune 2.

BHARAT ENGINEERS AND TRADERS Station Road, Pimpri, Pune 8.

BUILDERS HOME 19K/2 Somwar Peth, Pune 11.
Show Room: 1053 Budhwar Peth, Pune 2.

DECCAN ENGINEERS 767 Budhwar Peth, Pune 2.

MODERN SANITARY APPLIANCES CO. 557 Sadashiv Peth, Laxmi Road, Pune 30.

PATEL TRADERS 22 New Timber Market, Pune 2.

SATHE AND CO. 678 Shukrawar Peth, Pune 2.

SHAHARAD STONE AND CO. 1004 Budhwar Peth, Pune 2.

VISHWANATH AND CO. 1053 Budhwar Peth, Pune 2.

SEEDS

A. NAIK CO. Swargate, Pune 2.

D. J. DAMANI AND CO. Near S. T. Stand, Shivajinagar, Pune 5.

INTERNATIONAL AGRI INDUSTRIES 40 Shukrawar Peth, Pune 2.

KISSAN ASSOCIATES 2032 Sadashiv Peth, Pune 2

KRISHNAJI BALLAL AND CO. Bajirao Road, 1278 (New) Sadashiv Peth, Pune 30.

L. V. NAVLAKHA AND SONS 1379 Bhawani Peth, Pune 2.

MADHURI V. BORKAR 435 Solapur Road, Hadapsar, Pune 13.

N. KAPOOR AND CO. 3 Queens Garden, Pune 1.

NATIONAL SEEDS CORPORATION 497/1 Bhawani Peth, Pune 2.

OVHAL AGRI AGENCIES Shukrawar Peth, Pune 2.

PAREKH TRADERS 81/9-A Bhawani Peth, Pune 2.

PESTONJEE P. POCHA AND SONS LTD. 1-A Middle Road, Pune 1.

SHETI UDYOG BHANDAR Swargate, Pune 2.

SUNRISE COLD STORAGE CO. 813/14 Bhawani Peth, Pune 2.

SUNRISE MANURES AND CHEMICALS 813/14 Bhawani Peth, Pune 2.

VILAS AGENCIES 655 Shukrawar Peth, Pune 2.

VISHNU SADASHIV AND CO. Near Zilla Parishad,
Pune 1.

WOODLAND STORES 1254 Shivadarshan Building,
Deccan Gymkhana, Pune 4.

SHAHABAD STONE & TILES

AJANTHA CORPORATION Laxmi Road, Pune 30.

DATTATRAYA BROS. P. No. 257/3 Bhavaní Peth,
Pune 2.

HANUMANTRAO & SONS 55/56 Somwar Peth, Pune 11.

LAXMI STONE DEPOT 425 Mangalwar Peth, Pune 11

MADHAV & CO. 204 Mangalwar Peth, Pune 11.

POONA STONE TRADING CO. 156/3 Mangalwar
Peth, Pune 11.

PRABHAKAR & CO. 204 Mangalwar Peth, Pune 11.

SATHE & CO. Rameshwar Chowk, Shukrawar Peth'
Pune 2.

SHAHABAD STONE CO. 1004 Budhwar Peth, Pune 2.

SHRIKRISHNA BAHETI 21 Somwar Peth, Pune 11.

VISHWANATH & CO. 1053 Budhwar Peth, Pune 2.

STATIONERY & CUTLERY

A-ONE TRADING CO. 413 Raviwar Peth, Pune 2.

ADARSH CROCKERY & GLASSWARE AGENCY
185 Ganesh Peth, Pune 2.

AGARWAL & CO. 1532 Shukrawar Peth, Pune 2.

AJANTHA 520 Shivajinagar, Pune 5.

ALANKAR 499 'B' Rasta Peth, Pune 11.

ALANKAR PLASTIC HOUSE 667 Raviwar Peth, Pune 2.

ALKA BHANDAR 1418 Sadashiv Peth, Pune 30.

ALLIED AGENCY 958/59 Budhwar Peth, Pune 2.

AMAR PRODUCTS 42/9 Karve Road, Pune 4.

ANAND GENERAL STORES 31/1 Karve Road, Pune 4.

ANAND STORES 544 Sadashiv Peth, Pune 30.

ANTARBHARATI 701 Shivajinagar, Pune 5.

ART CENTRE 12 Budhwar Peth, Pune 2.

ARUN STATIONERS 18-19 Raviwar Peth, Pune 2.

ASHIYA GENERAL STORES 966 Raviwar Peth, Pune 2.

ASHOK EMBROIDERY 1130 Budhwar Peth, Pune 2.

ASHOK MEDICO 1278 Sadashiv Peth, Pune 30.

B. ANANT & CO. 607 Sadashiv Peth, Pune 30.

BALDOTA PETHKAR & CO. 975 Budhwar Peth, Pune 2

BALMUKUND SHRIKISAN 349 Raviwar Peth, Pune 2.

BATTURKAR & BROS. 447 Raviwar Peth, Pune 2.

BEDEKAR MASALEWALE 1230 Sadashiv Peth, Pune 30.

- BHAGAT GENERAL STORES 1374 Bhavani Peth, Pune 2. DECCAN GENERAL STORES 257 Budhwar Peth, Pune 2.
- BHARATKUMAR DEEPCHAND 667 Raviwar Peth, Pune 2. DECCAN TRADING AGENCY 17 Shukrawar Peth, Pune 2.
- BHARAT STATIONERY MART 630 Budhwar Peth, Pune 2. DEODHAR ELECTRIC STORES 722/3 Navi Peth, Pune 30.
- BHARAT TRADING CO. 938 Budhwar Peth, Pune 2. DEODHAR ELECTRIC WORKS 1428 Sadashiv Peth, Pune 30.
- BHAVARMAL MAHINDRAKUMAR 769/85 Guruwar Peth, Pune 2. DEVAL UTENSIL STORES 506 Sadashiv Peth, Pune 30.
- BHAVARMAL MOHANLAL 1156 Raviwar Peth, Pune 2. DHANPAL & CO. 1609 Shukrawar Peth, Pune 2.
- BHIKAJI BALWANT PANSE 1429 Shukrawar Peth, Pune 2. DHANRAJ PUKHARAJ 1176 Raviwar Peth, Pune 2.
- BHURMAL B. OSWAL 667 Raviwar Peth, Pune 2. DIAMOND STORES 969 Raviwar Peth, Pune 2.
- BHUTADA TRADING CORPORATION 567 Raviwar Peth, Pune 2. DINESH 727'B' Shivajinagar, Pune 5.
- BINA STORES 1161 Budhwar Peth, Pune 2. DINSHA CO. 696 Shaniwar Peth, Pune 30.
- BOMBAY BOOK MFG. CO. 244 Raviwar Peth, Pune 2. DURGA STATIONERY MART 174 Budhwar Peth, Pune 2.
- BOMBAY STORES 1059 Budhwar Peth, Pune 2. EMPIRIAL STATIONERY MART 6 Budhwar Peth, Pune 2.
- BORANA STORES 1998 Sadashiv Peth, Pune 30. FASHION 1142 Budhwar Peth, Pune 2.
- BORANA TRADING CO. 2138 Sadashiv Peth, Pune 30. G. R. AGARWAL 1019 Budhwar Peth, Pune 2.
- BUDHWANI GENERAL STORES 500 Ganesh Peth, Pune 2. GAVATE BROTHERS 14 Budhwar Peth, Pune 2.
- C. D. SHAHA 249 Raviwar Peth, Pune 2. GEETA 1142 Budhwar Peth, Pune 2.
- CAMLIN PVT. LTD. Budhwar Peth, Pune 2. GEETA GRAHAK VASTU BHANDAR 928 Shivajinagar, Pune 5.
- CHANDRAKANT MANILAL 25 Shukrawar Peth, Pune 2. GHARE & CO. 12 Budhwar Peth, Pune 2.
- CHANDRASHEKHAR PROVISION STORES 157 Mukundnagar, Pune 9. GRUHINI 11/15 Karve Road, Pune 4.
- D. KADAM & CO. 1182 Sadashiv Peth, Pune 30. GUJARAT GLASSWARE 180 Budhwar Peth, Pune 2.
- DAUDBHAI ABDULALI 235 Raviwar Peth, Pune 2. GURUPRAKASH STORES 295 Somwar Peth, Pune 11.
- DEEPAK NOVELTY 618 Sadashiv Peth, Pune 30. HANUMAN STORES 973 Budhwar Peth, Pune 2.
- HANUMAN STORES 11/3 Erandwana, Pune 4.

- HAPPY KANGAN 1142 Budhwar Peth, Pune 2.
- HARIHAR PAPER MART 943 Budhwar Peth, Pune 2.
- HASMUKH NOVELTIES 357 Raviwar Peth, Pune 2.
- HEJIB 1111 Budhwar Peth, Pune 2.
- HIND GENERAL STORES 1169 Budhwar Peth, Pune 2.
- HONESTY & CO. Budhwar Peth, Pune 2.
- INDIA GENERAL STORES 257 Budhwar Peth, Pune 2.
- INDIA PEN CENTRE 665 Shaniwar Peth, Pune 30.
- INDUSTRIAL STATIONERY MART 665 Shaniwar Peth, Pune 30.
- ISHWARDAS & BROS. 1340 Shivajinagar, Pune 5.
- J. D. BROS. 701 Sadashiv Peth, Pune 30.
- JEEVAN GENERAL STORES 782 Sadashiv Peth, near Shanipar, Pune 30.
- JEEVEN GENERAL STORES Laxmi Park, Pune 30.
- JEVAJI KASAMJI 1094 Budhwar Peth, Pune 2.
- JOGESHWAR TRADING CO. 1546 Shukrawar, Pune 2.
- JOGLEKAR BROS. 1187/60 Shivajinagar, Pune 5.
- JOGLEKAR BROS. 743 Sadashiv Peth, Pune 30.
- JOSHI & CO. 657 Shivajinagar, Pune 5.
- JUMKHARAM ISHWARDAS 1089 Budhwar Peth, Pune 2.
- K. N. SHAH 363/64 Shivajinagar, Pune 5.
- K. P. JOSHI 606 Sadashiv Peth, Pune 30.
- KAILASH TRADING AGENCY 707 Shukrawar Peth, Pune 2.
- KAKADE & SONS 399 Sadashiv Peth, Pune 30.
- KALPANA STORES 31 Shukrawar Peth, Pune 2.
- KAMAL BHANDAR 377 Shaniwar Peth, Pune 30.
- KAMBLE SUITCASE DEPOT 727 Budhwar Peth, Pune 2.
- KANPUR LEATHER WORKS 723 Budhwar Peth, Pune 2.
- KASAMJI IBRAHIMJI 234 Raviwar Peth, Pune 2.
- KELKAR BROTHERS 777 Sadashiv Peth, Pune 30.
- KESHAV-LAXMI PRASADHAN 556 Shaniwar Peth, Pune 30.
- KHILLONA BHANDAR 601 Sadashiv Peth, Pune 30.
- KHINWASARA METAL MART 1027 Sadashiv Peth, Pune 30.
- KHIWASARA STORES 1347 Shukawar Peth, Pune 2.
- KIRAN GENERAL STORES 500 Ganesh Peth, Pune 2.
- KISHOR TRADING CO. 357 Budhwar Peth, Pune 2.
- KOHINOOR STORES 619 Budhwar Peth, Pune 2.
- KUSUMA GENERAL STORES 583 Shaniwar Peth, Pune 30.
- LAXMI STORES 597 Sadashiv Peth, Pune 30.
- LOKMANYA PRODUCTS Laxmi Park, Navi Peth, Pune 30.
- LUCKY GENERAL STORES 501 Rasta Peth, Pune 11.
- MAHARASHTRA GENERAL STORES 759/51 Karve Road, Pune 4.
- MAHARASHTRA STATIONERY 149 Budhwar Peth, Pune 2.
- MAHARASHTRA TRADING CO. 1248 Shivajinagar, Pune 5.
- MAHAVIR STORES 242 Budhwar Peth, Pune 2.
- MAHINDRA NOVELTIES 1161 Budhwar Peth, Pune 2.
- MANCHAND STORES 1028 Raviwar Peth, Pune 2.

- MANGAL STORES** 295 Somwar Peth, Pune 11.
- MANIK STORES** 20/21 Saraswati Vilas, Narayan Peth, Pune 30.
- MATRO COTTAGE INDUSTRIES** 13 Kasba Peth, Pune 11.
- MAYUR** 73 Budhwar Peth, Pune 2.
- MEDEECO DISTRIBUTORS** 1051 Sadashiv Peth, Pune 30.
- MEGHANI STORES** 620 Budhwar Peth, Pune 2.
- MEHTA GENERAL STORES** 793 Budhwar Peth, Pune 2.
- MICA** 6 Budhwar Peth, Pune 2.
- MILAN STORES** 1088 Budhwar Peth, Pune 2.
- MODERN JEWELLERS** 107 Budhwar Peth, Pune 2.
- MOHAN SLATE DEPOT** 1482 Shukrawar Peth, Pune 2.
- MULCHAND GULABJI JAIN** 1589 Shukrawar Peth, Pune 2.
- MURLIWALA STORES** 753 Ganesh Peth, Pune 2.
- N. BANSILAL** 234 Budhwar Peth, Pune 2.
- N. G. RAJIWADEKAR** 177 Budhwar Peth, Pune 2.
- N. H. PUNDYA** 1142 Budhwar Peth, Pune 2.
- N. S. JAIN** 629 Raviwar Peth, Pune 2.
- NARENDRA BHANDAR** 1764 Budhwar Peth, Pune 2.
- NATIONAL NOVELTY** 667 Raviwar Peth, Pune 2.
- NATRAJ MINI MARKET** 62/9 Karve Road, Pune 4.
- NEELA VARIETIES & GENERAL STORES** 802 Sadashiv Peth, Pune 30.
- NEW DECCAN STORES** 428 'A' Rasta Peth, Pune 11.
- NEW SOUBHAGYA ALANKAR STORES** 503 Rasta Peth, Pune 11.
- NIHALCHAND MOTAJI** 667 Raviwar Peth, Pune 2.
- NIRJARA STORES** 1641 Sadashiv Peth, Pune 30.
- NUPUR** 22 Budhwar Peth, Pune 2.
- NUTAN** 759/54 Karve Road., Pune 4.
- P. N. SALVEKAR** Shukrawar Peth, Pune 2.
- P. R. NAGARKAR** 1187/69 Shivajinagar, Pune 5.
- P. Y. VAIDYA** 893/8 Shivajinagar, Pune 5.
- PAISA FUND VASTU BHANDAR** 366 Narayan Peth, Pune 30.
- PANGARKAR & CO.** 1275 Sadashiv Peth, Pune 30.
- PARSHWANATH STORES** 841 Sadashiv Peth, Pune 30.
- PATANKAR & CO.** 1087 Sadashiv Peth, Pune 30.
- PATEL STOVE & CUTLERY MART** 257 Budhwar Peth, Pune 2.
- PATWA BROTHERS** 634 Budhwar Peth, Pune 2.
- POONA CROCKERY & GLASSWARE AGENCY** 188. Budhwar Peth, Pune 2.
- POONA GENERAL STORES** 769 Raviwar Peth, Pune 2.
- POONA GLASSWARE & STORES DEPT.** 841 Budhwar Peth, Pune 2.
- PORWAL & CO.** 2041 Sadashiv Peth, Pune 30.
- PRABHA NOVELTIES** 1131 Budhwar Peth, Pune 2.
- PRABHAT GENERAL STORES** 494 Shaniwar Peth, Pune 30.
- PRADEEP TRADERS** 500 Rasta Peth, Pune 11.
- PRAKASH DEPARTMENTAL STORES** 500 Budhwar Peth, Pune 2.
- PRAKASH GENERAL STORES** 15/3 Karve Road, Pune 4.

- PRAKASH NOVELTY KANGAN** 715 Shaniwar Peth, Pune 30.
- PRASAD** 612 Sadashiv Peth, Pune 30.
- PRAVADA** 1392 Shukrawar Peth, Pune 2.
- PRAVIN MASALEWALE** 1425 Raviwar Peth, Pune 2.
- PRAVIN NOVELTY** 667 Raviwar Peth, Pune 2.
- PUROHIT ELECTRIC GENERAL STORES** 413 Shaniwar Peth, Pune 30.
- R. B. AGARWAL** 1533 Shukrawar Peth, Pune 2.
- R. P. DATAR** 1164 Budhwar Peth, Pune 2.
- RAJAS SUPPLIERS** 1506 Sadashiv Peth, Pune 30.
- RAJENDRA GENERAL STORES** 585 Shaniwar Peth, Pune 30.
- RAJESH TRADERS** 1187 Raviwar Peth, Pune 2.
- RAJHANS NOVELTIES** 1119 Budhwar Peth, Pune 2.
- RAJPUTANA** 629 Shivajinagar, Pune 5.
- RAMBHAGAT P. SOMANI** 610 Raviwar Peth, Pune 2.
- RAMESHWAR KRISHNA DEODHAR** 107 Budhwar Peth, Pune 2.
- RATANCHAND SITARAMJI** 432 Budhwar Peth, Pune 2.
- RUPNIKETAN** 691 Shaniwar Peth, Pune 30.
- S. RAM & CO.** 1482 Shukrawar Peth, Pune 2.
- S. VIRCHAND SHAHA** 1187/66 Shivajinagar, Pune 5.
- SAFE STORES** 1101 Budhwar Peth, Pune 2.
- SAGAR** Shukrawar Peth, Pune 2.
- SANSAR** 1087 Sadashiv Peth, Pune 30.
- SANGITA AGENCY** 581 Sadashiv Peth, Pune 30.
- SAMRAT GENERAL STORES** 1150 Budhwar Peth, Pune 2.
- SAMRAT GENERAL STORES** 1650 Sadashiv Peth, Pune 30.
- SATISH MAHINDRA & CO.** 668 Raviwar Peth, Pune 2.
- SATHE BROS.** 1878 Sadashiv Peth, Pune 30.
- SEASONAL STORES** 506 'A' Shaniwar Peth, Pune 30.
- SELECT MINI STORES** 63/10 Karve Rd., Pune 4.
- SHAH NATWARLAL VITHALDAS** 243 Budhwar Peth, Pune 2.
- SHAH TRADERS** 444 Rasta Peth, Pune 11.
- SHARAD GENERAL STORES** 1274 Shivajinagar, Pune 5.
- SHARADA NOVELTIES** 1161, Budhwar Peth, Pune 2.
- SHARMA CUTLERY STORES** 1650 Shukrawar Peth, Pune 2.
- SHIRAJ** 31 Shukrawar Peth, Pune 2.
- SHRI CHANDRAGURU STORES** 503 Rasta Peth, Pune 11.
- SHRIDHAR N. INAMDAR** 606 Sadashiv Peth, Pune 30.
- SHRIKRISHNA METAL MART** 100 Guruwar Peth, Pune 2.
- SHRIRAM BHANDAR** 1998 Sadashiv Peth, Pune 30.
- SHROFF GENERAL STORES** 455 Raviwar Peth, Pune 2.
- SINDH TRADING CO.** 923 Budhwar Peth, Pune 2.
- SONA NOVELTIES** 725 'B' Shivajinagar, Pune 5.
- SOUBHAGYA ALANKAR STORES** 1126 Budhwar Peth, Pune 2.
- SOUBHAGYA SEETA BHANDAR** 1142 Budhwar Peth, Pune 2.
- SUNIL STORES** 893/6 Shivajinagar, Pune 5.

SUVIDHA 562 Sadashiv Peth, Pune 30.
SUYOG 1180 Budhwar Peth, Pune 2.
SWAGAT Karve Road, Pune 4.
SWASTIK STORES 177 Budhwar Peth, Pune 2.
U. J. SOLANKI 667 Raviwar Peth, Pune 2.
UDAY STATIONERY MART 1622 Shukrawar Peth, Pune 2.
V. B. PATWARDHAN 236 Raviwar Peth, Pune 2.
V. G. GOKHALE 257 Budhwar Peth, Pune 2.
VANGUARD 245 Budhwar Peth, Pune 2.
VARDHAMAN PROVISION STORES 1051 Sadashiv Peth, Pune 30.
VARIETY STORES 613 Sadashiv Peth, Pune 30.
VARMA BOOK CENTRE 649 Shaniwar Peth, Pune 30.
VASANT G. PARASWAR 558 Sadashiv Peth, Pune 30.
VIJAY GENERAL STORES 243 Budhwar Peth, Pune 2.
VIJAY PROVISION STORES 2008 Sadashiv Peth, Pune 30.
VIJAY TRADERS 769/85 Guruwar Peth, Pune 2.
VIJAYA JEWELLERS 1482 Shukrawar Peth, Pune 2.
WOODLAND Deccan Gymkhana, Pune 4.

TELEVISIONS

BHARAT TV :

BHARAT ELECTRONICS LTD. 14 Ramnagar Colony, Pune 21.

CINEVISTA TV :

M. R. BHINGARWALA 1029/2 Laxmi Road, Pune 30.
PAREKH RADIOS Udyog Bhavan, Tilak Road, Pune 2.

CROWN TV :

BAPAT & SONS 480 Narayan Peth, Pune 30.

G.J. GHASIAS & CO. Near Natraj, Deccan Gymkhana, Pune 4.

MAHARASHTRA AGENCIES 52 Budhwar Peth, Pune 2.

DIANORA TV :

SANDEEP ELECTRONICS 743 Budhwar Peth, Pune 2.

ECTV :

ELECTRONIC CORPORATION OF INDIA LTD. 42/9 Karve Road, Pune 4.

J. K. TV :

J. K. TV SALES AND SERVICE 67 Narayan Peth, Pune 30.

STANDARD TV :

HANS RADIOS Pimpri, Pune 18.

PANKAJ GENERAL TRADING CO. Laxmi Road, Pune 30.

TELERAD TV :

APOLLO MUSIC HOUSE 325 M. G. Road, Pune 1.

EMPIRE MUSIC HOUSE 75 M. G. Road, Pune 1.

RHYTHM HOUSE 2/59 New Bazar, Khadki, Pune 3.

ROOPNAAD Karve Road, Pune 4.

SAMARTH RADIO AGENCY Laxmi Road, Pune 2.

TELERAD TV 4/3 Karve Road, Pune 4.

TELEVISTA TV :

AGENTS CORNER 661/A Shivajinagar, Pune 4.

ABDUL REHMAN 3/3 M. G. Road, Pune 1.

K. M. BEHARAY AND CO. 354 Narayan Peth, Laxmi Road, Pune 30.

POONA MUSIC CENTRE 93/1 Budhwar Peth, Pune 2.

POONA RADIO ELECTRIC CORPORATION 611 Sadashiv Peth, Pune 30.

TELEVISTA ELECTRONICS PVT. LTD. 768/9/16 Shivajinagar, Pune 4.

WESTON TV :

MODERN ELECTRONICS 286A Ganesh Peth, opp. Alpna Talkies, Pune 2.

PAIKH ENGINEERING CORPORATION Ganesh Bhavan, S. No. 243 Bombay-Poona Road, Chinchwad, Pune 19.

TEXTILES

NIRMAL TEXTILES 629 Sadashiv Peth, Phadtare Chowk, Pune 30.

GIRISON DISTRIBUTORS 64/C/1 Bombay-Pune Road, Near Shivajinagar Railway Station.

HIND SADI CENTRE Kunte Chowk, Laxmi Road, Pune 30.

MOMSHA 685 Raviwar Peth, Pune 2.

WATCHES

A. DINSHAW & CO. 2 Mahatma Gandhi Road, Pune 1

AMBICA WATCH CO. Govind Halwai Chowk, Pune 2.

ARVIND WATCH CO. New Bazar, Khadki, Pune 3

ASHOK WATCH CO. Opp. Gokhale Hall, Laxmi Road, Pune 30.

BASTA WATCH CO. Near Shrinath Talkies, Pune 2.

BELL & CO. 220 Budhwar Peth, Pune 2.

BEST WATCH CO. Budhwar Peth, Laxmi Road, Pune 2.

BUNDER WATCH CO. 61 M. G. Road, Pune 1.

C. T. PUNDOLE & SONS M. G. Road, Pune 1.

CAMP WATCH TRADERS M. G. Road, Pune 1.

CENTRAL WATCH CO. Bajirao Road, Pune 30.

CHOICE WATCH CO. Budhwar Peth, Pune 2.

CITY WATCH HOUSE Near Datta Mandur, Pune 2.

CORNER WATCH CO. Rameshwar Chowk, Shukrawar Peth, Pune 2.

DANTALE WATCH CO. Sonya Maruti Chowk, Pune 2.

DECCAN WATCH CO. 731 Budhwar Peth, Pune 2.

DEEPAK OPTICAL & LENS Laxmi Road, Pune 2.

DEEPAK WATCH CO. & GENERAL STORES Near Vijay Talkies, Pune 30.

DERBY WATCH HOUSE 240 Budhwar Peth, Pune 2.

DIAMOND WATCH CO. Budhwar Peth, Pune 2.

DIAMOND WATCH CO. Deccan Gymkhana, Pune 4.

- ERA WATCH CO. Laxmi Road, Pune 30.
- FERGUSSON WATCH CO. Deccan Gymkhana, Pune 4.
- GOOD LUCK WATCH CO. Budhwar Peth, Pune 2.
- HINDUSTAN WATCH CO. Laxmi Road, Pune 2.
- HINDVIJAY WATCH CO. Budhwar Peth, Pune 2.
- HIND WATCH CO. Budhwar Peth, Pune 2.
- IJANTAKAR WATCH CO. Near Sambhaji Bridge, Pune 30.
- INDIAN WATCH CO. Centre Street, Pune 1.
- JAI WATCH CO. Laxmi Road, Pune 2.
- K. D. CHANDAK & SONS 390 Budhwar Peth, Pune 2.
- KAMAL WATCH HOUSE Raviwar Peth, Pune 2.
- MADHU WATCH CO. Near Alpana Talkies, Pune 2.
- MAHAMAYA WATCH HOUSE Raviwar Peth, Pune 2.
- MAHESH BROS. 218 Rasta Peth, Pune 11.
- MASTER SALES CORPORATION Ganj Peth, Pune 2.
- MODERN WATCH CO. M. G. Road, Pune 1.
- N. RUSTOMJI & SONS M. G. Road, Pune 1.
- NAGPURKAR WATCH CO. Budhwar Peth, Pune 2.
- NEW DIAMOND WATCH CO. Khadki, Pune 3.
- NILAM WATCH CO. Laxmi Road, Pune 30.
- NITU WATCH CO. Ghorpadi, Pune 1.
- P. G. KANITKAR & CO. Chimanbag, Tilak Road, Pune 30.
- POONA WATCH CO. Saraswati Vilas, Laxmi Road, Pune 30.
- POPULAR WATCH CO. 732 Budhwar Peth, Laxmi Road, Pune 2.
- PRAKASH WATCH CO. Budhwar Peth, Pune 2.
- PUNDOLE ENTERPRISES M. G. Road, Pune 1.
- RANADE TIME INSTRUMENTS Narayan Peth, Laxmi Road, Pune 30.
- RUBY INDUSTRIES Khadki, Pune 3.
- SAIFEE WATCH CO. M. G. Road, Pune 1.
- SARDAR WATCH CO. Khadki, Pune 3.
- SHARAD WATCH CO. Somwar Peth, Pune 11.
- SHRI PRASAD WATCH CO. Near Sambhaji Bridge, Pune 30.
- STANDARD WATCH CO. M. G. Road, Pune 1.
- STAR WATCH CO. & PEARL CO. Saraswati Vilas, Pune 30.
- SUNDER WATCH CO. Budhwar Peth, Pune 2.
- TARKAR WATCH CO. Khadki, Pune 3.
- TILAK WATCH CO. Near Datta Mandir, Pune 2.
- VASANT WATCH CO. Near Shani par, Sadashiv Peth, Pune 30.
- VASUDEO WATCH CO. Tilak Road, Pune 30.
- VIJAY WATCH CO. 713 Narayan Peth, Pune 30.
- YESHWANT SHOPPING CENTRE Budhwar Peth, Pune 2.

MISCELLANEOUS**AGRICULTURAL PRODUCE :**

KRISHI UTPADAN BAJAR SAMITI Poona Market
Yard, Gultekadi, Pune 9.

ASBESTOS SHEETS & CEMENT TILES :

RASHID KHODADAD & CO. Thumayya Road, Pune 1.

BROILERS :

BORAWAKE D. N. Sakhunandan, 37 Deccan Gymkhana,
Pune 4.

COAL & COKE :

MEHER MANJI & CO. 200 Mangalwar Peth, Pune 11.

EDIBLE OIL :

JAIHIND OIL MILLS 678 Shukrawar Peth, Pune 2.

L. P. GAS :

L. D. BHAVE & CO. 1258B Shivajinagar, opp. Natraj
Talkies, Pune 4.

MANGO PLANTS & FRUITS :

DESAI S. R. C/o Desai Bandhu Ambewale, 1483 Shu-
krawar Peth, Pune 2.

FLOUR WHEAT :

ALSALES LTD. Western India Flour Mills, 103/104
Hadapsar Ind. Estate, Pune 13.

Associations, Trade Unions & Govt. Offices

Associations
Trade Unions
Important
Government Offices

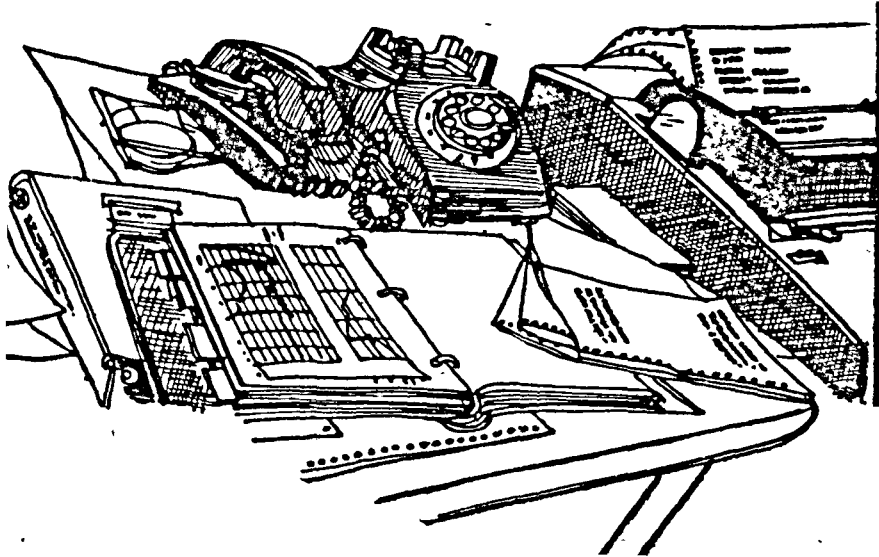

**ASSOCIATIONS
TRADE UNIONS &
GOVT. OFFICES**

- I. Associations
- II. Trade Unions
- III. Government Offices
 - Central
 - State
 - Municipal Offices
 - Financial Corporations
 - Other Important Offices

Effort has been made to cover all trade associations trade unions and important Government Offices in Pune.

ASSOCIATIONS

- ALL-INDIA BEE KEEPERS' ASSOCIATION** 727 Sadashiv Peth, Pune 30.
- ARCHITECTS' ASSOCIATION** C/o J. V. Gandhe, Indraprasth, 513/1 Shivajinagar, Pune 5.
- BRASS AND COPPER MERCHANTS' ASSOCIATION** 167 Guruwar Peth, Pune 2.
- BUILDERS' ASSOCIATION OF INDIA** Rajendra Sinhaji Road, Pune 1.
- DECCAN SUGAR TECHNOLOGISTS' ASSOCIATION** Opp. Shivajinagar Bus Stand, Shivajinagar, Pune 5.
- INDIAN MEDICAL ASSOCIATION** 60/61 Tilak Raod, Pune 2.
- INDIAN PHARMACEUTICAL ASSOCIATION** (Pune Branch) C/o. Godbole Joshi & Co 257-C Budhwar Peth, Pune 2.
- MAHARASHTRA RAJYA ALOHIT DHATU GHADKAM VIDHAYAK SANGH** 817 (New) Budhwar Peth, Pune 2.
- MAHARASHTRA SCHOOL BOOKS PUBLISHERS' ASSOCIATION** 2040 Sadashiv Peth, Tilak Road, Pune 30.
- POONA BRANCH OF THE WESTERN INDIA REGIONAL COUNCIL OF THE INSTITUTE OF CHARTERED ACCOUNTANTS OF INDIA** C/o. Bhide, Palnitkar, Shah, C. A., Vishal Apartments, opp. Shuvaji Mandir, 1025 Sadashiv Peth, Pune 30.
- POONA CHEMISTS' & DRUGISTS' ASSOCIATION** 90 Budhwar Peth, Pune 2
- POONA COCONUT MERCHANTS' ASSOCIATION** 1382 Raviwar Peth, Pune 2.
- POONA CYCLE HIRERS' AND REPAIRERS' ASSOCIATION** 1436 Shukrawar Peth, Pune 2.
- POONA DISTRICT BAKERY PRODUCTS MANUFACTURERS' ASSOCIATION** 201 Mangalwar Peth, Pune 11.
- POONA ELECTRICAL MERCHANTS' ASSOCIATION** (1) C/o. Rattan Electricals, 550 Narayan Peth, Pune 30.(2) Secretary, P. B. No. 527, Pune 2.
- POONA HOSIERY MANUFACTURERS' ASSOCIATION** 264 Shaniwar Peth, Pune 30.
- POONA IRON & STEEL HARDWARE MERCHANTS' ASSOCIATION** 926 Budhwar Peth, Pune 2.
- POONA KIRANA MERCHANTS' ASSOCIATION** 786 Sadashiv Peth, Pune 30.
- POONA KIRANA BHUSAR VYAPARI ASSOCIATION** 205 Ganesh Peth, Pune 2.
- POONA MANAGEMENT ASSOCIATION** 1332 Shivajinagar, Pune 5.
- POONA MERCHANTS' CHAMBER** 185 Bhawani Peth, Pune 2.
- POONA MOTOR DEALERS' ASSOCIATION** C/o. The Ram Agency, 458/2 Tilak Road, Pune 30.
- POONA MOTOR GOODS TRANSPORT AGENTS' ASSOCIATION** 1350 Bhawani Peth, Pune 2.
- POONA PAPER TRADERS' ASSOCIATION** C/o. Jupiter Paper Mart, 387 Raviwar Peth, Shroff Bazar, Pune 2.
- POONA PRESS OWNERS' ASSOCIATION** Mudran Bhavan, 1078 Sadashiv Peth, Pune 30.
- POONA TIMBER MERCHANTS & SAW MILL OWNERS' ASSOCIATION** 5/A New Timber Market, Pune 2.
- PUNE BOOKSELLERS' ASSOCIATION** C/o Hindustan Sahitya, 309 Shaniwar Peth, Pune 30.
- PUNE EXERCISE BOOKS MANUFACTURERS' ASSOCIATION** 18/19 Raviwar Peth, Pune 2.
- PUNE WATCH DEALERS' ASSOCIATION** 844 Budhwar Peth, Laxmi Road, Pune 2.

SPUN PIPE MANUFACTURERS' ASSOCIATION OF MAHARASHTRA 'Shradha', Opp. Octroi Naka, Satara Road, Pune 9.

STATIONERY CUTLERY & GENERAL MERCHANTS' ASSOCIATION 794 Sadashiv Peth, Pune 30.

STEEL STOCK HOLDERS' SYNDICATE 198 Ganesh Peth, Pune 2.

WESTERN INDIA AUTOMOBILE ASSOCIATION 6 Moledina Road, Pune 1.

TRADE UNIONS

A.S.C. WORKERS' UNION 70 Market Road, Khadki, Pune 3.

ABHI CHEMICAL PHARMACEUTICAL WORKERS' UNION Nehru Nagar, Ghodake Chawl, Pimpri, Pune 18.

ADVANI OERLIKON EMPLOYEES' UNION 8/6 Kalbhor Nagar, Akurdi, Pune 35.

AIR FORCE CIVILIAN EMPLOYEES' UNION 284/2 Somwar Peth, Pune 2.

AKHIL MANDAI MANDAL KAMGAR UNION Lanke Wada, Shukrawar Peth, Pune 2.

ALL-INDIA DEFENCE CANTEEN EMPLOYEES' UNION 70 Market Road, Pune 3.

✓
AMMUNITION FACTORY MAZDOOR UNION Khadki Block Congress Committee, M. G. Road, Khadki, Pune 3.

AMMUNITION FACTORY SAURAKSHAN KAMGAR SANGHATANA 57/6 Dhobi Galli, Old Bazar, Khadki, Pune 3.

✓
AMMUNITION FACTORY WORKERS' UNION 479 Old Bazar, Khadki, Pune 3.

LD., 26

AMPHETRONICS EMPLOYEES' UNION 779 Dastur Meher Road, Pune 1.

ARLABS EMPLOYEES' UNION 185 Shanwar Peth, Pune 30.

ARMY MEDICAL CORPS CIVILIAN EMPLOYEES' UNION 54 Budhwar Peth, Pune 2.

ARMY SCHOOL OF PHYSICAL TRAINING CIVILIAN WORKERS' UNION 2397 Solapur Road, Pune 1.

ARUDYOG KAMGAR SANGH 1434 Shukrawar Peth, Pune 2.

ASSOCIATED BEARING CO. EMPLOYEES' UNION Chinchwad, Pune 19.

THE ASSOCIATION OF CHEMICAL WORKERS, PUNE Congress House, Shivajinagar, Pune 5.

ASSOCIATION OF THE CIVILIAN EMPLOYEES OF THE 512 COMMAND & L.E.M.E. WORKSHOP 70 Market Road, Khadki, Pune 3.

THE ASSOCIATION OF THE WORKERS OF CENTRAL WATER & POWER RESEARCH STATION 373 Kasba Peth, Pawale Chowk, Pune 11.

ASSOCIATION OF JUNIOR ARTISTS 248 Somwar Peth, Pune 11.

ASSOCIATION OF 'SCIENTIFIC WORKERS' ORDINANCE ESTABLISHMENT Joglekar Quarters, Pune 4.

ATLAS COPCO KAMGAR SANGHATANA 'Sveanagar Dapodi, Pune 12.

AUDYOGIK KAMGAR SANGHATANA Deluxe Talkies, Bldg, Pimpri Colony, Pune 17.

AUTOMOTIVE SERVICES WORKERS' UNION 1271 opp. Deccan Gymkhana Post Office, Pune 4.

AYURVEDIYA AUSHADHI KAMGAR SABHA 546 Shaniwar Peth, Pune 30.

No. 9 B.R.D. AIR FORCE CIVILIANS' UNION Anusaya Sadan, Chandan Nagar, Pune 14.

BAJAJ AUTO KAMGAR SANGHATANA 479 Old Bazar, Khadki, Pune 3.

- BAJAJ TEMPO CONVOY DRIVERS' UNION** Bagal Chawl, Datta Wadi, Akurdi, Pune 35.
- BANK KARMACHARI SANGH** 1721 Shukrawar Peth, Pune 2.
- BANK OF MAHARASHTRA OFFICERS' ORGANIZATION** 617 Shaniwar Peth, opp. Laxmi Krida Mandir, Pune 30.
- BHARAT FORGE EMPLOYEES' UNION** 75 Ghorpadi Gaon, Pune 1.
- BHARAT FORGE KAMGAR SANGH** 185 Shaniwar Peth, Pune 30.
- BHARATIYA SANRAKSHAN KAMGAR SANGH D. O. D.** Talegaon Dabhade, 185 Shaniwar Peth, Pune 30.
- BHARATIYA SAMRAKSHAN KAMGAR SANGH** 866 Sadashiv Peth, Pune 30.
- BHARATIYA SANRAKSHAN KAMGAR SANGH C. O. D.** Dehu, 185 Shaniwar Peth, Pune 30.
- BOMBAY STATE HUME PIPE KAMGAR SABHA** 491 Raviwar Peth, Moti Chowk, Pune 2.
- BUCKAU WOLF WORKERS' UNION** Station Road, Near Pimpri Railway Station, Pimpri, Pune 18.
- C.A.F.V.D. KAMGAR UNION** 55 Juna Bazar, Khadki, Pune 3.
- C & G KAMGAR UNION** 203 Dapodi, Pune 12.
- C.I.S.V. CIVILIAN EMPLOYEES' UNION** Gokul Nivas, Talegaon Dabhade, Dist. Pune.
- C.M.E. WORKERS' UNION** Trade Union Centre, 101 Shivajinagar, Pune 5.
- C.W. & P.R.S. KAMGAR SABHA** Kakakuwa Mansion, 54 Budhwar Peth, Pune 2.
- CANTEEN WORKERS UNION** B Block, 10/3 Pimpri Colony, Pune 17.
- CANTONMENT BOARD DEHU ROAD WORKERS' UNION** 166 New Bazar, Dehu Road, Dist. Pune.
- CANTONMENT BOARD EMPLOYEES' UNION** 17 Frere Road, Khadki, Pune 3.
- CANTONMENT BOARD SEVAK SANGH** 866 Sadashiv Peth, Tarachand Market, Pune 30.
- CENTRAL BANK EMPLOYEES' CONGRESS (PUNE DIVISION)** 2044/49 Sahyadri Sadan, Tilak Road, Pune 30.
- CENTRAL BANK OFFICERS' ASSOCIATION** Central Bank of India, Staff Training Centre, Ganeshkhind, Pune 16.
- CENTRAL BANK OF INDIA EMPLOYEES' ASSOCIATION** 1768 Shukrawar Peth, Pune 2.
- CENTRAL ORDNANCE DEPOT WORKERS' UNION** 116 New Bazar, Dehu Road, Dist. Pune.
- CENTURY ENKA KAMGAR SABHA** Bhosari, Pune 26.
- CENTURY ENKA MAZDOOR SABHA** A-192 H. A. Colony, Pimpri, Pune 18.
- CHAKRADHARI MAHAMANDAL** 356 Somwar Peth, Pune 11.
- CHEMICAL KAMGAR SANGH** 866 Sadashiv Peth, Pune 30.
- THE CHEMICAL WORKERS' UNION** 327/28 Kasba Peth, Pune 11.
- CHIEF INSPECTORATE OF ARMAMENT EMPLOYEES' UNION** 70 Market Road, Khadki, Pune 3.
- CHIEF INSPECTOR OF MILITARY EXPLOSIVES EMPLOYEES UNION** 70 Market Road, Khadki, Pune 3.
- CLERICAL STAFF ASSOCIATION (A.R.D.E.)** Armament Research & Development Establishment, Pashan, Pune 8.
- CONTRACT WORKERS' UNION** Nath Kripa, Mitra Mandal Colony, Pune 9.
- CONTROLLERATE OF INSPECTION (AMMUNITION) EMPLOYEES' UNION** 70 Market Road, Khadki, Pune 3.
- CO-OPERATIVE BANK WORKERS' SANGH** 134 Narayan Peth, Manishalaya, Pune 30.

- COOPER ENGINEERING (MACHINE) TOOLS KAMGAR SANGH** 506 Phugewadi, Pune 12.
- DAI ICHI STAFF ASSOCIATION** Trade Union Centre, 101 Shivajinagar, Pune 5.
- DAINIK TARUN BHARAT & HINDUSTAN MUDRAN KAMGAR SANGH** 469 Raviwar Peth, Pune 2.
- DAIRY DEVELOPMENT EMPLOYEES' ASSOCIATION** 437-C Narayan Peth, Pune 30.
- DALCO WORKERS' UNION** Pimpri, Pune 18.
- DEHU AMMUNITION DEPOT WORKERS' UNION** 116 New Bazar, Dehu Road, Dist. Pune.
- DEHU VEHICLE DEPOT KAMGAR UNION** 54 Budhwar Peth, Pune 2.
- DENA BANK OFFICERS' ASSOCIATION** Pune Region, 615 Budhwar Peth, Pune 2.
- DIVGI METAL WARES EMPLOYEES' ASSOCIATION** 1314 Raviwar Peth, Pune 2.
- DR. BECK EMPLOYEES' UNION** 207 Sant Tukaram Nagar, Pimpri, Pune 18.
- E.S.L.S. HOSPITAL KAMGAR SENA** 317/1 Bopodi, Pune 12.
- ELECTRIC SUPERVISORS' ASSOCIATION** 776 Bhawani Peth, Pune 2.
- ENGINEERING & GENERAL WORKERS' TRADE UNION** No. 1 H. A. Colony, Paud Phata, Karve Road, Pune 4.
- ENGINEERING KAMGAR SANGH** 866 Sadashiv Peth, Pune 30.
- THE ENGINEERING STORES DEPOT KAMKARI SANGH** New Bazar, Dehu Road, Dist. Pune.
- FINOLEX PLASTICS EMPLOYEES' UNION** Finolex Plastics Pvt. Ltd., Bombay-Poona Road, Pimpri, Pune 18.
- GAS WORKERS' UNION** 27/219 Maharshi Nagar, Pune 9.
- GENERAL & ENGINEERING KAMGAR SANGHATANA** Congress House, Pune 5.
- GENERAL & ENGINEERING WORKERS' TRADE UNION** 475 Kasba Peth, Pune 11.
- THE GENERAL ENGINEERING & METAL WORKERS' UNION** 327-28 Kasba Peth, Pune 11.
- GIRANI KAMGAR SANGHATANA** Congress House, Pune 5.
- GLASS & CHEMICAL MAZDOOR SABHA** 491 Raviwar Peth, Pune 2.
- GOVERNMENT MILK SUPPLY SCHEME KAMGAR SABHA** 54 Budhwar Peth, Pune 2.
- GOVERNMENT PHOTO ZINCO PRESS RASHTRIYA WORKERS' UNION** 93B Kasba Peth, Pune 11.
- THE GOVERNMENT PRESS EMPLOYEES' UNION** C/o. Photozinco Press, 5 Finance Road, Pune 1.
- GOVERNMENT PRINTING PRESS RASHTRIYA KAMGAR SANGH** New Press Staff Colony, Block No 4, Yerawada, Pune 6.
- HAFFKINE INSTITUTE KAMGAR SANGH** Pimpri, Pune 18.
- HAMAL PANCHAYAT** 135 Nana Peth, Pune 2.
- HANDLOOM KAMGAR UNION** 327/28 Kasba Peth, Pune 11.
- HAVELI TALUKA SAKHAR KAMGAR SABHA** 54 Budhwar Peth, Pune 2.
- HIGH EXPLOSIVES FACTORY SWATANTRA KAMGAR UNION** 228/90 Mangalwar Peth, Pune 11.
- HIGH EXPLOSIVES FACTORY WORKERS' UNION** 70 Market Road, Khadki, Pune 3.
- HIND CONDENSOR MAZDOOR SANGH** 209 Bombay-Poona Road, Pimpri, Pune 18.
- HIND OIL KAMGAR SABHA** 54 Budhwar Peth, Kakakuwa Mansion, Laxmi Road, Pune 2.
- HINDUSTAN ANTIBIOTICS MAZDOOR SANGH** A-8 H. A. Colony, Pimpri, Pune 18.

- HORSTMANN INDIA KAMGAR SANGHATANA** Geetabai Patil Chawl, Vadgaon Sheri, Pune 14.
- HOSPITAL KARMACHARI UNION** 327/28 Kasba Peth, Pune 11.
- HOTEL KAMGAR UNION** 327/28 Kasba Peth, Pune 11.
- HUNDEKARI GOODS TRANSPORT SERVICE WORKERS' UNION** 117 Parvati Gaon, Pune 9.
- I.A.F. KAMGAR UNION** 211 New Khadki, Yerawada, Pune 6.
- I.C.L. (I) MANUFACTURING LTD. EMPLOYEES' UNION** 681 Taboot Street, Pune 1.
- I.C.L. EMPLOYEES' ASSOCIATION** 10 Frere Road, Pune 1.
- INCAB EMPLOYEES' ASSOCIATION (PUNE WORKS)** H. A. Employees Colony, Poud Phata, Karve Road, Pune 4.
- INDIAN CABLE EMPLOYEES' UNION** Indian Cable Industries, Bombay-Pune Road, Pimpri, Pune 18.
- INDIAN CARD CLOTHING MAZDOOR SABHA** 491 Raviwar Peth, Pune 2.
- INDIAN ORDNANCE & CLOTHING FACTORIES EX-APPRENTICES ASSOCIATION** 18 Aundh Road, Khadki, Pune 3.
- INSURANCE CORPORATION EMPLOYEES' UNION** River Side, Pimpri, Colony, Pune 17.
- INSURANCE EMPLOYEES' UNION, POONA DIV.** 567 Sadashiv Peth, Pioneer House, Pune 2.
- IRRIGATION DEPT. WORKSHOP TECHNICAL WORKERS' NON-GAZETTED OFFICERS' SAMANVAY SAMITI** 416 Kindre Niwas, Dapodi, Pune 12.
- J. G. GLASS KAMGAR SANGH** 185 Shanwar Peth, Pune 30.
- J. G. GLASS WORKERS' UNION** Post Pimpri Gaon, Pune 17.
- JG WORKERS' UNION** 180 Shivajinagar, Pune 5.
- JANATA KAMGAR SANGH** Inspectorate of Armaments, 8 Mula Road, Khadki, Pune 3.
- JUNIOR FILM ARTISTS' ASSOCIATION** Alankar Cinema Bldg., North Wing, 2nd floor, 16 Wasvani Road, Pune 1.
- K.C.L. STAFF ASSOCIATION** 406 Shukrawar Peth, Pune 2.
- K.S.B. EMPLOYEES' ASSOCIATION** 13/2 'C' Type Range Hills, Khadki, Pune 3.
- K.S.B. MAZDOOR UNION** 479 Old Bazar, Khadki, Pune 3.
- K.S.B. PUMPS EMPLOYEES' UNION** 419 Raviwar Peth, Pune 2.
- KALYANI STEELS KAMGAR SANGHATANA** Kalyani Steels Ltd., Mundhwa, Pune 36.
- KAPAD KAMGAR UNION** 101 Shivajinagar, Pune 5.
- KAPAD KARKHANA KAMGAR SANGH** 124/1 Mangalwar Peth, Pune 2.
- KADABA VAHATUK KAMGAR SABHA** 228 Mangalwar Peth, Pune 11.
- KAMDHENU PESTICIDES WORKERS' UNION** 50/A Hadapsar Industrial Estate, Pune 13.
- KESARI MAHRATHA KAMGAR UNION** 298 Budhwar Peth, Pune 2.
- KHADKI CANTONMENT KAMGAR SANGH** 1388 Bhipura, Pune 1.
- KHADKI CHINCHWAD SWASTIK RUBBER PRODUCTS KAMGAR SANGH P.W.D.** Quarters, Bungalow No. 12, Dapodi, Pune 12.
- KHOSLA GROUP KAMGAR UNION** 47 Bombay-Poona Road, Khadki, Pune 3.
- KIRLOSAR CUMMINS EMPLOYEES' UNION** 749 Kasba Peth, Pune 11.
- KIRLOSAR FILTER EMPLOYEES' UNION** 31 Erandawana, Pune 4.
- KIRLOSAR KAMGAR SANGH** 866 Sadashiv Peth, Pune 30.

- KIRLOSKAR KISAN EMPLOYEES' UNION** 739
Kasba Peth, Pune 11.
- KIRLOSKAR PNEUMATIC EMPLOYEES' UNION**
727 Kasba Peth, Pune 11.
- KIRLOSKAR PNEUMATIC KAMGAR SANGH** 791
Bhawani Peth, Pune 2.
- KUKKUT PALAN KAMGAR SANGH** 866 Sadashiv
Peth, Pune 30.
- LALWANI & SUPERCANE WORKERS' UNION** No.
12 Harpale Chawl, Hadapsar, Pune 28.
- LA SPRING KAMGAR UNION** Bombay-Poona Road,
Chichwad, Pune 18.
- LOKMANYA KAMGAR SANGH** (Talegaon Dabhade),
866 Sadashiv Peth, Tarachand Market, Pune 30.
- M.E.S. EMPLOYEES' UNION** 568 Shaniwar Peth,
Pune 30.
- M. T. STORE SUB-DEPOT WORKERS' UNION** 70
Market Road, Khadki, Pune 3.
- MADHAV CAPACITORS KAMGAR UNION** 1/3 Sant
Tukaram Nagar, Pimpri, Pune 18.
- MADHYAMIK PARIKSHA MANDAL KAMGAR
SANGH** Congress House, Pune 5.
- MADHYAWARTI MANORIGNALAYA KAMGAR
SANGH** Vishrantwadi, 113/8 Alandi Road, Pune 15.
- MAHANAGARPALIKA BACKWARD CLASS WORK-
ERS' UNION** M.N.P. P.M.T. School Board, 337 A,
Mangalwar Peth, Pune 11.
- MAHINDRA OWEN STAFF UNION** 101 Shivajinagar,
Pune 5.
- MAHARASHTRA LEATHER TANNERY WORKERS'
UNION** Khandare Chawl, Kasarwadi, Pune 18.
- MAHARASHTRA REGION BANK OF BARODA
EMPLOYEES' UNION** 32 Karve Road, Pune 4.
- MAHARASHTRA RAJYA JILHA PARISHAD KRISHI
PADVIDHAR KARMACHARI SANGHATANA** Jilha
Parishad, Pune 11.
- MAHARASHTRA RAJYA JILHA PARISHAD
TANTRIK SEVA SANGHATANA** 180 Rasta Peth,
Pune 11.
- MAHARASHTRA RAJYA RASTA, VEEJ, PATBAN-
DHARE KAMGAR SANGH** 866 Sadashiv Peth, Pune 30.
- MAHARASHTRA RAJYA SHETI MAHAMANDAL
KARMACHARI SANGH** 101 Shivajinagar, Pune 5.
- MAHARASHTRA RAJYA SHRAMIK SANGH** Con-
gress House, Pune 5.
- MAHARASHTRA RAJYA VEEJ MANDAL NOKAR
SANGH** 101 Shivajinagar, Pune 5.
- MAHARASHTRA RAJYA VEEJ PATBANDHARE
KAMGAR SANGH** Congress House, Pune 5.
- MAHARASHTRA RAJYA VIDI KAMGAR SANGH**
185 Shanwar Peth, Pune 30.
- MAHARASHTRA SHRAMIK SEVAK SANGH** 545/P.
M.T. /A/3, Bhawani Peth, Pune 2.
- THE MAHARASHTRA STATE CO-OPERATIVE
UNION EMPLOYEES' ASSOCIATION** Sahakari
Vidyalaya, B. J. Road, Pune 1.
- MAHARASHTRA STATE GOVERNMENT EMPLO-
YEEES' NURSES' ASSOCIATION** 207/2 Mangalwar
Peth, Pune 2.
- MAHARASHTRA STATE ROAD TRANSPORT COR-
PORATION MINISTERIAL STAFF ASSOCIATION**
865 Sadashiv Peth, Pune 30.
- MAHARASHTRA STATE ROAD TRANSPORT
(THIRD CLASS) SECURITY WORKERS' UNION**
Central Workshop Compound, Dapodi, Pune 12.
- MAHARASHTRA STATE TRANSPORT MAZDOOR
SABHA** 54 Budhwar Peth, Kakakuwa Mansion, Pune 2.
- MAHARASHTRA STATE WARE HOUSING CORPO-
RATION KARMACHARI SANGH** 318 Narayan Peth,
Pune 30.
- MAHARASHTRA VEEJ KAMGAR MAHASANGH** 185
Shaniwar Peth, Pune 30.
- MAHARASHTRA VEEJ MANDAL KAMGAR SANGH**
866 Sadashiv Peth, Pune 30.

- MAHATMA PHULE MARKET KANDA BATATA VYAPARI ASSOCIATION** Gala No. 419, Mahatma Phule Market, Pune 2.
- MAHATMA PHULE MARKET VEGETABLE TRADERS' UNION** Mahatma Phule Market, Ganpati Mandir, Pune 2.
- MAHINDRA & MAHINDRA EMPLOYEES' UNION** 1433 Shukrawar Peth, Pune 2.
- MAHINDRA ELECTRO CHEMICAL PRODUCTS EMPLOYEES' UNION** Pimpri, Pune 18.
- MAHINDRA EMPLOYEES' UNION** 479 Old Bazar, Khadki, Pune 3.
- MAHINDRA OWEN EMPLOYEES' UNION** 101 Shivajinagar, Pune 5.
- MAHINDRA SINTERED EMPLOYEES' UNION** Kharadwadi, Near Primary School, Pune 18.
- MANJRI FARM KAMGAR UNION** Ghorpade Peth, Pune Municipal Colony, Room No. 134, 'L' Block, Pune 2.
- MARC-ZIP SHRAMIK SANGH** Mula Road, No. 8, Khadki, Pune 3.
- THE MARSHALL GROUP INDUSTRIES EMPLOYEES' UNION** 583 Tilak Road, Pune 30.
- MATADOR CONVOY DRIVERS' UNION** C/o. L.A. Gawade, Chinchwad Station, Chinchwad, Pune 19.
- MAVAL TALUKA KAMGAR SANGH** 866 Sadashiv Peth, Pune 30.
- MEHTA PACKARD AND PAPERTAKE WORKERS' UNION** No. 12 Harpale Bldg., Gadi Tal, Hadapsar, Pune 28.
- MILAN SHOE COMPANY KAMGAR SANGH** 506 Phugewadi, Pune 12.
- MILITARY DAIRY FARM CIVILIAN WORKERS' UNION** 54 Budhwar Peth, Pune 2
- MUNDHWA PAPER MILLS KAMGAR SANGH** 1241 Mangalwar Peth, Pune 11.
- MUNICIPAL MAZDOOR SABHA** 54 Budhwar Peth, Laxmi Road, Pune 2.
- ORDNANCE DEPOT INDUSTRIAL WORKERS' UNION** 960 Budhwar Peth, Talegaon Dabhade, Dist. Pune
- ORDNANCE DEPOT WORKERS' UNION** (Talegaon Dabhade,) Kakakuwa Mansion, 54 Budhwar Peth, Pune 2.
- NATIONAL DEFENCE EMPLOYEES' ASSOCIATION** High Explosive Factory, 102/9 Range Hills, Khadki, Pune 3.
- NATIONAL DEFENCE EMPLOYEES' UNION** 93B Kasba Peth, Pune 2.
- NATIONAL DEFENCE EMPLOYEES' UNION** Artificial Limbs Centre, 430 Somwar Peth, Pune 11.
- NATIONAL DEFENCE EMPLOYEES' UNION** Research and Development Establishment (Engineers), Dighi, Pune 15.
- NATIONAL DEFENCE EMPLOYEES' UNION** Explosive Research, Development Laboratory, Pashan, 12/3 'H' Type, Range Hills, Khadki, Pune 3.
- NATIONAL DEFENCE KAMGAR UNION** 430 Somwar Peth, Pune 11.
- NATIONAL DEFENCE KARMACHARI UNION** C.I. (M.E.) 430 Somwar Peth, Pune 11.
- NATIONAL DEFENCE WORKERS' UNION** 512 Command Workshop, 93-B Kasba Peth, Pune 11.
- NATIONAL WORKERS' UNION** E.S.T. Dehu Road, 91 Main Bazar, Dehu Road, Dist. Pune.
- NAVNAGARPALIKA KAMGAR AAGHADI PIMPRI CHINCHWAD** Deluxe Talkies Bldg., Pimpri, Pune 17
- P.C.M.T. KAMGAR AAGHADI** Deluxe Talkies Bldg., Pimpri Colony, Pune 17.
- P.M.C. EMPLOYEES' UNION** Trade Union Centre 101 Shivajinagar, Pune 5.
- P.M.T. BACKWARD CLASS LABOUR UNION** 357/721 Ghorpade Peth, Pune 2.
- P.M.T. KAMGAR SANGH** House No. 740/2, 2nd floor, Raviwar Peth, Pune 2.

- PANI PURAVATHA DRAINAGE KAMGAR SANGH** Congress House, Pune 5.
- PATHEJA KAMGAR SANGH** 188 Dapodi, Pune 12.
- PHADKE HOUD AUTO RIKSHA DRIVERS' ASSOCIATION** 791 Kasba Peth, Pune 11.
- PHIJIJS EMPLOYEES' UNION** 635-36 Sadashiv Peth, Vijaynagar Colony, Pune 30.
- PHILIPS WORKERS' UNION PIMPRI** 163 Shukrawar Peth, Shinde Ali, Pune 2.
- PHOTO REGISTRY KAMGAR SANGH** 5 Finance Road, Pune 1.
- PHOTO REGISTRY KAMGAR UNION** Government Photo Registry Office, Pune 1.
- PIMPRI CHINCHWAD NAV NAGARPALIKA KARMACHARI SANGH** Pimpri, Pune 18.
- THE POONA BIDI MANUFACTURERS' ASSOCIATION** 29 Ganesh Peth, Pune 2.
- THE POONA CANTONMENT KAMGAR SANGH** 1388 Bhimpura, Camp, Pune 1.
- THE POONA CYCLE HIRE AND REPAIRERS' ASSOCIATION** 841 Sadashiv Peth, Pune 30.
- POONA DAL MILL WORKERS' UNION** 71 Hadapsar Industrial, Estate, Pune 13.
- THE POONA DISTRICT HOSPITALS DISPENSARIES STAFF & NURSES' ASSOCIATION** 1567/68 Sadashiv Peth, Pune 30.
- POONA DISTRICT STATE GOVERNMENT INDUSTRIAL EMPLOYEES' UNION** 650 Shurkarwar Peth, Pune 2.
- POONA DIVISION INSURANCE WORKERS' ORGANISATION** 185 Shaniwar Peth, Pune 30.
- POONA GENERAL WORKERS' UNION** No. 12 Elphinston Road, Khadki, Pune 3.
- POONA GIRNI KAMGAR UNION** 1241 Mangalwar Peth, Pune 2.
- POONA HAWKERS' ASSOCIATION** 1388 Bhimpura, Pune 1.
- PUNE CANTONMENT AUTO RIKSHA DRIVERS' SANGHATANA** 62 M. G. Road, Pune 7.
- PUNE CANTONMENT AUTO RIKSHA OWNERS' ASSOCIATION** 62 M. G. Road, Pune 1.
- PUNE CANTONMENT KARMACHARI SANGH** Room No 11, Coach House, Kawale Road, Pune 1.
- PUNE DISTRICT CENTRAL LABOUR UNION B** Block, 10/3 Pimpri Colony, Pimpri, Pune 18.
- PUNE GENERAL EMPLOYEES' UNION** 327/28 Kasba Peth, Near Phadke Houd, Pune 2.
- PUNE JILHA BAKERS' ASSOCIATION** 201 Mangalwar Peth, Pune 11.
- PUNE JILHA IMARAT, DALANVALAN & PAT-BANDHARE KAMGAR UNION** Trade Union Centre, 101 Shivajinagar, Pune 5.
- PUNE JILHA KAMGAR SEVA SANGHATANA** Plot 10, S. No. 498, Ashoknagar Colony, Bhawani Peth, Pune 2.
- PUNE JILHA KAMGAR SANGH** 185 Shaniwar Peth, Pune 30.
- PUNE JILHA LAL BAVTA MUNICIPAL KAMGAR UNION** 327/28 Kasba Peth, Pune 11.
- PUNE JILHA NATIONAL PARKS & GARDEN KAMGAR SABHA** Kakakuwa Mansion, Laxmi Road, Pune 2.
- PUNE JILHA PITH GIRNI KAMGAR SANGHATANA** 849 Raviwar Peth, Lonar Ali, Pune 2.
- PUNE JILHA SAHAKARI KARKHANA KAMGAR UNION** 327/28 Kasba Peth, Pune 11.
- PUNE JILHA SAHAKARI CHITNIS SANGH** 608 Shaniwar Peth, Pune 30.
- PUNE JILHA SAHAKARI DUDH UTPADAK SANGH KAMGAR UNION** 209 Kasba Peth, Pune 11.

- PUNE JILHA SARKARI SHETI & BAGAYATI KAMGAR UNION** Trade Union Centre, 101 Shivajinagar, Pune 5.
- POONA LABOUR UNION** 454 Budhwar Peth, Pune 2.
- POONA MAHANAGARPALIKA KAMGAR UNION** Trade Union Centre, 101 Shivajinagar, Pune 5.
- PUNE MAHANAGARPALIKA MAZDOOR SANGH** 866 Sadashiv Peth, Pune 2.
- PUNE MAHANAGARPALIKA MUKADAM SANGH** 866 Sadashiv Peth, Tarachand Market, Pune 2
- PUNE MAZDOOR SABHA** Kakakuwa Mansion, 54 Budhwar Peth, Pune 2
- POONA MAZDOOR SABHA** Kakakuwa Mansion, 54 Budhwar Peth, Laxmi Road, Pune 2.
- POONA MAZDOOR UNION** 219 Somwar Peth, Pune 11.
- PUNE MALDHAKKA SHRMAJIVI SANGHATANA** 1122 Bhawani Peth, Pune 2.
- THE POONA MILK PRODUCTS DEALERS' ASSOCIATION** 89 Shukrawar Peth, Pune 2.
- PUNE MUNICIPAL CORPORATION ENGINEERS' ASSOCIATION** 1332 Shivajinagar, Pune 5.
- THE POONA MUNICIPAL CORPORATION SERVANTS' ASSOCIATION** 773 Sadashiv Peth, Deshmukh Wada, Pune 30.
- PUNE MUNICIPAL CORPORATION SERVANTS' CO-OP. URBAN BANK LTD.** 101 Shivajinagar, Pune 5.
- THE POONA MUNICIPAL TRANSPORT DRIVERS' KAMGAR EKJOOT SANGH** H. No. 82, Kawade wadi, Koregaon Park, Pune 1.
- POONA MUNICIPAL TRANSPORT KAMGAR UNION** 740/2 Raviwar Peth, Pune 2.
- PUNE NAVYUVAK TAXI SANGHATANA** 39 Wana-wadi Bazar, Pune 1.
- PUNE PROFESSIONAL PHOTOGRAPHERS' ASSOCIATION** 494 Budhwar Peth, Pune 2.
- POONA RASHTRIYA THEATRE KAMGAR SANGH** 53 Nana Peth, Pune 2.
- PUNE SAHKAR GUMASTA MANDAL** 185 Shanwar Peth, Pune 30.
- PUNE SHRAMIK PATRAKAR SANGH** 72 Municipal Commercial Bldg., Sadashiv Peth, Pune 30
- POONA SODA LEMON GOLD SPOT WORKERS' UNION** 479 Old Bazar, Khadki, Pune 3
- PUNE S. T. KAMGAR SENA** 145 Tingre Chawl, Ward No 3, Near Railway Gate, Dapodi, Pune 12.
- POONA TAXI CABS' UNION** 117 Nana Peth, Pune 2.
- POONA TELEPHONES KAMGAR UNION** 479 Juna Bazar, Khadki, Pune 3.
- PUNE WHOLESALE CHARCOAL MERCHANTS' ASSOCIATION** 201 Mangalwar Peth, Pune 11.
- POONA WORKERS' UNION** 479 Old Bazar, Khadki Pune 3.
- POWERLOOM KAMGAR UNION** 327/28 Kasba Peth, Pune 2.
- POWERLOOM WORKERS' UNION** 27/219 Maharashtra, Pune 9.
- PRESS KAMGAR SABHA** 54 Budhwar Peth, Kakakuwa Mansion, Laxmi Road, Pune 2.
- PUBLIC HEALTH DEPT. ENGINEERS' UNION** 196/53 Tilak Road, Pune 2.
- PUDUMJEE PAPER KAMGAR UNION** Janata Plots, Chinchwadgaon, Pune 33.
- RAKESH BULB INDUSTRIES EMPLOYEES' UNION** 475 Kasba Peth, Pune 11.
- RASHTRIYA ENGINEERING SHRAMIK SANGH** New Kumbhar Building, Ground Floor, Elphinstone Road, Khadki, Pune 3.

- RASHTRIYA SHRAMIK SANGH** 2064 Vijaynagar Colony, Anant Smruti, Pune 30.
- RATHI ENGINEERING KAMGAR UNION** 27 Shankarshet Road, Pune 9.
- RANGE HILLS HATGADI SANGH** 46-A Aundh Road, Pune 3.
- RESERVE BANK OF INDIA EMPLOYEES' ASSOCIATION** R.B.I. Building, Ganeshkhind Road, Pune 16
- RESERVE BANK OF INDIA WORKERS' UNION** R.B.I. Building, Ganeshkhind Road, Pune 16.
- RESEARCH & DEVELOPMENT ESTABLISHMENT (ENGINEERS) EMPLOYEES' UNION** 70 Market Road, Khadki, Pune 3.
- RIKSHA DRIVERS' ASSOCIATION** Trade Union Centre, 101 Shivajinagar, Pune 5.
- RIKSHA EMPLOYEES' UNION** 53/2 Parvati Darshan, Pune 9.
- ✓ **ROPLAS EMPLOYEES' UNION** Pimpri Colony, Pune 17.
- ✓ **RUSTON & GREAVES GROUP EMPLOYEES' UNION** Pimple Building, Pimpri, Pune 18.
- SANDVIK ASIA EMPLOYEES UNION** 117/7 Guru Prasad Co-op. Housing Society, 24 Bund Garden Road, Pune 1.
- S. T. STAFF'S UNION MAHARASHTRA** Kedari Vasti, S. No. 14, Wanawadi, Pune 1.
- SAHAKARI BANKS KARMACHARI SANGH** 185 Shaniwar Peth, Pune 30.
- SAHAKAR CONTRACTORS KAMGAR SANGHATANA** 415 Old Bazar, Khadki, Pune 3.
- SAKAL PAPERS PVT. LTD. EMPLOYEES' UNION** C/o. V. S. Shinde, 487 Kasba Peth, Pune 2.
- ✓ **SALESWIN (I) WORKERS' UNION** Kasarwadi, Kondhiba Landge Chawl, Pune 18.
- SAMYUKTA KAMGAR SANGH** Ganapati Chowk, Talegaon Dabhade, Dist. Pune.
- SALRAKSHAN KAMGAR SABHA** 115 Sitalanagar, Dehu Road, Dist. Pune.
- SANRAKSHAN KAMGAR SANGHATANA CAFVD KHADKI** 410 Shaniwar Peth, Pune 30.
- SANYUKTA ENGINEERING KAMGAR SANGH** 124,1 Mangalwar Peth, Pune 2.
- SARVA SHRAMIK KARMACHARI MAHASANGH** 625 Nana Peth, Pune 2
- SARVA SHRAMIK SANGHATANA** Trade Union Centre, 101 Shivajinagar, Pune 5.
- SATHE BISCUIT & CHOCOLATE KAMGAR SABHA** 101 Shivajinagar, Trade Union Centre, Pune 5.
- SOLDAMINI INSTRUMENTS KAMGAR UNION** More Chawl, Gujarath Colony, Vetalnagar, Kothrud, Pune 29
- SCIENTIFIC STAFF ASSOCIATION OF A.R.D.F./E.R.D.L.** Pashan, Pune 8
- SEMICONDUCTORS EMPLOYEES' UNION** 441/42 Somwar Peth, Pune 11.
- SHARDA ENTERPRISES WORKERS' UNION** C/o S. R. Thopte, near Varje Jakat Naka, Pune 29.
- SHETKARI SHETMAJOUR PANCHAYAT** 54 Budhwar Peth, Laxmi Road, Pune 2.
- SHRI CHHATARAPATI SHIVAJI MANDAL** 8/5 Mangalwar Peth, Pune 2.
- SHIKSHAN MANDAL (M.N.P.) SHIPAI SEVAK SANGHATANA** School No. 8, Kasba Peth, Pune 11.
- SOUTHERN COMMAND SIGNAL CIVILIAN WORKERS' UNION** R. No. 180 Chota Ghorpari, Pune 1.
- SOUTHERN COMMAND MILITARY FARMS CIVILIAN EMPLOYEES' TRADE UNION CENTRE** Pune Area Excellent Mess, M. G. Road, Khadki, Pune 3.
- SOUTHERN COMMAND STATIONERY DEPOT KAMGAR SANGH** 607 Rasta Peth, Pune 11.
- SPICA PLASTIC & LEO MAZDOOR SANGH** Ward No. 4, Room No. 17, Yerawada, Pune 6.

- SPRAY METAL WORKERS' UNION** No. 12 Harpale Building, Gadi Tal, Hadapsar, Pune 28.
- STATE TRANSPORT KAMGAR SABHA, DAPODI** 54 Budhwar Peth, Laxmi Road, Pune 2.
- THE STATE TRANSPORT WORKERS' UNION** Congress House, Pune 5.
- STATION WORKSHOP E.M.E. WORKERS' UNION** Dehu Road, Dist. Pune.
- SUDARSHAN CHEMICAL KAMGAR SANGHATANA** Plot No. 8, Room No. 9, Mula Road, Khadki, Pune 3.
- SUDARSHAN CHEMICAL KAMGAR UNION** 168 Ambedkar Road, Pune 1.
- SUDARSHAN INDUSTRIES WORKERS' UNION** 829 Ganj Peth, Pune 2.
- SUTI KAMGAR SANGH** 185 Shaniwar Peth, Pune 30.
- SUTI MAZDOOR SANGH** 815 Shaniwar Peth, Pune 30.
- SWASTIK KAMGAR SANGHATANA** 479 Old Bazar Khadki, Pune 3.
- SWASTIK RUBBER MAZDOOR SANGH** 185 Shaniwar Peth, Pune 30.
- SWASTIK RUBBER STAFF EMPLOYEES' UNION** 866 Sadashiv Peth, Pune 30.
- SWATANTRA KAMGAR SANNGH** Inspectorate of Armaments, Khadki, Pune 3.
- SWATANTRA MAZDOOR SANGH** 1388 Bhimpura, Pune 1.
- TELCO CANTEEN KAMGAR SANGHATANA** 459 Budhwar Peth, Pune 2.
- TELCO KAMGAR UNION** 479 Old Bazar, Khadki, Pune 3.
- TEXTILE KAMGAR SANGHATANA** (Talegaon Dabhade) Congress House, Shivajinagar, Pune 5.
- TRAINED NURSES' UNION** Sassoon General Hospital 2284 New Moeikhana, Pune 1.
- UCO BANK EMPLOYEES' UNION** 79 M. G. Road, Pune 1.
- UNIONBANK OF INDIA EMPLOYEES' UNION** Block No. 250, R & D Quarters, Dighi Camp, Pune 15.
- UNITED CINE ARTISTS' ASSOCIATION** 11 Narvir Tanajiwadi, Shivajinagar, Pune 5.
- THE UNIVERSITY OF POONA EMPLOYEES' UNION** C/o. Y. R. Kavatkar, Clerks' Quarters, Poona University Camps. Ganeshkhind, Pune 7.
- VACUUM PLANT KAMGAR SANGHATANA** 1232 Raviwar Peth, Pune 2.
- VANAZ ENGINEERS EMPLOYEES' UNION** 1420 Sadashiv Peth, Pune 30.
- THE VETERINARY STOCKMEN'S ASSOCIATION** Post Box No. 571, Pune City.
- VIDI KAMGAR SANGH** 1170 Bhawani Peth, Padma-shali Pura, Pune 2.
- VISHRANTWADI LABOUR UNION** Anand Office, Vishrantwadi, Pune 15.
- VIVIDH KAMGAR SABHA** 1170/31/2 Magifor Bungalow, Revenue Colony, Shivajinagar, Pune 5.
- VULCAN LAVAL CLERICAL, ADMINISTRATIVE & SUPERVISORY STAFF ASSOCIATION** 491 Raviwar Peth, Pune 2.
- VULCAN LAVAL KAMGAR UNION** 1386 Kasba Peth, Pune 11.
- VULCAN LAVAL STAFF UNION** Rasta Peth, Shiral Shet Chowk, Pune 1.
- W.N.C. KAMGAR SANGHATANA** Gheetabai Chawl, Wadgaon Sheri Road, Ramwadi, Pune 14.
- WEIKFIELD KAMGAR UNION** 1029 Raviwar Peth, Chhajed Hall, Pune 2.
- WESTERN MAHARASHTRA DEVELOPMENT CORPORATION EMPLOYEES' UNION** 535 Budhwar Peth, Old Tapkir Galli, Pune 2.

**WESTERN INDIA RACE STABLE KAMGAR SA-
GHATANA** Nath kripa, 104 Mitra Mandal Colony,
Pune 9.

YESHWANT SAHAKARI SAKHAR KAMGAR SANGH
Theur, Dist. Pune .

IMPORTANT GOVERNMENT OFFICES

CENTRAL

The Station Director, **ALL INDIA RADIO (AKASHWANT)**
Shivajinagar, Pune 5.

Conservation Assistant, **ARCHAEOLOGICAL SURVEY
OF INDIA**, Patalshwar, Pune 5.

Engineer, SD, **ATOMIC ENERGY**, Power Projects,
Engineering Divn, 407/2 Nana Peth, Pune 2.

Deputy Director, **BOTANICAL SURVEY OF INDIA**,
7 Koregaon Road, Pune 1.

Collector, **CENTRAL EXCISE & CUSTOMS COLLE-
CTORATE**, PMC Commercial Bldg., Tilak Road, Pune 2.

Office-in-Charge, **CENTRAL FAMILY PLANNING
FIELD UNIT**, 322/20 Shankarshet Road, Pune 9.

Office-in-Charge, **CENTRAL GROUND WATER
BOARD**, District Unit, No. XV, 247/11 Deccan College
Road, Pune 7.

Executive Engineer, **CENTRAL PUBLIC WORKS DE-
PARTMENT**, Pune Central Division, 51 Shankarshet
Road, Pune 2.

The Scientist-in-Charge, **CENTRAL PUBLIC HEALTH
ENGINEERING RESEARCH INSTITUTE**, Pune Field
Unit, Swargate Water Works Compound, Pune 9.

Director, **CENTRAL WATER & POWER RESEARCH
STATION**, Khadakwasla, Pune 24.

DEFENCE, COMMON ESTABLISHMENTS :

CONTROLLERATE OF DEFENCE ACCOUNTS, off
Golubar Maidan, Southern Command, Pune 1.

CONTROLLERATE OF INSPECTION (Ammunition),
Khadki, Pune 3.

CONTROLLERATE OF INSPECTION (VEHICLES),
Dehu Road, (Pune).

**CONTROLLERATE OF INSPECTION (ENGINEERING
EQUIPMENT)**, Dighi, Pune 15.

INSPECTORATE OF ELECTRONICS WING, C I A
Campus, Khadki, Pune 3.

**RESEARCH & DEVELOPMENT ESTABLISHMENT
(ENGINEERS)**, Dighi, Pune 15.

AIRFORCE :

AIR FORCE STATION, Lohagaon, Pune 32.

ARMY :

COMMANDER WORKS ENGINEER, Range Hills
Road, Pune 3.

CHIEF ENGINEER, Pune Zone, Manekji Mehta Road,
Pune 1.

CHIEF INSPECTORATE OF EXPLOSIVES, Khadki,
Pune 3.

NAVY :

INSPECTORATE OF NAVAL ARMAMENTS, Ammuni-
tion Factory, Khadki, Pune 3.

Assistant Collector, **DIRECTORATE OF INSPECTION,
CUSTOMS AND CENTRAL EXCISE**, Guru Nanak
Nagar, Pune 2.

Deputy Director, **EXPORT INSPECTION AGENCY**
34-D Swapna Samraj Society, Karve Road, Pune 4.

The Regional Officer, **FIELD PUBLICITY DIRECTORATE**, 3 Vidya Vihar, Pune 16.

Director, **FILM & TELEVISION INSTITUTE OF INDIA**, Law College Road, Pune 4.

Demonstration Officer, **FOOD & AGRICULTURE DIRECTORATE**, Community Canning & Preservation Centre, 1974 Gaffar Bag St., Pune 1.

The Director, **GEOLOGICAL SURVEY OF INDIA**, Maharashtra Circle (West), 7 Deccan College Road, Pune 6.

The Commissioner of Income Tax, **INCOME TAX DEPARTMENT**, Sadhu Vaswani Road, Pune 1.

Assistant Registrar, **INCOME TAX APPELLATE TRIBUNAL**, 94 M. G. Road, Pune 1.

Senior Deputy Director of Audit, **INDIAN AUDIT & ACCOUNTS DEPT.** Defence Services, Southern Command, Pune 1.

Inspecting Officer, **DIRECTORATE OF INSPECTION**, (U. G. P. & D.) Pune Centre Squad, 106/13 Erandawana, Pune 4.

INSPECTORATE OF VEHICLES WING, Khadki, Pune 3.

The Labour Enforcement Officer, (Central), **LABOUR DEPARTMENT**, 481 Sardar Mudliar Road, Pune 11.

Scientist-in-charge, **MECHANICAL ENGINEERING RESEARCH AND DEVELOPMENT ORGANISATION**, NCL Colony, Pashan, Pune 8.

Deputy Director General, **METEOROLOGICAL DEPARTMENT**, Shivajinagar, Pune 5.

Regional Director, **MINISTRY OF EDUCATION**, Central Building, Pune 1.

Assistant Supervisor of Hindi Teaching Scheme, **MINISTRY OF HOME AFFAIRS** 1, Finance Road, Pune 1.

Assistant Director, **NATIONAL SAMPLE SURVEY ORGANISATION**, 1/1 Gultekadi, Pune 9

Regional Director, **NATIONAL SAVINGS ORGANISATION**, 303 Narayan Peh, Pune 30.

Assistant Regional Director, **PUNE DIVISION**, 12 Ambedkar Road, Pune 1.

Chief Technologist, **NATIONAL SUGAR INSTITUTE**, Advisory Cell, Shivaji Society, Pune 16.

Director, **OVERSEAS COMMUNICATION SERVICE**, Beam Wireless Station, Dighi, Pune 15.

Deputy Regional Provident Fund Inspector, **PROVIDENT FUND OFFICE**, 47/1 Satara Road, Pune 9.

Superintending Surveyor, **SURVEY OF INDIA**, 106/107 Koregaon Park, Pune 1.

Station Engineer, **TELEVISION RELAY CENTRE** 83/12 A-2, Law College Road, Pune 4.

Regional Director, **WORKERS' EDUCATION CENTRE**, 1035 Shivajinagar, Pune 16.

Deputy Director, **ZOOLOGICAL SURVEY OF INDIA**, Western Regional Stn. 1182/2 Fergusson College Road, Pune 5.

STATE

Director of Agriculture, **AGRICULTURAL DEPARTMENT**, Central Building, Pune 1.

Director of Animal Husbandry, **ANIMAL HUSBANDRY DEPT.** Central Building, Pune 1.

Additional Chief Engineer, **BUILDING & COMMUNICATION (PWD) DEPT.** Central Building, Pune 1.

Collector & District Magistrate, **COLLECTORATE OF PUNE** Suzzee Sorabji Road, Pune 1.

Commissioner for Co-operation and Registrar Co-operative Societies, **COOPERATIVE DEPARTMENT** Central Building, Pune 1.

Regional Dairy Development Officer, **DAIRY DEVELOPMENT DEPT.**, Commonwealth Building, Laxmi Road, Pune 30.

District and Sessions Judge, **DISTRICT COURT** Shivajinagar, Pune 5.

District and Sessions Judge, **LABOUR COURT** 473 Sadashiv Peth, Pune 30.

Administrative Medical Officer, **E.S.I. SCHEME W. M. REGION** Aundh Camp, Pune 7.

District Statistical Officer, **ECONOMIC & STATISTICS DIRECTORATE** Fule Market, Pune 2.

Director of Education, **EDUCATION DIRECTORATE** Central Building, Pune 1.

Deputy Director, **EDUCATION (GENERAL)**, Pune Region, 17 Ambedkar Road, Pune 1.

Sub-regional Employment Officer, **EMPLOYMENT EXCHANGE**, 481 Sardar Mudliyar Road, Pune 11.

Employment Officer, **UNIVERSITY EMPLOYMENT INFORMATION AND GUIDANCE BUREAU**, Pune 7.

Deputy Director of Accounts & Treasury, **FINANCE DEPARTMENT** New Treasury Building, Pune 1.

Superintendent, **FISHERIES** 873, B. J. Road, Pune 1.

Joint Commissioner, **FOOD & DRUG ADMINISTRATION** 791/93 Guruwar Peth, Pune 2.

Foodgrain Distribution Officer, **FOODGRAIN DISTRIBUTION DEPARTMENT** A Barrack, Central Building, Pune 1.

Chief Conservator of Forests, **FOREST DEPARTMENT** Central Building, Pune 1.

Conservator of Forests, **POONA CIRCLE** PMT Building, Swargate, Pune 9.

Joint Director, **HEALTH SERVICES**, New Central Bld. Pune 1.

INDUSTRIES DEPARTMENT

DISTRICT INDUSTRIES OFFICER, 7/1 B. J. Road, Pune 1.

Collector & Deputy Industries Commissioner, **INDUSTRIES DEPARTMENT**, Old Central Bldg., Pune 1.

Joint Director, **INDUSTRIES DEPARTMENT** (Pune Region) Udyog Bhavan, Tilak Road, Pune 2.

Electrical Inspector, **INDUSTRIES & LABOUR DEPT.** 759 Datar Bungalow, D. G. Pune 4.

IRRIGATION DEPARTMENT

Additional Chief Engineer, **IRRIGATION DEPARTMENT, PUNE IRRIGATION CIRCLE**, 436 Somwar Peth, Pune 11.

Supdtg. Engineer, **CENTRAL DESIGNS ORGANISATION** (Power Houses), G Barrack, Central Building, Pune 1

Supdtg. Engineer, **MECHANICAL CIRCLE, (CP.)** Central Building, Pune 1

Supdtg. Engineer, **PUNE IRRIGATION PROJECT CIRCLE**, B. J. Road, Pune 1.

Director, **DIRECTORATE OF IRRIGATION, RESEARCH & DEVELOPMENT**, 1 Molodina Road, Pune 1.

Supdt. Engineer, **ENVIRONMENTAL ENGINEERING CIRCLE, UD. & P. H. DEPT.** Central Building, Pune 1.

Additional Commissioner of Labour, **LABOUR DEPARTMENT**, 5 Bombay-Pune Road, Pune 5.

Executive Engineer, Housing Division, **MAHARASHTRA HOUSING BOARD**, Agarkar Nagar, Pune 1.

Director, **MARKETING DIRECTORATE**, Central Bldg., Pune 1.

Regional Transport Officer, Pune Region, **MOTOR VEHICLES DEPARTMENT**, 39 Ambedkar Road, Pune 1.

Commissioner of Police, **POLICE COMMISSIONERATE**, Sadhu Vaswani Road, Pune 1.

Manager, Government Photo Zinco Press, **PRINTING & STATIONERY DEPT.**, 5 Soozee Sorabjee Road, Pune 1.

Supdt. Pune Division, **PROHIBITION & EXCISE**, 14-A Vaswani Road, Pune 1.

Deputy Architect, Regional Office, **PUBLIC WORKS & HOUSING DEPT.**, Central Bldg. Compound, Pune 1.

Regional Publicity Officer, PUBLICITY DEPARTMENT,
New Central Bldg., (Annex), Pune 1.

Commissioner, PUNE DIVISION (Revenue), 12 Bund
Garden Road, Pune 1.

Dy. Commissioner of Sales Tax (I), Central Divn.,
SALES TAX, 21 Ambedkar Road, Pune 1.

Settlement Commissioner and Director of Land Records,
SETTLEMENT & LAND RECORDS DEPARTMENT,
7/9 B.J. Road, Pune 1.

Director of Sugar, SUGAR DIRECTORATE, Mithapalli
Estate, Shankarshet Road, Pune 9.

Deputy Director, TECHNICAL EDUCATION DEPT.
Ghole Road, Pune 5.

Director, TOWN PLANNING & VALUATION
DEPARTMENT, Central Building, Pune 1.

MUNICIPAL OFFICES

Pune Municipal Corporation
Municipal Commissioner, PUNE MUNICIPAL CORPO-
RATION, Shivajinagar, Pune 5.

City Engineer, PUNE MUNICIPAL CORPORATION,
Shivajinagar, Pune 5.

Chief Inspector, SHOPS & ESTABLISHMENTS DE-
PARTMENT, Ghole Road, Pune 5.

FIRE BRIGADE STATIONS

Budhwar Peth Fire Brigade Station, Pune 2. (Tel. 448950)

Municipal Fire Brigade Head Quarters, Bhawani Peth,
Timber Depot, Pune 2 (Tel. 444894, 444187)

Suburban Municipal Fire Station, Civil Lines, Pune 1.
(Tel. 22105)

Hadapsar Fire Brigade Station, Pune 13. (Tel. 7207)

OCTROI POSTS

Bopodi (Tel. 56691)

Yerawada (Tel. 23952)

Hadapsar (Tel. 7230)

Swargate (Tel. 440088)

Shivajinagar, Nava Pool, (Tel 57905)

PUNE MUNICIPAL TRANSPORT

Head Office, Shankarshet Road, Swargate, Pune 9. (Tel.
447437)

Pimpri Chinchwad Municipal Council

Chief Officer, PIMPRI CHINCHWAD MUNICIPAL
COUNCIL, Pimpri, Pune 18.

FIRE BRIGADE & AMBULANCE (Tel. 83333)

OCTROI POSTS

Bhosari (Tel. 83411)

Nigadi (Tel. 82166)

Phugewadi (Tel. 83458)

Pimpri Colony (Tel. 83361)

FINANCIAL CORPORATIONS

INDUSTRIAL FINANCE CORPORATION OF INDIA,
353-A Boat Club Road, Pune 1.

MAHARASHTRA AGRO INDUSTRIES DEVELOP-
MENT CORPORATION, Bhawani Peth, Pune 2.

MAHARASHTRA INDUSTRIAL DEVELOPMENT
CORPORATION, 11 Link Road, Chinchwad, Pune 19.

MAHARASHTRA STATE FINANCIAL CORPORA-
TION, Tilak Road, Pune 30.

WESTERN MAHARASHTRA DEVELOPMENT COR-
PORATION LTD., 11 M. G. Road, Pune 1.

OTHER IMPORTANT OFFICES

Liaison Officer, EXPORT CREDIT & GUARANTEE CORPORATION LTD., C/o. Mahratta Chamber of Commerce & Industries, Tilak Road, Pune 2.

INDIAN STANDARDS INSTITUTION, 680/2 Shivajinagar, Pune 4.

MAHARASHTRA STATE ELECTRICITY BOARD, Administrative Building, Rasta Peth, Pune 11.

MAHARASHTRA STATE KHADI & VILLAGE INDUSTRIES BOARD, 727 Sadashiv Peth, Pune 30.

MAHARASHTRA STATE WAREHOUSING CORPORATION B-583 Market Yard, Gultekdi, Pune 9.

PIMPRI CHINCHWAD NEW TOWN DEVELOPMENT AUTHORITY 14/3 Nigadi Village, Pune 35.

Senior Superintendent, POST OFFICES, PUNE CITY CTO Compound Pune 1.

General Manager, PUNE TELEPHONES, Telephone Bhavan, Bajirao Road, Pune 2.

SMALL INDUSTRIES DEVELOPMENT INSTITUTE, Agriculture College Compound, Pune 5.

SMALL INDUSTRIES SERVICE INSTITUTE, Samaj Kalyan Bldg., Near P.M.T. Bldg., Shankarshet Road, Pune 9.

STEEL AUTHORITY OF INDIA LTD. 1038/9 Gokhale Road, Pune 16.

Sales office: 321/A-1 Mahatma Phule Peth, Pune 2.

TRUSTED NAMES IN INDUSTRIES
BRITEX CORPORATION

1032, Raviwar Peth, Pune 411 002

Phone : Offi. 449470 - C/o. 470190 - Resi. 7247

Authorised Distributors for :

'NKD' make M. S. Forged Fittings.

Authorised Registered Dealers of :

'IPW' make M. S. & G. I. Bends, Rabro number & letter Punches, 'PAT' make Nylon, Copper, Rawhide hammers, & Meckoni Wheel Dresser cutters. Also we are dealing in Hardware, Tools & G. I. & M. S. Pipes.

Specialist :—M. S. & S. S. Slipon & Blank flanges; M. S. Butt welded & I. B. R. approved pipe fittings as per your requirements.

Britex Corporation Cumi Division

1032, Raviwar Peth, Laxmi Road, Pune 411 002

Gram : 'BRITEX' Pune

Phone : off. : 470190, c/o. 449470

Authorised Registered Dealers of :

M/s. Carborundum Universal Ltd. for Coated & Bonded Abrasives.

Grinding wheels of All varieties, Cup Wheels, Mounted Points, Sticks, Stones, Bricks, Valve Grinding Compound, Emery Cloth Sand Papers, Waterproof Abrasive Papers, Belts, Rolls, Discs, Etc.

H. V. Corporation

Phone : office : 449470 C/o. 470190 Resi : 7247

376, Raviwar Peth, Pune 411 002.

Dealing in :—Precision Tools, Hardware, Pipe Fitting, Cutting Tools & General Suppliers.

WE ARE ALWAYS AT YOUR SERVICE



DATA EXPRESS

**DATA PROCESSING PROFESSIONALS
& MANAGEMENT CONSULTANTS**

- Rental of computer time on our own IBM 1401 16 k Tape/Disk System.
- Systems & Programming.
- Specialised software for converting Unit Record Applications on to Computer systems.
- Key Punching.
- Maintenance of Computers and Data Processing Equipments.

203, Maharashtra
Commercial House
Pimpri, Pune 411 018
Phone : 82734

201, Embassy Centre
Nariman Point
Bombay 400 021
Phone : 536863

*With Best Compliments
From*



JG

**VACUUM FLASKS
LIMITED**

Akurdi, Chinchwad, Pune 411 019

*Manufacturers of Quality
Vacuum Flasks & VF Refills.*

Telephone . 82911 Telex 0145-269 PUNE
Telegram : JGFLASKS

**CONSULT TCI
THE TOUR AND TRAVEL EXPERTS**

With Worldwide net-work of Agents and Correspondents. The next time you travel by air within India or abroad consult TCI..... India's foremost Travel and Tour organisation with branches all over India and abroad



**TRAVEL CORPORATION (I)
PRIVATE LIMITED**

(Registered Office : Chander Mukhi,
Nariman Point, Bombay 400 021)
HOTEL BLUE DIAMOND
11, Koregon Road, Pune 411 001
Tel. Nos. - 22260 28874 (International)
28919 (Domestic)



**High-quality
microscreens
for the
sugar
industries**

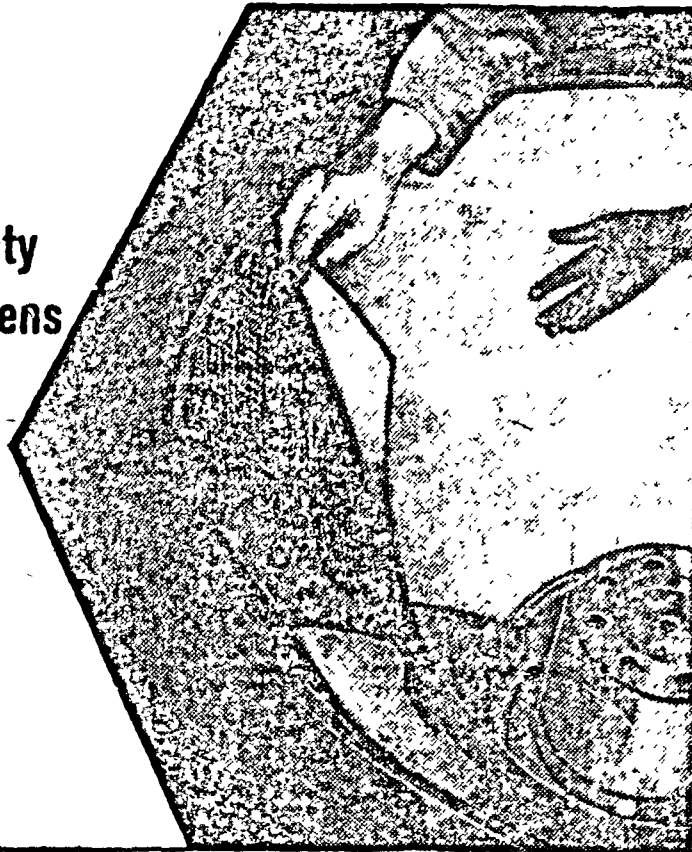

SALES PROMOTERS

SOVIRA & Co.,

1108, E. GANGA NIWAS
SHAHUPURI, KOLHAPUR
(Maharashtra)

CHICKAR SALES CORPORATION - 56, CIVIL LINES
BAREILLY (U P)

RAMJAY ENTERPRISES

SHOP NO 1, JAWAN'S BHAVAN
MUNICIPAL T B. ROAD,
COIMBATORE (T N.)

ATUL ELECTRO FORMERS PVT. LTD.,

408, GHORPADE PETH, SHANKARSHET ROAD,
GRAM : "LOWLOSS" PUNE PUNE 411002. PHONE 445543

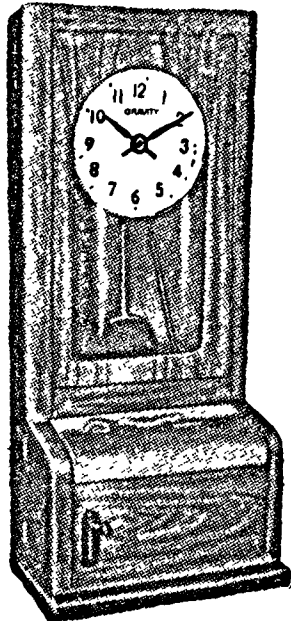

Sales * Repairs * Maintenance

Authorised Dealers For :

"GRAVITY" Make Time Recorder

hmt WATCHES AT

**COMPANY'S RATE. STOP
WATCHES, TALE-TELL CLOCKS,
OTHER STANDARD WATCHES
LIKE TIME-STAR, SUNTREK,
SANDOZ INDIA, I. S. T. &
PUREWAL AT REASONABLE
RATE.**

**RANADE
TIME INSTRUMENTS**

**Near Vijay Talkies, Laxmi Road,
Pune 411 030**

Phone (Office) - 443115 Res. 447811



Sushanco Traders

Shubhanjali, 661 Narayan Peth, Appa Balwant Chowk,

Pune : 411 030.

Phone No. 449225, 447056 & Res. : 440914.

Sole Agent Of:

John Oakey & Mohan Ltd.,

World Famous Coated & Bonded Abrasives

Technical Collaboration with :

'English Abrasives' of London

Manufacturers of famous Coated & Bonded Abrasives such as :

**Coated : Sand Paper, Emery Paper, Sil. Carb. Water Proof Paper,
Resin Sander Discs, Sleeves, RIC Belts, Emery Cloth
Belts/Rolls etc.**

**Bonded : Resinoid GrindingWheels, Vetrified Wheels, Depressed
Centre Wheels, 'Cut-off Wheels etc.**

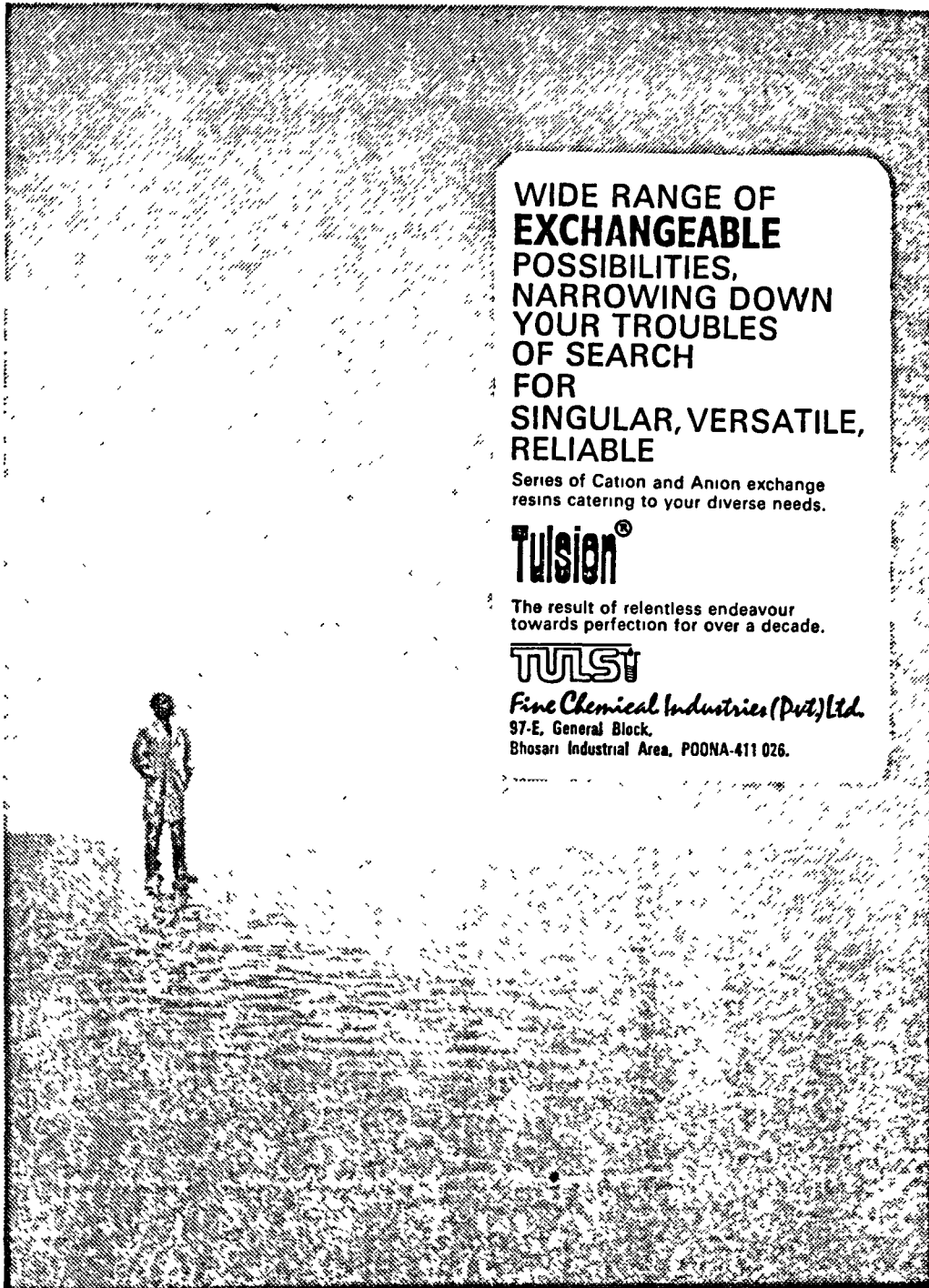

WIDE RANGE OF
EXCHANGEABLE
POSSIBILITIES,
NARROWING DOWN
YOUR TROUBLES
OF SEARCH
FOR
SINGULAR, VERSATILE,
RELIABLE

Series of Cation and Anion exchange
resins catering to your diverse needs.

Tulsion®

The result of relentless endeavour
towards perfection for over a decade.

TULSI

Fine Chemical Industries (Pvt) Ltd.
97-E, General Block,
Bhosari Industrial Area, POONA-411 026.

With Compliments From :

Sahyadri Udyog

Telephone : 50498

Telex : 0145-396

Preet Chambers, 36, Bombay-Poona Road, Pune 411_003

Engineers and Manufacturers of :

All types of Industrial and Heat Treatment Furnaces for different processes and applications.

A manufacturing Licensee of
Sunbeam Equipment Corporation of America.

Representative in India for :

Hot Air Fans : Manufactured by Industrial Gas Engineering Co. Inc., U.S.A

Solid & Slurry Pumps : Manufactured by Morris Pumps Inc. USA.

Phone : Off.-445371

Resi.- 440987



**ENGINEERING
CORPORATION**



**Steel Fabricators & Structural
Engineers**

**41, Gultekadi Industrial Estate
Pune 411 009**

STUDIO HIMLAND

Commercial & Industrial
Photographers

**667 (New) Sadashiv Peth,
Sadashiv Apartments,
Near Sadashiv Houd
Pune 411 030**

Prop.™ A. S. Kulkarni

COOPER MACHINE TOOLS

precision at high speed

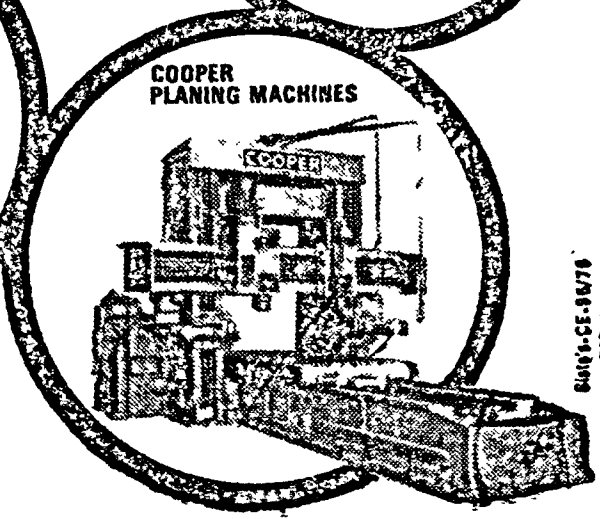
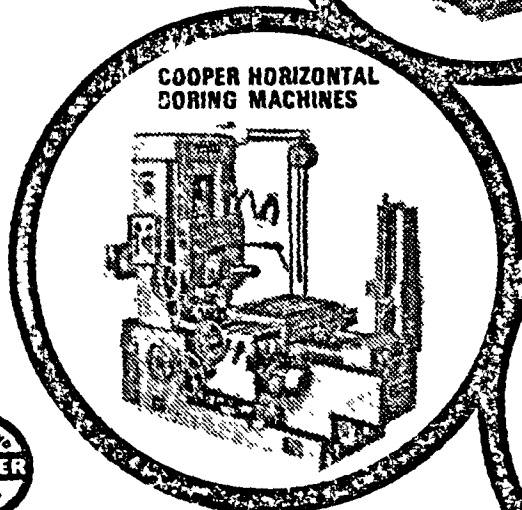
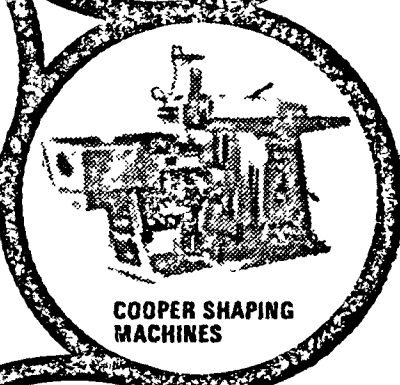
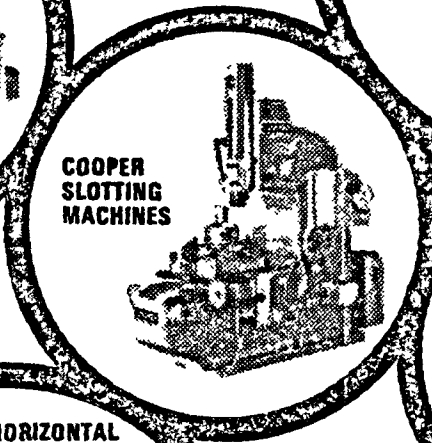
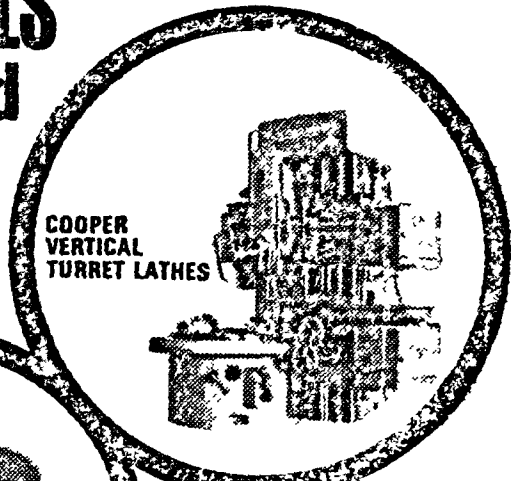
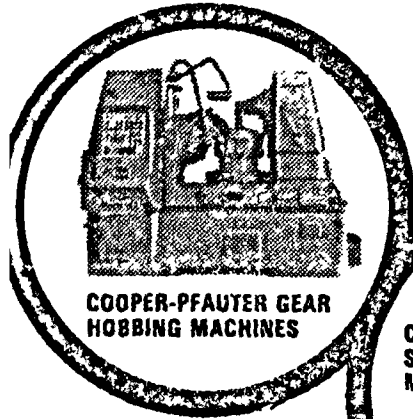

COOPER ENGINEERING LTD.
Machine Tools Division
Waghwade, Pune 411 019.
Selling Agents for India:
TAS LIMITED P. O. Box 900, Bombay-400 001.

8109-CE-8/78

With Best Compliments From :

M/s. INEX ENGINE VALVES LIMITED

17-B, Hadapsar Industrial Estate,
Pune 411 013.

Telephone Nos.

7183

7283

7483

Telegram : INEXVALVES

Telex : 0145-312

**Leading Manufacturers and Exporters of
Engine Valves for I. C. Engines**

**BUILDING A NEW COMPLEX ?
COME TO KIRLOSKAR ENGINEERING FOR
BASIC SERVICES IN ELECTRICITY, WATER
& AIR**

Experts in turnkey projects for :

- Electrification. ■ Marine piping and electrification.
- Diesel generating stations. ■ WV Engines- spares and servicing.
- Raw water pumping and sewage pumping stations.
- Fire hydrant systems. ■ Clean air systems.

Also Manufacture :

- Switchgear control panels and motor control centres.
- Alternator control panels. ■ Mobile fire pumps.
- Laminar flow work stations. ■ Electric air cleaners.

**Kirloskar Engineering Services
Private Limited**

15/16 Kaka Halwai Industrial Estate, Parvati, Pune 411 009

Proverbs to ponder :



"Expensive wife,
pensive husband."



Save before you're sorry—
with Vijaya Bank!

Vijaya Bank Ltd.

Registered Office : Light House Hill Road, Mangalore - 575 003

Administrative Office : 2, Residency Road, - Bangalore - 560 025

Chairman : **M. SUNDER RAM SHETTY**

With Best Compliments From

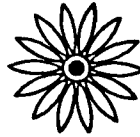

**HINDUSTAN ANTIBIOTICS
LIMITED**

(A Govt. of India Enterprise)

Pioneers in Antibiotics

Pimpri, Pune 411 018

Nicest Flooring Means

**NUTAN TILES
OF
PATEL SPUN PIPE COMPANY**

Manufacturers of :

**Mosaic, Terrazo, Plain Cement Tiles, R. C. C. Spun
Pipes, V Type & Half Round Gutters, Septic Tank,
Water Tank, & R. C. C. Dust Bins.**

**Plot No. 19, D-1 Block, M. I. D. C. Area,
Near Wanson India, Chinchwad, Pune 411 019.**

Phone : 82677 Gram : SPANCO

PARASHURAM PROCESS OFFSET PRINTERS

34/8 Erandavana, Pune 411 004

Phone : 54112.

**FOR A COMFORTABLE
STAY IN PUNE-COME
TO PATHIK**



HOTEL PATHIK

OFF. J. M. ROAD

PUNE 411 004

TELEPHONE : 50586/4 LINES

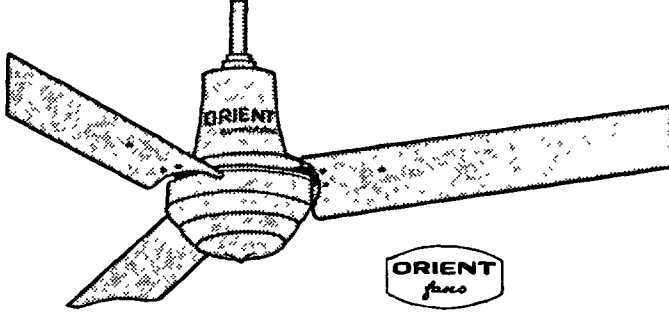

ORIENT
fans

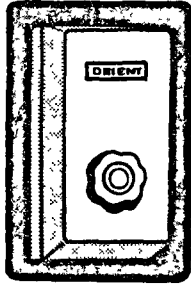

ओरिएण्ट समरकिंग

विशेष स्वीपचे सिलिंग पंखे
• १००० मि.मि.(४०") • ११२५ मि.मि.(४५")
• १२५० मि.मि.(५०")

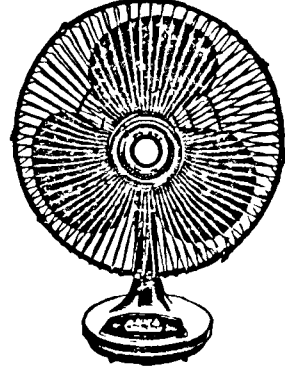

डिस्ट्रीब्यूटर :
**लखमी
कॉर्पोरेशन**

१५९, बुधवार पेठ,
पुणे ४११ ००२.
फोन नं. ४४२७९६

WOODCRAFT

Manufacturer of :
Wooden Packing Cases & Furniture.
Dealers in Timber.

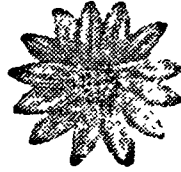

Office .

C/o G. L. Shukla & Bros.
110, Rasta Peth, Pune 11
Phone : 25925

Factory :

Plot No. 9, 'S' Block
Bhosari Industrial Area, Pune 26
Phone : 82745



PROFILOFORMS

Manufacturers of Profile Tools.

Works : Plot 64, 'S' Block M. I. D. C.

**Bhosari Industrial Area,
Pune 411 026 (INDIA)**

Post Bag No. 19, Pune 26.

Phone : 83315 Gram : PROFILTOOL, Pune 26.

CONTACT

Custom- engineered special profile
tools In High Speed Steel & Tungsten Carbide

- Circular Form Tools
- Flat Form Tools
- Special Multi-Point Tools
- Two-lip Cutters for Automats
- Serrated Blade Insert Cutters & Blades

*With Best Compliments
From*



**Bodhe
Industries**

**, 842, Kasba Peth
Pune 411 011
Phone : 449593**

Chitra-yug

**759/94, Prabhat Road
Pune 411 004**



**Makers
of
Short and
Feature Films**

If you are satisfied
with the service
tell others;
if not, us.



**AMMONIA PRINTING
CYCLOSTYLING**

Chitra-Rekha

VIJAY TALKIES-BHAVE SCHOOL ROAD,
NEW 712, SADASHIV PETH, POONA-411 030.
TEL : 443982

Our Specialities :

- Marine Heat Exchangers.
- Heat Exchangers for Generating Sets.
- Industrial Heat Exchangers.
- Oil Coolers for all applications.

Our products conform to TEMA
or any other Standards specified
by our customers.

*For your requirements of above
Please contact*

RADIANT ENGINEERS

Plot No. 19, 'S' Block
M. I. D. C. BHOSAR
PUNE 411 0026



The most reliable name in
Industrial Hand Gloves.

Use Mobsun gloves and keep
your workers safe on their job.

We manufacture wide range of Industrial Leather Hand gloves,
Asbestos Hand gloves and Canvas Hand gloves.

Contact :- **M/s. Mobsun Products (S.S.I. unit)**
5/6, Gavathan Bholawale, BHOR, Dist. Pune. Pin 412 206

D. J. DAMANI & CO.

Seeds Growers and Exporters,
For Everything in Gardening &
Farming

- Seeds ■ Plants ■ Implements

RAJAN TRADERS

Dealers in everything in Electricals and
Electronic items.

- Polyurathene Coatings ■ V Belts
- Bearings

APPROVED SUPPLIERS TO THE GOVERNMENT, M. E. S. & INDUSTRIES

25/2 Shivajinagar, Pune 411 005

Tel. : 57076, 55472 Grams : "DAMANISEED"

WITH BEST COMPLIMENTS FROM



**M/s TATA
ENGINEERING
AND
LOCOMOTIVE
CO. LTD.**

BOMBAY - POONA - JAMSHEDPUR

Industrial Director,



It took a man years to acquire such beauty

It was centuries ago, when Aurangabad was young. Some distance away, an old sculptor was busy putting life into stone. Hundreds of other artists were busy all around, creating eternal beauty in the wilderness. Year in, year out, they cut, carved and painted. Till a dead, barren hillside came to life... and started throbbing with beauty and art...

Even today, this place lives in the past. Its Ajanta frescoes welcome you to 200 B.C. Its Ellora sculptures talk to you of days that used to be. And, its Aurangabad caves, only about 3 kilometres from the city, enchant you with the fascinating 'dancing panel' wherein stone figures have danced for years and years...

Plunge into this glorious past.. Fly to Aurangabad any day of the week.

Aurangabad will be the experience of your life. We promise.

Go places...
save time, fly
Indian Airlines

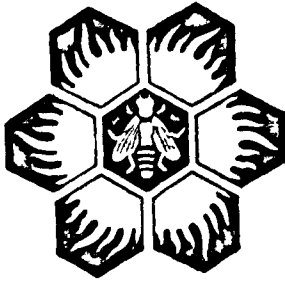

*For 60 years
Helping where
it helps most-
(1918-78)*

**The
Saraswat
Co-operative
Bank Ltd.,
Bombay**

Diamond Jubilee year

Branches in Pune :

- (i) Zilla Parishad Building,
(Somwar Peth), Pune 1.
- (ii) Mhaske Smarak Mandir,
Tilak Road, Pune 30.
- (iii) British Council Library Compound,
Fergusson College Rd. Pune 4.

Shortly opening a branch in Pimpri.

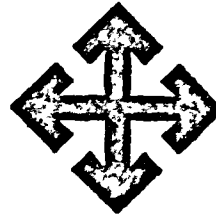

**GIRIKAND
TRAVELS (Regd)**
759/90B] Bhandar-
kar Institute Road
Deccan
Gymkhana
Pune 411 004

All India tourist information centre.
Hotel accomodation, air, sea, rail and motor
coach reservation all over India.
Car and Coaches on Hire.

Special Tours arranged by bus, train and special
bogie for delux and economy class. Sight e r g
tours planned for individuals and groups.

Trekking routes suggested.
Our tours cover the whole of India and Sri Lanka
and Nepal.

We also Handle Conferences and Seminars

M/s Unity Gauge & Tool Co.

101, Rasta Peth, Pune 411 011

Grams : UNITGAUGE Tele : 27697



Manufacturers of :

1. Plain Plug, Ring, Snap Gauge & Taper Plug & Ring Gauges.
2. Special Gauges to suit customers design.
3. Jigs & Fixtures, Piston Pins, Dowel Pins, Jig Bushes.
4. Lapping Machine, Comparator Stand.

Trust on DOLPHIN
INTER COMMUNICATION SYSTEM

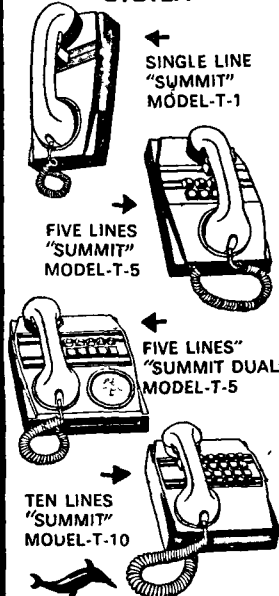

← SINGLE LINE "SUMMIT" MODEL-T-1

→ FIVE LINES "SUMMIT" MODEL-T-5

← FIVE LINES "SUMMIT DUAL" MODEL-T-5

→ TEN LINES "SUMMIT" MODEL-T-10

CALCULATIONS AT FINGER TIPS.

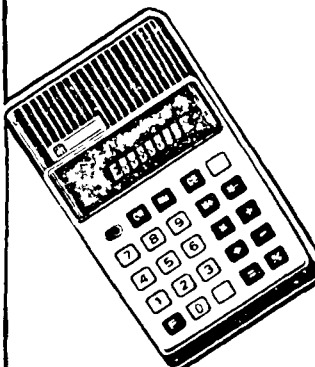

SOLUTRON
ELECTRONIC POCKET CALCULATOR

★ **BLUE STAR**

Authorised Distributors
Poona Sales & Service
Jeevan Darshan, Laxmi Road,
Pune 411 030.
Tel, 440064
(PALLOD ENTERPRISES)



Engineering Works

D 2 Block, Plot No. 29/14,

M. I. D. C. Chinchwad, Pune 411 019.

Manufacturers of DISH-ENDS, PRESSURE VESSELS AND

INDUSTRIAL EQUIPMENTS IN S. S. AND M. S.

Tel. : 82696

*With Best Compliments
From*



GLASS MINERALS

MANUFACTURERS & EXPORTERS OF
VACUUM FLASK REFILLS &
"SAHARA" VACUUM FLASKS

PAISA FUND GLASS WORKS COMPOUND
TALEGAON DABHADE (C. RLY.)
DISTRICT : PUNE
MAHARASHTRA

Phone : 82

Telex : CARE PN 0145.269

Liper FILTERS

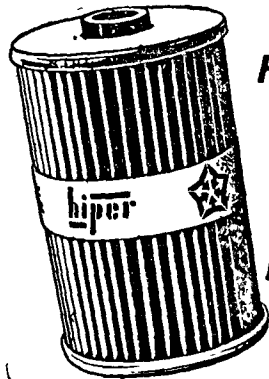

**FOR SAFETY
OF
YOUR
EQUIPMENT**

MANUFACTURED BY
KIRLOSKAR FILTERS
PRIVATE LTD.,
PUNE-411029 (INDIA)



KIOSK ADVERTISING

ON STREET TELEPHONE &
TELEGRAPHIC POLES
FOR
MAHARASHTRA CIRCLE
INCLUDING UNION TERRITORY OF
GOA
(EXCLUDING BOMBAY & NAGPUR)
AND
POONA

Miniature hoardings for mass
communication!

CONTACT :



**ASTAVISION
ADVERTISING**

4, EAST STREET, POONA - 1.

PHONE : 27337

आरामदायक
युनायटेड
होजिअरी

बेबटपर्यंत आकार
कायम राहाणारे,
मुलायम व
टिकाऊ
भनियन्स व
अंडरवेअर

युनायटेड होजिअरी, पुणे-३०



SKF

Ball Bearings

Specialists :
**BALL BEARING &
TOOLS TRADERS**
357, Shukrawar Peth, Poona-411 002.
■ Tel. : 41731

COLOR

TEL :
441731

SYMBOL
OF
SERVICE

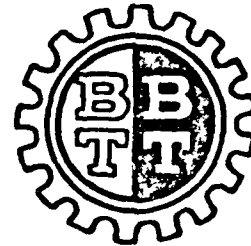

**LGTS,
AUDCO**



Most Reliable Valve

Stockist:
**POONA BEARING
HOUSE**
357/3, Shukrawar Peth, Poona-411 002
■ Tel. : 41731

COLOR

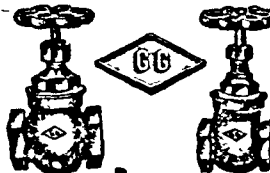

**Bronze
Globe-Gate Valves**

Authorised Stockist:
**POONA BEARING
HOUSE**
357/3, Shukrawar Peth, Poona-411 002.
■ Tel. : 41731

COLOR

Specialists in :
All types of Industrial Valves

With Best Compliments From

PRAKASHI TOFINIE CATERIERS

MOBILE CATERING

Shri. G. N. SARPOTDAR
99 Budhwar Peth
Laxmi Road,
Pune 411 002
Tel. No. 443770

Shri. GURUCHARAN SINGH
Plot No. 2A, Cycle Merchant
Housing Society
Rasta Peth, Pune 411 011
Tel. No. 24226

Specialised in Profile Cutting
from M. S. Plates.
Any thickness any size-
competitive prices.

Please contact Chief Executive,

**Prachi Profiles &
Sheet Cutting & Fabrication**

990/2, Shukrawar Peth
Tilak Road, Sing Garage
Pune 411 002

Phone No. C/o. 440238

BHOR RUBBER PRODUCTS

Manufacturer of :

Agriculture Hoses, Garden
Tubings, and Industrial,
Automobile components, etc.

Factory :

**MIDC
Plot No. T-97
BHOSARI, Pune 26.**

Banker :

**Syndicate Bank
Laxmi Road
Pune 30.**



**kalpana
glass fabritek**

720/20 Sadashiv (Navi) Peth
Poona-411 030

Manufacturers of :

- Mercury Switches
- Vacuum Gauges
- Laboratory Glassware
- Graduated Glassware
- FRP Moulding



**Industrial
Photographers**

- Color
- Black & White
- Blow Ups
- Transparencies

**Distributors
for COLORAMA
Photographic
Chemicals**

- Color Processing
- Black & White
- Graphic Art
- X-Ray

" Smriti ", Rambag Colony
L. B. Shastri Marg, Pune 411 030

PHONE : 443335

Gram : HELIUM

Phone : 470086

The Symbol of Indigeneous Development and Quality



**helium products (india)
private limited**

**Indigeneous Processors and Manufacturers of Carbon Products
and Carbon Brushes**

Works & Regd. Office :

513, Shanwar Peth, Pune 411 030

Bombay Representatives :

PAT AND COMPANY

Gorkalyanji Ratansi Trust Bldg. 19/21 Bora Bazar Street
Manohardas Lane, V. T., Bombay 400 001



VULCAN LAVAL

Manufacturers of Equipment and Machinery For

Dairy Industry

Food Processing Industry

Beverage Industry

Chemical and Pharmaceutical Industry

Mining

P.O. Box 735 Bombay-1

P.O. Box 710 Madras-6

VULCAN LAVAL LTD P.O. Box 2300 Calcutta-1

P.O. Box 627 New Delhi-1

P.O. Box 53 Poona-1

FOR THE MAN ON BUSINESS

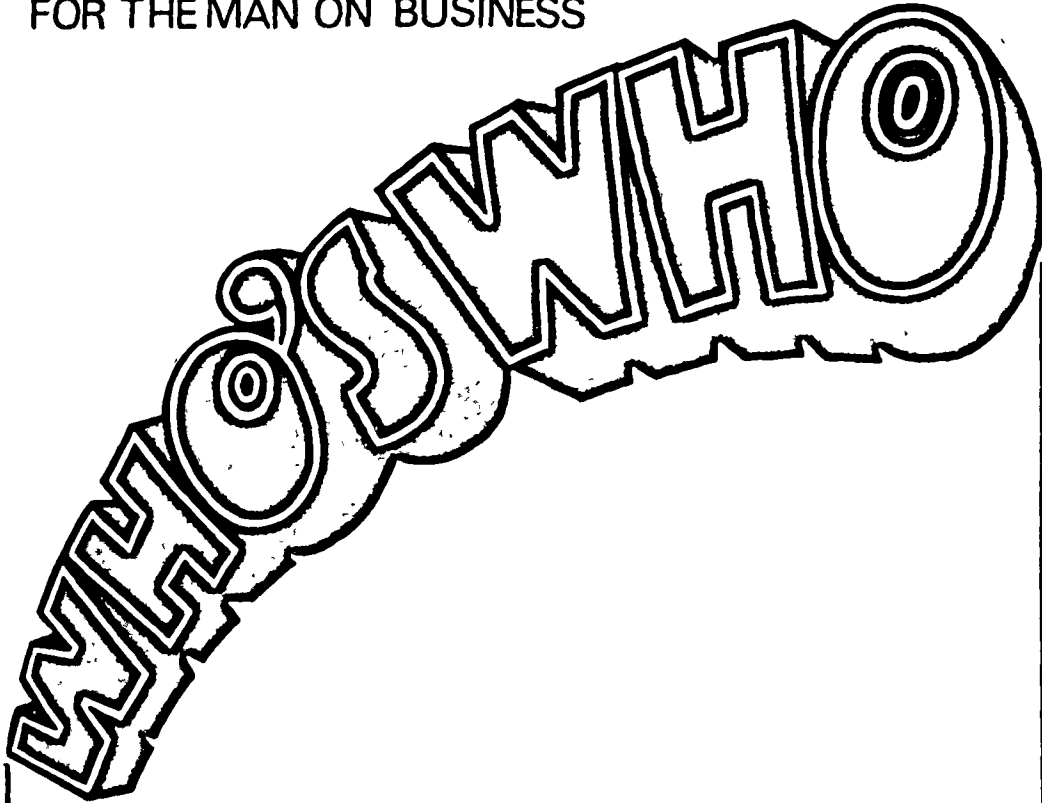

MEET THEM ALL AT
HOTEL BLUE DIAMOND 

11 Koregaon Road Pune 411 001

Telephone : 28725. Cable : Bludiamond Telex : 0145-369

- Centrally air conditioned
- 92 superb rooms and suites
- Swimming pool ● Bank ● Travel Agent
- Three cuisines, two restaurants and a bar

The Export Credit & Guarantee Corporation Ltd.

(A Government of India Enterprise)

Regd. Office : Express Towers, Nariman Point, Bombay 400 021

THERE IS ONLY ONE WAY TO JUDGE OUR FUTURE-
JUDGE US BY OUR PAST

1957. The Export Risks Insurance Corporation (ERIC) was set up beginning with Standard Policies.

1960. The year packing credit guarantee was introduced.

1964. ERIC became ECGC. The Export Credit and Guarantee Corporation Ltd.

1965. Post Shipment and Export Finance Guarantees were introduced.

1967. A decade completed.

1971. The first construction works policy was issued.

1973. Our risk value crossed the Rs. 1000 crore mark. Rs. 1215/- crores to be exact.

1977. Another successful decade. Rs. 2086 lakhs paid out as claims during the decade.

4841 policyholders were insured with us with the value of risks covered exceeding Rs. 752 crores under Policies and Rs. 2492 crores under bank guarantees.

For 20 years we have taken the risks out of your Export Credit risks.

Branches : Bombay, Madras, Calcutta, Delhi, Cochin.
Pune, Ludhiana, Bangalore, Ahmedabad
and Hyderabad

Tourism

Pune City
Cinema Theatres
Clubs
Drama Theatres
Hotels
Luxury Taxi Services
Public Halls
Tourist Services
Travel Agents

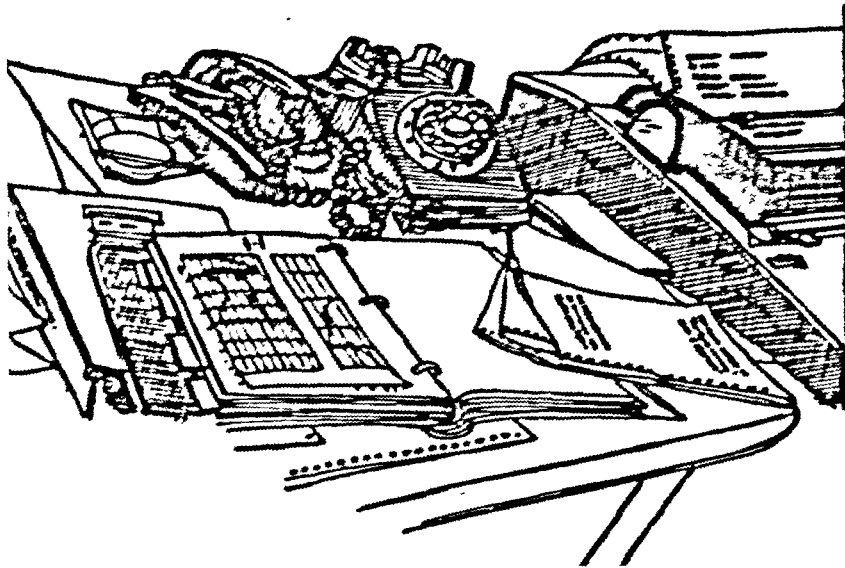

TOURISM

Pune City

Cinema Theatres

Clubs

Drama Theatres

Hotels

Luxury Taxi Services

Public Halls

Tourist Services

Travel Agents and Airlines

PUNE CITY

Climate

Summer: Max 40° C, Min. 26°C.

Winter: Max. 29°C, Min 19°C.

Rainfall: 673.10 mms. (20.49" July-October).

Season: Throughout the year.

Type of clothing required: Light woollen in winter.

Languages spoken: Marathi, Hindi, English, Gujarati.

Communications and Transport

AIR

Indian Airlines Corporation's service is daily operated between Bombay and Pune (two flights).

Time: 30 minutes. Fare: Rs. 65 (single).

Booking Office: 15 Waswani Road, Pune 1.

Tel: 24940-28179. Aerodrome Office : Tel. 24839-28072

RAIL

Pune is a junction for the three railway routes—Central, South Central and Southern Railway. It is directly connected to many important cities in South India such as Hyderabad, Secunderabad, Madras, Mysore, Bangalore, Belgaum, Solapur, Mangalore, Cochin etc. There are four direct trains running daily between Pune and Bombay, and in addition ten through-trains pass through Pune for Bombay. The mileage between Pune and other important cities by rail is as follow: :

Pune-Bombay: 192 km; Pune-Madras: 1357.8 km, Pune-Delhi: 1592 km; Pune-Calcutta: 2472 km, Pune-Bangalore: 840 km; Pune-Belgaum: 336 km; Pune-Aurangabad: 228 km; Pune-Nagpur: 747 km; Pune-Kolhapur: 308 km; Pune-Kopargaon (for Shirdi): 192 km; Pune-Secunderabad: 609 km; Pune-Mysore: 900 km; Pune-Solapur: 241.6 km; Pune-Panjim: 496 km; Pune-Hyderabad: 599 km.

ROAD

Pune is connected by National Highways with the important cities in India.

The distance of important cities from Pune is as under; Bangalore 840 km; Belgaum 336 km; Bombay 184 km; Madras 1356 km; Miraj 241.6 km; Mysore 900.00 km; Secunderabad 721.6 km; Solapur 241.6 km, Nasik 184 0 km; Mahableshwar 120.0 km.

Maharashtra State is operating its own transport service throughout the State. It has three bus stands in Pune having routes as under:

Shivajinagar Bus Stand

1. Ahmednagar 120.4 km; 2. Aurangabad 236.8 km; 3. Amraoti 595 km; 4. Alandi 22.7 km. 5. Bhimashankar 122 km; 6. Jalgaon 416 km; 7. Jalna 291.2 km; 8. Nagpur 747 km; 9. Nasik 206.4 km; 10. Lonavala 64 km, 11 Murud 25 km; 12. Dehu 25 km; 13. Nanded 444.3 km; 14. Indore 617.7 km; 15. Bombay 156 km.

Railway Station Bus Stand

1. Mahableshwar 120 km; 2. Panchgani 102 km; 3. Kolhapur 236 8 km; 4. Satara 112.3 km; 5. Ratnagiri 364.8 km; 6. Sangli 236.8 km; 7. Solapur 248.6 km, 8. Belgaum 336 km; 9. Betum 489.6 km; 10 Pandharpur 209.6 km; 11. Baramati 96 km.

Swargate Bus Stand

1. Saswad 30.7 km; 2. Purandar 45.3 km; 3. Khadakwasla 20 km, 4. Bhatghar 52.8k m; 5 Baneshwar 48 km; 6. Morgaon 48 km; 7. Sinhagad 16.3 km, 8. Shivapur 23 km, 9. Daund 64 km; 10 Urulikanchan 48 km;

All buses to Kolhapur, Satara pass through the Swargate bus stand.

Special buses for excursion and for special occasion are available at the following addresses:

1. The Depot Manager, S. T., Swargate, Pune. Tel. 441591.
2. The Depot Manager, S. T., Shivajinagar, Pune. Tel. 56316. 3. The Divisional Controller, S. T., Shankarshet Road, Pune. Tel. 440209.

Rates for Round Trip Contract

| Seating capacity | Rate per km. | Detention charges per hour |
|------------------|--------------|----------------------------|
| Up to 40 | Rs. 2.55 | } Rs. 10 |
| 41 to 50 | 3.20 | |
| 51 to 55 | 3.55 | |
| Semi-luxury bus | 2.75 | |
| Luxury bus | 4.00 | |

Minimum charges for ordinary or luxury bus are Rs. 60-00. Cancellation charges are the same as minimum charges.

Rates for Drop Contract

| Seating capacity | Rate per km. | Detention charges per hour |
|------------------|--------------|---|
| Up to 40 | Rs. 4.50 | Ordinarily, there is no detention in case of drop contract. In exceptional cases where detention takes place, detention charges of Rs. 10 per hour are charged. |
| 41 to 50 | 5.80 | |
| 51 to 55 | 6.15 | |
| Semi-luxury bus | 4.85 | |
| Luxury bus | 7.45 | |

Minimum charges and cancellation charges are Rs. 60.

Concession for Students

| Seating capacity | Rate per km. | Detention charges per hour |
|------------------|--------------|----------------------------|
| Up to 40 | Rs. 1.30 | } Rs. 5.00 |
| 41 to 50 | 1.65 | |
| 51 to 55 | 1.75 | |
| Semi-luxury bus | 1.40 | |

Minimum charges and cancellation charges are the same as round trip contract.

Taxis

Minimum charge Rs. 1.80 is for the first 1.6 km. For subsequent distance per km Rs. 1'20.

Rikshaws

Minimum charge Re. 1 is for the first 1 6 km. For subsequent distance per km 50 paise.

Local Sight-seeing Tours

A. Conducted by Pune Municipal Transport From Pune Railway Station—8.00 hrs. to 11.30 hrs. and 15.30 hrs. to 19.30 hrs. Rates: for adult Rs. 6 and for child Rs. 3. Tickets are available at the Pune Railway Station and Deccan Gymkhana bus stands. Booking can be made three days in advance between 9 a.m. to 11 a.m. and 5 p.m. to 7 p. m.

Route No. 1: From Pune Railway Station

Pune Railway Station—Sasoon Hospital, Dr. Babasaheb Ambedkar Garden, Collector Office, Zilla Parishad, Mal Dhakka, Sangam Bridge, Engineering College, Shivaji Bridge, Municipal Corporation Office, Congress Bhavan, Rani Laxmibai Putala, Balgandharva Rangamandir, Ghole Road, Fergusson College Road, Model Colony,

Ganeshkhind Road, Pashan Road, Loyola High School, Chavannagar Police Headquarters.

National Chemical Laboratory, Poona University, Chaturshringi, Polytechnic College, Agriculture College, Observatory, Radio Station, S. S. C. Board Office, Pataleshwar Mandir, Jangli Maharaj Road.

Peshwe Park and Saras Bag, Dadawadi, PMT Workshop, Shankarshet Road, Artificial Limb Centre.

Shinde's Chhatri, Empress Garden, Race Course, Circuit House, Bund Garden, Yeravada.

Kasturba Gandhi Samadhi, Agakhan Palace, Pune-Nagar Road.

Bund Gardens, Petit Institute, Wadia College, Shahu Palace, Poona Station.

Route No. 2. From Deccan Gymkhana

Deccan Gymkhana, Shivaji Putala, Saniwar Wada, Municipal Corporation, Congress Bhavan, Balgandharva Rangamandir, Mahatma Phule Sangrahalaya, Fergusson College Road, National Chemical Laboratory, Loyola High School, Poona University, Polytechnic College, Agricultural College, Radio Station, S. S. C. Board Office, Sassoon Hospital, Wadia College, Bund Garden, Pune-Nagar Road, Kasturba Samadhi, National Model School, Rajendra Singhji Stadium, Race Course, Empress Gardens.

Shinde Chhatri, Artificial Limb Centre, Cantonment Hospital, Defence Accounts Office, Shankarshet Road, Dadawadi, Sarasbag, Peshwe Park, Raja Kelkar Museum, Maharashtra Housing Board, Alka Talkies and Deccan Gymkhana.

B. The Divisional Tourist office of the Directorate of Tourism, Government of Maharashtra, conducts some regular package tours to some places of tourist interest in Maharashtra. Contact: New Central Building, Pune 1. Tel. 26697.

Places of Tourists' Interest in the City and nearabout

1. Kasturba Samadhi—Agakhan Palace

Agakhan Palace is a conspicuous landmark in the neighbourhood of Pune. During 1942 "Quit India" movement Mahatma Gandhi was incarcerated in this place along with Kasturba Gandhi and Shri Mahadeobhai Desai. Katurba Gandhi and Mahadeobhai Desai died here and their marble Samadhis are erected on the ground of this palace.

2. Bund Gardens

Situated on the right bank of the Mula-Mutha River,

Bund Gardens are about 2 km north east of Railway Station. It is one of the attractive evening resorts with added attraction of boating facility.

3. Chaturshringi Temple

This is a shrine of Durga (or Ambreswari). The temple is reached by a flight of steps in stone and concrete. During 'Navaratra', the first nine days of the month of Ashvin, a big fair is held here.

4. Empress Gardens

It is a beauty spot. The gardens are artificially laid out on an area of 24 hectares. There are tall majestic trees as well as innumerable varieties of plants and flowers.

5. Bhandarkar Oriental Research Institute

Situated in the picturesque surroundings at the foot of the Law College hill, this famous institution has devoted to the study of oriental learning. It has a splendid stone building built in oriental style and ample guest houses. It contains nearly 20,000 manuscripts collected by Prof. Bolher Keilhorn and Prof. Bhandarkar.

6. Central Water & Power Research Station (CW & PRS)

It is located below the Khadakwasla irrigation dam on the Mutha River. The research work on local problems of land, drainage, reclamation and hydro-dynamics is carried on here. The institution is specially renowned for its large-scale model experiments on taming of rivers such as Ganga, Yamuna and Brahmaputra.

7. Bharat Itihas Sanshodhan Mandal

This institution devoted to historical research was founded in 1910 by V. K. Rajwade, one of the pioneers in historical research in Maharashtra and a well-known scholar. In its Fine Arts Section there are more than 1400 exhibits of which 1050 are old paintings, 75 illustrated manuscripts, maps and charts, 100 articles of armoury, 50 Moghal, Nizamshahi, Marathi, Persian, and English documents and hundreds of other miscellaneous objects.

8. Gliderdrome (Phursungi about 13 km south-east of Pune on the Southern Railways)

This gliderdrome is maintained by the Indian Gliding Association Ltd. It trains persons in gliding. The centre is equipped with a number of primary and secondary gliders, and there is a winch for launching the gliders.

9. National Chemical Laboratory

It is situated on the Pashan Road on a beautiful plateau covering an area of about 188 hectares. This institution is one of the important links in the chain of national laboratories which the Council of Scientific and Industrial Research has sponsored.

10. National Defence Academy

This is situated at Khadakwasla (17 km from Pune) and imparts basic training to officer-cadets of all the three branches of the Defence Services for commissions in the Army, Navy and Air Force.

11. Pataleshwar Caves (God of the nether world)

This is a rock-cut cave temple in Shivajinagar on the Jangli Maharaj Road. It has huge pillars and a shrine of Shiva in centre, with the Nandi in front under a circular canopy, all apparently hewn from a single rock.

12. Parvati Hill and Temples

This hill commands superb panoramic view of Pune and its environs. Up runs a broad flight of 108 steeply rising steps, leading to an imposing 'Nagarkhana', a big drum-house, which is the entrance to an octagonal enclosure containing the historical temple of Parvati and Devadeveshwar.

13. Raja Kelkar Museum

A three-storeyed building houses one-man collection of historical exhibits. It has rare collection of lamps, nut, crackers, number of varieties of musical instruments and many more. All these are from Mogul and Maratha periods. A masterpiece among the exhibits is 'Mastani Mahal,' which was brought and erected as it was from its original place. Mastani was the mistress of Peshwa Bajirao, who was Prime Minister of Chhatrapati of Satara. This museum is one of the 'must be visited' spots in Pune.

14. Mahatma Phule Vastu-Sangrahalaya

The museum has number of sections, viz. Information Bureau, Library and Reading Room, Emporium of Arts and Crafts and Educational Displays on Industries.

15. Observatory

It is a three-storeyed building, dominated by a clock-tower more than 36 meters high and surrounded by a well-laid-out garden with lawns and variegated flower beds.

16. Shaniwar Wada

Here are the ruins of old palaces which were built as the chief residence of the Peshwas during the 18th century. The balcony of the Nagarkhana gives a magnificent view of the whole enclosure inside.

17. Saras Bag

It is a picturesque and beautiful garden with a temple of Ganapati in the centre and ever-green lawns around it with fountains with colourful lighting arrangements.

18. Shinde's Chhatra

Amongst architectural prides of Pune, the memorial of the Great Mahadji Shinde, known as Shinde's Chhatra, would rank very high. It is a handsome and imposing edifice at Vanavadi, about 5 km. from Pune.

19. University of Poona

The site of the Poona University, the stately mansion at Ganeshkhind, was the official residence of the Governor of Bombay during the monsoon season. It is a large building in Italian Gothic Style and built of the local gray trap rock. It is surrounded by a high square tower (30 metres high) and a flag staff. The mansion has two well kept lawns adjoining it and is surrounded by a variety of majestic trees.

20. Vishrambag Wada

It is a large three-storeyed mansion 78 meters broad and 66 meters long. The Wada is remarkable for its beautiful entrance surrounded by a balcony.

21. Film and Television Institute of India, Ministry of Information and Broadcasting, Prabhat Road, Pune 4.

It imparts training in all branches of film industry viz. direction, music, screen play, acting, editing, photography etc. Office of the National Film Archives is also located in its campus.

22. Tilak Smarak Mandir

This beautiful monument of Lokmanya Tilak is situated at Tilak Road near S. P. College.

PLACES OF EXCURSIONS NEAR PUNE

1. Alandi: Here is the Samadhi of Shri Dnyaneshwar, the author of Dnyaneshwari, the famous Marathi Commentary on the Bhagwat Gita. A big fair is held twice a year. Alandi is on the bank of river Indrayani 19 Km. from Pune.

2. Baneshwar: It is a temple of Shiva in jungle surroundings about 35 Km. from Pune. The temple, built by Peshwa Bajirao I, has a pleasant and copious water supply skillfully engineered from a constructed tank with a perennial source of water. It is a very good picnic spot.

3. Bhedasa Caves (48 Km): Famous Buddhist caves of about first century A. D. They consist of a Chaitya (Chapel) and a Vihara (dwelling cave) with some Dagobas (relic shrines), wells and cells.

4. Bhaja Caves (42 Km): There are eighteen early Buddhist caves of about the second and the first century B. C. The twelfth cave forms a chaitya and is, according to Dr. Burges, of the greatest importance for the history of cave architecture. It is 17.7 x 8.7 meters with apse and aisle one meter wide separated from the cave with 27 plain octagonal shafts 3-4 meters high. The remaining caves are also interesting.

5. Bhimashankar (128 Km): The place is 1034 meters above the sea level and is famous for its temple of Mahadeva. It is one of the twelve Jyotirlingas of India. The entrance portal of the temple is elaborately carved. A yearly fair, attended by about 20,000 pilgrims, is held on "Mahasivaratri."

6. Bhor: It is situated on the bank of Nira River at a distance of 56 Km. (35 miles) south of Pune City. There is one big temple of Shiva and Rajasabeb's Palace which contains a private museum. It is also an industrially developed town.

7. Chinchwad (16 Km): It is famous for the temples and Samadhi of Moraya Gosavi, the founder of Ganapatya Cult and his descendants known as "Deves". A yearly fair is held on Margasirs Vadya 6 (December).

8. Dehu: Situated on the right bank of Indrayani River, about 29 Km north-west of Pune is a place of pilgrimage. It is the birth place of Tukaram, a great poet-saint of Maharashtra of the 17th century.

9. Jejuri: It is about 51 Km from Pune. It is also a place of pilgrimage. Fairs are held in honour of the god Khandoba, also called Bhairoba, Malhari and Martand.

10. Karla Caves (40 Km): These caves are situated high in the range of hills and about 4 Km from Malavli station and 8 Km from Lonavala. They consist of a large Chaitya and several Viharas. The Chaitya is the largest and finest as well as the best preserved of its class.

11. **Lohagad Fort:** It is about 6 Km south of Malavali Railway Station and is situated on a striking hill in the same range as the neighbouring fort of Visapur. It is a good spot for picnic as well as for trekking and hiking.

12. **Lonavala:** A Hill Station situated on the top of the Bor Pass off the Sahyadris and at a distance of 64 Km from Pune. It is an ideal place for picnics, surrounded as it is by woods and valleys.

13. **Purandhar Fort:** A hill-fort 40 Km south-east of Pune. The summit on which it is built, is 1,350 metres high. It was a capital of Shivaji Maharaj for some time.

14. **Bhatgar Dam:** It is 52 Km. from Pune. It is a good holiday resort.

15. **Mahabaleshwar and Panchgani:** Mahabaleshwar is situated at a height of 1,350 metres above sea level. It is a paradise of the tourists with a variety of attractions. Panchgani, situated at the foot of the Mahabaleshwar is a tourist resort all the year round.

16. **Shivneri Fort:** It is 88 Km. from Pune. Nearest S. T. Bus Stop is Junnar which is 84.8 Km. from Pune and from there Shivneri is 4.8 Km. It is the birth place of Chhatrapati Shivaji Maharaj. It is an important national monument.

The most striking feature of the fort is a mosque with two flanking minarets, a graceful flying arch uniting the latter.

17. **Sinhagad Fort:** It is situated at a height of 1,290 meters and is 25 Km (16 miles) from Pune. This fort is famous for a historical episode.

18. **Shivapur:** Here is the famous shrine of Qamarali Darvesh with its incredible levitating stone. It is about 18 Km from Pune on Satara Road.

19. **Theur :** The Ganapati temple at Theur is one of the Ashtavinayakas in Maharashtra. Besides here are the Samadhis of Peshawa Madhavrao I and his wife Ramabai. This spot of religious and historical importance is very near from Pune, off Solapur Road.

SHOPPING AREAS :

(1) Mahatma Gandhi Road (Camp), (2) Laxmi Road (City) and (3) Deccan Gymkhana (City).

CINEMA THEATRES

ALANKAR Sadhu Vaswani Road, Pune 1. (Tel. 23333).

ALKA 8-1 Sadashiv Peth, Tilak Road, Pune 30. (Tel. 443038).

ALPANA 283 Ganesh Peth, Laxmi Road, Pune 2. (Tel. 449924).

ANANT Ghorpadi, Pune 1. (Tel. 28502).

APOLLO 549 Rasta Peth, Pune 11. (Tel. 28974).

APSARA 36/2 Shankarshet Road, Pune 9. (Tel. 440420).

ARUN Dapodi, Pune 12. (Tel. 58670).

ASHOK Pimpri, Pune 17. (Tel. 82848).

ARYAN Phule Market, Pune 2. (Tel. 443006).

BHANUVILAS 405 Narayan Peth, Pune 30. (Tel. 448891).

CAPITOL East Street, Pune 1. (Tel. 22545).

CHITRA Yerawada, Pune 6.

DECCAN Deccan Gymkhana, Pune 4. (Tel. 56613).

DELUX Pimpri Colony, Pune 17.

EMPIRE 3 Bund Road, Pune 1. (Tel. 22478).

EXCELSIOR 481 Khadki, Pune 3. (Tel. 54834).

GUNJAN Yerawada, Nagar Road, Pune 6. (Tel. 20680).

JAIHIND 482-A Bombay-Poona Road, Khadki, Pune 3. (Tel. 57741).

JAYASHREE Chinchwad, Pune 19. (Tel. 83494).

LIBERTY Parade Ground Road, Pune 1. (Tel. 25185).

- LAXMI-NARAYAN** Swargate, Volga Chowk, Pune 9. (Tel. 440910).
- MANGALA** Near Municipal Corporation, Shivajinagar, Pune 5.
- MINERVA** Phule Market, Pune 2. (Tel. 443477).
- NEELAYAM** Opp. Peshave Park, Pune 30. (Tel. 443520).
- NATRAJ** 658 J. M. Road, Pune 4. (Tel. 56548).
- NISHAT** Pudumjoo Road, Nana Peth, Pune 2. (Tel. 23092).
- PRABHAT** 681 Budhwar Peth, Pune 2. (Tel. 448856).
- RAHUL** 3 Ganeshkhind Road, Pune 5. (Tel. 50021).
- RATAN** 629 Budhwar Peth, Pune 2. (Tel. 448935).
- SHRIKRISHNA** 267/13 Budhwar Peth, Pune 2. (Tel. 447631).
- SHRINATH** 1100 Budhwar Peth, Pune 2. (Tel. 443515).
- VAIBHAV** Solapur Road, Hadapsar, Pune 13. (Tel. 7211).
- VASANT** 598 Budhwar Peth, Pune 2. (Tel. 448047).
- VIJAY** 310 Narayan Peth, Laxmi Road, Pune 30. (Tel. 444830.)
- VIJAYANAND** 1633 Shukrawar Peth, Pune 2. (Tel. 445433).
- WEST END**, 9 Moledina Road, Pune 1. (Tel. 22662)
- GIANTS INTERNATIONAL** Deccan Gymkhana Pune 4.
- JAYCEES INTERNATIONAL**
Pune Jaycees 766/2 Deccan Gymkhana, Pune 4. Tel. 53456. (Governing Body meets on 1st Thursday every month. General Body meets on 2nd and 4th Friday every month.)
- Pune Deccan Jaycees Pune 22/324 Lokmanya Nagar, Pune 30. Tel. 443221.
- Mid-Town Jaycees Amrit Enterprises, 601/2 Rasta Peth, Pune 11. Tel. 20285 or 54683.
- Pune Sangam Jaycees C/o Allovers & Lace Pvt. Ltd. EF7-9 M.I.D.C., Bhosari, Pune 26. Tel. 82465.
- Saras Jaycees 581 Guruwar Peth, Pune 2. Tel. 447057.
- Pimpri-Chinchwad Jaycees 206 Chhada Mansion, Pimpri, Pune 18.
- LADIES CLUB** 3 Taraporewala Road, Pune 1.
- LIONS CLUBS OF PUNE (AND LEO CLUBS OF PUNE)**
Lions Club of Pune 2nd and 4th Tuesday 7.30 p.m. at Poona Club Ltd.
- Lions Club of Pune Deccan Gymkhana. 2nd and 4th Wednesday, 8.00 p.m. at Royal Connaught Boat Club.
- Lions Club of Pune Sarashbag 2nd & 4th Friday, 7.30 p.m. at Ogale Hall, Mahratta Chamber of Commerce & Industries.
- NEW CLUB** 2 Rajendrasinghaji Road, Pune 1.
- P. Y. C. GYMKHANA** Pune 4.
- PARSHI GYMKHANA CLUB** Pune 1.
- POONA AND HOUNDS** Prince of Wales Drive, Pune 1.
- POONA CLUB LTD.** 6 Bund Garden Road, Pune 1.
- RANGERS GOLF CLUB** Wanawadi, Pune 1.

CLUBS

- CLUB OF MAHARASHTRA LTD.** Hira Bag, Tilak Road, Pune 2.
- ROTARY CLUBS OF PUNE (AND ROTARACT CLUBS OF PUNE)**

Poona Main: Monday, 7 p.m. at Poona Club Ltd.

Poona North: Wednesday, 6.30 p.m. at Shivaji Hall, Pune University.

Poona West: Friday, 7 p.m. at Abasaheb Garware College.

Poona South: Tuesday, 7 p.m. at IMA Hall, Tilak Road.

Poona Midtown: Saturday, 7.50 p.m. at RCM Gujarathi High School.

Pimpri: Tuesday, 12.30 noon at Hotel Supreme, opp. Garware Nylons.

Fellowship half an hour earlier.

ROYAL CONNAUGHT BOAT CLUB 7/8 Boat Club Road, Pune 1.

ROYAL WESTERN INDIA TURF CLUB LTD.
6 Burnet Road, Pune 1.

R.S.I. (ARMY OFFICERS') CLUB Gen. Thimayya Road, Pune 1.

DRAMA THEATRES

ARYABHUSHAN 262 Ganesh Peth, Laxmi Road Pune 2. (Tel. 446294).

BALGANDHARVA RANGAMANDIR Jangali Maharaj Road, Pune 5. (Tel. 57243).

BHARAT NATYA MANDIR 1320 Sadashiv Peth, Pune 30. (Tel. 440095).

TILAK SMARAK MANDIR Tilak Road, Pune 30 (Tel. 445004).

HOTELS

HOTEL AJIT 766/3 Deccan Gymkhana, opp. D. G. Club House, Pune 4. Tel. 56476-77-78-79-94. Rate per day A. C. Rooms—Double room Rs. 65; Double room single occupancy Rs. 50, Non-A.C. Rooms—Double room Rs. 50, Double room single occupancy Rs. 35. Suite Rs. 65., Suite single occupancy Rs. 50. Extra bed each Rs. 10. A. C. Discussion Room—Capacity 15 persons Check-out time 12 Noon.

HOTEL ALANKAR Near Pune Rly. Station, Pune 1. No. of rooms 34. Single room Rs. 18, Double room Rs. 26, Three-seated room Rs 39; Four-seated room Rs. 52.

HOTEL AMIR 15 Sadhu Waswani Road, Pune 1. Tel. 27371, 22584 Rate per day: Single non-A C room Rs. 35-45, Double non-A. C room Rs. 60; Deluxe single room Rs. 65, Deluxe double A. C. room Rs. 85, Deluxe suite 'Rana' Rs. 110; Luxury suite 'Samrat' Rs. 150. Extra person: Non-A.C. Rs. 15; A. C. Rs. 20; Children between 3 and 12 years. Rs. 10 extra. Conference Halls Rs. 150-250. Season: August, September, October. Rs. 5 per room extra to the above. Check-out time 12 Noon.

HOTEL ASHOKA Sane Guruji Road, near Peshwe Park, Pune 30. Tel. 442264. Double-room charges per day: One person Rs. 25; two persons Rs. 35. Extra person Rs. 8 per day. Children between 3 and 10 yrs. Rs. 5 per day extra. Service charge 10% extra. All rooms are with attached bath and separate balcony. Conference Hall available. Check-out time 12 noon.

HOTEL AVANTI 1011 Shukrawar Peth, Opp Hotel Natraj, Swargate, Pune 2. Tel. 445975-76. Rooms with balcony. Charges per day: One person Rs. 25; two persons Rs. 35. Extra person Rs. 10 per day. Service charge: 10% extra on bill. Check-out time 24 hours.

BHARAT LODGE Near Sambhaji Park, Deccan Gymkhana, Pune 4. Tel. 55107. No. of rooms 18. Rates per day: Double Rs. 16; three-bed room Rs. 24, Four-bed room Rs. 32. Tea twice.

HOTEL BHUSHAN 1070/7 Shivajinagar, Pune 5. Tel. 57725. Double-room charges per day Rs. 35; Single occupancy in double room Rs. 25. Extra-person charges

Rs. 10. Children below 10 years, no charge. All rooms are with attached bath and w.c. Service charges 10% extra. Check-out time 12 noon.

HOTEL BLUE DIAMOND 11 Koregaon Road, Pune 1. Tel. 28735-36-37-38-39. Cable: BLUDIAMOND. Telex: 0145-369. Hotel is centrally air conditioned. Rooms 92. Individual room rates: Single Rs. 130; Double Rs. 250. Suite Rs. 200 (single), Rs. 250 (double). Grand suite Rs. 275 (single), Rs. 325 (double). Children between 3 and 12 Rs. 30. Additional third person Rs. 70. All rooms are with attached bathrooms. 4-channel piped music in all rooms. Banquet and Convention rooms with Syndicate rooms. Restaurant serving Indian, Continental and Chinese food. Coffee Shop, Bar, Swimming Pool, Travel Agent, Shopping Arcade. Foreign Currency Exchange. Rates include bed morning tea and breakfast only. Meals A-la-carte. Service charge 10% extra. Check-out time 12 noon.

CENTRAL LODGE 13 Wilson Garden, near Pune Station, Pune 1. Tel. 20770, 28231. No single room. Double room per head per day Rs. 15. Per day Rs. 6.

HOTEL DREAMLAND Opp. Pune Rly. Station, Pune 1. Tel. 22960, 27391-92-93 A. C. rooms two persons Rs. 40; Non-A.C. rooms two persons Rs. 40, Extra person Rs. 10 Rates include morning tea only. Meals vegetarian.

HOTEL ELLORA Opp. Neelayam, Sadashiv Peth, Pune 30. Rooms 18. Double room Rs 15 per day per head. Three-bed room Rs. 20 per day per head. Double room with balcony Rs. 20 per day per head. All rooms are with attached bath.

HOTEL GULMOHR 15-A/1 Waswani Road, Pune 1. Tel. 23545-6-20614. Cable GULMOHR. Rooms 25. Rooms single Rs. 22 and 33, double Rs. 43 and 58. A. C. double room Rs. 83. Service charges 5%.

HOTEL JAWAHAR 1302 Sanas Estate, Tilak Road, Pune 2. Tel. 441019. Double-room charges per day Rs. 40. Double room charges per day A. C. Rs. 50. Single occupancy in double room Rs. 30. Extra person charge Rs. 10. Children below 10 years—no charge. Check-out time 12 noon.

MAHARASHTRA LODGE Deccan Gymkhana, Pune 4. Tel. 50023. Double-room charges per day Rs. 15. Single-room charges per day Rs. 9. Extra-person charge Rs. 15. Children above four years Rs. 4. Check-out time 24 hours.

HOTEL MEGHDOOT J M Road, Deccan Gymkhana, Pune 4. Tel. 54925 Cable: HOTEL MEGHDOOT. No. of rooms 11. Rates per day: Single room Rs. 17; double room Rs 22; with attached bath Rs. 20 and Rs. 30 respectively; single seated Rs 10; Extra bed Rs. 5.

MOBO'S HOTEL 20 Bund Garden Road, Pune 1. Tel. 24025, 20064 Double-room charges per day Rs 55. Double room type (ii) Rs 35. Extra person Rs 10 per day. Children below 10 years—no charge. All rooms have attached toilet. Check-out time 12 noon.

NATRAJ LODGE Opp. Swargate S. T. Stand, Pune 2. Tel. 441187, 447586. Rooms 16. 4 three-bed rooms, 12 double rooms. Rates. Double room Rs 12, Three-bed room Rs. 15

HOTEL PATHIK Off J. M. Road, Deccan Gymkhana Pune 4. Tel. 50586-7-8-9 Rates Single rooms non-A.C. Rs. 38, double rooms non-A. C. Rs 50 Single rooms A. C. Rs. 58, double rooms A. C. Rs. 70. Deluxe A. C. single room Rs. 64, double room Rs. 80 Extra person Rs. 10 per day. Child between 3 and 12 years Rs. 7 per day. Service charges 5% on total bill. Check-out time 12 noon.

HOTEL PEARL 1286/13 J. M. Road, Shivajinagar, Pune 5. Tel. 53247-8-9. Room charges per day Non-A. C. single Rs. 40, double Rs. 50 A. C. single Rs. 65, double Rs. 70. A. C. suite Rs. 90. Conference Room 4 hours Rs. 50, 8 hours Rs. 75, 12 hours Rs. 100. Service charge 5% extra on bill. Foreign currency accepted. Diners Club Membership, Traveller cheques accepted. Travel Agent, Trade Wings Office in premises.

HOTEL POONAM 651-A-1 Shivajinagar, Pune 5. Tel. 54252. Rates per day: De luxe suites (double occupancy) Rs. 45. Children above five years Rs. 10. Rooms with, attached bath: Double room Rs. 30. Single room Rs. 25. Extra bed Rs. 10. Rooms economical: Double room Rs. 20. Single room Rs. 15. Check-out time 12 noon.

POONA GUEST HOUSE 100 Budhwar Peth, Laxmi Road, Pune 2. Tel. 445679. No. of rooms 15. Double rooms 10, 3-bed rooms 3, 4-bed room 1, 6-bed room 1. Rates: Rs. 6 per day per head. Arrangements are done for tourist groups. The charges include two times tea and hot water for bath. Common toilet only.

HOTEL PRINCE 36/2 Shankarshet Road, Pune 9. Tel. 440167. Rooms: 10 ordinary double, 10 Deluxe. Charges: De luxe Rs. 35 per day. Ordinary Rs. 30 per day. All rooms have attached bath. Check-out time 24 hours.

HOTEL RAJMAHAL 494/5 Parvati, opp. Mitramandal Colony, Pune 9. Tel. 440571, 440425, 440708. No. of rooms 18. All rooms are double rooms and are with attached w. c. and bath. Rates per day Rs. 25 and Rs. 30. Extra-person charge Rs. 5. Food is served at the rooms with extra charges.

HOTEL RITZ 6 Sadhu Waswani Road, Opp. G.P.O., Pune 1. Tel. 22995 (11 extns). Cable: 'RITZ' Pune. Double-room charges per day Rs. 36. Extra-person charge Rs. 25. Service charge 5% extra. Check-out time 24 hours.

HOTEL SANMAN Opp. Sambhaji Park, Shivajinagar, Pune 5. Tel. 57287 (3 lines). Rates per day:—With balcony. Single room, one person, Rs. 30; Single room, two persons, Rs. 40; Double room, one person, Rs. 35; Double room, two persons, Rs. 45. Suite, one person, Rs. 45. Suite two persons, Rs. 55. Without balcony: Single room, one person, Rs. 25, Single room, two persons, Rs. 35. Double room, one person, Rs. 30, Double room, two persons, Rs. 40. A. C. charges Rs. 20 extra. Extra person Rs. 10 per day. Children above 10 years Rs. 10 per day. Check-out time 12 noon

HOTEL SAPNA 573/7 J. M. Road, near Sambhaji Park, Pune 5. Tel. 55022, 56129. Rooms with attached bath: Single Rs. 30; Double Rs. 40 per day; Family room with foam bed Rs. 60. Rooms with common toilet: Single Rs. 20; Double Rs. 25 per day. Extra person Rs. 10 per day. Rates include bed tea only. Room used as a conference room: additional charge Rs. 30 per day. Meals, B/F and other services on request.

HOTEL 7 LOVES Shankarshet Road, Pune 9. Tel. 442247, 446760. No Single room. Total rooms 13. One A. C. double room with two beds, attached bath and balcony Rs. 35 per day. Four-bed room Rs. 60 per day A. C. room Rs. 80 per day. Service charge 10% extra on bill. Check-out time 12 noon.

HOTEL SHALIMAR 12/A Sadhu Waswani Road. Pune 1. Tel. 20290-91. No. of rooms 45. Single room Rs. 18. Double room Rs. 25. Suite Rs. 40.

SHIVADARSHAN LODGE Deccan Gymkhana, Pune 4. Tel. 57986. Cable: 'SHIVADARSHAN' Pune. Double-room charges per day Rs. 18. Extra-person charges Rs. 9. Check-out time 24 hours.

HOTEL SHREYAS Deccan Gymkhana, 1242B Apte Road, Pune 4. Tel. 56423- 5 lines. Gram: SHREYAS Telex: 0145-212. Rooms 48. Rooms are with attached toilet and balcony. Average charges: One person Rs. 35, two persons Rs. 45. Charges vary according to size and the special features, such as dressing apartment, corner balcony, Indian or/ and western style w. c. pan. The room can be air-conditioned on additional charges. Extra-person charge Rs. 10 per day. The rates include lodging only. Check hour 12 noon. Maharashtrian vegetarian meals are served at the dining hall. Banquets, parties, buffets, conferences etc. are arranged.

HOTEL SUTLEJ Fergusson College Road, Pune 4. Tel. 57182, 53367-68-69. 23 rooms of different sizes from 120 sq. ft. to 400 sq. ft. area. Rates per day: Single occupancy Rs. 25, 30 and 35 as per size. Double occupancy Rs. 35 and 40 as per size. There are 5 rooms with balconies, Rs. 35 and Rs. 45 for single and double occupancy respectively. Extra-person charge Rs. 10 per day. The rates are inclusive of bed tea only. Service charge 10% additional. All rooms are with WC bath. Check-out time: 12 noon.

HOTEL SWASTI 1234 Apte Road, Deccan Gymkhana, Pune 4. Tel. 54621. All double rooms. Rates per day: Double Rs. 32, single Rs. 26.

UDYAN NIVAS 1712/1-B Sadashiv Peth, Pune 30. Tel. 442441. Cable: KARYODYAN. Double-room charges per day Rs. 12. General room: 6 cots in one room, per cot charge Rs. 5. De luxe charge per day Rs. 18, extra-person charge Rs. 12. Check-out time 24 hours.

HOTEL VISHVAKAMAL 475 Gultekadi, Pune-Satara Road, Pune 9. Tel. 441328, 443288. Double-room charges per day Rs. 30. Four-bed room Rs. 50. Extra person Rs. 10 per day. Children below 8 years no charge. All rooms are attached with Bath and WC. Check-out time 12 noon.

VISITORS' HOME (Lodge) 759/55 Deccan Gymkhana, Pune 4. (Near D. G Post office) Tel. 53645.

LUXURY TAXI SERVICES

- BANDAL N. V.** 1251/6 Shivajinagar, Pune 4. Tel. 55698.
- BHAGWAT M. M.** 3 Murarji Peth, Solapur. 746-A Shivajinagar, Pune 5. Normally stationed at Solapur.
- BHATIA V. C.** 86/2 Market Road, Khadki, Pune 3. Tel. 57495.
- BHOKARE B. R.** 883 Kasba Peth, Pune 11.
- BHOKARE G. R.** 107 Shivajinagar, Pune 5.
- BORADE M. P.** Mobo's Hotel, Bund Garden Road, Pune 1, Tel. 20064.
- DE-LUX TOURIST SERVICE** 959 Shukrawar Peth, Pune 2.
- DESHMUKH V. P.** 990/2 (Singh Garage) Shukrawar Peth, Hira Baug, Pune 2.
- GANJARE S. L.** Bhawani Peth, Pune 2. Balaji Tourist Taxi.
- HUNDEKARI B. V.** 408/1 Gultekdi, Pune 9. Tel. 442371.
- JONDHALE V. L.** 67 Narayan Peth, Pune 30.
- KAKADE B. B.** Nishat Talkies Compound, 1011/12 Nana Peth, Pune 2.
- KALE B. P.** 68 Narayan Peth, Pune 30. Tel. 448552.
- KARANDE V. T.** C/o. Kumar Travel. 1020/9 Chaturshringi Road, Pune 16. Tel. 58599.
- KATE S. N.** 1185 Kasba Peth, Pune 11.
- KRISHNA TOURIST CAR SERVICE** 2 Thube Park, Pune 5. Tel. 58547.
- KUDALE K. S.** Aloha Luxury Service, 1263/3 Jangli Maharaj Road, Pune 5. Tel. 58314.
- KULKARNI R. S.** 1960 Madiwale Colony, Sadashiv Peth, Pune 30. Tel. 448098.
- KULKARNI S. K.** 35/15 Erandawana, Pune 4.
- LADKAT E. R.** 513 Kasba Peth, Pune 11. Tel. 448293.
- MAHAJAN P. C.** 583/36 Shukrawar Peth, Pune 2. Tel. 442579.
- MANADARE B. R.** 623/4 Deshmukh Wadi, Sadashiv Peth, Pune 30.
- MANADODY E.C.N.** 23 Dilip Lodge, Jangli Maharaj Road, Pune 5.
- METRO MOTORS** 2418 Thimayya Road, Pune 1. Te. 20436.
- PANARKAR B. K.** Appa Balwant Chowk, C/o Milan Photo Studio, Pune 2.
- PATIL B. B.** 149 Bopodi, Pune 3. Tel. 55600.
- PROMPT TOURIST MOTORS** 459/9A Sadashiv Peth, Pune 30.
- RAJGAONKAR S. G.** 113/1 Prabhat Road, Pune 4
- RAVINDRA SINGH SARDOOT SINGH** 24 Kahun Road, Pune 1.
- RUKARI N. V.** 408/1 Gultekadi, Pune 9. Tel. 23172. (149 Mukundnagar, Pune 9. Tel. 442786).
- SANAS S. B.** 1302 Hotel Jawahar, Tilak Road, Pune 2. Tel. 441019.
- SHELAR B. L.** 95/2 Yerawada, Pune 6. Tel. 26098.
- SHELUKAR R. D.** Jyoti Society, Sahakar Nagar, Pune 9.
- SHINDE B. N.** 23 Dapodi, Pune 12. Tel. 55365.
- SHINDE R. C.** Bharat Garage, Pune-Statara Road, Pune 9. Tel. 27121.
- SHIROLKAR S. H.** 993 Sadashiv Peth, Pune 30.
- SHIROLKAR B. H.** 262 Sadashiv Peth, Pune 30.
- SHIROLKAR D. D.** 198 Sadashiv Peth, Pune 30.

SWIFT TOURIST SERVICE 281 (New) Narayan Peth, Pune 30.

WADHWA G. P. 1205/8 Shivajinagar, Pune 4.

WAGHWALE B. S. 1130 Kasba Peth, Pune 11.

SHIVAJI MANDIR Sadashiv Peth, Pune 30.

TILAK SMARAK MANDIR Near S. P. College, Tilak Road, Pune 30. Tel. 445004.

UDYAN PRASAD 1712/1-B Sadashiv Peth, Pune 30. Tel. 442441. Capacity 475 chairs (fixed).

PUBLIC HALLS

GOKHALE HALL Laxmi Road, Pune 30.

GULATI HALL St. Vincent's High School, 2005/6 St. Vincent Street, Pune 1. Tel. 24235 Capacity 550 chairs

KALE HALL Gokhale Institute of Politics and Economics, Pune 4 Tel. 54287-56581. Capacity 315 chairs

LADY RAMABAI HALL S. P. College, Tilak Road, Pune 30.

LAKAKI BOARD ROOM (Air conditioned), Mahratta Chamber of Commerce and Industries, Tilak Road, Pune 2. Capacity up to 65 chairs. Tel. 440371.

LAXMI KRIDA KENDRA Appa Balwant Chowk, Pune 30.

MAHARASHTRA SAHITYA PARISHAD Tilak Road, Pune 30. Tel. 442963. Capacity up to 200 chairs.

NEHRU MEMORIAL HALL 3 Dr. Ambedkar Road, Pune 1. Tel. 20783. Capacity 779 chairs (fixed).

OGALE MEMORIAL HALL Mahratta Chamber of Commerce and Industries, Tilak Road, Pune 2. Capacity up to 50 chairs. Tel. 440371

POONA CLUB LTD. 6 Bund Garden Road, Pune 1. Tel. 20754, 20777.

PUDUMJEE ASSEMBLY HALL (Auditorium) Mahratta Chamber of Commerce and Industries, Tilak Road, Pune 2. Capacity 150 chairs (fixed). Tel. 440371.

TOURIST SERVICES

BHARAT PRAVASI 1028 Sadashiv Peth, Pune 30.

BHARAT TOURIST SERVICE Pune-Satara Road, Pune 9. Tel. 27121.

BHARAT YATRA GUIDE 1056 Shukrawar Peth, Pune 2

CHANDRIKA YATRA COMPANY 228 Kasba Peth, Pune 11.

CHULANI TRAVEL SERVICE CHAMBERS 1727 Kedari Road, Pune 1.

DAMALE SHORT TRAVEL SERVICES 1208 Sadashiv Peth, Pune 30.

DATTA DIGAMBAR YATRA CO. Opp Gokhale Hall, Laxmi Road, Pune 30. Tel. 444390.

DECCAN LUXURY SERVICES 1251/6 Deccan Gynkhana, Pune 4 Tel. 55698

DEEPAK TRAVEL SERVICES 1702/3 Kedari Road Pune 1 Tel 27002.

GIRIKAND TRAVELS 759/90B Bhandarkar Insttand Road, Pune 4. (All-India tourist information centre and specialised in industrial tours.)

GURUNATH TRAVELS Zanjle Vitthal Mandir, opp Vishrambagwada, Pune 2.

IDEAL TOURIST AGENCY 484 Narayan Peth, Pune 30

- J. K. LUXURY SERVICES** 72 Narayan Peth, Pune 30.
- JANATA TRAVEL SERVICES** 1511 Sadashiv Peth, Pune 30.
- JAYASHREE TRAVEL SERVICES** 1155 Budhwar Peth, Pune 2. Tel. 443825.
- JAYALAXMI YATRA CO.** 184 Budhwar Peth, Pune 2.
- KISHOR TRAVEL SERVICES** 691 Budhwar Peth, Pune 2. Tel. 55809.
- MAHARASHTRA TRAVEL SERVICES** 1103 (New) Sadashiv Peth, Pune 30. Tel. 448309.
- PRAVASI MITRA** Deccan Gymkhana, Pune 4.
- RAJ TOURIST SERVICE** C/o. 889/90 Sai Service Station, J. M. Road, Pune 4. Tel. 50042.
- RAJKAMAL YATRA CO.** 625 Narayan Peth, near Lokhande Talim, Pune 30. Tel. 447357.
- RAMESH TRAVEL SERVICE** 96/97 M. G. Road, Pune 1. Tel. 23868.
- SUNDER SAHAL KENDRA** Yashashree, 9-A Budhwar Peth, Pune 2.
- AIR FREIGHT PVT. LTD.** Ambedkar Road, Pune 1. Tel. 26071, 26073.
- AIR INDIA** 1 Moledina Road, Pune 1. Tel. 28747, 28090.
- AJANTA EXPRESS SERVICE** Travel Agents and Carriers, 433/24 Somwar Peth, Pune 11. Tel. 26185.
- BOMBAY TRAVEL PVT. LTD.** Shivadarshan Lodge, Pune 4. Tel. 55668.
- GEM TRAVELS** Hotel Shalimar, Pune 1.
- IND TRAVELS** Atur House, Pune 1.
- INDIAN AIRLINES** Hotel Amir, 15 Waswani Road, Pune 1. Tel. 28179. Airport Office Tel 28072.
- RAMESH TRAVEL SERVICE** 96/97 M. G. Road, Pune 1. Tel. 23868.
- SUNBEAM TRADE WINGS** 13 Bhawani Peth, Pune 2. Tel. 24566.
- TRADE AND TRAVEL SERVICE** Opp City Post-Laxmi Road, Pune 2. Tel. 445470.
- TRADE WINGS LTD.** 321 M. G. Road, Pune 1. Tel. 23983, 23985.
- TRAVEL CORNER** Deccan Gymkhana, Pune 4.
- TRAVEL CORPORATION PVT. (INDIA) LTD.** C/o. Hotel Blue Diamond, Pune 1. Tel. 28919. For International booking: Hotel Amir Bldg., Pune 1. Tel. 22260.
- TRAVEL INTERNATIONAL** 211 M. G. Road, Pune 1. Tel. 20221.
- WESTERN INDIA SERVICES** 267 M. G. Road, Pune 18. Tel. 23442.

TRAVEL AGENTS AND AIRLINES

AIR CARRIERS 'Yashonand', 17 Shyam Sunder Society, Dattawadi, Pune 30.

Publicity & Publications

Advertising Agencies
Advertising Media
and their Rates
Commercial Artists
Hoarding Advertisers
News Agencies
Booksellers
Publications
Publishers

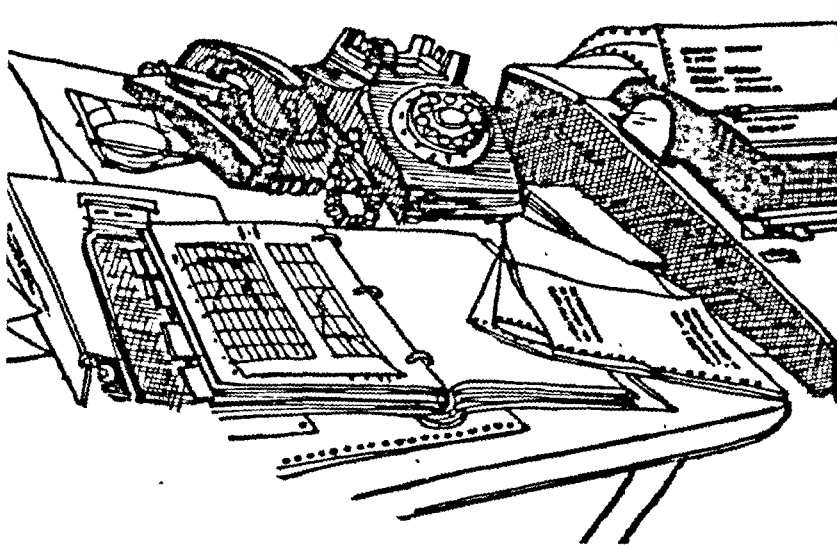

**PUBLICITY &
PUBLICATION**

Advertising Agencies

Advertising Media and Their Rates

Commercial Artists

Hoarding Advertisers

News Agencies

Booksellers

Publications

Publishers

ADVERTISING AGENCIES

- AJANTA PUBLICITY** 799/6 Bhawani Peth, Pune 2.
- AN PUBLICITY** 441 Rasta Peth, Pune 11.
- ALKA ADVERTISING** Opp. Vasant Talkies, Budhwar Peth, Pune 2.
- ALPHA ADVERTISERS** 392A/5 Shivajinagar, Pune 16.
- ARUN ADVERTISERS** 12 Somwar Peth, Pune 11.
- ASTAVISION ADVERTISING** 4 Thumayya Road, Pune 1.
- BLAZE ADVERTISING PVT. LTD.** 16 Sadhu Waswani, Pune 1.
- DA-AD ADVERTISING** 917/4 Ganesh Wadi, Deccan Gymkhana, Pune 4.
- D. BAL PUBLICITY** 599/600 Kasba Peth, Pune 11.
- DEEPA ADVERTISERS** 797 Sadashiv Peth, Laxmi Road., Pune 30.
- EXPRESS ADVERTISING** 223 Raviwar Peth, Pune 2.
- FLASH PUBLICITY** 693 Sadashiv Peth, near Chitrasahala, Pune 30.
- FOCUS ADVERTISINGS PVT. LTD.** Prasad Chamber, 17-A/2 Erandawana, Karve Road, Pune 4.
- HEMBAWL PUBLICITY** 567 Sadashiv Peth, Pune 30.
- HINDUSTAN ADVERTISING AGENCY** 4 Ambedkar Road, Pune 1.
- HIND PUBLICITY** 20 Karve Road, Swapnanagari, Pune 4.
- IMPRESS ADVERTISING** 461/1 Sadashiv Peth, Tilak Road, Pune 30.
- INAMDAR BROTHERS** 637 Sadashiv Peth, Pune 30.
- J. J. & COMPANY ADVERTISERS** 489 Shaniwar Peth, Pune 30.
- JAYA ADVERTISING** 34/4 Erandawana, Karve Road, Pune 4.
- KALPANA PUBLICITY** 40/649 Lokmanyagar, Pune 30.
- LEENA ADVERTISERS** 687 Budhwar Peth, Pune 2.
- MANORANJAN KARYALAYA ADVERTISING DEPARTMENT** 48 Shivajinagar, Pune 5.
- MASS COMMUNICATION & MARKETING (P) LTD.** 15 Ambodkar Road, Pune 1.
- MAYUR PUBLICITY** Shaniwar Peth, Appa Balwant Chowk, Pune 30.
- MEENAL PUBLICITY** 409 Narayan Peth, Pune 30.
- NANDADEEP PUBLICITY** 1093 Sadashiv Peth, Pune 30.
- NAVATARANG PUBLICITY** 592 Budhwar Peth, Pune 2.
- P.H.D. ADVERTISERS** Kasba Peth, Pune 11.
- *PADMAJA ADVERTISERS** 172 Shaniwar Peth, Pune 30.
- PANKAJA ADVERTISING** Chitrasahala Bhavan, Laxmi Road, Pune 30.
- PAPREX PUBLICITY** 394 Narayan Peth, Pune 30.
- PARAMOUNT PUBLICITIES** 245 Narayan Peth, Pune 30.
- PARAMOUNT PUBLICITY SYNDICATE PVT. LTD.** 481 Shaniwar Peth, Pune 30.
- POONA PUBLICITY SERVICE** Opp. Bhanuvilas Talkies, Pune 30.
- PRABHANATH PUBLICITY SERVICE** 49/1 Budhwar Peth, Pune 2.
- PRABHANSH ADVERTISERS** 484 Kasba Peth, Pune 11.
- *PRATIBHA ADVERTISING 'Cosmos',** Prabhat Road Pune 4.
- PRESS PUBLICITY SERVICE** 296-A/1 Shaniwar Pune 30.

- PUBLICIS ADVERTISING** 2 M.G. Road, Pune 1.
- PUNAM PUBLICITY SYNDICATE** 58/451 Laxmi Nagar, Pune 9.
- PUSHKARAJ PUBLICITY** 2nd floor, Alankar Talkies, Pune 1
- RAVIRAJ PUBLICITY** 203 Shanwar Peth, Pune 30.
- RISING PRESS SERVICE** 354 Narayan Peth, Pune 30.
- SADHANA ADVERTISING** 243 Rasta Peth, Pune 11
- SAHITYA ADVERTISING** 2011 Sadashiv Peth, Tilak Road, Pune 30.
- SAPPHIRES** Gangi Bhuvan, 759/102 Deccan Gymkhana, Pune 4.
- SHREE ADVERTISING** 58 Budhwar Peth, Pune 2.
- *STUDIO PARKERSON** 'Parvati Darshan', Deccan Gymkhana, Pune 4.
- SUREKHA ADVERTISING** Near Commonwealth Building, Laxmi Road, Pune 30.
- TARA ADVERTISING** 'Vivek', Peshve Park Road, behind Municipal Sports Club, Pune 30.
- THE EVENS ADVERTISING & MARKETING** 1226,5 Hiranivas, Deccan Gymkhana, Pune 4.
- *TOM & BAY (ADVT) PVT. LTD.** 658 J. M. Road, Pune. 4
- ULKA PUBLICITY** 759/51 Deccan Gymkhana, Pune 4.
- USHA ADVERTISING AGENCY** 2115 Vijaynagar Colony, Pune 30
- USHA PUBLICITY** 425 Sadashiv Peth, Pune 30
- V. G. & CO.** 65/2 Somwar Peth, Pune 11
- VIDYA ADVERTISERS** 374 Shanwar Peth, Pune 30.
- VIJAY PUBLICITY** Bhanuvilas Compound, Narayan Peth, Pune 30.
- VIMAL ADVERTISING** 319 Sadashiv Peth, Perugate, Pune 30.
- WESTERN INDIA THEATERS PVT. LTD.** 9 Moledina Road, Pune 1.
- *WESTERN ADVERTISING & MARKETING SERVICE** Prasad Chambers, opp. H. P. Petrol Pump, Karve Road, Pune 4.
- * These agencies are accredited by The Indian & Eastern Newspaper Society.

ADVERTISING MEDIA AND THEIR RATES

I. COMMERCIAL BROADCASTING SERVICE

ALL INDIA RADIO RATES FOR SPOT ADVERTISEMENTS & TIME CHECKS*

| Time Category | Duration in Seconds | Bombay/ Pune/ Nagpur | | Calcutta | | Delhi | | Madras/Tiruchi Chandigarh/Jullundur Bangalore/Dharwar Hyderabad/Vijaywada Ahmedabad/Rajkot Kanpur/Lucknow/ Allahabad (Patna/ Ranchi) Cuttack Bhopal/Indore Jaipur/ Jodhpur/Trivandrum/ Calicut/Srinagar | |
|---------------|---------------------|----------------------------|--------------|---------------|--------------|---------------|--------------|---|--------------|
| | | Week- days | Sun- days | Week- days | Sun- days | Week- days | Sun- days | Week- days | Sun- days |
| Super | 7" | 90.00 | 130.00 | 75.00 | 100.00 | 60.00 | 85.00 | 45.00 | 60.00 |
| A | 15" | 130.00 | 210.00 | 100.00 | 165.00 | 90.00 | 135.00 | 75.00 | 105.00 |
| | 30" | 235.00 | 345.00 | 180.00 | 270.00 | 160.00 | 240.00 | 120.00 | 180.00 |
| | 60" | 370.00 | 580.00 | 285.00 | 450.00 | 250.00 | 400.00 | 195.00 | 300.00 |
| A | 7" | 60.00 | 85.00 | 50.00 | 65.00 | 40.00 | 55.00 | 30.00 | 40.00 |
| | 15" | 85.00 | 140.00 | 65.00 | 110.00 | 60.00 | 90.00 | 50.00 | 70.00 |
| | 30" | 155.00 | 230.00 | 120.00 | 180.00 | 105.00 | 160.00 | 80.00 | 120.00 |
| | 60" | 245.00 | 385.00 | 190.00 | 300.00 | 165.00 | 265.00 | 130.00 | 200.00 |
| C | 7" | 30.00 | 40.00 | 25.00 | 30.00 | 20.00 | 25.00 | 20.00 | 25.00 |
| | 15" | 30.00 | 40.00 | 25.00 | 30.00 | 20.00 | 25.00 | 20.00 | 30.00 |
| | 30" | 55.00 | 55.00 | 40.00 | 40.00 | 40.00 | 50.00 | 35.00 | 40.00 |
| | 60" | 70.00 | 100.00 | 55.00 | 80.00 | 55.00 | 75.00 | 50.00 | 65.00 |

*With effect from 16-7-1975.

SCHEDULE OF RATES TO BE CHARGED FOR EXTRA TIME ALLOTTED FOR INCLUSION OF RETAIL PRICES IN SPORTS*

| | Bombay | | Calcutta | | Delhi | | Other Stations | |
|------------------|----------|-----------|----------|----------|----------|----------|----------------|----------|
| | W | S | W | S | W | S | W | S |
| Super 'A' | | | | | | | | |
| 3" | Rs. 24/- | Rs. 35/- | Rs. 18,- | Rs. 27,- | Rs. 16,- | Rs. 24/- | Rs. 12,- | Rs. 18,- |
| 6" | Rs. 47/- | Rs. 69,- | Rs. 36,- | Rs. 54,- | Rs. 32,- | Rs. 48,- | Rs. 24,- | Rs. 36,- |
| 10" | Rs. 79,- | Rs. 115/- | Rs. 60/- | Rs. 90,- | Rs. 54,- | Rs. 80,- | Rs. 40,- | Rs. 60,- |
| 'A' | | | | | | | | |
| 3" | Rs. 16,- | Rs. 23,- | Rs. 12,- | Rs. 18,- | Rs. 11,- | Rs. 16,- | Rs. 8,- | Rs. 12,- |
| 6" | Rs. 31,- | Rs. 46,- | Rs. 24,- | Rs. 36,- | Rs. 21,- | Rs. 32,- | Rs. 16,- | Rs. 24,- |
| 10" | Rs. 52,- | Rs. 77,- | Rs. 40,- | Rs. 60,- | Rs. 35,- | Rs. 54,- | Rs. 27,- | Rs. 40,- |
| 'C' | | | | | | | | |
| 3" | Rs. 6,- | Rs. 6,- | Rs. 4,- | Rs. 4,- | Rs. 4,- | Rs. 5,- | Rs. 4,- | Rs. 4,- |
| 6" | Rs. 11,- | Rs. 11,- | Rs. 8,- | Rs. 8,- | Rs. 8,- | Rs. 10/- | Rs. 7,- | Rs. 8,- |
| 10" | Rs. 19/- | Rs. 19/- | Rs. 14,- | Rs. 14,- | Rs. 14,- | Rs. 17/- | Rs. 12,- | Rs. 14,- |

*"W" - Weekdays -- "S" - Sundays

NOTE: Rates are per Spot/Timecheck and shall be applied separately for each station or group of stations.

- | | |
|--|------------|
| i) Fix spot | 25 % Extra |
| ii) Special Position | 25% Extra |
| iii) Saturdays between 2.30 p.m. and 3.30 p.m. | |
| 10% Extra for Bombay and Calcutta | |

DISCOUNTS PAYABLE TO ADVERTISERS ONLY --For annual Business placed by an advertiser during the period of contract.

| | |
|---------------------------|---------------------------------|
| On first Rs. 50,000/- Nil | On next Rs. 50,000/- 3% |
| On next Rs. 50,000/- 2% | On next Rs. 50,000/- & above 4% |

NOTE:—Discount will be paid to the advertisers on the confirmation of the total gross business placed by them with All India Radio during the financial year commencing from 1st April to 31st March every year. This payment is subject to the clearance of outstanding payment against them if any and will be made in Air time.

AGENCY COMMISSION:—The Accredited and Recognised Advertising Agencies will be allowed 15% Commission
CANVASSERS' COMMISSION —Canvassers will be allowed 6½% Commission.

RATES FOR SPONSORED PROGRAMMES

| | Weekdays | Sundays | | Weekdays | Sundays |
|--|----------|---------|---|----------|---------|
| | Rs. | Rs. | | Rs. | Rs. |
| 10 Mts. Talks. | | | 30 Mts. Programmes other than Variety & Skits | | |
| BOMBAY | 505.00 | 785.00 | BOMBAY | 1680 00 | 2450 00 |
| DELHI | 470 00 | 730.00 | DELHI | 1560.00 | 2275 00 |
| OTHER STNS. | 430 00 | 670 00 | OTHER STNS | 1440 00 | 2100.00 |
| 10 Mts. other Programmes | | | 30 Mts. Variety Programmes and Skits | | |
| BOMBAY | 560 00 | 875 00 | BOMBAY | 1440 00 | 2045 00 |
| DELHI | 520 00 | 810.00 | DELHI | 1300.00 | 1900 00 |
| OTHER STNS. | 480 00 | 750.00 | OTHER STNS. | 1200.00 | 1750 00 |
| 15 Mts. Programmes other than Variety & Skits | | | For each additional quarter hour over 30 Mts. | | |
| BOMBAY | 840.00 | 1225 00 | BOMBAY | 700.00 | 1015 00 |
| DELHI | 780 00 | 1135 00 | DELHI | 650 00 | 940 00 |
| OTHER STNS. | 720.00 | 1050 00 | OTHER STNS. | 600.00 | 870 00 |
| 15 Mts. Variety Programmes & Skits | | | | | |
| BOMBAY | 700 00 | 1015 00 | | | |
| DELHI | 650 00 | 940 00 | | | |
| OTHER STNS | 600.00 | 870 00 | | | |

- NOTES:— 1) Thirty per cent extra for programmes based purely or mainly on Indian Film Music.
2) Twenty per cent discount for sponsorship of concerts of Indian or Western Music from Concert Halls
3) Sponsors would be entitled to the normal discount available to advertisers.

INSTRUCTIONS TO AGENCIES/ADVERTISERS

1 Procedure for payments

Except Advertising Agencies accredited to A.I.R., who are allowed 45 days credit period as per clause 17 of the contract, all other agencies/canvassers/direct advertisers are required to pay in advance of broadcast. Payments are to be made in cash or by Crossed Cheques/Demand Drafts on Bombay Bank drawn in favour of "RESERVE BANK OF INDIA, ACCOUNT— ALL INDIA RADIO "

2. All communications to be addressed to :

The Director of Sales, Central Sales Unit, Commercial Broadcasting Service, ALL INDIA RADIO, Broadcasting House Backbay Reclamation, Post Box No 11106, Bombay-400 020.

Stations other than Bombay/Pune/Nagpur are authorised to book some time directly at their stations. Correspondence relating to such bookings may be addressed to the respective Station Directors (Commercial), All India Radio, Delhi/Calcutta/Chandigarh/Ahmedabad/Bangalore/Hyderabad/Madras/Kanpur -Bhopal/Patna/ Jaipur/Trivandrum/Cuttack/Shrinagar

II ADVT. SLIDES EXHIBITION RATES OF PUNE CINEMAS
(Issued on 1-1-1978)

| Cinema | Capacity | One month (Rs.) | Three months (Rs.) | Six months (Rs.) | One year (Rs.) |
|------------------|----------|--------------------|-----------------------|---------------------|-------------------|
| ALANKAR A/c | 1142 | 150 | 400 | 700 | 1250 |
| *ALKA | 839 | 50 | 140 | 275 | 500 |
| ALPANA | 726 | 45 | 115 | 210 | 360 |
| APOLLO | 935 | 100 | 250 | 500 | 1000 |
| APSARA | 755 | 45 | 115 | 210 | 360 |
| ARUN A/c | 1001 | 60 | 150 | 275 | 500 |
| BHANUVILAS | 610 | 45 | 115 | 210 | 360 |
| CAPITOL | 551 | 45 | 115 | 210 | 360 |
| CHITRA | 550 | 45 | 115 | 210 | 360 |
| DECCAN | 550 | 45 | 115 | 210 | 360 |
| EMPIRE | 460 | 35 | 75 | 120 | 180 |
| EXCELSIOR | 553 | 35 | 90 | 160 | 300 |
| GUNJAN | 958 | 45 | 115 | 210 | 360 |
| JAYASHREE | 800 | 35 | 90 | 160 | 300 |
| MANGALA A/c | 1180 | 150 | 400 | 700 | 1250 |
| MINERVA | 610 | 45 | 115 | 210 | 360 |
| NATRAJ A/c | 1024 | 100 | 250 | 450 | 800 |
| NEELAYAM A/c | 1060 | 100 | 250 | 450 | 800 |
| NISHAT | 635 | 50 | 130 | 235 | 435 |
| LAXMINARAYAN A/c | 913 | 100 | 250 | 450 | 800 |
| LIBERTY | 536 | 25 | 60 | 100 | 180 |
| PRABHAT | 635 | 55 | 140 | 275 | 550 |
| RAHUL A/c | 1114 | 100 | 250 | 450 | 800 |
| RATTAN | 490 | 55 | 140 | 275 | 550 |
| SONMARG | 1000 | 100 | 250 | 500 | 950 |
| SRIKRISHNA | 650 | 45 | 115 | 210 | 360 |
| SRINATH | 664 | 50 | 130 | 235 | 435 |
| *VAIBHAV | 630 | 45 | 115 | 210 | 360 |
| VASANT | 880 | 75 | 195 | 350 | 625 |
| VIJAYANAND | 600 | 45 | 115 | 210 | 360 |
| VIJAY CH. MDR. | 761 | 75 | 195 | 350 | 625 |
| *WEST END | 585 | 50 | 120 | 210 | 360 |

*Rates at these cinemas are exclusive of 15% Maharashtra Surcharge.

III. RATES OF ADVERTISEMENTS IN DAILY NEWSPAPERS

438

| * NAME | KESARI | | POONA HERALD | | PRABHAT | | SAKAL | |
|--|--|--------|--|--------|--|--------|---|--------|
| * ADDRESS OF THE JOURNAL | 568, Narayan Peth, Pune 30. Tel. 57278 | | General Thimayya Pune 1 Tel. 20432, 26572. | | 303, Narayan Peth, Pune 30. Tel. 444841. | | 595, Budhwar Peth, Pune 2. Tel. 448403. | |
| * LANGUAGE | Marathi | | English | | Marathi | | Marathi | |
| * PUBLICATION | Daily | Sunday | Daily | Sunday | Daily | Sunday | Daily | Sunday |
| * CATEGORY OF ADVERTISEMENT | (Rates in rupees per column centimeter) | | | | | | | |
| 1) Display: Casual (up to 249 col. cms.) | 8.00 | 9 00 | 7 50 | 7 50 | 4 00 | 4.00 | 12 50 | 14 00 |
| 2) Notices, financial announcements, & fixed deposit advertisements. | 8.00 | 9 00 | 7 50 | 7 50 | 4 00 | 4 00 | 12 50 | 14 00 |
| 3) Display: Contract (250 col. cms & over) | 6.00 | 7.00 | 6 00 | 6 00 | 3.00 | 3 00 | 10 50 | 12 00 |
| 4) Display: Contract (501 col. cms. & over) | 5 00 | 7.00 | — | — | — | — | — | — |
| 5) Books & periodicals | — | — | — | — | — | — | 10.50 | 12.00 |
| 6) Ear panels: (per insertion) | 70 00 | 70.00 | 50.00 | 50.00 | 25.00 | 25 00 | 85 00 | 95 00 |
| 7) Entertainment & cinema | — | — | 4 00 | 4 00 | 2 00 | 2 00 | — | — |
| * SPECIAL POSITION | | | | | | | | |
| 1) Front page | 100 % | extra | 50 % | extra | 50 % | extra | 100 % | extra |
| 2) Other special positions | 25 % | extra | 25 % | extra | — | — | 25 % | extra |
| 3) Colour | 50 % | extra | — | — | — | — | — | — |
| * CLASSIFIED ADVERTISEMENTS | | | | | | | | |
| 1) For first 15 words | — | — | 6.00 | 6 00 | 2 00 | 2 00 | 6 00 | 6 00 |
| 2) For each additional word | — | — | 0.30 | 0 30 | 0 20 | 0 20 | 0 35 | 0 35 |
| 3) Box No. charges | — | — | — | — | 1 00 | 1 00 | 2 00 | 2 00 |
| 4) Maximum No. of words accepted | — | — | 50 | 50 | 40 | 40 | 50 | 50 |
| * MECHANICAL DATA | | | | | | | | |
| 1) Printed page size | 53 cms x 38 cms. | | 52 cms x 38 cms. | | 50 cms x 38 cms | | 53 cms x 39 cms | |
| 2) Columns per page | 8 | | 8 | | 8 | | 8 | |
| 3) Width of column | 4 8 cms. | | 5 cms. | | 4 8 cms. | | 4 8 cms. | |
| 4) Materials accepted | Matrices, blocks, stereos | | Fully mounted stereos only | | Blocks & mounted stereos only | | Matrices, blocks & stereos unmounted | |
| 5) Half-tone screen | 65 | | — | | 65 to 75 | | 55 to 60 | |
| 6) Members | I.E.N.S.; A.B.C.; ILNA, AINEC | | — | | — | | A B C | |

Industrial Directory of Pune

—(Contd.)

| * NAME * ADDRESS OF THE JOURNAL | SAKAL (combined rates for Pune-Bombay edition) Dr. N.B. Parulekar Marg, Bombay 25. Tel. 455387 | | TARUN-BHARAT 1375, Shukrawar Peth. Pune 2. Tel. 441750 | | VISHAL-SAHYADRI 'Sahyadri Sadan,' Tilak Rd., Pune 30. Tel. 442720; 442071 | |
|---|--|-------|---|-------|--|-------|
| | * LANGUAGE * PUBLICATION | | Marathi Daily Sunday | | Marathi Daily Sunday | |
| * CATEGORY OF ADVERTISEMENT | | | | | | |
| 1) Display Casual (up to 249 col. cms) | 15.50 | 16.70 | 9.00 | 9.00 | 5.50 | 5.50 |
| 2) Notices, financial announcements & fixed deposit advertisements | 15.50 | 16.70 | 9.00 | 9.00 | 5.50 | 5.00 |
| 3) Display:Contract (250 col. cms. & over) | 13.00 | 14.20 | 7.75 | 7.75 | 4.75 | 4.75 |
| 4) Display:Contract (501 col cms. & over) | — | — | 7.00 | 7.00 | 4.00 | 4.00 |
| 5) Books & periodicals | — | — | 7.50 | 7.50 | 3.50 | 3.50 |
| 6) Ear panels (per insertion) | — | — | 50.00 | 50.00 | 35.00 | 35.00 |
| 7) Entertainment & cinema | — | — | 3.00 | 3.00 | 2.25 | 2.25 |
| * SPECIAL POSITION | | | | | | |
| 1) Front page | 100 % extra | | 50 % extra | | 50 % extra | |
| 2) Other special positions | 25 % extra | | — | | — | |
| 3) Colour | — | | — | | 100 % extra | |
| * CLASSIFIED ADVERTISEMENTS | | | | | | |
| 1) For first 15 words | — | — | 5.00 | 5.00 | 3.00 | 3.00 |
| 2) For each additional word | — | — | 20 P. | 20 P. | 30 P. | 30 P. |
| 3) Box No. charges | — | — | — | — | — | — |
| 4) Maximum No of words accepted | — | — | 45 | 45 | 50 | 50 |
| * MECHANICAL DATA | | | | | | |
| 1) Printed page size | 53 cms × 39 cms. | | 52 cms × 39 cms. | | 52 cms × 8 cms | |
| 2) Columns per page | 8 | | 8 | | 8 | |
| 3) Width of column | 4.8 cms. | | 4.87 cms. | | 4.87 cms. | |
| 4) Material accepted | Matrices, blocks & sterios unmounted | | Blocks | | Sterios & matrices | |
| 5) Half-tone screen | Artpulls upto 133 screen | | 60 to 65 | | 65 | |
| 6) Members | A.B.C. & I.E.N.S. | | A.B.C. & I.E.N.S. | | I. E. N. S., ILNA | |

* All rates are subject to 20% surcharge. The rates are in general for the year 1978 and are subject to change.

**IV ADVERTISEMENTS ON PUNE MUNICIPAL TRANSPORT BUSES/SHELTERS
TARIFF CARD (EFFECTIVE FROM 1st APRIL 1977).**

| <i>Buses</i> | | | | |
|--|----------------|---------------------|---------------------------|---|
| <i>1. Main Back Panels (Size 5' 3" or 4' x 3')</i> | <i>Rent Rs</i> | <i>M. L. F. Rs.</i> | <i>Board hire charges</i> | <i>Painting charges Rs.</i> |
| <i>No. of spaces</i> | | | | |
| 1 to 30 panels | 40/- | — | 1/- | Rs. 50/- per panel, for 31 panels and above |
| 31 and above | 38/- | — | 1,- | Rs. 45/- per panel |
| <i>2 Side Panels (Size 15' x 1')</i> | | | | |
| 1 to 15 panels | 13 50 | 8/- | 0 50 | Same as above |
| 16 to 30 panels | 12 50 | 8/- | 0 50 | |
| 31 and above | 11 50 | 8/- | 0 50 | |
| <i>3. Inside Panels (Size 3' x 1')</i> | | | | |
| 1 to 15 panels | 4/- | | | Rs. 10/- per panel |
| 16 to 50 panels | 3/- | | | Rs. 7/- per panel for 50 panels and above |
| 51 to 100 panels | 2.50 | | | |
| 101 and over | 2 00 | | | |

| <i>Shelters</i> | | | | |
|---|------|------|------|---------------------|
| Average 90 sq. ft. | 40/- | 10/- | 10/- | Rs. 3/- per sq. ft. |
| 'A' (City areas) | | | | |
| 'B' (Outside City) | | | | |
| (covering Chinchwad, Pimpri, Dapodi, Dehu Rd., Yerwada) | 35/- | 10/- | 10/- | ,, |
| <i>Prominent areas</i> | | | | |
| Deccan Gymkhana | 75/- | 10/- | 10/- | ,, |
| Laxmi Road (except near City Post) | 60/- | 10/- | 10/- | ,, |
| Shivajinagar | 50/- | 10/- | 10/- | ,, |

1. Minimum period of contract is 12 months.
2. Short term contracts of less than 12 months (but not less than 3 months will be accepted on 12½% surcharge on rental)

SOLE AGENTS :

ASSOCIATED ADVERTISERS & PRINTERS,
Bharatiya Vidya Bhavan, K. M. Munshi Marg, Bombay 400 007. Tel. 351461, 357675.

Authorised Representatives in Pune :
VIDYA ADVERTISERS, 374 Shaniwar Peth, Pune 411 030. Tel. 470806.

V. RATES OF ADVERTISEMENTS ON TELEVISION

I. RATES OF FILM SPOT ADVERTISEMENTS TIME CLASSIFICATION

| Time | Super A. (Prime Time) | A 7 45 p. m. to 10 00 p.m. | B Beginning of transmission to 7.45 p.m. & 10 05 p.m. to end of transmission |
|------------|--------------------------|-------------------------------------|---|
| | Rs. | Rs. | Rs. |
| 10 seconds | 2,000 | 1,500 | 1,000 |
| 20 seconds | 4,000 | 3,000 | 2,000 |
| 30 seconds | 6,000 | 4,500 | 3,000 |
| 40 seconds | 8,000 | 6,000 | 4,000 |
| 50 seconds | 10,000 | 7,500 | 5,000 |
| 60 seconds | 12,000 | 9,000 | 6,000 |

Super A Time/Prime Time includes Sports events, Feature film, Phool Khile Hain Gulshan Gulshan, Chitrahaar, Chhaya Geet, Chitramala, Oliyum Oliyum, Yaden Jo Kuchh Yaad Rahen, other feature-film-based programmes and special programmes telecast at any time during the transmission. For further details and bookings please contact:

Shri S. N. Sivaswamy, Controller of Sales (TV), Doordarshan, Mandi House, Copernicus Road, New Delhi 110 001.

1. The Director of Sales, Commercial Broadcasting Service, Bombay Television Centre, Worali, Bombay 400 025.
2. State Bank of India, Doordarshan, New Delhi.

II. RATES OF STATIC CAPTION ADVERTISEMENTS TIME CLASSIFICATION

| Time | Super A (Prime Time) | A 7 45 p.m. to 10 00 p.m. | B Beginning of transmission to 7.45 p.m. & 10 05 p.m. to end of transmission |
|------------|-------------------------|------------------------------------|---|
| | Rs. | Rs. | Rs. |
| 10 seconds | 1,000 | 750 | 500 |
| 20 seconds | 2,000 | 1,500 | 1,000 |
| 30 seconds | 3,000 | 2,250 | 1,500 |
| 40 seconds | 4,000 | 3,000 | 2,000 |
| 50 seconds | 5,000 | 3,750 | 2,500 |
| 60 seconds | 6,000 | 4,500 | 3,000 |

Super A Time/Prime Time includes Sports events, Feature film, Phool Khile Hain Gulshan Gulshan, Chitrahaar, Chaya Geet, Chitramala, Oliyum Oliyum, Yaden Jo Kuchh Yaad Rahen other feature film based programmes and special programmes telecast at any time during the transmission.

III. RATES FOR SPONSORED PROGRAMMES PER HOUR PRODUCED BY TV CENTRES

Rate for sponsored programme will be the rate for spot time as in Annexures I & II plus the following different rates for programmes to be sponsored in the case of different centre.

| Bombay-Pune | Delhi | Amritsar or Calcutta | Madras or Lucknow or Srinagar |
|-----------------------|-----------------------|-------------------------|-------------------------------------|
| Rs. 9,000 per hour | Rs. 6,000 per hour | Rs. 5,000 per hour | Rs. 4,000 per hour |

IV. RATES FOR PROGRAMMES PRODUCED BY ADVERTISERS

No charges will be levied for the transmission time but the advertiser will have to provide advertisement.

(static or animated) for a minimum of one minute which can be inserted at the beginning of the programme or in half-minute duration each before or after the programme

DISCOUNT

| | |
|--|-----|
| Business up to Rs. 2 lakhs | Nil |
| Business from Rs. 2 lakhs to Rs. 3 lakhs | 2% |
| Business from Rs. 3 lakhs to Rs. 4 lakhs | 3% |
| Business from Rs. 4 lakhs to Rs. 5 lakhs | 4% |
| Business above Rs. 5 lakhs | 5% |

TECHNICAL SPECIFICATIONS OF TV ADVERTISEMENT MATERIALS

1 Acceptable formats

Advertisement material for television should be prepared in one of the following formats

- i Standard slide with sound as tape.
- ii. Caption/Graphic on a grey cardboard, with sound on tape
- iii 16 mm positive film with optical/magnetic sound.
- iv 35 mm positive film with optical sound.

2. Contents of Advertisement

Sound part of advertisement should either be in the form of specially composed background instrumental music or verbal message which should preferably be of some social significance.

The advertisement may include besides the credit title of the sponsor, the brand name of the product manufactured or marketed by him and prices of the products.

3. Specification (picture)

3 1 Slides

Slides shall be mounted in standard 50mm (2"×2") mounts having picture aspect ratio of 4 horizontal 3 vertical. Any written material or titles should be restricted to TV safe title area

3 2 Captions

Caption card size shall be 305 (12") horizontal×228" (9"). Matter should be plain written words or graphic design, in white letters on a dull background. In case of pictures or photographs contrast range shall be limited to 1:30. This matter should be restricted to an area of 6"×8" in the centre of the card.

3 3 16mm film/35mm film

16mm or 35mm/print on a film spool may be given. Spool hub shall be as per the standard used at the respective Doordarshan Kendras. Material shall be photographic positive with film density range restricted to 0.35 to 1.6 for proper TV reproduction. Any written word of titles etc should be within the TV safe title area. The film shall be free from dust/dirt or scratches. (A protective leader of not less than 3.5 metres length shall be provided on both sides of the film. Identification of the advertisements, name of the company and duration at 25 frames per second, shall be written on the leader.) In case of 16mm optical sound film (COMOPT) emulsion position should also be indicated. (Academic leader is expected to be provided with the film)

Labels indicating the same information shall also be affixed on the film spool and film box if any

4 Sound specifications

Audible matter in the advertisement shall be recorded in the manner specified below, and shall not be excessively noisy or strident.

4 1 Sound for caption or slide

4.1.1 Sound accompanying slides or captions shall be on 6.25 mm (1/4") tape on 178mm (7") plastic reel with standard hubs.

A leader tape or blank tape of about 5 M shall be provided before the start of the recording

4.1.2 The recording shall be full track of standard play professional quality audio tape at a speed of (19.05) 7-1/2" per second.

The recording shall comply with the CCIR standard in respect of frequency response, distortion and noise level etc.

4.1.3 Before the start of the recording, a spoken word identification announcement shall be recorded giving details of corresponding caption, name of the sponsored programme to which it relates

4.4.4 Labels should be affixed on to the tape reel and the carton containing the tape giving following details

- (1) Tape No.;
- (2) Advertiser.
- (3) Product/Service advertised;
- (4) Agency, and
- (5) Duration.

4.2 Film sound

4.2.1 Sound on 35mm film shall be married optical (COMOPT) side track. Variable area recording is preferred. The location and dimension of picture frames and sound track should conform with the appropriate international standards. Useful frequency range should be 40 to 8000 Hz.

4.2.2 16mm film sound shall be married optical side track (COMOPT) or married magnetic side track (COMMAG). Variable area optical recording is preferred.

The location and dimension of picture frames and sound track should conform with appropriate international standard. Useful frequency range should be 50 to 5000 Hz. The magnetic sound recording characteristic should be same as those for magnetic tape recording at a speed of 19.05 on (7.5") per second.

COMMERCIAL ARTISTS

AGATE MALATI A-1 Renuka Apartments, Erandawana, Pune 4.

APHALE S. D. 559 Narayan Peth, near Modi Ganpati, Pune 30.

APTE J. P. "Manikmoti", Mitramandal Colony, Pune 9.

AWCHAT PRAVINA 15/218 Lokmanya Nagar, Pune 30.

AWCHAT SUBHASH 203 Sadashiv Peth, Pune 30.

BAGUL DEVIDAS 4/30 Co-op. Colony, Pune 4.

BANDMANTRI D. A. 332 Burma Shell Quarters, Pune 6.

BANKAR VASANT 1 Stavely Road, Pune 1.

BAPAT D. D. 318 Narayan Peth, Pune 30.

BHANDARE DILEEP Vijay Talkies Chowk, Pune 30.

BHARTAL RAMESH 1006 Sadashiv Peth, Pune 30.

CHANDEKAR SADANAD 1355 Sadashiv Peth, Pune 30.

DENGALE D. K. 980 Raviwar Peth, Laxmi Road, Pune 2.

DIGHE ISWAR "Ravi", 8/2 Sadashiv Peth, near Alka Talkies, Pune 30.

DIXIT J. B. 1140 Sadashiv Peth, Chitale Wada, Pune 30.

GHORPADE JAYSINGRAO 34/4 Erandwana, Karve Road, Pune 4.

GHORPADE SARJERAO 461/1 Sadashiv Peth, Tilak Road, Pune 30.

GONDHALEKAR J. D. 1015 Sadashiv Peth, Pune 30.

HAWALDAR S. S. 860 Sadashiv Peth, Pune 30.

JADHAV G. N. 383 (old) Sadashiv Peth, near Nagnath Par, Pune 30.

JOSHI PRANESH 'Anand', 16 Seetabag Colony, Vithalwadi Road, Pune 30.

JOSHI ARTS 1006 Sadashiv Peth, near Perugate, Pune 30.

JOSHI PRABHAKAR 484 Kasba Peth, near Kasba Peth Post Office, Chafa's Lane, Pune 11.

KADU L. M. 379 Shaniwar Peth, Pune 30.

KATE PRABHAKAR Ganeshwadi, Pune 4

KELKAR MUKUND 25 Budhwar Peth, Pune 2.

KELKAR N. P. 759/100 Deccan Gymkhana, Pune 4.

KHARE BHAU 325/A Sadashiv Peth, near Perugate, Pune 30.

KAHRE JAYANT 754 Shukrawar Peth, Patwardhan Wada, Pune 30.

KHASAGIWALE SUDHAKAR 355 Narayan Peth, opp. Bhanuvilas, Pune 30.

KISHOR YASHWANT 1496 Sadashiv Peth, Pune 30.

- KOKAD A. D. 591 Budhwar Peth, Pune 2
- LACHAKE HARISHCHANDRA 64/24 'Mandaloni', Erandawana, Pune 4
- LAHOTI M. R. 122 Nana Peth, Pune 2
- MAHABAL C. M. 241 Shukrawar Peth, Pune 2
- MAHABALESHWARKAR DATTA 2136 Vijaynagar Colony, Pune 30.
- MAHAMUNI BASWANT 373/A Shaniwar Peth, Pune 30.
- MANOHAR C. G. E-4 M.S.E.B. Colony, Ashoknagar, Pune 7.
- MODAK S. A. 254 Narayan Peth, Pune 30
- MUDHOLKAR RAMESH C/o Jayalaxmi Travels, Nagarwachan Mandir Bldg., Laxmi Road, Pune 2
- MULIK PRATAP 1194/6 Shivajinagar, Pune 5
- NADGAUDA N. R. 527 Shaniwar Peth, Pune 30.
- NANGRE N. M. 516 Shivajinagar, Pune 5
- NAMJOSHI S. S. 50 Parvati, Athawale Wada, Pune 9.
- NARVEKAR S. A. 373/A Shaniwar Peth, Pune 30.
- NAYAKWADI PRAKASH "Ravi", 8/2 Sadashiv Peth, Pune 30.
- OMKAR BHAYYASAHEB 495 Shaniwar Peth, Pune 30.
- PANSE B. M. 121 Kasba Peth, Pune 11
- PARADKAR B. D. 1275 Shukrawar Peth, Subhashnagar, Pune 2.
- PATHARKAR V. S. 1316 Sadashiv Peth, Pune 30.
- PATIL C. H. 40 Tilak Road, Pune 2.
- PHADNIS S. D. 1233 Subhashnagar, Shukrawar Peth, Pune 2.
- PHANSALKAR RAJANI 551 New Rasta Peth, Pune 11.
- PRABHANATH 45/1 Ganpati Chowk, Laxmi Road, Pune 30.
- REGE D. D. 260 Somwar Peth, Pune 11
- SAGAR ART SERVICE 42 Ganj Peth, Kastute Chowk Pune 30.
- SAHASRABUDHE VASANT 634 Sadashiv Peth, Golav Wada, Pune 30
- SALI V. R. 391 Narayan Peth, Pune 30
- SALKAR A. D. 650 Shaniwar Peth, Pune 30
- SOVANI M. V. 492 Shaniwar Peth, Pune 30.
- SAPPHIRES Ganga Bhuvan, 759/102 Deccan Gymkhana Pune 4
- SUBHASH PAWAR 1225/8 Awate Quarters. Apte Road, Deccan Gymkhana, Pune 4
- TADPHALE JAYANT 39 Rajendra Nagar, Pune 30
- TANNU SATYAWAN 578 Sadashiv Peth, Laxmi Road, Pune 30.
- TATAKE GANGADHAR Near Gokhale Hall, Laxmi Road, Pune 30.
- TENDULKAR MANGESH 196/67 Sadashiv Peth, Pune 30.
- THATTE C. P. 439 Shaniwar Peth, Pune 2
- VELANKAR VIVEK 246 Shaniwar Peth, Pune 30

HOARDING ADVERTISERS

- ASHA PUBLICITY 3 Shau College Road, Pune 9
Phone: 442095.
- ASTAVISION 4 Gen. Thimmayya Road, opp Hotel Latif, Pune 1. Phone: 27337.

B. K. NAIK & SONS 'Chandrakunj,' Bhandarkar Road, Pune 4. Phone: 57007.

HIGHWAYS ADVERTISING 245 Narayan Peth, Pune 30. Phone: 44171.

PUBLICITY ARTS 27 Budhwar Peth, Pune 2 Phone: 57769.

RAJENDRA ARTS SERVICE 1187/69 J. M. Road, near Rakhana's Hotel, Pune 5. Phone: 58763.

S. KARI & CO. Behind City Post, Pune 2. Phone: 445343.

SELECT OUTDOOR ADVERTISING 366 Narayan Peth, Pune 30. Phone: 44171.

SELLER 'Venunath', Mukund Nagar, Pune 9. Phone: 445343

NEWS AGECCIES

HINDUSTAN SAMACHAR A. B. Sidhaye, 1491 Sada shiv Peth, Tilak Road, Pune 30. Tel. 446342.

PRESS TRUST OF INDIA LTD. K. D. Joshi, 391 New Mangalwar Peth, Dudhat Bldg., Station Road, Pune 1. Tel. 22631/22181.

UNITED NEWS OF INDIA M. S. Pagar, 1966 Sadashiv Peth, Tara Bhavan, Madiwale Colony, Pune 30. Tel. 444615.

BOOK SELLERS

ABHIJAT Opp. S. P. College, Tilak Road, Pune 30.

ABHINAV PUSTAK MANDIR Fergusson Road, 917 Gnaesh Wadi, Pune 4.

AJIT BOOK SUPPLIERS A. S. Rahatekar, 32 Budhwar Peth, Pune 2.

AKSHAR BHANDAR Umbrya Ganpati Chowk, Laxmi Road, Pune 30.

ALLIES BOOK STALL Deccan Gymkhana, Pune 4

AMOD BOOK SELLERS 26 Budhwar Peth, Appa Balwant Chowk, Pune 2

ANAND PUSTAK MANDIR V. N. Gogate, 1635 Tilak Road, Pune 30

ANAMOL PUSTAKALAYA R. D. Nandurkar, 683 Budhwar Peth, Pune 2.

ARGADE & CO. Appa Balwant Chowk, Pune 30.

ASHOK BOOK DEPOT P. E. Shaha, 685 Budhwar Peth, Pune 2.

AVINASH BOOK DEPOT 786 Kasba Peth, Pune 11.

BHALERAO N. R. Prabhat Talkies Road, Pune 30.

BHARAT BOOK SERVICE Deccan Gymkhana, Pune 4.

BHAVE PUSTAK BHANDAR 917/22 Fergusson College Road, Pune 4.

CHITRASHALA GRANTH BHANDAR Laxmi Road, Bhanuvilas Chowk, Pune 30.

CHOICE BOOK STALL M. D. Katariya, 28B Budhwar Peth, Pune 2

CITY BOOK STALL Bajrao Road, near Shani Par, Pune 30.

COLLEGE BOOK DEPOT Appa Balwant Chowk, Pune 30.

CONTINENTAL BOOK SERVICE Smt. Sushila Patankar, 652 Narayan Peth, Appa Balwant Chowk, Pune 30.

DASTANE RAMCHANDRA & CO. 456 Raviwar Peth, Pune 2.

DECCAN BOOK STALL Fergusson Road, Deccan Gymkhana, Pune 4.

- DHARMIK PUSTAK BHANDAR** R. G. Patil, 938 Sadashiv Peth, Pune 30
- GANDHI SAHITYA BHANDAR** Laxmi Road, Bhanu-
vilas, Pune 30.
- HINDMATA PUSTAK MANDIR** 41 Budhwar Peth,
Pune 2.
- HINDUSTAN SAHITYA** H. V. Datye, 309 Shanwar,
Moti Bag, Pune 30.
- IMPERIAL BOOK DEPOT** 366 Mahatma Gandhi Road,
Pune 1
- INDIA BOOK CO.** Anant Ballal, 1275 Sadashiv Peth,
Pune 30
- INTERNATIONAL BOOK DEPOT** Deccan Gymkhana,
Pune 4.
- JOSHI BROTHERS BOOK SELLERS & PUBLISHERS**
K. V. Joshi, 25 Budhwar Peth, Appa Balwant Chowk,
Pune 2.
- JUPITER BOOK STALL** S. K. Gajare, 538 Shanwar
Peth, Pune 30.
- KEDAR PUSTAK MANDIR** Thorale Bajirao Road,
Pune 2.
- KOTHARI BOOK DEPOT** 156/57 Raviwar Peth,
Pune 2.
- L. N. GODBOLE BOOK SELLERS** Opp. City Post,
Laxmi Road, Pune 2.
- LAW BOOK HOUSE** V. S. Kulkarni, 543//2 Sadashiv
Peth, Pune 30.
- LAW BOOK HOUSE** 278/3 Narayan Peth, Pune 30
- M. K. BOOK CORNER** M. K. Tale 917/19B F. C
Road, Pune 4.
- M. M. LALWANI** 34/494 Lokmanyagar, Sadashiv
Peth, Pune 30.
- MADAN PUSTAKALAYA** Deccan Gymkhana, Pune 4
- MAHARASHTRA BOOK DEPOT** Appa Balwant
Chowk, Pune 2
- MAHARASHTRA VASTU BHANDAR** A. S. Wadod-
kar, 1786 Sadashiv Peth, Pune 30
- MAJESTIC BOOK STALL** R. G. Modi, near Shan-
Par, Pune 2
- MANISHA BOOK SELLERS & STATIONERS** 1392
Shukrawar Peth, Pune 2
- MILIND AGENCIES** 475/2 Shanwar Peth, Pune 30
- MODERN BOOK DEPOT** 12 Budhwar Peth, Bajirao
Road, Pune 2.
- MODERN BOOK STALL** East Street, Pune 1.
- NATRAJ BOOK DEPOT** Appa Balwant Chowk, near
Jogeshwari, Pune 2
- NAVIN KITABKHANA** S. V. Damale, 627 Budhwar
Peth, Pune 2.
- NEW ASHOKA BOOK DEPOT** 31 Budhwar Peth,
Pune 2.
- NEW POONA BOOK DEPOT** D. M. Kulkarni, 538
Shanwar Peth, Pune 30.
- NEW ROYAL BOOK DEPOT** Appa Balwant Chowk,
Pune 2.
- NEW & SECONDHAND BOOK DEPOT** D. S. Kulkarni,
495 Shanwar, Pune 30
- NERLEKAR BOOK DEPOT** Budhwar Peth, Pune 2
- NERLEKAR BOOK SELLERS** Budhwar Chowk,
Pune 2.
- OMKAR BOOK STALL AND LIBRARY** Chunchwad
Station, Pune 19
- P. G. GOVILKAR** S. T. Stand. Swargate, Pune 9.
- PEOPLES BOOK HOUSE** Laxmi Road, L.I.C. Bldg
Pune 30
- POPULAR BOOK HOUSE** Deccan Gymkhana, Pune 4.
- PRABHAT BOOK STALL** Appa Balwant Chowk,
Pune 30.

- PRAGATI BOOK CENTRE** Appa Balwant Chowk, Pune 2.
- PRAPHULL BOOK STALL** Appa Balwant Chowk, Pune 30.
- PUNE ORIENTAL BOOK HOUSE** 1055 Sadashiv Peth, Pune 30
- PUSTAK BHANDAR** 354 Narayan Peth, Laxmi Road, Pune 30.
- RAJESHREE BOOK STALL** Opp. Telco, Gawade Colony, Chinchwad, Pune 18.
- RAKA BOOK AGENCY** Appa Balwant Chowk, Pune 30.
- RASIK SAHITYA** M. D. Nandurkar, Appa Balwant Chowk, Pune 30.
- RAVINDU BOOK SELLERS** Appa Balwant Chowk, Pune 2.
- SAHITYA SAHAKAR SANGH LTD.** 672 Narayan Peth, Pune 30.
- SAHITYA SHILPI** Vasant Limaye, Udayan Prasad, Pune 30.
- SAHYADRI BOOK STALL** Sou Sudha Jawadekar, 39/1 Karve Road, Pune 4.
- SARATHI PRAKASHAN** 1005 Sadashiv Peth, near Perugate, Pune 30.
- SARASWAT** Sharad Gogate, 1321/1 opp. Modern High School, Pune 5.
- SARASWATI GRANTH BHANDAR** R. U. Kundur, 681 Budhwar Peth, Pune 2.
- SHRI GAJANAN BOOK DEPOT** Opp. Bharat Natya Mandir, Pune 30.
- SHRI GRANTHAGAR** 352 Narayan Peth, Laxmi Road, Pune 30
- SHRI LEKHAN WACHAN BHANDAR** G. L. Thokal, Laxmi Road, Pune 30.
- SHRI SAMARTH GRANTH BHAVAN** S. B. Dhawale, 550 Narayan Peth, Pune 30.
- SHRIRAM BOOK AGENCY** 727 D Sadashiv Peth, Pune 30.
- SUHAS AGENCY** Appa Balwant Chowk, Pune 30.
- SURESH AGENCY** 205 Shukrawar Peth, Pune 2.
- SWASTIK GRANTH BHANDAR** Opp. Prabhat Talkies, Pune 30
- UJWAL GRANTH BHANDAR** 683 Budhwar Peth, Appa Balwant Chowk, Pune 2
- UTKARSH BOOK SERVICE** S. V. Joshi, 701 Shivajinagar, Pune 4.
- VAIDYAK GRANTH BHANDAR** 360 Shaniwar Peth, Pune 30.
- VARMA BOOK CENTRE** R. V. Joshi, Appa Balwant Chowk, Pune 30.
- VENUS BOOK STALL** Appa Balwant Chowk, Pune 30.
- VICTORY BOOK CENTRE** Appa Balwant Chowk, Pune 30.
- VIDYA AGENCIES** 22 Prasad Chambers, Karve Road Pune 4.
- VIYANKATESH BOOK DEPOT** V. V. Puntambekar, 643 Narayan Peth, Pune 30.
- YESHWANT PRAKASHAN** A. S. Vaidya, 602 Sadashiv Peth, Pune 30

PUBLICATIONS

DAILIES

- KESARI** 538 Narayan Peth, Pune 30. Phone:56356
- POONA HERALD** Gen Thimmayya Road, Pune 1. Phone:23332.

- PRABHAT 303 Narayan Peth, Pune 30. Phone:56161
 PUNE SAMACHAR 136 Shukrawar Peth, Pune 2.
 SAKAL 595 Budhwar Peth, Pune 2. Phone:56107-8-9.
 SANDHYA 977 Sadashiv Peth, Pune 30. Phone:56959.
 TARUN BHARAT 1365 Shukrawar Peth, Pune 2.
 Phone : 56446

VISHAL SAHYADRI Sahyadri Bhavan, Tilak Road,
 Pune 30

WEEKLIES

- ASIDHARA G. Y. Prabhune, Purandare Wada,
 Chinchwad, Pune 33.
 AKHANDA BHARAT 281 Budhwar Peth, Pune 2.
 ANDOLANA 565 Shanwar Peth, Pune 30
 DINBANDHU 444 Rasta Peth, Pune 11
 GATIMAN Narubhau Limaye, Sahyadri Sadan, Tilak
 Road, Pune 30
 HORA 476 Shanwar Peth, Hasabnis Bakhhal, Pune 30.
 JATRA P. V. Behare, 560 Narayan Peth, Pune 30.
 MANUS 1025 Sadashiv Peth, near Nagnath Par, Pune 30.
 MANOHAR 1934 Kirloskar Press, Veer Savarkar Nagar,
 Pune 9.
 SADHANA 430 Shanwar Peth, Pune 30
 SOBAT 458/2 Sadashiv Peth, Tilak Road, Pune 30.
 SWARAJYA 595 Budhwar Peth, Pune 2
 WORLD OF BUSINESS Mahratta Chamber of
 Commerce & Industries, Tilak Road, Pune 2

FORTNIGHTLIES

- ARTHA 823 Shuvajinagar, Pune 4
 KHATEDAR PATRIKA 396 Narayan Peth, Pune 30,

- MOTOR VAHATUK 125 Shukrawar Peth, Pune 2.
 MAHARASHTRA 1398 Sadashiv Peth, Pune 30
 NABHOVANI 568 Narayan Peth, Pune 30.
 RUDRAVANI 499 Rasta Peth, Pune 11.

MONTHLIES

- ADARSHA VIDYARTHI 681 Budhwar Peth, Pune 2
 ALANKAR 1195 Kasba Peth, Karpe Sadac, Pune 11
 ANAND 1015 Sadashiv Peth, Pune 30.
 APALE SWASTHYA Ayurved Rasashala, Karve Road,
 Pune 4.
 APALI SHETI 874 Sadashiv Peth, Pune 30.
 APARADH 1286 Sadashiv Peth, Pune 30.
 AROGYA DEEP Oriental Watchman Pub. House,
 P. B. 35, Pune 1.
 AYURVED PRACHARAK 250-D Shanwar Peth,
 Pune 30.
 BAHAR 808 Sadashiv Peth, Barrister Gadgil Street,
 Pune 30.
 BALIRAJA Municipal Bank Bldg, Phadtare Chowk,
 Pune 30.
 BALWANT 898 Mangalwar Peth, Pune 11.
 BHAVISHYA & UPASANA 64/4 Mira Housing Society,
 Shankarshet Road, Pune 9.
 BIRBAL 461/1 Sadashiv Peth, Pune 30.
 BUVA 458/2 Sadashiv Peth, Pune 30
 CHAITRALI 57-A More, Niwas, Law College Rasta
 Pune 4.
 DHANANJAY 1286 Sadashiv Peth, Pune 30
 DHARMIK 1083 Sadashiv Peth, near Shampar, Pune 30

- DVAITA SIDHANTA KESARI 58 Shaniwar Peth, Pune 30.
- DYANODAYA Aryabhushan Press, Pune 4.
- EKALAVYA 1334 Shukrawar Peth, Pune 2.
- EKATA 1365 Shukrawar Peth, Natu Baug, Pune 30.
- EXCISE PATRIKA 3 Bhawani Peth, Pune 2.
- GANIT SHIKSHAN P. G Vaidya, Apte Prashala, Apte Road, Pune 4.
- GEETA DARSHAN Geeta Dharma Mandal, 1141 Sadashiv Peth, Pune 30.
- GHARMALAK SANGH PATRIKA 560 Shaniwar Peth, Pune 30.
- GOKUL 1194 Sadashiv Peth, Pune 30.
- GOWARDHAN 1384 Shukrawar Peth, Pune 2.
- GRAHAK SHAKTI Grahak Bhavan, Tilak Road, Pune 30.
- HANSA 474/1 Sadashiv Peth, Tilak Road, Pune 30.
- JAIN JAGRUTI 146 Nana Peth, Pune 2.
- JATRA 560 Narayan Peth, Pune 30.
- JIVAN SHIKSHAN Maharashtra Rajya Shikshan Shastra, Sadashiv Peth, Pune 30.
- JYOTISH DARSHAN 578 Shaniwar Peth, Pune 30.
- JYOTISH SAMACHAR Bhandarkar Institute Road, Pune 4.
- KADAMBARI 458/2 Sadashiv Peth, Tilak Road, Pune 30.
- KATHA LAXMI Durga Cottage, Prabhat Rasta, Galli No, 4, Pune 4.
- KIRLOSekar Kirloskar Press, Veer Sawarkar Nagar, Swargate, Pune 9.
- KRIDANGAN 461/1 Sadashiv Peth, Tilak Road, Pune 30.
- LD..29
- KRIDA KHABAR 728 Budhwar Peth, Laxmi Road, Pune 2.
- KUMAR 1272 Sadashiv Peth, Laxmi Road, Pune 30
- LOKSHIKSHAN Shikshanadhikari, Maharashtra Rajya, Central Bldg., Pune 1.
- MADHUKANS 125 Shukrawar Peth, Pune 2.
- MAHARASHTRA 1398 Sadashiv Peth, Pune 30.
- MAHARASHTRA DHARMA 1194 Sadashiv Peth, Pune 30.
- MAHATMA Pratibha Press, Tilak Road, Pune 30.
- MAHER 563 Narayan Peth, Pune 30.
- MAJDOOR MORCHA Trade Union Centre, 101 Shivajinagar, Pune 5.
- MANINI 1945 Sadashiv Peth, Pune 30.
- MANORA 186 Shaniwar Peth, Pune 30.
- MASIK POCKET BOOK 184-B Shaniwar Peth, Pune 30
- MATRIC VIDYARTHI 632/29 Sadashiv Peth, Pune 30.
- MAYAMARATHI C/o Kesari, 568 Narayan Peth, Pune 30.
- MENAKA 560 Narayan Peth, Pune 30.
- MINANJALI 35 Mahatma Gandhi Road, Pune 1.
- MOHINI 474/1 Sadashiv Peth, Tilak Road, Pune 30.
- MUDRAN PRAKASH 1078 Sadashiv Peth, Pune 30.
- NAGARI JEEVAN Pune Mahanagarपालिका, Pune 5.
- NAVAL 474/1 Sadashiv Peth, Tilak Road, Pune 30.
- NEELAMBARI Vaghire Chawl, Kharalwadi, Pimpri, Pune 18.
- PADAVIKA DARPAN Nilkantha Prakashan, Tilak Road, Pune 30.

- PAINJAN 464/1 Sadashiv Peth, Tilak Road, Pune 30.
- PANCHAYAT 977 Sadashiv Peth, Laxmi Road, Pune 30.
- PANCHSADHAN S. K. Kulkarni, 1183 Shivajinagar, Pune 5.
- PARYATAN 797 Sadashiv Peth, Pune 30.
- PATHALAG 1286 Sadashiv Peth, Pune 30.
- PRADHYAPAK Symbiosis College, Pune 4.
- PRAPANCHA 1691 Sadashiv Peth, Pune 30.
- PRASAD 1886 Sadashiv Peth, Pune 30.
- RAJAHANSA 146 Narayan Peth, Pune 30.
- RAJAS 495/96 Shaniwar Peth, Mehunpura, Pune 30.
- RAMYAKATHA 392 Narayan Peth, Pune 30.
- RASHTRA SEVADAL PATRIKA Sane Guruji Smarak, Sinhagad Rasta, Parvati, Pune 30.
- ROHINI 977 Sadashiv Peth, Laxmi Road, Pune 30.
- RUPA 1945 Sadashiv Peth, Pune 30.
- SAHAKARI JAGAT Block No. 10, Jilha Parishad Bldg., Pune 2.
- SAHYADRI 568 Narayan Peth, Pune 30.
- SAMACHAR 1786 Sadashiv Peth, Pune 30.
- SAMPADA Mahratta Chamber Bhavan, Tilak Road, Pune 2.
- SAMRUDHHA BHARAT 1759 Sadashiv Peth, Pune 30.
- SANTKRUPA 83/1/20 'Raturaj', Sarang Society, Pune 9.
- SANYOJAN 97 Rasta Peth, Pune 11.
- SATWIK SAMARTH 425/88 T.M.V. Nagar, Pune 9.
- SHALAPATRAK 1026 Sadashiv Peth, Pune 30.
- SHARVILAK 578 Sadashiv Peth, Laxmi Road, Pune 30.
- SHETAKARI Central Building, Pune 1.
- SHETAKI & SHETAKARI Gokhale Institute, Pune 4.
- SHIKSHAK 192 Shukrawar Peth, Pune 2.
- SHIKSHAN SANKRAMAN S. S. C. Board, Shivajinagar, Pune 5.
- SHYAMSUNDER 48 Deccan Gymkhana, Pune 4.
- SKYLINE 228 M. G. Road, Pune 1.
- SNEHANKIT Laxman Jawalkar Chawl, Kasarwadi, Pune 18.
- SNEHAPRABHA 1148 Sadashiv Peth, Pune 30.
- SRIYUT 290 Narayan Peth, Pune 30.
- SRUSTIDNYAN M. Phule Vastu Sangrahalaya, Ghole Road, Pune 5.
- STRI Kirloskar Press, Veer Savarkar Nagar, Pune 9.
- SUDARSHAN 468/2 Sadashiv Peth, Pantacha Got, Pune 30.
- SUGAVA 861/1 Sadashiv Peth, Pune 30.
- SUMEDH 1368 Bhimpura, Camp, Pune 1.
- SUSA C/o. Suyog Sadhana, Sadashiv Peth, Pune 30.
- TARZAN 461/1 Sadashiv Peth, Tilak Road, Pune 30.
- TEHLANIBURUJ 430-31 Shaniwar Peth, Pune 30.
- TILAK MAHARASHTRA VIDYAPEETH PATRIKA Vidyapeeth Nagar, Pune 9.
- USAMALA 977 Sadashiv Peth, Laxmi Road, Pune 30.
- UTTAM KATHA 608 Sadashiv Peth, Phadtare Chowk, Pune 30.
- VANGMAYA SHOBHA 1609 Sadashiv Peth, Pune 30.
- VAHINI 800-A Sadashiv Peth, Sathe Wada, Pune 30.
- VICHAR BHARATI Bharati Vidyapeeth, Erandwana, Pune 4.
- VICHITRA VISHVA 392 Narayan Peth, Pune 30.

VIDNYANYUG 1493 C Sadashiv Peth, Pile Bangala, Tilak Road, Pune 30.

VISHAKHA 58 Shaniwar Peth, Pune 30.

VYAPARI MAHARASHTRA 711 Narayan Peth, Pune 30.

VYAPARI MITRA 901 Budhwar Peth, Pune 2.

BIMONTHLY

NEW QUEST 'Aboli', 850/8A Shivajinagar, Pune 4.

SAMAJ PRABODHANA PATRIKA 430-31 Shaniwar Peth, Pune 30.

QUARTERLIES

ARTHASANWAD A-3 Prabodhan Society, Erandawana Pune 4.

MAHARASHTRA SAHITYA PATRIKA M.S. Parishad, Tilak Road, Pune 30.

PREETAM Sahyadri Sadan, Tilak Road, Pune 30.

BIANNUALS

ANJALI 42 Vijayanagar Colony, Pune 30.

BEYOND FRIENDSHIP Student's Welfare Association, 1182 F. C. Road, Pune 5.

SAHITYA PARIJAT 1027 Sadashiv Peth, Pune 30.

VIDNYAPANA 1053 Budhwar Peth, Pune 2.

ANNUALS

AMARENDRA 1000/2 Sudhanshu, Navi Peth, Pune 30.

AWANI 1436 Shukrawar Peth, Pune 2.

BALWADI Kirloskar Press, Veer Savarkar Nagar, Pune 9.

DEEPMALA 245 Narayan Peth, Pune 30.

DHANASHREE 477 Narayan Peth, Pune 30.

GRAHANKIT 644 Budhwar Peth, Pune 3.

KATKAT 930/3 Shukrawar Peth, Pune 2.

MOHIT 576 Ganesh Peth, Pune 2.

PARAMOUNT UDYOG VYAPAR 245 Narayan Peth, Pune 30.

PISARA 472 Shaniwar Peth, Pune 30.

RANGAVALI Hotel Pathik, J.M. Road, Pune 4.

RASIK Suvichar Prakashan Mandal, 461/4 Sadashiv Peth, Pune 30.

REVATI 7/4 Erandawana, Karve Road, Pune 4.

SHRAMASATTA 2181 Sadashiv Peth, Tilak Road, Pune 30.

SMITA 930/3 Shukrawar Peth, Pune 2.

UDGAR Nalini Prakashan, 977 Sadashiv Peth, Pune 30.

PUBLISHERS

ABHAYA SAHITYA 3(old), Sadashiv Peth, Pune 30.

ANAMOL PRAKASHAN Appa Balwant Chowk, Pune 2.

ANANT PRAKASHAN 433/3 Saraswat Colony, Pune 11.

ANAND KARYALAYA 1015 Sadashiv Peth, Near Nagnath Par, Pune 30.

ANIRUDHA SAHITYA 1493C Sadashiv Peth, Tilak Road, Pune 30.

ANUPAM PRAKASHAN Plot No. 31, Sabakarnagar, Pune 9.

ARAGADE-KULKARNI PRAKASHAN 16/224 Lokmanya Nagar, Pune 30.

ARN VIDYUTSHALA PRAKASHAN 1452 Kasba Peth, Pune 11.

- ASMITA PRAKASHAN 468/2 Sadashiv Peth, Tilak Road, Pune 30.
- ATUL PRAKASHAN 1493C Sadashiv Peth, Pune 30.
- AVINASH PRAKASHAN 786 Kasba Peth, Pune 11.
- BHARAT PRAKASHAN 1313 Sadashiv Peth, Pune 30.
- BHARATIYA CHARITRA-KOSHA MANDAL 1209/A/45 Shivajinagar, Pune 4.
- BHARATIYA SANSKRITI-KOSHA MANDAL 413 Shaniwar Peth, Pune 30.
- CHIRANJEEV GRANTH PRAKASHAN 2011 Sadashiv Peth, Pune 30.
- CONTINENTAL BOOK SERVICE Appa Balwant Chowk, Pune 30.
- CONTINENTAL PRAKASHAN 2011 Sadashiv Peth, Pune 30.
- DASTANE RAMCHANDRA AND CO. 456 Raviwar Peth, Phadake Houd, Pune 2.
- DEEPJYOTI PRAKASHAN Geet Govind, 230 Sadashiv Peth, Pune 30.
- DESHMUKH AND CO. 739 Budhwar Peth, Pune 2.
- DHARMIC PRAKASHAN 657 Narayan Peth, Pune 30.
- DILIPRAJ PRAKASHAN 852 Raviwar Peth, Pune 2.
- DUTTA PRAKASHAN 1623 Sadashiv Peth, Pune 30.
- GOKUL PRAKASHAN 1194 Sadashiv Peth, Pune 30.
- HANS PUBLICATIONS 474/4 Sadashiv Peth, Tilak Road, Pune 30.
- HINDUSTAN SAHITYA 309 Shaniwar, Moti Bag, Pune 30.
- IDEAL BOOK SERVICE 722 AB Navi Peth, Pune 30.
- INAMDAR BROS. 637 (New) Sadashiv Peth, Pune 30.
- INDRAYANI SAHITYA 1257 Sadashiv Peth, Pune 30.
- JAGTAP-KARALE PRAKASHAN 192 Shukrawar Peth Pune 2.
- JAYSHREE PRAKASHAN 'Rama Niwas', 992 Sadashiv Peth, Pune 30.
- JEEVANI WACHAN SAHITYALAY 31 Guru Nanak Nagar, Pune 2.
- JOMEPEH PUBLISHERS 1006 Sadashiv Peth, Pune 30.
- JOSHI BROTHERS BOOK SELLERS 25 Budhwar Peth, Pune 2.
- KALINDI PRAKASHAN 11 Pramodban, 242 Shukrawar Peth, Pune 2.
- KARMAVEER PRAKASHAN 22 Ambika Society, Chaturshringi, Pune 16.
- KEMKAR PRAKASHAN 152 Shaniwar Peth, Pune 30.
- KESARI PRAKASHAN 568 Narayan Peth, Pune 30.
- KIRLOSKAR PRESS Veer Savarkar Nagar Pune 9.
- KULKARNI GRANTHAGAR 186 Shaniwar Peth, Pune 30.
- MADHUKUNJ PUBLICATIONS 4 Nagar Wachan Mandir Bldg., Pune 2.
- MAGOWA PRAKASHAN 1259/2 J. M. Rd., Pune 4.
- MAHARASHTRA RASHTRABHASHA SABHA Rashtrabhasha Bhavan, Narayan Peth, Pune 30.
- MAHARASHTRA SAHITYA PARISHAD Tilak Rd., Pune 30.
- MANMOHINI PRAKASHAN Udyan Karyalaya, Sadashiv Peth, Pune 30.
- MANOHAR GRANTHAMALA 1609 Sadashiv Peth Pune 30.
- MARATHI POCKET BOOKS 43/348 Sant Tukaram Nagar, Pimpri, Pune 18.
- MENAKA PRAKASHAN 560 Narayan Peth, Pune 30.
- MODERN BOOK DEPOT Bajrao Rd., opp. Prabhat Cinema, Pune 30.

- MOGHE PRAKASHAN** 1440 Shukrawar Peth, She-wade Bol, Pune 2.
- MRUGAYA PRAKASHAN** 1540 Sadashiv Peth, Tilak Rd., Pune 30.
- NALINEE PRAKASHAN** 977 Sadashiv Peth, Laxmi Rd., Pune 30.
- NARENDRA PRAKASHAN** 683 Appa Balwant Chowk, Budhwar Peth, Pune 2.
- NEELKANTH PRAKASHAN** 1643 Sadashiv Peth, Tilak Rd., Pune 30.
- NIRMAL PRAKASHAN** 65/2/33 Amruteshwar Society, Padmawati, Pune 9.
- NISHANT PRAKASHAN** 14 Jeevan Prakash Society, 47/2 Parvati, Pune 9.
- NITIN PRAKASHAN** 1182 Sadashiv Peth, Pune 30.
- NUTAN PRAKASHAN** 2181 Sadashiv Peth, Tilak Rd., Pune 30.
- PADMAJA PRAKASHAN** 882 Padmakunj, Deccan Gymkhana, Pune 4.
- PARAMOUNT PRAKASHAN** 245 Narayan Peth, Laxmi Rd., Pune 30.
- PRAMOD PRAKASHAN** 1019 Sadashiv Peth, Pune 30.
- PRAPANCH PRAKASHAN** 1945 Sadashiv Peth, Pune 30.
- PRASAD PRAKASHAN** 1886 Sadashiv Peth, Pune 30.
- PRAVASI PRAKASHAN** 'Sushildatta', Sangamnagar, Patmawati, Pune 9.
- PRESTIJ PRAKASHAN** 461/1 Sadashiv Peth, Tilak Rd., Pune 30.
- PUNE VIDYAPEETH** Ganeshkhind Rd., Pune 7.
- PUNE VIDYARTHI GRUHA PRAKASHAN** 1783 Sadashiv Peth, Pune 30.
- PUSHPAK PRAKASHAN** 381A Shanwar Peth, Pune 30.
- RAJHANS PRAKASHAN** 1025 Sadashiv Peth, Pune 30.
- RAMYAKATHA PRAKASHAN** 392 Narayan Peth, Pune 30.
- RANE G. Y.** 2049 Sadashiv Peth, Pune 30.
- RASIK PRAKASHAN** 657 Narayan Peth, Pune 30.
- RAVIRAJ PRAKASHAN** 458/2 Sadashiv Peth, Tilak Rd., Pune 30.
- ROHI PRAKASHAN** 80 Raviwar Peth, Kasture Chowk, Pune 2.
- RUCHI PRAKASHAN** 565 Shaniwar Peth, Pune 30.
- S. P. PUBLICATIONS** 1518 Sadashiv Peth, Pune 30.
- SADANAND PRAKASHAN** Near Chimanya Ganpati, Sadashiv Peth, Pune 30.
- SADHANA PRAKASHAN** 430/31 Shaniwar Peth, Pune 30.
- SAI PRAKASHAN** A30 Amruteshwar Apartments, Pimpri, Pune 18.
- SAHITYA VASANT** 33L Nirant Condominiyam, Bibawewadi, Pune 9.
- SAMAJ PRABHODHAN SANSTHA** 430 Shaniwar Peth, Pune 30.
- SAMAJ SHIKSHAN MALA** 'Jawahar,' Vinayanagar Colony, Pune 30.
- SANJAYA PRAKASHAN** 917/22 F. C. Road, Pune 4.
- SARATHI PRAKASHAN** 1006 Sadashiv Peth, Pune 30.
- SARITA PRAKASHAN** 'Varda', Senapati Bapat Rd., Pune 16.
- SAVITRI PRAKASHAN** 1522 Sadashiv Peth, Pune 2.
- SATHE PRAKASHAN** 608 Sadashiv, Phadtare Chowk, Pune 30.
- SHRI PRAKASHAN** 495/96 Shaniwar Peth, Pune 30.
- SHRIRAM PRAKASHAN** 216 Shaniwar Peth, Pune 30.
- SHRI LEKHAN WACHAN BHANDAR** Thokal Bhavan, Narayan Peth, Laxmi Rd., Pune 30.

- SHRI SAHITYA 657 Narayan Peth, Pune 30.
- SHRI SHARADA PRAKASHAN 594 Narayan Peth, Pune 30.
- SHRI VIDYA PRAKASHAN 250C/16 Shaniwar Peth, Pune 30.
- SHRI VISHAKHA PRAKASHAN 58 Shaniwar Peth, Pune 30.
- SHUBHADA-SARASWAT 67 Patil Estate, Bombay-Pune Rd., Pune 5
- SUHAS PRAKASHAN Appa Balwant Chowk, Pune 30.
- SULABH RASHTRIYA GRANTHMALA 291 Shaniwar Peth, Pune 30.
- SUPARNA PRAKASHAN 26 Parvati, Pune 9.
- SUVICHAR PRAKASHAN MANDAL 461/4 Sadashiv Peth, Tilak Rd., Pune 2.
- SWADHYAYA MAHAVIDYALAYA PRAKASHAN 567 Sadashiv Peth, Pune 30.
- SWATI PRAKASHAN 2117 Sadashiv Peth, Pune 30.
- TILAK MAHARASHTRA VIDYAPEETH Gultekadi, Pune 9.
- TIRTHROOP PRAKASHAN 917/22 F. C. Rd., Pune 4.
- TUTORIAL INSTITUTE PRAKASHAN 'Paramdham', Madiwale Colony, Pune 30.
- UJAWAL PRAKASHAN Appa Balwant Chowk, Pune 2.
- UTKARSHA PRAKASHAN 885 Shivajinagar, Bhandarkar Rd., Pune 4
- VAHINI PRAKASHAN 800A Sadashiv Peth, Pune 30.
- VARADA BOOKS Senapati Bapat Marg, Pune 16.
- VIDARBHA MARATHWADA BOOK CO. 1324 Shukrawar Peth, Pune 2.
- VIDYARTHI PRAKASHAN 178-B Parvati, Pune 9.
- VENUS PRAKASHAN 'Tapascharya', 381C Shaniwar Peth, Pune 30.
- VISHWAKARMA SAHITYALAYA 2035/2 Sadashiv Peth, Pune 30.
- VISHWA MOHINI 62/12 Karve Rd., Pune 4.
- VITASTA PRAKASHAN 1206/1B Shivajinagar, Pune 4.
- YANDE R. D.—D. S. MANDALE 83 Parvati, Pune 9.
- YANTRAVIDYANA PRAKASHAN 264/3 Shaniwar Peth, Pune 30.
- YESHODA PRAKASHAN 1209 Sadashiv Peth, Pune 30.
- YESHWANT PRAKASHAN Sadashiv Peth, near Sadashiv Houd, Pune 30.

Education

Colleges and Institutions
affiliated to the University of
Poona
Other Educational Institutions
Technical Institutions
Libraries
Important Institutions

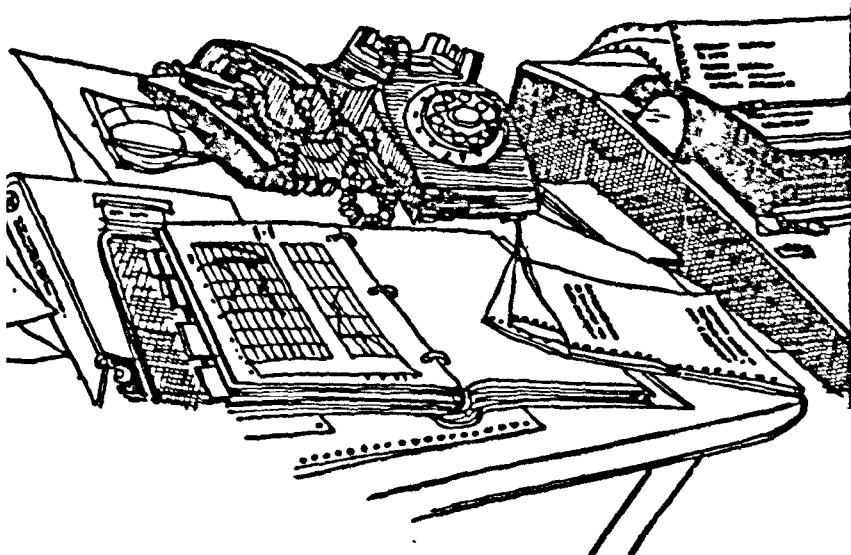

EDUCATION

**Colleges & Institutions Affiliated
to the University of Poona**

Other Educational Institutions

Technical Institutions

Libraries

Important Institutions

COLLEGES AND INSTITUTIONS AFFILIATED TO THE UNIVERSITY OF POONA

COLLEGES

- ABASAHEB GARWARE COLLEGE OF ARTS AND SCIENCE** Karve Road, Pune 4.
- ADARSHA COLLEGE OF EDUCATION** Erandawana, Karve Road, Pune 4.
- ADHYAPAK MAHAVIDYALAYA** Aranyeshwar, Pune 9.
- AKHIL BHARATIYA MARATHA SHIKSHAN PARISHAD'S LAW COLLEGE** Pune 9.
- ARMED FORCES MEDICAL COLLEGE** Solapur Rd., Pune 1.
- ARTS AND COMMERCE COLLEGE** Hadapsar, Pune 28.
- ASHTANG AYURVED MAHAVIDYALAYA** Tilak Road, Pune 30.
- BAIRAMJI JIJIBHOY MEDICAL COLLEGE** Pune 1.
- BHARATI VIDYAPEETH'S LAW COLLEGE** 48 Erandawana, Pune 4.
- BRIHAN MAHARASHTRA COLLEGE OF COMMERCE** Deccan Gymkhana, Pune 4.
- COLLEGE OF ENGINEERING** Shivajinagar, Pune 5.
- COLLEGE OF PHYSICAL EDUCATION** Gultekadi, Savarkar Nagar, Pune 9.
- FERGUSSON COLLEGE** F. C. Road, Pune 4.
- GARWARE COLLEGE OF COMMERCE** Karve Road, Pune 4.
- INDIAN LAW SOCIETY'S LAW COLLEGE** Pune 4.
- LOYOLA COLLEGE** Pashan Road, Pune 8.
- MODERN COLLEGE** Shivajinagar, J. M. Road, Pune 4.
- NESS WADIA COLLEGE OF COMMERCE** Bund Garden Road, Pune 1.
- NOWROSJEE WADIA COLLEGE** Bund Garden Road, Pune 1.
- POONA COLLEGE OF ARTS, SCIENCE AND COMMERCE** New Modikhana, Pune 1.
- SHRI JAIN COLLEGE OF ARTS AND COMMERCE** Chinchwad, Pune 19.
- SHRI SHAHU MANDIR MAHAVIDYALAYA** Laxmi Nagar, near Parvati Ramana, Pune 9.
- SIR PARSHURAMBHAU COLLEGE** Tilak Road, Pune 30.
- ST. MIRA'S COLLEGE FOR GIRLS** Pune 1.
- ST. VINCENT COLLEGE** St. Vincent Road, Pune 1.
- SYMBIOSIS SOCIETY'S LAW COLLEGE** Pune 16.
- TILAK AYURVED MAHAVIDYALAYA** 583/2, Rasta Peth, Pune 1.
- TILAK COLLEGE OF EDUCATION** Pune 30.
- YASHWANTRAO MOHITE COLLEGE OF ARTS, SCIENCE AND COMMERCE** Bharati Vidyapeeth, Pune 4.

INSTITUTIONS

BHANDARKAR ORIENTAL RESEARCH INSTITUTE
812 Bhandarkar Institute Road, Pune 4.

BHARATI VIDYAPEETH'S INSTITUTE OF MANAGEMENT 48 Erandawana, Pune 4.

CENTRAL WATER & POWER RESEARCH STATION
Khadakwasla, Pune 25.

COLLEGE OF MILITARY ENGINEERING Pune 12.

DECCAN COLLEGE OF POST - GRADUATE STUDIES & RESEARCH INSTITUTE Pune 6.

GOKHALE INSTITUTE OF POLITICS & ECONOMICS Deccan Gymkhana, Pune 4.

HINDUSTAN ANTIBIOTICS LTD. Pimpri, Pune 18

INDIAN DRUG RESEARCH LABORATORY 561-B Shivajinagar, Pune 5.

INDIAN INSTITUTE OF TROPICAL METEOROLOGY
Shivajinagar, Pune 5.

INSTITUTE OF ARMAMENT TECHNOLOGY Girinagar, Pune 25.

INSTITUTE OF MANAGEMENT DEVELOPMENT & RESEARCH Pune 4.

KARVE INSTITUTE OF SOCIAL SERVICE Hingane, Pune 29.

MAHARASHTRA ASSOCIATION FOR CULTIVATION OF SCIENCE 173-B Law College Road, Pune 4.

MAHARASHTRA RAJYA SHIKSHAN SHASTRA SANSTHA Sadashiv Peth, Pune 30.

METEOROLOGICAL OBSERVATORY Pune 5.

NATIONAL CHEMICAL LABORATORY Pune 8.

NATIONAL INSTITUTE OF VIROLOGY 20-A Ambedkar Road, Pune 1.

SYMBIOSIS SOCIETY'S INSTITUTE OF MANAGEMENT SCIENCE Pune 16

OTHER EDUCATIONAL INSTITUTIONS

ACADEMY OF MARKETING AND MANAGEMENT SCIENCE Prabhat Chambers, 685 Bhudhwar Peth, Pune 2. Director : S. M. Jawadekar.

ARMY CADET COLLEGE Ghorpuri, Pune 1. Tel. 22301.

COLLEGE OF AGRICULTURAL BANKING Ganeshkhind Road, Pune 16.

D'NOBILI COLLEGE (Christian College of Theology) Village Ramwadi, Pune-Nagar Road, Pune 14.

GOVERNMENT TRAINING COLLEGE FOR WOMEN 17 Ambedkar Road, Pune 1. Tel. 22711.

GOVERNMENT URDU TRAINING COLLEGE FOR MEN Camp, Pune 1. Tel. 24407.

HOMEOPATHIC MEDICAL COLLEGE Karve Rd., Pune 4.

INDIAN RAILWAY SCHOOL OF ADVANCED PERMANENT WAY ENGINEERING Near Pune Railway Station, Pune 1.

POONA CHAPTER OF COST ACCOUNTANTS, Fergusson College Road, Pune - 5.

POONA COLLEGE OF PHARMACY 890 Bhandarkar Institute Road, Pune 4.

RESERVE BANK STAFF TRAINING COLLEGE 131 Ganeshkhind Road, Pune 16. Tel. 56573.

S. N. D. T. COLLEGE FOR WOMEN Karve Road, Pune 4. Tel. 56689.

S. N. D. T. COLLEGE OF EDUCATION Karve Road, Pune 4. Tel. 55363.

S. N. D. T. COLLEGE OF HOME SCIENCE Karve Road, Pune 4.

SPICER MEMORIAL COLLEGE Ganeshkhind, Aundh Road, Pune 7.

TATA MANAGEMENT TRAINING CENTRE No.1 Mangaldas Road, Pune 1. Tel. 25494 & 25386.

TILAK MAHARASHTRA VIDYAPEETH Gultekdi, Pune 9. Tel. 440856.

TRAINING COLLEGE FOR WOMEN TEACHERS 424 Rasta Peth, Pune 11. Tel. 24820.

VAIKUNTH MEHTA NATIONAL INSTITUTE OF CO-OPERATIVE MANAGEMENT 131 Ganeshkhind Rd., Pune 16.

ments is presently under consideration of the Ministry of Industry, Government of India. Training facilities: The Institute conducts I.T.L. training course of 2 years' duration in two trades : (1) fitter and (2) mechanical-draughtsman.

THE BHARATIYA AGRO INDUSTRIES FOUNDATION 'Kamdhenu', Senapati Bapat Road, Pune 16. (For details, see page No. 280)

CENTRAL BEE RESEARCH INSTITUTE 839/1 Deccan Gymkhana, Pune 4. (For details, see page No. 280)

CENTRAL INSTITUTE OF ROAD TRANSPORT (TRAINING & RESEARCH) Pune-Nasik Road, Bhosari, Pune 26. Tel. 83671-72. Director: Brig. Lokesh Dhar (Retd.). (For details, see page No. 281)

COLLEGE OF ENGINEERING Shivajinagar, Pune 5. (For details see page No. 284)

TECHNICAL INSTITUTIONS

ABHINAV KALA VIDYALAYA 2038 Sadashiv Peth, Tilak Road, Pune 30. Tel. 441055, 442128. Principal: Shri D. K. Dengle. Nature of management: Govt. aided private institution managed by the Bharatiya Kala Prasari Sabha, a registered body. Training facilities: The institution runs the following courses: (1) Diploma in Fine Arts (five years' duration); (2) Diploma in Applied Arts (five years' duration); and (3) Art Teacher's Diploma (two years' duration).

ARN VIDYUT SHALA 1452 Kasba Peth, Pune 11. Principal: Shri P. P. Shah. Nature of Management: Private. Training facilities: Short duration trade courses of 3 months in (1) electrical wireman (2) electrician (3) motor rewinding and (4) radio and transistor repairing.

AUDYOGIK TANTRA SHIKSHAN SANSTHA C-2 MIDC Industrial Area, Chinchwad, Pune 19. Tel. 82079. Director & Secretary: Shri M. D. Jambhekar. Nature of management: Managed by a registered public trust. A proposal for expanding and modernising this institute with assistance from the Danish and German Govern-

COMMUNITY CANNING AND PRESERVATION CENTRE Gaffar Beg Street, Pune 1. Tel. 27406. Demonstration officer: Shri V. R. Rane. Nature of management: Under the Deptt. of Food, Ministry of Agriculture & Irrigation, Government of India. Training facilities: 1. 2-week course for housewives in canning and food preservation 2. Assistance in the preparation of fruit products for domestic consumption. The equipment available at the Centre can be used for this purpose at nominal charges.

COLLEGE OF ARCHITECTURE 2038 Sadashiv Peth, Tilak Road, Pune 30. Tel. 442128, 441055 Principal: Shri V. R. Sardesai. Nature of management: Government aided private institution managed by the Bharatiya Kala Prasari Sabha, a registered body. Training facilities: The College runs regular courses of five years' duration leading to the Bachelor's Degree in Architecture (B. Arch.)

CUSROW WADIA INSTITUTE OF TECHNOLOGY 19 Bund Garden Road, Pune 1, Tel. 24058. Principal: A. G. Patwardhan. Nature of management: Managed by the Modern Education Society, Pune 1. Training facilities: (1) Diploma courses in mechanical engineering, electrical engineering, civil engineering, and electronics and radio engineering; certificate courses in radio engineering; and (2) certificate courses in radio servicing, and television servicing.

DECCAN EDUCATION SOCIETY'S TECHNICAL INSTITUTE Servants of India Society Road, near Gokhale Institute, Deccan Gymkhana, Pune 4. (For details see page No. 287).

DECCAN SUGAR INSTITUTE Project Office, 270 Senapati Bapat Road, Pune 16. (For details see page No. 287).

FOOD CRAFT INSTITUTE Opp. 'Lokmangal', Shivajinagar, Pune 5. (For details see page No. 288).

GOOD AND SUITABLE RADIO CLASSES 170 Budhwar Peth, Pune 2. Principal and owner: Shri P. V. Godbole. Nature of management: Private. Estd. 1949. Training facilities: Short-duration training courses of 2 to 6 months in (i) radio repairing (govt. recognised), (ii) transistor and television repairing, (iii) electrical wireman (govt. recognised), (iv) motor rewinding, and (v) projector operation.

GOVERNMENT POLYTECHNIC Pune University Road, Pune 16. (For details see page No. 289).

GOVERNMENT TECHNICAL HIGH SCHOOL Ghole Road, Pune 5. Tel. 57190. Superintendent: Shri P. W. Rego. Nature of management: Under the Government of Maharashtra. Training facilities: 1. Training to students of various high schools from Standard VIII to Standard XII in technical subjects only. 2. Part-time I.T.I. courses of two years' duration for employed industrial workers in the following trades: (i) turner, (ii) fitter, (iii) mechanical draughtsman, and (iv) motor vehicle mechanic. 3. Scheme of basic Training and Related Instructions Classes once a week for apprentices employed in industries under the Apprenticeship Act 1961.

HANDMADE PAPER RESEARCH INSTITUTE K.B. Joshi Road, Agriculture College Campus, Pune 5. (For details, see page No. 289).

THE INDIAN DRUGS RESEARCH ASSOCIATION, DRUG RESEARCH LABORATORY 561-B, Shivajinagar, Pune 5. (For details, see page No. 289).

INDIAN PHYSICS ASSOCIATION (POONA CHAPTER) Department of Physics, University of Poona, Ganeshkhind Road, Pune 7. Tel. 56061. Chairman: Dr. A. S. Nigavekar. Nature of management: Under the Indian Physics Association, Bombay. C.O.P. Course in-charge: Shri A.V. Nandgaonkar. Training facilities: Part-time coaching courses for the Certificate of Proficiency

Examination in wireless trades on merchant ships, conducted by the Ministry of Communications, Government of India. The coaching includes theoretical and practical training. Min. qualifications for admission: S.S.C. Successful candidates can be appointed as Radio Officers on merchant ships.

INDUSTRIAL CHEMICAL LABORATORY Poona University Campus, opp. Raj Bhavan, Ganeshkhind Road, Pune 7. (For details see page 289).

INDUSTRIAL TECHNICAL INSTITUTE 3B 'Lajwanti', Erandawana, Karve Road, Pune 4. Tel. 55848, 54685. Principal and Proprietor: Shri S. D. Mahulikar. Nature of management: Private. Training facilities: (1) The Institute conducts special courses in the following trades for industrial workers by special arrangement with industries: (i) industrial draughtsman, (ii) turner, and (iii) fitter. 2. Technical career guidance.

INDUSTRIAL TRAINING INSTITUTE Aundh, Pune. Tel. 58284. Principal: Shri N. M. Bedse. Nature of management: Under the Technical Education Department, Government of Maharashtra. Training facilities: The Institute conducts various technical courses through three training schemes of the Government of Maharashtra, viz. (1) Craftsmanship Training Scheme (2) Advanced Vocational Training System and (3) Production Oriented Training Scheme. The Craftsmanship Training Scheme Consists of three courses: (1) Training course of 1 year's duration in the trades of blacksmith, welder, sheet metal worker, moulder, carpenter, painter, mechanic (diesel), mechanic (tractor), and plumber. (2) Training courses of 2 years' duration in the trades of mechanic—motor vehicle, building constructor, pattern-maker, wireman, farm mechanic, fitter, turner, machinist, grinder machinist, watch and clock maker, electroplater, electrician, mechanic instrument, tool & die maker, mechanic (refrigeration) and air-conditioning, draughtsman (mechanical), draughtsman (civil), surveyor, mechanic (radio and television), and electronics. (3) Training courses of 1 year duration in the trades of wireless operator, auto electrician, hand composition & proof-reading, book-binding, printing—machine operator, cutting and tailoring, manufacture of suit cases and other leather goods, stenography (English) and stenography (Marathi). The Advanced Vocational Training System has been launched jointly by the Government of India and the Government of Maharashtra in collaboration with the United Nations Development Programme and the International Labour Organisation, based on the working experience at the Advanced Training Institute, Madras. The System aims at giving a stimulus

and support for the accelerated development of critical skills needed for industrial development in India. It offers programmes for upgrading and updating the skills of industrial workers through need-based and tailor-made courses of shorter duration on a modular basis. Large and small industries can avail of this system by enrolling their workers for these courses and also by arranging with the Institute for special courses for groups of workers. Even workers without the requisite educational qualification but having adequate industrial experience are admitted to these courses. Presently, the Institute conducts training courses in the following trades under this system : (i) Reading of Indian standards and engineering drawings; (ii) tool and die making; (iii) machine tool maintenance (conventional machines); and (iv) electrical maintenance.

The Production Oriented Training Scheme has been introduced by the Government of Maharashtra in May 1976. Under this scheme job-orders are accepted by the Institute from industries and individuals and these are entrusted to the concerned sections. Job-orders in all the trades mentioned above under the craftsmanship training scheme are accepted. The job-work is carried out by the trainees under the supervision and guidance of instructors and the amount received through such job orders is shared between the institute, trainees and staff. Thus, through this scheme practical training is imparted to the trainees in production work.

INSTITUTE OF ARMAMENT TECHNOLOGY Girinagar, Pune 25. Tel. 440050, 440501, 440701-2-3, Director & Dean : Air Commodore S. K. Nair AVSM. Nature of management : Under the Research and development Organisation, Ministry of Defence, Government of India. Training facilities : Training of Defence and Defence-civilian personnel, mainly of the officer's cadre. Recognised by the University of Poona for post-graduate studies in (i) Physics, (ii) Chemistry, (iii) Mathematics (Mechanism & Ballistics), (iv) Telecommunication, and (v) Metallurgy.

KIRLOSKAR FOUNDATION 13 Elphinstone Road, Khadki, Pune 3. (For details see page No. 290)

MAHARASHTRA PRINTING SCHOOL 1786 Sadashiv Peth, Pune 30. Tel. 444531, 440888. Principal : Shri M. D. Kasture. Nature of management : Private, run by the Pune Vidyarthi Griha, a renowned educational and social institution. Estd. 1929. Training facilities : The school is recognised by the Government of Maharashtra for imparting education in printing. It is also recognised as a Basic Training and Related Instruction Centre for apprentices in the printing trade. The school conducts the following courses : (1) Full-time 3 years' diploma course

in letterpress printing and litho offset printing. (2) Part-time 4 years' diploma course in letter-press printing, and litho offset printing. (3) One years' full-time certificate courses in (i) letterpress printing, (ii) hand composing and (iii) binding. (4) Under the Basic Training & Related Instruction Scheme, part-time technical training is provided to apprentices in the following trades : (i) Mono casting, (ii) mono operating (iii) letterpress machine minder, (iv) hand composition and (v) book-binding.

MECHANICAL ENGINEERING RESEARCH AND DEVELOPMENT ORGANISATION N.C.L. Campus, Pune 8. (For details see page No. 291)

MODERN TECHNICAL CENTRE 144 Narayan Peth, Pune 30. Tel. 446503. Proprietor & Superintendent : Shri C. V. Pathak. Nature of management : Private. Branches : Satara & Karad. Training facilities : The Centre conducts full-time and part-time certificate training courses of 6 months to 1 year's duration in the trades of (i) turner, (ii) fitter, (iii) machinist, (iv) job inspector, (v) mechanical draughtsman, and (vi) scooter mechanic. The Centre imparts technical training in these trades to dumb, deaf and mentally retarded students also.

NATIONAL INSTITUTE OF ENGINEERING 826/B Dastur Meher Road, Pune 1. Tel. 24522, Principal : Shri R. P. Puri. Nature of management : Private, recognised by the City and Guilds of London Institute for different courses in engineering. Training facilities : Full-time and part time 1. Engineering diploma courses of the City and Guilds of London and State Boards in the following branches : (i) mechanical, electrical engineering, (ii) building & civil engineering, (iii) mechanical & production engineering, (iv) electrical engineering (v) radio & television engineering and (vi) automobile engineering. These diplomas are recognised by the Government of India and Union States as equivalent to polytechnic diplomas of the State Board of Technical Education in India. 2. Student-ship section for parts A & B of (i) A.M.I.E. (ii) I.E.T.E., (iii) I.E.R.E. (UK); (iv) A.M.I.Mech. E. (v) I.L.Chem. E. (vi) A. Textile I. (UK) (vii) A.T.A.; (viii) Aeronautical Engineering and (ix) Surveyor. These examinations are recognised by the Government of India as equivalent to the B.E. Degree.

NATIONAL INSTITUTE OF VIROLOGY 20-A, Dr. Ambedkar Road, Post Box No. 11, Pune 1. (For details see page No. 292)

OLYMPIA INSTITUTE OF TECHNOLOGY Prem Kutir, opp. St. Mira's College, Sadhu Vaswani Road,

Pune 1. Tel. 28212. Director : Shir Kannara Vijaykumar. Nature of management : Private, registered as a society and public trust; recognised & affiliated to the Indian Technical Education Society. Training facilities : The Institute conducts training courses for qualifying examinations conducted by the Deptt. of Technical Education Government of Maharashtra, the City and Guilds of London, the Indian Technical Education Society and the Industrial Training Institute. The certificate courses are of 1 month to 4 months duration in the following trades : (i) Tape recorder servicing, (ii) radio, transistor apprentice (iii) television apprentice, (iv) air-conditioning and refrigeration apprentice, (v) P.W.D. electrical wireman apprentice, (vi) electrician, (vii) armature motor winding, (viii) motor mechanic, (ix) auto electrician, (x) scooter technology and (xi) job inspector. The diploma courses are of 2-months to 6-months duration in the following trades : (i) Radio, transistor and tape-recorder technology, (ii) television technology, (iii) industrial electronics, (iv) electrical supervisor, (v) bench and pipe fitter, (vi) automobile technology, (vii) mechanical draughtsman & designer, (viii) building construction technology, interior decoration & designing, (x) air-conditioning and refrigeration practice and (xi) air-conditioning, ventilation, heating and refrigeration engg. technology.

PREMIER ELECTRIC CLASSES Near Seva Sadan, 791 Sadashiv Peth, Pune 30. Tel. 445219. Principal and owner : Shri K. C. Bhatia. Nature of management : Private. Training facilities : Training centre for (i) Electric wireman, (ii) radio, transistor and television repairing, and (iii) motor rewinding.

PROGRESSIVE TECHNICAL CLASSES 661/A Shivajinagar, opp. Deccan Talkies, Deccan Gymkhana, Pune 4. Tel. 52444, 50427. Director and owner : Shri S. N. Joshi. Nature of management : Private. Training facilities : Government recognised short-duration courses of 6 months to one year in the following trades : (i) Radio, transistor & television repairing, (ii) mechanical draughtsman, and (iii) wireman apprentice.

QUEEN MARY'S TECHNICAL SCHOOL FOR DISABLED INDIAN SOLDIERS Park Road, Kirkee, Pune 20. Tel. 56779. Superintendent : Col. S.M.S. Nicholson I.M.S.(Retd.) Nature of management : Charitable school, registered under the Indian Companies Act VII of 1913. Estd. 1917. Training facilities : I.T.I. and diploma courses for disabled ex-servicemen in the following trades under the National Council for Training in Vocational Trades Scheme : (i) electrician, (ii) fitter, (iii) mechanic (radio and television), (iv) wireman, (v) mechanic (diesel), (vi)

watch and clock maker, (vii) cutting and tailoring (viii) hosiery knitting, (ix) hand and power-loom weaving, (x) dyeing and printing, (xi) telephone switch-board operating and, (xii) stenography.

SHRI CHHATRAPATI SHIVAJI AUDYOGIK PRA-SHIKSHAN SANSTHA 626 Shukrawar Peth, Pune 2. Tel. 440459. Superintendent : Shri M. B. Govande. Nature of management : Semi-govt., under the Pune Municipal Corporation. Training facilities : 1. L.T.I. courses of two-year duration in the following trades : (i) Turner, (ii) fitter, and (iii) mechanical draughtsman. 2. One-year tailoring course for ladies.

THE SKYLINE INSTITUTE OF RADIO & ELECTRONICS 228 Mahatma Gandhi Road, Pune 1. Tel. 26337. Principal and owner : Shri P. V. Nikhal. Nature of management : Private. Estd. 1947. Training facilities : Post-S.S.C. one-year full-time certificate level courses and two-year part-time certificate level courses for the Government Examination in (i) radio and transistor servicing, and (ii) television servicing.

SMALL INDUSTRIES DEVELOPMENT INSTITUTE Agriculture College Campus, Shivajinagar, Pune 5. (For details see page No. 295)

SMALL INDUSTRIES SERVICE INSTITUTE-INDUSTRIAL EXTENSION CENTRE Shankarshot Road, Swargate, Pune 9. (For details see page No. 295)

SPICER MEMORIAL COLLEGE Ganeshkhind Road, Pune 7. Tel. 57262/3 and 56675. Principal : Dr. M.E. Chorian. Nature of management : Private. Training facilities : 1. The College runs regular courses of four years' duration leading to the degree of (i) Bachelor of Applied Arts, and (ii) Bachelor of Liberal Arts. For these degrees, practical training is given in printing-press technology, auto mechanics, dairy farming and food industry. There are two-year diploma courses in (i) home science, (ii) stenography, and (iii) agriculture.

ST. JOSEPH'S TECHNICAL INSTITUTE Shankarshot Road, Pune 9. Tel. 446492. Managing Director : Fr. Ivo Meyer S. J. Nature of management : Public charitable trust. Training facilities : 1. I.T.I. courses in the following trades : (i) turning, (ii) grinding, (iii) tool & die making; 2. Supervisory courses; 3. Job work.

ST. MARY'S ENGINEERING INSTITUTE 'Yashoranga', 364 Navi Peth, Ganjve Chowk, Pune 30. Principal and owner : Shri Y. S. Phukne. Nature of management :

Private. Training facilities: There are courses in the following trades: (i) Draughtsman (Mechanical), (ii) Job Inspector, and (iii) Tracer.

SYSTEMS RESEARCH INSTITUTE 6 Parvati Villa Road, Pune 7. Tel. 27071. Executive Director: Prof. J. G. Krishnaya. Nature of management: The institute is a non-profit 'Think Tank', registered as a trust and managed by an All-India Council. Training facility: The Institute runs courses on systems analysis and computer methods. For research activities and services please see under 'Consultancy Services' section.

TECHNICAL TEACHERS' TRAINING COLLEGE Government Polytechnic Campus, University Road, Pune 16. Tel. 58220. Principal: Prof. R. N. Belwalkar. Nature of management: Under the Government of Maharashtra. Training facilities: Training of technical teachers from government owned Polytechnic Institutions. The college conducts courses of 18 months' duration for technical teachers holding a degree or diploma in engineering so as to upgrade and update their knowledge in specialised subjects.

VIDYUT YANTRIKY VIDYALAY (Institute of Electrical Engineering) 1241 Sadashiv Peth, Pune 30. Tel. 448410. Principal: Mrs. Y. S. Pathak. Nature of management: Private. Training facilities: Short-duration certificate courses of 3 months in the following trades: (i) Electrical wireman, (ii) electric motor rewinding and (iii) electrical supervisor.

LIBRARIES

ABHINAV KALA VIDYALAYA LIBRARY Tilak Road, Pune 2.

AKASHWANI All-India Radio Library, Pune 5.

ANANDASHRAM SANSKRIT LIBRARY 22 Budhwar Peth, Pune 2.

ARMAMENT RESEARCH AND DEVELOPMENT ESTABLISHMENT LIBRARY Ministry of Defence, Khadki, Pune 3.

ASHTANG AYURVED MAHAVIDYALAYA LIBRARY 497/11 Sadashiv Peth, Pune 30.

AUTOMOTIVE RESEARCH ASSOCIATION OF INDIA LIBRARY 102 Paud Road, Pune 4.

BAR ASSOCIATION LIBRARY Civil Court, Shivajinagar, Pune 5.

BHANDARKAR ORIENTAL RESEARCH INSTITUTE LIBRARY Pune 4.

BHARAT GAYAN SAMAJ GRANTHALAYA Bajirao Road, Pune 2.

BHARAT ITIHAS SAMSHODHAN MANDAL 1321 Sadashiv Peth, Pune 30.

BHARATIYA SANSKRITI KOSH MANDAL LIBRARY Shanwar Peth, Pune 30.

BOTANICAL SURVEY OF INDIA LIBRARY 7 Koregaon Road, Pune 1.

THE BRITISH LIBRARY Fergusson College Road, Pune 4.

CENTRE OF ADVANCED STUDY IN SANSKRIT LIBRARY Poona University, Pune 7.

CENTRAL WATER & POWER RESEARCH STATION LIBRARY Khadakwasla (South), Pune 24.

COLLEGE OF MILITARY ENGINEERING Central Library, Dapodi, Pune 12.

CO-OPERATIVE TRAINING COLLEGE GRANTHALAYA 10 B. J. Road, near Central Building, Pune 1.

D'NOBILI COLLEGE LIBRARY Pune 14.

DECCAN COLLEGE OF POST-GRADUATE RESEARCH INSTITUTE LIBRARY Yerwada, Pune 6.

DIRECTOR OF EDUCATION Government of Maharashtra, Central Building, Pune 1.

FILM & TELEVISION INSTITUTE OF INDIA LIBRARY Prabhat Nagar, Pune 4.

GEOLOGICAL SURVEY OF INDIA LIBRARY 106/107 Koregaon Park, Pune 1.

- GOKHALE INSTITUTE OF POLITICS & ECONOMICS LIBRARY** Pune 4.
- HINDUSTAN ANTIBIOTICS RESEARCH CENTRE LIBRARY** Pimpri, Pune 18.
- INCOME TAX DEPARTMENT LIBRARY** Sadhu Waswani Road, Pune 1.
- INDIAN DRUG RESEARCH ASSOCIATION LIBRARY** 955 Sadashiv Peth Pune, 30.
- JAYAKAR GRANTHALAYA** University of Poona, Pune 7.
- KESARI MARATHA GRANTHASHALA** 568 Narayan Peth, Pune 30.
- MAHARASHTRA ASSOCIATION FOR THE CULTIVATION OF SCIENCE LIBRARY** Pune 4.
- MAHARASHTRA RASHTRABHASHA SABHA** Narayan Peth, Pune 30.
- MAHARASHTRA SAHITYA PARISHAD LIBRARY** Tilak Road, Pune 30.
- MAHATMA PHULE VASTUSANGRAHALAYA & LIBRARY** Ghole Road, Pune 5.
- MAHARASHTRA PRADESHIK GRANTHALAYA** Vishrambag Wada, Pune 30.
- MAHARASHTRA STATE BUREAU OF TEXT BOOK PRODUCTION & CURRICULUM RESEARCH** Near Law College, Pune 7.
- MAHRATTA CHAMBER OF COMMERCE & INDUSTRIES' COMMERCIAL REFERNECE LIBRARY** Tilak Road, Pune 2.
- METEOROLOGICAL OFFICE LIBRARY** Shivajinagar, Pune 5.
- NATIONAL CHEMICAL LABORATORY LIBRARY** Pashan, Pune 8.
- NATIONAL DEFENCE ACADEMY LIBRARY** Khadakwasla, Pune 24.
- NATIONAL INSTITUTE OF VIROLOGY LIBRARY** 20A Dr: Ambedkar Road, Pune 1.
- NEW AERIAL LIBRARY** 399 Nana Peth, Pune 2.
- POONA DIVISIONAL PRODUCTIVITY COUNCIL LIBRARY** Mahratta Chamber Bhavan, Tilak Road, Pune 2.
- PT. RAGHUNATHSHASTRI PATWARDHAN JYOTISH SAMSHODHAN GRANTHSANGRAHA** 140 Shukrawar Peth, Pune 2.
- PUNE DISTRICT LAW LIBRARY** District court, Shivajinagar, Pune 5.
- PUNE MARATHI GRANTHALAYA** 437/13 Narayan Peth, Pune 30.
- PUNE NAGAR WACHAN MANDIR** Laxmi Road, Pune 2.
- PUNE VAIDYAK MANDAL** Library Department, 784 Sadashiv Peth, Pune 30.
- RESEARCH & DEVELOPMENT ESTABLISHMENT** Technical Information Centre Library, Dighi, Pune 15.
- S.N.D.T. WOMEN'S UNIVERSITY, PUNE BRANCH LIBRARY** Karve Road, Pune 4.
- SAKAL GRANTHALAYA** 595 Budhwar Peth, Pune 2.
- SERVANTS OF INDIA SOCIETY LIBRARY** Pune 4.
- SHANKAR BRAMHE SAMAJVIDNYAN LIBRARY** J. M. Road, Pune 4.
- SOUTHERN COMMAND HEADQUARTER LIBRARY** Ministry of Defence, Pune 1.
- STATE INSTITUTE OF EDUCATION MAHARASHTRA STATE LIBRARY** Training College, Pune 30.
- TILAK MAHARASHTRA VIDYAPEETH LIBRARY** 521 Sadashiv Peth, Pune 30.
- TILAK SMARAK MANDIR LIBRARY** Tilak Road, Pune 30.
- VED PATHSHALA LIBRARY SECTION** 28 Budhwar Peth, Pune 2.
- VAIDIK SAMSHODHAN MANDAL LIBRARY** Tilak Vidyapeeth Nagar, Pune 9.

VAIKUNTHA MEHTA NATIONAL INSTITUTE OF CO-OPERATIVE MANAGEMENT LIBRARY Ganeshkhind, Pune 7.

ZOOLOGICAL SURVEY OF INDIA LIBRARY 1182/2, Fergusson College Road, Pune 5.

IMPORTANT INSTITUTIONS

AMERICAN INSTITUTE OF INDIAN STUDIES Deccan College, Pune 6.

AUTOMOTIVE RESEARCH ASSOCIATION OF INDIA Paud Road, Pune 4.

BHARAT ITIHAS SAMSHODHAN MANDAL 1321 Sadashiv Peth, Pune 30.

BHARAT OUTWARD BOUND PIONEERS Prasanna 722 Navi Peth, Pune 30.

CENTRAL BEE RESEARCH & TRAINING INSTITUTE 839/1 Shivajinagar, Pune 4.

CENTRAL WATER & POWER RESEARCH STATION Khadakwasla, Pune 24.

DECCAN EDUCATION SOCIETY'S TECHNICAL INSTITUTE Pune 4.

DECCAN INSTITUTE OF COMMERCE 717 Budhwar Peth, Pune 2.

DEPARTMENT OF JOURNALISM, UNIVERSITY OF POONA Ranade Institute, Fergusson College Road, Pune 4.

DEPARTMENT OF MODERN EUROPEAN LANGUAGES Ranade Institute Fergusson College Road, Pune 4.

EXECUTIVE FORUM OF INDIA 528 Shaniwar Peth, Pune 30.

FILM & TELEVISION INSTITUTE OF INDIA Prabhat Nagar, Pune 4.

HANDMADE PAPER RESEARCH INSTITUTE Agriculture College Compound, Pune 5.

HINGANE STREE SHIKSHAN SANSTHA Karve Nagar, Hingne, Pune 4.

INDIAN CHILD EVANGELISM FELLOWSHIP 2 Jubilee Road, Pune 1.

INDIAN DRUG RESEARCH CENTRE Shivajingar, Pune 5.

INDIA FOUNDATION 595 Budhwar Peth, Pune 2.

INDIAN BUDDHIST SOCIETY 207 Ghorpade Peth, Pune 2.

INDIAN INSTITUTE OF GERMAN STUDIES 14/3 Boat Club Road, Pune 1.

INDUSTRIAL CHEMICAL RESEARCH LABORATORY University Compound, Pune 7.

KARVE INSTITUTE OF SOCIAL SERVICES Karve Nagar, Pune 4.

LINGUISTIC SOCIETY OF INDIA C/o Deccan College, Pune 6.

MAHARASHTRA KARKHANDAR SANGH 82/5 Sadashiv Peth, P.B. No. 533, Pune 30.

MAHARASHTRA STATE HORTICULTURAL DEVELOPMENT ASSOCIATION Horticultural Section, College of Agriculture, Pune 5.

MAHARASHTRA STATE POULTRY ASSOCIATION C/o Poultry Development Officer, Government of Maharashtra, Pune 3.

MAHATMA PHULE VASTU SANGRAHALAYA Ghole Road, Pune 5.

MAHARATTA CHAMBER OF COMMERCE & INDUSTRIES Tilak Road, Pune 2.

METEOROLOGICAL OFFICE Shivajinagar, Pune 5.

त्रिमूर्ति सहकारी बँक लिमिटेड

मुख्य कार्यालय : १९०९ सदाशिव पेठ, पुणे ४११ ०३०

शाखा : ४२५।८८ टि. म. वि. नगर, पुणे ४११ ००९

☆ ☆ ☆

१. सहकार क्षेत्रातील जिम्हाळ्याची बँक.
२. या बँकेत आपले खाते उघडून विविध लाभदायी योजनांत सहभागी होण्यास विळंब लावू नका.
३. मध्यमवर्गीयांच्या सर्व प्रकारच्या आर्थिक सेवेस आम्ही तत्पर आहोत.

☆ ☆ ☆

बँकेची आर्थिक व्यवहारातील किमया-

१. तारणावर ताबडतोब कर्ज मिळते.
२. महाराष्ट्रातील प्रमुख शहरी डिमांड ड्राफ्ट त्वरित मिळतो.
३. व्याजाचे फायदेशीर दर.
४. मासिक व्याज योजना.
५. ठेवींची सुरक्षितता.
६. शाखा विस्तार.
७. कर्ज वितरणाची सुलभ सोय.

नवनवीन योजनांसाठी त्वरित संपर्क साधा.

संचालक मंडळ



COMEEX !! A House of Precision !

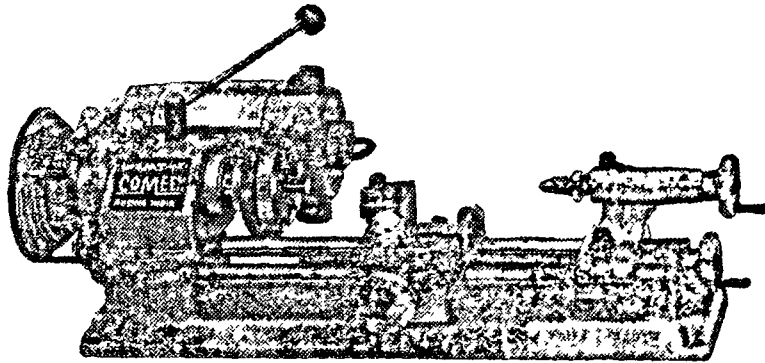

Mfrs of

- COMEEX MINILATHE 9
- COMEEX SENSITIVE DRILLING & TAPPING M/C.
- COMEEX SPECIAL PURPOSE MACHINE.

M/s. COMEEX INDUSTRIES, 38/39 H I E. PUNE 411 013, Phone : 7226 Cable · COMEEX

With the best compliments from :

**DEMECH
DECCAN MECHANICAL & CHEMICAL
INDUSTRIES PRIVATE LIMITED**

**78, Bhosari Industrial Area,
Pune 411 026.**

OUR SPECIALITY :

- ★ E. O. T. Cranes
- ★ Material Handling Equipments
- ★ Chemical, Sugar & Cement Plants
- ★ Hydraulic, Pneumatic Mechanical Ash Handling System
For Thermal Power Stations.

**Phone : 82994/95
83032/33 34**

**Gram : DEMECH
Telex : PN-388**

With Best Compliments From
**INDOSWE
ENGINEERS
PRIVATE LIMITED**

*Manufacturers of Non-ferrous Metal Extrusions
and Extruded Products*

| | | Phone Nos. | Telex Nos. |
|-----------------|--|----------------|---------------|
| Regd. Office | : 5, Bund Garden Road Pune 411 001 | 25334 28807 | 0145-342 |
| Works | : Plot No. 4, M. I. D. C. Bhosari Industrial Estate Pune 411 026 | 82520 82852 | 0145-343 |
| Bombay Office | : 1302, Prasad Chambers Off New Charni Road Near Roxy Cinema Bombay 400 004 | 350225 | 011-3563 |
| Delhi Office | : 1001, Akashdeep Barakhamba Road New Delhi 1100 001 | 44420 | 031-3584 |
| Calcutta Office | : 1/120 Jodhpur Park Gariahat Road South Calcutta 700 068 | | |
| Madras Office | : 22 Venkatarama Iyer Street Thiagaraya Nagar Madras 600 017 Cable : 'INDOSWE' | | |

SKF revolutions ahead in quality and technology

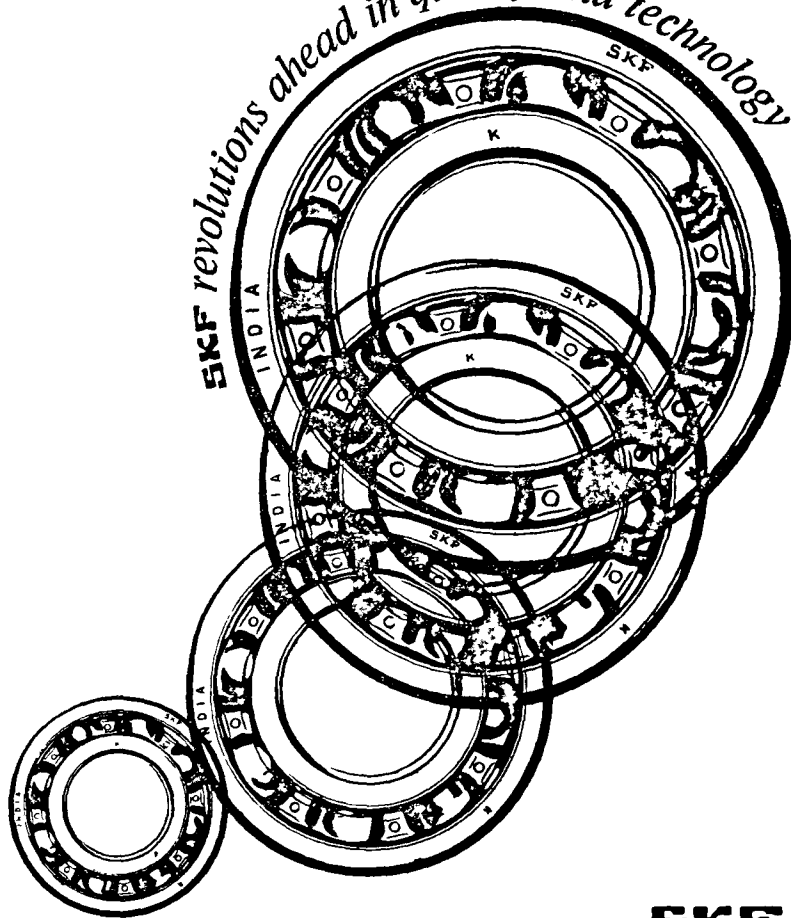

SKF

ASSOCIATED BEARING COMPANY LTD. Chinchwad, Poona 19.

Bombay,
Phone-291199
Gram-SAHARVIND
Telex-(011) 2460

Pune,
Phone-440868 &
441875
Gram-SAHARVIND

Sahyadri Dyestuffs & Chemicals
Division of
Mafatlal Industries Ltd.

- Regd. Office -

Asarva Road, Post Box No. 2006, AHMEDABAD, 380 016.

- Head Office -

Mafatlal House, Backbay Reclamation, BOMBAY 400 020.

- Factory -

117, Parvati-Vithalwadi Road, Pune 400 030.

**Pioneers and one of the leading manufacturers of
Basic Dyes, Acrylic Dyes & Intermediates**

INK BLUE

METHYL VIOLET

RHODAMINE-B-BASE

METHYL VIOLET BASE

MALACHITE GREEN

AURAMINE 'O'

**MALACRYL DYES FOR ACRYLIC FIBRE
DIETHYL META AMINO PHENOL
RESORCINOL
DIMETHYLANILINE**

भरघोस
पिकासाठी
अनुभवाने
सिद्ध झालेले
एकमेव खत
म्हणजेच



स
य
फ
ल
छ
प

सु पर फॉ स्फ ट

: लिहा :

वेस्ट इंडिया

केमिकल्स लिमिटेड

मु. पो. लोणी-काळभोर (ता. हवेली, जि. पुणे)

तार : सल्फासीड दूरध्वनी : २०८, २०९

FRANKEL'S

Xerox Copying,
Multi Xerox Copies on Offset
Offset Printing &
Cyclostyling Jobs at

**FRANKEL'S
COPIERS**

288, M. G. Road
Pune 411 001

Phones : O { 22657
23011
R 22657

CALPANA CHEMIE-TECHNICK

Manufactures of

- I Continuous Oil extractor / Chips Wringer
Swarf/Metal Chips Crusher / Metal Chips Conveyors
To Salvage 90-95% of cutting oil.
- II Nylon / Plastic Grinders for grinding Thermoplastic
Material
- III Vertical Cone-Screw Mixers for thorough uniform
blending of powders, pastes, liquids etc. Three to
Four Times More output per sq. ft. floor area per
horse power consumed.

1/32 Calpana Saha Niwas, Ghantali,
Naupada, THANE 400 602 (India).

Tel. : 593515

Gram : CALTECH, Thane

With best Compliments from :

**M/s. VACUUM PLANT &
INSTRUMENTS MFG. CO.
PVT. LTD.**

Mundhawa, Pune 411 036 (India).

Talex : 0145-366

Telephone : 7258, 7792
7545, 7525

Manufacturers of :

1. High Vacuum Transformer Oil Filtration Plant.
2. Vacuum Impregnating Plant.
3. Vacuum Drying Plant.
4. Epoxy Mixing & Casting Plant.
5. Vapour Degreasing Plant.
6. Vacuum Degassing Plant.
7. Complete Paper Capacitor Manufacturing Plant.
8. Complete Electrolytic Capacitors Manufacturing Plant.
9. Vacuum and Pressure Impregnating Plant.
10. Capacitor Winding Machine.
11. Filament Winding Machine.
12. Coil Winding Machine.
13. Capacitor Testing Instruments.
14. Foil Forming Plant.

You can safely Bank upon

The Poona Co-op. Rupee Bank Ltd., Poona.

**For all your financial need in Industry, Trade,
Commerce and also for household difficulties.
We have different schemes—**

Contact any of our following Branches—

- | | |
|--|---|
| (1) Laxmi Road Branch Phone-445598 | (2) Budhwar Peth Branch Phone-445213 |
| (3) Bhawani Peth Branch Phone-27044 | (4) Market Yard Branch Phone-470634 |
| (5) Chinchwad Branch Phone-82612 | |

*** Bank of Common Man progressing dynamically in
Poona City and Poona District.**

**** Deposits Rs. 225 Lakhs. ** Working Capital]3 Crores.**

S. K. Patki
General Manager

K. S. Gandhi
Vice-Chairman

Dr. K. N. Bhade
Chairman



WEIKFIELD





WEIKFIELD
BAKING POWDER
SCOURING POWDER



WEIKFIELD
JELLY CRYSTALS
RASPBERRY



WEIKFIELD
CUSTARD
SPECIAL BLEND FOR
ICE CREAMS, BISCUITS, GELATINE
VANILLA



WEIKFIELD
MUSTARD POWDER



WEIKFIELD
GLUCOSE-D

Weikfield products are manufactured to International Standards & have found their way to the people's heart in homes, hotels, catering establishments, the Defence Forces and abroad too.

FOOD DIVISION : Custard Powder
Cornflour, Jelly Crystals,
Drinking Chocolate, Icecream
Mix Powder, Creamelle Dessert
Mix Powder, Arrowroot Powder,
Glucose-D, Pudding Mixes,
Ready Tea and Coffee Mixes,
Juice Beverage Powders.

SPICE DIVISION : Mustard Powder,
Jerola, Black & White Pepper.

BAKERY DIVISION: Baking Powder,
Cake Flour, Icing Sugar,
Baker's Hoppe Mix, Powder
Flavours, etc.

FOOD DYE DIVISION : Edible
Supra and Wepcol Food Colours
in a wide range.

GENERAL PRODUCTS DIVISION :
Emulsifiers, Stabilisers, Laundry
Starch Wep (Scouring Powder) etc.

WEIKFIELD THE TASTE THAT'S GREAT

WEIKFIELD PRODUCTS CO. (INDIA) PVT. LTD.

Weikfield Estate, Nagar Road, Pune 411 014 (India)

MOHAN PLASTIC INDUSTRIES

Manufacturers of all types Blow Moulded Plastic containers, bottles, jerry cans and other plastic articles

Factory :

**A/17 'H' Block, MIDC
Pimpri, Pune 411 018
Phone : 83717**

Office :

**1/37, Shastri Apartments
4, Moledina Road, Pune, 411 001
Phone : 24113**



Phone : 272944
270325

B. K. TRADERS

Dealers in :

- Ball Rollers Taper and Thrust Bearing
- Engineering Tools
- Precision Tools
- Machine Tools

Praful Sheth

**71/73, Mint Road, Bhagwan, Bhuvan
Fort, Bombay 400 023**

**M
A
A
L
T
A**

PRODUCTS

**1266 Shukrawar Peth
Lane No. 6, Subhashnagar
Pune 411 002**

**For Quality Soft Drinks
Tel. 442448**

For Reliable and Long Lasting
Joints/Terminations on Cables up to
33 K. V. M-Seal Epoxy Cable
Jointing Kits

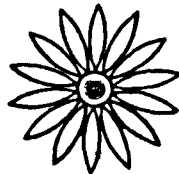

Mahindra Electro-Chemical Products

145, Bombay-Poona Road, Pune 411 018

**Cable : EMSEAL
PIMPRI PF**

**Phone : 82771
83177
83178**

**Telex : PN-209
PN-250**

FOR
XEROX
 PHOTO COPIES &
 MULTI COPIES
 By
OFFSET



QUICK PRINTS

465 SADASHIV PETH,
 OPP ALAKA TALKIES,
 POONA 30 PHONE 446808
 QUICK SERVICE IS OUR TRADITION

ALPHA 78043



Automatic Electric Ltd.

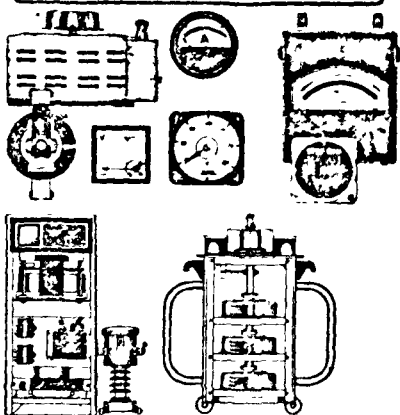

• AMMETERS • VOLT METERS • POWER
 FACTOR METERS • FREQUENCY METERS
 • RECTIFIERS • DIMMERSTATS
 • WATTMETERS • VOLTAGE STABILIZERS

HINDUSTAN ELECTRIC CORPORATION
Opp. Nehru Hall, 6, Dr. Ambedkar Rd., Pune 411 001
 PHONE - 24210

For your requirements of

GREASEPROOF AND GLASSINE PAPER

Please Contact :

**Pudumjee Pulp & Paper
 Mills Limited**

Registered Office :
 Thergaon
 Pune 411 033
 Tel : 82090, 82070,
 82540

Sales Office :
 60, Dr. V. B. Gandhi
 Marg, Bombay 400 023
 Tel : 274532, 274529,
 274485

MANDKE COLD STORAGE

Regd. Office : 707, Sadashiv Petb,
Pune 411 030

Phone : 443234

BHOSARI located at a distance of about 15 Km. from Pune, on Nasik Road, has a very big M. I. D. C. area, wherein Mandke Cold Storage, with a capacity of 500 tonnes is situated on Plot No. 112 near Philips India.

Mandke Cold Storage is the latest and most modern Cold Store in and around Pune to serve as a repository of perishables. This unit is the FIRST of its kind to have the combination of Cold Store and Ice Plant.

Masterwheels Engineering Private Limited

T-35, M. I. D. C. Bhosari,
Pune 411 026



Manufacturers of:

Parallel Keys, Taper Keys, Gibhead Keys & Woodruff Keys in carbon steels, alloy steels or stainless steels as per I. S. S., D.I. N or B. S. S. specifications & also parts for Automobile Components.

'NIRBHAYA'

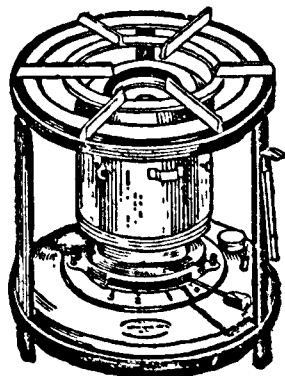

**A Product of
Indian
Craftsmanship**

M/s B. A. Tarkar

38/39, Hadapsar

Industrial Estate

Pune 411 013

Safety Wick Stove

Phone : 7182

nandan 95

LETTER EMBOSSING GUN

Letter Embossing Tape

The NANDAN LETTER EMBOSSING GUN labels neatly, clearly and conveniently. It is a simple, portable device which enables you to emboss a letter or a number on an "Embossing Tape".

You need neither gum nor sticking material to affix the tape. It is adhesive backed. Nor do you require scissors or blade to cut the tape, for it has a built-in cutter to make things easier for you. The tape sticks to any surface—wood, plastic, metal, paper, cloth, leather, bakelite, glass etc. Size of tapes 9.5 mm in width and 170 cm in length.

Available in different attractive colours

Useful for Industries, Secretaries, Executives, Shopkeepers.

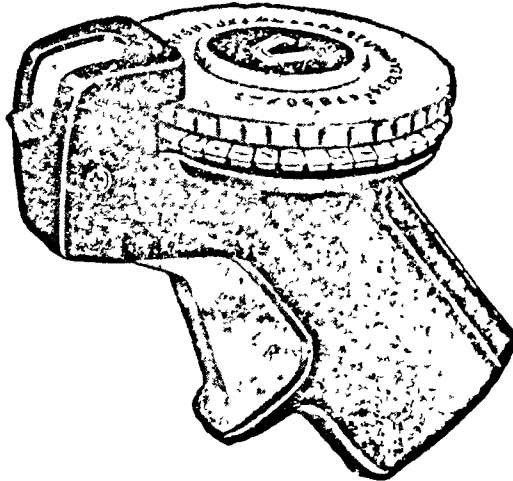

nandan & nandan

'KRISHI' 1144, Shukrawar Peth

Off Tilak Road, Pune 411 002 (India)

Telephone : 443639 Telex : WIE PN 221

TARPAULINS

FAMOUS ALL OVER INDIA!

— USE —

★ **KOHINOOR** ★

☸ **TARPAULIN** ☸

100% WATERPROOF ★

DURABLE ★ GUARANTEED

MAFATLAL & CO.

SHA. CHHAGANLAL & CO.

★ 1380 Bhavani Peth, Burudi Pool, Pune-411002 ★ Resi : 27087

Only

Our Associates

Mani-Jara Canvas Emporium, Pune.

Kohinoor Proofing & Tarpaulin Industries, Kalol (Gujarat).

Grant 48 78

Want a pump that's designed to keep your sewage and effluent systems going on and on?

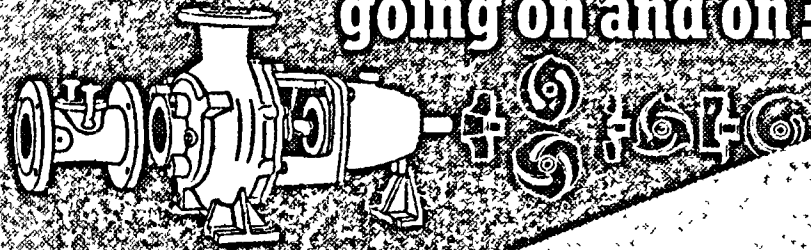

KSB non-clogging pumps enable

- continuous handling of contaminated fluids, sludges, etc.
- easy interchanging of parts
- minimum down-time in re-aligning
- simple maintenance due to back pull-out design

All this is due to the sophisticated design and manufacturing specifications of Klein, Schanzlin & Becker AG. As technical collaborators, they provide KSB-India with the complete know-how of one of the world's leading pump manufacturers.

A wide range of industries including chemical, iron and steel, paper, sugar, canned foods and sewage disposal systems use KSB non-clogging pumps.

750 units ordered for major paper mill project

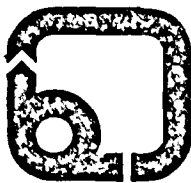

Manufactured by **KSB PUMPS LIMITED** in technical collaboration with Klein, Schanzlin & Becker AG Frankenthal, West Germany at their modern factories in Pimpri and Chinchwad, Poona and Vambori, Ahmednagar Dist.



Consultation • Sales • Service
PROTOS ENGINEERING COMPANY PRIVATE LIMITED
173, Jamsheedji Tata Road, Churchgate, Bombay 400 020, New Delhi P.O. Box 431 Calcutta P.O. Box 2549 Madras P.O. Box 375 Ahmedabad P.O. Box 4057,

Come to KSB

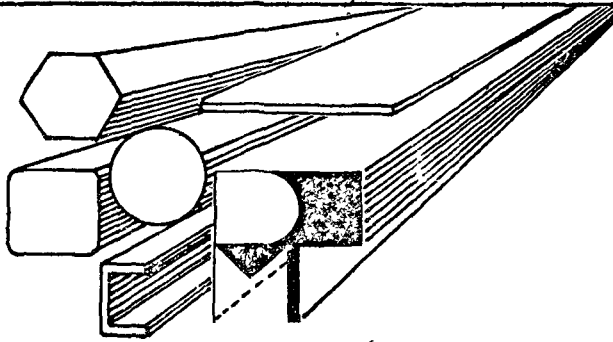

COME TO
**DHANASHRI
METALS**

FOR ALL YOUR REQUIREMENTS OF
NON FERROUS METALS

COPPER • BRASS • STAINLESS STEEL AND
ALUMINIUM RODS • PIPES • SHEETS
• SHEETINGS • WIRES • STRIPS • LEAD ZINC
• WHITE METAL INGOTS • TIN
& REFRIGERATION COPPER TUBES ETC.



**DHANASHRI
METALS**

DEALERS & STOCKISTS OF
NON FERROUS METALS

321/4 Timber Market Road
Shantinagar Society
Pune 411 002. Phone : 27035

Contact :

*Manufacturers for Standard Quality
and Prompt Delivery*

**BHOPATKAR
ELECTRICALS**

1032, Shukrawar Peth, Tilak Road, Pune 411 002

Tel. No. : 440416

For All Your Requirements Of

- A. (i) Low Voltage High Current Transformer,
(ii) Low Tension Power Transformer,
(iii) Three Phase Double Wound Transformer,
(iv) Furnace Transformers,
- B. (i) Current Transformers in 50/5 to 1200/5 Ratios, 5 VA to 15 VA Burdens.
- C. (i) Rectifier Units for Electroplating and Anodizing Plants, 8 V 2000 Amps to 24 V to 2000 Amps.
(iii) Cinema Arc Rectifiers.

*With All Good Wishes
From*



SANDVIK ASIA LTD.

Manufacturers in India of SANDVIK COROMANT
Cemented Carbide Products

- Bangalore ● Bombay ● Calcutta ● Delhi ● Hyderabad
- Jabalpur ● Madras ● Pune

PROSPERITY THROUGH APPROPRIATE TECHNOLOGY

- Ferro-cement :- Mollasses Tanks * Water & Sewage Treatment Plants * Silos * Gobar Gas Plants * Fish Farms * Canals * Fishing Boats * Jetties etc.

- Ground Water Surveys,
- Quantity Surveys of Mines,
- Land & Off Shore Surveys,
- Irrigation Schemes,
- Boat Building,
- Marine Diesel Services,
- Rural Development Projects.

JALSEVA

Civil - Electrical Engineers and Geo-physicists
1475, Sadashiv Peth, 'Shreedham',
Pune 411 030

Branch : 'Amba-Nivas', Zадgaon
Ratnagiri 415 612

Water Treatment Plants of
Following Types :

Swimming Pools
Pressure Filters

Chlorinators (Both Pressure
and Gravity Feed Type)
Displacement Dosers and
For Spares / Overhauling /
Renovation of any of the
Above Plants.

Please Contact

Chlorination Engineering
46, 2nd Floor, Tardeo Air-conditioned
Market, Bombay 400 034

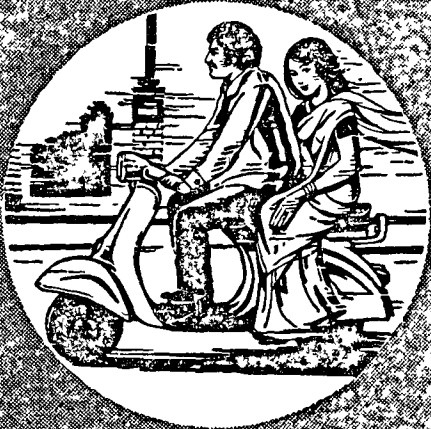
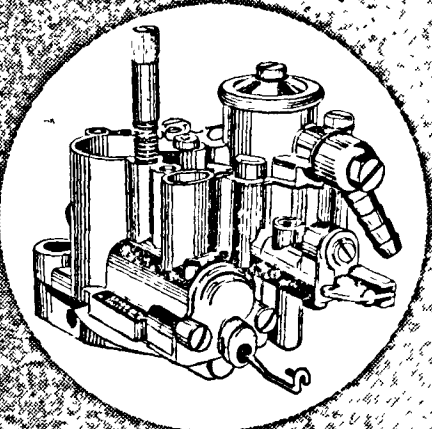

SPACO
Carburettor

**Heart of
Two and Three
Wheelers**

SPACO. premier carburettor...100% indigenous . competes with the world's best... its quality ensured by continuous R & D. Available in various regulations. SPACO carburettor enjoys the preference of the manufacturers of Bajaj, Chetak, Priya, Vijai, Lambretta, Lambi, Luna, Laxmi, Ramona, Hitodl...famous names all.



SPACO carburettor has no equal for more mileage... fuel economy...easy starting...smooth running. And the replacement market insists upon **SPACO** genuine spares.

Manufacturers
Spaco Carburettors (India) Ltd
 Chinchwad
 Pune 411 019

SPACO...a byword for Super Performance.

PRATIBHA 78-33

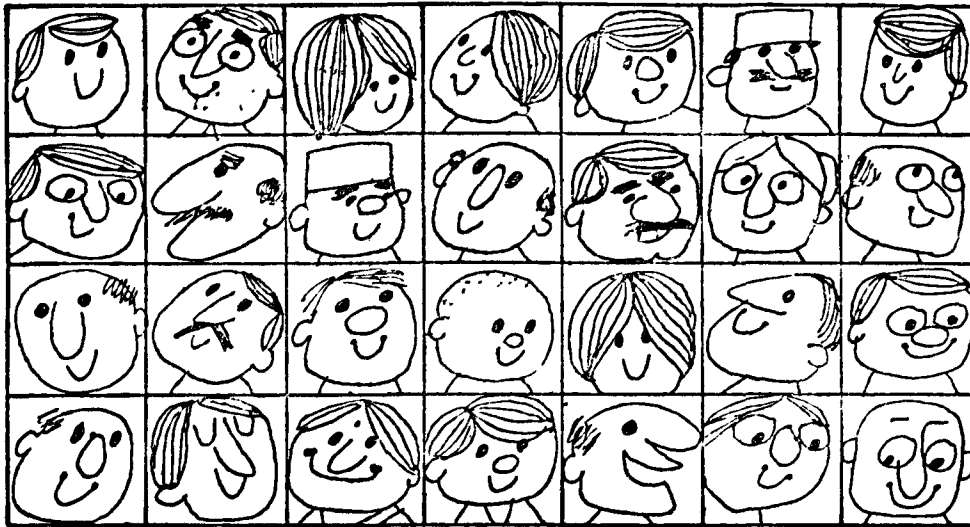

Everybody's saying things about Camlin



good things !

When people say things about us, we prick up our ears.

To us, what they say is most important. Even more important than boosting our sales.

Are the millions who use our products pleased with our quality?

Yes! Quality is a vital word at all our Camlin Divisions:- Stationery, Art Materials, Pencils and Cosmetics. Forty years back, we resolved never to compromise on quality; and we never have.

So when we listen to people saying things about 'Camel' and 'Camlin' products, we invariably end up happy For we find the things they're saying... are good things!

camlin

PRIVATE LIMITED

J. B. Nagar
Bombay 400059, INDIA



Visitor

PROFILE CUTTING MEANS PROFICIENCY

And that's what you can be sure of at
STANDARD PROFILE INDUSTRIES
In fact we've been pioneers in the field.

Yes !

Proficiency aimed at maintaining the highest
standards in Steel Profile Cutting.

That's what we strive for !

When you entrust your work to us
you can relieve yourself of all worries
and rest assured of

- Skill in executing the most complicated of jobs
- The best quality of material
- Timely delivery and
- Standard rates

We have executed orders for Indian Defence to
their satisfaction.

We also deal in and supply M. S. Plates &
iron goods.

STANDARD PROFILE INDUSTRIES

**Bombay-Poona Road
Nasik Phata, Pune 411 018**

Tele : Pune 82098
Bombay 374476

(A sister concern of PARAS PROFILES, Bombay)

| | |
|---|--|
| NATIONAL CHEMICAL LABORATORY Pashan, Pune 8. | RESEARCH (AGRICULTURE) SCHOOL Manjari, Pune 1. |
| NATIONAL DEFENCE ACADEMY Khadakwasla, Pune 24. | SERVANTS OF INDIA SOCIETY Deccan Gymkhana, Pune 4. |
| NATIONAL INSTITUTE OF ENGINEERING 829-B Dastur Meher Road, Pune 1. | SHRI SHIVAJI PREPARATORY MILITARY SCHOOL Shivajinagar, Pune 5. |
| NATIONAL SAMPLE SURVEY Swargate, Pune 9. | SMALL INDUSTRIES DEVELOPMENT INSTITUTE Agriculture College Compound, Pune 5. |
| POONA CHAPTER OF COST ACCOUNTANTS F.C. Road, Pune 5. | SMALL INDUSTRIES SERVICE INSTITUTE Shankarshet Road, Pune 9. |
| POONA DIVISIONAL PRODUCTIVITY COUNCIL Maharatta Chamber Bhavan, Tilak Road, Pune 2. | |

Do you need any information?

**Mahratta Chamber of Commerce and Industries
May Help You**

Our Library contains most of the best world-wide classified and regional directories; unique collection of I. S. I. specifications with up-to-date amendments; Patents and Trade Marks; Foreign Journals and Periodicals; Gazettes, Notifications on import and export, excise, custom, taxation, labour matters etc.

Member or Non-Member :

You are invited to make use of our Library and Reference Section.
Telephone: 440371, 440472.

**INDEX
TO
ADVERTISERS**

| | Page |
|---|----------------|
| A. J. Electronics | 113 |
| Able Engineering Co. | 66 |
| Academy of Marketing & Management Science | 86 |
| Accurate Engg. Co. Ltd. | Spl. Page |
| Advani Oerlikon | 41 |
| Agarwal Containers P. Ltd. | Spl. Page |
| Ajay Engg. Works | 106 |
| Ajay Metachem | Spl. Page |
| Ajco Electronics | 44 |
| Alurkar Music House | 62 |
| Amit Lubricants & Chemicals | 107 |
| Analogue & Digital Measurement Co. | 127 |
| Aram Gadi Karkhana | 46 |
| Ashok (India) | 119 |
| Associated Bearing Co. Ltd. | 156 |
| Associated Transport Co. | 47 |
| Astavision Advtg. | 148 |
| Atul Electrofarmers | 131 |
| Atur India P. Ltd. | 78 |
| Atur Rubber Products | 62 |
| Automotive Mfrs. Ltd. | 10 |
| B. A. Tarkar | 165 |
| B. K. Traders | 162 |
| B. U. Bhandari | 119 |
| Bajaj Auto Ltd. | Cover Page (4) |
| Bajaj Tempo Ltd. | 11 |
| Ball Bearing & Tools Traders | 149 |
| Bank of Baroda | 91 |
| Bank of Maharashtra | Cover Page (3) |
| Bhagini Nivedita Sahakari Bank | 97 |
| Bharat Forge Co. Ltd. | Spl. Page |
| Bhopatkar Electricals | 168 |
| Bhor Rubber Products' | 150 |

| | Page |
|-----------------------------|-----------|
| Bijlee | 117 |
| Bodhe Inds. | 141 |
| Boxfab | 105 |
| Brazasil Enterprises | 81 |
| Britex Corpn. | 129 |
| British Airways | 86 |
| Buckau Wolf | 124 |
| Kalpana Chemitechnick | 158 |
| Camlin P. Ltd. | 171 |
| Capacitor Mfg. Co. | 114 |
| Caravan Engrs. | 89 |
| Century Enka Ltd. | 39 |
| Ceramica | 98 |
| Chaney & Co. | 87 |
| Chitale Bandhu (Mithaiwale) | 40 |
| Chitra Rekha | 142 |
| Chitrayug | 141 |
| Chloride India | 27 |
| Chlorination Engg. | 169 |
| Clean Energy Systems | 126 |
| Comeex Inds. | 154 |
| Cooper Engg. Ltd. | 135 |
| Cosmos Coop Urban Bank | Spl. Page |
| Crown Engg. Works | 146 |
| D. D. Chhaganlal & Co. | 88 |
| D.G. Copiers | 127 |
| D. J. Damani & Co. | 142 |
| Dalco Engg. P. Ltd. | 108 |
| Data Express | 130 |
| Datsons Electronics | 116 |
| Datta Digambar Yatra Co. | 42 |
| Deccan Dyes & Chem. Inds. | 16 |
| Deccan Embroidery Mfg. Co. | 96 |
| Deccan Mech. & Chem. Inds. | 154 |
| Deepa Electronics | 82 |
| Deepak Engg. Co. | 76 |
| Devraj Enterprises | 127 |

| | Page |
|-----------------------------|-----------|
| Deval Utensils Factory | 25 |
| Devkaran Mulji | 119 |
| Dhanashri Metals | 168 |
| Diamond Clock Mfg. Co. | 56 |
| Digitronics | 14 |
| Dr. Beck & Co. | Spl. Page |
| Drillco Metal Carbides | 114 |
| D'Rona Rohitra P. Ltd. | 122 |
| Dye Chem. Corpn. | 117 |
| Edison Elec. Appliance Co. | 46 |
| Eisen Pharmaceuticals | 110 |
| Electrocrank Associates | 119 |
| Electronics Laboratories | 125 |
| Electroding Inds. | 83 |
| Elpro International | 31 |
| Emnvee Sci. Instru. Co. | 99 |
| Essar Associates | 80 |
| Excelsior Trdg. Co. | 23 |
| E.C.G.C. | Spl. Page |
| Finolex Cables Ltd. | 79 |
| Florra P. | 74 |
| Formica India Ltd. | 43 |
| Frankle's Copiers | 158 |
| G. S. Anand & Co. | 78 |
| Gadre Bros. | 61 |
| Garware Nylons | 48 |
| Girikand Travels | 145 |
| Glass Minerals | 147 |
| Grafis | 151 |
| Greaves Cotton & Co. | 3 |
| Grindwell Norton Ltd. | 22 |
| Guru Nanak Inds. | 126 |
| H. Fillunger & Co. | 19 |
| H. M. Sales Corpn. | 36 |
| Hi-clif Enggrs. P. Ltd. | 36 |
| Hakamchand Ishwardas | 24 |
| Helium Products (I) P. Ltd. | 151 |

| | Page |
|--------------------------------------|-----------|
| Hind Condensors Pvt. Ltd. | 125 |
| Hind Engg. Co. | 50 |
| Hindustan Antibiotics | 138 |
| Hindustan Elec. Corpn. | 164 |
| Hirlekar Precision Engg. Co. | 29 |
| Hindustan Engg. Works | 70 |
| Horstmann (I) P. Ltd. | 30 |
| Hollywood Studio | 106 |
| Hotel Amir | 59 |
| Hotel Awanti | 42 |
| Hotel Blue Diamond | Spl. Page |
| Hotel Pathik | 139 |
| I.E.C. Pumps & Tools P. Ltd. | 117 |
| Ideal Engg. Works | 18 |
| Indian Airlines | 144 |
| Indian Cable Co. Ltd. | 22 |
| Indian Card Clothing Co. | Spl. Page |
| Indian Overseas Bank | 57 |
| Indoplast | 28 |
| Inodswe Engr. P. Ltd. | 155 |
| Incl. Electronics & Instruments | 102 |
| Industrial Oxygen Co. P. Ltd | Spl. Page |
| Industrial Paper Co. | 42 |
| Industrial Products | 15 |
| Inex Engine Valves | 136 |
| Instt. of Management Dev. & Res. | 76 |
| International Computers Indian Mfrs. | 5 |
| J. N. Marshall P. Ltd. | 95 |
| Jay Agencies | 18 |
| Jain Trdg. Co. | 84 |
| Jalseva | 169 |
| Jams Engg. (I) | 84 |
| Janaseva Sahakari Bank | 94 |
| Janata Elec. Stores | 23 |
| Jay Sci. & Chem. Corpn. | 18 |
| Jay Watch Co. | 116 |
| Jekuma Enggrs. | 110 |

| | Page |
|--------------------------------------|----------------|
| Jg Vacuum Flasks | 130 |
| Jinku Radiators P. Ltd. | 14 |
| K. D. Joshi & Co. | 40 |
| KSB Pumps Ltd. | 167 |
| K. S. Nagori | 28 |
| Kalpana Glass Fabritek | 151 |
| Karachi Sweet Mart | 100 |
| Kelkar Bros. | 121 |
| Khosla Plastics Pvt. Ltd. | Spl. Page |
| Kiran Engg. Works | 126 |
| Kirloskar Cummins Ltd. | Spl. Page |
| Kisloskar Engg. Services P. Ltd. | 136 |
| Kirloskar Filters P. Ltd. | 148 |
| Kirloskar Oil Engines | Cover Page (2) |
| Kisloskar Pneumatic Co. Ltd. | 13 |
| Kishor Pumps P. Ltd. | 54 |
| Kothari Electronics | 15 |
| Kotibhaskar Smurti Udyog | 61 |
| Krån Radar Pvt. Ltd. | 6 |
| Quality Plastic Products | 92 |
| La Roz Elegans | 104 |
| Labour Research & Consultancy Bureau | 94 |
| Lakhmi Corpn. | 140 |
| Lalit Profiles & Steel Inds. | 63 |
| Laxmi Vilas Bank | 64 |
| Libra Drugs (I) | 70 |
| Link | 128 |
| Lubricare | 104 |
| Lunar Caustic P. Ltd. | 16 |
| Maalta Products | 162 |
| Macc Engg. Co. | 23 |
| Machinall P. Ltd. | 118 |
| Mafatlal & Co. | 166 |
| Maharashtra Coop. Engg. Society | 10 |
| Maharashtra Indl. Devl. Corpn. | Spl. Page |
| Maharashtra Road Carrier | 101 |
| Maharashtra S.S.I.D.C. | 123 |

| | Page |
|----------------------------------|------|
| Maharashtra S.F.C. | 65 |
| Mahindra Electro Chem. | 163 |
| Mahindra Owen Ltd. | 75 |
| Mak Corpn. | 98 |
| Mandke Cold Storage | 165 |
| Manisha Suppliers | 56 |
| Mangal Plastics | 127 |
| Manwani Machnie Tools | 123 |
| Mark Electra | 102 |
| Mastersales | 58 |
| Mastersales | 74 |
| Master Wheels Engg. | 165 |
| Mather Platt (I) Ltd. | 34 |
| Mehta Packard Inds. | 112 |
| Menon & Menon | 12 |
| Mobsons | 142 |
| Modern Engg. & Spring Co. | 50 |
| Mohan Plastic Inds. | 162 |
| Morris Electronics Co. | 6 |
| Mosh Inds. | 111 |
| Mukesh Engrs. | 22 |
| Muslim Coop. Bank Ltd. | 77 |
| Naik & Sons | 51 |
| Nana Inds. | 32 |
| Nandan & Nandan | 166 |
| Nath Electricals | 22 |
| Nav Maharashtra Chakan Oil Mills | 88 |
| New Ball Bearing Co. | 98 |
| New Bank of India Ltd. | 82 |
| Nichrome Metal Co. | 100 |
| Nirmal Trading Corp. | 44 |
| Nirmal Textiles | 38 |
| Oak Sunbreakers | 31 |
| PMT Machine Tools Auto. | 111 |
| PTC Sanghvi Co. | 4 |
| Painter Bedekar A. G. | 107 |
| Pankaj Engg. Works | 68 |

| | Page |
|-----------------------------------|------|
| Paper & Pulp Conversions | 120 |
| Parshuram Process | 139 |
| Patel Cement Concrete | 26 |
| Patel Spun Pipe Co. | 138 |
| Penosh Transport | 34 |
| Perfect Inds. | 92 |
| Philips India Ltd. | 33 |
| Phoenix Tdg. Co. | 64 |
| Pocha Seeds P. Ltd. | 80 |
| Poona Motor Goods Transport | 40 |
| Poona Pressings P. Ltd. | 115 |
| Poona Radiator & Oil Coolers | 8 |
| Poona Sales & Service | 146 |
| Poona Timber SS Inds. Association | 73 |
| Prachi Profiles & Sheet Cutting | 150 |
| Prakash Plating Inds. | 15 |
| Prakash Tiffin Caterers | 150 |
| Prasanna Inds. | 18 |
| Prashant Bearing | 62 |
| Pravin Enterprises | 93 |
| Precision Steel Fastners | 111 |
| Profiloforms | 141 |
| Pudumjee Pulp & Paper Mill | 164 |
| Quad Engrs. | 46 |
| Quality Steel Castigs | 108 |
| Quick Prints | 90 |
| Quick Prints | 164 |
| RCG Insrtuments | 67 |
| RCG Instruments | 85 |
| RG Joshi & Associates | 20 |
| Racold Appliances P. Ltd. | 32 |
| Radiant Engrs. | 142 |
| Raja Bahadur Motilal Poona Mills | 35 |
| Raj Engg. Works | 82 |
| Ramesh Fabricators | 116 |
| Ramkala | 90 |
| Ranade Time Instruments | 132 |

| | Page |
|--------------------------------------|-----------|
| Ranadey Elec. Co. | 46 |
| Rapicut Tools P. Ltd. | 84 |
| Ravindra | 110 |
| Relekar Engg. | 17 |
| Roplas India Ltd. | 9 |
| S. G. Gokhale & Co. | Book Mark |
| S.K. Enterprises | 55 |
| J.P. Handmade Paper & Board Mfg. Co. | 53 |
| Saaa Engrs. & Foundry | 86 |
| Sable Waghire & Co. | 54 |
| Sahyadri Dyestuffs | 157 |
| Sahyadri Udyog | 134 |
| Sales Corner | 42 |
| Sandvik Asia Ltd. | 169 |
| Sanghvi Metal Corpn. | 2 |
| Sapphire Exports P. Ltd. | Spl. Page |
| Sapre Bros. | 58 |
| Saraswat Coop. Bank Ltd. | 145 |
| Sathe Biscuit & Chocolate | 69 |
| Sealoflex Rubber & Plastic Inds. | 104 |
| Serson Inds. | 109 |
| Serum Instt. of India | Spl. Page |
| Shamrao Vitthal Coop. Bank | Spl. Page |
| Sharma Associates | 31 |
| Shetkari Sahakari Sangh | 30 |
| Shri Metal Containers Mfg. Co. | 4 |
| Shri Suvarna Sahakari Bank | 122 |
| Shrikant Engg. Corpn. | 134 |
| Shri Laxmi Saw Mill | 38 |
| Sidheshwar & Co. | 21 |
| Siporex India Ltd. | 45 |
| Sonnenflex Abrasives | 105 |
| South Indian Bank Ltd. | 70 |
| Spaco Carburettors India Ltd. | 170 |
| Speys Industrial Services | 102 |
| Standard Profile Industries | 172 |
| Star Dyes & Chemical Industries | 103 |

| | Page |
|---|------|
| Star Enterprises | 90 |
| Star Radio & Electronics | 94 |
| Star Rubber Products | 103 |
| State Bank of India | 1 |
| State Bank of Saurashtra | 93 |
| Studio Himland | 134 |
| Subhajay Electronics & Metal Processors (P) Ltd. | 109 |
| Sudarshan Chemical Industries Ltd. | 121 |
| Sukrut Udyog | 14 |
| Sunako Enterprises | 115 |
| Super Bright Mfg. Co. | 121 |
| Super Dry Cleaners | 118 |
| Sushanko Traders | 132 |
| Sweet Home | 42 |
| Symtronics | 115 |
| Talwalkar's Pharmaceutical Laboratory | 68 |
| Tata Engineering & Locomotive Co. | 143 |
| Tej Tools & Gauges | 100 |
| Thakur Savadekar & Co. Ltd. | 66 |
| The Poona Coop. Rupee Bank Ltd. | 160 |
| Topaz Antipest Service P. Ltd. | 76 |
| Travel Corpn. (India) P. Ltd. | 130 |
| Trimurti Sahakari Bank Ltd. | 153 |
| Trinity Engineers P. Ltd. | 15 |
| Trinity Forge | 2 |
| Tuga Biochemicals Labs. | 72 |
| Tulsi Fine Chem. Inds. P. Ltd. | 133 |
| Ubique Enterprises | 106 |
| Umesh Traders | 72 |
| Unique Systems | 60 |
| Unique Designers | 128 |
| United Enterprises | 52 |
| United Hosiery Works | 148 |
| United Tyre Crafts | 52 |
| United Western Bank Ltd. | 60 |
| Unity Gauge & Tool Co. | 145 |

| | Pages |
|------------------------------------|-----------|
| sal Engg. & Mfg. Inds. | 17 |
| Co. | 125 |
| n Plant & Instruments Co. P. Ltd. | 159 |
| Engg. Pvt. Ltd. | 49 |
| 1 Tiles | 31 |
| Studio | 103 |
| . Fine Art Litho Works | 38 |
| eshwar Hatcheries P. Ltd. | 7 |
| Sahakari Bank Ltd. | 71 |
| Bank Ltd. | 137 |
| 1 Tiles | 21 |
| Profile Inds. | 115 |
| mitra & Rathi | 72 |
| Laval Ltd. | 152 |
| ri Mitra | 20 |
| n India Ltd. | Spl. Page |
| oo Diesel Fuel Injection Pvt. Ltd. | 12 |
| eld Products Co. | 161 |
| ndia Chemicals Ltd. | 158 |
| n India Erectors Ltd. | Spl. Page |
| n India Flour Mills | 118 |
| Cloud Paper Mills | 37 |
| Shamshet & Sons | 88 |
| raft | 140 |
| ouse | 90 |
| 'ant Iron & Steel Works Ltd. | 68 . |

WE GIVE A LEAD TO THOSE WHO NEED...

Young talents will never go waste
when we are here to try our best.

Self-employment
is the only answer to unemployment.

Let young entrepreneurs come out
with their blue prints.

We offer them a pride of place
in our priority list.

At your service with a wide network of branches all over India.

**bank of
maharashtra**

(A Govt. of India undertaking)

H.O. : Lokmangal, Pune 411 005.

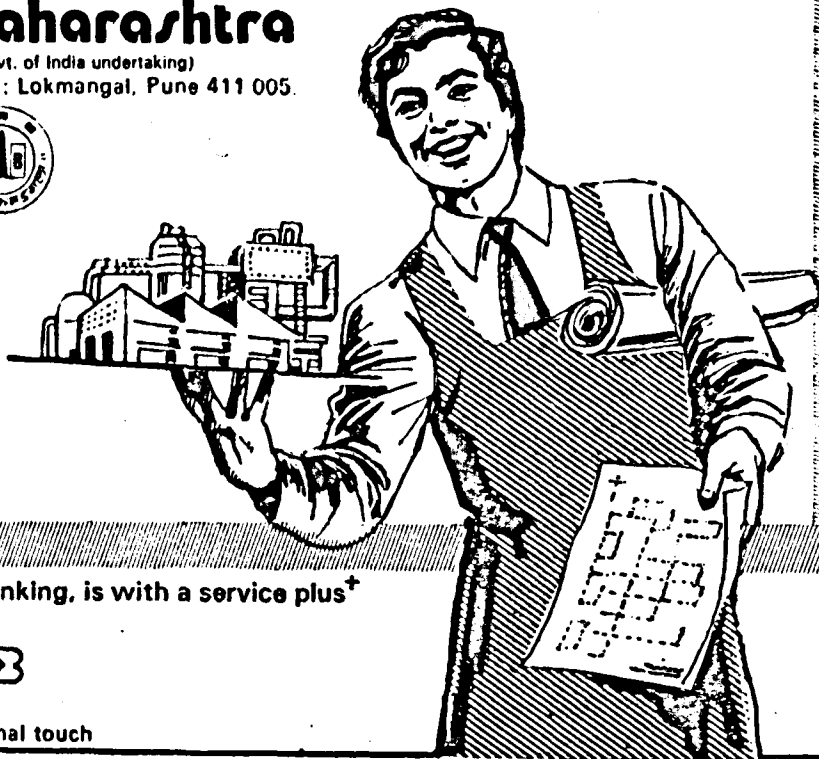

Where banking, is with a service plus[†]



† the personal touch

PRAJAKTA